

# The W. M. Keck Observatory Scientific Strategic Plan

*A.Kinney (Keck Chief Scientist), S.Kulkarni (COO Director, Caltech), C.Max (UCO Director, UCSC), H. Lewis, (Keck Observatory Director), J.Cohen (SSC Co-Chair, Caltech), C. L.Martin (SSC Co-Chair, UCSB), C. Beichman (Exo-Planet TG, NExScI/NASA), D.R.Ciardi (TMT TG, NExScI/NASA), E.Kirby (Subaru TG. Caltech), J.Rhodes (WFIRST/Euclid TG, JPL/NASA), A. Shapley (JWST TG, UCLA), C. Steidel (TMT TG, Caltech), S. Wright (AO TG, UCSD), R. Campbell (Keck Observatory, Observing Support and AO Operations Lead)*



## 1. Overview and Summary of Recommendations

The W. M. Keck Observatory (Keck Observatory), with its twin 10-m telescopes, has had a glorious history of transformative discoveries, instrumental advances, and education for young scientists since the start of science operations in 1993. This document presents our strategic plan and vision for the next five (5) years to ensure the continuation of this great tradition during a challenging period of fiscal constraints, the imminent launch of powerful new space telescopes, and the rise of Time Domain Astronomy (TDA).

Our overarching goal is to maximize the scientific impact of the twin Keck telescopes, and to continue on this great trajectory of discoveries. In pursuit of this goal, we must continue our development of new capabilities, as well as new modes of operation and observing. We must maintain our existing instruments, telescopes, and infrastructure to ensure the most efficient possible use of precious telescope time, all within the larger context of the Keck user community and the enormous scientific opportunities afforded by upcoming space telescopes and large survey programs.

## 1.1 Guiding Principles

This summary of the Strategic Plan is organized around the five Guiding Principles, described below.

### A. Push the limits in faint object spectroscopy.

Faint object spectroscopy, used to characterize and explore the astrophysics of distant or low luminosity sources is one of the areas historically dominated by the Keck Observatory telescopes. In order to continue our dominance in these areas, we need to maintain a stable of versatile work horse instruments (examples: LRIS, DEIMOS, MOSFIRE, OSIRIS) and ensure that each of them has the best possible performance and reliability. This in turn will require us to pay close attention to potential upgrades of our instruments. Upgrades offer increases in throughput or other key characteristics for a relatively small cost compared to that of designing and constructing new instruments. In an era of fiscal limitations and soaring costs for new instruments, which often overrun their initial budget estimate, we must ensure that affordable upgrade projects do not get squeezed out by other much larger expenses. At the same time we must continue to make progress on future large instruments in response to new opportunities such as enabling technologies and the opening of new key areas of research.

Ground-layer adaptive optics (GLAO) has the potential to provide a powerful enhancement to Keck's faint-object spectroscopy capabilities in the optical and near-IR by improving image quality over a moderately wide field, resulting in a major increase in spectroscopic sensitivity. The cost, although uncertain, is high and many technical issues remain to be resolved before a decision in favor of proceeding toward GLAO could be made. Keck should begin to examine the science cases, technical feasibility, and cost of implementing GLAO with an adaptive secondary mirror, to determine whether GLAO should become a major priority for the future of the Observatory.

### B. Lead AO imaging and spectroscopy with new capabilities.

Adaptive optics (AO) has been one of Keck's major strengths and a source of great scientific productivity. The implementation of laser guide-star AO at Keck, combined with Keck's excellent IR instrumentation (NIRSPEC, NIRC2, OSIRIS) has led to major progress in areas such as direct imaging of exoplanets, tracking stellar orbits around the black hole in the Galactic Center, and investigating the gas content and kinematics of high-redshift galaxies. The continued development of Keck's AO capabilities for high-resolution imaging and spectroscopy will be a key to the Observatory's future competitiveness and success.

The next step in the evolution of Keck AO will be the proposed Keck All-Sky Precision AO (KAPA) project, which includes a near-IR tip-tilt sensor and laser tomography for Keck II. Providing dramatic improvements in both sky coverage and image quality, KAPA will ensure that Keck continues to have the world's leading general-purpose AO capability for a broad range of science applications including Galactic Center studies, observations of gravitational lenses, and direct imaging of exoplanets. Another priority for AO development will be a new point-spread function (PSF) reconstruction facility designed to provide a PSF model for every AO science observation, greatly enhancing the accuracy of AO-based measurements.

In addition to the general-purpose KAPA system, more specialized capabilities for high-contrast AO (HCAO) are of growing interest for direct imaging and spectroscopy of exoplanets. Keck should support design studies for new HCAO capabilities that will enable major progress in exoplanet detection and characterization.

### **C. Prepare for increasing opportunities in Time Domain Astronomy (TDA).**

We are entering a new age; that of TDA, made possible by advances in digital electronics and computing. Surveys of large parts of the sky on cadences of days to weeks are already underway, e.g. Palomar Transit Factory (PTF), and the next generation of this survey (ZTF) will aim for a daily cadence over large areas on the sky. The Large Synoptic Survey Telescope (LSST), with an 8m diameter primary mirror, is now under construction, with operations expected to begin in 2023. It will have a single dedicated instrument, a very sensitive camera with an enormous field of 10 square degrees producing 30 terabytes of data per night, and will be able to deeply image the entire visible sky in just a few nights.

Such surveys produce alerts of time variable objects, including supernovae, variable stars, and far more exotic objects such as gamma ray bursts. A stream of alerts will be generated and distributed in almost real time from these survey programs. A way of picking the best sources to be observed already exists from some surveys (i.e. PTF), and will have to be developed for LSST (a key issue for LSST, as the number of LSST alerts is expected to be of order ten million per night, far more than can be followed up with spectroscopy on large telescopes). Keck needs to be ready to observe objects which are often very fleeting, fade rapidly, and must be observed very quickly, ideally on a timescale of hours, after their discovery.

As of 2016, gravitational-wave astronomy has become a reality, and the search for electromagnetic counterparts of sources detected through their gravitational waves by LIGO is a major new opportunity. While the first two LIGO detections appear to be from pairs of colliding black holes, which may not produce any visible radiation, in the future we may see LIGO detections with the signature of pairs of neutron stars, that are expected to be visible at optical and near-IR wavelengths. Recently, NSF listed "Windows on the Universe: the Era of Multi-Messenger Astrophysics" as one of six "big ideas" for future investment, and Keck will have a major role to play in multi-messenger astrophysics as a premier facility for optical/near-IR observations of transient gravitational-wave sources.

The Keck Observatory plans to move aggressively to exploit new TDA opportunities, and we have taken a number of steps in the past few years to enable TDA to flourish. Up to now, a target-of-opportunity policy existed within each of Caltech and UC. A few months ago we implemented an inter-partner target-of-opportunity (ToO) policy to maximize the probability of being able to actually observe such very rare events with very short notice, and the first such ToO was executed in April 2016. The development of the deployable tertiary for Keck I, expected to be commissioned in 2017, is crucial in our planning for the future of TDA at Keck, and we will need to study how best to implement a comparable capability at Keck II, which is somewhat more complex due to its instrument configuration.

We also need to better accommodate cadence observations for rare, critical events that can be predicted in advance, but only require a small part of a night. Examples include monitoring the volcanos on Titan by taking an image every night or every week, or observing exoplanet eclipses when the orbits are known so that the dates and times of the eclipses can be predicted. Effectively providing cadence observing will require new ways to assign time in pre-planned small chunks on one or more nights while still having a primary classical observer control most of the night.

### **D. Lead the ground-based preparation and follow-up for NASA's flagship missions.**

The identification and characterization of exoplanets is a field which is both intellectually challenging and of great interest to all humankind, with the ultimate goal of finding an analog to Earth, and perhaps eventually detecting biomarkers indicating intelligent life. This is an endeavor with tremendous appeal to the general public, and one at which Keck Observatory should aspire to excel, given that it has the sharpest images of any optical ground based telescope and with AO, it can outcompete any existing or planned space based telescope. Keck Observatory has been the leader to date in radial velocity detections

of exoplanets, with most exoplanet confirmations being based on HIRES spectroscopy. To maintain our lead in this field, we need to build the Keck Planet Finder (KPF) starting immediately; funding is currently in place through Preliminary Design Review. KPF observations will provide critical follow-up for exoplanet candidates identified by the upcoming TESS mission. Another priority for exoplanet science will be a new NIRSPEC fiber-fed precision radial velocity (PRV) capability, which will enable discovery and characterization of planets around cool stars and brown dwarfs.

The James Webb Space telescope (JWST) (a 6.5 meter diameter telescope which will be the successor to HST) is expected to be launched in 2018. Since it has a nominal lifetime of only five (5) years, the community needs to be ready on day one (1) to take full advantage of this marvelous instrument. In order for the Keck community to be prepared for early science with JWST, we should try to support observational programs at Keck aimed at generating compelling samples of objects for detailed study with JWST. A NASA call for early science with JWST is expected within a year.

JWST will be a cold telescope in space; it will therefore have unbeatable sensitivity in the H band and longward for imaging and for low resolution (including multi-object) spectroscopy at  $R \leq 3,000$ . Once JWST is launched, IR observation from the ground will shift towards higher spectral resolution. Due to the smaller diameter of the JWST primary mirror, adaptive optics imaging at Keck, with the proper hardware and software, will have better angular resolution than JWST imaging from space. Exoplanet imaging will still be compelling from the ground assuming we focus our AO efforts into achieving the best possible inner working angle for AO.

Euclid (an ESA mission with NASA participation) is scheduled for launch in 2020 and the NASA mission WFIRST will follow a few years later. These missions are focused on cosmology, and Keck can play a vital role in calibrating the various schemes that are planned to be used to measure crucial cosmological parameters, an example of which is calibrating the photometric redshift schemes with thousands of new spectroscopic redshifts of faint galaxies. NASA needs this for the success of these missions, and the twin Kecks are the only telescope capable of carrying out such a program in a timescale less than a decade; only Keck can get this work done before the launch dates for these missions.

#### **E. Continue Keck's emphasis on highly efficient operations.**

Observing at the Keck Observatory is unusual among major facilities in that the astronomer has complete freedom to control in real time how the telescope and instrument are used. This enables a rapid response to changes in weather and an ability to adopt programs to optimize results. We believe that this flexibility is an important contribution to the success of Keck Observatory, and we intend to continue operating in this “astronomer first” mode. A quote from a recent observer says it best: “I have now been coming to Keck Observatory for nearly 20 years, and it is reassuring to find that every observing run meets my highest expectations. I invariably leave with the best data in the bag, and with gratitude and respect for the Keck Observatory team who make it all possible. One aspect that may not get mentioned very often is how easy-going the whole observing process is at Keck Observatory. At other observatories, visiting astronomers are not in charge of the observing and one is mired in senseless bureaucracy.”

However, the telescopes are no longer young. Keck Observatory celebrated its 20 anniversary several years ago and some key components are suffering from obsolescence. This year we will complete an upgrade of the telescope pointing system. Upgrades of other key telescope systems are planned over the next decade.

In addition to the telescope and its instruments, we must maintain all other aspects of the observatory operations to continue to achieve maximum efficiency of operations. Our staff, from the Support Astronomers to the technicians who switch instruments in and out of the telescope, to the engineers, to the administrative assistants who work at our headquarters, are key assets of the observatory, and we must

retain and recruit the best possible personnel and make sure they enjoy their work and are proud to be associated with Keck Observatory. The knowledgebase of those staff members who have been with Keck Observatory for many years is irreplaceable.

As the complexity of instruments increases, the process of data reduction becomes dramatically more complex. This is particularly true of integral field spectrographs such as OSIRIS, and will be true of KCWI, which we expect to commission in 2017. Such spectrographs have a non-intuitive mapping of the data from multiple sources within the field in the final output image that cannot be analyzed without intricate reduction algorithms. We need to ensure that for each of our instruments the Keck Observatory community has access to a reliable data reduction pipeline (DRP) that removes the instrumental signature and produces output that is then ready for further analysis.

We are very grateful to NASA for funding the Keck Observatory Archive (KOA), which now contains all Keck Observatory observations dating back to the beginning of routine use of the telescope. This is a treasure trove of data, and the worldwide astronomical community has begun to use it. We aspire to serve processed data through KOA rather than raw, uncalibrated data, as our pipeline efforts bear fruit. In 2015, 13 % of the published papers from Keck Observatory used KOA to access archival data, and we expect that fraction to rise as the collection in KOA increases and its ease of use improves with time.

## 1.2 Strategic Planning Process and Summary of Recommendations

In the fall of 2015, the Keck Science Steering Committee (SSC), Observatory Directors, and Keck Observatory initiated this planning exercise. The previous strategic plan was last updated in 2009, and it was appreciated that the landscape of ground- and space-based astronomical facilities would change more rapidly over the next 5 to 10 years than perhaps at any time in the Observatory's past. The retreat obtained input from the broader astronomical community in order to identify synergies with these new facilities and evaluate the potential of new initiatives for enabling scientific discovery. The following seven topics were then explored in detail by task groups composed of members of the Keck community: 1. Characterizing Other Worlds with the Keck Telescopes, 2. Keck in the JWST Era and Beyond, 3. Optimizing the Joint Scientific Return of Keck, WFIRST, and Euclid, 4. Keck in the Era of TMT, 5. Strategic Recommendations for Keck Observatory; Time Domain Astronomy, 6. Enhancing the Keck/Subaru Partnership into the TMT Era, and 7. The Evolution of Adaptive Optics at Keck.

The recommendations from these seven (7) task groups resulted in the priorities summarized in Table 1. These recommendations are presented as an unranked list, grouped into three broad categories. First are major new instruments and AO projects. Second, we list recommended instrument upgrades and enhanced capabilities that will enable new scientific progress. Third, we present a list of recommended topics for design studies for future instrumentation and AO capabilities. For these topics, we plan to initiate a small number of large scale studies involving groups of people across the entire Keck partnership. We plan to continue our annual call for white papers for future instruments, upgrades, software improvements etc., which provides more limited funding for smaller scale efforts.

*Table 1: Strategic Plan Priorities.*

<b>Instruments</b>	<b>Notional First Light</b>	<b>Supports:</b>
Keck Planet Finder (KPF)	2020	Exo-planets, JWST, WFIRST, TMT
Keck All sky Precision AO (KAPA)	2019	Exo-planets, JWST, TMT
<b>Upgrades, Enhanced Capabilities</b>		
NIRSPEC PRV	2018	Exo-planets, Push limits of FOS
Keck Observatory Archive (KOA), Data Reduction Pipeline (DRP)	Ongoing	Maximize scientific impact, Efficiency of operations.

Instruments	Notional First Light	Supports:
AO PSF Facility	2018	Maximize scientific impact
<b>Design Studies</b>		
Highly multiplexed, highly sensitive spectroscopy, (e.g. doubling of DEIMOS FoV, detector upgrades, grating upgrades, etc.)		WFIRST, Euclid, TMT, Push limits of FOS.
High Contrast AO (HCAO)		Exo-planets, JWST, Subaru synergy, Maximize science impact.
Next generation instruments (e.g. Super NIRSPEC, Dream Machine, larger format IFU for AO, wide field UV imager)		Exo-planets, JWST, TMT, AO
GLAO, performance gains, cost of implementation on one or both telescopes, investigate performance of current suite of MOS's with GLAO, etc.		JWST, WFIRST, Euclid, TMT Improve efficiency of ops, maximize scientific impact.
Deployable tertiaries (mirror and/or dichroic)		JWST, WFIRST, TDA, Efficiency of operations, maximize scientific impact.

## 2. Keck Observatory: An Engine for Astrophysical Insight

The Keck Observatory was the first of the 10-m class telescopes to come on line. Located atop Maunakea, the Keck 10-m telescopes initially dominated optical/IR astronomy and even now, despite the proliferation of large telescopes (seven 8-m telescopes, three modern 6.5-m telescopes and three 10-m telescopes) the Keck Observatory continues to be the most productive large OIR ground-based observatory (Crabtree 2015).

The primary strengths of the Keck Observatory are its well-designed, work-horse instruments that, when combined with the 10-m aperture and excellent Maunakea seeing, offer high sensitivity measurements. Nightly operations focus on maximizing efficient data acquisition with an "astronomer first" approach that allows for agility and flexibility. These two strengths helped Keck Observatory to be a world leader at combining high sensitivity with high angular resolution when Adaptive Optics became available.

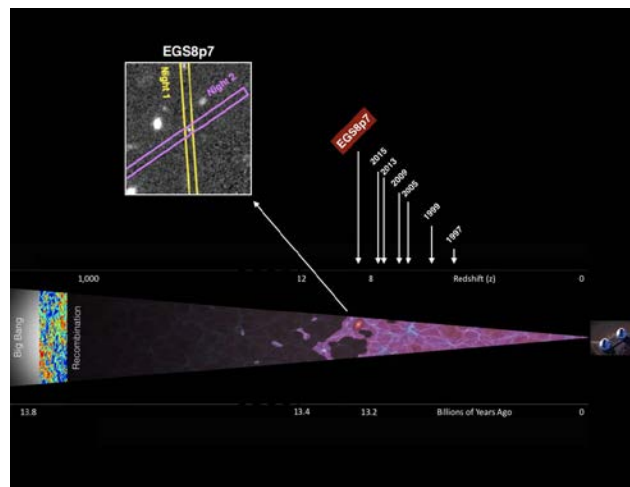

Figure 1: EGSY8p7 – Distant Galaxy Detected, Zitrin et al., 2015.

A review of Keck Observatory's greatest achievements shows that Keck Observatory works best by undertaking sensitive observations of sources found by surveys or other facilities. This synergy began with Keck providing the majority of the redshifts for the Hubble Space Telescope's deep fields and continued with Keck ESI observations of high redshift quasars selected from Sloan Digital Sky Survey (SDSS). These observations led to the first glimpse of the epoch of reionization, followed by a flurry of galaxy detections at the greatest distance ( $z=5.73$  Djorgovski et al., 2001 to  $z=8.68$  Zitrin et al., 2015, Figure 1, now superseded by a yet higher redshift galaxy). Flexibility allowed by classical observing and the high sensitivity of LRIS allowed Keck astronomers to show the fading afterglow of a BeppoSAX GRB to be of cosmological origin (Metzger et al., 1997). Observations of photometric samples of galaxies with LRIS and DEIMOS, both remarkably productive multiplexed spectrographs, led to large foundational samples of galaxies as a function of redshift.

Similar such examples abound in Galactic and stellar astronomy. Spectroscopy of brown dwarf candidates identified elsewhere (e.g. SDSS, WISE) allowed astronomers to establish new spectroscopic classes T and Y (McLean et al., 2003, McLean et al., 2007). The mass and distance to Milky Way's nuclear black hole, and a close-up view of the stars caught in its gravitational pull is a testament to Keck AO (Ghez, 2015, Figure 2a & 2b). It was Keck HIRES spectroscopy that enabled astronomers to identify planets from Kepler's list of candidates and establish an empirical basis for the fraction of stars hosting habitable planets (Petigura, Howard, & Marcy, 2013). Keck has played a critical role in solar system science, from monitoring Io's volcanoes to characterizing the composition of nearby comets and distant Kuiper Belt Objects. Additional Keck milestones include the first images of exoplanets (Marois et al., 2008), and new tests of the theory of General Relativity (Meyer et al., 2012).

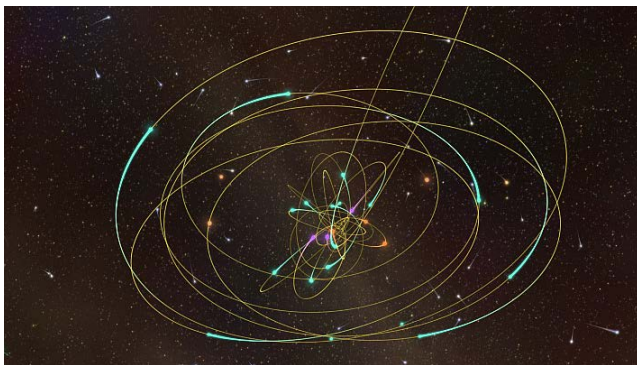

Figure 2a: Galactic Center

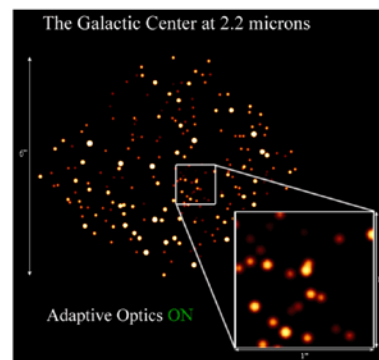

Figure 2b: Galactic Center with AO

The scientific discoveries made by Keck Observatory over the past two decades have resulted in numerous major prizes being awarded to members of the Keck Observatory community. A few highlights include: 1) the 1995 Heineman Prize, the 2010 Kavli Prize for Astrophysics, the 2012 Benjamin Franklin Medal in Electrical Engineering, and several other prestigious prizes awarded to Jerry Nelson of the University of California, Santa Cruz (UCSC) for the radical new segmented mirror design of the telescopes; 2) the Gruber Prize awarded to Charles Steidel of Caltech in 2010 for his observations of the earliest galaxies; 3) the Nobel Prize in Physics awarded to Saul Perlmutter of the Lawrence Berkeley National Laboratory in 2011 for the discovery of Dark Energy, and 4) the Crafoord Prize awarded to Andrea Ghez in 2012 for her work on the Galactic center.

These achievements were made possible by advances in instrumentation and AO, and by highly efficient observatory operations. Through the development of these technical capabilities and the execution of ground-breaking science programs, the Keck Observatory community has contributed to the education

and training of many young scientists who have since become leaders of the astronomical community. Keck Observatory maintains the highest productivity of any ground based telescope, as demonstrated in Figure 3, that shows the average impact per paper, where “impact is measured by the ratio of the number of citations that paper has received to the citation count for the median AJ paper of the same year”, times the number of papers (Crabtree, D., 2015).

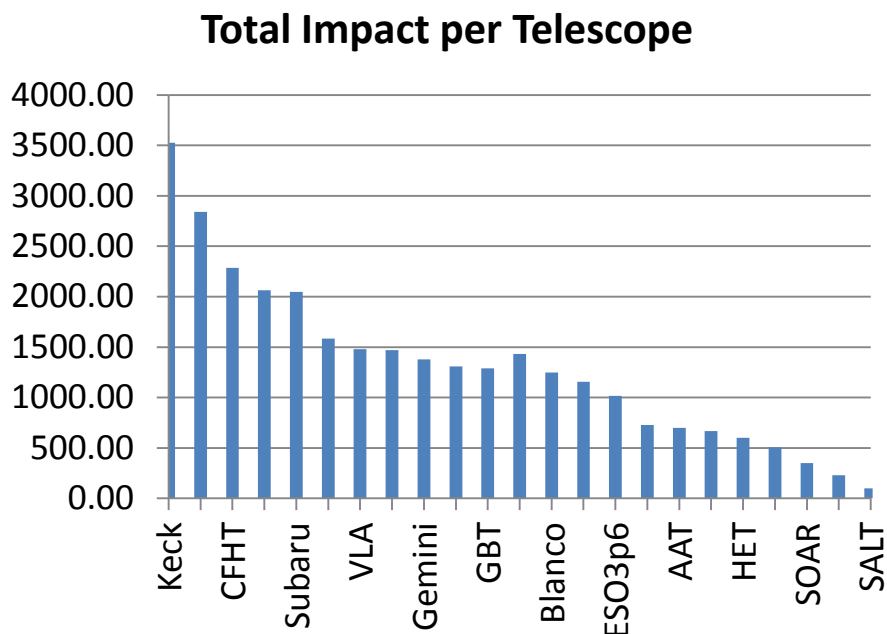

Figure 3. Total impact per telescope, Crabtree D, 2015. Full list of referenced telescopes is, respectively, Keck, UKIRT, CFHT, VLT, Subaru, Mayall, VLA, NTT, Gemini, Magellan, GBT, MMT, Blanco, JCMT, ESO3p6, eVLA, AAT, Arecibo, HET, WIYN, SOAR, LBT, and SALT.

### 3. Keck Observatory in the Astronomical Eco-system: A Forward View

Going forward the astronomical eco-system is amazingly rich. The on-going missions include HST, Chandra, Fermi, Spitzer, Swift, NuSTAR, Curiosity, New Horizons, and Gaia, and flagship ground-based facilities such as JVLA, and ALMA. The future promises even more dramatic capabilities including: TESS (2017), SRG/eROSITA (2017), JWST (2018), Euclid (2020), LSST (2022), WFIRST (2024).

There is little doubt that we are now squarely in the era of time domain astronomy (TDA). Synoptic and time domain surveys cover a wide swath of parameter space (magnitude, cadence): HSC/Subaru, DEC/Blanco, ODI/WIYN, Pan-STARRS-1+2, PTF/ZTF and ATLAS. ESA’s Gaia will be a game-changing mission for stellar and galactic astrophysics. A number of optical observatories are constructing highly multiplexed spectrographs (WEAVE, HERMES, PFS, DESI, 4MOST) for Gaia, emphasizing cosmography and Galactic Archeology.

We explicitly recognized the rich global eco-system and our broad user base as we began our strategic planning. Keck Observatory maintains a list of astronomers who used the Keck telescope. The list currently stands at 1,681 -- a testament to the fact that Keck's base goes well beyond California and Hawaii. All 1,681 users were invited to offer their services in the strategic planning. Over fifty responders were given a choice of the seven following working groups to join:

1. Characterizing Other Worlds with the Keck Telescopes



2. Keck in the JWST Era and Beyond
3. Optimizing the Joint Scientific Return of the Keck, WFIRST and Euclid
4. Keck in the Era of TMT
5. Strategic Recommendations for Keck Observatory; Time Domain Astronomy
6. Enhancing the Keck/Subaru Partnership into the TMT Era
7. Evolution of Adaptive Optics at Keck

Further details of these working groups and the timeline and methodology can be found in Appendix V.

As our discussions progressed a major topic that arose was the power of archives accompanied by data reduction pipelines (DRPs). The value of an archive such as Keck Observatory Archive (KOA), inspired and supported by NASA, with full public access, grows with time. With more and more observations being ingested into KOA, the archive enables scientific studies not originally envisioned by the original, single night of observations. The whole of a data archive is more than the sum of the parts. While the goal is to have DRPs which take the observer from raw data to scientifically publishable data, KOA is today a long way from that goal. An informal group was organized to address this important topic. As an indication of the power of KOA, the refereed publications in 2015 from KOA made up 13% of the total publications, a percentage that has grown steadily since the inauguration of KOA in 2003 into an archive which now curates all of the data from all of the Keck instruments going back to 1995.

## 4. Developing a Strategic Plan

The final reports from the seven (7) panels were made available to the integration panel and members of the SSC ahead of the February 2016 SSC meeting in Waimea. Presentations by each of the working groups were made in February 2016 in Waimea to the Integration Panel and SSC leaders. Each presentation was followed with a Q&A session. Following this meeting, we mapped the desired science aspirations to actionable recommendations for each working group.

Prior to ranking the following assumptions were made:

1. KCWI-B and KCWI-R will proceed to completion (which nicely dovetails into the fact that KCWI was the number one recommendation of the previous strategic planning exercise).
2. NIRES will be completed sometime in 2017.
3. The upgrade of NIRSPEC will happen (new H2RG detector, new SCAM).
4. OSIRIS will be upgraded (new detectors for IFU and imager).

The details and the timeline for these projects can be found in Appendix I.

The following guidelines were used in arriving at the recommendations: First, we followed the adage "if it ain't broke, don't fix it". For instance, a major strength and differentiation of Keck (with respect to VLT and Gemini) is that the majority of our observing to date is classical observing. This allows the PI to attend to developments since the time of submission of successful proposals. Some Principal Investigators (PIs) have historically been successful in playing, i.e. risking precious observing time for speculative but high pay-off ventures. On the other hand, cadence and ToO observing, which for sound reasons have steadily gained popularity in our community, come at the cost of both classical time and with added restrictions imposed on the PIs. The wisdom noted above led to a paced roadmap for new modes of observing, including cadence, cross-partner ToOs,<sup>1</sup> and judicious use of discretionary time.

---

<sup>1</sup> Our first cross-partner ToO was executed on April 7, 2016.

Recommendations that benefitted the broadest science received a higher rank. In the spirit with which this strategic planning was undertaken, science was ranked by those recommendations which resonated the most with upcoming missions and facilities, on the ground or in space. Secondly, cost-benefit analysis favored upgrades which promised great science returns.

Our recommendations are given in Section IV and organized into six (6) categories:

1. Instruments
2. Instrument Upgrades & Enhanced Capabilities
3. Design Studies
4. New modes of observing
5. Highly Efficient Operations
6. Retrospective Look

The report concludes with an Appendix listing

Appendix I	Instruments in Progress
Appendix II	New, intriguing ideas, not yet vetted
Appendix III	KI/KII Balance
Appendix IV	Methodologies & Acknowledgements
Appendix V	Science Vision from the Task Groups
Appendix VI	Acronym List

## 5. Recommendations

### 5.1 Instruments

**Keck Planet Finder (KPF):** The top priority, as expressed by the Task Groups representing Planet Finding, JWST, TMT, and WFIRST for the next instrument to be built and deployed on Keck is the KPF instrument, with Andrew Howard as Principal Investigator, and the Space Science Laboratory of the University of California at Berkeley as the instrument builder.

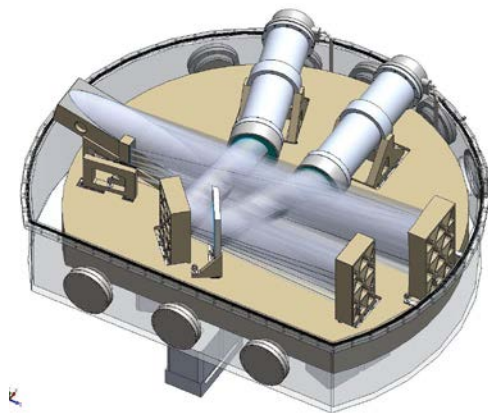

*Figure 4: Keck Planet Finder*

Historically, Keck Observatory has played a key role in identifying and characterizing Extrasolar Planets. Recently, a group of scientists, including KPF PI Andrew Howard (Petigura, Howard & Marcy 2013), used data gathered at Keck Observatory to demonstrate that 20 percent of sun-like stars have an approximately Earth-sized planet in their habitable zone. KPF is a thermally and seismically isolated

fiber spectrograph designed to detect velocity shifts in stars caused by the gravitational pull of orbiting planets. KPF will characterize hundreds of transiting planets identified by the Kepler, K2 and TESS spacecraft; a few of these may even be warm Earth-size planets orbiting near the Habitable Zones of their host stars. The combined radius and mass information will determine how the bulk density of these planets changes with radius and orbital location, giving clues to their formation and migration history. The most favorable candidates will be targets of spectroscopic observation with the James Webb Space Telescope. Long term surveys with KPF of nearby bright stars will address such game changing questions as; “Which nearby stars might host the closest Earth analogs?” These surveys will provide prime targets for direct imaging with the Thirty Meter Telescope (TMT), as well as characterization via spectral analysis with TMT and future space-borne telescopes. KPF will identify new targets for observation with the WFIRST coronagraph that will be sensitive to reflected light by mini-Neptunes and possibly Super-Earths.

**KAPA (Keck All sky Precision Adaptive optics):** Previous Keck Observatory strategic plans have identified the importance of high performance adaptive optics (AO), specifically high Strehl ratios with high sky coverage. As a result Keck Observatory has been engaged in a series of AO upgrades (e.g. laser center launch, new laser, near-infrared tip-tilt sensing, etc.). This strategic plan identifies KAPA, the next step in this upgrade process, as our second priority. The KAPA proposal, submitted to the National Science Foundation’s Mid-Scale Innovation Program’s 2016 proposal call, was not granted funding. However, KAPA is still an important component to our overall AO program and will provide significantly higher Strehl ratios and sky coverage in the near-infrared. KAPA would be coupled with the planned instrument upgrades (i.e. OSIRIS and NIRSPEC) to take full advantage of their combined capabilities.

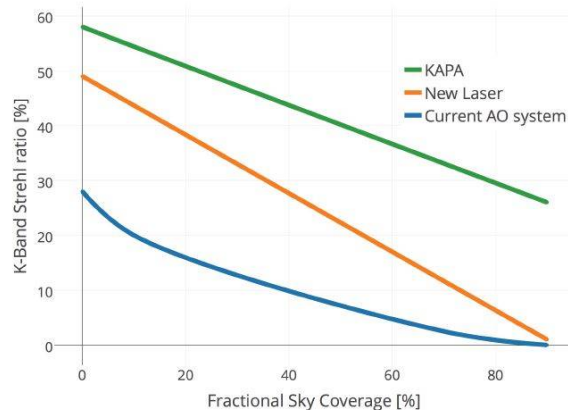

Figure 5: KAPA performance as measured by K-band Strehl which is directly proportional to the signal-to-noise in the AO corrected image. KAPA builds on the capability of the new laser installed in 2015.

The KAPA proposal highlighted four (4) high impact science projects that would be carried out with this system:

- 1) Constraining dark matter, the Hubble constant and dark energy, via strong gravitational lensing.
- 2) Characterizing galaxy kinematics and metallicity in rare highly magnified galaxies.

- 3) Testing General Relativity and understanding supermassive black hole interactions at the Galactic Center.
- 4) Characterizing planets around low mass stars via direct imaging and spectroscopy.

## 5.2 Instrument Upgrades & Enhanced Capabilities

**NIRSPEC PRV CAPABILITY:** The addition of a Precision Radial Velocity (PRV) capability to the Near InfraRed SPECTrograph (NIRSPEC) would give the Keck community a new tool to search for and characterize planets orbiting new classes of host stars, including the coolest M stars, stars with active photospheres such as young stars, and brown dwarfs. By taking advantage of breakthroughs in laser frequency comb technology as a wavelength standard (Yi et al 2016) and the improved sensitivity and spectral resolution of the upgraded NIRSPEC instrument, it will be possible to achieve 1-3 m/s precision for targets as faint as K= 8 mag. NIRSPEC PRV will open for the US science community the ability to search for sub-Neptunes and Super Earths orbiting cool stars and for "Hot Jupiters" orbiting young stars. Other science topics include the follow-up of transiting systems discovered by the Transiting Exoplanet Survey Satellite (TESS) and the physics of brown dwarfs. This effort would leverage an already-funded, single-mode fiber feed from the Adaptive Optics (AO) bench to NIRSPEC. With a thermal stability similar to the best visible PRV instruments, e.g. HARPS, and with the addition of stabilized illumination and a stable wavelength reference, NIRSPEC will provide the US community competitive access to NIRPRV performance similar to today's visible wavelength systems.

Although visible PRV capabilities have improved steadily to 0.5~1 m/s, near-IR PRV (NIR PRV) measurements have lagged for technological reasons. However, these wavelengths offer exciting scientific opportunities. First, Kepler has shown that each M star hosts a minimum of 2 planets of which ~25% are located in a broadly construed Habitable Zone (HZ; Dressing and Charbonneau 2015). The large RV amplitudes and short periods of these planets make them attractive targets for PRV observations while their deep transits make them attractive for transit spectroscopy with JWST. Yet cool M stars are challenging to observe in the visible as most of their luminosity is emitted in the infrared. Second, little progress has been made in the search for planets in close orbits around young stars because of "stellar jitter" due to star spots. This effect is reduced in the NIR where the effects of temperature contrast are muted. With NIRSPEC PRV we expect to find the "Hot Jupiters" which we know from planet formation theory must be present. Finally, NIR PRV can directly determine the masses of brown dwarfs in multiple or transiting systems, thereby anchoring the low mass end of stellar evolution theory.

*The Fiber feed subsystem.* NIRSPEC PRV upgrade would use the Keck II AO system to feed diffraction limited images to NIRSPEC's slit plane. Single mode fibers will take stellar and adjacent sky images at H and K-band from the AO bench and inject them into NIRSPEC without needing to reconfigure the instrument on the telescope. Switching between AO fiber-fed and seeing limited observations should be fast, enabling programs that rely on high cadence observations.

*A stable wavelength reference:* Recent tests of a laser frequency comb producing lines spaced 0.1 nm apart imaged across eight (8) orders with NIRSPEC have demonstrated a stable frequency standard that can achieve a radial velocity precision of ~ 1 m/s. Additional fibers will bring laser comb signals (two (2) each at H & K) to a fiber injector module, arranging them on either side of the stellar and sky fiber outputs to provide wavelength standard and monitoring of differential drifts across the slit.

**KECK OBSERVATORY ARCHIVE (KOA) AND DATA REDUCTION PIPELINES (DRP):** KOA recently completed archiving the entire Keck data base, a major accomplishment for the premier 10-m telescope operating continuously for nearly 25 years. In the last year alone, KOA produced 13 per cent of the published papers coming from Keck.

Meanwhile, the single item most often requested by KOA users is more reduced data in the archive. As anyone familiar with data reduction pipelines knows, a pipeline that is able to fully, accurately, and completely reduce astronomical data is not an easy or cheap thing to come by. This challenge is particularly acute for ground based facilities which operate under changing atmospheric conditions and with a multitude of instrument settings and calibration sequences determined by individual observers. KOA currently serves calibrated/reduced or level-1 products for just four (4) instruments. Generated by automated DRPs, these products are intended for quick-look, browsing purposes only. Our long-term goal is to make level-1 products, possibly of publishable-quality, available for all of the instruments, using DRPs developed by the Keck Observatory or re-using existing packages developed by the Keck community for cost-saving. New instruments should be required to be delivered with a DRP and made archive-ready from the first day of operation. As a benefit to the Keck Observatory, these level-1 products will enable the development of a rigorous instrument performance analysis program, which monitors and analyzes these data and leads to the improvement of calibration and maintenance of instruments. Using this feedback process, the latest and best calibrations can be used for “on-the-fly” data processing, helping observers to get the best-quality data. A testimony of the success of KOA is given in Figures 6a and 6b; 13 per cent of publications in 2015 had their basis in KOA data.

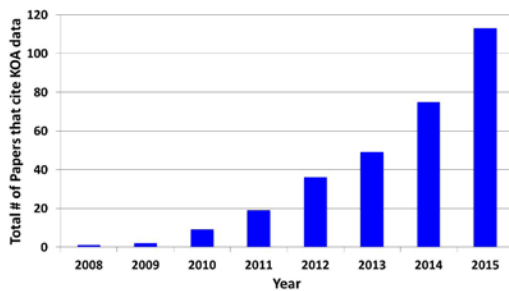

Figure 6a: Cumulative number of papers with KOA data

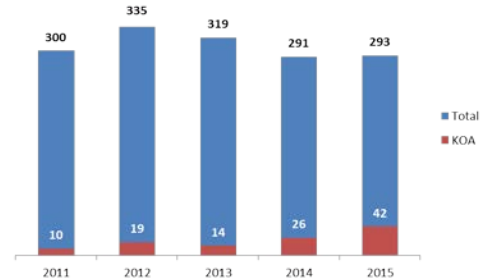

Figure 6b: Total of referred Keck papers per year compared with KOA papers

Being able to interact with and respond nimbly to the torrential flow of data from big surveys like LSST with follow-up observations at Keck is essential. The key is having archival level-1 data at the ready, with KOA serving as the distribution source. Having supported past NASA missions like Deep Impact and observations of the comet Ison by making public immediately time-critical data obtained with Keck instruments, KOA will continue to support future space missions. As an essential tool for researchers to develop and supplement observing programs envisioned for future space observatories like JWST and WFIRST, and giant ground-based telescopes like TMT and ELT, KOA must enhance its data discovery by improving interoperability with other NASA archive centers and the virtual observatory (VO).

**AO POINT SPREAD FUNCTION (PSF) RECONSTRUCTION FACILITY:** Accurate knowledge of the AO delivered PSF is extremely valuable to all quantitative science done with AO including astrometry, photometry, morphology and kinematics. Unfortunately very few science exposures taken with the Keck AO systems include a star to provide real-time PSF knowledge. Keck Observatory and UCLA have performed demonstrations that the PSF can be reconstructed from a combination of AO telemetry, atmospheric turbulence profiling data and science instrument characterization. A PSF-R facility based on these demonstrations has been proposed that would provide field-dependent PSF estimates with every AO science observation as a product of KOA. Successful implementation of such a facility was the second highest priority of the AO strategic working group and would represent a revolution in the quantitative science that can be done with Keck AO data.

### 5.3 Design Studies

**DEIMOS/WFIRST/Euclid:** A top priority for design studies is to investigate, first, the possibility of doubling the field of view of DEIMOS, and second the option of an XSHOOTER type instrument. Either effort would be a major cost and effort, more in the class of building a new instrument than in the category of an instrument upgrade.

The WFIRST Task Group report describes the value of adding a blue arm to DEIMOS, which would significantly improve the efficiency of Keck to study and obtain redshifts for galaxies at  $z$  from 1.5 to 2.0. Among the multitude of uses for such an upgrade, the capability provided by a blue arm on DEIMOS would be important for training the algorithms needed to produce large numbers of photometric redshifts, studying galaxy evolution for both galactic satellites, as well as studying distant large-scale structure identified by both satellites. Additionally, the TMT Task Group describes the value of having a 2-wavelength channel on a DEIMOS-like instrument with similar or larger field of view, noting that Subaru/PFS, being fiber-based, is unlikely to be the instrument of choice for high quality spectra of the very faint targets which have been the mainstay of Keck spectroscopy in recent years. Worthy of debate would be the development of a blue arm versus or possibly in addition to the augmentation of the current red arm.

**GROUND LAYER AO (GLAO):** The atmospheric profile above Maunakea is well suited to providing seeing improvements with GLAO and many of the strategic working groups (WFIRST, JWST, TMT, Subaru and AO) identified GLAO as a priority for enhancing the Observatory's competitiveness. The highest priority design study recommended by the AO strategic planning working group was therefore that a conceptual design study should be performed for GLAO on either Keck I or II to support observations with DEIMOS, LRIS and MOSFIRE. The study should include the science case, technical feasibility studies and performance predictions for implementing GLAO with the science instruments, an adaptive secondary mirror feasibility study, and a cost estimate. The results of the study, coupled with a review of the strategic priority, would determine whether Keck Observatory should implement GLAO and for which instrument(s).

In Sendai 2015 (the first Keck-Subaru Strategy Meeting) it became clear that our Subaru colleagues are keenly interested in a Subaru-based GLAO program. Even undertaking preliminary studies for GLAO --establishing the gains of GLAO at Keck or Subaru via pilot projects itself --can be expensive, let alone downstream technical activities and modification of existing instruments to accommodate the hoped for seeing improvements). Clearly, it is important for us to be in close touch with our Subaru colleagues.

**HIGH CONTRAST AO CAPABILITIES:** Keck AO and NIRC2 provided the emblematic images of HR 8799 with at least 4 massive planets around it, and numerous similar images. Keck also pioneered interferometric techniques, including aperture masking, e.g. the protoplanetary disk first imaged by Keck, LkCa 15, as well as nulling interferometry (exo-zodiacal survey) revealing regions on a scale of a few AU. OSIRIS, while not optimized for high contrast imaging, has provided the highest spectral resolution spectra of two (2) exoplanets to date (HR8799b and HR8799c). New capabilities in LGS and near-IR tip-tilt sensing have enhanced the sky coverage, enabling spectroscopy of companions to M stars. This background set the stage for multiple strategic Task Groups (TMT, Exoplanets, Subaru and AO) to recommend further developing unique high contrast AO capabilities on Keck II in areas where Keck can provide competitive and complementarity capabilities to instruments like Gemini Planet Imager (GPI) and Spectro-Polimetric High-contrast Exoplanet REsearch (SPHERE) for the detection and characterization of exoplanets (e.g. L- and M-bands, and higher sky coverage). These areas include the already funded NIRSPEC fiber injection module along with the proposed coronagraphic enhancements to this module, and the proposed near-infrared pyramid wavefront sensor and KAPA.

**DEPLOYABLE TERTIARY ON KECK I:** The addition of a deployable tertiary on Keck I, K1DM3, will have a significant impact on TDA by making instruments readily available or “hot” (i.e. prepared for observing on short notice) for targets of opportunity, ToO, and/or cadence observing. This is especially true since the bulk of the time will be scheduled for the two (2) most popular instruments LRIS and MOSFIRE that happen to be Cassegrain instruments. Table 2 shows the enormous flexibility that KIDM3 adds to KI via the matrix of possible instrument changes. The added value makes it logical to consider extending the idea to Keck II.

*Table 2. Availability of Keck I instruments with K1DM3. If the telescope is scheduled with the instrument in the left-hand column, reading across for green cells with “OK” in them tells you which other instruments are available. Note that only one of MOSFIRE or LRIS will be available, most likely dependent on lunation.*

Switch to: Scheduled instrument:	HIRES	LRIS (if dark time)	MOSFIRE (if bright time)	OSIRIS	PCS/SSC
HIRES	OK	OK	OK	OK	OK
LRIS	OK	No	No	OK	OK
MOSFIRE	OK	No	OK	OK	OK
OSIRIS	OK	OK	OK	OK	OK
PCS/SSC	OK	OK	OK	OK	OK

**DEPLOYABLE TERTIARY/ DICHOIC TERTIARY ON KECK II:** The potential benefits of K2DM3 are not as extensive as the K1DM3, as can be seen in Table 3. This is partly due to the fact that KII has only one Cassegrain instrument, ESI. The configurable Nasmyth focus makes the situation yet more complicated. Note also that Keck Observatory could adopt a scheduling policy that tries to makes certain combinations of Keck I and Keck II instruments “hot” to anticipate possible ToO requests. An example of this would be to have MOSFIRE available on Keck I when ESI is scheduled on Keck II to have both an IR and visible spectrometer available for the ToO. This concept should cover most ToO requests with having to develop a K2DM3.

Table 3. Availability of Keck II instruments is more complicated than Keck I since several instruments can be exchanged at Nasmyth focus and NIRSPEC can be moved to AO. The yellow cells show where the potential gains might be for switching to or from ESI with a deployable tertiary.

TO:	DEIMOS	ESI	KCWI	NIRC2	NIRES	NIRSPA0	NIRSPEC	PCS/SSC
Scheduled instrument								
DEIMOS		no	No	OK	OK	sometimes <sup>2</sup>	no	OK
ESI			No	No	no	No	no	no
KCWI	no	no		OK	OK	sometimes <sup>2</sup>	no	OK
NIRC2	sometimes <sup>1</sup>	no	sometimes <sup>1</sup>		OK	sometimes <sup>2</sup>	usually <sup>1</sup>	OK
NIRES	sometimes <sup>1</sup>	no	sometimes <sup>1</sup>	OK		sometimes <sup>2</sup>	usually <sup>1</sup>	OK
NIRSPA0	sometimes <sup>1,2</sup>	no	sometimes <sup>1,2</sup>	OK	OK		no	OK
NIRSPEC	no	no	No	OK	OK	No		OK
PCS/SSC	sometimes <sup>1</sup>	no	sometimes <sup>1</sup>	OK	OK	sometimes <sup>2</sup>	usually <sup>1</sup>	

Note:

1. Either NIRSPEC, DEIMOS, or KCWI can be available on the right Nasmyth platform, but not more than one of them at a time.
2. NIRSPA0 (NIRSPEC moved to behind the AO system) is only available during scheduled NIRSPA0 observing runs.

The suggestion of a K2 dichroic tertiary was brought up as a way to use ESI and NIRES simultaneously and possibly ESI and NIRSPEC (XSHOOTER mode). This interesting concept could be studied as part of the K2DM3 and would necessitate two (2) separate deployable optic elements in the tertiary module, one (1) to reflect IR light to the bent-cass or Nasmyth focus while transmitting visible light to ESI and the other all-reflective mirror would pass the visible and IR light to the Nasmyth and bent-cass focii. The feasibility of such a concept would need to be carefully considered and would need to be compatible with other possible upgrades such as increasing the field of view for DEIMOS.

**ADDITIONAL DESIRES:** Finally, the Task Groups found a number of areas that, while very interesting, did not rise to the top priority given their level of resonance with the larger context of upcoming missions, but that could be further developed in white papers. These include such varied topics as; 1) a new AO science instrument, 2) the KRAKEN detector, and 3) design efforts towards the “Dream Machine”, the term used for the ultimate planet finding instrument with Resolution ~ 150,000 and very high stability <10-20 cm/s.

## 5.4 New Modes of Observing

TDA is an important operational capability for Keck Observatory, in the near term and well into the future. In the near term Keck Observatory is developing a deployable tertiary on Keck I, KIDM3, to be



commissioned in 2017, ushering in a new era of TDA at Keck (see Table 1 for availability of Keck I instruments with KIDM3, and Figure 6 for distribution of time amongst the modes). Keck Observatory's goal is to enable TDA modes of operation without significantly impacting the traditional classic modes of operation that are highly valued at Keck.

We define TDA to have 3 forms: 1) Cadence Observations - periodic series of observations of objects that may be evolving on time scales of weeks or months; 2) Targets of Opportunity, ToOs - observations needing rapid response observations within hours or days and; 3) Discretionary time - blocks of time kept open for observations of topical interest.

**Cadence:** Cadence programs are defined as those that require a periodic series of exposures on an object over time scales of days, weeks, or months. Examples include monitoring of solar system objects and precision radial velocity observations of exoplanet systems. The implementation of cadence is primarily a scheduling and support issue for Keck Observatory. The current scheduling process blocks out observing time per institution in units of nights, half nights, and occasionally quarter nights. It is difficult to squeeze in shorter blocks of time and particularly a series of shorter blocks. A cross-institutional agreement, similar to the one for ToO's, would allow for better capability to schedule cadence programs. Note also that much of the engineering time is cadence in nature. Thus, engineering tests could be more efficient and timely if they could be scheduled in shorter periodic blocks of time.

Keck Observatory observing support for cadence does represent an increase in workload, particularly for support astronomers. Another possible negative aspect is a reduction in efficiency resulting from an increase in multi-program split nights. If the demand for cadence observations is such that these two (2) issues become significant, some sort of limit may need to be implemented. The current distribution of partial nights is shown in Figure 6. An increase of 10 per cent in partial nights would facilitate cadence programs for both science and engineering without creating a huge workload or inefficiency problem. This modest change would leave the vast majority of whole night (and even half night) of classically scheduled programs unaffected.

*Figure 7. The Keck Observatory distribution of partial and whole nights. A TDA implementation of cadence observations would increase the partial nights by roughly 10 per cent, thus keeping the vast majority of whole night allocations intact.*

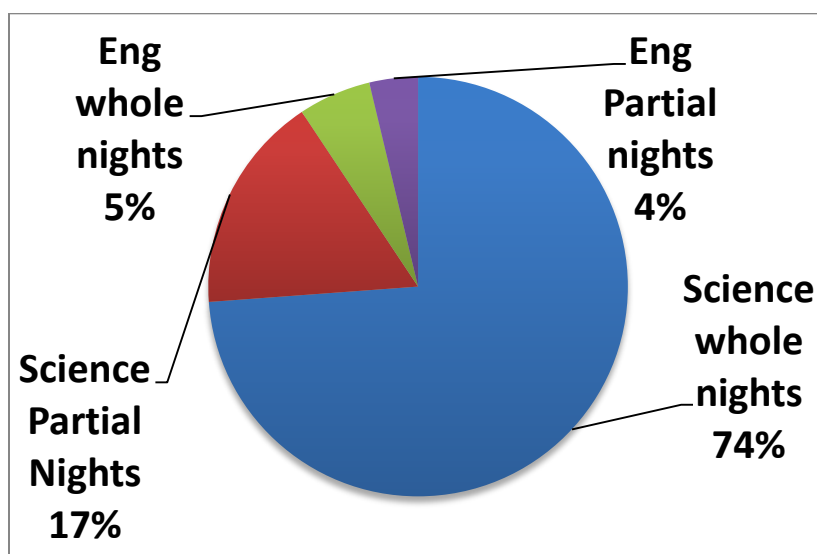

**ToO's:** Keck Observatory has recently implemented a ToO program<sup>2</sup> and it is enabling ToO science on a limited basis. It is authorized by an inter-institutional agreement to allow approved programs the ability to interrupt between UC and CIT, although other Keck Observatory partners are not yet participating. Those institutions with smaller allocations of time are concerned that ToO's will have too great of impact on the classical scheduled PI. Nevertheless, the ToO program is considered successful and with some improvements such as at the K1 deployable tertiary, will likely satisfy the future needs of Keck Observatory in the era of Zwicky Transient Factory (ZTF), Large Synoptic Survey Telescope (LSST), Pan-STARRS, and other TDA oriented science operations. Full participation by all institutions would help fully realize the program although it might require a more equitable method of compensating interrupted classical observers.

**Discretionary time (flex time, reserve time):** Another way to accomplish topical programs and perform science on short time-scale turnaround is to hold a small amount of telescope time in reserve and allocate it at the discretion of an authority, typically the Director, on short time scales. This is already being done at Keck where some institutions will keep a night or two in reserve. Flex/Discretionary is also used for engineering time as an exchange between science and engineering when the engineering time is not needed. The current flextime model could benefit from a more formalized program where each institution allows for short turnaround proposals and has a better mechanism for allocating the time effectively. Although much of this is already in place at Keck Observatory, the process is somewhat cumbersome and labor intensive. Also, the observing community is not included and usually not aware that this time may be available. There is room for improvement in the methods used while meeting the anticipated demand for quick turnaround proposals based on hot new discoveries.

## 5.5 Highly Efficient Operations

Highly efficient operations have always been, and will continue to be, a key strategic priority for Keck Observatory. Optimizing Keck Observatory for science requires a combination of 1) percentage of telescope time performing science, 2) the integration time taken to achieve the required SNR, 3) angular and/or spectral resolution, 4) the scientific field of view, or the number of simultaneous targets (i.e. multiplexing as in MOS's or IFU's), and finally, 5) the quality of the scientific program.

From the perspective of the first three (3) items, highly efficient operations includes maintaining and optimizing a) the fraction of time spent on scientific integration, b) the time spent on scientific observations, c) the image quality at the science instrument focal plane(s), and d) the throughput and emissivity of the telescopes and the science instruments.

A number of tools, procedures and databases must be maintained and potentially optimized to support highly efficient operations including performance monitoring (e.g. image quality, open shutter time), performance maintenance (e.g. segment exchanges), preventative maintenance (to prevent breakdowns), daytime calibration and checkout (to ensure the systems are ready for the night), and user interfaces (to maximize nighttime efficiency).

From the perspective of highly efficient operations, this includes maintaining and optimizing the:

- Information and support available to the observer for proposing, planning and carrying out their observations, and for reducing their data.

The maintenance of the items listed above is covered by Keck Observatory's operations budget and modest improvements are covered by an annually-vetted list of continuous improvement projects. Mid-scale upgrades are covered by an annual infrastructure renewal budget. Large facility renewal upgrades

---

<sup>2</sup> [http://www2.keck.hawaii.edu/inst/common/too\\_policies.html](http://www2.keck.hawaii.edu/inst/common/too_policies.html)

are periodically required to replace aging infrastructure and to maintain and improve performance. The large facility renewal projects currently identified in the Observatory's Board-approved five (5) year plan include:

- Upgrading the telescope control system used to slew, point and guide the telescopes.
- Repairing the cracks in the primary mirror segments in order to prevent catastrophic failure.
- Upgrading the active control system that maintains the primary mirror shape as a function of elevation and temperature.
- Upgrading the cameras in the phasing camera system that are used to measure and optimize the telescope optical performance.

This strategic plan reiterates the importance of maintaining Keck Observatory's high standards in the area of highly efficient operations and supports Keck Observatory in continuing to recommend and implement improvements in this area. Efficiency improvements (e.g. acquisition time, telescope throughput, image quality, detector readout time), even at the few percent level, directly improve the overall scientific productivity of the observatory.

## 5.6 Retrospective Look

We set forth to develop a strategic vision for Keck Observatory. This report is the culmination of a major meeting of leadership, prominent astronomers within and without our community and colleagues from Keck Observatory (Oxnard 2014), Subaru (Sendai - Keck Strategy Meeting, 2015), which involved a total of nearly 30 astronomers from both CARA community and Japan, and the specific exercise involving the entire community as described in Appendix IV.

The authors of this report acknowledge that the final report has equal elements of strategy, by which one usually means long-term objectives that anticipate changes, and tactics by which one responds to issues that are primarily on short timescales. It may even be argued that the report is more tactical than strategic.

The ground is changing rapidly in OIR astronomy. Oxnard 2014 was organized with the clear expectation that TMT was "round the corner" and a major issue was "Keck in the TMT era". It is now clear that TMT is no earlier than 2026 (likely 2027+) and ELT is 2024+. Keck has the opportunity to shine for an additional decade!

Next, only in the last year has it become clear that WFIRST, which started as a dry cosmography mission, is now poised to become a multi-objective mission which now includes exo-planets (micro-lensing and imaging) and a space based NIR survey that touches upon everything from our Galaxy to cosmography. The exquisite wide-field imaging of WFIRST in the NIR essentially has made an NIR equivalent of LSST (or even a paler version) on ground irrelevant. Next, slowly but surely Gaia is now penetrating the ecosystem of American astronomy. And finally, the blooming of multiplexed spectroscopic surveys is actually happening (PFS, DESI, WEAVE, 4MOST, HERMES).

In short, our field is in a dramatic state of change, churn and turmoil. An indication of the dizzying pace of change that is happening to our field is the number of interesting ideas that emerged during the last month when we were integrating the reports. A few of these have been listed in the Appendix.

Given these conditions, we recommend that a review and recalibration of this report be performed in two years' time, an activity that would be extremely useful, especially after the first tranche of Gaia data has been released and the fate of TMT will be clear.

Crabtree, D.R., 2015, ASPC, 492, 90.

Djorgovski, S.G., Castro, S., Stern, D. & Mahabod, A.A. 2001, Ap.J.Lett. 560, 1.

Dressing and Charbonneau 2015, ApJ, 807, 45.

Ghez, A., 2015, IAU, Meeting #29, id.2258598

Marois, C., Barman, T. Zuckerman, B., Song, I., Patience, J., Lafrenière, D., Doyon, R. 2008, *Science*, **322**, 1348–1352.

McLean, I.S., McGovern, M.R., Burgasser, A.J., Kirkpatrick, J.D., Prato, L., & Kim, S.S. 2003, *Ap.J.* 596, 561.

McLean, I.S., Prato, L., McGovern, M.R. Burgasser, A.J., Kirkpatrick, J.D., Rice, E.L., & Kim, S.S. 2007, *Ap.J.* 658, 1217.

Metzger, M.R., Djorgovski, S.G., Kulkarni, S.R., Steidel, C.C., Adelberger, K.L., Frail, D.A., Costa, E., Frontera, F. 1997, *Nature*, 387, 878.

Meyer, L., Ghez, A.M., Schodel, R., Yelda, S., Boehle, A., Lu, R.J., Do, T., Morris, M.R., Becklin, E.E., Mathews, K. 2012, *Science*, 338, 84.

Petigura, E.A., Howard A.W., & Marcy, G.W. 2013, *PNAS*, 110, 19273.

Yi, X. et al. 2016, *Nature Communications*, 7, 10436.

Zitrin, A., Labbe, I., Belli, S., Bouwens, R., Ellis, R.S, Roberts-Borsani, G., Stark, D.P., Oesch, P.A., & Smit, R. 2015, *Apj. Lett*, 810, L12.

## Appendix I. Instruments in Progress

**KCWI-B, KCWI-R:** The Keck Cosmic Web Imager (KCWI) is an integral field spectrograph designed for sky-limited spectroscopy of low surface brightness sources. The blue channel will be commissioned in 2016, with an initial wavelength coverage of  $\sim 0.35\text{-}0.70\ \mu\text{m}$ . The red channel is planned for a 2019 commissioning, with a wavelength passband of  $\sim 0.53\text{-}1.05\ \mu\text{m}$ , limiting the blue channel to a wavelength cut-off of  $\sim 0.56\ \mu\text{m}$ . The KCWI instrument, with its blue and red arms, is strongly supported as a perfect complementary facility to the upcoming space missions JWST, WFIRST and Euclid. Spectroscopy of extremely faint objects is an essential ingredient for obtaining accurate mass models, and is critical for measuring the redshifts of multiply-imaged lensed sources at  $z=1\text{-}5$  and the velocity dispersion of cluster galaxies. JWST will dominate this field beyond 1 micron, but Keck will be the main workhorse at shorter wavelengths. KCWI will also be the ideal instrument to complement the GO science of WFIRST. With the unprecedented sensitivity and exquisite background subtraction offered by KCWI, Keck can play a major role in preparatory observations in fields such as near-field cosmology, lensing, high-redshift quasars. After WFIRST comes online, KCWI will be the ideal instrument for follow up of newly discovered high-redshift galaxies, dark matter clumps, and large scale structures.

**NIRES:** NIRES is being built at Caltech with Keith Matthews as Principal Investigator. When commissioned at Keck, NIRES is expected to be the most efficient single-object, near-infrared spectrograph on an 8-10m telescope, covering the full  $zJHK$  windows simultaneously at moderate resolution. The broad wavelength coverage and simple instrumental design with no moving parts make it perfectly suited for follow-up observations of targets identified by surveys such as LSST, ZTF and WFIRST. It will play an important role in the study of the early universe, where objects contain visible rest-frame diagnostic lines that have been redshifted into the near-IR. It would also serve as the near-IR arm of an instrumental combination with ESI on K2 to provide full spectral coverage from UV-optical-near-IR with the proposed dichroic K2DM3. Such an efficient, wide-band instrument with fast acquisition would provide a powerful tool for rapid TDA/ToO spectroscopic follow-up that is expected to be increasingly in demand.

**NIRSPEC DETECTOR UPGRADE:** Funding through the MRI instrument development program has been obtained to upgrade NIRSPEC. The existing science detector, a 1024 x 1024 Aladdin-3 installed 16 years ago, will be replaced by a 2048 x 2048 H2RG detector sensitive from 1 - 5.3 microns. The improved dark current, read-noise, and quantum efficiency of the H2RG array will result in a ~1 magnitude improvement to the limiting magnitude of objects observed with NIRSPEC. The larger format array with smaller pixels (18 micron), will provide increased wavelength coverage with higher spectral dispersion. With the new detector, the 0.29 arcsecond slit will be well sampled with three pixels for  $R=37,500$ , thus improving the radial velocity precision in the near-IR out to 5 microns.

Another component of the NIRSPEC upgrade will be to replace the original slit viewing imager (SCAM) with a HIRG detector, thereby extending the wavelength coverage into the L and M-bands, which will provide accurate slit placement and guiding at these longer wavelengths. On-slit guiding with fainter sources ( $>1.5$  mag.) will now be possible making optically obscured regions in star forming environments more accessible to NIR spectroscopy. Acquisition and guiding of non-sidereal objects will also be more efficient.

NIRSPEC continues to be the only cross-dispersed high resolution NIR spectrometer available to the US astronomy community, and the improvements to its performance outlined here will ensure that it stays in high demand for years to come.

**OSIRIS UPGRADES:** OSIRIS, the AO-fed Integral Field Spectrograph on K1 has two funded upgrades. The upgrade for the spectrograph has replaced the H2 detector with a H2RG that shows lower read noise and dark current and was funded via an NSF ATI grant with PI James Larkin and Co-Is Sean Adkins and Richard Ellis. The upgrade for the imager channel will replace the H1 detector with an H2RG which yields 10 mas pixels but still over the 20 arcsec FOV. The imager upgrade was funded by the Gordon and Betty Moore Foundation with PIs Andrea Ghez and Mike Fitzgerald and Co-Is James Larkin and Ian McLean. The upgraded OSIRIS spectrograph returned to service in April 2016 and the OSIRIS imager upgrade will occur between January and May of 2017.

## Appendix II. New ideas not yet vetted.

**FIBER-BASED MULTI-OBJECT SPECTROSCOPY:** Keck Observatory has traditionally eschewed fiber-fed MOS spectroscopy on the grounds of light loss. With its large aperture and excellent seeing, Keck Observatory is in position to assemble the faintest possible samples at the limits of current astronomical technology, and we have made it a point to lead in this field. Moreover, path-breaking developments in camera optics and detector technology at Keck Observatory have produced a good match between the number of spectra that can be captured by the camera-detector system and the density of objects on the sky at the faintest limits being probed. Increasing the field of view using fibers but at the same time incurring significant light loss has not therefore been a good tradeoff for us. The poorer sky subtraction accuracy historically attainable with fibers further degraded the deepest achievable magnitude limit.

This balance has changed lately with developments in fiber technology, which are improving throughput, increasing sky subtraction accuracy, and increasing the density of fibers that can be stacked along the fiber pseudo-slit. All of these trends deepen the limiting magnitude attainable with fibers, as well as the number of objects than can be surveyed. It may also be possible to maximize the total number of detector pixels available by making multiple copies of inexpensive spectrographs rather than building single, large focal planes, as has traditionally been our approach. Moreover, recent studies of how Keck Observatory observers actually choose samples with LRIS and DEIMOS suggest that our target samples on the sky are actually denser than can be serviced in a single slit-spectrograph pointing, in which case using fibers to increase target density on the sky would reap rewards.

## Appendix III. KI / KII Balance

As the instrument suite for Keck Observatory develops, it becomes of key interest to balance the desire for time on Keck I versus Keck II. Currently Keck I has two (2) bright time instruments, MOSFIRE and OSIRIS, and two (2) dark time instruments, HIRES and LRIS. Keck II currently has two (2) bright time and two (2) dark time instruments, but in the near future will have four (4) bright time instruments (NIRSPEC, NIRC2, and NIRES and KFP, the last two (2) not yet available) plus three (3) dark time instruments (ESI, DEIMOS, and KCWI-B & R, not yet available). While that balance is now slightly on the Keck I side, once NIRES, KCWI-B and KCWI-R, and KPF are up and operating, the Keck II time will become highly competitive. To make matters worse, the KAPA proposal is written to utilize the Keck II fiber laser and calls for moving OSIRIS to Keck II.

One possible option perhaps in the light of a major DEIMOS upgrade, is that DEIMOS be moved to KI so as to restore the balance for time between the two telescopes.

Note that upon delivery of NIRES, KCWI, and KPF, KI + KII will have eleven (11) instruments total. Should there be some consideration of retiring an instrument, and if so, which one?

## Appendix IV. The Methodologies and Acknowledgements.

The previous Keck Strategic Plan was dated 2009 and it is worth noting that two (2) out of three (3) of the top priorities of the 2009 Keck Strategic Plan are now being implemented; the Keck Cosmic Web Imager, and the completion of MAGIQ. The third priority, in the “Mega Class” of greater than \$20M, NGAO, has not been completed.

In the fall of 2015, a kickoff meeting was held for this current Strategic Plan. It was appreciated that the landscape of ground- and space-based astronomical facilities would change more rapidly over the next five (5) to ten (10) years than perhaps at any time in Keck Observatory’s past. The retreat obtained input from the broader astronomical community in order to identify synergies with these new facilities and evaluate the potential of new initiatives for enabling scientific discovery.

Keck observers were invited to participate on strategic planning in an email sent to the 1,681 Keck observers on record. Approximately 50 members of the Keck observers community responded, and a further 12 observers were recruited to serve in critical positions on the panels. Seven (7) panels were formed to address the topics of; Keck and Exo-Solar Planets (Chair Chas Beichman, Executive Secretary Greg Doppmann), Keck and JWST (Chair Alice Shapley, Executive Secretary Randy Campbell), Keck and TDA (Chair David Ciardi, Executive Secretary Scott Dahm), Keck and WFIRST/Euclid (Chair Jason Rhodes, Executive Secretary Mark Kassis), Keck and Subaru (Chair Evan Kirby, Executive Secretary Luca Rizzi), Keck and TMT (Chair Chuck Steidel, Executive Secretary Hein Tran and Jim Lyke), and finally, Keck and Adaptive Optics (Chair Shelley Wright, Executive Secretary Peter Wizinowich).

First draft write-ups were expected by the time of the February American Astronomical Society (AAS) meeting, January 3, 2016. During the meeting, a plenary session was held to allow for follow on discussion of the strategic plan drafts.

The Keck Observatory Support Astronomers played a critical role in the process, serving as Executive Secretaries to each of the Chairs, giving presentations to many of the Task Groups, and in general, maintaining a balanced view of what can sometimes be very high stakes discussion. The write-ups from the seven Task Groups were presented to the Integration Panel following the Science Steering Committee

on Wednesday, February 24, with all the options discussed and a rough prioritization given in the categories below. This write-up, together with the reports of the seven (7) Task Groups makes up the 2016 Keck Strategic Plan.

## Appendix V. Science Vision from the Task Groups

### I. Characterizing Other Worlds with the Keck Observatory Telescopes, Chair, C. Beichman (NExSci), Executive Secretary, G. Doppmann (WMKO)

The coming decade will see great advances in exoplanet research at Keck Observatory as new instruments and technologies enable new measurement capabilities. The Keck Planet Finder (KPF) will enable higher precision (<1m/s) and higher efficiency precision radial velocity (PRV) measurements that will provide RV confirmation and mass determinations for super-Earths in the habitable zones of nearby stars discovered by the Transiting Exoplanet Survey Satellite (TESS). KPF will efficiently identify Uranus mass objects suitable for follow up study by NASA's Wide Field Infrared Survey Telescope (WFIRST).

The approved upgrade of the NIRSPEC spectrometer at Keck Observatory will provide atmospheric characterization of exoplanets and give precision RV masses for planets orbiting cool stars using near-infrared PRV with an accuracy of 1-3 m/s. Upgrades to Keck's AO system will allow the capability of direct imaging and spectroscopy of planets by injecting AO-corrected images into NIRSPEC via fibers. In the long term, a replacement near-IR spectrograph to NIRSPEC is needed which would take advantage of larger format detectors (4K x 4K) and immersion gratings giving broader wavelength coverage (0.7-4.6 ~~0.9 and 1.5  $\mu$ m~~ and 150,000). This capability will enable higher precision near-IR PRV of cool stars and active stars, as well as permit direct studies of the physical properties of exoplanet atmospheres, leading to the direct detection of bio-markers.

### II. Keck in the JWST Era and Beyond, Chair, A. Shapley (UCLA), Executive Secretary, R. Campbell (WMKO)

The JWST is planned to launch in 2018 and will have a major impact in the near to mid-term on science programs performed at Keck Observatory. The five (5) main science themes for JWST include: First Light and Reionization; Assembly of Galaxies; Birth of Stars and Planetary systems; Planets and Origins of Life; and Solar System Science. With orders of magnitude better sensitivity in the IR, diffraction limited spatial resolution longer than 1.5 microns, and a continuous IR bandpass, JWST will be the preferred instrument for studies of the faint high-redshift universe at the epoch of reionization,  $z \sim 8$ . In order to complement the JWST work at higher redshift, Keck could focus on understanding in detail the very late stages of reionization ( $z \sim 6-7$ ) using its multi-object and high-resolution spectrographs. In studies of the properties of galaxies, Keck will emphasize complementary projects, one example being able to provide rest-UV diagnostics to complement the rest-optical ones obtained by JWST out to  $z \sim 6$ .

JWST will enable the study of many unanswered questions in star formation, protoplanetary disks, low mass stars, and exo-planets with its superior sensitivity and competitive spatial resolution. If Keck improves its AO/instrument capabilities in the shorter wavelength regime by pushing to the diffraction limit in the J, Z, I, and R bands, it will have the performance needed in these bands to remain vital in trying to answer these questions. Boosting the sensitivity of the near-IR and optical multiobject spectrometers with GLAO would also give Keck Observatory a competitive edge for many programs. The study of orbital dynamics in exoplanets with precision radial velocity measurements will continue to be an important aspect of Keck Observatory in the era of the JWST. Thus, the development and improvement of high spectral resolution instruments and calibration techniques should continue to be emphasized.

### **III. Optimizing the Joint Scientific Return of the Keck Observatory, WFIRST and Euclid, Chair, J. Rhodes (Caltech), Executive Secretary, M. Kassis (WMKO)**

The launch of Euclid, a project led by the European Space Agency, and NASA's WFIRST in 2020 and 2024, respectively, will revolutionize the fields of extragalactic astronomy, cosmology (especially relating to dark matter and dark energy), and exoplanets. The two space-based optical and near infrared wide-field survey missions will significantly improve our understanding of strong lensing events, supernova, the epoch of reionization, dark matter, exoplanets, and galactic science. In particular, Euclid's survey will be optimized for weak gravitational lensing (imaging) and galaxy clustering (spectroscopy). WFIRST's primary missions will include a 2200 square degree NIR imaging and grism spectroscopy survey several magnitudes deeper than Euclid's (matching the LSST optical depth), a few smaller and deeper surveys for studying supernova and micro-lensed exoplanets, and finally, coronagraph exoplanet observations.

In the near term, the Keck observing community will acquire optical and infrared preparatory images and spectra for the two missions. A primary objective of both missions is to provide a three-dimensional map of the distribution of matter across a significant fraction of the universe from the weak-lensing shear field, but to do so accurately require robust distance estimates to billions of faint galaxies. Thus, the first precursor observations that will be essential to the success of both missions are robust photometric redshifts, and Keck Observatory astronomers have already started obtaining data to calibrate the intended survey fields. Second, The WFIRST microlensing program can benefit from two types of Keck Observatory precursor observations. Both types of observations can be crucial for breaking degeneracies among microlensing models and fully characterizing the planetary systems. These two (2) precursor surveys are: 1) a precursor astrometric survey of the WFIRST microlensing survey area, and 2) concurrent and follow-up observations of current ground-based microlensing surveys. Third, because the baseline WFIRST supernova observing strategy is to discover SNe via imaging a pre-determined wide area, and then follow-up with targeted IFU spectro-photometry, a possible ground-based survey of considerable value to the WFIRST SNIa observing program would be to obtain photometric redshifts of all the galaxies in the fields planned for the WFIRST SNIa program. And last, the Guest Observer (GO) program will allow PI-led WFIRST observing programs an opportunity to pursue galactic astronomy at moderate to high redshifts as well as provide opportunities to understand wide orbit exoplanets. For all of the above programs, it is essential that preparatory observations be completed in advance of the space based missions.

### **IV. Keck Observatory in the Era of TMT, Chair, C. Steidel (Caltech), Executive Secretary, H. Tran (WMKO)**

By the middle of the next decade, there will be three (3) O/IR telescopes with apertures  $D \geq 2.3-3.9$  times larger than Keck Observatory. All other things being equal, seeing-limited observations with these new facilities would have an aperture advantage proportional to  $D^2 \sim 5-15$ , while background-limited observations of point sources would enjoy an advantage  $\sim D^4 \sim 30-230$ . Only TMT ( $D = 30\text{m}$ ) will share access to the northern sky with Keck Observatory. Keck Observatory's strategic priorities have long been to capitalize on being the largest-aperture O/IR telescope on the planet by providing 1) the most sensitive faint object spectroscopy and 2) the highest angular resolution achievable. Keck Observatory has maintained a lead in sensitivity for faint object spectroscopy by making wise choices about how to deploy comparatively limited resources and building "no frills" workhorse instruments optimized for sensitivity. Keck Observatory in the ELT era may enjoy some years of providing the best far blue science with deep multi-object spectroscopy and AO performance, eventually evolve toward more specialized "survey" mode with fewer operational instruments.

Active and new areas of science that Keck Observatory is expected to lead well into the TMT era include epoch of reionization, nature of fast transients and radio bursts, counterparts to gravitational waves, high-redshift supernovae, and absorption line systems in the early universe. New capabilities that will keep



Keck at the forefront of these fields include a wide-field near-IR IFU, GLAO to feed instruments like MOSFIRE, a wide-field UV-optical imager, and a single object, wide-band, XShooter-like spectrometer. Major overhaul or replacement of “workhorse” instruments like LRIS and DEIMOS should be considered, and to best take advantage of existing infrastructure and get the best “bang for the buck”, major upgrades to detector systems of some current instruments and exploration of innovative hybrid coatings that will significantly improve the telescope throughput are recommended.

#### **V. Strategic Recommendations for Keck Observatory; Time Domain Astronomy (TDA), Chair, D.R. Ciardi (Caltech), Executive Secretary, S. Dahm (WMKO)**

TDA has arisen in the past few years as a dominant theme in the astronomical landscape. In addition to more traditional time domain programs oriented around the study of individual objects (e.g., variable stars, supernovae), there are now large projects dedicated to time-dependent behavior of the Universe which include, but are not limited to, Pan-STARRS, PTF, ZTF, Kepler/K2, TESS, and LSST. The science questions addressed range from the census and characterization of near Earth objects (NEOs) to the discovery and analysis of the Universe’s most distant phenomena. From planet formation to HI reionization, TDA science is at the forefront of modern astronomy. Within this highly dynamic field, Keck Observatory must adapt from its classical approach to astronomy to reap maximal advantage in TDA science. It is also recognized that one of Keck Observatory’s greatest strengths is classical observing and the creative flexibility and serendipitous discovery that goes along with that classical observing.

Keck Observatory will continue to play an important role in the characterization of extragalactic transient objects, one example being the emerging area of detection of the electromagnetic counterparts to gravitational wave detections. Facilities like Keck Observatory can provide observational constraints vital to understanding the physics of the progenitor systems of transient events in the distant universe. The study of the galactic center where dynamics acts on many time scales will require well-planned cadence observations to ensure capturing both predictable and unforeseen phenomena. Exo-planet studies will also continue to be a major science driver of TDA given that Keck’s current and planned instrumentation will be the superior tools for precision radial velocity measurements. There will be increased demand for cadence programs that are more targeted towards predictable exo-planet observations, such as transits and eclipses, those that would otherwise be inefficient to schedule classically. And nearer to home solar system studies of effects like weather and volcanism variability will continue to drive the need for both continuous monitoring and transient event observations.

#### **VI. Enhancing the Keck Observatory/Subaru Partnership into the TMT Era, Chair, E. Kirby (Caltech), Executive Secretary, L. Rizzi (WMKO)**

Keck Observatory and Subaru have enjoyed a fruitful partnership for many years, the continuation of which is crucial to maximize the science return of both observatories. The basic synergy between Subaru and Keck Observatory over the next decade would be for Subaru to identify interesting targets in survey mode and for Keck Observatory to follow them up with targeted observations: deep imaging with HyperSuprime Cam or wide-field spectroscopy with PFS could be followed by deep spectroscopy at Keck Observatory. Thus, it is imperative to keep Keck Observatory nimble and flexible without locking one or both telescopes into a survey mode. The advent of 30m class telescopes will not diminish Keck Observatory’s “astronomer-first” guiding principle, meaning that PI-led projects rather than big surveys will remain the clearest path toward excellent science, even in the TMT era.

In the field of AO instrumentation, Subaru’s near term focus is on near-IR, extreme AO, which would be perfectly matched by the development of a thermal IR-optimized planet imager at Keck Observatory. In the field of optical spectroscopy, the new PFS on Subaru would be the perfect counterpart for upgraded versions of LRIS, DEIMOS and MOSFIRE, with increased sensitivities and larger multiplexing capabilities.

The key for this partnership to continue is to keep Keck Observatory flexible and PI-driven, promote collaboration both for science and instrument development, and focus on complementarity rather than competition.

## **VII. Evolution of Adaptive Optics at Keck Observatory, Chair, S. Wright (UCSD), Executive Secretary, P. Wizinowich (WMKO)**

The Keck Observatory adaptive optics (AO) systems have been very productive scientifically and have enabled a wide range of new science including the first image of another solar system (i.e. HR 8799), the identification of the supermassive black hole at the center at the Galactic Center, the discovery of the coldest binary brown dwarfs, and the dissection of the kinematics and metallicities of distant star-forming galaxies. The Keck Observatory science community has had a strategic advantage versus other ground-based telescopes with the high performance Keck Observatory AO facilities and science instruments.

Keck Observatory AO has also proven to be complementary with HST by providing higher spatial resolution in the near-infrared. We recommend continuing to maintain this advantage with further investments to improve the Strehl ratio and sky coverage of these systems. We also need to ensure that these facilities are equipped with powerful new science instrumentation. These recommendations are driven by a wide range of science questions ranging from understanding the nature of dark matter and energy, to how galaxies, black holes, stars and planets form and evolve. These investments will ensure that precision Keck Observatory AO will continue to play a critical and competitive scientific role in the era of new ground and space-based facilities. For example, Keck Observatory AO's high-precision astrometry will allow tests of General Relativity around a supermassive black hole and will support the WFIRST microlensing survey. Keck AO's contrast will be needed to image and spectroscopically characterize exoplanets. Keck AO's higher angular resolution at wavelengths  $< 2 \mu\text{m}$  will make it a strong complement to science with JWST. Precision Keck AO will be needed to complement and prepare the science programs (and technologies) that will be carried out with TMT AO.

We also recommend determining the strategic benefit of seeing improvements for existing Keck Observatory science instruments with ground-layer AO. Ground-layer AO is driven by the need for sensitive and efficient multi-object spectroscopy in support of future space and ground-based telescopes. For example, GLAO-assisted DEIMOS would be the most sensitive optical wavelength multi-object spectrograph and could be used to constrain the luminosity function in the dark matter-rich, galaxy poor voids mapped by WFIRST.

## **Appendix VI. Acronym List**

AAT: Anglo-Australian Telescope  
ALMA: Atacama Large Millimeter Array  
AO: Adaptive Optics  
ATLAS: Asteroid Terrestrial-impact Last Alert System  
BeppoSAX: Guiseppe "Beppo" Occhialini Satellite per Astronomia X  
CFHT: Canada-France-Hawaii Telescope  
COO: Caltech Optical Observatories  
DEIMOS; Deep Imaging Multi-Object Spectrograph  
DRP: Data Reduction Pipeline  
ELT: Extremely Large Telescope  
ESI: Echellette Spectrograph and Imager  
ESA: European Space Agency  
ESO: European Southern Observatory  
GBT: Green Bank Telescope

GLAO: Ground Layer Adaptive Optics  
 GRB: Gamma Ray Burst  
 HARPS: High Accuracy Radial Velocity Planet Search  
 HET: Hobby-Eberly Telescope  
 HCAO: High Contrast Adaptive Optics  
 HIRES: High Resolution Echelle Spectrometer  
 HSC/Subaru: Hyper Suprime Cam on Subaru Telescope  
 IFU: Integral Field Unit  
 JCMT: James Clerk Maxwell Telescope  
 JVLA: Jansky Very Large Array  
 JWST: James Webb Space Telescope  
 KAPA: Keck All sky Precision Adaptive optics  
 KCWI: Keck Cosmic Web Imager  
 KOA: Keck Observatory Archive  
 KPF: Keck Planet Finder  
 LIGO: Laser Interferometer Gravitational-Wave Observatory  
 LRES: Low Resolution Imaging Spectrometer  
 LSST: Large Synoptic Survey Telescope  
 MOSFIRE: Multi-Object Spectrograph For InfraRed Exploration  
 MMT: Used to stand for Multiple Mirror Telescope. Now stands for MMT, 6.5 m single mirror.  
 MOS: Multi-Object Spectrograph  
 NExScI: NASA Exoplanet Science Institute  
 NIRC2: Near Infra-Red Camera 2  
 NIRSPEC: Near Infra-Red SPECTrograph  
 NTT: New Technology Telescope  
 NuSTAR: Nuclear Spectroscopic Telescope ARray  
 OSIRIS: OH-Suppressing Infra-Red Imaging Spectrograph  
 Pan-STARRS: PANoramic Survey Telescope & Rapid Response System  
 PI: Principal Investigator  
 PRV: Precision Radial Velocity  
 PSF: Point Spread Function  
 PTF: Palomar Transit Factory  
 SALT: South African Large Telescope  
 SDSS: Sloan Digital Sky Survey  
 SSC: Science Steering Committee  
 SOAR: Southern Astrophysical Research Telescope  
 TDA: Time Domain Astronomy  
 TESS: Transiting Exoplanet Survey Satellite  
 TG: Task Group  
 ToO: Target of Opportunity  
 TMT: Thirty Mirror Telescope  
 UCO: University of California Observatories  
 UKIRT: United Kingdom Infrared Telescope  
 VLA: Very Large Array  
 VLT: Very Large Telescope  
 WFIRST: Wide Field InfraRed Survey Telescope  
 WISE: Wide-field Infrared Surveyor Explorer  
 WIYN: Wisconsin, Indiana, Yale, National Optical Astronomy Observatory (Yale no longer a member)  
 XSHOOTER: Not an acronym but a multi-wavelength medium resolution spectrograph  
 ZTF: Zwicky Transit Factory