

# One City Built to Last

Technical Working Group Report

**TRANSFORMING NEW YORK CITY BUILDINGS  
FOR A LOW-CARBON FUTURE**



The City of New York  
Mayor Bill de Blasio  
Mayor's Office of Sustainability

# One City Built to Last

Technical Working Group Report

## TRANSFORMING NEW YORK CITY BUILDINGS FOR A LOW-CARBON FUTURE



**The City of New York**

**Mayor Bill de Blasio**

**Mayor's Office of Sustainability**

# Letter from the Mayor



Friends,

Climate change is an existential threat to humanity, and New York City is on the front lines. That's why we are committed to reduce our greenhouse gas emissions 80 percent by 2050. The comprehensive report of the Buildings Technical Working Group that we release today marks a milestone in our fight against climate change.

In September 2014, when we announced our 80 x 50 target in *One City: Built to Last*, we committed to launch a task force and assess how to place our buildings on a pathway to achieve this vital goal. Following this commitment, the Buildings Technical Working Group engaged in a collaborative, data-driven effort that was unprecedented in its level of ambition and the depth of research on actual buildings and how they use energy. More than 50 leaders in real estate, architecture, engineering, construction, finance, affordable housing, and environmental justice, in addition to countless City staff and volunteers, met for more than a year to deliver the recommendations in this report. With their assistance, the City also conducted the most comprehensive analysis of energy use in New York City's buildings to date. The data showed us the best opportunities for buildings to reduce GHG emissions and put New York City on a pathway to 80x50. This report and its recommendations were created by New Yorkers, for New Yorkers.

In this report you will be able to explore the way energy is used in New York City buildings, the most common types of buildings citywide, and the most effective strategies to reduce energy use and GHG emissions in both new and existing buildings. In addition to these findings, we have outlined a series of new actions that the City will take, including adopting new codes and measures for energy performance, requiring comprehensive upgrades to heating distribution systems, and integrating deep energy retrofits into capital planning.

The initiatives in this report will save building owners on energy costs, cut greenhouse gas emissions, and improve our air quality. They will create jobs, and improve the comfort and quality of the spaces where New Yorkers live, work, and play. They are an investment in our future. Together, these initiatives will help New York City rise to the global challenge of averting the most disastrous impacts of climate change and protect the planet for future generations to come.

A handwritten signature in black ink that reads "Bill de Blasio". The signature is written in a cursive, flowing style.

Mayor Bill de Blasio

# Acknowledgements

This valuable work was conducted by more than 50 leaders from New York City's world-class real estate, engineering, architecture, labor union, affordable housing, academic, government, and environmental advocacy sectors who were appointed to serve on the Buildings Technical Working Group (TWG). This unprecedented level of effort would not have been possible without the following individuals and organizations.

**Director Nilda Mesa**

New York City Mayor's Office of Sustainability

**Commissioner Vicki Been**

Department of Housing Preservation and Development

**Commissioner Rick Chandler**

Department of Buildings

**Commissioner Lisette Camilo**

Department of Citywide Administrative Services

**President Lorraine Grillo**

School Construction Authority

**Chair Shola Olatoye**

New York City Housing Authority

**Commissioner Feniosky Peña-Mora**

Department of Design and Construction

**Commissioner Carl Weisbrod**

Department of City Planning

The incredibly hardworking staffs at HDR, Inc. and the Department of Buildings, Department of City Planning, Department of Citywide Administrative Services, Department of Design and Construction, Department of Housing Preservation and Development, Landmarks Preservation Commission, New York City Housing Authority, Office of Sustainability, Office of Management and Budget, and the School Construction Authority; and a special thanks to:

Ellen Abramowitz, Mina Agarabi, Brian Baldor, Denis Belic, Chris Benedict, Josh Berengut, Jonathan Beuttler, Jennifer Bienemann, Michael Blasnik, Jason Block, Gina Bocra, Tara Boirard, Eric Boorstyn, Daniel Bower, Jeff Brodsky, Ryan Cassidy, Margaret Castillo, Christopher Cayten, Nicole Ceci, Kimberly Darga, Jennifer Davis, Minelly De Coe, Emily Dean, Donna DeCostanzo, Michael DeLoach, David Dimitri, Dan Donnelly, Richard Eiden, Thomas Eisele, Luke Falk, Gary Fescine, Amy Furman, Jocelyn Gan, Chris Garvin, John Gearrity, Diana Glanternik, Erick Gregory, Elizabeth Hanson, Chris Haun, Cory Scott Herralá, Melanie Ho, Emily Hoffman, Michael Ingui, Bomee Jung, Eric Kane, Larry Katz, Jennifer Klein, Ben Kornfield, Serguei Kouznetsov, Talia Kula, Emily Kurtz, Jonah Lee, John Lee, Stacy Lee, Luke Leung, Ken Levenson, Alexandra Levine, Aaron Lewis, Gwendolyn Litvak, Patrick Love, Ross MacWhinney, Samuel Man, Michael Marrella, Richard Morales, Robert Muldoon, Jennifer Nagle, Robin Neri, Heather Nolen, Ozgem Ornektekin, Thomas Paino, Cathy Pasion, Francis Redhead, Dan Rieber, Jeff Rios, Luis Rios, Lindsay Robbins, Paul Rode, Paul Romano, George Roussey, Kristine Ryan, Arianna Sacks-Rosenberg, Grant Salmon, Pinky Samat, Holly Savoia, Scott Short, Howard Slatkin, Laura Slutsky, Amy Spitalnick, Chris Starkey, Carter Strickland, Wilson Suarez, Amy Sugimori, Laura Tajima, Jenna Tatum, Shanta Tucker, Dara Yaskil, and Mark Zimet

**Roger Anderson**

**Daniel Avery**

Building Owners and Managers Association

**Ryan Baxter**

Real Estate Board of New York

**Michael Bobker**

CIUS Building Performance Lab, City College of New York, CUNY

**Gene Boniberger**

Rudin Management Co., Inc.

**Louis Coletti**

Building Trades Employers' Association of New York City

**Michael Colgrove**

New York State Energy Research and Development Authority

**Rebecca Craft**

Consolidated Edison, Inc.

**David Davenport**

Urban Greenfit

**Aurelio Mark de Yoanna**

National Grid

**Christopher Diamond**

New York City Energy Efficiency Corporation

**Natasha Dwyer**

The New York City Environmental Justice Alliance

**Wilmouth Elmes PE**

Manhattanville Development Group/Columbia University

**Héctor Figueroa**

32BJ Service Employees International Union

**Wendy Fok**

Natural Resource Defense Council-Center for Market Innovation

**Scott Frank**

American Council of Engineering Companies of New York

**Jonathan Flaherty**

Tishman Speyer

**Nancy Aber Goshow**

American Institute of Architects New York

**Alexandra Hanson**

New York State Association for Affordable Housing

**Nicholas Holt**

Skidmore, Owings & Merrill, LLP

**Carl Hum**

Real Estate Board of New York

**Brook Jackson**

Partnership for New York City

**Aaron Jones**

32BJ Service Employees International Union

**Ilana Judah (FXFOWLE)**

New York Building Congress

**Josh Kellermann**

ALIGN: The Alliance for a Greater New York

**Judi Kende**

Enterprise Community Partners

**Laurie Kerr**

Urban Green Council

**Nico Kienzl**

Atelier Ten

**Vicki Kuo**

Consolidated Edison, Inc.

**Dominique Lempereur**

KW Engineering, Inc.

**Paimaan Lodhi**

Real Estate Board of New York

**Murray Levi, AIA LEED AP**

IFMA International Facility Managers Association

**Terri Ludwig**

Enterprise Community Partners

**Tony Malkin**

Empire State Realty Trust

**Charlie Marino (AKF Group)**

American Society of Heating, Refrigerating, & Air-Conditioning Engineers

**Bobbi McGowan**

Building Owners and Managers Association

**Jolie Milstein**

New York State Association for Affordable Housing

**Juan Camilo Osorio**

The New York City Environmental Justice Alliance

**Steve Pekofsky**

Glenwood Management Corp.

**Frank Ricci**

Rent Stabilization Association

**Mary Ann Rothman**

Council of New York Cooperative and Condominiums

**Dana Robbins Schneider**

JLL, Empire State Realty Trust

**Cecil Scheib**

Urban Green Council

**Laurie Schoemann**

Enterprise Community Partners

**Patrick Siconolfi**

Community Housing Improvement Program

**Zach Stern**

Local 94 Operating Engineers

**Russell Unger**

Urban Green Council

**Elizabeth Velez**

Velez Organization

**Michael Northrop**

Rockefeller Brothers Fund

**Lee Wasserman**

Rockefeller Family Fund

**Donald J. Winston PE FASHRAE**

**Jennifer Wilcox**

City Council Speaker's Office

**Steven Winter**

Steven Winter Associates, Inc

**Richard Yancey**

Building Energy Exchange

**Marc Zuluaga**

Steven Winter Associates, Inc.

80  
50

## EXECUTIVE SUMMARY

Climate change is an existential threat to New York City and humanity. As the climate changes, New York City faces the prospect of more frequent and intense extreme weather events including storms, heavy downpours, heat waves, droughts, and high winds. Chronic conditions such as rising sea levels, higher average temperatures, and increased annual precipitation will exacerbate these extreme weather events and their impacts on the city's residents.

Cities play an important role in addressing global climate change and mitigating these risks. More than half of the world's inhabitants live in urban areas, where population growth is expected to continue through the 21st century. Already, cities are responsible for more than 70 percent of global energy-related carbon dioxide emissions.<sup>1</sup> In September 2014, New York City Mayor Bill de Blasio committed to reduce New York City's greenhouse gas (GHG) emissions 80 percent below 2005 levels by 2050 (80 x 50), joining other leading cities around the world in committing to the target the United Nations set for developed countries to avert the worst impacts of climate change. Since then, the Mayor has committed to additional targets, which include the "Under 2 MOU," a commitment among subnational governments to limit GHG emissions to under two metric tons of carbon dioxide equivalent (tCO<sub>2</sub>e) per capita, and an interim target of a 40 percent GHG reduction by 2030 (40 x 30). Because the energy used in New York City's buildings accounts for nearly three-quarters of citywide GHG emissions, addressing building energy performance will be critical to meeting these commitments. This report presents the strategies that New York City will pursue to meet its GHG reduction goals within the building sector.

### Background

New York City's GHG emissions come from the electricity and fuel used to heat, power, and cool our businesses, homes, and institutions, the vehicles that are used to transport us across, into, and out of the city and the removal and disposal of our solid waste. More than 80 percent of the energy consumed for these activities is generated from the combustion of fossil fuels.<sup>2</sup>

These actions have regional impact. Approximately 40 percent of New York State's GHG emissions are generated in New York City, which is by far the state's largest urban area. Because of our extensive transit system and low private vehicle use, the energy used in buildings accounts for 73 percent of citywide GHG emissions, which is well above the national average of 40 percent attributed to buildings.<sup>3</sup>

To achieve our 80 x 50 commitment, citywide emissions from all sources will need to be reduced by 44.5 million metric tons of carbon dioxide equivalent (MtCO<sub>2</sub>e) from a 2005 baseline by 2050 – or more than the total annual GHG emissions produced by the entire state of Connecticut.<sup>4</sup>

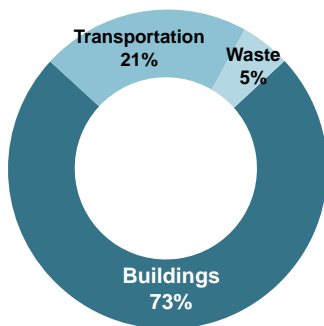

Fig. E1. Share of New York City Greenhouse Gas Emissions by Sector

Source: NYC Mayor's Office



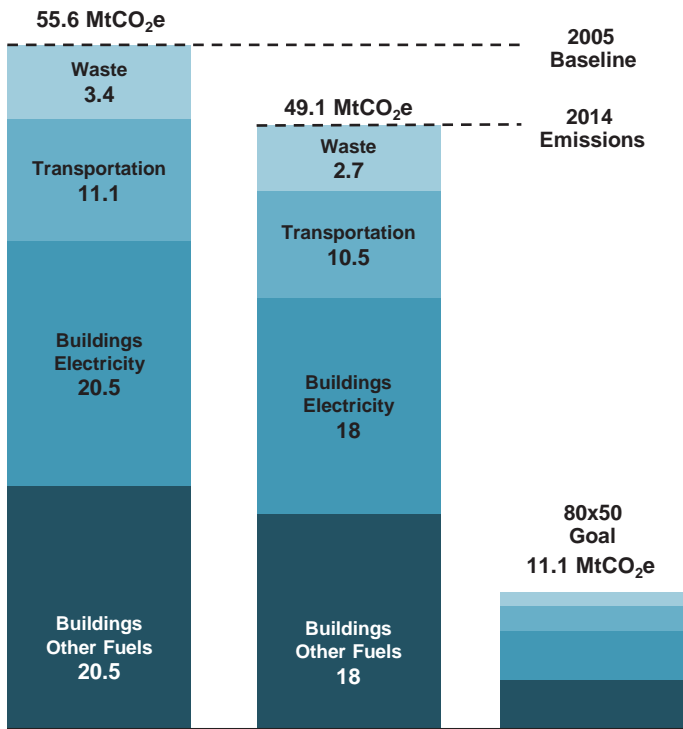

Fig. E2. 80 Percent GHG Emissions Reduction to 2050, in Million Metric Tons of Carbon Dioxide Equivalent (MtCO<sub>2</sub>e)

Source: NYC Mayor's Office

The City of New York's (City's) updated *Inventory of New York City Greenhouse Gas Emissions* found that from 2005 to 2014, New York City reduced its annual GHG emissions by 11.7 percent (6.5 MtCO<sub>2</sub>e), and reduced per capita emissions by 15.9 percent. New York City's per capita emissions are now 5.8 MtCO<sub>2</sub>e per person, which is just over one-third of the American average of 17 MtCO<sub>2</sub>e per capita.<sup>5</sup> In the same period, GHG emissions from the energy used in buildings decreased by 12.8 percent, or 5.9 MtCO<sub>2</sub>e, even as built square footage increased by roughly six percent and economic output increased by 15.8 percent. However, the rate of these reductions has slowed in recent years, primarily due to the colder winters of 2013 and 2014 that increased demand for heating fuel. While New York City's GHG reductions represent progress, the reductions achieved to date will need to be accelerated to reach 80 x 50.

### Buildings Technical Working Group Approach

Last year, Mayor Bill de Blasio convened more than 50 leaders from New York City's world-class real estate,

engineering, architecture, labor, affordable housing, academic, and advocacy sectors to serve on the Buildings Technical Working Group (TWG). The TWG was tasked with identifying the leading edge standards that should be developed for new construction and substantial renovations and the systems-specific efficiency measures for existing buildings that would be necessary to transform the city's building stock to achieve deep carbon reductions. At the time, the City expected that the best strategy to cut GHG emissions from buildings would be achieved through a combination of identifying these measures and setting GHG reduction targets, that, if not met voluntarily, would trigger actions to be mandated.

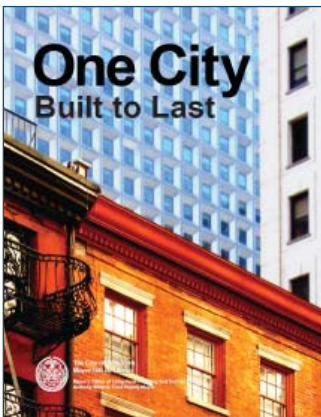

To better understand the drivers of energy use in existing buildings and the opportunities to improve energy efficiency, the City conducted the most comprehensive analysis of energy use in New York City's buildings to date, based largely on energy audit data for several thousand large buildings. The TWG study identified 21 building typologies based on primary use, age, and height in order to identify common effective strategies to reduce energy use and GHG emissions. The TWG also evaluated financial and regulatory structures that serve as opportunities and barriers to scaling up investments in energy efficiency and assessed the operations, maintenance, and training that will be needed to realize the full potential of GHG reductions. Throughout the process, the City assessed both the cost-effectiveness and the potential GHG reductions for the measures that were analyzed.

Members of the TWG and other stakeholders provided valuable input on the appropriate strategy to put buildings on the pathway to 80 x 50 through many consultations and discussions over the course of the year. One key finding is that building owners and decision-makers need certainty for their building budget and planning cycles. Capital projects are proposed, planned, and financed years in advance, and to the extent energy efficiency can be incorporated into planning and budget cycles, costs can be managed more effectively. While the industry is familiar with rising to meet changes in building codes, energy codes, and local laws, it is not as well equipped to address the risk involved with the uncertainty that mandates may be triggered suddenly and at some uncertain future time period.

Based on this feedback, the slowing pace of GHG reductions measured to date, and the urgency of progress necessary to reach 80 x 50, the City has updated its approach to deep carbon reductions. The findings and initiatives in this report outline a series of actions that the City will require moving forward along a timeline that is responsive to both the urgency of the challenge, and the needs of the industry.

The City will begin implementing the top actions immediately. These include developing a new energy code that requires holistic energy performance, requiring comprehensive retrofits to heating distribution systems, integrating capital planning for deep energy reductions into existing energy audit requirements, and incorporating the energy conservation measures (ECM) identified by the TWG into the New York City Energy Conservation Code (Energy Code) or as standalone mandates. All together, these ECMs have the potential to reduce current building-based emissions by 33 percent, yielding \$2.7 billion in energy cost savings and creating approximately 15,000 direct construction-related jobs. The City will implement the simplest and most effective actions as soon as possible while adopting others on a longer timeframe to align with planning and replacement cycles and allow time for owners, managers, the labor force, and professionals to build capacity to meet the new requirements. The City will begin by requiring the ECMs that yield the greatest citywide GHG reduction relative to their cost, starting with: improving burner controls for boilers, restricting open refrigerators in retail stores, installing thermal de-stratification fans in heated industrial spaces, sealing roof vents in elevator shafts, and upgrading exterior lighting to current Energy Code standards.

The City is also prepared to provide technical assistance and support through enhanced policies and programs such as the NYC Retrofit Accelerator and to work over the next few years to remove regulatory and other barriers to implementing efficiency projects. In addition, the City is prepared to lead by example through the implementation of high performance standards for municipal buildings, in accordance with Local Law 31 of 2016, which will require new capital projects for City-owned property to be built to consume 50 percent less energy than buildings built under current standards.

Through implementation of these strategies, we will put New York City's building stock on a path towards meeting our 80 x 50 commitment while creating jobs and developing capacity in the market.

## MAJOR FINDINGS AND NEXT STEPS

### 1. Existing buildings must scale up upgrades to improve energy efficiency and reduce GHG emissions.

More than 90 percent of the one million buildings that exist in New York City today will still exist in 2050. Heating and hot water production account for nearly three-quarters of GHG emissions from multifamily buildings. By contrast, in commercial buildings, GHG emissions are derived more evenly across the energy used for heating, cooling, plug loads, and lighting — roughly 15 to 21 percent each. Strategies for reducing emissions from existing buildings must target these different energy patterns across buildings. The City can begin by scaling up the most cost-effective energy conservation measures in its existing buildings, but eventually will need to achieve greater reductions. While it is technically possible to reduce energy use from typical buildings in New York City by 40 to 60 percent with existing technologies and strategies, new solutions will need to be developed to help bring these deep carbon reductions to scale.

The City will take the following steps:

- **Require owners of large and mid-sized buildings to repair and improve heating distribution systems, including specific requirements for steam systems, within the next 10 years.**
- **Require owners of mid-sized buildings to upgrade lighting in non-residential areas to meet current Energy Code standards by 2025.**
- **Require owners of large and mid-sized buildings to assess deep energy retrofit strategies as part of the Local Law 87 energy audit through a simple template developed by the City.**
- **Require implementation of efficiency measures in existing buildings by incorporating low- and medium-difficulty measures into the codes or as standalone mandates. The City will begin with requiring digital burner controls for boilers, restrictions on open refrigerators in retail stores, thermal de-stratification fans in heated industrial spaces, sealed roof vents in elevator shafts, and upgrades of exterior lighting to current Energy Code standards.**

The City will support these efforts through the following actions:

- Establish a Codes Advisory Committee to produce code language for ECMs identified by the TWG to be adopted by local law.
- Incorporate efficiency measures into the NYC Retrofit Accelerator to provide guidance to building owners to implement measures on a voluntary basis, including specific assistance to help them access financing and incentives to cover the costs.

- Pursue amendments to the State Multiple Dwelling Law to remove requirements in conflict with energy efficiency standards.
- Launch a “High Performance Retrofit Track” of the Retrofit Accelerator to assist in implementing higher-difficulty, deeper-impact measures and identify the financial, educational, and technical resources necessary to bring these types of upgrades to scale.
- Expand the NYC Solar Partnership and the Solarize NYC program to scale up on-site renewable energy investments in private sector buildings.
- Work with participants in the NYC Carbon Challenge to test innovative retrofit strategies and renewable energy options across multiple sectors.

## **2. New buildings must be designed and constructed for whole building energy performance.**

While new construction will account for a significantly smaller proportion of New York City’s building stock in 2050, new developments in New York City must be part of the solution to begin achieving 2050-ready buildings in the near-term. There is growing consensus that the current approach of incremental improvements to the Energy Code’s prescriptive requirements for specific building systems will not be sufficient to achieve the necessary carbon reductions in the near-term. Instead, a new energy code must consider the entire building as an integrated system by requiring new buildings and substantial renovations to be designed to a whole building energy performance standard. Implementing these standards as soon as possible will prevent the need for future retrofits in these buildings and contribute to citywide GHG emission reductions, energy cost savings, and quality of life improvements.

The City will take the following steps:

- **Require new buildings and major alterations be designed to an energy performance metric beginning in 2019 and set an energy performance design target beginning in 2022.**
- **Lead by example through required low-energy performance design targets for City-owned new buildings and substantial renovations.**

The City will support these efforts through the following actions:

- Establish a Codes Advisory Committee to produce code language for a whole building energy performance standard, to be adopted by local law.
- Develop proof of concept and details for very low-energy buildings across multiple typologies and deliver training, education, and market support through a program that awards the design and construction or renovation of exemplary buildings.
- Develop standards and practices for the City’s own buildings to serve as models and support the development of capacity in the New York City market.

### **3. All buildings, including small, mid-sized, and historic buildings must be included in the path to 80 x 50.**

To date, New York City’s building efficiency policies have focused on large buildings over 50,000 square feet in floor area, which account for two percent of the city’s building stock and 45 percent of citywide energy use. Small and mid-sized buildings less than 50,000 square feet make up 98 percent of the city’s building stock and account roughly 50 percent of built square footage and building-based energy use. In addition, historic buildings make up 11 percent of the city’s built square footage but are not subject to the Energy Code — missing a sizeable opportunity for GHG reductions. To reach 80 x 50, the City must expand its policies to include all buildings in the path to deep carbon reductions.

The City will take the following steps:

- **Require annual energy use benchmarking in mid-sized buildings.**
- **Require retro-commissioning every 10 years in mid-sized buildings.**
- **Require utility benchmarking in all buildings receiving City financing from the NYC Department of Housing Preservation and Development or NYC Housing Development Corporation.**
- **Tailor energy standards for appropriate application to historic buildings, which are currently exempt from Energy Code compliance.**
- **Pursue changes to State laws to require energy information disclosures during real estate transactions.**

The City will support these efforts through the following actions:

- Improve compliance with and enforcement of Local Law 87 energy auditing and retro-commissioning.
- Improve compliance with and enforcement of the Energy Code.
- Work with the Landmarks Preservation Commission to update its rules and procedures to streamline the process of energy efficiency upgrades in landmarked buildings and historic districts.

### **4. Tenant energy use and other “unregulated” loads in tenant spaces must be addressed to comprehensively reduce building-based energy use.**

Within commercial spaces, tenant leased spaces typically account for 40 to 60 percent or more of a building’s overall energy use, and present a significant opportunity to reduce GHG emissions. However, there are major barriers to coordination on energy efficiency projects between tenants and landlords. These include split incentives, in which the party responsible for making the energy improvement does not necessarily reap the energy savings, as well as lack of coordination between base building and

supplemental heating and cooling systems and oversizing of equipment in new tenant space fit-outs. Additionally, energy costs are often included in the rent, which can result in tenants not having access to information on their usage.

The City will take the following step:

- **Require sub-metering in non-residential tenant spaces larger than 5,000 square feet in area in all large and mid-sized buildings.**

The City will support these efforts through the following actions:

- Develop a comparative metric for commercial tenant energy use and create a voluntary benchmarking program for commercial tenants.
- Launch a Commercial Landlord/Tenant Carbon Challenge to identify best practices in efficient operations that can be replicated in commercial buildings across the city.
- Work with the Public Service Commission and utilities to provide resources for customers to understand and decrease their energy use.

## **5. New York City's workforce must be ready to deliver high performance buildings.**

As new building energy systems are put in place, building staff will need to know how best to operate, monitor, and maintain the systems. New training opportunities must reach a wider audience of building operators, building staff, contractors, and industry professionals. Training can also provide career advancement opportunities available to those skilled in energy efficiency best practices.

The City will support this effort through the following actions:

- Connect building owners and decision-makers to trainings that are best suited for their buildings through the NYC Retrofit Accelerator.
- Develop a resource guide for building owners and managers that catalogs operations and maintenance requirements and includes best practice guides and case studies.
- Develop and provide practical and tailored energy efficiency trainings to building staff to advance their professional capacity and improve building operations.

## **6. Energy efficiency improvements will require investment on the part of building owners and decision-makers, and the City can help bring down these costs.**

New York City building owners face a range of competing needs that limit the amount of capital that can be spent on energy efficiency upgrades, particularly in affordable

housing. In addition, implementing deep energy retrofits and leading edge new construction techniques today can be costly because the market for these services and products is not yet mature. It will be essential to help bring down these costs and work with the private sector to improve access to financing and incentives for energy improvements.

The City will take the following actions:

- Connect building owners and decision-makers to financial resources best suited for their buildings through the NYC Retrofit Accelerator.
- Identify opportunities and work to lower hard and soft costs of retrofitting existing buildings and constructing high performance buildings through the NYC Retrofit Accelerator and programs that support exemplary new buildings.
- Work with the City's affordable housing agencies and other organizations to identify new financing and incentives and create new options to help building owners and developers cover the costs of efficiency measures.
- Work with the local utilities and New York State to identify new financing and incentives to help building owners and developers cover the costs of efficiency measures.
- Continue working to build demand for energy efficiency and clean energy services through programs to foster a thriving market.

## **7. To achieve the City's 80 x 50 commitment, GHG reduction strategies from buildings must be integrated into a comprehensive 80 x 50 plan.**

Roughly half of the energy used in buildings comes from New York City's electric grid. Currently, less than two percent of New York City's grid is powered by renewable sources. Even as the City works to bring down energy consumption, we must also increase the amount of clean and renewable generation on-site and on the grid. In addition, GHG reductions from New York City's transportation networks and management of our solid waste must also be included in an integrated strategy to achieve 80 x 50.

The City will take the following action:

- Work with stakeholders to develop an integrated 80 x 50 plan to reduce GHG emissions from the city's energy supply, buildings, transportation, and solid waste.

## SUMMARY OF RESEARCH AND ANALYSIS

Over the past year, the City conducted the most comprehensive analysis of building energy use in New York City to date. The findings below form the foundation upon which the City will begin implementing its next steps.

Multifamily and commercial buildings make up nearly two-thirds of the total square footage of buildings in New York City. Small buildings and homes account for the largest absolute number of buildings — numbering more than 800,000, but make up a significantly smaller share of citywide GHG emissions.

Fig. E3. **Building Uses by Building Count, Floor Area, and GHG Emissions**

Source: NYC Mayor's Office

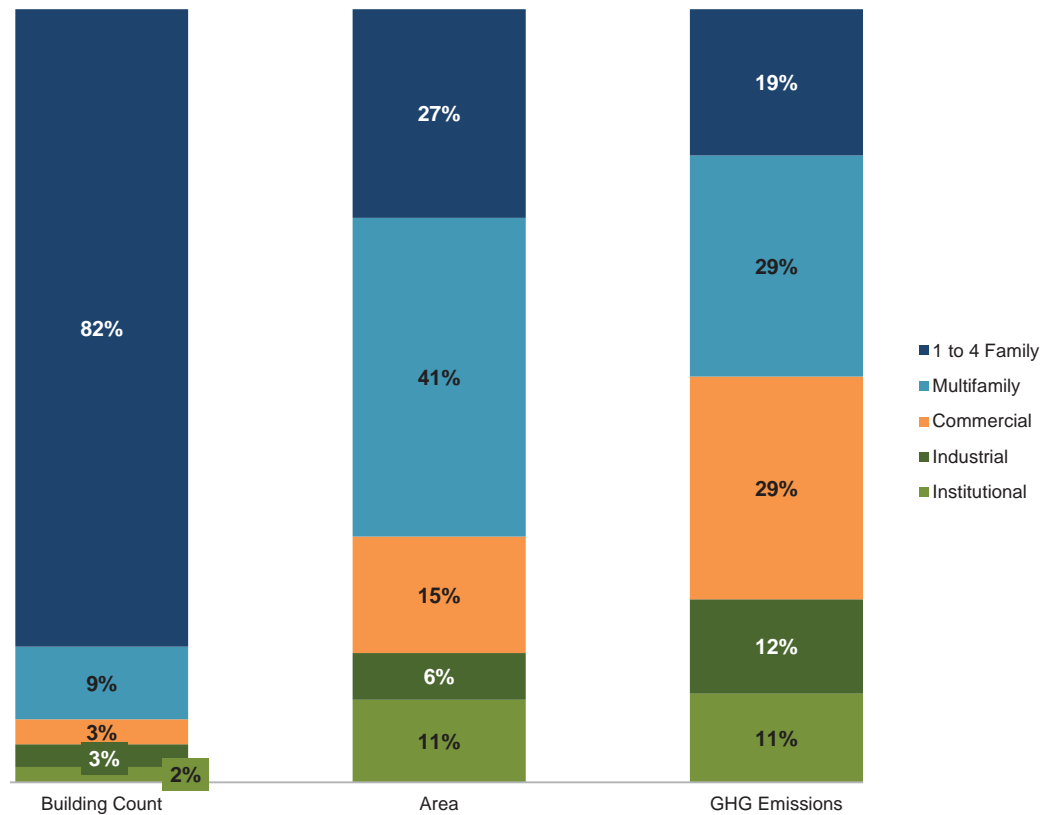

The whole building energy use intensity (EUI, measured as thousand British thermal units (kBtu) per square foot) varies significantly across different building uses and typologies. There is also a wide variation in whole building EUIs even within building typologies. Whole building EUI is a useful metric for understanding trends in energy use across New York City buildings, but is an imperfect metric to understand the drivers of energy use within buildings.

For large buildings that measure over 50,000 square feet in size (those required to provide energy audit data under Local Law 87 of 2009 (LL87)), space heating accounts



for the largest share of energy use and GHG emissions. Based on this data, space heating and domestic hot water (DHW) production account for nearly three-quarters of GHG emissions from multifamily buildings, while in commercial buildings, the energy used for cooling, plug loads, and lighting account for more proportionately equivalent sources of GHG emissions. Some, but not all, tenant energy use is captured in the energy audit data, and therefore is likely to be significantly underrepresented in the results.

Fig. E4. **Building GHG Emissions by End Use\***

\* The energy use breakdown of tenant-owned equipment is not collected in the LL87 submission forms which may impact the overall building energy use breakdown data. Original LL87 data has not been adjusted to accommodate for this limitation.

Source: NYC Mayor's Office

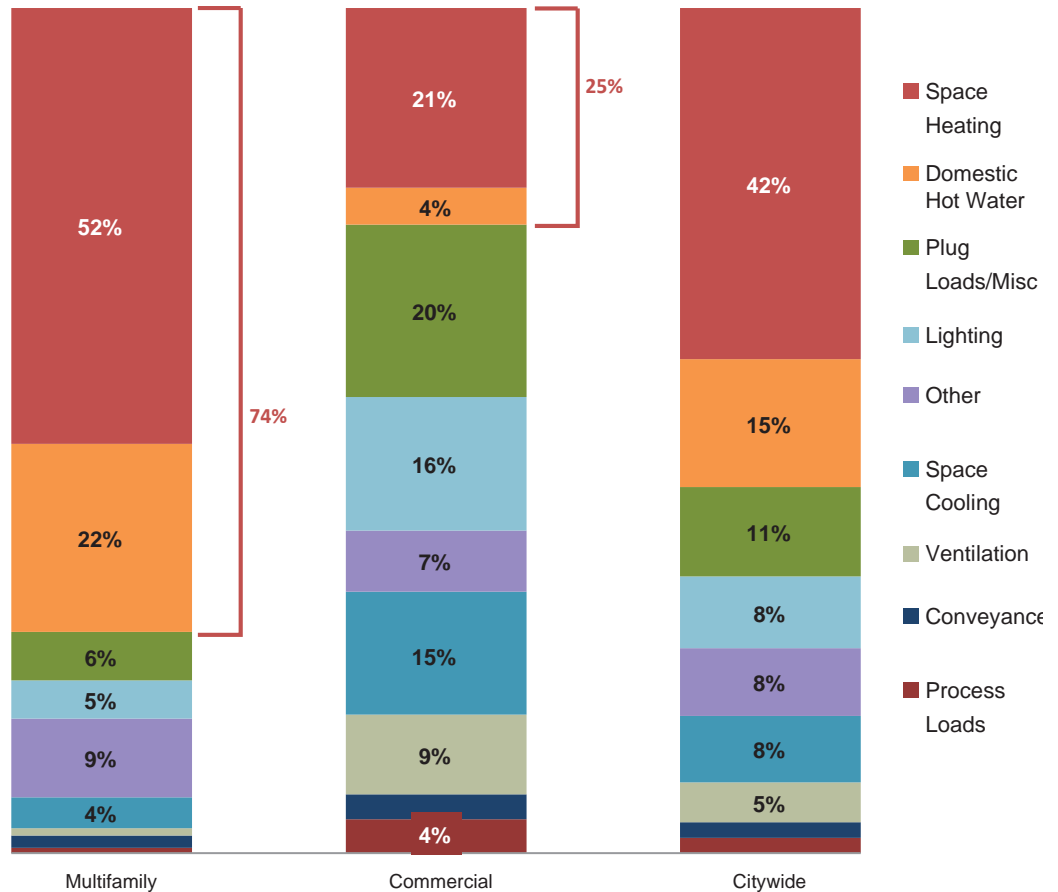

More than 70 percent of all New York City buildings are using some form of steam distribution to heat the building. In multifamily buildings, one-pipe steam systems are significantly more energy intensive on average than those with two-pipe systems, which in turn use more energy than multifamily buildings served by hydronic (hot water) distribution systems. With respect to cooling, central systems in New York City are relatively uncommon. Within multifamily buildings, at least 90 percent of buildings use non-central systems such as window and through-wall air conditioners. These smaller air conditioning units pose unique challenges because air leaks through the exterior walls around the edges of the units, reducing the efficiencies of cooling in the summer and heating in the winter.

The energy audits reported to the City for large buildings recommend measures that would result in a 14 percent average reduction in GHG emissions from the buildings subject to the law. To help determine where the City and building owners could prioritize additional efforts for deeper reductions, the City analyzed nearly 100 “low- and medium-difficulty” ECMs for their technical GHG reduction potential. All together, these ECMs have the potential to reduce current building-based emissions by 33 percent, yielding \$2.7 billion in energy cost savings and creating approximately 15,000 direct construction-related jobs.

Fig. E5. **GHG Reduction Potential of Identified ECMs (MtCO<sub>2</sub>e)**

Source: NYC Mayor’s Office

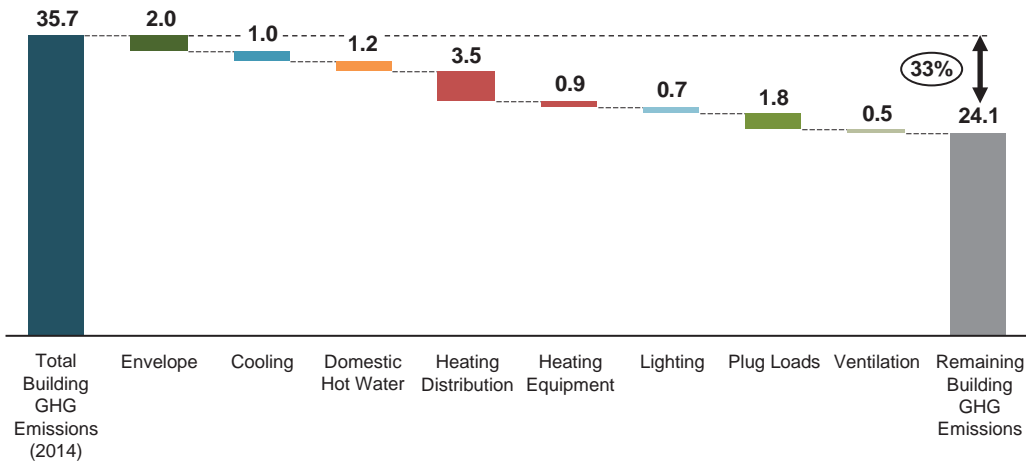

Upgrading steam systems across the city’s building stock is one of the largest single system-specific opportunities for GHG reductions in New York City. If all relevant buildings implemented comprehensive steam system upgrades, this would have the potential to reduce building-based GHG emissions by five percent.

The “low- and medium-difficulty” ECM opportunities are just a first step to reaching 80 x 50. To understand the dramatic transformation that will ultimately be necessary across New York City’s building stock, the City analyzed multiple “retrofit paths” for eight key building typologies that would achieve energy reductions of 40 to 60 percent or more using currently available technologies and strategies. The results of the analysis indicate that achieving these deep reductions in energy use is technically possible through integrated improvements to heating, cooling, and building envelopes.

### **Making New Buildings Leaders in Energy Efficiency**

New development in New York City is part of the solution to achieve 2050-ready buildings in the near-term while also contributing to long-term GHG reductions. By 2050, New York City’s population is anticipated to reach 9.1 million residents. This growth is projected to increase total building area by 8.6 percent by 2050, with a corresponding 8.9 percent increase in citywide GHG emissions if all new buildings and major alterations are constructed to current codes and standards.

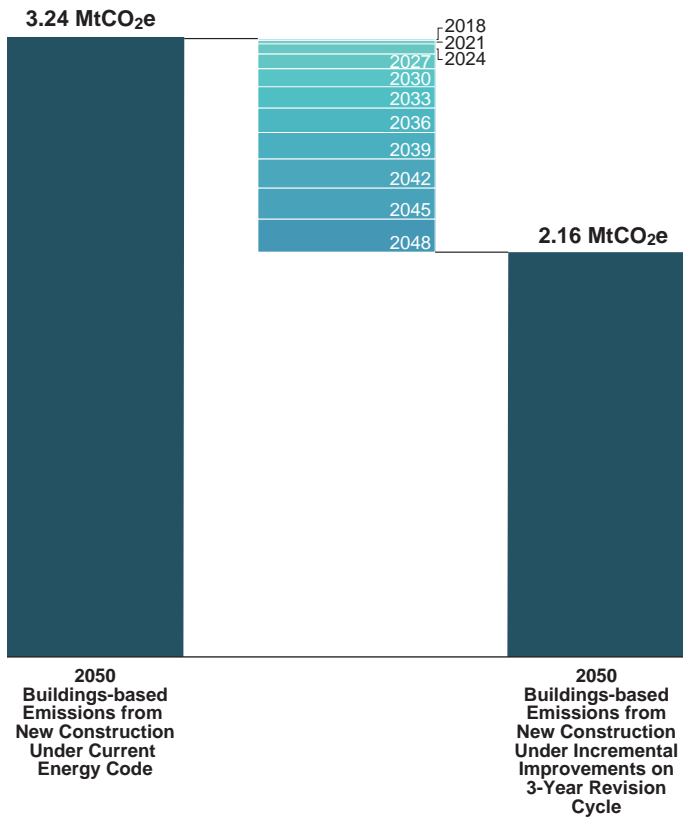

Fig. E6. Projected GHG Abated from New Construction Under Scenario of Replicating Historical Energy Code Advancements

Source: NYC Mayor's Office

The current approach to revising the Energy Code every three years has led to significant energy and GHG reductions to date. The de Blasio administration is working with City Council to pass a major update in 2016, another critical step to improving energy efficiency in the city's new buildings. However, there is growing consensus that the current approach of incremental improvements to systems is reaching its limitations in terms of possible future reductions. This approach places increasingly stringent requirements on disparate components and systems without considering the holistic building energy performance. Analysis completed by the City shows that this approach will not achieve the scale of reductions needed to prepare buildings for 80 x 50.

Future revisions to codes must encourage developers to maximize the efficiencies of all systems and address how building systems interact to avoid missed opportunities for reducing energy use. Requiring new building and substantial renovations to be designed to meet an energy performance target will lead to greater energy savings and GHG reductions than the current approach. This significant reduction in energy usage will also correlate with significantly lower utility costs, which have greater

impacts on affordable housing. However, because this represents a major shift in how buildings are typically designed and constructed today, professional services and construction labor will need time to adapt to these new requirements.

### Realizing the Full Potential of GHG Reductions in Buildings

Regulatory barriers, financial structures, and the skills of the workforce are also important factors to realizing the City's full potential to reduce GHG emissions from buildings.

Meeting our 80 x 50 commitment will require all buildings to be part of the solution, including small, mid-sized, and historic buildings. Small and mid-sized buildings that are less than 50,000 square feet in floor area account for 98 percent of New York City's building stock, but many residents of these buildings currently lack access to information about their building's energy use. There are roughly 15,000 buildings (10,000 properties) that are between 25,000 to 50,000 square feet in floor area, which include 275,000 residential units and more than 365 million square feet of space, which should be brought under the City's energy use benchmarking and retro-commissioning laws.

New York City has more than 33,000 landmarked properties, located in 114 historic districts and 20 historic district extensions across all five boroughs. All together, these buildings represent 11 percent of the city’s built square footage. Historic buildings on the State and National Historic Registers are not subject to the Energy Code because of a New York State exemption.

Tenant energy use must also be addressed, particularly in commercial buildings where the energy used in commercial leased spaces can account for 40 to 60 percent of energy use or more of whole building energy use.

Construction trades and professionals will need to be trained to meet the broad economic opportunities that will be generated by the demand for low-energy buildings. In addition, the costs of energy efficiency retrofits and leading edge standards for new construction can be high in today’s market, but the City can help bring down these costs.

### The importance of comprehensive planning for 80 by 50

Achieving 80 x 50 will require comprehensive planning across all of New York City’s sources of GHG emissions to evaluate the most effective combination of measures in addition to the energy used in buildings. This includes sources of emissions from the city’s energy supply, solid waste generation, and transportation sector.

The City assessed a “business as usual” (BAU) scenario in which no changes are made to current policies and the fuel mix used to generate electricity remains the same. Under this scenario, GHG emissions from buildings are anticipated to decrease by 22 percent from 2005 levels by 2050 as a result of current policies and programs. The specific steps outlined in the TWG report are projected to reduce GHG emissions

Fig. E7. **Business as Usual GHG Emissions Projection from Buildings, with Current Electric Grid and Existing Policies**

Source: NYC Mayor’s Office

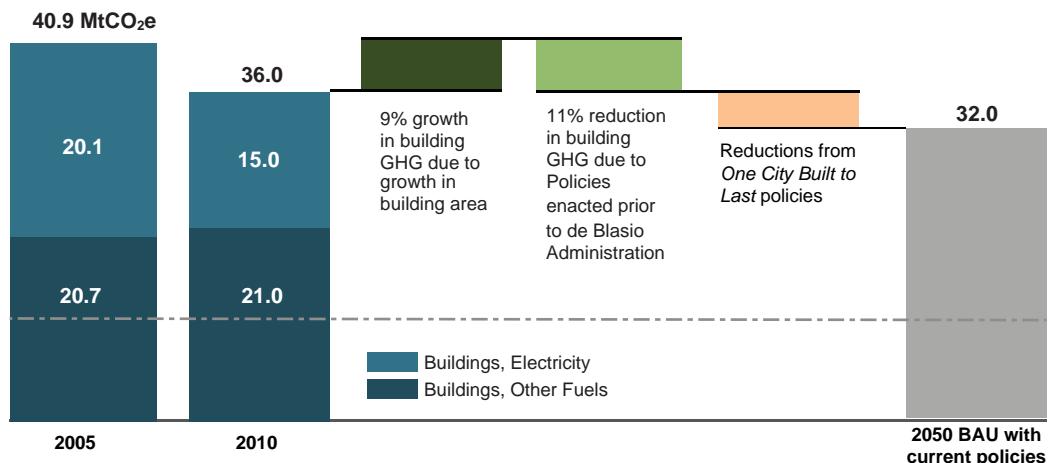

from buildings by 2.7 MtCO<sub>2</sub>e and save building owners approximately \$900 million annually in energy costs. Combined with the policies and programs announced in *One City: Built to Last*, the City's initiatives are expected to reduce GHG emissions from buildings by a total of 6 MtCO<sub>2</sub>e by 2025, with additional reductions possible as the TWG-identified energy conservation measures are integrated into the City's codes.

Changes to the waste, power, and transportation sectors by 2050 will also affect the City's opportunities for reducing energy use in buildings. Potential changes to the city's energy supply will have a particularly significant impact on building-based emissions. Electrifying heating and hot water systems in buildings, which are currently powered primarily by fossil fuels, could take advantage of a cleaner grid to yield greater citywide GHG reductions. However, without corresponding improvements to energy efficiency, new electrical load demand could compromise the reliability of the electric grid. Under any approach to deep carbon reductions, the City must reduce the amount of energy used in our buildings through energy efficiency.

The City will develop integrated strategies for reducing GHG emissions from New York City's buildings, energy supply, transportation, and solid waste as part of a forthcoming integrated 80 x 50 action plan.



# 1

## Background & Building Sector Analysis

## INTRODUCTION

Climate change is an existential threat to New York City and humanity. In 2015, the world saw tremendous progress for climate action, capped off by the United Nations Climate Change Conference in Paris (COP21). National leaders from 195 countries came together and committed to limit global temperature rise to under two degrees Celsius—the target the United Nations set to avert the worst impacts of climate change.

Cities can and must play a critical role in the global effort to address climate change. More than half of the world’s inhabitants live in urban areas, where population growth is expected to continue through the 21st century. Today, cities are responsible for more than 70 percent of global energy-related carbon dioxide emissions,<sup>1</sup> and this share is expected to grow. At the same time, cities offer unique opportunities to significantly reduce GHG emissions while improving quality of life for residents through urban density, mass transit, and sustainable, low-energy building design. In fact, per capita emissions in US cities are already lower than the national average, and per capita emissions in New York City are just over one-third of the national average.<sup>6</sup>

Cities are also taking the lead in the global effort to reduce GHG emissions. In 2014, New York City joined leading cities around the world in committing to cut citywide GHG emissions by 80 percent by 2050 (80 x 50) — defined by the United Nations as the reduction necessary in developed countries to limit global temperature rise to under two degrees Celsius.

Fig. 1. **80 Percent Reduction in Greenhouse Gas Emissions by 2050 in Million Metric Tons Carbon Dioxide Equivalent (MtCO<sub>2</sub>e)**

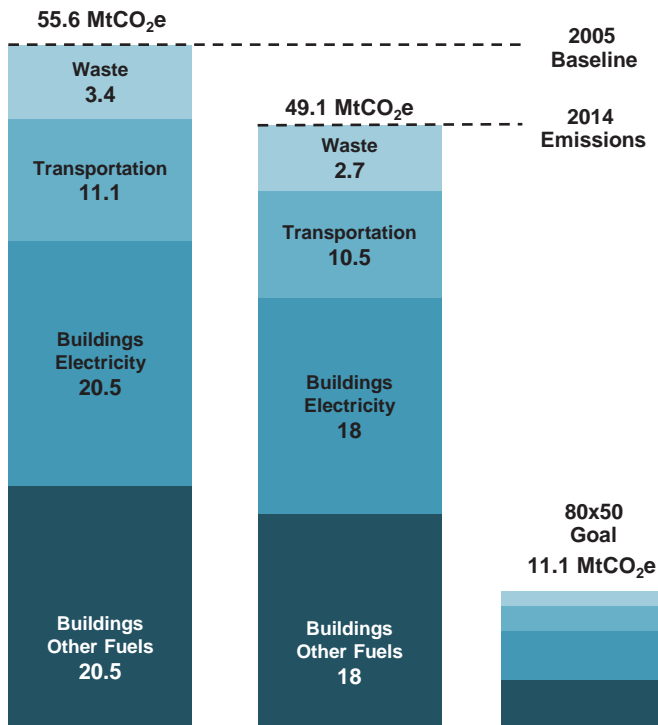

Source: 2015 Inventory of New York City Greenhouse Gas Emissions

### Achieving 80 x 50 will require a dramatic transformation in the way New Yorkers use energy, and the energy used in buildings accounts for the greatest share of citywide emissions.

Reducing GHG emissions by 80 percent in New York City is an enormous challenge and must be accomplished without compromising economic and population growth. By 2050 New York City will have to reduce its annual GHG emissions 44.5 million metric tons of carbon dioxide equivalent (MtCO<sub>2</sub>e) from its 2005 baseline of 55.6 MtCO<sub>2</sub>e — or by more than the current GHG emissions from the entire state of Connecticut.<sup>4</sup> This will require decreasing total energy use in New York City and converting a significant proportion of fossil fuel-based energy to cleaner sources, including renewable energy sources. Currently, more than 80 percent of the energy used in New York City comes from the combustion of fossil fuels to: generate electricity, produce heat for buildings, and power on-road vehicles.



Since 2007, the City of New York (“City”) has committed to measure citywide GHG emissions annually and report progress in reducing energy use and emissions. According to the *2015 Inventory of New York City Greenhouse Gas Emissions*, New York City’s emissions decreased by 11.7 percent between 2005 and 2014. Because New York City’s population grew by almost 400,000 residents during this period, this translates to a 15.9 percent decrease in GHG emissions per capita. In the same period, GHG emissions from the energy used in buildings decreased by 12.8 percent, even as the population grew and built square footage increased by roughly six percent.

These GHG reductions are attributed to a number of factors, including improvements to the city’s electric grid due to the transition away from oil-fired power plants (largely to natural gas-fired plants), the construction of new energy-efficient power facilities, and improved utility operations. Reductions are also attributed to conversions away from heavy heating oil in large buildings, reductions in fugitive emissions from landfills and wastewater treatment plants (WWTP), improved efficiency of City government operations, and reduced energy consumption in buildings.

New York City has made progress in reducing GHG emissions, but to achieve 80 x 50, the pace and scope of these reductions must increase. To determine the policies and programs that will be required to achieve these deep carbon reductions, New York City

**Fig. 2. GHG Emissions in New York City 2005 - 2014 (MtCO<sub>2</sub>e)**

Source: *2015 Inventory of New York City Greenhouse Gas Emissions*

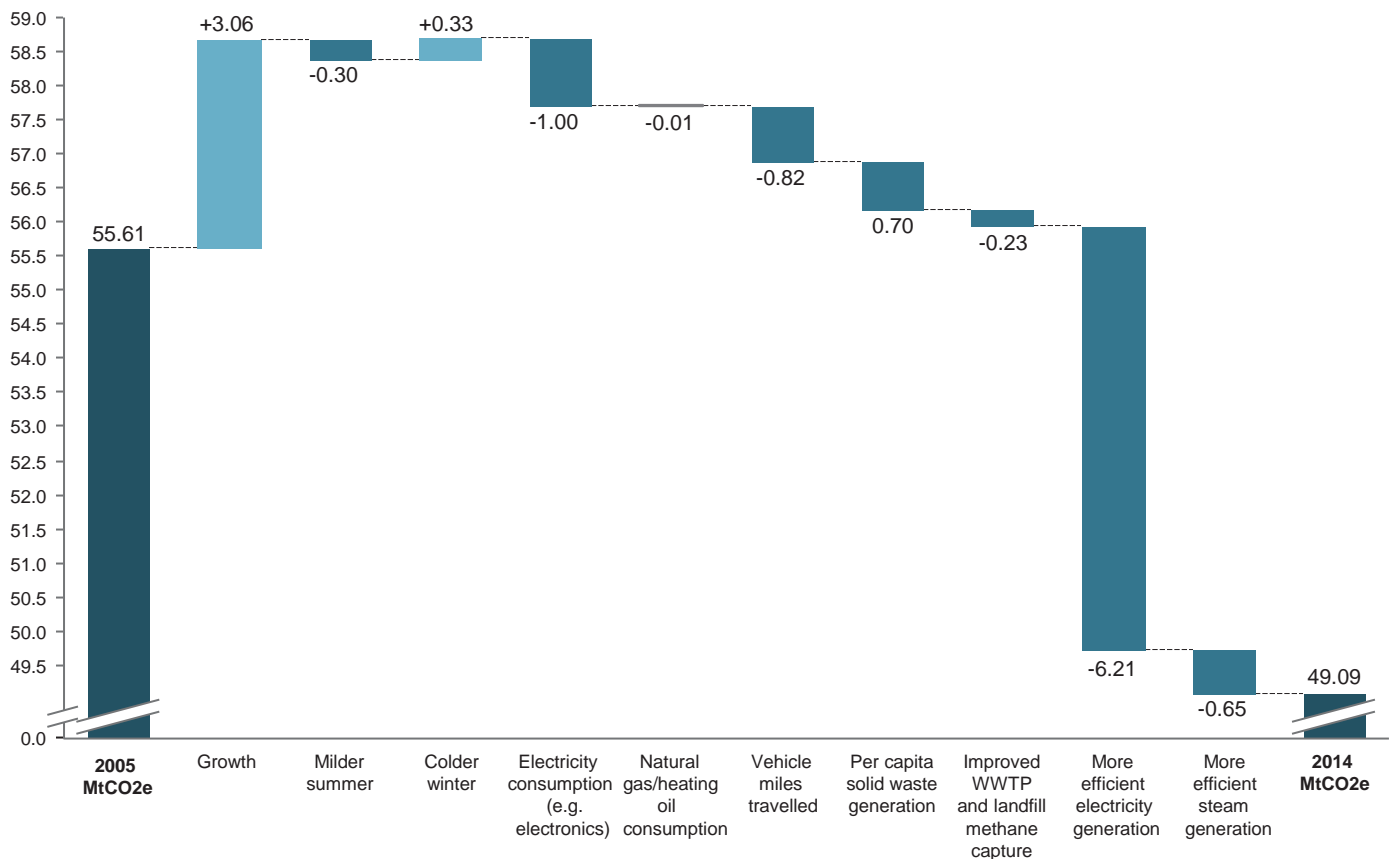

32 BJ: Service Employees International Union	Community Housing Improvement Program	New York State Energy Research and Development Authority
Alliance for a Greater New York	Consolidated Edison	Partnership for New York City
American Council of Engineering Companies in New York	Council of New York Cooperatives and Condominiums	Real Estate Board of New York*
American Institute of Architects	Empire State Building	Rent Stabilization Association
American Society of Heating, Refrigerating, and Air-Conditioning Engineers - New York	International Facility Managers Association	Rockefeller Brothers Fund
Atelier Ten	International Union of Operating Engineers: Local 94	Skidmore, Owings & Merrill
Building Congress of New York	National Grid	Steven Winter Associates
Building Owners and Managers Association	Natural Resources Defense Council – Center for Market Innovation	Urban Greenfit
Building Trades Employers' Association	New York City Energy Efficiency Corporation	Urban Green Council*
City Council Speaker's Office	New York City Environmental Justice Alliance	Velez Organization
Columbia Manhattanville University	New York State Association for Affordable Housing	
NYC Department of Buildings	NYC Department of Design and Construction	NYC School Construction Authority
NYC Department of City Planning	NYC Department of Housing Preservation and Development	
NYC Department of Citywide Administrative Services	New York City Housing Authority	

\* Strategic Advisor

Fig. 3. **Technical Working Group Member Organizations**

Mayor Bill de Blasio has convened a broad range of stakeholders to help the City meet its 80 x 50 commitment.

### **The Role of Buildings**

New York City’s dense, transit oriented development shapes the city’s iconic skyline and its GHG emissions profile. The energy used to heat, power, and cool New York City’s one million buildings accounts for nearly 73 percent of citywide GHG emissions.

This sizeable contribution of GHG emissions from buildings is typical of densely populated global cities with mass transit systems. In areas that lack urban density and rely on fossil fuel-based vehicle travel, the share of transportation-based emissions is typically higher than in urban areas, and this share of emissions also tends to lead to higher per capita emissions overall.

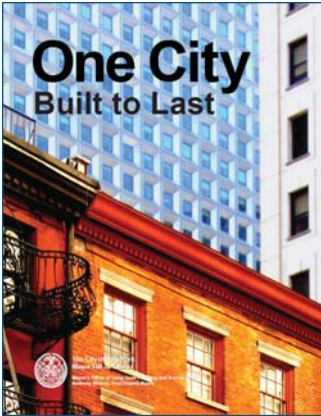

To date, the City has prioritized efforts to reduce GHG emissions from buildings through a range of approaches. New York City’s building codes have improved the sustainability of our buildings. A mandated phase-out of heavy heating oil use in large buildings has lowered GHG emissions and improved air quality across the city. The City’s landmark Greener, Greater Buildings Plan (GGBP) requires building owners to make common sense upgrades to building systems and provides transparent building energy use information at an unprecedented scale. The NYC Carbon Challenge has also promoted progress with private sector leaders, developing proof of concept and best practice case studies. Meanwhile, the City has led by example by implementing energy efficiency retrofits across the large portfolio of City-owned and operated buildings. These efforts have resulted in reduced GHG emissions from buildings, improved energy efficiency, and lower energy costs for residents.



## RETROFIT ACCELERATOR

In the fall of 2015, the City launched the NYC Retrofit Accelerator, a one-stop resource provided free of charge by the City to help owners and operators of privately owned buildings complete energy and water upgrades. The NYC Retrofit Accelerator offers a team of efficiency advisors who provide independent guidance and customized advisory services for building decision-makers to help navigate the energy and water retrofit process. This service includes assistance: complying with local building energy laws, interpreting energy audit recommendations, selecting energy and water efficiency projects, selecting contractors to complete these projects, and identifying financing and incentives to help cover the costs. The NYC Retrofit Accelerator also continues the City’s mission to assist all buildings still burning heavy heating oil to convert to cleaner heating fuels.



## CLEAN HEAT

In April 2011, the NYC Department of Environmental Protection (DEP) issued regulations to eliminate the use of No.6 heating oil by June 2015 and phase out No.4 heating oil by 2030. These regulations eliminate the use of heavily polluting heating oil in New York City’s buildings, which the City found had significant potential to both improve local air quality and reduce GHG emissions. The NYC Clean Heat program was launched in 2012 to assist building owners comply with the law and convert to the cleanest available heating fuels and alternative energy options through project guidance and improved access to financing and incentives. To date, DEP’s heating oil regulations have resulted in nearly 6,000 heavy heating oil conversions, with 100 percent compliance with the No.6 phase out. The vast majority of these properties received assistance from the NYC Clean Heat program. This progress has reduced fine particulate matter (PM 2.5) emissions from buildings by more than 65 percent and helped achieve a 23 percent reduction in PM 2.5 emissions citywide. New Yorker residents and visitors now enjoy the cleanest air in over 50 years.

## GREENER, GREATER BUILDINGS PLAN

In 2009, the City enacted the Greener, Greater Buildings Plan (GGPB), a comprehensive set of building efficiency laws that primarily impact the largest buildings in New York City, including buildings larger than 50,000 square feet in area, or multiple buildings on a lot that together make up more than 100,000 square feet. These buildings make up just two percent of citywide gross floor area, but account for nearly half of the built square footage and 45 percent of total citywide energy use. The GGBP laws include:

**LOCAL LAW 84 OF 2009 (LL84):** Benchmarking: annual requirement to benchmark energy and water consumption and submit data to the City, starting in 2011

**LOCAL LAW 85 OF 2009 (LL85):** New York City Energy Conservation Code: New York City's local energy code which is more stringent than the New York State Energy Code and is updated every three years, applicable to buildings of all sizes, for new construction and alterations

**LOCAL LAW 87 OF 2009 (LL87):** Energy Audits & Retro-commissioning: conduct an energy audit and perform retro-commissioning once every 10 years, starting in 2013

**LOCAL LAW 88 OF 2009 (LL88):** Lighting & Sub-metering: Upgrade lighting in non-residential spaces to meet code and provide large commercial tenants with sub-meters by 2025

## GREEN CODES TASK FORCE



The Green Codes Task Force (GCTF) was convened in 2008 by the City and the Urban Green Council to recommend

changes within the City's codes and regulations to make buildings more energy efficient and sustainable. The GCTF brought together more than 200 design, real estate, engineering, and sustainability experts for extensive stakeholder sessions to develop code proposals with supporting cost-benefit analyses. In 2010, GCTF released a report with 111 recommendations ready for implementation; by 2015, more than 50 recommendations were enacted into laws and regulations.



## NYC CARBON CHALLENGE

Launched in 2007, the NYC Carbon Challenge is a voluntary leadership program for 17 leading universities, 11 hospital organizations, 11 commercial offices, 17 residential property management firms, and 17 hotels in New York City, who have committed to reduce their GHG emissions by 30 percent or more over 10 years. The Carbon Challenge works by inspiring a high-level commitment within organizations, creating a platform for the exchange of information and ideas, and providing simple tools to track progress. Current participants represent more than 275 million square feet of space and seven percent of citywide building-based emissions. Since the program started in 2007, eight participants have met the 30 percent goal, and all together, participants have collectively reduced their carbon emissions by 160,000 tCO<sub>2</sub>e and saved \$175 million in annual costs.

In 2014, at the same time that New York City Mayor Bill de Blasio committed to 80 x 50, the City released *One City: Built to Last (Built to Last)*, a 10-year plan to reduce building-based emissions 30 percent by 2025. This plan aims to improve the energy efficiency of New York City's one million buildings by catalyzing the private market for energy efficiency and clean energy services through a voluntary Retrofit Accelerator program and additional supporting policies. The City also pledged to continue leading by example by committing to retrofit every City-owned building with significant energy use by 2025 and enhanced initiatives to achieve a 35 percent reduction in GHG emissions from City-owned buildings by 2025.

All together, *Built to Last* includes 22 initiatives that the City is now implementing. In addition to the NYC Retrofit Accelerator, these include the Green Housing Preservation Program, an Energy Code enforcement program for alterations, the initiation of efficiency projects in 810 City-owned buildings, and the installation of 4.9 megawatts of solar photovoltaic (PV) panels on City-owned properties.

To identify the steps that will ultimately be necessary to achieve the City's 80 x 50 commitment, *Built to Last* also included a pledge to convene a group of experts to advise the City on how to ensure buildings are on a path to achieving deep carbon reductions.

In 2015, Mayor de Blasio convened this group, consisting of more than 50 leaders from New York City's world-class real estate, engineering, architecture, labor, affordable housing, academic, and advocacy sectors, to help develop the next set of recommendations. The resulting Buildings Technical Working Group (TWG) was tasked with identifying the leading edge standards that should be developed for new construction and alterations and the systems-specific opportunities for existing buildings to transform the City's building stock to achieve deep carbon reductions. The TWG also evaluated financial and regulatory structures and assessed the operations, maintenance, and training that will be needed. Through the process, the City also analyzed the measures to assess cost effectiveness as well as potential for GHG reductions.

To better understand energy use in New York City buildings and the opportunities to reduce GHG emissions, the City analyzed a vast swath of City data sources. This analysis included building and energy data that is newly available from the benchmarking, energy audits, and retro-commissioning ordinances enacted through the GGBP — without which the technical analysis presented in this report would not have been possible.

# ANALYSIS OF NEW YORK CITY BUILDINGS TODAY AND IN 2050

## Characteristics of Buildings Today

The nearly one million buildings in New York City were constructed through a rich history of evolving building technologies spanning many eras of economic expansion and contraction. New York City's buildings account for more than five billion square feet, used for a varied spectrum of purposes in residential, commercial, and industrial activities. Together in 2014, the energy used for the activities in these buildings emitted 35.9 MtCO<sub>2</sub>e.

Fig. 4. Age of NYC Buildings by Use and Size

Source: NYC Mayor's Office

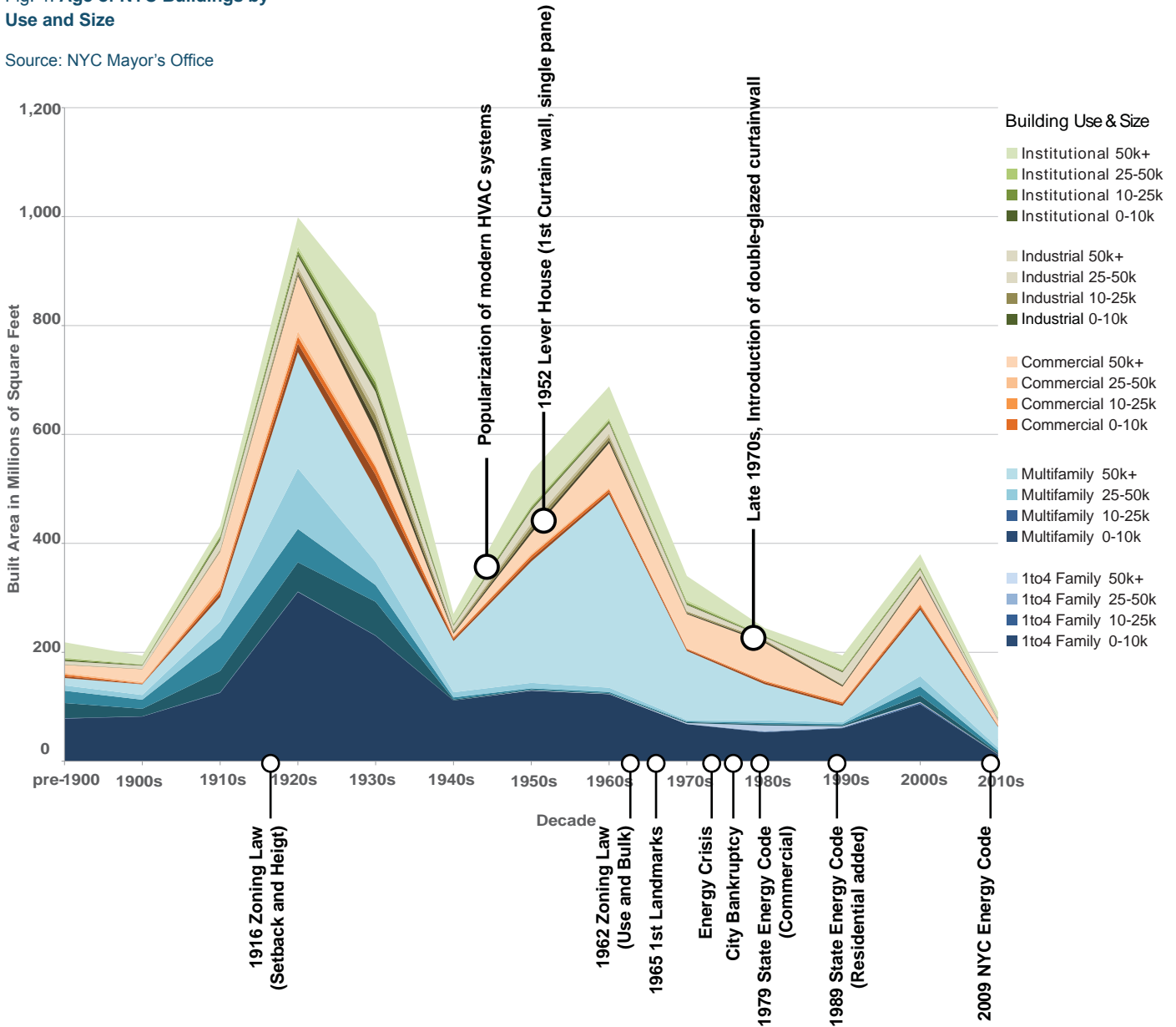

New York City’s buildings vary widely by size, age, and use, but can be categorized into typologies that exhibit similar characteristics. The buildings that exist in the city today are largely from construction booms in the 1920s, 1950s, and 2000s and reflect the codes and building technologies of those eras. Buildings from similar eras typically share commonalities in construction materials, fabrication techniques, and installed heating and cooling systems. These commonalities can help identify similar opportunities and approaches to reducing energy use and GHG emissions. In addition, a building’s height can indicate which systems are in place, while a building’s primary use can reflect how occupants use energy.

The TWG identified 21 common building typologies based on the buildings’ primary use, age, and height.<sup>7</sup> These typologies help identify similar, and potentially replicable, opportunities to reduce energy use and GHG emissions from New York City’s existing buildings.

Buildings that are over 50,000 square feet in floor area represent two percent of the New York City’s building stock, but account for nearly half of all built square footage in the city. The owners of these buildings are currently required to measure energy and water use to benchmark their consumption and to complete energy audits under Local

Fig. 5. Distribution of Built Area by Building Typology

Source: NYC Mayor’s Office

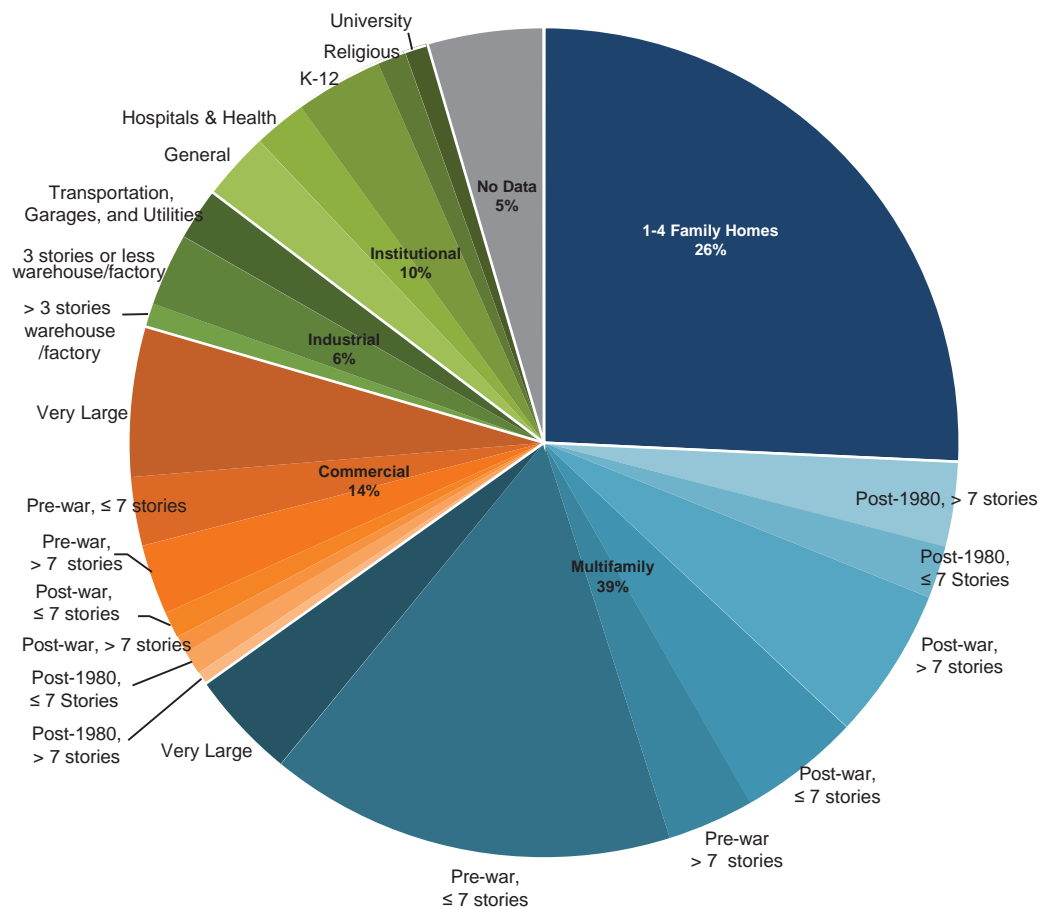

Fig. 6. Built Square Footage (SF) by Building Typology

Source: NYC Mayor's Office

Primary Building Use	Building Area (SF)	Building Typology	Building Area (SF)	% of Citywide Building Area
<b>1 to 4 Family</b>	1,399,973,934	1 to 4 Family Home	1,399,973,934	25.73%
<b>Multifamily</b>	2,139,468,795	Post-1980, > 7 stories	180,032,498	3.31%
		Post-1980, ≤ 7 stories	110,960,071	2.04%
		Post-war, > 7 stories	322,288,773	5.92%
		Post-war, ≤ 7 stories	257,279,576	4.73%
		Pre-war, >7 stories	182,922,725	3.36%
		Pre-war, ≤ 7 stories	862,122,847	15.84%
		Very Large	229,297,263	4.21%
<b>Commercial</b>	782,642,506	Post-1980, > 7 stories	27,540,768	0.51%
		Post-1980, ≤ 7 stories	50,638,663	0.93%
		Post-war, >7 stories	36,451,018	0.67%
		Post-war, ≤ 7 stories	55,392,825	1.02%
		Pre-war, > 7 stories	148,838,402	2.74%
		Pre-war, ≤ 7 stories	145,655,151	2.68%
		Very Large	318,125,679	5.85%
<b>Industrial</b>	314,039,626	> 3 stories warehouse/factory	49,967,460	0.92%
		≤ 3 stories warehouse/factory	154,315,198	2.84%
		Transportation, Garages, and Utilities	109,756,968	2.02%
<b>Institutional</b>	553,318,019	Hospital and Health Facilities	145,595,550	2.68%
		Institutional General	111,971,789	2.06%
		K-12 Schools	184,865,861	3.40%
		Religious	61,398,255	1.13%
		University	49,486,564	0.91%
<i>No Data</i>	246,698,832	<i>No Data</i>	246,698,832	4.53%

Laws 84 and 87 of 2009. Benchmarking provides a snapshot of whole building energy use, which can help building owners track their energy use and manage their energy costs and provides the City with a basic understanding of patterns in energy use. Energy audits provide more detailed information about the specific systems in a building and the amount of energy used by these systems.

These data sources provide the City with a comprehensive understanding of the energy used in our large buildings and can be used to project energy use profiles in mid-sized and small buildings. However, new data sources will be increasingly important to develop a more complete picture of the how buildings use energy, and to ensure building owners have all the information they need to make cost effective and meaningful upgrades.



## Emissions from Energy Used in Buildings Today

Across the city, the multifamily and commercial sectors account for the vast majority of built floor area and nearly two-thirds of the GHG emissions from energy used in buildings. While smaller residential buildings (one- to four-family homes) make up the greatest absolute number of buildings in New York City by far — numbering more than 800,000 — their total built square footage and GHG emissions are significantly less

Fig. 7. **Building Uses by Building Count, Floor Area, and GHG Emissions**

Source: NYC Mayor's Office

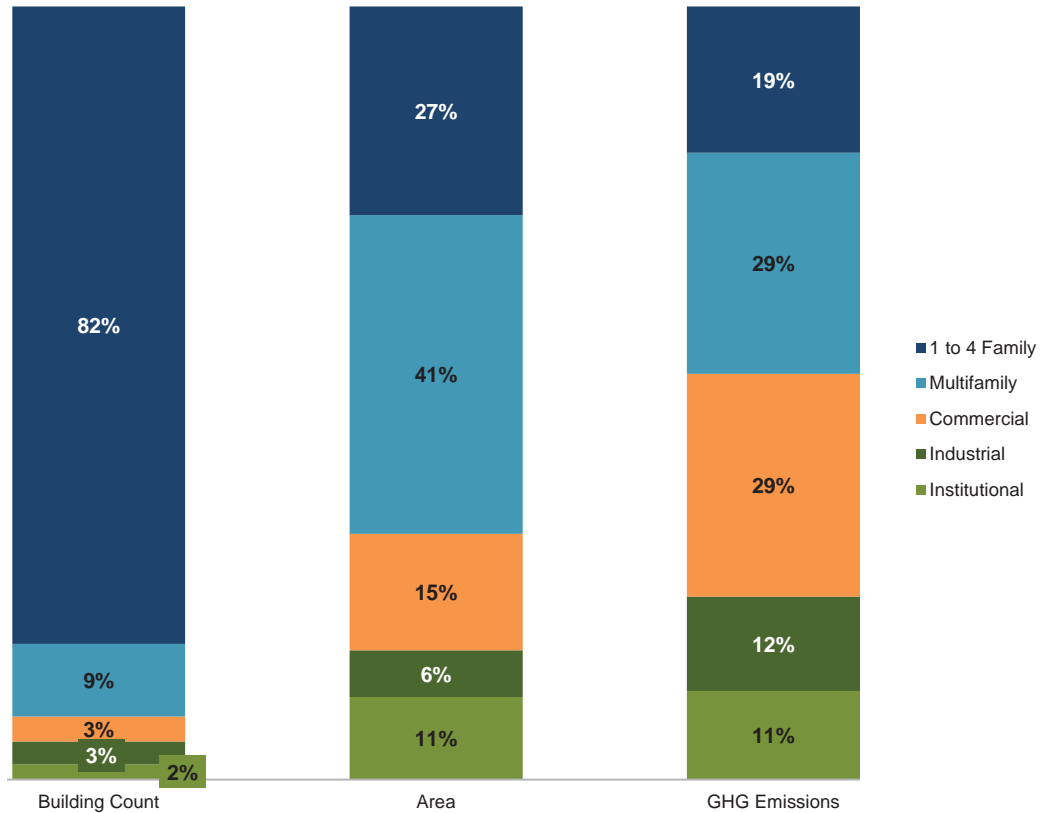

than the multifamily and commercial sectors.

Since 2005, GHG emissions from the energy used in buildings have decreased by 12.8 percent, even as built square footage has increased by six percent and economic output increased by 15.8 percent.<sup>8</sup> Emissions from multifamily buildings have decreased by 21 percent since 2005, while emissions from commercial buildings have decreased by six percent in the same period. These reductions are largely a result of the decreasing carbon intensity of electric generation, conversions away from heavy heating oil to cleaner heating fuels in large buildings, and increased energy efficiency in the way businesses and residents use energy in the buildings in which they live and work.

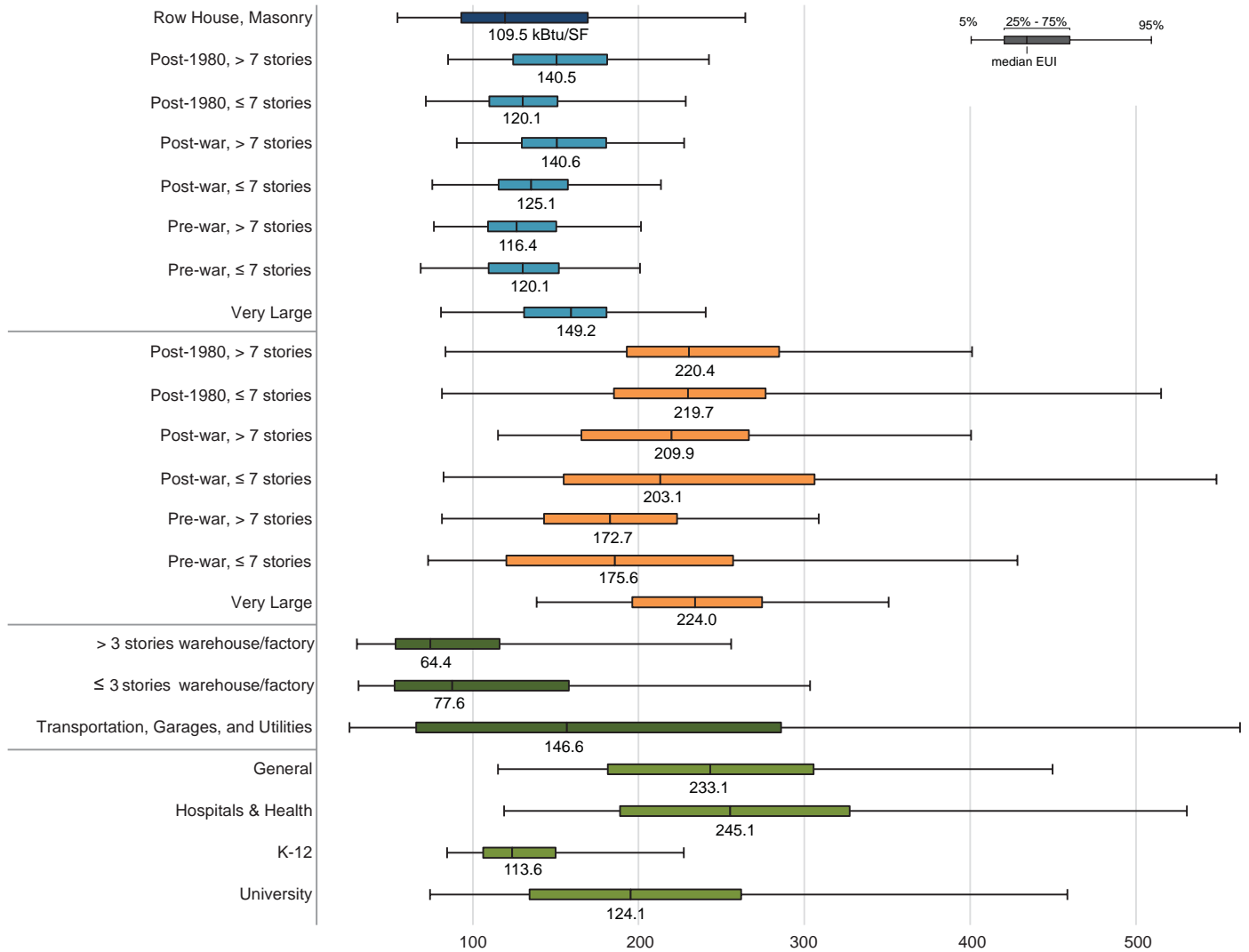

**Fig. 8. Median and Distribution of Source EUI by Building Typology (kBtu/SF)**

Source: NYC Mayor's Office

New York City's buildings exhibit a wide range of energy use profiles and intensities. Energy benchmarking information from Local Law 84 provides the energy use intensity (EUI, measured as thousand British thermal units (kBtu) per square foot) in large buildings over 50,000 square feet. In addition, Residential Energy Consumption Survey (RECS) data provides a similar snapshot of energy use for one- to four-family homes.

Median EUIs across building typologies vary significantly. Multifamily buildings and one- to four-family homes tend to have significantly lower median EUIs than commercial, industrial, and institutional buildings, as well as a narrower range of EUIs. This is likely attributable to the fact that residential spaces are typically used less intensively and have more uniform use patterns than non-residential buildings, while non-residential uses are engaged in a myriad of activities across commercial businesses, institutions, and industrial production.

There is also a wide variation in EUIs within specific building typologies, as indicated by the range of EUIs between the 5th and 95th percentiles. In many typologies, this

range varies by orders of magnitude, which indicates that even in buildings that are similar in size, age, and class, there are factors that lead to major differences in reported energy consumption. The ranges can be attributed to differences in building systems, space types, space uses, occupant density, and varying operations and maintenance practices.

EUI is a useful metric for understanding trends in whole building energy use across New York City’s buildings. However, it is an imperfect metric to understand the drivers of energy use within buildings because EUI does not capture differences in building systems and types of occupant activity.

### Characteristics of Buildings in 2050

By 2050, the population is anticipated to grow by 700,000 New Yorkers. From now to 2050, between 8,000 and 30,000 new buildings are expected to be constructed. In addition, roughly 70,000 existing buildings are anticipated to be demolished and replaced, typically with larger buildings.

Fig. 9. Projected Built Area Growth in Million Square Feet (2010-2050)

Source: NYC Mayor’s Office

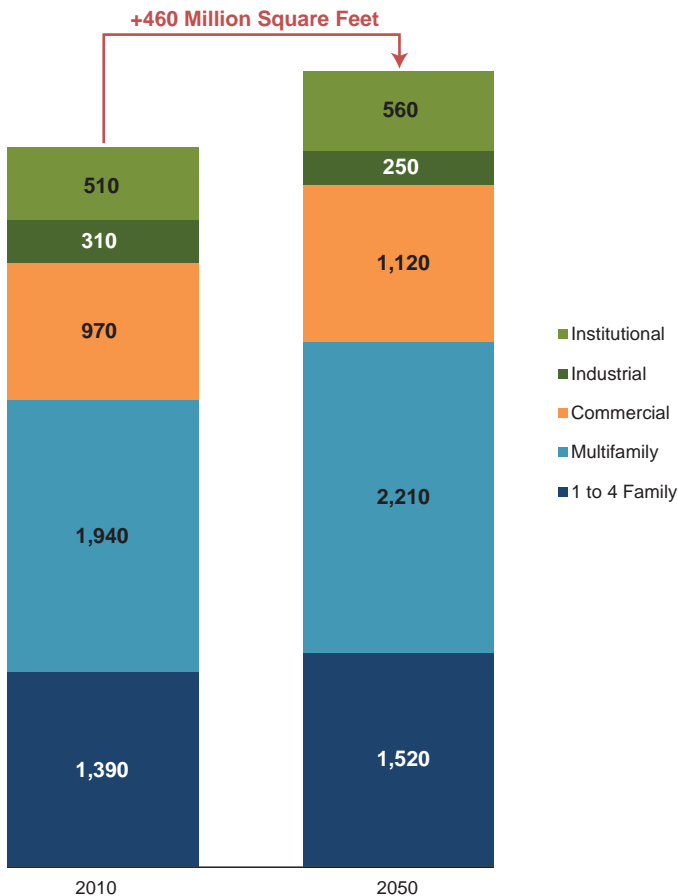

If recent construction trends continue, these buildings will be predominantly residential and commercial.<sup>9</sup> Since 2002, New York City has experienced a 36 percent increase in floor area from mixed residential and commercial buildings, and sizeable increases in floor area from one- and two-family homes, multifamily buildings, and commercial office buildings. New York City also experienced growth in public facilities and institutional buildings, as well as open and outdoor spaces. Meanwhile, the city saw declines in parking facilities, industrial and manufacturing buildings, transportation and utility spaces, and vacant land.

Based on these historic trends and analysis of data from the U.S. Census and NYC Department of City Planning, total built floor area in New York City is projected to increase from 5.4 billion square feet to 5.8 billion square feet by 2050, or an 8.6 percent increase. This includes a 14 percent projected increase in multifamily building area, 15 percent increase in commercial building area, and 10 percent increase in the built area for one- to four-family homes by 2050. Multifamily buildings are expected to continue to dominate the city’s total building area, accounting for 38 percent of New York City’s built square footage by 2050.

Fig. 10. Change in Building Area, Number of BBLs, and Number of Buildings by Land Use Category (2002-2014)

Source: NYC Mayor's Office

PLUTO Land Use Category	Percent Change 2002-2014			
	Square Footage	Number of Properties	Number of Buildings	
Mixed Residential & Commercial	36%	8%	19%	Growing Sectors
Public Facilities & Institutions	13%	9%	34%	
Open Space & Outdoor	12%	135%	90%	
One & Two Family Buildings	7%	3%	33%	
Multi-Family Walk-Up Buildings	7%	8%	29%	
Multi-Family Elevator Buildings	5%	13%	22%	
Commercial & Office Buildings	3%	-3%	5%	Declining Sectors
Parking Facilities	-5%	-12%	14%	
Industrial & Manufacturing	-25%	-17%	-10%	
Transportation & Utility	-18%	-6%	24%	
Vacant Land	--	-35%	--	
(Not Available)	-34%	-26%	-6%	
All Land Uses	7%	1%	30%	

Building operations may also change by 2050 due to changes in New York City's climate as a result of global climate change. Data from the National Oceanic and Atmospheric Administration (NOAA) indicate that by 2050, New York City is expected to experience decreased "heating degree days," which is a measure of the number of degrees and days outside air temperature is below 65 degrees Fahrenheit in a given year. Climate change is also projected to increase the number of "cooling degree days" in New York City, defined as the number of degrees and days outside air temperature

Fig. 11. Historical and Projected Number of Heating and Cooling Degree Days per Year for New York City (1980-2050)

Sources: NOAA (Central Park Weather Station); New York City Panel on Climate Change (2015)

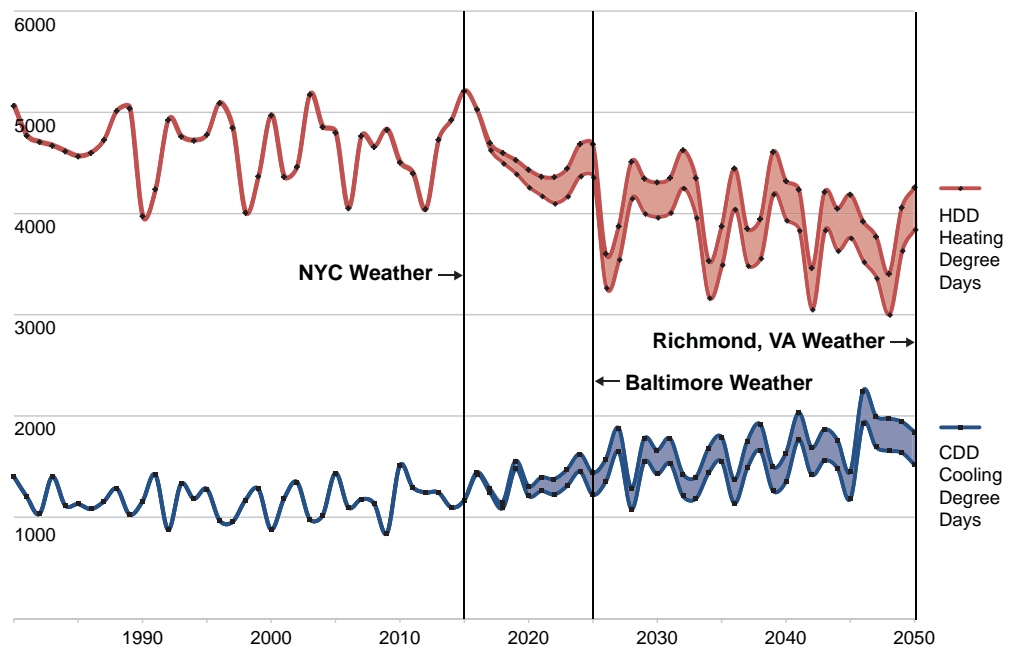

is greater than 65 degrees Fahrenheit in a year. This suggests weather conditions in New York City in 2050 will be similar to the mid-Atlantic today, potentially driving up cooling needs in 2050. However, heating degree days are still projected to vastly outnumber cooling degree days, so space heating is therefore still expected to dominate building energy use in 2050.

### **GHG Emissions from Energy Used in Buildings in 2050**

In the aggregate, growth in urban areas has a positive impact on GHG emissions by concentrating populations in denser areas served by mass transit, which can lead to GHG reductions on a national and international level. Still, New York City has the responsibility and capability to continue reducing its emissions. The projected growth in New York City's population and building area is projected to increase GHG emissions from New York City's buildings by as much as nine percent by 2050, not taking into account existing policies. New policies and programs aimed at reducing citywide GHG emissions should take this growth into account if New York City is to achieve 80 x 50.

Fortunately, the policies that New York City has enacted to date will help mitigate this projected growth in GHG emissions from buildings, allowing us to grow more sustainably. In fact, the anticipated reductions from GGBP legislation and the phase-out of heavy heating oil are expected to offset the entire increase in emissions from new buildings. In addition, the new policies and programs announced in *Built to Last* are projected to reduce GHG emissions by 3.4 MtCO<sub>2</sub>e.

Altogether and including GHG reductions that have been achieved to date, these policies and programs would reduce building-based GHG emissions in New York City by 22 percent from 2005 levels by 2050 if emissions from the electric grid remain constant.

One critically important factor to achieving GHG reductions in buildings is the carbon intensity of New York City's electricity supply is a critically important factor to achieving GHG reductions in buildings.

An increase in the proportion of clean or renewable energy sources in the electric grid would result in an immediate reduction in the GHG emissions from the energy used in buildings. A scenario in which the current electric grid becomes 80 percent cleaner would reduce GHG emissions from buildings by 41 percent compared to 2005 levels. With additional reductions from the City's existing policies and programs, including initiatives that were launched as part of *Built to Last*, this could reduce GHG emissions from the energy used in buildings by as much as 50 percent from 2005 levels. On the other hand, a scenario that includes the decommissioning of the Indian Point nuclear power plant could result in as much as an eight percent increase in GHG emissions from electricity use in buildings, even with a significant increase in renewable generation by 2050.<sup>10</sup>

Under a scenario in which the electric grid becomes much cleaner, the energy use in buildings typically powered by fossil fuels, such as space heating and domestic hot water production, could be placed on the electrical grid to take advantage of cleaner electricity. However, this transition would need to be carefully balanced with utility infrastructure considerations, as increased electricity loads without corresponding investments in the electric grid could compromise reliability of the system. In all scenarios, decreasing energy use in buildings will be necessary to minimize electric loads and reduce fossil fuel-based energy use in order to dramatically reduce emissions.

Fig. 12. **Business as Usual GHG Emissions Projection from Buildings, with Current Electric Grid and Existing Policies (MtCO<sub>2</sub>e)**

Source: NYC Mayor's Office

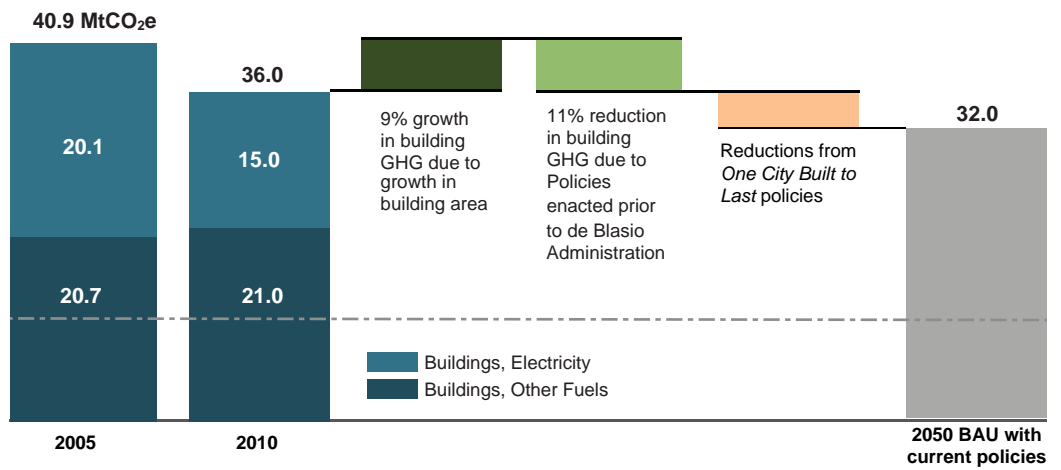

# 2

## Reducing Energy Use in Existing Buildings

## **MORE THAN 90 PERCENT OF THE BUILDINGS THAT EXIST TODAY IN NEW YORK CITY WILL STILL EXIST IN 2050**

This means that to achieve an 80 percent greenhouse gas (GHG) reduction by 2050, compared to 2005 levels (80 x 50), nearly all of the city's existing buildings will need to be retrofitted to become more energy efficient and transition towards the use of renewable energy sources over the next 34 years.

To map the trajectory towards 80 x 50, the City has taken the critical first step of completing the most comprehensive evaluation of energy use in New York City's existing buildings to date. Drawing on energy audit data from Local Law 87 (LL87) for several thousand large buildings measuring over 50,000 square feet in floor area, the City was able to analyze building systems and end uses across its building stock. Until now, the City only had energy benchmarking data from Local Law 84 to assess differences in whole building energy use in large buildings, which does not provide insight on the underlying drivers of building energy consumption.

The groundbreaking analysis of energy audit data provides a more granular perspective on energy use in New York City's buildings, yielding critical new insights on the opportunities available to reduce energy use and GHG emissions.

### **Energy Use in Existing Buildings**

Across New York City's large buildings, space heating accounts for the largest share of energy use, followed by domestic hot water (DHW) production, electric plug loads, lighting, and space cooling. The energy used for space heating accounts for over a third of energy use in large buildings and more than 40 percent of GHG emissions.<sup>11</sup>

In large multifamily buildings, space heating and DHW production dominate energy use and GHG emissions. Space heating alone accounts for the majority of GHG emissions in these buildings. Taken together, space heating and DHW production account for nearly two-thirds of total energy use and three-quarters of GHG emissions.

In large commercial buildings, the LL87 energy audit data indicates that energy use and associated GHG emissions are more equally distributed across heating, plug loads, lighting, and cooling. In particular, plug loads and lighting make up a much more significant share of GHG emissions in these buildings.

It is important to note that LL87 energy audit data captures some, but not all, of tenant energy consumption. Some of the energy that is reported in the "other" category is assumed to be from tenants-driven loads, but there may be additional tenant energy uses that go unreported. This means that the energy used for tenant-based loads, which include lighting, plug loads, space cooling, and ventilation, are likely underestimated in these findings.<sup>12</sup>

Still, it is clear that there are dramatic differences in the energy use and associated emissions from space heating, cooling, and DHW production between multifamily and



Fig. 13. **Building Greenhouse Gas Emissions by End Use\***

\* The energy use breakdown of tenant-owned equipment is not collected in the LL87 submission forms which may impact the overall building energy use breakdown data. Original LL87 data has not been adjusted to accommodate for this limitation.

Source: NYC Mayor's Office

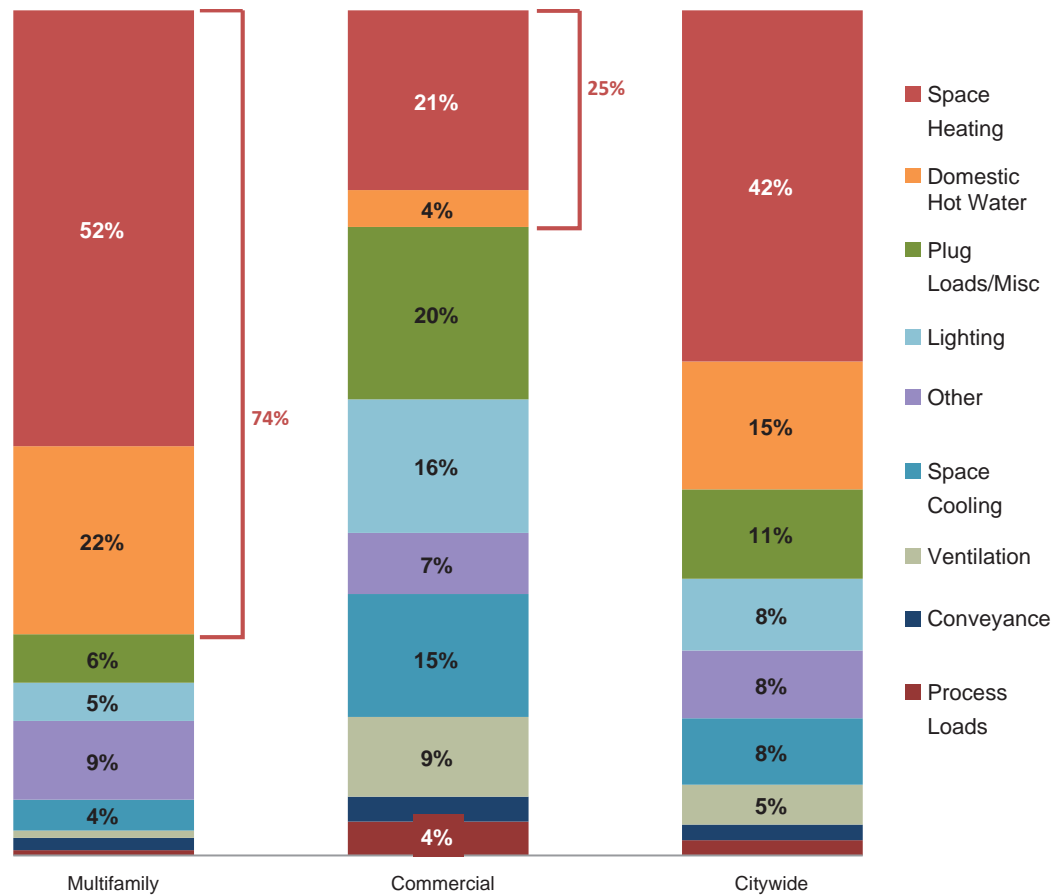

commercial buildings. The significantly greater portion of energy that is used for space heating and DHW production in multifamily buildings may be due in part to differences in building systems and equipment as well as operations and maintenance practices. It is also likely due to differences in hours of operation for these buildings, since multifamily buildings must be heated at night and on weekends while many commercial buildings are only conditioned during working hours during weekdays.

### Fuel Use in Existing Buildings

New York City buildings are heated, cooled, and powered by a diversity of on-site and off-site fuels, including electricity, natural gas, heating oil, biodiesel, and district steam provided by Consolidated Edison (Con Edison).

Electricity and natural gas dominate fuel use and the resulting GHG emissions in New York City's buildings. Natural gas combusted on-site accounts for 56 percent of energy use and 46 percent of GHG emissions from New York City's buildings, while electricity makes up 30 percent of energy use and 40 percent of GHG emissions from buildings. Natural gas combusted on-site is currently cleaner per unit of energy than electricity from the grid due to energy losses resulting from the generation, transmission, and distribution of electricity. However, this may not be the case in future grid scenarios with an increase in renewable energy sources.

Fig. 14. **GHG Emissions by Building Use and Fuel Types\*** in Million Metric Tons of Carbon Dioxide Equivalent (MtCO<sub>2</sub>e)

\* As of December 2015, No. 6 fuel oil has been phased out in accordance with City regulations.

Source: NYC Mayor's Office

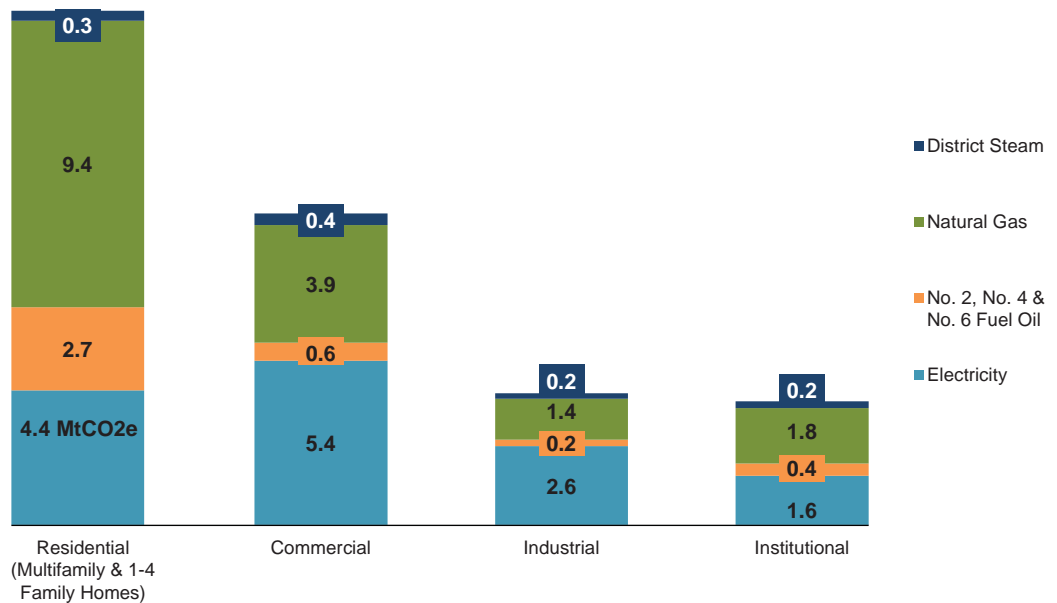
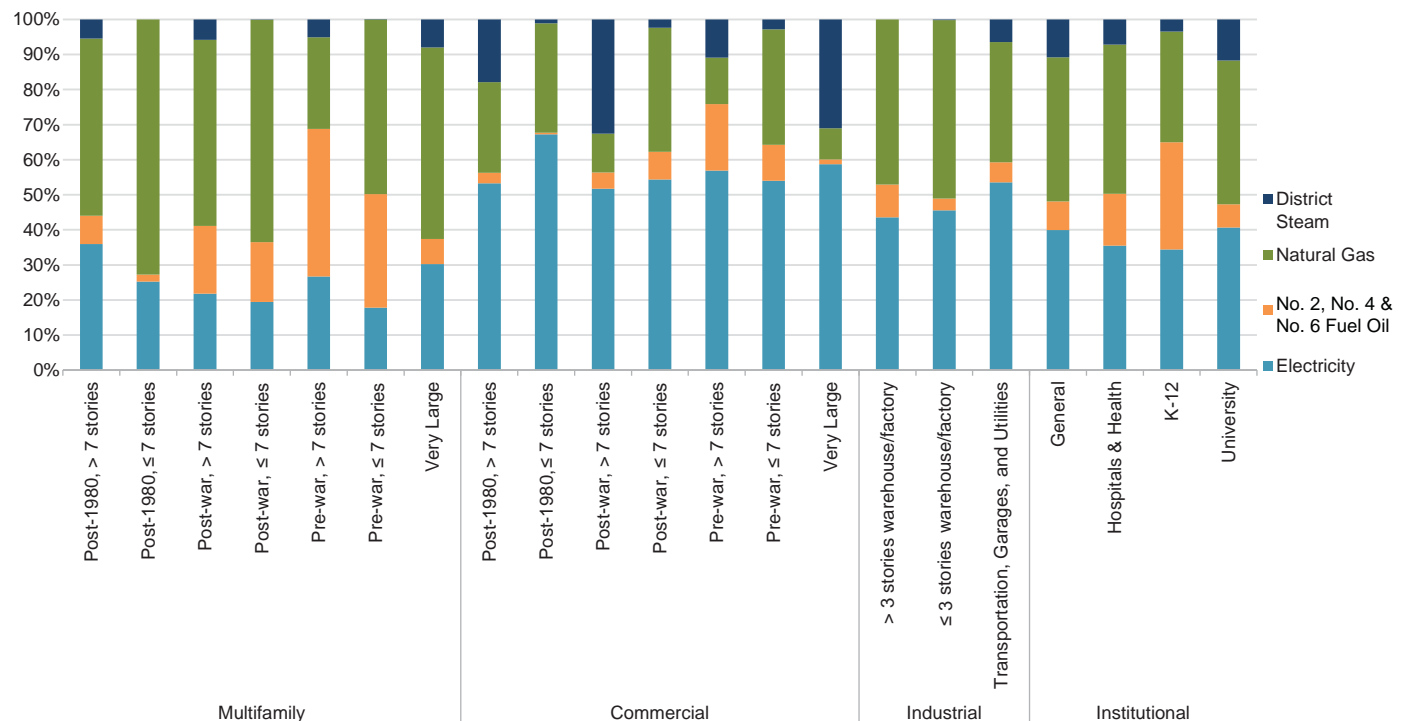

Fig. 15. **Source Energy Use by Building Typology and Fuel Type\***

\* As of December 2015, No. 6 fuel oil has been phased out in accordance with City regulations.

Source: NYC Mayor's Office

Within large buildings, natural gas, which is primarily used for space heating, DHW production, and cooking, dominates as an on-site fuel source. Many buildings still burn fuel oil as a heating source, although the share of heavy heating oil (No. 6 and No. 4) has decreased significantly as a result of the NYC Department of Environmental Protection's heating oil regulations and the successful NYC Clean Heat Program. District steam from Con Edison, which is often used to produce both space heating and cooling for these buildings, makes up a sizeable portion of fuel sources in very large commercial buildings.



## Energy Use in Building Systems

While there is a diversity of building systems across New York City’s building stock, some similarities and trends emerge. Concentrations of building systems within certain building types can help identify energy efficiency and GHG reduction measures that could be replicated at a wider scale throughout the city.

This study largely focuses on multifamily and commercial buildings because these sectors account for the majority of square footage and GHG emissions from New York City’s buildings. This study also focuses on the energy used in heating, DHW, and cooling systems because they account for the greatest proportion of energy use from the buildings captured in the LL87 energy audit data.

## Heating Systems in New York City Buildings

Heating systems are characterized by the equipment that produces heat, such as a boiler; the primary fuel used to create this heat, which may include natural gas, heating oil, biodiesel, district steam, or electricity; and the systems that distribute the resulting steam, hot water, or warm air throughout the building to deliver space heating, such as pipes or air ducts.

Space heating that is distributed as steam is most prevalent system type in New York City’s building stock, particularly in buildings constructed prior to the 21st century.

Fig. 16. Heating Systems by Building Typology\*

\* Distribution based on floor area

Source: NYC Mayor’s Office

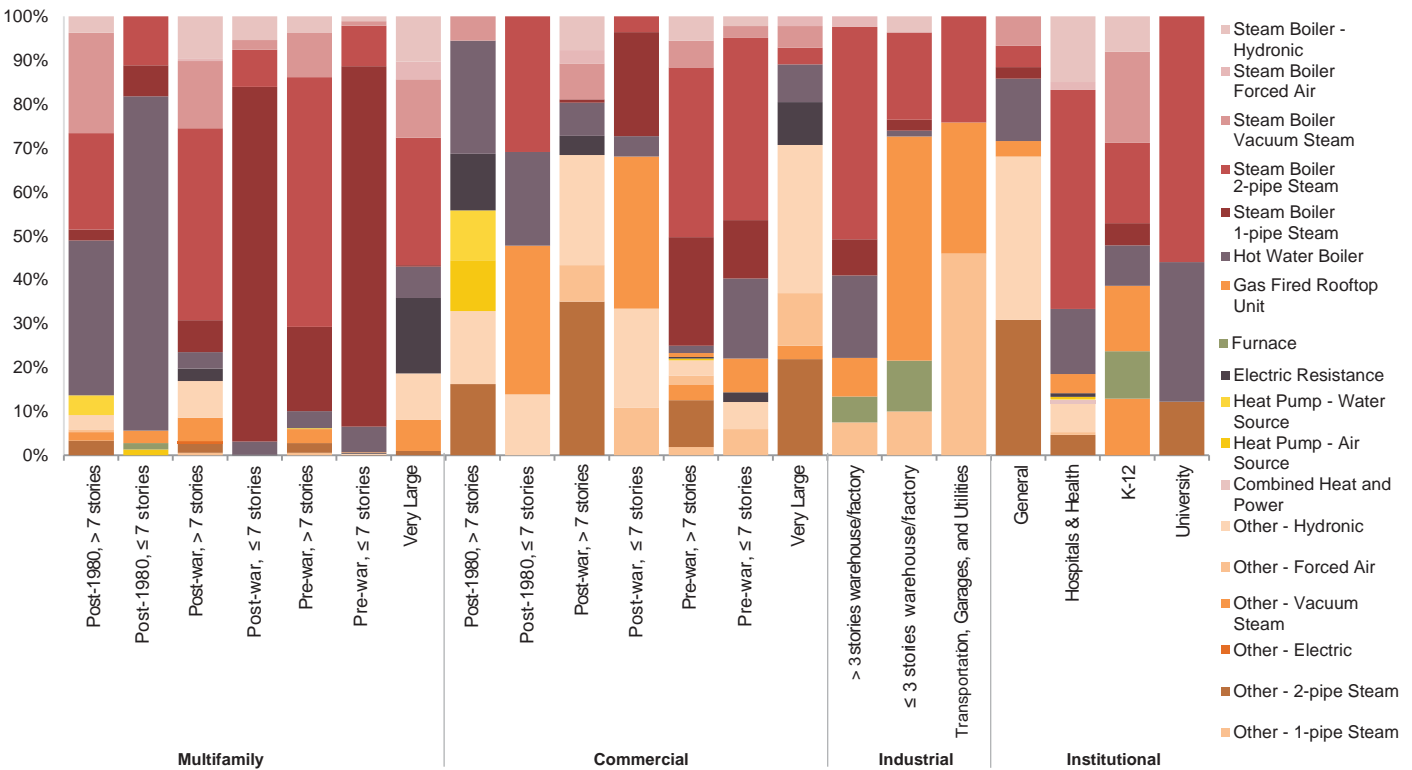

More than 70 percent of large buildings in the city use some form of steam heating distribution. In steam-heated buildings, water is boiled on-site, usually by burning fossil fuels such as oil or natural gas, or is sourced from the New York City's district steam system, and the resulting steam is distributed by pipes to radiators throughout the building. Because heating distribution systems are not typically replaced, many of these systems are decades old and may not be well-maintained. This can lead to energy waste and result in uncomfortably cold spaces and overheated rooms in the same building.

The prevalence of steam heating distribution systems is especially pronounced in the multifamily sector, where it is present in more than 80 percent of large multifamily buildings. Most multifamily buildings that are less than seven stories are equipped with one-pipe steam systems, where the steam delivery and condensate (water) return share the same pipe. Taller multifamily buildings have a greater share of two-pipe steam systems, where steam delivery and condensate return use separate pipes. Multifamily buildings constructed post-1980, after the first New York State Energy Conservation Construction Code (NYSECCC) was established, are typically equipped with either two-pipe steam systems or hydronic systems, which use hot water rather than steam to deliver space heating. There is also a sizeable number of multifamily buildings that have steam boilers that are serving hydronic distribution systems — a combination that represents a particularly significant energy saving opportunity.<sup>13</sup>

In commercial buildings, steam distribution systems are installed in more than 60 percent of buildings, and are also most prevalent in pre-war construction. Many large commercial heating systems use district steam from Con Edison as their fuel source, which can serve one-pipe, two-pipe, vacuum steam, forced air, or hydronic distribution systems.<sup>14</sup>

### **Energy Use in Space Heating and DHW Systems**

The energy use intensity (EUI) of space heating, measured as the total source energy that is used for space heating divided by building square footage (kBtu/SF), varies widely even among buildings with the same heating distribution system type.<sup>15</sup> In both commercial and multifamily buildings, buildings with the best performing one-pipe, two-pipe, and hydronic systems use less than half of the the energy for space heating than the median building. This range in performance is likely driven by differences in operations, maintenance, and controls — suggesting that there are major opportunities by replicating best practices to reduce energy use and bring buildings with heating systems that are currently using more energy closer in line with their more efficient peers.

Controls for the distribution of space heating throughout a building vary widely in complexity. Many systems operate by using outdoor air temperature to estimate how much heat a building needs. These systems lack indoor temperature feedback and therefore are not able to automatically respond to reduced heating needs in a building. Energy management systems (EMS) incorporate indoor temperature sensors to shut off parts of a heating system when spaces are comfortable. In the largest and most complex facilities, building management systems (BMS) monitor and control additional

**Fig. 17. Distribution of Heating EUIs by Heating Distribution Type in Multifamily Buildings (kBtu/SF)**

Source: NYC Mayor's Office

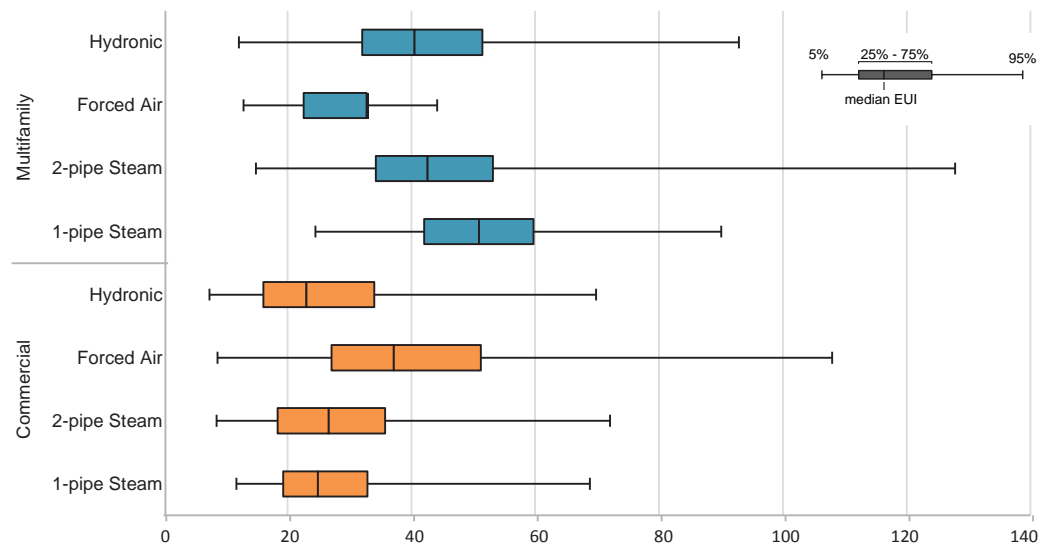

mechanical systems for heating and sometimes cooling based on space requirements. Paired with good operations and maintenance, these systems save energy by helping to achieve balanced heating and cooling throughout the building.

Despite these benefits, there are still many buildings in New York City that do not have an EMS or BMS in place. Roughly 35 percent of large multifamily buildings reported an EMS or BMS in their LL87 energy audit, while in large commercial buildings, just 25 percent reported these systems.

**Fig. 18. Median Heating EUI by Heating Distribution System Type (kBtu/SF)**

Source: NYC Mayor's Office

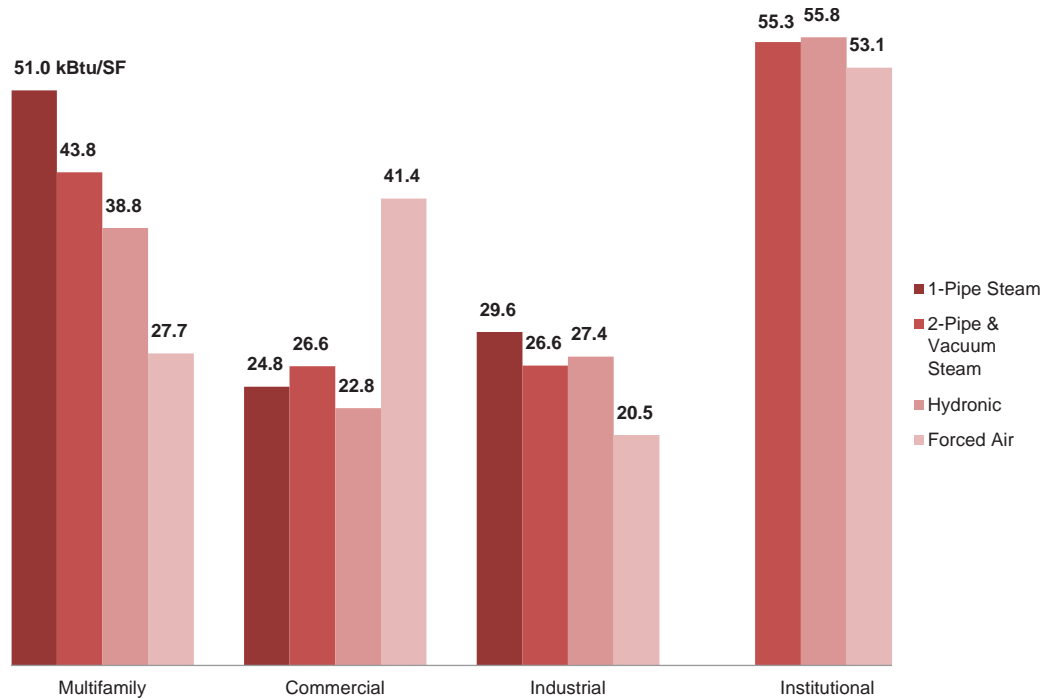

Certain types of heating systems also use consistently more energy than other types of heating systems. Steam distribution systems in multifamily buildings, and in particular one-pipe steam distribution systems, use more energy per square foot than other types of heating distribution systems. Steam distribution can offer advantages as a heating design solution, however many of the systems in buildings today may not be properly maintained leading to losses in efficiency.

In commercial buildings, forced air systems appear to use energy for heating more intensively than other heating systems, but this is likely due to fact that outdoor air is mechanically supplied in these buildings, which increases the electricity use of the system. The median heating EUI of one-pipe steam systems in both commercial buildings and institutional buildings is roughly equivalent or slightly lower than two-pipe steam and hydronic systems, which may suggest that well-maintained and controlled steam systems are capable of performing on par with these other systems.

The proportion of total building energy consumption that is used for space heating and DHW production varies significantly across New York City’s building typologies. In multifamily buildings, particularly those under seven stories, the energy consumed for space heating and DHW is on average two- to three-times greater than in commercial buildings, accounting for as much as 70 percent of total energy use and 75 percent of resulting GHG emissions in some typologies. This difference is due at least in part to the longer heating hours and greater hot water needs of residents in multifamily buildings. In addition, commercial buildings have greater cooling needs and plug loads, so heating makes up proportionally less of the total energy consumed. Still, some of the

Fig. 19. Space Heating and Domestic Hot Water Source Energy Use

Source: NYC Mayor’s Office

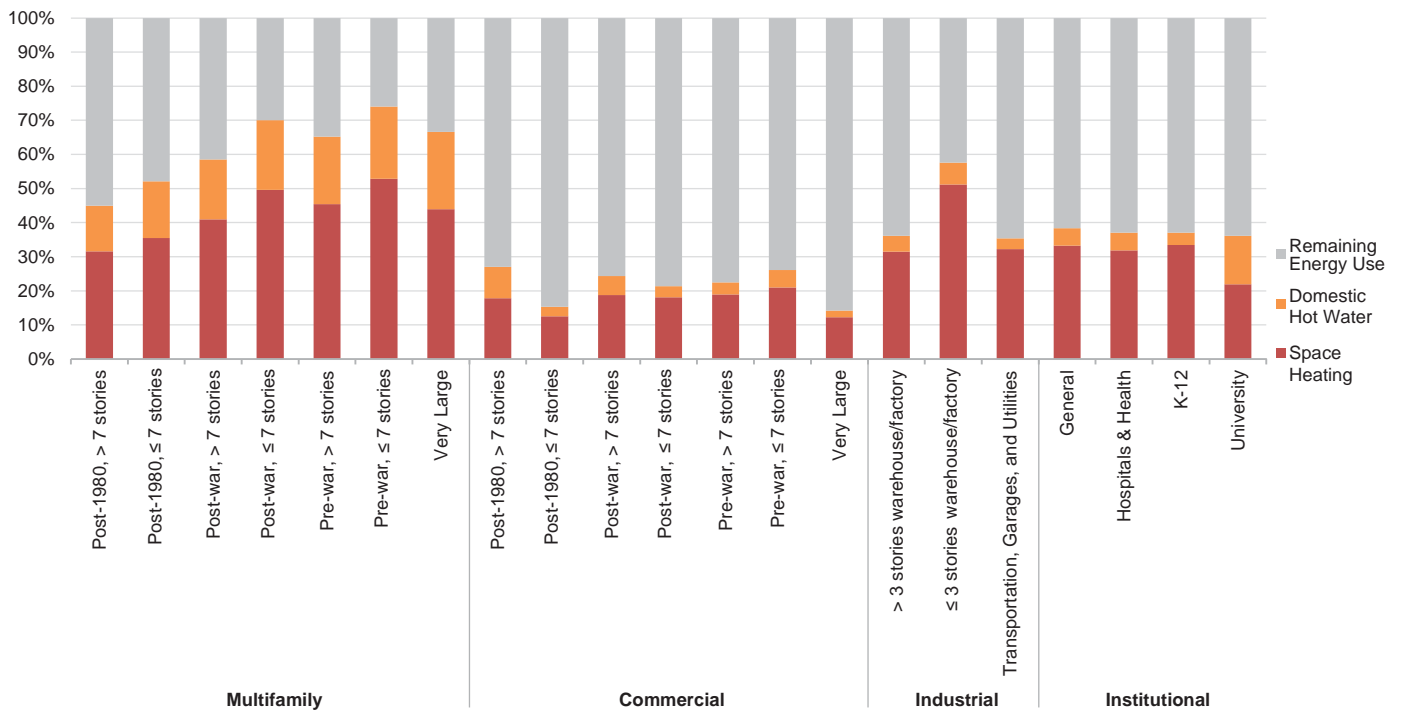

difference is also likely due to the differences in efficiencies of these buildings' space heating and DHW systems.

Median heating EUIs are twice as high in many multifamily building typologies as compared to the median heating EUIs in commercial typologies. Many institutional building typologies also have high median heating EUIs, accounting for up to three times as much energy use per square foot than in commercial buildings. This is likely due to the fact that some of these buildings, such as hospitals, are in use 24 hours a day, seven days a week.

There are dramatic differences in DHW system energy use between commercial and multifamily buildings. DHW systems in multifamily buildings consume up to 10 times more energy per square foot than in commercial buildings. This is likely correlated to space use and the significantly greater need for hot water in residential buildings. Other determinants of DHW energy use include whether a building uses a steam boiler plant to create both domestic hot water and steam for heating — meaning the boiler must be kept running during the summer — and flow rates of building fixtures such as showerheads and faucets.

## **Cooling Systems in New York City Buildings**

Cooling systems are generalized as either central or non-central systems. Central cooling systems are characterized by cooling equipment, such as a chiller or water-cooled package unit, and distribution systems that deliver space cooling throughout the building. These systems are most commonly powered by electricity, district steam, or natural gas.

Non-central cooling systems include air-conditioning units or other cooling equipment that are distributed in close proximity to spaces that require cooling. These systems are typically powered by electricity and include window or through-wall air conditioners, packaged terminal air conditioner (PTAC) units, direct-expansion (DX) units, single split systems, mini-split systems, and air-cooled units.

Cooling systems are not as well documented within LL87 energy audit data as heating systems. This is because tenants often own and operate cooling equipment within a building, which are not required to be included in an energy audit. Additionally, many buildings have multiple cooling systems in place, some or all of which may go unreported. A quarter of energy audits reported having at least two cooling systems within the building. Based on industry experience, the proportion of buildings with secondary or even tertiary systems is likely even higher.

Despite these potential gaps, the energy audit data clearly indicates that central cooling systems in New York City are relatively uncommon and a significant majority of buildings use non-central cooling systems. Within multifamily buildings, more than 90 percent of buildings that reported a cooling system in their energy audit reported using a non-central cooling system. Most of these are room air conditioners, which

Fig. 20. Median Heating EUI by Building Typology (kBtu/SF)

Source: NYC Mayor's Office

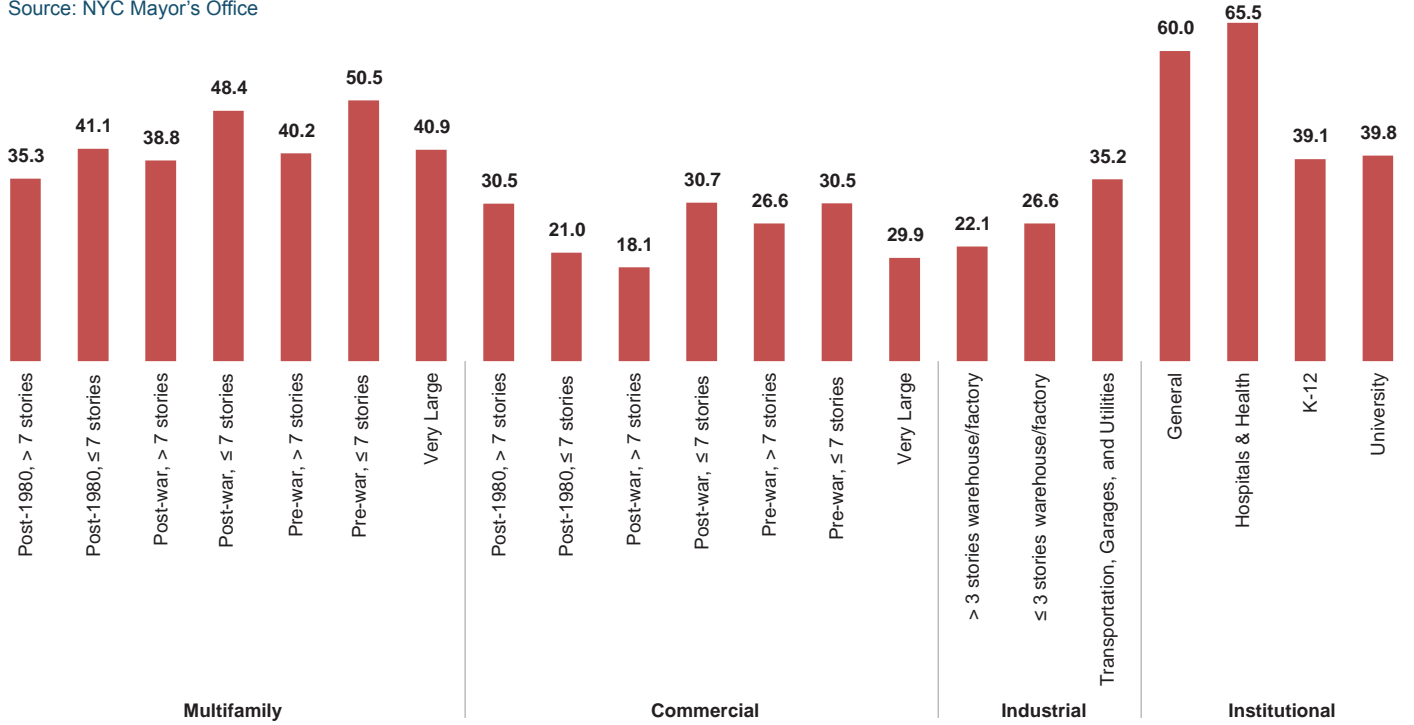
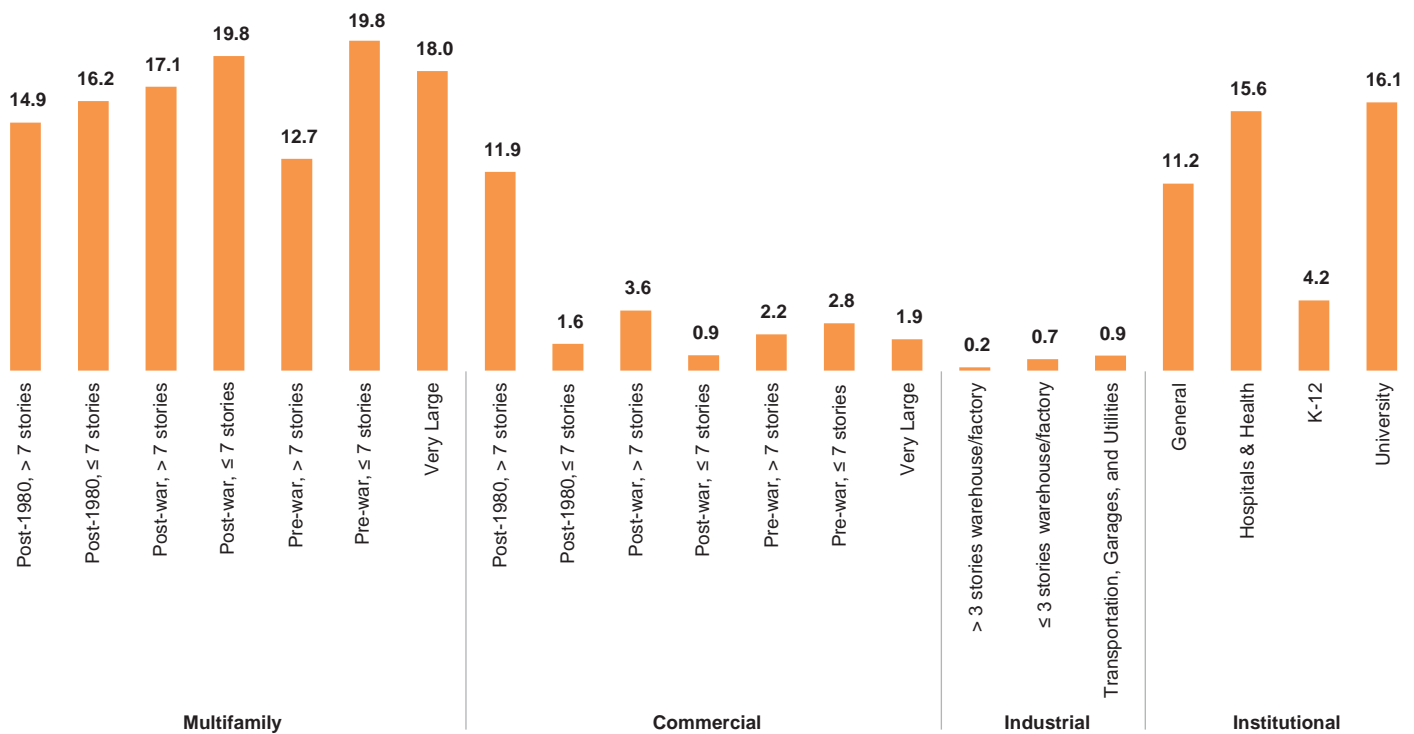

Fig. 21. Median Domestic Hot Water EUI by Building Typology (kBtu/SF)

Source: NYC Mayor's Office





include window air conditioners, through-wall air conditioners, and PTACs. While high efficiency versions of these cooling systems are available, they pose unique challenges to reducing energy use in buildings due to air leakage around the edges of the units, which can be the result of poor maintenance of weather sealing or by design. This air leakage often leads to excessive space heating during the winter and inefficient cooling during the summer.

Many of the missing records for cooling systems in the energy audit data are assumed to have tenant-supplied room air conditioners. Multifamily buildings constructed in the post-war and post-1980 periods are likely to have more building-supplied cooling, which could include either central or non-central cooling systems.

Commercial buildings are more likely to have central cooling systems than multifamily buildings, particularly in large commercial buildings built in the 21st century. Still, smaller and pre-war commercial buildings tend to have a wider range of systems, and many of the unreported cooling systems are likely tenant-supplied systems. Additionally, commercial building tenants may operate secondary or supplemental systems to the central cooling system, many of which are likely unreported in the energy audit data.

Fig. 22. Cooling Systems by Building Typology\*

\* Distribution based on floor area

\*\* Assumed to be room air conditioners and tenant-operated systems

Source: NYC Mayor's Office

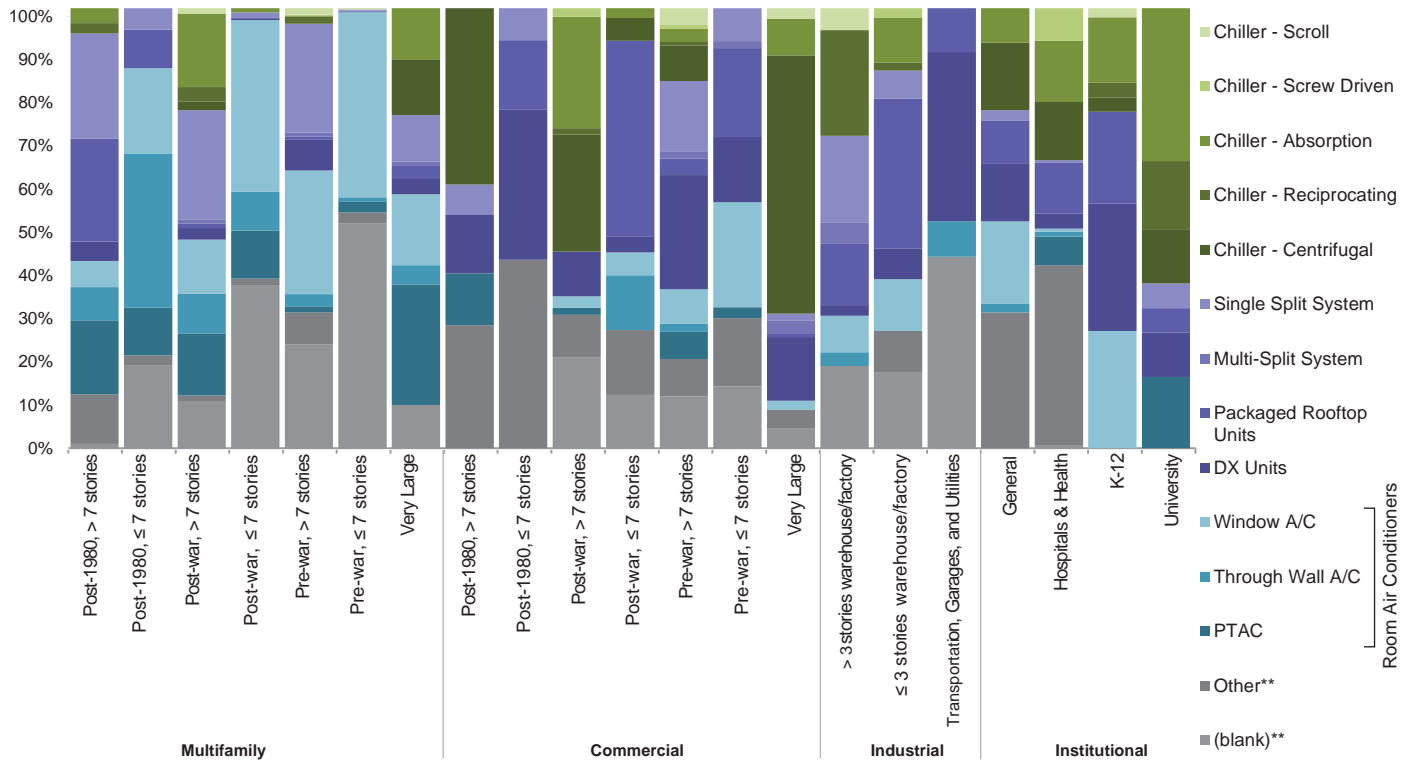

## **Building Envelopes in NYC Buildings**

The building envelope, which consists of the roof, exterior walls, windows, doors, and the foundation, is an important determinant of the intensity of energy used for space heating and cooling in a building. Envelopes that are poorly insulated, have significant thermal bridges that reduce the overall thermal insulation due to significantly higher rates of heat transfer than surrounding materials, or have many wall penetrations that lead to air leakage, require additional energy use for heating and cooling to maintain stable indoor air temperatures.

These factors are often affected by the wall construction of the building. A building with mass wall construction may feature either a wood or steel frame, typically has walls constructed out of heavy materials such as brick or concrete, and features punched openings for windows. Nearly all existing windows in buildings with punched openings will be replaced before 2050. Replacing them with better insulated windows and frames can yield dramatic improvements in comfort and energy performance of a building envelope.

A building with a curtain wall construction typically has a steel frame and includes outer walls that are non-structural, often made of glass or other lightweight materials. Curtain walls can be extremely air tight, but typically have less insulation than mass walls. Curtain walls also tend to have more glazing, which transmits heat, and can result in higher heating and cooling loads.

New York City's buildings exhibit a mix of mass wall and curtain wall construction, but it was not possible to determine the proportion of buildings with each construction type with the existing energy audit data due to inconsistencies in the way the information is reported.

Another major factor for building envelope performance is air leakage through wall penetrations. Typical issues include leaky dampers, exhausts and vents that lack dampers, and envelope penetrations from chimneys, pipes, and room air conditioning units. An additional source of energy waste in many New York City buildings is operational air leakage as a result of open windows during the winter, which can occur when rooms overheat in buildings with unbalanced heating distribution systems. Open loading dock doors and lobby doors in tall buildings without vestibules can also result in substantial air leakage and energy waste.

## **Efficiency Opportunities Identified in Large Building Energy Audits**

LL87 energy audit reports for large buildings include recommended “energy conservation measures” (ECMs) that can improve specific systems within a building, along with their associated costs and simple paybacks. These recommendations provide building owners and decision-makers with useful information to help prioritize energy efficiency investments. LL87 also requires buildings to complete retro-commissioning

to ensure that existing equipment and building systems are operating as intended by current facility requirements.

The first two years of reported LL87 energy audits recommended ECMs that would result in a 14 percent annual reduction in GHG emissions on average if building owners implemented all measures. Retro-commissioning measures, which are required to be implemented, are estimated to have reduced these buildings' GHG emissions by an average of 2.5 percent.

The opportunities that are identified through Local Law 87 are important first steps that owners and decision-makers in large buildings can take to begin reducing their energy use and GHG emissions. However, even if all recommended ECMs were implemented, these opportunities alone are not sufficient to put New York City's existing buildings on the path to 80 x 50. Currently, energy auditors are not required to report all potential ECMs for a building in an energy audit. Typically auditors include only the most cost-effective measures with paybacks of less than 10 years, sometimes at the specific request of building owners. Moreover, LL87 energy audit recommendations and retro-

**Fig. 23. Average Energy Savings from ECMs Recommended as Percentage of Total Building Energy Consumption**

Source: NYC Mayor's Office

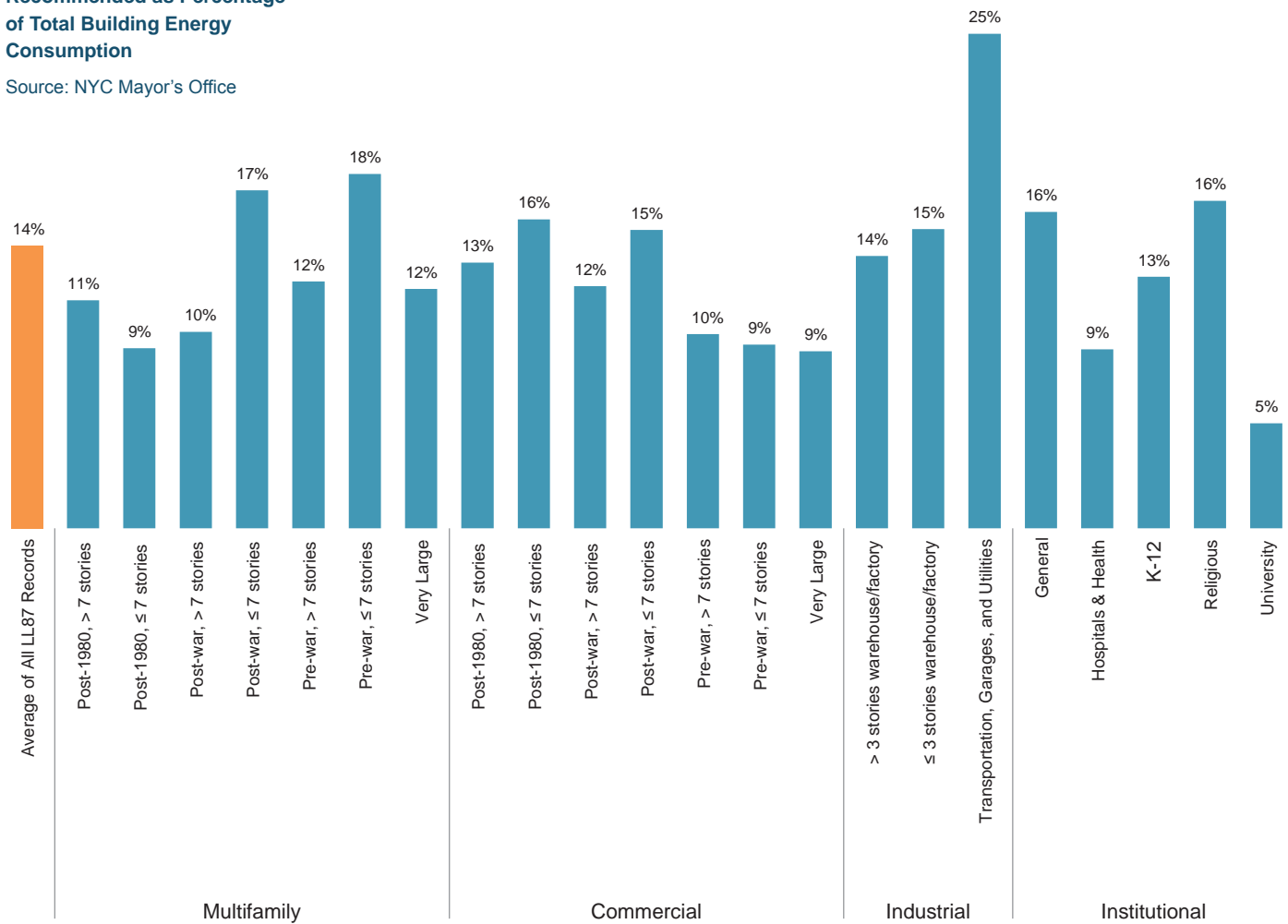

commissioning measures may capture some, but not all, efficiency opportunities in tenant-leased spaces.

Programs implemented from *Built to Last*, including the NYC Retrofit Accelerator and the NYC Department of Building's Energy Code Review Program, will help achieve energy and GHG reductions above what is captured through LL87. However, additional policies, enhanced programs, and revisions to codes will still be needed to realize more significant GHG reductions from existing buildings.

### **Low- and Medium-Difficulty Best Practice Measures**

One of the key tasks of the Technical Working Group (TWG) was to identify the full range of systems-specific opportunities in existing buildings that would reduce energy use and GHG emissions. To help identify the most cost-effective measures that could be implemented across the city's building stock, TWG members developed a list of nearly 100 low- and medium-difficulty ECMs to consider for near-term implementation.<sup>16</sup>

These ECMs were analyzed for their "technical" potential to reduce citywide GHG emissions if each measure was implemented in every relevant building, as well as the average implementation cost of the measure. These metrics were assessed using LL87 energy audit data combined with existing research and industry experience. The citywide GHG impact of these low- and medium-cost measures is based on a combination of the average GHG reduction potential of an individual ECM as well as the square footage of all buildings that could feasibly implement the ECM.

Individual ECMs may provide greater or lesser savings in any given building, but the goal of the analysis is to provide aggregate information at a citywide level to help prioritize efforts for City policymakers. In some instances, ECMs that are particularly effective in an individual building may not yield significant GHG reductions on a citywide scale simply because there are relatively few buildings where the ECM is applicable. Each ECM was also analyzed independently of other related ECMs, which means that the effects of one ECM are not reflected in the effects of other ECMs.

The City compared the ECMs analyzed for each building system to understand the relative GHG reduction potential and costs for similar measures.

## LIGHTING EFFICIENCY MEASURES

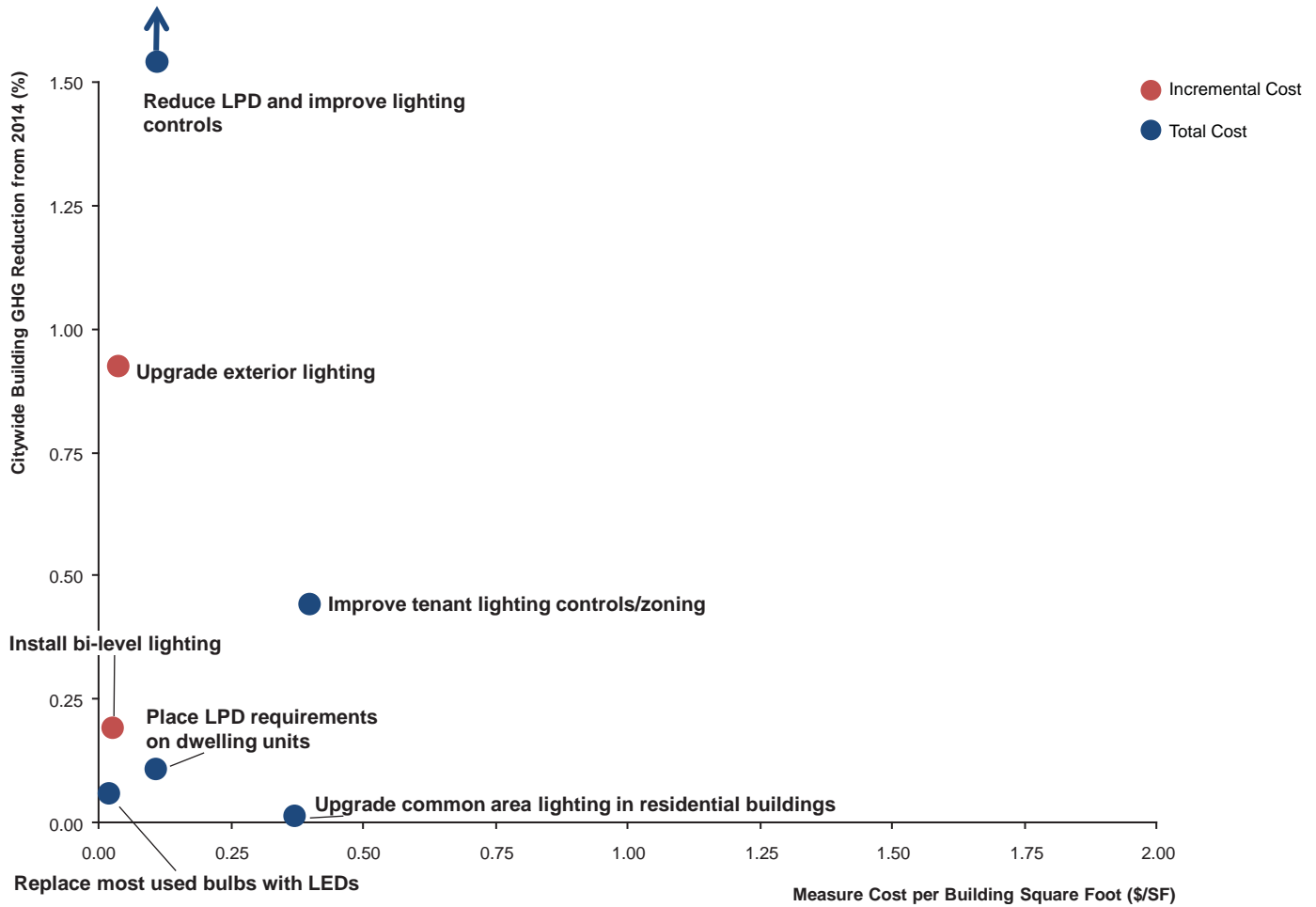

Individual lighting ECMs tend to be low cost, but also generally would yield limited citywide GHG reductions. However, reducing lighting power density (LPD)<sup>17</sup> by roughly 20 percent has the potential to significantly reduce citywide GHG emissions, which is possible given dramatic improvements in lighting technology made in the past several years. Additionally, upgrading the exterior lighting of all buildings could yield significant GHG reductions at a low incremental cost.

Lighting technology is improving rapidly and the City’s existing codes and laws will need to keep pace. The City already requires owners of large buildings greater than 50,000 square feet in area to implement lighting upgrades that meet the current New York City Energy Conservation Code (Energy Code) in all non-residential leased spaces larger than 10,000 square feet by 2025. The City can work to bring these requirements, and the associated energy-saving opportunities, to more buildings across the city.

## Summary of Lighting Efficiency Measures

ECM name	Cost per SF of building (\$/SF)	Reduction in building citywide GHG (%)	Annual cost savings per SF of building (\$/SF)	Total GHG reduction (MtCO2e)	Cost per lb. of CO2e abated (\$/lb. CO2e)	Average reduction in GHG for applicable buildings (%)	Percent of citywide building area applicable (%)**	Applicable typologies
Reduce LPD and improve lighting controls	\$ 0.11	2.08%	\$ 0.04	0.74	\$0.35	2.1%	96%	F, M, C, ID, IS
Install bi-level lighting*	\$ 0.03	0.19%	\$ 0.01	0.07	\$0.66	0.3%	60%	M, C, ID, IS
Improve tenant lighting controls/zoning	\$ 0.40	0.44%	\$ 0.07	0.16	\$0.68	2.0%	11%	C
Upgrade common area lighting in residential buildings	\$ 0.37	0.01%	\$ 0.00	0.00	\$28.99	0.1%	13%	M
Upgrade exterior lighting	\$ 0.04	0.92%	\$ 0.02	0.33	\$0.20	1.4%	67%	F, M, C, ID, IS
Place LPD requirements on dwelling units	\$ 0.11	0.10%	\$ 0.01	0.04	\$1.43	0.7%	20%	M
Replace most used bulbs with LEDs	\$ 0.02	0.06%	\$ 0.00	0.02	\$0.81	0.2%	33%	F, M

\*Indicates Incremental Measures  
 \*\*Applicable area includes the whole building floor area of all buildings in which the measures can be implemented  
 F = 1-4 Family, M = Multifamily, C = Commercial, ID = Industrial, IS = Institutional

Note: Because of overlap between ECMs, reductions in building-based GHG emissions from individual measures cannot be added together.

# PLUG LOAD EFFICIENCY MEASURES

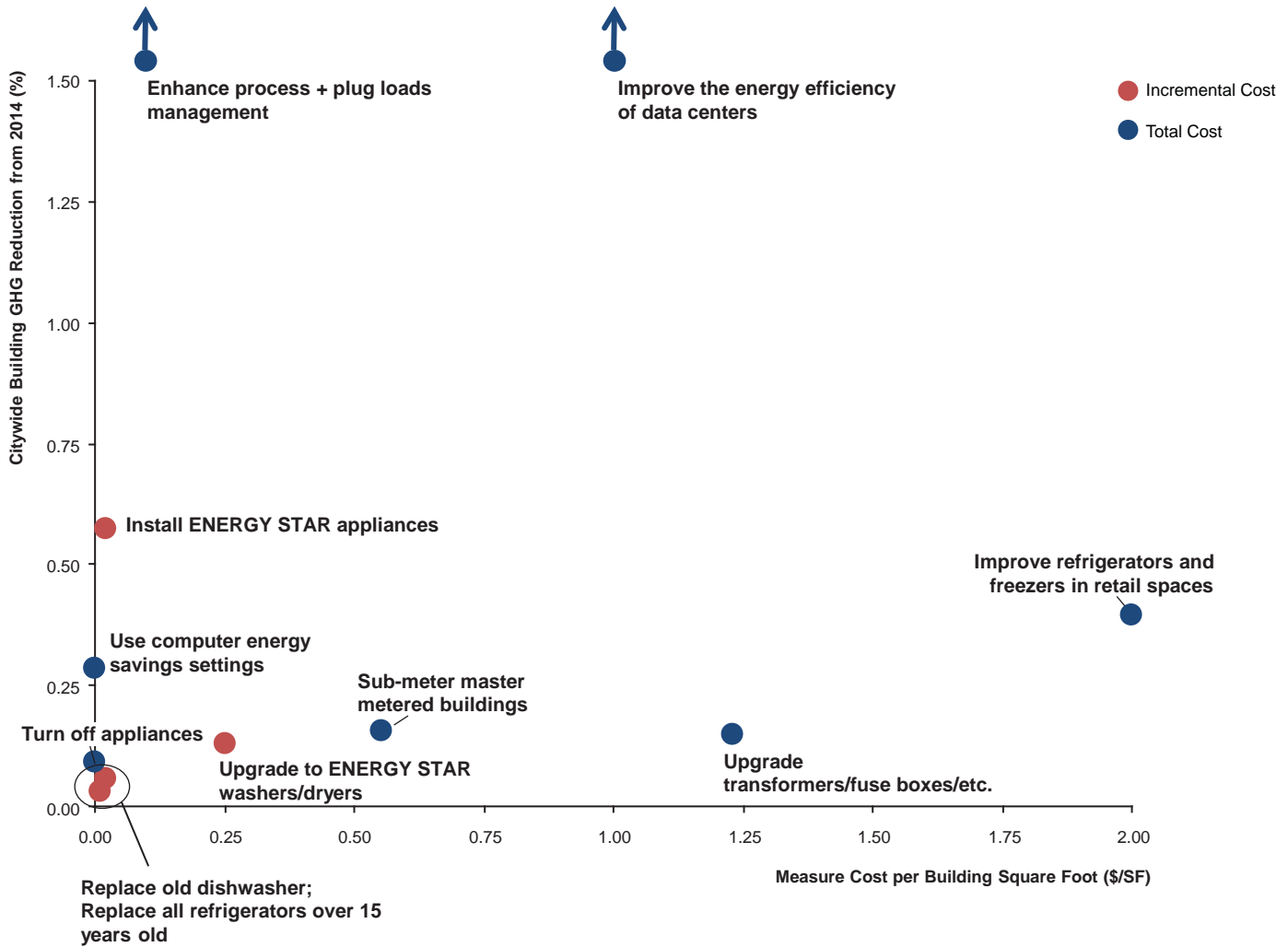

Plug load energy use is attributable to the electricity used by items that are plugged into an electrical outlet, which range from appliances and personal electronics to computers, data centers, and laboratory equipment. Many ECMs that address plug load energy consumption are relatively low cost and several have the potential to yield significant citywide GHG reductions. Particularly cost-effective ECMs include managing process loads from computers, improving the efficiency of data servers, replacing appliances with ENERGY STAR® appliances, and improving the efficiency of refrigerators and freezers in retail spaces. Much of this potential is currently unregulated by existing laws and would require increased coordination and engagement with building tenants and residents to foster fundamental behavior changes among building occupants.

## Summary of Plug Load Measures

ECM name	Cost per SF of building (\$/SF)	Reduction in building citywide GHG (%)	Annual cost savings per SF of building (\$/SF)	Total GHG reduction (MtCO2e)	Cost per lb. of CO2e abated (\$/lb. CO2e)	Average reduction in GHG for applicable buildings (%)	Percent of citywide building area applicable (%)**	Applicable typologies
Sub-meter master metered buildings	\$ 0.55	0.15%	\$ 0.03	0.05	\$2.08	2.5%	8%	F, M, C
Replace all refrigerators over 15 years old*	\$ 0.02	0.06%	\$ 0.01	0.02	\$0.26	0.7%	11%	F, M
Enhance process & plug load management	\$ 0.10	2.02%	\$ 0.04	0.72	\$0.33	2.0%	96%	F, M, C, ID, IS
Upgrade transformers/fuse boxes/etc.	\$ 1.23	0.15%	\$ 0.01	0.05	\$19.64	0.4%	34%	M, C, ID, IS
Improve the energy efficiency of data centers	\$ 1.00	1.67%	\$ 0.24	0.60	\$0.48	7.3%	12%	C
Install ENERGY STAR appliances*	\$ 0.02	0.57%	\$ 0.04	0.20	\$0.05	2.4%	23%	F, M, C, IS
Improve refrigerators and freezers in retail spaces	\$ 2.00	0.39%	\$ 1.36	0.14	\$0.17	40.8%	1%	C
Replace old dishwasher*	\$ 0.01	0.03%	\$ 0.00	0.01	\$0.48	0.2%	21%	F, M
Turn off appliances	\$ -	0.09%	\$ 0.01	0.03	\$0.00	1.0%	13%	F, M
Use computer energy savings settings	\$ -	0.28%	\$ 0.04	0.10	\$0.00	1.3%	12%	C, IS
Upgrade to ENERGY STAR washers/dryers	\$ 0.25	0.13%	\$ 0.01	0.05	\$3.36	0.7%	25%	F, M

\*Indicates Incremental Measures

\*\*Applicable area includes the whole building floor area of all buildings in which the measures can be implemented  
F = 1-4 Family, M = Multifamily, C = Commercial, ID = Industrial, IS = Institutional

Note: Because of overlap between ECMs, reductions in building-based GHG emissions from individual measures cannot be added together.



## VENTILATION EFFICIENCY MEASURES

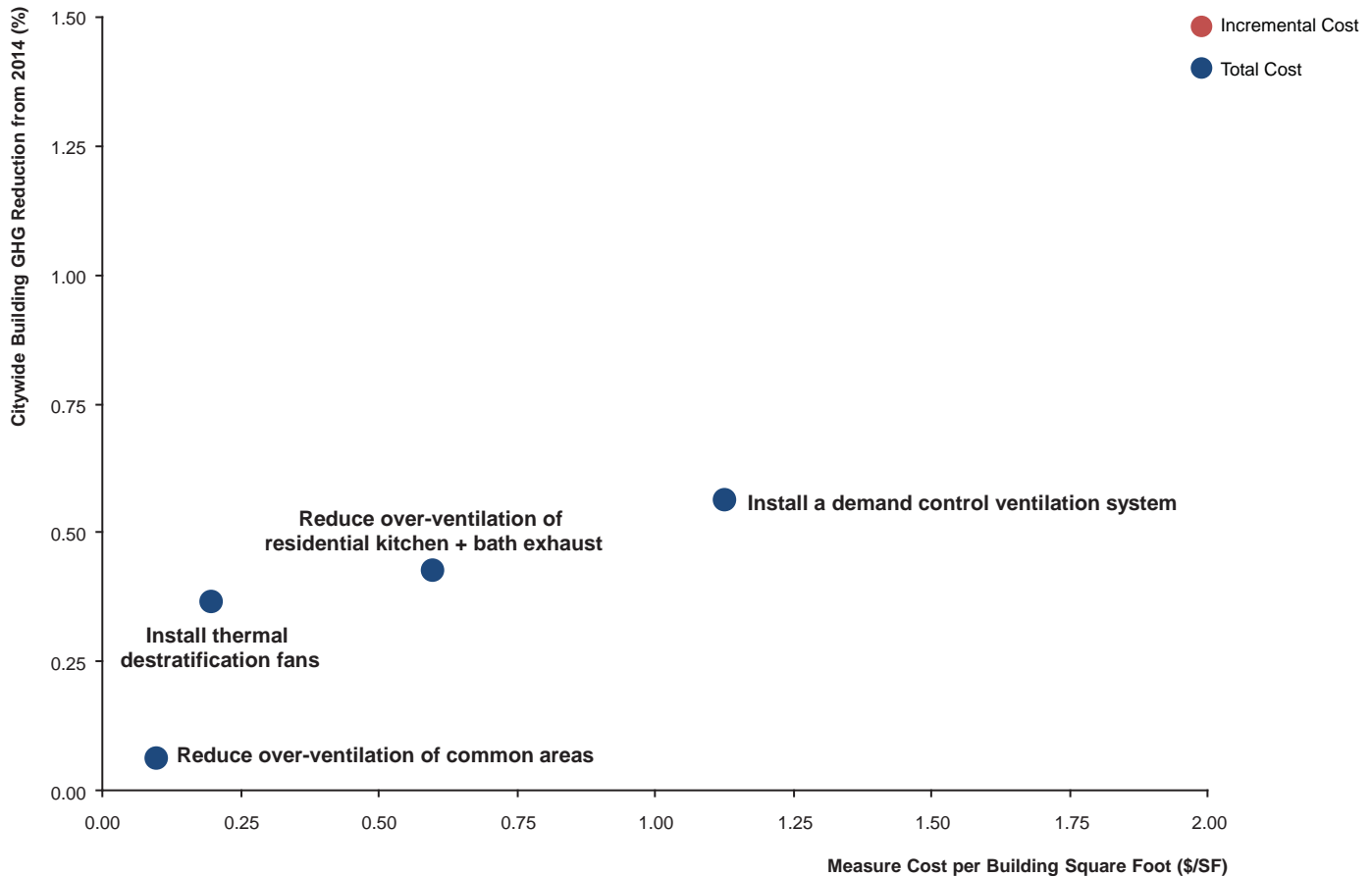

Ventilation systems include all systems that are used to introduce outdoor air into a space or exhaust stale air in order to control thermal comfort and indoor air quality. Ventilation systems are particularly important to implement and properly maintain in conjunction with measures to improve the building envelope in order to ensure adequate supplies of outdoor air to meet indoor air quality requirements.

ECMs that address ventilation systems are relatively low cost. Installing thermal destratification fans in industrial buildings and other large spaces is relatively low cost and could yield substantial energy and GHG reductions in these buildings by significantly improving heating system efficiencies. It is important to note that realizing the full benefits of several of these ECMs, including installing demand controlled ventilation systems, would require enhanced operations and maintenance practices as these systems include more sophisticated controls that need to be monitored.

## Summary of Ventilation Measures

ECM name	Cost per SF of building (\$/SF)	Reduction in building citywide GHG (%)	Annual cost savings per SF of building (\$/SF)	Total GHG reduction (MtCO2e)	Cost per lb. of CO2e abated (\$/lb. CO2e)	Average reduction in GHG for applicable buildings (%)	Percent of citywide building area applicable (%)**	Applicable typologies
Reduce over-ventilation in bath + kitchen exhaust	\$ 0.60	0.42%	\$ 0.03	0.15	\$0.61	9.4%	6%	M
Install a demand control ventilation system	\$ 1.13	0.56%	\$ 0.03	0.20	\$3.68	1.2%	26%	C, ID, IS
Install thermal destratification fans	\$ 0.20	0.37%	\$ 0.32	0.13	\$0.05	12.0%	1%	ID
Reduce over-ventilation of common areas	\$ 0.10	0.06%	\$ 0.03	0.02	\$0.38	1.8%	3%	M, C

\*Indicates Incremental Measures

\*\*Applicable area includes the whole building floor area of all buildings in which the measures can be implemented  
F = 1-4 Family, M = Multifamily, C = Commercial, ID = Industrial, IS = Institutional

Note: Because of overlap between ECMs, reductions in building-based GHG emissions from individual measures cannot be added together.

## BUILDING ENVELOPE EFFICIENCY MEASURES

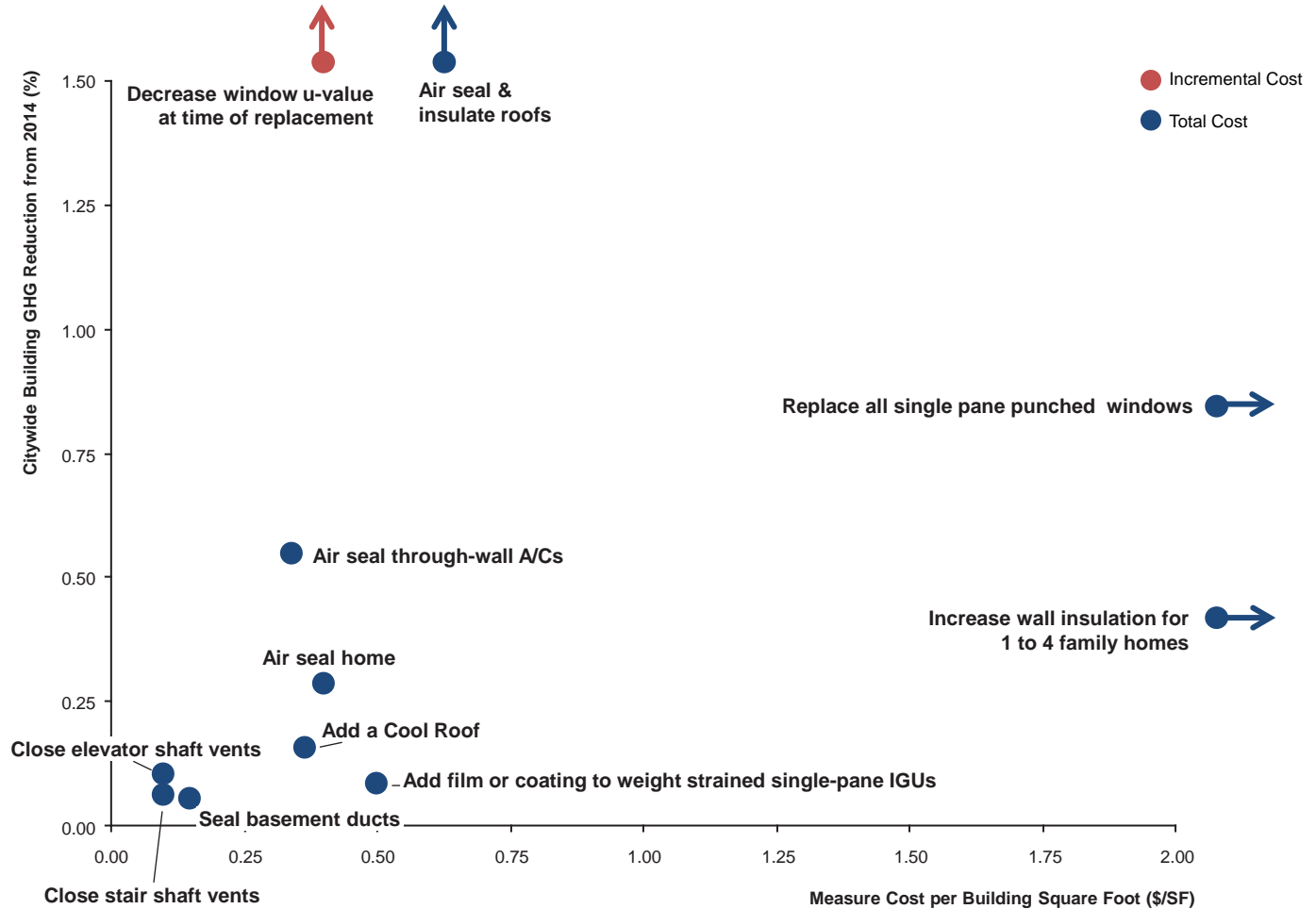

The building envelope consists of a building’s roof, exterior walls, windows, doors, and the foundation. Upgrades to the building envelope have the potential to yield significant citywide GHG reductions through better insulation and air tightness, which reduce demands placed on heating and cooling systems. In some cases these measures can be expensive, but there are a number of low cost measures the City could pursue to capture some of the potential GHG reductions, such as air sealing, closing shaft vents, and sealing basement ducts.

Many of the assessed building envelope measures are only applicable small and mid-sized buildings because this analysis focused on “low- and medium-difficulty” ECMs. For example, wall insulation upgrades in large buildings can be difficult and costly, but can make sense to consider at the time of replacement of major façade components or as part of a strategy to re-position a building in the market. In one- to four-family wood frame homes, blowing wall insulation into existing cavities is a proven and relatively cost-effective method to significantly improve envelope performance in these smaller buildings.

## Summary of Building Envelope Measures

ECM name	Cost per SF of building (\$/SF)	Reduction in building citywide GHG (%)	Annual cost savings per SF of building (\$/SF)	Total GHG reduction (MtCO2e)	Cost per lb. of CO2e abated (\$/lb. CO2e)	Average reduction in GHG for applicable buildings (%)	Percent of citywide building area applicable (%)**	Applicable typologies
Air seal through wall A/Cs	\$ 0.34	0.55%	\$ 0.02	0.19	\$1.83	1.6%	42%	F, M, C, ID, IS
Close elevator shaft vents	\$ 0.10	0.10%	\$ 0.01	0.04	\$1.74	0.3%	26%	M, C, ID, IS
Air seal & insulate roofs	\$ 0.69	1.66%	\$ 0.04	0.59	\$1.99	2.6%	69%	F, M, C, ID, IS
Add a Cool Roof	\$ 0.37	0.15%	\$ 0.01	0.06	\$6.18	0.2%	38%	F, M, C, ID, IS
Replace all single pane punched windows	\$ 5.00	0.84%	\$ 0.06	0.30	\$8.71	3.2%	21%	F, M, C, ID, IS
Decrease window u-value at time of replacement*	\$ 0.33	2.30%	\$ 0.08	0.82	\$0.48	5.3%	49%	F, M, C
Increase wall insulation for 1 to 4 Family Homes	\$ 3.77	0.42%	\$ 0.05	0.15	\$9.46	3.8%	15%	F
Add film or coating to weight strained single-pane IGUs	\$ 0.50	0.08%	\$ 0.03	0.03	\$1.73	1.0%	4%	C
Close stair shaft vents	\$ 0.10	0.06%	\$ 0.01	0.02	\$2.92	0.2%	26%	M, C, ID, IS
Air seal home	\$ 0.40	0.28%	\$ 0.04	0.10	\$1.26	3.0%	13%	F
Seal basement ducts	\$ 0.15	0.05%	\$ 0.00	0.02	\$3.77	0.4%	19%	F

\*Indicates Incremental Measures

\*\*Applicable area includes the whole building floor area of all buildings in which the measures can be implemented  
F = 1-4 Family, M = Multifamily, C = Commercial, ID = Industrial, IS = Institutional

Note: Because of overlap between ECMs, reductions in building-based GHG emissions from individual measures cannot be added together.

## HEATING EQUIPMENT EFFICIENCY MEASURES

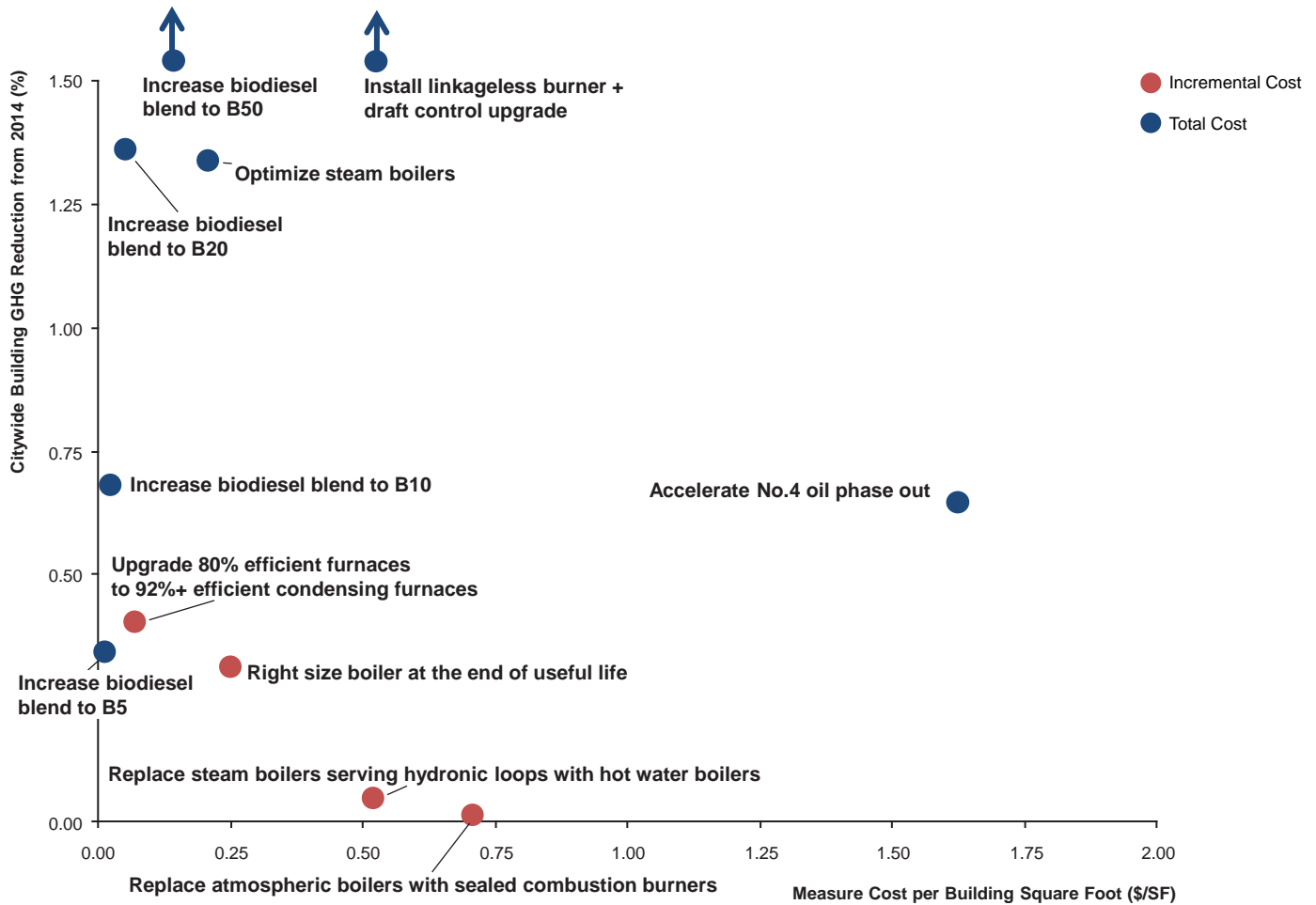

Heating equipment includes the boiler, furnace, or other mechanical means to generate space heating for a building. This category does not include the heating distribution system, which distributes space heating throughout a building, or the DHW system, which produces hot water. Because the energy used for space heating is the most significant end use in New York City buildings and heating equipment is found in every building, many of these ECMs could yield significant citywide GHG reductions.

The incremental cost of implementing heating equipment measures at the time of replacement can make some measures extremely cost-effective. There is also tremendous potential to improve heating system performance at the end of equipment life. For example, atmospheric boilers can be replaced with sealed combustion equipment, new steam boilers can be right sized, steam boilers connected to hydronic heating systems can be replaced with new hydronic boilers, and linkage style burners can be replaced with linkageless technology that automates controls. Given the sizable portion of citywide GHG emissions from space heating, the City may also need to explore opportunities to reduce energy from heating equipment through date-certain requirements, such as accelerating the phase out of No. 4 heating oil.

## Summary of Heating Equipment Measures

ECM name	Cost per SF of building (\$/SF)	Reduction in building citywide GHG (%)	Annual cost savings per SF of building (\$/SF)	Total GHG reduction (MtCO2e)	Cost per lb. of CO2e abated (\$/lb. CO2e)	Average reduction in GHG for applicable buildings (%)	Percent of citywide building area applicable (%)**	Applicable typologies
Install linkageless burner + draft control upgrade	\$ 0.45	2.49%	\$ 0.08	0.89	\$0.58	5.4%	47%	M, C, ID, IS
Replace atmospheric boilers with sealed combustion burner*	\$ 0.71	0.01%	\$ 0.17	0.00	\$0.50	11.4%	0%	M, C
Replace steam boilers serving hydronic loops with hot water boilers*	\$ 0.52	0.05%	\$ 0.05	0.02	\$1.09	3.6%	1%	M, C
Upgrade 80% efficient furnaces to 92%+ efficient condensing furnaces*	\$ 0.07	0.40%	\$ 0.08	0.14	\$0.11	5.7%	9%	F, M, ID, IS
Increase biodiesel blend to B5	\$ 0.01	0.34%	N/A	0.12	\$0.05	2.1%	18%	F, M, C, ID, IS
Accelerate No. 4 oil phase out	\$ 1.60	0.67%	\$ 0.23	0.24	\$0.56	32.1%	4%	F, M, C, ID, IS
Increase biodiesel blend to B10	\$ 0.03	0.68%	N/A	0.24	\$0.05	4.1%	18%	F, M, C, ID, IS
Increase biodiesel blend to B20	\$ 0.05	1.36%	N/A	0.48	\$0.05	8.3%	18%	F, M, C, ID, IS
Increase biodiesel blend to B50	\$ 0.21	1.34%	\$ 0.04	0.48	\$0.05	2.9%	0%	F, M, C, ID, IS
Optimize steam boilers	\$ 0.25	0.31%	\$ 0.01	0.11	\$0.00	0.7%	47%	M, C, ID, IS
Right size steam boilers at the end of useful life*	\$ 0.45	2.49%	\$ 0.08	0.89	\$2.59	5.4%	47%	M, C, ID, IS

\*Indicates Incremental Measures

\*\*Applicable area includes the whole building floor area of all buildings in which the measures can be implemented  
F = 1-4 Family, M = Multifamily, C = Commercial, ID = Industrial, IS = Institutional

Note: Because of overlap between ECMs, reductions in building-based GHG emissions from individual measures cannot be added together.

# DOMESTIC HOT WATER EFFICIENCY MEASURES

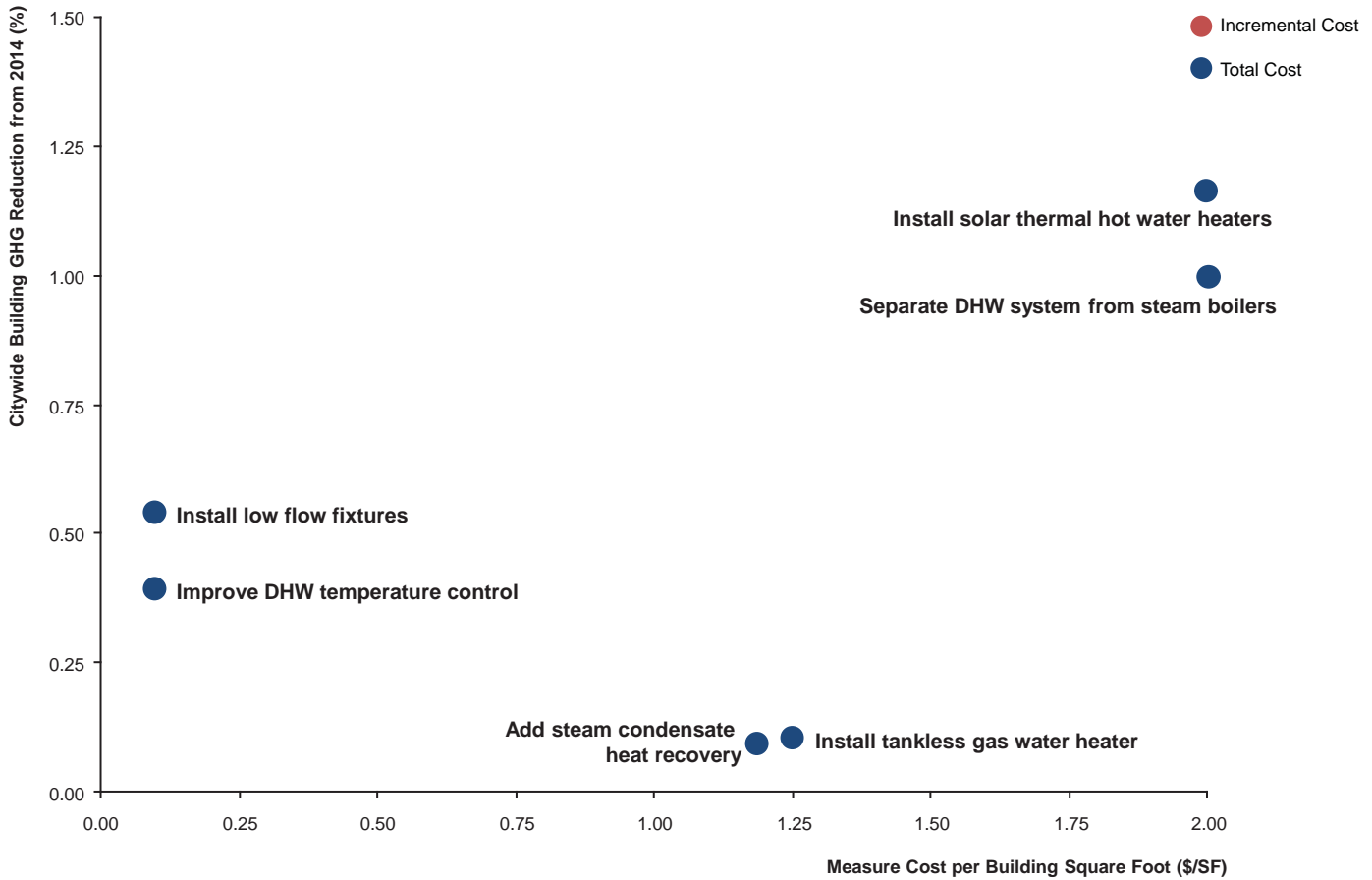

DHW systems produce and distribute the hot water that tenants and residents use in a building at sinks, showerheads, clothes washers, and dishwashers. Given the large share of energy that is used for DHW production in multifamily buildings, improving the efficiency of these systems can have a significant impact on the energy used in these buildings, although the citywide impact for most measures is less significant than measures for other systems. Particularly cost-effective opportunities include improving DHW temperature control and installing low flow fixtures. While more expensive, the installation of solar thermal systems (also referred to as solar hot water) presents a clean, renewable energy solution to DHW production, although it would require new policies and markets to help bring these projects to scale.

## Summary of DHW Measures

ECM name	Cost per SF of building (\$/SF)	Reduction in building citywide GHG (%)	Annual cost savings per SF of building (\$/SF)	Total GHG reduction (MtCO2e)	Cost per lb. of CO2e abated (\$/lb. CO2e)	Average reduction in GHG for applicable buildings (%)	Percent of citywide building area applicable (%)**	Applicable typologies
Install low flow fixtures	\$ 0.10	0.54%	\$ 0.01	0.19	\$1.13	0.6%	88%	F, M, C, ID, IS
Improve DHW temperature control	\$ 0.10	0.39%	\$ 0.02	0.14	\$0.71	1.0%	40%	F, M, C
Add steam condensate heat recovery	\$ 1.19	0.09%	\$ 0.01	0.03	\$47.32	0.2%	52%	M, C, ID, IS
Separate DHW system from steam boilers	\$ 2.07	0.96%	\$ 0.05	0.34	\$0.00	4.1%	0%	M, C
Install solar thermal hot water heaters	\$ 2.00	1.16%	\$ 0.15	0.41	\$1.50	9.1%	17%	F, M, C, ID, IS
Install tankless gas water heater	\$ 1.25	0.10%	\$ 0.01	0.04	\$16.14	0.7%	19%	F

\*Indicates Incremental Measures

\*\*Applicable area includes the whole building floor area of all buildings in which the measures can be implemented  
F = 1-4 Family, M = Multifamily, C = Commercial, ID = Industrial, IS = Institutional

Note: Because of overlap between ECMs, reductions in building-based GHG emissions from individual measures cannot be added together.



# CENTRAL COOLING SYSTEM EFFICIENCY MEASURES

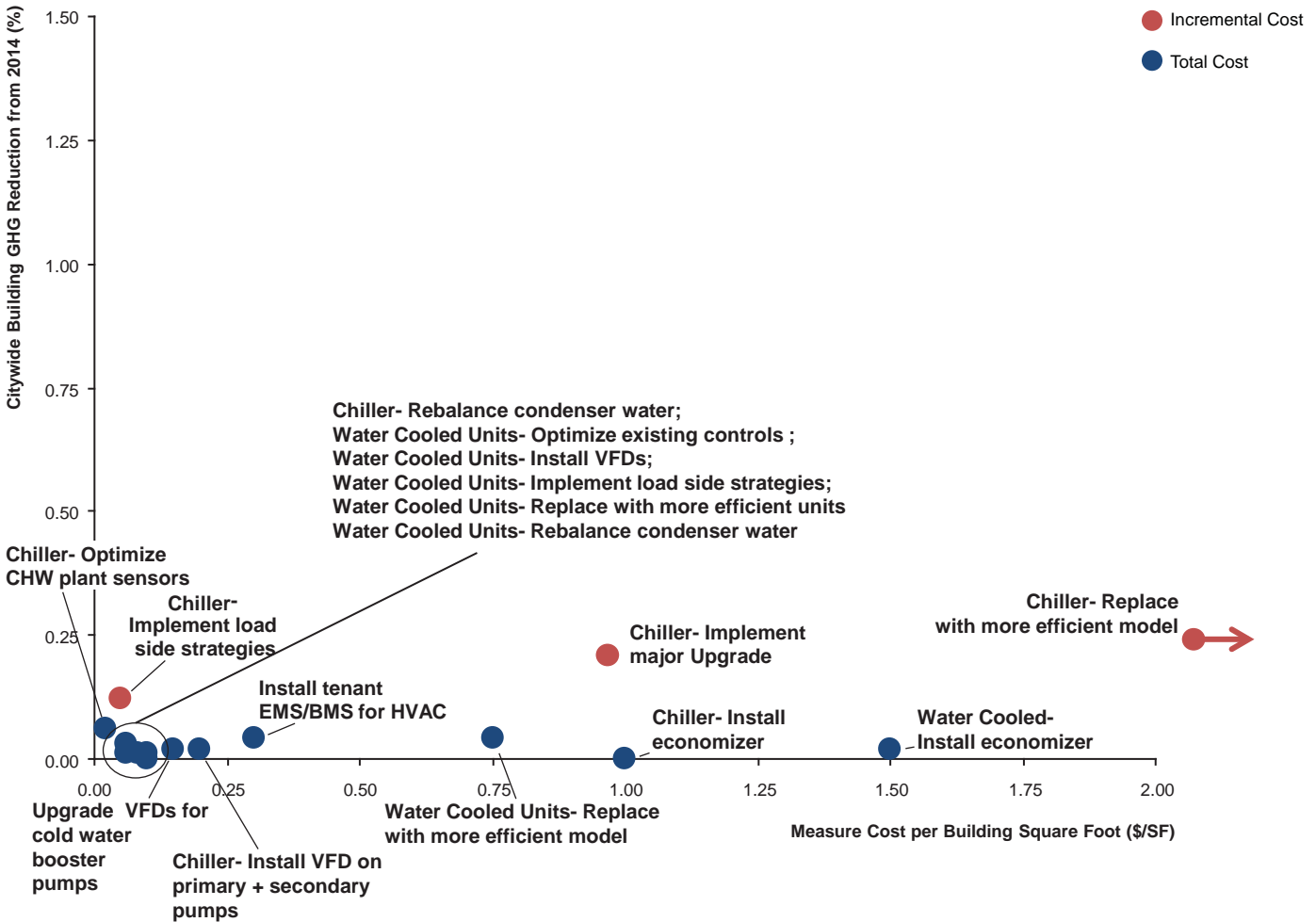

Central cooling systems include central chilled water systems — which consist of chillers, cooling towers, and ancillary equipment that serve air handling units and perimeter systems — or base-building condenser water loops that serve water-cooled DX units. Central cooling systems are common in large commercial buildings built in the 21st century, and upgrades to these systems can yield significant savings for individual buildings. These measures can be highly cost-effective when implemented at the time of system replacement, and cooling loads could be further reduced by addressing other sources of thermal loads in a building, such as process loads. However, given that central cooling systems vary significantly across building typologies and are relatively uncommon in New York City’s buildings, most of these ECMs would not yield significant GHG reductions at a citywide level.

## Summary of Central Cooling Measures

ECM name	Cost per SF of building (\$/SF)	Reduction in building citywide GHG (%)	Annual cost savings per SF of building (\$/SF)	Total GHG reduction (MtCO2e)	Cost per lb. of CO2e abated (\$/lb. CO2e)	Average reduction in GHG for applicable buildings (%)	Percent of citywide building area applicable (%)**	Applicable typologies
Install tenant BMS for HVAC	\$ 0.30	0.04%	\$ 0.01	0.02	\$4.70	0.2%	10%	C
Chiller- Replace with more efficient model*	\$ 0.82	0.14%	\$ 0.04	0.05	\$2.26	1.7%	6%	M, C, ID, IS
Chiller- Rebalance condenser water	\$ 0.06	0.03%	\$ 0.00	0.01	\$1.12	0.2%	10%	M, C, ID, IS
Chiller- Install major upgrade*	\$ 3.00	0.24%	\$ 0.06	0.09	\$4.76	2.9%	6%	M, C, ID, IS
Chiller- Optimize CHW plant sensors	\$ 0.02	0.06%	\$ 0.01	0.02	\$0.25	0.4%	11%	M, C, ID, IS
Chiller- Implement load side strategies	\$ 0.05	0.12%	\$ 0.02	0.04	\$0.32	0.7%	11%	M, C, ID, IS
Chiller- Install VFD on primary + secondary pumps	\$ 0.20	0.02%	\$ 0.00	0.01	\$4.21	0.2%	5%	M, C, ID, IS
Chiller- Install economizer	\$ 1.00	0.00%	\$ 0.00	0.00	\$31.58	0.2%	2%	M, C, ID, IS
Water Cooled Units- Rebalance condenser water	\$ 0.10	0.00%	\$ 0.00	0.00	\$4.53	0.1%	0%	M, C, IS
Water Cooled Units- Optimize existing controls	\$ 0.06	0.01%	\$ 0.02	0.00	\$0.26	0.9%	1%	M, C, IS
Water Cooled Units- Implement load side strategies	\$ 0.10	0.01%	\$ 0.01	0.00	\$1.70	0.2%	2%	M, C, IS
Water Cooled Units- Install VFDs	\$ 0.08	0.01%	\$ 0.01	0.00	\$0.68	0.5%	1%	M, C, IS
Water Cooled- Install economizer	\$ 1.50	0.02%	\$ 0.02	0.01	\$6.83	0.9%	1%	M, C, IS
Water Cooled Units- Replace with more efficient model*	\$ 0.75	0.04%	\$ 0.05	0.01	\$1.59	1.8%	1%	M, C, IS
Upgrade VFD for cold water booster pumps	\$ 0.15	0.02%	\$ 0.01	0.01	\$4.65	0.3%	8%	M

\*Indicates Incremental Measures

\*\*Applicable area includes the whole building floor area of all buildings in which the measures can be implemented  
F = 1-4 Family, M = Multifamily, C = Commercial, ID = Industrial, IS = Institutional

Note: Because of overlap between ECMs, reductions in building-based GHG emissions from individual measures cannot be added together.

## NON-CENTRAL COOLING SYSTEM EFFICIENCY MEASURES

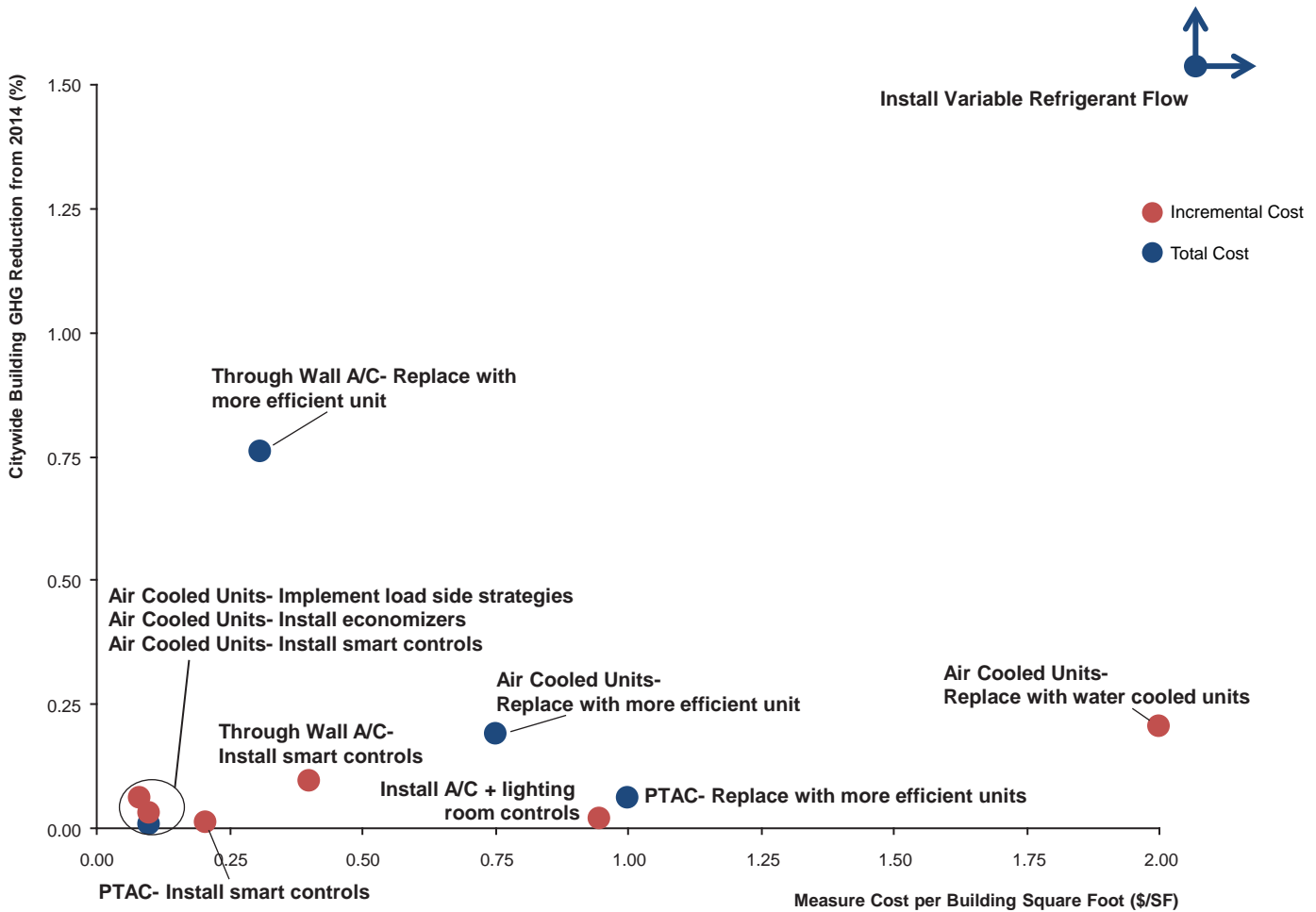

Non-central cooling systems provide cooling to individual rooms or specific zones of a building. These systems include PTACs, window air conditioners, through-wall air conditioners, and air-cooled packaged units (ACPU). Non-central cooling systems are much more common than central cooling systems in New York City buildings, particularly in residential buildings and in pre-war commercial buildings.

Because these cooling systems vary significantly across building typologies, individual ECMs would not yield significant citywide GHG reductions. However if all relevant buildings implemented these ECMs, altogether they would yield a 2.5 percent reduction in citywide building-based GHG emissions. These systems typically have relatively short replacement cycles and there have been dramatic improvements in their efficiency in recent years, meaning that many non-central cooling systems are already operating relatively efficiently. The key exception is installing variable refrigerant flow (VRF) systems, which has a significant potential to reduce GHG emissions in many commercial buildings — and could even be used to provide heat in some buildings — although these systems can be costly to implement. In addition, air sealing room air conditioners and PTACs at the time of replacement could significantly improve efficiencies by reducing heating losses in the winter and cooling losses in the summer.

## Summary of Non-Central Cooling System Measures

ECM name	Cost per SF of building (\$/SF)	Reduction in building citywide GHG (%)	Annual cost savings per SF of building (\$/SF)	Total GHG reduction (MtCO2e)	Cost per lb. of CO2e abated (\$/lb. CO2e)	Average reduction in GHG for applicable buildings (%)	Percent of citywide building area applicable (%)**	Applicable typologies
PTAC- Replace with more efficient units	\$ 1.00	0.06%	\$ 0.05	0.02	\$2.45	3.3%	2%	M, C, IS
Install A/C + Lighting room controls	\$ 0.95	0.02%	\$ 0.35	0.01	\$0.31	10.6%	0%	C
Through Wall A/C- Replace with more efficient unit	\$ 0.31	0.76%	\$ 0.05	0.27	\$0.70	3.6%	25%	F, M, C, ID, IS
Air Cooled Units- Install smart controls	\$ 0.08	0.06%	\$ 0.02	0.02	\$0.40	0.9%	5%	M, C, ID, IS
Air Cooled Units- Install load side strategies	\$ 0.10	0.03%	\$ 0.01	0.01	\$2.09	0.2%	9%	M, C, ID, IS
Air Cooled Units- Install economizer	\$ 0.10	0.01%	\$ 0.03	0.00	\$0.42	1.1%	1%	M, C, ID, IS
Air Cooled Units- Replace with more efficient unit	\$ 0.75	0.19%	\$ 0.00	0.07	\$2.22	1.5%	8%	M, C, ID, IS
Air Cooled Units- Replace with water cooled units	\$ 2.00	0.20%	\$ 0.07	0.07	\$3.02	2.9%	5%	M, C, ID, IS
PTAC- Install smart controls	\$ 0.20	0.01%	\$ 0.01	0.00	\$3.47	0.5%	3%	M, C, IS
Through Wall A/C- Install smart controls	\$ 0.40	0.09%	\$ 0.01	0.03	\$6.14	0.5%	21%	F, M, C, ID, IS
Install variable refrigerant flow	\$ 10.92	1.53%	\$ 0.47	0.55	\$2.33	18.0%	5%	C, IS

\*Indicates Incremental Measures

\*\*Applicable area includes the whole building floor area of all buildings in which the measures can be implemented  
F = 1-4 Family, M = Multifamily, C = Commercial, ID = Industrial, IS = Institutional

Note: Because of overlap between ECMs, reductions in building-based GHG emissions from individual measures cannot be added together.

## HEATING DISTRIBUTION SYSTEM MEASURES (NON-STEAM)

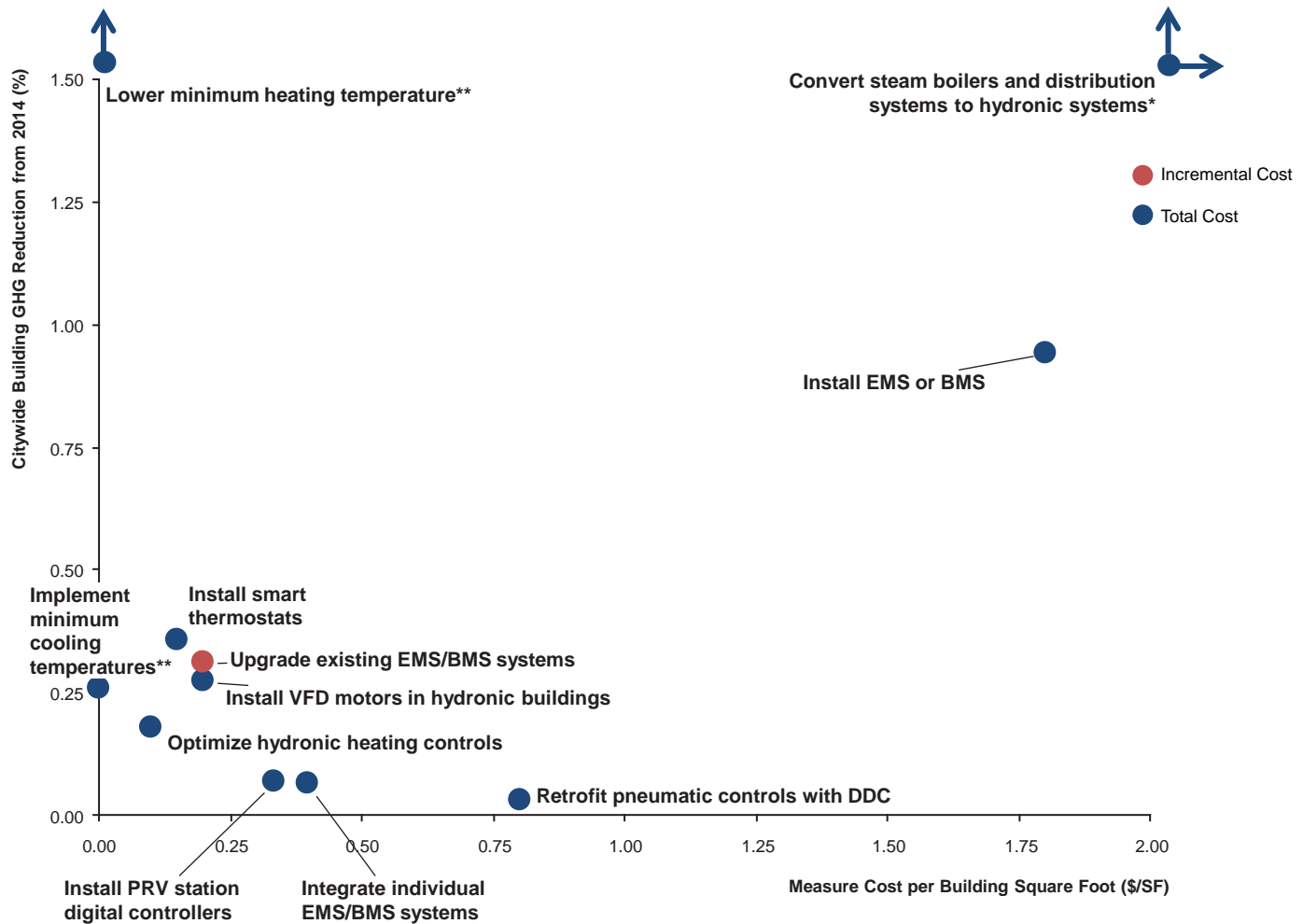

\*Analysis of the impacts of converting steam boilers and distribution systems to hydronic systems applies only to buildings with on-site boilers. The analysis does not include buildings converting off of Con Edison's district steam system.

\*\*Assumes system is operating at optimally to achieve GHG reductions at no cost.

Heating distribution for non-steam systems include systems in a building that carry hot water or warm air from a space heating generation device, such as a boiler or heat pump, to the end unit in a room, such as a radiator or fan coil. Given the prevalence of steam heating systems in New York City and the significant opportunities that exist to improve their efficiency, ECMs for non-steam distribution systems were analyzed separately from steam heating distribution system measures.

There are many opportunities to improve non-steam heating distribution system performance through the use of EMS or BMS. However, realizing this potential would require some level of operations and maintenance for these systems and training for building staff to monitor and properly calibrate these systems. Installing smart thermostats to provide building occupants with control over temperatures in individual rooms and apartments is one relatively low-cost option, but, in large buildings, this would require that an EMS or BMS has already been installed.

## Summary of Non-Steam Heating Distribution System Measures

ECM name	Cost per SF of building (\$/SF)	Reduction in building citywide GHG (%)	Annual cost savings per SF of building (\$/SF)	Total GHG reduction (MtCO2e)	Cost per lb. of CO2e abated (\$/lb. CO2e)	Average reduction in GHG for applicable buildings (%)	Percent of citywide building area applicable (%)**	Applicable typologies
Install PRV station digital controllers	\$ 0.33	0.07%	\$ 0.01	0.02	\$2.06	0.7%	6%	C, ID, IS
Lower minimum heating temperature***	\$ -	2.65%	\$ 0.04	0.95	\$0.00	2.7%	96%	F, M, C, ID, IS
Upgrade existing EMS/BMS systems*	\$ 0.20	0.31%	\$ 0.06	0.11	\$0.33	2.5%	7%	C, IS
Integrate individual EMS/BMS systems	\$ 0.40	0.07%	\$ 0.04	0.02	\$1.24	1.3%	3%	C, IS
Install EMS or BMS	\$ 1.80	0.94%	\$ 0.11	0.34	\$1.57	5.0%	12%	C, IS
Retrofit pneumatic controls with DDC	\$ 0.80	0.03%	\$ 0.03	0.01	\$2.36	1.2%	1%	C
Convert steam boilers and distribution to hydronic	\$ 9.97	11.71%	\$ 0.32	4.18	\$3.42	21.5%	58%	F, M, C, ID, IS
Implement minimum cooling temperature***	\$ -	0.26%	\$ 0.11	0.09	\$0.00	0.9%	14%	C
Install VFD motors in hydronic buildings	\$ 0.20	0.27%	\$ 0.05	0.10	\$0.53	2.2%	11%	M, C, ID, IS
Optimize hydronic heating controls	\$ 0.10	0.18%	\$ 0.04	0.06	\$0.27	2.2%	7%	M, C, ID, IS
Install smart thermostats	\$ 0.15	0.36%	\$ 0.06	0.13	\$0.29	4.9%	10%	F

\*Indicates Incremental Measures

\*\*Applicable area includes the whole building floor area of all buildings in which the measures can be implemented

\*\*\*Measures assume system is operating optimally in order to achieve GHG savings at no cost

F = 1-4 Family, M = Multifamily, C = Commercial, ID = Industrial, IS = Institutional

Note: Because of overlap between ECMs, reductions in building-based GHG emissions from individual measures cannot be added together.

## STEAM HEATING DISTRIBUTION SYSTEM EFFICIENCY MEASURES

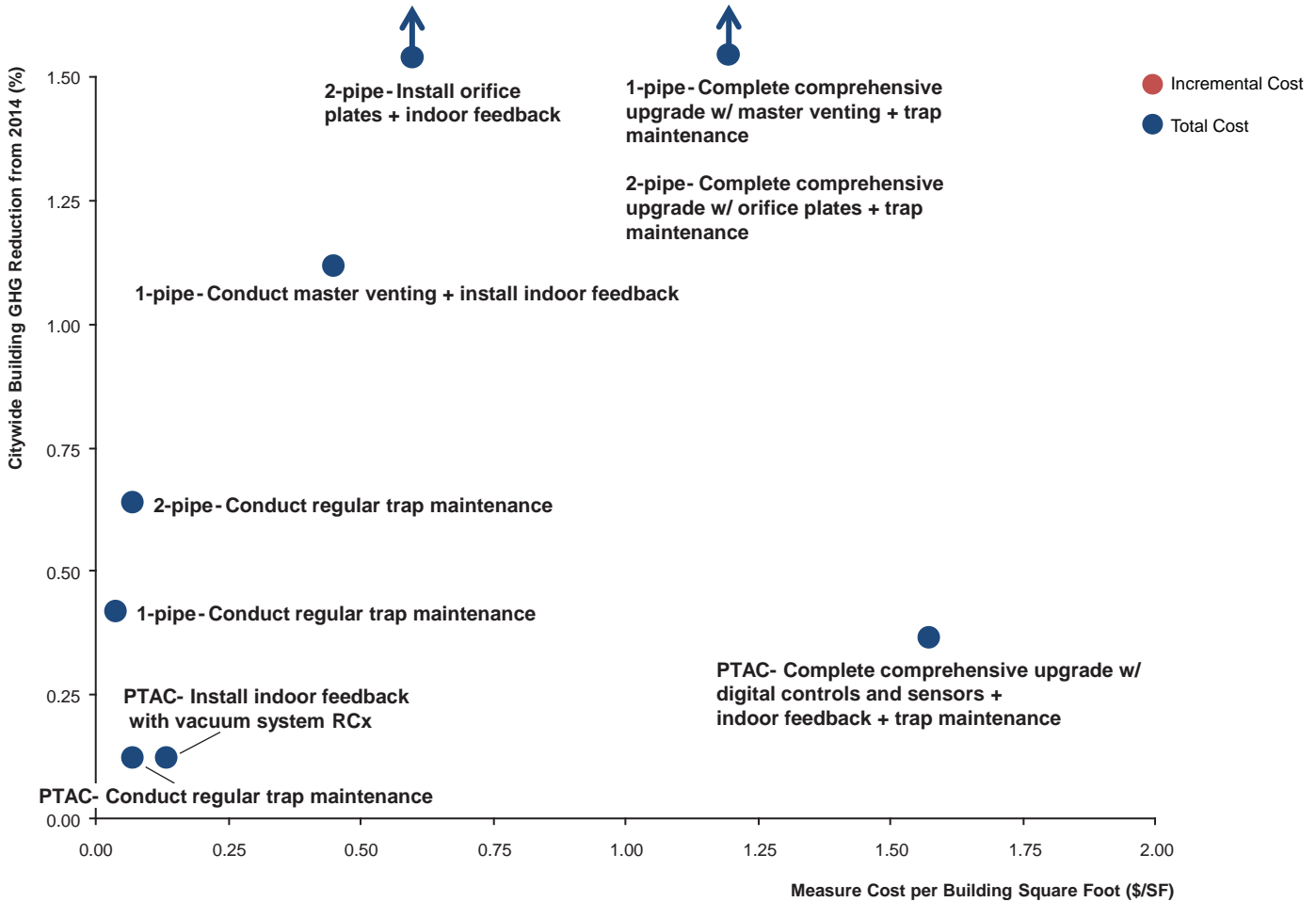

Given the prevalence of steam heated buildings in New York City, ECMs targeted at improving the performance of steam systems represent one of the most significant opportunities to reduce citywide GHG emissions. Comprehensive steam system upgrades in all buildings with steam distribution systems could collectively reduce building-based GHG emissions by five percent.

Incremental upgrades, such as regular maintenance and steam trap replacements, can be cost-effective options that could yield a meaningful portion of all of this potential. Realizing the comfort and quality of life benefits associated with well-balanced steam distribution systems would require a comprehensive scope of work to address the root causes of unbalanced systems that cause over- and under-heating within a building.

## Summary of Steam Heating Distribution System Measures

ECM name	Cost per SF of building (\$/SF)	Reduction in building citywide GHG (%)	Annual cost savings per SF of building (\$/SF)	Total GHG reduction (MtCO2e)	Cost per lb. of CO2e abated (\$/lb. CO2e)	Average reduction in GHG for applicable buildings (%)	Percent of citywide building area applicable (%)**	Applicable typologies
1 Pipe- Conduct master venting + install indoor feedback	\$ 0.45	1.12%	\$ 0.09	0.40	\$0.57	6.4%	21%	M, C, ID, IS
1 Pipe- Conduct regular trap maintenance	\$ 0.04	0.42%	\$ 0.03	0.15	\$0.13	2.4%	21%	M, C, ID, IS
1 Pipe- Complete comprehensive upgrade w/ room controls + master venting + trap maintenance	\$ 1.20	2.09%	\$ 0.17	0.75	\$0.82	12.0%	21%	M, C, ID, IS
2 Pipe- Conduct regular trap maintenance	\$ 0.07	0.64%	\$ 0.05	0.23	\$0.13	3.1%	17%	M, C, ID, IS
2 Pipe- Install orifice plates + indoor feedback	\$ 0.60	1.53%	\$ 0.13	0.55	\$0.46	7.4%	17%	M, C, ID, IS
2 Pipe- Complete comprehensive upgrade w/ room controls + orifice plates + trap maintenance	\$ 1.20	2.56%	\$ 0.22	0.91	\$0.56	12.4%	17%	M, C, ID, IS
PTAC- Conduct regular trap maintenance	\$ 0.07	0.12%	\$ 0.05	0.04	\$0.14	3.4%	3%	M, C, ID, IS
PTAC- Install indoor feedback with vacuum system RCx	\$ 0.13	0.12%	\$ 0.00	0.04	\$0.26	3.4%	3%	M, C, ID, IS
PTAC- Complete comprehensive upgrade with digital controls and sensors + Indoor feedback + trap maintenance	\$ 1.57	0.36%	\$ 0.16	0.13	\$1.03	10.2%	3%	M, C, ID, IS

\*Indicates Incremental Measures

\*\*Applicable area includes the whole building floor area of all buildings in which the measures can be implemented  
F = 1-4 Family, M = Multifamily, C = Commercial, ID = Industrial, IS = Institutional

Note: Because of overlap between ECMs, reductions in building-based GHG emissions from individual measures cannot be added together.



## ON-SITE DISTRIBUTED GENERATION MEASURES

On-site distributed generation measures include technologies that can generate electricity directly on the property for a building. For this study, the City analyzed the potential of solar photovoltaic (PV) and packaged combined heat and power (CHP) systems of 50-500 kilowatts (kW) that could be installed on-site in a building and serve a portion of that building's electric load.

Installing solar PV on rooftops with available space represents significant citywide GHG reduction potential. While solar PV currently has a high cost, these costs are rapidly decreasing as the technology improves. Packaged CHP systems of 50-500 kW, which are typically sized to meet a building's DHW load, do not yield significant citywide GHG reductions. The modest citywide savings associated with this ECM are due in part to the fact that this analysis only considered the largest multifamily buildings and hotels. In addition, New York City's electricity supply is relatively clean compared to other cities, which reduces the potential carbon savings from on-site CHP.

It is important to note that greater efficiencies could be realized through district energy solutions to distributed generation. District CHP systems were not analyzed in this study. These opportunities will be further assessed as part of the City's comprehensive 80 x 50 planning process.

### Summary of On-site Distributed Generation Measures

ECM name	Cost per SF of building (\$/SF)	Reduction in building citywide GHG (%)	Annual cost savings per SF of building (\$/SF)	Total GHG reduction (MtCO2e)	Cost per lb. of CO2e abated (\$/lb. CO2e)	Average reduction in GHG for applicable buildings (%)	Percent of citywide building area applicable (%)**	Applicable typologies
Install packaged cogeneration systems (50-500 kW)	\$10.91	0.04%	\$0.00	0.01	\$516.77	0.2%	26%	M
Install solar PV on all buildings with enough roof space	\$14.00	5.54%	\$0.70	1.98	\$2.32	43.2%	13%	F, M, C, ID, IS

\*Indicates Incremental Measures  
 \*\*Applicable area includes the whole building floor area of all buildings in which the measures can be implemented  
 F = 1-4 Family, M = Multifamily, C = Commercial, ID = Industrial, IS = Institutional

Note: Because of overlap between ECMs, reductions in building-based GHG emissions from individual measures cannot be added together.

## FINDINGS

Fig. 24. Technical Potential for GHG Reductions from ECMs by Building System (MtCO<sub>2</sub>e)

Source: NYC Mayor's Office

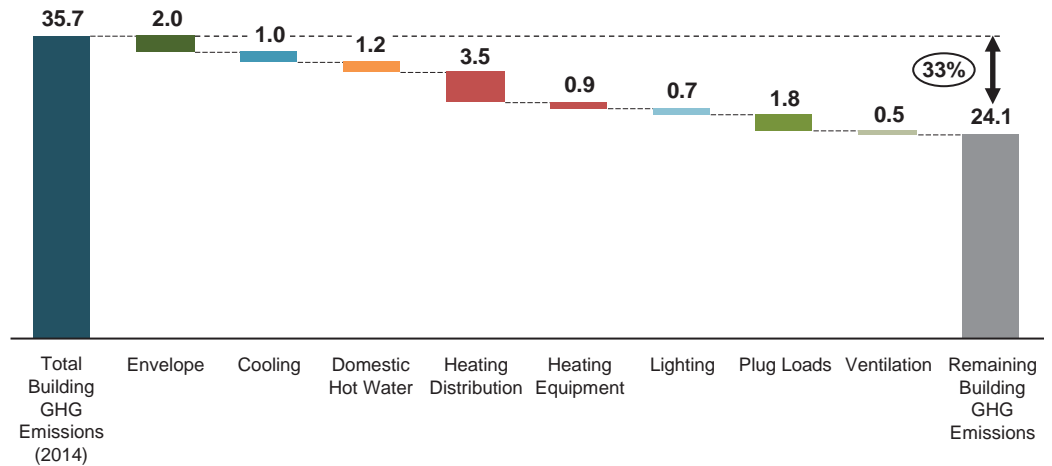

If every applicable building immediately implemented these cost-effective ECMs, they would reduce GHG emissions by 11.6 MtCO<sub>2</sub>e. This translates to a 33 percent reduction in current GHG emissions from the energy used in New York City's buildings and a 21 percent reduction in citywide emissions from 2005 levels. In addition, implementing these measures across New York City's buildings has the potential to reduce energy costs for New Yorkers by an estimated \$2.7 billion and create 15,000 direct construction-related jobs.

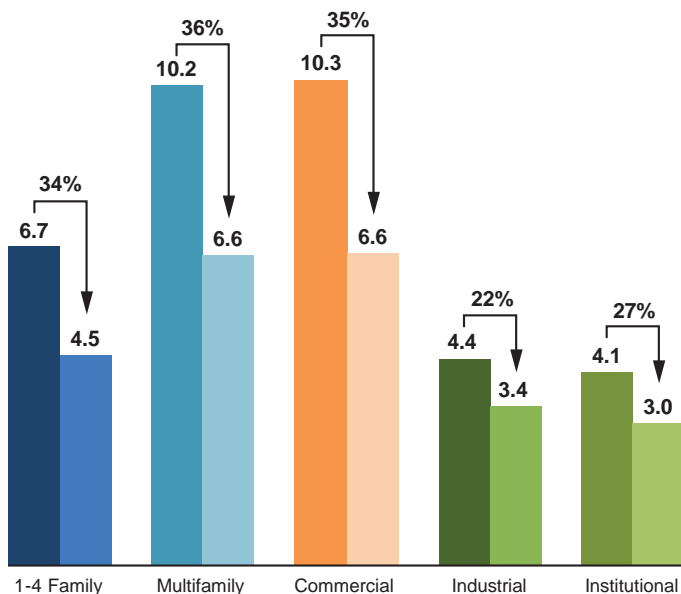

Fig. 25. Technical Potential for GHG Reductions from ECMs by Building Sector (MtCO<sub>2</sub>e)

Source: NYC Mayor's Office

Some ECMs are more cost-effective than others when measured based on their cost per amount of GHG emissions reduced. Roughly two-thirds of the measures assessed cost less than two dollars per pound of carbon dioxide equivalent (CO<sub>2</sub>e) reduced. Implementing these measures in all relevant buildings would result in a 29 percent reduction in current building-based GHG emissions in New York City, and a 19 percent reduction in citywide emissions from 2005 levels. This would lead to an estimated \$2.4 billion in energy cost-savings for New Yorkers and create 7,600 direct construction-related jobs.

Fig. 26. ECM Measures Under \$2/lb. of CO2e Abated

Source: NYC Mayor's Office

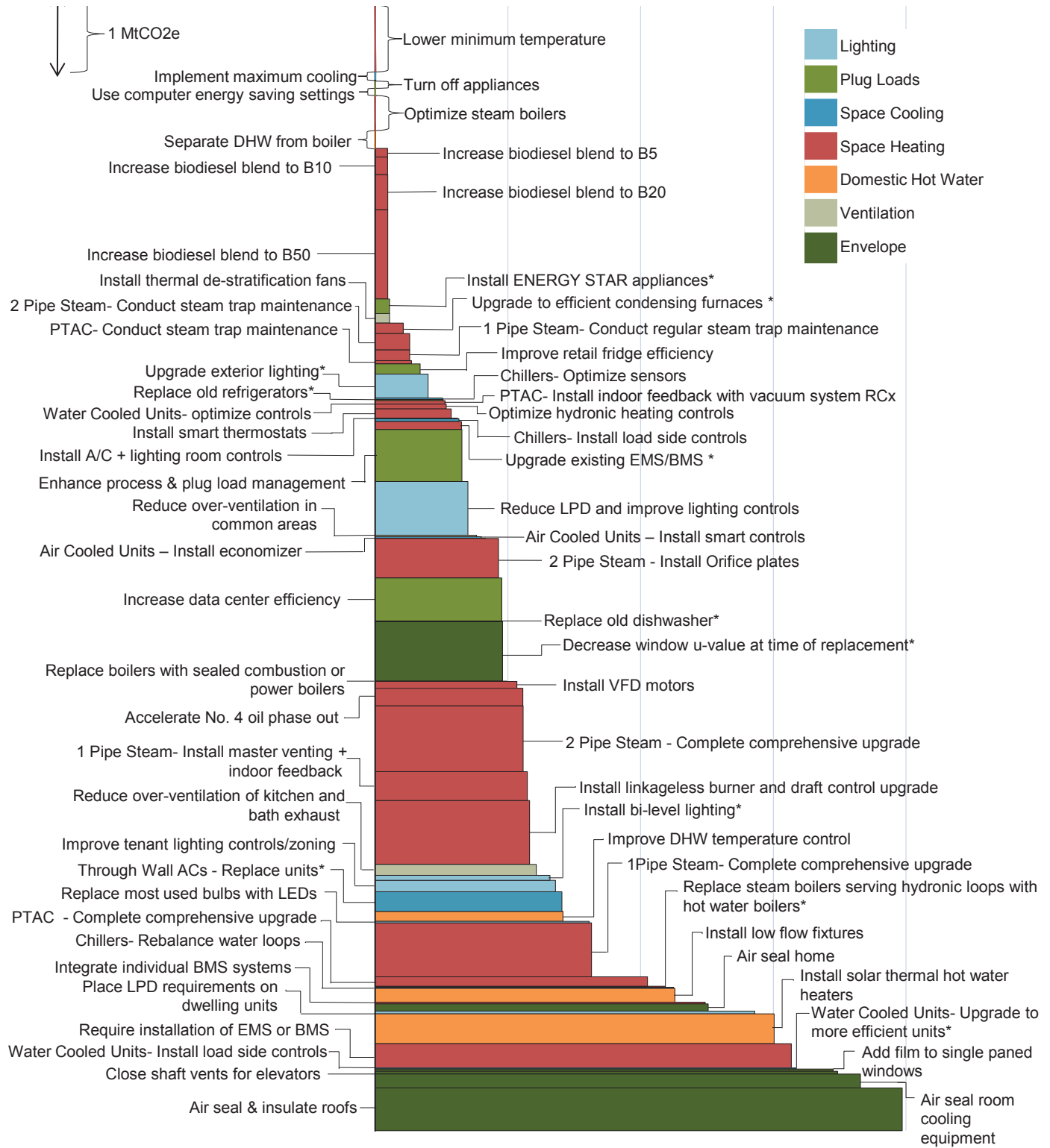

### Case Study: Terrific Tenements

An affordable multifamily building that has phased in heating system upgrades to cost-effectively achieve superior energy performance

**425 W 48th Street and 527 W 47th Street, Manhattan**

**Multifamily, Pre-War, Up to 7 Stories**

**Owner: The Related Companies**



Terrific Tenements is a two-building complex with 88 units of affordable housing subsidized under the Federal Section 8 program and located in the Hell's Kitchen neighborhood of Manhattan. The buildings were built in 1901 and 1920, and were typical of New York City's pre-war multifamily building stock. In 1983, as part of a major rehabilitation, the original one-pipe steam heating distribution system was replaced with a hydronic heating loop, which was served by a high mass boiler burning a mix of natural gas and fuel oil.

In 2010, Terrific Tenements' owner, the Related Companies, decided to install new sealed combustion boilers with smart controls to reduce energy use, control building operating costs, and help preserve the buildings' affordability. The new gas boilers are high efficiency models that are able to modulate, which allows the boiler to operate at lower firing rates and cycle on and off less frequently. Smart controls also allow the boiler to better control the domestic hot water temperature throughout the year and reset hot water temperature based on outdoor air temperature during the winter. These heating system upgrades cut the amount of natural gas used for heating energy by 50 percent, with a corresponding decrease in energy costs. At 425 West 48th Street, the upgrade resulted in cost savings of \$551 per apartment in the first year, while at 527 West 47th Street, the upgrades yielded \$355 in savings per apartment in the first year.

These upgrades and others over the years have led to persistently exceptional energy performance as compared to similar buildings in New York City. In 2015, Terrific Tenements used an average of just 32 kBtu of natural gas per square foot for heating, which is less than the heating EUI for 95 percent of pre-war multifamily buildings up to seven stories in New York City. By aligning upgrades over the years with capital planning and other real estate investments, the Related Companies were also able to cost-effectively realize these significant performance improvements.

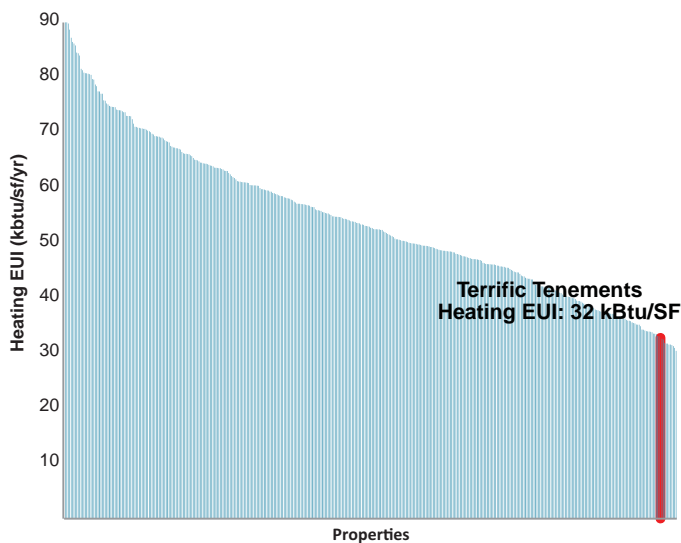

Heating EUIs in Building Typology: Multifamily, Pre-war, ≤ 7 Stories

## Case Study: 720 Greenwich Street

Integrated energy improvements lead to a high-performing steam system and enhanced resident comfort in this pre-war co-op

### 720 Greenwich Street, Manhattan, NY

#### Multifamily, Pre-War, Greater than 7 Stories

Owner: Greenwich Tower Owners Corporation

Property Management: Douglas Elliman



720 Greenwich Street is a 10-story, 157-unit pre-war vaulted brick apartment building. Originally constructed as two warehouses in 1898 and 1902, it was converted into a multifamily building in the 1970s and became a co-op in 1989. Over the years, the building has benefitted from a series of upgrades and ongoing operational improvements that have allowed this one-pipe steam-heated building to achieve superior energy performance.

The building superintendent and the co-op board at 720 Greenwich began implementing efficiency improvements in 2006, and soon realized that to address the largest source of energy use in the building they would need to tackle the steam distribution system. Beginning in 2007, repairs and operational improvements to the steam system were implemented that included replacing broken air vents, radiator valves, and steam traps; fixing the “back-pitch” of steam distribution piping, allowing for faster and more even steam distribution and alleviating clanging during operation; and adding insulation to distribution piping. Much of this work was done as part of early compliance with Local Law 87 retro-commissioning requirements.

During this work, it was discovered that air leakage through misaligned windows and un-insulated window air conditioners was causing under-heating in some apartments. By adjusting and insulating the windows, it became possible to lower the heat for the entire building. In apartments that remained overheated, thermostatic radiator valves (TRVs) were installed, allowing residents to have greater control of their heat and reducing their need to open windows in order to cool apartments. These relatively simple upgrades not only saved energy, but improved comfort for residents.

From 2014 to 2016, the co-op took another major step: replacing the decades-old, single pane windows with new double pane, argon filled, low e-coated windows with insulated frames and insulated panels for room air conditioners. This has substantially improved the thermal performance of the building’s envelope, with efficiency benefits to the heating system. In addition, the building has also taken on a series of other efficiency measures including a common area lighting upgrade, installation of low-flow plumbing fixtures and efficient front-loading washing machines, and via NYC’s “Cool Roof” program, a reflective white roof coating to deflect heat and reduce cooling use in the summer.

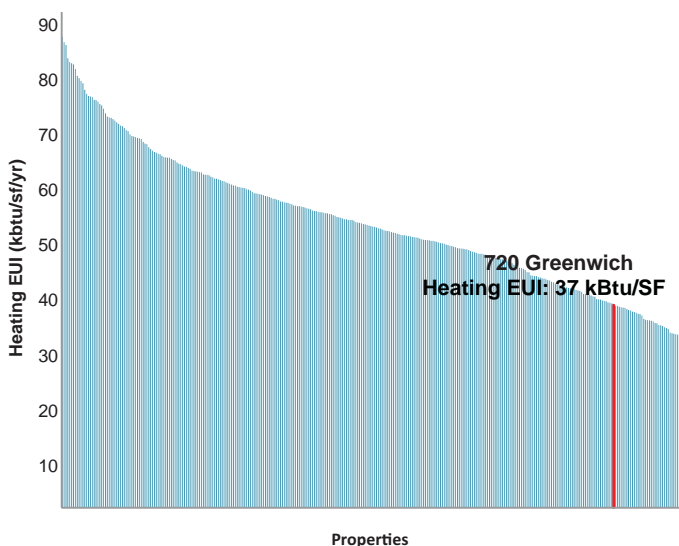

Heating EUIs in Multi-Family Buildings with One-Pipe Steam Systems

These upgrades have allowed 720 Greenwich to achieve exceptional energy performance compared to its peers. In 2013, 720 Greenwich used an average of just 37 kBtu of natural gas per square foot for heating, which is less than the heating EUI for 75 percent of pre-war multifamily buildings greater than seven stories in New York City, and less than the heating EUI of 90 percent of all multifamily buildings with one-pipe steam distribution systems.\* With a continued focus on operational improvements to the steam distribution system and the building envelope, 720 Greenwich has shown it is possible to be a very high-performing steam building in New York City.

\*The heating EUI for 720 Greenwich increased in 2014 and 2015, likely due in part to issues the building had with access to natural gas in 2014 and changes that were made to the gas pressure in the boiler room in 2015 partly as a result of these issues. Despite these issues and corresponding increases in heating energy use, the whole building EUI actually stayed relatively constant in 2014 and 2015, meaning that the increase was offset by other efficiency measures. The increase in heating energy use was discovered when analyzing energy data specifically for the heating system, enabling 720 Greenwich’s building superintendent to diagnose the problem and take steps to address it. The experience of 720 Greenwich is illustrative of the fact that maintaining energy performance requires continued effort, as all buildings experience changes to equipment and other circumstances that continually affect energy performance.

## Case Study: Rudin Management Company, Inc.

A commercial real estate owner that focused on operations and building controls to achieve significant portfolio-wide GHG reductions

Representing one of the largest privately-owned portfolios of real estate in New York City, Rudin Management Company, Inc. (RMC) has long considered energy management to be an integral part of good building operations. By employing innovative strategies to track and manage energy consumption in their commercial portfolio, RMC has dramatically reduced GHG emissions, enhanced tenant experience, and reduced energy costs.

The Rudin Organization owns a commercial real estate portfolio that is comprised of 10 million square feet of Class A commercial office buildings, which all fall in the City's Commercial, Very Large building typology. RMC first began manually tracking monthly energy consumption in the 1970s, and by the 1990s, RMC began using Con Edison's energy visualization software to monitor daily energy consumption and control utility costs. As energy monitoring tools have become more sophisticated, RMC has developed and integrated a digital operating system into existing building systems, including sensors and variable frequency drives, to recommend real-time system adjustments, identify operational inefficiencies, target preventative maintenance, and provide continuous commissioning. The current version of this software platform, called "Nantum," is supported by Prescriptive Data, a subsidiary of RMC.

The resulting real time data visualization has given RMC's building operators the ability fine tune base building heating and cooling equipment start times and automate equipment capacity control based on occupancy. On average, RMC engineers have reduced equipment run-times by an average of 45 minutes per day while still maintaining tenant comfort. Additionally, by continuously monitoring occupancy patterns via turnstiles, the data platform allows electric demand patterns of heating, cooling, and ventilation to follow occupancy through automated resets.

To encourage additional energy reductions, in 2005 RMC also gave building operators a target to reduce their building's district steam consumption by 15 percent. RMC's operators responded by meeting or exceeding this goal in every building. RMC continues to improve building performance by challenging building operators to meet an additional two percent reduction year over year. RMC Operating engineers regularly engage in mandatory building operations training programs offered by the International Union of Operating Engineers (Local 94).

Many have also completed additional technical training, including programs in operational efficiency such as Urban Green Council's Green Professional Buildings Skills Training (GPRO). The result is a skilled workforce of building operators who work closely with the building management staff to implement comprehensive maintenance and energy efficient strategies across the portfolio.

RMC's innovative approach to energy management has resulted in dramatic reductions in portfolio-wide energy use. Across the seven buildings equipped with Nantum, district steam consumption has been reduced by 38 percent and whole building electricity consumption has decreased by 20 percent. This includes a 48 percent reduction in base building electricity use at 345 Park Avenue and a 44 percent reduction at 560 Lexington Avenue since 2005. All together, RMC has achieved a 28 percent reduction in GHG emissions across its portfolio since 2005.

Moving forward, RMC will use passive sensors to track building occupancy, which will allow for additional control over fan speeds, supply air static pressure, and temperature to anticipate and adjust for shifting loads on a real time basis. Additionally, RMC plans to provide access to Nantum to its commercial tenants, allowing them to see the electricity consumption of their lighting, plug loads, and supplemental units in real time. More information about RMC's current collaboration with tenants on energy efficiency projects can be found in Chapter 4.

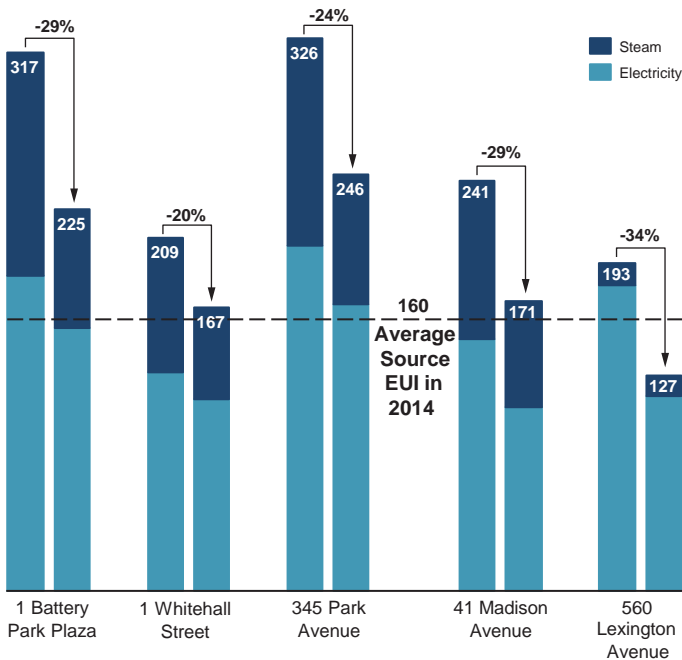

Whole Building Source EUI Reduction from RMC Commercial Portfolio (2005-2014)

## NEXT STEPS

The low- and medium-difficulty efficiency measures identified by the TWG have the technical potential to reduce current building-based GHG emissions by 33 percent. This represents a significant opportunity for GHG reductions that the City will seek to capture as soon as possible.

When the TWG was launched in 2015, the City expected that the best strategy to reduce GHG emissions from buildings would be through a combination of GHG reduction targets and voluntary measures, that, if not met, would trigger mandated actions. Through many discussions over the course of the year, one key finding is that building owners and decision-makers need certainty for their building budget and planning cycles. Capital projects are proposed, planned, and financed years in advance. Costs can be managed more effectively when energy efficiency can be incorporated into planning and budget cycles well in advance of requirements. The industry is familiar with adapting to changes in building and energy codes, but it is not as well equipped to address the risk involved with the uncertainty of mandates that may be suddenly triggered.

Based on this feedback, the City has updated its approach. The City will immediately adopt the most cost-effective ECMs identified by the TWG through integration into the codes or as standalone mandates. This will require capital spending on behalf of building owners, but will also lead to operational cost-savings, increase the value of properties, and improve comfort for tenants and residents. While the simplest and most effective measures will be required as soon as possible, the City can reduce costs to building owners by applying requirements at the time of replacement or end of useful life. The City is also prepared to provide technical assistance and training to help building owners and decision-makers navigate the retrofit process and ensure that building staff members are trained to operate and maintain new building systems.

To capture the GHG reduction potential from cost-effective efficiency measures, the City will:

- **Require large and mid-sized buildings to repair and improve heating distribution systems, including specific requirements for steam systems, within the next 10 years.**

The City will amend the requirements for retro-commissioning in LL87 to ensure better performance of heating distribution systems for large buildings over 50,000 square feet in floor area, and will pursue a similar requirement for mid-sized buildings between 25,000 and 50,000 square feet. This includes clarifying steam system requirements within the existing law to capture the significant citywide GHG reduction potential from improving the operations and maintenance of these systems. These changes will not only decrease citywide GHG emissions, but also improve the comfort of New York City's building residents and quality of life for New Yorkers. This has the potential to reduce building-based emissions by 1.4 MtCO<sub>2e</sub>, or four percent from current levels—

one of the single most impactful measures the City can pursue to reduce energy use and GHG emissions from New York City buildings.

- **Require owners of all large and mid-sized buildings to upgrade lighting in non-residential areas to meet current Energy Code standards by 2025.**

As lighting technology continues to improve, it will be necessary for the City's existing codes and laws to keep pace. Local Law 88 of 2009 currently requires owners of non-residential buildings over 50,000 square feet in floor to upgrade all lighting to meet current Energy Code requirements by 2025. Expanding this requirement to buildings over 25,000 square feet in size will realize the cost-effective potential of lighting upgrades across a significantly greater footprint, adding up to 5,000 buildings (3,770 properties) that will be required to upgrade lighting by 2025, with the potential to reduce GHG emissions by 7,500 tCO<sub>2</sub>e.

- **Require implementation of efficiency measures in existing buildings by incorporating low- and medium-difficulty ECMs into the codes or as standalone mandates.**

For the ECMs that have the best GHG reduction impact relative to cost, the City will pursue standalone requirements that will ensure their near-term implementation. The City will pursue several of the most cost-effective measures first, based on their cost per pound of CO<sub>2</sub>e abated. These include adding digital burner controls for boilers, restricting open refrigerators in retail stores, installing thermal de-stratification fans in heated industrial spaces, sealing roof vents in elevator shafts, and upgrading exterior lighting to current Energy Code standards. Implementing these ECMs alone is projected to reduce GHG emissions by 1.1 MtCO<sub>2</sub>e, or three percent of current building-based emissions.

For the remaining ECMs, the City will seek to amend the construction codes to capture additional GHG reductions while lowering the costs by requiring them at time of replacement. The long replacement cycles of several major building components, particularly windows and other exterior wall elements, mean that new standards must take effect soon in order to have an impact in the next 34 years. Additionally, the City will work with New York State and City affordable housing agencies and external stakeholders to consider implications of code measures on affordable housing, including the NYC J-51 and NY State Rent Stabilization and Rent Control Laws. The outcomes of this process will also be used to inform the City's efforts to reform both programs to better encourage energy efficiency investments.

The City will support these efforts through the following actions:

- **Establish a Codes Advisory Committee to produce code language for ECMs to be adopted by local law.**



Through the convening of a Codes Advisory Committee, the City will work with leaders in the building sector to ensure proper implementation of ECMs through the City's various construction codes. The Codes Advisory Committee will be responsible for developing code-ready legislative language to be submitted to City Council.

- **Incorporate efficiency measures into the NYC Retrofit Accelerator and provide guidance to building owners to implement measures on a voluntary basis.**

Through the NYC Retrofit Accelerator, the City will encourage voluntary adoption of the most impactful ECMs on an accelerated timeframe. The Retrofit Accelerator's team of efficiency advisors will work with building owners and decision-makers to identify and implement the best measures for their buildings and access existing financing and incentives to help cover costs. The program will also connect building operators and other decision-makers to trainings to help realize the full GHG reduction potential of implemented measures and improve their skills in the market.

- **Pursue amendments to the State Multiple Dwelling Law to remove requirements in conflict with energy efficiency standards.**

The City will advocate for changes to the Multiple Dwelling Law to remove the requirement for open shaft vents at the top of stairwells. This requirement was initially required as a fire safety function, but alternate fire protection solutions exist today. Adopting this simple change in stairwells is a cost-effective first step to improving building envelopes by sealing the holes in our building rooftops that unnecessarily result in energy losses and increased energy costs.

## **COMPREHENSIVE BUILDING SYSTEM UPGRADES**

Existing buildings will eventually need to move beyond "low- and medium-difficulty" ECMs alone to achieve deep energy reductions.

While there are some case studies of existing buildings that have achieved significant energy use and GHG reductions, the City generally lacks examples of comprehensive retrofits that could be implemented across its diverse building stock to achieve dramatic reductions. Uncertainties about future changes in the city's energy supply also make it difficult to predict which fuels will be least carbon intensive in 2050 and the implications that the grid composition will have for buildings.

To help address this knowledge gap, the City analyzed eight key building typologies, which cover roughly 60 percent of New York City's built square footage, and developed holistic retrofit options for a "typical" building in each typology. The City created an energy model of the typical building based on the most common construction methods and building systems in each typology. The modeled buildings have EUIs similar to

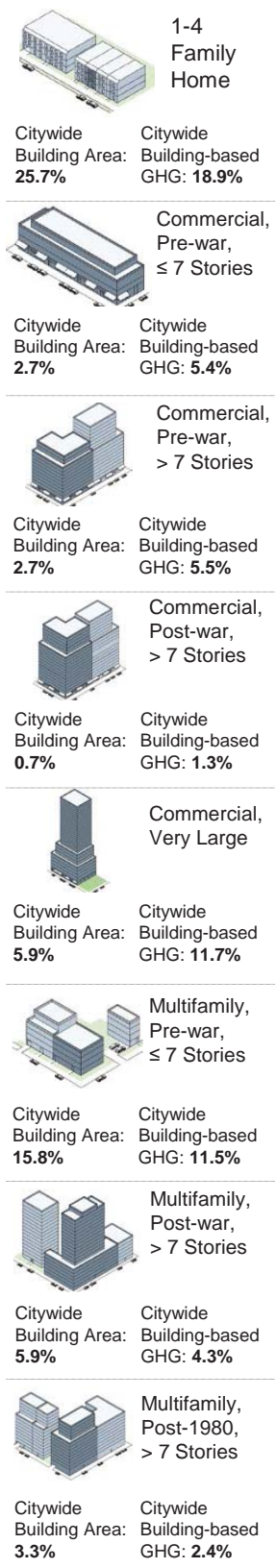

real buildings within their respective typology that exhibit similar construction and building systems based on their Local Law 87 reports.

The City then developed four retrofit “paths” for each baseline modeled building that were targeted to achieve at least 40 to 60 percent reductions in energy use with currently available technologies and strategies, the range projected to be necessary from existing buildings to achieve 80 x 50. The City analyzed the retrofit paths using energy modeling software, which accounts for the interaction between the building systems, to determine the resulting energy use and GHG emissions. The models were informed using a combination of Local Law 84 and 87 data, third-party research, and industry experience.

Due to the significant portion of energy that is used for space heating, all of the retrofit paths include major upgrades to the heating equipment and improvements to the heating distribution system that are aimed at dramatically reducing heating loads. All retrofit paths include improvements to the building envelope with measures that range from sealing through-wall penetrations to re-cladding entire facades. Each building typology also received at least one pathway in which some or all of the fossil fuel-based heating or DHW energy use are electrified to test the results under a scenario in which the future electric grid becomes much cleaner. Additionally, all paths seek to reduce electricity use by addressing cooling, lighting, and plug loads and also include some integration of on-site renewable energy generation, such as solar PV or solar thermal hot water systems.

The results of this analysis are promising, showing it is possible to use existing technologies and strategies to reduce energy use and GHG emissions by 40 to 60 percent in typical New York City buildings. These results become even more dramatic when the analysis includes reductions from a significantly cleaner electric grid.

Any preliminary conclusions drawn from this analysis should be treated as a starting point for future study before being considered for broad-based application to real buildings. There are limitations to the predictive capacity of energy models because some factors cannot be fully captured in a model, such as differences in the way a building is operated and maintained or different occupancy types or space uses within a building. Many of the technologies and strategies included in the modeled retrofit paths have not yet been widely deployed in New York City, so it was not possible to calibrate the energy models to real buildings. Still, the retrofit paths are an important step to understanding the kinds of dramatic transformations that will help us achieve 80 x 50.

**Fig. 27. Eight Building Typologies Analyzed for Holistic Retrofit Paths**

Source: NYC Mayor’s Office

# ONE- TO FOUR-FAMILY HOMES

This typology includes both one- to four-family freestanding homes and row homes, which covers both the greatest absolute number of buildings and the most square footage of the City’s 21 building typologies. The baseline building includes a steam boiler with one-pipe steam distribution for heating, window air conditioning units for cooling that cause air leakage, and exhibits a high air infiltration rate that is typical of these buildings.

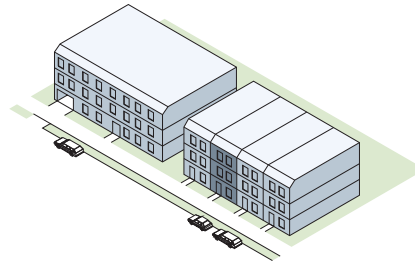

<b>Size</b>	3,000 SF average
<b>Height</b>	3 Stories + 1 Below-grade

### Baseline Conditions

- Wall Construction:** Mass wall with infiltration (R-5)
- Roof:** Modified bitumen roof on wood rafters, crawl space (R-15)
- Windows and Glazing:** Double-pane windows, vinyl frame
- Lighting:** 0.90 Watts/SF
- Plug Loads:** 0.67 Watts/SF
- Heating System:** Gas boiler, 1-pipe steam, radiators
- Cooling System:** Window A/Cs
- DHW System:** Direct fired storage tank, natural gas

### Efficiency Measures Applied to All Paths

- **Lighting:** Reduce LPD
- **Plug loads:** Replace appliances; Master switching; Smart plugs
- **Ventilation:** Reduce over-ventilation; Upgrade Fans
- **Envelope:** Maximize roof insulation; Air Sealing
- **DHW:** Install low flow fixtures; On-demand gas hot water heater
- **Renewables:** Solar PV on 20% of the roof

### Path 3 Electrification + Path#2 Envelope

- Air source heat pump for heating and cooling
- Electric DHW heat pump
- *Row Home:* Reclad/insulate rear exterior wall
- *Freestanding Home:* Insulate wall cavities
- Insulate basement walls
- Install ERVs
- Install triple pane windows

### Path 1 Hydronic Conversion

- Hydronic conversion
- Upgrade boiler
- ENERGY STAR A/C
- Replace windows

### Path 4 High Performance Envelope

- *Row Home:* Spray foam on inside of all exterior walls
- *Freestanding Home:* Apply rigid exterior insulation
- Extensive air sealing
- Insulate basement walls
- Install triple pane windows
- Install ERVs
- Hydronic conversion
- Upgrade boiler
- Multisplit A/C

### Path 2 Envelope + Hydronic Conversion

- *Row Home:* Reclad/insulate rear exterior wall
- *Freestanding Home:* Insulate wall cavities
- Insulate basement walls
- Install ERVs
- Hydronic conversion
- Upgrade boiler
- ENERGY STAR A/C
- Install triple pane windows

### Path 5 Electrification + Path#4 Envelope

- Air source heat pump for heating and cooling
- DHW heat pump
- *Row Home:* Spray foam on inside of all exterior walls
- *Freestanding Home:* Apply rigid exterior insulation
- Extensive air sealing
- Insulate basement walls
- Install ERVs

Path Source EUI Reduction (kBtu/SF)

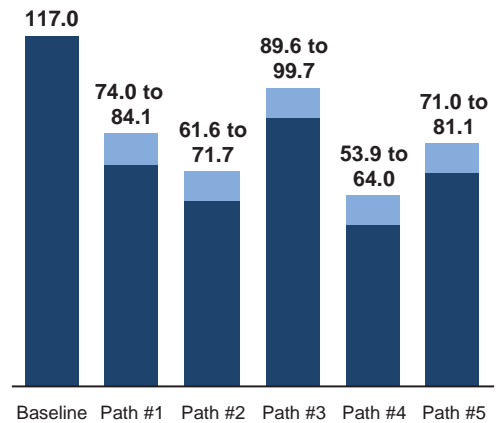

Path GHG Emissions Reduction (MtCO<sub>2</sub>e)

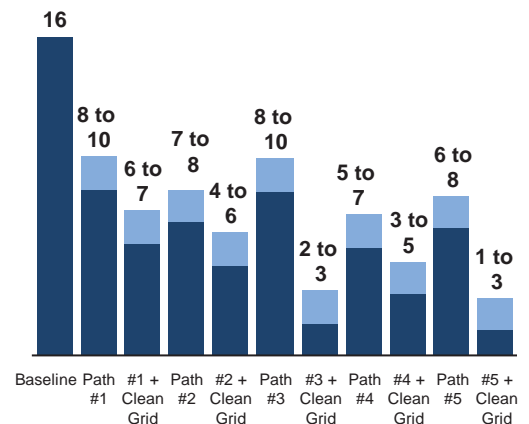

**RETROFIT PATHS:** All retrofit paths for this typology include upgrades to the heating system and improvements to the building envelope, including attic air sealing and increasing ceiling insulation. Paths 1 and 2 also include blowing insulation into existing wood stud wall cavities and installing continuous exterior insulation, which can be performed with residents in place and can be timed at the end of useful life of existing cladding. Paths 3 and 4 include insulating historic masonry facades from the interior or applying rigid exterior insulation, which is more invasive but can be coordinated at the time of ownership turn-over. Paths 3 and 5 include air source heat pumps (ASHPs) as an option to electrify the heating system. All paths also include improvements to lighting efficiency; reductions in plug loads from master switching, smart strips, and more efficient appliances; reduced ventilation; the installation of low-flow fixtures and an on-demand gas water heater; and maximizing roof space for solar PV.

**RESULTS:** Paths 1 and 2 achieve a 30 to 40 percent reduction in source energy use, largely through incremental improvements to the existing heating system and the building envelope. Path 3 did not result in a major decrease in energy use, but could yield significant GHG reductions from electrifying the heating system if the electric grid becomes much cleaner. Paths 4 and 5 yield significant source energy use reductions due to major improvements to the building envelope, and Path 5 could also achieve very significant GHG emissions with a cleaner electric grid. Installing solar PV on 20 percent of the roof is also able to offset between 10 and 30 percent of this building's electricity load across all paths.

## MULTI-FAMILY, PRE-WAR UP TO 7 STORIES

This typology includes the most square footage in New York City after one- to four-family homes. These buildings typically include one-pipe steam distribution systems with limited or no controls to provide space heating. Window air conditioners provide summertime cooling and create window or wall penetrations and lead to air leakage year-round and a high air infiltration rate.

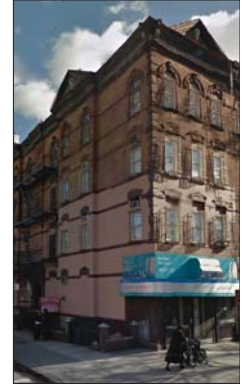
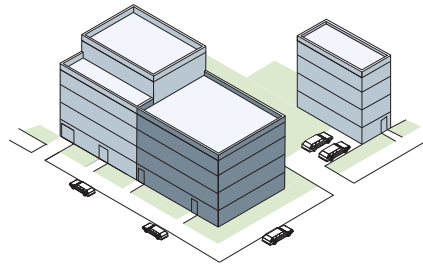

<b>Size</b>	12,600 SF average
<b>Height</b>	4 Stories + 1 Below-grade

### Baseline Conditions

- Wall Construction:** Mass wall (R-5)
- Roof:** Insulation above deck (R-12)
- Lighting:** 0.40Watts/SF
- Plug Loads:** 0.55 Watts/SF
- Heating System:** Dual fuel boiler, 1-Pipe Steam
- Cooling System:** Window A/C
- DHW System:** Indirect coil in steam boiler

### Efficiency Measures Applied to All Paths

- Lighting:** Reduce LPD
- Plug loads:** Master switching; Smart plugs; Replace appliances
- DHW:** Install low flow fixtures; Condensing gas boiler
- BMS/EMS:** Controls to provide indoor feedback and implement set-backs
- Ventilation:** Unitized through-wall exhaust ventilation

#### Path 1 Efficient Systems

- Optimized best in class natural gas steam boiler and steam distribution
- ENERGY STAR A/C
- Solar PV on 25% of the roof

#### Path 3 Electrification

- Remove window A/C
- Air source heat pump with minisplits for heating and cooling
- Solar thermal for 50% of the DHW load

#### Path 2 Hydronic Conversion

- Remove Window A/C
- Water source heat pump with gas boiler and air cooled condenser for heating and cooling
- Solar PV on 25% of the roof

#### Path 4 Electrification + Re-cladding

- Re-clad 100% of facade
- Remove window A/C
- Air source heat pump with minisplits for heating and cooling
- Solar thermal for 50% of the DHW load

Path Source EUI Reduction (kBtu/SF)

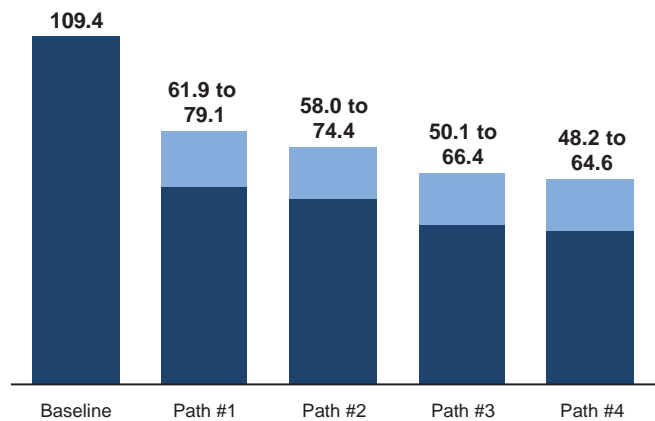

Path GHG Emissions Reduction (MtCO<sub>2</sub>e)

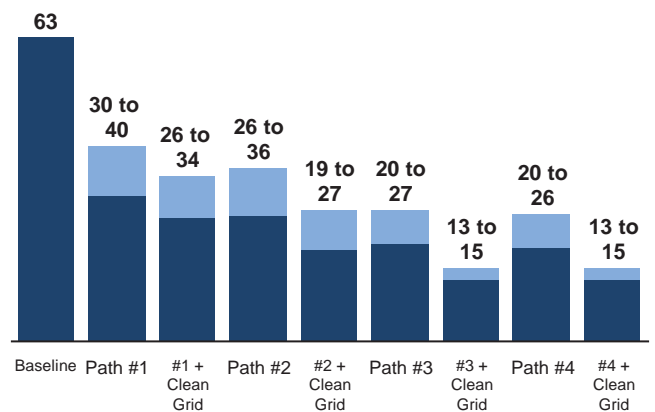

**RETROFIT PATHS:** The retrofit paths for this typology include several major heating system upgrades, including distribution system improvements in Paths 1 and 2 and ASHPs in Paths 3 and 4 that provide electric space heating and cooling. The paths also include a range of improvements to the building envelope and the removal of window air conditioners in Paths 2 through 4 to reduce wall penetrations. Roof space is maximized for solar PV in Paths 1 and 2, while solar thermal water heaters are included in Paths 3 and 4 to cover half of the DHW load. In addition, all paths include: improvements to lighting efficiency; plug load reductions from master switching, smart strips, and more efficient appliances; installation of low flow fixtures and a condensing gas boiler for DHW; the addition of heating equipment controls to provide indoor feedback and temperature set-backs; and installation of unitized through-wall exhaust fans to provide mechanical ventilation as the building envelope is tightened.

**RESULTS:** Paths 1 and 2 achieved between a 30 and 50 percent reduction in source energy use, although the model assumes that these systems are operated optimally. Path 1 retains the original heating and cooling systems, but greater reductions are possible in Path 2 from converting to a hydronic distribution system and installing a water source heat pump (WSHP) for cooling, which also improves the performance of the building envelope by removing the window air conditioners. Paths 3 and 4 electrify the heating system and achieve even greater reductions in source energy use of 40 to 60 percent, even under the current electric grid mix. In Paths 2 through 4, some of the reductions in heating and cooling energy use may be partially offset by increased cooling system use as additional systems are added. Installing solar PV on 25 percent of roof space offsets the electric load by 30 to 40 percent in Paths 1 and 2, while installing solar thermal reduces natural gas use by over 40 percent in Paths 3 and 4. The wide ranges across the results of the retrofit paths are largely reflective of the potential variability occupant behavior and uncertainties in characterizing air infiltration reductions.

## MULTI-FAMILY, POST-WAR GREATER THAN 7 STORIES

This building typology includes taller buildings that were constructed in the post-war period but before the first Energy Code was enacted in New York City. The baseline building includes a two-pipe steam heating system with a steam boiler and limited heating system controls. In addition, this building uses through-wall sleeve air conditioners for cooling, which result in the potential for air leakage at wall penetrations.

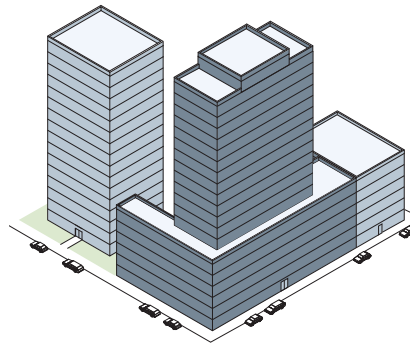

<b>Size</b>	185,600 SF average
<b>Height</b>	16 Stories + 1 Below-grade

### Baseline Conditions

- Wall Construction:** Mass wall (R-5)
- Roof:** Insulation above deck (R-12)
- Lighting:** 0.50 Watts/SF
- Plug Loads:** 0.65 Watts/SF
- Heating System:** Natural gas boiler, 2-Pipe Steam
- Cooling System:** Through-wall A/C
- DHW System:** Indirect coil in steam boiler

### Efficiency Measures Applied to All Paths

- Lighting:** Reduce LPD
- Plug loads:** Master switching; Smart plugs; Replace appliances; Replace old elevators
- DHW:** Install low flow fixtures; Condensing gas boiler
- BMS/EMS:** Controls to provide indoor feedback and implement set-backs
- Ventilation:** Seal and balance kitchen and toilet risers; Upgrade fans
- Envelope:** Replace windows; Maximize roof insulation; Air Sealing

### Path 1 Efficient Systems

- Optimized best in class natural gas steam boiler and steam distribution
- Solar PV on 23% of the roof

### Path 3 Electrification

- Remove Through-wall A/C
- Variable Refrigerate Flow for heating and cooling
- Solar thermal for 50% of the DHW load

### Path 2 Hydronic Conversion

- Remove Through-wall A/C
- Water source heat pump with gas boiler and cooling tower for heating and cooling
- Solar PV on 23% of the roof

### Path 4 Electrification + Re-cladding

- Re-clad 100% of facade
- Remove Through-wall A/C
- Variable Refrigerate Flow for heating and cooling
- Solar thermal for 50% of the DHW load

Path Source EUI Reduction (kBtu/SF)

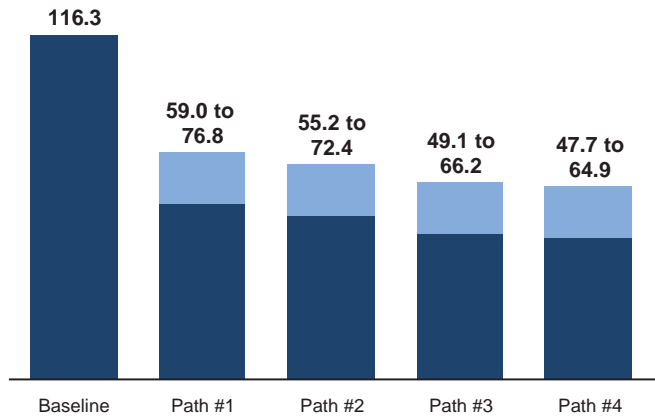

Path GHG Emissions Reduction (MtCO<sub>2</sub>e)

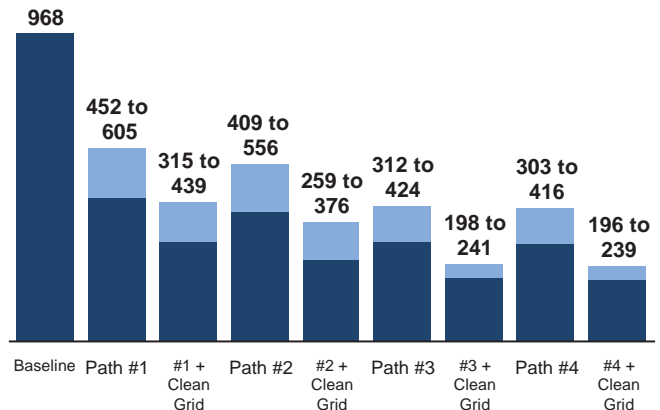

**RETROFIT PATHS:** The retrofit paths for this typology test the results of several distribution system upgrades, as well as the use of VRF systems as an option to electrify space heating. Roof space is maximized for solar PV in Paths 1 and 2, while solar thermal water heaters are included in Paths 3 and 4 to cover half of the DHW load. All paths also include: improvements to lighting efficiency; plug load reductions from master switching, smart strips, and more efficient appliances; installation of low flow fixtures and a condensing gas boiler for DHW; the addition of controls to provide indoor feedback and set-backs for space heating; upgrading fans and balancing ventilation shafts; and improvements to the building envelope that include air sealing, roof insulation, and replacing windows at the end of their useful life.

**RESULTS:** Path 1, which retains the original heating and cooling systems, achieves between a 35 and 45 percent reduction in source energy use, although the model assumes these systems are operated optimally. Paths 2 through 4, which replace PTACs, allow for greater reductions from higher efficiency cooling systems as well as reduced air infiltration, yielding between a 40 and 55 percent reduction in source energy use for these paths. Installing solar PV on 23 percent of roof space can offset roughly 10 percent of the electric load in Paths 1 and 2, while installing solar thermal reduces natural gas use in Paths 3 and 4 by over 40 percent. Installing VRF systems to electrify space heating and cooling also allows for significant GHG reductions under a scenario with a much cleaner electric grid. The wide ranges in the results of each retrofit path are largely reflective of the potential variability in occupant behavior and uncertainties in characterizing air infiltration reductions.



## MULTI-FAMILY, POST-1980 GREATER THAN 7 STORIES

This building typology includes taller buildings that were constructed after the first Energy Code was enacted in New York City. The baseline building for this typology includes a hydronic heating system, PTACs for cooling, and steel framed window-wall construction.

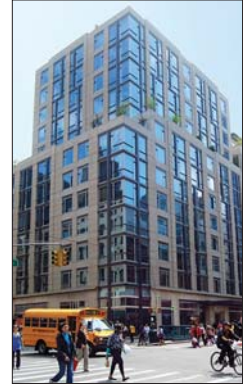
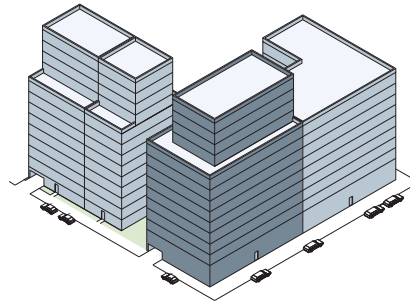

<b>Size</b>	78,00 SF average
<b>Height</b>	11 Stories + 1 Below-grade

### Baseline Conditions

- Wall Construction:** Steel framed window wall with some insulation (R-6)
- Roof:** Insulation above deck (R-19)
- Lighting:** 0.50 Watts/SF
- Plug Loads:** 0.67 Watts/SF
- Heating System:** Natural gas boiler, Hydronic with PTACs
- Cooling System:** PTACs
- DHW System:** Indirect storage tank, natural gas boiler

### Efficiency Measures Applied to All Paths

- Lighting:** Reduce LPD
- Plug loads:** Master switching; Smart plugs; Replace appliances; Replace old elevators
- DHW:** Install low flow fixtures; Condensing gas boiler
- BMS/EMS:** Controls to provide indoor feedback and implement set-backs
- Ventilation:** Seal and balance kitchen and toilet risers; Upgrade fans
- Envelope:** Replace windows; Maximize roof insulation; Air Sealing

### Path 1 Efficient Systems

- Optimized best in class natural gas steam boiler and steam distribution
- Upgrade PTACs
- Solar PV on 19% of the roof

### Path 2 Water Source Heat Pump Upgrade

- Remove PTACs
- Water source heat pump with gas boiler and cooling tower for heating and cooling
- Solar PV on 19% of the roof

### Path 3 Electrification

- Remove PTACs
- Variable Refrigerate Flow for heating and cooling
- Solar thermal for 50% of DHW load

### Path 4 Electrification + Re-cladding

- Re-clad 100% of facade
- Remove PTACs
- Variable Refrigerate Flow for heating and cooling
- Solar thermal for 50% of DHW load

Path Source EUI Reduction (kBtu/SF)

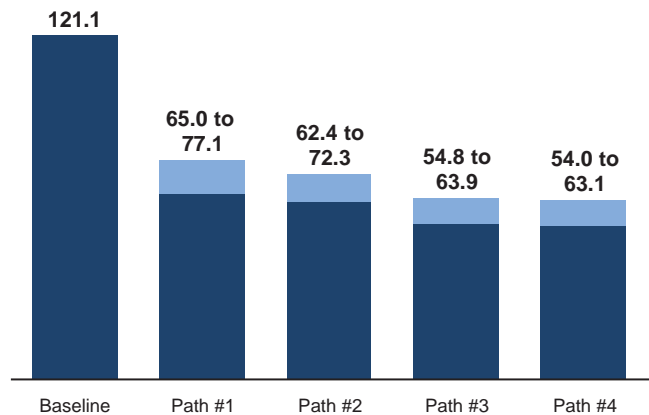

Path GHG Emissions Reduction (MtCO<sub>2</sub>e)

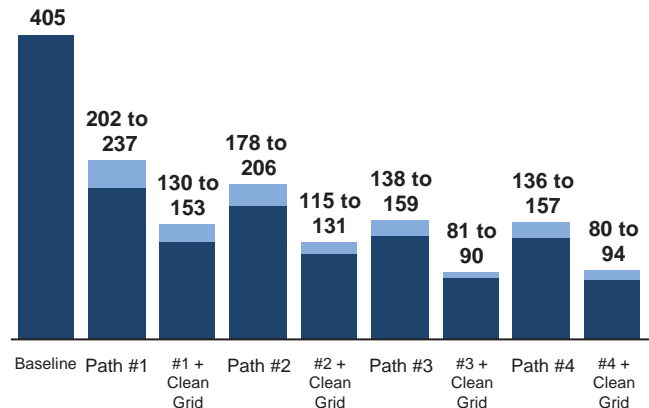

**RETROFIT PATHS:** Although the baseline building for this typology is much different than the previous multifamily typologies, the measures included in the retrofit paths are similar. These include improvements to the heating distribution system, upgrades or removal of PTACs for cooling, and installation of a VRF system to electrify heating. All paths also include improvements to lighting efficiency; plug load reductions; installation of low flow fixtures and a condensing gas boiler for DHW; the addition of controls to provide indoor feedback and set-backs for space heating; upgrading fans and sealing risers; and air sealing, roof insulation, and replacing windows at the end of their useful life.

**RESULTS:** Paths 1 and 2 achieve between a 35 and 50 percent reduction in source energy use for this typology, with slightly greater reductions possible in Path 2 by installing a WSHP for cooling and improving insulation for the building envelope. Paths 3 and 4 achieve even more significant reductions of up to 55 percent by converting the space heating and cooling to a VRF system. Installing solar PV on 14 percent of roof space can offset electric loads by six to seven percent in Paths 1 and 2, while installing solar thermal reduces natural gas use by over 40 percent. GHG emissions can also be reduced further for all paths under a scenario with a cleaner electric grid, particularly for Paths 3 and 4.

## COMMERCIAL, PRE-WAR UP TO 7 STORIES

This building typology includes relatively simple low-rise commercial buildings with many building systems that may not have been recently replaced. The baseline building includes mass wall construction with a one-pipe steam heating system and window air conditioners for cooling. The building is also modeled as an office building with corresponding tenant energy use.

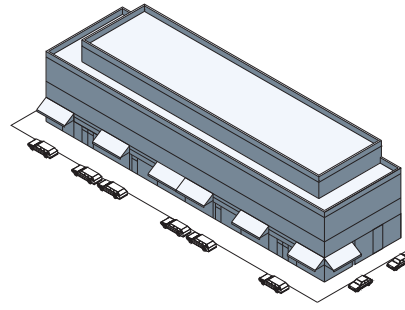

<b>Size</b>	12,500 SF average
<b>Height</b>	4 Stories + 1 Below-grade

### Baseline Conditions

- Wall Construction:** Mass wall (R-5)
- Roof:** Insulation entirely above deck (R-15)
- Windows and Glazing:** Double pane, aluminum frame, no glass coating
- Lighting:** 0.75 Watts/SF
- Plug Loads:** 0.75 Watts/SF
- Heating System:** Natural Gas Steam Boiler, 1-Pipe Steam
- Cooling System:** Window A/Cs
- DHW System:** Direct Fired Storage Tank, Natural Gas

### Efficiency Measures Applied to All Paths

- Lighting:** Reduce LPD and install sensors
- Plug loads:** Master switching; Smart plugs
- Envelope:** Replace windows; Maximize roof insulation; Air Sealing; Cool Roofs
- DHW:** Install low flow fixtures
- EMS/BMS:** Controls to provide indoor feedback and implement set-backs
- Renewables:** Solar PV on 15% of the roof
- Tenant Measures:** Replace appliances; Address supplemental heating and cooling

### Path 1 Steam System Upgrade

- Optimized best in class natural gas steam boiler and steam distribution
- Upgrade boiler
- ENERGY STAR A/C
- Condensing gas tankless DHW

### Path 3 Electrification

- Air source heat pump for heating and cooling
- Install ERVs
- Electric tankless DHW at point of use
- Remove Window A/C

### Path 2 Hydronic Conversion

- Hydronic conversion
- Upgrade boiler
- ENERGY STAR A/C
- Condensing gas tankless DHW

### Path 4 Electrification + Re-cladding

- Re-clad 50% of façade
- Air source heat pump for heating and cooling
- Install ERVs
- Electric tankless DHW at point of use
- Remove Window A/C

Path Source EUI Reduction (kBtu/SF)

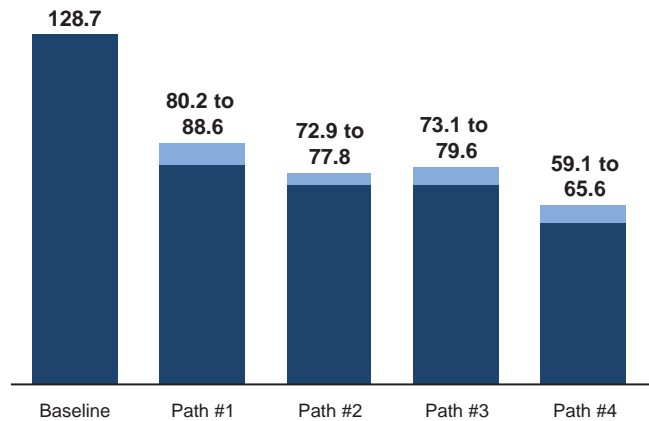

Path GHG Emissions Reduction (MtCO<sub>2</sub>e)

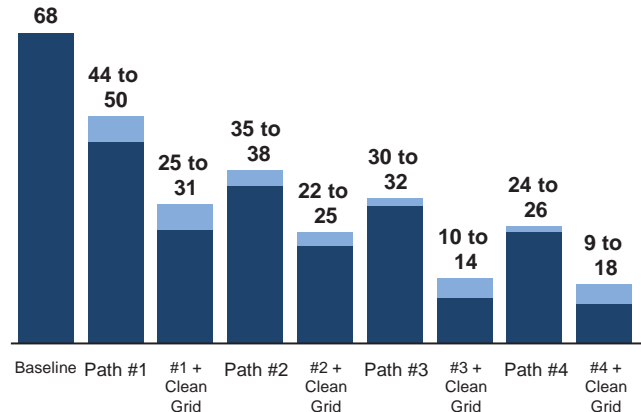

**RETROFIT PATHS:** The retrofit paths for this typology resemble several of the retrofit paths for the multifamily typologies. Major measures include improvements to the heating distribution system in Paths 1 and 2, installation of ASHPs to electrify the heating system in Paths 3 and 4, and envelope improvements across all paths. In addition, all paths include improvements in lighting efficiency and the installation of occupancy sensors; reductions in tenant energy use and plug loads from master switching, smart plugs, and more efficient appliances; improvements to supplemental heating and cooling systems in tenant spaces; installation of controls to provide indoor feedback for temperature set-backs; installation of low-flow fixtures; and maximizing roof space for solar PV.

**RESULTS:** Paths 1 and 2 achieve between 30 and 40 percent reductions in source energy use, although the model assumes these systems are operated optimally. Path 1 retains the original heating and cooling systems, but greater reductions are possible in Path 2 with a hydronic conversion and addition of variable speed drives (VFDs). Path 3 does not yield additional source energy reductions as compared to Path 2, but does yield greater GHG reductions, particularly in a scenario when the electric grid is much cleaner. When combined with re-cladding, this can yield up to a 55 percent reduction in source energy use and even greater reductions in GHG emissions. Installing solar PV on 15 percent of the roof space also offsets between eight and 15 percent of the electric load across the paths.

## COMMERCIAL, PRE-WAR GREATER THAN 7 STORIES

This building typology also tends to have many building systems that have not been recently replaced. The baseline building is modeled with mass wall construction, a two-pipe steam distribution system for space heating, and a mix of air-cooled DX units and window air conditioning units for cooling.

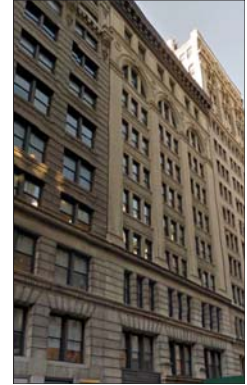
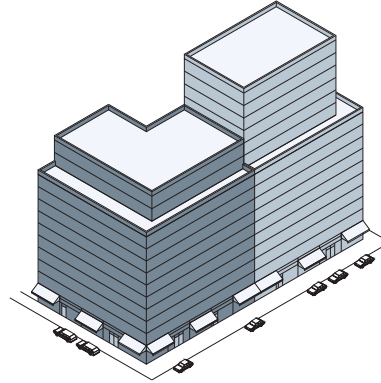

<b>Size</b>	82,700 SF average
<b>Height</b>	12 Stories + 1 Below-grade

### Baseline Conditions

- Wall Construction:** : Mass wall (R-5)
- Roof:** Insulation entirely above deck (R-15)
- Windows and Glazing:** Double pane, aluminum frame, no glass coating
- Lighting:** 1.20 Watts/SF
- Plug Loads:** 0.75 Watts/SF (receptacle equipment), 0.75 Watts/SF (Servers, process loads)
- Heating System:** Natural Gas Steam Boiler, 2-Pipe Steam
- Cooling System:** Air-cooled DX Units
- DHW System:** Indirect coil in steam boiler

### Efficiency Measures Applied to All Paths

- Lighting:** Reduce LPD and install sensors
- Plug loads:** Master switching; Smart plugs; Replace old elevators
- Envelope:** Replace windows; Maximize roof insulation; Air Sealing; Cool Roofs
- DHW:** Install low flow fixtures; Tankless electric hot water boiler
- EMS/BMS:** Upgrade to DDC system, with resets
- Renewables:** Solar PV on 8% of the roof
- Tenant Measures:** Replace appliances; Address supplemental heating and cooling; Improve data center efficiency
- Ventilation/Pumps:** Demand control ventilation with ERVs; Install pumps with premium efficiency motors with VFD

### Path 1 Cooling System Upgrade

- High efficiency Air Cooled DX Units

### Path 3 Electrification

- Variable Refrigerant Flow and Air Source Heat Pump for heating, cooling, and ventilation
- Electric tankless DHW at point of use

### Path 2 Hydronic Conversion

- Hydronic conversion
- Upgrade boiler
- High efficiency Water Cooled DX Units with cooling tower

### Path 4 Electrification + Re-cladding

- Re-clad 50% of façade
- Variable Refrigerant Flow and Air Source Heat Pump for heating, cooling, and ventilation
- Electric tankless DHW at point of use

Path Source EUI Reduction (kBtu/SF)

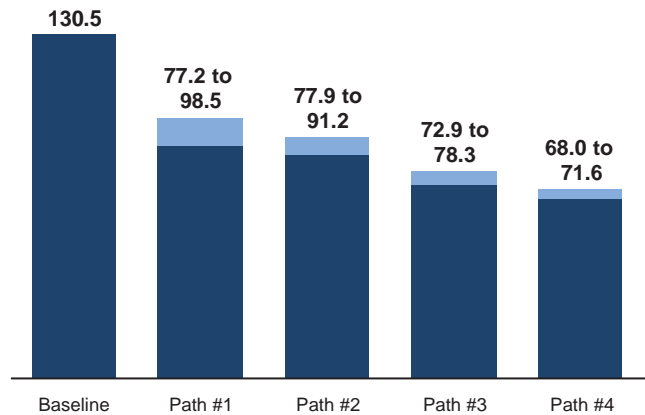

Path GHG Emissions Reduction (MtCO<sub>2</sub>e)

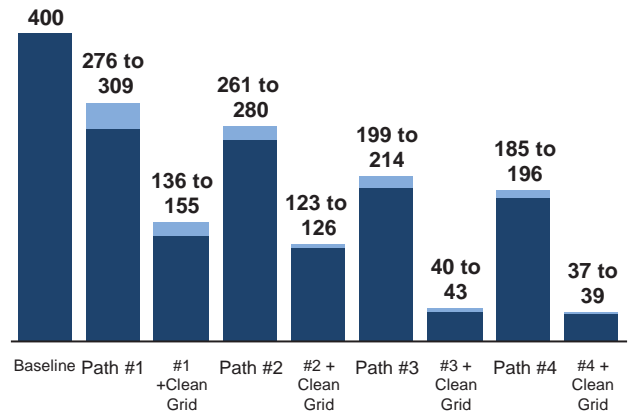

**RETROFIT PATHS:** Path 1 does not upgrade the heating or distribution system, while Path 2 includes a hydronic conversion and Paths 3 and 4 incorporate VRF systems for heating and cooling. All paths include some improvements to the building envelope, while Path 4 tests the results of fully re-cladding the building. All paths include improvements in lighting efficiency; reductions in plug loads; reductions in tenant energy use from improvements to the efficiency of IT equipment and supplemental heating and cooling systems; upgrades to the existing controls system; DHW improvements; installation of demand controlled ventilation, premium efficiency motors, and VFDs; and maximizing roof space for solar PV.

**RESULTS:** Without major upgrades to the heating and cooling systems, Path 1 achieves less than a 40 percent reduction in source energy use. Path 2 achieves slightly greater reductions of 40 to 45 percent. The greatest reductions are possible by converting heating and cooling to a VRF system under Paths 3 and 4, which also yield significant GHG reductions under a scenario in which the electric grid becomes much cleaner. Only eight percent of roof space is assumed to be usable for solar PV, which offset roughly two percent of the electric load across all retrofit paths. More significant reductions could also be achievable in this typology with additional engagement with tenants for energy use reductions.

## COMMERCIAL, POST-WAR GREATER THAN 7 STORIES (EARLY CURTAIN WALL)

This building typology is typical of many large commercial buildings that were built during the post-war construction boom but before the first Energy Code was enacted in New York City. The baseline building has an early curtain wall design with little insulation and issues with thermal bridging. The building is served by New York City's district steam system for space heating and cooling, with a two-pipe steam distribution system.

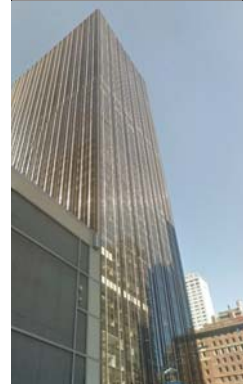
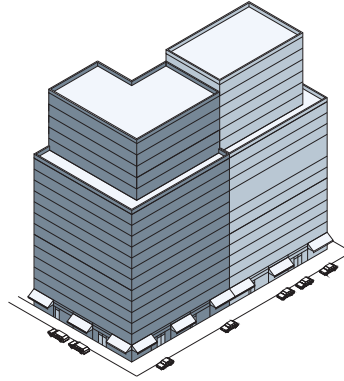

<b>Size</b>	160,000 SF average
<b>Height</b>	18 Stories + 1 Below-grade

### Baseline Conditions

- Wall Construction:** Single pane curtain wall construction; Steel-framed wall with some insulation (R-2)
- Roof:** Uninsulated roof construction (R-5)
- Lighting:** 1.2 Watts/SF
- Plug Loads:** 1.3 Watts/SF (receptacle equipment), 0.21 Watts/SF (Servers, process loads)
- Heating System:** District Steam, 2-Pipe Steam
- Cooling System:** Packaged water cooled DX units
- DHW System:** Indirect heat exchanger from boiler

### Efficiency Measures Applied to All Paths

- Lighting:** Reduce LPD and install sensors
- Plug loads:** Master switching; Smart plugs; Replace old elevators
- Envelope:** Maximize roof insulation; Cool Roofs
- DHW:** Install low flow fixtures
- BMS:** Upgrade to DDC system, with resets
- Renewables:** Solar PV on 7% of the roof
- Tenant Measures:** Replace appliances; Address supplemental heating and cooling; Improve data center efficiency
- Ventilation/Pumps:** Demand control ventilation with ERVs; Install pumps with premium efficiency motors with VFD

### Path 1 Steam System and Envelope Upgrades

- Upgrade IGU and insulate behind spandrel
- Optimized best in class natural gas steam boiler and steam distribution
- High efficiency Water Cooled DX Units
- Condensing gas tankless DHW

### Path 3 Re-cladding

- Re-clad 50% façade and insulate behind spandrel
- Hydronic conversion
- Install natural gas boiler
- High efficiency Water Cooled DX Units
- Electric tankless DHW at point of use

### Path 2 Hydronic Conversion

- Hydronic conversion
- Install natural gas boiler
- High efficiency Water Cooled DX Units
- Electric tankless DHW at point of use
- Upgrade IGU and insulate behind spandrel

### Path 4 Electrification + Re-cladding

- Install electric boiler
- Electric tankless DHW at point of use
- Upgrade IGU and insulate behind spandrel
- High efficiency Water Cooled DX Units

Path Source EUI Reduction (kBtu/SF)

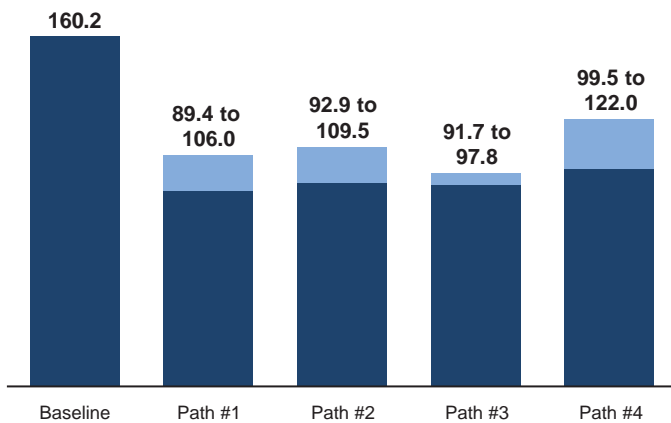

Path GHG Emissions Reduction (MtCO<sub>2</sub>e)

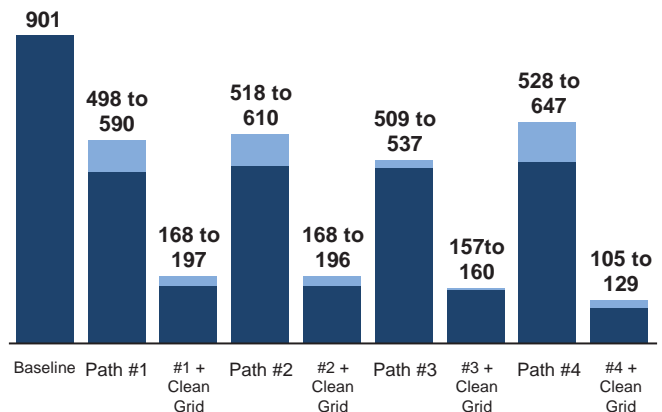

**RETROFIT PATHS:** Three of the retrofit paths improve the envelope by increasing the insulated glass units (IGU) of the window glazing and insulating behind the assembly spandrel. Path 3 increases envelope insulation by re-cladding with a triple pane curtain wall system, which could be implemented at the time of ownership turn-over or a major renovation to reposition the building in the market. Path 4 includes an option for electrifying the heating system with an electric boiler. In addition, all paths include improvements in lighting efficiency; reductions in plug loads and tenant energy use that include improvements to the efficiency of data centers and supplemental heating and cooling systems; replacing elevators; adding roof insulation and a Cool Roof; upgrades to the existing controls system for space heating and cooling; installation of low-flow fixtures; installation of demand controlled ventilation, premium efficiency motors, and VFDs; and maximizing roof space for solar PV.

**RESULTS:** Paths 1 and 2 yield source energy reductions of 30 to 40 percent. Path 3, which includes re-cladding, achieves between a 40 and 43 percent reduction, with less potential variability. Path 4 yields a lower reduction in source energy use than other paths, but potentially the greatest reductions in GHG emissions under a scenario in which the electric grid is much cleaner. The wide range in the results of Paths 1, 2, and 4 is partly indicative of the potential variability in occupant behavior and uncertainties in characterizing air infiltration reductions. Only seven percent of roof space is assumed to be usable for solar PV, which offset roughly one percent of the electric load across all retrofit paths. Additional reductions could be achievable with further energy use reductions in tenant spaces, particularly if there are significant existing process loads from computers and servers in the building.



## COMMERCIAL, VERY LARGE

This typology includes commercial buildings over 500,000 square feet in floor area. This includes a relatively small absolute number of buildings in New York City, but accounts for six percent of the built square footage and a significant portion of GHG emissions. The baseline building is served by a central chiller plant for space cooling and a hydronic distribution system supplied by district steam for space heating and using perimeter induction units. The building includes a glass curtain wall construction and relatively high process loads from tenants in the building, which is typical of large commercial office buildings.

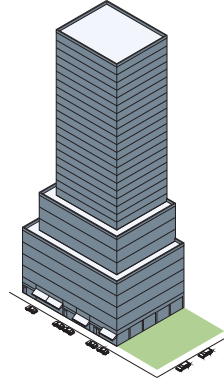

**Size** 773,000 SF average

**Height** 32 Stories + 1 Below-grade

### Baseline Conditions

**Wall Construction:** Double pane curtain wall construction; Steel-framed wall with some insulation (R-4)

**Roof:** Insulation above deck (R-15)

**Lighting:** 1.3Watts/SF

**Plug Loads:** 1.5 Watts/SF (receptacle equipment), 0.5 Watts/SF (Servers, process loads)

**Heating System:** District steam, hydronic distribution with induction units

**Cooling System:** Water-cooled centrifugal chiller

**DHW System:** Storage tank with district steam heat exchanger

### Efficiency Measures Applied to All Paths

**Lighting:** Reduce LPD and install sensors

**Plug loads:** Master switching; Smart plugs; Replace old elevators

**Envelope:** Maximize roof insulation; Cool Roofs

**DHW:** Install low flow fixtures

**BMS:** Upgrade to DDC system, with resets

**Renewables:** Solar PV on 11% of the roof

**Tenant Measures:** Replace appliances; Address supplemental heating and cooling; Improve data center efficiency

**Ventilation/Pumps:** Demand control ventilation with ERVs; Install pumps with premium efficiency motors with VFD

### Path 1

#### Cooling System and Envelope Upgrades

- Upgrade IGU and insulate behind spandrel
- High efficiency chiller with VFDs

### Path 3

#### Re-cladding

- Re-clad façade and insulate behind spandrel
- Install Dedicated Outdoor Air System
- Install natural gas boiler
- Condensing gas DHW
- High efficiency chiller with VFDs
- Remove induction units

### Path 2

#### Fuel switching

- Install natural gas boiler
- Condensing gas DHW
- High efficiency chiller with VFDs
- Upgrade induction units
- Upgrade IGU and insulate behind spandrel

### Path 4

#### Electrification

- Install electric boiler
- Electric tankless DHW at point of use
- Upgrade IGU and insulate behind spandrel
- High efficiency Water Cooled DX Units
- High efficiency chiller with VFDs

Path Source EUI Reduction (kBtu/SF)

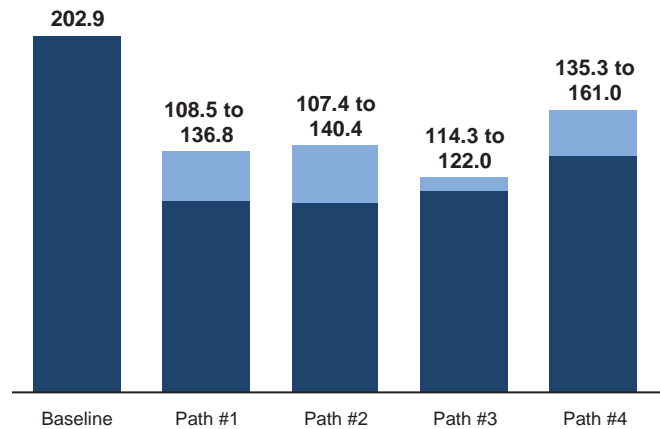

Path GHG Emissions Reduction (MtCO<sub>2</sub>e)

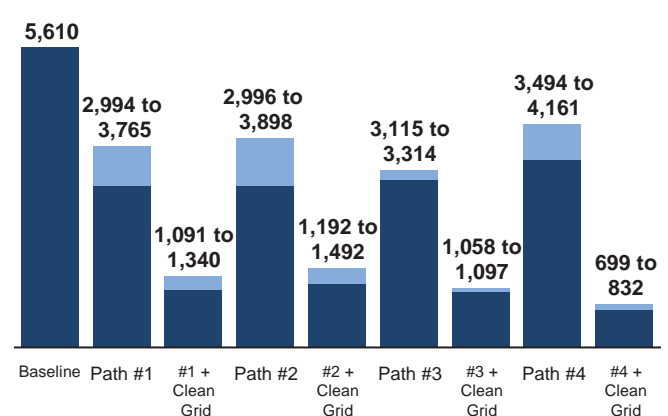

**RETROFIT PATHS:** Three of the retrofit paths increase the IGU of the window glazing and insulate behind the assembly spandrel to improve the existing envelope. Path 3 includes re-cladding, which could be implemented at the time of ownership turn-over or a major renovation. Path 4 includes an option for electrifying the heating system with an electric boiler. Upgrades or replacement of induction units are tested in Paths 2, 3, and 4, and roof space is maximized for solar PV in all paths. In addition, all paths include improvements in lighting efficiency; reductions in plug loads and tenant energy use that include improvements to data centers and supplemental heating and cooling systems; replacing elevators; adding roof insulation and a Cool Roof; installation of low-flow fixtures; upgrades to the controls system for space heating and cooling; installation of demand controlled ventilation, premium efficiency motors, and VFDs; and maximizing roof space for solar PV.

**RESULTS:** Paths 1 and 2 yield source energy reductions of 30 to 50 percent, with a wide range that is partly reflective of potential variability in occupant behavior and uncertainties in characterizing air infiltration reductions. Path 3, which includes re-cladding, achieves between a 40 and 45 percent reduction in source energy, with less potential variability. Path 4 yields a lower reduction in source energy use than the other paths, but could yield significant GHG emissions with a much cleaner grid, although further analysis is needed on this path. Eleven percent of roof space is assumed to be usable for solar PV, which offset less than one percent of the electric load across the paths. Additional reductions could potentially be achieved with further energy use reductions in tenant spaces.

## Applicability of Packaged Combined Heat and Power (CHP) Systems

As part of the retrofit path analysis, the City assessed the applicability of packaged CHP systems, typically 50kW to 500kW in size, which could be installed on-site to serve part of a building's heat and electricity loads. CHP systems can reduce energy use and GHG emissions by using waste heat from electric generation, usually powered by natural gas, to produce space heating, cooling, or DHW.

In multifamily buildings, CHP units are typically sized to the constant year-round thermal loads for DHW and sometimes a portion of space heating in a building with a hydronic heating loop. For commercial buildings, the waste heat from a CHP system can sometimes provide cooling, which may offset an existing chiller and can allow for greater system efficiencies. On-site CHP systems offer the flexibility to create electricity and heat when it is most advantageous to do so.

Fig. 28. CHP Carbon Savings vs Electric Grid Carbon Coefficient (tCO<sub>2</sub>e/kWh)

Source: NYC Mayor's Office

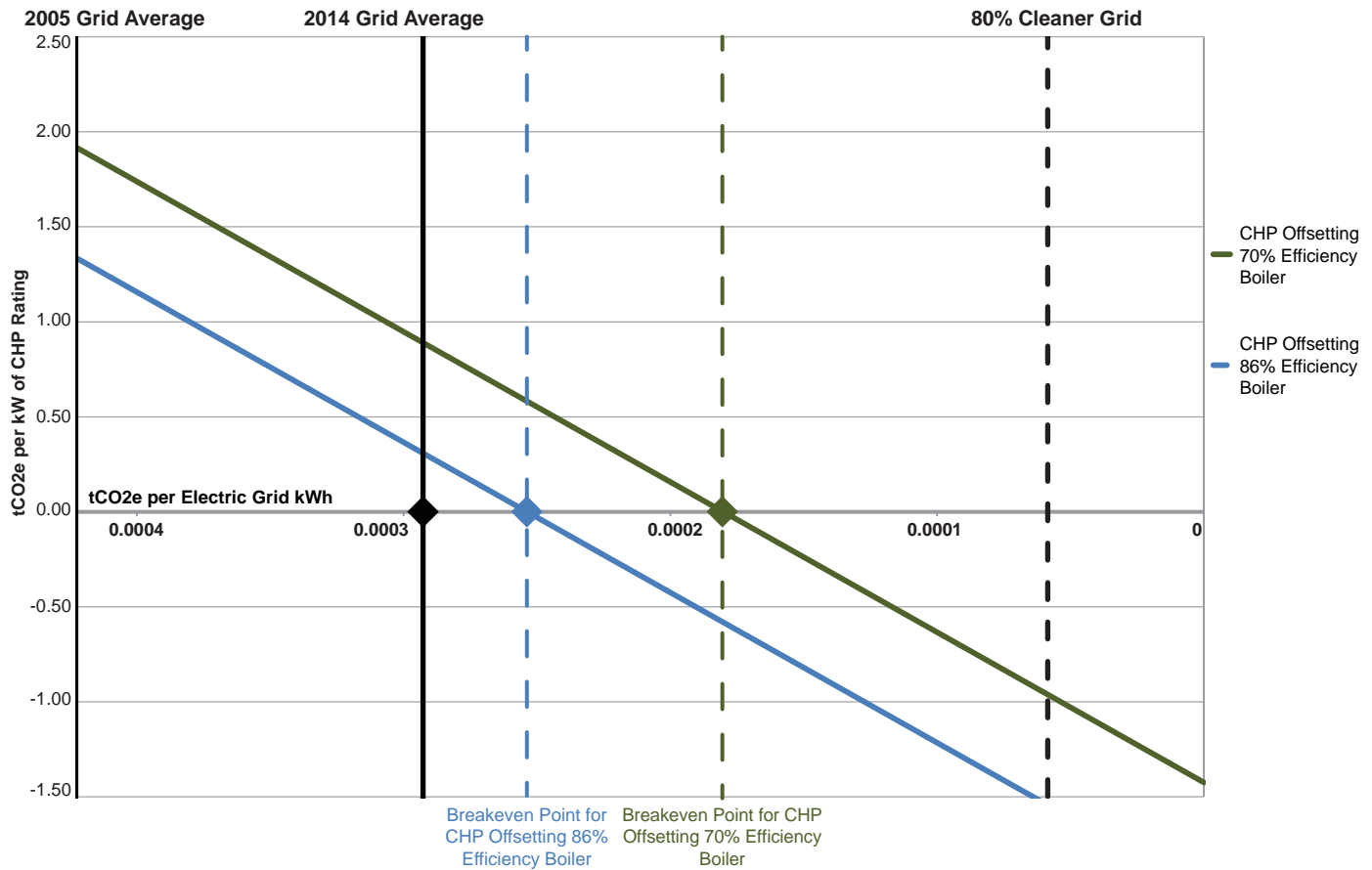

Based on the current average emissions intensity of the electric grid in New York City, the energy supplied by a CHP system, when installed and operated correctly, will reduce GHG emissions. However, if the grid continues to become cleaner, CHP systems will eventually reach a “breakeven” point at which they begin to emit more GHG emissions than power from the grid. The breakeven point for a particular system depends on a number of factors, including the efficiency of the CHP system, the efficiency of system that the CHP is offsetting, the thermal load of the building, the GHG intensity of the electric grid, and the time of use of the CHP system.

Two examples in the chart show the potential applicability for packaged CHP units based on the current average GHG emissions intensity from the electric grid. In both examples, a reciprocating engine CHP system uses the waste heat to offset the operation of a boiler. In the first scenario, a CHP system that functions at 95 percent of its rated efficiency offsets the operation of a typical, 70 percent seasonal efficiency boiler. Under this scenario, the CHP system will not reach its breakeven point until the grid becomes roughly 40 percent cleaner than it is today. In the second scenario, an optimal CHP system functioning at 100 percent of its rated efficiency offsets the operation of a high performance, 86 percent seasonal efficiency boiler. Under this scenario, the CHP system will reach its breakeven point when the grid becomes about 15 percent cleaner than it is today. These scenarios illustrate how the breakeven point of a given CHP system shifts according to the specifications of the system.

This analysis does not take into account time-of-use considerations, in which CHP systems could be designed to operate to a greater degree during peak load hours when more carbon intensive power plants tend to operate. In addition, this analysis does not include district CHP systems, which serve multiple buildings and, as a result of their scale, tend to have greater overall system efficiency than smaller packaged systems. District CHP capacity could also allow additional renewables to be integrated into the grid by providing a relatively clean and stable energy supply, and can provide additional benefits in terms of grid reliability and resiliency. Additional analysis of the potential system-wide benefits of district CHP systems will be completed as part of the City’s comprehensive 80 x 50 planning.

### **Applicability of Electrification in Large Commercial Buildings**

Each typology modeled at least one retrofit path in which the energy used for space heating, and in some cases DHW loads, is transitioned away from fossil fuels and to electrically powered systems. This is particularly beneficial under a scenario in which the electric grid becomes much cleaner than it is today. However, the electrification pathway for the “Commercial, Very Large” typology stands out because, more so than other pathways, it relies heavily on technology that is largely untested in buildings of this size and complexity. Such increases in electric demand from very large buildings may also require major additional utility grid infrastructure. Further research is

therefore needed to assess costs of these infrastructure changes against potential benefits from the electrification of space heating systems in very large buildings.

### **The Benefits of District Steam**

Several of the retrofit paths for commercial building typologies include conversions away from district steam as a fuel source to a high efficiency natural gas boiler that can lead to on-site energy and carbon reductions in buildings. However, New York City's district steam system realizes significant system-wide efficiencies because it is cogenerated with electric power. There are also economies of scale from district steam, which result in reduced costs by providing an energy source beyond the load of a single building. Additionally, there are benefits in terms of diversification of different load profiles, which allows the system to run more consistently and creates additional opportunities to add district energy sources to the grid. Further analysis is therefore needed to assess the potential system-wide impacts from buildings converting off district steam.

### **The Role of Commercial Tenants**

The results of the commercial retrofit paths assume some energy reductions from lighting, plug loads, and cooling in tenant spaces. However greater reductions are likely possible through increased outreach and coordination with tenants. Tenant energy use and unregulated plug loads must be addressed as part of a comprehensive package of measures for any building, particularly in commercial buildings, where tenant leased spaces can account for 40 to 60 percent or more of total energy use.

The City is currently working with 11 major commercial tenants and owner-occupiers of space in New York City to pilot tenant-based energy reduction measures through the NYC Carbon Challenge (Challenge) for Commercial Offices. These companies have committed to reduce their New York City-based GHG emissions by 30 percent or more over 10 years and have implemented innovative solutions that have already achieved significant results. Since the beginning of the Challenge, participants have reduced GHG emissions from their respective base years by more than 65,000 tCO<sub>2</sub>e, or roughly a 16 percent total reduction.

To realize these reductions, nearly all participants have capitalized on the dramatic improvements in lighting technology to reduce their lighting energy use. Many have also replaced older office equipment with new, energy efficient equipment and implemented energy saving settings on computers and monitors. Participants have also moved towards greater automation of lighting and controls for supplemental heating and cooling systems that can link equipment use to occupancy. Additionally, participating companies have densified their office spaces into smaller areas to decrease per capita energy use and plug loads and increase the use of natural daylighting.

Several participants have also realized enormous reductions from consolidating data centers and virtualizing servers to achieve greater utilization rates. Combined with strategies to optimize data center layout to reduce cooling loads, consolidating and virtualizing data centers are some of the most significant drivers of energy reductions for tenants in the Challenge.

Fig. 29. NYC Carbon Challenge Completed and Projected ECMs

Source: NYC Mayor's Office

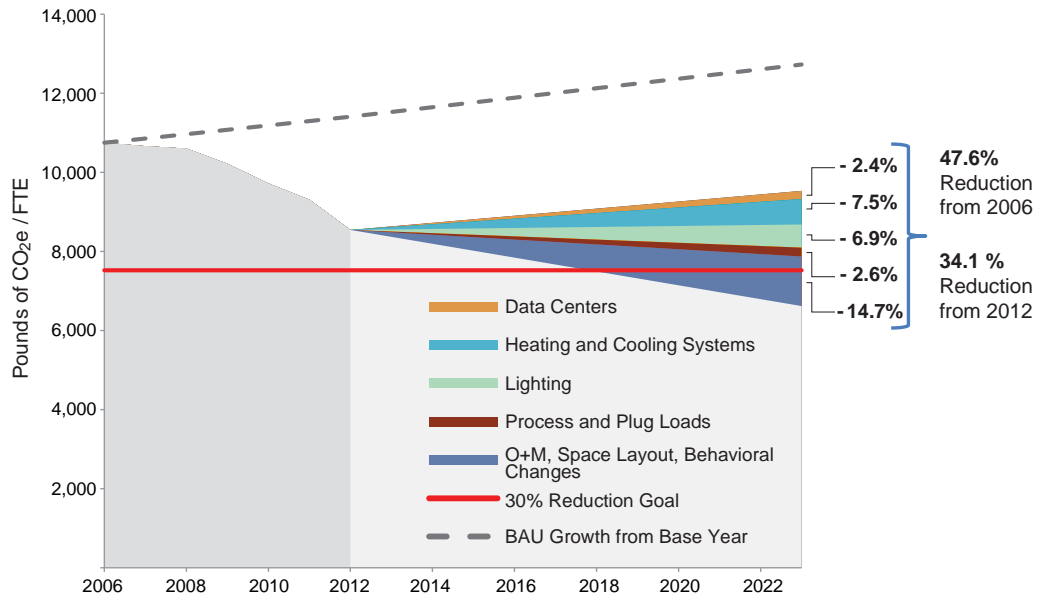

The success of the Challenge participants demonstrates that there are many strategies to significantly reduce energy use and GHG emissions from tenant spaces. The key to realizing this potential will be to replicate the most successful measures across additional leased spaces while also helping to reduce barriers to coordination between tenants and landlords that can prevent these investments from happening at scale.

## FINDINGS

**It is possible to reduce energy use from typical buildings in New York City by 40 to 60 percent with existing technologies and strategies.**

The development of the retrofit paths is a significant step. These paths illustrate the potential to transform the way energy is used in New York City's buildings and dramatically reduce their GHG emissions. The results of the analysis demonstrate that using existing technologies and strategies, energy use reductions of between 40 and 60 percent are possible from typical New York City buildings.

Because of the limitations to the predictive capacity of energy models, it will be extremely important to implement these strategies in the real buildings to determine

their empirical results. Key findings from the retrofit path analysis can inform this effort.

**Buildings must comprehensively address heating and cooling systems to realize significant energy and GHG reductions.**

The results of the analysis show that it is critical to comprehensively address a building's space heating system to reduce energy use and GHG emissions. This is particularly true in multifamily buildings and one- to four-family homes, where space heating accounts for such a significant portion of total energy use. For all paths, either the repair or replacement of the heating distribution system must be a component of improving heating system performance. For steam heated buildings, conversions to hydronic systems can achieve greater energy reductions than comprehensive steam system upgrades, but a comprehensive steam upgrade can also be a viable pathway if combined with a robust operations and maintenance plan to keep the system in working order. Heating equipment must also be upgraded to higher efficiency models, right-sized to building loads, and outfitted with better controls to improve system efficiencies.

To realize the full potential of space heating measures, such measures must also be paired with improvements to the building envelope to reduce air leakage. Major building envelope improvements are available for mass walls of built-up construction, including opportunities for increasing insulation and reducing exterior wall penetrations that cause air leakage and thermal bridges. At a minimum, these penetrations will need to be properly sealed and maintained, which for some buildings may require reconfiguring and maintaining room air conditioning units. In the long term, more comprehensive envelope upgrades that improve insulation and air tightness of both mass wall and curtain wall construction can significantly increase the effectiveness of energy efficiency improvements if paired with properly sized equipment and controls that sense space heating needs and adjust temperatures accordingly. Additional reductions can be achieved by improving efficiencies in DHW systems.

Upgrades to existing cooling systems are another major opportunity for large commercial buildings that have central cooling systems. In multifamily buildings and small commercial buildings, the best performance is achieved by removing room air conditioning units and installing central cooling systems or mini-splits for combined heating and cooling. These systems not only improve space cooling efficiency, but also reduce through-wall and window penetrations that cause air leakage.

**Operations and maintenance is critical for realizing the projected reductions.**

Across all retrofit paths, robust operations and maintenance is essential to realizing the full potential for energy reductions. Proper training ensures that the building staff

understands how to operate new systems. Addressing tenant energy use is also essential to achieve deep carbon reductions, particularly in commercial buildings. While lighting and plug load management strategies are generally well understood, additional opportunities such as improved IT efficiency and better controls for supplemental heating and cooling equipment should be explored by working with leading commercial tenants.

### **The energy supply significantly affects the potential for significant GHG reductions from buildings.**

The retrofit path analysis also shows the significant impact that a significantly cleaner electric grid has on resulting GHG emissions. This impact is greatest for the commercial typologies because of their larger share of electricity consumption as compared to their total energy use, although the results of a cleaner grid are significant in all building typologies. The analysis also shows that electrifying heating systems via air source heat pumps, VRF systems, or other existing technologies is technically feasible, and would be particularly beneficial under the scenario in which the electric grid is much cleaner. However, the electrification of very large commercial buildings deserves further analysis given the limited experience with these technologies in complex buildings and potential exogenous impacts on the electric grid from significantly increasing the electric load.

Renewable energy options, such as solar PV and solar thermal, will also need to be scaled up across the city to reduce dependence on fossil fuels, although the applicability for any given building depends on usable roof space and projected electric loads. Increasing the use of biofuels could be another option for reducing consumption of fossil fuels in buildings. On-site installations of CHP may also be an option and can lead to additional resiliency benefits during blackouts or other emergencies, but should be further assessed for their GHG reduction potential based on the future carbon intensity of the grid. Additional study is also needed to assess the citywide GHG impacts if some buildings move off of New York City's district steam system.

### **2050 retrofit paths are potentially replicable across a wide range of New York City's buildings.**

For the eight baseline buildings analyzed, the retrofit paths tend to replicate across different building typologies, meaning that potential 2050-ready buildings may be similar to one another. While residential and multifamily typologies tended to yield greater percentage reductions in energy use and emissions as compared to the commercial typologies, the resulting EUIs of similar retrofit paths begin to converge even when applied to different baseline buildings.



While many of the retrofit paths may be costly under current market conditions, replicability could lead to cost reductions for these strategies through economies of scale if implemented across a broad swath of buildings. The City can also help bring down these costs by working with early adopters to implement these strategies in their buildings, providing support to emerging industries and service providers to employ these technologies and strategies, and training building staff to operate and maintain new building systems. As buildings implement the retrofit paths, the City will check the modeled potential of the paths against building data to better understand their replicability across New York City's diverse building stock.

## NEXT STEPS

The retrofit path analysis helps to illustrate the kinds of strategies that would need to be scaled up to achieve our ambitious climate goals. Based on these findings, the City will:

- **Require large building owners to assess deep energy retrofit strategies as part of their Local Law 87 energy audit through a simple template developed by the City.**

Long-term energy planning is essential to ensure that as buildings are renovated, energy reduction goals are incorporated as a fundamental objective. The City will begin to require owners of large buildings over 50,000 square feet in floor area to identify strategies that would lead to deep energy reductions if implemented, develop a plan for how they could be phased in over time, and report this information in their Local Law 87 energy audits. To lower the potential cost of developing these strategies, the City will build on the retrofit path analysis to develop a template and replicable guides for identifying deep retrofit options by building typology. By requiring building owners to plan ahead, deep energy retrofit strategies can inform long-term capital planning and decision-making about renovations and upgrades in the decades leading up to 2050.

The City will support this effort through the following actions:

- **Launch a high performance retrofit track of the NYC Retrofit Accelerator.**

Drawing on the findings of the retrofit path analysis, the City will develop a “High Performance Retrofit Track” within the NYC Retrofit Accelerator, supported by funding from the New York State Energy Research and Development Authority (NYSERDA), to work with building owners to deploy these strategies and measures in the real world. Building on the Retrofit Accelerator's innovative approach to scaling up energy efficiency projects in buildings, the High Performance Retrofit Track will aim to increase demand and market participation for comprehensive retrofits that result in very low-energy-consuming buildings. This includes developing clear guidance for building owners and decision-makers on options for achieving deep energy savings, including

a package of strategies to phase in retrofits over time and a guide to applicable technologies and products. The City will work closely with the Building Energy Exchange to provide additional educational and training resources to assist this effort, as well as with the New York City Energy Efficiency Corporation (NYCEEC) and other lenders to develop standardization mechanisms for energy efficiency and clean energy financing and lower the “soft” costs of financing products.

- **Expand the NYC Solar Partnership and the Solarize NYC program to scale up on-site renewable energy investments in private sector buildings.**

Despite the dramatic expansion of solar capacity in New York City buildings over the past few years, building owners and managers still face an array of challenges to implementing their on-site renewable energy projects. The City will expand the NYC Solar Partnership to help overcome these challenges by continuing its work to reduce market barriers for solar, attract more solar energy companies to the city, and increase the citywide installed solar capacity. This includes expanding the Solarize NYC program to reduce barriers for communities with historically limited access to solar by providing informational resources at no cost and offering discounted pricing to customers through community aggregation. Building on the successful first campaign in Brooklyn’s Community Board 6 in 2015, the NYC Solar Partnership will administer more campaigns in the coming years to scale up solar installations across the city to reduce GHG emissions and ensure equitable access to the benefits of renewable energy.

- **Work with participants in the NYC Carbon Challenge to test innovative retrofit strategies across multiple building sectors.**

The NYC Carbon Challenge is the City’s voluntary program to work with leaders in the private and institutional sectors to reduce energy use and GHG emissions by 30 percent or more over ten years. The Carbon Challenge has rapidly expanded in recent years and now includes more than 70 institutions and private companies across five different sectors — universities, hospitals, commercial firms, multifamily buildings, and hotels. In 2015, 12 participants extended their commitments to a 50 percent reduction in GHG emissions by 2025, paving the way for others to follow on the path to deep carbon reductions. The City will work with these leaders to test the strategies and measures developed for the retrofit paths to test their applicability in the real world, including the cost-effective ways to implement deep energy retrofits.

# 3

## Designing for Whole Building Energy Performance

## **THE BUILDINGS BUILT TODAY WILL SHAPE FUTURE OUTCOMES**

Buildings constructed between now and 2050 will account for a significantly smaller proportion of New York City's building stock than those that exist today, but these buildings are still a critical part of achieving the City's commitment to an 80 percent reduction in greenhouse gas (GHG) emissions by 2050, compared to 2005 levels (80 x 50). In recent decades, the City has advanced incremental progress to improving the energy efficiency of building systems in new and substantially renovated buildings through continued updates to the New York City Energy Conservation Code (Energy Code or Energy Code). These updates, which were developed in partnership with the building industry, have improved building construction, reduced GHG emissions, and laid a critical foundation for incorporation of energy efficiency into building design.

Achieving 80 x 50 will require an acceleration of this progress. There is growing consensus that the current approach of making incremental improvements to specific building systems within the Energy Code will not be sufficient to achieve the deep carbon reductions required. A new approach to the Energy Code that considers the entire building as an integrated system that is designed to a whole building energy performance standard can achieve significantly greater GHG reductions in the near-term. Implementing these standards as soon as possible would prevent the need for future retrofits in these buildings, while also contributing to energy cost savings and improvements to building quality.

### **Growth in New York City Buildings**

As New York City continues to attract new residents, businesses, and organizations to live and work within its boundaries, the demand for new buildings will increase. Based

Fig. 30. Projected Building Demolition and New Construction, 2015-2050

Source: NYC Mayor's Office

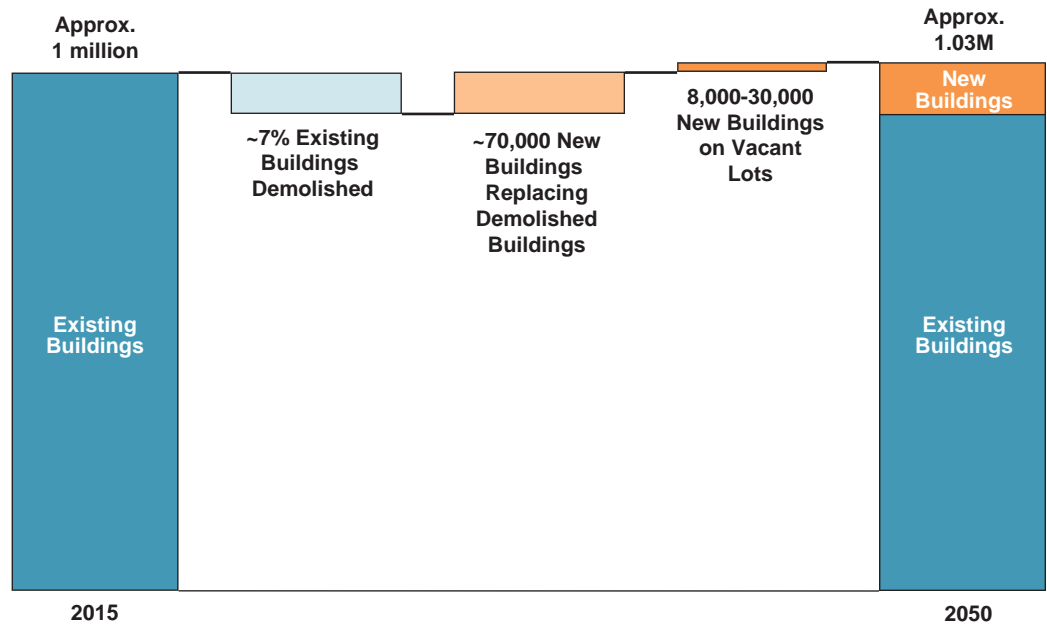

on historic permit data and expected population growth, the City projects that from now to 2050, between 8,000 and 30,000 new buildings will be constructed on vacant lots, and approximately 70,000 existing buildings will be demolished and rebuilt on existing lots, often with larger buildings.

These projections for new construction and substantial renovations are expected to increase building area in New York City by 8.6 percent, or more than 450 million square feet, by 2050, growth that is essential to meet the demands of a thriving city. Under a “business as usual” (BAU) scenario, in which these buildings are built to current standards, this increase in built square footage is projected to increase of GHG emissions from the building sector by 8.9 percent.

Fig. 31. Projected Growth in Building Area and Greenhouse Gas Emissions, in Million Metric Tons of Carbon Dioxide Equivalent (MtCO<sub>2</sub>e)

Source: NYC Mayor's Office

Improving the energy efficiency of new construction and substantial renovations

General Building Type	Building Area (SF)		GHG Emissions Based on Area (MtCO <sub>2</sub> e)		% of Total Building GHG Emissions	
	2010 (actual)	2050 (predicted)	2010 (actual)	2050 (predicted)	2010	2050
1 to 4 Family	1,385,544,887	1,524,099,376	6.8	7.5	19%	19%
Multifamily	1,942,657,115	2,211,870,450	10.8	12.3	30%	31%
Commercial	973,390,709	1,116,926,401	10.1	11.5	28%	29%
Industrial	310,447,131	248,357,705	4.4	3.5	12%	9%
Institutional	511,032,401	562,135,641	4.0	4.4	11%	11%
No Data	257,266,090	180,086,263	--	--	--	--
<b>Total</b>	<b>5,380,338,333</b>	<b>5,843,475,836</b>	<b>36.0</b>	<b>39.2</b>	<b>100%</b>	<b>100%</b>

represents an important opportunity for achieving 80 x 50. Catalyzing the market to ensure that these buildings are built to higher standards as soon as possible will decrease the burden of future retrofits and allow for the city to grow in a manner that is sustainable in the long-term.

### **New York City Energy Conservation Code**

New York City has already made significant strides to reduce the GHG impact of new buildings through the adoption and enforcement of a local Energy Code and implementation of incremental upgrades to the Energy Code every three years. New York City is authorized by New York State to enact its own energy code provided that it is equal to or more stringent than the State requirements. In 2009, the City established the New York City Energy Conservation Code (Energy Code) by local law. Since then, the City has consistently updated the Energy Code to be more stringent than the State requirements. The Energy Code sets the minimum threshold for energy efficiency in New York City's buildings.

New York State, New York City, and many other jurisdictions use the International Energy Conservation Code (IECC) as a model to develop their local energy codes. Using the IECC and the American Society of Heating, Refrigerating and Air-conditioning Engineers (ASHRAE) 90.1 standards to inform a local Energy Code has benefited the City by alleviating the burden of developing an individual code and aligning construction practices across jurisdictions nationwide. The International Code Council, comprised of code enforcement officials, industry representatives, design professionals and other interested parties, update the IECC model code on a three-year revision cycle through a consensus development process. The IECC model code also references the ASHRAE 90.1 standard, which is the federally established local energy code baseline that the IECC must meet or exceed.

Both IECC and ASHRAE 90.1 provide prescriptive requirements that regulate the performance of specific building systems. Compliance with the Energy Code is typically demonstrated by meeting efficiency requirements for specific pieces of equipment through a "prescriptive path," which does not necessarily evaluate resulting whole building energy performance. Compliance can also be demonstrated through an energy model, in which tradeoffs in the efficiencies of systems are allowed without evaluating the efficiencies of all systems together.

### **Recent Energy Code Advancement**

New York City's existing Energy Code update process has been extremely successful to date in moving the industry toward incorporating energy efficiency in new buildings and substantial renovations. Since the enactment of the first national ASHRAE Standard in 1975, code improvements have cumulatively realized a nearly 45 percent energy reduction in buildings constructed nationwide.

Fig. 32. ASHRAE 90.1 Energy Savings Advancements Since 1975

Source: NYC Mayor's Office

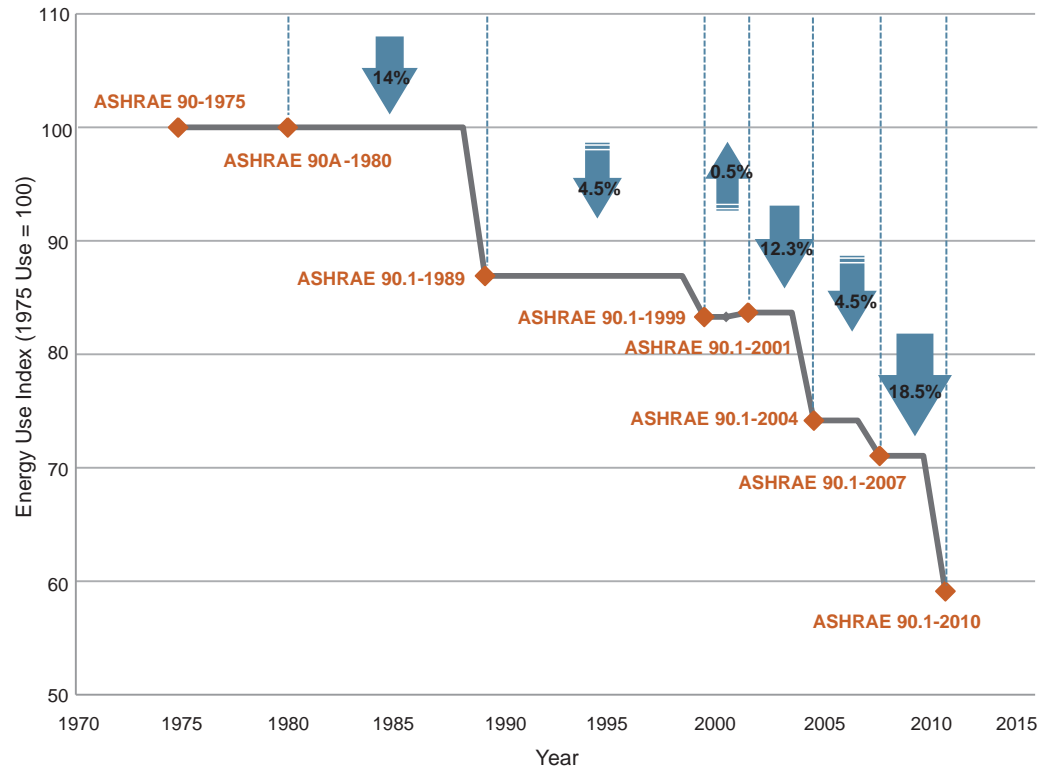

Recent efforts in New York City have built upon this foundation and incorporated the best available information into local code updates. The industry in New York City has continuously met the challenge of routine upgrades and worked closely with the NYC Department of Buildings (DOB) to incorporate New York City specific changes into the Energy Code.

In 2015, the City engaged an energy codes advisory committee to propose updates to the latest New York State Energy Conservation Construction Code, which will bring New York State in line with ASHRAE 90.1 2013 and IECC 2015. In addition to its usual analysis, this group carefully considered the work of the Buildings Technical Working (TWG) and proposed system-specific efficiency measures that were ready for near-term market adoption. Recognizing the importance of the building envelope to overall energy performance, the City has included a proposal in the 2016 Energy Code to require air-leakage testing for new buildings to verify the air-tightness of the building envelope, which will prevent energy losses. For residential construction, exterior walls will be required to conform to more stringent climate zone specifications that will result in homes and low-rise residential buildings that are better insulated and provide improved comfort. In addition, the Energy Code will also require a solar-ready zone on the roofs of one- and two-family homes that have sufficient solar potential, meaning that an area of the roof will be reserved for future installation of a solar system.

The City projects that the new 2016 NYCEEC will result in at least an 8.5 percent reduction in energy use in new commercial buildings and at least a 25 percent reduction

in energy use in new residential buildings as compared to the existing Energy Code, a significant step forward in reducing GHG emissions from new buildings.

### The Future of Code Development

These successes have been critical to improving energy efficiency and reducing GHG emissions in New York City. However, there is growing consensus that the current approach of incremental improvements to the prescriptive requirements of the Energy Code will not be sufficient to achieve necessary carbon reductions to reach 80 x 50. Updating the Energy Code in this manner would place increasingly stringent requirements on specific building systems, which cannot continue to yield energy reductions to the levels achieved to date. Additionally, this approach does not take into account the integration of these systems and opportunities to improve holistic building energy performance.

The City completed an analysis of projected GHG reductions from potential future Energy Code updates based on historic ASHRAE 90.1 updates, using U.S. Department of Energy studies completed by the Pacific Northwest National Laboratories (PNNL).<sup>18</sup> The City correlated PNNL’s energy use profiles of six prototype buildings in New York State, which cover the significant changes in the most recent ASHRAE code upgrades, with DOB permit data.

**Fig. 33. Projected GHG Abated from New Construction Under Scenario of Replicating Historical Code Advancements**

Source: NYC Mayor’s Office

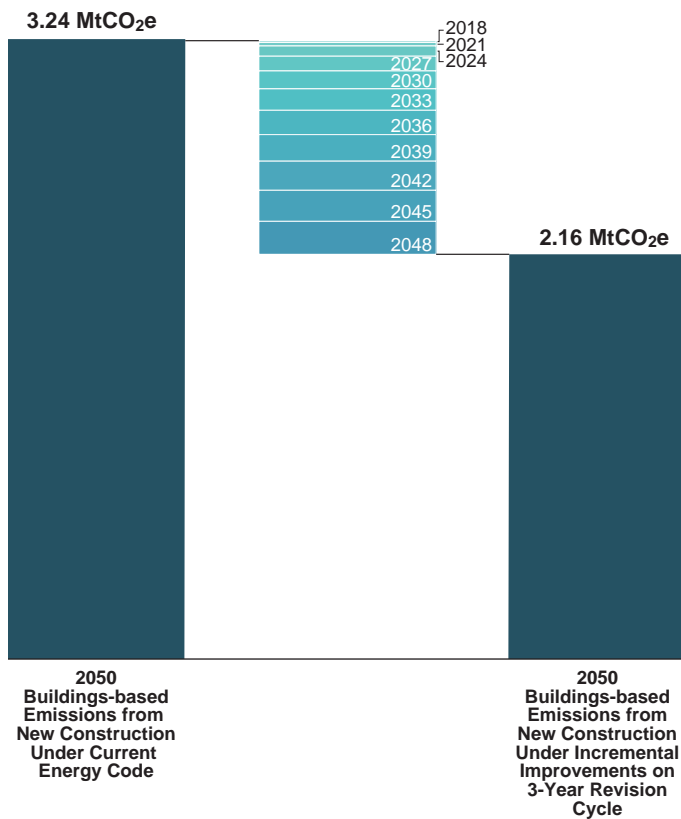

Under a scenario of incremental upgrades, the analysis assumes that starting in 2018 future code upgrades would continue every three years, as they have historically. The model utilizes the average energy reductions achieved from the ASHRAE 2007 to the 2010 upgrade and the 2010 to the 2013 upgrade, resulting in roughly an eight percent average energy reduction for a typical New York City building.<sup>19</sup>

Projecting the effects of these upgrades on expected new construction and substantial renovations out to 2050 yields a GHG reduction of roughly one million tons of carbon dioxide equivalent (MtCO<sub>2</sub>e), as compared to current Energy Code standards and under the current electric grid. This reduces the projected growth in GHG emissions from new buildings and substantial renovations from roughly 3.2 MtCO<sub>2</sub>e to 2.2 MtCO<sub>2</sub>e, meaning that the City would still need to offset a 2.2 MtCO<sub>2</sub>e increase in building-based emissions by 2050. Moreover, any new building that is not constructed to high performance standards today would need to be retrofitted in the future to achieve the reductions necessary from existing buildings to meet 80 x 50.



**Fig. 34. Projected Incremental Costs of New Energy Code with Scenario of Replicating Historical Code Advancements**

Source: NYC Mayor's Office

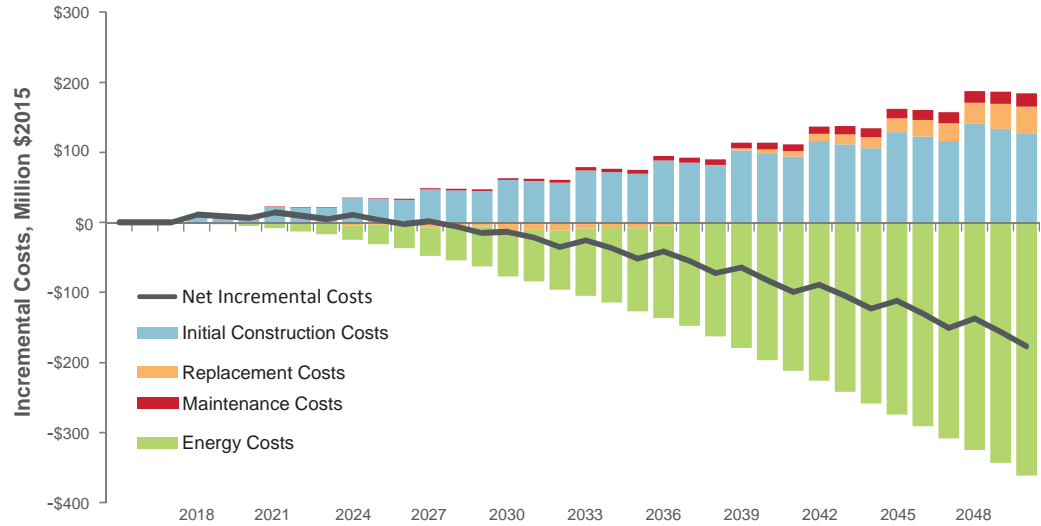

One major benefit of the incremental approach to code updates is the limited increase in construction costs from each new standard. Moreover, any increases in costs can be offset by the long-term operational energy savings.

The City evaluated the incremental costs for initial construction, maintenance, and replacement of systems for standards based on ASHRAE 90.1 updates, as well as the projected resulting operational energy costs savings for electricity and natural gas. The analysis assumes an increase in initial construction costs of five percent with each new standard upgrade and roughly one percent of energy savings each year over the study period. Using a conservative estimate of linear decline of construction costs to zero over 30 years, and including future maintenance and replacement costs, the energy cost savings accrued would total nearly \$300 million annually by 2050 in new buildings, resulting in a net impact of \$200 million in savings by 2050.

The long term projections for continuing an incremental, systems-based approach to upgrading the Energy Code would result in manageable increases to the costs of construction and sizeable reductions in operational costs for building owners. However, this approach places strain on the industry to adjust building standards every three years and the GHG reductions achievable through this approach are not on the scale needed to achieve the City's 80 x 50 commitment. Buildings that are constructed in the near term must be held to the highest standard possible to capture the full GHG reduction potential from new construction and substantial renovations.

### **A Paradigm Shift in Our Energy Code**

A growing body of research shows that an updated approach to the Energy Code must consider the entire building as an integrated system to achieve significant reductions in energy use and GHG emissions.<sup>20</sup> Energy performance design standards that specify a whole building performance target for energy use, as opposed to standards that apply to

individual building systems, are well equipped to achieve this change. Whole building standards typically results in very well-insulated buildings that have minimal air leakage and are heated, cooled, and ventilated with very little energy. A whole building standard, such as energy use intensity (EUI) per square foot, would account for the interaction of systems within a building, but is an imperfect metric because it does not account for variations in occupant uses. Energy performance requirements could also include on-site renewable energy sources as a means to offset building electric loads drawn from the utilities.

Continuing to pursue improvements to individual pieces of equipment through incremental Energy Code upgrades will eventually encounter diminishing returns in both energy use and cost savings. A holistic approach to the Energy Code can reduce construction costs by comprehensively incorporating measures that not only save energy but also reduce upfront equipment costs.<sup>21</sup> For example, integrating building systems to achieve holistic energy performance can allow for smaller building systems, such as a boiler, that will cost less than an oversized piece of equipment regardless of its efficiency. Moreover, the operational cost savings in very low-energy buildings will continue to pay off for building owners and residents for many years.

While New York City has yet to develop its own uniform whole building design standard, this type of standard has been implemented through both mandatory and voluntary codes in jurisdictions globally and shows great promise for significantly reducing energy consumption and costs for new buildings and substantial renovations.

**Fig. 35. Median EUI of Buildings Built to Code Compared to NYC and Passive House (kBtu/SF)**

Sources: NYC Mayor's Office and Pacific Northwest National Laboratory

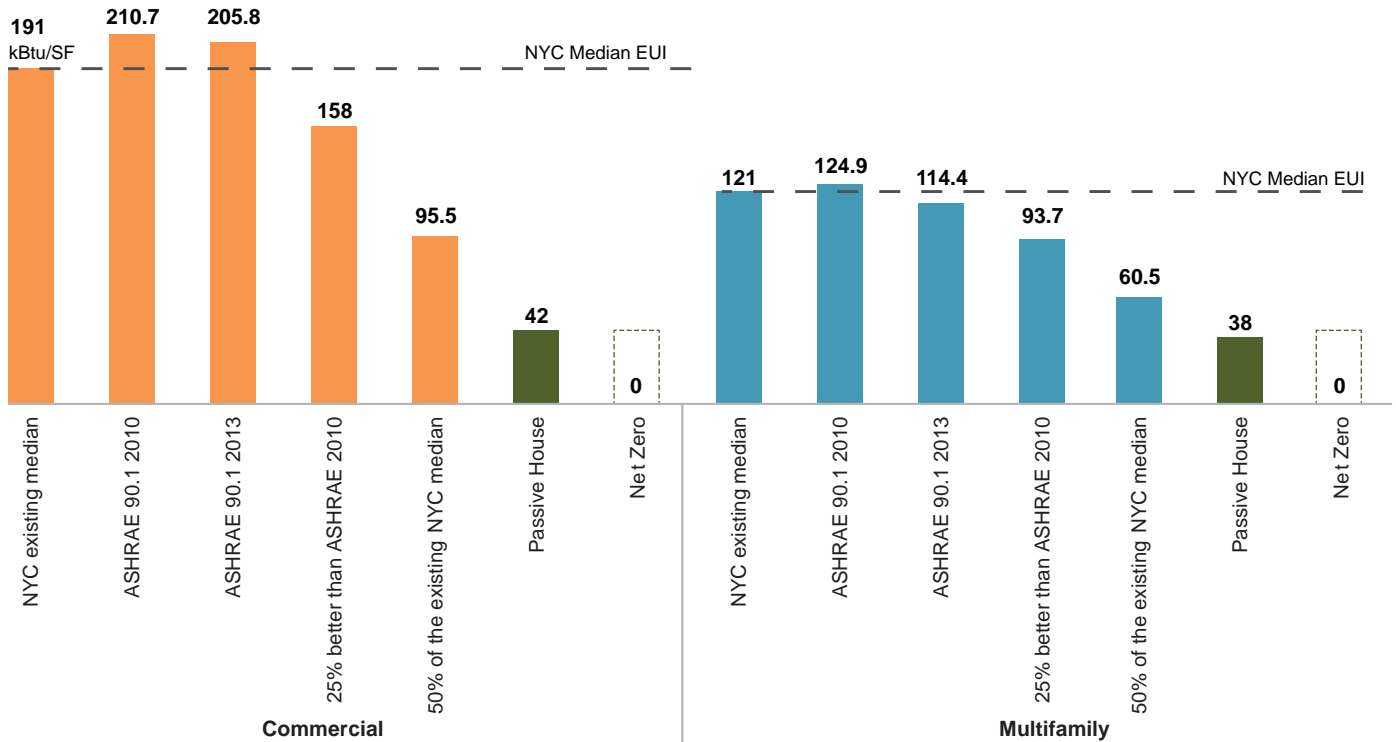

## **BRUSSELS EXEMPLARY BUILDING PROGRAM AND PASSIVE HOUSE REGULATION**

In 2015, the City of Brussels in Belgium became the first European city to enact regulations that require all new construction to be built to Passive House standards. This impressive move came after the Brussels launched a six-year program, called the Brussels Exemplary Buildings Program, to stimulate demand, increase industry knowledge and skills, and develop proof of concept details for very low-energy buildings. Between 2007 and 2013, Brussels issued six calls for sustainable buildings that met energy, environmental, reproducibility, and design criteria. A jury selected the winning project teams, who received a financial award that totaled roughly \$12 per square foot of the building and received access to a tailored marketing, networking and education program.

Over the course of the program, Brussels supported 243 projects, totaling 6.7 million square feet. These projects included both new construction and substantial renovations and covered a range of buildings types, sizes, uses, and regulatory structures. Nearly four million square feet of winning buildings were Passive House certified, and the remaining met very low-energy design standards.

By 2014, 8.6 million square feet of buildings were in design or under construction in Brussels that met Passive House standards. These projects provided the proof of concept and best practices necessary prior to Brussels' 2015 Passive House requirement. In less than two decades, Brussels has gone from being pegged as having "the worst wall insulation in Europe"<sup>22</sup> to becoming an international leader on building construction and a hub for building innovation, with designers, developers, and contractors traveling to Brussels to learn first-hand how their standard was achieved. Leaders in New York City have engaged with the officials responsible for developing the Exemplary Buildings Program and to share best practices for scaling up high-quality, low-energy buildings. The lessons learned will inform New York City's pursuit of a similar paradigm shift for new construction.

The most notable of these standards includes Passive House design and "Zero Net Energy," both of which have been executed in a handful of built projects throughout New York City. These standards have been proven to achieve very low-energy consumption in buildings of all uses and sizes, particularly in Europe, and often use existing technologies and techniques that are familiar to the New York City industry.

### **A New Metric**

Pursuing a paradigm shift towards holistic building energy performance for the Energy Code will require updating the metric by which applicants model energy use and the City assesses Energy Code compliance. The City currently allows applicants that pursue whole building design to use the Energy Cost Budget (ECB) method in ASHRAE Standard 90.1 to assess compliance with the Energy Code. Under this compliance method, an applicant develops a building energy model of their proposed building design and creates a baseline ECB of the same building that follows the prescriptive, systems-based requirements of the Energy Code. The ECB of the proposed building must be less than or equal to the ECB baseline. Because ECB is based on the current cost of energy, this type of modeling relies on fluctuating energy prices and is therefore not always aligned with the goals of energy efficiency and GHG reductions.

Whole building energy performance design standards, such as Passive House, typically do not prescribe the ECB method. Instead, these standards often use absolute energy performance targets, such as annual energy per square foot. These absolute targets provide more certainty to energy performance outcomes, but are not commonly used in the New York City building industry today. In addition, a metric for New York City must account for the varying space uses and differences in building occupancy in the city to avoid penalizing industries that have high energy use profiles, such as trading floors and television studios. Collaboration with other jurisdictions and leaders on this effort is also key to ensuring market alignment of any new standards.

Once an energy performance target is set, a prescriptive path that includes specific system requirements will also be necessary to support the transition of the industry towards low-energy performance. These prescriptive requirements would be developed to result in a building that will perform at an equivalent level to the predictive energy performance target in the energy performance design standards.

### **Supporting the Market**

The City and its design and construction partners in the private sector must work together to realize this paradigm shift in the Energy Code. The City is already leading by example by enacting Local Law 31 of 2016, which requires all new capital projects for City-owned properties to be constructed to consume at least 50 percent less energy than buildings constructed to today's standards. These projects will help develop replicable models for the private sector and provide training opportunities for the industry to deliver on very-low-energy buildings.

Facilitating the implementation of an energy performance design standard will require a major escalation of education and training to prepare the industry for this shift. Proof of concept details and other resources will need to be brought to scale quickly. Industry professionals including architects, engineers, developers, and manufacturers will need to be trained on whole building energy performance design. Facilitating more coordination in the industry between designers and builders through all phases is necessary to achieve better construction.

## **FINDINGS**

Pursuing a paradigm shift in the City's Energy Code is an important step towards putting New York City on a path to 80 x 50. The current approach to the Energy Code that regulates incremental improvements to discreet building systems will not be sufficient enough to substantially offset the growth in GHG emissions from new construction and substantial renovations.

Realizing this potential through energy performance design may incur near-term incremental costs, both in terms of the hard costs of construction and soft costs of design and development as the market gets used to the standards. Public resources will be necessary to help bring down these costs, avoid adverse impacts on construction and development, and prepare a workforce to deliver on a new era of construction in New York City. Market education at a very large scale will also be necessary to increase demand among developers and residents for these buildings.

The City will create new programs and policies that will ensure that New York grows in a sustainable manner that welcomes new residents and businesses while also continuing to decrease emissions.

## NEXT STEPS

- **Require new buildings and major alterations be designed to an energy performance metric beginning in 2019 and set an energy performance design target beginning in 2022.**

New York City will initiate a fundamental change to our Energy Code by requiring new buildings to be designed to a whole building energy standard. The new standards will include an effective metric by building type that defines an energy performance target and accounts for the varying uses and occupancy intensities. These standards will reflect the diverse uses of New York City's building stock and enable continued growth to accommodate new residents and businesses. The City will also develop prescriptive requirements that collectively achieve equivalency with the energy performance design standards.

Because the market needs time and resources to adjust, these requirements will be implemented over multiple code cycles. The City will phase in the requirement for meeting this new metric in 2019 and will require compliance with an energy performance design target beginning in 2022. In addition, this process will be informed by ongoing U.S. Department of Energy, ASHRAE, and other efforts to improve the national energy performance standards and supported by resources necessary to educate the market.

- **Lead by example through required low-energy performance design targets for new capital projects for City-owned properties.**

In March 2016, the City enacted an amendment of the City's Green Building Law requiring all new capital projects for City-owned properties to be constructed to consume at least 50 percent less energy than buildings constructed to today's standards. The experience of the City as client and the industry actors who will develop these new City buildings will help create the proof of concept needed for low-energy consumption targets in the broader New York City market and generate data to assist in development of an energy performance metric. The City's efforts will also provide a training ground for the skills that will be necessary for local professionals and contractors to develop and construct very low-energy buildings.

To support these efforts, the City will:

- **Establish a Codes Advisory Committee to produce code language to be adopted by local law.**

In order to achieve this shift towards holistic building energy performance, the City will convene a Codes Advisory Committee of code experts, architects, engineers, and real estate professionals to develop the energy performance design metric and standards by building type for new buildings and substantial renovations.

- **Develop proof of concept and details for very low-energy buildings across multiple typologies and deliver training, education, and market support through a program that awards the design and construction or renovation of exemplary buildings.**

To develop additional proof of concept and allow the industry time for experimentation, the City will launch a large-scale competition for the design and construction of very low-energy buildings, which will include incentives, education, training, and marketing for competition participants. An industry-wide program will accelerate the growth in the knowledge base for energy performance design and construction to help spur the transition to a new era of world-class low-energy buildings. The program will also provide market support to help reduce the costs of related products and services and will develop proof of concept details across a broad range of building types. The proof of concept details will also help inform the energy performance metric to be incorporated in the 2022 Energy Code revision for new buildings and major alterations.

- **Develop standards and practices for the City's own buildings to serve as models and support the development of capacity in the New York City market.**

Pursuant to the City's Green Building Law, by 2017, the City will establish a low-energy performance metric based on use and typology for City-owned properties, so that new City buildings and major renovations are designed to consume at least 50 percent less energy than buildings constructed to current standards.



## **Case Study: Residential Tower at Cornell Tech**

The world's largest Passive House breaks ground in New York City.

**1 East Loop Road, New York**

**Owner: Cornell University, Hudson Companies and Related Companies**

**Developer: Hudson Companies and Related Companies**

**Architect: Handel Architects**

**Engineer: Buro Happold**

**Sustainability: Steven Winter Associates**

**Exterior Wall: Vidaris**

**Contractor: Monadnock Construction**

In the summer 2015, Cornell Tech broke ground on its new campus on Roosevelt Island and made the momentous announcement that the campus will boast the largest Passive House building in the world. Co-developers Related and Hudson Companies are now developing the University's 26-story, 350-unit residential tower that will be complete in time for students and faculty to move in for the fall semester of 2017.

Passive House construction focuses on energy efficiency and indoor air quality through rigorous standards for building insulation, space heating, and cooling and must adhere to a strict energy budget. A Passive House-certified building must use less than 4.75 kBtu per square foot per year of source energy for heating and another 4.75 kBtu per square foot per year for cooling, which equates to 60 to 70 percent less energy than standard construction in New York City.

To achieve this low-energy performance, the tower at Cornell Tech will be wrapped in a super air-tight envelope comprised of pre-fabricated panels clad in metal rain screens and shipped to the site by barge. The entire building skin is only allowed 0.6 air changes per hour under 50 pascals of pressurization—or more than seven times tighter than typical construction. In addition to this tight construction, the envelope has more insulation than a typical building. The exterior wall has a weighted thermal performance value of R-20, even after accounting for thermal bridging, and triple-paned, thermally broken windows with an R-5 performance value and a low solar heat gain coefficient to keep heat in during the winter and keep it out during the summer. The robust thermal properties of the envelope will also ensure durability over time.

Enhanced indoor air quality for occupants is also a priority. Each habitable space in the building is served with fresh air ducted directly from outside. All of the supply and exhaust air systems, including kitchens and bathrooms, are tied together using energy recovery ventilator (ERV) technology, which recycles heat from the exhaust air and uses it to precondition incoming supply air to reduce heating and cooling energy demand. In addition, all of the ductwork in the building is tightly sealed to ensure proper performance using a technology called Aeroseal®.

The envelope and ERV systems will drastically reduce the need for space conditioning in the building. The remaining heating and cooling load is served primarily by a commercial-grade, split refrigerant, air-source heat pump (ASHP) system. The highly energy efficient heat pumps are powered by electricity, allowing for the potential of further GHG reductions under a cleaner electric grid future scenario, and are capable of operating well even in locations where space conditioning demand is minimal. Each room in the building also has a thermostat for individual thermal comfort.

In order to support the efficient design of the building, Cornell Tech is planning a robust resident engagement program to reduce discretionary energy consumption. Residents will be billed for their electricity use, as well as, heating and cooling energy through a sub-metering system. Additionally, each resident will have real-time access to energy use information via computer, tablet, or phone to help integrate energy use into their decision-making.

With Cornell Tech's pioneering Passive House residential tower, the University is paving the way for high performance construction in New York City. This groundbreaking building will serve as a model for others as the City pursues its commitment to 80 x 50.

## Case Study: Highbridge Overlook

A cost-effective high performance affordable housing development

240 West 167th Street, Bronx

Owner/Developer: Dunn Development Corp.

Architect: SLCE Architects, LLP

General Contractor: HLS Builders Corp.

Structural Engineer: DeNardis Engineering

MEP Engineer: Rodkin Cardinale Consulting Engineers

Energy Consultant: Steven Winter Associates

Solar Consultant: Bright Power

Construction Cost: \$197/square foot

HPD Average Construction Cost: \$233/square foot<sup>23</sup>

Highbridge Overlook is an 11-story, 155-unit apartment building in the Bronx that provides affordable rental housing and integrated supportive housing, with 40 studio apartments for formerly homeless single adults on all floors and on-site support services. Construction commenced in January 2012 and was completed in July 2014. Dunn Development Corp. was selected by New York City Housing Authority (NYCHA) and the NYC Department of Housing Preservation and Development (HPD) to develop a formerly vacant lot on the NYCHA's Highbridge Gardens campus through a large-scale competitive RFP process with financing from HPD, the NYC Housing Development Corporation (HDC), and New York State Homes and Community Renewal (HCR).

All City-financed affordable properties must meet certain energy efficiency requirements, which includes meeting ENERGY STAR standards and certification through Enterprise Green Communities. In addition to achieving these standards, Highbridge Overlook participated in NYSERDA's Multifamily Performance Program and was designed with a focus on a well-insulated building envelope and properly sized mechanical systems, which includes a building-wide hydronic heating distribution system served by three sealed-combustion condensing boilers that operate at up to 93% efficiency. Other major efficiency components include aerosolized duct sealing for mechanical exhaust risers to optimize ventilation performance, a rooftop ERV that captures heat from building exhaust fans, a 4.4 kilowatt (kW) micro-combined heat and power (CHP) unit that provides the building's domestic hot water, and a 45 kW solar array on the roof that provides electricity to the building's common areas.

The energy used for space heating at Highbridge Overlook is in the top 15 percent of similar multifamily buildings,<sup>24</sup> and in the top two percent of all multifamily buildings, approaching the level of heating energy use that existing multifamily buildings will eventually need to achieve without the use of emerging or untested technologies. This also leads to significant operational cost savings that will help preserve the affordability of the property. Moreover, construction costs for Highbridge Overlook were \$197 per square foot, significantly below the average residential construction cost of \$233 per square foot for HPD-financed non-prevailing wage, non-union, block-and-plank buildings in Fiscal Year 2012. This cost was maintained despite a challenging construction site due to diligent efforts by the developer and design team to design around the existing conditions, oversee construction, and enforce the design documents.

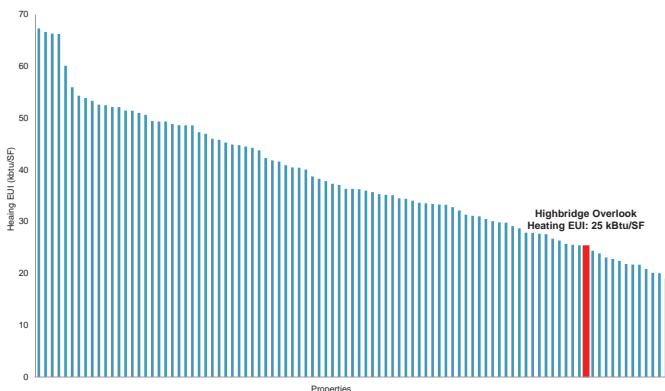

Heating EUIs in Building Typology: Multifamily, Post1980, >7 Stories



The energy performance of Highbridge Overlook is indicative of a wholesale shift towards high performance buildings in the affordable housing development community over the last 10 years, which is largely a result of the enhanced incentives offered by the State and local utilities for energy performance and energy efficiency requirements for City financing through HPD and HDC. The results provide direction for scaling up the development of high performance buildings across the City. By focusing on best practices in construction management and continuing to encourage the market towards higher levels of energy performance through incentives, market education, and new City requirements, many more new buildings can yield similar results.



## Ridgewood Bushwick Senior Citizens Council

An affordable housing developer that has become a national leader in developing and renovating high performance buildings.

Founded in 1976, the Ridgewood Bushwick Senior Citizens Council (RBSCC) is a nonprofit organization that provides social services, including affordable and supportive housing, to residents of all ages across Brooklyn and Queens. Since then, RBSCC has developed more than 150 affordable housing properties, totaling 1800 units, to serve low- to moderate-income families in these neighborhoods.

RBSCC first began incorporating energy efficiency into its developments in 2000 with its Rheingold Brewery Redevelopment, which included more than 500 condominiums and rental apartments that were developed on a former brownfield site in Brooklyn. In partnership with HPD, HDC, and New York State Homes and Community Renewal (HCR) RBSCC participated in NYSERDA's first pilot programs for multifamily building efficiency. As part of the NYSERDA Multifamily

Performance Program, RBSCC implemented basic insulation, ventilation, and water efficiency measures, which significantly lowered the development's operating costs once completed. RBSCC soon realized that the focus on energy efficiency and lower operating costs could free up additional capital to reinvest in affordable properties that have restricted income from rents.

Following this project, RBSCC began constructing all of its new developments to meet high performance energy efficiency standards. RBSCC began looking to Passive House standards as a way to cut energy costs even further, by 70 percent or more from typical construction. RBSCC completed the Mennonite United Revival Housing Apartments in 2013, a 24-unit affordable rental housing building, as the first multifamily affordable Passive House in the country. RBSCC completed its second Passive House building, Knickerbocker Commons, in 2014.

By focusing on best practices in construction management, RBSCC was able to construct both Passive House projects at or below the average price as other typical affordable multifamily developments that are financed by HPD.\* Specialized consultants and contractors were not employed for either project. Instead, the architect closely monitored the construction team to ensure adherence to design documents and RBSCC led regular meetings to troubleshoot any problems as they arose. Some materials for both projects cost more than they would under conventional construction practices, such as high performance windows, energy-recovery units, and increased amount of insulation. However, RBSCC was able to offset these expenses through savings in masonry and a significantly smaller heating plant and distribution system. With both buildings currently operating as designed, RBSCC has seen a 75% energy savings compared to typical HPD projects.

Building on this success, RBSCC is now pursuing renovations to 11 of its existing buildings, totaling 264 units, to meet Passive House standards by the end of 2019. These buildings were selected based on a combination of upcoming refinancing with HPD and their high utility costs. By focusing on improvements to the building envelope, air sealing, and ventilation control, RBSCC plans on reducing heating and cooling loads with minimal interference with existing tenants. RBSCC will also maintain construction costs for the renovations by bundling the procurement of construction materials across the 11 buildings into bulk purchases. When complete, these buildings will be the first affordable housing buildings in New York City to be retrofitted to Passive House standards.

Beginning with early participation in NYSERDA pilot programs and now pushing the envelope towards Passive House retrofits, RBSCC has become a national leader in high performance buildings. As a result, RBSCC has also been able to cost-effectively preserve and develop thousands of units of affordable housing while reducing citywide GHG emissions and lowering operating costs that can be reinvested into the communities they serve.



**Mennonite United Revival Housing Apartments**

Image Credit: Ryan Cassidy

\* Total hard costs for Mennonite United Revival Housing Apartments were \$220 per square foot and \$206 per square foot for Knickerbocker Commons. HPD's average residential hard cost for non-prevailing wage, non-union, block-and-plank new construction ranged from \$239 to \$250 per square foot between FY 2012 and FY 2015.



# 4

GHG  
Reductions  
from All  
Buildings

## **REALIZING THE FULL POTENTIAL OF GHG REDUCTIONS IN BUILDINGS**

To realize the technical potential for deep carbon reductions in both new construction and existing buildings, significant supporting efforts will be critical to prepare the market for change, educate the industry on new standards, and help bring down potential costs. As the City continues to build demand among building owners and decision-makers for energy efficiency and clean energy services, it must also work to increase the supply of qualified professionals who are able to serve this market. Training and education will be critical throughout the building sector and new options for financing may be necessary to cover the costs.

These changes will not happen overnight, but the City will immediately implement new policies and programs to help meet these growing needs. The City will work to address existing barriers that prevent building owners and decision-makers from investing in energy efficiency and partner with early adopters to scale up action in the near-term. The City will also ensure that these efforts lead to enhanced job opportunities for New Yorkers, expanded access to energy efficiency and clean energy services, and support the preservation of housing affordability in the city.

Working with members of the Technical Working Group (TWG), the City will prioritize the following efforts to realize the full potential for reducing greenhouse gas (GHG) emissions from its buildings.

**All buildings, including small, mid-sized, and historic buildings, must be included in the path to 80 x 50.**

Existing building energy efficiency policies in New York City primarily focus on capturing opportunities in large buildings. While this approach has been effective to

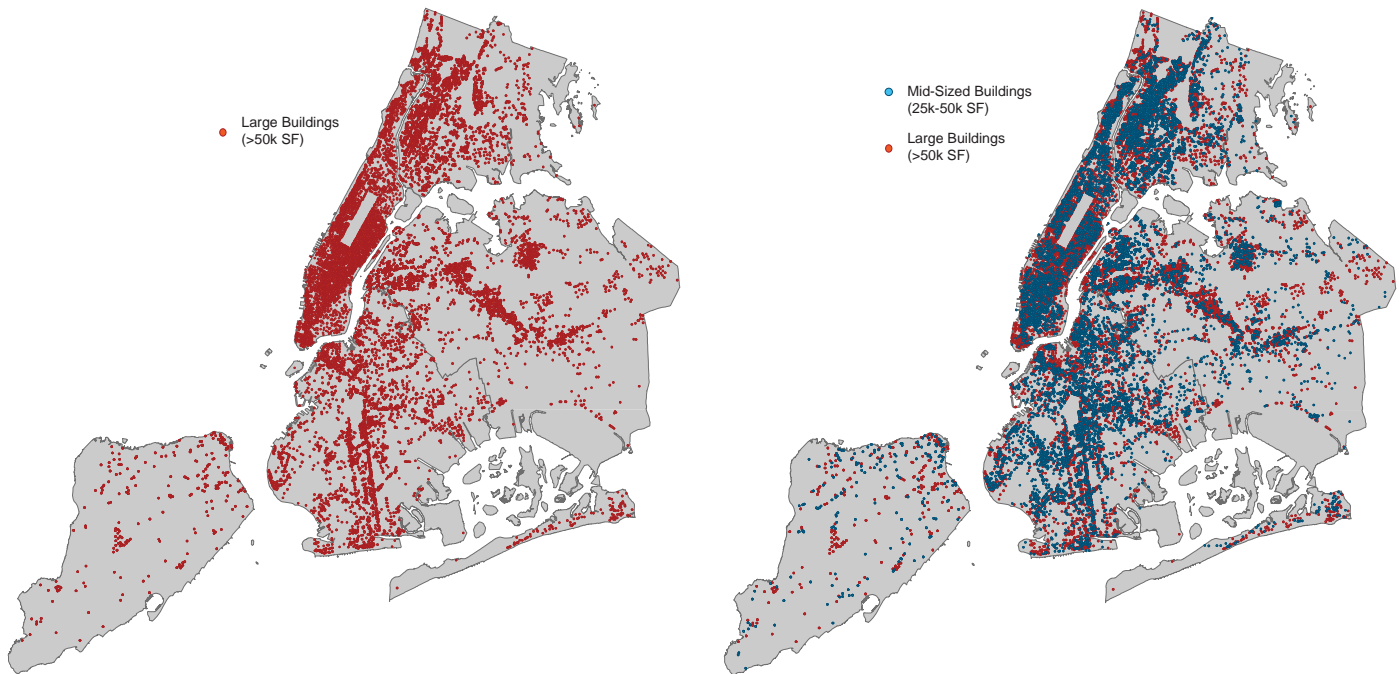

**Fig. 36. Large and Mid-Sized Buildings in New York City**

Source: NYC Mayor's Office

date, reaching an 80 percent reduction in GHG emissions by 2050 from 2005 levels (80 x 50) will require a more comprehensive set of policies that include all buildings.

In 2009, the City enacted the Greener, Greater Buildings Plan (GGBP) to ensure that owners and decision-makers of large buildings have access to information about their energy and water use. Buildings over 50,000 square feet in floor area, which are subject to the GGBP laws, account of just two percent of the City's building stock but nearly half of the built square footage and 45 percent of citywide energy use. The laws require building owners to complete energy and water use benchmarking annually, which provides a snapshot of annual whole building energy use, and complete an energy audit and retro-commissioning once every 10 years to repair equipment deficiencies for existing building systems and gain more granular information about efficiency opportunities.

### COMMUNITY RETROFIT NYC

In the summer of 2016, the City will launch a dedicated outreach and assistance program called Community Retrofit NYC to help owners and operators of small and mid-sized multifamily buildings in Central Brooklyn and Southern Queens implement energy and water efficiency upgrades. This is a complementary program to the NYC Retrofit Accelerator, which is geared towards larger buildings that must comply with the City's existing building energy laws. Community Retrofit NYC will develop a community-driven approach to scaling up investments in energy and cost-saving measures, provide technical guidance to building owners and decision-makers interested in pursuing retrofits, and develop resources for these smaller buildings that can be replicated in other neighborhoods. In addition, the program will help building owners connect with the NYC Department of Housing Preservation and Development's (HPD's) new Green Housing Preservation Program or other financing and incentive programs to help cover the costs of upgrades.

Information about building systems and energy and water use should be available to the residents, owners, and decision-makers of all buildings, not just the largest buildings. Energy use benchmarking allows owners and decision-makers to consistently measure efficiency, track energy and water performance, and create a baseline for improvements that will reduce utility costs. Energy audits provide recommendations for the specific measures an individual building owner or decision-maker could implement to save energy and reduce costs, along with the associated costs, paybacks, and return on investment to help prioritize potential capital investments. Retro-commissioning also requires certain adjustments to existing building systems and equipment that will help improve energy performance and prolong the life of the equipment.

The City can expand the GGBP laws to incorporate mid-sized properties and develop new opportunities to provide energy and water use information to owners and residents of smaller properties, while taking into account different ownership patterns and available resources in small and mid-sized buildings. The City must also enforce the laws in order to ensure compliance and improve reporting quality so that all building owners, decision-makers, and residents have access to high-quality information that can help save energy and cut costs.

Effective enforcement of New York City Energy Conservation Code (Energy Code) is another critical component of ensuring that all newly constructed and renovated buildings meet the standards that require them to be more energy efficient and resilient. Because the Energy Code applies to buildings of all sizes, this helps ensure that owners and residents of all buildings benefit from reduced operating costs by ensuring the most efficient pieces of equipment are installed at the time of new construction, replacement, or renovation.

**Fig. 37. National and State Historic Districts**

Source: NYC Mayor's Office

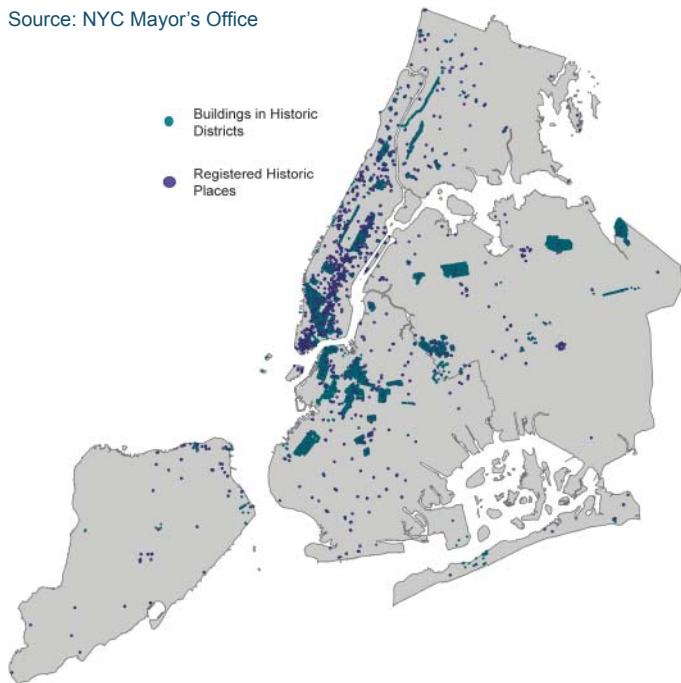

New York City's many historic neighborhoods and landmarked buildings contribute greatly to the city's unique character. We share a collective responsibility to preserve these spaces, which include more than 33,000 landmarked properties located in 114 historic districts and 20 historic district extensions across all five boroughs. However, almost all buildings in historic districts are not subject to the Energy Code because of a New York State exemption. In addition, landmarked properties can face barriers to implementing energy efficiency projects due to existing City, State, and Federal requirements regulating the renovation of these properties. All together, these buildings represent 11 percent of the city's built square footage and can play a key role in reducing emissions and improving efficiency.

## NEXT STEPS

To achieve 80 x 50, all buildings must be part of the solution. This includes ensuring that decision-makers in buildings of all sizes have access to their energy use information and understand their opportunities to increase efficiency. It also means ensuring that historic and landmarked buildings meet basic energy requirements and can pursue efficiency retrofits when desired. Accordingly, the City will:

- **Require annual energy use benchmarking in mid-sized buildings.**

To bring the benefits of energy and water use benchmarking to mid-sized buildings, the City will expand Local Law 84 to bring all buildings over 25,000 square feet in floor area under the law. Expanding these laws to include mid-sized buildings will add up to 14,650 buildings (10,195 properties) subject to the benchmarking requirements, which include 275,000 residential units and more than 365,000,000 square feet of space. As part of this anticipated expansion, the City has launched the NYC Benchmarking Help Center to provide technical assistance and support for all covered buildings in the benchmarking process.

### NYC BENCHMARKING HELP CENTER

In January 2016, the City launched the NYC Benchmarking Help Center (Help Center) to provide technical assistance and support for all covered buildings in the benchmarking process. In partnership with the City University of New York's (CUNY) Building Performance Lab and the Building Energy Exchange, the Help Center offers a free support service for building owners that need help at any stage in the benchmarking process. The Help Center focuses on increasing compliance rates for buildings owners in most need, improving data accuracy, and assisting new building owners.

- **Require retro-commissioning every ten years in mid-sized buildings.**

To help mid-sized buildings reduce their energy consumption and improve equipment reliability, the City will require all buildings over 25,000 square feet in floor area to retro-commission their building systems once every 10 years, again adding an additional 14,650 buildings (10,195 properties) subject to retro-commissioning requirements. Because these buildings tend to have less complex systems and equipment, the retro-commissioning requirements will be less invasive and costly than the existing requirements for larger buildings over 50,000 square feet.

- **Require utility benchmarking in buildings receiving City financing from the NYC Department of Housing Preservation and Development (HPD) or NYC Housing Development Corporation (HDC).**

Affordable housing of all sizes can benefit from access to utility benchmarking to measure efficiency and track energy and water performance. To facilitate this practice in City-financed affordable housing, the HPD and HDC now requires benchmarking for buildings that enter their financing programs with the help of a pre-qualified vendor who will provide automatic utility uploads into an accessible platform that displays

utility usage. Once fully implemented, this will allow property owners and managers of affordable housing control and reduce utility costs through targeted efficiency improvements.

- **Tailor energy standards for appropriate application to historic buildings, which are currently exempt from Energy Code compliance.**

All buildings and districts that are on the New York State or National Register of Historic Places are currently not subject to the Energy Code. The City will work with the State as appropriate to develop an energy standard for historic buildings and districts. The City will also ensure that the adopted energy standard does not degrade the historic form, fabric, or function of a building during the time of renovation.

Based on projected renovation cycles, requiring renovations to historic buildings and buildings within historic districts to comply with a specifically tailored Energy Code could reduce citywide GHG emissions by at least 155,000 metric tons of carbon dioxide equivalent (tCO<sub>2</sub>e) by 2050. As the Energy Code becomes more stringent, these buildings will continue to reduce incrementally more emissions over time.

- **Pursue changes to State laws to require energy information disclosures during real estate transactions.**

Improvements are often made to homes and properties when they are sold, which is an ideal time to include energy- and water-saving measures. Prospective buyers and renters should have access to information about how much it will cost to live and work in their new spaces. The City will work with the State and other partners to explore opportunities to require energy disclosure at the time of sale by working to amend relevant State laws, such as the Truth in Heating Law and Real Property Law. The City will also examine ways to process this information so buyers and sellers of all buildings, including single family homes, understand the improvements they can make to reduce their energy costs. This could include integrating energy data into Multiple Listing Services, mortgage calculators, and property appraisals.

The City will support these efforts through the following actions:

- **Improve compliance with and enforcement of Local Law 87 energy auditing and retro-commissioning.**

The City will expand the enforcement personnel at the NYC Department of Buildings (DOB) who are dedicated to enforcement of Local Law 87 energy audits and retro-commissioning. The City will work to enhance audit quality standards and improve reporting accuracy as additional buildings are brought under the energy auditing and retro-commissioning requirements and the market for these services continues to mature. Ultimately, this will help building owners of all sizes more effectively use their audits to identify and execute energy and water efficiency projects.



- **Improve compliance with and enforcement of the Energy Code.**

The City is currently running a program to assess opportunities for enhanced Energy Code enforcement on permitting applications for building alterations that have an energy impact. Prior to the de Blasio administration, DOB only had dedicated Energy Code enforcement staff for permits for new construction and major renovations, meaning that opportunities to realize GHG reductions from existing Energy Code requirements on smaller renovations might have been missed. Based on the findings of this program, the City will tailor additional Energy Code enforcement efforts to the most impactful opportunities. DOB will also work closely with architects, engineers, contractors, developers, tradespersons, and laborers to ensure education about and compliance with the Energy Code and realign design and construction priorities. The City will continue to invest in DOB personnel and additional resources for building owners, including technology improvements to streamline permit applications and code compliance.

- **Work with the Landmarks Preservation Commission to update its rules and procedures to streamline the process of energy efficiency upgrades in landmarked buildings and historic districts.**

The Landmarks Preservation Commission (LPC) will continue to support owners of landmarked buildings throughout the permitting approval process and work through a City rulemaking process in 2016 to update its rules and procedures to streamline the approvals process for retrofits of landmarked buildings and buildings that lie within historic districts. In particular, the City will use this opportunity to integrate information and best practices from prior retrofit projects in landmarked buildings into the allowable scope of alteration and renovation projects.

### **Tenant energy use and other “unregulated” loads in tenant spaces represent a substantial untapped source of GHG emission reductions.**

Tenant energy use makes up a sizeable portion of building energy consumption, and much of it is currently not subject to regulation since tenant energy use includes appliances for which there is no federal or state efficiency standard. Commercial tenant spaces can account for 40 to 60 percent or more of a building’s overall energy use, presenting a significant opportunity to reduce GHG emissions.

Realizing many of the opportunities to reduce energy use from commercial tenant spaces would require better alignment between landlords and tenants to ensure they are approaching energy efficiency upgrades in concert. Although many of New York City’s major commercial landlords and tenants are publicly committed to energy efficiency and sustainability, barriers to meaningful coordination persistently delay or prevent uptake of energy efficiency measures. Split incentives — in which the building owner pays for an efficiency improvement but the tenant reaps the cost-savings — can prevent landlords and tenants from collaborating to improve efficiencies. Many commercial tenants are experiencing increasing energy use from space densification, plug loads,

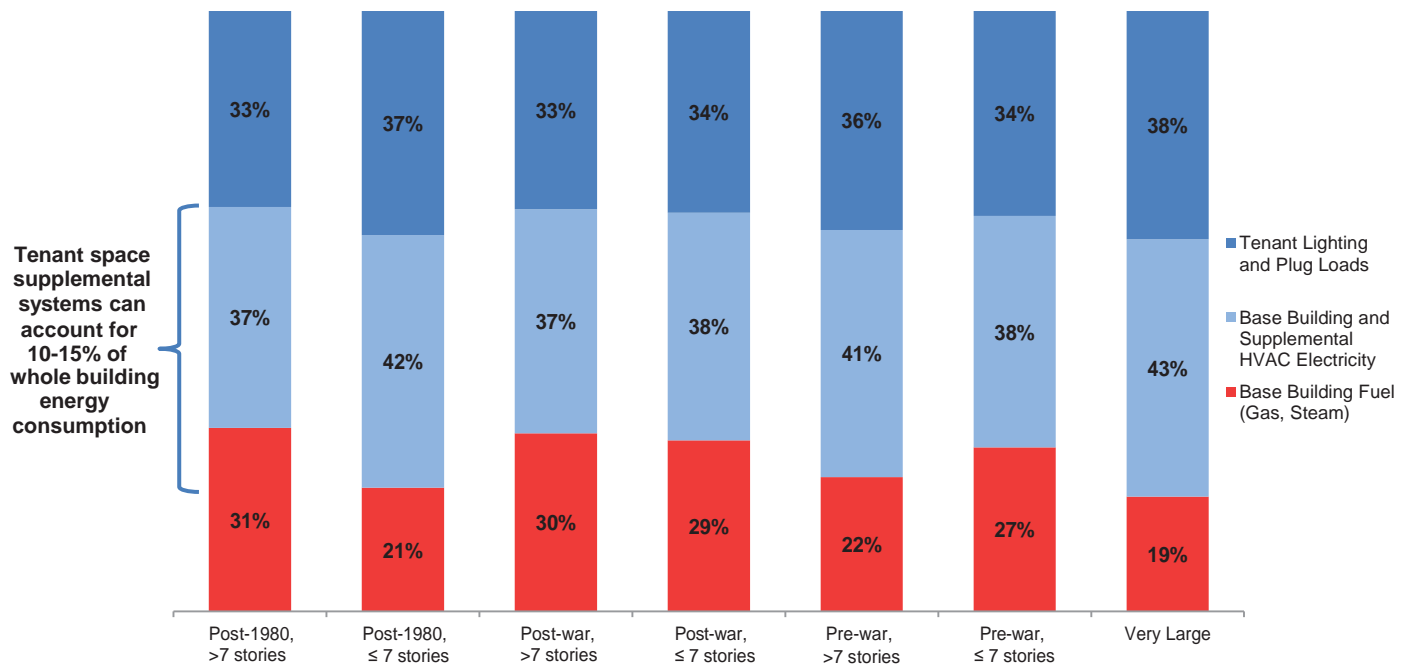

Fig. 38. **Tenant Lighting, Tenant Plug Loads, and Base Building Energy in Commercial Buildings**

Source: NYC Mayor's Office

and information technology equipment, which leads to increased demands on the base building systems and increases whole building energy consumption. Moreover, a lack of coordination between base building and supplemental heating and cooling systems in tenant spaces and limited operations and maintenance for shared systems can often lead to inefficient operation of both. Oversizing of equipment in new tenant space fit-outs can also lead to inefficient operations once the space is occupied.

Another important step to helping tenants and landlords work together to maximize energy efficiency is to ensure both parties have access to their energy use data. Many tenants do not have access to this information and do not pay directly based on usage, which can prevent tenant-driven action. In fact, many buildings still bill tenants for electricity use on a standard rate through rent inclusion, regardless of their consumption. Providing energy use data on both whole-building and tenant levels would help support informed decision-making about energy efficiency improvements.

## NEXT STEPS

Building tenants, and commercial tenants in particular, must be part of the pathway to 80 x 50. The City will work to ensure that tenants and landlords have access to the energy use information they need to make informed decisions. In addition, the City can work with private sector leaders to develop solutions to other intractable barriers to tenant-landlord coordination on energy efficiency investments. Specifically, the City will:

- **Require sub-metering in non-residential tenant spaces larger than 5,000 square feet in area in all large and mid-sized buildings.**

Local Law 88 of 2009 currently requires owners of non-residential buildings over 50,000 square feet to install electric sub-meters in non-residential tenant spaces greater than 10,000 square feet by 2025 and provide monthly energy statements to these tenants. The expansion of this law to include buildings greater than 25,000 square feet and non-residential tenant spaces greater than 5,000 square feet will dramatically expand the number of tenant leased spaces that will benefit from sub-metering, including many retail spaces and Class B and C commercial tenants.

The City will support these efforts through the following actions.

- **Develop a comparative metric for commercial tenant energy use and create a voluntary benchmarking program for commercial tenants.**

The City will also develop a New York City-specific tenant energy performance scoring program to provide a quantifiable metric for tenants to compare their energy consumption against similar office-use types. The metric will incentivize new tenants to fit out their office space more efficiently, as well as motivate existing tenants to better manage their energy consumption by aspiring towards a third-party verified voluntary accreditation. This program will be aligned with the U.S. Environmental Protection Agency (EPA) and U.S. Department of Energy's (DOE) tenant-focused version of EPA's ENERGY STAR for Buildings Program. The City will also work closely with the private sector to collect volunteer tenant data from major commercial landlords to help develop this metric and to publicly report on this metric annually.

The City will support these efforts through the following actions:

- **Launch a Commercial Landlord/Tenant Carbon Challenge to identify best practices in efficient operations that can be replicated in commercial buildings across the city.**

In 2013, the City launched the NYC Carbon Challenge for Commercial Offices, which includes some of New York City's largest commercial tenants and owner-occupiers of office space. The 11 participating companies have pledged to voluntarily take the necessary steps to reduce their GHG emissions intensity, measured either per square foot or per full-time employee, by 30 percent or more in 10 years.

Using the NYC Carbon Challenge platform, the City will bring together New York City's largest commercial landlords and tenants to identify the best practices to achieve a common GHG reduction goal. The focus of the program will be to work with landlord and tenant leaders to identify strategies to coordinate implementation of energy efficiency projects, with a long-term focus on replicable and scalable solutions that the City will work to publicize. The City will build on the successful NYC Carbon Challenge for Commercial Offices by including the landlords of existing participants in the program and welcoming new participants to the Challenge. This expansion of the program has the potential to reduce emissions by 45,000 tCO<sub>2</sub>e.

- **Work with the Public Service Commission and utilities to provide resources for customers to understand and decrease their energy use.**

The City will work with the New York State Public Service Commission (PSC) to expand all utility customers' access to their energy use information. The City will continue to advocate that utilities provide automatic uploads of aggregated building energy use data to EPA's Portfolio Manager free of charge, which would ease the Local Law 84 compliance process and reduce costs for building owners. This would also ensure that customers have accurate energy data when tracking their usage and comparing against historical data, a critical component of managing energy.

Local Law 88 requires large building owners to install sub-meters for non-residential tenants greater than 10,000 square feet and provide monthly energy statements. However, even sub-metering and energy disclosure does not ensure tenants are billed based on their energy usage. As more commercial buildings install sub-meters to comply with Local Law 88 by 2025, the City will engage the PSC to encourage billing based on energy usage for sub-metered tenants. Having tenants billed based on energy usage will increase tenants' awareness of energy consumption and provide them with a financial incentive to improve energy management. Additionally, the City will work with the PSC and utilities to roll out on-bill tools that provide both commercial and residential tenants with a comparative metric for their energy use and potential measures to reduce their consumption.

### **New York City's workforce must be ready to deliver high performance buildings.**

The full potential for GHG reductions in buildings will require having a workforce that is trained and knowledgeable about energy efficient operations of building systems. Whether a building owner is investing in state of the art technologies or upgrading existing systems to reduce energy costs, the proper installation, operations, and maintenance of building systems is essential to achieving optimal energy performance. Building operators must be trained on the interactions of systems to realize the greatest efficiency benefits and reduce energy costs. Manufacturing specifications for the operation of individual building systems exist, but these can be difficult to align with the unique characteristics of a building and the interaction of multiple systems.

New York City is fortunate to have a range of training and workforce development resources for building operators, particularly for those working in large, complex commercial buildings. As the City seeks to scale up energy efficiency best practices across additional building types, it will be essential to ensure that these resources meet the evolving needs of the industry. Training and educational resources appropriate for smaller or simpler buildings will have to reach a broader audience of building operators and focus on different building systems.

Building owners and operators also face a broad and fragmented landscape of laws and regulations for required operations and maintenance of buildings. Relevant local laws include Article 3 of the Building Code, the NYC Department of Environmental Protection's Air Code, the NYC Fire Department Fire Code, and the New York City Housing Maintenance Code. Operations and maintenance plans can help buildings meet these requirements and ensure that controls, equipment, and other building systems are operating as originally designed and reduce the effects of wear and tear that can lead to energy waste. Best practice guides are available, but it can be difficult to tailor them to the specific requirements for New York City buildings.

To change the way we build and operate our buildings, training must also reach a broader range of industry professionals. This includes architects, engineers, trades, contractors, and laborers, who will all need to be educated to prioritize energy efficiency and deliver new services and skills. Strong partnerships between building owners, property managers, and operators will also be required to ensure proper integration of operations and maintenance into building plans.

To realize the full potential for GHG reductions, the City will directly connect building professionals to existing trainings, expand training opportunities, and provide new resources to support building operators. Specifically, the City will:

- **Connect building owners and decision-makers to trainings in the market best suited for their buildings through the NYC Retrofit Accelerator.**

The NYC Retrofit Accelerator is a one-stop resource to help building owners and decision-makers to navigate the retrofit process. As part of this service, the Retrofit Accelerator's team of efficiency advisors will connect building decision-makers, staff, and industry professionals with the resources available to complete these upgrades, including existing trainings in energy efficiency best practices through organizations such as the Real Estate Board of New York (REBNY), Buildings Operators Management Association NY (BOMA NY), and Urban Green Council. The Retrofit Accelerator will serve as a clearinghouse for these training opportunities and will identify market gaps to provide direct trainings, hosted by the Building Energy Exchange, for particular building types, building systems, types of retrofit projects, or other market needs. The Retrofit Accelerator staff will also work with the City's Department of Small Business Services to connect New Yorkers to job placement

services and local firms to business development services to help them capitalize on increasing demand for energy efficiency services and grow their businesses.

- **Develop a resource guide for building owners and managers that catalogs operations and maintenance requirements and includes best practice guides and case studies.**

To ease compliance with New York City's existing regulations, the City will aggregate these laws and regulations into one central resource. This will help make requirements accessible to a broader range of building owners and operators, particularly those for which extensive training is not feasible. This resource will include all operation and maintenance requirements from the City, important dates and forms, and contact information for relevant City, State, and Federal agencies. The City will also pull upon lessons learned from the City's *Built to Last* implementation of preventative maintenance plans in City-owned buildings and best practices from NYC Carbon Challenge participants to develop guides that assist owners of various building types in developing their own building-specific operations and maintenance plans.

## **IMPROVING THE OPERATIONS AND MAINTENANCE OF CITY-OWNED BUILDINGS**

Recognizing the importance of education and professional development in successful energy management, the City created the Energy Management Institute (EMI) in partnership with the CUNY's Building Performance Lab. To bring municipal employees to the forefront of energy management best practice, the EMI offers a broad range of training, certifications, and technical support. Since 2009, the EMI has trained more than 2,000 municipal building operators on building optimization, new and emerging technologies, and trade specific energy courses with the aim of extending equipment life and ensuring City investments operate at peak efficiencies.

As part of its commitment to lead by example, the City has also invested significantly in the operations and maintenance in City-owned buildings through the Preventative Maintenance Collaborative and Expenses for Conservation and Efficiency Leadership (ExCEL) programs. The Preventative Maintenance Collaborative strategically funds skilled staff, tools, and the resources necessary to properly maintain key systems in municipal buildings. The ExCEL program provides agencies the opportunity to apply for funding to support operations and maintenance improvements such as repair upgrades and basic energy-saving retrofits, as well as specialized training and diagnostic tools and equipment. These programs save taxpayer dollars through utility cost reductions and offer best practices that will help guide additional resource development and City programs to support improved operations and maintenance in private sector buildings.

- **Develop and provide practical and tailored energy efficiency trainings to building staff to advance their professional capacity and improve building operations.**

To help expand access to training beyond existing options, the City has committed to creating a new building operator training program that will be practical and tailored to the needs of operators in underrepresented building types, such as small, mid-sized, and affordable rate buildings. Tailored training can help building staff to understand how to operate new and more energy efficient equipment, particularly for those that have not

been formally trained in building sciences. This can take many forms, from classroom training to hands-on apprenticeship programs, and can range from general energy efficiency training to trade-specific education. This program will initially be targeted at assisting operators in the City's affordable housing stock to ensure that energy cost savings from increased efficiency accrue to those most in need.

Additionally, the City will continue to leverage the existing training resources from local unions such as 32BJ Service Employees International Union and the Local 94 Operating Engineers to provide technical training programs for building staff involved in improving the efficiency of building operations. The City will also continue to work with organizations such as CUNY's Building Performance Lab and the Building Energy Exchange to ensure that a broader range of building decision-makers understand the importance and benefits of energy efficiency, including property managers, superintendents, and engineers.

**Energy efficiency improvements will require investment on the part of building owners and decision-makers, and the City can help bring down these costs.**

New York City building owners face a range of requirements to ensure their buildings are safe, comfortable, and desirable for tenants. They must meet legislative and regulatory obligations at the federal, state, and local level, while also addressing the needs of their unique occupants in a highly competitive real estate market. This is particularly true of affordable housing, which faces limits on income due to rent restrictions.

These competing needs limit the amount of capital that can be spent on energy efficiency and clean energy upgrades, and for many buildings owners and decision-makers, financing is a major barrier. Buildings may lack the capital reserves or creditworthiness to access commercial financing options and lending for these projects can also require specialized technical analysis. Traditional loan products do not recognize energy savings in the underwriting process. Current regulations that govern rent increases and define scopes of work as major capital improvements should be considered with respect to integrating energy efficiency and resiliency measures into capital projects in the affordable housing sector.

However, because buildings must play a critical role in achieving City's 80 x 50 commitment, the public and private sector must work together to develop the appropriate financing mechanisms to assist building owners in making the most effective investments. The City can work to help bring down these costs, both through innovative programs to support the market and direct financing and incentives to building owners. The City will take the following actions:

- **Connect building owners and decision-makers to financial resources best suited for their buildings through the NYC Retrofit Accelerator.**

The NYC Retrofit Accelerator’s team of efficiency advisors connect building owners and decision-makers interested in pursuing energy efficiency projects to the existing financing and incentives best tailored to meet their needs. Efficiency advisors will direct customers to existing programs offered by the New York State Energy Research and Development Authority (NYSERDA), NYCEEC, and the local utilities, as well as water conservation programs such as the Department of Environmental Protection’s Toilet Replacement Program. To ensure the greatest potential impact, the City will work with these organizations to coordinate messaging and connect customers to the right programs. As the landscape for financing and incentives changes under the State-driven “Reforming the Energy Vision” (REV) process, this function will become increasingly important to help ensure building owners and decision-makers understand these changes and have access to the capital they need to make energy efficiency investments.

- **Identify opportunities and work to lower hard and soft costs of retrofitting existing buildings and constructing high performance buildings through the NYC Retrofit Accelerator and a program that awards the design and construction or renovation of exemplary buildings.**

One way the City can help lower the soft costs for energy efficiency retrofits is through the services provided by the NYC Retrofit Accelerator. Program staff will develop resources and guidance for building owners and decision-makers on efficiency investments, including options for achieving deep energy savings. These will include a package of strategies to phase in retrofits over time to align with capital planning, guides to applicable technologies and products, and additional educational, training, and financial resources to help building owners and decision-makers understand their options. The City will also work closely with NYCEEC and other lenders to develop standardization mechanisms for energy efficiency and clean energy financing and lower the soft costs of financing products.

In addition, the City will work to lower the costs of high performance new construction and major renovations through a program that will provide direct incentives to help defray predevelopment and soft costs. The program will also offer education and training for building professionals and contractors to help them deliver on high performance buildings for competitive costs. Additionally, the program will provide market support to help reduce the costs of related products and services and will develop proof of concept details across a broad range of building types. This industry-wide program will accelerate the knowledge base for energy performance design and construction to help spur the transition to a new era of world-class low-energy buildings.

- **Work with the City’s affordable housing agencies and other organizations to identify new financing and incentives and create new options to help building owners and developers cover the costs of efficiency measures.**



The City will continue to work closely with NYCEEC to catalogue existing financing and incentives and identify market gaps, including the specific needs for the City's affordable housing stock. Where existing lenders do not currently offer financing products that meet building owners' needs for investing in energy efficiency, NYCEEC will work to create new products on its own or with market partners. As part of this effort, the City has also created the Green Housing Preservation Program, which provides no- and low-cost financing for energy efficiency and water conservation improvements along with moderate rehabilitation work for small- to mid-sized multifamily buildings in exchange for the preservation of affordable housing.

- **Work with the local utilities and New York State to identify new financing and incentives to help building owners and developers cover the costs of efficiency measure.**

The PSC is responsible for regulating the state's utilities, including Con Edison and National Grid, and overseeing NYSERDA's energy efficiency and renewable energy programs. In 2015, the PSC began an ambitious process to revise how electric service is provided to customers throughout the State — the Reforming Energy Vision (REV) proceeding. Through the REV and other proceedings, the PSC is reviewing and revising the manner in which energy efficiency and renewable energy projects are funded and administered. The City will continue to work with State agencies throughout this process to achieve the shared goals of expanding clean and renewable energy generation, catalyzing widespread energy retrofits, and creating a low-carbon, energy efficient future. The City will also work to ensure that there continues to be a strong focus on addressing energy efficiency needs of the affordable multifamily sector. This includes encouraging utilities and state-run incentive programs to become more customer-centric and to make the energy efficiency, demand response, and renewables programs less complicated so more building owners and decision-makers are able to access these incentives.

The City will continue to coordinate with the State to shape the future of incentives and investment opportunities to enable energy retrofits at scale. The City will also take feedback from the NYC Retrofit Accelerator's team of efficiency advisors, who are directly engaged with the market, to understand which financing and incentive resources work and what additional resources may be needed.

- **Continue working to build demand for energy efficiency and clean energy services through programs to foster a thriving market.**

The City will continue to provide resources and information to the market on the benefits of energy efficiency to empower building decision-makers to undertake energy efficiency projects and construct more efficient buildings. The NYC Retrofit Accelerator will continue its outreach efforts to help private building owners and decision-makers accelerate efficiency retrofits and clean energy investments. Additionally, as current participants in the NYC Carbon Challenge commit to deeper reductions and the program expands to new participants and sectors, these organizations

will continue to demand energy efficiency and clean energy services to help them meet their goals. These participants will provide a proof of concept to the rest of the market that a diverse range of organizations can dramatically improve the energy efficiency of their buildings and cut GHG emissions while adding value to their core strategic goals. The City will also accelerate the growth in the knowledge base for energy performance design and construction through an industry wide competition for the design and construction of very low-energy buildings, The continued growth in demand for energy efficiency and clean energy services will create new jobs for New Yorkers, growth opportunities for local businesses, and training opportunities for building staff, contractors, and laborers to advance their careers and enhance their earning potential.



## **GREEN HOUSING PRESERVATION PROGRAM**

In May 2015, the NYC Department of Housing Preservation and Development (HPD) launched the Green Housing Preservation Program (GHPP), which provides no- and low-cost financing for energy efficiency and water conservation improvements along with moderate rehabilitation work for small- to mid-sized multifamily buildings that are greater than five units and less than 50,000 square feet (approximately 50 units). The program is aimed at assisting owners of small- to mid-sized multifamily properties across the city in undertaking energy efficiency and water conservation improvements as well as moderate rehabilitation to improve building conditions, reduce GHG emissions, and preserve affordability.

The GHPP provides zero percent interest, evaporating loans for energy efficiency and water conservation improvements and one percent repayable loans to help cover the costs of moderate rehabilitation improvements that go beyond the energy efficiency measures. Based on a typical scope of work, buildings may reduce utility costs by approximately 10 percent or more annually. This represents an average savings of approximately \$1,500 for a 10-unit building and \$3,000 for a 20-unit building. In exchange for City financial assistance, properties will be required to enter a regulatory agreement to keep rents affordable. Additionally, the improvements will result in lower overall utility costs, which will further safeguard affordability and promote the sustainability of the city's housing stock.

HPD will provide direct financing, and encourage owners to leverage private financing and other incentive programs where feasible. This includes local utility incentive and public programs for energy efficiency, and private funding through the GHPP's participating lenders – the Community Preservation Corporation (CPC), Enterprise Community Partners, the Low Income Investment Fund (LIIF), and the Local Initiative Support Corporation (LISC). Additionally, NYCEEC created a fund that is available to participating building owners who need assistance financing predevelopment requirements necessary for participation in the program, including a Green Physical Needs Assessment.

## Case Study: BlackRock and Rudin Management Coordination

One of New York City's major commercial tenants leads the way in reducing GHG emissions through innovative efficiency strategies and coordination with the building owner.

BlackRock is a global investment management corporation headquartered in midtown Manhattan, with 580,000 square feet of leased office space across three buildings. As a participant in the NYC Carbon Challenge for Commercial Offices, BlackRock has reduced energy use and GHG emissions from its leased office spaces and data centers through a combination of energy efficiency retrofits, efficient space utilization, and coordinated upgrades in tenant and landlord shared building systems.

Working with New York City-based CodeGreen Solutions, BlackRock has identified numerous energy savings measures. To date, BlackRock's greatest reduction in energy use has come from a data server virtualization project that reduced the electricity use of their data center at 40 East 52nd Street by more than 50 percent. BlackRock has also retrofitted all lighting fixtures and controls at its three office locations, replacing many existing halogen and fluorescent fixtures with LED-based technology with occupancy-based sensors. This project is expected to reduce electricity consumption by over 950,000 kiloWatt hours (kWh) and yield an estimated \$180,000 in annual savings. Additionally, BlackRock installed 75 new electricity sub-meters across its three buildings, allowing operations staff to monitor existing lighting, plug loads, and heating, ventilation and air-conditioning (HVAC) systems in near real-time to gather information on energy consumption patterns and quickly identify and correct energy use anomalies, such as excessive after-hours consumption. The sub-meters will also allow BlackRock to baseline, evaluate, and track the impact of additional energy conservation measures as they are planned and implemented.

BlackRock has also partnered closely with its owner, Rudin Management Company, Inc. (RMC), to reduce the energy consumption of shared building systems within BlackRock's office space at 40 East 52nd Street. Both parties have agreed to split the capital costs and cost savings of ten air handling units that are being retrofitted with variable frequency drive (VFD) enabled, premium efficiency motors for all return and supply fans. This project is expected to reduce electricity consumption by 850,000 kWh and yield an estimated \$160,000 in annual savings. The VFDs are able to modulate the air flow more precisely, improving tenant comfort and control. This project also opens up potential for future demand response opportunities by allowing for time of day load adjustment reductions.

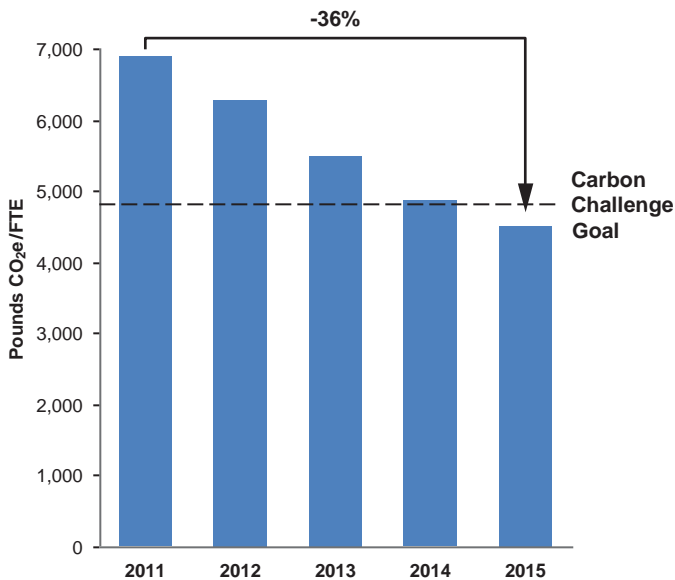

To meet the Carbon Challenge goal, which is measured per full time equivalent employee, BlackRock also worked to use its office space more efficiently by converting underutilized office space to denser workplaces and building out new spaces to highly energy efficient standards. Since 2011, BlackRock has added over 650 employees while reducing the overall energy use in its office space by over 15 percent.

In just five years, BlackRock has achieved the Carbon Challenge goal by reducing GHG emissions per full time employee from the energy used in their office spaces and data centers by more than 36 percent. Over the coming years, BlackRock will continue to invest in efficiency projects and explore additional coordination opportunities with RMC to further reduce energy consumption and GHG emissions.

## **Case Study: Empire State Building**

One of New York City's most iconic skyscrapers takes a lead in energy efficiency and tenant engagement to achieve deep energy reductions

**Owner: Empire State Realty Trust**

**Property Manager: Empire State Building**

**Energy and Sustainability Lead: Dana Robbins Schneider, JLL**



The Empire State Building became a symbol of human ingenuity when it was constructed in 1931 and became the tallest building in the world. Today, the iconic skyscraper continues to inspire innovation as a leading example of sustainability through a deep energy retrofit that has reduced the whole building energy use by more than 40 percent. The efficiency measures implemented in the Empire State Building include retrofitting all of its windows, adding insulation behind all of the radiators, retrofitting the chiller plant, upgrading to an advanced BMS, conversion of constant volume (CV) to variable air volume (VAV) air handling units, installing Demand Controlled Ventilation, reducing lighting, plug, and HVAC loads in all spaces, and the development of a Tenant Energy Management system.

Many of the base building initiatives have significantly reduced tenant energy usage. However, the building's management soon realized that enhanced tenant engagement would be necessary to achieve further reductions. To assist with this effort, management developed a quantitative, holistic, replicable process and tools that allow tenants to reduce their energy usage by over 38 percent with a 3 year payback. In addition, the building's owner, Empire State Realty Trust (ERST), developed a lease clause that includes provisions for transparent data sharing, "use or lose" provisions for power provided by the owner, and high performance design standards and construction guidelines for all new tenant fit-outs. The design standards and guidelines include a comprehensive approach to coordinate tenant and base building HVAC systems, advanced lighting controls, enhanced plug load management, and tenant engagement strategies. The Empire State Building also sub-meters all spaces over 2,500 square feet, and recommends subpanels for HVAC, plug, and lighting loads. Building management also provides ongoing professional support to tenants interested in pursuing energy efficiency measures in their leased spaces.

ESRT's efforts to engage tenants served as the framework for the creation of the national Tenant Star program and the recently passed Better Buildings Act. Through these innovative approaches to tenant engagement and ongoing efforts to improve energy efficiency and sustainability, the Empire State Building has continued to lead the way for New York City's real estate industry.

# 5

## Conclusion

## **NEW YORK CITY CONTINUES TO LEAD THE WAY ON ADDRESSING GLOBAL CLIMATE CHANGE**

By committing to an 80 percent greenhouse gas (GHG) reduction by 2050 compared to a 2005 baseline (80 x 50), the City has joined leaders around the world doing their part to avert the most disastrous impacts of climate change, protecting New Yorkers from future sea level rise, heat waves, and other consequences right here at home.

The policies and programs that the City has enacted to date build a solid foundation for achieving deep carbon reductions. In 2015, the City completed the most comprehensive evaluation ever conducted of how New York City buildings use energy, which was made possible by the data collected through the City's benchmarking, auditing, and retro-commissioning requirements under its landmark 2009 Greener, Greater Buildings Plan. Underpinned by this analysis, the City now understands the next steps that will be necessary to place buildings on a pathway to 80 x 50.

New York City's building stock is diverse, but distinct trends have emerged. The energy that is used to produce space heating and domestic hot water, which typically comes from burning fossil fuels, accounts for the majority of GHG emissions from New York City buildings. Reducing the energy used for space heating and hot water in existing buildings must be a key strategy to achieve our goals. Steam heating distribution systems are particularly prevalent in our buildings, and because heating distribution systems are not typically replaced, most will still be here in 2050. The wide variation in the energy used by these systems indicates that there are major opportunities to improve their performance through repair and maintenance.

Many of the best practice and cost-effective energy conservation measures (ECMs) identified in this report can be implemented immediately to begin reducing energy use in buildings. The City will adopt these measures through codes or stand-alone retrofit mandates in the near-term. All together, the ECMs analyzed by the Technical Working Group (TWG) have the potential to reduce current building-based emissions by 33 percent, yielding \$2.7 billion in energy cost savings and creating approximately 15,000 direct construction-related jobs.

The City will begin by requiring building owners to implement several of the most cost-effective measures and expand the existing requirements to upgrade lighting in non-residential spaces to include mid-sized buildings. In addition, the City will require improved maintenance of heating distribution systems, including specific requirements for steam systems, in all large and mid-sized buildings. This has the potential to reduce New York City's building-based emissions by 1.4 MtCO<sub>2</sub>e, or four percent from current levels — one of the single most impactful opportunities to reduce energy use and GHG emissions from our buildings.

Comprehensive retrofits in our existing buildings will be necessary to achieve 80 x 50. Analysis of holistic retrofit options for typical buildings in eight key building typologies shows that energy reductions of 40 to 60 percent are technically feasible in New York

City buildings using existing technologies and strategies. The potential GHG reductions from these retrofit paths are even greater if the current electric grid becomes much cleaner. Using this analysis, the City will develop a simple, easy to use template that will identify the deep retrofit options for individual buildings and will require owners of large and mid-sized buildings to report the results in their energy audits. This will allow owners and decision-makers to begin factoring the results into their capital planning cycles.

Improvements to the design and construction of new buildings must also be part of the 80 x 50 solution. The City has made great strides through the successive implementation of incremental improvements to the NYC Energy Code, but the types of buildings needed to reach 80 x 50 will require a new approach. This new paradigm will require a holistic approach to energy use in new buildings and substantial renovations. The City will work with stakeholders and the industry to create a new metric to assess whole building energy performance that takes into account differences in occupancy and space uses.

To support this comprehensive change, the City will lead by example. Starting in 2017, all new capital projects for City-owned properties will meet an energy performance target of 50 percent below the median energy use today. The City will also develop proof of concept and details for very low-energy buildings across multiple typologies and deliver training, education, and market support through a program that awards the design and construction or renovation of exemplary buildings. By pairing these low-energy targets with a cleaner electrical grid, the City intends to move the market to constructing 80 x 50 ready buildings in New York City.

To achieve the full potential of GHG reductions, the City will work to remove barriers and expand opportunities to implementing energy efficiency measures. Buildings in new sectors, sizes, and use categories will need to contribute to the City's energy reduction goals. Professionals and trades alike will need to be trained in new methods and technologies. Increased coordination between landlords and tenants on energy efficiency must become standard practice. Investments in energy efficiency will yield operational cost-savings that will lower housing costs for New Yorkers, but the City must work to bring down the upfront costs and help building owners undertake these investments through new and existing financing options.

All together, the steps outlined in this report are projected to reduce GHG emissions from New York City's buildings by 2.7 million metric tons and save building owners roughly \$900 million in energy costs each year. This also has the potential to create an estimated 1,300 direct construction-related jobs. Combined with the policies and programs announced in *One City: Built to Last*, the City's new initiatives are expected to reduce GHG emissions from existing buildings by a total of six million metric tons by 2025, with additional reductions to be achieved as cost-effective ECMs are integrated into the City's codes.

With the contributions of the Technical Working Group, the City now has a roadmap to dramatically reduce the GHG emissions from our buildings. In the coming months, this study will be aligned with additional GHG reduction opportunities from the City's energy supply, solid waste, and transportation sectors and incorporated into a comprehensive implementation plan to place New York City on the pathway to 80 x 50.

**Existing buildings must scale up upgrades to improve energy efficiency and reduce GHG emissions.**

- **Require owners of large and mid-sized buildings to repair and improve heating distribution systems, including specific requirements for steam systems, within the next 10 years.**
- **Require owners of mid-sized buildings to upgrade lighting in non-residential areas to meet current Energy Code standards by 2025.**
- **Require owners of large and mid-sized building to assess deep energy retrofit strategies as part of the Local Law 87 energy audit through a simple template developed by the City.**
- **Require implementation of efficiency measures in existing buildings by incorporating low- and medium-difficulty measures into the codes or as standalone mandates. The City will begin with requiring digital burner controls for boilers, restrictions on open refrigerators in retail stores, thermal de-stratification fans in heated industrial spaces, sealed roof vents in elevator shafts, and upgrades of exterior lighting to current Energy Code standards.**
- Establish a Codes Advisory Committee to produce code language for ECMs identified by the TWG to be adopted by local law.
- Incorporate efficiency measures into the NYC Retrofit Accelerator to provide guidance to building owners to implement measures on a voluntary basis, including specific assistance to help them access financing and incentives to cover the costs.
- Pursue amendments to the State Multiple Dwelling Law to remove requirements in conflict with energy efficiency standards.
- Launch a "High Performance Retrofit Track" of the Retrofit Accelerator to assist in implementing higher-difficulty, deeper-impact measures and identify the financial, educational, and technical resources necessary to bring these types of upgrades to scale.
- Expand the NYC Solar Partnership and the Solarize NYC program to scale up on-site renewable energy investments in private sector buildings.
- Work with participants in the NYC Carbon Challenge to test innovative retrofit strategies and renewable energy options across multiple sectors.



**New buildings must be designed and constructed for whole building energy performance.**

- **Require new buildings and major alterations be designed to an energy performance metric beginning in 2019 and set an energy performance design target beginning in 2022.**
- **Lead by example through required low-energy performance design targets for City-owned new buildings and substantial renovations.**
- Establish a Codes Advisory Committee to produce code language for a whole building energy performance standard, to be adopted by local law.
- Develop proof of concept and details for very low-energy buildings across multiple typologies and deliver training, education, and market support through a program that awards the design and construction or renovation of exemplary buildings.
- Develop standards and practices for the City's own buildings to serve as models and support the development of capacity in the New York City market.

**All buildings, including small, mid-sized, and historic buildings must be included in the path to 80 x 50.**

- **Require annual energy use benchmarking in mid-sized buildings.**
- **Require retro-commissioning every 10 years in mid-sized buildings.**
- **Require utility benchmarking in all buildings receiving City financing from the NYC Department of Housing Preservation and Development or NYC Housing Development Corporation.**
- **Tailor energy standards for appropriate application to historic buildings, which are currently exempt from Energy Code compliance.**
- **Pursue changes to State laws to require energy information disclosures during real estate transactions.**
- Improve compliance with and enforcement of Local Law 87 energy auditing and retro-commissioning.
- Improve compliance with and enforcement of the Energy Code.
- Work with the Landmarks Preservation Commission to update its rules and procedures to streamline the process of energy efficiency upgrades in landmarked buildings and historic districts.

**Tenant energy use and other “unregulated” loads in tenant spaces must be addressed to comprehensively reduce building-based energy use.**

- **Require sub-metering in non-residential tenant spaces larger than 5,000 square feet in area in all large and mid-sized buildings.**

- Develop a comparative metric for commercial tenant energy use and create a voluntary benchmarking program for commercial tenants.
- Launch a Commercial Landlord/Tenant Carbon Challenge to identify best practices in efficient operations that can be replicated in commercial buildings across the city.
- Work with the Public Service Commission and utilities to provide resources for customers to understand and decrease their energy use.

**New York City’s workforce must be ready to deliver high performance buildings.**

- Connect building owners and decision-makers to trainings that are best suited for their buildings through the NYC Retrofit Accelerator.
- Develop a resource guide for building owners and managers that catalogs operations and maintenance requirements and includes best practice guides and case studies.
- Develop and provide practical and tailored energy efficiency trainings to building staff to advance their professional capacity and improve building operations.

**Energy efficiency improvements will require investment on the part of building owners and decision-makers, and the City can help bring down these costs.**

- Connect building owners and decision-makers to financial resources best suited for their buildings through the NYC Retrofit Accelerator.
- Identify opportunities and work to lower hard and soft costs of retrofitting existing buildings and constructing high performance buildings through the NYC Retrofit Accelerator and programs that support exemplary new buildings.
- Work with the City’s affordable housing agencies and other organizations to identify new financing and incentives and create new options to help building owners and developers cover the costs of efficiency measures.
- Work with the local utilities and New York State to identify new financing and incentives to help building owners and developers cover the costs of efficiency measures.
- Continue working to build demand for energy efficiency and clean energy services through programs to foster a thriving market.

**To achieve the City’s 80 x 50 commitment, GHG reduction strategies from buildings must be integrated into a comprehensive 80 x 50 plan.**

- Work with stakeholders to develop an integrated 80 x 50 plan to reduce GHG emissions from the city’s energy supply, buildings, transportation, and solid waste.

# 6

## Appendix

In 2015, the City undertook more in-depth analysis than previously conducted in order to best assess the current state of buildings in New York City and projections for 2050. In assessing current and future conditions, the City examined existing analyses of greenhouse gas (GHG) emissions, citywide gross floor area, business as usual (BAU) scenarios, building typologies, building systems, and prior policy proposals. The following sections describe the most significant inputs that informed the analysis.

### **KEY DATA SETS**

#### Local Laws 84 and 87

Most of the building energy data available to the City was collected through Local Law 84 of 2009 (LL84) benchmarking and Local Law 87 of 2009 (LL87) audit and retro-commissioning requirements for buildings larger than 50,000 square feet and groups of smaller buildings within a single property that collectively were larger than 100,000 square feet. The Department of Citywide Administrative Services also provided audit and retrocommissioning data for City properties down to 25,000 square feet.

Under current requirements for LL84, data quality is not enforced by a third party, nor is required for compliance. As a result, erroneous entries were removed, or “cleaned” from the data set. Entries that are deleted include those with non-New York City zip codes, missing property area information, energy use intensity (EUI) outliers, duplicate submissions, etc. LL87 data cleaning required additional steps related to building systems.

## **SMALL BUILDING DATASETS**

Because of the limited City data available for buildings under 50,000 sq ft, additional datasets were collected from local, state and private energy efficiency programs focused on small and mid-sized buildings. This data was utilized to assist in extrapolating LL84 and LL87 data, and developing the ECMs and Retrofit Paths applicable to smaller buildings.

### **Inventory of New York City Greenhouse Gas Emissions**

Since 2007, the City has committed to measure and annually report citywide GHG emissions and track the city's progress in reducing emissions. The annual *Inventory of New York City Greenhouse Gas Emissions* (NYC GHG Inventory) compiles data, analysis, year over year trends, totals, charts, conversion tables, and other related information, providing a valuable foundation for New York City's sustainability policies. Coordinated by the Mayor's Office of Sustainability, the inventory incorporates data from utilities, City agencies, and other entities to tally citywide emissions generated and reduced from the previous calendar year and give a comprehensive picture of the City's progress in carbon mitigation. In 2015, New York City joined the Compact of Mayors and updated its inventory to be Global Protocol for Community-Scale Greenhouse Gas Emissions Inventories (GPC) compliant, as required by the commitment.

### **Department of City Planning Primary Land Use Tax Lot Output (PLUTO) database**

Extensive land use and geographic data at the tax lot level in comma-separated values (CSV) file format. The PLUTO files contain more than seventy fields derived from data maintained by city agencies.

## **KEY ASSUMPTIONS**

### **Population and Building Growth**

Population for 2010 was based on US Census, as adjusted for flaws by Department of City Planning (DCP). Population for 2050 was based on DCP's submission to NYMTC. Employment figures are also from NYCDCP submissions to NYMTC for "workers needing office space." The City assumed a 10% reduction in square feet of usable space per employee over 35 years, to account for shrinkage in office space balanced with overall building footprint. Trends towards larger living spaces documented in State of Real Estate 2014 (Furman Center) suggest an increase in mean residential space, which the City assumed would result in a 10% increase in mean living space over 35 years. The City applied the increased space to new residents, as a proxy for the new construction built to meet this market demand. Growth and declines by sector were based on review of historical buildings data and professional judgment.

### **Climate Change Impacts**

In order to understand current building operations in response to weather and future operations, the City assessed historic and projected daily values for heating and cooling degree days. Heating degree days (HDD) and cooling degree days (CDD) are measurements of the demand for energy needed to heat or cool a building, respectively. Historic daily values were calculated for the period of January 1, 1980 to March 31, 2015, and were also summed into monthly values. To project HDD and CDD through 2050, the City used projected mean annual increase temperatures and applied them to the historic daily values to generate future HDD and CDD for 2016-2050. The mean annual increase temperatures were calculated by the New York Academy of Sciences, estimating a 1.5 to 3.0 degree Fahrenheit (°F) increase in mean annual temperature by 2025, and a 3.0 to 5.0°F increase in mean annual temperature by 2050. These temperature ranges takes into account the atmosphere's natural monthly and yearly temperature variation.

#### Business as Usual

To develop the BAU scenario, the City revised the 2005 baseline to be consistent with the methodology used in the 2015 NYC GHG Emissions Inventory (CY2014). 2005 and 2010 emissions are as reported in Inventory of 2015 NYC GHG Emissions (CY2014); 2050 emissions projections for transportation and waste sectors per NYC's Pathways to Deep Carbon Reductions (December 2013). Building growth was calculated as described above.

### **KEY METHODOLOGY**

#### Energy Conservation Measures

A total of 97 ECMs were analyzed for GHG and cost impacts. Percent typology impacted of each ECM was determined per LL87 data, PLUTO data, and industry expertise. Energy savings for each was estimated per LL87 ECM average savings, previous studies, and industry experience. Costs were calculated per AccuCost analysis, LL87 ECM average costs, and TWG input. Existing energy consumption data was based on 2015 GHG Inventory (CY2014) and LL87 distribution of building systems/fuel use. Together, these were scaled up to citywide impact for each measure. A review of each ECM was conducted to determine if it overlapped with other ECMs in order to avoid double counting of potential citywide buildings based GHG savings.

The "technical" citywide GHG reduction potential is based on the average energy or GHG reduction of an ECM multiplied by the square footage of buildings in which the measure could be implemented. Average energy or GHG reductions were assessed using LL87 energy audit data, combined with existing research and industry experience. Each ECM was then assessed for applicability in each building typologies and the percentage of covered square footage, again based on LL87 data combined with existing research and industry experience. Applicability of buildings

was determined based on the breakdown of building systems in each typology and the assumed proportion of buildings that have already implemented the ECM, using a combination of LL87 and PLUTO data, as well as estimates based on industry experience. The average GHG reduction per square foot was then multiplied by the square footage for each typology that would be affected to find the total technical citywide GHG reduction potential. Average costs were assessed using Local Law 87 data, existing studies, and industry experience. In some cases, the “incremental” cost of an ECM is included to determine the cost if the measure was completed at the end of the useful life of a piece of equipment, which lowers the total cost of an ECM to just the marginal cost of installing a more energy efficient version of that piece of equipment.

To assess the citywide GHG reduction potential of all ECMs, overlapping ECMs were taken into account. For ECMs with overlapping energy savings, the ECM with the greatest GHG savings is considered the comprehensive ECM and is included within the “stack analysis” of ECMs. Typically this assumes 100% of the energy savings of the comprehensive ECM and all remaining ECMs removed from the analysis except in instances where ECMs are partially overlapping. For example, the ECM “Air seal through wall A/Cs,” applies an energy savings to 100% of buildings reported with Window A/C, Through Wall A/Cs, and PTAC systems. The ECM “Through Wall A/C-Replace with more efficient unit” includes savings from both a more efficient unit and from air sealing when the unit is replaced, which results in a higher GHG reduction than “Air seal through wall A/Cs,” and therefore is considered the comprehensive ECM. However, it applies to 70% of buildings with Window A/C, Through Wall A/Cs, and PTAC systems, assuming 30% of buildings already have efficient units. Therefore 30% of the energy savings from “Air seal through wall A/Cs” are not incorporated into the “stack analysis” to account for additional savings. The full GHG reduction potential was therefore calculated by adding together the reductions from the most comprehensive ECMs as well as remaining reductions from the partially overlapping ECMs.

#### Retrofit Paths

To assess the retrofit paths, the City developed baseline energy models using eQuest energy modeling software for a “typical” building within each of the eight building typologies, based on the most common construction methods and building systems in these buildings. The baseline models were calibrated using a combination of LL84 and LL87 data, third-party research, and industry experience for buildings with similar construction methods and building systems to the “typical” building, meaning that the median EUI for a building typology may not be the same as the EUI of the modeled baseline building for the typology. Baseline models were then run using hourly weather file for New York City for a typical meteorological year, which is compiled by the World Meteorological Organization. The City and industry experts then developed retrofit paths using combinations of existing technologies and strategies that were expected to yield 40 to 60 percent energy savings. These were translated into energy model inputs

based on third party research and industry experience. The models were then run on the baseline buildings for each retrofit path and against the predicted 2050 climate for NYC. The source energy outputs of the model were then compared to real buildings with similar characteristics in NYC to develop ranges for energy performance in order to account for factors outside of the energy model that lead to differences in predicted and actual building energy use. The solar PV potential for buildings was assessed using industry standard solar specifications and an estimation of the average rooftop solar potential using CUNY's Solar Map. Finally, GHG emissions were calculated using carbon coefficients for the current electric grid and under a "clean grid" scenario in which it becomes 80 percent cleaner than today.

#### Code Revisions

The City analyzed the cost and GHG impacts of future code upgrades utilizing existing Pacific Northwest National Laboratory (PNNL) cost-effectiveness research. PNNL utilizes prototype building energy models that provide coverage of the significant changes in ASHRAE Standard 90.1 from 2010 to 2013 and show the impacts of the changes on energy savings. The six building types represent approximately 80 percent of commercial floor space, but have low coverage in multifamily sector and exclude 1 to 4 Family buildings. Code model analysis was based on exogenous square footage forecasts of new build in New York City for the six selected building prototypes using NYC Department of Buildings (DOB) new building permit data, and accounted for roughly twenty percent of anticipated new building square footage growth. Results were then extrapolated to the full growth projection. Modeled costs include incremental initial construction, maintenance and replacement costs (or savings) per square foot. Energy cost savings include electricity and natural gas price forecasts based on EIA data. Future standard upgrades are based on impacts from the average of ASHRAE upgrades from 2007 to 2010 and from 2010 to 2013. Baseline 2015 energy use per square foot is based on PNNL study data for ASHRAE 90.1 2010 adoption in New York City. Study costs and savings are based on a combination of New York-specific values and national averages adjusted for New York City construction cost indices.

#### Alternative Scenarios to BAU

The Business as Usual Scenario utilized for the TWG study holds the current electrical grid mix constant. Because this is unlikely to be the case, three other scenarios were analyzed to determine the impact on building-based emissions. A scenario in which the 2050 carbon intensity of electricity grid increased by 8 percent assuming decommissioning of Indian Point and implementation of existing state renewable energy plans would result in a 9 percent increase in building-based emissions. A grid with the 2050 carbon intensity of electricity grid reduced by 60 percent, translates to a 25 percent reduction in building GHG emissions. A grid with a 2050 carbon intensity reduced by 80 percent, translates to a 33 percent reduction in building GHG emissions.



# 7

## End Notes

## END NOTES

### Executive Summary

1. UN-HABITAT (2011). Cities and Climate Change: Global Report on Human Settlements 2011, retrieved from: <http://unhabitat.org/books/cities-and-climate-change-global-report-on-human-settlements-2011/>
2. City of New York (2016). City of New York Inventory of New York City's Greenhouse Gas Emissions, retrieved from:
3. US Energy Information Administration (2016). Frequently Asked Questions, retrieved from: <http://www.eia.gov/tools/faqs/faq.cfm?id=86&t=1>
4. US Energy Information Administration (2016). Energy-Related Carbon Dioxide Emissions at the State Level, 2000-2013, retrieved from: <http://www.eia.gov/environment/emissions/state/analysis/>
5. Global Carbon Project (2015). Global Carbon Atlas: Emissions, retrieved from: <http://www.globalcarbonatlas.org/?q=en/emissions>

### Chapter 1

6. Global Carbon Project (2015). Global Carbon Atlas: Emissions, retrieved from: <http://www.globalcarbonatlas.org/?q=en/emissions>. Per capita emissions in New York City are 5.8 MtCO<sub>2</sub>e per person. The US average is 17 MtCO<sub>2</sub>e per capita.
7. Building typologies were assigned using a combination of the New York City Department of Citywide Planning Primary Land Use Tax Lot Output (PLUTO) Database Building Classification Codes, Building Area, Number of Floors, and Year Built.
8. Based on data from the NYC Department of Finance.
9. Based on PLUTO Land Use Categories. Within the TWG building typologies, approximately 80 percent of the mixed used building area falls under residential typologies; 7 percent under commercial typologies; and the remaining did not have sufficient data to determine typology.
10. Based on the assumption that decommissioning Indian Point would result in a loss of 2,000 megawatt (MW) that would be replaced with 2,000 MW of renewable power, and the resulting gap in power generation due to lower renewable energy capacity factors is filled by natural gas-fired power plants.

### Chapter 2

11. Local Law 87 of 2009 (LL87) requires auditors to provide information on energy end use breakdowns in large buildings and report this information to the City, allowing the City to project aggregate breakdowns based on a sample set of several

thousand buildings. It is important to note that methodologies for determining end use breakdowns between some types of systems are not standardized, meaning that auditors have some leeway in determining these breakdowns. Still, reported end use breakdowns are expected to be representative of large New York City buildings on the whole.

12. LL87 does not require tenant systems to be included in the building system inventory and energy audit recommendations. However, surveys of auditing firms indicate that many auditors do provide at least some of this information in LL87 energy audits.
13. Shapiro, Ian. ASHRAE Journal (2010). Water and Energy Use in Steam Heated Buildings, retrieved from: <http://www.taitem.com/wp-content/uploads/SteamBoilerReplacements.pdf>
14. For some building typologies, there were not enough records within the first two years of LL87 energy audit data to draw statistically significant conclusions about the breakdown of heating and cooling systems in these typologies.
15. Reported heating energy use intensities (EUIs) are from energy audit data are not weather normalized. While the weather does significantly affect heating EUIs in any given year, because the sample set of data is from 2013 and 2014 only, the relative position of heating EUIs will remain the same year over year, all else being equal.
16. Efficiency measures were considered “low- or medium-difficulty” if, based industry experience, the measure has a payback period of roughly ten years or less and does not typically pose an unreasonable burden on most building owners if implemented properly.
17. Lighting Power Density is the watts per square foot of the lighting equipment in a given area.

### Chapter 3

18. Hart, R., Althalye, R., Xie, Y. et al. Pacific Northwest National Laboratory (2015). Cost-Effectiveness of ASHRAE Standard 90.1-2013 for the State of New York, retrieved from: PNNL-24223 Rev-1 Cost-Effectiveness of ASHRAE Standard 90.1-2013 for the State of New York, D  
Hart, R., Athalye, RA., Halverston, MA., et al. Pacific Northwest National Laboratory (2015). National Cost-effectiveness of ANSI/ASHRAE/IES Standard 90.1-2013, retrieved from: PNNL-23824 National Cost-effectiveness of ANSI/ASHRAE/IES Standard 90.1-2013, January 2015  
Hart, R., Liu, B. US Department of Energy (2015). Methodology for Evaluating Cost-Effectiveness of Commercial Energy Code Changes, retrieved from: [https://www.energycodes.gov/sites/default/files/documents/commercial\\_methodology.pdf](https://www.energycodes.gov/sites/default/files/documents/commercial_methodology.pdf) december 2015
19. The percent reductions included in the stepped chart of historical national average

impacts is representative of long-term impacts. Since the impacts of each code are typology-specific, some codes will have a lower impact in New York (as was the case for 2007-2013), and some would have a higher than the national average. The analysis conducted by the City utilized US DOE-estimated reductions achieved by recent code upgrades in New York State, and weighted the impacts by square footage to account for variations across typologies.

20. Rosenberg, M., Hart, R., Zhang, J., Athalye, R. Pacific Northwest National Laboratory (2015). Roadmap for the Future of Commercial Energy Codes, retrieved from: [http://www.pnnl.gov/main/publications/external/technical\\_reports/PNNL-24009.pdf](http://www.pnnl.gov/main/publications/external/technical_reports/PNNL-24009.pdf)
21. Lovins, A., Lovins, H., Hawken, P. Rocky Mountain Institute (1999). Tunneling through the Cost Barrier, retrieved from: [http://www.rmi.org/Knowledge-Center/Library/NC99-06\\_TunnelingThroughCostBarrier](http://www.rmi.org/Knowledge-Center/Library/NC99-06_TunnelingThroughCostBarrier)
22. Clergayt, Gregoire. Brussels Environment Agency (2015). 2015: Brussels goes passive!, retrieved from: [http://www.energy-cities.eu/IMG/pdf/35\\_brussels\\_passive\\_house\\_clerfayt.pdf](http://www.energy-cities.eu/IMG/pdf/35_brussels_passive_house_clerfayt.pdf)
23. HPD average residential hard cost for non-prevailing wage, non-union, block-and-plank new construction buildings in FY 2012, the same year that Highbridge Overlook was constructed.
24. Based on heating EUIs for multifamily buildings in the Multifamily, Post-1980, >7 Stories typology.

## ACRONYMS AND ABBREVIATIONS

80 x 50 – An eighty percent reduction in citywide greenhouse gas emissions by 2050 from a 2005 baseline

A/C – Air Conditioner

ACPU – Air Cooled Packed Unit

ASHRAE – American Society of Heating, Refrigerating and Air-Conditioning Engineers

ASHP – Air Source Heat Pump

BAU – Business as Usual

BBL – Borough, Block, and Lot

BMS – Building Management System

BOMA NY– Building Operators Management Association NY

BPL – Building Performance Lab

CDD – Cooling Degree Days

CHP – Combined Heat and Power, also known as cogeneration

COP21 – United Nations Climate Change Conference

CO<sub>2</sub>e – Carbon Dioxide Equivalent

Con Edison – Consolidated Edison, Inc.

CPC – Community Preservation Corporation

CUNY – City University of New York

DCAS – Department of Citywide Administrative Services

DCP – NYC Department of City Planning

DDC – Direct Digital Control

DEP – NYC Department of Environmental Protection

DHW – Domestic Hot Water

DOB – NYC Department of Buildings

DX – Direct Expansion

ECB – Energy Cost Budget

ECM – Energy Conservation Measure

EMI – Energy Management Institute

ERV – Energy Recovery Ventilation

EUI – Energy Use Intensity

ExCEL – Expenses for Conservation and Efficiency Leadership

FTE – Full Time Employee

GCTF – Green Codes Task Force

GGBP – Greener, Greater Buildings Plan

GHG – Greenhouse Gas

GHPP – Green Housing Preservation Program

GPRO – Green Professional Building Skills Training

HCR – New York State Homes and Community Renewal

HDC – NYC Housing Development Corporation

HDD – Heating Degree Days

HPD – NYC Department of Housing Preservation and Development  
HVAC – Heating, Ventilation and Air Conditioning  
IGU – Insulated Glass Units  
kW – Kilowatt  
kWh – Kilowatt Hour  
kBtu - Thousand British Thermal Units  
LED – Light Emitting Diode  
LIIF – Low Income Investment Fund  
LISC – Local Initiative Support Corporation  
LL84 – Local Law 84 of 2009: Benchmarking  
LL85 – Local Law 85 of 2009: NYC Energy Conservation Code  
LL87 – Local Law 87 of 2009: Energy Audits & Retro-commissioning  
LL88 – Local Law 88 of 2009: Lighting & Sub-metering  
LPC – Landmarks Preservation Commission  
LPD – Lighting Power Density  
MOU – Memorandum of Understanding  
MtCO<sub>2</sub>e – Million Metric Tons Carbon Dioxide Equivalent  
MW – Megawatt  
NOAA – National Oceanic and Atmospheric Administration  
Energy Code – New York City Energy Conservation Code or Energy Code  
NYCEEC – New York City Energy Efficiency Corporation  
NYCHA – New York City Housing Authority  
NYSERDA – New York State Energy Research and Development Authority  
PM2.5 – Fine Particulate Matter  
PNNL – Pacific Northwest National Laboratories  
PSC – Public Service Commission  
PTAC – Packaged Terminal Air Conditioner  
PV – Photovoltaic  
R-CX – Retro-commissioning  
REBNY – Real Estate Board of New York City  
RECS – Residential Energy Consumption Survey  
REV – Reforming the Energy Vision  
SBS – Department of Small Business Services  
TRV – Thermostatic Radiator Valve  
TWG – Technical Working Group  
UGC – Urban Green Council  
US DOE – U.S. Department of Energy  
US EPA – U.S. Environmental Protection Agency  
VFD – Variable Frequency Drive  
VRF – Variable Refrigerant Flow  
WAP – Weatherization Assistance Program  
WSHP – Water Source Heat Pump