



— BUREAU OF —
RECLAMATION

Knowledge Stream

Research and Development Office

*Big Data in
Condition Monitoring*

Research and Development Office (R&D) Contacts

Program Manager

Levi Brekke

lbrekke@usbr.gov

Science and Technology

Program Administrator

John Whittler

jwhittler@usbr.gov

Desalination and Water

Purification Research

Program Administrator &

Advanced Water Treatment

Coordinator

Yuliana Porras-Mendoza

yporras@mendoza@usbr.gov

Hydropower and Water

Infrastructure Research Coordinator

Erin Foraker

eforaker@usbr.gov

Water Availability Research

Coordinator

Ken Nowak

knowak@usbr.gov

Technology Transfer Specialist

Vacant

research@usbr.gov

Prize Competitions Program

Administrator

Jennifer Beardsley

jbeardsley@usbr.gov

Open Water Data Coordinator

Allison Odell

aodell@usbr.gov

Programs Analyst

Katie Hill

khill@usbr.gov

Budget Analyst

Rosann Velnich

rvelnich@usbr.gov

Administrative Assistant

Vacant

research@usbr.gov

Message from R&D

Welcome to this issue of the *Knowledge Stream*. In this issue we spotlight Reclamation's efforts to rapidly and reliably assess the conditions of its built infrastructure and natural assets to support management decisions. As technologies are rapidly advancing to support retrieval of large amounts of condition information, Reclamation is challenged to find better ways to efficiently collect, analyze and manage these large volumes of data – often coined “big data.”

Reclamation innovators are striving to make progress in various related areas, aiming to yield new tools and best practices. In this issue, you'll read about:

- Efforts to advance data collection, such as the collection of emergency response digital elevation data at Merritt Dam, high-resolution images of rockface conditions above Hoover Dam visitor center, cavitation monitoring at Grand Coulee Dam's Third Powerhouse to optimize operating zones for hydraulic turbines, and new tools to monitor invasive species in ecological data collection.
- Efforts to make big data analysis more efficient and informative for condition assessment, including new machine-learning algorithms to automate data analysis and rapidly detect relevant features, and better data visualization tools to support hydropower machine condition analysis as well as tools to synthesize three-dimensional field data describing Reclamation infrastructure and its surrounding environment.
- Efforts to improve big data management, including development of a central repository of information about Reclamation's roadway assets, and opportunities to publish big data collections through the Reclamation Information Sharing Environment.

As always, we appreciate you reading about innovation funded by Reclamation's R&D programs. Please enjoy this issue of the *Knowledge Stream* and offer us any feedback for improving our strategies to transfer solutions to users.

About the *Knowledge Stream*

The *Knowledge Stream*, published by the Bureau of Reclamation's Research and Development Office, is a quarterly magazine bringing mission-critical news about the agency's innovations in the following:

- Science and Technology Program
- Desalination and Water Research Purification Program
- Prize Competitions
- Technology Transfer
- Open Water Data...and more.

Content Lead

Contact

Bobbi Jo Merten, Ph.D.
bmerten@usbr.gov

More Information

usbr.gov/research

For more information on articles within this issue, please contact listed author or Bobbi Jo Merten.

Contents

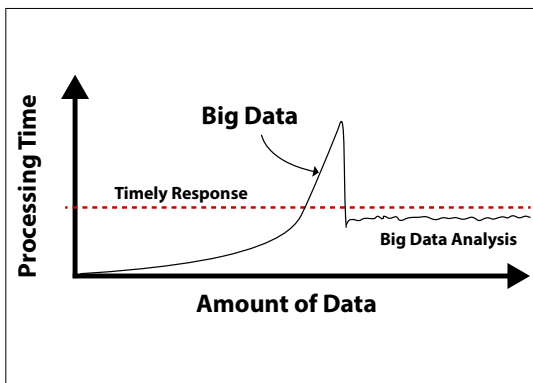

Key Perspectives: **pg. 6**

<i>Community Needs</i>	4
<i>Key Perspectives</i>	6
<i>Data Collection</i>	8
<i>Data Analysis</i>	18
<i>Data Management</i>	22
<i>Water Infrastructure Research Updates</i>	25

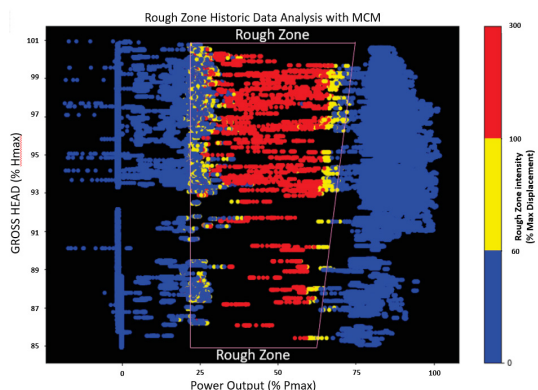

Data Analysis: **pg. 19**

Front Cover: Hoover Dam rockfall project results consisting of over 5,000 images combined with software into a single 3-dimensional model.

Community Needs

What is the Big [Data] Deal?

By **Bobbi Jo Merten, Ph.D.**

bmertent@usbr.gov

The Information Age fundamentally changed the way Reclamation scientists and engineers approach technical challenges. The generation that designed and constructed Reclamation's assets accomplished remarkable feats with a pencil, paper, and slide rule—state-of-the-art tools of the day. Today's generation of scientists and engineers carries a computer in their pocket, i.e., a smartphone, and designs using 3-dimensional computer programs.

The timing of recent advancements could not have been better. Reclamation's mission has shifted from construction to stewardship of the aging structures and dynamic environments for which it is responsible. Perhaps one of the greatest examples of new approaches to condition monitoring is through electronic and

digital means, such as real time monitoring of hydro units, i.e., machine condition monitoring, or unmanned aerial system (UAS) digital image surveys to produce data-rich photogrammetric models for analysis. This issue of the Knowledge Stream spotlights research and development to monitor or assess the condition of Reclamation assets better, faster, cheaper, and safer, through the efficient analysis of large volumes of new data, often coined *Big Data*.

Adopting big data for condition assessments requires addressing a wide range of necessary steps. Data is collected and analyzed using the following workflow:

- 1) What is the purpose of the data?
- 2) What planning is needed for the data to be collected?
- 3) How is the data collected?
- 4) What data modifications, processing, and analysis are needed?
- 5) How will the data be archived?

Each of these steps requires careful research, development, and implementation. Reclamation's Research and Development (R&D) Office sponsors efforts to make progress in each of these areas. For example, the recent Knowledge Stream issues "Canal Health", June 2020, and "Open Data Access through the Reclamation Information Sharing Environment" or – RISE, September 2020, outlined a data collection and analysis framework for Reclamation's lined and unlined canal system and focused on the archiving and publication of Reclamation's data.





A diagram depicting the complexities of condition monitoring and Big Data

The R&D Office also hosted a Data Research Workshop on September 23 and 24, 2020, that highlighted data collection and analysis efforts across Reclamation. The workshop included research roadmapping with participants and identified the following needs rated highest:

1. Payload: Sensors with enhanced or additional capabilities;
2. Navigation: GPS-denied environment mission planning;
3. Analysis: Training, hardware, software, storage for automated data processing.

Coordination with other Reclamation offices and partnerships drives innovations in big data collection and analysis. This issue includes insight from several Reclamation programs to illustrate how the role of policy, security, and other interests interacts with these technological opportunities and challenges. One such issue being the recent Secretarial Order (SO) #3379, Temporary Cessation of Non-Emergency Unmanned Aircraft Systems Fleet Operations, which has grounded our current fleet UAS operations.

Reclamation researchers have also collaborated with other agencies, including the U.S. Geological Survey and the U.S. Army Corps of Engineers, creating opportunities to information share and leverage each other's progress while addressing each agency's specific mission. Further, the Reclamation facilities participating in data collection research demonstrations play perhaps the most invaluable role in the progress made to date because their structures, ecosystems, and, often in-kind, staff support generate the big data that makes this all possible.

Reclamation is a leader, collaborator, and partner in big data collection and analysis research to meet the evolving demands of its mission of water and power distribution in the Western United States. We hope this issue of the Knowledge Stream provides context to the past successes and future direction for this research area and fosters new concepts for innovative condition assessment and monitoring across Reclamation's assets.

Key Perspectives

Big Data (or BIG DATA)

By **Matthew Klein, PE, PhD**

mjklein@usbr.gov

The title of this Knowledge Stream issue is admittedly attention-seeking. What is Big Data versus BIG DATA and how does it relate to Reclamation condition monitoring? The term BIG DATA within this issue is simply referring to a LARGE amount of data, which could easily be confused with the more mainstream and modern understanding of “Big Data,” which is defined in the next paragraph. However, as the data sets become larger, the difference between these definitions becomes more obscure.

The origin of the term “Big Data” is somewhat vague, but this buzzword describes a situation where the data set is so large and complex it cannot be processed and analyzed efficiently by traditional methods—“traditional methods” being those that process or consider every discrete data point.

Put more clearly, Big Data is so large that processing every data point requires too much time to resolve. Thus, Big Data processing uses predictive or statistical methods to arrive at the solution.

Throughout this issue, the idea of condition monitoring will refer to a broad category that encompasses collecting and analyzing data related to different material and/or structural parameters in their current state. For instance, when unmanned aerial system (UAS) or Machine Condition Monitor (MCM) data is collected—for rockfall mitigation or for combining with SCADA (supervisory control and data acquisition) systems—it assesses a particular condition or constraint (or even multiple constraints) at that point in time.

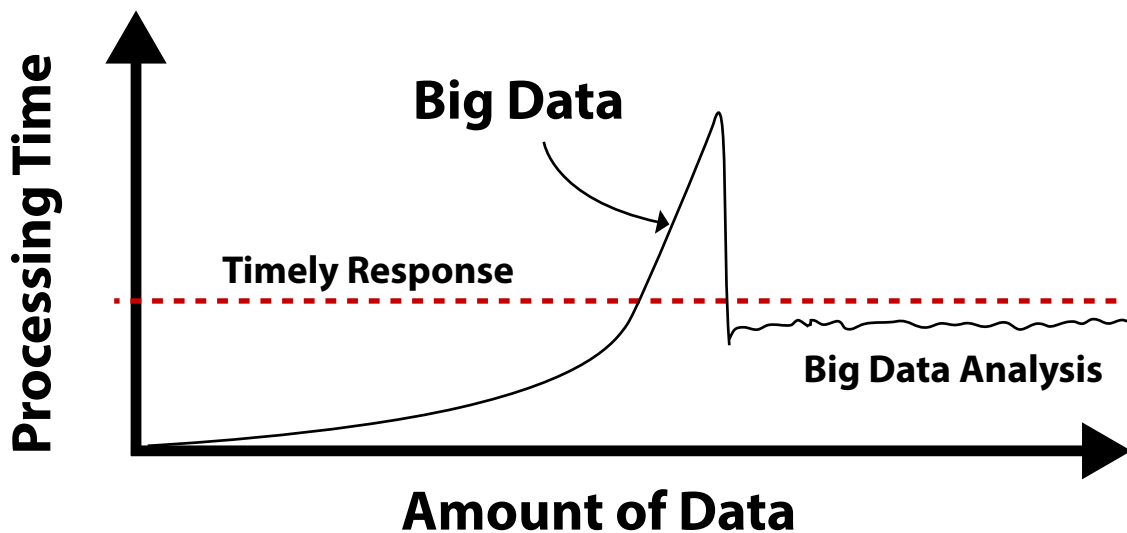
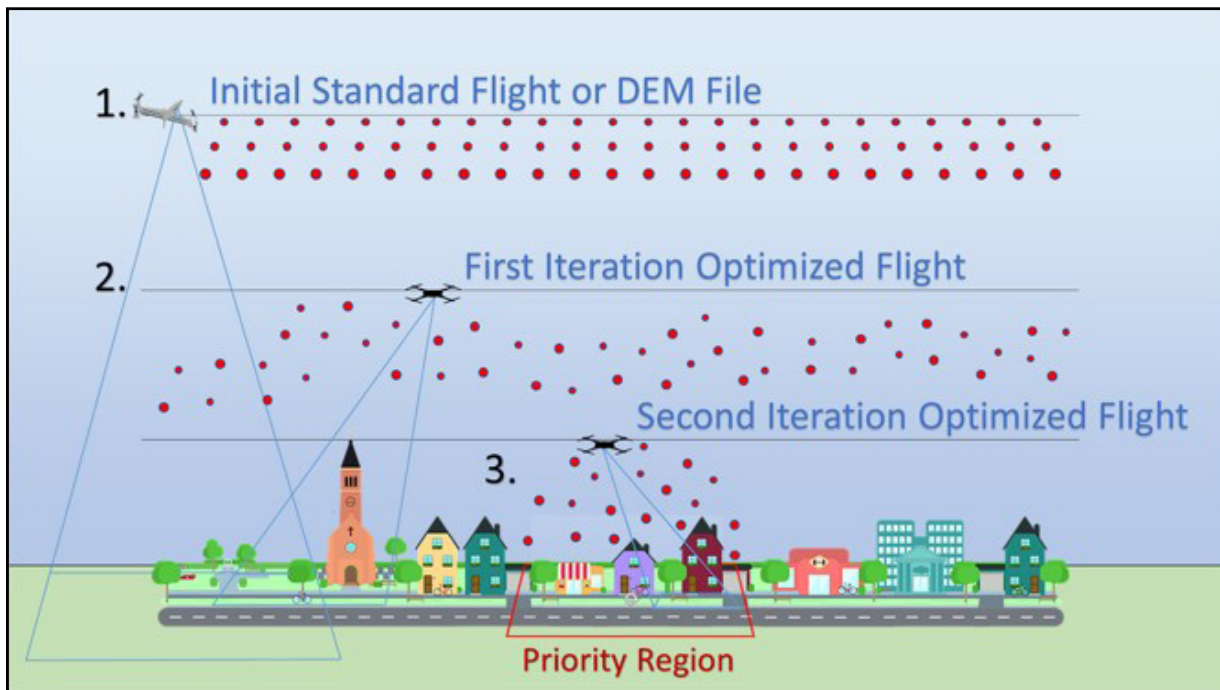

Diagram showing the difference between BIG DATA and Big Data based on the processing time and amount.”



Schematic for an efficient approach to high resolution data collection.

The results of the data analysis are then used to take action on the component or element. (UAS and MCM are discussed in more detail in Kevin Tibbs's and Patrick Council's articles).

Reclamation BIG DATA collection and analysis are on the edge of transitioning to the modern application of Big Data, a necessary step that will provide decision makers with speedier access to complex analyses and results, improving both the decisions and timeliness. When the data processing and analysis time exceeds the time required for prompt and decisive decision making, other statistical and interpolative methods should be considered.

A great example of this is the work that Michael Freeman, a civil engineer and Reclamation Remote Pilot-in-Command at the Provo Area Office, is doing in collaboration with the Center for UAS (C-UAS) and Brigham Young University (BYU). Freeman is field validating a UAS flight system that can optimize UAS navigation to consider high resolution data collection only in areas where the greater resolution is required instead of collecting a massive amount of data across the entire subject area.

This helps to reduce not only the flight time of the UAS and operators in the field, but also the processing time. In addition, software companies are improving algorithms within the software to reduce processing time in areas such as photogrammetric three-dimensional (3D) modeling where only adjacent images are considered for matching 3D points.

Moving forward, Reclamation data collection is actively working to consider the implications of both BIG DATA and Big Data to help drive faster and more precise solutions. This is being done by both users and policy makers to efficiently deliver data products, provide access Reclamation-wide, and consider the storage requirements of these data sets. Find these themes throughout this issue as well as different key players in Reclamation's emerging world of condition monitoring.

Data Collection

Emergency Response Data Collection at Merritt Dam

By Alex Duwe

aduwe@usbr.gov

In July 2020, the Nebraska-Kansas Area Office was contacted regarding voids underneath Merritt Dam Spillway, located in north-central Nebraska. This request merited serious attention, as a void under a concrete spillway can undermine the integrity of the infrastructure and lead to possible failure. However, before being able to take action, the team leading this investigation needed current digital elevation data to produce conceptual drawings, which aid in project planning and repair. Unmanned Aerial Systems (UAS) was the fastest and most cost-effective option to collect and deliver the necessary data in a timely manner. The data would be collected in a single day with a 1-2 week processing time. Due to the grounding of all Department of Interior (DOI) and Reclamation UAS in October 2019, additional steps were necessary to gain an Emergency Response waiver to conduct this mission.



A comparison of available imagery between ESRI World Imagery Basemap and orthomosaic imagery captured by UAS.

The objective was to provide the investigative team with up-to-date digital elevation data using photogrammetric methods. To accomplish this, a UAS, the 3DR Solo, was equipped with a Ricoh GRII digital camera. Flights were conducted

at 150 feet above ground level, capturing one image every second. Using flight-planning software, waypoints were marked throughout the flight area to create a 3-dimensional (3D) grid with the required overlap.

Once the flights were complete, the nearly 5,000 photos captured were loaded into a photogrammetry software which aligns each photo and generates the image tie points. After several iterations to reduce error, a dense point cloud was derived from the optimized camera positions. Using this dense point cloud, a 3D digital surface model (DSM) was produced, allowing for the construction of contour lines. The geometrically corrected photos were then used to create orthomosaic imagery, which are orthorectified images stitched together to create a seamless mosaic dataset. The final product had a ground resolution of 0.44 inches per pixel (1.12cm/pix), and a reprojection error of 0.319 pixels or 0.14 inches. The accuracy of the elevation data directly correlates to the height of vegetation which ranged from bare ground to 30-inch-tall grass around the spillway. As an additional ground truth measure, a manual elevation survey was completed around the immediate area of interest to compare the data sets.

All these products were exported and shared to a GIS (geographical information system) interface. In this instance, an ArcGIS Online Web Application was created and shared with the investigative team as a tool to visually track project progress. This is an example of how UAS data can be used to efficiently generate data products for collaboration and decision making in a timely manner.

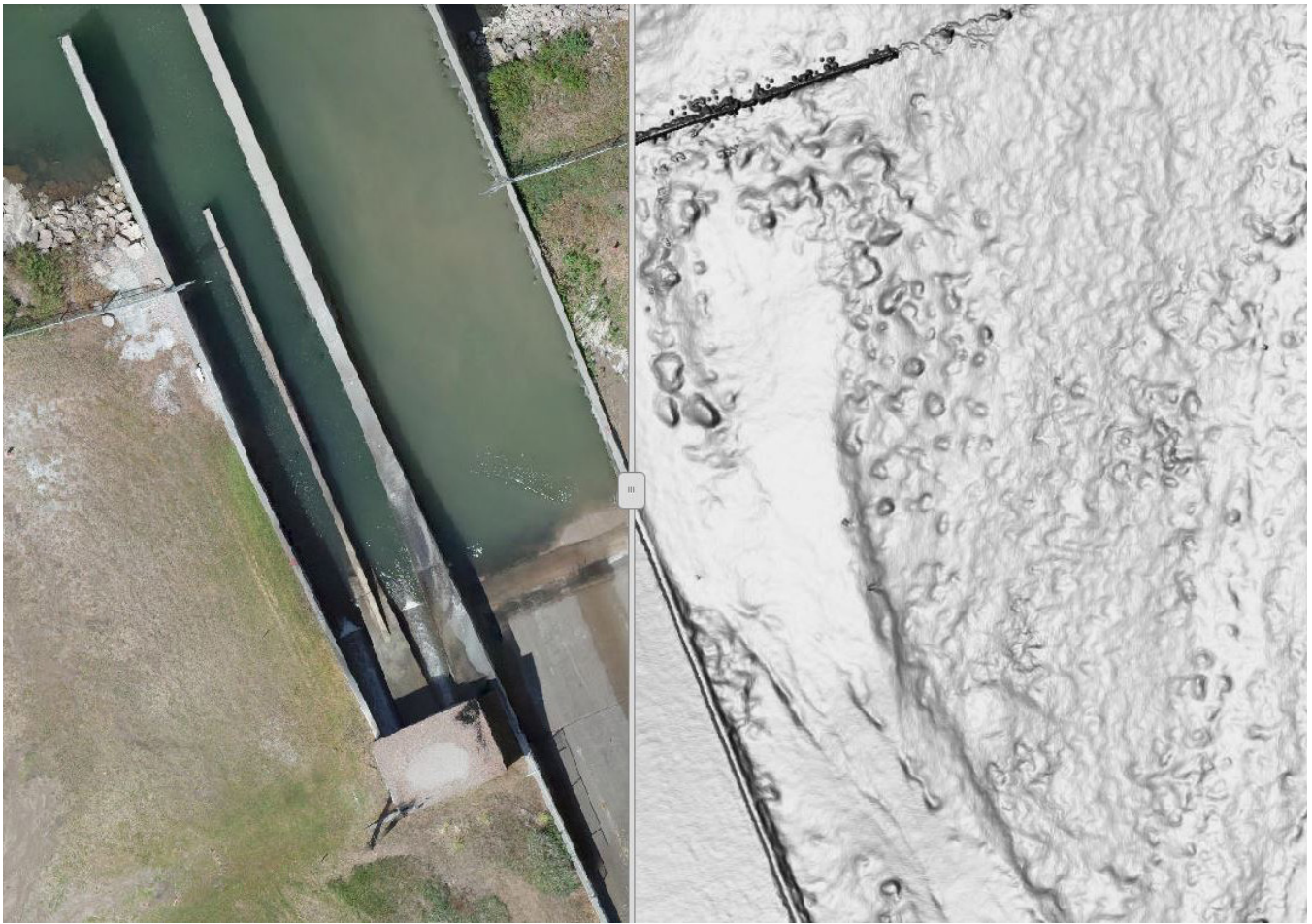

A screenshot showing ArcGIS Online Web Application Swipe widget. The center divider can be slid to reveal predefined layers for split screen comparisons.

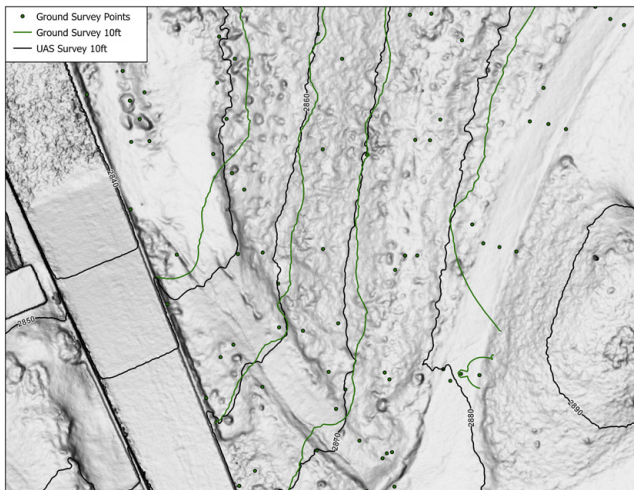

A comparison between the ground survey contours (green) and the photogrammetric contours from the UAS data (black).



A digital elevation model showing Merritt Dam Spillway.

Rockfall Data Collection to Mitigate Hazards

By **Kevin Tibbs, Grace Weber, and Matthew Klein**

ktibbs@usbr.gov, gweber@usbr.gov, mjklein@usbr.gov

S&T Project page: <https://www.usbr.gov/research/projects/detail.cfm?id=7109>

Rockfall events can disrupt water and power deliveries, cause costly damage to Reclamation infrastructure and equipment, and even result in severe injury or death.

This project was one of Reclamation's first targeted applications of unmanned aerial systems (UAS) technology, investigating UAS at Hoover Dam to assist in managing rockfall hazards above the parking garage and visitor center. The team included staff from the Technical Service Center, Lower Colorado Basin Regional Office, Lower Colorado Dams Office, Hoover Dam, and Hoover Dam Security Response Force. Sixteen total flights resulted in more than 5,000 images of the rockfaces at a resolution of approximately 0.13 inches per pixel. These images were processed using photogrammetry to create a 3D point cloud consisting of more than 500 million points for the nearly 6-acre area.

Reclamation geologists used these point clouds to analyze different rockfaces and fracture locations to determine the probable failure type and potential energy of a loosened rock—a more comprehensive and quantitative inspection than previously possible with traditional methods. Future data collections can also be used to compare 3D models created

at different times to detect movement within the rockface and identify potentially unstable fragments before they loosen from the rockface.

This application of UAS data collection demonstrates the value of comprehensive data collection for rockface analysis and provides a baseline from which to compare future 3D models. It can be used to help Hoover Dam and other Reclamation facilities target rockfall mitigation efforts to more effectively and efficiently reduce risk. The research also included several notable preliminary UAS flight exercises, in which the researchers:

1. Examined line voltage effects on UAS flight control to establish a minimum safe flying distance between the UAS and the numerous powerlines present at the dam.
2. Developed techniques to rapidly generate vertical and inclined waypoint navigation for precise flight planning.
3. Demonstrated photogrammetric change detection sensitivity by analyzing data collected at two different times.
4. Tested the effect of shadows on modeling results.



Test flight for vertical waypoint navigation along a rockface.

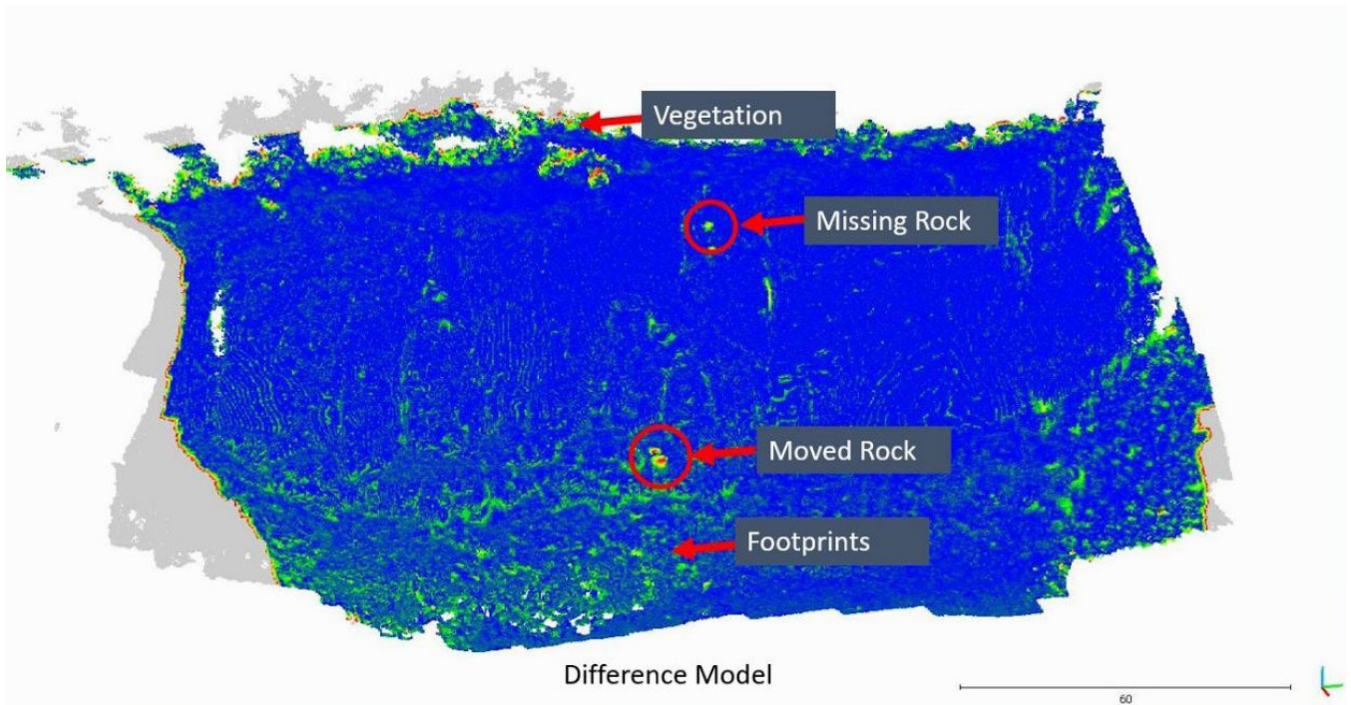

Difference model generated to show changes in rockface from September to October 2017, including both intentionally moved rock and missing rock that was not intentionally moved.

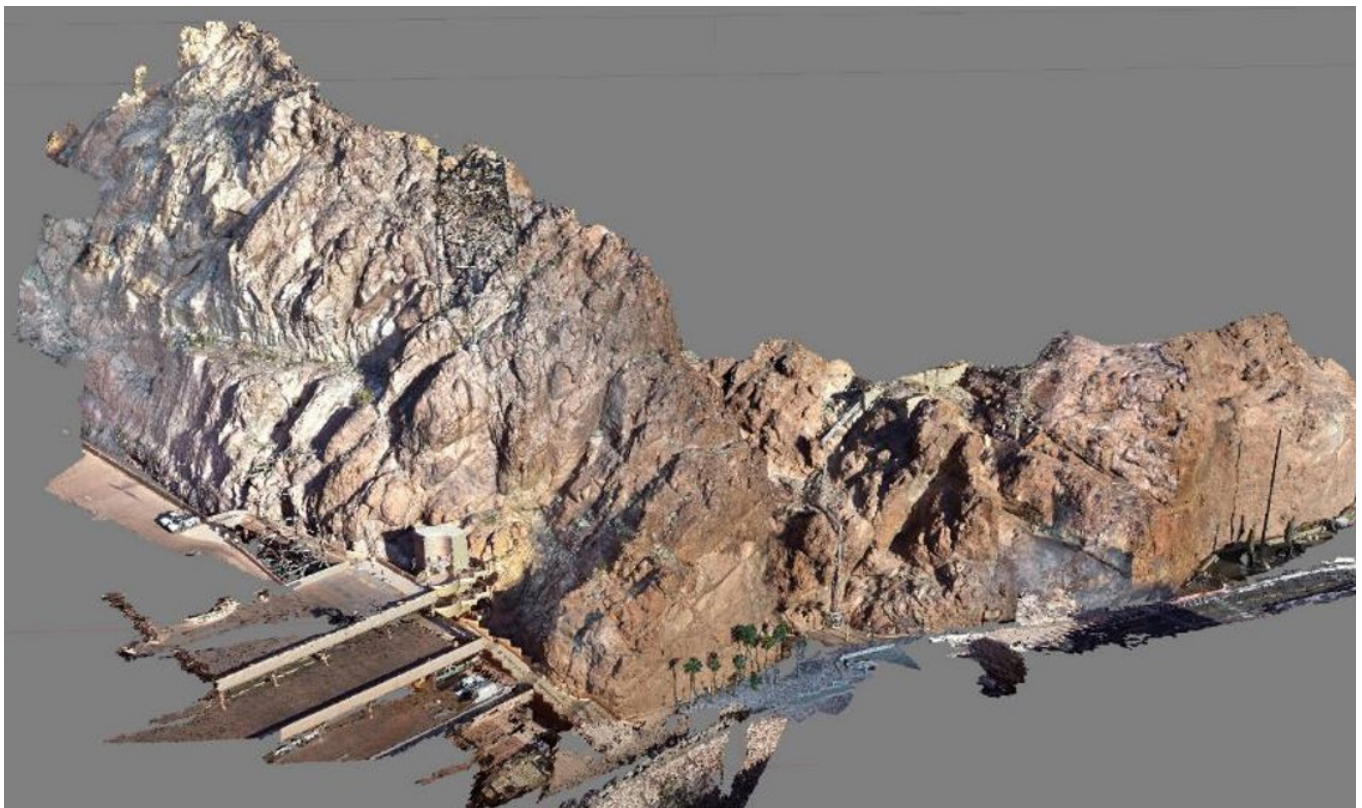

Baseline data for the Hoover rockface test, consisting of over 5,000 images combined with software into a single model.

Optimizing Hydraulic Turbine Operating Zones Through Cavitation Monitoring and Air Injection

By John Germann, Richard "Rusty" Miller, and Erin Foraker

jgermann@usbr.gov, rmiller@usbr.gov, eforaker@usbr.gov

S&T Project page: <https://www.usbr.gov/research/projects/detail.cfm?id=21104>

Turbine cavitation and rough zone operation is a costly and complex problem across the hydropower industry. When hydropower turbines operate at conditions away from their design efficiency, undesired effects can occur such as turbine runner cavitation metal erosion, excessive pressure pulsations, and high vibration 'rough-zones'.

Reclamation and General Electric (GE) are performing research at the Nathaniel 'Nat' Washington Powerplant, previously known as the Grand Coulee Dam's Third Powerhouse, to improve techniques to detect and map damaging turbine cavitation. The goal is to quantify this cavitation damage by identifying and trending ranges of operation where cavitation is produced and the intensity of the cavitation activity. This project capitalizes on GE and Reclamation expertise and prior research on cavitation phenomenon.

These tests are being conducted on an 805-MW hydroelectric generator, which is one of the largest hydroelectric machines in the world. Initial tests for cavitation activity identified and mapped areas of interblade vortex cavitation, inlet suction cavitation, and the hydraulic induced turbine rough zone, as well as an operating range where damaging strong pressure pulsations occur within the turbine. Research found that these violent surges, which were causing plant structural damage, could effectively be mitigated by injecting small amounts of air into the water leaving the turbine runner.

Reclamation and GE developed and installed cavitation monitors on the generator unit. These monitors will accurately identify cavitation 'zones' and translate sensor activity into cavitation intensity. A permanent air injection system and controls have also been designed and installed on the unit to minimize the damaging pressure pulsations on the low-pressure side of the turbine.

Researchers are designing artificial intelligence-based tools to better analyze and portray the large amounts of real-time and trended data that is collected by the monitors. Using special techniques, the effects of erosive cavitation, the cavitation induced rough zone and the special pressure pulsations can be displayed over time as water flow and reservoir elevation change. This allows for better mapping of the cavitation. Proposed prognostic models and the creation of a cavitation damage algorithm will help to accurately predict and assess cavitation erosive damage and provide operators with better tools to avoid operating in zones where cavitation is occurring.

This research will ultimately extend the service life of the turbine components and help outage scheduling by minimizing down time for cavitation inspections and repairs. Ultimately this will maximize unit availability for renewable power generation and reduce operation and maintenance costs.



Inlet Suction



IBV

G24 June 25, 2019 Cavitation FFT Waterfall
 D:/Grand Coulee/G24 Cavitation June 24, 2019/AE_Wicket Gate_Raw_Peak_AllValues_20190625134500To20190625180000_0000.csv
 Channel: Wicket Gate AE Hardware Peak Detection 600Hz Sample Rate - 4 Hours of Data

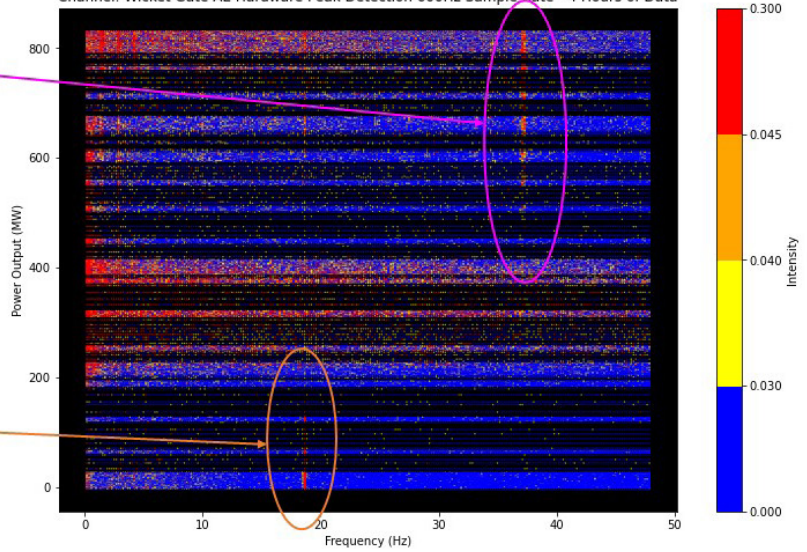

This color map indicates suspected areas of cavitation activity occurring on the turbine runner and the corresponding acoustic emission sensor frequency response illustrating cavitation intensity.

Turbine Pressure Pulsations

Addition of Air

Turbine Air Injection Results

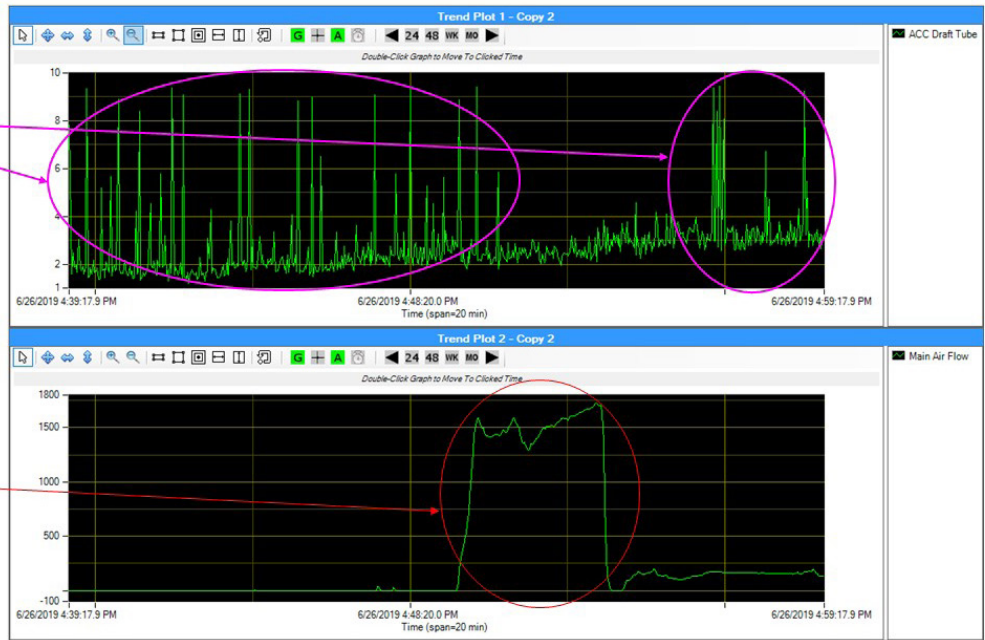

This figure displays sensor output showing how the injection of a small amount of air into the turbine runner cone effectively mitigates the strong special pressure pulses that are occurring.

Laser Metrology with FARO Technology

By Chad Paulson

cpaulson@usbr.gov

S&T Project page: <https://www.usbr.gov/research/projects/detail.cfm?id=19146>

The digital age has drastically changed the world of metrology and engineering. Measurements once completed with piano wire datums, dial indicators, and calipers can now be measured with laser technology. Drawings once done on engineering paper are now ripe for input directly from the measurement software into computer aided design (CAD). Researchers are using a laser tracker, arm, and laser line probe (LLP), manufactured by FARO, paired with Innovmetric's Polyworks software to aid Reclamation personnel in accomplishing operation and maintenance goals with modern metrology solutions.

Although limited to line-of-site measurements, the laser tracker is capable of collecting data up to 80 feet away. The tracker has been used to plot asymmetries and other critical measurements of turbine components such as concentricity, plumbness, and diameters.

The accuracy of this tracker is 0.0015 inches, which is less than the average width of human hair. During measurements, the tracker has been able to capture and localize 5,000 data points to accurately outline runner surfaces and detail deviations from calculated features. This allowed engineers to determine areas of interference during a runner reinstallation. Future opportunities to test the tracker capabilities include measuring a variety of large equipment features and analyzing crane rails for deviated conditions.

The laser arm and LLP, capable of capturing greater than 400,000 points per square inch, have been used together to gather dense point clouds with location accuracies of equal to or less than 0.001 inches. These point clouds, routinely comprised of more than 1 million data points, have proved useful in reverse engineering mechanical components, analyzing component features, and conducting part quality control post fabrication.

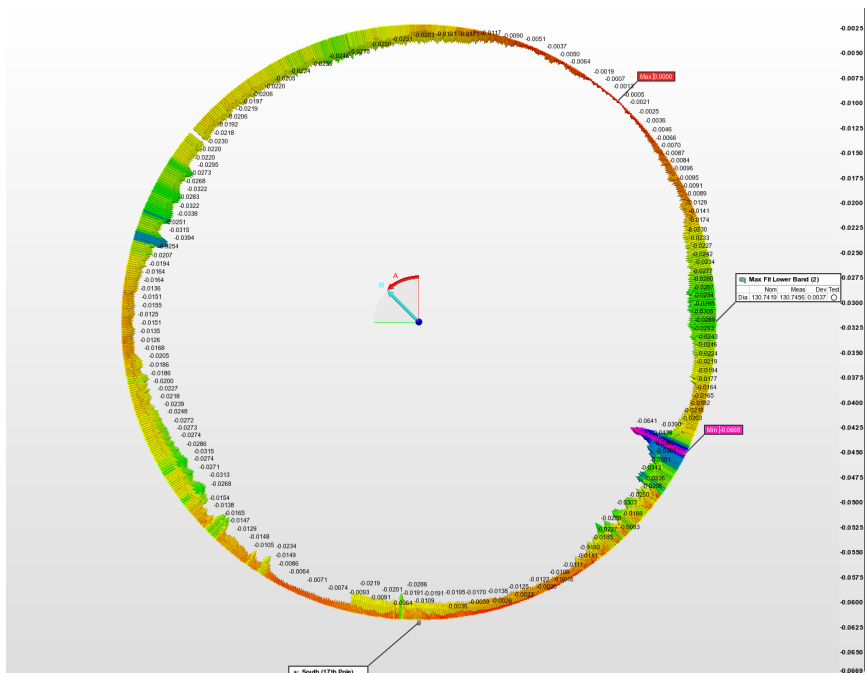

Data visualization of turbine runner interference areas for reinstallation, showing maximum fit deviations (units in inches).

Moving forward, the LLP could also be useful in digitizing and cataloging common parts for in-house manufacturing and calculating volumes of cavitation damage.

Researchers continue to explore the capabilities of the FARO technology within Reclamation's mission and welcome suggestions. For complex measurements, the accuracy and speed of this equipment is unparalleled by traditional means. Most importantly, measurements are done with something every engineer has: a laptop. So, forget the cocktail napkin, metrology has gone fully digital.

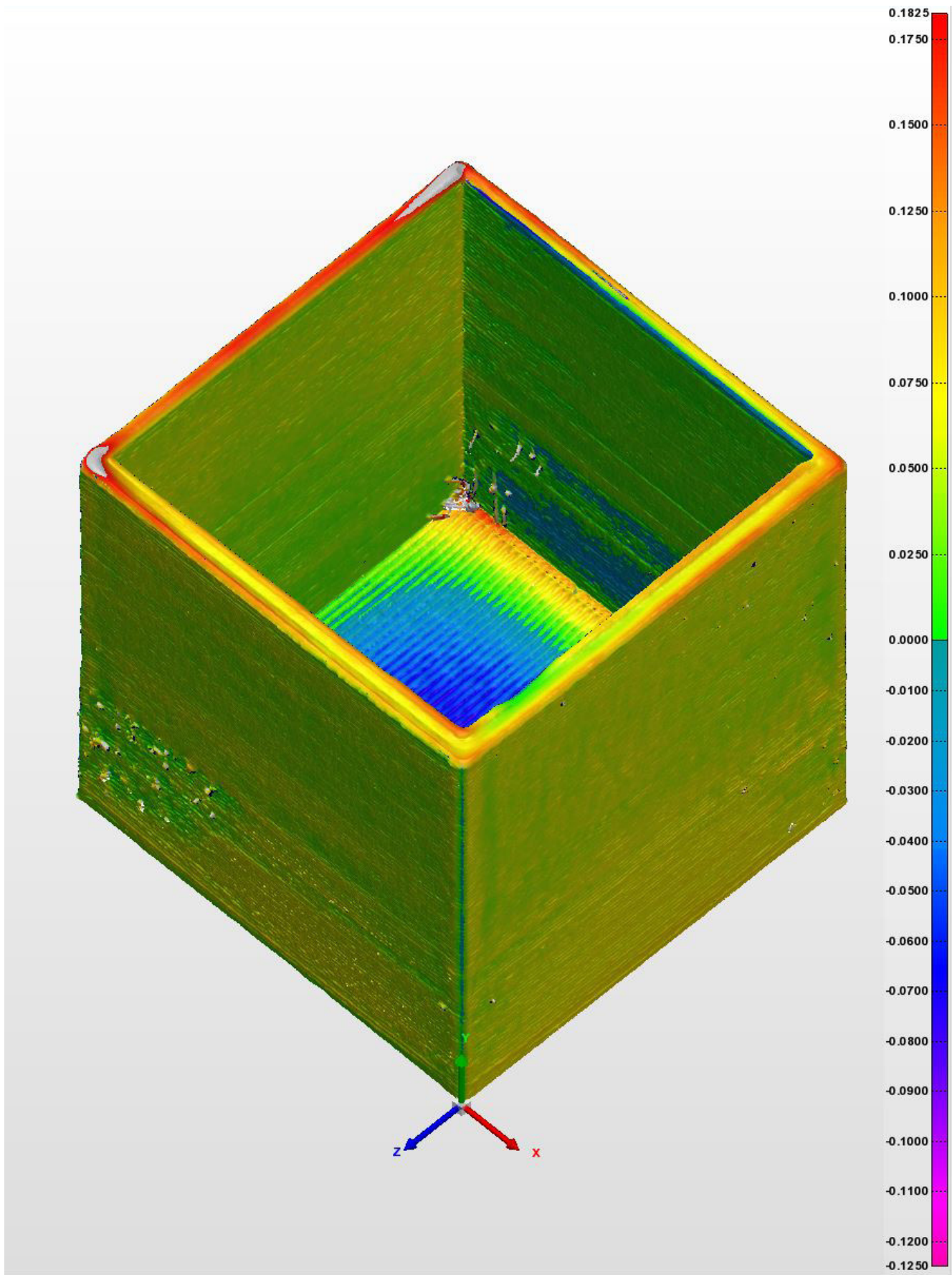

3D Printed Metal Cube Quality Verification. Color map of measured deviations for quality control of a 3D printed metal cube (units in inches).

Ecological Data Collection: New Tools to Combat Invasive Species

By **Aaron Murphy**

amurphy@usbr.gov

S&T Project page: <https://www.usbr.gov/research/projects/detail.cfm?id=19012>, <https://www.usbr.gov/research/projects/detail.cfm?id=1748>, <https://www.usbr.gov/mussels>

The Ecological Research Laboratory (Eco Lab) at Reclamation's Technical Service Center (TSC) collects and analyzes a variety of ecological data to detect, monitor, and manage invasive species infestations. Data collection often occurs in remote locations, amidst dense vegetation, or at spatial scales that necessitate long hours on foot. In recent years, Reclamation adopted unmanned aerial systems (UAS), mobile apps, and environmental DNA (eDNA) to meet the challenges associated with the collection of ecological data.

UAS have the potential to support rapid data collection across large areas with limited road access. Both terrestrial and aquatic invasive plants can be identified and mapped using simple digital cameras, multispectral sensors, and LiDAR (light ranging and detection). UAS have also been deployed to collect water samples where boat access is not possible, and to monitor the effectiveness of pest management actions.

The Eco Lab is also incorporating mobile apps into existing ecological data collection workflows, reducing the need for pen and paper recording and expediting data analysis. Apps, such as ESRI's ArcCollector and QuickCapture, allow staff to rapidly collect georeferenced data in the field and instantly share it with researchers in the office. Users can customize these apps to fit the task and collect data while offline in remote areas.

Early detection and rapid response is the most effective method for limiting the spread of invasive species, but detection is difficult because early populations are typically small.

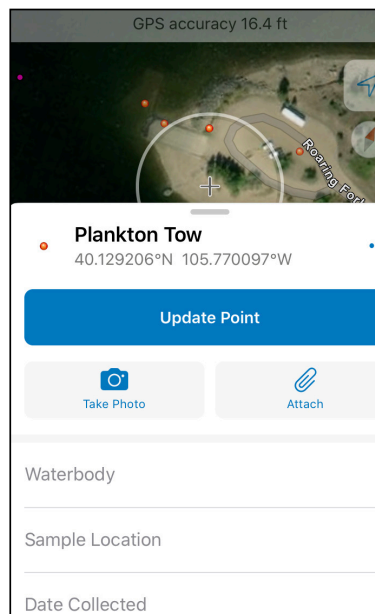

Mobile apps, such as ESRI's ArcCollector, can eliminate the need for paper data collection sheets and expedite data analysis.

The Eco Lab has developed new methods using eDNA to improve the likelihood of early detection. Organisms shed eDNA into the environment where it can be extracted from water or soil samples. Combining eDNA with traditional survey methods allows scientists to significantly increase the amount of data collected when evaluating a waterbody.

The Eco Lab currently uses eDNA data to support Reclamation's invasive mussel early detection program and is exploring opportunities to use UAS to collect imagery of invasive weeds along the Lower Colorado River. Incorporating these, and other, emerging data collection tools will allow researchers to rapidly identify new invasive species and implement effective control measures.



Giant salvinia infestations often extend deep into riparian vegetation and could be more easily monitored using UAS.

Data Analysis

Machine Learning to Advance Data Analysis

By Zack Leady

zleady@usbr.gov

S&T Project page: <https://www.usbr.gov/research/projects/detail.cfm?id=20105>

Big Data has created the need for improved data analytics. It is not a coincidence that unparalleled improvements in data-driven modeling and analysis—often termed machine or deep learning—have accompanied the rise of Big Data. These methods learn advanced pattern matching techniques between large data sets and human labelled targets, without direct rulesets. This allows humans to leverage Big Data for actionable insights without direct feature engineering.

Reclamation’s shift toward managing large amounts of aging concrete infrastructure increased the need for monitoring the safety and integrity of that infrastructure. The introduction of unmanned aerial systems (UAS)-based monitoring methods to collect visual imagery of these structures provides data that could be processed into orthoimagery. To date, the orthoimagery has been analyzed manually by an engineer to identify concrete cracks and assess the potential safety risks. This process of manual delineation is time consuming and prone to human error.

Reclamation recently demonstrated a proof-of-concept automated concrete crack detection model using orthoimagery of a concrete structure, collected by UAS. The approach utilized a deep learning semantic segmentation (pixel-by-pixel labeling) convolutional neural network. The neural network effectively learned to label concrete cracks in unseen images through ‘training’ on large amounts of input, label pairs.

By leveraging state-of-the-art deep learning convolutional neural networks (i.e. U-nets), Researchers developed a proof-of-concept deep learning pipeline for automatically delineating concrete cracks in UAS collected orthoimagery. This sparks the beginning of the integration of significant advancements in machine and deep learning for increasing the efficiency of processing and analyzing Big Data at Reclamation, while also decreasing the cost to maintain Reclamation’s strict safety standards for the public on its aging infrastructure.

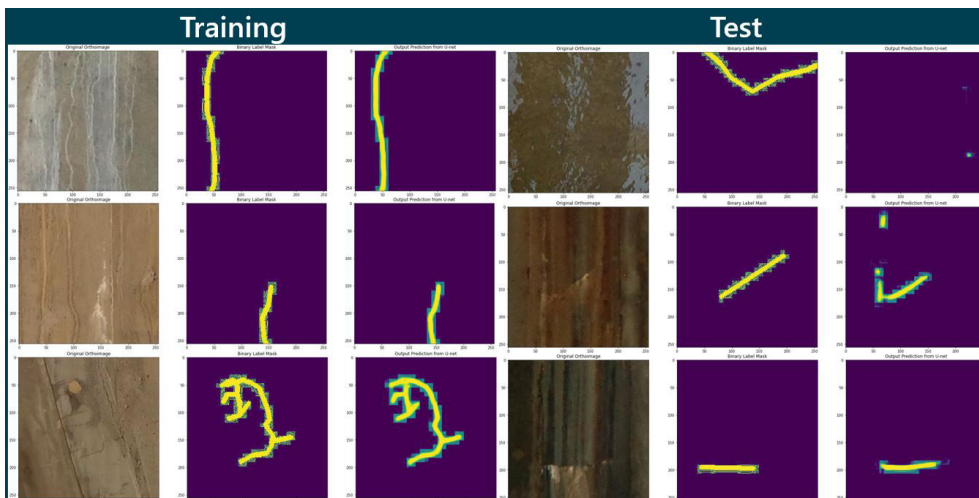

Training and test example predictions from the U-net model for delineating concrete cracks from orthoimagery. The first column is the orthoimage input; the middle column is the target label; the last column is the U-net prediction.

Machine Condition Monitor Rough Zone Analysis

By Patrick Council

pcouncil@usbr.gov

S&T Project page: <https://www.usbr.gov/research/projects/detail.cfm?id=1719>

The Machine Condition Monitor (MCM) developed by the Denver Technical Service Center Hydropower Diagnostics & SCADA Group has been recording data on generators in Reclamation's power plants for over 10 years, enabling facilities to trend and store large amounts of data. Until recently, this data has largely been visualized and trended using time graphs, which makes it challenging to visualize big data sets on one plot.

The MCM's development was largely driven by the 2009 Sayano-Shushenskaya Power Station accident to provide an affordable vibration monitoring solution to Reclamation's fleet of hydroelectric generators. Many facilities have implemented additional data acquisition with the MCM, combined with data analytics. Notably the addition of rough zone monitoring demonstrates how data analytics can produce insights into generator operation.

For the analysis of rough zone, MCM data and historic SCADA data needed to be evaluated together, but security purposes require the two systems to be isolated. Combining two different historical data sets necessitated the development of a software tool to merge into the same database. Leveraging the data science tools readily available in the Python programming community, researchers developed software to analyze the combined data sets that span nearly a year's worth of data, containing well over 12 million data points. To visualize a generator rough zone, the processed data was then formatted to be plotted on a scatter plot. The plot illustrates the Turbine Rough Zone magnitude making the zone boundaries easy to identify.

This data visualization allows Reclamation's facilities to adjust operation of generators to avoid operating in these rough zones. This helps prevent damage that could lead to catastrophic failure if left unchecked.



Adjustment of Proximity Probes at the Turbine Guide Bearing used for Vibration Monitoring.

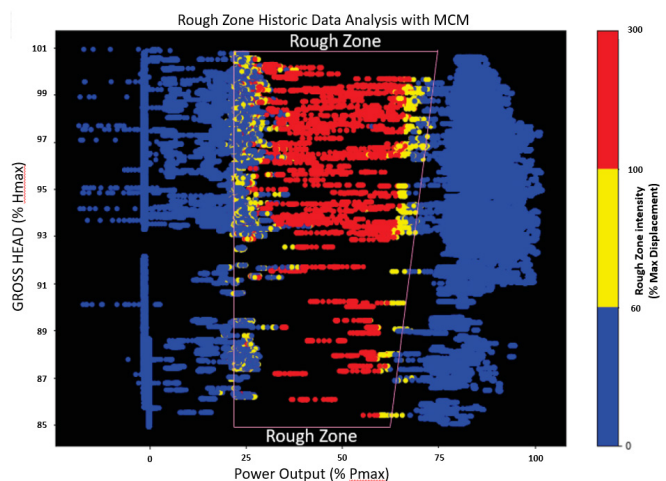

Normalized Rough Zone Scatter Plot Generated Using 12 Million+ Data Points MCM and SCADA DATA

3D Tools to Enhance Data Visualization

By **Evan J. Lindenbach, PE, PG**
elindenbach@usbr.gov

Reclamation's structures can be described spatially in three dimensions: north-south, east-west, and elevation. This description is further emphasized by including a time-dependent temporal aspect either at regular intervals or by single events. Reclamation engineers, scientists, and technicians collect structural, performance, and subsurface data at intervals ranging from frequent (i.e., nearly real-time performance data) to very infrequent (i.e., drilling and sampling as part of a geologic investigation) and increasingly this data includes spatial metadata, coordinates and reference locations, or actual three dimensional (3D) positions. Given this increasing amount of data, developing tools for visualization of these related data products and improved methods for storing and quickly accessing the data has become an imperative for improving the analysis and management of our infrastructure.

The engineering industry as whole is trending toward the development of "digital twins" as part of a standard workflow. Simply put, a digital twin is a digital copy of an existing or proposed structure/feature that can be used to visualize and analyze the current structure/feature and model any proposed modifications,

replacement parts, structural changes, or provide a means to give a virtual tour for stakeholders. Developing digital twins of Reclamation's structures represents an opportunity to have spatially and temporally referenced, feature specific databases which can be used at any time. These visualizations can, among other opportunities, inform our understanding of data gaps, help our modeling capabilities and event trees for dam safety analyses, improve our operations and maintenance strategies and tracking, and provide stakeholders a means to explore our structures. Given that Reclamation has transitioned from designing and building dams to long-term operations and maintenance, digital twins provide a means to store data and monitor the performance of a facility.

A recent Dam Safety Office Technology Development Program research project sought to investigate surface and subsurface data visualization using commercially available software. The data visualization software Leapfrog Works (version 3.1) was used to combine, reference, and visualize multiple disparate data sources, as well as offer modeling tools to interpolate the data visualization implicitly.

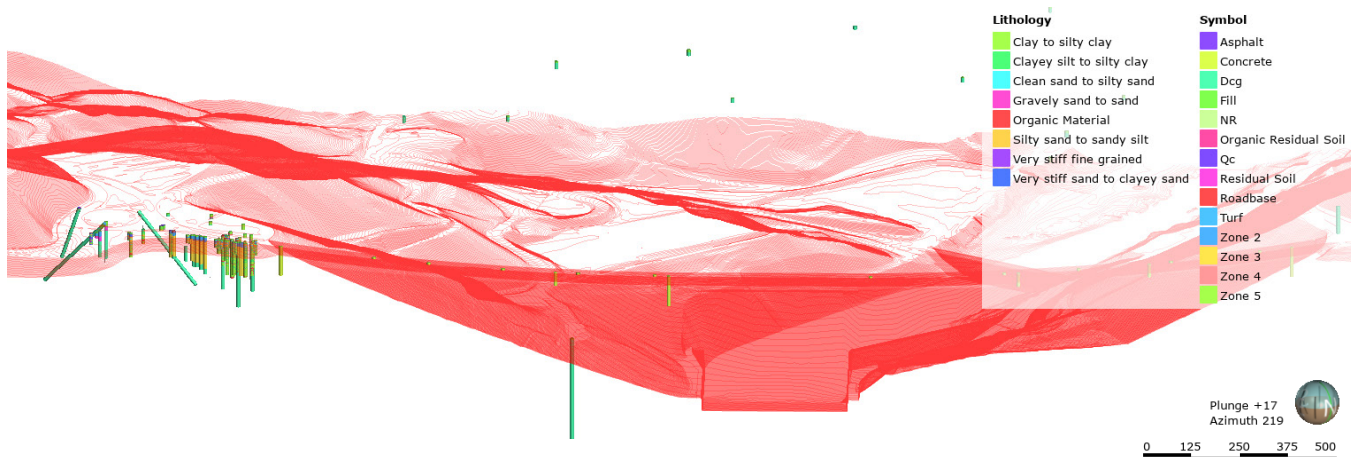

Example of the visualization of a concrete dam structure and topography in red, along with subsurface data including geological lithology. See key inset for interpretation.

Datatypes contained within the visualization software can quickly be toggled to allow for a robust discussion and analysis of ground conditions. The software can also be used to quickly generate and modify cross-sections through the various datasets. In addition, multiple data types can be superimposed allowing intelligent analysis of relevant data. The visualizations can be updated as more data becomes available resulting in a dynamic platform for long-term, big-data analysis and retention.

Future work is planned to merge this information with building information models (BIM) along with unmanned aerial system (UAS) data collection and related products such as 3D point clouds, condition assessment analysis, as-built surfaces, and topography to create a full digital twin of the structure.

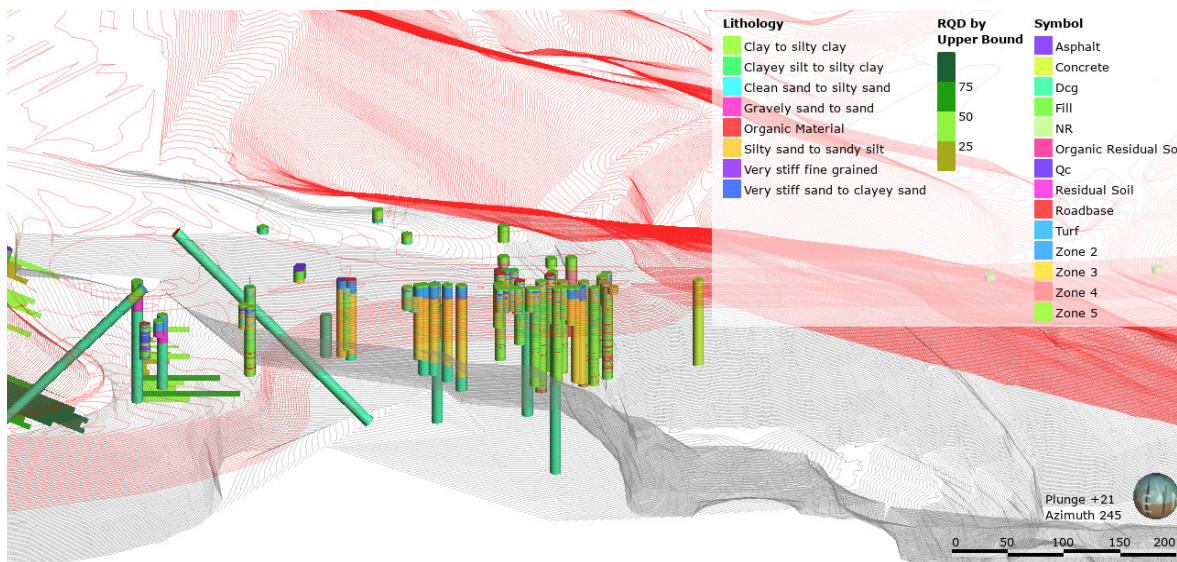

Subsurface data visualization including lithology, CPT, and Rock Quality Designation (RQD) data as well as the pre-construction topography in grey and the existing surface in red. See key inset for interpretation.

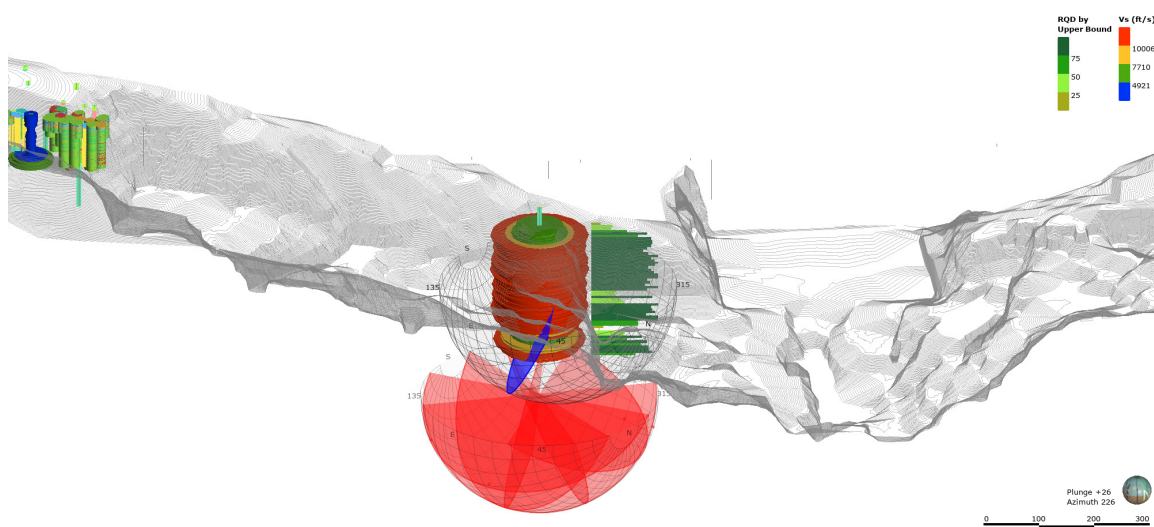

Subsurface data showing lower hemisphere stereonet plots of a shear zone in blue and other discontinuity orientations in red with the preconstruction topography in grey. Shear wave velocity is shown on the boring trace in red/yellow/green/blue, with the RQD provided in green offset from the boring.

Data Management

Data Management Tools for Reclamation's Roadway Inventory and Assessment Program

By **Dan Staton and Dave Tordonato**

dstaton@usbr.gov, dtordonato@usbr.gov

Reclamation's transportation infrastructure includes a network of roads and parking lots designated for administrative or public use. The public road network consists of approximately 800 miles of paved roads and about 2,000 miles of unpaved roads. Reclamation is directly responsible for maintaining one third of the inventory, whereas managing partners such as State Parks and other agencies are responsible for the remaining portion.

Reclamation's Asset Management Division (AMD) is responsible for administering and coordinating funding from the Federal Highway Administration (FHWA) to assist with planning, design, and construction of transportation projects. A Road Inventory Program (RIP) is currently being rolled out across Reclamation, by region, in accordance with Reclamation Manual Directive and Standard Transportation Program (FAC 07-01) and is expected to be completed in FY21. The goal is to provide an accurate inventory of Reclamation's roads in a central repository along with road condition data to help quantify the rehabilitation need on Reclamation roads and to make data-driven investment decisions for roadway related projects.

The inventory is being developed in a collaborative effort between each region and AMD and includes the collection of basic information for each route, such as: alignment, unique name/identifier, surface type, functional class, Federal Lands Transportation Program (FLTP) funding eligibility, land status, and ownership/maintainer status.



Deteriorated pavement with severe alligator cracking

A condition assessment is also performed every 5 years for each route segment and the information is captured via:

1. Written report,
2. Electronic geodatabase and spatial data files,
3. Condition photographs

As part of the condition assessment, paved road sections and parking lots are assigned a Pavement Condition Rating (PCR); unpaved segments are assigned a Pavement Surface Evaluation Rating (PASER). All completed route and segment information is uploaded into the Bureau of Reclamation Geographic Information System (BORGIS) system where it is viewable by users within Reclamation in a geospatial format. Route segments are color coded and displayed in accordance with their condition; detailed condition assessment reports are stored in the system and accessed through the online interface.

The system provides an at-a-glance overall breakdown of current conditions for paved roads, unpaved roads, as well as paved and unpaved parking lots. Work is in-progress for the Columbia-Pacific Northwest Region, Missouri Basin Region, and Arkansas-Rio Grande-Texas-Gulf Region. These ratings can then be used to assist managers with making treatment recommendations, planning, prioritizing funding, and informing Reclamation's Long Range Transportation Plan. Lifecycle cost optimization for the network will be pursued through a Pavement Preservation Program (PPP) once the RIP is complete.

The condition assessment process has been completed for the Lower Colorado Basin Region, Upper Colorado Basin Region, and partially completed for California-Great Basin Region.

New methods for automated data collection and condition assessment on paved segments are currently being evaluated by Reclamation in partnership with FHWA. Similar programs are currently in place for Reclamation's Bridge Inventory (RBI) and are being pursued for other asset classes such as dams and reservoirs with the ultimate goal of creating a comprehensive online asset registry.



Example of pavement distress documented during a parking lot condition assessment.

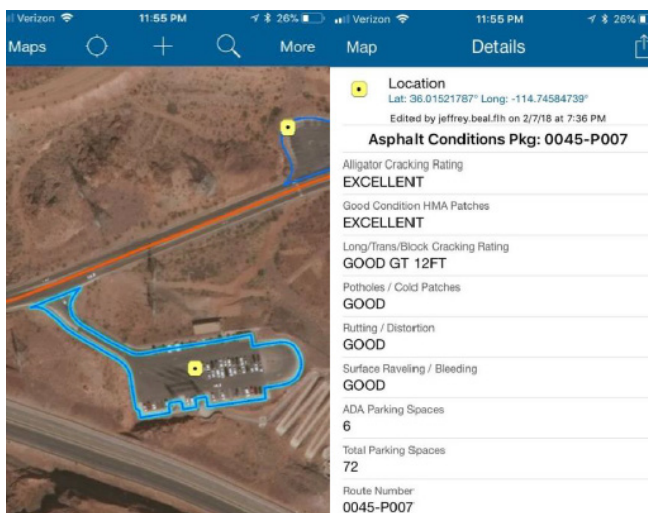

Example of detailed pavement condition data available in BORGIS.

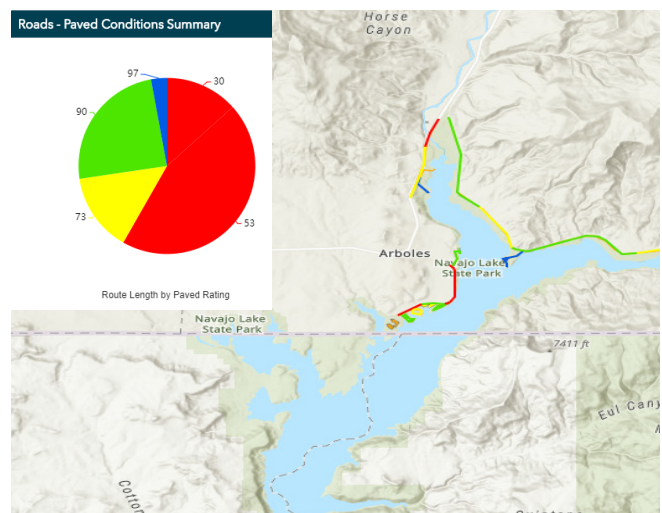

BORGIS paved parking lots conditions summary.

Publishing Condition Monitoring Data: Publishing in RISE

By Allison Odell
aodell@usbr.gov

Condition monitoring efforts have evolved to be heavily reliant on data and frequently result in the collection of large amounts of data. With all that data, it is important to consider whether and how datasets will be shared beyond the immediate team working on a specific condition assessment activity. One option for data sharing is the Reclamation Information Sharing Environment (RISE). RISE is Reclamation's new portal for publishing data generated in conducting Reclamation's mission, such as water operations, water quality, infrastructure, hydropower, and environmental data. RISE standardizes and centralizes Reclamation's data publication to serve data from multiple offices and programs in a single portal, making it faster and easier for users to get the data they need. RISE, located at data.usbr.gov, publishes data in open formats that can be accessed via a map interface, catalog search, time series data query, or Application Programming Interface (API).

RISE has three data publication formats available: time series datasets stored in the RISE MySQL database, geospatial datasets hosted through ArcGIS Online, and binary files uploaded to a Minio database.

Because not all condition assessment monitoring data may be appropriate for public consumption, RISE implements a robust screening process to ensure that datasets that are published do not contain sensitive information. The RISE team is also working towards building an internal-only portion of RISE to allow staff within Reclamation to share datasets that may not be appropriate for public release.

Visit RISE at data.usbr.gov to see the data that is currently available. For more information about publishing data in RISE, please contact the RISE team at data@usbr.gov.

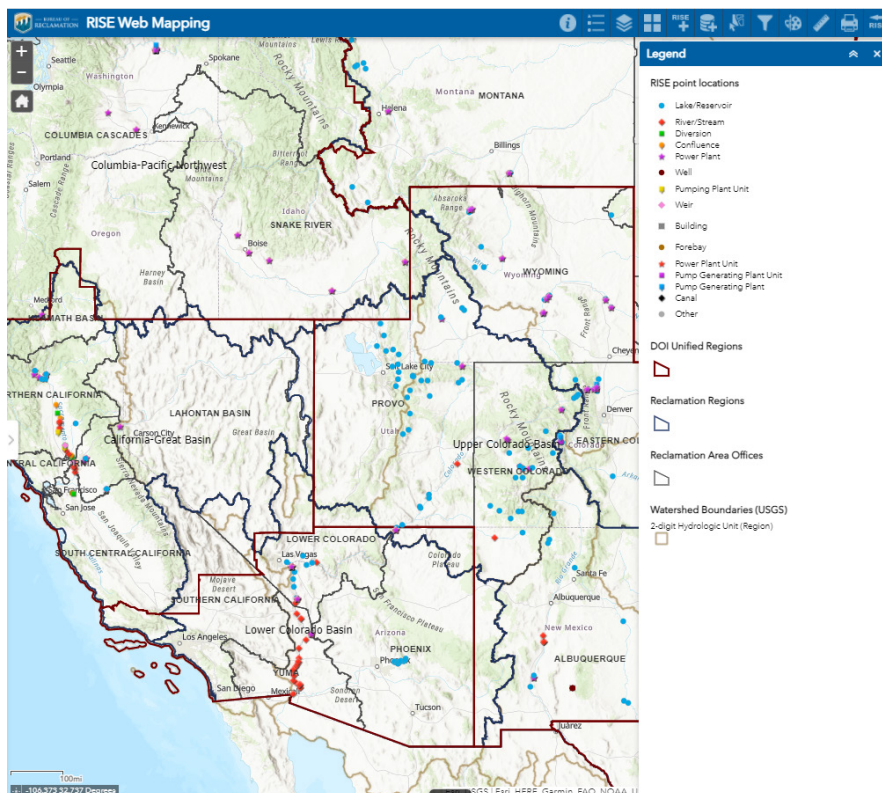

The RISE catalog (<https://data.usbr.gov/catalog>), filtered to display some of the infrastructure-related datasets currently available in RISE.

Water Infrastructure Research Updates

Additive Manufacturing

By **Dave Tordonato, Stephanie Prochaska, Grace Weber and Jonny Rogado**

dtordonato@usbr.gov, sprochaska@usbr.gov, gweber@usbr.gov, jrogado@usbr.gov

S&T Project page: <https://www.usbr.gov/research/projects/detail.cfm?id=19085>

As Reclamation's infrastructure ages and some replacement parts are becoming difficult or impossible to find, TSC researchers have begun evaluating additive manufacturing (AM) as a potential solution. AM, also known as 3D printing, involves building a part layer-by-layer, as opposed to the conventional subtractive manufacturing by which a part is cut from a large block of material.

AM production rates, technology, and economics are improving, which may allow the technology to become practical for a variety of applications, including the hydropower industry.



AM can provide an advantage over traditional manufacturing methods in situations where production of parts is limited (custom fabrication), or where parts are complex and challenging to manufacture using traditional methods.

This project involves mechanical and metallurgical evaluation of AM versions of materials commonly used on Reclamation structures such as stainless steel, aluminum, and bronze alloys. Researchers have performed mechanical testing and metallography on printed materials and compared these to results from traditionally-manufactured counterparts. Preliminary findings have shown mechanical properties of printed parts to differ with AM technique and build orientation, which could prompt further research.

TSC's Materials and Corrosion Laboratory has also partnered with field offices across Reclamation who are interested in exploring AM processes as an operation and maintenance tool.

Additively-manufactured part during printing process.

Together with Oak Ridge National Laboratory's Manufacturing Demonstration Facility, the research team pursued several use case studies involving parts of various sizes, functions, and materials including slinger rings, governor parts, and log boom anchors. Log boom anchors, used with buoys to prevent river debris from impacting critical infrastructure near shores, are traditionally machined from one large block of steel with significant material waste and require frequent replacement.

manufactured log boom anchor replacement part through a process of stress analysis of the original part and then creative changes to the structural volume, incorporating experience in operation and maintenance failures and machine design principles. The new design reduced the amount of material needed by approximately 50 percent while eliminating all material waste and minimizing post-processing. Several of the printed aluminum log boom anchors will soon be placed in service for testing at Nimbus Dam.

TSC researchers and mechanical engineer Jonny Rogado, Central California Area Office, worked together to design an additively

Print-on-demand replacement parts? Coming soon to a dam or powerplant near you.

Conventionally-manufactured log boom anchors



Conventionally-manufactured log boom anchor at Nimbus Dam, California.



The log boom anchors are cut from a large block of material, resulting in material waste and manual labor. After approximately one year in service, the log boom anchors become worn and corroded and need to be replaced.

Process for additively manufactured log boom anchor

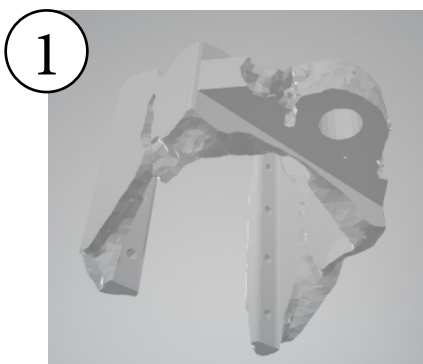

Finite element stress analysis was conducted on a 3D model of the part using estimated in-service forces and topology was optimized.

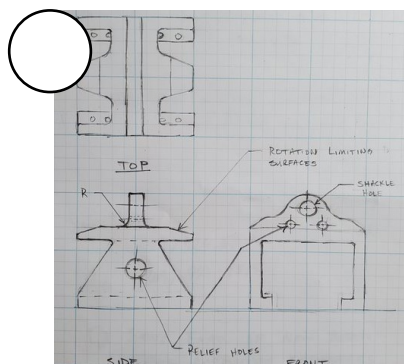

Inspired by the software-generated design, the log boom anchor was redesigned by hand to produce a more symmetrical part.

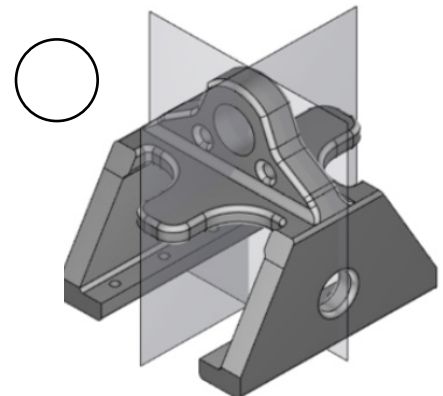

The design was then modelled in 3D and converted to a file type compatible with 3D printers.

4



The additively manufactured log boom anchor was printed via a powder bed fusion process using an aluminum alloy. Delrin rails and a steel eyelet were added to fully ready the part for field installation.

Featured Faces:



Stephanie Prochaska is a Materials Engineer at Reclamation for the past 4 years. She holds a B.S. in Materials Science & Engineering, an M.S. in Petroleum Engineering from the University of Utah, and an M.S. in Innovation Management from Brown University. Stephanie is currently pursuing a PhD in Materials Science at the Colorado School of Mines where her research focus is on corrosion mechanisms of additively manufactured parts. At Reclamation, she performs field inspections of protective coatings and researches protective coatings, electrochemical impedance spectroscopy, and additive manufacturing. Stephanie has helped to develop the technique of performing field EIS which provides quantitative data on coating health.



Matthew Jermyn is a Materials Engineer for Reclamation's Materials and Corrosion Laboratory. Matthew received his B.S. in Metallurgy and Materials Engineering from Colorado School of Mines and came to Reclamation from industry in 2019. Matthew's work and research at Reclamation focuses on corrosion prevention using cathodic protection and coatings. He has provided field inspections of both coatings and cathodic protection systems, furthered inspection procedures, conducted laboratory analysis on coating and additively manufactured samples, and coordinated the installation of a prestressed concrete cylinder pipe display on the Denver Federal Center.

- Ground Survey Points
- Ground Survey 10ft
- UAS Survey 10ft

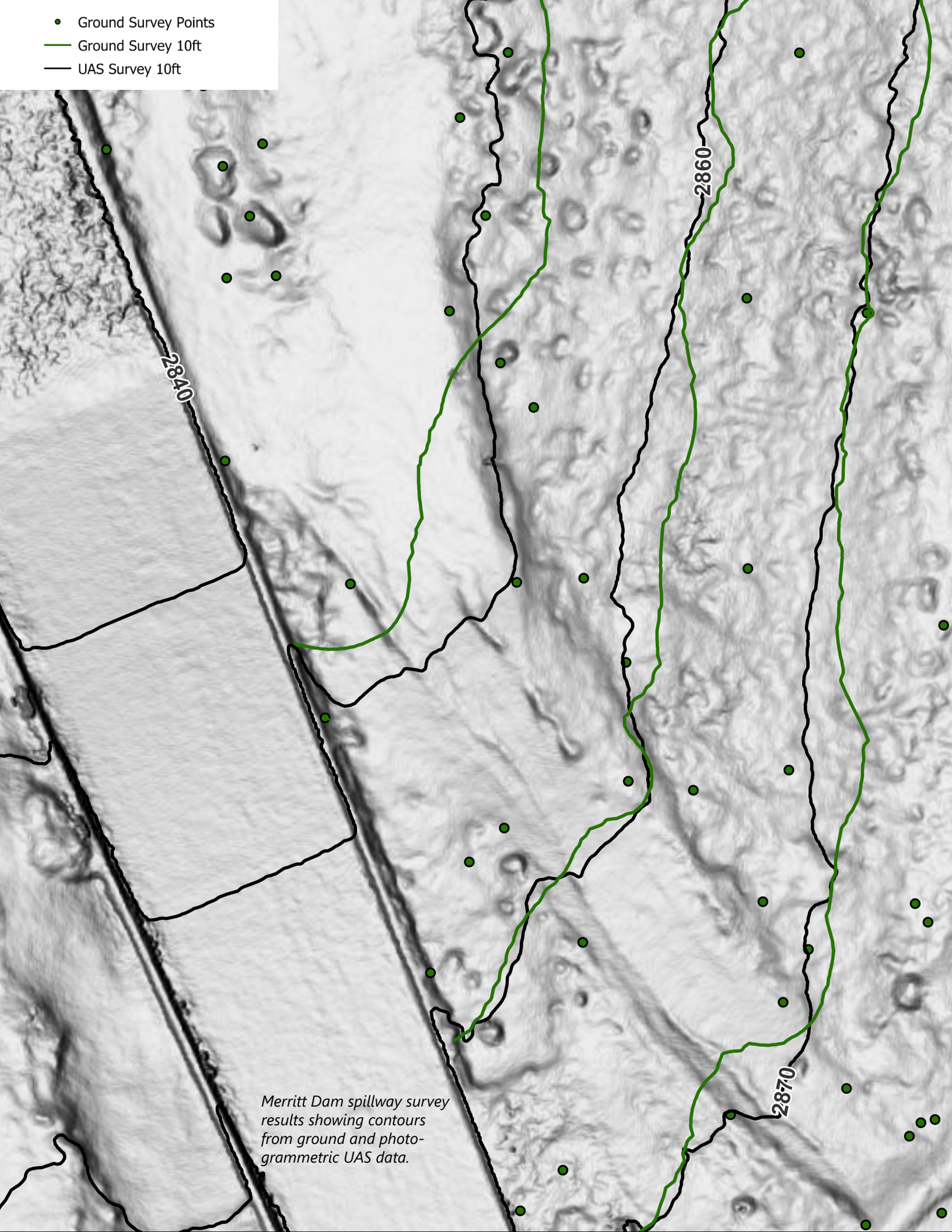

Merritt Dam spillway survey results showing contours from ground and photogrammetric UAS data.