



KONGSBERG

# General Catalogue

Fishery Products

**SIMRAD**  
By KONGSBERG

Kongsberg Discovery

# Protecting people and planet





Kongsberg Discovery has a long history of providing products, systems, and solutions for commercial and non-commercial customers in the broader Ocean Space, encompassing subsea, offshore, merchant, fishery, naval, onshore and space applications. We are constantly working alongside industry, authorities, institutes, and other key stakeholders to understand the evolving nature of their requirements and needs. With decades of in-house competence and experience, we are a trusted technology partner for our customers.

Our strong technology backbone within hydroacoustics, robotics, inertial navigation, positioning, laser, radar, and communication, blended with deep application know-how and software gives us the insights and drive to develop new products and solutions for our customers to excel and positioning them for a sustainable tomorrow.

Pairing our hardware design and sensor knowledge with intelligent software yields unmatched solutions for multiple areas. The joy of creating is in Kongsberg Discovery's DNA.





# Contents

## **04** SIMRAD

05 Innovation

06 History

## **08** Fishfinder Transducers

10 Transducers

12 Trigger Unit

14 BR90 FishNet

## **16** Sonars

18 MKII

19 ST90 MKII

20 SU90 MKII

21 SX90 MKII

22 MF90

23 SY50

24 SN90

25 SN50

26 Specifications

## **32** Echosounders

34 EQ50

36 ES80

38 CP60

39 Specifications

## **42** Gear Monitoring

44 PX Family

46 TV80

47 miniCatch

47 FS70

48 FX system

50 FM90i

52 Specifications

## **58** Support

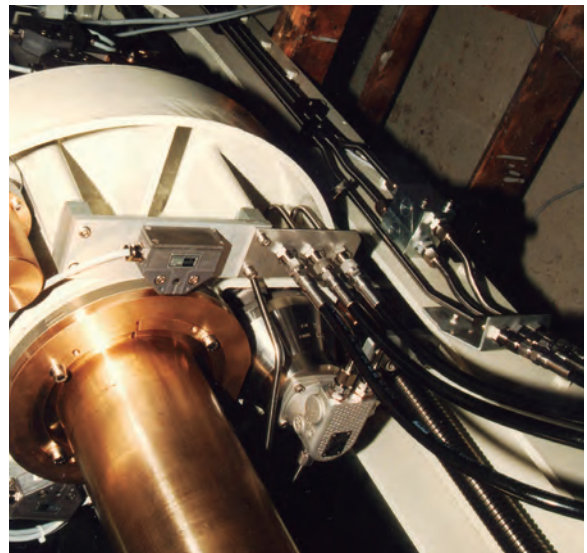
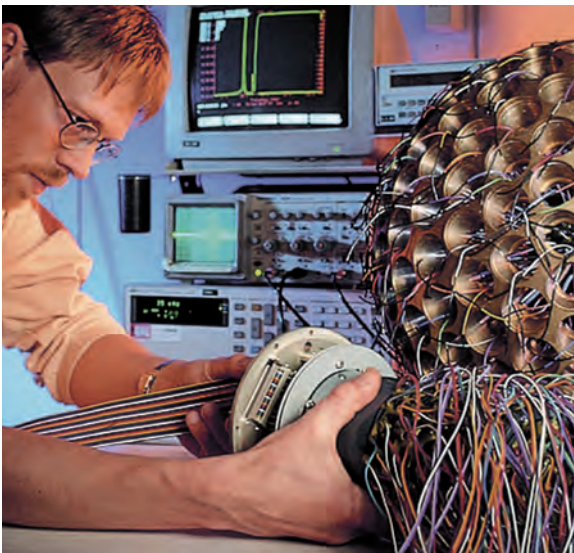

# SIMRAD

## More than 75 years of innovation

SIMRAD's slogan is "Technology for sustainable fisheries" and we live by this slogan every day. SIMRAD believes that a sustainable fishery worldwide is the only right way to survive. By sustainable we mean a healthy take out of the world fish stocks as well as an efficient and profitable fishery for the fisherman. SIMRAD believes that technology is an important factor to achieve this. Products that we believe have contributed to a sustainable fishery are Echosounders with a split beam technology: this makes it possible to catch the right size fish. Gear Monitoring instruments: this will reduce the impact of a trawl on the fauna, catch the right fish at the right time for better quality, catch the right species and disregard by-catch before it is taken to the surface. These and many more reasons will help obtain a sustainable and profitable fisheries in many years to come.

Efficiency and profitability mean sustainable fishery. SIMRAD believes that an efficient fishing vessel will save the environment in many ways. One is saving fuel and therefore the CO<sub>2</sub> emission is reduced since the vessel spends less time on the sea. Efficiency is key to become profitable, however, other factors are also important. Catching the right size of fish, for example, will give the fisherman a better price and ensure that they are not catching small non-reproductive fish, cutting off the lifeline to the future. The right species is another important factor. To be able to see what species of fish enters your trawl and to be able to guide not wanted fish out will save the environment. To be able to make an early decision of what school to catch will save the environment as the vessel will not travel more than strictly needed. All this is possible by using technology made by SIMRAD, and we will not stop here. Our goal is to always improve, in performance as well as with groundbreaking technology.



The SIMRAD brand name is owned by the Kongsberg Group, a Norwegian technology company. The Kongsberg Group has a strong position in the maritime sector through its company Kongsberg Discovery (KD), where the SIMRAD brand name is sold from. KD manufactures products like MRUs (Motion Reference Units), high accuracy surface and underwater positioning systems, multi and single beam echosounders, sonars, autonomous underwater vehicles (AUVs) and uncrewed surface vessels (USVs), as well as all the SIMRAD products.

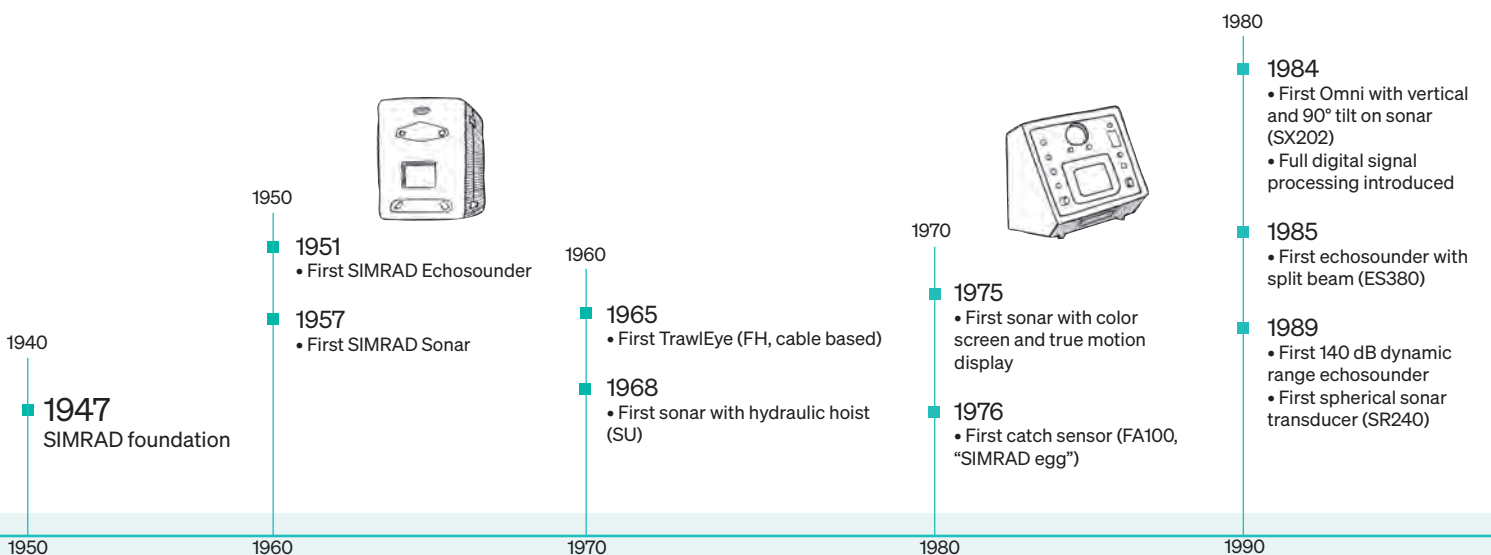



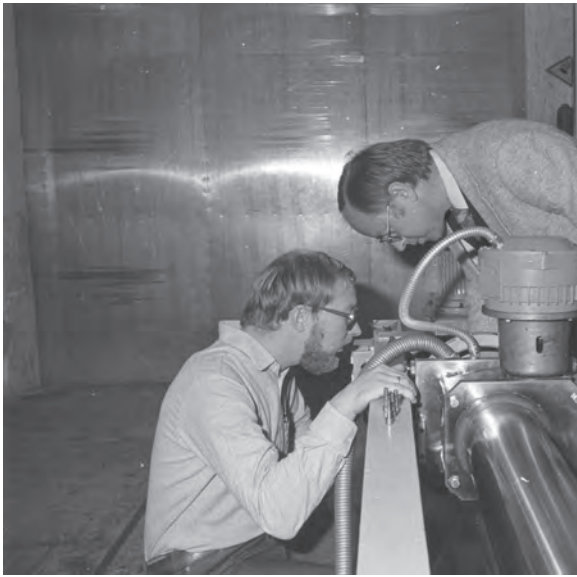

## History

SIMRAD was founded in 1947 by Mr. Willy Simonsen. The name SIMRAD derives from "SIMonsen RADio" and, as the name indicates, it all started with radios. But this shortly developed into echosounders and sonars. Today, SIMRAD is recognised all over the world for premium performance products, manufacturing sonars, echosounders and Gear Monitoring equipment.

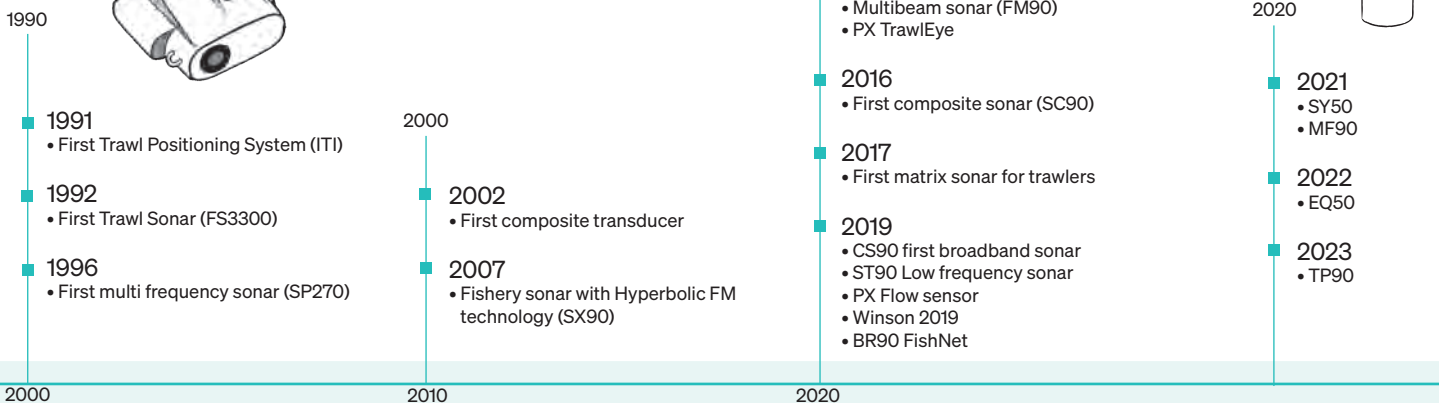

## Fishfinder transducers

SIMRAD is one of the very few producers of transducers. The transducer is an important part of an echosounder's performance. A transducer is the combination of a microphone and a loudspeaker, all in one. The transducer is converting electrical energy into sound waves and vice versa. What you see on the echosounder screen is actually echoes from transmitted sound.

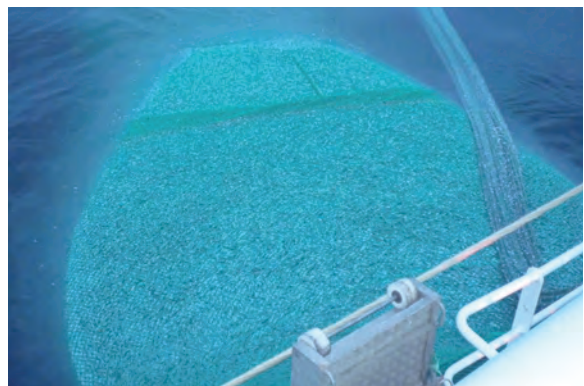

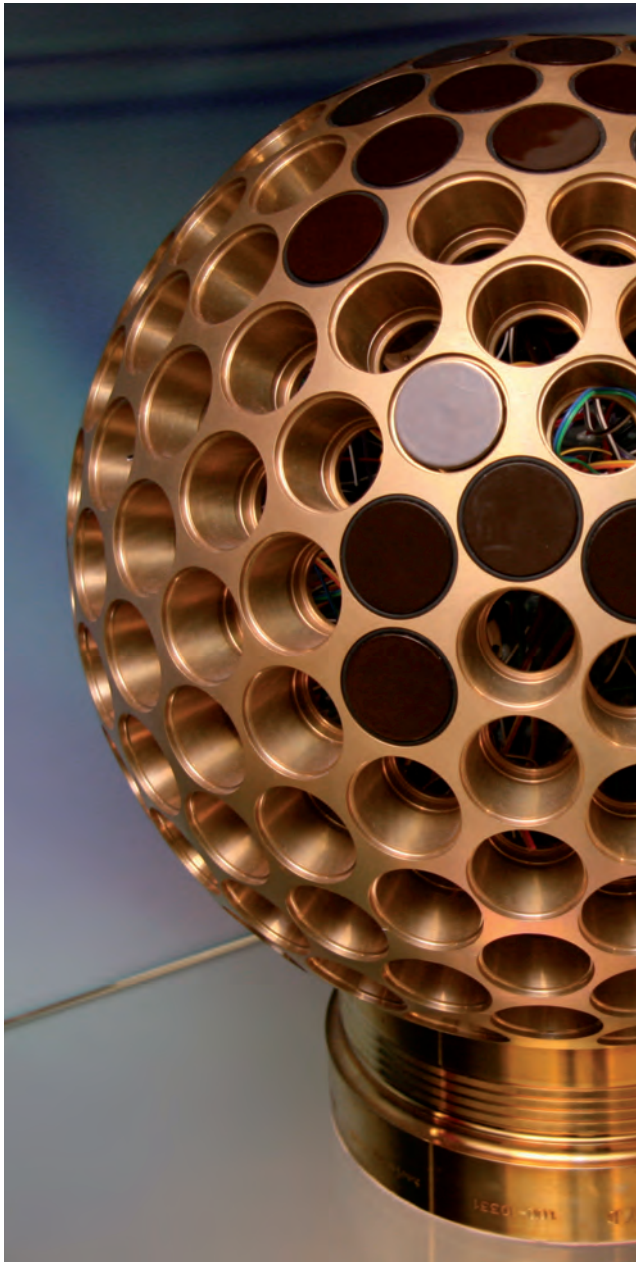

## From electricity to sound

The transducers' ability to convert electrical energy into sound depends on how it is built. The better it converts, the better the transducer is (and the echosounder performs better). There are several ways to make a transducer with different materials that can be used. Today, ceramics is the best material to use, seen from a performance view. Other materials such as nickel or ferrite have a lower price but will not convert electrical energy as efficient as the more costly ceramic material. Also, the way the material has been used in the production also matters to the final performance. The latest on the scene is to produce the transducers by using a "composite" technology. The advantages are that the transducer has an efficiency of up to 75 %, meaning if you put 1000 w into the transducer 750 w comes out into the water. The same conversion is valid when the signal comes back and it is vital for detection of weak targets even when using low powered transceivers.

Also, the transducer needs to be designed in such a way that it will not ring when not wanted to. Like a church bell continues to ring after one beat, the transducer needs to shut off immediately after one ping in order not to disturb the next ping. SIMRAD's design and choice of material ensures a ring free transducer.



# Single beam, split beam and wideband transducers

SIMRAD makes a wide spectre of transducers and hydrophones to fit various echosounders frequencies and configurations. We can divide the transducers in three categories:

“We are at the forefront of performance through innovative design and a unique production technology.”

**KJELL GJESTAD**  
Value Chain Manager

## Single beam transducers

A single beam transducer will give you the normal information expected from an echosounder, like a school of fish, depth to bottom, separation of target from bottom, etc. It is still a must to have a high quality

transducer to get a good picture on the echosounder. SIMRAD has many single beam transducers and some have a dual frequency configuration, like 50/200 kHz or 38/200 kHz.

Single beam transducers					
Model	Part number	Frequency	Power	Opening angle	Material
38-7	KSV-082776	38 kHz	2 kW	7°	Ceramic
38-9	KSV-203635	38 kHz	1,5 kW	9°	Ceramic
50-7	KSV-203635	50 kHz	1 kW	7°	Ceramic
120-25-E	KSV062615	120 kHz	1 kW	10°	Ceramic
COMBI-D	KSV-203004	38/200 kHz	1 kW	13° x 21° and 7° x 7°	Ceramic
COMBI-D	KSV-203005	50/200 kHz	1 kW	10° x 16° and 7° x 7°	Ceramic
COMBI-C	KSV-202192	38/200 kHz	1 kW	13° x 21° and 7° x 7°	Ceramic
COMBI-C	KSV-202193	50/200 kHz	1 kW	10° x 16° and 7° x 7°	Ceramic
COMBI-W	KSV-208845	38/200 kHz	1 kW	31° x 31° and 31° x 31°	Ceramic/composite
COMBI SPLIT	398445/424437	200 kHz	500 W	18° x 18°	Composite

## Split beam transducers

A split beam transducer is made to send out one beam and receive in three or four. The return echo is then analysed and it enables the user to see the size of the fish before catching it.

SIMRAD commercialised this technology in 1984 with its ES380 echosounder. Today, the ES80 has become the benchmark for split beam echosounders.

Split beam transducers					
Model	Part number	Frequency	Power	Opening angle	Material
ES18	KSV-088694	18 kHz	2 kW	11°	Ceramic
ES38-10	KSV-202714	38 kHz	1,5 kW	10°	Ceramic
ES38B	KSV-074531	38 kHz	4 kW	7°	Ceramic
ES70-11	KSV-110280	70 kHz	1 kW	11°	Ceramic
ES70-7C	KSV-203678	70 kHz	1 kW	7°	Composite
ES120-7C	KSV-204580	120 kHz	1 kW	7°	Composite
ES200-7C	KSV-203003	200 kHz	1 kW	7°	Composite
COMBI SPLIT	398445/424437	38 kHz	500 W	18° x 18°	Ceramic

**Wideband transducers**

A wideband transducer is a transducer that can transmit on a wide frequency range, for example 50-110 kHz, 100-160 kHz or 160-300 kHz. This means you only need 3 transducers under your vessel to cover a frequency range of 50-300 kHz. To make a transducer that is capable of doing this, composite technology is the best suited material to use. All SIMRAD wideband transducers are produced with composite material.

With the SIMRAD wideband transducers, it is possible to make sweep transmissions (sending out starting at a low frequency and go up), chirp transmissions (FM transmission where the echosounder transmits a signature of several frequencies) and also just sending on several discrete frequencies, one at the time. This opens up a whole new world in interpretation of the echo. Maybe in the future, we will be able to have a species identification echosounder...

Wideband transducers					
Model	Part number	Frequency	Power	Opening angle	Material
ES70-7C	KSV-203678	60/80 kHz	1 kW	7°	Composite
ES120-7C	KSV-204580	100/140 kHz	1 kW	7°	Composite
ES200-7C	KSV-203003	160/220 kHz	1 kW	7°	Composite
C-ALL	435953	35/42 kHz 60/80 kHz 100/140 kHz 160/220 kHz	250 W 250 W 250 W 250 W	18°	Tonpiltz/composite

It is possible to combine a wideband transducer with a single beam or split beam transducer.

the latest theories of sound propagation in water as well as the latest materials and production methods. Our factory uses modern robots with the latest cutting edge technology for optimum results. The factory has been on a constant improvement programme in order to follow the development in this new production technology.

SIMRAD is one of even fewer making wideband transducers using the composite technology. At the SIMRAD's factory, transducers are designed using only the best skills in hydroacoustics available using

**Did you know...?**

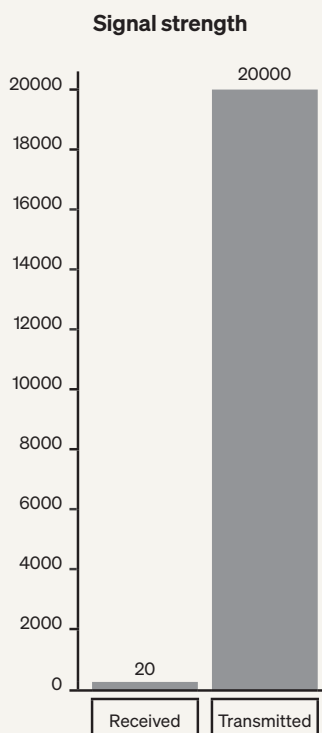

The signal returned by a 10 cm length sardine is around 10,000 times smaller than the transmitted by the echosounder. This relationship between signal strength is not easily understandable unless we use a logarithmic scale.

The decibel is the logarithmic unit used to illustrate the relationship between two signals.

$$\text{Relation in dB} = 10 \log (TS1 / TS2)$$

In the case of the 10 cm sardine, the target signal strength would be:

$$\text{Target strength} = 10 \log (20/20,000) = -40 \text{ dB}$$

In our echosounders the colour changes every 3 dB step. An increase of 3 dB in the target strength means that the signal received is double the strength.



A 0 dB target strength means that the target returns back all the received energy

## Acoustic Synchronisation Unit **TU40**

The key to achieve a sustainable fishery is the ability to perform a preliminary evaluation of the fish schools. The best way to evaluate those fish schools is by the use of acoustic equipment, like echosounders and sonars.

The new generation fishing vessels have more and more acoustic equipment working simultaneously to have as much information as possible to take the right decision.

Imagine all those equipment transmitting pulses in various frequencies, with various strengths and pulse durations. In case that these acoustic waves were visible, we would see something similar to the waves in the water when we threw, at the same time, several stones, with different sizes and shapes: an acoustic chaos.

Most of the acoustic equipment has interference reject abilities, this filters removes from the screen the transmission pulses from other systems. However, those pulses are so strong that it is impossible to “see” anything else at the same time.

There is only one good way to avoid this interference, synchronising all the transmission pulses. By doing that, all the equipment will transmit at the same time, eliminating the annoying interference between them.

Apart from that, not all the equipment has the same

transmission rate, some are transmitting very fast, others very slow. Having only one equipment as master and the rest, as slaves, will not work fine.

The acoustic synchronisation is an issue that Kongsberg/SIMRAD fixed a long time ago in the research vessels, where the acoustic equipment is the main scientific tool. Nothing should disturb the received echoes or the researchers will have unusable data. The solution is a scientific synchronisation unit named K-Sync, which deals with all the acoustic systems onboard, synchronising them in groups by the transmission rate.

SIMRAD experience in this subject is unbeatable, but the K-Sync is too powerful for a fishing vessel. That is the reason why SIMRAD developed a similar concept for the fishing vessels, the Trigger Unit TU40, oriented to synchronise the acoustic equipment on fishing vessels.

The TU40 has twelve independent channels. All the channels are isolated and the unit is compatible with most of the commercial acoustic equipment, not only with SIMRAD equipment.

In the picture on the next page, we can see the ES80 echogram from a tuna purse seiner, where at the same time they are operating; five echosounders, three omnidirectional sonars, one seine sonar and one current profiler.

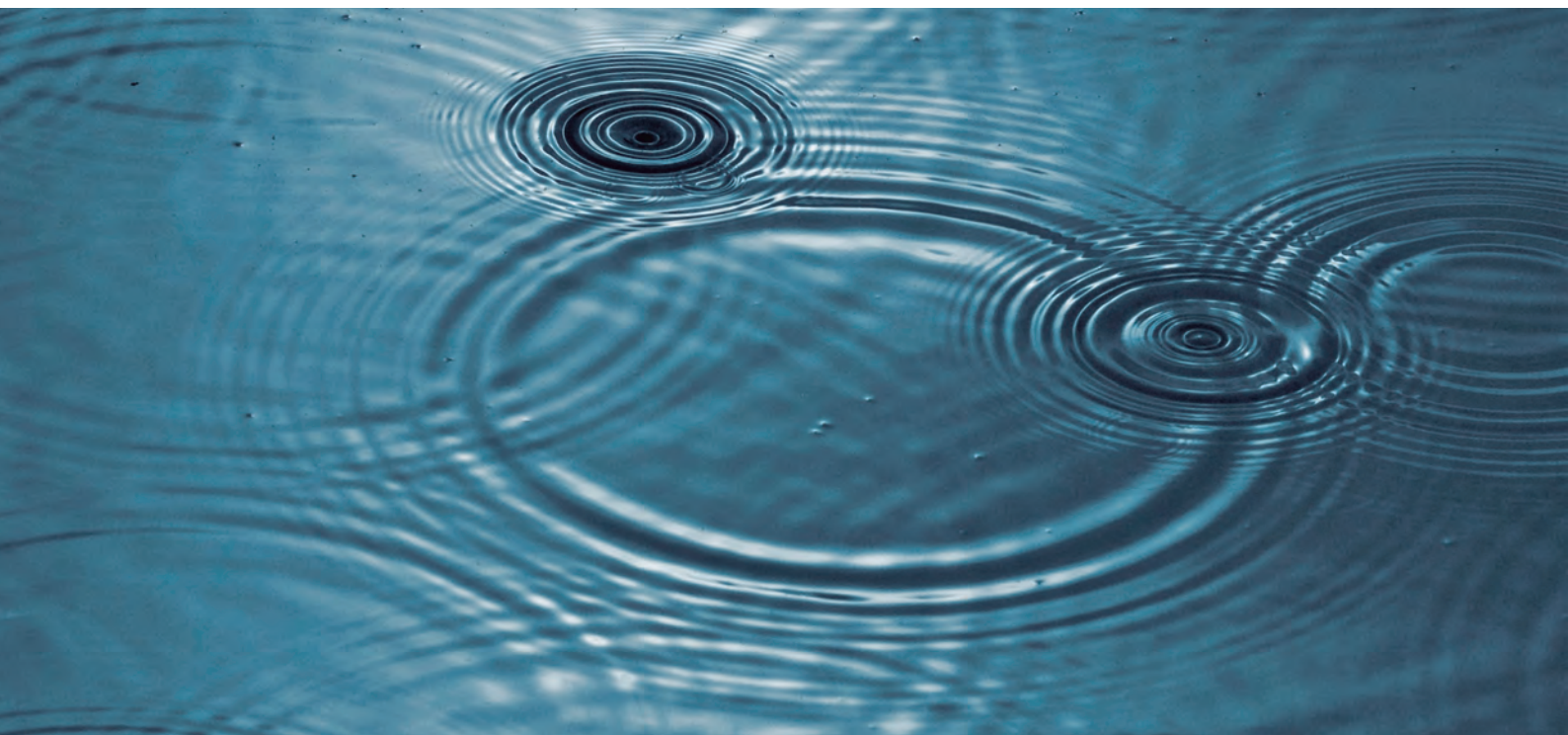

## Silence, please!

The TU40 consists of two main components:

- TU40 top side software application (typically run from existing computer onboard).
- TU40 synchronising (Trigger) Unit that interfaces with the acoustic systems.

The TU40 application provides the user interface,

which allows monitoring of status, modifying settings, trigger schedule as well as performing diagnostics. The Trigger Unit does not need the software application running. Once configured, the TU40 will work in the background, organising the trigger sequence automatically, with an intelligent algorithm assuring the fastest ping rate for each equipment.

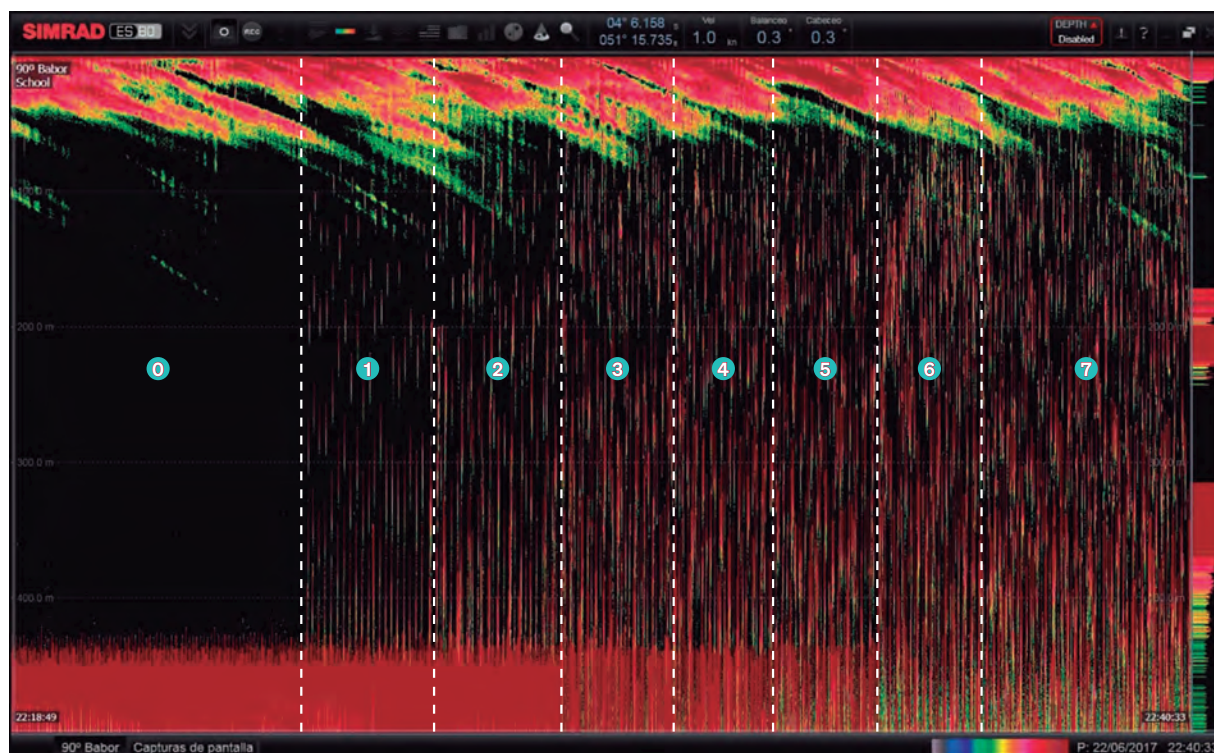

**0**

The TU40 synchronises all the equipment. The echogram is clean and the skipper will be able to identify small fish targets.

**1 2**

Two echosounders are running free. We can see short, but strong pulses interfering. With two more echosounders not synchronised, as we can see in section nº 2, the number of short pulses increases.

**3 to 6**

The TU40 synchronisation is disabled in the four sonars. The interference pulses are longer and stronger, now the echogram is full of noise, making it very difficult to see any fish target.

**7**

All the acoustic equipment onboard is running free. The echogram is a chaos of interference and the echosounder is nearly useless, if we want to evaluate the fish underneath the vessel.

When you compare the sections 0 and 7, the benefits of using the TU40 are clear despite the range, the transmission frequency and the pulse length selected in each acoustic equipment onboard.

With a unique technological backbone and in-house competence, Kongsberg Discovery serves several markets with cutting-edge solutions. Our joy in creating

solutions to protect the people and planet, yields unmatched products for sustainable management of marine life, based on our core technological backbone.

## Motion Reference Unit (MRU)

The MRU S model is typically used for real-time roll, pitch and heave compensation of fishery sonars and echosounders. In rough weather conditions, the MRU S provides vessel motion data to the fish finding equipment to present a display free from wave motion due to vessel rolling, pitching and heaving.

### Features:

- 0,3° roll and pitch accuracy
- Outputs real-time roll, pitch and heave measurements

- Outputs on RS-232, RS-422 and Ethernet
- High output data rate (200 Hz)
- Lever arm compensation to two individually configurable monitoring points
- Small size, light weight and low power consumption
- Each MRU delivered with Calibration Certificate
- Selectable communication protocols in the Windows based MRU configuration software
- Export licence not required
- 2-year warranty

## BR90 FishNet, maritime broadband radio

The FishNet solution is designed for use in fishery applications where digital high-speed reliable communication and data transfer is crucial for efficient and safe operations. Completely enclosed with integrated antennas, the FishNet is designed for installations on small manned and unmanned vessels.

### FishNet - pair trawling

FishNet connects both vessels to transfer real time data from echosounder, sonar, trawl instrumentation and even cameras. This will give each skipper an overview of the other vessel detections or fishing gear telemetry. Remote operation is possible too, so the skipper of vessel A can change settings on vessel B equipment and vice versa.

### FishNet - purse seining

FishNet connects the mother vessel with the skiff, where an echosounder transceiver, with or without screen and operating panel could be installed. The skipper from the mother vessel will then be able to see the fish detection underneath the skiff in his echosounder screen, as if there was, another transducer more of the system onboard. The skiff could be moved on top of the fish school without any risk of losing the catch.

### Motion Gyro Compass (MGC)

Type approved compass for ships and high-speed crafts. The MGC R1 COMPASS system is an IMO type

approved as a gyro compass for navigation purposes and to use together with a heading and bearing repeater. Very high reliability is achieved by using Ring Laser Gyros with no rotational or mechanical wear-out parts.

The MGC R1 can be operated as an inertial navigation system as well as a gyro compass with output of position and heading. Linear position and velocity measurements can then be output in up to four different points on the vessel.

It is delivered with configuration software. In the software, the user selects output formats on the different communication lines in addition to other configuration purposes.

### Features:

- 0,2° heading accuracy GNSS aided
- 0,05° roll and pitch accuracy (Subject to license)
- No rotational or mechanical wear-out parts
- Outputs on RS-422 and Ethernet
- High output data rate (200 Hz)
- Small size, light weight and low power consumption
- IMO type approved
- Each MGC delivered with Calibration Certificate
- Selectable communication protocols in the configuration software



### Seanav 300

The SeaPos 300 series of GPS navigation sensors is designed to be fully integrated with other navigation systems. This means that these models are per default delivered without external display for configuration and operation. All operations and functionality are typically handled from the ECDIS in an integrated bridge system.

The SeaPos 300 sensors are hence type approved with ECDIS from different manufacturers and brands, in order to avoid installing a redundant display/keyboard. One important principle of e-navigation is to reduce the number of displays on the bridge. The navigator needs to have important information easily available in order to reduce response time for decisions. Better integration will lead to a better bridge environment as well as a simpler installation.

### Scientific equipment

Kongsberg Discovery is a principal manufacturer of scientific echosounder systems for underwater science and fishery research organisations all over the world. Close to 80 % of all biomass quotas are salt water and they are set based on technology from Kongsberg Discovery.

The EK80 scientific echosounder systems provide high-quality target strength, target position, and volume backscattering strength measurements over a large dynamic range for a wide range of frequencies.

The EK80 Family comprises transceivers, transducers, EK80 software, and planning tools for all types of marine excavations using echosounders.

### Kongsberg Maritime – ship design

The NVC-series of vessels for fishery and aquaculture are recognised by their excellent performance and seakeeping characteristics. We use our hydrodynamic expertise to optimise hull for high speed and low fuel consumption. Kongsberg lays great emphasis on interaction between the propulsion system and the hull to provide the best pulling capacity possible and, at the same time, low underwater radiated noise signatures – all to ensure an efficient catcher.

- Stern trawler design
- Pelagic vessel designs
- Longliner design

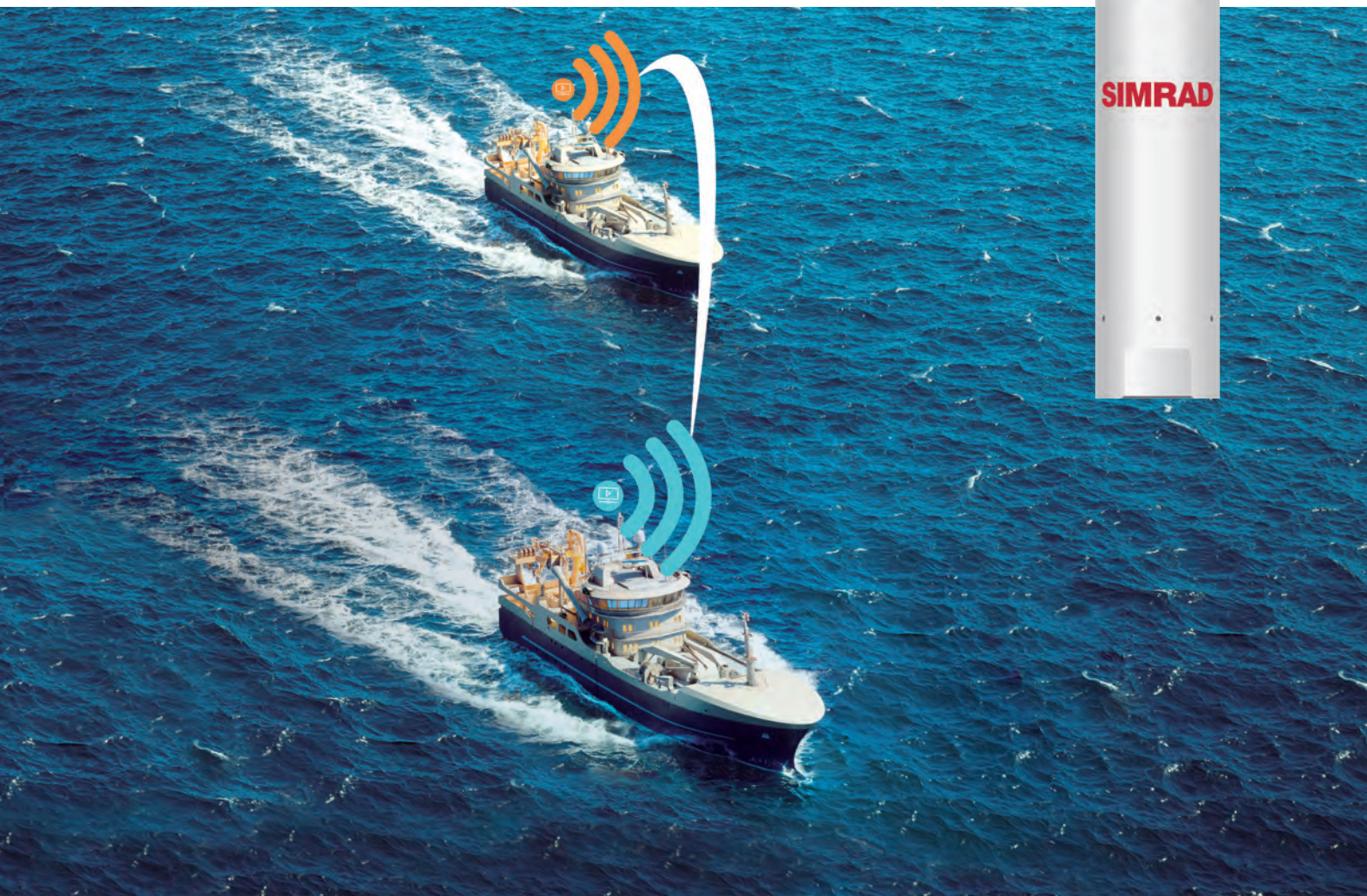



# Sonars

**Still setting the standards!**

The first sonar introduced to the commercial fishing fleet was in 1952. The first vessel was a Norwegian fishing vessel called "Ramoen". This was the world's first sonar for the commercial fishing fleet. Soon after, SIMRAD made the "Basdic", where the operator manually directed the transducer in all directions. More than 5000 units of the "Basdic" sonar were sold.

Since then, SIMRAD has been first with a number of revolutionary features, such as going from paper sonar to CRT, from black&white to color, from CRT to LCD, vertical view, spherical transducer, etc. Today, the sonar family has grown to include 6 different sonars: low frequency sonars (SU90, SX90, ST90) and high frequency sonars (SC90, CS90) and the revolutionary matrix SN90 Seine sonar and SN90 Trawl sonar.



“Our vision is to give the fisherman what he needs to remain sustainable and efficient. Our sonars will always be using the latest in technology to achieve this.”

**MARTIN TOLLEFSEN**

Product Manager  
Sonars

## MKII

### The latest generation of transceiver technology

In search for optimum sustainability and efficiency and to give the operator the best possible tool to make a decision optimised for the environment and quality of the catch.

The whole sonar range has been upgraded with the latest technology in components and signal processing, maximising the full potential of the state-of-the-art transducers connected to the sonars. All sonars with the “MKII” transceiver will benefit from

higher source level (more power), better discrimination and better signal-to-noise ratio. The MKII transceiver is based on the recent success of the MF90 sonar where noise suppression has been the main focus. Enabling the MKII transceiver on the low frequency platforms opened up for higher source level (especially on the lowest frequencies like for the ST90) as well as enabling the high discrimination on short range or difficult conditions with hard bottom or choppy surface.

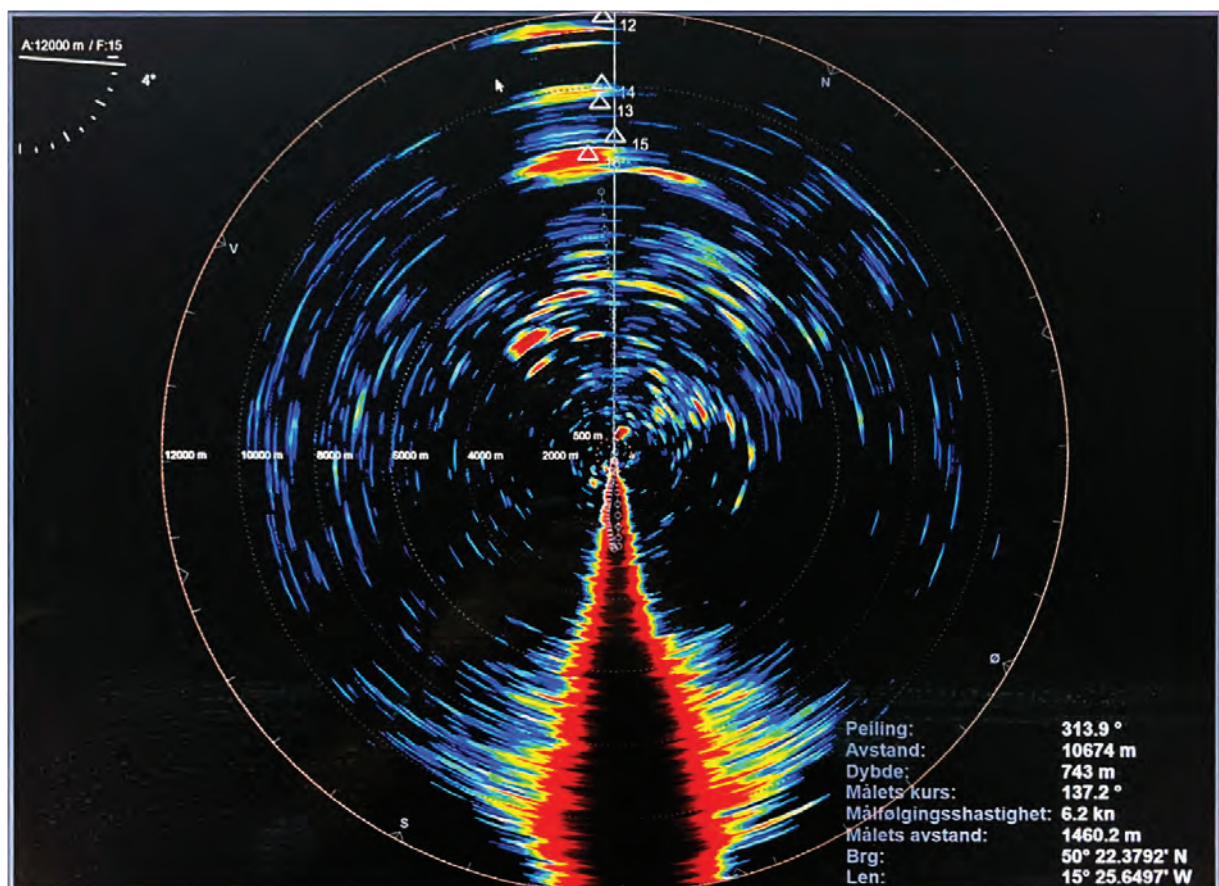

The picture above shows Blue Whiting at 12 000 m range. This proves the power of the ST90's performance in real life.

**Stay ahead, upgrade now!**

## SIMRAD ST90 MKII

### Range definition

SIMRAD is continuously developing the sonar range by utilising the latest in technology combined with over 75 years of experience. The low frequency sonar, ST90 MKII is our sonar which transmits at the lowest frequency. With the ST90 we have lowered this frequency range to 14-22 kHz.

The ST90 is made to search at very long ranges in all conditions. Whether it is heavy weather, hard bottom, open waters, weak targets, it all will be handled by the ST90 due to the fully stabilised and very narrow beams combined with state of the art signal processing. The ST90 will also feature the powerful Winson sonar operating SW with all the benefits described below.



## Winson sonar operating software

The current operating software in SIMRAD sonars has been a tremendous success with its intuitive and easy to use interface. The Winson is used through the full product ranges making an echosounder as easy to use as a sonar. Great new features are also a part of this upgrade.

### Optimised for multiple displays

The “docking” function enables the user to take any window and place it on a separate screen or display. If you move the vertical view to another display, it will automatically scale the window for best viewing of long range in shallow water for example.

### “All in one ping”

Modern sonars today use multiple pings to generate the various views. For example, one for the omni 360° view and maybe two different vertical view are three

pings, now all three will be transmitted and received in one ping. This dramatically improves the update rate on the screens giving a more real-time information.

### Recording

The Winson has several real-time recording functions. Screenshots, screen video and raw data can be recorded to the hard drive or external storage media. Before, only screen captures were recorded. Now the real echoes are recorded, making it possible to replay sequences like in real life. During playback, vital information can be viewed for training and/or troubleshooting purposes.

### Tracker function

The tracker function has been further developed and can now utilise information from both the horizontal and vertical ping.

## SIMRAD SU90 MKII sonar

The SU90 sonar is made with no compromises. The number of channels has been increased by 50 % compared to the SX90 sonar giving the sonar an even better performance in selectivity and range. Its operational frequency is 20 to 30 kHz. The narrow opening angle (4,9° at 30 kHz) and the increased source level (3 dB) makes the SU90 a very powerful and high resolution low frequency sonar.

The narrow beam makes the SU90 even more ideal for searching fish close to the bottom or close to the surface at long ranges. It will also give a far better vertical view with less “bottom climbing” than is seen on sonars with a wider beam. The SU90 is equipped with the celebrated signal processing seen on the SX90 such as Hyperbolic FM transmission giving the user, a clutter-free picture with very high resolution in range.

The higher source level (3 dB higher than SX90) will increase the detection range and enhance the detected echoes in general. It is almost impossible to calculate how much longer a range is, as temperature layers, salinity, bottom hardness, target strength and sea conditions will never be the same for a good comparison. However, the sonar will have a longer range than the SX90.



### Multi frequency 20 to 30 kHz!

Fishing in the same area as others can be a challenge as other vessels might have sonars transmitting on the same, or close to the frequency you are using. With the SIMRAD multi frequency, you are able to tune your sonar for maximum performance and avoid interference from other vessels. With 11 different frequencies with 1 kHz separation, interference is no longer a problem.

Only a wideband transducer can be used to be able to transmit and receive at such a widespread band of frequencies. SIMRAD designs and produces our own transducers for this purpose.

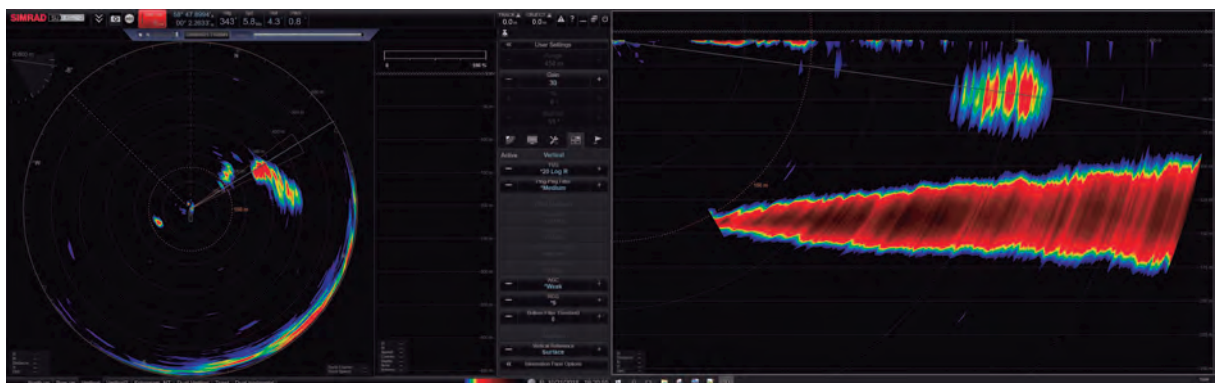

*When connecting two displays, any sonar presentation can be placed on any of the two. In the above example, the vertical view has been placed on the display to the right. Notice that the scaling is different in horizontal and vertical plane. This makes the vertical slice useful when fishing in shallow water at long range.*

## SIMRAD SX90 MKII

### The cost-effective workhorse

The SX90 is a low frequency, high definition, long range sonar that utilises the latest high-end computer to process data from the transducer. The SX90 is specially designed for vessels where high resolution combined with long range is needed. With the state-of-the-art processor, there are several unique possibilities for advanced signal processing. Three different vertical beam widths, single or dual vertical view and 180° tiltable vertical view are available. At 30 kHz operating frequency, the vertical beam width is only 7,1°.

The SIMRAD SX90 sonar offers unique features such as full circle beam stabilisation for easier fish detection in poor weather conditions and 11 different sonar operating frequencies with 1 kHz separation to avoid interference from other sonars. The long range and higher definition of the SX90 will improve your catching abilities and help you make better use of your time at sea. Great emphasis has been placed on giving the best possible overview in the search and catch situation. In addition, full screen echo presentation, resizeable windows, off centre, zoom and dual operation are standard functions on all sonar models. You can evaluate one school while tracking two other targets, giving you full control of schools and net from detection to catch.



## Mackerel

School of mackerel detected at 40° starboard and marked as “6”. Sonar is operated in “Bow Up” mode with “Full Screen”. Range is 2000 meter and tilt is set at 5°. Range to school is 1952 meter and depth is indicated to be 93 fathoms saying that the Mackerel school is on the bottom. Echoes between the mackerel and the vessel are wake from pair trawlers coming towards the vessel.

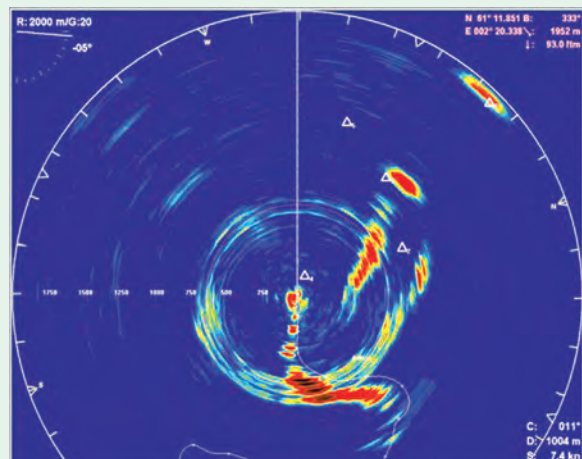

## SIMRAD MF90

### Medium frequency catch sonar

The MF90 is the latest addition to medium frequency SIMRAD Omni sonars.

The composite transducer makes it possible to transmit and receive in a wide range of frequencies, in fact 75-85 kHz! This makes it possible to achieve high resolution on longer ranges as well as tuning the frequency for better detection or avoiding a noisy source such as another echosounder or any other acoustic source. The MF90 also has the latest Winson SW, enabling the user to view the various windows

on separate displays using the new docking feature. Another great feature with the new SW is that it will ping all beams at the same time reducing the ping rate and increasing the update rate on the screen dramatically.

The composite transducer is more complicated to produce than traditional transducers with large investments in the production line. Today, SIMRAD has one of the most sophisticated transducer production lines and design departments in the industry.

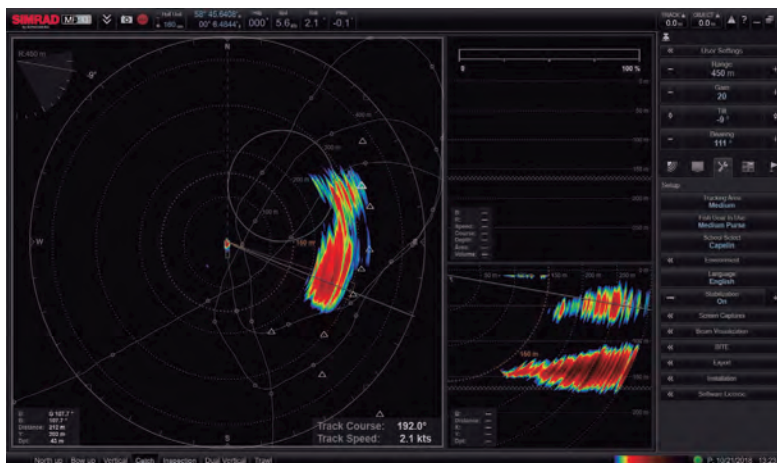

The MF90 is a broadband sonar capable of transmitting between 75 and 85 kHz. It features the new operating SW and is optimised for the new joystick Operating Panel. This makes the MF90 very efficient to use during purse seine operations when a lot of equipment must be operated at the same time.

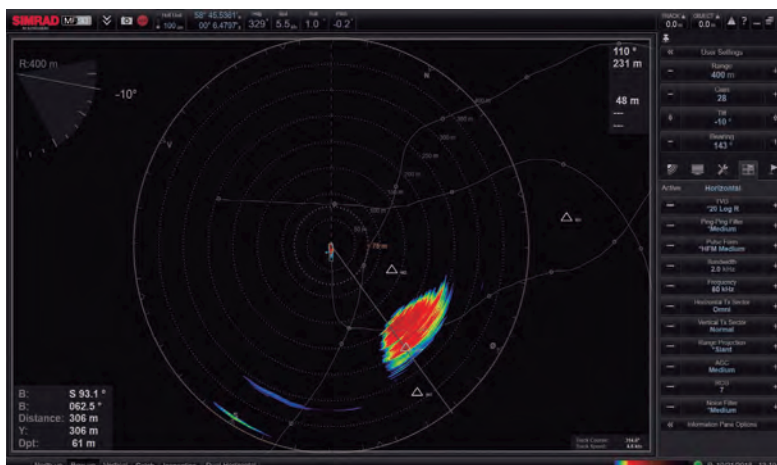

Notice the bandwidth here is 2 kHz with a center frequency of 80 kHz. This can be adjusted between 75-85 kHz.

The MF90 is an Omni broadband sonar with a composite transducer. Here is an example from Mackerel Fishery in the North Sea. The MF90 includes the new Winson 2019 operating SW which provides several benefits.



# SIMRAD SY50

## An affordable sonar with high-end features

### Features

The SIMRAD SY50 is the latest addition to the evergrowing SIMRAD Omni sonar family. Up until now, SIMRAD sonars have been targeting the larger commercial fishing vessels around the world.

We have taken the knowledge and technology from these sonars and made them into an affordable, compact and high performance sonar for the coastal fleet.

Unparalleled features like full beam stabilisation, “all in one ping”, vertical view, dual view and FM transmissions are now available for the smaller coastal vessels where the size of the sonar room can be an issue.

The sonar has no external transceiver cabinet as everything is incorporated inside the transducer. This means only Ethernet and power cables from the Hull Unit to the power supply, making the installation simple and fast.

### Easy installation

In order to ease the installation of the sonar even more, an interactive installation manual for the Hull Unit has been made available on all platforms: PC/

Windows, Mac/OS, iPad, Android tab, iPhone and Android phone. This manual has easy to follow step by step instructions.

The sonar fits into a standard 8” sonar trunk with a minimum length of 600 mm. The length of the transducer shaft can be purchased to fit the vessel’s characteristics. It comes in 4 different lengths.

If no suitable length is available, the shaft can be cut onsite. The centre operational frequency is 57 kHz, but you can select any operational frequency from 55 to 59 kHz in steps of 1 kHz. This can be used to avoid acoustic interference from other equipment or vessels.

The sonar can run on 24 VDC or 220 VAC depending on what is available on the vessel and the correct voltage must be specified when ordering.

### Options

When purchasing, the customer can select between two hoist length alternatives, 400 mm or 600 mm. If there is enough space in the sonar room, we recommend a 600 mm travel. You will then get the transducer as far away from the hull as possible, avoiding flow noise.

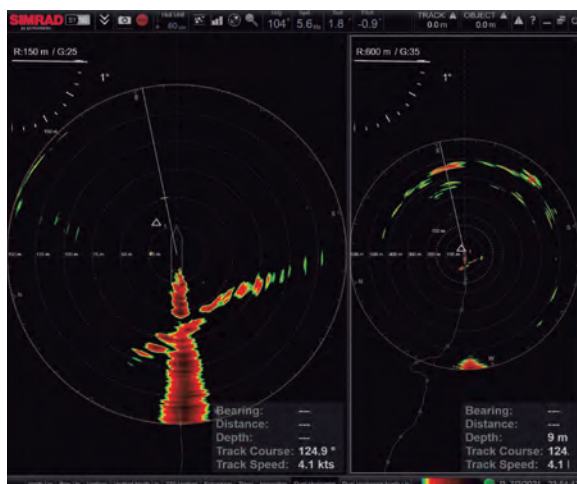

*In dual mode, it is like having two sonars in one. To the left the range is 200 m, to the right the range is 600 m. You can have different tilt, gain, frequency, etc. as well.*

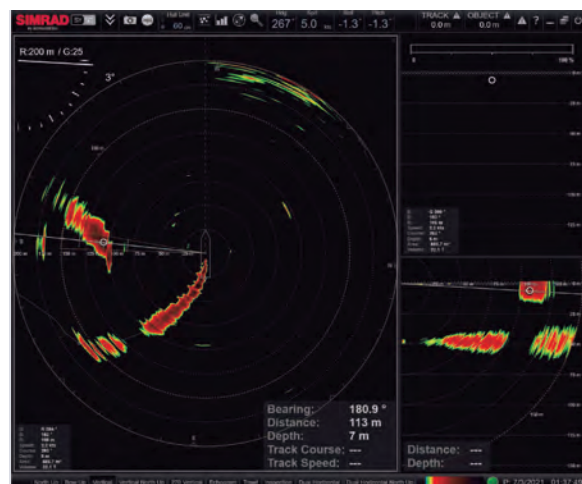

*The vertical mode will present the school in two dimensions, from above and as a slice through the school. The horizontal and vertical will ping at the same time, improving the picture update rate.*



## SIMRAD SN90

### The first matrix sonar in the market

The well-proven SN90 sonar has been unmatched for many years in the market. The SN90 transducer can be installed without a retractable Hull Unit to the side of the keel facing the purse seine or forward-looking, ideal for trawlers. The 256 individual elements allow for narrow beams in a 120° swath and the vertical beam width is typically 6° (varies with the frequency from 6° to 8°). The beams are tiltable from 0° down to 90°.

In addition to this, five steerable inspection beams of 6° x 6° can be used for more detailed inspection of a school like observing fish behaviour, target strength and biomass. This enables the purse seiners to run alongside a school of fish and observe, like a horizontal echosounder, and analyse the school without passing over it, minimising fish avoidance.

For pelagic or bottom trawlers, the SN90 can be used to determine fish species and size close to the bottom or surface, ensuring sustainable and profitable fishery.

The SN90 is mounted forward for pelagic and bottom trawlers. The uniqueness in the SN90 is its capability to detect fish close to the bottom and general extreme resolution. It can be compared with an echosounder pointing forward. All beams are transmitted and received in each ping, giving a fast update rate and are steerable in any direction within the swath.

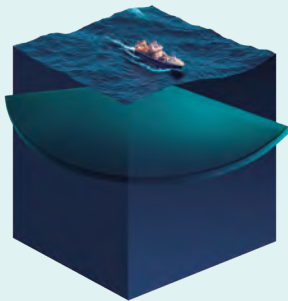

The SN90 has a 120° fan that is tiltable from 0° down to 90°. This will enable to see the purse seine during the whole setting of the net.

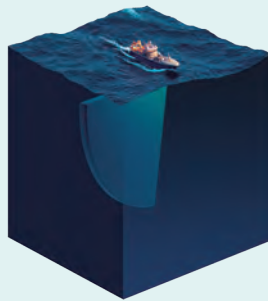

The SN90 has one vertical slice that can be trained in any direction within the fan. This will give full control of the edges of the school during setting of the net.

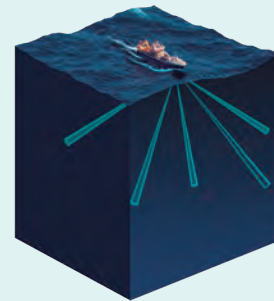

The SN90 has five individually steerable inspection beams that can be trained and tilted with any frequency between 75 and 95 kHz. The inspection beam will give a detailed high resolution echogram.

## SIMRAD SN50

### Taking matrix sonar to the next level!

The SN50 is based on the acclaimed SY50 technology, utilising optimum production technology and maintaining acoustic performance. The SN50 has no external transceiver, all is embedded in the transducer leaving only an Ethernet and power cable coming from the transducer. This enables easy installation and low noise operation of the sonar. A matrix sonar, as opposed to an Omni sonar, is a fixed, square transducer where the elements are placed in a matrix pattern. The advantage is a focused coverage area in the direction the transducer is installed. Facing straight down, it will act as a multibeam echosounder, facing horizontal to the side, as seine sonar looking into the purse seine and facing forward, it will act as a sonar for trawling or navigation.



*The SN50 transducer and transceiver, all in one. Only one cable containing Ethernet and power.*

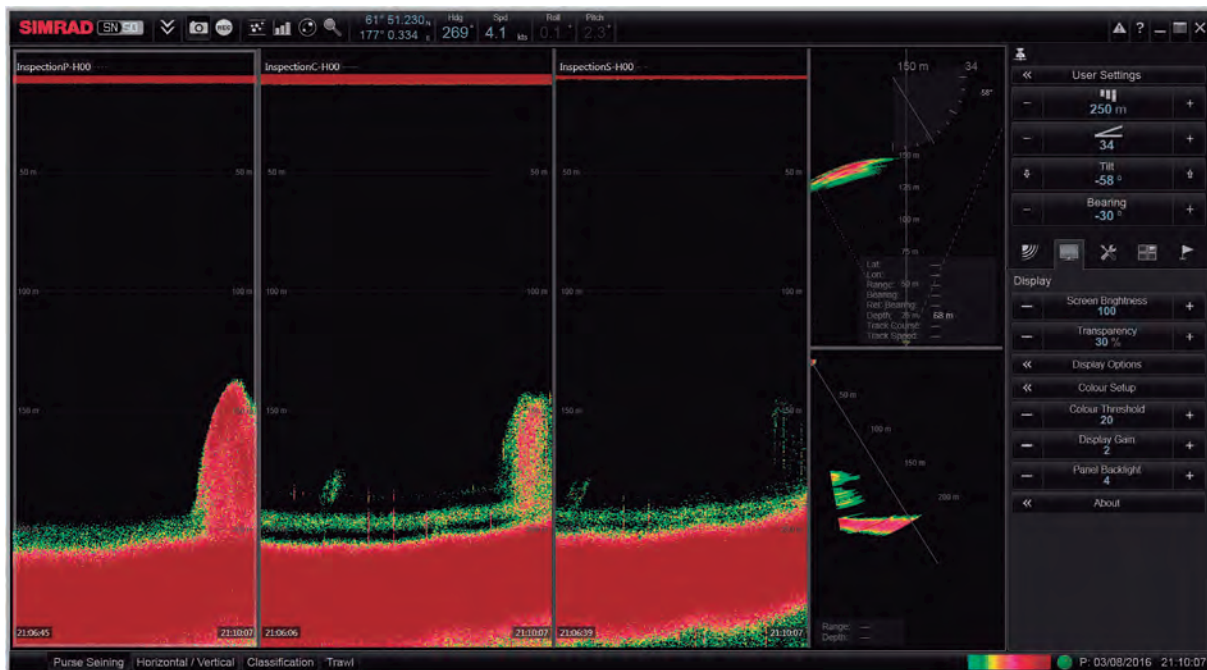

*Like the SN90, the SN50 has all the features like inspection beams, vertical view and sonar view. The lower frequency of the SN50 will give a longer range than on the SN90. All the features in the Winson SW like dual screen, "one ping", etc. are included.*

# Sonar Operating Panel (SOP)

The new Sonar Operating Panel (SOP) includes a handy multifunction joystick. It allows the operator to control the tilt, vertical and inspection beams easily just by pushing it and/or turning its top knob. With one single Operating Panel you can control up to four sonars with the Winson 2019 SW. Or right the opposite: you can connect up to three different Operating Panels on different locations onboard to operate one

sonar just by means of an Ethernet connection. One on the bridge, one on the wing and one in the tower, for example. Also, the front panel USB port makes it possible to upgrade sonar SW as well as saving/importing user settings. Dedicated buttons as well as programmable buttons/knobs are also available. The new SOP fits in the previous SIMRAD SOP spot using a bracket and making the installation easy as well.

1. USB port
2. Trackball
3. User defined function buttons
4. User defined potmeters (gain, range, etc.)
5. Physical buttons for tilt, train and range



## Sonar upgrades

### High frequency sonars

From	Upgrade to	Requirements
		<ul style="list-style-type: none"> <li>• Transceiver and processor</li> <li>• Return old transceiver and power supply</li> <li>• SOP optional</li> </ul>
		<ul style="list-style-type: none"> <li>• Transceiver and processor</li> <li>• Return old transceiver and power supply</li> <li>• SOP optional</li> </ul>
		<ul style="list-style-type: none"> <li>• Complete sonar</li> </ul>

### Low frequency sonars

From	Upgrade to	Requirements
MKI	MKII	<ul style="list-style-type: none"> <li>• New transceiver</li> <li>• New SW</li> </ul>
		<ul style="list-style-type: none"> <li>• Return a full operating SX90</li> <li>• Remember adapter on trunk</li> </ul>
		<ul style="list-style-type: none"> <li>• Return a full operating SX90</li> <li>• Remember adapter on trunk</li> </ul>
	Winson 2019	<ul style="list-style-type: none"> <li>• Including the latest Processor Unit</li> <li>• SOP optional</li> </ul>
		<ul style="list-style-type: none"> <li>• Return a full operating SU90</li> <li>• Remember adapter on trunk</li> </ul>
	Winson 2019	<ul style="list-style-type: none"> <li>• Including the latest Processor Unit</li> <li>• SOP optional</li> </ul>

**Note!** The SOP will not work with old SW!  
(But old SOP will work with new SW, expect delivery time)  
SOP = Sonar Operating Panel

# Sonar specifications

SY50	MF90	SN90	SN50	SX90	SU90	ST90
------	------	------	------	------	------	------

## Processing Unit

Voltage	110/220 VAC and 24 VDC on selected systems						
Consumption	5 A						
Processor type	Specially adapted for sonar use						
Operating system	Windows™ 10						
Display output	Triple						
Serial interface I/O	Multiple ports available						
Ethernet interface	4 ports available						
Display resolution	1920 × 1080 or 1920 × 1200						
Operating ranges	25 to 2500 m	25 to 2000 m	25 to 2000 m	25 to 2000 m	25 to 5000 m*	25 to 5000 m*	25 to 5000 m**

## Transceiver Unit

Voltage	110/220 VAC, 24 DC	110/220 VAC					
Consumption	1000 VA	750 VA	400 VA	500 VA	750 VA	750 VA	750 VA
Operating frequency	55 to 59 kHz	75 to 95 kHz	75 to 85 kHz	55 to 59 kHz	20 to 30 kHz (1 kHz step)	20 to 30 kHz (1 kHz step)	14 to 24 kHz (1 kHz step)
Modulation	CW and Linear FM						

## Beam

Horizontal coverage	Omni	Omni	120°	120°	Omni	Omni	Omni
Vertical beam width	10°	8°	6°	7°	See table below	See table below	6°
Transceiver channels	256	480	256	256	256	384	384
Pitch & roll stabilisation	-10 to +60	-10 to +60	Depending on install	Depending on install	-10 to +60	-10 to +60	-10 to +60
External pitch & roll interface	MRU Kongsberg Discovery (Seatex) format (Optional)						
Scientific data output	Optional						

## Hull Unit

Voltage	110/220 VAC, 24 DC	230/380/440 VAC 3 Phase	230/380/440 VAC 3 Phase	N/A	230/380/440 VAC 3 Phase	230/380/440 VAC 3 Phase	230/380/440 VAC 3 Phase
Consumption	1000 VA	1100 VA	3000 VA - 1100 VA	N/A	3000 VA - 1100 VA	3000 VA - 1100 VA	3000 VA - 1100 VA
Selectable transducer position	No	Yes	Yes	N/A	Yes	Yes	Yes
20 knots Hull Unit	No	Yes	No	N/A	SX92 and SX93	SU92	No
2,1 m transducer lowering	No	MF94	N/A	N/A	N/A	SU94 Hull Unit	ST94 Hull Unit
1,6 m transducer lowering	No	N/A	N/A	N/A	SX93 Hull Unit	SU93 Hull Unit	ST93 Hull Unit
1,2 m transducer lowering	No	N/A	SN92H	N/A	SX92 Hull Unit	SU92 Hull Unit	ST92 Hull Unit
1 m transducer lowering	No	MF90	N/A	N/A	SX95 Hull Unit	N/A	N/A

\*Optional extended range 6000 to 10000 m, requires export licence in selected countries

\*\*Optional extended range 12000 m, requires export license in selected countries

## Opening angles on SX and SU sonars

	SX90			SU90		
	Wide	Normal	Narrow	Wide	Normal	Narrow
20 kHz	14,8°	11,0°	10,7°	10,7°	7,8°	7,2°
21 kHz	14,1°	10,5°	10,2°	10,2°	7,4°	6,9°
22 kHz	13,5°	10,0°	9,7°	9,7°	7,1°	6,5°
23 kHz	12,9°	9,6°	9,3°	9,3°	6,8°	6,3°
24 kHz	12,3°	9,2°	8,9°	8,9°	6,5°	6,0°
25 kHz	11,8°	8,8°	8,6°	8,6°	6,2°	5,8°
26 kHz	11,4°	8,5°	8,2°	8,2°	6,0°	5,5°
27 kHz	11,0°	8,1°	7,9°	7,9°	5,8°	5,3°
28 kHz	10,6°	7,9°	7,6°	7,6°	5,6°	5,1°
29 kHz	10,2°	7,6°	7,4°	7,4°	5,4°	5,0°
30 kHz	9,9°	7,3°	7,1°	7,1°	5,2°	4,8°

# Basic sonar theory

A sonar can sometimes be a challenging tool to operate. There are never two days at sea that are the same; weather, water temperature, bottom conditions, fish behaviour, temperature layers, plankton layers, ships noise, sonar settings etc., all influence the performance of a sonar.

The horizontal transmission of sound is defined by SIMRAD as a sonar. If transmitted vertically, then it is defined as an echosounder. Sending sound vertically is not as challenging as sending it horizontally and therefore an echosounder performance can be compared from day to day or between vessels.

On a sonar this is not true. Even between vessels fishing on the same fishing grounds, sonar can perform differently. Ship's noise, electrical and/or acoustic, is different from vessel to vessel, transducer installation is different from vessel to vessel, filter settings and general sonar operation is different from vessel to vessel and will affect the sonar performance.

On this page we have made some illustrations to consider when operating a sonar. There are many more but these are the most common ones that will change from day to day and between vessels.

With decreasing temperature (A) the beam will bend towards the bottom shortening the range (B).

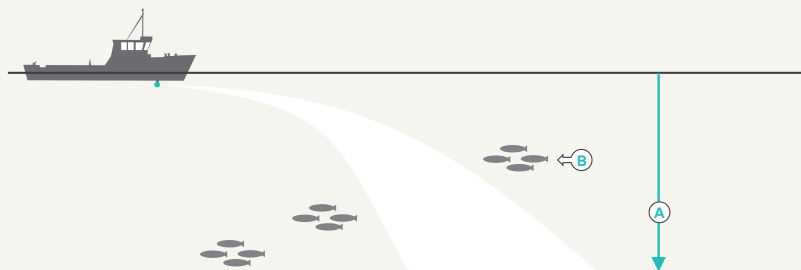

With increasing temperature (A) the beam will bend towards the surface shortening the range (B).

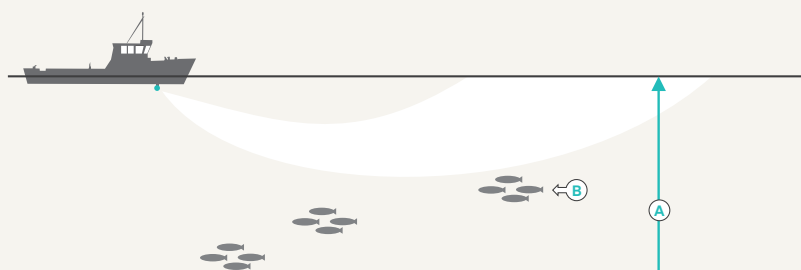

Propeller noise is caused by cavitation as illustrated in the picture to the left. A clean propeller will still cavitate but much less than a propeller with marks and damages. Also, a large propeller will cavitate much less than a small due to the lower RPM.

## SN50 system diagram

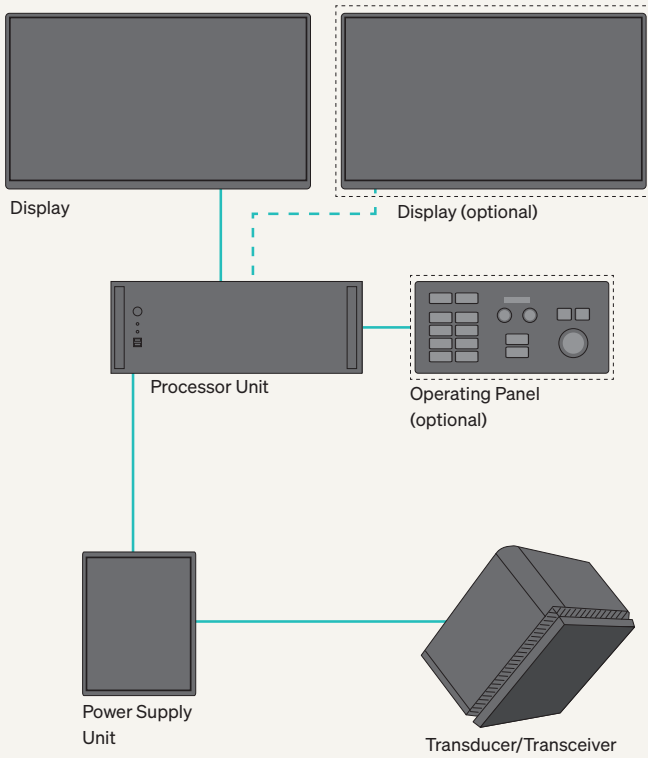

## SY50 system diagram

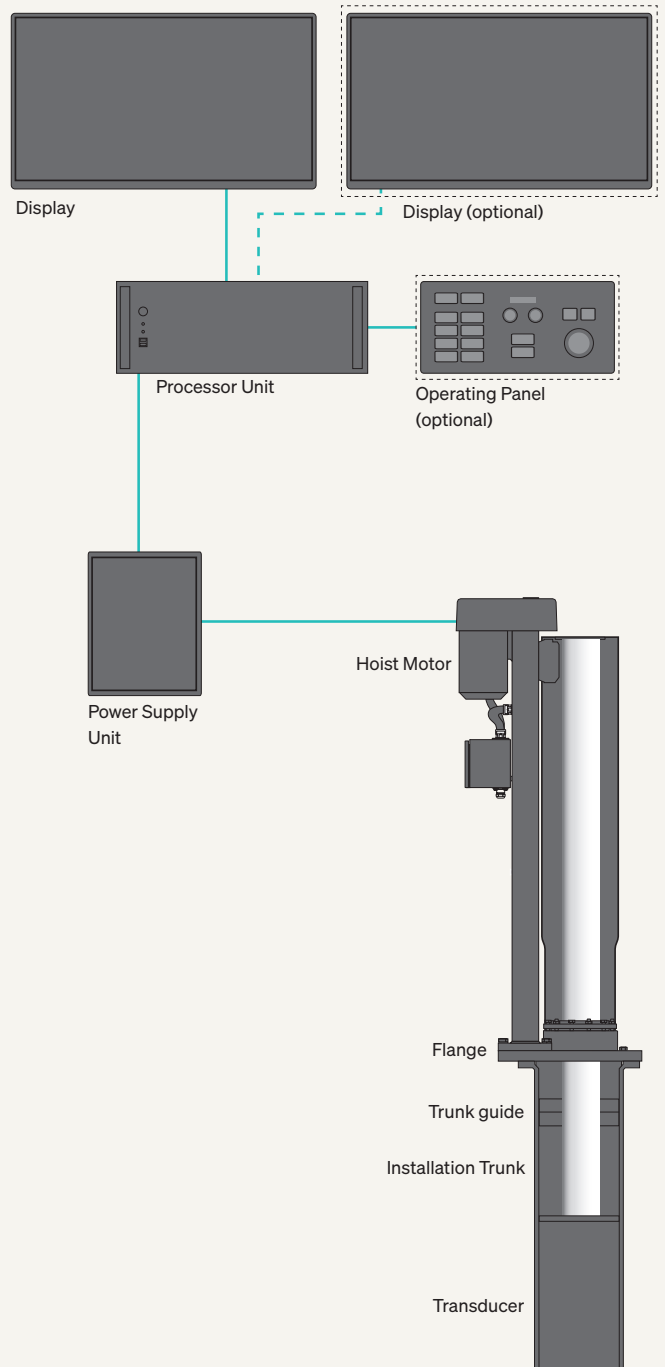

## MF system diagram

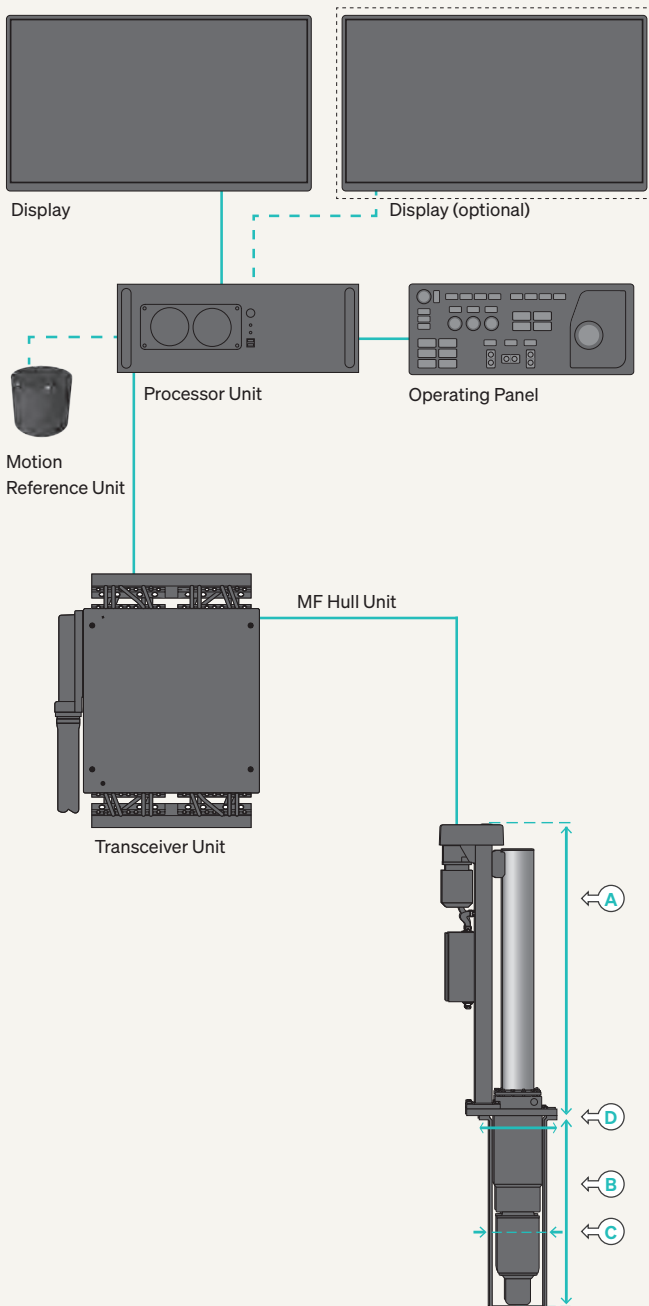

- A.** Height over trunk:  
SC90 - 1390 mm
- B.** Height of trunk:  
SC90 - 970 mm
- C.** Trunk diameter:  
SC90 - 273 mm
- D.** Flange diameter:  
SC90 - 370 mm

## SN90 system diagram

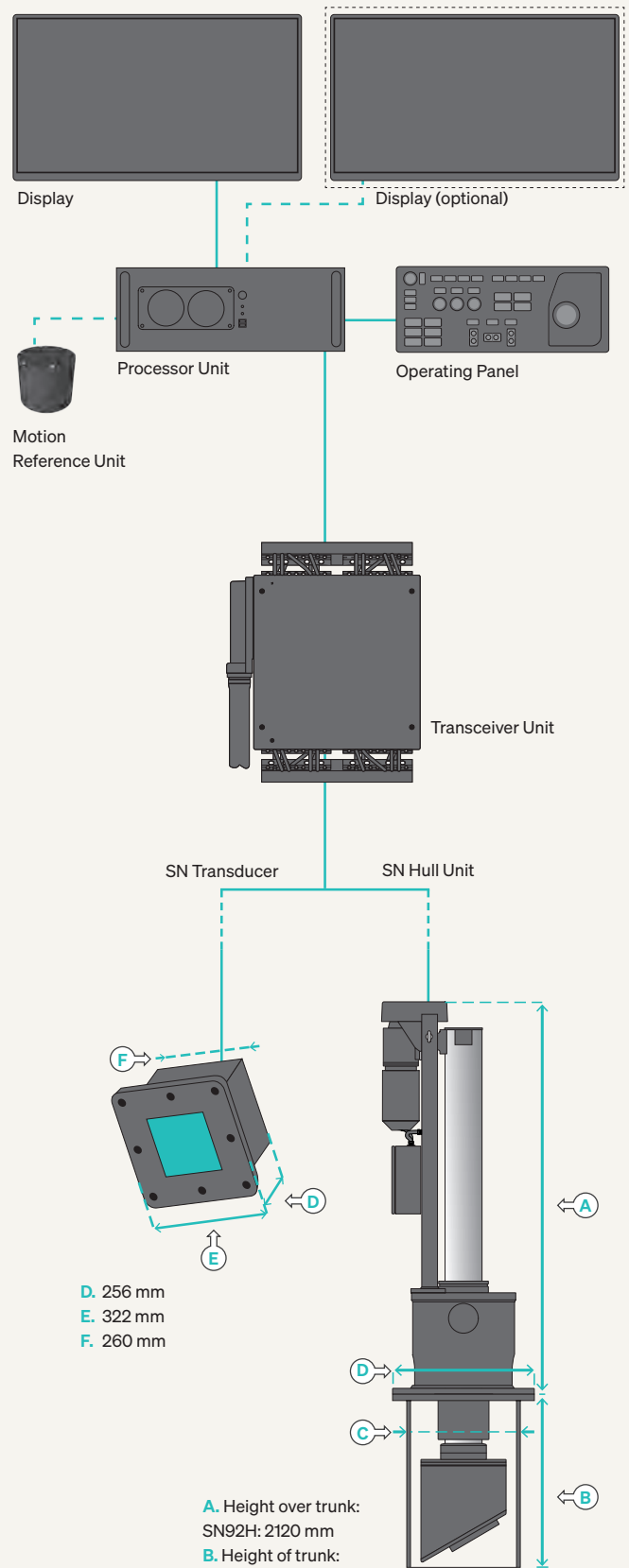

- D.** 256 mm
- E.** 322 mm
- F.** 260 mm

- A.** Height over trunk:  
SN92H: 2120 mm
- B.** Height of trunk:  
SN92H: 930 mm
- C.** Trunk diameter:  
SN92H: 610 mm
- D.** Flange diameter:  
SN92H: 761 mm



# SX - SU - ST system diagram

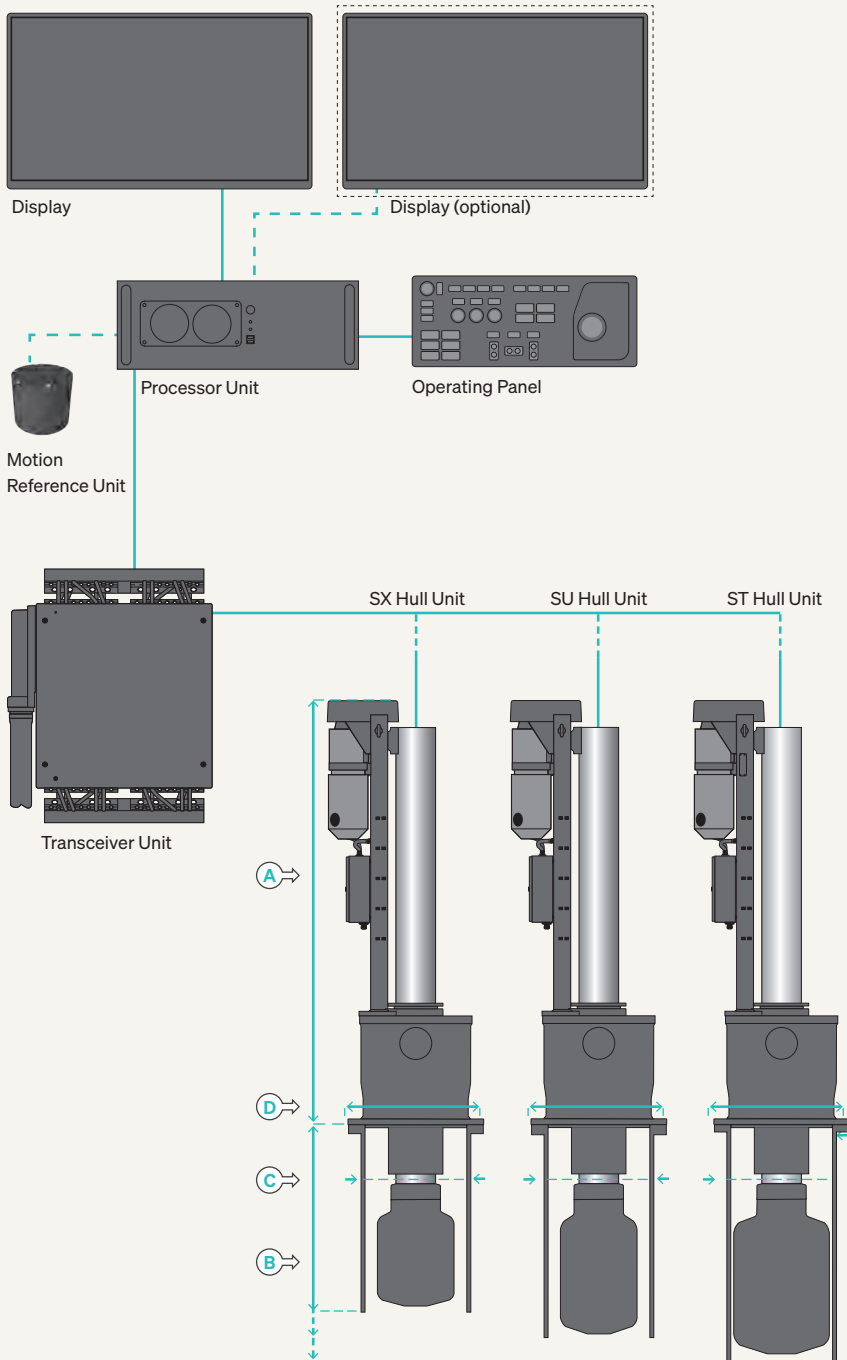

## Processor Unit

Width: 600 mm  
Height: 220 mm  
Depth: 520 mm

(Shipping dimensions)

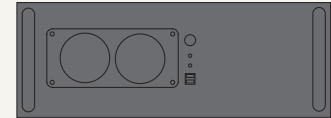

## Operating Panel

Width: 470 mm  
Height: 230 mm  
Depth: 320 mm

(Shipping dimensions)

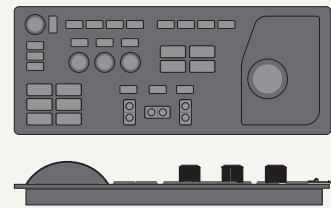

## Transceiver Unit

Width: 770 mm  
Height: 940 mm  
Depth: 760 mm

(Shipping dimensions)

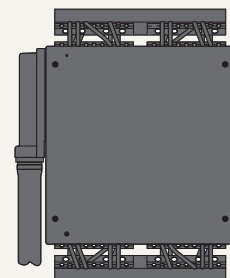

(SX92/SX93/SX95)

**A. Height over trunk:**  
SX92 - 2118 mm  
SX93 - 2518 mm  
SX95 - 1645 mm

**B. Height of trunk:**  
SX92 - 930 mm  
SX93 - 930 mm  
SX95 - 910 mm

**C. Trunk diameter:**  
SX92 - 610 mm  
SX93 - 610 mm  
SX95 - 508 mm

**D. Flange diameter:**  
SX92 - 760 mm  
SX93 - 760 mm  
SX95 - 580 mm

(SU92/SU93/SU94)

**A. Height over trunk:**  
SU92 - 2118 mm  
SU93 - 2518 mm  
SU94 - 3018 mm

**B. Height of trunk:**  
SU92 - 1110 mm  
SU93 - 1110 mm  
SU94 - 1110 mm

**C. Trunk diameter:**  
SU92 - 610 mm  
SU93 - 610 mm  
SU94 - 610 mm

**D. Flange diameter:**  
SU92 - 760 mm  
SU93 - 760 mm  
SU94 - 760 mm

(ST92/ST93/ST94)

**A. Height over trunk:**  
ST92 - 2118 mm  
ST93 - 2518 mm  
ST94 - 3018 mm

**B. Height of trunk:**  
ST92 - 1280 mm  
ST93 - 1280 mm  
ST94 - 1280 mm

**C. Trunk diameter:**  
ST92 - 610 mm  
ST93 - 610 mm  
ST94 - 610 mm

**D. Flange diameter:**  
ST92 - 760 mm  
ST93 - 760 mm  
ST94 - 760 mm

An aerial photograph of a large fishing vessel, likely a trawler, moving through the ocean. The ship is white with a dark blue hull and is leaving a white wake. A prominent, bright blue sonar beam is visible in the water, extending from the ship towards the bottom right of the frame. The water is a deep, textured blue.

# Echosounders

**Taking fishfinding to the next level**

Professional mariners around the world rely on SIMRAD electronics to deliver a safer and more profitable time at sea.

The new professional range of SIMRAD fishfinders for the commercial market offer a choice of models from 18 kHz to 200 kHz, single or split beam or a combination of the two.

High power, advanced receiver technology and effective SIMRAD transducers ensure a detailed, clear and positive graphic depiction of the seabed and of single fish.



“Echosounders are our DNA. We will continue to finetune the transducer, electronics and software to make the most trustworthy and reliable echosounder on the market. What you see is what you get!”

**ARNE FURDAL**  
Product Manager  
Echosounders

## SIMRAD EQ50

The EQ50 comes standard with digital CW transmission. This is the transmission form that has been used since SIMRAD, as the industry first, digitised the echosounder back in the mid 80's. Then it is possible to add a FM transmission module to the system, making the ES80 a true chirp echosounder.

The advantage of chirp is that it is possible to transmit with a short pulse length at long ranges giving maximum resolution. What determines a good

chirp echosounder, is how long range it gets using the shortest pulse. In addition to this, with the long experience in making scientific echosounders, the EQ50 is also able to show biomass and fish size even without a split beam transducer.

Having a system with multiple frequencies, now also possible with one transducer (the C-All), it is easier to determine the species you are fishing by comparing the target frequency response on different frequencies.





## Wideband Transceiver (WBT)

The Wideband Transceiver (WBT) is designed for applications where performance is the top priority. The WBT has four 500 W channels that can either work independently with single beam transducers, or together with a split beam transducer.

The WBT transceiver is capable of operating on an entire band from 10 kHz to 500 kHz, only limited by the transducer's bandwidth. The WBT is operated by the ES80 SW, and depending on the settings it can be used either in narrowband or wideband mode. The WBT itself is capable of doing CW, FM and also user defined signals.



## SIMRAD ES80 - The original

### All fishing vessels depend on a good echosounder

The SIMRAD ES80 is the benchmark in the echosounder market. The split beam technology enables true fish size estimation, giving the user the most accurate pre-catch information available. Combined with the SIMRAD split beam transducer, no other echosounder will give you a more accurate or trustworthy information. With the wideband transceiver, a true FM chirp pulse (optional) is sent out giving a very high resolution on long ranges. In addition, the intuitive Winson SW makes the operation of the echosounder easy to use. All the Winson features such as recording in .raw files, screenshots or even video replay are included as well. The variety of high end split beam transducers available, make the ES80 echosounder the most versatile and profit-making echosounder on the market.

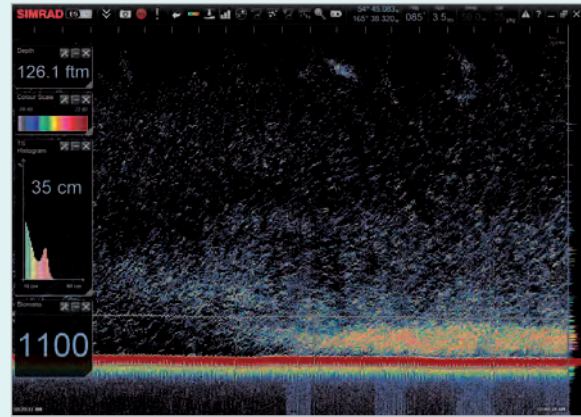

The ES80 delivers unprecedented resolution on all ranges. This example underlines the statement, details make the difference and give the user much more information to make the correct decision. Both economically and environmentally.

#### Did you know...?

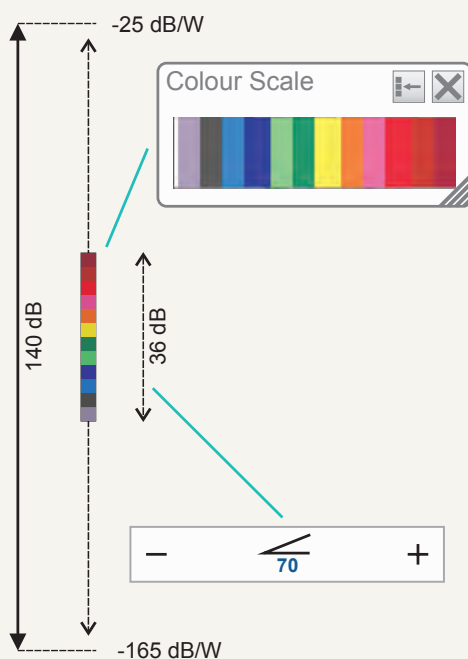

The ES80 echosounder has a dynamic range of 140 dB. This means that the sounder can receive both very strong and very weak echoes. Actually, the ES80 will detect echoes from plankton to whales, bottom on most depths, and present the information free from distortion.

Naturally, we cannot present all these echoes on the display simultaneously, as this would create a mess of colours. So we create a 36 dB section and give each colour a 3 dB (12 colours) or 0,5 dB strength (64 colours).

The colour range goes from grey to brown. Grey is used for the weakest echoes, while the strongest echoes are brown. All echoes stronger than brown will still be brown, while echoes weaker than grey will not be shown.

As a comparison, our old echosounders ES380 and ET100 had -using analogue TVG- a dynamic range corresponding to approximately 65 dB. The old paper sounders had a dynamic range of 12 dB in their printouts using the "colours" from light grey to black.

The dynamic range in the ES80 colour presentation is thus a lot larger; 24 dB or 250 times.

# Wideband echosounders

The SIMRAD series of echosounders have wideband capabilities. That means that you can transmit a signal that varies in frequency across the transmission. The most common way to operate the sounder is to use linear FM, or chirp. In an ES80 chirp transmission you utilise the effective frequency band of your transducer, starting low and continuing higher until you reach the frequency where the transducer efficiency drops off.

Due to advanced matched filtering techniques you can correlate the returned signal with what you sent out,

and the result is improved range resolution of single targets. The improved range resolution is obtained when you have targets that are in comparable size. When you have very weak targets in the near vicinity of strong ones, such as small fish close to bottom, you might want to use a different pulse shape. A dolphin's click is shorter, but still spans over a large bandwidth and might be better suited for such environments. The ES80 has this capability and, as the SW continues to be developed, new functions would be available.

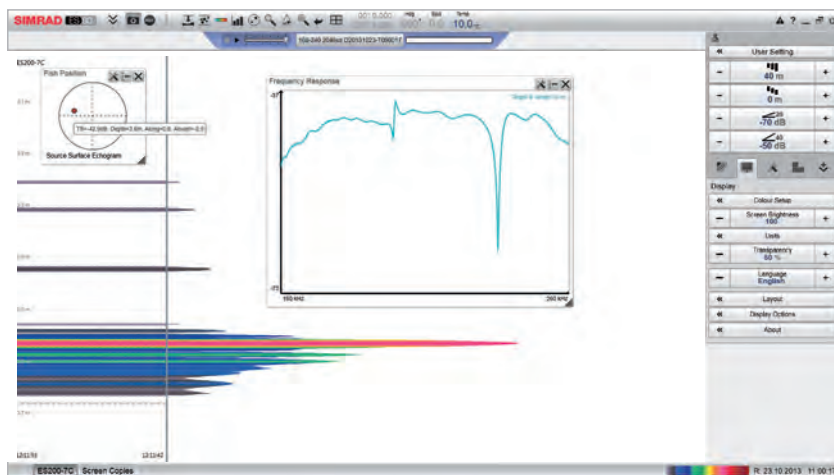

*Range resolution and target ID are improved. Echo from a 38,1 mm tungsten sphere is measured, and you can clearly see how the target strength changes with frequency. This frequency response is unique to this particular target, and corresponds well with the theoretical curves. Resolution is excellent, and you can clearly see the knot on the fishing line where the suspended sphere is attached to the line, around 10 cm from the sphere itself.*



## SIMRAD CP60

### Five layers of perfection

The CP60 is a cost-effective system, especially if you already have an EQ50 or ES80 onboard. You can then use the same computer and monitor already installed. It can be integrated into the EQ50 or ES80 with its own “tab” and pop-up window.

When purchased as a stand-alone system, a computer and a monitor are needed in addition to the transceiver and transducer.

The CP60 can measure up to 5 layers of current individually set by the user. The transducer is 200 kHz which gives a range that is deep enough for most purse seines. The measurements provided are the speed of

the current and NSWE direction. A backscatter display for each channel is also present.

The current data can be exported to other equipment and it is especially designed for exporting to a SIMRAD sonar, but having a standard NMEA telegram, other products can also be interfaced.

In addition to the current measurements, the CP60 also has a built-in single beam echosounder. The beam has an opening angle of 27° making it ideal for fish detection high up in the water column, i.e. before setting the purse seine or in similar scenarios.

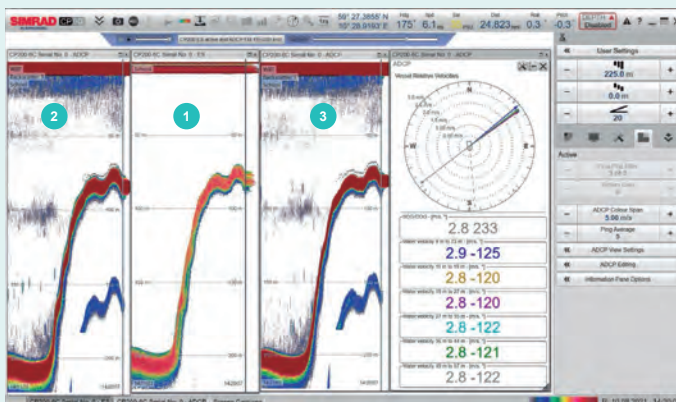

The CP60 has one additional internal transducer pointing straight down. This transducer has a 27° opening angle (1). Then it can also use two beams from the current measurement as an echosounder (2 and 3). These beams point 60° to each side, and 15° forward. Both of these beams have a 5° opening angle. A very useful function to see at what side the school is. The current measurements can be seen on the right of the picture in a numeric view and a PPI view with arrows. Furthermore, you will also get SOG (Speed Over Ground) and COG (Course Over Ground).

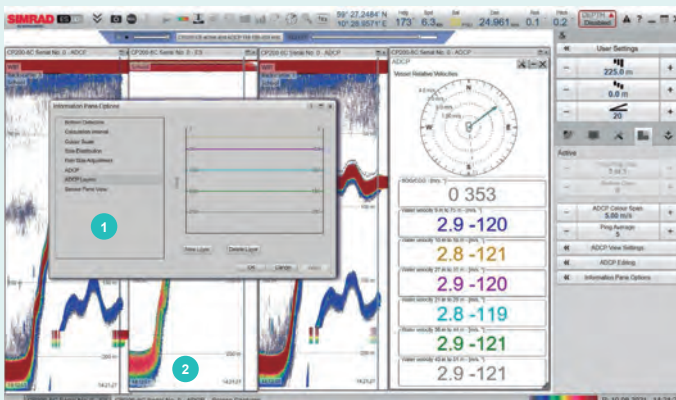

The CP60 can measure current speed and direction in up to 5 layers in the water column. The depth of the layers can be easily set by the user, as well as the number of layers (between 1-5) (1). When used together with an ES80 echosounder (as in the picture above), the current profiling will show as a tab where the user normally can select between frequencies/transducers (2).



# Footprint on different transducer beamwidths

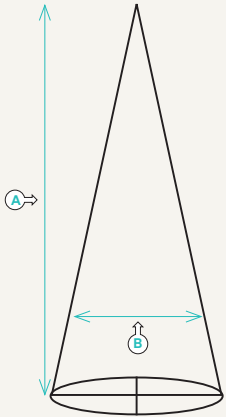

A		Meters	10	20	30	40	50	60	70	80	90	100	110	120	130	140	150
		Feet	33	66	98	131	164	197	230	262	295	328	361	394	426	459	492
B		Fathoms	5	11	16	22	27	33	38	44	49	55	60	66	71	77	82
		7°	Meters	1	2	4	5	6	7	9	10	11	12	13	15	16	17
Feet	4		8	12	16	20	24	28	32	36	40	44	48	52	56	60	
10°	Meters	2	4	5	7	9	11	12	14	16	18	19	21	23	25	26	
	Feet	6	11	17	23	29	34	40	46	52	57	63	69	75	80	86	
13°	Meters	2	5	7	9	11	14	16	18	21	23	25	27	30	32	34	
	Feet	7	15	22	30	37	45	52	60	67	75	82	90	97	105	112	
30°	Meters	5	11	16	21	27	32	38	43	48	54	59	64	70	75	80	
	Feet	18	35	53	70	88	105	123	141	158	176	193	211	228	246	264	

# Resolution on various frequencies (metric measure)

	64 μs	128 μs	256 μs	512 μs	1024 μs	2048 μs	4096 μs	8192 μs	16384 μs
12 kHz					75 cm	150 cm	300 cm	600 cm	1200 cm
18 kHz				40 cm	75 cm	150 cm	300 cm	600 cm	
27 kHz				40 cm	75 cm	150 cm	300 cm	600 cm	
38 kHz			20 cm	40 cm	75 cm	150 cm	300 cm		
50 kHz		10 cm	20 cm	40 cm	75 cm	150 cm			
70 kHz		10 cm	20 cm	40 cm	75 cm	150 cm			
120 kHz		10 cm	20 cm	40 cm	75 cm				
200 kHz	5 cm	10 cm	20 cm	40 cm	75 cm				
333 kHz	5 cm	10 cm	20 cm	40 cm	75 cm				

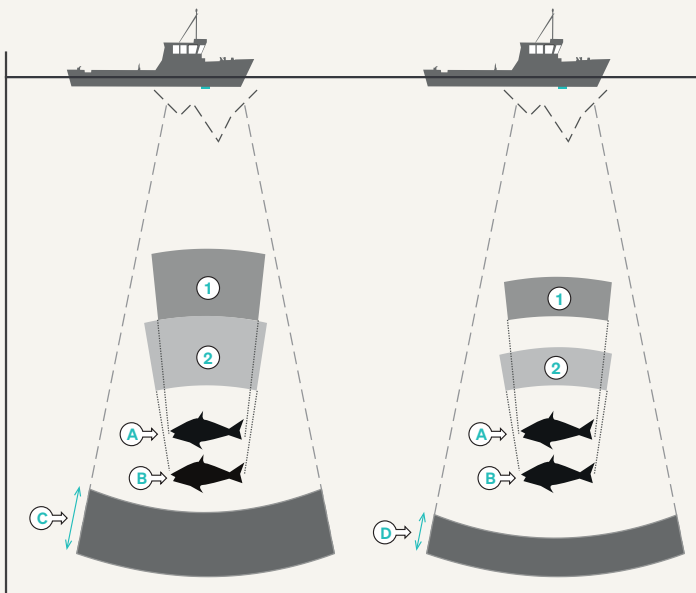

The left vessel uses a long pulse duration (C). As you can see, this causes the echoes from the two fishes (A) and (B) to merge.

The right vessel uses a shorter pulse duration (D), and the two fishes will then appear as two separate echoes on the echogram.

Thus, short pulses will provide the best resolution and separation of individual fishes, but the echosounder is more sensitive to noise.

Two targets need to be min. 1/2 pulse length apart, in order to be seen as two targets. This can be measured in cm. (Table above).

# Detection depths

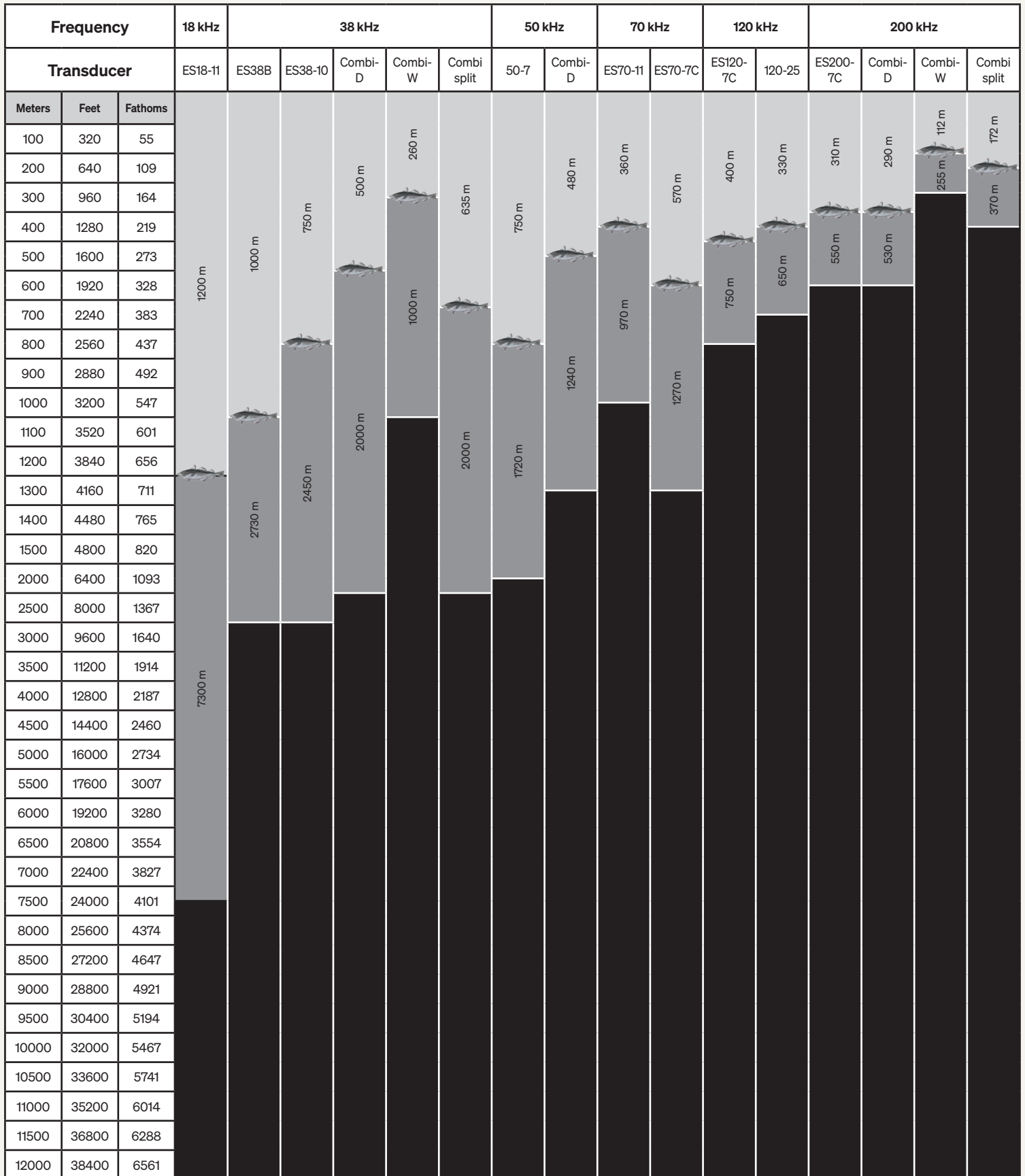

**Note!** For TS = -32 dB in salt water 35 ppt and 10 °C at 38 kHz this relates to a cod of length 60 cm. Bottom Sb = -30 dB/m<sup>2</sup>

# Echosounder specifications

	EQ50	ES80	CP60
--	------	------	------

Operational frequency transceiver	10-500 kHz		200 kHz
Operational mode	Active, passive		Active
Transmit mode	CW, chirp		
Pulse duration (depends on frequency)	64-16384 μs		N/A
Split beam capability	No	Yes	No
Max. number of channels per transceiver	4		
DC voltage	12 V		
AC voltage	100-240 V		
Average power consumption active	20 W		
Power consumption inactive	4 W		
Requires processing unit during operation	Yes		
Ethernet interface	Yes		
Data format	RAW (complex)		
Built-in multiplexer	No		

## Transceiver Unit

Voltage	12 VDC		
Consumption	100 W		
Interface input	Navigation, motion sensor, annotation, TX synchronisation and temperature		
Interface output	Survey line, remote power and TX synchronisation	NMEA CUR telegram	
Ethernet interface	One		

## Software options

Biomass	Included	
Fish sizing	Included	
FM transmission	Optional	Included

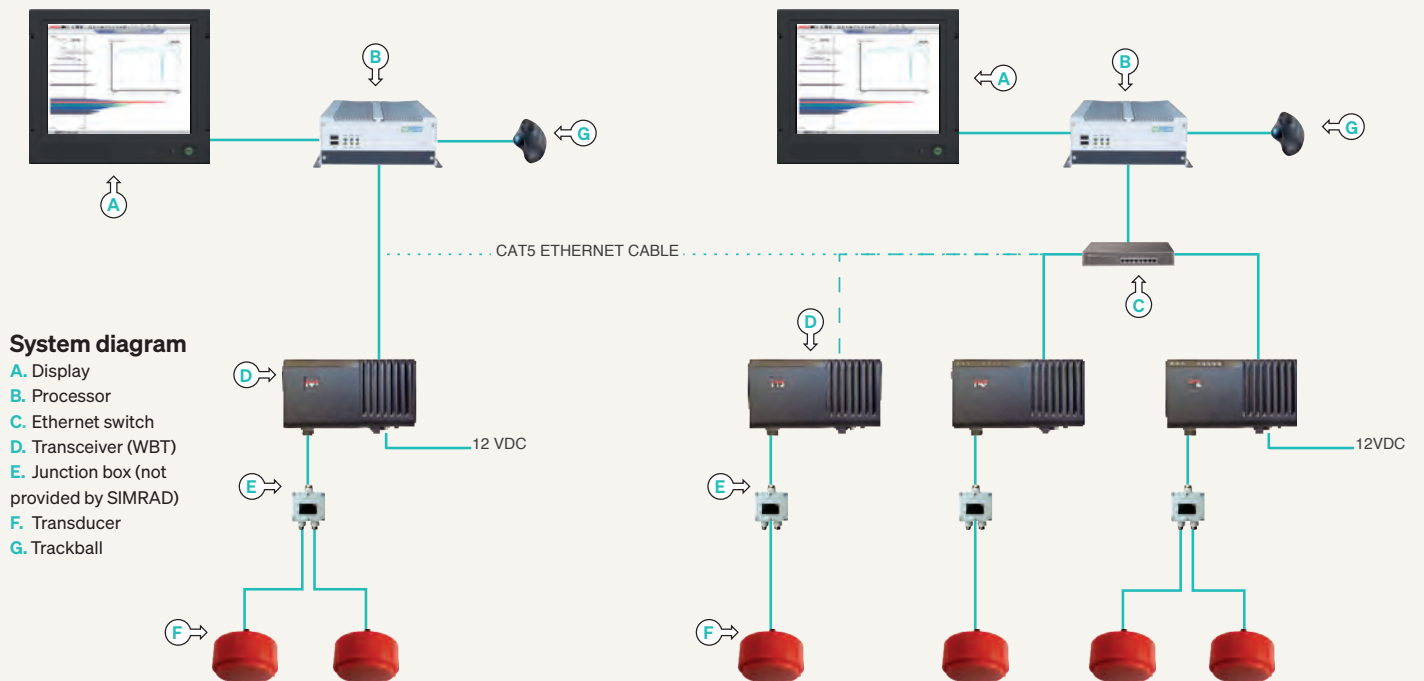

**Note!** In split beam configuration only one transducer can be connected to the WBT

An underwater photograph showing a fishing net being pulled across the seabed. A large, cylindrical sensor is attached to the net's line, and another smaller sensor is visible further down the net. The seabed is sandy with some small rocks and debris. The water is clear and blue.

# Gear Monitoring

**Net awareness x 8!**

Fishermen all over the world have relied on information from SIMRAD Gear Monitoring solutions every day since the early 60s. Information about door spread, door stability, geometry, water speed, cod-end filling, height of trawl and/or door are vital to be efficient. In addition, as aid for safe navigation, the location of gear can be provided.

For a purse seiner you get information about net depth, distance to bottom, sinking rate and temperature.

Today, the SIMRAD range of gear sensors, both wireless and cable based, can be combined. Interfacing SIMRAD Gear Monitoring to other equipment gives you full control from setting to catch, thus enabling you to fish more efficiently, sustainably and safer.

Combining SIMRAD sonar, echosounder and Gear Monitoring gives you optimal interoperability.

An underwater photograph showing a fishing net with a mesh pattern and floats, partially filled with small fish. The net is suspended in clear blue water. The background shows the seabed with some dark spots, possibly rocks or sand. The overall lighting is bright and clear, typical of an underwater environment.

“Our goal is to provide to the fishermen all the essential information that they need to perform their work sustainably, efficiently, and safely. Providing high quality gear sensors in which the fisherman can trust.”

**JENS HEINSDORF**  
Product Manager  
Gear Monitoring

## The SIMRAD PX family, sensors made to work!

The PX sensor family comes in four different bodies and a range of different HW configurations. At the same time, several sensors read up to 8 different measurements and position sensors provide additional location information. In addition, the TV80 can do further calculations based on the measurements. A standard sensor has all data readings available for use without any additional licence.

The complete PX sensor family is depth rated to 1000 m including the depth sensors and seine sounders. The previous PX Multisensor MKII can be easily upgraded to the new electronics. The difference between the original MKII and the new electronics is that it has support for Triple Trawl and a power-save mode for extended operational use.

The PX sensor comes either as a standard sensor, a Universal sensor, a Flow sensor or a miniCatch sensor.

**Remember:  
port door is always  
the reference!**



## SIMRAD PX TrawlEye

The SIMRAD PX TrawlEye provides a real-time echogram from the trawl via a wireless link. In addition to the echogram, the PX TrawlEye can give information about battery status, roll, pitch and optional depth and temperature.

Occupying only 2 normal PX channels, the PX TrawlEye provides an efficient use of the wireless frequency spectrum, allowing you to use all the sensors you need without restrictions on your Single, Twin or Triple net.

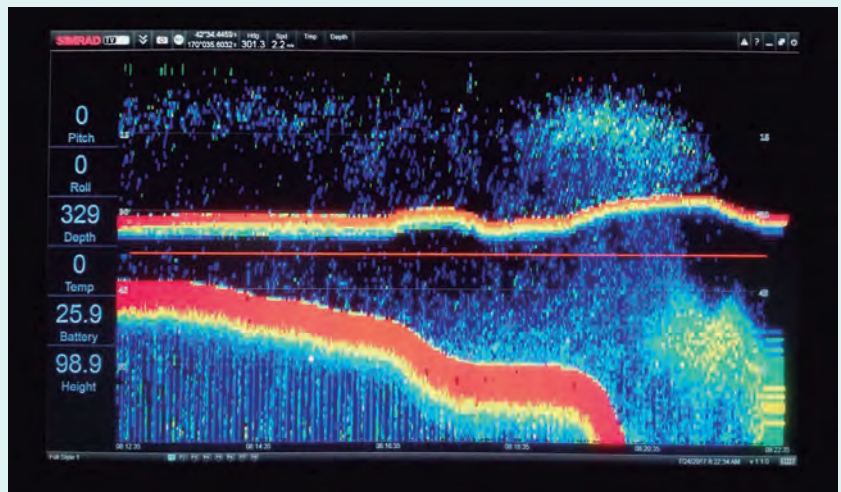

## SIMRAD PxPos sensor

SIMRAD was first to monitor the position of the net with the ITI system made in the 90's. Today a complete new Trawl Positioning System has been developed with the latest use of new components. This has resulted in a small compact transceiver called TP90 that will communicate with the PxPos sensor. By using the acclaimed split beam technology, it is possible to determine the latitude and longitude of the PxPos sensor. The obvious advantage is to avoid wrecks and

obstacles on the sea floor but also it is a very useful tool for aimed fishing. When you see a school of fish on the sonar or echosounder, it is now possible to aim the trawl towards the school.

Sometimes it looks like the trawl is on either side by looking at the wires, but in reality the trawl could still be on the opposite side as the wires could snake.

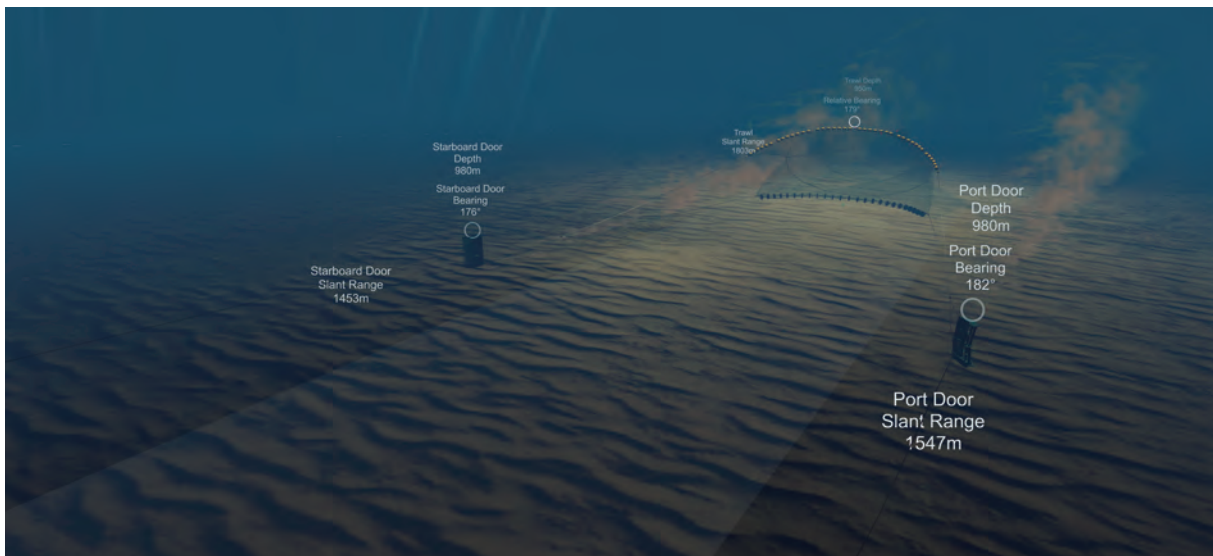

## SIMRAD PX Flow sensor

### Go with the flow

The PX Flow sensor is the latest addition to the PX sensor family. This new sensor measures water speed in trawl opening or inside the trawl. It is the trawl's speed through the water that is of importance, not the vessel's GPS speed. The sensor can also be configured to measure geometry, height, roll, pitch, etc. Unlike other water speed sensors, this sensor utilises the

Doppler principle to measure the speed. Using the Doppler principle is a huge benefit because it enables you to measure the speed of water at a distance from the net. This is particularly important if you want to measure inside a trawl where you have a boundary layer with much less water speed close to the net than in the centre of the funnel.

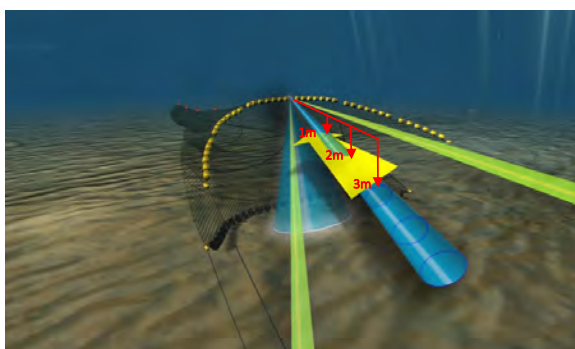

## SIMRAD TV80

### Making sensor data understandable

With the introduction of multifunction Gear Monitoring Sensors, the challenge is how to show the information in a friendly way for the skipper, who wants to receive the relevant information in a quick look on the screen. The TV80 is designed to fulfill this concept.

The TV80 can work with a single, dual or triple monitor configuration and can display information simultaneously from all existing SIMRAD Gear Monitoring Systems, ITI, PI, FS and SR. This feature provides an easy update path for SIMRAD customers, in spite of the system they are using or want to use. In addition to the data supplied by SIMRAD Gear Monitoring Systems, the TV80 accepts data from other

sources like GPS receivers, echosounders, heading sensors, winch sensors, etc.

The user can create his own layout of up to four independent views to fit his operating scenario. He can also decide what information is going to be presented on every view. Each view is assigned to a function key, allowing a fast and efficient swap between predefined views with a single keystroke.

The TV80 has a built-in recording function for all the received data. The user can either use the recorded data to replay or export it to a compatible CSV file format for later analysis or study.

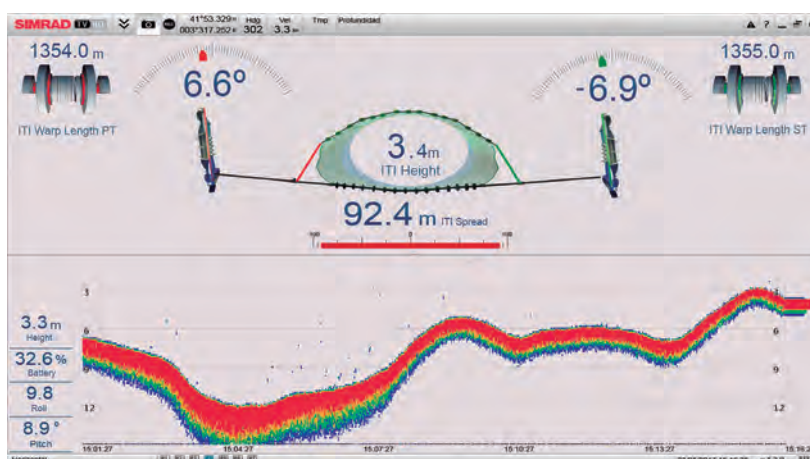

### Frequency spectrum

The acoustic communication link between the receiver and the sensors could be challenging in a fishing vessel, due to propeller, pumps, compressors and other electric systems onboard generating noise. When the noise is in the same frequency range than the sensor, the result is unstable or even worse, has no data readings. The TV80 has a built-in spectrum analyser that shows the signals coming through each hydrophone. With this advanced tool, the user will be able to identify the noise and find the cleanest frequencies. Programming the communication channel of the sensors in the “quiet” frequencies to assure a stable data reading from the sensor.

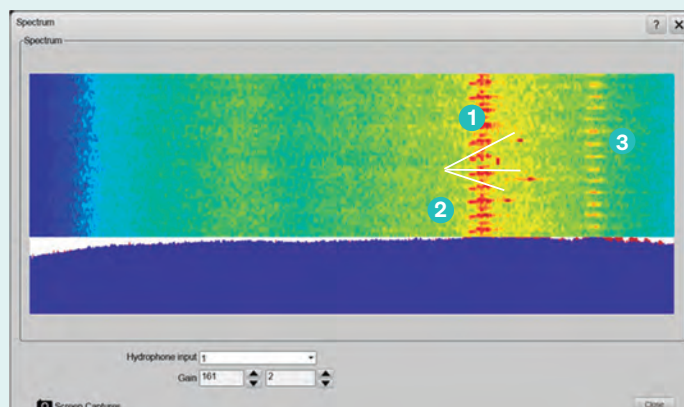

*Spectrum example with PX sensors configured away from the echosounder interference*

1. PX TrawlEye signal
2. PX sensors (three different channels)
3. Echosounder interference



## SIMRAD PX miniCatch

The SIMRAD PX miniCatch is a new member to the PX sensor family.

The PX miniCatch sensor is the smallest and lightest sensor of the PX family. It includes standard catch triggering through the side-pull wire and optional back-pull via the catch/temperature extension lid, being the perfect choice for different mesh types, as diamond or square trawl net expand differently. Being

both smaller and lighter, ensures minimum down force on the net.

For both trawl and purse seiners, the SIMRAD PX miniCatch can give information about battery status, roll, pitch, height and optional depth via the depth/temperature extension lid. For trawlers this means that its possible to get simultaneous depth and catch measurements.

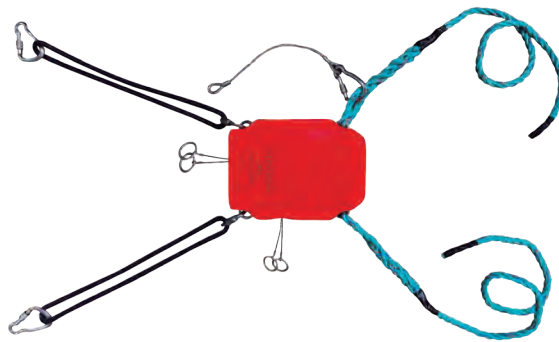

## SIMRAD FS70

### The trawl sonar platform combining the best of two worlds

The SIMRAD FS Trawl System provides the full picture of the trawl by utilising the ultimate FS third wire system with integrated PX sensors. This sophisticated solution enables the fisherman to have full control of any type of trawl fishery.

The system provides real-time images from the trawl sonar head and the data from the PX sensors to the bridge, thus maximising the quality of the catch and increasing efficiency at sea.

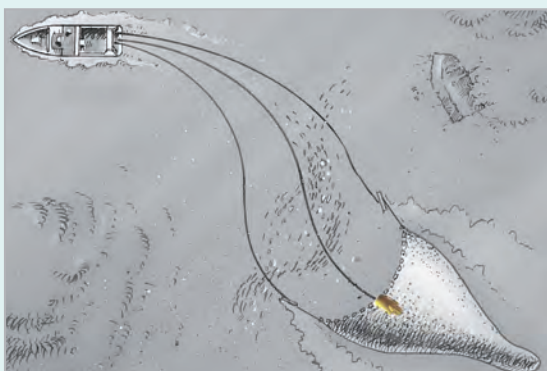

A major benefit of the 3<sup>rd</sup> wire integration with PI Sensors is to prevent loss of communication with the trawl as the vessel is changing course or in heavy sea conditions.



#### FS70 Trawl Unit

The FS70 trawl housing unit is designed for the harshest environments and for withstanding the extreme forces encountered when shooting a trawl. However, it is easy to handle and the hyper yellow colour makes it easy to see even in the dark.

## SIMRAD **FX** system

### Real-time video for real-time decisions

A real solution to the challenge of sustainable fishing. The FX system is SIMRAD's answer.

The FX system is a next-generation SIMRAD trawl monitoring system. SIMRAD was one of the pioneers of cable-based Trawl Monitoring Systems and is credited with introducing the world's first trawl sonar in 1986.

In addition to acoustically identifying species and fish

size, our customers want to see what actually goes into the net and to be able to take action immediately to avoid bycatch.

The FX system features the industry's fastest data link and is able to stream sonar images, sensor data, and video in real-time. The system is expandable and can be interfaced with various compatible devices.

### Deployment options:

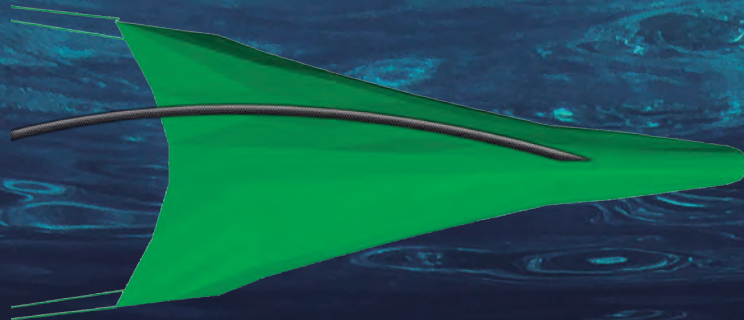

**Subsea cable attached to codend**  
For pelagic and semi-pelagic trawlers

**Subsea cable attached to headrope**  
For bottom trawlers with a vertical net opening of <12 meters

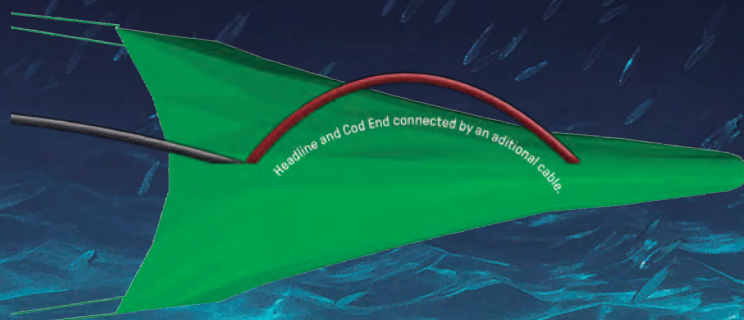

**Subsea cable attached to headrope and codend**  
For shrimp nets, smaller vessels, and research vessels

# FX system capabilities

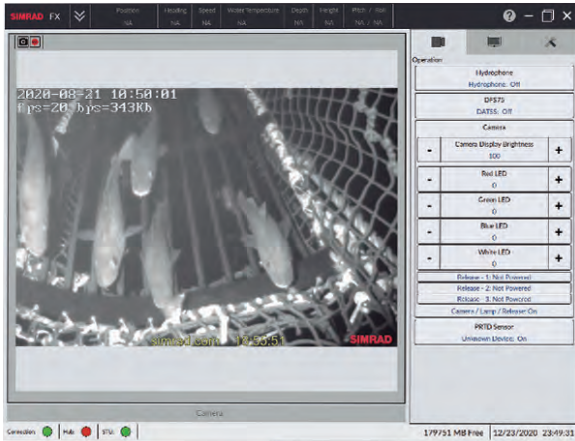

Live camera

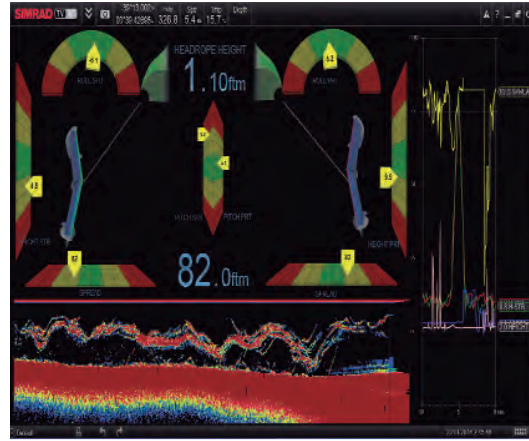

TrawlEye and sensors

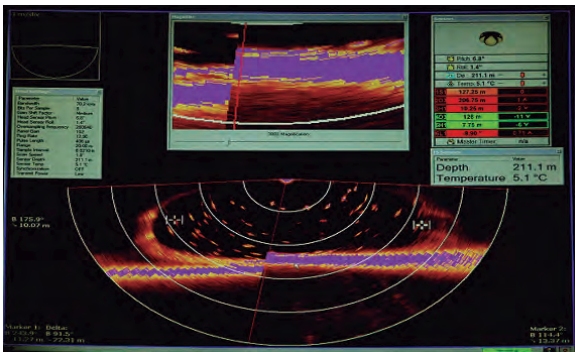

Trawl sonar

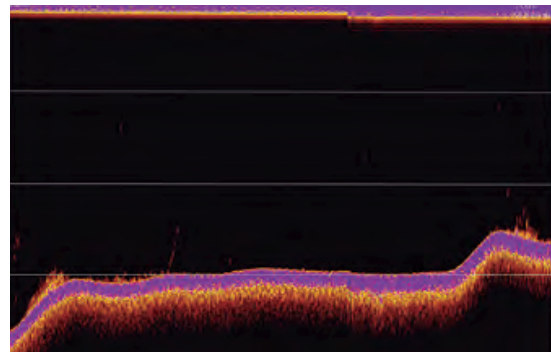

Trawl sounder

## Current choice of configurations



FM90i

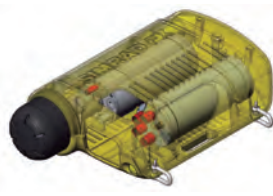

FX80i



Colour IP camera



Mechanical release

## SIMRAD FM90i Multibeam trawl sonar

SIMRAD invented the “3<sup>rd</sup> wire” trawl sonar back in the early 80s. Back then, nobody could foresee the impact this has had to the pelagic and semi pelagic fishing industry. Imagine back then, nobody had a “3<sup>rd</sup> wire” winch and nobody had handled this type of equipment before, making the learning curve steep. But as with everything, if you see the benefit of something, you go the extra mile to be able to benefit from it. For the pelagic and semi pelagic industry the trawl sonar is so important that you will not go out fishing without it.

Traditionally, the trawl sonar has been a scanning search light sonar installed in the vertical plane. The advantage with a search light sonar is the resolution, the disadvantage is its real time capabilities. It takes time to scan a trawl opening and time is valuable. The FM90i will instantly give you a picture of the net opening and fish enter. The challenge up until now has been the ability to detect fish and the net geometry when the net is getting closer to the bottom. The FM90i has solved this using all the multibeam technology and knowledge within the SIMRAD organisation.

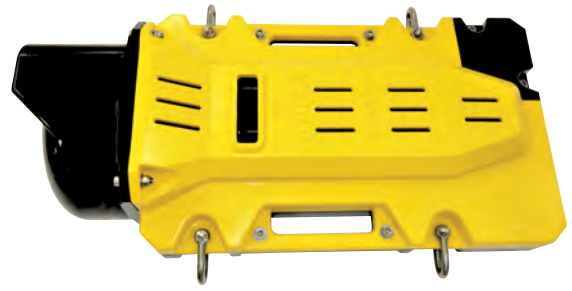

### FM90i Trawl Unit

The FM90i Deployment Pack has a yellow top and black bottom to confirm correct orientation prior to launching and to assist in visual sighting during recovery. It also has improved hand holds to assist handling even with gloves on. The strain relief can be accessed using standard tools without opening the entire Deployment Pack and the is quick filling and draining.



The transducer of the FM90i has no moving parts thus being less vulnerable to damage and less maintenance is needed.

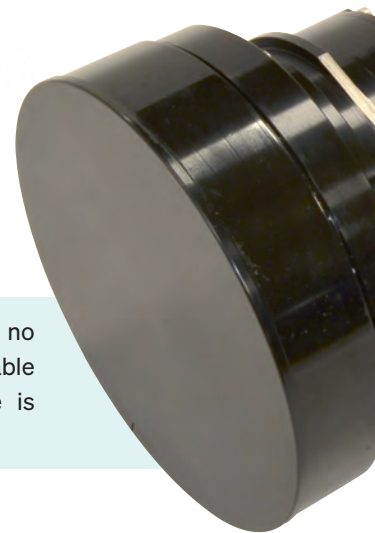

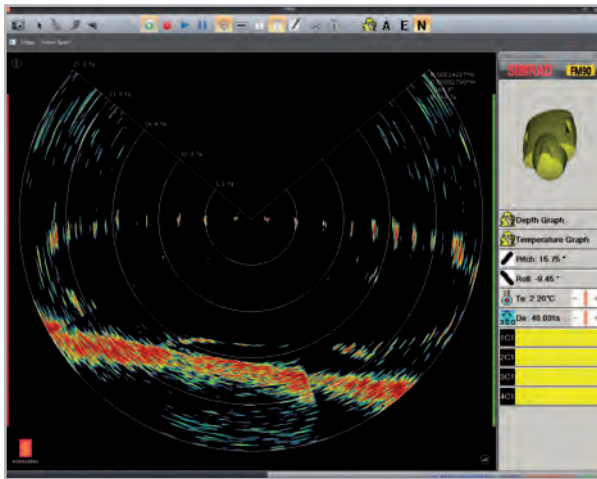

This picture shows Pollock in Alaska. Notice the trawl is actually touching bottom on starboard but on the echosounder it looks like the trawl is off the bottom. This is only truly possible with a multibeam trawl sonar. A traditional search light trawl sonar could lose this information as it takes too long time to draw the picture.

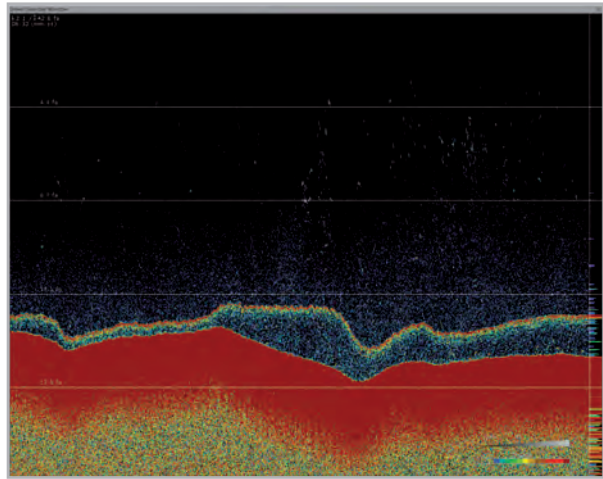

This part is the 200 kHz down looking echosounder. The line above the bottom is the footrope of the trawl. It is easy to see fish escaping below the footrope.

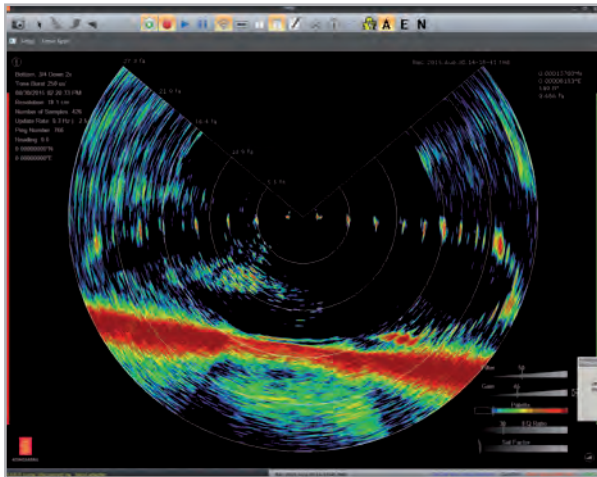

This picture shows Pollock in Alaska. Here the net is almost on the bottom and still the contour of the net is easily seen along with fish entering the trawl opening. Again, the trawl is touching bottom on the starboard side while port side is clear of the bottom.

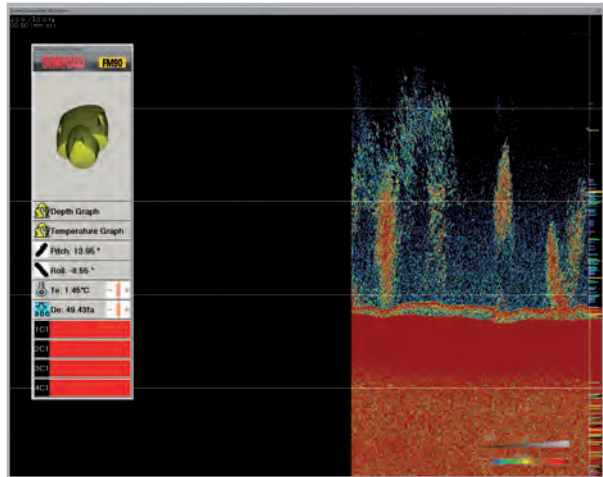

On the down looking echosounder, fish entering the trawl opening is easily seen with great details. Also, notice the footrope almost touching the bottom. Here four catch sensors have been triggered and it's time to haul!

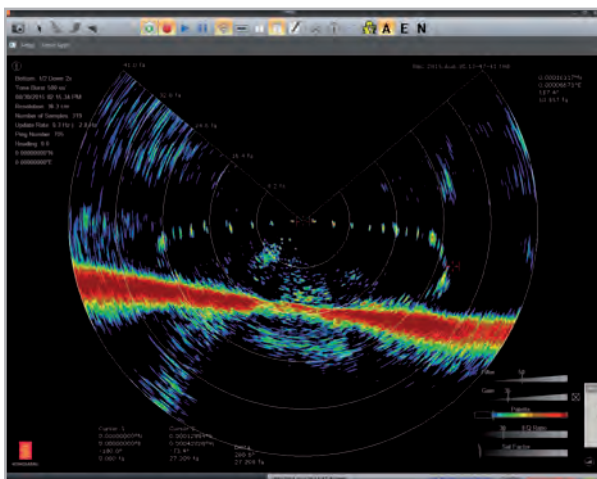

In the above picture the net is solid on the bottom and still the net geometry and fish entrance is easily seen.

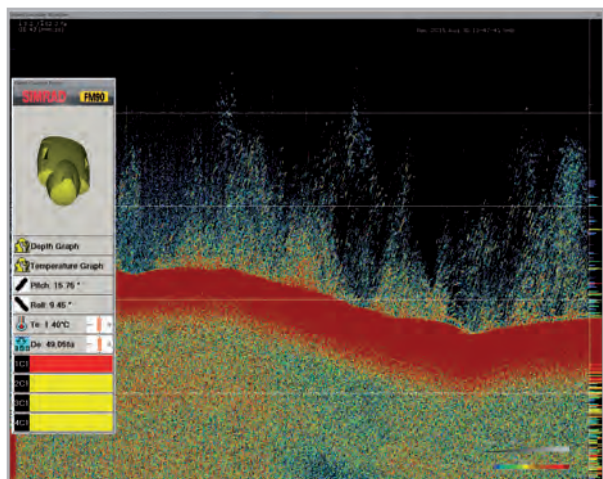

# Sensor location and available functions

## 1 Doors (Multisensor MK2)

Function	Lid type
Spread	Any
Roll	Any
Pitch	Any
Height	Any
Depth	Depth/temp lid
Temperature	Depth/temp lid
Remote for geometry	Geometry transponder lid
Remote for spread	Any

## 2 Wings (Multisensor MK2)

Function	Lid type
Spread	Any
Height	Any
Depth	Depth/temp lid
Temperature	Depth/temp lid
Remote for geometry	Geometry transponder lid
Remote for spread	Any

## 3 Clump (Multisensor MK2)

Function	Lid type
Remote for geometry	Any
Remote for spread	Any

## 4 Headline (Multisensor MK2)

Function	Lid type
Geometry	Any
Height	Any
Roll	Any
Pitch	Any
Depth	Depth/temp lid
Temperature	Depth/temp lid

## 5 Headline (TrawlEye)

Function	Lid type
Echogram	Any
Geometry	Any
Height	Any
Roll	Any
Pitch	Any
Depth	Depth/temp lid
Temperature	Depth/temp lid

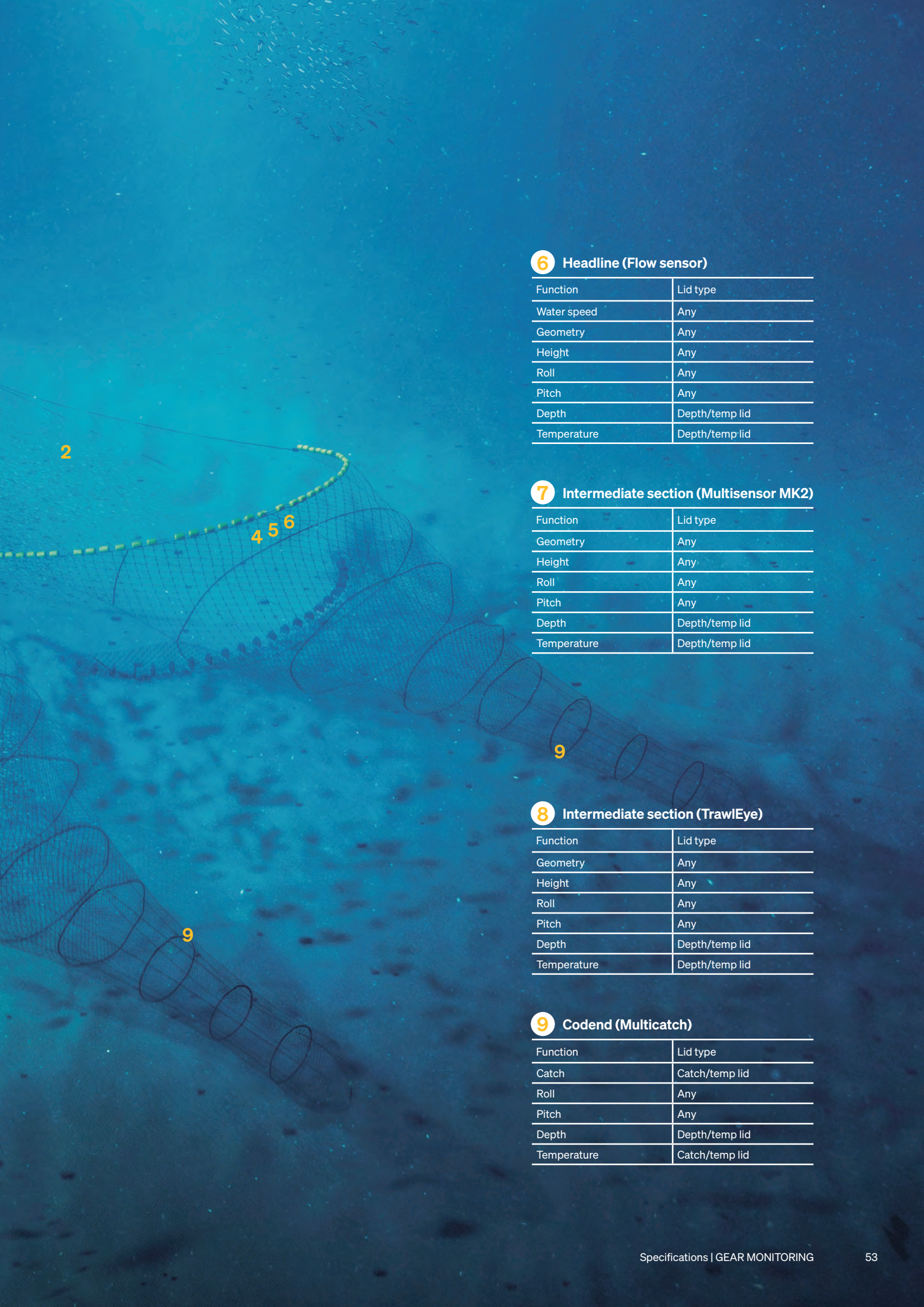

**6** **Headline (Flow sensor)**

Function	Lid type
Water speed	Any
Geometry	Any
Height	Any
Roll	Any
Pitch	Any
Depth	Depth/temp lid
Temperature	Depth/temp lid

**7** **Intermediate section (Multisensor MK2)**

Function	Lid type
Geometry	Any
Height	Any
Roll	Any
Pitch	Any
Depth	Depth/temp lid
Temperature	Depth/temp lid

**8** **Intermediate section (TrawlEye)**

Function	Lid type
Geometry	Any
Height	Any
Roll	Any
Pitch	Any
Depth	Depth/temp lid
Temperature	Depth/temp lid

**9** **Codend (Multicatch)**

Function	Lid type
Catch	Catch/temp lid
Roll	Any
Pitch	Any
Depth	Depth/temp lid
Temperature	Catch/temp lid

# Trawl sensor specifications

	PX universal		PX multisensor		PX Flow sensor	PX miniCatch		PxPos
	Depth	Standard	Multisensor MK2	TrawlEye		Depth	Standard	
Communication frequency	39-50 kHz		39-50 kHz		39-50 kHz	40-70 kHz		27-33 kHz
Echosounder / Transverse working frequency	70 kHz		70 kHz	200 kHz	70 kHz	70 kHz		70 kHz
Maximum communication distance	2500 m		2500 m	2000 m <sup>(1)</sup>	2500 m	2500 m		2000 m
Depth rating	1400 m <sup>(2)</sup>		1400 m <sup>(2)</sup>		1400 m	1400 m		1400 m
Maximum number of measurements	8		8	6	8	8		4
Update interval	2 s.		2 s.	0,5 s.	2 s.	2 s.		7 s.

## Charging time

Up to 70 % of total capacity (hours)	2,5	2,5	2,5		
Up to 100 % of total capacity (hours)	4	4	4	2	4

## Weight

In air	6,5 kg	7,6 kg	7,3 kg	9,5 kg	5 kg	7,6 kg
In water	3,5 kg	3,5 kg	3,5 kg	3,5 kg	1,5 kg	3,5 kg

Door spread maximum range		600 m	N/A	N/A	N/A	N/A	600 m
Geometry maximum range		N/A	600 m	N/A	600 m	N/A	N/A
Acoustic depth / Height maximum range	100 m	100 m		100 m	50 m	100 m	

(1) Depending on sea conditions, noise level, sensor alignment, output power

(2) Note: depth lid only goes to 1000 m





# Trawl Unit specifications

	SR15	SR70	TP90	FX
--	------	------	------	----

## Processing Unit

Voltage	9-30 VDC, 110/220 VAC		9-48 VDC, 100-240 VAC	
Consumption	120 W, 24 VDC		120 W	
Processor type	Fanless PC computer		Intel Core i7-7700T, 2.9 GHz, 4 Cores	
Operating system	Windows™ 10		Windows™ 10 IoT	
Display output	Dual		Multiple	
Serial interface I/O	2 x RS232 / 6 x USB		2 x RS232 / 6 x USB	
Ethernet interface	3		2 x GbE LAN	
Display resolution	HDMI / DP		2 x DP, 1 x DVI-I, 2 x DP to HDMI ADAPTER	
Software	TV80*		FX, DATTS, FM90i, TV80*	

## Surface Telemetry Units (STU)

Input voltage, VAC		115-240
Power consumption, W		800
Subsea cable voltage, VDC		400
Link speed		Up to 8 Mbps
Dimensions, cm		48,3 × 12,6 × 49,2
Weight, kg		10,07

## Wireless sensors TX / RX / Headrope Unit

	(Installed on boat)	(Installed on boat)	
Voltage	24 VDC **		12 VDC, 100/230 VAC
Consumption	2 A		5 A, 12 VDC
Hydrophone connection	1	4	2
Hydrophone type	Single beam with preamplifier		Split beam
Frequency range	39,4-50,5 kHz		
Ethernet interface	1		1
Maximum range to sensors ***	2500 m		2500 m
Sensor compatibility	SIMRAD PX Sensors		SIMRAD PxPos
RX channels	16		10
Measurements	Max. 8 per sensor		Like PX + bearing and distance

	FM90i	FX80i	Camera HUB
--	-------	-------	------------

## Headrope Units

Sonar head	Multibeam 200 kHz CHIRP	Single beam CHIRP, choice of 120, 330 or 675 kHz	N/A
Sonar beamwidth, deg	3 × 20	5 × 40/3 × 30/2,7 × 25	N/A
Echosounder frequency	200 kHz	200 kHz CHIRP	N/A
Echosounder beamwidth, deg	10 × 20	10 × 20	N/A
Depth rating, m	1000	1000	1000
Pitch / roll / depth / temperature	External, included	External, included	Optional
Available Ethernet ports for cameras and other sonars	1	2	3
Wireless sensor receiver	SR15	SR15	N/A
Sensor compatibility	PX MK2	PX MK2	N/A
Deployment package	Urethane	Urethane	Urethane
Dimensions, cm	83,6 × 40,6 × 29,2	76,8 × 50,9 × 21,8	73,9 × 42,5 × 27,2
Weight in air, kg	37,6	44,54	30

\* TV80 included in models with built in sensor receiver

\*\* 115/230 VAC to 24 VDC Adaptor included with the delivery

\*\*\* Detection range depends on transducer installation, ambient noise level, temperature gradient and sensor alignment

# FS70 system diagram

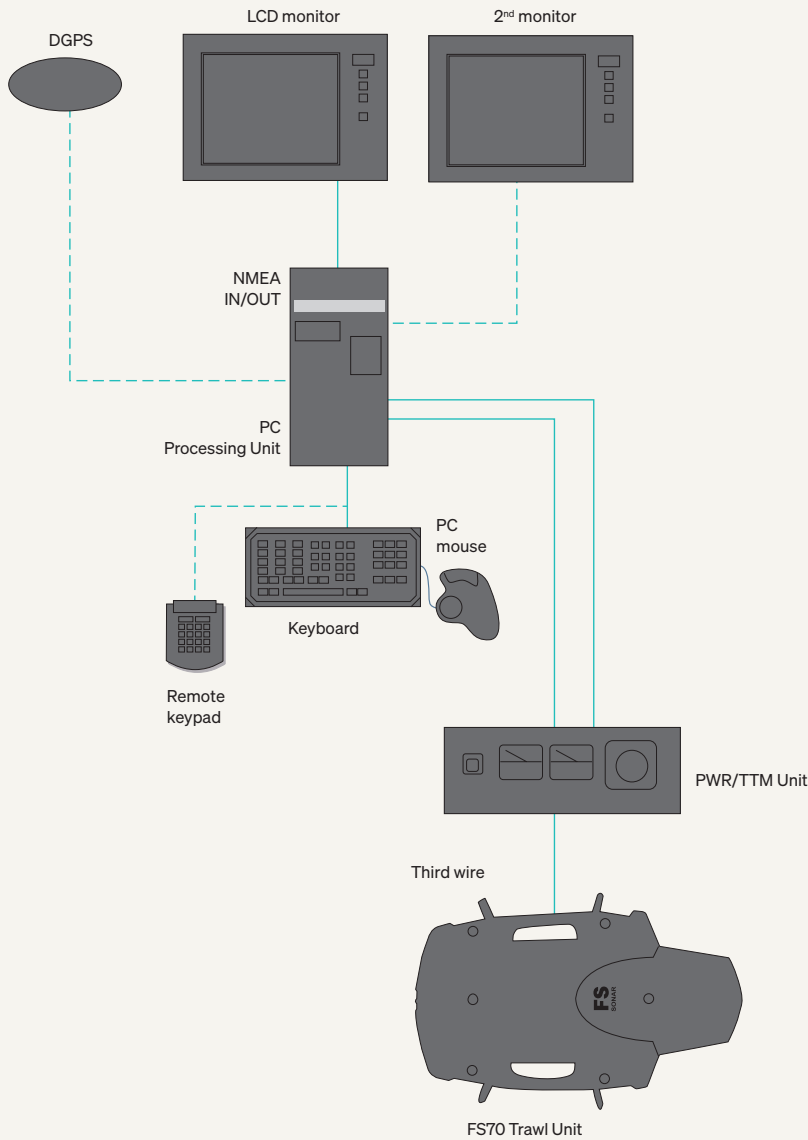

## FS70 Trawl Unit

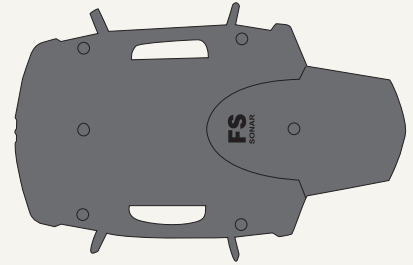

Width: 790 mm  
 Height: 430 mm  
 Depth: 270 mm  
 Weight: 28 kg

## FS70 Trawl Unit

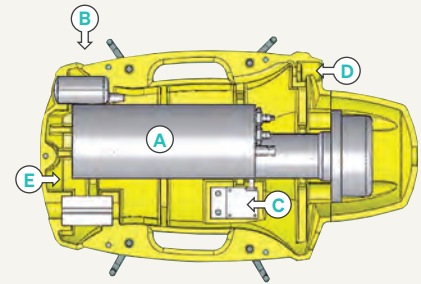

- A. Sonar head
- B. Receiving hydrophone (PI, PX, FA701)
- C. Echosounder transducer
- D. Receiving hydrophone (PI, PX)
- E. Cable strain relief

## FS70 Head



# Gear Monitoring components typical configuration



## System diagram

- A. Display
- B. Keyboard and trackball
- C. Processor
- D. SR70 transceiver
- E. Hydrophones
- F. Sensors charger

# FM90i system diagram

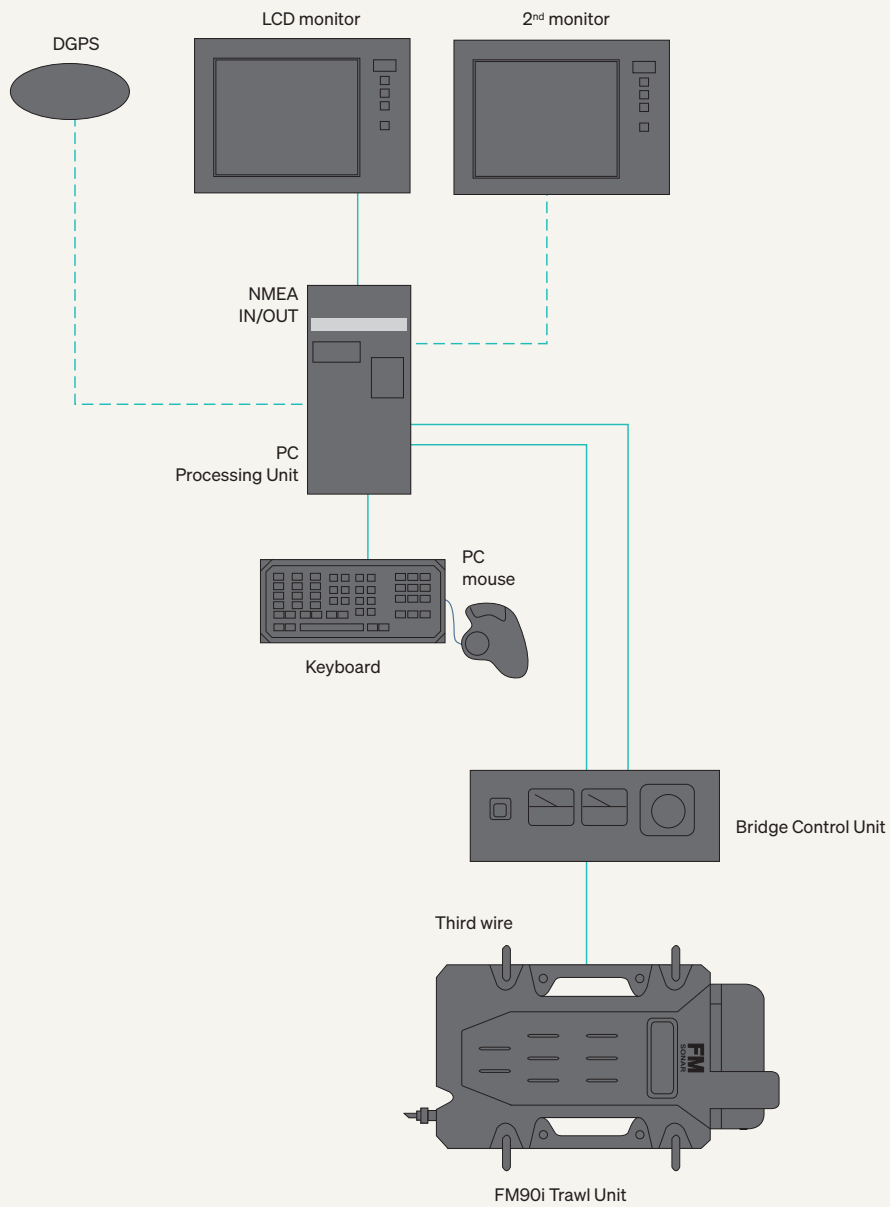

**FM90i Trawl Unit**



Width: 410 mm  
 Height: 300 mm  
 Length: 840 mm  
 Weight: 35,5 kg

**FM90i Trawl Unit**

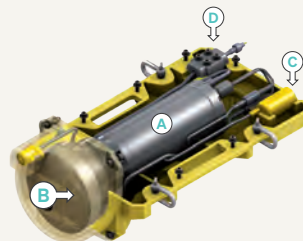

**A.** Sonar head  
**B.** Receiving hydrophone (PI, PX)  
**C.** Receiving hydrophone (PI, PX)  
**D.** Cable strain relief

**FM90i Head**



# Support

## Main services centers

### Kongsberg Discovery AS

SIMRAD Fisheries  
Strandpromenaden 50, 3191 Horten, Norway  
Ph.: +47 3303 4000  
simrad.sales@simrad.com

### SIMRAD Fisheries North America

19210 33rd Ave W, Suite B, Lynnwood, WA 98036, USA  
Ph.: +1 425 712 1136  
simrad.usa@simrad.com

### Kongsberg Maritime Mesotech Ltd.

1598 Kebet Way, Port Coquitlam B.C., V3C 5M5, Canada  
Ph.: +1 604 464 8144  
km.sales.vancouver@kongsberg.com

### Kongsberg Discovery Spain

Partida Atalayas 20, 03570 Villajoyosa, Spain  
Ph.: +34 966 810 149  
simrad.spain@simrad.com

### Kongsberg Discovery Spain

5 rue de Men Meur, 29730 Guilvinec, France  
Ph.: +33 298 582 388  
simrad.france@simrad.com

### Kongsberg Maritime Malaysia Sdn. Bhd

Unit 27-5 Signature Offices, The Boulevard, Mid Valley City,  
Lingkar Syed Putra, 59200 Kuala Lumpur, Malaysia  
Ph.: +65 64117488 Local: +60 32201 3358  
simrad.asia@simrad.com

### Kongsberg Maritime Korea Ltd.

SIMRAD Korea  
#1101-Harbor Tower, 113-1, Nampodong 6-Ga, Jung-Gu, Busan  
600-046 Korea  
Ph.: +82 512 42 9933  
simrad.korea@simrad.com

### Kongsberg Maritime China Ltd.

555 Chuanqiao Road, China (Shanghai) Pilot Free Trade Zone  
201206 China  
Ph.: +86 21 3127 9888  
simrad.china@simrad.com

## SIMRAD distributors

### Argentina

R.C. International  
Av. Santa Fe 5009, 18th 03 T1, Ciudad de  
Buenos Aires (1425), Argentina  
Ph.: +54 11 4773 5376  
info@rcinternational.com.ar

### Chile

Robinson Marine Electronics S.A.  
Avenida Gomez Carreno 3189, Talcahuano,  
Chile  
Ph.: +56 4157 7480 Mobile: +56 9599 2409  
servicio@robinsonme.cl

### Greece & Cyprus

Aegean Electronics SA  
4, Zosimadon Street, 185 31 Piraeus, Greece  
Ph.: +30 210 412 3000  
service@aegeanel.com

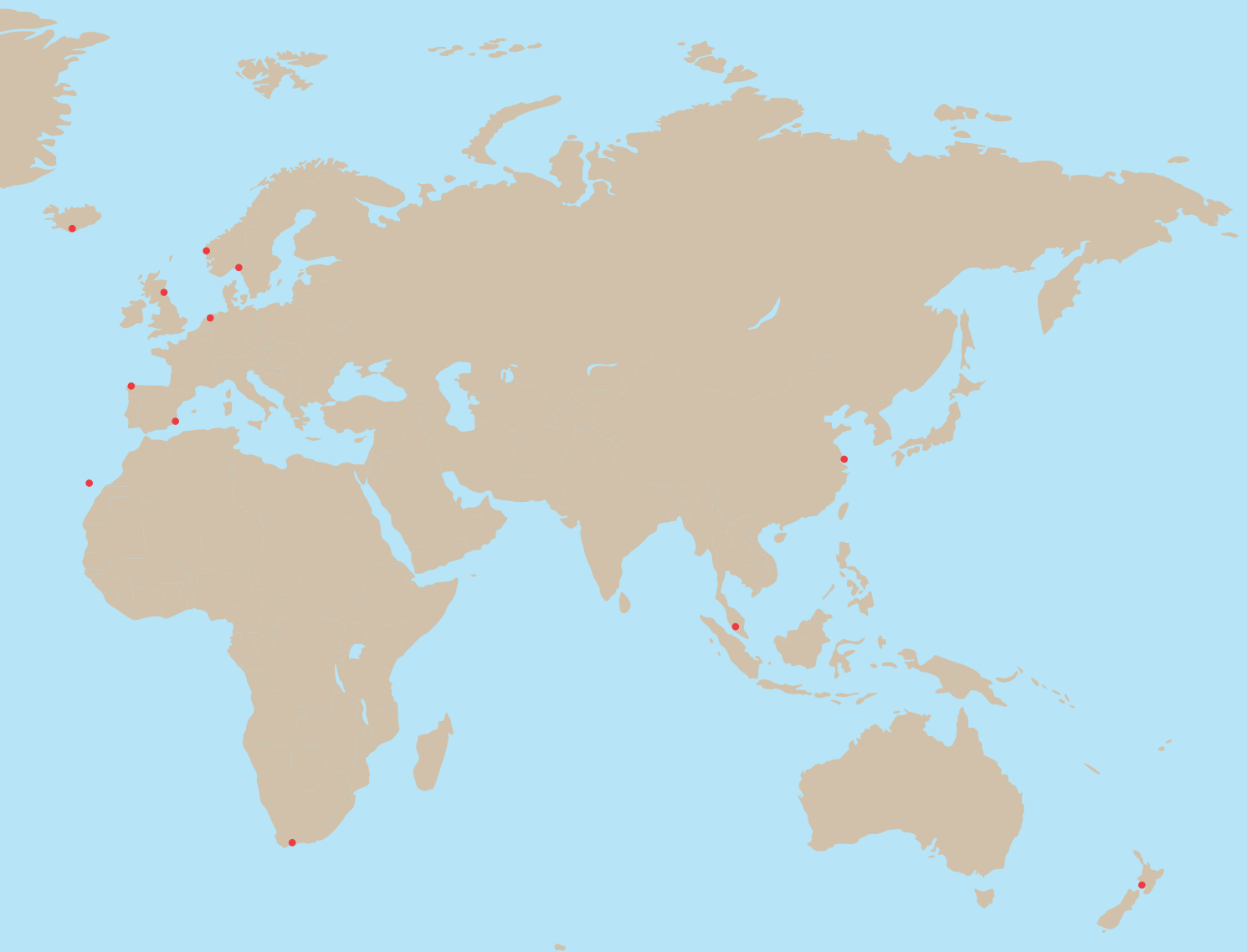

**Iceland**

Simberg ehf  
Askalind 2, 201 Kópavogur,  
Iceland  
Ph.: +354 4144414  
valdi@simberg.is

**New Zealand & Australia**

Advance Trident Ltd.  
383 New North Road, Kingsland,  
Auckland, New Zealand  
Ph.: +64 9 845 5347  
craigg@advancetrident.com

**Peru**

Robinson Marine Electronics  
S.R.L.  
Av. Los Topacios 268, Urb. San  
Antonio. Callao-2, Peru  
Ph.: + 51 1 715 6848  
robinsonperu@robinsonme.com

**South Africa**

Marine Radio Acoustic Devices  
P.O.Box 12076, N1 City, 7463 Cape  
Town, South Africa  
Ph.: +27 21 559 4003  
simradsa@iafrica.com

**Turkey**

Promar (Marine Equipment Inc)  
Deniz Malzemeleri Ltd. STI.  
Postane Mah. Bozdogan Sok. no. 8,  
34940 Tuzla - Istanbul, Turkey

**UK & Scotland**

Echomaster Marine Ltd., 25 Shore  
St, Macduff AB44 1TX, Great  
Britain  
Ph.: +44 1261 831644

For additional support centers,  
please see [www.kongsberg.com](http://www.kongsberg.com) for  
more details.









# Drawings

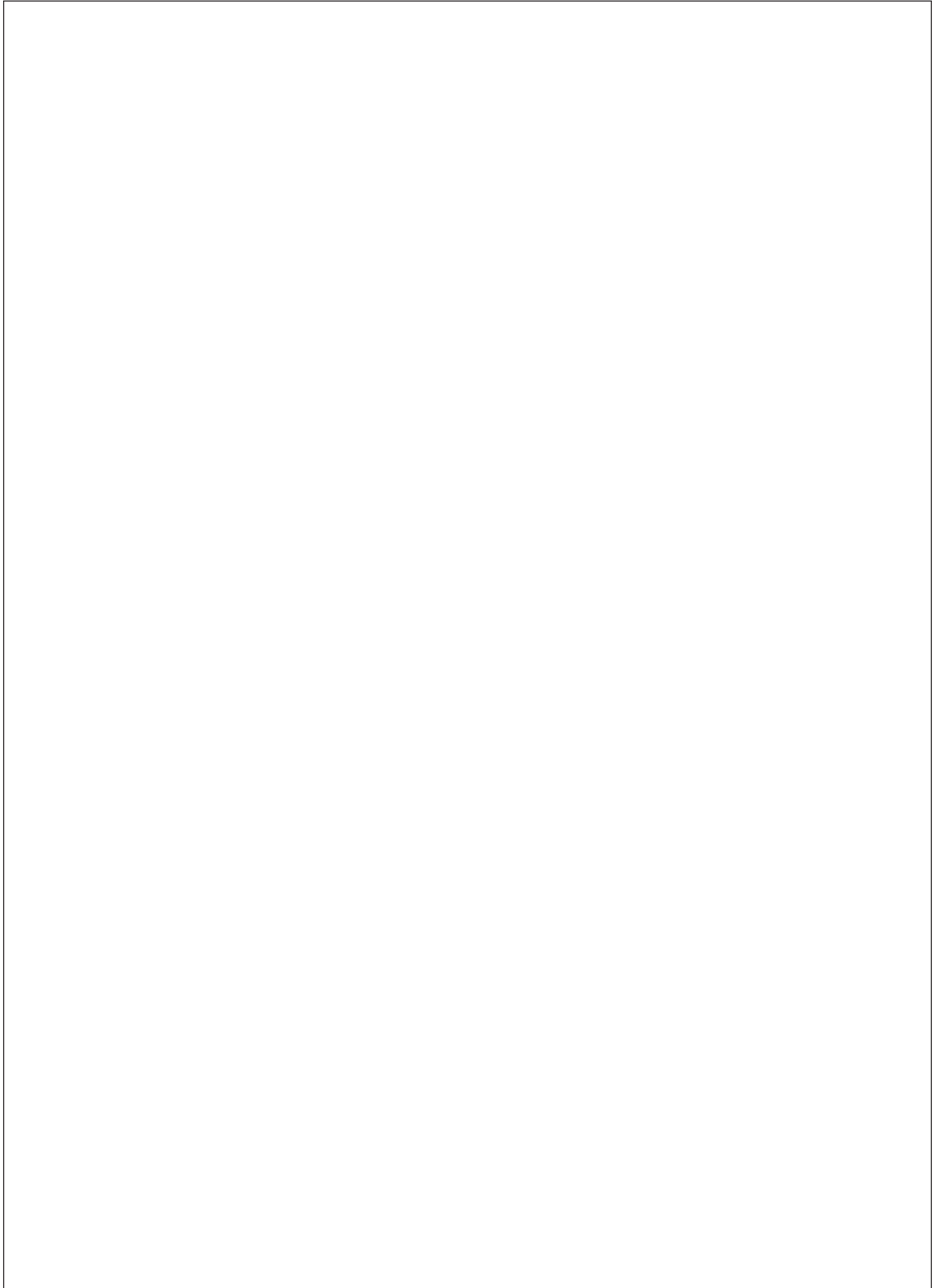



Discovering the  
**secrets** of the ocean

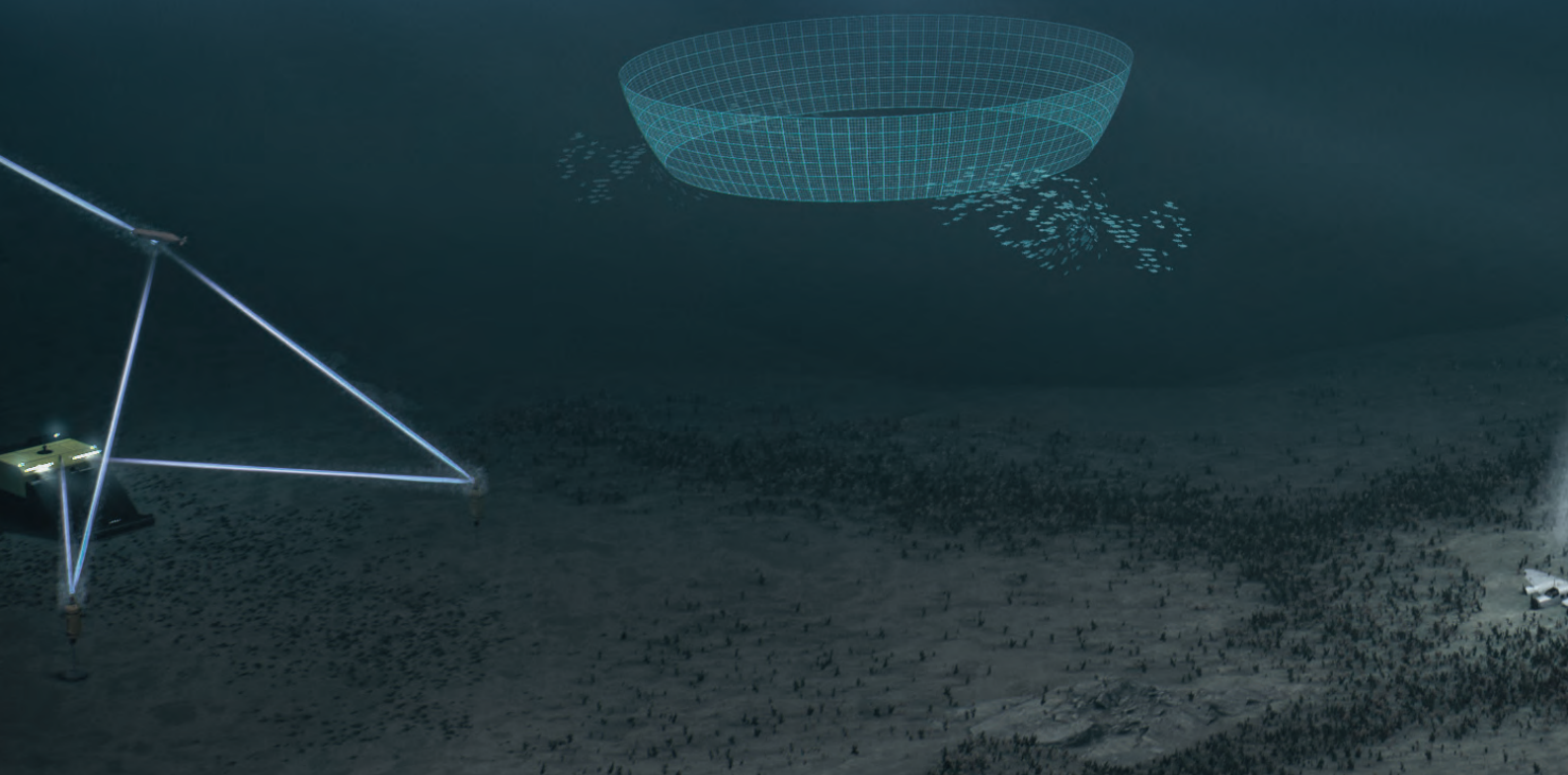



KONGSBERG



# Protecting people and planet