



Water Prediction and Ecosystem Services

Theme Leads:

Naresh Devineni and Tarendra Lakhankar



Funded by the National Oceanic and Atmospheric Administration – Center for Earth System Sciences and Remote Sensing Technologies under the Cooperative Agreement Grant # NA16SEC4810008



Task 1: Drought risk assessment using demand data and remote sensing products

Task Lead: Nir Krakauer / Tarendra Lakhankar (CCNY)
Researchers: Naresh Devineni, Indrani Pal and Reza Khanbilvardi
NOAA Collaborator(s): Xiwu Zhan (NOAA/NESDIS/STAR) and Roger Pulwarty* (ERSL)

Expected Outcome: Estimating trends in natural hazards and hydrologic droughts, along with a complete database of demand-based drought indices and real-time probabilistic forecast methods for drought quantiles.

- Assessment of risk for various sectoral operations could be much better informed if appropriate stress indices were developed for drought conditions relative to current and projected demands and their quantiles predicted ahead with period real-time update using satellite remote sensing data.
 - Develop drought indices that consider variability in climate and changing demands to accurately represent the duration and severity of drought at monthly to annual timescales.
 - Validate drought indices with SMOS and SMAP soil moisture data. Soil moisture anomalies will be combined with NDVI to provide current assessments of vegetation health.
 - Assess the long-term trends in droughts and explore the potential for drought predictability at lead times of 0-6 months using multi-model seasonal ensemble forecasts and climate predictors to potentially inform decision making at the sector level for near-term adaptation and risk hedging.
-
- Cassandra Calderella (PhD student) is processing the vegetation and soil moisture (AMSR2) data using Python and Matlab scripting.
 - Abraham Rubel (UG Student) is working on the demand drought indices and developing extreme value distributions for droughts in the US.
 - Damien Hudson (MS Student) joined this summer. He will start working on economic impacts on extremes in the US.

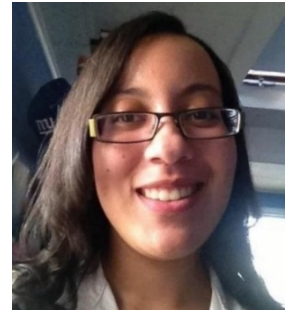

Cassandra Calderella
(PhD Student, Cohort I)



Damien Hudson
(MS Student, **new**)



Abraham Rubel
UG Student, Cohort I

Task 1: Drought risk assessment using demand data and remote sensing products

Researcher: Indrani Pal
Students: Nicolas Maxfield (MS Student) and Jahnelle Howe (UG student)
NOAA Collaborator(s): Dr. Cameron Speir (NOAA Southwest Fisheries Science Center)

Diagnosing low flows across the U.S. and their implications on fishery

- Nicolas Maxfield and Jahnelle Howe are working on identifying the most vulnerable locations where human modifications, along with meteorological drought incidence shapes the dynamics of low river flows across the U.S.
- Ariel Avgi (UG scholar) has been working on identifying concurrent incidences of extreme hot and dry spells over the global croplands and studying implications on wheat production in the major growing countries. Ariel presented an oral presentation at the NOAA EPP Forum 2018.



Nicolas Maxfield
(MS Student)



Jahnelle Howe
(UG student)-
MS Student/ESE 2018



Ariel Avgi
(UG Student)

Study locations: Reference and non-reference river gauges

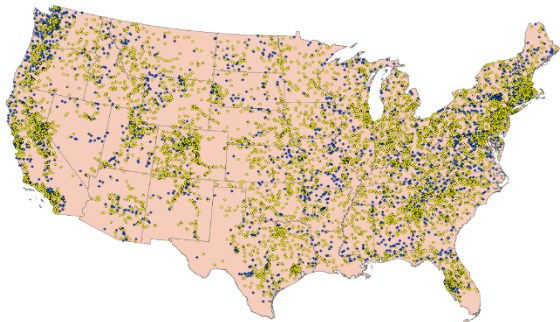

Watershed regions

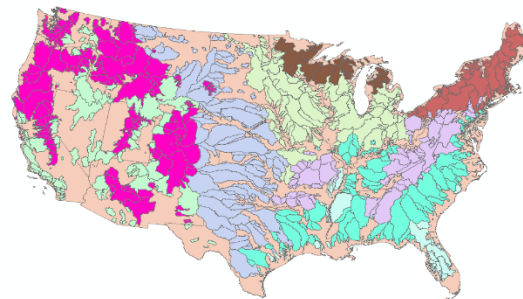

NERTO Project:

Maxfield is currently doing his NERTO (summer 2018) at NOAA/NMFS/SFSC, Santa Cruz, CA (June 12, 2018-September 14, 2018)

He working on the ecological and fish data collected from specific locations that fall under “vulnerable” category to study the implications of low flow incidence on fish productivity.

Task 2: Flood risk assessment using in-situ data and remote sensing data products

Task Lead: Tarendra Lakhankar
NOAA Collaborator(s): Xiwu Zhan (NESDIS/STAR), Bob Rabin (NSSL)
 Dennis Atkinson and Jack Harlan, Alan Cope (NWS)

Expected Outcome: A high-resolution blended precipitation product using our latest New York City urban Hydro-Meteorological Testbed (NY-uHMT) and remote sensing data for flood prediction and vulnerability mapping.

- Adedoja Adeyeye is engaged in installing weather stations for the urban Hydro meteorological Testbeds (uHMT) across New York City. A total of 17 weather stations were installed during last year and the data is being processed in real-time.
- Aye Phyu and Cesar Hincapie are working on NCDC stations and radar rainfall data to develop flood risk assessment models.



Adedoja Adeyeye
(Cohort I: MS Student)



Aye Phyu (UG Student)
2018-2020 NOAA
Hollings Scholars

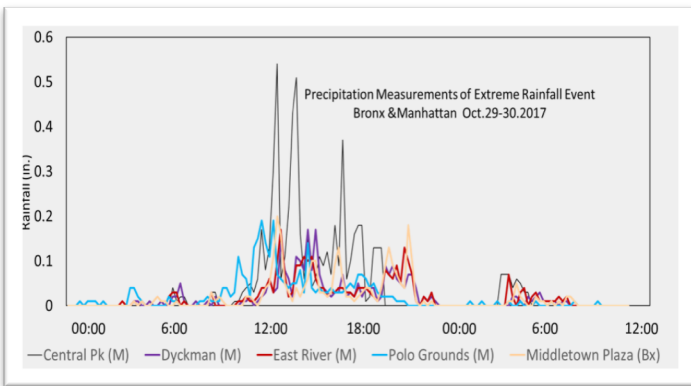

NERTO Project Title for Adedoja Adeyeye:
 Statistically evaluating the quality of satellite based SM products for flood assessment and drought monitoring applications
NERTO Location: STAR office, College Park, MD
NERTO Period: June 4 – August 24, 2018



Siena Dante
(Cohort II: UG Student)

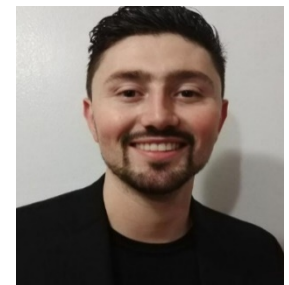

César Hincapie
(Cohort II: UG Student)

- To understand the **intra-urban variability** in hydro-meteorological properties
- To aid in designing **early warning systems** for heatwaves and storms
- To aid in developing **mitigation strategies** to combat extreme heat and flooding. (e.g. green infrastructure)
- To help urban climate **modeling framework**.
- Serve as an **educational platform** for the City and beyond.

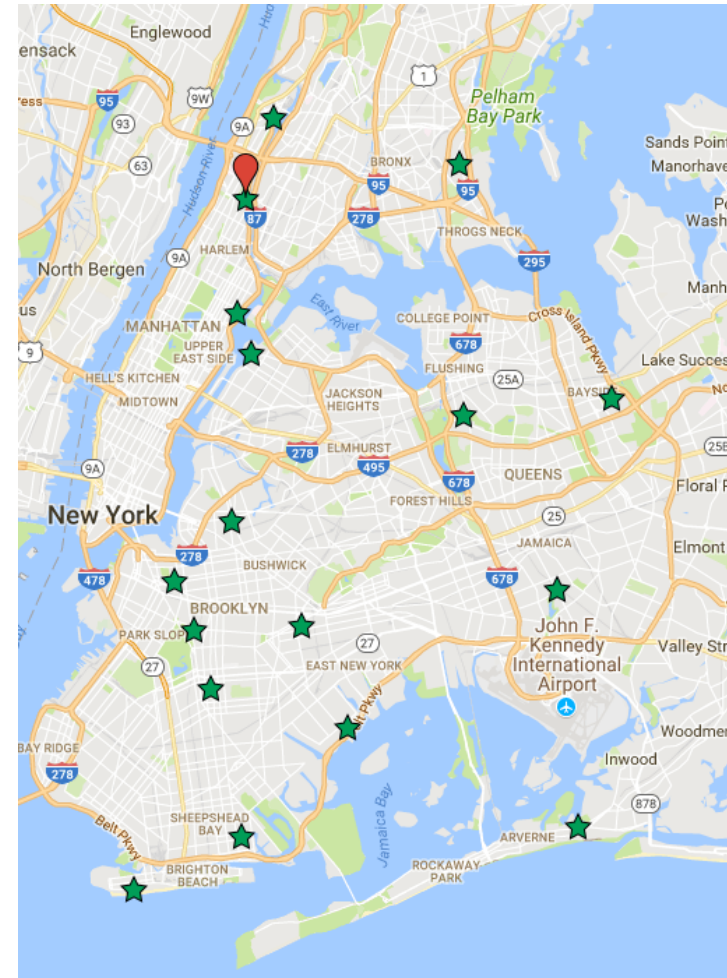
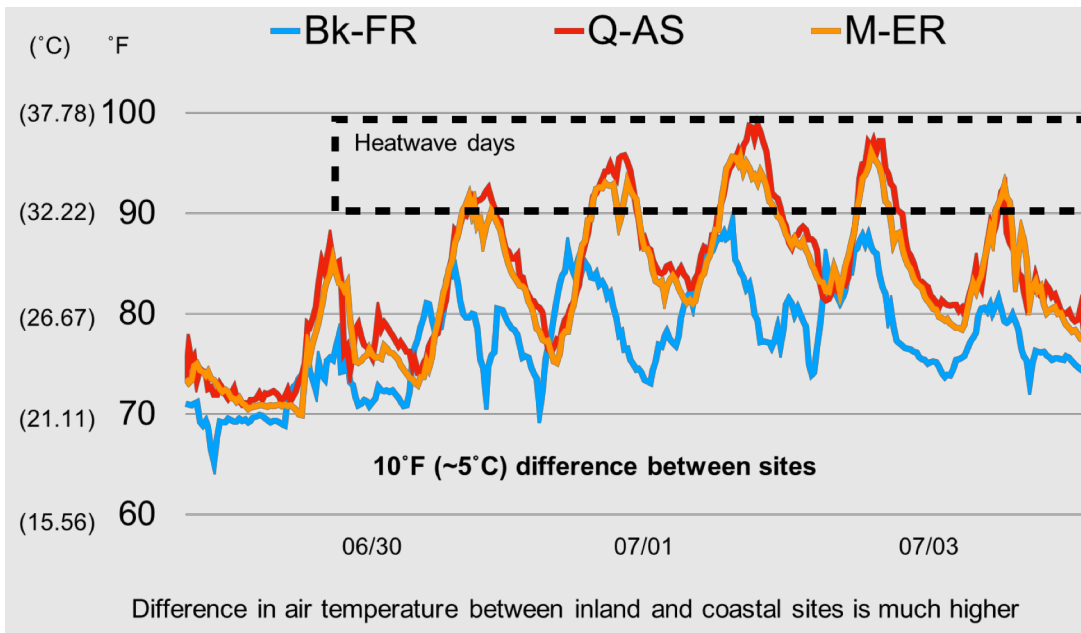

<http://www.noaacrest.org/uHMT/>

Sites located in Schools, Botanical Gardens, and in NYCHA Properties.

Task 3: Assessment and Improvement of National Water Model Development and validation of snow data product

Task Lead: Tarendra Lakhankar
Researchers: Peter Romanov, Naresh Devineni, Nir Krakauer
NOAA Collaborator(s): Ralph Ferraro (NESDIS/STAR), ** ESRL Team

Expected Outcome: Development of a new snow and ice climatology product, assessment of remote sensing based forcings, and their integration into the National Water Model. Exploration of the utility of the National Water Model for flash flood predictions.

- The primary intent is to develop new and improved snow and ice cover climatology and a corresponding daily dataset covering the period from 1998 to 2016 for use in climate modeling and in particular within the joint NOAA and NASA Global Precipitation Mission (GPM) project.
- This task also complements the derived high-resolution snow extent maps with snow depth and snow water equivalent (SWE) data. Information on the snow depth and SWE will be derived from observations of SSM/I, SSMIS and AMSR2 sensors.
- Integration of satellite observations into hydrological models is crucial for the future development of the National Weather Service (NWS) operational streamflow and flood forecast system. The National Water Model (NWM) is a hydrologic model that simulates current and forecast streamflow over the entire continental United States (CONUS).
- This task aims at improved understanding of physical processes represented in NWM and future model development. Under this task, we will investigate the use of the Weather and Research Forecasting Hydrological modeling system (WRF-Hydro), which is the core of the NWM operated by the NOAA's National Water Center (NWC), in simulating streamflow and major flood events caused by heavy rainfall and snowmelt.
- This research would include assessing the efficacy and impacts of atmospheric forcings used to drive the NWM for both wet and dry extreme conditions and in monitoring and prediction to inform drought and flood risk management.



Stephany Paredes Mesa
(Cohort I: MS Student)



Jessica Chiu
(Cohort II: UG Student)
Study Abroad, Spain June 2018



Engela Stapit
(Cohort III: PhD Student)
joining in Fall 2018)



CREST Microwave Radiometers

CREST-SAFE	SSMI	AMSR-E/2	TMI	WindsAT	GMI (GPM)
		6.93 VH		6.8 VH	
10.65 VH		10.65 VH	10.7 VH	10.7 VH	10.65 VH
19 VH	19 VH	18.7 VH	19.4 VH	18.7 VH	18.7 VH
	22 V	23.8 VH	21.3 V	23.8 VH	23.8 V
37 VH	37 VH	36.7 VH	37 VH	37.0 VH	36.5 VH
89 VH	87 VH	89 VH	85.5 VH		89.0 VH



CREST-SAFE Microwave Observations

- Spectral bands same as at satellites
- Polarized (V,H)
- Collected at 30 sec interval 24/7
- Resampled to 5 min interval
- Calibration 3-4 times a year
- Less than 3% data loss in the last two winter seasons

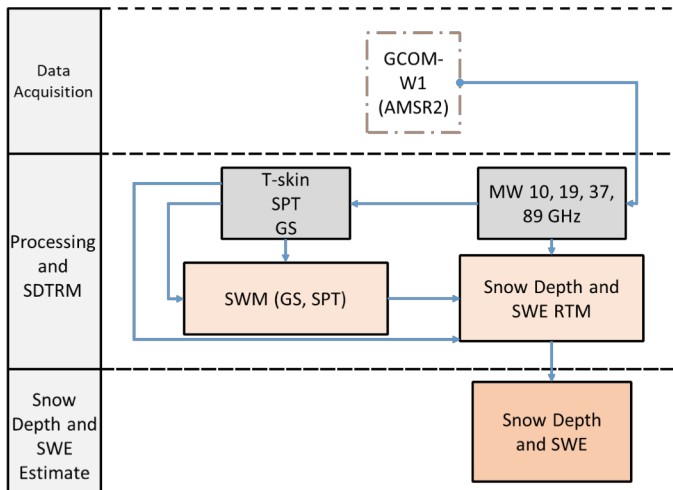
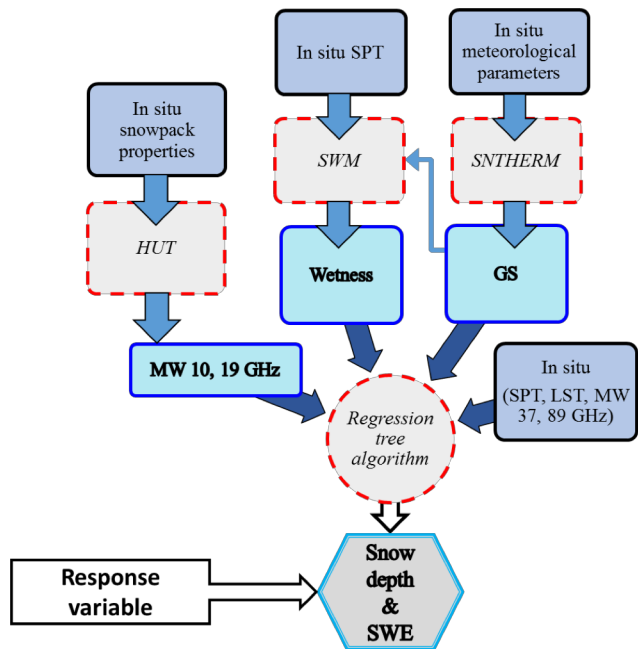

Snow depth

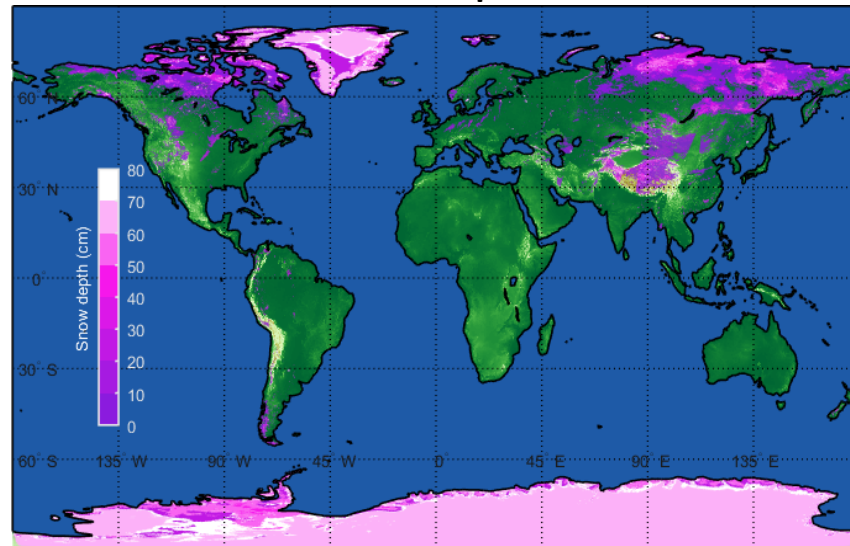

SWE

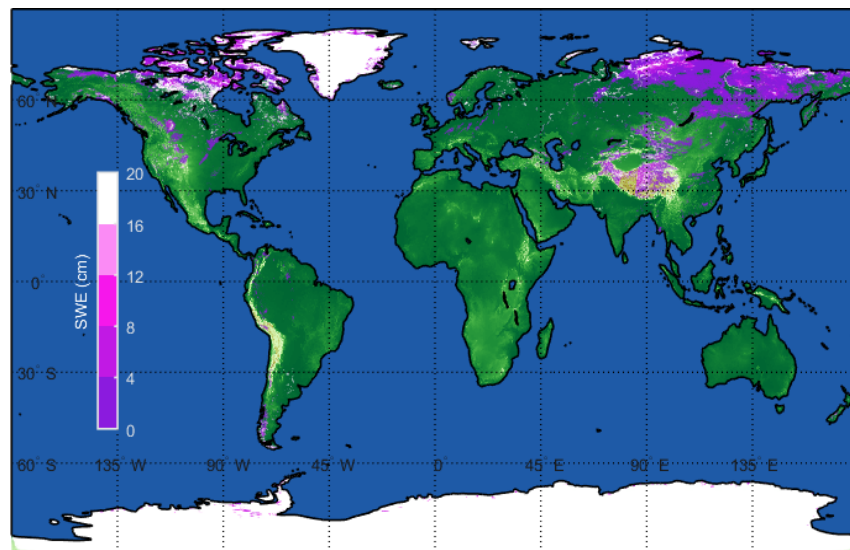

Task 3: Assessment and Improvement of National Water Model

Development and validation of snow data product

Task Lead: Tarendra Lakhankar
 Researchers: Jonathan Munoz
 NOAA Collaborator(s): Ernesto Rodriguez (NWS), Robin Webb, Richard Lataitis and Rob Cifelli (PSD/ESRL)



Jean P. Valle
(Cohort II: MS Student)

- Jean P. Valle is working on implementation and validation of WRF-Hydro for watersheds in Puerto Rico with complex Topography & Land Cover. He will test the application of WRF-Hydro for a Distributed Flash Flood Guidance system in Puerto Rico.
- Jean was selected to participate in: (1) NCAR Training Workshop: The Community WRF-Hydro Modeling System and (2) CUAHSI - Summer Institute at National Water Center. Both activities will help Jean's to acquire the necessary skills to implement and improve the model for Puerto Rico watershed.

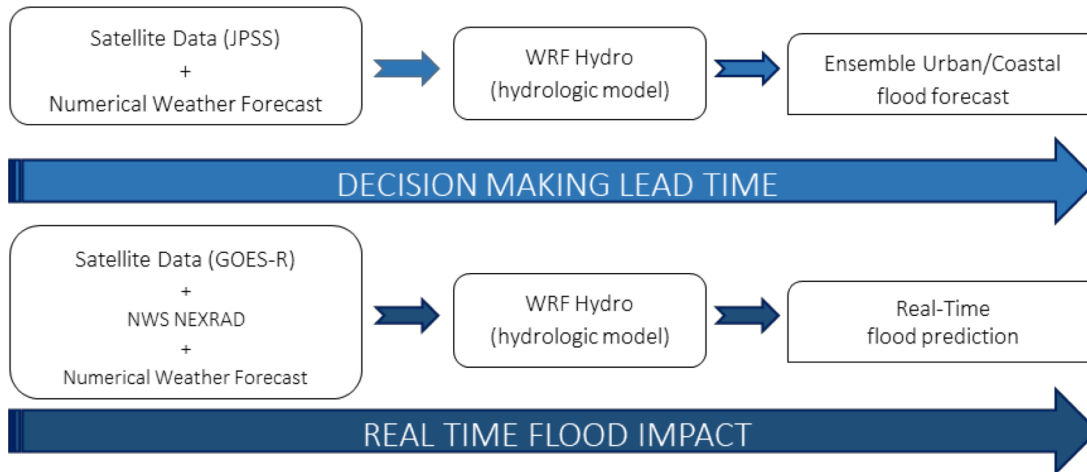

Visit to NWS- San Juan
(February 2018)

NERTO Project Title for Jean P. Valle:
 Ensemble flood forecasting system coupling WRF-Hydro with Satellite Data for Puerto Rico
 NERTO Location: TBD (NWS-San Juan or ERSL or NWC)
 NERTO Period: Spring 2019

Task 4: Monitoring land-atmosphere-ocean fluxes

Task Lead: Walter Oechel (SDSU)
 CREST Researchers: Trent Briggs, Fernando De Sales
 NOAA Collaborator(s): Alexander Tardy (NWS)

Expected Outcome: Monitoring environmental and flux data from SDSU's eddy covariance flux towers and mapping regional ET of the recent decades (2000 - 2018) for implementation of SEBAL and METRIC models in the Western United States.

- Corrie has been working on model configuration for domain and model physics; has also conducted statistical analysis for Southern California's surface climate and winegrape suitability (including variables such as Growing Degree Days).
- Her work is focused on conducting a regional assessment of recent and future change in evapotranspiration, soil moisture, precipitation, and winegrape suitability in Southern California from the perspective of regional climate modeling.



Corrie Monteverde
(MS Student)

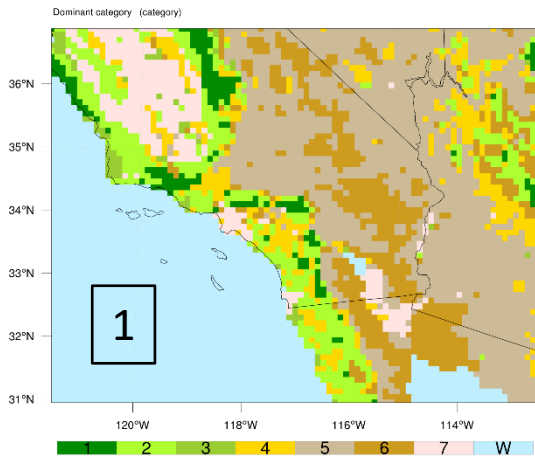

- [1] Evergreen forest
- [2] Grassland
- [3] Deciduous forest
- [4] Shrub with ground cover
- [5] Shrub without ground cover
- [6] Bare ground
- [7] Crops/urban
- [W] Water

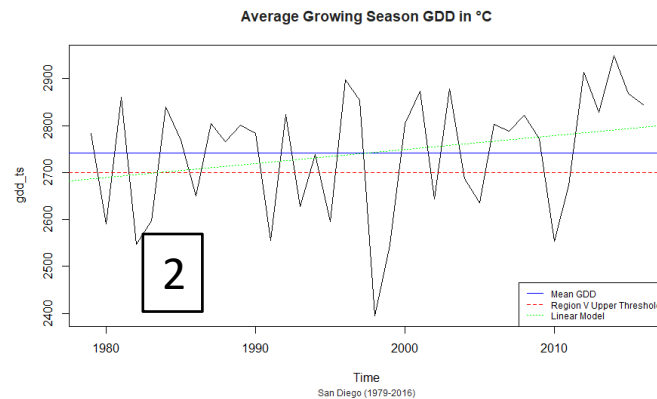

NERTO Project Title for Corrie Monteverde:
 Assessing the impacts of global warming on Southern California's evapotranspiration and winegrape suitability
 NERTO Location: National Weather Service, Rancho Bernardo, CA
 NERTO Period: June 4 – August 24, 2018

- [1] Vegetation map for Southern California, produced by climate model data and based on MODIS measurements
- [2] Growing Degree Days (San Diego)

Task 4: Monitoring land-atmosphere-ocean fluxes

Task Lead: Walter Oechel (SDSU)
NOAA Collaborator(s): Lauren Jarlenski and Mareike Sudek (NOS)

- Andrea Fenner is currently investigating the effects of drought conditions on CO₂ flux in a semi-arid chaparral ecosystem of Southern California through the use of eddy covariance techniques.



Andrea Fenner
(Ph.D. Student)



Jessica Montes
(UG Student)

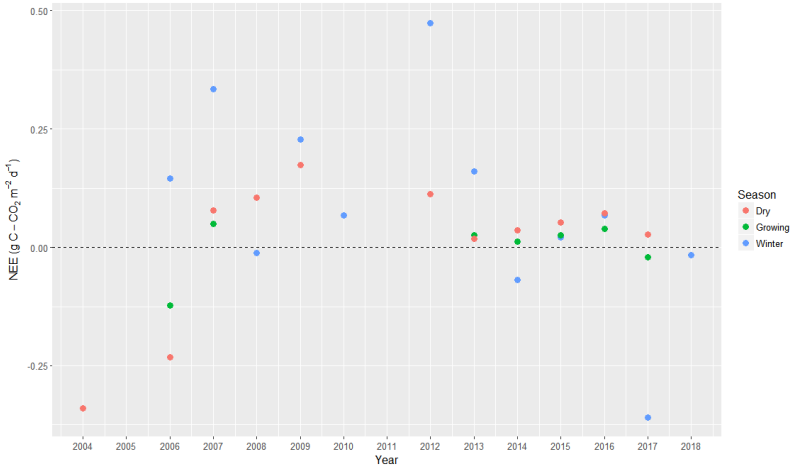

Average seasonal net ecosystem exchange (NEE) during the years of 2004 to 2018 collected by one of the eddy covariance towers in Southern California: New Stand Tower, winter season (November 1st to February 28th), growing season (March 1st to June 30th), dry season (July 1st to October 31st).



Young Stand Eddy Covariance Tower



Old Stand Eddy Covariance Tower



Sky Oaks Ecological Reserve.
Chaparral/Southern California



New Stand Eddy Covariance Tower

NERTO Project Title for Andrea Fenner:
The effects of land cover, land use, and runoff on CO₂ flux and coral reef health in American Samoa
NERTO Location: National Marine Sanctuary of American Samoa (NMSAS) and the American Samoa Observatory (SMO)
NERTO Period: June 4 – August 27, 2018

Task 4: Monitoring land-atmosphere-ocean fluxes

Task Lead: Dr. Walter Oechel / Donatella Zona
 NOAA Collaborator(s): Lauren Jarlenski and Mareike Sudek (NOS)

- Michael (MS student) is working on the efflux of CO₂ over ecosystems and how it is changing as anthropogenic factors are an increasing effect on said ecosystems.
- Michael will be working in American Samoa taking in situ measurements in several ecosystems around the island.



Michael Trunkhill
(MS Student)

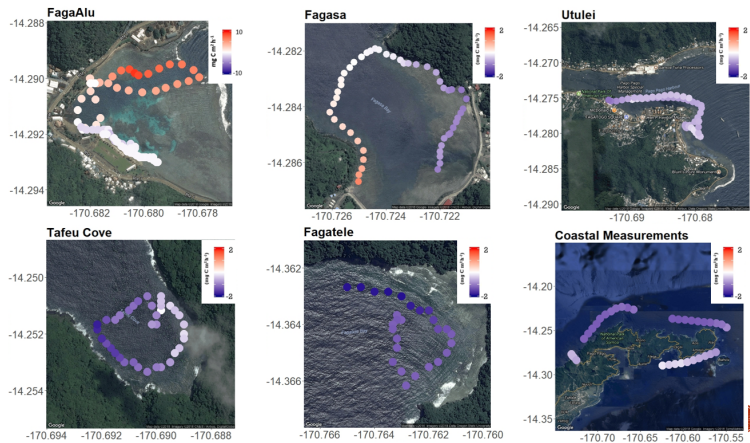
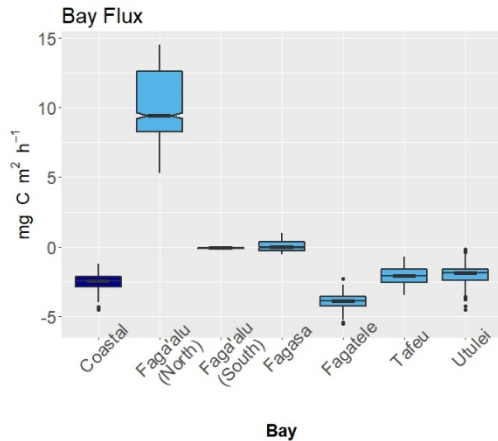

NERTO Project Title for Michael Trunkhill:
 Understanding CO₂ output in relation to the biological assemblage of coral reefs
 NERTO Location: National Marine Sanctuary of American Samoa (NMSAS) and the American Samoa Observatory (SMO)
 NERTO Period: June 4 – August 27, 2018

Task 5: Development of sensors for UAS platforms for environmental intelligence and satellite product validation

Task Lead: Rafael A. Rodriguez Solís
NOAA Collaborator(s): Gary Wick (NOAA/ESRL)

Expected Outcome: A small UAV mounted multiband microwave sensor for monitoring ocean salinity and soil moisture tested in different regions in PR. Coastal risk and vulnerability mapping using UAV and radar technologies.

- Carlos Wah-González (PhD Student) is working on the development of a low SWaP, dual-band rf receiver for a compact microwave radiometer for soil moisture and ocean salinity applications.
- He also worked on a shared aperture dual band antenna and his research was accepted for presentation at the IEEE APS in Boston, in July 2018.
- Kayleen Torres (UG Student) is a NOAA EPP Fellow and has been working in the evaluation of the low-band (1.4 GHz) receiver section
- An additional leveraged student (Daniel Mera) has been working on the digital receiver section with Carlos.



Carlos Wah-González
(Ph.D. Student)



Kayleen Torres
(UG Student NOAA
USP Scholar)

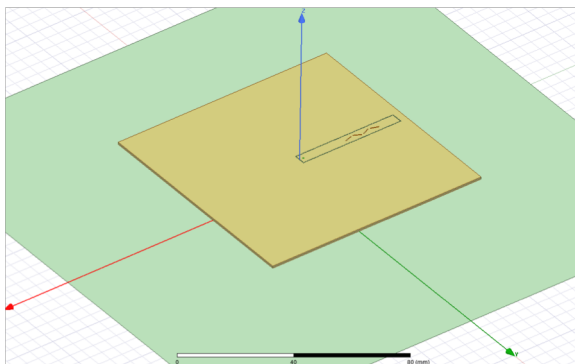

Shared aperture antenna concept

NERTO Project Title for Carlos Wah-González:
Development of compact dual-band microwave radiometer for small UAS platforms
NERTO Location: NOAA/OAR/ESRL, Boulder CO
NERTO Period: May 15 to August 8 2018