

EQUIPMENT DESCRIPTIONS

**A-UYYYYA**  
AGITATORS/MIXERS  
HP: 1.0 kcal/hr  
MATERIAL:  
INSULATION/THK: N-NT

**B-UYYYYA**  
BLOWERS  
CAPACITY: 1.0 m³/hr  
HP: 1.0 kcal/hr  
MATERIAL:  
INSULATION/THK: N-NT

**C-UYYYYA**  
COMPRESSORS  
CAPACITY: 1.0 m³/hr  
HP: 1.0 kcal/hr  
MATERIAL:  
INSULATION/THK: N-NT

**F-UYYYYA**  
FURNACES  
DUTY: 1.0 kcal/hr  
MATERIAL:  
INSULATION/THK: N-NT

**E-UYYYYA**  
HEAT EXCHANGERS  
DUTY: 1.0 kcal/hr  
SHELL DP/DT: 1.0 kgf/cm²/1.00 °C  
TUBE DP/DT: 1.0 kgf/cm²/1.00 °C  
MATERIAL (SHELL/TUBE): /  
INSULATION/THK: N-NT

**P-UYYYYA**  
PUMPS  
CAPACITY: 1.0 m³/hr  
HP: 1.0 kcal/hr  
MATERIAL:  
INSULATION/THK: N-NT

**T-UYYYYA**  
TOWER  
SIZE: 1 mm ID X 1 mm T-T  
CAPACITY: 1.0 m³  
DP/DT: 1.0 kgf/cm²/1.00 °C  
MATERIAL:  
INSULATION/THK: N-NT

**TK-UYYYYA**  
TANKS  
SIZE: 1 mm ID X 1 mm T-T  
CAPACITY: 1.0 m³  
DP/DT: 1.0 kgf/cm²/1.00 °C  
MATERIAL:  
INSULATION/THK: N-NT

**V-UYYYYA**  
VESSELS  
SIZE: 1 mm ID X 1 mm T-T  
CAPACITY: 1.0 m³  
DP/DT: 1.0 kgf/cm²/1.00 °C  
MATERIAL:  
INSULATION/THK: N-NT

PUMPS

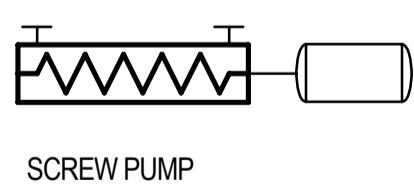
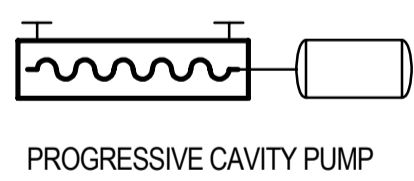
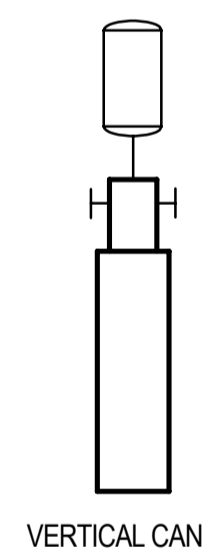
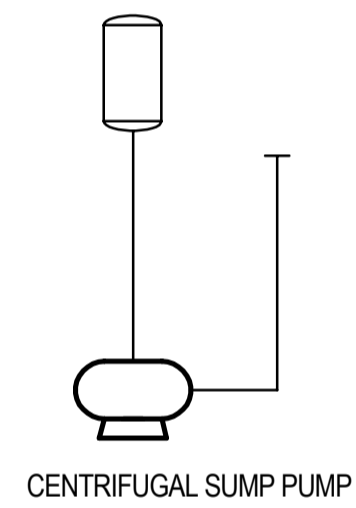
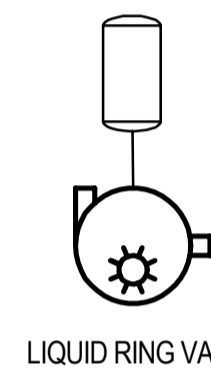
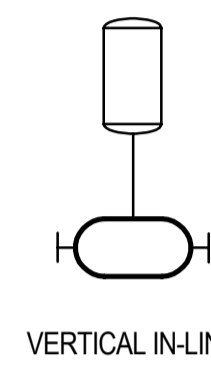
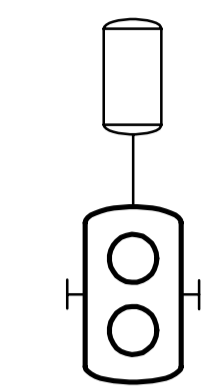
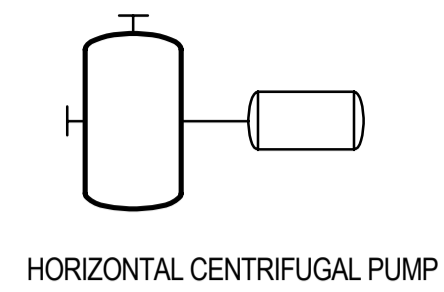

COMPRESSORS AND BLOWERS

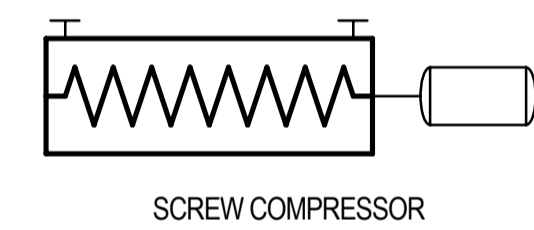
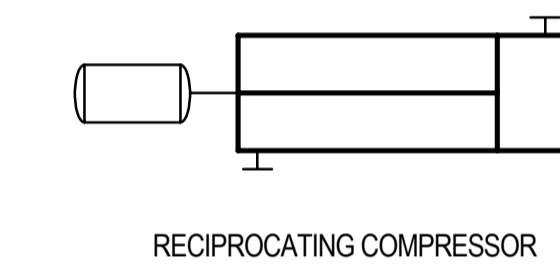
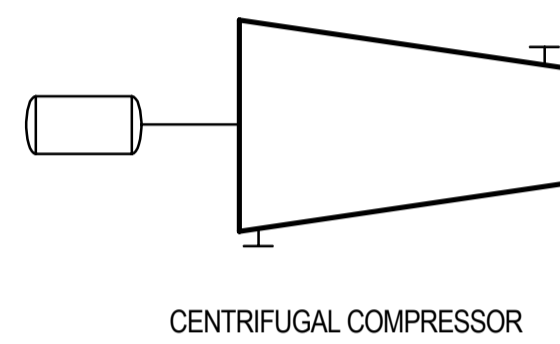
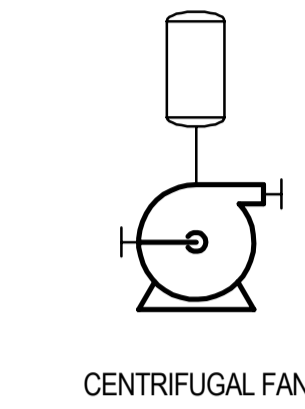
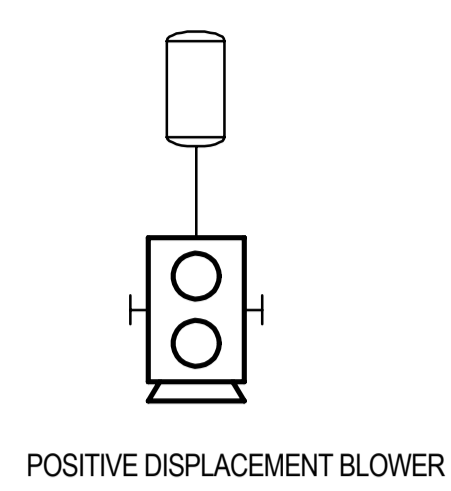

DRIVERS

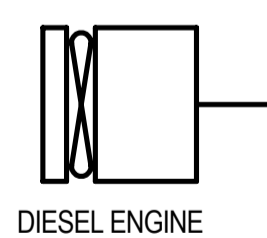
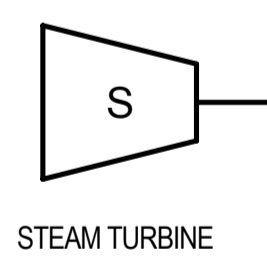
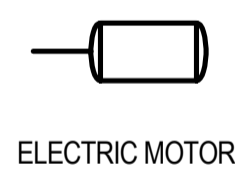

EXCHANGERS

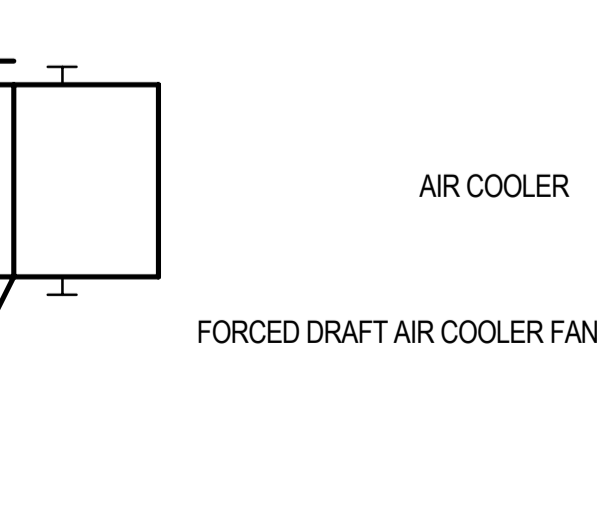
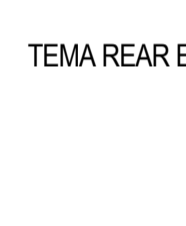
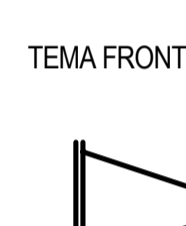
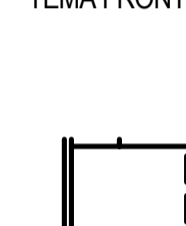
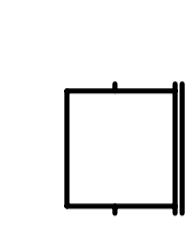
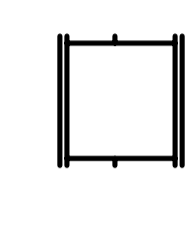
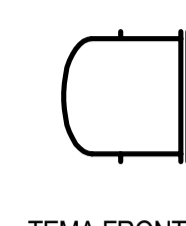
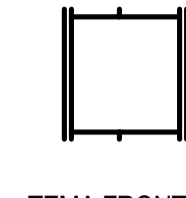
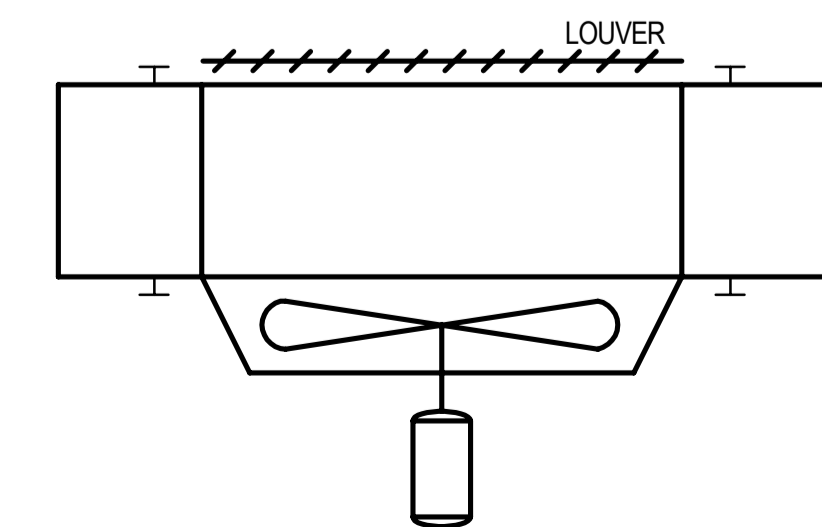
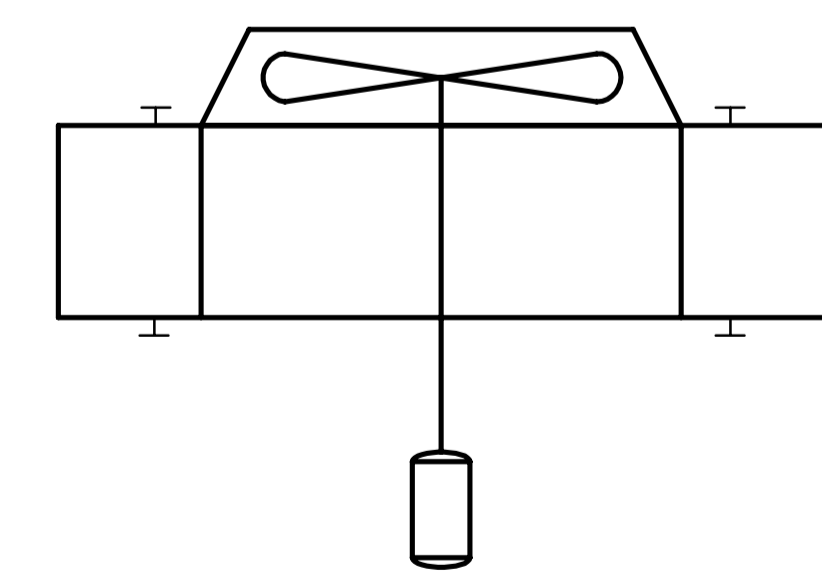
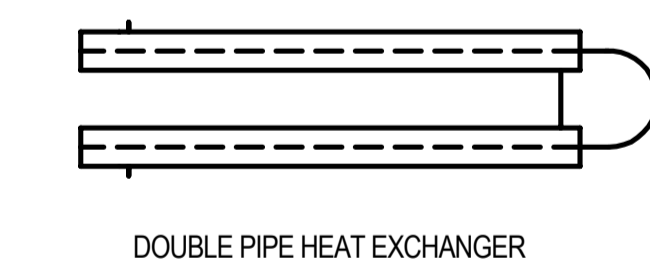
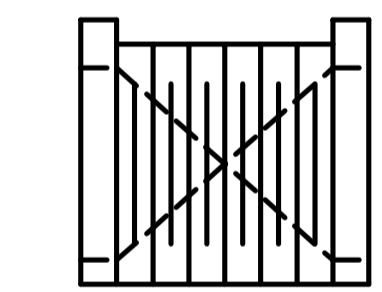
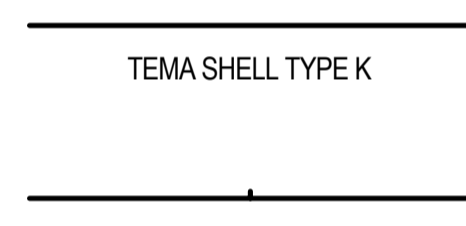
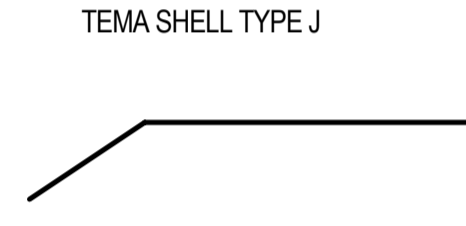
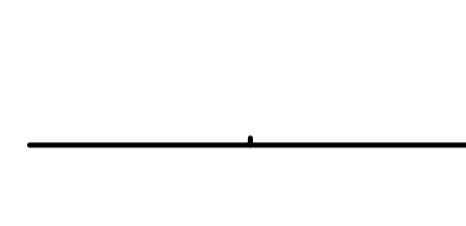
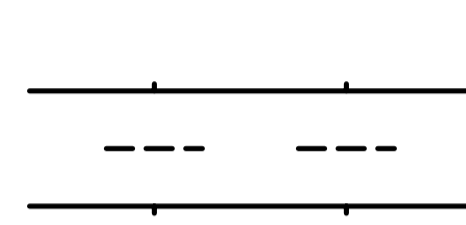
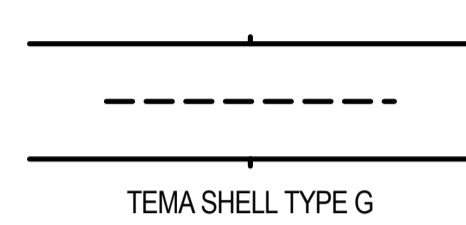
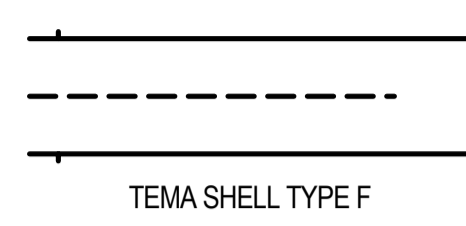
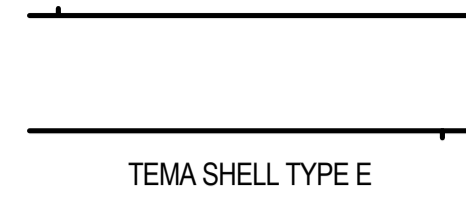

VESSELS

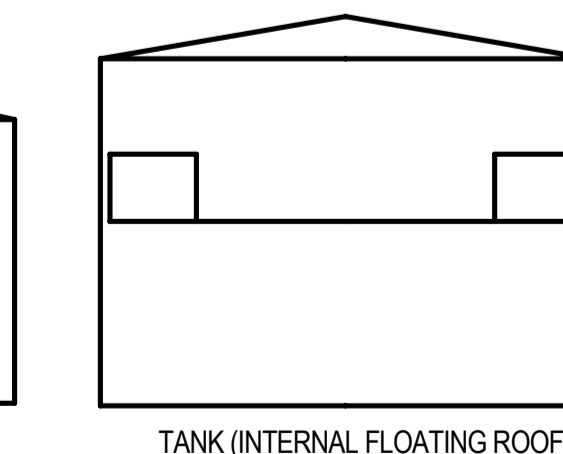
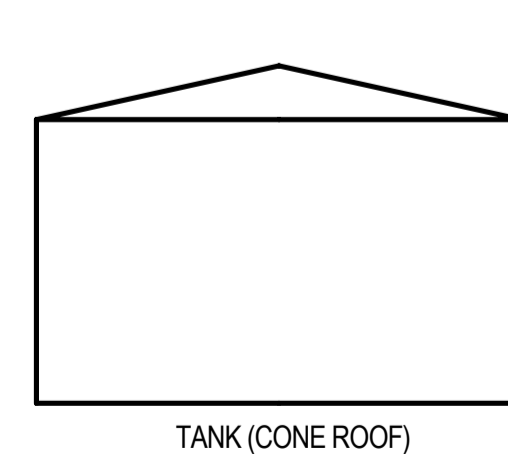
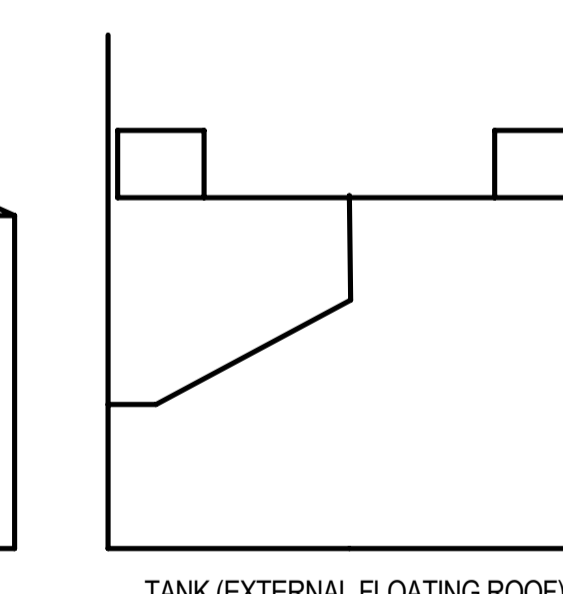
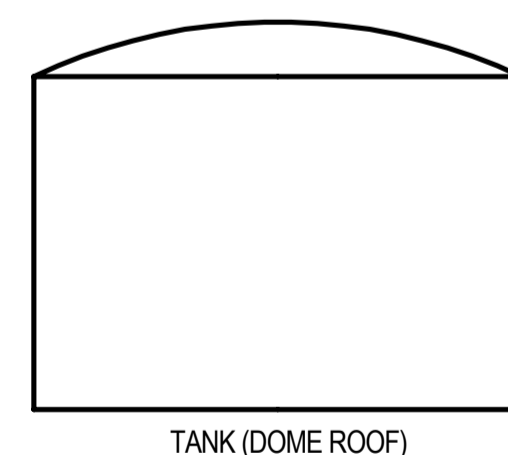
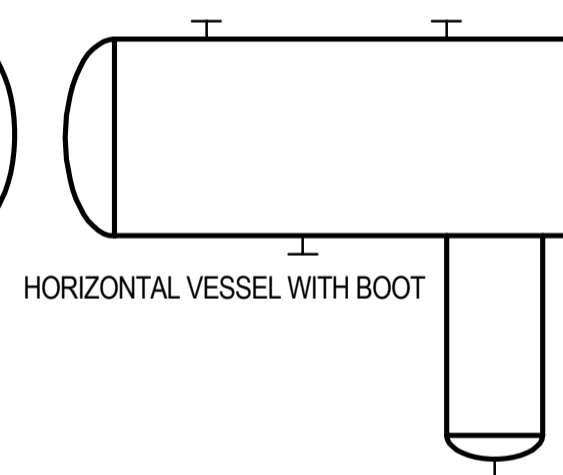
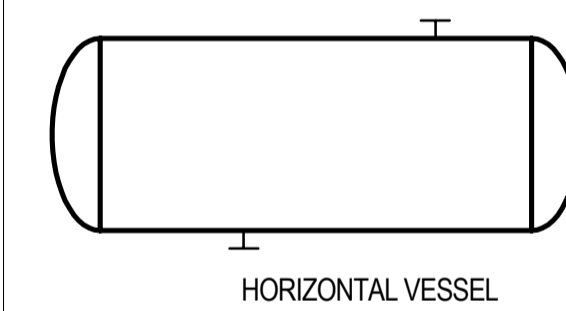
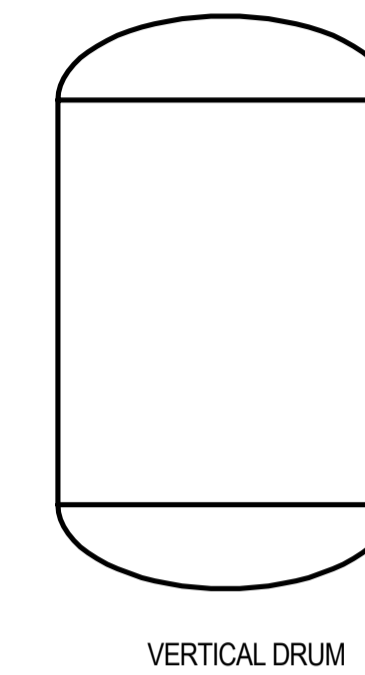
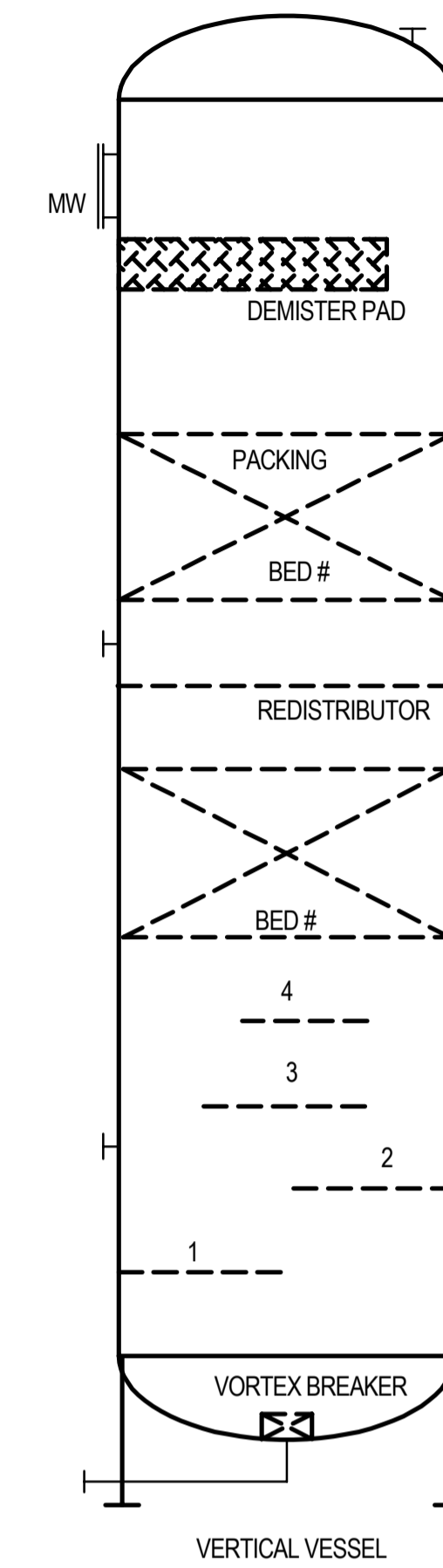

NOTES:

REV	DATE	DESCRIPTION	BY	CHK	ENG	PEM	PM
A	26-Jul-12	ISSUE FOR REVIEW					



CLIENT/PROJECT TITLE  
**WORLEYPARSONS MIMOSA**

PROJECT NO.  
**PIPING AND INSTRUMENT DIAGRAM  
LEGEND SHEET  
EQUIPMENT SYMBOLS**

SCALE  
**NONE**

DWG. NO.  
**LEGEND-002**

REVISION  
**A**

NOTE: THIS DRAWING AND THE DATA CONTAINED HEREIN ARE OF A CONFIDENTIAL NATURE AND ARE THE PROPERTY OF WORLEYPARSONS. NO PART OF THIS DRAWING OR THE DATA CONTAINED HEREIN SHALL BE REPRODUCED OR TRANSMITTED IN ANY FORM OR BY ANY MEANS, ELECTRONIC OR MECHANICAL, INCLUDING PHOTOCOPYING, RECORDING, OR BY ANY INFORMATION STORAGE AND RETRIEVAL SYSTEM, WITHOUT THE WRITTEN PERMISSION FROM THE DRAWING OWNER.

EQUIPMENT LABELING

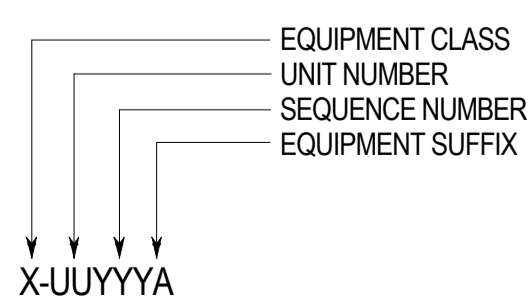

NUMBERING FOR MULTIPLE EQUIPMENT ITEMS

**P-UYYYYA/B**  
PUMPS  
CAPACITY: 1.0 m³/hr  
HP: 1.0 kcal/hr  
MATERIAL:  
INSULATION/THK: N-NT

MISCELLANEOUS

