

# ELEMENTS OF CHEMICAL REACTION ENGINEERING

FIFTH EDITION

H. SCOTT FOGLER



CE HAL INTERNATIONAL SERIES IN THE  
PHYSICAL AND CHEMICAL ENGINEERING SCIENCES

FREE SAMPLE CHAPTER

SHARE WITH OTHERS



*Elements  
of Chemical  
Reaction  
Engineering*

*Fifth Edition*



*Elements  
of Chemical  
Reaction  
Engineering*

*Fifth Edition*

H. SCOTT FOGLER

Ame and Catherine Vennema Professor of Chemical Engineering  
and the Arthur F. Thurnau Professor  
The University of Michigan, Ann Arbor

Boston • Columbus • Indianapolis • New York • San Francisco • Amsterdam • Cape Town  
Dubai • London • Madrid • Milan • Munich • Paris • Montreal • Toronto • Delhi • Mexico City  
São Paulo • Sidney • Hong Kong • Seoul • Singapore • Taipei • Tokyo

Many of the designations used by manufacturers and sellers to distinguish their products are claimed as trademarks. Where those designations appear in this book, and the publisher was aware of a trademark claim, the designations have been printed with initial capital letters or in all capitals.

The author and publisher have taken care in the preparation of this book, but make no expressed or implied warranty of any kind and assume no responsibility for errors or omissions. No liability is assumed for incidental or consequential damages in connection with or arising out of the use of the information or programs contained herein.

For information about buying this title in bulk quantities, or for special sales opportunities (which may include electronic versions; custom cover designs; and content particular to your business, training goals, marketing focus, or branding interests), please contact our corporate sales department at [corpsales@pearsoned.com](mailto:corpsales@pearsoned.com) or (800) 382-3419.

For government sales inquiries, please contact [governmentsales@pearsoned.com](mailto:governmentsales@pearsoned.com).

For questions about sales outside the United States, please contact [international@pearsoned.com](mailto:international@pearsoned.com).

Visit us on the Web: [informit.com](http://informit.com)

*Library of Congress Cataloging-in-Publication Data*

Fogler, H. Scott, author.

Elements of chemical reaction engineering / H. Scott Fogler.—Fifth edition.

pages cm

Includes index.

ISBN 978-0-13-388751-8 (hardcover : alk. paper)

1. Chemical reactors. I. Title.

TP157.F65 2016

660'.2832—dc23

2015032892

Copyright © 2016 Pearson Education, Inc.

All rights reserved. Printed in the United States of America. This publication is protected by copyright, and permission must be obtained from the publisher prior to any prohibited reproduction, storage in a retrieval system, or transmission in any form or by any means, electronic, mechanical, photocopying, recording, or likewise. For information regarding permissions, request forms and the appropriate contacts within the Pearson Education Global Rights & Permissions Department, please visit [www.pearsoned.com/permissions/](http://www.pearsoned.com/permissions/).

ISBN-13: 978-0-13-388751-8

ISBN-10: 0-13-388751-0

Text printed in the United States on recycled paper at RR Donnelley in Kendallville, Indiana.

First printing, January 2016

*Dedicated to*

*Janet Meadors Fogler*

*For her companionship, encouragement,  
sense of humor, love, and support throughout the years*

*This page intentionally left blank*

# Contents

<i>PREFACE</i>	<b>xvii</b>
<i>ABOUT THE AUTHOR</i>	<b>xxxiii</b>
<i>CHAPTER 1 MOLE BALANCES</i>	<b>1</b>
1.1 The Rate of Reaction, $-r_A$	<b>4</b>
1.2 The General Mole Balance Equation	<b>8</b>
1.3 Batch Reactors (BRs)	<b>10</b>
1.4 Continuous-Flow Reactors	<b>12</b>
1.4.1 <i>Continuous-Stirred Tank Reactor (CSTR)</i>	<b>12</b>
1.4.2 <i>Tubular Reactor</i>	<b>14</b>
1.4.3 <i>Packed-Bed Reactor (PBR)</i>	<b>18</b>
1.5 Industrial Reactors	<b>22</b>
<i>CHAPTER 2 CONVERSION AND REACTOR SIZING</i>	<b>31</b>
2.1 Definition of Conversion	<b>32</b>
2.2 Batch Reactor Design Equations	<b>32</b>
2.3 Design Equations for Flow Reactors	<b>35</b>
2.3.1 <i>CSTR (Also Known as a Backmix Reactor or a Vat)</i>	<b>36</b>
2.3.2 <i>Tubular Flow Reactor (PFR)</i>	<b>36</b>
2.3.3 <i>Packed-Bed Reactor (PBR)</i>	<b>37</b>
2.4 Sizing Continuous-Flow Reactors	<b>38</b>
2.5 Reactors in Series	<b>47</b>
2.5.1 <i>CSTRs in Series</i>	<b>48</b>
2.5.2 <i>PFRs in Series</i>	<b>52</b>
2.5.3 <i>Combinations of CSTRs and PFRs in Series</i>	<b>53</b>
2.5.4 <i>Comparing the CSTR and PFR Reactor Volumes and Reactor Sequencing</i>	<b>57</b>



2.6	Some Further Definitions	<b>58</b>	
2.6.1	<i>Space Time</i>	<b>58</b>	
2.6.2	<i>Space Velocity</i>	<b>60</b>	
<b>CHAPTER 3 RATE LAWS</b>			<b>69</b>
3.1	Basic Definitions	<b>70</b>	
3.1.1	<i>Relative Rates of Reaction</i>	<b>71</b>	
3.2	The Reaction Order and the Rate Law	<b>72</b>	
3.2.1	<i>Power Law Models and Elementary Rate Laws</i>	<b>72</b>	
3.2.2	<i>Nonelementary Rate Laws</i>	<b>76</b>	
3.2.3	<i>Reversible Reactions</i>	<b>80</b>	
3.3	Rates and the Reaction Rate Constant	<b>83</b>	
3.3.1	<i>The Rate Constant <math>k</math></i>	<b>83</b>	
3.3.2	<i>The Arrhenius Plot</i>	<b>90</b>	
3.4	Present Status of Our Approach to Reactor Sizing and Design	<b>93</b>	
<b>CHAPTER 4 STOICHIOMETRY</b>			<b>105</b>
4.1	Batch Systems	<b>107</b>	
4.1.1	<i>Batch Concentrations for the Generic Reaction, Equation (2-2)</i>	<b>109</b>	
4.2	Flow Systems	<b>113</b>	
4.2.1	<i>Equations for Concentrations in Flow Systems</i>	<b>114</b>	
4.2.2	<i>Liquid-Phase Concentrations</i>	<b>114</b>	
4.2.3	<i>Gas-Phase Concentrations</i>	<b>115</b>	
4.3	Reversible Reactions and Equilibrium Conversion	<b>126</b>	
<b>CHAPTER 5 ISOTHERMAL REACTOR DESIGN: CONVERSION</b>			<b>139</b>
5.1	Design Structure for Isothermal Reactors	<b>140</b>	
5.2	Batch Reactors (BRs)	<b>144</b>	
5.2.1	<i>Batch Reaction Times</i>	<b>145</b>	
5.3	Continuous-Stirred Tank Reactors (CSTRs)	<b>152</b>	
5.3.1	<i>A Single CSTR</i>	<b>152</b>	
5.3.2	<i>CSTRs in Series</i>	<b>155</b>	
5.4	Tubular Reactors	<b>162</b>	
5.5	Pressure Drop in Reactors	<b>169</b>	
5.5.1	<i>Pressure Drop and the Rate Law</i>	<b>169</b>	
5.5.2	<i>Flow Through a Packed Bed</i>	<b>170</b>	
5.5.3	<i>Pressure Drop in Pipes</i>	<b>174</b>	
5.5.4	<i>Analytical Solution for Reaction with Pressure Drop</i>	<b>177</b>	
5.5.5	<i>Robert the Worrier Wonders: What If...</i>	<b>181</b>	
5.6	Synthesizing the Design of a Chemical Plant	<b>190</b>	

<b>CHAPTER 6</b>	<b><i>ISOTHERMAL REACTOR DESIGN: MOLES AND MOLAR FLOW RATES</i></b>	<b>207</b>
6.1	The Molar Flow Rate Balance Algorithm	<b>208</b>
6.2	Mole Balances on CSTRs, PFRs, PBRs, and Batch Reactors	<b>208</b>
6.2.1	<i>Liquid Phase</i>	<b>208</b>
6.2.2	<i>Gas Phase</i>	<b>210</b>
6.3	Application of the PFR Molar Flow Rate Algorithm to a Microreactor	<b>212</b>
6.4	Membrane Reactors	<b>217</b>
6.5	Unsteady-State Operation of Stirred Reactors	<b>225</b>
6.6	Semibatch Reactors	<b>227</b>
6.6.1	<i>Motivation for Using a Semibatch Reactor</i>	<b>227</b>
6.6.2	<i>Semibatch Reactor Mole Balances</i>	<b>227</b>
<b>CHAPTER 7</b>	<b><i>COLLECTION AND ANALYSIS OF RATE DATA</i></b>	<b>243</b>
7.1	The Algorithm for Data Analysis	<b>244</b>
7.2	Determining the Reaction Order for Each of Two Reactants Using the Method of Excess	<b>246</b>
7.3	Integral Method	<b>247</b>
7.4	Differential Method of Analysis	<b>251</b>
7.4.1	<i>Graphical Differentiation Method</i>	<b>252</b>
7.4.2	<i>Numerical Method</i>	<b>252</b>
7.4.3	<i>Finding the Rate-Law Parameters</i>	<b>253</b>
7.5	Nonlinear Regression	<b>258</b>
7.6	Reaction-Rate Data from Differential Reactors	<b>264</b>
7.7	Experimental Planning	<b>271</b>
<b>CHAPTER 8</b>	<b><i>MULTIPLE REACTIONS</i></b>	<b>279</b>
8.1	Definitions	<b>280</b>
8.1.1	<i>Types of Reactions</i>	<b>280</b>
8.1.2	<i>Selectivity</i>	<b>281</b>
8.1.3	<i>Yield</i>	<b>282</b>
8.2	Algorithm for Multiple Reactions	<b>282</b>
8.2.1	<i>Modifications to the Chapter 6 CRE Algorithm for Multiple Reactions</i>	<b>284</b>
8.3	Parallel Reactions	<b>285</b>
8.3.1	<i>Selectivity</i>	<b>285</b>
8.3.2	<i>Maximizing the Desired Product for One Reactant</i>	<b>285</b>
8.3.3	<i>Reactor Selection and Operating Conditions</i>	<b>291</b>
8.4	Reactions in Series	<b>294</b>

- 8.5 Complex Reactions **304**
  - 8.5.1 *Complex Gas-Phase Reactions in a PBR* **304**
  - 8.5.2 *Complex Liquid-Phase Reactions in a CSTR* **307**
  - 8.5.3 *Complex Liquid-Phase Reactions in a Semibatch Reactor* **310**
- 8.6 Membrane Reactors to Improve Selectivity in Multiple Reactions **312**
- 8.7 Sorting It All Out **317**
- 8.8 The Fun Part **317**

## CHAPTER 9 REACTION MECHANISMS, PATHWAYS, BIOREACTIONS, AND BIOREACTORS

333

- 9.1 Active Intermediates and Nonelementary Rate Laws **334**
  - 9.1.1 *Pseudo-Steady-State Hypothesis (PSSH)* **335**
  - 9.1.2 *Why Is the Rate Law First Order?* **338**
  - 9.1.3 *Searching for a Mechanism* **339**
  - 9.1.4 *Chain Reactions* **343**
- 9.2 Enzymatic Reaction Fundamentals **343**
  - 9.2.1 *Enzyme-Substrate Complex* **344**
  - 9.2.2 *Mechanisms* **346**
  - 9.2.3 *Michaelis-Menten Equation* **348**
  - 9.2.4 *Batch-Reactor Calculations for Enzyme Reactions* **354**
- 9.3 Inhibition of Enzyme Reactions **356**
  - 9.3.1 *Competitive Inhibition* **357**
  - 9.3.2 *Uncompetitive Inhibition* **359**
  - 9.3.3 *Noncompetitive Inhibition (Mixed Inhibition)* **361**
  - 9.3.4 *Substrate Inhibition* **363**
- 9.4 Bioreactors and Biosynthesis **364**
  - 9.4.1 *Cell Growth* **368**
  - 9.4.2 *Rate Laws* **369**
  - 9.4.3 *Stoichiometry* **371**
  - 9.4.4 *Mass Balances* **377**
  - 9.4.5 *Chemostats* **381**
  - 9.4.6 *CSTR Bioreactor Operation* **381**
  - 9.4.7 *Wash-Out* **383**

## CHAPTER 10 CATALYSIS AND CATALYTIC REACTORS

399

- 10.1 Catalysts **399**
  - 10.1.1 *Definitions* **400**
  - 10.1.2 *Catalyst Properties* **401**
  - 10.1.3 *Catalytic Gas-Solid Interactions* **403**
  - 10.1.4 *Classification of Catalysts* **404**
- 10.2 Steps in a Catalytic Reaction **405**
  - 10.2.1 *Step 1 Overview: Diffusion from the Bulk to the External Surface of the Catalyst* **408**
  - 10.2.2 *Step 2 Overview: Internal Diffusion* **409**

10.2.3	<i>Adsorption Isotherms</i>	<b>410</b>	
10.2.4	<i>Surface Reaction</i>	<b>416</b>	
10.2.5	<i>Desorption</i>	<b>418</b>	
10.2.6	<i>The Rate-Limiting Step</i>	<b>419</b>	
10.3	<i>Synthesizing a Rate Law, Mechanism, and Rate-Limiting Step</i>		<b>421</b>
10.3.1	<i>Is the Adsorption of Cumene Rate-Limiting?</i>	<b>424</b>	
10.3.2	<i>Is the Surface Reaction Rate-Limiting?</i>	<b>427</b>	
10.3.3	<i>Is the Desorption of Benzene Rate-Limiting?</i>	<b>429</b>	
10.3.4	<i>Summary of the Cumene Decomposition</i>	<b>430</b>	
10.3.5	<i>Reforming Catalysts</i>	<b>431</b>	
10.3.6	<i>Rate Laws Derived from the Pseudo-Steady-State Hypothesis (PSSH)</i>	<b>435</b>	
10.3.7	<i>Temperature Dependence of the Rate Law</i>	<b>436</b>	
10.4	<i>Heterogeneous Data Analysis for Reactor Design</i>	<b>436</b>	
10.4.1	<i>Deducing a Rate Law from the Experimental Data</i>		<b>438</b>
10.4.2	<i>Finding a Mechanism Consistent with Experimental Observations</i>	<b>439</b>	
10.4.3	<i>Evaluation of the Rate-Law Parameters</i>	<b>440</b>	
10.4.4	<i>Reactor Design</i>	<b>443</b>	
10.5	<i>Reaction Engineering in Microelectronic Fabrication</i>		<b>446</b>
10.5.1	<i>Overview</i>	<b>446</b>	
10.5.2	<i>Chemical Vapor Deposition</i>	<b>448</b>	
10.6	<i>Model Discrimination</i>	<b>451</b>	
10.7	<i>Catalyst Deactivation</i>	<b>454</b>	
10.7.1	<i>Types of Catalyst Deactivation</i>	<b>456</b>	
10.7.2	<i>Reactors That Can Be Used to Help Offset Catalyst Decay</i>	<b>465</b>	
10.7.3	<i>Temperature–Time Trajectories</i>	<b>465</b>	
10.7.4	<i>Moving-Bed Reactors</i>	<b>467</b>	
10.7.5	<i>Straight-Through Transport Reactors (STTR)</i>		<b>472</b>

**CHAPTER 11 NONISOTHERMAL REACTOR DESIGN—THE STEADY-STATE ENERGY BALANCE AND ADIABATIC PFR APPLICATIONS**

**493**

11.1	<i>Rationale</i>	<b>494</b>	
11.2	<i>The Energy Balance</i>	<b>495</b>	
11.2.1	<i>First Law of Thermodynamics</i>	<b>495</b>	
11.2.2	<i>Evaluating the Work Term</i>	<b>496</b>	
11.2.3	<i>Overview of Energy Balances</i>	<b>498</b>	
11.3	<i>The User-Friendly Energy Balance Equations</i>		<b>502</b>
11.3.1	<i>Dissecting the Steady-State Molar Flow Rates to Obtain the Heat of Reaction</i>	<b>502</b>	
11.3.2	<i>Dissecting the Enthalpies</i>	<b>504</b>	
11.3.3	<i>Relating <math>\Delta H_{RX}(T)</math>, <math>\Delta H_{RX}^{\circ}(T_R)</math>, and <math>\Delta C_P</math></i>		<b>505</b>
11.4	<i>Adiabatic Operation</i>	<b>508</b>	
11.4.1	<i>Adiabatic Energy Balance</i>	<b>508</b>	
11.4.2	<i>Adiabatic Tubular Reactor</i>	<b>509</b>	

11.5	Adiabatic Equilibrium Conversion	<b>518</b>
11.5.1	<i>Equilibrium Conversion</i>	<b>518</b>
11.6	Reactor Staging	<b>522</b>
11.6.1	<i>Reactor Staging with Interstage Cooling or Heating</i>	<b>522</b>
11.6.2	<i>Exothermic Reactions</i>	<b>523</b>
11.6.3	<i>Endothermic Reactions</i>	<b>523</b>
11.7	Optimum Feed Temperature	<b>526</b>

**CHAPTER 12 STEADY-STATE NONISOTHERMAL REACTOR DESIGN—FLOW REACTORS WITH HEAT EXCHANGE 539**

12.1	Steady-State Tubular Reactor with Heat Exchange	<b>540</b>
12.1.1	<i>Deriving the Energy Balance for a PFR</i>	<b>540</b>
12.1.2	<i>Applying the Algorithm to Flow Reactors with Heat Exchange</i>	<b>542</b>
12.2	Balance on the Heat-Transfer Fluid	<b>543</b>
12.2.1	<i>Co-current Flow</i>	<b>543</b>
12.2.2	<i>Countercurrent Flow</i>	<b>544</b>
12.3	Algorithm for PFR/PBR Design with Heat Effects	<b>545</b>
12.3.1	<i>Applying the Algorithm to an Exothermic Reaction</i>	<b>548</b>
12.3.2	<i>Applying the Algorithm to an Endothermic Reaction</i>	<b>555</b>
12.4	CSTR with Heat Effects	<b>564</b>
12.4.1	<i>Heat Added to the Reactor, <math>\dot{Q}</math></i>	<b>564</b>
12.5	Multiple Steady States (MSS)	<b>574</b>
12.5.1	<i>Heat-Removed Term, <math>R(T)</math></i>	<b>575</b>
12.5.2	<i>Heat-Generated Term, <math>G(T)</math></i>	<b>576</b>
12.5.3	<i>Ignition-Extinction Curve</i>	<b>578</b>
12.6	Nonisothermal Multiple Chemical Reactions	<b>581</b>
12.6.1	<i>Energy Balance for Multiple Reactions in Plug-Flow Reactors</i>	<b>581</b>
12.6.2	<i>Parallel Reactions in a PFR</i>	<b>582</b>
12.6.3	<i>Energy Balance for Multiple Reactions in a CSTR</i>	<b>585</b>
12.6.4	<i>Series Reactions in a CSTR</i>	<b>585</b>
12.6.5	<i>Complex Reactions in a PFR</i>	<b>588</b>
12.7	Radial and Axial Variations in a Tubular Reactor	<b>595</b>
12.7.1	<i>Molar Flux</i>	<b>596</b>
12.7.2	<i>Energy Flux</i>	<b>597</b>
12.7.3	<i>Energy Balance</i>	<b>598</b>
12.8	Safety	<b>603</b>

**CHAPTER 13 UNSTEADY-STATE NONISOTHERMAL REACTOR DESIGN 629**

13.1	Unsteady-State Energy Balance	<b>630</b>
13.2	Energy Balance on Batch Reactors	<b>632</b>
13.2.1	<i>Adiabatic Operation of a Batch Reactor</i>	<b>633</b>
13.2.2	<i>Case History of a Batch Reactor with Interrupted Isothermal Operation Causing a Runaway Reaction</i>	<b>640</b>

- 13.3 Semibatch Reactors with a Heat Exchanger **646**
- 13.4 Unsteady Operation of a CSTR **651**
  - 13.4.1 *Startup* **651**
- 13.5 Nonisothermal Multiple Reactions **656**

## CHAPTER 14 MASS TRANSFER LIMITATIONS IN REACTING SYSTEMS **679**

- 14.1 Diffusion Fundamentals **680**
  - 14.1.1 *Definitions* **681**
  - 14.1.2 *Molar Flux* **682**
  - 14.1.3 *Fick's First Law* **683**
- 14.2 Binary Diffusion **684**
  - 14.2.1 *Evaluating the Molar Flux* **684**
  - 14.2.2 *Diffusion and Convective Transport* **685**
  - 14.2.3 *Boundary Conditions* **685**
  - 14.2.4 *Temperature and Pressure Dependence of  $D_{AB}$*  **686**
  - 14.2.5 *Steps in Modeling Diffusion without Reaction* **687**
  - 14.2.6 *Modeling Diffusion with Chemical Reaction* **687**
- 14.3 Diffusion Through a Stagnant Film **688**
- 14.4 The Mass Transfer Coefficient **690**
  - 14.4.1 *Correlations for the Mass Transfer Coefficient* **690**
  - 14.4.2 *Mass Transfer to a Single Particle* **693**
  - 14.4.3 *Mass Transfer-Limited Reactions in Packed Beds* **697**
  - 14.4.4 *Robert the Worrier* **700**
- 14.5 What If . . . ? (Parameter Sensitivity) **705**

## CHAPTER 15 DIFFUSION AND REACTION **719**

- 15.1 Diffusion and Reactions in Homogeneous Systems **720**
- 15.2 Diffusion and Reactions in Spherical Catalyst Pellets **720**
  - 15.2.1 *Effective Diffusivity* **721**
  - 15.2.2 *Derivation of the Differential Equation Describing Diffusion and Reaction in a Single Catalyst Pellet* **723**
  - 15.2.3 *Writing the Diffusion with the Catalytic Reaction Equation in Dimensionless Form* **726**
  - 15.2.4 *Solution to the Differential Equation for a First-Order Reaction* **729**
- 15.3 The Internal Effectiveness Factor **730**
  - 15.3.1 *Isothermal First-Order Catalytic Reactions* **730**
  - 15.3.2 *Effectiveness Factors with Volume Change with Reaction* **733**
  - 15.3.3 *Isothermal Reactors Other Than First Order* **733**
  - 15.3.4 *Weisz-Prater Criterion for Internal Diffusion* **734**
- 15.4 Falsified Kinetics **737**
- 15.5 Overall Effectiveness Factor **739**
- 15.6 Estimation of Diffusion- and Reaction-Limited Regimes **743**
  - 15.6.1 *Mears Criterion for External Diffusion Limitations* **743**

15.7	Mass Transfer and Reaction in a Packed Bed	744
15.8	Determination of Limiting Situations from Reaction-Rate Data	750
15.9	Multiphase Reactors in the Professional Reference Shelf	751
15.9.1	Slurry Reactors	752
15.9.2	Trickle Bed Reactors	752
15.10	Fluidized Bed Reactors	753
15.11	Chemical Vapor Deposition (CVD)	753

## CHAPTER 16 RESIDENCE TIME DISTRIBUTIONS OF CHEMICAL REACTORS 767

16.1	General Considerations	767
16.1.1	Residence Time Distribution (RTD) Function	769
16.2	Measurement of the RTD	770
16.2.1	Pulse Input Experiment	770
16.2.2	Step Tracer Experiment	775
16.3	Characteristics of the RTD	777
16.3.1	Integral Relationships	777
16.3.2	Mean Residence Time	778
16.3.3	Other Moments of the RTD	778
16.3.4	Normalized RTD Function, $E(\Theta)$	782
16.3.5	Internal-Age Distribution, $I(\alpha)$	783
16.4	RTD in Ideal Reactors	784
16.4.1	RTDs in Batch and Plug-Flow Reactors	784
16.4.2	Single-CSTR RTD	785
16.4.3	Laminar-Flow Reactor (LFR)	786
16.5	PFR/CSTR Series RTD	789
16.6	Diagnostics and Troubleshooting	793
16.6.1	General Comments	793
16.6.2	Simple Diagnostics and Troubleshooting Using the RTD for Ideal Reactors	794

## CHAPTER 17 PREDICTING CONVERSION DIRECTLY FROM THE RESIDENCE TIME DISTRIBUTION 807

17.1	Modeling Nonideal Reactors Using the RTD	808
17.1.1	Modeling and Mixing Overview	808
17.1.2	Mixing	808
17.2	Zero-Adjustable-Parameter Models	810
17.2.1	Segregation Model	810
17.2.2	Maximum Mixedness Model	820
17.3	Using Software Packages	827
17.3.1	Comparing Segregation and Maximum Mixedness Predictions	829
17.4	RTD and Multiple Reactions	830
17.4.1	Segregation Model	830
17.4.2	Maximum Mixedness	831

**CHAPTER 18 MODELS FOR NONIDEAL REACTORS****845**

- 18.1 Some Guidelines for Developing Models **846**
  - 18.1.1 *One-Parameter Models* **847**
  - 18.1.2 *Two-Parameter Models* **848**
- 18.2 The Tanks-in-Series (T-I-S) One-Parameter Model **848**
  - 18.2.1 *Developing the E-Curve for the T-I-S Model* **849**
  - 18.2.2 *Calculating Conversion for the T-I-S Model* **851**
  - 18.2.3 *Tanks-in-Series versus Segregation for a First-Order Reaction* **852**
- 18.3 Dispersion One-Parameter Model **852**
- 18.4 Flow, Reaction, and Dispersion **854**
  - 18.4.1 *Balance Equations* **854**
  - 18.4.2 *Boundary Conditions* **855**
  - 18.4.3 *Finding  $D_a$  and the Peclet Number* **858**
  - 18.4.4 *Dispersion in a Tubular Reactor with Laminar Flow* **858**
  - 18.4.5 *Correlations for  $D_a$*  **860**
  - 18.4.6 *Experimental Determination of  $D_a$*  **862**
- 18.5 Tanks-in-Series Model versus Dispersion Model **869**
- 18.6 Numerical Solutions to Flows with Dispersion and Reaction **870**
- 18.7 Two-Parameter Models—Modeling Real Reactors with Combinations of Ideal Reactors **871**
  - 18.7.1 *Real CSTR Modeled Using Bypassing and Dead Space* **872**
  - 18.7.2 *Real CSTR Modeled as Two CSTRs with Interchange* **878**
- 18.8 Use of Software Packages to Determine the Model Parameters **880**
- 18.9 Other Models of Nonideal Reactors Using CSTRs and PFRs **882**
- 18.10 Applications to Pharmacokinetic Modeling **883**

**APPENDIX A NUMERICAL TECHNIQUES****897**

- A.1 Useful Integrals in Reactor Design **897**
- A.2 Equal-Area Graphical Differentiation **898**
- A.3 Solutions to Differential Equations **900**
  - A.3.A *First-Order Ordinary Differential Equations* **900**
  - A.3.B *Coupled Differential Equations* **900**
  - A.3.C *Second-Order Ordinary Differential Equations* **901**
- A.4 Numerical Evaluation of Integrals **901**
- A.5 Semilog Graphs **903**
- A.6 Software Packages **903**

**APPENDIX B IDEAL GAS CONSTANT AND CONVERSION FACTORS****905****APPENDIX C THERMODYNAMIC RELATIONSHIPS INVOLVING THE EQUILIBRIUM CONSTANT****909**



<i>APPENDIX D</i>	<i>SOFTWARE PACKAGES</i>	<b>915</b>
D.1	Polymath	<b>915</b>
D.1.A	About Polymath	<b>915</b>
D.1.B	Polymath Tutorials	<b>916</b>
D.2	MATLAB	<b>916</b>
D.3	Aspen	<b>916</b>
D.4	COMSOL Multiphysics	<b>917</b>
<i>APPENDIX E</i>	<i>RATE LAW DATA</i>	<b>919</b>
<i>APPENDIX F</i>	<i>NOMENCLATURE</i>	<b>921</b>
<i>APPENDIX G</i>	<i>OPEN-ENDED PROBLEMS</i>	<b>925</b>
G.1	Design of Reaction Engineering Experiment	<b>925</b>
G.2	Effective Lubricant Design	<b>925</b>
G.3	Peach Bottom Nuclear Reactor	<b>925</b>
G.4	Underground Wet Oxidation	<b>926</b>
G.5	Hydrodesulfurization Reactor Design	<b>926</b>
G.6	Continuous Bioprocessing	<b>926</b>
G.7	Methanol Synthesis	<b>926</b>
G.8	Cajun Seafood Gumbo	<b>926</b>
G.9	Alcohol Metabolism	<b>927</b>
G.10	Methanol Poisoning	<b>928</b>
<i>APPENDIX H</i>	<i>USE OF COMPUTATIONAL CHEMISTRY SOFTWARE PACKAGES</i>	<b>929</b>
<i>APPENDIX I</i>	<i>HOW TO USE THE CRE WEB RESOURCES</i>	<b>931</b>
I.1	CRE Web Resources Components	<b>931</b>
I.2	How the Web Can Help Your Learning Style	<b>933</b>
I.2.1	Global vs. Sequential Learners	<b>933</b>
I.2.2	Active vs. Reflective Learners	<b>934</b>
I.3	Navigation	<b>934</b>
<i>INDEX</i>		<b>937</b>

# Preface

The man who has ceased to learn ought not to be allowed to wander around loose in these dangerous days.

M. M. Coady

## A. Who Is the Intended Audience?

This book and interactive Web site is intended for use as both an undergraduate-level and a graduate-level text in chemical reaction engineering. The level will depend on the choice of chapters, the *Professional Reference Shelf (PRS)* material (from the companion Web site) to be covered, and the type and degree of difficulty of problems assigned. It was written with today's students in mind. It provides instantaneous access to information; does not waste time on extraneous details; cuts right to the point; uses more bullets to make information easier to access; and includes new, novel problems on chemical reaction engineering (e.g., solar energy). It gives more emphasis to chemical reactor safety (Chapters 12 and 13) and alternative energy sources—solar (Chapters 3, 8, and 10) and biofuel production (Chapter 9). The graduate material on topics such as effectiveness factors, non-ideal reactors, and residence time distribution is in Chapters 14–18 and now includes the software solutions for maximum mixedness and segregation models. A draft version of this book was class tested at the University of Michigan and other leading universities; then the text was further revised, taking into account the suggestions of more than 100 students. Much of the material was revised and reworked based on that feedback.

## B. What Are the Goals of This Book?

### B.1 To Have Fun Learning Chemical Reaction Engineering (CRE)

Chemical reaction engineering (CRE) is one of two core courses that is unique to chemical engineering and that separates the chemical engineer from other

engineers. CRE is a great subject that is fun to learn and is the heart of chemical engineering. I have tried to provide a little Michigan humor as we go. Take a look at the humorous YouTube videos (e.g., “Black Widow” or “Chemical Engineering Gone Wrong”) that illustrate certain principles in the text. These videos were made by chemical engineering students at the universities of Alabama and Michigan. In addition, I have found that students very much enjoy the Interactive Computer Games (ICGs) that, along with the videos, are linked from the CRE homepage (<http://www.umich.edu/~elements/5e>).

## B.2 To Develop a Fundamental Understanding of Reaction Engineering

The second goal of this book is to help the reader clearly understand the fundamentals of CRE. This goal is achieved by presenting a structure that allows the reader to solve reaction engineering problems through reasoning rather than through memorization and recall of numerous equations and the restrictions and conditions under which each equation applies. The algorithms presented in the text for reactor design provide this framework, and the homework problems give the reader practice using the algorithms described in Figures P-1 and P-2, shown in Section C. The conventional homework problems at the end of each chapter are designed to reinforce the principles in the chapter. These problems are about equally divided between those that can be solved with a calculator and those that require a personal computer with a numerical software package, such as Polymath, AspenTech, or COMSOL.



To give a reference point as to the level of understanding of CRE required in the profession, a number of reaction engineering problems from the California Board of Registration for Civil and Professional Engineers—Chemical Engineering Examinations (PECEE) are included in the text.<sup>1</sup> Typically, these problems should each require approximately 30 minutes to solve.

Finally, the companion Web site should greatly facilitate learning the fundamentals of CRE because it includes Summary Notes of the material in each chapter, PowerPoint slides of class lecture notes, additional examples, expanded derivations, and self-tests. A complete description of these learning resources is in Appendix I.

## B.3 To Enhance Thinking Skills

A third goal of this text is to enhance *critical thinking skills* and *creative thinking skills*. How does the book help enhance your critical and creative thinking skills? We discuss ways to achieve this enhancement in Section I of the Preface.

---

<sup>1</sup> The permission for use of these problems—which, incidentally, may be obtained from the Documents Section, California Board of Registration for Civil and Professional Engineers—Chemical Engineering, 1004 6th Street, Sacramento, CA 95814, is gratefully acknowledged. (Note: These problems have been copyrighted by the California Board of Registration and may not be reproduced without its permission.)

## C. What Is the Structure of CRE?

### C.1 What Are the Concepts that Form the Foundation of CRE?

The strategy behind the presentation of material is to build continually on a few basic ideas in CRE to solve a wide variety of problems. These ideas, referred to as the Pillars of Chemical Reaction Engineering (Figure P-1), are the foundation on which different applications rest. They represent not only components of chemical reaction analysis, but also the physical phenomena of diffusion and contacting that affect chemical reactor design.

Figure P-2 shows the first building blocks of CRE and the primary algorithm that allows us to solve CRE problems through logic rather than memorization. We start with the *Mole Balance Building Block* (Chapter 1) and then place the other blocks one at a time on top of the others until we reach the *Evaluate Block* (Chapter 5), by which time we can solve a multitude of isothermal CRE problems. As we study each block we need to make sure we understand everything in that block and don't leave anything out so we don't wind up with a cylindrical block. A tower containing cylindrical blocks would be unstable and would fall apart as we study later chapters. See the end of Chapter 1 lecture notes on the CRE Web site to see the tower of CRE fall if you have blocks with rounded edges.

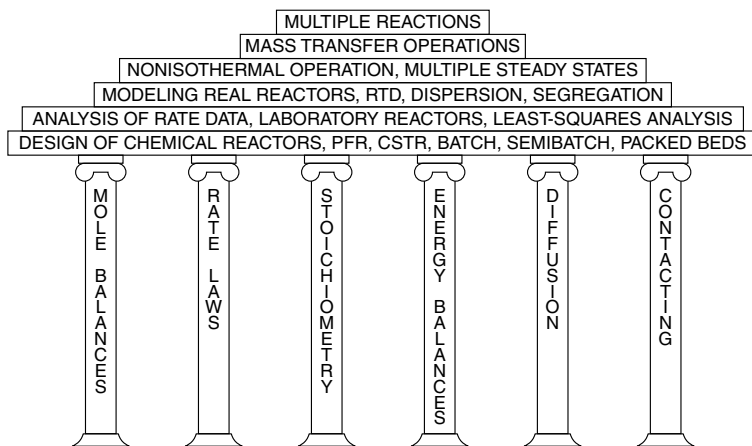

Figure P-1 Pillars of Chemical Reaction Engineering.

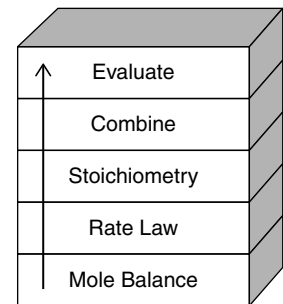

Figure P-2 Building blocks.

From these pillars and building blocks, we construct our CRE algorithm:

**Mole Balance + Rate Laws + Stoichiometry + Energy Balance + Combine → Solution**

With a few restrictions, the contents of this book can be studied in virtually any order after students have mastered the first six chapters. A flow diagram showing the possible paths is shown in Figure P-3.

The reader will observe that although metric units are used primarily in this text (e.g.,  $\text{kmol}/\text{m}^3$ ,  $\text{J}/\text{mol}$ ), English units are also employed (e.g.,  $\text{lb}_\text{m}/\text{ft}^3$ ,  $\text{Btu}$ ). This choice is intentional! We believe that whereas most papers published today use the metric system, a significant amount of reaction engineering data exists in the older literature in English units. Because engineers will be faced with extracting information and reaction rate data from older literature as well as from the current literature, they should be equally at ease with both English and metric units.

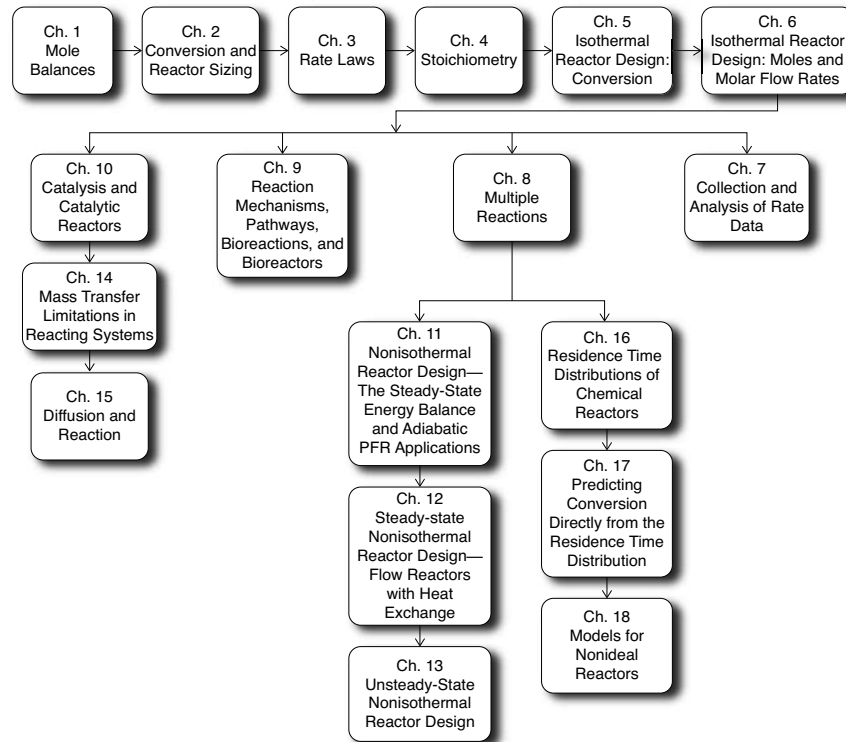

**Figure P-3** Sequences for study using this text.

## C.2 What Is the Sequence of Topics in which This Book Can Be Used?

Table P-1 shows examples of topics that can be converged in a graduate course and an undergraduate course. In a four-hour undergraduate course at the University of Michigan, approximately thirteen chapters are covered in the following order: Chapters 1 through 7 (Exam 1); Chapters 8, 11, and 12 (Exam 2); and Chapter 13 and parts of Chapters 9 and 10 (Exam 3).

There are notes in the margins, which are meant to serve two purposes. First, they act as guides or commentary as one reads through the material. Second, they identify key equations and relationships that are used to solve CRE problems.

## D. What Are the Components of the CRE Web Site?

The companion, interactive Web site material is an updated version of the CRE Web site and is a novel and unique part of this book. The main purposes of the Web site are to serve as an enrichment resource and as a “professional reference shelf.” The home page for the CRE Web site (<http://www.umich.edu/~elements/5e/index.html>) is shown in Figure P-4. For discussion of how to use the Web site and text interactively, see Appendix I.

TABLE P-1 UNDERGRADUATE/GRADUATE COVERAGE OF CRE

<i>Undergraduate Material/Course</i>	<i>Graduate Material/Course</i>
Mole Balances (Ch. 1)	Short Review (Ch. 1–8, 11–12)
Smog in Los Angeles Basin (PRS Ch. 1)	Collision Theory (PRS Ch. 3)
Reactor Staging (Ch. 2)	Transition State Theory (PRS Ch. 3)
Hippopotamus Stomach (PRS Ch. 2)	Molecular Dynamics (PRS Ch. 3)
Rate Laws (Ch. 3)	Aerosol Reactors (PRS Ch. 4)
Stoichiometry (Ch. 4)	Multiple Reactions (Ch. 8):
Reactors (Ch. 5):	Fed Membrane Reactors
Batch, PFR, CSTR, PBR	Bioreactions and Reactors (Ch. 9, PRS 9.3–9.5)
Reactors (Ch. 6):	Polymerization (PRS Ch. 9)
Semibatch, Membrane	Co- and Countercurrent Heat Exchange
Data Analysis: Regression (Ch. 7)	(Ch. 12)
Multiple Reactions (Ch. 8)	Radial and Axial Gradients in a PFR
Bioreaction Engineering (Ch. 9)	COMSOL (Ch. 12)
Adiabatic Reactor (Ch. 11)	Reactor Stability and Safety (Ch. 12, 13, PRS
Steady-State Heat Effects (Ch. 12):	12.3)
PFR and CSTR with and without a	Runaway Reactions (PRS, Ch. 12)
Heat Exchanger	Catalyst Deactivation (Ch. 10)
Multiple Steady States	Residence Time Distribution (Ch. 16, 17)
Unsteady-State Heat Effects (Ch. 13)	Models of Real Reactors (Ch. 18)
Reactor Safety	Applications (PRS): Multiphase Reactors,
Catalysis (Ch. 10)	CVD Reactors, Bioreactors

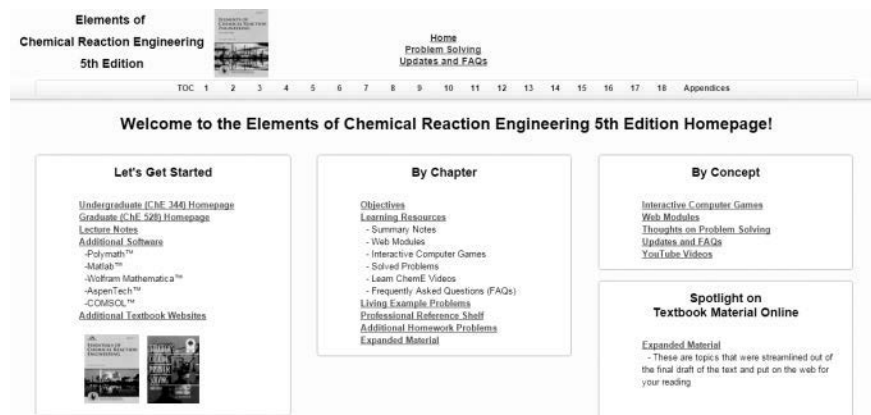

**Figure P-4** Screen shot of the book's companion Web site (<http://www.umich.edu/~elements/5e/index.html>).

The objectives of the Web site are fourfold:

- (1) To facilitate the learning of CRE by using the companion Web site to actively address the Felder/Solomon Inventory of Learning Styles 7 discussed in Web Appendix I
- (2) To provide additional technical material

- (3) To provide tutorial information and self-assessment exercises
- (4) To make the learning of CRE fun through the use of interactive games

The following sections (D.1 through D.4) are listed at the end of most chapters and can be accessed from each chapter in the companion Web site.<sup>2</sup>

## D.1 Expanded Material

The expanded material consists of material that was removed from the printed text and moved to the Web site to reduce the size and weight of the physical textbook. Reducing the weight makes it easier for the students to carry the book with them at all times, such as while on the campus shuttle or while eating at the cafeteria or the student union. The expanded material includes derivations, examples, and novel applications of CRE principles.

## D.2 Learning Resources

The Learning Resources give an overview of the material in each chapter and provide extra explanations, examples, and applications to reinforce the basic concepts of CRE; the Learning Resources are described in Appendix I. The CRE Web site includes the following additional resources:

### 1. *Summary Notes and PowerPoint Slides*

The Summary Notes give an overview of each chapter and provide on-demand additional examples, derivations, and audio comments, as well as self-tests to assess each reader's understanding of the material. Copies of the PowerPoint slides are available from this course taught at the University of Michigan as well as those from Professor Mary Kraft's class at the University of Illinois.

### 2. *What Entertainment Is on the Web Site?*

#### 2.A. *YouTube Videos*

We have included links to humorous YouTube Videos made by students in Professor Alan Lane's 2008 chemical reaction engineering class at the University of Alabama, as well as videos from the University of Michigan 2011 class. Specifically, check out "The Black Widow Murder Mystery" (Chapter 3), "CRF Reactor," and "Diet Coke and Mentos" (Chapter 4); learn a new dance and song ("CSTR" to the tune of "YMCA"); hear a rap song ("Find Your Rhythm," an "Ice Ice Baby" remix (Chapter 5)); and watch University of Michigan videos, including the ever-popular chemical engineering classic, "Reaction Engineering Gone Wrong."

#### 2.B. *Interactive Computer Games (ICGs)*

Students have found the Interactive Computer Games to be both fun and extremely useful to review the important chapter concepts and then apply them to real problems in a unique and

---

<sup>2</sup> <http://www.ncsu.edu/felder-public/ILSdir/styles.htm>

entertaining fashion. The following ICGs are available on the Web site:

- Quiz Show I (Ch. 1)
- Reactor Staging (Ch. 2)
- Quiz Show II (Ch. 4)
- Murder Mystery (Ch. 5)
- Tic Tac (Ch. 5)
- Ecology (Ch. 7)
- The Great Race (Ch. 8)
- Enzyme Man (Ch. 9)
- Catalysis (Ch. 10)
- Heat Effects I (Ch. 12)
- Heat Effects II (Ch. 12)

As you play these interactive games, you will be asked a number of questions related to the corresponding material in the textbook. The ICG keeps track of all the correct answers and at the end of the game displays a coded performance number that reflects how well you mastered the material in the text. Instructors have a manual to decode the performance number.

### 2.C. Web Modules

The Web Modules are a number of examples that apply key CRE concepts to both standard and nonstandard reaction engineering problems (e.g., glow sticks, the use of wetlands to degrade toxic chemicals, and pharmacokinetics of death from a cobra bite). The Web Modules can be loaded directly from the CRE Web site ([http://www.umich.edu/~elements/5e/web\\_mod/index.html](http://www.umich.edu/~elements/5e/web_mod/index.html)).

### 3. Solved Problems

A number of solved problems are presented along with problem-solving heuristics. Problem-solving strategies and additional worked example problems are available in the Problem Solving section of the CRE Web site.

## D.3 Professional Reference Shelf

This section of the CRE Web site contains

1. Material from the fifth edition of *Elements of Chemical Reaction Engineering* that is not included in the printed textbook.
2. Material that is important to the practicing engineer, such as details of the industrial reactor design for the oxidation of  $\text{SO}_2$  and design of spherical reactors and other material that is typically not included in the majority of chemical reaction engineering courses but is included here.

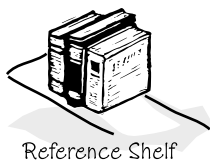

## E. Why Do We Assign Homework Problems?

The working of homework problems facilitates a true understanding of CRE. After reading a chapter the student may feel they have an understanding of the material. However, when attempting a new or slightly different application of CRE in a homework problem, students sometimes need to go back and re-read



different parts of the chapter to get the level of understanding needed to eventually solve the homework problem.

The end-of-chapter problems numbered “2” (e.g., P3-2<sub>A</sub>, P11-2<sub>B</sub>) ask questions about the example problems in that chapter. These example problems are a key resource. These number-2-level problems should be worked before tackling the more challenging homework problems in a given chapter. The subscript letter (A, B, C, or D) after each problem number denotes the difficulty of the problem (i.e., A = easy; D = difficult).

## F. What Is a Living Example Problem (LEP)?

The example problems that use an Ordinary Differential Equation (ODE) solver (e.g., Polymath) are referred to as “Living Example Problems” or “LEPs” because students can load the Polymath program directly onto their own computers in order to study the problem. Students are encouraged to change parameter values and to “play with” the key variables and assumptions. Using the LEPs to explore the problem and asking “what if...?” questions provide students with the opportunity to practice critical and creative thinking skills.



## G. What Software Is Available to Solve the LEPs?

*Polymath.* Polymath was developed by Professors Michael Cutlip and Mordechai Shacham. The Polymath software includes an ordinary differential equation (ODE) solver, a nonlinear equation solver, and nonlinear regression. As with previous editions of this book, Polymath is used to explore the example problems and to solve the homework problems. Polymath tutorials with screen shots are given on the CRE Web site Summary Notes in Chapter 1 and can also be accessed from the Home Page by going to Living Example Problems (LEPs) and then clicking on Polymath. Most chemical engineering departments in the United States have site licenses for Polymath. If your department does not have a site license and would like one, have your instructor e-mail the CACHE Corporation at [cache@uts.cc.utexas.edu](mailto:cache@uts.cc.utexas.edu) to learn how to obtain one. The LEPs need to be copied from the CRE Web site and pasted into the Polymath software. The Polymath software used in the examples in the text is available in most department computer labs in the United States. If you want to have Polymath on your personal laptop computer, you will need to purchase the program. An educational version of the software has been made available by Professors Cutlip and Shacham to students for \$20 for a 4-month license, \$30 for a 12-month license, or for \$39 for a perpetual-use license. Polymath 6.1 is compatible with Windows XP, Windows Vista, Windows 7, and Windows 8. See the Polymath Web site (<http://www.polymath-software.com>) to obtain the laptop version. A special Polymath Web site (<http://www.polymath-software.com/fogler>) has been set up for this book by Polymath authors Professors Cutlip and Shacham.

*AspenTech.* AspenTech is a process flow sheet simulator used in most senior chemical engineering design courses. It is now routinely introduced in earlier chemical engineering courses, such as thermodynamics, separations, and now in CRE. See the AspenTech Web site (<http://www.aspentech.com>) for more

information. Like Polymath, AspenTech site licenses are available in most chemical engineering departments in the United States. Four AspenTech simulation examples specific to CRE are provided on the CRE Web site with step-by-step tutorial screen shots.

As with Polymath programs, the input parameters in AspenTech can be varied to learn how they change the temperature and concentration profiles. Further details are given in Appendix D.

*COMSOL Multiphysics.* The COMSOL Multiphysics software is a partial differential equation solver that is used with Chapters 12 and 18 to view both axial and radial temperature and concentration profiles. For users of this text, COMSOL has provided a special Web site that includes a step-by-step tutorial, along with examples. See <http://www.comsol.com/ecre>. Further details are given in Appendix D.

Further details of these three software packages can be found in Appendix D.

## H. Are There Other Web Site Resources?

*FAQs.* The Frequently Asked Questions (FAQs) page on the CRE Web site contains a compilation of questions collected over the years from undergraduate students taking reaction engineering.

*Visual Encyclopedia of Equipment* (<http://encyclopedia.che.engin.umich.edu>). This section was developed by Dr. Susan Montgomery at the University of Michigan. Here, a wealth of photographs and descriptions of real and ideal reactors are given. Students with visual, active, sensing, and intuitive learning styles of the Felder/Solomon Index will particularly benefit from this section.

*Reactor Lab* (<http://www.ReactorLab.net>). Developed by Professor Richard Herz at the University of California at San Diego, this interactive tool will allow students not only to test their comprehension of the CRE material, but also to explore different situations and combinations of reaction orders and types of reactions.

*CRE Web Site.* The CRE Web site (<http://www.umich.edu/~elements/5e/index.html>) will be used to update the text and identify typographical and other errors in the first and later printings of this text—available under **Updates and FAQs** on the CRE Web site home page. Additional material may also be added to include more solved problems, as well as additional Web Modules, which will also be found under **Updates and FAQs**.

## I. How Can Critical Thinking and Creative Thinking Skills Be Enhanced?

### I.1. Enhance Critical Thinking Skills

A third goal of this book is to enhance critical thinking skills. How does one enhance their critical thinking skills? Answer by learning how to ask the critical thinking questions in Table P-2 and carry out the actions in Table P-3. A number of homework problems have been included that are designed for this purpose. Socratic questioning is at the heart of critical thinking, and a number of homework problems draw from R. W. Paul's six types of Socratic questions,<sup>3</sup> shown in Table P-2 and given in the expanded material on the Web site.

TABLE P-2 SIX TYPES OF SOCRATIC QUESTIONS USED IN CRITICAL THINKING

---

(1) <i>Questions for clarification:</i> Why do you say that? How does this relate to our discussion? "Are you going to include diffusion in your mole balance equations?"
(2) <i>Questions that probe assumptions:</i> What could we assume instead? How can you verify or disprove that assumption? "Why are you neglecting radial diffusion and including only axial diffusion?"
(3) <i>Questions that probe reasons and evidence:</i> What would be an example? "Do you think that diffusion is responsible for the lower conversion?"
(4) <i>Questions about viewpoints and perspectives:</i> What would be an alternative? "With all the bends in the pipe, from an industrial/practical perspective, do you think diffusion and dispersion will be large enough to affect the conversion?"
(5) <i>Questions that probe implications and consequences:</i> What generalizations can you make? What are the consequences of that assumption? "How would the results be affected if you neglected diffusion?"
(6) <i>Questions about the question:</i> What was the point of this question? Why do you think I asked this question? "Why do you think diffusion is important?"

---

It is important to know these six types and be able to apply them when investigating a problem such as "Is there a chance the reactor will run away and explode?" or "Why did the reactor explode?"

Critical thinking skills are like any skill, they must be practiced. Scheffer and Rubinfeld<sup>4,5</sup> describe how to practice critical thinking skills using the activities, statements, and questions shown in Table P-3. The reader should try to practice using some or all of these actions every day, as well as asking the critical thinking questions in Table P-1 and on the Web site.

<sup>3</sup> R. W. Paul, *Critical Thinking* (Santa Rosa, CA: Foundation for Critical Thinking, 1992).

<sup>4</sup> Courtesy of B. K. Scheffer and M. G. Rubinfeld, "A Consensus Statement on Critical Thinking in Nursing," *Journal of Nursing Education*, 39, 352–359 (2000).

<sup>5</sup> Courtesy of B. K. Scheffer and M. G. Rubinfeld, "Critical Thinking: What Is It and How Do We Teach It?" *Current Issues in Nursing* (2001).

TABLE P-3 CRITICAL THINKING ACTIONS<sup>6</sup>

---

<b>Analyzing:</b> separating or breaking a whole into parts to discover their nature, function, and relationships “I studied it piece by piece.” “I sorted things out.”
<b>Applying Standards:</b> judging according to established personal, professional, or social rules or criteria “I judged it according to....”
<b>Discriminating:</b> recognizing differences and similarities among things or situations and distinguishing carefully as to category or rank “I rank ordered the various....” “I grouped things together.”
<b>Information Seeking:</b> searching for evidence, facts, or knowledge by identifying relevant sources and gathering objective, subjective, historical, and current data from those sources “I knew I needed to look up/study....” “I kept searching for data.”
<b>Logical Reasoning:</b> drawing inferences or conclusions that are supported in or justified by evidence “I deduced from the information that....” “My rationale for the conclusion was....”
<b>Predicting:</b> envisioning a plan and its consequences “I envisioned the outcome would be....” “I was prepared for....”
<b>Transforming Knowledge:</b> changing or converting the condition, nature, form, or function of concepts among contexts “I improved on the basics by....” “I wondered if that would fit the situation of ....”

---

I have found that the best way to develop and practice critical thinking skills is to use Tables P-2 and P-3 to help students write a question on any assigned homework problem and then to explain why the question involves critical thinking.

More information on critical thinking can be found on the CRE Web site in the section on Problem Solving (<http://www.umich.edu/~elements/5e/prob-solv/index.htm>).

## I.2 Enhance Creative Thinking Skills

The fourth goal of this book is to help enhance creative thinking skills. This goal is achieved by using a number of problems that are open-ended to various degrees. With these, students can practice their creative skills by exploring the example problems, as outlined at the beginning of the home problems of each chapter, and by making up and solving an original problem. Problem P5-1 in the text gives some guidelines for developing original problems. A number of techniques that can aid students in practicing and enhancing their creativity

---

<sup>6</sup> R. W. Paul, *Critical Thinking* (Santa Rosa, CA: Foundation for Critical Thinking, 1992); B. K. Scheffer and M. G. Rubenfeld, “A Consensus Statement on Critical Thinking in Nursing,” *Journal of Nursing Education*, 39, 352–359 (2000).

can be found in Fogler, LeBlanc, and Rizzo<sup>7</sup> (and its companion Web site), *Strategies for Creative Problem Solving, Third Edition*. The Web site for that book can be accessed from the CRE Web site home page. We use these techniques, such as Osborn's checklist and de Bono's lateral thinking (which involves considering other people's views and responding to random stimulation) to answer add-on questions such as those in Table P-4.

TABLE P-4 PRACTICING CREATIVE THINKING

- 
- (1) Brainstorm ideas to ask another question or suggest another calculation that can be made for this homework problem.
  - (2) Brainstorm ways you could work this homework problem incorrectly.
  - (3) Brainstorm ways to make this problem easier or more difficult or more exciting.
  - (4) Brainstorm a list of things you learned from working this homework problem and what you think the point of the problem is.
  - (5) Brainstorm the reasons why your calculations overpredicted the conversion that was measured when the reactor was put on stream. Assume you made no numerical errors in your calculations.
  - (6) "What if..." questions: The "What if..." questions are particularly effective when used with the *Living Example Problems*, where one varies the parameters to explore the problem and to carry out a sensitivity analysis. For example, *what if someone suggested that you should double the catalyst particle diameter, what would you say?*
- 

One of the major goals at the undergraduate level is to bring students to the point where they can solve complex reaction problems, such as multiple reactions with heat effects, and then ask "What if . . . ?" questions and look for optimum operating conditions and unsafe operating conditions. The solution to one problem exemplifies this goal: the Manufacture of Styrene (Chapter 12, Problem P12-26<sub>c</sub>). This problem is particularly interesting because two reactions are endothermic and one is exothermic.

- (1) Ethylbenzene  $\rightarrow$  Styrene + Hydrogen: Endothermic
- (2) Ethylbenzene  $\rightarrow$  Benzene + Ethylene: Endothermic
- (3) Ethylbenzene + Hydrogen  $\rightarrow$  Toluene + Methane: Exothermic

The student could get further practice in critical and creative thinking skills by adding any of the following exercises (x), (y), and (z) to any of the end-of-chapter homework problems.

- (x) How could you make this problem easier? More difficult?
- (y) Critique your answer by writing a critical thinking question.
- (z) Describe two ways you could work this problem incorrectly.

To summarize, it is this author's experience that both critical and creative thinking skills can be enhanced by using Tables P-2, P-3, and P-4 to extend any of the homework problems at the end of each chapter.



---

<sup>7</sup> H. S. Fogler, S. E. LeBlanc, with B. Rizzo, *Strategies for Creative Problem Solving*, 3rd Ed. (Upper Saddle River, N.J.: Prentice Hall, 2014).

## J. What's New in This Edition?

### J.1 Pedagogy

This book maintains all the strengths of the fourth edition of *Elements of Chemical Reaction Engineering* by using algorithms that allow students to learn chemical reaction engineering through logic rather than memorization. It has the added strength of breaking down the material into smaller bites, as there are now 18 chapters to cover the same concepts as the 14 chapters in the fourth edition.

At the same time, this edition provides new resources that allow students to go beyond solving equations in order to get an intuitive feel and understanding of how reactors behave under different situations. This understanding is achieved through more than 80 interactive simulations (LEPs) provided on the Web site. The Web site has been greatly expanded to address the Felder/Solomon Inventory of Different Learning Styles<sup>8</sup> through interactive Summary Notes and new and updated Interactive Computer Games (ICGs). For example, as discussed in Appendix I the Global Learner can get an overview of the chapter material from the Summary Notes; the Sequential Learner can use all the  hot buttons; and the active learner can interact with the ICGs and use the  hot buttons in the Summary Notes.

A new pedagogical concept is introduced in this text through expanded emphasis on the example problems. Here, the students simply load the Living Example Problems (LEPs) onto their computers and then explore the problems to obtain a deeper understanding of the implications and generalizations before working the homework problems for that chapter. This exploration helps students get an innate feel for reactor behavior and operation, as well as develop and practice their creative thinking skills.

To develop critical thinking skills, instructors can assign one of the new homework problems on troubleshooting, as well as ask the students to expand homework problems by asking a related question that involves critical thinking using Tables P-2 and P-3.

Creative thinking skills can be enhanced by exploring the example problems and asking “What if . . . ?” questions, by using one or more of the brainstorming exercises in Table P-4 to extend any of the homework problems, and by solving the open-ended problems. For example, in the case study on safety, students can use the LEP on the CRE Web site to carry out a postmortem analysis on the nitroaniline explosion in Example 13-2 to learn what would have happened if the cooling had failed for five minutes instead of ten minutes. To this end, a new feature in the text is an Analysis paragraph at the end of each example problem. Significant effort has been devoted to developing example and homework problems that foster critical and creative thinking.

---

<sup>8</sup> <http://www.ncsu.edu/felder-public/ILSdir/styles.htm>

## J.2 Content

The following areas have an increased emphasis in this new edition over previous CRE editions by including thorough example problems and homework problems:

1. Safety: Three industrial explosions are discussed and modeled.
  - a. Ammonium Nitrate CSTR Explosion (Chapters 12 and 13)
  - b. Nitroaniline Batch Reactor Runaway (Chapter 13)
  - c. T2 Laboratories Batch Reactor Runaway (Chapter 13)
  - d. Resources from SChE and CCPS (Chapter 12)
2. Solar Energy: Three examples of solar energy conversion are discussed.
  - a. Solar Chemical Reactions (Chapter 3)
  - b. Solar Thermal Reactors (Chapter 8)
  - c. Solar Catalytic Water Splitting (Chapter 10)
3. Alternative Fuels:
  - a. Production of Algae for Biomass (Chapter 9)
4. AspenTech: An AspenTech tutorial for chemical reaction engineering and four example problems are provided on the CRE Web site. The example problems are
  - a. Production of Ethylene from Ethane
  - b. The Pyrolysis of Benzene
  - c. Adiabatic Liquid Phase Isomerization of Normal Butane
  - d. Adiabatic Production of Acetic Anhydride

*However, all intensive laws tend often to have exceptions. Very important concepts take orderly, responsible statements. Virtually all laws intrinsically are natural thoughts. General observations become laws under experimentation.*

## K. How Do I Say Thank You?

There are so many colleagues and students who contributed to this book that it would require another chapter to thank them all in an appropriate manner. I again acknowledge all my friends, students, and colleagues for their contributions to the fifth edition of *Elements of Chemical Reaction Engineering*. I would like to give special recognition as follows.

First of all, I am indebted to Ame and Catherine Vennema, whose gift of an endowed chair greatly facilitated the completion of this project. My colleague Dr. Nihat Gürmen coauthored the original Web site during the writing of the fourth edition of this book. He has been a wonderful colleague to work with. I also would like to thank University of Michigan undergraduate students Arthur Shih, Maria Quigley, and Brendan Kirchner, who worked on earlier versions of the Web site. Their hard work and suggestions are greatly appreciated. Ben Griessmann was instrumental in making everything come together for the Web site for the fifth edition, including converting the fourth edition's physical CD-ROM to online-only content for this new edition.

The many stimulating discussions on activation energy with Professor Michael Stamatakis in the Chemical Engineering Department at University College London are greatly appreciated. Michael B. Cutlip, coauthor of *Poly-math*, not only gave suggestions and a critical reading of many sections, but also, most importantly, provided continuous support and encouragement throughout the course of this project. Professor Chau-Chyun Chen provided two AspenTech examples. Ed Fontes at COMSOL Mutiphysic not only provided encouragement, but also provided a COMSOL Web site containing a tutorial with CRE examples. Bernard Goodwin and Laura Lewin, editors at Prentice Hall, were extremely encouraging, helpful, and supportive throughout. Julie Nahil, full-service production manager at Prentice Hall, was fantastic throughout. She provided encouragement, attention to detail, and a great sense of humor, which were greatly appreciated. Indian Institute of Technology (IIT) students Darshan Shah, Anamika Singh, and Sravya Jangareddy, along with Fan Zhang, a University of Michigan student, and Keyvan Edrisi from Swedish Royal Institute of Technology, not only participated in the preparation of the solutions manual, but along with Maithri Venkat worked on the Web site to place many of the LEPs in Wolfram. Richa Motwani from IIT Guwahati, and Gunish Handa and Prafful Bhansali from IIT Bombay, did an extraordinary job in proofreading the galley proofs of the manuscript and making helpful suggestions for changes as well as putting the solution manual in final form. Thank you to students Krittin Binabdullah, Apirak Hanpan, and Thanaphoom Khrutphisit from Chulalongkorn University in Bangkok, along with Ph.D. candidate Cláudio Vilas Bôas Fávero for help in meeting the final deadline for this manuscript.

I very much appreciated the patience of all my Ph.D. students during the period in which this book was written, Michael Senra, Zhenyu Huang, Michael Hoepfner, Nasim Haji Akbari Balou, Claudio Vilas Boas Favero, and Mark Sheng Zheng. Mark helped proofread a number of chapters of the page proofs; Professor Michael Senra class-tested the draft version of the fifth edition, and he and his students gave many valuable suggestions to this edition. There are others I would like to thank for a variety of different reasons: David Bogle, Lee Brown, Brice Carnahan, John Chen, Stu Churchill, Rane Curl, Jim Duderstadt, Tom Edgar, John Falconer, Rich Felder, Asterios Gavriilidis, Joe Goddard, Jay Jorgenson, Costas Kravaris, Steve LeBlanc, Joe Martin, Susan Montgomery, Max Peters, Phil Savage, Johannes Schwank, Mordechai Shacham, Klaus Timmerhaus, Ron West, Jim Wilkes, June Wispelwey, Max, Joe (aka “Jofo”), Sophia, Nicolas, and to the Starbucks staff at Plymouth Road Mall, where most of my final editing of this book was accomplished.

Laura Bracken is very much a part of this book. I appreciate her excellent deciphering of equations and scribbles, her organization, her discovery of mistakes and inconsistencies, and her attention to detail in working with the galleys and proofs. Through all this was her ever-present wonderful disposition. Thanks, Radar!!

Finally, to my wife Janet, love and thanks. Not only did she type the first edition of this book—on a Royal Select typewriter!—she also was a sounding board for so many things in this edition. She was always willing to help with



the wording and sentence structure. For example, I often asked her, “Is this the correct phrase or word to use here?” or “Should I mention Jofostan here?” Jan also helped me learn that creativity also involves knowing what to leave out. Without her enormous help and support the project would never have been possible.

HSF  
Ann Arbor, Michigan  
November 2015

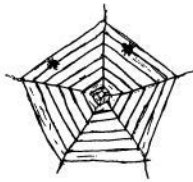

For updates and new and exciting applications, go to the Web site:

*<http://www.umich.edu/~elements/5e/index.html>*

For typographical errors, click on Updates & FAQ on the Home page to find

*<http://www.umich.edu/~elements/5e/updates/index.html>*

## *About the Author*



**H. Scott Fogler** is the Ame and Catherine Vennema professor of chemical engineering and the Arthur F. Thurnau professor at the University of Michigan in Ann Arbor, and was the 2009 National President of the American Institute of Chemical Engineers, a 50,000-member organization. He received his B.S. from the University of Illinois and his M.S. and Ph.D. from the University of Colorado. He is also the author of the *Essentials of Chemical Reaction Engineering* and co-author, with Steven LeBlanc and Benjamin Rizzo, of *Strategies for Creative Problem Solving, Third Edition*.

Professor Fogler's research interests include flow and reaction in porous media, wax and asphaltene deposition, asphaltene flocculation kinetics, gelation kinetics, colloidal phenomena, and catalyzed dissolution. He has been research advisor to more than forty-five Ph.D. students and has more than two hundred thirty-five refereed publications in these areas. Fogler has chaired ASEE's Chemical Engineering Division, served as director of the American Institute of Chemical Engineers, and earned the Warren K. Lewis Award from AIChE for contributions to chemical engineering education. He also received the Chemical Manufacturers Association's National Catalyst Award and the 2010 Malcom E. Pruitt Award from the Council for Chemical Research (CCR). He is the recipient of 11 named lectureships and is associate editor of *Energy & Fuels*.

*This page intentionally left blank*

# *Mole Balances* 1

The first step to knowledge  
is to know that we are ignorant.

—Socrates (470–399 B.C.)

## **The Wide Wild World of Chemical Reaction Engineering**

Chemical kinetics is the study of chemical reaction rates and reaction mechanisms. The study of chemical reaction engineering (CRE) combines the study of chemical kinetics with the reactors in which the reactions occur. Chemical kinetics and reactor design are at the heart of producing almost all industrial chemicals, such as the manufacture of phthalic anhydride shown in Figure 1-1. It is primarily a knowledge of chemical kinetics and reactor design that distinguishes the chemical engineer from other engineers. The selection of a reaction system that operates in the safest and most efficient manner can be the key to the economic success or failure of a chemical plant. For example, if a reaction system produces a large amount of undesirable product, subsequent purification and separation of the desired product could make the entire process economically unfeasible.

How is a chemical  
engineer different  
from other  
engineers?

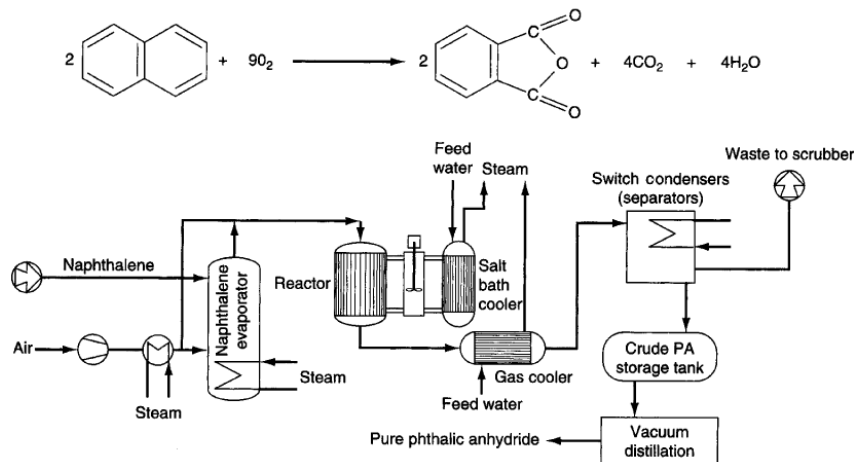
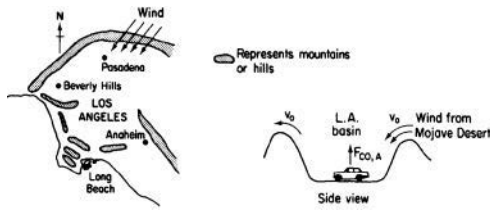
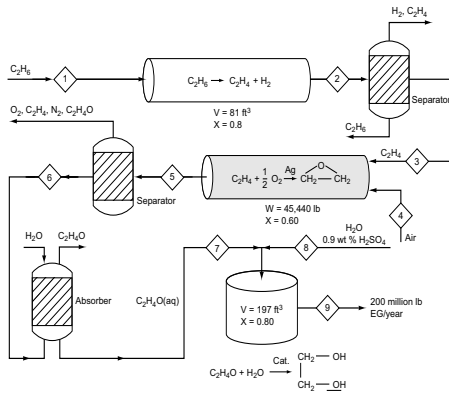

Figure 1-1 Manufacture of phthalic anhydride.

The chemical reaction engineering (CRE) principles learned here can also be applied in many areas, such as waste treatment, microelectronics, nanoparticles, and living systems, in addition to the more traditional areas of the manufacture of chemicals and pharmaceuticals. Some of the examples that illustrate the wide application of CRE principles in this book are shown in Figure 1-2. These examples include modeling smog in the Los Angeles (L.A.) basin (Chapter 1), the digestive system of a hippopotamus (Chapter 2 on the CRE Web site, [www.umich.edu/~elements/5e/index.html](http://www.umich.edu/~elements/5e/index.html)), and molecular CRE (Chapter 3). Also shown are the manufacture of ethylene glycol (antifreeze), where three of the most common types of industrial reactors are used (Chapters 5 and 6), and the use of wetlands to degrade toxic chemicals (Chapter 7 on the CRE Web site). Other examples shown are the solid-liquid kinetics of acid-rock interactions to improve oil recovery (Chapter 7); pharmacokinetics of cobra bites (Chapter 8 Web Module); free-radical scavengers used in the design of motor oils (Chapter 9); enzyme kinetics (Chapter 9) and drug delivery pharmacokinetics (Chapter 9 on the CRE Web site); heat effects, runaway reactions, and plant safety (Chapters 11 through 13); and increasing the octane number of gasoline and the manufacture of computer chips (Chapter 10).



Smog (Ch. 1)



Chemical Plant for Ethylene Glycol (Ch. 5)

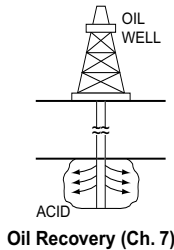

Oil Recovery (Ch. 7)



Pharmacokinetics of Cobra Bites  
Multiple Reactions in a Batch (Body) Reactor

Cobra Bites (Ch. 8 on the CRE Web site)



Effective Lubricant Design Scavenging Free Radicals  
Lubricant Design (Ch. 9)

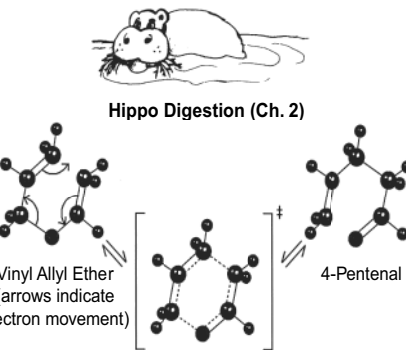

Hippo Digestion (Ch. 2)

Transition State (dashed lines show transition state electron delocalization)

Molecular CRE (Ch. 3)

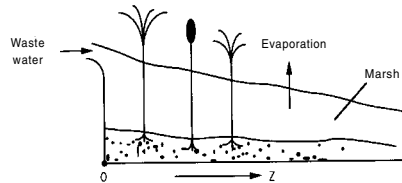

Wetlands Remediation of Pollutants (Ch. 7 on the CRE Web site)

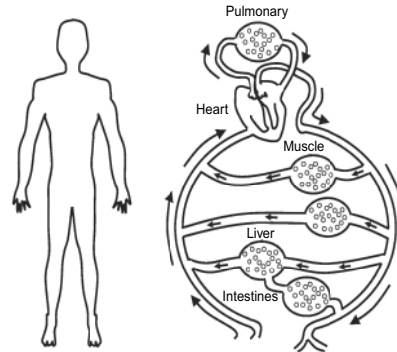

Pharmacokinetics (Ch. 9 on the CRE Web site)

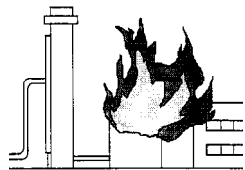

Nitroanaline Plant Explosion  
Exothermic Reactions That Run Away  
Plant Safety (Ch. 11 to Ch. 13)

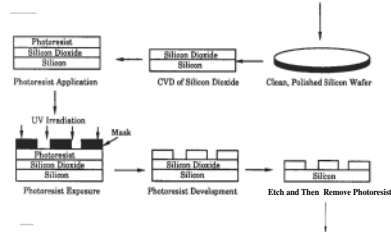
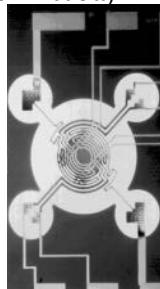

Microelectronic Fabrication Steps (Ch. 10)

Figure 1-2 The wide world of CRE applications.

**Overview—Chapter 1.** This chapter develops the first building block of chemical reaction engineering, *mole balances*, which will be used continually throughout the text. After completing this chapter, the reader will be able to:

- Describe and define the rate of reaction
- Derive the general mole balance equation
- Apply the general mole balance equation to the four most common types of industrial reactors

Before entering into discussions of the conditions that affect chemical reaction rate mechanisms and reactor design, it is necessary to account for the various chemical species entering and leaving a reaction system. This accounting process is achieved through overall mole balances on individual species in the reacting system. In this chapter, we develop a general mole balance that can be applied to any species (usually a chemical compound) entering, leaving, and/or remaining within the reaction system volume. After defining the rate of reaction,  $-r_A$ , we show how the general balance equation may be used to develop a preliminary form of the design equations of the most common industrial reactors:

- Batch Reactor (BR)
- Continuous-Stirred Tank Reactor (CSTR)
- Plug-Flow Reactor (PFR)
- Packed-Bed Reactor (PBR)

In developing these equations, the assumptions pertaining to the modeling of each type of reactor are delineated. Finally, a brief summary and series of short review questions are given at the end of the chapter.

## 1.1 The Rate of Reaction, $-r_A$

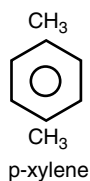

The rate of reaction tells us how fast a number of moles of one chemical species are being consumed to form another chemical species. The term *chemical species* refers to any chemical component or element with a given *identity*. The identity of a chemical species is determined by the *kind*, *number*, and *configuration* of that species' atoms. For example, the species para-xylene is made up of a fixed number of specific atoms in a definite molecular arrangement or configuration. The structure shown illustrates the kind, number, and configuration of atoms on a molecular level. Even though two chemical compounds have exactly the same kind and number of atoms of each element, they could still be different species because of different configurations. For example, 2-butene has four carbon atoms and eight hydrogen atoms; however, the atoms in this compound can form two different arrangements.

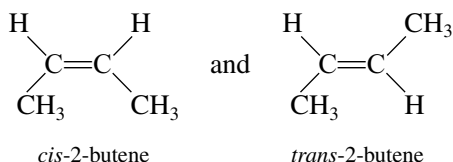

As a consequence of the different configurations, these two isomers display different chemical and physical properties. Therefore, we consider them as two different species, even though each has the same number of atoms of each element.

When has a chemical reaction taken place?

We say that a *chemical reaction* has taken place when a detectable number of molecules of one or more species have lost their identity and assumed a new form by a change in the kind or number of atoms in the compound and/or by a change in structure or configuration of these atoms. In this classical approach to chemical change, it is assumed that the total mass is neither created nor destroyed when a chemical reaction occurs. The mass referred to is the total collective mass of all the different species in the system. However, when considering the individual species involved in a particular reaction, we do speak of the rate of disappearance of mass of a particular species. *The rate of disappearance of a species, say species A, is the number of A molecules that lose their chemical identity per unit time per unit volume through the breaking and subsequent re-forming of chemical bonds during the course of the reaction.* In order for a particular species to “appear” in the system, some prescribed fraction of another species must lose its chemical identity.

There are three basic ways a species may lose its chemical identity: decomposition, combination, and isomerization. In *decomposition*, the molecule loses its identity by being broken down into smaller molecules, atoms, or atom fragments. For example, if benzene and propylene are formed from a cumene molecule,

A species can lose its identity by

- Decomposition
- Combination
- Isomerization

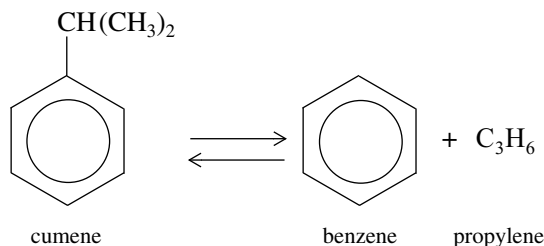

the cumene molecule has lost its identity (i.e., disappeared) by breaking its bonds to form these molecules. A second way that a molecule may lose its chemical identity is through *combination* with another molecule or atom. In the above reaction, the propylene molecule would lose its chemical identity if the reaction were carried out in the reverse direction, so that it combined with benzene to form cumene. The third way a species may lose its chemical identity is through *isomerization*, such as the reaction

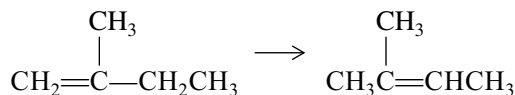

Here, although the molecule neither adds other molecules to itself nor breaks into smaller molecules, it still loses its identity through a change in configuration.



To summarize this point, we say that a given number of molecules (i.e., moles) of a particular chemical species have reacted or disappeared when the molecules have lost their chemical identity.

The rate at which a given chemical reaction proceeds can be expressed in several ways. To illustrate, consider the reaction of chloral and chlorobenzene to produce the banned insecticide DDT (dichlorodiphenyl-trichloroethane) in the presence of fuming sulfuric acid.

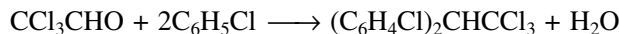

Letting the symbol A represent chloral, B be chlorobenzene, C be DDT, and D be  $\text{H}_2\text{O}$ , we obtain



The numerical value of the rate of disappearance of reactant A,  $-r_A$ , is a positive number.

What is  $-r_A$ ?

The rate of reaction,  $-r_A$ , is the number of moles of A (e.g., chloral) reacting (disappearing) per unit time per unit volume ( $\text{mol}/\text{dm}^3\cdot\text{s}$ ).

### Example 1-1

Chloral is being consumed at a rate of 10 moles per second per  $\text{m}^3$  when reacting with chlorobenzene to form DDT and water in the reaction described above. In symbol form, the reaction is written as

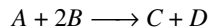

Write the rates of disappearance and formation (i.e., generation) for each species in this reaction.

#### Solution

- (a) *Chloral*[A]: The rate of reaction of chloral [A] ( $-r_A$ ) is given as  $10 \text{ mol}/\text{m}^3\cdot\text{s}$   
 Rate of disappearance of A =  $-r_A = 10 \text{ mol}/\text{m}^3\cdot\text{s}$   
 Rate of formation of A =  $r_A = -10 \text{ mol}/\text{m}^3\cdot\text{s}$
- (b) *Chlorobenzene*[B]: For every mole of chloral that disappears, two moles of chlorobenzene [B] also disappear.  
 Rate of disappearance of B =  $-r_B = 20 \text{ mol}/\text{m}^3\cdot\text{s}$   
 Rate of formation of B =  $r_B = -20 \text{ mol}/\text{m}^3\cdot\text{s}$
- (c) *DDT*[C]: For every mole of chloral that disappears, one mole of DDT [C] appears.  
 Rate of formation of C =  $r_C = 10 \text{ mol}/\text{m}^3\cdot\text{s}$   
 Rate of disappearance of C =  $-r_C = -10 \text{ mol}/\text{m}^3\cdot\text{s}$
- (d) *Water*[D]: Same relationship to chloral as the relationship to DDT  
 Rate of formation of D =  $r_D = 10 \text{ mol}/\text{m}^3\cdot\text{s}$   
 Rate of disappearance of D =  $-r_D = -10 \text{ mol}/\text{m}^3\cdot\text{s}$

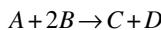

The convention

$-r_A = 10 \text{ mol A/m}^3\cdot\text{s}$ $r_A = -10 \text{ mol A/m}^3\cdot\text{s}$ $-r_B = 20 \text{ mol B/m}^3\cdot\text{s}$ $r_B = -20 \text{ mol B/m}^3\cdot\text{s}$ $r_C = 10 \text{ mol C/m}^3\cdot\text{s}$
---

**Analysis:** The purpose of this example is to better understand the convention for the rate of reaction. The symbol  $r_j$  is the rate of formation (generation) of species  $j$ . If species  $j$  is a reactant, the numerical value of  $r_j$  will be a negative number. If species  $j$  is a product, then  $r_j$  will be a positive number. The rate of reaction,  $-r_A$ , is the rate of disappearance of reactant A and must be a positive number. A mnemonic relationship to help remember how to obtain relative rates of reaction of A to B, etc., is given by Equation (3-1) on page 71.

In Chapter 3, we will delineate the prescribed relationship between the rate of formation of one species,  $r_j$  (e.g., DDT [C]), and the rate of disappearance of another species,  $-r_i$  (e.g., chlorobenzene [B]), in a chemical reaction.

Heterogeneous reactions involve more than one phase. In heterogeneous reaction systems, the rate of reaction is usually expressed in measures other than volume, such as reaction surface area or catalyst weight. For a gas-solid catalytic reaction, the gas molecules must interact with the solid catalyst surface for the reaction to take place, as described in Chapter 10.

What is  $-r'_A$ ? The dimensions of this heterogeneous reaction rate,  $-r'_A$  (prime), are the number of moles of A reacting per unit time per unit mass of catalyst (mol/s·g catalyst).

Definition of  $r_j$  Most of the introductory discussions on chemical reaction engineering in this book focus on homogeneous systems, in which case we simply say that  $r_j$  is the rate of formation of species  $j$  per unit volume. It is the number of moles of species  $j$  generated per unit volume per unit time.

We can say four things about the reaction rate  $r_j$ . The reaction rate law for  $r_j$  is

The rate law does not depend on the type of reactor used!!

- **The rate of formation of species  $j$  (mole/time/volume)**
- **An algebraic equation**
- **Independent of the type of reactor (e.g., batch or continuous flow) in which the reaction is carried out**
- **Solely a function of the properties of the reacting materials and reaction conditions (e.g., species concentration, temperature, pressure, or type of catalyst, if any) at a point in the system**

What is  $-r_A$  a function of?

However, because the properties and reaction conditions of the reacting materials may vary with position in a chemical reactor,  $r_j$  can in turn be a function of position and can vary from point to point in the system.

The chemical reaction rate law is essentially an algebraic equation involving concentration, not a differential equation.<sup>1</sup> For example, the algebraic form of the rate law for  $-r_A$  for the reaction

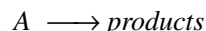

may be a linear function of concentration,

$$-r_A = kC_A \quad (1-1)$$

or, as shown in Chapter 3, it may be some other algebraic function of concentration, such as

<sup>1</sup> For further elaboration on this point, see *Chem. Eng. Sci.*, 25, 337 (1970); B. L. Crynes and H. S. Fogler, eds., *AIChE Modular Instruction Series E: Kinetics*, 1, 1 (New York: AIChE, 1981); and R. L. Kabel, "Rates," *Chem. Eng. Commun.*, 9, 15 (1981).

$$-r_A = kC_A^2 \quad (1-2)$$

or

The rate law is an algebraic equation.

$$-r_A = \frac{k_1 C_A}{1 + k_2 C_A}$$

The convention

For a given reaction, the particular concentration dependence that the rate law follows (i.e.,  $-r_A = kC_A$  or  $-r_A = kC_A^2$  or ...) must be determined from *experimental observation*. Equation (1-2) states that the rate of disappearance of A is equal to a rate constant  $k$  (which is a function of temperature) times the square of the concentration of A. As noted earlier, by convention,  $r_A$  is the rate of formation of A; consequently,  $-r_A$  is the rate of disappearance of A. Throughout this book, the phrase *rate of generation* means exactly the same as the phrase *rate of formation*, and these phrases are used interchangeably.

## 1.2 The General Mole Balance Equation

To perform a mole balance on any system, the system boundaries must first be specified. The volume enclosed by these boundaries is referred to as the *system volume*. We shall perform a mole balance on species  $j$  in a system volume, where species  $j$  represents the particular chemical species of interest, such as water or NaOH (Figure 1-3).

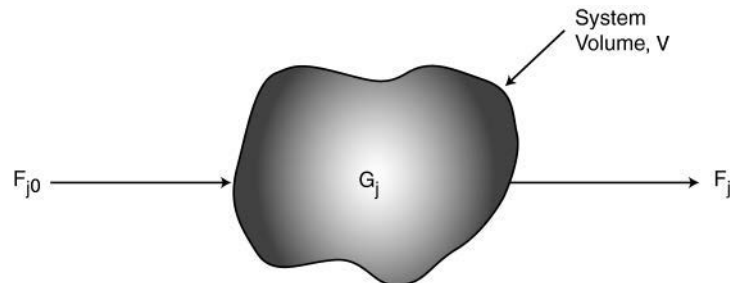

**Figure 1-3** Mole balance on species  $j$  in a system volume,  $V$ .

A mole balance on species  $j$  at any instant in time,  $t$ , yields the following equation:

$$\begin{array}{l}
 \left[ \begin{array}{c} \text{Rate of flow} \\ \text{of } j \text{ into} \\ \text{the system} \\ \text{(moles/time)} \end{array} \right] - \left[ \begin{array}{c} \text{Rate of flow} \\ \text{of } j \text{ out of} \\ \text{the system} \\ \text{(moles/time)} \end{array} \right] + \left[ \begin{array}{c} \text{Rate of generation} \\ \text{of } j \text{ by chemical} \\ \text{reaction within} \\ \text{the system} \\ \text{(moles/time)} \end{array} \right] = \left[ \begin{array}{c} \text{Rate of} \\ \text{accumulation} \\ \text{of } j \text{ within} \\ \text{the system} \\ \text{(moles/time)} \end{array} \right] \\
 \text{Mole balance} \quad \mathbf{In} \quad - \quad \mathbf{Out} \quad + \quad \mathbf{Generation} \quad = \quad \mathbf{Accumulation} \\
 F_{j0} \quad - \quad F_j \quad + \quad G_j \quad = \quad \frac{dN_j}{dt} \quad (1-3)
 \end{array}$$

In this equation,  $N_j$  represents the number of moles of species  $j$  in the system at time  $t$ . If all the system variables (e.g., temperature, catalytic activity, and concentration of the chemical species) are spatially uniform throughout the system volume, the rate of generation of species  $j$ ,  $G_j$ , is just the product of the reaction volume,  $V$ , and the rate of formation of species  $j$ ,  $r_j$ .

$$G_j = r_j \cdot V$$

$$\frac{\text{moles}}{\text{time}} = \frac{\text{moles}}{\text{time} \cdot \text{volume}} \cdot \text{volume}$$

Now suppose that the rate of formation of species  $j$  for the reaction varies with position in the system volume. That is, it has a value  $r_{j1}$  at location 1, which is surrounded by a small volume,  $\Delta V_1$ , within which the rate is uniform; similarly, the reaction rate has a value  $r_{j2}$  at location 2 and an associated volume,  $\Delta V_2$ , and so on (Figure 1-4).

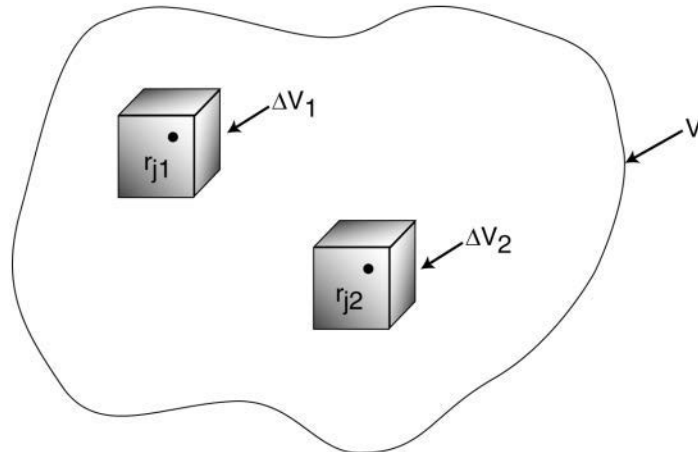

**Figure 1-4** Dividing up the system volume,  $V$ .

The rate of generation,  $\Delta G_{j1}$ , in terms of  $r_{j1}$  and subvolume  $\Delta V_1$ , is

$$\Delta G_{j1} = r_{j1} \Delta V_1$$

Similar expressions can be written for  $\Delta G_{j2}$  and the other system subvolumes,  $\Delta V_i$ . The total rate of generation within the system volume is the sum of all the rates of generation in each of the subvolumes. If the total system volume is divided into  $M$  subvolumes, the total rate of generation is

$$G_j = \sum_{i=1}^M \Delta G_{ji} = \sum_{i=1}^M r_{ji} \Delta V_i$$

By taking the appropriate limits (i.e., let  $M \rightarrow \infty$  and  $\Delta V \rightarrow 0$ ) and making use of the definition of an integral, we can rewrite the foregoing equation in the form

$$G_j = \int^V r_j dV$$

From this equation, we see that  $r_j$  will be an indirect function of position, since the properties of the reacting materials and reaction conditions (e.g., concentration, temperature) can have different values at different locations in the reactor volume.

We now replace  $G_j$  in Equation (1-3)

$$F_{j0} - F_j + G_j = \frac{dN_j}{dt} \quad (1-3)$$

by its integral form to yield a form of the general mole balance equation for any chemical species  $j$  that is entering, leaving, reacting, and/or accumulating within any system volume  $V$ .

This is a basic equation for chemical reaction engineering.

$$F_{j0} - F_j + \int^V r_j dV = \frac{dN_j}{dt} \quad (1-4)$$

From this general mole balance equation, we can develop the design equations for the various types of industrial reactors: batch, semibatch, and continuous-flow. Upon evaluation of these equations, we can determine the time (batch) or reactor volume (continuous-flow) necessary to convert a specified amount of the reactants into products.

### 1.3 Batch Reactors (BRs)

When is a batch reactor used?

A batch reactor is used for small-scale operation, for testing new processes that have not been fully developed, for the manufacture of expensive products, and for processes that are difficult to convert to continuous operations. The reactor can be charged (i.e., filled) through the holes at the top (see Figure 1-5(a)). The batch reactor has the advantage of high conversions that can be obtained by leaving the reactant in the reactor for long periods of time, but it also has the disadvantages of high labor costs per batch, the variability of products from batch to batch, and the difficulty of large-scale production (see Industrial Reactor Photos in *Professional Reference Shelf [PRS]* on the CRE Web site, [www.umich.edu/~elements/5e/index.html](http://www.umich.edu/~elements/5e/index.html)).



Reference Shelf

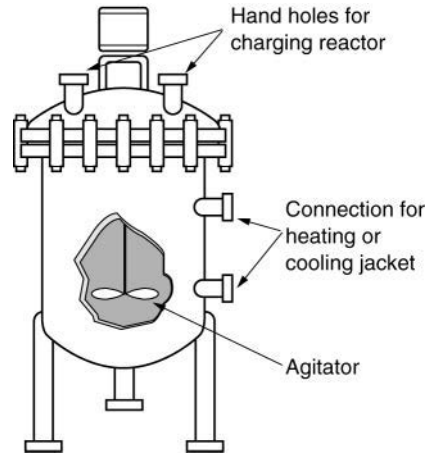

**Figure 1-5(a)** Simple batch homogeneous batch reactor (BR). [Excerpted by special permission from *Chem. Eng.*, 63(10), 211 (Oct. 1956). Copyright 1956 by McGraw-Hill, Inc., New York, NY 10020.]



**Figure 1-5(b)** Batch reactor mixing patterns. Further descriptions and photos of the batch reactors can be found in both the *Visual Encyclopedia of Equipment* and in the *Professional Reference Shelf* on the CRE Web site.

A batch reactor has neither inflow nor outflow of reactants or products while the reaction is being carried out:  $F_{j0} = F_j = 0$ . The resulting general mole balance on species  $j$  is

$$\frac{dN_j}{dt} = \int^V r_j dV$$

If the reaction mixture is perfectly mixed (Figure 1-5(b)) so that there is no variation in the rate of reaction throughout the reactor volume, we can take  $r_j$  out of the integral, integrate, and write the mole balance in the form

Perfect mixing

$$\boxed{\frac{dN_j}{dt} = r_j V} \quad (1-5)$$

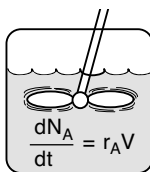

Batch Reactor

Let's consider the isomerization of species A in a batch reactor

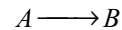

As the reaction proceeds, the number of moles of A decreases and the number of moles of B increases, as shown in Figure 1-6.

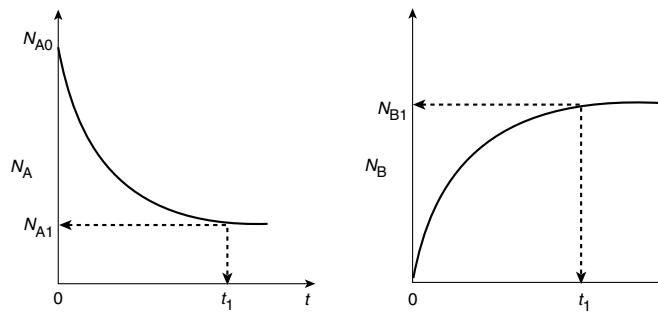

Figure 1-6 Mole-time trajectories.

We might ask what time,  $t_1$ , is necessary to reduce the initial number of moles from  $N_{A0}$  to a final desired number  $N_{A1}$ . Applying Equation (1-5) to the isomerization

$$\frac{dN_A}{dt} = r_A V$$

rearranging,

$$dt = \frac{dN_A}{r_A V}$$

and integrating with limits that at  $t = 0$ , then  $N_A = N_{A0}$ , and at  $t = t_1$ , then  $N_A = N_{A1}$ , we obtain

$$t_1 = \int_{N_{A1}}^{N_{A0}} \frac{dN_A}{-r_A V} \quad (1-6)$$

This equation is the integral form of the mole balance on a batch reactor. It gives the time,  $t_1$ , necessary to reduce the number of moles from  $N_{A0}$  to  $N_{A1}$  and also to form  $N_{B1}$  moles of B.

## 1.4 Continuous-Flow Reactors

Continuous-flow reactors are almost always operated at steady state. We will consider three types: the *continuous-stirred tank reactor* (CSTR), the *plug-flow reactor* (PFR), and the *packed-bed reactor* (PBR). Detailed physical descriptions of these reactors can be found in both the *Professional Reference Shelf* (PRS) for Chapter 1 and in the *Visual Encyclopedia of Equipment*, [encyclopedia.che.engin.umich.edu](http://encyclopedia.che.engin.umich.edu), and on the CRE Web site.

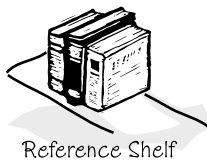

Reference Shelf

### 1.4.1 Continuous-Stirred Tank Reactor (CSTR)

A type of reactor commonly used in industrial processing is the stirred tank operated continuously (Figure 1-7). It is referred to as the *continuous-stirred tank reactor* (CSTR) or *vat*, or *backmix reactor*, and is primarily used for

What is a CSTR used for?



**Figure 1-7(a)** CSTR/batch reactor. (Photo courtesy of Pfaunder, Inc.)

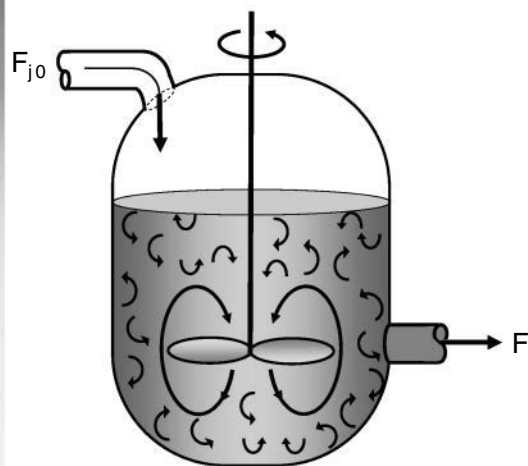

**Figure 1-7(b)** CSTR mixing patterns. Also see the *Visual Encyclopedia of Equipment* on the CRE Web site.

liquid-phase reactions. It is normally operated **at steady state** and is assumed to be **perfectly mixed**; consequently, there is no time dependence or position dependence of the temperature, concentration, or reaction rate inside the CSTR. That is, every variable is the same at every point inside the reactor. Because the temperature and concentration are identical everywhere within the reaction vessel, they are the same at the *exit point* as they are elsewhere in the tank. Thus, the temperature and concentration in the exit stream are modeled as being the same as those inside the reactor. In systems where mixing is highly nonideal, the well-mixed model is inadequate, and we must resort to other modeling techniques, such as residence time distributions, to obtain meaningful results. This topic of nonideal mixing is discussed in Chapters 16, 17, and 18 on nonideal reactors.

When the general mole balance equation

$$F_{j0} - F_j + \int_V r_j dV = \frac{dN_j}{dt} \quad (1-4)$$

is applied to a CSTR operated at steady state (i.e., conditions do not change with time),

$$\frac{dN_j}{dt} = 0$$



in which there are no spatial variations in the rate of reaction (i.e., perfect mixing),

The ideal CSTR is assumed to be perfectly mixed.

$$\int^V r_j dV = Vr_j$$

it takes the familiar form known as the *design equation* for a CSTR

$$V = \frac{F_{j0} - F_j}{-r_j} \quad (1-7)$$

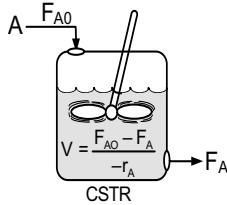

The CSTR design equation gives the reactor volume  $V$  necessary to reduce the entering flow rate of species  $j$  from  $F_{j0}$  to the exit flow rate  $F_j$ , when species  $j$  is disappearing at a rate of  $-r_j$ . We note that the CSTR is modeled such that the conditions in the exit stream (e.g., concentration and temperature) **are identical** to those in the tank. The molar flow rate  $F_j$  is just the product of the concentration of species  $j$  and the volumetric flow rate  $v$

$$F_j = C_j \cdot v$$

$$\frac{\text{moles}}{\text{time}} = \frac{\text{moles}}{\text{volume}} \cdot \frac{\text{volume}}{\text{time}} \quad (1-8)$$

Similarly, for the entrance molar flow rate we have  $F_{j0} = C_{j0} \cdot v_0$ . Consequently, we can substitute for  $F_{j0}$  and  $F_j$  into Equation (1-7) to write a balance on species A as

$$V = \frac{v_0 C_{A0} - v C_A}{-r_A} \quad (1-9)$$

The ideal CSTR mole balance equation is an algebraic equation, not a differential equation.

#### 1.4.2 Tubular Reactor

In addition to the CSTR and batch reactors, another type of reactor commonly used in industry is the *tubular reactor*. It consists of a cylindrical pipe and is normally operated at steady state, as is the CSTR. Tubular reactors are used most often for gas-phase reactions. A schematic and a photograph of industrial tubular reactors are shown in Figure 1-8.

In the tubular reactor, the reactants are continually consumed as they flow down the length of the reactor. In modeling the tubular reactor, we assume that the concentration varies continuously in the axial direction through the reactor. Consequently, the reaction rate, which is a function of concentration for all but zero-order reactions, will also vary axially. For the purposes of the material presented here, we consider systems in which the flow field may be modeled by that of a plug-flow profile (e.g., uniform velocity as

When is a tubular reactor most often used?

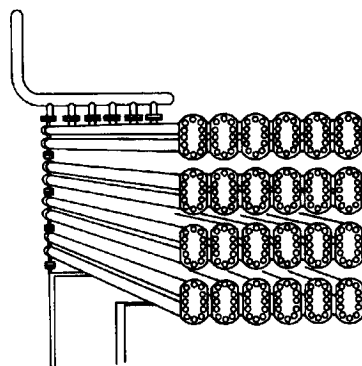

**Figure 1-8(a)** Tubular reactor schematic. Longitudinal tubular reactor. [Excerpted by special permission from *Chem. Eng.*, 63(10), 211 (Oct. 1956). Copyright 1956 by McGraw-Hill, Inc., New York, NY 10020.]

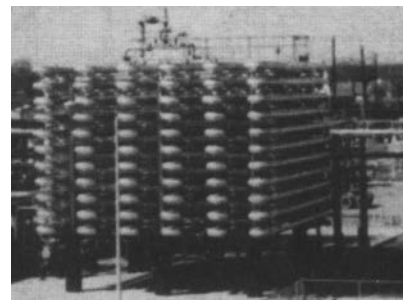

**Figure 1-8(b)** Tubular reactor photo. Tubular reactor for production of Dimersol G. (Photo courtesy of Editions Techniq Institut français du pétrole.)

in turbulent flow), as shown in Figure 1-9. That is, there is no radial variation in reaction rate, and the reactor is referred to as a *plug-flow reactor* (PFR). (The laminar-flow reactor is discussed in Chapters 16 through 18 on nonideal reactors.)

Also see PRS and *Visual Encyclopedia of Equipment*.

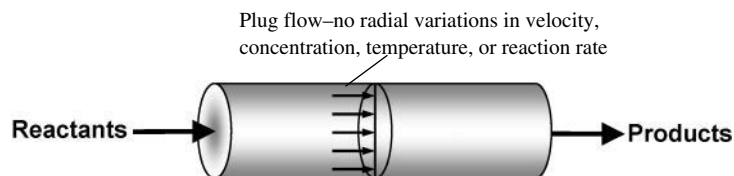

**Figure 1-9** Plug-flow tubular reactor.

The general mole balance equation is given by Equation (1-4)

$$F_{j0} - F_j + \int^V r_j dV = \frac{dN_j}{dt} \quad (1-4)$$

The equation we will use to design PFRs at steady state can be developed in two ways: (1) directly from Equation (1-4) by differentiating with respect to volume  $V$ , and then rearranging the result or (2) from a mole balance on species  $j$  in a differential segment of the reactor volume  $\Delta V$ . Let's choose the second way to arrive at the differential form of the PFR mole balance. The differential volume,  $\Delta V$ , shown in Figure 1-10, will be chosen sufficiently small such that there are no spatial variations in reaction rate within this volume. Thus the generation term,  $\Delta G_j$ , is

$$\Delta G_j = \int^{\Delta V} r_j dV = r_j \Delta V$$

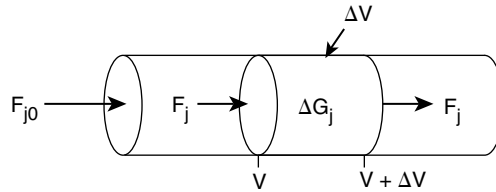

Figure 1-10 Mole balance on species  $j$  in volume  $\Delta V$ .

$\left[ \begin{array}{l} \text{Molar flow} \\ \text{rate of species } j \\ \text{In at } V \\ \text{moles/time} \end{array} \right]$	-	$\left[ \begin{array}{l} \text{Molar flow} \\ \text{rate of species } j \\ \text{Out at } (V + \Delta V) \\ \text{moles/time} \end{array} \right]$	+	$\left[ \begin{array}{l} \text{Molar rate of} \\ \text{Generation} \\ \text{of species } j \\ \text{within } \Delta V \\ \text{moles/time} \end{array} \right]$	=	$\left[ \begin{array}{l} \text{Molar rate of} \\ \text{Accumulation} \\ \text{of species } j \\ \text{within } \Delta V \\ \text{moles/time} \end{array} \right]$
<b>In</b>		<b>Out</b>		<b>Generation</b>		<b>Accumulation</b>
$F_j _V$		$F_j _{V+\Delta V}$		$r_j \Delta V$		$= 0$ (1-10)

Dividing by  $\Delta V$  and rearranging

$$\left[ \frac{F_j|_{V+\Delta V} - F_j|_V}{\Delta V} \right] = r_j$$

the term in brackets resembles the definition of a derivative

$$\lim_{\Delta x \rightarrow 0} \left[ \frac{f(x + \Delta x) - f(x)}{\Delta x} \right] = \frac{df}{dx}$$

Taking the limit as  $\Delta V$  approaches zero, we obtain the differential form of steady state mole balance on a PFR

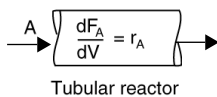

$$\boxed{\frac{dF_j}{dV} = r_j} \quad (1-11)$$

We could have made the cylindrical reactor on which we carried out our mole balance an irregularly shaped reactor, such as the one shown in Figure 1-11 for reactant species A.

However, we see that by applying Equation (1-10), the result would yield the same equation (i.e., Equation (1-11)). For species A, the mole balance is

$$\boxed{\frac{dF_A}{dV} = r_A} \quad (1-12)$$

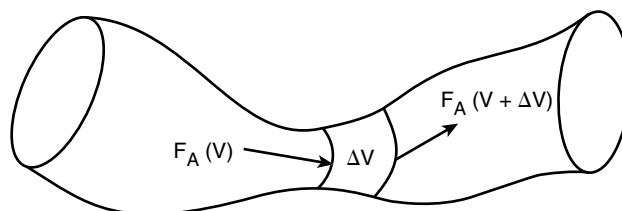
Picasso's  
reactor**Figure 1-11** Pablo Picasso's reactor.

Consequently, we see that Equation (1-11) applies equally well to our model of tubular reactors of variable and constant cross-sectional area, although it is doubtful that one would find a reactor of the shape shown in 1-11 unless it were designed by Pablo Picasso.

The conclusion drawn from the application of the design equation to Picasso's reactor is an important one: the degree of completion of a reaction achieved in an ideal plug-flow reactor (PFR) does not depend on its shape, only on its total volume.

Again consider the isomerization  $A \rightarrow B$ , this time in a PFR. As the reactants proceed down the reactor, A is consumed by chemical reaction and B is produced. Consequently, the molar flow rate  $F_A$  decreases, while  $F_B$  increases as the reactor volume  $V$  increases, as shown in Figure 1-12.

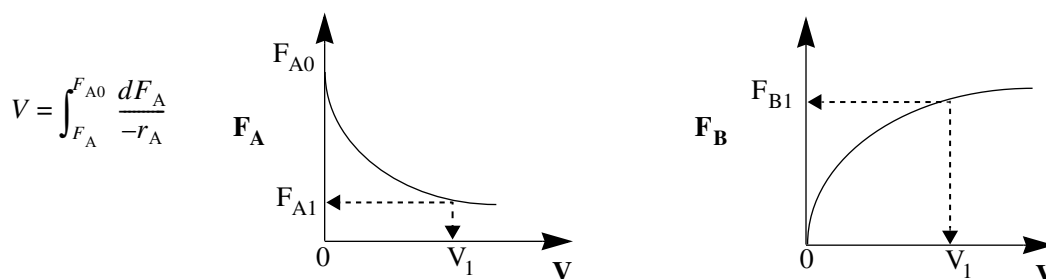
**Figure 1-12** Profiles of molar flow rates in a PFR.

We now ask what is the reactor volume  $V_1$  necessary to reduce the entering molar flow rate of A from  $F_{A0}$  to  $F_{A1}$ . Rearranging Equation (1-12) in the form

$$dV = \frac{dF_A}{r_A}$$

and integrating with limits at  $V = 0$ , then  $F_A = F_{A0}$ , and at  $V = V_1$ , then  $F_A = F_{A1}$

$$V_1 = \int_{F_{A0}}^{F_{A1}} \frac{dF_A}{r_A} = \int_{F_{A1}}^{F_{A0}} \frac{dF_A}{-r_A} \quad (1-13)$$

$V_1$  is the volume necessary to reduce the entering molar flow rate  $F_{A0}$  to some specified value  $F_{A1}$  and also the volume necessary to produce a molar flow rate of B of  $F_{B1}$ .

### 1.4.3 Packed-Bed Reactor (PBR)

The principal difference between reactor design calculations involving homogeneous reactions and those involving fluid-solid heterogeneous reactions is that for the latter, the reaction takes place on the surface of the catalyst (see Chapter 10). The greater the mass of a given catalyst, the greater the reactive surface area. Consequently, the reaction rate is based on mass of solid catalyst,  $W$ , rather than on reactor volume,  $V$ . For a fluid–solid heterogeneous system, the rate of reaction of a species A is defined as

$$-r'_A = \text{mol A reacted}/(\text{time} \times \text{mass of catalyst})$$

The mass of solid catalyst is used because the amount of catalyst is what is important to the rate of product formation. We note that by multiplying the heterogeneous reaction rate,  $-r'_A$ , by the bulk catalyst density,  $\rho_b \left( \frac{\text{mass}}{\text{volume}} \right)$ , we can obtain the homogeneous reaction rate,  $-r_A$

$$-r_A = \rho_b (-r'_A)$$

$$\left( \frac{\text{mol}}{\text{dm}^3 \cdot \text{s}} \right) = \left( \frac{\text{g}}{\text{dm}^3} \right) \left( \frac{\text{mol}}{\text{g} \cdot \text{s}} \right)$$

The reactor volume that contains the catalyst is of secondary significance. Figure 1-13 shows a schematic of an industrial catalytic reactor with vertical tubes packed with solid catalyst.

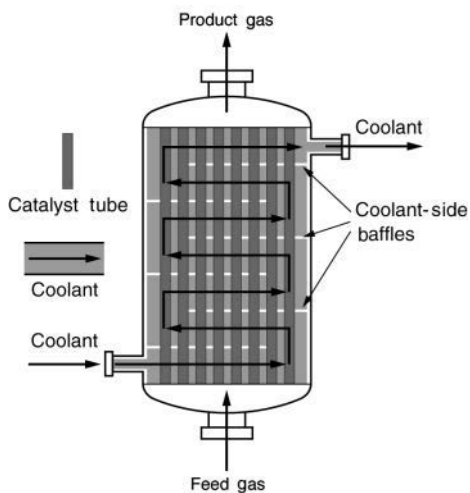

**Figure 1-13** Longitudinal catalytic packed-bed reactor. [From Cropley, *American Institute of Chemical Engineers*, 86(2), 34 (1990). Reproduced with permission of the American Institute of Chemical Engineers, Copyright © 1990 AIChE. All rights reserved.]

PBR  
Mole Balance

In the three idealized types of reactors just discussed (the perfectly mixed batch reactor, the plug-flow tubular reactor [PFR]), and the perfectly mixed continuous-stirred tank reactor [CSTR]), the design equations (i.e., mole balances) were developed based on reactor volume. The derivation of the design equation for a packed-bed catalytic reactor (PBR) will be carried out in a manner analogous to the development of the tubular design equation. To accomplish this derivation, we simply replace the volume coordinate in Equation (1-10) with the catalyst mass (i.e., weight) coordinate  $W$  (Figure 1-14).

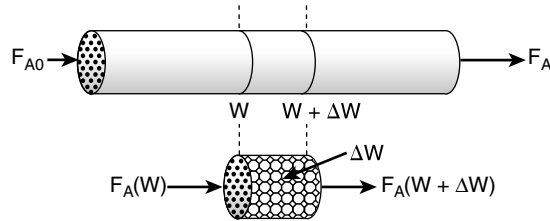

Figure 1-14 Packed-bed reactor schematic.

As with the PFR, the PBR is assumed to have no radial gradients in concentration, temperature, or reaction rate. The generalized mole balance on species A over catalyst weight  $\Delta W$  results in the equation

$$\begin{aligned} \text{In} - \text{Out} + \text{Generation} &= \text{Accumulation} \\ F_{A|W} - F_{A|(W+\Delta W)} + r'_A \Delta W &= 0 \end{aligned} \quad (1-14)$$

The dimensions of the generation term in Equation (1-14) are

$$(r'_A) \Delta W \equiv \frac{\text{moles A}}{(\text{time})(\text{mass of catalyst})} \cdot (\text{mass of catalyst}) \equiv \frac{\text{moles A}}{\text{time}}$$

which are, as expected, the same dimensions of the molar flow rate  $F_A$ . After dividing by  $\Delta W$  and taking the limit as  $\Delta W \rightarrow 0$ , we arrive at the differential form of the mole balance for a packed-bed reactor

Use the differential form of design equation for catalyst decay and pressure drop.

$$\boxed{\frac{dF_A}{dW} = r'_A} \quad (1-15)$$

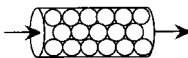

When pressure drop through the reactor (see Section 5.5) and catalyst decay (see Section 10.7 on the CRE Web site Chapter 10) are neglected, the integral form of the packed-catalyst-bed design equation can be used to calculate the catalyst weight

You can use the integral form **only** when there is no  $\Delta P$  and no catalyst decay.

$$W = \int_{F_{A0}}^{F_A} \frac{dF_A}{r'_A} = \int_{F_A}^{F_{A0}} \frac{dF_A}{-r'_A} \quad (1-16)$$

$W$  is the catalyst weight necessary to reduce the entering molar flow rate of species A,  $F_{A0}$ , down to a flow rate  $F_A$ .

For some insight into things to come, consider the following example of how one can use the tubular reactor design in Equation (1-11).

**Example 1-2 How Large Is It?**

Consider the liquid phase *cis* – *trans* isomerization of 2-butene

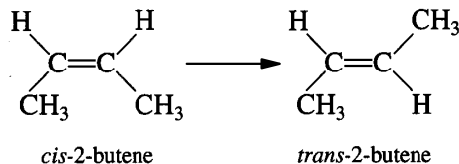

which we will write symbolically as



The reaction is first order in A ( $-r_A = kC_A$ ) and is carried out in a tubular reactor in which the volumetric flow rate,  $v$ , is constant, i.e.,  $v = v_0$ .

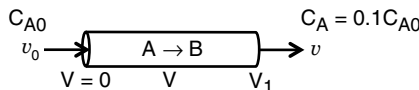

1. Sketch the concentration profile.
2. Derive an equation relating the reactor volume to the entering and exiting concentrations of A, the rate constant  $k$ , and the volumetric flow rate  $v_0$ .
3. Determine the reactor volume,  $V_1$ , necessary to reduce the exiting concentration to 10% of the entering concentration, i.e.,  $C_A = 0.1C_{A0}$ , when the volumetric flow rate is 10 dm<sup>3</sup>/min (i.e., liters/min) and the specific reaction rate,  $k$ , is 0.23 min<sup>-1</sup>.

**Solution**

1. Sketch  $C_A$  as a function of  $V$ .

Species A is consumed as we move down the reactor, and as a result, both the molar flow rate of A and the concentration of A will decrease as we move. Because the volumetric flow rate is constant,  $v = v_0$ , one can use Equation (1-8) to obtain the concentration of A,  $C_A = F_A/v_0$ , and then by comparison with the Figure 1-12 plot, obtain the concentration of A as a function of reactor volume, as shown in Figure E1-2.1.

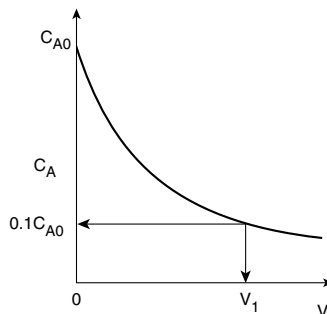

**Figure E1-2.1** Concentration profile.

2. Derive an equation relating  $V$ ,  $v_0$ ,  $k$ ,  $C_{A0}$ , and  $C_A$ .

For a tubular reactor, the mole balance on species A ( $j = A$ ) was shown to be given by Equation (1-11). Then for species A ( $j = A$ )

$$\text{Mole Balance:} \quad \frac{dF_A}{dV} = r_A \quad (1-12)$$

For a first-order reaction, the rate law (discussed in Chapter 3) is

$$\text{Rate Law:} \quad -r_A = kC_A \quad (E1-2.1)$$

Because the volumetric flow rate,  $v$ , is constant ( $v = v_0$ ), as it is for most all liquid-phase reactions,

$$\frac{dF_A}{dV} = \frac{d(C_A v)}{dV} = \frac{d(C_A v_0)}{dV} = v_0 \frac{dC_A}{dV} = r_A \quad (E1-2.2)$$

Multiplying both sides of Equation (E1-2.2) by minus one and then substituting Equation (E1-2.1) yields

$$\text{Combine:} \quad -\frac{v_0 dC_A}{dV} = -r_A = kC_A \quad (E1-2.3)$$

Separating the variables and rearranging gives

$$-\frac{v_0}{k} \left( \frac{dC_A}{C_A} \right) = dV$$

Using the conditions at the entrance of the reactor that when  $V = 0$ , then  $C_A = C_{A0}$

$$-\frac{v_0}{k} \int_{C_{A0}}^{C_A} \frac{dC_A}{C_A} = \int_0^V dV \quad (E1-2.4)$$

Carrying out the integration of Equation (E1-2.4) gives

$$\text{Solve:} \quad \boxed{V = \frac{v_0}{k} \ln \frac{C_{A0}}{C_A}} \quad (E1-2.5)$$

We can also rearrange Equation (E1-2.5) to solve for the concentration of A as a function of reactor volume to obtain

$$C_A = C_{A0} \exp(-kV/v_0)$$

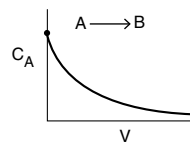

Reactor sizing

Concentration Profile



3. Calculate  $V$ . We want to find the volume,  $V_1$ , at which  $C_A = \frac{1}{10}C_{A0}$  for  $k = 0.23 \text{ min}^{-1}$  and  $v_0 = 10 \text{ dm}^3/\text{min}$ .

**Evaluate:**

Substituting  $C_{A0}$ ,  $C_A$ ,  $v_0$ , and  $k$  in Equation (E1-2.5), we have

$$V = \frac{10 \text{ dm}^3/\text{min}}{0.23 \text{ min}^{-1}} \ln \frac{C_{A0}}{0.1C_{A0}} = \frac{10 \text{ dm}^3}{0.23} \ln 10 = 100 \text{ dm}^3 \text{ (i.e., 100 L; } 0.1 \text{ m}^3\text{)}$$

Let's calculate the volume to reduce the entering concentration to  $C_A = 0.01 C_{A0}$ . Again using Equation (E1-2.5)

$$V = \frac{10 \text{ dm}^3/\text{min}}{0.23 \text{ min}^{-1}} \ln \frac{C_{A0}}{0.01C_{A0}} = \frac{10 \text{ dm}^3}{0.23} \ln 100 = 200 \text{ dm}^3$$

*Note:* We see that a larger reactor ( $200 \text{ dm}^3$ ) is needed to reduce the exit concentration to a smaller fraction of the entering concentration (e.g.,  $C_A = 0.01 C_{A0}$ ).

We see that a reactor volume of  $0.1 \text{ m}^3$  is necessary to convert 90% of species A entering into product B for the parameters given.

**Analysis:** For this irreversible liquid-phase first order reaction (i.e.,  $-r_A = kC_A$ ) being carried out in a PFR, the concentration of the reactant decreases exponentially down the length (i.e., volume  $V$ ) of the reactor. The more species A consumed and converted to product B, the larger must be the reactor volume  $V$ . The purpose of the example was to give a vision of the types of calculations we will be carrying out as we study chemical reaction engineering (CRE).

## 1.5 Industrial Reactors<sup>2</sup>

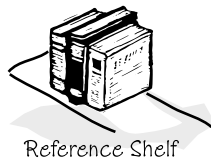

Be sure to view the actual photographs of industrial reactors on the CRE Web site. There are also links to view reactors on different Web sites. The CRE Web site also includes a portion of the *Visual Encyclopedia of Equipment*, [encyclopedia.che.engin.umich.edu](http://encyclopedia.che.engin.umich.edu), "Chemical Reactors" developed by Dr. Susan Montgomery and her students at the University of Michigan. Also see *Professional Reference Shelf* on the CRE Web site for "Reactors for Liquid-Phase and Gas-Phase Reactions," along with photos of industrial reactors, and Expanded Material on the CRE Web site.

In this chapter, and on the CRE Web site, we've introduced each of the major types of industrial reactors: batch, stirred tank, tubular, and fixed bed (packed bed). Many variations and modifications of these commercial reactors (e.g., semibatch, fluidized bed) are in current use; for further elaboration, refer to the detailed discussion of industrial reactors given by Walas.<sup>3</sup>

<sup>2</sup> *Chem. Eng.*, 63(10), 211 (1956). See also *AIChE Modular Instruction Series E*, 5 (1984).

<sup>3</sup> S. M. Walas, *Reaction Kinetics for Chemical Engineers* (New York: McGraw-Hill, 1959), Chapter 11.

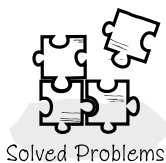

The CRE Web site describes industrial reactors, along with typical feed and operating conditions. In addition, two solved example problems for Chapter 1 can be found on the CRE Web site.

**Closure.** The goal of this text is to weave the fundamentals of chemical reaction engineering into a structure or algorithm that is easy to use and apply to a variety of problems. We have just finished the first building block of this algorithm: mole balances.

### Mole Balance

This algorithm and its corresponding building blocks will be developed and discussed in the following chapters:

- Mole Balance, Chapters 1 and 2
- Rate Law, Chapter 3
- Stoichiometry, Chapter 4
- Combine, Chapter 5
- Evaluate, Chapter 5
- Energy Balance, Chapters 11 through 13

With this algorithm, one can approach and solve chemical reaction engineering problems through logic rather than memorization.

## SUMMARY

Each chapter summary gives the key points of the chapter that need to be remembered and carried into succeeding chapters.

1. A mole balance on species  $j$ , which enters, leaves, reacts, and accumulates in a system volume  $V$ , is

$$F_{j0} - F_j + \int_V r_j dV = \frac{dN_j}{dt} \quad (\text{S1-1})$$

If, and only if, the contents of the reactor are well mixed will the mole balance (Equation (S1-1)) on species A give

$$F_{A0} - F_A + r_A V = \frac{dN_A}{dt} \quad (\text{S1-2})$$



2. The kinetic rate law for  $r_j$  is

- The rate of formation of species  $j$  per unit volume (e.g., mol/s·dm<sup>3</sup>)
- Solely a function of the properties of reacting materials and reaction conditions (e.g., concentration [activities], temperature, pressure, catalyst, or solvent [if any]) and does not depend on reactor type
- An intensive quantity (i.e., it does not depend on the total amount)
- An algebraic equation, not a differential equation (e.g.,  $-r_A = kC_A$ ,  $-r_A = kC_A^2$ )

For homogeneous catalytic systems, typical units of  $-r_j$  may be gram moles per second per liter; for heterogeneous systems, typical units of  $r'_j$  may be gram moles per second per gram of catalyst. By convention,  $-r_A$  is the rate of disappearance of species A and  $r_A$  is the rate of formation of species A.

3. Mole balances on species A in four common reactors are shown in Table S1-1.

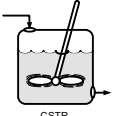
TABLE S1-1 SUMMARY OF REACTOR MOLE BALANCES

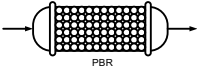
Reactor	Comment	Mole Balance Differential Form	Algebraic Form	Integral Form
 BR	No spatial variations	$\frac{dN_A}{dt} = r_A V$		$t_1 = \int_{N_{A1}}^{N_{A0}} \frac{dN_A}{-r_A V}$
 CSTR	No spatial variations, steady state	—	$V = \frac{F_{A0} - F_A}{-r_A}$	—
 PFR	Steady state	$\frac{dF_A}{dV} = r_A$		$V_1 = \int_{F_{A1}}^{F_{A0}} \frac{dF_A}{-r_A}$
 PBR	Steady state	$\frac{dF_A}{dW} = r'_A$		$W_1 = \int_{F_{A1}}^{F_{A0}} \frac{dF_A}{-r'_A}$

## CRE WEB SITE MATERIALS

- **Expanded Materials**

1. *Industrial Reactors*

- **Learning Resources**

1. *Summary Notes*

2. *Web Material*

- A. Problem-Solving Algorithm

- B. Getting Unstuck on a Problem

This Web site gives tips on how to overcome mental barriers in problem solving.

- C. Smog in L.A. Web module includes a *Living Example Problem*.

### B. Getting Unstuck



### C. Smog in L.A.



Fotografiert von ©2002 Hank Good.

3. *Interactive Computer Games*  
A. Quiz Show I



4. *Solved Problems*

CDP1-A<sub>B</sub> Batch Reactor Calculations: A Hint of Things to Come

- **FAQ [Frequently Asked Questions]**—In Updates/FAQ icon section
- **Professional Reference Shelf**  
R1.1 *Photos of Real Reactors*



R1.2 *Reactor Section of the Visual Encyclopedia of Equipment (encyclopedia.che.engin.umich.edu)*

This section of the CRE Web site shows industrial equipment and discusses its operation. The reactor portion of this encyclopedia is included on the CRE Web site.

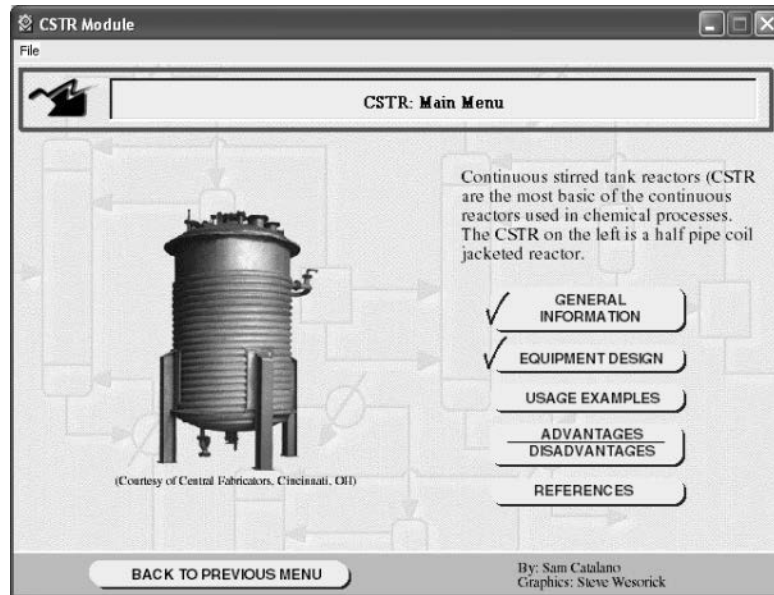

R1.3 *Industrial Reactors*

A. Liquid Phase

- Reactor sizes and costs
- Battery of stirred tanks
- Semibatch

B. Gas Phase

- Costs
- Fluidized bed schematic

R1.4 *Top Ten List of Chemical Products and Chemical Companies*

## QUESTIONS AND PROBLEMS

I wish I had an answer for that, because I'm getting tired of answering that question.

—Yogi Berra, New York Yankees  
*Sports Illustrated*, June 11, 1984

The subscript to each of the problem numbers indicates the level of difficulty, i.e., A, least difficult; B, moderate difficulty; C, fairly difficult; D, (double black diamond), most difficult. A = ● B = ■ C = ◆ D = ◆◆  
For example, P1-5<sub>B</sub> means "1" is the Chapter number, "5" is the problem number, "B" is the problem difficulty, in this case B means moderate difficulty.

Before solving the problems, state or sketch qualitatively the expected results or trends.

## Questions

- Q1-1<sub>A</sub>** Read through the Preface. Write a paragraph describing both the content goals and the intellectual goals of the course and text. Also describe what's on the Web site and how the Web site can be used with the text and course.
- Q1-2<sub>A</sub>** View the photos and schematics on the Web site under Essentials of Chemical Reaction Engineering—Chapter 1. Look at the QuickTime videos. Write a paragraph describing two or more of the reactors. What similarities and differences do you observe between the reactors on the Web (e.g., *www.loe-bequipment.com*), on the Web site, and in the text? How do the used reactor prices compare with those in Table 1-1?
- Q1-3<sub>A</sub>** Surf the Web and the CRE Web site (*www.umich.edu/~elements/5e/index.html*). Go on a scavenger hunt using the summary notes for Chapter 1 on the Web site. Take a quick look at the Web Modules and list the ones that you feel are the most novel applications of CRE.
- Q1-4<sub>A</sub>** What does a negative number for the rate of formation of species (e.g., species A),  $r_A = -3 \text{ mol/dm}^3 \cdot \text{s}$ , signify? What does a positive number signify? Explain.
- Q1-5<sub>A</sub>** What assumptions were made in the derivation of the design equation for:
- The batch reactor (BR)?
  - The CSTR?
  - The plug-flow reactor (PFR)?
  - The packed-bed reactor (PBR)?
  - State in words the meanings of  $-r_A$  and  $-r'_A$ .
- Q1-6<sub>A</sub>** Use the mole balance to derive an equation analogous to Equation (1-7) for a fluidized CSTR containing catalyst particles in terms of the catalyst weight,  $W$ , and other appropriate terms.

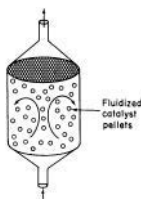

$$W = \frac{F_{A0} - F_A}{-r'_A} \quad (\text{Q1-6})$$

Figure Q1-6 Fluidized Bed CSTR.

## Problems

- P1-1<sub>A</sub>** (a) **Revisit Example 1-1.** Rework this example using Equation (3-1) on page 71.  
 (b) **Revisit Example 1-2.** Calculate the volume of a CSTR for the conditions used to calculate the plug-flow reactor volume in Example 1-2. Which volume is larger, the PFR or the CSTR? Explain why. Suggest two ways to work this problem incorrectly.  
 (c) **Revisit Example 1-2.** Calculate the time to reduce the number of moles of A to 1% of its initial value in a constant-volume batch reactor for the same reaction and data in Example 1-2. Suggest two ways to work this problem incorrectly.
- P1-2<sub>A</sub>** (a) Find the Interactive Computer Games (ICG) on the CRE Web site. Play this game and then record your performance number, which indicates your mastery of the material.

ICG Quiz Show

Mole Balance	Reactions	Rate Laws
100	100	100
200	200	200
300	300	300

ICG Kinetics Challenge 1 Performance # \_\_\_\_\_

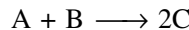
P1-3<sub>A</sub> The reaction

takes place in an unsteady CSTR. The feed is only A and B in equimolar proportions. Which of the following sets of equations gives the correct set of mole balances on A, B, and C? Species A and B are disappearing and species C is being formed. Circle the correct answer where all the mole balances are correct.

$$\begin{aligned} \text{(a)} \quad F_{B0} - F_A - \int^V r_A dV &= \frac{dN_A}{dt} \\ F_{B0} - F_B - \int^V r_A dV &= \frac{dN_B}{dt} \\ -F_C + 2 \int^V r_A dV &= \frac{dN_C}{dt} \end{aligned}$$

$$\begin{aligned} \text{(b)} \quad F_{A0} - F_A + \int^V r_A dV &= \frac{dN_A}{dt} \\ F_{A0} - F_B + \int^V r_A dV &= \frac{dN_B}{dt} \\ -F_C - 2 \int^V r_A dV &= \frac{dN_C}{dt} \end{aligned}$$

$$\begin{aligned} \text{(c)} \quad F_{A0} - F_A + \int_0^V r_A dV &= \frac{dN_A}{dt} \\ F_{A0} - F_B + \int^V r_A dV &= \frac{dN_B}{dt} \\ F_C + \int^V r_C dV &= \frac{dN_C}{dt} \end{aligned}$$

$$\begin{aligned} \text{(d)} \quad F_{B0} - F_A - \int^V r_A dV &= \frac{dN_A}{dt} \\ F_{B0} - F_{A0} - \int^V r_A dV &= \frac{dN_B}{dt} \\ -F_C + \int^V r_C dV &= \frac{dN_C}{dt} \end{aligned}$$

(e) None of the above.

P1-4<sub>B</sub> Schematic diagrams of the Los Angeles basin are shown in Figure P1-4<sub>B</sub>. The basin floor covers approximately 700 square miles ( $2 \times 10^{10} \text{ ft}^2$ ) and is almost completely surrounded by mountain ranges. If one assumes an inversion height in the basin of 2,000 ft, the corresponding volume of air in the basin is  $4 \times 10^{13} \text{ ft}^3$ . We shall use this system volume to model the accumulation and depletion of air pollutants. As a very rough first approximation, we shall treat the Los Angeles basin as a well-mixed container (analogous to a CSTR) in which there are no spatial variations in pollutant concentrations.

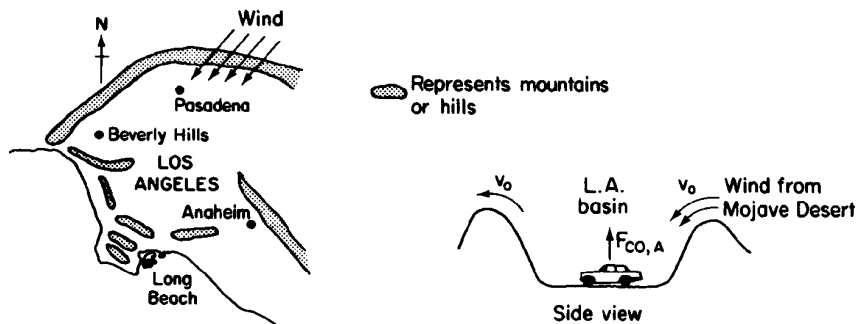

Figure P1-4<sub>B</sub> Schematic diagrams of the Los Angeles basin.

We shall perform an unsteady-state mole balance (Equation (1-4)) on CO as it is depleted from the basin area by a Santa Ana wind. Santa Ana winds are high-velocity winds that originate in the Mojave Desert just to the northeast of Los Angeles. Load the **Smog in Los Angeles Basin Web Module**. Use the data in the module to work parts 1–12 (a) through (h) given in the module. Load the **Living Example Polymath code** and explore the problem. For part (i), vary the parameters  $v_0$ ,  $a$ , and  $b$ , and write a paragraph describing what you find.

There is heavier traffic in the L.A. basin in the mornings and in the evenings as workers go to and from work in downtown L.A. Consequently, the flow of CO into the L.A. basin might be better represented by the sine function over a 24-hour period.

**P1-5<sub>B</sub>** The reaction



is to be carried out isothermally in a continuous-flow reactor. The entering volumetric flow rate  $v_0$  is 10 dm<sup>3</sup>/h. (Note:  $F_A = C_A v$ . For a constant volumetric flow rate  $v = v_0$ , then  $F_A = C_A v_0$ . Also,  $C_{A0} = F_{A0}/v_0 = ([5 \text{ mol/h}]/[10 \text{ dm}^3/\text{h}]) 0.5 \text{ mol/dm}^3$ .)

Calculate both the CSTR and PFR reactor volumes necessary to consume 99% of A (i.e.,  $C_A = 0.01C_{A0}$ ) when the entering molar flow rate is 5 mol/h, assuming the reaction rate  $-r_A$  is

(a)  $-r_A = k$  with  $k = 0.05 \frac{\text{mol}}{\text{h} \cdot \text{dm}^3}$  [Ans.:  $V_{\text{CSTR}} = 99 \text{ dm}^3$ ]

(b)  $-r_A = kC_A$  with  $k = 0.0001 \text{ s}^{-1}$

(c)  $-r_A = kC_A^2$  with  $k = 300 \frac{\text{dm}^3}{\text{mol} \cdot \text{h}}$  [Ans.:  $V_{\text{CSTR}} = 660 \text{ dm}^3$ ]

(d) Repeat (a), (b), and/or (c) to calculate the time necessary to consume 99.9% of species A in a 1000 dm<sup>3</sup> constant-volume batch reactor with  $C_{A0} = 0.5 \text{ mol/dm}^3$ .

**P1-6<sub>B</sub>** This problem focuses on using Polymath, an ordinary differential equation (ODE) solver, and also a nonlinear equation (NLE) solver. These equation solvers will be used extensively in later chapters. Information on how to obtain and load the Polymath Software is given in **Appendix D** and on the CRE Web site.

(a) There are initially 500 rabbits ( $x$ ) and 200 foxes ( $y$ ) on Farmer Oat's property near Riça, Jofostan. Use Polymath or MATLAB to plot the concentration of foxes and rabbits as a function of time for a period of up to 500 days. The predator-prey relationships are given by the following set of coupled ordinary differential equations:

$$\frac{dx}{dt} = k_1 x - k_2 x \cdot y$$

$$\frac{dy}{dt} = k_3 x \cdot y - k_4 y$$



Constant for growth of rabbits  $k_1 = 0.02 \text{ day}^{-1}$

Constant for death of rabbits  $k_2 = 0.00004/(\text{day} \times \text{no. of foxes})$

Constant for growth of foxes after eating rabbits  $k_3 = 0.0004/(\text{day} \times \text{no. of rabbits})$

Constant for death of foxes  $k_4 = 0.04 \text{ day}^{-1}$

What do your results look like for the case of  $k_3 = 0.00004/(\text{day} \times \text{no. of rabbits})$  and  $t_{\text{final}} = 800$  days? Also, plot the number of foxes versus the number of rabbits. Explain why the curves look the way they do.

(b) Use Polymath or MATLAB to solve the following set of nonlinear algebraic equations

$$x^3 y - 4y^2 + 3x = 1$$

$$6y^2 - 9xy = 5$$

with initial guesses of  $x = 2$ ,  $y = 2$ . Try to become familiar with the edit keys in Polymath and MATLAB. See the CRE Web site for instructions

**Screen shots on how to run Polymath are shown at the end of Summary Notes for Chapter 1 or on the CRE Web site, [www.umich.edu/~elements/5e/software/polymath-tutorial.html](http://www.umich.edu/~elements/5e/software/polymath-tutorial.html).**

**P1-7<sub>A</sub>** **Enrico Fermi (1901–1954) Problems (EFP).** Enrico Fermi was an Italian physicist who received the Nobel Prize for his work on nuclear processes. Fermi was famous for his “Back of the Envelope Order of Magnitude Calculation” to obtain an estimate of the answer through *logic* and then to make reasonable assumptions. He used a process to set bounds on the answer by saying it is probably larger than one number and smaller than another, and arrived at an answer that was within a factor of 10. See <http://mathforum.org/workshops/sum96/interdisc/sheila2.html>.



**Enrico Fermi Problem**

(a) **EFP #1.** How many piano tuners are there in the city of Chicago? Show the steps in your reasoning.

1. Population of Chicago \_\_\_\_\_
2. Number of people per household \_\_\_\_\_
3. Etc. \_\_\_\_\_

An answer is given on the CRE Web site under Summary Notes for Chapter 1.

(b) **EFP #2.** How many square meters of pizza were eaten by an undergraduate student body population of 20,000 during the Fall term 2016?

(c) **EFP #3.** How many bathtubs of water will the average person drink in a lifetime?

**P1-8<sub>A</sub>** **What is wrong with this solution?** The irreversible liquid phase second order reaction ( $-r_A = kC_A^2$ )

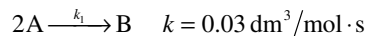

is carried out in a CSTR. The entering concentration of A,  $C_{A0}$ , is 2 molar, and the exit concentration of A,  $C_A$  is 0.1 molar. The volumetric flow rate,  $v_0$ , is constant at 3 dm<sup>3</sup>/s. What is the corresponding reactor volume?

Solution

1. Mole Balance

$$V = \frac{F_{A0} - F_A}{-r_A}$$

2. Rate Law (2nd order)

$$-r_A = kC_A^2$$

3. Combine

$$V = \frac{F_{A0} - F_A}{kC_A^2}$$

$$4. F_{A0} = v_0 C_{A0} = \frac{3 \text{ dm}^3}{\text{s}} \cdot \frac{2 \text{ molA}}{\text{dm}^3} = \frac{6 \text{ molA}}{\text{s}}$$

$$5. F_A = v_0 C_A = \frac{3 \text{ dm}^3}{\text{s}} \cdot \frac{0.1 \text{ molA}}{\text{dm}^3} = \frac{0.3 \text{ molA}}{\text{s}}$$

$$6. V = \frac{(6 - 0.3) \frac{\text{mol}}{\text{s}}}{\left(0.03 \frac{\text{dm}^3}{\text{mol} \cdot \text{s}}\right) \left(2 \frac{\text{mol}}{\text{dm}^3}\right)^2} = 47.5 \text{ dm}^3$$

For more puzzles on what's wrong with this solution, see additional material for each chapter on the CRE Web site home page, under "Expanded Material."

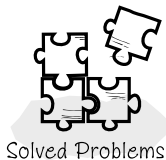

Solved Problems

**NOTE TO INSTRUCTORS:** Additional problems (cf. those from the preceding editions) can be found in the solutions manual and on the CRE Web site. These problems could be photocopied and used to help reinforce the fundamental principles discussed in this chapter.

**SUPPLEMENTARY READING**

1. For further elaboration of the development of the general balance equation, see not only the Web site [www.umich.edu/~elements/5e/index.html](http://www.umich.edu/~elements/5e/index.html) but also

FELDER, R. M., and R. W. ROUSSEAU, *Elementary Principles of Chemical Processes*, 3rd ed. New York: Wiley, 2000, Chapter 4.

SANDERS, R. J., *The Anatomy of Skiing*. Denver, CO: Golden Bell Press, 1976.

2. A detailed explanation of a number of topics in this chapter can be found in the tutorials.

CRYNES, B. L., and H. S. FOGLER, eds., *AIChE Modular Instruction Series E: Kinetics*, Vols. 1 and 2. New York: AIChE, 1981.

3. A discussion of some of the most important industrial processes is presented by

AUSTIN, G. T., *Shreve's Chemical Process Industries*, 5th ed. New York: McGraw-Hill, 1984.

*This page intentionally left blank*

# Index

## A

- Accumulation in bioreactors, 382
- Acetaldehyde
  - decomposition of, 334
  - from ethanol, 301
  - pyrolysis of, 390
- Acetic anhydride
  - cytidine reaction with, 817–820
  - production, 556–563
    - adiabatic operation, 558–559
    - co-current heat exchange, 561–563
    - constant heat exchange fluid temperature, 559–560
    - countercurrent heat exchange, 562–563
- Acetylation reactions, 226
- Activation energies
  - barrier height, 86
  - and bond strength, 92–93
  - determination, 90–93
  - in rate laws, 76
  - and reaction coordinates, 84
- Active intermediates, 334–335
  - chain reactions in, 343
  - enzymatic reactions, 343–346
  - first-order rate law, 338–339
  - mechanism searches in, 339–342
  - PSSH in, 336–338
  - summary, 385–386
- Active sites
  - in catalysts, 404, 410–411
  - in enzymes, 344
- Actual rate of reaction in internal effectiveness factor, 731, 733
- Adenosine diphosphate (ADP), 366, 760
- Adenosine triphosphate (ATP), 366, 760
- ADH (alcohol dehydrogenase), 359
- Adiabatic operations
  - acetic anhydride production, 558–559
  - batch reactors, 633–639
  - butane isomerization, 55–58, 554–555
  - complex reactions with heat effects, 594–595
  - CSTRs, 568–572
  - energy balance, 500–502
    - batch reactors, 633–639
    - equilibrium temperature, 521–522
    - steady-state nonisothermal design, 508–509
    - tubular reactors, 510
  - exothermic irreversible gas-phase reactions, 67
  - interstage heat transfer, 522–526
  - nitroaniline production, 643–644
  - PFRs, 594–595
  - propylene glycol production in, 568–572, 634–639
  - temperature and equilibrium conversion, 518–522
  - tubular reactors, 509–518
- Adjustable parameters for nonideal reactors, 846–847
- Adsorption, 403
  - of cumene, 421–427
  - in CVD, 449–451
  - dissociative, 270, 412–415, 450
  - equilibrium constant, 412
  - isotherms, 410–415
  - rate constant, 412
  - in toluene hydrodemethylation, 439–440
- Aerobic organism growth, 367
- Aerosol reactors, 236–238
- Affinity constant in Michaelis–Menten equation, 348
- Aging in catalyst deactivation, 456–459
- Air pollution, 28–29
- Alcohol dehydrogenase (ADH), 359
- Alcohol metabolism, 927
- Algae as alternative energy source, 396–397
- Algorithms
  - complex reactions, 304
  - CRE problems, 142
  - data analysis, 244–245
  - ethylene glycol production, 150
  - vs. memorizing, 140
  - multiple reactions, 282–284
- Aliphatic alcohol, 341
- Alkenes, ozone reactions with, 277
- Alternative energy, 396–397
- Alumina-silica catalyst, 483–484
- Amino acids
  - in chymotrypsin enzyme, 344
  - synthesis, 366
- Ammonia
  - from hydrogen and nitrogen, 420
  - nitroaniline from, 640–646
  - from urea, 355–356
- Ammonolysis, 226
- Analytical solution for pressure drop, 174, 177–188
- Anthracene dimerisation, 103

Antibiotics, 364–365, 369  
 Antifreeze  
   from ethylene glycol, 157  
   from ethylene oxide, 185  
 Antithrombin, 303  
 Ants running speed, 100  
 Apparent order in active intermediates, 338  
 Apparent reactions  
   in azomethane decomposition, 338  
   in falsified kinetics, 737–738  
   in kinetic rate law, 77–78  
 Approximations in segregation model, 815  
 Aqueous bromine, photochemical decay of, 276–277  
 Area balance in CVD, 449  
 Aris–Taylor analysis for laminar flow, 870–871  
 Aris–Taylor dispersion  
   dispersion model, 852  
   tubular reactors, 859–860  
 Arrhenius, Svante, 83  
 Arrhenius equation  
   Arrhenius plots, 90–93  
   sintering, 456  
   temperature behavior of reaction rate constants, 83–84  
 Arrhenius temperature dependence, 356  
 Arterial blood in capillaries, 275  
 Artificial kidneys, 346  
 Aspen program, 188  
   acetic anhydride production, 563  
   explanation of, 916  
   instructions for, 903  
 Asymmetric distribution  
   maximum mixedness model, 834  
   segregation model, 833  
 Atoms  
   in diffusion, 681  
   in reactions, 70  
 Attainable region analysis (ARA), 320–321  
 Autocatalytic reactions, 367  
 Automobile emissions  
   nitrogen oxides, 277, 485–486  
   in smog formation, 28–29  
 Average molar flux in diffusion, 690  
 Axial concentration profiles, 871  
 Axial diffusion, 698  
 Axial dispersion  
   dispersion model, 852  
   packed beds, 745–746  
 Axial variations in tubular reactors, 595–596  
   energy balance, 598–603  
   energy flux, 597–598  
   molar flux, 596–597  
 Azomethane decomposition, 336–338

## B

Back-of-the-envelope calculations, 705  
 Backmix reactors. *See*  
   Continuous-stirred tank reactors (CSTRs)  
 Bacteria, 364–365. *See also* Cells  
   in batch reactors, 378–381  
   in cell growth, 367–369  
   in enzyme production, 344  
 Balance dispersion, 854  
 Balance in CSTRs, 872–873  
 Balance on heat transfer fluid in tubular reactors, 543–545  
 Balance on hydrogen in membrane reactors, 219, 222  
 Balance on reactor volume in CSTR parameter modeling, 876  
 Bartholomew, C. H., 461, 465  
 Basis of calculation in conversions, 32  
 Batch reactors  
   adiabatic operation, 633–639  
   bacteria growth in, 378–381  
   bioreactors, 377  
   catalyst decay, 457–458  
   concentration equations, 109–111  
   cylindrical, 137  
   data analysis methods, 246–247  
     differential, 251–258  
     integral, 247–251  
     nonlinear regression, 258–263  
   design equations, 32–34, 94  
   energy balance, 499, 632–639  
   enzymatic reaction calculations, 354–356  
   interrupted isothermal operation, 640–646  
   isothermal design, 144–151  
   mean conversion in, 816, 819  
   mole balances on, 10–12  
     in design equations, 33  
     gas phase, 210–212  
     integral data analysis, 248  
     liquid phase, 208, 210  
   RTDs in, 784–785  
   series reactions in, 294–298  
   space time in, 59  
   stoichiometry in, 107–113  
 Bed fluidicity in hydrazine decomposition, 704  
 Beetles, 100  
 Benzene  
   adsorption of, 426  
   from cumene, 5  
   from cyclohexane, 714  
   desorption of, 423, 429–430  
   in Langmuir–Hinshelwood kinetics, 421–422  
   in reversible reactions, 80–82  
   from toluene, 79, 437–446  
 Berra, Yogi  
   on destinations, 680  
   on observation, 243  
   on questions, 26  
   on termination, 679  
 Berzelius, J., 400  
 Best estimates of parameter values in nonlinear regression, 261  
 Bifurcation problems, 609  
 Bimodal distributions, 833  
 Bimolecular reactions, 70  
 Binary diffusion, 684–688  
 Biochar gasification, 331  
 Bioconversions, 365  
 Biomass reactions  
   in biosynthesis, 364–365  
   in reaction rate law, 76  
 Bioprocessing design problem, 926  
 Bioreactors, 364–367  
   cell growth in, 368–369  
   chemostats, 381–383  
   mass balances in, 377–381  
   rate laws in, 369–371  
   stoichiometry in, 371–377  
   summary, 385–386  
   wash-out in, 383–384  
 Biosynthesis, 365–367  
 Blindness from methanol, 359  
 Blood coagulation, 302–303, 323  
 Bodenstein number  
   dispersion and T-I-S models, 869  
   tubular reactors, 855  
 Boltzmann's constant, 905  
 Bomb calorimeter reactors, 34  
 Bond distortions in reaction systems, 86–87  
 Bonding for enzyme–substrate complex, 344  
 Boundary conditions  
   diffusion, 408–409, 685–688, 690, 726, 728  
   dispersion coefficient determination, 863–866  
   dispersion models, 918  
   mass transfer to single particles, 695, 697  
   maximum mixedness model, 823–824  
   spherical catalyst pellets, 726, 728  
   tubular reactors, 600, 855–858  
 Bounded conversions in nonideal reactors, 846  
 Briggs–Haldane Equation, 354  
 Bromine cyanide in methyl bromide production, 230–232

- Bulk catalyst density
  - packed bed flow, 172
  - pressure drop, 180
- Bulk concentration
  - diffusion and reaction, 742
  - mass transfer to single particles, 695
- Bulk diffusivity, 721
- Bulk phase, diffusion in, 686–687
- Butadiene from ethanol, 281
- Butane
  - butene from, 221
  - isomerization of, 55–56, 512–518, 548–555
- Butanol dehydration, 483–484
- Butyl alcohol (TBA), 482
- Bypassing
  - in CSTRs, 795–796, 871–873, 880–882
  - in tubular reactors, 797–798
- C**
- C curves
  - pulse input experiment, 770–776
  - single-CSTR RTDs, 785
- Cajun seafood gumbo, 926–927
- Calculations
  - back-of-the-envelope, 705
  - enzymatic reactions, 354–356
  - propylene glycol production, 570
- Calorimeters, 34
- Carbon dioxide from urea, 355–356
- Carbon monoxide
  - adsorption, 412–415
  - methane from, 266–270
- Carbonylation reactions in MCMT
  - production, 661
- Cartilage forming cells, 763–765
- Catalysts and catalytic reactors, 399
  - adsorption isotherms, 410–415
  - benzene rate-limiting, 429–430
  - catalysis, 400–401
  - classification, 404–405
  - CRE Web site material, 480–481
  - deactivation. *See* Deactivation of catalysts
  - definitions, 400–401
  - desorption, 418
  - for differential reactors, 264–265
  - diffusion in
    - from bulk to external transport, 408–409
    - differential equation for, 723–725, 729–730
    - dimensionless form, 726–728
    - effective diffusivity in, 721–723
    - internal, 409–410
    - for tissue engineering, 763–765
  - in ethylene oxide production, 191
  - heterogeneous data analysis for, 436–437
    - mechanisms, 439–440
    - rate laws, 438–442
    - reactor design, 443–446
  - in heterogeneous reactions, 79
  - membrane reactors, 217–219
  - in microelectronic fabrication
    - chemical vapor deposition in, 448–451
    - overview, 446–448
  - model discrimination in, 451–454
  - properties of, 401–402
  - rapid reactions on, 693–697
  - rate data, 266–270
  - rate laws, 421–424
    - deducing, 438–439
    - derived from PSSH, 435
    - evaluating, 440–442
    - temperature dependence of, 436
  - rate-limiting, 419–420, 427–430
  - reforming, 431–435
  - shell balance on, 723
  - steps, 405–420
  - surface reaction, 416–418
  - weight
    - ethylene oxide, 185
    - heterogeneous reactions, 7
    - membrane reactors, 219
    - PBR, 37, 172
    - with pressure drop, 178–182
- Catalytic dehydration of methanol, 484–485
- Catalytic reactions, isothermal
  - first-order, 730–733
- Cells
  - cartilage forming, 763–765
  - growth and division
    - chemostats for, 381–383
    - and dilution rate, 383
    - growth, 368–371
    - Luedeking–Piret equation, 375
    - mass balances, 377–381
    - rate laws, 369–371, 374
    - stoichiometry, 371–377
    - wash-out, 383–384
  - reactions in, 365–366
- Center for Chemical Process Safety (CCPS), 604
- Centers in catalysts, 404
- Cerius program, 335
- Certificate programs, 605
- CFBs (circulating fluidized beds), 472–476
- Chain reactions, 343
- Chain rule for diffusion and reaction, 726
- Chain transfer step, 343
- Channels and channeling
  - microreactors, 212
  - tubular reactors, 797–798
- Characteristic reaction times in batch operation, 147
- Chemical reaction engineering (CRE), 1–3
- Chemical species, 4–5
- Chemical vapor deposition (CVD)
  - in diffusion, 753
  - overview, 448–451
  - professional reference shelf for, 757
- Chemisorption, 403–404, 410
- Chemostats, 381–383
- Chesterton, G. K., 399
- Chipmunk respiration rate, 713
- Chirping frequency of crickets, 99
- Chloral in DDT, 6
- Chlorination
  - membrane reactors, 312
  - semibatch reactors, 226
- Chlorobenzene
  - from benzene diazonium chloride, 91
  - in DDT, 6
- Churchill, Winston, 895
- Chymotrypsin enzyme, 344–345
- Circulating fluidized beds (CFBs), 472–476
- Classes of cell reactions, 366
- Clinoptilolite in toluene
  - hydrodemethylation, 437–446
- Closed-closed boundary conditions
  - dispersion coefficient determination, 863–864
  - tubular reactors, 855–858
- Closed systems, first law of thermodynamics for, 495
- Closed vessel dispersion, 855
- Clotting of blood, 302–303, 323
- CMRs (catalytic membrane reactors), 217–218
- Co-current flow
  - acetic anhydride production, 561–563
  - butane isomerization, 550–551
  - PFR complex reactions with heat effects, 590–591
  - tubular reactors, 543–544
- Coagulation of blood, 302–303, 323
- Cobalt-molybdenum catalyst, 483
- Cobra bites, 322
- Cocci growth, 367
- Coking, catalyst decay, 459–461
- Colburn J factor
  - hydrazine decomposition, 704
  - mass transfer correlations, 701
- Collision rate in adsorption, 412
- Collision theory, 74
  - active intermediates in, 335
  - professional reference shelf for, 97
  - in reaction systems, 87–90

- Combination step
  - acetic anhydride production, 557
  - batch operation, 145–146, 295–296
  - butane isomerization, 513
  - catalyst decay, 458
  - CSTRs
    - with cooling coils, 573
    - parameter modeling, 876
    - series reactions, 299
    - single, 153–155
  - ethylene glycol production, 150, 159
  - ethylene oxide production, 187
  - gas-oil catalytic cracking, 470
  - gas phase, 211
  - glucose-to-ethanol fermentation, 379
  - laminar flow reactors mean
    - conversion, 818
  - membrane reactors
    - flow and reaction, 223
    - in multiple reactions, 315
  - mole balance design, 209
  - nitroaniline production, 642
  - nitrogen oxide production, 215
  - nonisothermal reactor design, 494–495
  - PFR reactor volume, 142–144
  - pressure drop
    - isothermal reactor design, 170
    - tubular reactors, 179
  - propylene glycol production, 569–570, 635–636
  - semibatch reactors, 230
  - tubular reactors
    - adiabatic, 510
    - flow in, 163–164, 167
    - urea decomposition, 354
- Combinations
  - CSTRs and PFRs in, 53–57
  - and species identity, 5
- Competing reactions, 280
- Competitive inhibition, 357–359
- Complete segregation in nonideal reactor modeling, 809–810
- Complex reactions, 304
  - CSTRs, 307–312
  - description, 280–281
  - PBRs, 304–307
  - PFRs with heat effects, 588–595
- Compressibility factors in flow systems, 116
- Compression of ultrasonic waves, 340–342
- Compression ratio and octane number, 432
- COMSOL program
  - diffusion, 682, 685–686
  - dispersion, 870–871, 918
  - explanation of, 917–918
  - instructions, 903
  - overview, 602–603
  - tubular reactors, 601
- Concentration-time data
  - batch reactors, 246
  - nonlinear regression, 261–262
- Concentrations and concentration profiles
  - active site balances, 411
  - batch reactors, 247–248, 296–297
  - CSTRs, 13, 300
  - differential reactors, 264–265
  - diffusion, 723, 727, 729
  - dilution, 383
  - dispersion model, 852
  - enzyme, 346–348
  - flow systems, 114
    - gas-phase, 115–126
    - key reactants, 118
    - liquid-phase, 114–115
    - species, 115–117
  - laminar flow, 871
  - mass transfer
    - correlations, 701
    - to single particles, 695
  - methane production, 268–269
  - with pressure drop, 178
  - rate data analysis, 244–245
  - semibatch reactors, 232
  - spherical catalyst pellets, 723, 727, 729
  - T-I-S model, 851
  - toluene hydrodemethylation, 440
  - tubular reactors, 855
- Confidence limits in nonlinear regression, 261
- Configuration in chemical species, 4
- Consecutive reactions, 280
- Constant heat capacities in enthalpy, 505
- Constant-volume batch systems, 110–111, 251
- Constant-volume decomposition of dimethyl ether, 276
- Constant volumetric flow for differential reactors, 265
- Constriction factor in effective diffusivity, 721
- Continuous-flow systems, 113–114
  - in mole balance, 12–22
  - reactor time, 35
  - RTDs, 768–769
  - sizing, 38–47
- Continuous-stirred tank reactors (CSTRs)
  - in butane isomerization, 517–518
  - bypassing in, 795–796, 871–873, 880–882
  - complex reactions, 307–312
  - conversion in, 868
  - with cooling coils, 572–574
  - dead space in, 871–873, 880–882
  - design, 14, 152
    - design equations, 36, 94
    - ethylene glycol, 157–162
    - series, 155–157
    - single, 152–155
  - diagnostics and troubleshooting, 794–797
  - energy balance, 498–499, 565, 572–574, 585–588, 653
  - in equilibrium equation, 129–130
  - ethylene glycol, 148–151
  - with heat effects, 564–574
  - for liquid-phase reactions, 12–14
  - mass balances, 377
  - modeled as two CSTRs with
    - interchange, 878–880
  - mole balances, 36, 208–212
  - multiple reactions, 585–588
  - with multiple steady states, 574–581
  - nonideal reactors using, 882–883
  - parallel reactions, 159–160, 288–291
  - propylene glycol production in, 568–572
  - RTDs in, 768–769, 785–786, 794–797
  - in segregation models, 813–814
  - in series, 48–50
    - design, 155–157, 160–161
    - with PFRs, 53–57
    - sequencing, 57–58
    - series reactions, 298–302
  - sizing, 42–43, 46–47
  - space time in, 59
  - for toluene hydrodemethylation, 445–446
  - unsteady-state operation
    - energy balance, 499
    - startup, 651–656
- Convection
  - in diffusion, 685–686
  - mass transfer coefficient in, 691, 693
  - in tubular reactors, 854, 859
- Convective-diffusion equation, 859
- Conversion and reactor sizing, 31–32
  - batch reactors, 32–34
  - continuous-flow reactors, 38–47
  - conversion definition, 32
  - CRE Web site material, 64
  - equilibrium. *See* Equilibrium conversions
  - flow reactors, 35–38
  - PBRs, 21
  - with pressure drop, 178–180
  - rate laws in, 93–94
  - reactors in series, 47–58
  - space time, 58–60
  - space velocity, 60–61

- Conversion bounds in maximum mixedness model, 823–824
  - Conversion factors for units, 906–907
  - Conversion using RTDs, 807
    - nonideal reactor modeling, 807–808
    - zero-adjustable-parameter models. *See* Zero-adjustable-parameter models
  - Cooking
    - potatoes, 96
    - seafood gumbo, 926–927
    - spaghetti, 197
  - Coolant balance in tubular reactors, 543–545, 600
  - Coolant temperature
    - semibatch reactors, 646–651
    - steady-state tubular reactors, 544
  - Cooling coils in CSTRs, 572–574
  - Coordinates, reaction, 84
  - Correlations
    - dispersion coefficient, 860–862
    - mass transfer coefficients, 690–693, 700–704
  - Corrosion of high-nickel stainless steel plates, 100
  - Costs in ethylene glycol production, 191–192
  - Countercurrent flow
    - acetic anhydride production, 562–563
    - butane isomerization, 551–553
    - PFR complex reactions with heat effects, 592
    - tubular reactors, 544–545
  - Cracking in moving-bed reactors, 469–472
  - Creativity in reactor selection, 884
  - Cricket chirping frequency, 99
  - Critiquing journal articles
    - diffusion, 765
    - mass transfer limitations, 717
  - Crystalline aluminosilicates, 401
  - Crystals in microelectronic fabrication, 447
  - CSTRs. *See* Continuous-stirred tank reactors (CSTRs)
  - Cumene
    - adsorption, 421–427
    - decomposition, 5, 430–431
    - in Langmuir–Hinshelwood kinetics, 421–422
    - rate law, 429–430
  - Cumulative distribution function, 777
  - Curie, Marie, 767
  - CVD (chemical vapor deposition), 448–451
    - in diffusion and reaction, 753
    - professional reference shelf for, 757
  - Cyanide as enzyme inhibitor, 357
  - Cyclobutane, 335
  - Cyclohexane, benzene and hydrogen from, 714
  - Cyclohexanol, 486–487
  - Cylindrical pellets, 703
  - Cytidine, acetic anhydride reaction with, 817–820
  - Cytoplasm, 365–366
  - Czochralski crystallizers, 447
- D**
- Damköhler numbers
    - in CSTRs
      - parallel, 160
      - series, 156–157, 160
      - single, 154–155
    - in gas-oil catalytic cracking, 471
    - in segregation models, 813, 815, 818
    - in tubular reactors, 854, 858
  - Danckwerts, P. V.
    - on boundary conditions in tubular reactors, 856–858
    - on RTDs, 769, 777
    - on segregated mixing, 810
  - Danckwerts boundary conditions
    - in diffusion and reaction, 685
    - in dispersion coefficient determination, 863
    - in dispersion models, 918
    - in tubular reactors, 856–858
  - Darcy's Law, 314
  - Data acquisition for differential reactors, 264
  - Data analysis. *See* Rate data collection and analysis
  - DDT (dichlorodiphenyl-trichloroethane) production, 6
  - Deactivation of catalysts
    - by coking and fouling, 459–461
    - empirical decay laws, 464–465
    - moving-bed reactors, 467–472
    - overview, 454–456
    - by poisoning, 461–464
    - reactors offsetting, 465
    - by sintering, 456–459
    - straight-through transport reactors, 472–476
    - temperature-time trajectories, 465–467
  - Dead volume
    - CSTRs, 796–797, 871, 880–882
    - tubular reactors, 798
    - zones, 768
  - Dean, A. R. C., 371
  - Death phase in cell growth, 369
  - Death rate in winemaking, 371
  - Decay rate laws
    - catalyst deactivation, 456–458, 464–465
    - gas-oil catalytic cracking, 470
    - moving-bed reactors, 468–469
    - straight-through transport reactors, 474–475
  - Decomposition
    - in active intermediates, 338
    - in reactions, 5
  - Dehydration butanol of alumina, 202
  - Dehydration reactions, 483–484
  - Dehydrogenation reactions, 220–221
  - Denatured enzymes, 344, 356
  - Deoxygenation of hemoglobin, 275
  - Deoxyribonucleic acid (DNA) in protein production, 366
  - Deposition rate laws, 449
  - Design and design equations
    - batch reactors, 32–34, 94
    - CSTRs, 14, 152
      - design equations for, 36, 94
      - ethylene glycol, 157–162
      - series, 155–157
      - single, 152–155
    - flow reactors, 35–38
    - propylene glycol production, 569
    - toluene hydrodemethylation reactors, 443–445
  - Desired products
    - multiple reactions, 281
    - parallel reactions, 285–291
    - series reactions, 294–302
  - Desorption, 414, 418
    - of benzene, 425, 429–430
    - in toluene hydrodemethylation, 439–440
  - Dichlorodiphenyl-trichloroethane (DDT) production, 6
  - Diethanolamine formation, 280
  - Differential forms and equations
    - batch reactors, 34, 251–258
    - for diffusion in pellets, 723–725, 729–730
    - Ergun equation, 173
    - ethylene oxide production, 186
    - isothermal reactor design, 169
    - PBRs, 19, 38, 163, 245
    - PFR mole balance, 15–16
    - solutions to, 900
    - triphenyl methyl chloride-methanol reaction, 256–258
    - tubular flow reactor design equations, 37
  - Differential reactors, rate data collection and analysis in, 264–270
  - Differentiation, equal-area graphical, 255–256, 898–899

- Diffusion, 679, 719  
 binary, 684–688  
 boundary conditions in, 408–409, 685–688, 690, 726, 728  
 from bulk to external transport, 408–409  
 with catalysts, 408–410, 720–721  
   differential equation for, 723–725, 729–730  
   dimensionless form, 726–728  
   effective diffusivity in, 721–723  
   for tissue engineering, 763–765  
 chemical vapor deposition in, 753  
 convection in, 685–686  
 definitions, 681–682  
 diffusion- and reaction-limited regime estimation in, 743–744  
 dispersion model, 852  
 falsified kinetics in, 737–739  
 Fick's first law in, 683–684  
 fundamentals, 680–681  
 homogeneous systems, 720  
 internal, 409–410  
 internal effectiveness factor, 730  
   isothermal first-order catalytic reactions, 730–733  
   isothermal non-first-order catalytic reactions, 733–734  
   Thiele modulus estimates, 735–737  
   volume change with reaction, 733  
   Weisz–Prater criterion, 734–735  
 journal article problems, 765  
 journal critique problems, 765  
 limiting situations for, 750–751  
 mass transfer coefficients, 690  
   correlations, 690–693  
   mass transfer-limited reactions, 697–700  
   mass transfer to single particles, 693–697  
   operating condition changes in, 700–704  
 mass transfer in packed beds, 744–750  
 Mears criterion for, 743–744  
 modeling with, 687–688  
 molar flux in, 681–686  
 multiphase reactors in, 751–753  
 overall effectiveness factor in, 739–743  
 questions and problems, 757–765  
 through stagnant film, 688–690  
 temperature and pressure dependence in, 686–687
- Digital-age problems, 317–318
- Dilution rate  
 bioreactors, 381–382  
 chemostats, 381  
 wash-out, 383
- Dimensionless cumulative distributions, 788–789
- Dimensionless groups in mass transfer coefficient, 691
- Dimerize propylene, 53
- Dimethyl ether (DME)  
 decomposition, 276  
 from methanol, 484–485
- Diphenyl in reversible reactions, 80–82
- Dirac delta function  
 in PFR RTD, 784  
 in segregation models, 813  
 in step tracer experiment, 776
- Disappearance of substrate, 349, 378
- Disappearance rate, 5–6
- Disguised kinetics, 738–739
- Disk rupture in nitroaniline production, 645–646
- Dispersion  
 catalysts, 404  
 COMSOL for, 870–871, 918  
 one-parameter models, 847  
 in packed beds, 862  
 vs. T-I-S models, 869  
 in tubular reactors, 852–854, 858–862, 866–868
- Dispersion coefficient  
 experimental determination of, 862–866  
 tubular reactors, 860–862
- Dissociative adsorption, 270, 412–415, 450
- Distortions in reaction systems, 86–87
- Divide and be conquered case, 705–707
- Division of cells, 369–371
- DME (dimethyl ether)  
 decomposition of, 276  
 from methanol, 484–485
- DNA (deoxyribonucleic acid) in protein production, 366
- Doubling times in growth rates, 371
- Drinking and driving, 324–325
- Drug therapy, 357–359
- Dual sites  
 irreversible surface-reaction-limited rate laws in, 435  
 surface reactions in catalysts, 416–417
- E**
- E-curves  
 nonideal reactor modeling, 808  
 in normalized RTD function, 782–783  
 in pulse input experiment, 770–775  
 in RTD moments, 780
- Eadie–Hofstee plots, 351–353
- Early mixing in nonideal reactor modeling, 809
- Economic decisions and incentives for separations systems, 281
- Effective diffusivity in spherical catalyst pellets, 721–723
- Effective transport coefficient, 695
- Effectiveness factor  
 in internal diffusion, 730  
 isothermal first-order catalytic reactions, 730–733  
 isothermal non-first-order catalytic reactions, 733–734  
 overall, 739–743  
 Thiele modulus estimates, 735–737  
 volume change with reaction, 733  
 Weisz–Prater criterion, 734–735  
 in nitrous oxide reductions, 748–750
- Efficient parallel reactor schemes, 285
- Electronics industry, microelectronic fabrication  
 chemical vapor deposition in, 448–451  
 overview, 447–448
- Elementary rate laws, 72–75
- Elementary reactions, 74, 412
- Eley–Rideal mechanism, 431  
 irreversible surface-reaction-limited rate laws, 435  
 in surface reactions in catalysts, 418  
 in toluene hydrodemethylation, 439–440
- Elution, 776
- EMCD (equimolar counterdiffusion), 724
- Emissions, automobile  
 nitrogen oxides in, 277, 485–486  
 in smog formation, 28–29
- Empirical decay laws, 464–465
- Endothelium in blood clotting, 302
- Endothermic reactions  
 equilibrium conversion in, 518  
 interstage heat transfer, 523–524
- Energy  
 alternative, 396–397  
 conversion factors, 906
- Energy balances  
 acetic anhydride production, 557–558  
 adiabatic operations, 500–502  
 batch reactors, 633–639  
 equilibrium temperature, 521–522  
 in steady-state nonisothermal design, 508–509  
 tubular reactors, 510  
 butane isomerization, 513, 550



- CSTRs, 498–499  
 with cooling coils, 572–574  
 heat exchanger in, 565  
 in multiple reactions, 585–588  
 unsteady-state operation, 653  
 enthalpies in, 497, 504–505  
 ethyl acetate saponification, 649  
 first law of thermodynamics,  
 495–496  
 heat of reaction in, 505–508  
 MCMT production, 665  
 nitroaniline production, 642  
 overview of, 498–501  
 PBRs, 499  
 PFRs, 499  
 with heat effects, 546–547  
 with heat exchange, 540–543  
 multiple reactions, 581–588  
 parallel reactions, 583  
 propylene glycol production, 570,  
 636, 653  
 semibatch reactors, 499  
 with heat exchangers, 647  
 multiple reactions, 658  
 steady-state molar flow rates, 502–504  
 tubular reactors, 540–543, 598–603  
 unsteady-state nonisothermal  
 reactors, 630–632  
 work term in, 496–498
- Energy barriers, 84–87  
 Energy distribution function, 88, 90  
 Energy economy  
 hydrogen-based, 239–240  
 membrane reactors, 220–221  
 Energy flux, tubular reactors, 597–598  
 Energy flux vectors, 597  
 Energy rate change with time, 907  
 Engine knock, 431–433  
 Engineering experiment design problem,  
 925  
 Engineering judgment in reactor  
 selection, 884  
 Enthalpies in energy balance, 497,  
 504–505  
 Enzymatic reactions, 76, 343–344  
 batch reactor calculations, 354–356  
 Briggs–Haldane Equation, 354  
 Eadie–Hofstee plots, 351–352  
 enzyme-substrate complex, 344–346  
 induced fit model, 344  
 inhibition of. *See* Inhibition of  
 enzyme reactions  
 lock-and-key model, 344  
 mechanisms, 346–348  
 Michaelis–Menten equation, 348–354  
 temperature in, 356  
 Epidemiology, PSSH for, 392  
 Epitaxial germanium, 448–449  
 Epoxydation of ethylene, 329  
 Equal-area differentiation, 255–256,  
 898–899
- Equations  
 batch concentrations, 109–111  
 concentrations in flow systems, 114  
 differential. *See* Differential forms  
 and equations
- Equilibrium  
 in adiabatic equilibrium temperature,  
 519–522  
 in CVD, 451
- Equilibrium constant  
 in adiabatic equilibrium temperature,  
 520  
 adsorption, 412, 423  
 in thermodynamic relationships,  
 909–914
- Equilibrium conversions, 518  
 and adiabatic temperature, 518–522  
 butane isomerization, 514  
 endothermic reactions, 518–524  
 exothermic reactions, 518–522  
 feed temperature, 526–528  
 semibatch reactors, 233  
 stoichiometry, 126–130
- Equimolar counterdiffusion (EMCD), 724  
 Ergun equation, 170–173, 177  
 Esterification reactions, 226  
 E(t) curves in maximum mixedness  
 model, 827–828
- Ethane  
 from azomethane, 336–338  
 ethylene from, 483  
 in ethylene glycol production, 192  
 ethylene hydrogenation to, 452–454
- Ethanol  
 acetaldehyde from, 301  
 ADH with, 359  
 butadiene from, 281  
 in glucose-to-ethanol fermentation,  
 378–381
- Ethoxylation reactions, 312  
 Ethyl acetate, 204  
 Ethyl acetate saponification, 647–650  
 Ethylbenzene  
 hydrogenation to ethylcyclohexane,  
 492  
 styrene from, 220–221
- Ethylene  
 adsorption of, 403–404  
 epoxydation of, 329  
 from ethane, 483  
 ethane from, 452–454  
 PBRs for, 165–168
- Ethylene chlorohydrin, 240  
 Ethylene glycol (EG)  
 CSTRs for, 148–151  
 from ethylene chlorohydrin and  
 sodium bicarbonate, 240  
 from ethylene oxide, 185  
 production of, 157–162  
 synthesizing chemical plant design  
 for, 190–192
- Ethylene oxide (EO), 280  
 CSTRs for, 148–151  
 in ethylene glycol production, 191  
 production of, 185–190
- Eukaryotes, doubling times for, 371  
 Euler method, 825  
 Evaluation  
 batch operations, 145–146, 297–298  
 CSTR series reactions, 300–301  
 ethylene glycol production, 150, 159  
 gas phase, 211  
 nitrogen oxide production, 215  
 PFR reactor volume, 142–143  
 propylene glycol production,  
 651–656  
 toluene hydrodemethylation, 446  
 triphenyl methyl chloride-methanol  
 reaction, 254  
 tubular reactor design, 167–168  
 tubular reactor flow, 163–164
- Excel  
 activation energy, 91–92  
 CSTR parameter modeling,  
 874–876  
 trityl-methanol reaction, 250–251
- Excess method in batch reactors, 246  
 Exchange volumes in CSTR parameter  
 modeling, 879–880
- Exhaust streams, automobile  
 nitrogen oxides in, 277, 485–486  
 in smog formation, 28–29
- Exit-age distribution function, 777  
 Exit temperature in interstage cooling,  
 524–525
- Exothermic reactions, 507, 518–522  
 equilibrium conversion, 518–522  
 interstage heat transfer, 523–526  
 safety issues, 603–605, 640–646
- Experimental observation and  
 measurements, 8, 75  
 for dispersion coefficient, 862–866  
 for mass transfer limitations, 712
- Experimental planning  
 professional reference shelf for, 273  
 in rate data collection and analysis,  
 271
- Explosions  
 Monsanto plant, 640–646  
 nitrous oxide plant, 613, 673–674  
 T2 Laboratories, 604, 660–668
- Explosive intermediates, microreactors  
 for, 212
- Exponential cell growth, 368–370  
 Exponential decay rate law in catalyst  
 deactivation, 464  
 Exponential integrals, 815  
 External diffusion effects. *See* Diffusion  
 External mass transfer in nitrous oxide  
 reductions, 749  
 Extinction temperature in multiple  
 steady states, 579

**F**

- F-curves  
 nonideal reactor modeling, 808  
 RTD, 777
- Fabrication, microelectronic  
 chemical vapor deposition in,  
 448–451  
 overview, 446–448
- Facilitated heat transfer, 712
- Falsified kinetics  
 in diffusion and reaction, 737–739  
 exercise, 763
- Fan, L. T.  
 on RTD moments, 778  
 on tracer techniques, 777
- Fanning friction factor, 175
- Fast orange formation, 135–136
- Fed batch reactors. *See* Semibatch reactors
- Feed stocks, catalyst poisoning in, 461
- Feed temperature in equilibrium  
 conversion, 526–528
- Femtosecond spectroscopy, 335
- Fermentation  
 glucose-to-ethanol, 378–381  
 wine-making, 370–371
- Fermi, Enrico, 29–30
- Fibers, terephthalic acid for, 326–327
- Fibrinogen, 302
- Fick's law  
 in diffusion, 683–684  
 in dispersion, 852, 859
- Film, diffusion through, 690
- Finlayson, B. A., 745
- Firefly flashing frequency, 99
- First law of thermodynamics,  
 495–496
- First-order rate laws, 75, 338–339
- First-order reactions, 73  
 batch operations, 146  
 CSTR design  
 series, 155–156  
 single, 152–153  
 differential equations for  
 diffusion in spherical catalyst  
 pellets, 729–730  
 solutions, 900  
 multiple steady states, 577  
 nonideal reactor modeling, 809  
 PFR reactor volume for, 142–144  
 reversible, 518  
 segregation models, 812
- Fitting tail, 801
- Five-point quadrature formula  
 PFR sizing, 44  
 solutions, 902–903
- Fixed-bed reactors. *See* Packed-bed reactors (PBRs)
- Fixed concentration in mass transfer  
 correlations, 701
- Fixed coordinate systems in molar flux,  
 682
- Flashing frequency of fireflies, 99
- Flat velocity profiles, 848
- Flow  
 in energy balance, 496  
 numerical solutions to, 870–871  
 through packed beds, 170–174  
 in pipes  
 dispersion, 860–861  
 pressure drop, 174–177
- Flow rates  
 mass transfer and reaction, 745  
 mass transfer correlations, 700  
 membrane reactors, 314, 316  
 multiple reactions, 282  
 space time, 59
- Flow reactors, 113–114. *See also* specific  
 flow reactors by name  
 concentrations in, 114  
 gas-phase, 115–126  
 liquid-phase, 114–115  
 design equations, 35–38  
 CSTR, 36  
 PBRs, 37–38  
 tubular, 36–37  
 with heat exchange, 539–540  
 balance on transfer fluid,  
 543–545  
 CRE Web site material, 607–609  
 CSTRs, 564–574  
 multiple steady states, 574–581  
 nonisothermal reactions,  
 581–595  
 PFR/PBR design algorithm,  
 545–563  
 questions and problems, 610–626  
 radial and axial variations in  
 tubular reactors, 595–603  
 safety, 603–605  
 steady-state tubular reactors,  
 540–543  
 summary, 606–607  
 supplementary reading, 626–627  
 with variable volumetric flow rate,  
 115–126
- Fluid fraction in laminar flow reactors,  
 787
- Fluid Peclet number, 855
- Fluidized-bed reactors, 79, 753, 756–757
- Fluidized continuous-stirred tank  
 reactors, 445–446
- Flux equation for diffusion in spherical  
 catalyst pellets, 724
- Force, conversion factors for, 906
- Forced convection, mass transfer  
 coefficient in, 691, 693
- Formaldehyde  
 from methanol, 359  
 oxidation of, 328–329
- Formation enthalpies, 504–505
- Formation rates in azomethane  
 decomposition, 336–337
- Fouling in catalyst decay, 459–461
- Four-point rule in integral evaluation,  
 902
- Fourier's law, 683
- Fraction of collisions, 88–89
- Fractional area balance in CVD, 449
- Free radicals  
 as active intermediates, 335  
 in bimolecular reactions, 70
- Frequency factors in activation energy,  
 91
- Freudlich isotherms, 415
- Friction factor in pipe pressure drop, 175
- Frog legs experiments, 683–684
- Frossling correlation, 692, 694
- F(t) function in integral relationships,  
 777
- Fuel cells, 239–240
- G**
- Gallium arsenide layers, 448
- Gas-hourly space velocity (GHSV), 61
- Gas oil, catalytic cracking of, 469–472
- Gas phase and gas-phase reactions  
 adiabatic exothermic irreversible, 67  
 batch systems, 34, 144  
 complex reactions with heat effects  
 in PFRs, 589  
 in CVD, 449  
 diffusion in, 686–687  
 elementary and reversible, 80  
 equilibrium constant, 909–911  
 flow reactors, 35–36  
 flow reactors with variable  
 volumetric flow rate,  
 115–126  
 liquid-phase concentrations, 114–115  
 microreactors, 213–217  
 mole balances on, 210–212  
 packed beds, 140  
 PBRs, 304–307  
 PFR reactor volume, 142–144  
 pressure drop in, 169–170  
 tubular reactors, 14, 163–165,  
 542–543
- Gas-solid heterogeneous reactions, 244
- Gas volumetric flow rate in space  
 velocity, 61
- Gasoline  
 catalyst poisoning, 461  
 octane number, 523–524
- Gaussian program, 335

- General mole balance equation, 8–10  
 CSTRs, 13  
 tubular reactors, 15
- Generation heat in multiple steady states, 576–578
- Generic power law rate laws in gas phase, 210
- Germanium epitaxial film, 448–449
- GHSV (gas-hourly space velocity), 61
- Gibbs free energy  
 in cumene adsorption, 425  
 in equilibrium constant, 910–911
- Globules in segregation models, 810–812
- Glow sticks, 342
- Glucose in wine-making, 370
- Glucose-to-ethanol fermentation, 378–381
- Goals for nonideal reactors, 846
- Goodness of fit in rate data analysis, 245
- Gradientless differential reactors, 264
- Graphical methods  
 batch reactor data analysis, 252  
 equal-area differentiation, 898–899  
 triphenyl methyl chloride-methanol reaction, 255–256
- Gravitational conversion factor, 907
- Greek symbols, 923
- Growth of microorganisms. *See* Bioreactors
- Gumbo, 926–927
- ## H
- Hagen–Poiseuille equation, 858
- Hanes–Wolf model  
 for Michaelis–Menten equation, 351–353  
 of Monod equation, 376
- Heat capacities in enthalpy, 505
- Heat effects. *See also* Temperature COMSOL for, 917  
 CSTRs with, 564–574  
 in semibatch reactors, 647–650  
 in steady-state nonisothermal reactors. *See* Steady-state nonisothermal reactors
- Heat exchangers  
 acetic anhydride production, 559–560  
 adiabatic operations, 638–639  
 energy balance, 565  
 interstage cooling, 525–526  
 microreactors, 212  
 PFR/PBR with heat effects, 547  
 semibatch reactors, 646–651  
 steady-state nonisothermal reactors. *See* Flow reactors
- Heat load in interstage cooling, 525–526
- Heat of reactions  
 in energy balance, 505–508  
 molar flow rates for, 502–504
- Heat terms in multiple steady states, 575–578
- Heat transfer  
 to CSTRs, 565  
 in diffusion, 683  
 in mass transfer coefficient, 691  
 in mass transfer limitations, 712  
 in octane number, 523–524  
 in pressure drop, 185  
 in tubular reactors, 543–545
- Height, energy barrier, 85
- Helium mixture in monopropellant thrusters, 702
- Hemoglobin, deoxygenation of, 275
- Hemostasis process, 302
- Heptane, 431–432
- Heterogeneous catalytic processes  
 in methane production, 269  
 phases in, 401
- Heterogeneous data analysis, 436–437  
 mechanisms, 439–440  
 rate laws, 438–442  
 reactor design, 443–446
- Heterogeneous reactions, 7, 70, 79–80  
 data for, 244  
 external diffusion effects on. *See* Diffusion  
 mass transfer of reactants in, 720
- High-fructose corn syrup (HFCS), 344
- High-nickel stainless steel plates, 100
- High temperature in multiple steady states, 577
- Hilder's approximation, 815
- Holding time in space time, 59
- Homogeneous reactions, 70, 76–77  
 data for, 244  
 rate law parameters for, 246
- Homogeneous systems, diffusion and reactions in, 720
- Honeybee flight speed, 100
- Hot spots in microreactors, 212
- Hydrazine for space flights, 702–704
- Hydrocarbons, partial oxidation of, 312
- Hydrocracking, temperature-time trajectories, 466–467
- Hydrodemethylation of toluene, 79–80, 437–446
- Hydrodesulfurization reactor design problem, 926
- Hydrodynamic boundary layer in diffusion, 688
- Hydrogen  
 ammonia from, 420  
 from cyclohexane, 714  
 dissociative adsorption of, 450  
 in enzyme-substrate complex, 344  
 in membrane reactors, 219  
 in methane production, 266–270  
 in reversible reactions, 80–82  
 from water-gas shift reaction, 912–914  
 water splitting, 487–488
- Hydrogen-based energy economy, 239–240
- Hydrogen peroxide  
 decomposition, 392  
 sodium thiosulfate reaction, 574
- Hydrogenation reactions  
 of ethylene to ethane, 452–454  
 membrane reactors for, 312
- Hydrolases enzymes, 346
- Hydrolysis  
 semibatch reactor operation, 226  
 starch, 394
- Hydrophobic forces for enzyme-substrate complex, 344
- Hyperbolic decay rate law, 464
- Hypothetical stagnant film in diffusion, 689
- ## I
- Ideal gas constant, 905
- Ideal gas law, 35
- Ideal reactors  
 RTD for, 794–799  
 batch and plug-flow, 784–785  
 laminar flow, 786–789  
 single-CSTR RTD, 785–786  
 in two-parameter models, 871–873
- Identity  
 in chemical species, 4  
 in reactions, 5
- Ignition-extinction curves, 578–581
- Ignition temperature  
 in equilibrium conversion, 527  
 in multiple steady states, 579
- Imperfect pulse injection in step tracer experiment, 776
- IMRCFs (inert membrane reactors with catalyst pellets on the feed side), 217–218
- Independent reactions, 280–281, 581
- Induced fit model for enzyme-substrate complex, 344
- Industrial reactors  
 dimerize propylene into olefins, 53  
 in mole balance, 22–23  
 space time in, 59–60
- Inert membrane reactors with catalyst pellets on the feed side (IMRCFs), 217–218

- Inhibition of enzyme reactions, 356–357  
 competitive, 357–359  
 noncompetitive, 361–363  
 substrate, 363–364  
 uncompetitive, 359–361
- Inhibitor molecules, 361
- Inhibitors, 356–357
- Initial conditions in tubular reactors, 600
- Initial rates for differential reactors, 264
- Initiation step in chain reactions, 343
- Inlet conditions  
 differential reactors, 266  
 equilibrium conversion, 527–528
- Instantaneous selectivity  
 multiple reactions, 281  
 parallel reactions, 285, 291  
 semibatch reactors, 227
- Instantaneous yield in multiple reactions, 282
- Insulin production, 364
- Integral data analysis method, 247–251
- Integral reactors, 19, 37
- Integral relationships in RTDs, 777–778
- Integrals  
 numerical evaluation of, 901–902  
 in reactor design, 897–898
- Integrated circuit fabrication  
 CVD in, 448–451  
 overview, 446–448
- Interchange in CSTR modeling, 878–880
- Interfacial area for catalytic reactions, 401
- Intermediates, active. *See* Active intermediates
- Internal-age RTDs, 783–784, 801
- Internal diffusion, 409–410
- Internal effectiveness factor  
 in diffusion, 730  
 isothermal first-order catalytic reactions, 730–733  
 isothermal non-first-order catalytic reactions, 733–734  
 Thiele modulus estimates, 735–737  
 volume change with reaction, 733  
 Weisz–Prater criterion, 734–735  
 in nitrous oxide reductions, 748–750
- Interrupted isothermal operations, 640–646
- Interstage heating and heat transfer reactor staging with, 522–526  
 reactor trains with, 536
- Ionic forces for enzyme-substrate complex, 344
- Irreversible reactions, 70  
 endothermic, 532–534  
 exothermic, 67  
 isomerization, 436  
 order in, 246
- Irreversible surface-reaction-limited rate laws, 435
- Iso-octane, 431–433
- Isobutane production, 512–518, 548–555
- Isomerases enzymes, 346
- Isomerization  
 batch reactors, 11–12  
 butane, 55–58, 512–518, 548–555  
 irreversible, 436  
 isothermal gas-phase, 39  
 in reactions, 5
- Isopropyl isocyanate decomposition, 278
- Isotherm equation in adsorption, 415
- Isothermal operations  
 catalytic reactions  
 first-order, 730–733  
 non-first-order, 733–734  
 flow reactors, 121  
 gas-phase isomerization, 39  
 interrupted, 640–646  
 nitroaniline production, 642–643  
 sulfur dioxide gas-phase reactions, 121  
 sulfur dioxide rate law, 124
- Isothermal reactors, 139  
 batch, 144–151  
 COMSOL for, 918  
 CRE Web site material, 195–196  
 CSTRs, 152  
 design equations, 94  
 ethylene glycol, 157–162  
 series, 155–157  
 single, 152–155  
 learning resources for, 195–196  
 molar flow rates. *See* Molar flow rates  
 ODE solver algorithm, 194  
 pressure drop, 169  
 analytical solution, 177–188  
 flow through packed beds, 170–174  
 pipes, 174–177  
 rate law, 169–170  
 questions and problems, 196–205  
 structure for, 140–144  
 summary, 193–194  
 supplementary reading, 205  
 synthesizing chemical plant design, 190–192  
 tubular reactors, 162–168
- Isotherms, adsorption, 410–415
- J**
- Januvia, 357
- Johnson, Samuel, 333
- Journal critique problems  
 diffusion, 765  
 mass transfer limitations, 717
- Junction balance in CSTR parameter modeling, 873, 877
- K**
- Key reactant concentrations, 118
- Kidneys, artificial, 346
- Kind in chemical species, 4
- Kinematic viscosity  
 of helium, 702  
 in mass transfer coefficient, 691
- Kinetic energy in energy balance, 497
- Kinetic rate law, 72, 77–78
- Kinetics in catalyst deactivation, 455, 463
- Knee joint replacements, 763–765
- Knudsen diffusion, 721
- Knudsen phase, diffusion in, 686–687
- Kunii–Levenspiel fluidization model, 753
- L**
- Labs-on-a-chip, 212
- Lag phase in cell growth, 368
- Laminar flow  
 Aris–Taylor analysis for, 870–871  
 dispersion for  
 pipes, 860–861  
 tubular reactors, 858–860
- Laminar flow reactors (LFRs)  
 mean conversion in, 817–820  
 RTDs in, 786–789  
 in segregation models, 813–815
- Langmuir, Irving, 413
- Langmuir–Hinshelwood kinetics  
 in catalyst surface reactions, 418  
 for heterogeneous reactions, 79, 244  
 nonlinear regression for, 259  
 in rate limiting, 419  
 single-site mechanisms, 694  
 steps, 421–422
- Langmuir isotherm, 413–415
- Large molecules, synthesis of, 366
- Late mixing, nonideal reactor modeling, 809
- Le Châtelier’s principle, 911
- Lead in gasoline, 461
- Lead titanate, 715
- Least-squares analysis  
 batch reactors, 259  
 multiple reaction analysis, 317  
 professional reference shelf for, 273
- LeBlanc, Steve, 629, 807
- Levenspiel, O.  
 on dispersion coefficient determination, 864  
 on dispersion model, 853  
 on reaction combinations, 883  
 on tubular reactor boundary conditions, 858

- Levenspiel plots
    - adiabatic isomerization, 57
    - butane isomerization, 515
    - flow reactors, 41–42, 129–130
    - PFRs in series, 52
  - LFRs (laminar flow reactors)
    - mean conversion in, 817–820
    - RTDs in, 786–789
    - in segregation models, 813–815
  - LHSV space velocity, 61
  - Ligases enzymes, 346
  - Light from ultrasonic waves, 340–342
  - Limiting reactants
    - in batch systems, 112–113
    - in conversion, 32
  - Limiting situations for diffusion, 750–751
  - Linear decay rate law in catalyst
    - deactivation, 464
  - Linear least squares, 259
  - Linear plots in batch reactor data
    - analysis, 247–249
  - Lineweaver–Burk plots
    - for inhibition
      - competitive, 359
      - noncompetitive, 362–363
      - uncompetitive, 361
    - for Michaelis–Menten equation, 350–351
  - Liquid-hourly space velocity (LHSV), 61
  - Liquid phase and liquid-phase reactions
    - batch systems, 34, 110–111, 144
    - butane isomerization, 55–58, 512–518
    - complex reactions, 307–312
    - concentrations, 114–115
    - CSTRs for, 12–14, 307–312
    - diffusion in, 686–687
    - flow reactors, 35, 114–115
    - MCMT production, 660
    - methanol–triphenyl reaction, 276
    - mole balances, 208, 210
    - pressure drop, 169
    - selectivity in, 227
    - semibatch reactors, 310–312
    - tubular reactors, 163, 543
  - Living example problems (LEPs)
    - active intermediates, enzymatic
      - reactions, pharmacokinetic models, and bioreactors, 387
    - catalysts, 480
    - flow reactors with heat exchange, 608
    - isothermal reactors, 196
    - molar flow rates, 236, 238
    - multiple reactions, 321
    - nonideal reactors, 887
    - nonisothermal reactors
      - steady-state, 530
      - unsteady-state, 670
    - rate data collection and analysis, 273
    - RTDs, 801
    - zero-adjustable-parameter models, 837
  - Locally stable steady-state values, 580
  - Lock-and-key model, 344
  - Log-log paper
    - batch reactor analysis, 252
    - triphenyl methyl chloride–methanol reaction, 256
  - Logic vs. memorizing, 140, 142
  - Logistic growth law, 395
  - London van der Waals forces, 344
  - Los Angeles basin, 28–29
  - Low temperature in multiple steady
    - states, 577
  - Lubricant design problem, 925
  - Luedeking–Piret equation, 375
  - Luminescence from ultrasonic waves, 340–342
  - Lyases enzymes, 346
- ## M
- Macrofluids in nonideal reactor
    - modeling, 809–810
  - Macromixing, 769, 809
  - Maintenance in cell growth, 373
  - Marx, Groucho, 139
  - Mass, conversion factors for, 906
  - Mass balances. *See also* Mole balances
    - in cell growth, 377–381
    - in glucose-to-ethanol fermentation, 378–381
  - Mass flow rate through packed beds, 171
  - Mass transfer boundary layers, 688
  - Mass transfer coefficients
    - in diffusion, 690
      - correlations, 690–693
      - example, 700–704
      - mass transfer-limited reactions, 697–700
      - mass transfer to single particles, 693–697
    - in hydrazine decomposition, 703
    - in nitrous oxide reductions, 749
    - in PBRs, 750
    - “what if” conditions for, 705–709
  - Mass transfer limitations, 679–680
    - diffusion
      - binary, 684–688
      - fundamentals, 680–684
      - mass transfer coefficient, 690–704
        - through stagnant film, 688–690
      - on metallic surfaces, 712
      - in PBRs, 697–700
      - “what if” conditions for, 705–709
  - Mass transfer
    - in diffusion, 683
    - in heterogeneous reactions, 720
    - mass transfer-limited reactions, 697–700
    - in microreactors, 212
      - in packed beds, 697–700, 744–750
      - to single particles, 693–697
  - Material Safety Data Sheets (MSDS), 162
  - Mathematically tractable nonideal
    - reactor models, 846
  - MATLAB program
    - adiabatic tubular reactors, 511
    - CSTR parameter modeling, 874–876
    - ethylene oxide production, 188
    - explanation of, 916
    - instructions, 903
    - isothermal reactors, 194
    - membrane reactors, 223–224
    - non-adiabatic PFR energy balance, 501
    - nonlinear regression, 261
  - Maximum mixedness model, 820–826
    - multiple reactions in, 831–835
    - nonideal reactor modeling, 809
    - vs. segregation model, 829–830
    - software packages for, 827–829
  - Maxwell–Boltzmann distribution, 87–90
  - MCMT (methylcyclopentadienyl manganese tricarbonyl)
    - production, 660–668
  - Mean conversion
    - laminar flow reactors, 817–820
    - real reactors, 816–817
    - segregation models, 811–813
  - Mean residence time
    - dispersion coefficient determination, 865
    - RTDs, 778, 788
    - in space time, 59
  - Mears criterion, 743–744
  - Measured variables
    - in rate data analysis, 244
    - in triphenyl methyl chloride–methanol reaction, 254
  - Mechanism searches, 339–342
  - Medical applications. *See* Pharmacokinetics
  - MEK (methyl ethyl ketone) production, 486
  - Membrane reactors
    - design, 217–225
    - mole balances, 208–209
    - for multiple reactions, 312–316
    - packed bed, 172
  - Memorization vs. logic, 140, 142
  - Metabolism of alcohol, 927
  - Metallic surfaces, mass transfer-limited
    - reactions on, 712
  - Metaxylene isomerization, 202
  - Methane
    - from carbon monoxide and hydrogen, 266–270
    - para-xylene from, 401
    - from toluene, 79, 437–446

- Methanol  
 ADH with, 359  
 dimethyl ether from, 484–485  
 poisoning by, 359, 928  
 synthesis problem, 926  
 in triphenyl methyl chloride reaction, 254–258  
 in trityl-methanol reaction, 249–251
- Methyl amine, 230–233
- Methyl bromide production, 230–233
- Methyl ethyl ketone (MEK) production, 486
- Methylcyclohexane, toluene from, 489
- Methylcyclopentadienyl manganese tricarbonyl (MCMT) production, 660–668
- Michaelis constant, 348–350, 359
- Michaelis–Menten kinetics and equations, 334  
 in competitive inhibition, 357  
 in enzymatic reactions, 348–354  
 substrate concentration in, 355  
 in uncompetitive inhibition, 359–361
- Microbial growth. *See* Bioreactors
- Microelectronic fabrication  
 chemical vapor deposition in, 448–451  
 overview, 446–448
- Microfluids in nonideal reactor modeling, 809–810
- Micromixing, 769, 809
- Microorganism growth. *See* Bioreactors
- Microreactors  
 molar flow rate algorithm, 212–217  
 for phosgene, 203–204
- Mild reaction conditions in bioconversions, 365
- Minimum mixedness, 820
- Mixed inhibition, 361–363
- Mixers in microreactors, 212
- Mixing  
 nonideal reactors, 769, 808–809  
 RTDs, 770  
 segregation models, 810–811
- Model discrimination in catalysts, 451–454
- Modeling nonideal reactors  
 using RTDs, 807–808  
 zero-adjustable-parameter models. *See* Zero-adjustable-parameter models
- Molar average velocity in diffusion, 683
- Molar feed rate in flow reactors, 35
- Molar flow rates, 114, 207  
 balance equation, 208  
 binary diffusion, 684–687  
 CRE Web site material, 236–237  
 CSTRs, 14  
 diffusion, 681–686  
 ethylene glycol production, 191  
 flow reactors, 35, 115–117, 128  
 gas phase, 210  
 heat of reaction, 502–504  
 learning resources, 236  
 membrane reactors, 217–225, 313–314  
 microreactors, 212–217  
 mole balances, 208–212  
 multiple reactions, 282, 313–314, 316  
 ODE solver algorithm, 235  
 PFR/PBR with heat effects, 546–547  
 PFRs, 16–17  
 semibatch reactors, 227–233  
 tracer, 852  
 unsteady-state operation of stirred reactors, 225–226
- Molar flux in tubular reactors, 596–597
- Molar rate of mass transfer in diffusion, 739–740, 742
- Mole balances, 1–4  
 acetic anhydride production, 556–557  
 adiabatic tubular reactors, 510  
 batch reactors, 10–12, 144–146  
 in design equations, 33  
 enzymatic reactions, 354  
 integral data analysis, 248  
 series reactions, 295–296  
 butane isomerization, 512, 549  
 catalyst decay, 458  
 CFRs (continuous flow reactors), 12–22  
 CRE (chemical reaction engineering) Web site material, 24–26  
 CSTRs, 36, 872  
 with cooling coils, 573  
 in design, 152, 156  
 liquid phase, 308  
 multiple reactions, 586  
 series reactions, 49, 299–300  
 unsteady-state operation, 652–653  
 diffusion, 681–682, 724  
 ethyl acetate saponification, 648  
 ethylene glycol production, 148–149, 158  
 gas-oil catalytic cracking, 470  
 gas phase, 210–212, 304  
 general mole balance equation, 8–10  
 homogeneous systems, 720  
 industrial reactors, 22–23  
 inert tracer in dispersion model, 853  
 isothermal reactors, 169, 209  
 learning resources for, 24–25  
 liquid phase, 208, 210, 308, 310  
 mass transfer and reaction in packed beds, 745  
 maximum mixedness model, 822–823  
 MCMT production, 663–664  
 mean conversion in laminar flow reactors, 818  
 membrane reactors, 219, 221–222, 314  
 moving-bed reactors, 468  
 multiple reactions, 283–284, 314, 586, 657  
 nitroaniline production, 641  
 nitrogen oxide production, 214  
 nitrous oxide reductions, 748  
 nonisothermal reactor design  
 steady-state, 494  
 unsteady-state, 631  
 parallel reactions, 289, 583  
 PBRs, 18–19, 208–212, 304  
 PFRs  
 first-order gas-phase reaction, 142–143  
 with heat effects, 546, 583  
 pressure drop, 169, 178  
 professional reference shelf for, 25–26  
 propylene glycol production, 569, 635, 652–653  
 rate data analysis, 244  
 reaction rate, 4–8  
 semibatch reactors, 227–228, 230, 310, 657  
 straight-through transport reactors, 472–474  
 T-I-S model, 851  
 toluene hydrodemethylation, 446  
 triphenyl methyl chloride-methanol reaction, 254  
 tubular reactors, 37, 596–597  
 adiabatic, 510  
 design, 166  
 with heat exchange, 542
- Molecular adsorption, 412–415
- Molecular dynamics, 97–98
- Molecular sieves, 401
- Molecularity of reactions, 70
- Molecules in diffusion, 681
- Moles  
 in batch systems, 107–109  
 in reactors in series, 47
- Moments of RTDs, 778–782
- Momentum transfer in diffusion, 683
- Monod equation, 334  
 bioreactors, 364, 382  
 for exponential growth, 369–370  
 Hanes–Wolf form, 376
- Monoethanolamine formation, 280
- Monolithic catalysts, 401
- Monopropellant thrusters, 702–704
- Monsanto plant accident, 640–646

- Moser growth law, 370–371  
MOSFET devices, 447  
Moving-bed reactors, catalyst deactivation in, 467–472  
MSDS (Material Safety Data Sheets), 162  
Multiphase reactors in diffusion, 751–753  
Multiple reactions, 279  
  algorithms, 282–284  
  analysis for, 317  
  complex. *See* Complex reactions  
  CRE Web site material, 320–322  
  CSTRs, 298–302, 585–588  
  for digital-age problems, 317–318  
  membrane reactors for, 312–316  
  nonisothermal, 581  
  energy balance in, 581–588  
  unsteady-state, 656–668  
  packed bed flow, 172  
  parallel. *See* Parallel reactions  
  PBRs, 304–307  
  PFRs, 500, 581–582  
  RTD in, 830–835  
  series, 280  
  batch reactors, 294–298  
  in blood clotting, 302–303  
  CSTR, 298–302  
  types, 280–282  
Multiple regression techniques, 441–442  
Multiple steady states, 574–575  
  heat of generation in, 576–578  
  heat-removed terms, 575–578  
  ignition-extinction curves, 578–581  
Multiple substrate systems, 388  
Multiplication, cell, 367  
Mystery Theater module, 198
- N**
- N-butyl alcohol, dehydration of, 483–484  
National Oceanic and Atmosphere Administration (NOAA), 604  
Negative steps in step tracer experiment, 776  
Net rates  
  batch reactor series reactions, 296  
  CSTRs  
  liquid phase, 308  
  series reactions, 299  
  MCMT production, 664–665  
  membrane reactors, 314  
  multiple reactions, 284–285, 296  
  parallel reactions, 285, 289, 583  
  PBR gas phase reactions, 305  
  PFR complex reactions with heat effects, 589  
  of reaction, 71  
  semibatch reactors, 310, 658  
  Newberger, Tim, 105  
  Nickel catalysts, 266–270  
  Nitration reactions, 312  
  Nitroaniline from ammonia and ONCB, 604, 640–642  
  adiabatic operation, 643–644  
  batch operation with heat exchange, 644–645  
  disk rupture in, 645–646  
  isothermal operation, 642–643  
Nitrogen  
  ammonia from, 420  
  from azomethane, 336–338  
  from benzene diazonium chloride, 91  
  skin exposure to, 714  
Nitrogen dioxide  
  from nitrogen oxide, 390  
  from reversible gas-phase decompositions, 126–130  
Nitrogen oxides  
  in automobile emissions, 277, 485–486  
  nitrogen dioxide from, 390  
  production of, 213–217  
Nitrogen tetroxide decomposition, 126–130  
Nitrous oxides  
  in plant effluents, 746–750  
  in plant explosion, 613, 673–674  
Nomenclature, 921–923  
Non-adiabatic energy balance, 501  
Noncompetitive inhibition, 361–363  
Nondissociated adsorption, 412  
Nonelementary rate laws, 76–80, 334–335  
  chain reactions in, 343  
  mechanism searches in, 339–342  
  PSSH in, 335–338  
  summary, 385–386  
Nonenzymatic lipoprotein, 302  
Nonflat velocity profiles in dispersion, 858  
Nongrowth associated product formation, 372, 374  
Nonideal reactors, 845  
  considerations, 767–770  
  using CSTRs and PFRs, 882–883  
  dispersion flow solutions, 870–871  
  guidelines, 846–847  
  modeling using RTDs, 807–810  
  one-parameter models, 847–848  
  pharmacokinetic modeling, 883–884  
  T-I-S, 848–852, 869  
  tubular  
  balance equations in, 854  
  boundary conditions in, 855–858  
  dispersion, 852–854, 858–860  
  dispersion coefficient correlation, 860–862  
  dispersion coefficient  
  determination, 862–866  
  two-parameter models, 848, 871–873  
  Web site material, 886–887  
  zero-adjustable-parameter models.  
  *See* Zero-adjustable-parameter models  
Nonisothermal reactions, 581  
  COMSOL for, 918  
  steady-state. *See* Steady-state nonisothermal reactors  
  unsteady-state. *See* Unsteady-state nonisothermal reactors  
Nonlinear least-squares, 317  
Nonlinear regression  
  batch reactor data analysis, 258–263  
  cell growth, 376  
  ethylene hydrogenation to ethane, 452–453  
  Michaelis–Menten equation, 353  
  toluene hydrodemethylation, 441–442  
Nonseparable kinetics in catalyst deactivation, 455  
Normal pentane, octane number of, 433  
Normalized RTD function, 782–783  
Nuclear processes, Fermi work on, 29–30  
Nuclear region in cells, 366  
Number in chemical species, 4  
Numerical techniques  
  adiabatic tubular reactors, 511  
  batch reactor data analysis, 252–253  
  differential equations. *See* Differential forms and equations  
  equal-area graphical differentiation, 898–899  
  for flows with dispersion and reaction, 870–871  
  integrals  
  numerical evaluation of, 901–902  
  in reactor design, 897–898  
  MCMT production, 665–666  
  for membrane reactors, 223  
  semilog graphs, 903  
  software packages, 903  
Nusselt number, 691–692  
Nutrients in cell growth, 373–374
- O**
- Octane, butyl alcohol for, 482  
Octane number  
  interstage heat transfer in, 523–524  
  from lead, 461  
  in petroleum refining, 431–433  
ODE solvers. *See* Ordinary differential equation (ODE) solvers  
Olefins from dimerize propylene, 53

- One adjustable parameter models,  
nonideal reactor modeling, 808
- One-parameter models for nonideal  
reactors, 846–847  
characteristics, 847–848  
dispersion, 852–854  
T-I-S, 848–852
- One-third rule, 902
- Open-ended problems, 925–928
- Open-open boundary conditions  
in dispersion coefficient  
determination, 864–866  
in tubular reactors, 856–857
- Open systems, first law of  
thermodynamics for, 495
- Open vessel dispersion, 855
- Operating conditions  
mass transfer coefficients, 700–704  
parallel reactions, 291–294
- Operating costs in ethylene glycol  
production, 191–192
- Optimum feed temperature in  
equilibrium conversion, 526–528
- Optimum yield in batch reactor series  
reactions, 297
- Orbital distortions, 87
- Order, reaction, 72–83
- Order of magnitude of time in batch  
operation, 147
- Ordinary differential equation (ODE)  
solvers  
adiabatic tubular reactors, 511  
catalyst decay, 479  
gas phase, 211  
isothermal reactors, 194  
molar flow rates, 235  
multiple reactions, 317
- Organic reactions, liquid-phase, 110
- Orthonitroaniline from ammonia and  
ONCB, 135–136
- Orthonitrochlorobenzene (ONCB)  
nitroaniline from, 640–642  
orthonitroaniline from, 135–136
- Oscillating reactions, 323
- Outlet concentration in nonideal reactors,  
847
- Overall effectiveness factor  
diffusion and reaction, 739–743, 758  
nitrous oxide reductions, 748–750
- Overall mass balance, 228
- Overall mass transfer coefficient, 220
- Overall selectivity  
membrane reactors, 313  
multiple reactions, 282, 313
- Overall yield in multiple reactions, 282
- Overenthusiastic engineers, 707–709
- Oxidation  
of formaldehyde, 328–329  
membrane reactors for, 312
- Oxidoreductases enzymes, 346
- Oxygen-18 data, 717
- Oxygen in water splitting, 487–488
- Ozone reactions with alkenes, 277
- ## P
- Packed-bed reactors (PBRs), 12,  
18–22  
adiabatic, 509–517  
catalyst poisoning in, 462–463  
complex reactions, 304–307  
design equations for, 94  
dispersion in, 862  
energy balance for, 499  
flow reactor design equations, 37–38  
gas-phase reactions, 140  
with heat exchange, 499  
acetic anhydride production,  
556–563  
algorithm, 545–548  
butane isomerization, 548–555  
mass transfer, 697–700, 744–750  
mole balances, 18–19, 208–212  
ODE solvers algorithms for, 194  
pressure drop, 170–177  
RTDs, 768  
for toluene hydrodemethylation,  
443–445  
transfer-limited reactions in,  
750–751
- Parallel reactions, 280  
CSTRs, 159–160, 288–291  
desired products in, 285–291  
in mass transfer-limited reactions,  
705  
PFRs with heat effects, 582–585  
reactor selection and operating  
conditions, 291–294
- Partial differentiation (PDE) solvers for  
diffusion, 682, 685
- Partial oxidation, membrane reactors for,  
312
- Partial pressures  
profiles, 444–445  
in sulfur dioxide rate law, 123–126
- Particle size  
in internal diffusion, 409–410  
in pressure drop, 182–183
- PBRs. *See* Packed-bed reactors (PBRs)
- Peach Bottom nuclear reactor problem,  
925
- Peclet number  
in dispersion and T-I-S models, 869  
in dispersion coefficient  
determination, 862–864, 866  
nonideal reactor modeling, 808  
in tubular reactors, 854–855, 858
- Peclet–Bodenstein number, 869
- Pellets, 720–721  
differential equation for, 723–725,  
729–730  
dimensionless form, 726–728  
effective diffusivity in, 721–723  
in internal diffusion, 409
- Penicillium chrysogenum formation, 369
- Perfect mixing in CSTRs, 13, 36, 286
- Perfect operation  
in CSTRs, 794–795  
in tubular reactors, 797
- PFRs. *See* Plug-flow reactors (PFRs)
- Pharmacokinetics  
competitive inhibition, 357–359  
in drinking and driving, 324–325  
modeling, 883–884  
summary, 385–386  
Tarzlon, 325
- Phases  
cell growth, 368  
enthalpy, 504–505  
gas. *See* Gas phase and gas-phase  
reactions  
heterogeneous reactions, 7  
liquid. *See* Liquid phase and  
liquid-phase reactions
- Phosgene production, 203–204
- Photochemical decay of aqueous  
bromine, 276–277
- Photos of real reactors, 25
- Phthalic anhydride, 1–2
- Physical adsorption, 403
- Picasso's reactor, 17
- Pipes  
dispersion, 860–861  
pressure drop, 174–177
- Plant effluents, nitrous oxides in,  
746–750
- Platinum on alumina as reforming  
catalyst, 432–434
- Plug flow  
in diffusion, 684  
in tubular reactor design, 163, 166
- Plug-flow reactors (PFRs), 12, 14–18  
adiabatic, 509–518  
butane isomerization, 514–517  
complex reactions with heat effects,  
588–595  
conversion in, 868  
CSTRs in series as approximation of,  
51–57  
design equations for, 36–37  
energy balance, 499  
with heat exchange, 540–543  
multiple reactions, 581–582  
parallel reactions, 583  
ethylene production, 165–168  
for gas-phase reactions, 142–144  
with heat exchange, 545–548



- acetic anhydride production, 556–563
    - butane isomerization, 548–555
  - mean conversion in, 818
  - mole balances, 208–212
  - multiple reactions, 581–582
  - nonideal reactors using, 882–883
  - parallel reactions, 289–291, 582–585
  - reactor volume for, 142–144
  - RTDs for, 784–785
  - runaway in, 608–609
  - in segregation models, 813, 815–816
  - in series, 52
    - with CSTRs, 53–57
      - sequencing, 57–58
    - series reactions, 301–302
    - sizing, 43–47
  - Point of no return in nitroaniline production, 644
  - Poisoning
    - catalyst decay, 461–464
    - methanol, 359, 928
  - Polanyi–Semenov equation, 93
  - Polydisperse solids, mass transfer limitations of, 712
  - Polyesters
    - ethylene glycol for, 157
    - from ethylene oxide, 185
  - Polymath programs (Living Example Problems (LEPs))
    - acetic anhydride production, 558–563
    - adiabatic reactors, 501, 511
    - blood clotting, 303
    - butane isomerization, 516, 550, 552–553
    - catalyst decay, 458–459
    - cell growth, 376
    - CSTRs
      - with bypass and dead volume, 880–882
      - with cooling coils, 573–574
      - liquid phase, 309
      - with multiple reactions, 587–588
      - parameter modeling, 874–876
      - unsteady-state operation, 654–655
    - energy balance, 501
    - ethyl acetate saponification, 650
    - ethylene hydrogenation to ethane, 452–453
    - ethylene oxide production, 188–190
      - explanation of, 915–916
    - gas-oil catalytic cracking, 470–471
    - glucose-to-ethanol fermentation, 380
    - heat effects, 584
    - instructions, 903
    - isothermal reactors, 194
    - maximum mixedness model, 828–829
    - MCMT production, 665–667
    - mean conversion, 819
    - membrane reactors, 223–224, 315
    - methane production, 269–270
    - methyl bromide production, 231–232
    - Michaelis-Menten equation, 353
    - multiple reactions, 315, 587–588, 659–660, 833–835
    - nitroaniline production, 644
    - nitrogen oxide production, 215–216
    - nonlinear regression, 261–263, 376
    - PBR gas phase reactions, 306–307
    - PFRs, 584, 591–595
    - propylene glycol production, 571–572, 637–638, 654–655
    - RTD moments, 780–781
    - segregation models, 816, 824
    - semibatch reactors, 659–660
    - straight-through transport reactors, 475–476
    - toluene hydrodemethylation, 441–442, 444
    - trityl-methanol reaction, 250–251
    - tubular reactors, 511, 867
    - variable volumetric flow rate, 127–128
  - Polymerization
    - batch systems, 111, 147
    - bioreactors, 366
    - professional reference shelf for, 387–388
    - screw extruders in, 777
  - Polymers production, 364–365
  - Polynomial fit for E(t) curves, 827–828
  - Pore closure in catalyst deactivation, 456
  - Porous catalyst systems, 401
  - Potential energy in energy balance, 497
  - Power law
    - and elementary rate laws, 72–75
    - in gas phase, 210
    - for homogeneous reactions, 244
  - Practical stability limit
    - CSTR unsteady-state operation, 651
    - propylene glycol production, 654–655
  - Prandtl number, 691–692
  - Pressure
    - conversion factors for, 906
    - in diffusion, 686–687
    - in energy balance, 496
    - in flow reactors with variable volumetric flow rate, 116
    - in sulfur dioxide rate law, 123–126
  - Pressure drop
    - in ethylene oxide production, 185–190
    - in isothermal reactor design, 169, 209
      - analytical solution, 177–188
      - flow through packed beds, 170–174
      - pipes, 174–177
      - rate law in, 169–170
    - tubular reactors with heat exchange, 542
  - Pressure profiles, 444–445
  - Price in ethylene glycol production, 191–192
  - Product-enzyme complex, 353–354
  - Product formation in cell growth, 371–377
  - Production rate in dilution, 383
  - Products, catalyst poisoning by, 463
  - Promoters, 402
  - Propagation step in chain reactions, 343
  - Propane, dehydrogenation for, 221
  - Propylene
    - adsorption of, 422–423
    - from cumene, 5
    - in Langmuir–Hinshelwood kinetics, 421–422
  - Propylene glycol production
    - adiabatic reactors, 568–572, 634–639
    - CSTR unsteady-state operation, 651–656
  - Propylene oxide, propylene glycol from, 568–572
  - Prostaglandin, inhibiting production of, 357
  - Protease hydrolyzes, 343–344
  - Prothrombin, 303
  - Pseudo-steady-state-hypothesis (PSSH), 333
    - for active intermediates, 335–338
    - for epidemiology, 392
    - first-order rate law, 338–339
    - rate laws derived from, 435
  - Pulse injection, 770–771
  - Pulse input experiment for RTDs, 770–776
  - Pulse tracer inputs, 772–773, 785, 848, 862
  - Pyridine hydro-chloride, 249
- ## Q
- Q term in CSTRs with heat effects, 564–567
  - Quarderer, G. C., 271
- ## R
- Radial concentration profiles, 871
  - Radial mixing in tubular reactors, 858
  - Radial variations in tubular reactors, 595–596
    - energy balance, 598–603
    - energy flux, 597–598
    - molar flux, 596–597
  - Radioactive decay, 70
  - Raney nickel, 401
  - Rapid reactions on catalyst surfaces, 693–697

- Rate constant
  - adsorption, 412
  - reaction, 72, 83–93
- Rate data collection and analysis, 243
  - batch reactor data, 246–247
    - differential method, 251–258
    - integral method, 247–251
    - nonlinear regression, 258–263
  - CRE Web site material, 272–273
  - data analysis algorithm, 244–245
  - differential reactors, 264–270
  - experimental planning in, 271
- Rate laws, 69
  - acetic anhydride production, 557
  - adiabatic equilibrium temperature, 520
  - adsorption, 412
  - azomethane decomposition, 336–337
  - batch reactors, 145–146, 253–258, 295
  - butane isomerization, 512, 549–550
  - catalytic reactions, 421–424
    - deducing, 438–439
    - derived from PSSH, 435
    - evaluating, 440–442
    - temperature dependence of, 436
  - cell growth, 369–371, 374, 376–377
  - CRE Web site material for, 96–97
  - CSTRs
    - with cooling coils, 573
    - liquid phase, 308
    - multiple reactions, 586–587
    - parameter modeling, 876
    - series reactions, 299–300
    - single, 152
    - unsteady-state operation, 653
  - cumene decomposition, 430
  - CVD (chemical vapor deposition), 449
  - definitions, 70–72
  - dehydration butanol of alumina, 202
  - elementary, 72–75
  - ethyl acetate saponification, 649
  - ethylene glycol production, 149, 151, 158
  - ethylene hydrogenation to ethane, 452
  - ethylene oxide production, 186
  - gas-oil catalytic cracking, 470
  - gas phase, 210–211, 304–305
  - glucose-to-ethanol fermentation, 379
  - homogeneous reactions, 246
  - inhibition
    - competitive, 357
    - noncompetitive, 361
    - substrate, 363
    - uncompetitive, 360
  - irreversible surface-reaction-limited, 435
  - isothermal reactor design, 169–170, 209
  - kinetic, 77–78
  - mean conversion, 818
  - membrane reactors, 222, 314
  - methane production, 267–269
  - methyl bromide production, 230
  - multiple reactions, 284–285, 314, 317, 586–587, 658
  - nitroaniline production, 641
  - nitrogen oxide production, 214
  - nitrous oxide reductions, 748
  - nonelementary. *See* Nonelementary rate laws
  - nonlinear regression for, 262
  - parallel reactions, 285, 583
  - PBR gas phase reactions, 304–305, 546
  - PFR reactors
    - complex reactions, 588–589
    - with heat effects, 546, 588–589
    - parallel, 583
    - volume for first-order gas-phase reaction, 142–143
  - pressure drop, 169–170, 178
  - propylene glycol production, 569, 635, 653
  - from PSSH, 435
  - questions and problems, 98–103
  - rate data analysis, 244–245
  - and reaction order, 72–83
  - reactor sizing and design, 93–94
  - semibatch reactors, 227, 230, 310, 658
  - spherical catalyst pellets, 724–725
  - steady-state nonisothermal reactor design, 494
  - straight-through transport reactors, 474
  - sulfur dioxide, 123–126
  - summary, 95–96
  - supplementary reading for, 103–104
  - surface-reaction-limited irreversible isomerization, 436
  - surface reactions in catalysts, 416–417
  - temperature dependence of, 436
  - toluene hydrodemethylation, 438, 440, 443, 446
  - triphenyl methyl chloride-methanol reaction, 254–258
  - trityl-methanol reaction, 251
  - tubular reactors
    - adiabatic, 510
    - design, 163, 166
  - for urea
    - decomposition, 354
    - removal, 346–348
    - variable volumetric flow rate, 129
  - Web sites for, 919
- Rate-limiting
  - benzene, 429–430
  - in catalytic reactions, 419–420
  - cumene adsorption, 424–427
  - surface reactions, 427–428
- Rate of change of energy with time, 907
- Rate of consumption in spherical catalyst pellets, 727
- Rate of desorption, 418
- Rate of detachment in adsorption, 412
- Rate of disappearance of substrate, 349
- Rate of formation
  - azomethane decomposition, 336–337
  - in relative rates of reaction, 70–72
  - for species, 7–9
- Rate of generation, 8–9
- Rate of reaction, 4–8
  - azomethane decomposition, 336
  - catalysts in diffusion, 405
  - CSTRs, 13
  - diffusion and reaction, 739–742
  - internal effectiveness factor, 730–733
  - methane production, 266–267
  - multiple reactions, 282
  - nonlinear regression for, 259–260
  - packed bed transfer-limited reactions, 751
  - with pressure drop, 178, 185
  - relative, 70–72
- Rate of transport in membrane reactors, 220
- Rate selectivity parameter in parallel reactions, 286
- Reactants and reactant concentrations
  - catalyst poisoning by, 463
  - continuous-flow reactors, 39
  - in conversion, 32
  - desired products for, 285–291
  - differential reactors, 264
  - energy of formation of, 85
  - in heterogeneous reactions, 720
  - mass transfer of, 720
  - multiple reactions, 281
  - parallel reactions, 285–291
  - semibatch reactors, 233
- Reaction coordinates, 84
- Reaction-limited regime estimation, 743–744
- Reaction mechanisms, searching for, 339–342
- Reaction order, 72–83
- Reaction rate constant, 72, 83–93
- Reaction rate law
  - catalyst deactivation, 455–456
  - catalyst decay, 458
- Reaction steps with catalysts, 405–406
- Reaction surface area in heterogeneous reactions, 7
- Reaction time in batch reactors, 145–151
- Reaction yields in multiple reactions, 282
- Reactions
  - heterogeneous, 79–80
  - homogeneous, 76–77

- rates. *See* Rate of reaction
  - reversible, 80–83
  - temperature effects on, 92–93
  - Reactive distillation, 226
  - Reactor lab
    - isothermal reactor design, 195
    - multiple reactions, 321, 331
    - rate data collection, 273–274
  - Reactor length in nitrous oxide reductions, 750
  - Reactor-rate constant in adiabatic operations, 638–639
  - Reactor staging with interstate cooling or heating, 522–526
  - Reactor volume
    - butane isomerization, 55
    - continuous-flow reactors, 39–40
    - conversion factors, 906
    - CSTRs, 36, 49–51, 56–58
    - ideal gases, 905
    - membrane reactors, 219
    - PBRs, 18, 20–21
    - PFRs, 17–18, 22, 52, 57–58
    - in space time, 59
    - tubular reactors, 164
  - Reactors. *See also* specific reactor types
    - by name
    - in parallel reactions, 291–294
    - in rate data analysis, 244
    - in series, 47–48
      - CSTRs, 48–50
      - CSTRs and PFRs combination, 53–57
      - CSTRs and PFRs comparisons, 57–58
      - PFRs, 52
    - sizing. *See* Conversion and reactor sizing
    - for toluene hydrodemethylation, 443–445
  - Real reactors
    - mean conversions in, 816–817
    - in two-parameter models, 871–873
  - Realistic models for nonideal reactors, 846
  - Reciprocal concentrations, 248
  - Reciprocal power decay rate law, 464
  - Recycle reactors, 196
  - Recycle stream in parallel reactions, 291
  - Reforming catalysts, 431–435
  - Reforming process, 432
  - Regression
    - in activation energy determinations, 91
    - batch reactor data analysis, 258–263
    - cell growth, 376
    - ethylene hydrogenation to ethane, 452–453
    - methane production, 269–270
    - Michaelis–Menten equation, 353
    - toluene hydrodemethylation, 441–442
    - triphenyl methyl chloride-methanol reaction, 258
  - Relative rates of reaction
    - batch reactor series reactions, 295
    - CSTR liquid phase, 308
    - defined, 70
    - MCMT production, 665
    - multiple reactions, 284–285
    - parallel reactions, 583
    - PBR gas phase reactions, 305
    - PFR complex reactions with heat effects, 589
    - semibatch reactors, 310, 658
    - stoichiometric coefficients, 71–72
  - Residence time distribution function, 771
  - Residence time distributions (RTDs), 212, 767
    - considerations, 767–770
    - conversion prediction. *See* Conversion using RTDs
    - diagnostics and troubleshooting
      - CSTRs, 794–797
      - tubular reactors, 797–799
    - ideal reactors
      - batch and plug-flow, 784–785
      - laminar flow reactors, 786–789
      - single-CSTR, 785–786
    - integral relationships in, 777–778
    - internal-age distribution, 783–784
    - mean residence time in, 778, 788
    - measurements, 770–777
    - moments, 778–782
    - multiple reactions, 830–835
    - normalized function, 782–783
    - PBRs, 768
    - pulse input experiment for, 770–776
    - step tracer experiment, 775–777
    - T-I-S model, 850
    - two-parameter models, 871–872
    - Web site material, 801
  - Respiration rate of chipmunks, 713
  - Reversible gas-phase decompositions, 126–130
  - Reversible isomerization, 436
  - Reversible reactions, 70
    - overview, 80–83
    - stoichiometry, 126–130
  - Reynolds number
    - in dispersion, 860–861
    - in dispersion coefficient
      - determination, 862
    - in mass transfer coefficient, 691, 693, 696
    - in mass transfer correlations, 701
  - Ribonucleic acid (RNA), 366
  - Robert the Worrier, 700–704
  - RTDs. *See* Residence time distributions (RTDs)
  - Runaway reactions
    - batch reactors with interrupted isothermal operation, 639–646
    - from falsified kinetics, 739
    - PFRs, 608–609
    - SACHe materials, 604–605
    - T2 explosion, 660–668
- ## S
- Saccharomyces cerevisiae, 378–381
  - Safety
    - ethylene glycol, 162
    - exothermic reactions, 603–605, 640–646
  - Safety and Chemical Engineering Education (SACHe) program, 604–605
  - Santa Ana winds, 28
  - Saponification, 111–112
  - Satellite maneuvering, 702–704
  - Scale-up of batch reactor data, 144
  - Scavengers with active intermediaries, 341–342
  - Schmidt number
    - in diffusion, 692, 696
    - in dispersion, 860, 862
  - Seafood gumbo, 926–927
  - Searching
    - for mechanisms, 339–342
    - in nonlinear regression, 260–261
  - Second-order ODE solutions, 901
  - Second-order rate laws, 76
  - Second-order reactions, 73
    - batch reactor data analysis, 248
    - CSTR design, 153–154
    - irreversible, 155
    - isothermal, 146–147, 230–233
    - laminar flow reactors, 817–820
    - mean conversion, 817–820
    - multiple steady states, 577
    - PBRs, 178–179
  - Second reactors in interstage cooling, 525–526
  - Secondary nutrients, 374
  - Segregation model
    - in maximum mixedness model, 820, 824
    - vs. maximum mixedness model, 829–830
    - multiple reactions in, 830–835
    - vs. T-I-S model, 852
    - zero-adjustable-parameter, 810–820
  - Selectivity
    - CSTRs, 308
    - liquid-phase reactions, 227, 308, 310
    - membrane reactors for, 225, 312–316
    - multiple reactions, 281–282, 285, 312–316
    - parallel reactions, 291

- Selectivity (*continued*)  
 PBR gas phase reactions, 305  
 PFR complex reactions with heat effects, 590  
 semibatch reactors, 310  
 temperature effects on, 289  
 Trambouze reactions, 287–291
- Semibatch reactors, 225–226  
 energy balance, 499, 647, 658  
 with heat exchangers, 646–651  
 liquid phase, 310–312  
 multiple reactions in, 656–660  
 unsteady-state operation, 227–233
- Semiconductor fabrication  
 chemical vapor deposition in, 448–451  
 overview, 447
- Semilog plots, 92, 903
- Separable kinetics in catalyst  
 deactivation, 455, 463
- Separating variables with pressure drop, 179
- Separation systems, economic incentive for, 281
- Sequencing of reactors, 57–58
- Series, reactors in, 47–48  
 combinations, 53–57  
 CSTRs, 48–50  
 design, 155–157, 160–161  
 PFRs, 52
- Series reactions, 280  
 batch reactors, 294–298  
 blood clotting, 302–303  
 CSTRs, 298–302, 585–588  
 mass transfer-limited reactions, 705
- Seveso accidental release, 604
- Shaft work in energy balance, 496
- Shell balances on catalyst pellets, 723
- Sherwood numbers  
 in mass transfer coefficient, 691–692  
 in mass transfer correlations, 702
- Silicon dioxide for microelectronic devices, 447
- Simplifications  
 rate data analysis, 244  
 triphenyl methyl chloride-methanol reaction, 254
- Simpson's one-third rule, 902
- Simpson's three-eighths rule, 902
- Simpson's three-point formula, 56
- Single particles, mass transfer to, 693–697
- Single-site mechanisms  
 rate-limiting in, 427–428, 435  
 surface reactions in, 416, 435
- Sintering, 456–459
- Site balance  
 adsorption isotherms, 411  
 cumene adsorption, 426
- Sizing reactors. *See* Conversion and reactor sizing
- Skewness in RTD moments, 779
- Skin, nitrogen gas exposure to, 714
- Slow reactions in mass transfer to single particles, 696–697
- Slurry reactors, 751–752, 755
- Small molecule synthesis, 366
- Small-scale operations, 10
- Smog formation, 28–29
- Soap, saponification for, 111–112
- Socrates, 1
- Sodium hydroxide in saponification, 111
- Sodium in MCMT production, 661
- Sodium thiosulfate, 74
- Software packages. *See also specific software packages by name*  
 Aspen, 916  
 COMSOL, 917–918  
 instructions, 903  
 MATLAB, 916  
 Polymath, 915–916
- Solar energy  
 biochar gasification, 331  
 chemical storage, 103  
 field design, 330  
 water splitting, 487–488
- Solid catalysts in PBRs, 18
- Solvents from ethylene oxide, 185
- Space satellite maneuvering, 702–704
- Space time, 58–60  
 in CSTR modeling, 878  
 in dispersion coefficient determination, 866
- Space velocity, 60–61
- Spartan program, 335
- Specialty chemicals, 212
- Species, 4–5  
 mole balances on, 8–9  
 and variable volumetric flow rate, 115–117
- Specific rate of product formation, 372, 374–375
- Specific reaction rate, 72, 83–93
- Spectroscopic measurements, 435
- Spheres, mass transfer coefficient for, 694–695
- Spherical bacteria growth, 367
- Spherical catalyst pellets, 720–721  
 differential equation for, 723–725, 729–730  
 dimensionless form, 726–728  
 effective diffusivity, 721–723
- Spherical reactors, 196
- Spread of distributions, 779
- Square of the standard deviation, 779
- Stability rates  
 CSTR unsteady-state operation, 651  
 propylene glycol production, 654–655
- Stagnant film, diffusion through, 688–690
- Standard deviation, 779
- Standard temperature and pressure (STP)  
 in space velocity, 61
- Starch, hydrolysis of, 394
- Startup of CSTRs, 651–656
- Stationary phase  
 cell growth, 369, 374–375  
 substrate balance, 378
- Steady-state bifurcation, 609
- Steady state in CSTRs, 13
- Steady-state molar flow rates, 502–504
- Steady-state nonisothermal reactors, 493  
 adiabatic operation. *See* Adiabatic operations  
 CRE Web site material, 530–531  
 energy balance. *See* Energy balances  
 equilibrium conversion. *See* Equilibrium conversions  
 with heat exchange. *See* Flow reactors  
 information required for, 494–495  
 questions and problems, 531–536  
 summary, 529–530  
 supplementary reading, 536–537
- Steady-state operation in chemostats, 382
- Step tracer experiment, 775–777
- Stern–Volmer equation, 340–342
- Stirred reactors  
 CSTRs. *See* Continuous-stirred tank reactors (CSTRs)  
 unsteady-state operation  
 overview, 225–226  
 semibatch reactors, 227–233
- Stoichiometric coefficients  
 in conversion, 32  
 in relative rates of reaction, 71
- Stoichiometry, 69, 105–106  
 acetic anhydride production, 557  
 adiabatic equilibrium temperature, 520  
 batch systems, 107–113, 145–146  
 butane isomerization, 513, 549–550  
 catalyst decay, 458  
 cell growth, 371–377  
 CRE Web site material, 133  
 CSTRs  
 with cooling coils, 573  
 single, 152  
 ethyl acetate saponification, 649  
 ethylene glycol production, 149, 158–159  
 ethylene oxide production, 186–187  
 flow systems, 113–126  
 gas-oil catalytic cracking, 470  
 gas phase, 210–211, 306

- glucose-to-ethanol fermentation, 379  
 isothermal reactors, 209  
 liquid phase, 310  
 MCMT production, 665  
 mean conversion, 818  
 membrane reactors, 222–223, 314  
 multiple reactions, 284, 314, 658  
 nitroaniline production, 642  
 nitrogen oxide production, 215  
 parallel reactions, 583–584  
 PBR gas phase, 306  
 PFRs  
   with heat effects, 546–547, 583–584, 590  
   reactor volume, 142–143  
 pressure drop, 169–170, 178  
 propylene glycol production, 569, 635, 653  
 questions and problems, 133–138  
 reversible reactions and equilibrium conversion, 126–130  
 semibatch reactors, 310, 658  
 steady-state nonisothermal reactors, 494  
 straight-through transport reactors, 475  
 summary, 131–133  
 supplementary reading, 138  
 toluene hydrodemethylation reactors, 443–444, 446  
 triphenyl methyl chloride-methanol reaction, 254  
 tubular reactors  
   adiabatic, 510  
   design, 163–164, 166–167  
 STP (standard temperature and pressure) in space velocity, 61  
 Straight-through transport reactors (STTRs), 472–476  
 Streptomyces aureofaciens, 384  
 Stuart Prower factor, 303  
 Styrene from ethylbenzene, 220–221  
 Subscripts, 923  
 Substrates  
   in cell growth, 367, 373–376  
   and dilution rate, 383  
   disappearance, 349, 378  
   enzyme-substrate complex, 344–346  
   inhibition by, 359, 361, 363–364  
   mass balances, 378  
   in Michaelis–Menten equation, 348–349, 355  
   microelectronic fabrication, 447  
   multiple systems, 385  
 Sulfonation reactions, 312  
 Sulfur dioxide  
   gas-phase reactions, 120–123  
   rate law, 123–126  
 Sulfuric acid  
   DDT production, 6  
   ethylene glycol production, 192  
   professional reference shelf for, 609  
 Sums of squares  
   ethylene hydrogenation to ethane, 453  
   multiple reaction analysis, 317  
   nonlinear regression, 260, 263  
 Superficial mass velocity, 185  
 Supported catalysts, 402  
 Surface area  
   catalyst deactivation, 456–457  
   hydrazine decomposition, 703–704  
   mass transfer-limited reactions, 706  
   membrane reactors, 220  
   microreactors, 212  
   spherical catalyst pellets, 724  
 Surface-catalyzed reactions, 212  
 Surface-reaction-limited operations  
   cumene decomposition, 430  
   irreversible isomerization, 436  
   irreversible rate laws, 435  
 Surface reactions  
   catalysts, 416–418  
   CVD, 449–450  
   microelectronic fabrication, 447  
   packed bed transfer-limited reactions, 751  
   rapid, 694–695  
   rate laws, 422–423, 435  
   rate-limiting, 427–428  
   toluene hydrodemethylation, 439–440  
 Surfaces  
   catalyst, 693–697  
   in effectiveness factor, 739–740  
   in mass transfer to single particles, 695  
   metallic, 712  
 Surfactants from ethylene oxide, 185  
 Sweetland, Ben, 845  
 Swimming rate of small organisms, 760  
 Switch grass, 330  
 Synthesizing chemical plant design, 190–192  
 System volume in mole balance equation, 8  
 Szent-Gyorgyi, Albert, 539, 719
- T**
- T2 Laboratories explosion, 604, 660–668  
 Tails  
   fitting, 801  
   in pulse input experiment, 775  
 Tanks-in-series (T-I-S) models  
   conversion in, 866–868  
   vs. dispersion models, 869  
   nonideal, 848–852  
   one-parameter, 847  
   vs. segregation model, 852  
 Tau, space time, 58–60  
 Taylor series for energy balance, 565  
 Temperature, 493. *See also* Heat effects and activation energy, 92–93  
   adiabatic operations in batch reactors, 638–639  
   in adsorption, 412  
   in cell growth, 371  
   in collisions, 88–89  
   conversion factors, 906  
   in CSTRs, 13  
   in diffusion, 686–687  
   in enzymatic reactions, 356  
   in flow reactors with variable volumetric flow rate, 116  
   in internal effectiveness factor, 733–734  
   in mass transfer correlations, 700  
   in mass transfer to single particles, 695  
   nonisothermal reactors  
     steady-state. *See* Steady-state nonisothermal reactors  
     unsteady-state. *See* Unsteady-state nonisothermal reactors  
   in rate laws, 77, 436  
   selectivity affected by, 289  
 Temperature-concentration phase planes, 651  
 Temperature-time trajectories, catalyst deactivation of, 465–467  
 Tenebrionid beetles, 100  
 Terephthalic acid (TPA), 326–327  
 Termination step in chain reactions, 343  
 Termolecular reactions, 70  
 Tessier equation, 370–371  
 Testing new processes, batch reactors for, 10  
 Thermal decomposition of isopropyl isocyanate, 278  
 Thermal diffusivity in mass transfer coefficient, 691  
 Thermodynamic equilibrium constant, 80, 909–914  
 Thermodynamically limited reactions, 217  
 Thermodynamics  
   equilibrium conversion from, 521  
   first law of, 495–496  
   in reversible reactions, 83  
 Thiele modulus  
   in falsified kinetics, 737  
   in internal effectiveness factor, 731–737  
   in spherical catalyst pellets, 726–728  
 Third-order reactions, 73

- Thoenes–Kramers correlation  
 flow through packed beds, 700  
 hydrazine decomposition, 703–704  
 Mears criterion, 744  
 nitrous oxide reductions, 749
- Three-eighths rule, 902
- Three-point rule, 902
- Thrombin in blood clotting, 303
- Thrusters, monopropellant, 702–704
- Tic-Tac module, 236
- Time  
 in batch reactors, 146–147  
 concentration, 246  
 reactant, 33–34  
 in energy rate change, 907  
 in growth rates, 371
- Time order of magnitude in batch systems, 147
- Tissue engineering, 763–765
- Tissue factor in blood clotting, 302–303
- Titanium dioxide, 488–489
- TOF (turnover frequency), 404
- Toluene  
 hydrodemethylation of, 79, 437–446  
 from methylcyclohexane, 489  
 para-xylene from, 401  
 xylene from, 490–491
- Tortuosity in effective diffusivity, 721–723
- Total concentrations in flow reactors, 121
- Total cycle time in batch systems, 147
- Total energy in first law of thermodynamics, 495
- Total enzyme concentration, 346–348
- Total mass, 5
- Total molar flow rate  
 flow reactors, 115–116  
 gas phase, 210, 212
- Total volume  
 CSTRs in series, 51–52  
 PFRs in series, 52
- Toxic intermediates, 212
- TPA (terephthalic acid), 326–327
- Tracers  
 CSTR parameter modeling, 873–877, 879–880  
 dispersion coefficient determination, 862–863  
 dispersion model, 852–853  
 pulse input experiment, 773  
 RTDs, 770, 785  
 step tracer experiment, 775–777  
 T-I-S model, 849  
 two-parameter models, 871–872
- Trains of reactors with interstage heating, 536
- Trambouze reactions, 287–291
- Transfer. *See* Mass transfers
- Transferases enzymes, 346
- Transition state theory, 97
- Transition states and energy barriers, 85
- Transport  
 with catalysts, 405  
 in membrane reactors, 220, 222, 314
- Trapezoidal rule, 901
- Trial and error method, 880
- Trickle bed reactors, 752, 756
- Triethanolamine formation, 280
- Triphenyl methyl chloride, 254–258
- Trityl-methanol reaction, 249–251
- Troubleshooting, 793–794  
 corrosion, 100  
 CSTRs, 794–797  
 isothermal reactors, 200  
 tubular reactors, 797–799
- Truman, Harry S., 493
- Tubes  
 in microreactors, 212  
 in pressure drop, 185
- Tubular reactors, 14–18, 202–203  
 design equations, 36–37, 94  
 designing, 162–165  
 ethylene production, 165–168  
 gas-phase reactions, 14, 163–165  
 hemoglobin deoxygenation in, 275  
 nonideal, 847–848  
 balance equations, 854  
 boundary conditions, 855–858  
 dispersion, 852–854, 858–860  
 dispersion coefficient correlation, 860–862  
 dispersion coefficient determination, 862–866  
 plug-flow. *See* Plug-flow reactors (PFRs)  
 radial and axial variations, 595–596  
 energy balance, 598–603  
 energy flux, 597–598  
 molar flux, 596–597  
 RTDs for, 797–799  
 space time in, 59
- Turbulent diffusion, 852
- Turbulent flow  
 packed bed pressure drop, 176  
 pipes, 860–861
- Turnover frequency (TOF), 404
- Turnover number in Michaelis–Menten equation, 348
- Two parameter models for nonideal reactors, 808, 846, 848, 871–873
- Two-point rule, 901
- Tyrosinase, 344
- U**
- Ultraformers, 196
- Ultrasonic waves, light from, 340–342
- Unbound enzyme concentration, 346
- Uncompetitive inhibition, 359–361
- Underground wet oxidation problem, 926
- Undesired products in multiple reactions, 281
- Uniform surfaces, adsorption in, 415
- Unimolecular reactions, 70
- Units, conversion factors for, 906–907
- Unstable steady-state temperatures, 579–580
- Unsteady-state nonisothermal reactors, 629  
 batch reactors  
 adiabatic operation, 633–639  
 with interrupted isothermal operation, 639–646  
 CRE Web site material, 670–671  
 CSTR operation, 499, 651–656  
 energy balance, 499, 630–632  
 mole balances, 631  
 multiple reactions, 656–668  
 questions and problems, 671–677  
 semibatch reactors, 646–651  
 summary, 668–669
- Unsteady-state operation of stirred reactors, 225–233, 651–656
- Unsteady-state tracer balance, 862–863
- Unsupported catalysts, 402
- Unwanted products in parallel reactions, 291–292
- Urea removal, 346–348  
 batch reactor calculations, 354–356  
 Michaelis–Menten equation, 348–354
- Urease, 346–348
- User-friendly form of energy balance, 633
- V**
- Vacant sites in cumene adsorption, 426
- Van de Vusse kinetics, 321
- Vanadium oxides, 488
- Vanadium triisopropoxide (VTIPO), 488
- van't Hoff's equation, 910
- Vapor-phase reactions, irreversible endothermic, 534
- Variable heat capacities, 530
- Variable temperature in energy balance, 500
- Variable volume in gas phase flow systems, 115–126
- Variable volumetric flow rate, 115–126
- Variance  
 in ethylene hydrogenation to ethane, 453–454  
 in RTDs, 779–781, 784  
 in T-I-S model, 850–851
- Vat reactors. *See* Continuous-stirred tank reactors (CSTRs)

Velocity  
  fluid in mass transfer to single particles, 697  
  space, 60–61  
Velocity profiles in tubular reactors, 848, 858  
Venkatesan, R., 701  
Venting in MCMT production, 664  
Vermont Safety Information Resources, Inc. (Vermont SERI), 162  
Vessel boundary conditions  
  dispersion coefficient determination, 864–866  
  tubular reactors, 855–857  
Vessel dispersion number, 855  
Vibrational energy, 334  
Viscosity  
  conversion factors for, 906  
  of helium, 702  
  in mass transfer coefficient, 691  
Visual Encyclopedia of Equipment, 26  
Volume. *See* Reactor volume  
Volume-average particle diameter, 703  
Volume change with reaction, 733  
Volumetric feed rate in chemostats, 381  
Volumetric flow, 114  
  differential reactors, 264  
  ethylene oxide production, 188  
  methane production, 266–267  
  pulse input experiment, 771  
  RTDs, 778, 787  
  T-I-S models, 850  
  tubular reactors, 165  
  variable, 115–126  
VTIPO (vanadium triisopropoxide), 488

## W

Wafer fabrication  
  chemical vapor deposition in, 448–451  
  overview, 447  
Wash-out in cell growth, 383–384  
Washington, Booker T., 69  
Water  
  light from, 340–342  
  splitting, 487–488  
Water-gas shift reaction, equilibrium constant in, 912–914  
Watson, K. M., 419  
Web sites for rate law data, 919  
Weber, M., Jr., 769  
Weighted least squares analysis, 273  
Weisz–Prater criterion, 734–735  
Wen, C. Y.  
  on RTD moments, 778  
  on tracer techniques, 777  
Wet oxidation problem, 926  
Wetlands module, 236, 238  
“What if” conditions for mass transfer coefficients, 705–709  
Wine-making, 370–371  
Wooden, John, 31  
Work, conversion factors for, 906  
Work term in energy balance, 496–498

## X

Xylene from toluene, 490–491

## Y

Yeasts, 393  
  doubling times, 371  
  growth of, 367  
Yields  
  in bioconversions, 365  
  in cell growth, 372, 375–376  
  in multiple reactions, 282  
  series reactions in batch reactors, 297

## Z

Zeolite catalysts, 401  
Zero-adjustable-parameter models  
  maximum mixedness model, 820–826  
  multiple reactions in, 830–835  
  questions and problems, 837–842  
  segregation models, 810–820  
  software packages for, 827–830  
  summary, 835–836  
  supplementary reading, 842–843  
  Web site material, 836–837  
Zero-order reactions, 73, 247–248  
Zewail, Ahmed, 335  
Zwietering, T. N., 810