

The DSC Europe conference, held this year at the Arts et Métiers ParisTech, is a gathering event between two communities: scientific researchers interested in drivers' behaviour and perception, and developers of technologies for the rendering of the behaviour and environment of vehicles. These last years have witnessed the appearance of high performance driving simulators at several car makers and universities all over the world as well as a larger and larger use of low-cost simulators for a growing number of human factors, vehicle engineering, road traffic and training applications. Multi-sensory integration issues, including transport delay and rendering scaling, become more and more important with new scientific questions and are discussed by the authors. Thus, this DSC 2010 Europe conference brings a panorama of the most recent experiments and results that researchers and engineers have obtained in the field of driving simulation.

**Dr. Andras Kemeny**, *Engineering Department Manager, Head of Technical Center for Simulation, Renault; Associate Professor, Arts et Métiers ParisTech, France*

**Dr. Frédéric Mérienne**, *Professor and Director of Image Institut, Arts et Métiers ParisTech, France*

**Stéphane Espié**, *Research Director and Deputy Director, LEPSIS (INRETS - LCPC), France*

Couverture : crédit photo Renault CTS



The French national institute for transport and safety research

ISSN 0769-0266  
ISBN 978-2-85782-685-9

© Les collections de l'INRETS

A126

TRENDS IN DRIVING SIMULATION DESIGN AND EXPERIMENTS

Andras Kemeny  
Frédéric Mérienne  
Stéphane Espié  
Editors

TRENDS IN DRIVING  
SIMULATION DESIGN AND  
EXPERIMENTS



Driving Simulation Conference  
Europe 2010 Proceedings  
Arts et Métiers ParisTech  
September 9–10, 2010

85 €

Actes

Actes

Conformément à la note du 04/07/2014 de la direction générale de l'Ifsttar précisant la politique de diffusion des ouvrages parus dans les collections éditées par l'Institut, la reproduction de cet ouvrage est autorisée selon les termes de la licence CC BY-NC-ND. Cette licence autorise la redistribution non commerciale de copies identiques à l'original. Dans ce cadre, cet ouvrage peut être copié, distribué et communiqué par tous moyens et sous tous formats.



Attribution — Vous devez créditer l'Oeuvre et intégrer un lien vers la licence. Vous devez indiquer ces informations par tous les moyens possibles mais vous ne pouvez pas suggérer que l'Ifsttar vous soutient ou soutient la façon dont vous avez utilisé son Oeuvre.



Pas d'Utilisation Commerciale — Vous n'êtes pas autorisé à faire un usage commercial de cette Oeuvre, tout ou partie du matériel la composant.



Pas de modifications — Dans le cas où vous effectuez une adaptation, que vous transformez, ou créez à partir du matériel composant l'Oeuvre originale (par exemple, une traduction, etc.), vous n'êtes pas autorisé à distribuer ou mettre à disposition l'Oeuvre modifiée.

## Le patrimoine scientifique de l'Ifsttar

Le libre accès à l'information scientifique est aujourd'hui devenu essentiel pour favoriser la circulation du savoir et pour contribuer à l'innovation et au développement socio-économique. Pour que les résultats des recherches soient plus largement diffusés, lus et utilisés pour de nouveaux travaux, l'Ifsttar a entrepris la numérisation et la mise en ligne de son fonds documentaire. Ainsi, en complément des ouvrages disponibles à la vente, certaines références des collections de l'INRETS et du LCPC sont dès à présent mises à disposition en téléchargement gratuit selon les termes de la licence Creative Commons CC BY-NC-ND.

Le service Politique éditoriale scientifique et technique de l'Ifsttar diffuse différentes collections qui sont le reflet des recherches menées par l'institut :

- Les collections de l'INRETS, Actes
- Les collections de l'INRETS, Outils et Méthodes
- Les collections de l'INRETS, Recherches
- Les collections de l'INRETS, Synthèses
- Les collections du LCPC, Actes
- Les collections du LCPC, Etudes et recherches des laboratoires des ponts et chaussées
- Les collections du LCPC, Rapport de recherche des laboratoires des ponts et chaussées
- Les collections du LCPC, Techniques et méthodes des laboratoires des ponts et chaussées, Guide technique
- Les collections du LCPC, Techniques et méthodes des laboratoires des ponts et chaussées, Méthode d'essai



Institut Français des Sciences et Techniques des Réseaux,  
de l'Aménagement et des Transports  
14-20 Boulevard Newton, Cité Descartes, Champs sur Marne  
F-77447 Marne la Vallée Cedex 2

Contact : [diffusion-publications@ifsttar.fr](mailto:diffusion-publications@ifsttar.fr)

[www.ifsttar.fr](http://www.ifsttar.fr)



Andras Kemeny  
Frédéric Mérienne  
Stéphane Espié  
Coordinateurs

# **Trends in Driving Simulation Design and Experiments**

Proceedings of the Driving Simulation  
Conference Europe 2010

Arts et Métiers ParisTech, Paris, France  
September, 9<sup>th</sup> and 10<sup>th</sup> 2010

## **Direction**

Andras Kemeny                      Renault, Technical Center for Simulation  
andras.kemeny@renault.com

Renault, Technical Center for Simulation  
1 Avenue du Golf, 78288 Guyancourt  
Arts et Metiers ParisTech  
2 rue Thomas Dumorey, 71100 Chalon-sur-Saône

## **Organisation Committee**

Stéphane Espié, INRETS  
Frédéric Mérienne, Arts et Metiers ParisTech  
Andras Kemeny, Renault, Arts et Metiers ParisTech

## **Scientific Committee**

Andras Kemeny, Renault, Arts et Metiers ParisTech (France)  
Wade Allen, STI (United States)  
Jost Bernasch, The Virtual Vehicle (Austria)  
Alain Berthoz, LPPA (France)  
Willem Bles, TNO (Netherlands)  
Erwin R. Boer, University of California, San Diego (United States)  
Heinrich H. Bülthoff, Max Planck Institute for Biological Cybernetics (Germany)  
Viola Cavallo, INRETS (France)  
Stéphane Espié, INRETS (France)  
Jeff Greenberg, Ford Motor Co. (United States)  
Eric Groun, TNO (Netherlands)  
Alexander Huesmann, BMW Group R&T (Germany)  
Wilfried Käding, Daimler (Germany)  
Frédéric Mérienne, Arts et Metiers ParisTech (France)  
Staffan Nordmark, VTI (Sweden)  
Gilles Reymond, Renault (France)  
Nicholas Ward, University of Montana (USA)

## **Institut national de recherche sur les transports et leur sécurité – INRETS**

Direction scientifique / politique éditoriale – Aude Lauby  
25 avenue François Mitterrand Case 24, 69675 Bron Cedex, France  
Tél. : +33 (0)4 72 14 23 20 – Fax : +33 (0)4 72 37 68 37 – [www.inrets.fr](http://www.inrets.fr)

© Les collections de l'INRETS – Réf. A126

ISBN 978-2-85782-685-9

ISSN 0769-0266

---

En application du code de la propriété intellectuelle, l'INRETS interdit toute reproduction intégrale ou partielle du présent ouvrage par quelque procédé que ce soit, sous réserve des exceptions légales.

# Preface

The DSC Europe conference, held this year at the Arts et Métiers ParisTech, is a gathering event between two communities: scientific researchers interested in drivers' behaviour and perception, and developers of technologies for the rendering of the behaviour and environment of vehicles.

These last years have witnessed the appearance of several high performance driving simulators at several car makers and universities all over the world as well as a larger and larger use of low-cost simulators for a growing number of human factors, vehicle engineering, road traffic and training applications .

Multi-sensory integration issues, including transport delay and rendering scaling, become more important with new scientific questions and are discussed by the authors. Thus, this DSC 2010 Europe Conference will bring a panorama of the most recent experiments and results that researchers and engineers have obtained in the field of driving simulation.

This year, the plenary sessions allowing the participants to attend all sessions were completed with a Poster and Product Solutions session in order to provide attendees with a technological panorama also.

**The DSC Europe Organization Committee**



# Contents

Preface .....	4
Introduction ( <i>Andras Kemeny</i> ).....	10

## Keynote address

Visual control of driving and flying: Importance of optic flow rules, perceptual representation of 3-D space, and internal models of vehicle dynamics ( <i>Jack Loomis</i> ) .....	13
--	----

## Perception and human factors

Simulating the Effect of Low Lying Sun and Worn Windscreens in a Driving Simulator ( <i>Jonas Jansson, Anne Bolling, Gunilla Sörensen</i> ).....	23
Flexibility of the cognitive system to use various spatial coding: implication for driving situation ( <i>Eve Dupierrix, Alain Berthoz</i> ) .....	33
Drivers' perception of loss of adherence in bends ( <i>Thomas Denoual, Franck Mars, Jean-François Petiot, Gilles Reymond, Andras Kemeny</i> ) .....	43

## Simulation design and architecture

Heading towards Eye Limiting Resolution – Display systems in driving simulation ( <i>Alexander Huesmann, Martin Strobl</i> ).....	57
Impact of geometric field of view on speed perception ( <i>Florent Colombet, Frederic Merienne, Andras Kemeny, Damien Paillot</i> ) ..	69
Influence of display type and field of view on drivers' performance in a motion-based driving simulator ( <i>Volker Grabe, Paolo Pretto, Paolo Robuffo Giordano, Heinrich H. Bühlhoff</i> ) .....	81
Transport delay characterization of scanner driving simulator ( <i>François Saidi, Guillaume Millet, Gilles Gallee</i> ) .....	89
Software assembly and open standards for virtual reality and driving simulation ( <i>Nicolas Filliard, Emmanuel Icart, Jean-Luc Martinez, Sébastien Gerin, Frédéric Merienne, Andras Kemeny</i> ).....	99

## Motion rendering

Performance identification and compensation of simulator motion cueing delays ( <i>Zhou Fang, Gilles Reymond, Andras Kemeny</i> ) .....	111
---	-----

Motion cueing for 3, 6 and 8 degrees of freedom motion systems ( <i>Martin Fischer, Håkan Sehhammer, Göran Palmkvist</i> ).....	125
SHAKE – an approach for realistic simulation of rough roads in a moving base driving simulator ( <i>Anne Bolling, Anders Genell, Mattias Hjort, Mats Lidström, Staffan Nordmark, Göran Palmqvist, Håkan Sehhammer, Leif Sjögren, Mikael Ögren</i> ).....	135
Motion Cueing Algorithm online parameter switching in a blink of an eye – a time variant approach ( <i>Tobias Lorenz, Klaus Jaschke</i> ) .....	145

### **Keynote address**

Daimler's New Full-Scale, High-dynamic Driving Simulator – A Technical Overview ( <i>Eberhard Zeeb</i> ) .....	157
---	-----

### **Virtual prototyping and training**

Familiarization with a forward collision warning on driving simulator: cost and benefits on driver, system interactions and acceptance ( <i>Arnaud Koustanai, Arnaud Mas, Viola Cavallo, Patricia Delhomme</i> ).....	169
Eco-driving performance assessment with visual and haptic feedback assistance ( <i>Slim Azzi, Gilles Reymond, Frederic Merienne, Andras Kemeny</i> ) .....	181
Driver performance assessment in driving simulators ( <i>Bart Kappe, Leo De Penning, Maarten Marsman</i> ) .....	191
<i>Driver trust and reliance on navigation systems: effect of graphical display</i> ( <i>Adrien Barthou, Andras Kemeny, Gilles Reymond, Frederic Merienne, Alain Berthoz</i> ) .....	199

### **Product solution & posters session**

Toward a standard: RoadXML, the road network database format ( <i>Julien Chaplier, Thomas Nguyen That, Marcus Hewatt, Gilles Gallee</i> ).....	211
The Development of a Low Cost Driver Licensing Simulator ( <i>R. Wade Allen, Woon San Joe, George D. Park, John K. Grant</i> ) .....	221
OpenDrive 2010 and beyond-Status and future of the de facto standard for the description of road networks ( <i>Marius Dupuis, Martin Strobl, Hans Grezlikowski</i> ) .....	231
Truck simulator an instrument for research and training ( <i>Gianfranco Fancello, Agostino Bruzzone, Maria Grazia Carta, Enrico Bocca, Alberto Tremori, Paolo Fadda</i> ) .....	243
Design of a Modern Image Generation Engine for Driving Simulation ( <i>Bob Kuehne, Sean Carmody</i> ).....	259



Approach to Improvement of Realistic Sensation on Universal Driving Simulator ( <i>Daisuke Yamaguchi, Yoshihiro Suda, Masahiko Aki, Masaaki Onuki, Osamu Shimoyama</i> ).....	267
Pro-SiVIC and Roads, a software suite for sensors simulation and virtual prototyping of adas ( <i>Nicolas Hilot, Dominic Gruyer, Jean-Sébastien Barreiro, Bertrand Monnier</i> ).....	277



# Introduction

## **Andras Kemeny**

Technical Center for Simulation, Renault  
Arts et Métiers ParisTech  
andras.kemeny@renault.com

I had the privilege to organize the first Driving Simulation Conference in Sophia Antipolis, close to Nice at the Côte d'Azur, in 1995, with the support of Renault and ISIA, the Institute Superior of Informatics and Automation. It was then already an international conference in the fields of driving simulation, for the community of research and training simulators, automotive and train applications, simulator architecture and human factor studies. The main idea was to bring together engineers and researchers, computer scientists and psychologists, physiologists and physicians, developers, managers, experimenters and even sales managers (though the latter were not authorized to present product papers at the conference).

As the conference worked fairly well, I had the chance to be able to continue in Lyon, in 1997 and afterwards in Paris, in 1999, 2000, 2002, 2004 and 2006 with the only exception of a 2001 edition, again organized in Nice with the support of Renault and ISIA. The others were organized with the support of Renault, the CNRS (the French National Scientific Research organization) and the College of France and from 2002 with the active support of INRETS (the French National Research organization for Traffic and road Safety Studies).

These were the glorious years, plenty of freedom and finance to carry out research and to build driving simulators, with people who were disinterested in traditional carrier making but attracted to a new area of research, gathered from almost everywhere, Europe, the United States, Japan and even Korea, China and Australia, at a time when the international economical exchange and technological and workforce transfer were not as common as they are today. Driving simulation was not yet a key area for the Industry but pleasantly tolerated with a vague feeling that some day it could be somehow useful.

Our success gave way to the birth of the DSC NA, the Driving Simulation Conference North America, in 2003 and DSC Pacific and Asia, in 2006. The organization of these conferences became a little complicated with lots of discussions about where and when these conferences had to be organized, until the recent economical crisis came and wiping out the already planned DSC NA conference. The DSC Scientific Committee, renamed as DSC Europe SC, since the births of DSC NA, has decided to continue and I had again the chance to organize the 2008 and 2009 editions in Monte Carlo, with the support of Renault and hosted by the Imagina conference organization.

These last two years were the difficult years, rated down as a second rate conference on the lower floors. The economical crisis was there and expectations both in *Industry* and *Public Research* were growing. Digital vehicle prototypes were planned to reduce the number and cost of physical prototypes, as well as enhance engineering design robustness. Road safety and large collaborative project goals were demanding immediate results, without providing adequate tooling and human resources. Nevertheless research of the last decades started to give some results and we have decided to come back to Paris with the renewed help of INRETS and co-organized with the active help of Arts et Métiers ParisTech.

I have now the chance again to have a historical classified buildings for our conference, this time that of Arts et Métiers, which is comparable to that of the College de France or the Ministry of Research of the glorious days of 2000, 2002, 2004 and 2006. We will have our Interactive 3D Vision Simulation Cocktail Party at the house of the Major of Paris, 13<sup>th</sup> arrondissement in the huge and beautiful *Salle des Fêtes* with a 3D demonstration similar to the Avatar 3D film projection, only with scientific goals and without Hollywood support.

So everything seems now to be again on trajectory with some major driving simulation papers and events. The previous years have seen the development of computer graphics developments, motion platform design, validation studies and industrial, human factors and training applications. You will find these trends again with new developments and new facts. Some of the latter concern the enlarging field of studies around the scale factors, trying to deal with the consequences that in a virtual environment the ideal scaling of the different perceptual modalities seem to differ that of the *Real World*, supposing that there is one.

Another new development concern open formats (OpenDrive and RoadXML) and open sources (OpenSD2S), showing that if the standard industrial driving simulation software packages are still rare on the market, though with enhanced maturation, there is a place for open sources. Those will hopefully allow post-docs and independent labs to access the driving simulation field without expensive and sophisticated tools and large financial support, before moving towards more traditional organizations and contribute to the simulation community with creative approaches and new results.

Last but not least, new developments are the new bookstore edition of the DSC Proceedings in the Editions of INRETS and the selection of the best papers for publication in the JCISE Special Issue in Driving Simulation. All these events make me believe that we enter a new era of glorious days of Driving Simulation Conferences which should continue at this new location in the coming years with enhanced paper and poster quality and a developing driving simulation community.

# **Keynote address**



# Visual control of driving and flying: Importance of optic flow rules, perceptual representation of 3-D space, and internal models of vehicle dynamics

**Jack M. Loomis**

University of California , Department of Psychology  
Santa Barbara CA USA 93106  
loomis@psych.ucsb.edu

**Abstract** – Basic research on the visual control of locomotion has focused on optic flow rules that connect specific features of the optic flow field (e.g., global radial outflow, tau, and splay rate) with specific actions (aiming, braking, and alignment with a path, respectively). There is growing recognition that, while optic flow rules are important, visual control of vehicles involves much more, including perceptual representation of 3-D space and internal models of vehicle dynamics. Here I briefly describe experiments on a variety of visually-controlled maneuvers performed with ground vehicles and aircraft, both real and simulated, showing the importance of optic flow, 3-D space perception, and internal models of vehicle dynamics.

## Introduction

Over the past half century, there have been many studies dealing with visually controlled locomotion. Some of this work has been fundamental research with the goal of understanding the visual control of locomotion, and some of the work has addressed applied issues relating to driving safety, flight safety, robotics, the development of autonomous vehicles, and the development of flight displays. Over this time, there have been two quite distinct conceptions of how vision is used to control locomotion. One approach, taken mainly by control theory specialists, has been to conceptualize the control of a vehicle relative to 3-D distal variables in the environment (position relative to roadway markers or altitude above the ground and their temporal derivatives) and to come up with formal control models that characterize the control inputs of the human pilot/driver (e.g., Dickmanns, 1992; Donges, 1978; McRuer *et al.*, 1977). The second approach, inspired by James Gibson during the 1950's (e.g., Gibson, 1958; Gibson *et al.*,

1955) and pursued mostly by perceptual psychologists, has focused on perspective information, especially 2-D optic flow, as the input to visually controlled locomotion. Gibson had the important insight that 2-D optic flow rather than visual information about 3-D layout is often a sufficient input for visually controlled locomotion. For example, the global radial outflow of the translational flow field specifies the instantaneous direction of motion (Gibson *et al.*, 1955), the optical variable tau specifies the time for the eye of an unaccelerated observer to arrive at the location of a surface (time-to-contact) (Lee, 1976), and optical splay rate of a straight line on the ground plane provides an efficient basis for turning into alignment with the line (Beall & Loomis, 1997; Calvert, 1954).

**Aiming and braking judgments and behavior** Much of the recent experimental literature on visually controlled locomotion in the last 25 years has focused on two pairs of tasks, largely inspired by ideas about optic flow developed by Gibson and his followers (e.g., Lee, 1976). Each pair consists of a psychophysical task of perceptual judgment and a corresponding active control task. The first pair involves the judgment of one's travel direction (aimpoint) and the control of aiming with respect to a point in the environment. The theoretical idea motivating this research is that global radial outflow specifies instantaneous direction of travel (aiming), which is two-dimensional in the general case of travel through air or water but often constrained to one dimension.

There are two obvious examples of one-dimensional aiming. The first is the pilot's control of the airplane's descent with respect to the intended touchdown point on the runway (where alignment with the runway has already been established). The second is lateral aiming of a vehicle or an observer's body toward a point on the ground plane; here the observer steers left or right. Active control of aiming has been studied relatively little (e.g., Rushton *et al.*, 1998; Warren *et al.*, 2001) while much more research has been devoted to psychophysical judgments of aiming under the rubric of "heading perception" (e.g., Crowell & Banks, 1993; Royden *et al.*, 1994; Macuga *et al.*, 2006; Warren & Hannon, 1990). These studies have employed discrete trial psychophysics in which a brief presentation of optic flow is presented to a passive observer, who then makes a judgment of the simulated travel direction with respect to a target. While aiming is a very specific task, the perception of heading and more generally the perception of 2-D travel direction, may be of broader significance, for they may be involved in the control of other spatial tasks such as steering a curving path and control of altitude during terrain following.

The other pair of tasks involves the perception of "time-to-contact" and the active control of braking; these tasks have been largely motivated by Lee's theoretical analysis of braking in terms of tau (Lee, 1976). A number of have been done on the active control of braking (e.g., Fajen, 2005, 2006, 2007; Yilmaz & Warren, 1995) and provide support for the idea that the optic flow can be used to regulate braking. Associated perception studies have used discrete trial psychophysics, in which subjects make judgments relating to time-to-contact (e.g., Kaiser & Mowafy, 1993; Tresilian, 1991).

Given the wide variety of spatial behaviors that make up visually controlled locomotion, it may seem odd that so many studies of the past two decades have focused on these four tasks. Because aiming judgments deal with direction and



braking and time-to-contact judgments deal with the approach to a surface, it is plausible that other forms of controlling locomotion with respect to surfaces might be reducible to a succession of aiming and time-to-contact judgments. An example is the analysis of Loomis and Beall (1998) of how a pilot of an aircraft might judge whether the aircraft is going to pass clear of the ground during a pull-up maneuver following a dive; they suggest that if a succession of aiming judgments indicates that the aim point of the aircraft on the flat ground surface is accelerating toward the horizon, the pilot can correctly conclude that the aircraft will pass clear. (This will be discussed in more detail at the DSC 2010 meeting.) Generally, however, most researchers interested in other forms of visually controlled locomotion, such as steering a curving path or terrain following, have not attempted to analyze these behaviors in terms of aiming and braking judgments. Thus, the substantial amount of research devoted to aiming (including heading) and braking seems to have not taken us very far in understanding visually controlled locomotion more generally.

**Analysis of a broader range of maneuvers** Adopting this view, Loomis and Beall (1998) argued that there are a number of important visually-based maneuvers that require their own specific analyses in terms of stimulus support and perceptual process. For example, in other work these authors showed that when steering a straight path in the presence of lateral perturbing forces when the path is defined solely by continuous lane markers and no other visual information is present, steering cannot be understood in terms of heading perception because information about heading is unavailable, inasmuch as there is no information about the velocity component parallel to the path (Beall & Loomis, 1996). In this case, they showed that splay rate of the lane markers was the primary stimulus variable used for steering. Other behaviors not likely to be understood solely in terms of the perception of heading and time-to-contact are steering a car along a curving path (Donges, 1978; Godthelp, 1986; Kelly *et al.*, Land & Horwood, 1995; Land and Lee, 1994; Salvucci & Gray, 2004), turning into alignment with a straight path (Beall, 1998; Beall & Loomis, 1997), and terrain following by an aircraft (Zacharias *et al.*, 1985). These three behaviors will be discussed in some detail at the DSC 2010 meeting.

**3-D space perception and stored representations of the environment** Although the treatment so far has focused on optic flow, it is a mistake to assume that optical variables are the primary basis for all cases of visually controlled locomotion. As mentioned above, the classical control theory approach assumed that the controlling stimuli were distal entities in 3-D space, such as lateral position in a road, distance to a lane marker, and distance and direction of an obstacle to be avoided. Although much of the modern experimental literature shows the importance of optic array and optic flow variables, especially in connection with aiming and braking, the strong possibility remains that 3-D space perception is involved in many other behaviors, especially in their near term planning. Perhaps the best indication of this comes from research on open-loop behavior. In tasks involving open-loop behavior, the actor views a target from a fixed vantage point, and then attempts to carry out some locomotor response in relation to the target without receiving further perceptual information about its location. The simplest response is blind walking to the target location (e.g., Loomis *et al.*, 1992). A more complex response is to view a target and, then with

eyes closed, walk along an indirect path to the target (e.g., Philbeck *et al.*, 1997). On average, subjects walk to nearly the same location when proceeding along the different paths, indicating accurate perception of self motion. While it is true that optic flow is available when vision is continuous, the possibility remains that such 3-D representations are involved in the planning and regulation of spatial maneuvers both when vision is intermittent and when it is continuous (Loomis & Beall, 2004). In studies of car steering, for example, Godthelp (1985, 1986) and Hildreth *et al.* (2000) found little impact of short occlusions (up to 1.5 sec) on driving performance. More recently, a study by Macuga *et al.* (submitted) showed that drivers were to follow several segments of a simulated road during visual occlusion following a brief visual preview, indicating that they were using an internal representation of the path ahead to continue execution in the absence of vision. In this case, optic flow, when it is available, might then be seen as "fine tuning" the regulation of a maneuver.

**Internal representation of plant dynamics** Even optic flow rules and 3-D perceptual representations together are insufficient to explain the control of locomotion, for at least one important cognitive representation is also implicated--that of the plant dynamics (Loomis & Beall, 1998, 2004). When we move under our own power or within a vehicle, our locomotion is constrained by the plant dynamics of our body or vehicle; these determine how inputs (to the musculature or to the vehicle controls) result in the subsequent motions of the body or vehicle. A model of the plant dynamics of a vehicle, for example, can be used to predict the linear and rotary accelerations, thence the linear and rotary velocities, and thence the position and orientation of the vehicle in the absence of external perturbations; such perturbations cause position and orientation to diverge from the model predictions. The flight director/autopilot of a modern airliner contains a model of the aircraft dynamics and uses this to predict the near-term consequences of control inputs (in the absence of perturbations). Similarly, a skilled operator who is familiar with the vehicle he/she is controlling has internalized the dynamics of the vehicle well enough to be able to predict its short-term behavior. In driving, this means being able to gauge a comfortable stopping distance, how well the car can take a curve, and the distance needed to pass a car on a two-lane road as well as being to continue to steer the car during temporary visual occlusion. In the piloting of fixed-wing aircraft, this means being able to gauge how sharply a plane can be turned into alignment with the runway, whether the plane will be able to clear a mountain ridge up ahead, etc. One sign of a unskilled operator of a complex vehicle is overcontrolling--using inappropriately large control inputs with moderate to high intermittency. At the other extreme, a highly skilled operator can accomplish the desired maneuvering with a minimum of control inputs. Especially in airplanes, for example, where change of heading is the second integral of control yoke input, a small yoke input can result in very large heading changes over time. Thus, a highly skilled pilot can align an airplane with the runway with minimal yoke inputs provided that they are made at just the right time. It is to be expected that those pilots who have minimal root-mean-squared values of their control inputs during some specific maneuver, such as the landing approach, are those with the best internal model of the aircraft dynamics.

In connection with driving, model-based feedforward control has been the focus of some recent research. Fajen (2007, 2008) found evidence that drivers take into account the maximum braking capability of the simulated vehicle in how they allocate inputs to the braking system over the course of a deceleration and that they learn to adjust their braking inputs in response to changes in the braking system dynamics. As for steering, a number of recent studies have addressed the question of whether people develop internal models of the steering dynamics of a car. As mentioned above, the study by Macuga *et al.* (submitted) demonstrates that drivers can continue to steer a vehicle over several path segments without sensory feedback following a brief period of preview; however, steering performance rapidly accumulated error, indicating that the internal model of steering dynamics was quite noisy. Wallis *et al.* (2002) observed a dramatic failure of open-loop steering -- after observing a simulated two lane road ahead, drivers had their vision occluded and then attempted to sidestep the vehicle into the adjacent lane. Drivers steered the simulated vehicle (without a motion base) toward the adjacent lane but showed no evidence of the opposite turn needed to realign with the lane. This dramatic failure to realign is evidence that drivers have a poor internal model of steering dynamics. Macuga *et al.* (2007) challenged this conclusion somewhat by showing that drivers could do imprecise open loop steering of a three-segment path approximating a lane change or could perform a lane change maneuver when provided with inertial input while driving an electric scooter. Still more recent work by Cloete and Wallis (2009), however, showed that drivers, when attempting to perform a obstacle avoidance maneuver requiring a triphasic steering response, instead produced a biphasic steering response which failed to realign the vehicle with the path. Taken together, the results of the reported research indicates that drivers do not have good internal models of the steering dynamics of a car.

**Keywords:** driving, flying, visual control of locomotion, aiming, braking, steering, heading, optic flow, tau, splay rate, visual space perception, internal models, plant dynamics, vehicle dynamics

## Bibliography

- Beall, A. C. (1998). Visual control of the base-to-final turn in fixed wing aircraft. Unpublished doctoral dissertation, Department of Psychology, University of California, Santa Barbara.
- Beall, A. C. & Loomis, J. M. (1996). Visual control of steering without course information. *Perception*, 25, 481-494.
- Beall, A. C. & Loomis, J. M. (1997). Optic flow and visual analysis of the base-to-final turn. *The International Journal of Aviation Psychology*, 7, 201-223.
- Calvert, E. S. (1954). Visual judgments in motion. *Journal of the Institute of Navigation*, 7, 233-251.
- Cloete, S. R. & Wallis, G. (2009). Limitations of feedforward control in multiple-phase steering movements. *Experimental Brain Research*, 195, 481-487.

- Crowell, J. A. & Banks, M. S. (1993). Perceiving heading with different retinal regions and types of optic flow. *Perception & Psychophysics*, 53, 325-337.
- Dickmanns, E. D. (1992). A general dynamic vision architecture for UGV and UAV. *Journal of Applied Intelligence*, 2, 251-270.
- Donges, E. (1978). A two-level model of driver steering behavior. *Human Factors*, 20, 691-707.
- Fajen, B. R. (2005). Calibration, information, and control strategies for braking to avoid a collision. *Journal of Experimental Psychology: Human Perception and Performance*, 31, 480-501.
- Fajen, B. R. (2007). Rapid recalibration based on optic flow in visually guided action. *Experimental Brain Research*, 183, 61-74.
- Fajen, B. R. (2008). Perceptual learning and the visual control of braking. *Perception & Psychophysics*, 70, 1131-1138
- Gibson, J. J. (1958). Visually controlled locomotion and visual orientation in animals. *British Journal of Psychology*, 49, 182-194.
- Gibson, J. J., Olum, P., & Rosenblatt, F. (1955). Parallax and perspective during aircraft landings. *American Journal of Psychology*, 68, 372-385.
- Godthelp, J. (1985). Precognitive control: Open- and closed-loop steering in a lane-change manoeuvre. *Ergonomics*, 28, 1419-1438
- Godthelp, H. (1986). Vehicle control during curve driving. *Human Factors*, 28, 211-221.
- Hildreth, E. C., Beusmans, J. M. H., Boer, E. R., & Royden, C. S. (2000). From vision to action: Experiments and models of steering control during driving. *Journal of Experimental Psychology: Human Perception & Performance*, 26, 1106-1132.
- Kaiser, M. K., Mowafy, L. (1993). Optical specification of time-to-passage: Observers' sensitivity to global tau. *Journal of Experimental Psychology: Human Perception & Performance*, 19, 1028-1040.
- Kelly, J. W., Beall, A. C., Loomis, J. M., Smith, R. S., & Macuga, K.L. (2006). Simultaneous measurement of steering performance and perceived heading on a curving path. *ACM Transactions on Applied Perception*, 3, 83-94.
- Land, M. & Horwood, J. (1995). Which parts of the road guide steering. *Nature*, 377, 339-340.
- Land, M. F. & Lee, D. N. (1994). Where we look when we steer. *Nature*, 369, 742-744.
- Lee, D. N. (1976). A theory of visual control of braking based on information about time-to-collision. *Perception*, 5, 437-459.

- Loomis, J. M. & Beall, A. C. (1998). Visually-controlled locomotion: Its dependence on optic flow, 3-D space perception, and cognition. *Ecological Psychology*, 10, 271-285.
- Loomis, J. M. & Beall, A. C. (2004). Model-based control of perception/action. In L. Vaina, S. Beardsley, and S. Rushton (Eds.). *Optic Flow and Beyond* (pp. 421-441). Boston: Kluwer Academic Publishers.
- Loomis, J. M., Da Silva, J.A., Fujita, N., & Fukusima, S. S. (1992) Visual space perception and visually directed action. *Journal of Experimental Psychology: Human Perception and Performance*, 18, 906-921.
- Macuga, K.L, Beall, A.C., Smith,R.S., & Loomis, J. M. (in preparation). Visual control of steering along a curving path.
- Macuga, K. L., Beall, A. C., Kelly, J. W., Smith, R. S., & Loomis, J. M. (2007). Changing lanes: Inertial information facilitates steering performance when visual feedback is removed. *Experimental Brain Research*, 178, 141-150.
- Macuga, K. L., Loomis, J. M., Beall, A. C., & Kelly, J. W. (2006). Perception of heading without retinal optic flow. *Perception & Psychophysics*, 68, 872-878.
- McRuer, D. T., Allan, R. W., Weir, D. H., & Klein, R. H. (1977). New results in driver steering control models. *Human Factors*, 19, 381-397.
- Philbeck, J. W., Loomis, J. M., & Beall, A. C. (1997). Visually perceived location is an invariant in the control of action. *Perception & Psychophysics*, 59, 601-612.
- Royden, C. S., Crowell, J. A., & Banks, M. S. (1994). Estimating heading during eye movements. *Vision Research*, 34, 3179-3214.
- Rushton, S. K., Harris, J. M., Lloyd, M. R. & Wann, J. P. (1998). Guidance locomotion on foot uses perceived target location rather than optic flow. *Current Biology*, 21, 1191-1194.
- Salvucci, D. D., & Gray, R. (2004). A two-point visual control model of steering. *Perception*, 33, 1233-1248.
- Tresilian, J. R. (1991). Empirical and theoretical issues in the perception of time to contact. *Journal of Experimental Psychology: Human Perception and Performance*, 17, 865-871.
- Wallis, G., Chatziastros, A., & Bülhoff, H. (2002). An unexpected role for visual feedback in vehicle steering control. *Current Biology*, 12, 295-299.
- Warren, W. H. & Hannon, D. J. (1990). Eye movements and optical flow. *Journal of the Optical Society of America A*, 7, 160-169.
- Warren, W. H., Kay, B. A., Zosh, W. D., Duchon, A. P., & Sahuc, S. (2001). Optic flow is used to control human walking. *Nature Neuroscience*, 4, 213-216.

- Yilmaz, E. H. & Warren, W. H. (1995). Visual control of braking: a test of the tau-dot hypothesis. *Journal of Experimental Psychology: Human Perception and Performance*, 21, 996-1014.
- Zacharias, G. L., Caglayan, A. K., & Sinacori, J. B. (1985). A visual cueing model for terrain-following applications. *Journal of Guidance*, 8, 201-207.

# **Perception and human factors**





# Simulating the Effect of Low Lying Sun and Worn Windscreens in a Driving Simulator

**Anne Bolling, Gunilla Sörensen, Jonas Jansson**

Swedish Road and Transport Research Institute,

S581 95 Linköping, Sweden

anne.bolling@vti.se, gunilla.sorensen@vti.se, jonas.jansson@vti.se

**Abstract** - *In the VTI Simulator III a method to create dazzle was tested and driver behaviour during dazzling was observed. Three windscreens with different degree of wear were used. In order to simulate a low lying sun in the driving simulator a halogen lamp was mounted in front of the windscreen. There were 24 subjects that all drove with each of the three windscreens. The drivers passed two obstacles during each drive. Afterwards they were asked to express their opinion about the experiment. They assessed both the simulated environment, including the simulated sun, and the driving task as realistic. Speed, braking power, steering-wheel angle, lateral position, and sight length were measured. The results showed a reduction in sight length when driving with worn windscreens. When the drivers had to make way for an obstacle on the road they discovered the obstacles later, used a harder braking power and took a more powerful action to avoid the obstacle, despite the fact that the average speed decreased significantly. Only when driving with the new windscreen all drivers managed to avoid collisions when passing the obstacles. The results indicate that driver behaviour and safety margins are severely affected by worn windscreens. The halogen lamp used in this study proved to be sufficient enough to simulate a low lying sun, thereby creating a sense of dazzling.*

**Résumé** - *L'objectif de l'étude présente est de tester une nouvelle méthode pour créer un éblouissement dans un simulateur de conduite. Le comportement du conducteur au cours de l'éblouissement a été observé dans le simulateur de conduite III du VTI. Trois pare-brises avec différents degrés d'usure ont été utilisés. Afin de simuler un soleil de faible altitude dans le simulateur de conduite, une lampe halogène a été montée à l'avant du pare-brise. Au total, 24 sujets ont participé à cette expérience et ils ont tous conduit avec trois pare-brises différents. Les sujets ont subi deux obstacles au cours de chaque conduite. Après la conduite, ils ont été invités à exprimer leur opinion sur l'expérience. Ils ont évalué à la fois l'environnement simulé, y compris la simulation du soleil et si la tâche de conduite était réaliste. Les variables dépendantes mesurées sont les suivantes : vitesse, puissance de freinage, angle du volant, position latérale du*

*véhicule et la longueur de vue. Les résultats montrent une réduction de la durée de vue lors de la conduite avec le pare-brise très usés. Lorsque les sujets ont évité un obstacle placé sur la route, ils ont découvert les obstacles plus tard, ils ont utilisé une puissance de freinage plus grande et ont effectué une action plus efficace pour éviter l'obstacle en dépit du fait que la vitesse moyenne a diminué d'une manière significative. Aucune collision ne fut observée lors de la conduite avec le nouveau pare-brise. Les résultats indiquent que le comportement des conducteurs et des marges de sécurité sont largement influencés par l'état des pare-brises. La lampe halogène utilisée dans cette expérience c'est avérée suffisante pour simuler un soleil de faible altitude.*

## **Introduction**

Visual information is one of the most important factors influencing driving performance. The driver's vision can deteriorate due to dazzling. This may occur because of low lying sun. During the dark hours dazzling is most often caused by oncoming vehicles. Dirty and worn windscreens may cause more light to be refracted into the drivers' eyes, thereby increasing the problem of glaring and impairment of the driver's visibility. In Mace *et al.* (2001) an overview with particular emphasis on headlight glare is given. The traffic safety problems of dazzling and worn windscreens have been observed in several studies (Pronk *et al.*, 2001). Field studies by Lundkvist and Helmers (1993) showed that the sight distance decreases with the degree of windscreen wear. The test subjects drove in the dark and were dazzled by oncoming vehicles. Studies where glare is simulated in a driving simulator are relatively sparse. In Fullerton and Peli (2009) a method is described for creating a moving (oncoming vehicle) dazzling light source, using a LED matrix and a beam splitter. Moreover, in Rompe and Engel (1984) a study was conducted with different windscreens, in order to measure detection rate of projected symbols, while being dazzled.

The study presented in this paper is, as far as the authors know, one of the first to measure dazzled drivers' behaviour in critical situations and with different degree of windscreen wear. The aim of this study was both to create dazzle in the simulator and to perform an experiment on driver behaviour, in order to evaluate the possibilities to study the effect of dazzling when driving with worn windscreens.

## **Methods**

In this study VTI's driving simulator III was used (Figure 1). This simulator is equipped with a passenger car cabin and an advanced motion system for realistic simulation of forces felt when driving (Nordmark *et al.*, 2004; VTI, 26.03.2010). The surroundings of the driver are shown on a main screen with 120 degrees field of view, as well as in three back mirrors. A vibration table, which simulates road irregularities, is situated under the cabin and provides vibration movement relative

to the projection screen. The motion system also provides high performance linear lateral acceleration, as well as roll and pitch movements of the entire platform.



**Figure 1. VTI Simulator III**

## **Experimental setup**

In order to evaluate the effect of dazzling a within-subjects experimental design was used with a 3x2 setup (three windscreens and two critical events) and 24 test subjects. Only drivers that normally did not use lenses or glasses during driving were chosen. They were between 23 and 64 years old. Both men and women participated. Three windscreens were used; one new (windscreen 0); one worn, driven 150 000 kilometres (windscreen 15), and one very worn, driven 350 000 kilometres (windscreen 35).

In order to assess how worn the windscreens were, SLI (Stray Light Index, defined in German standard DIN 52298) was measured. Two instruments (DMO/Iris) were used. Each instrument gave considerable variations for each windscreen but repeated measurements, nevertheless, showed differences in the SLI values between the three windscreens. Windscreen 0 had a SLI value of approximately 0.05, windscreen 15 approximately 0.8 and windscreen 35 larger than 1.0.

Each driver drove with all three windscreens. They were instructed to drive as they would normally do under similar conditions. Between each drive the windscreen was replaced according to an experimental scheme with a balanced order. All windscreens were thoroughly cleaned in order to measure only the effect of the wear of the windscreen.

A road section of approximately 10 kilometres was created in the simulator. Two obstacles were placed by the roadside. One was a passenger car and the other an excavator. Both obstacles required an evasive manoeuvre. There were also some oncoming vehicles which occurred in predetermined places. The drivers had to pass each obstacle once during each drive. The distance between the two obstacles was 5 kilometres. In order to reduce the risk of the test subjects learning where the obstacles were placed, the starting point differed between the three drives. This resulted in different order of the obstacles and the distance to the first obstacle encountered.

Each drive was concluded with a measurement of the sight length. This was carried out on a completely straight road without other traffic. The test subjects were instructed to drive at 40 km/h and press a response meter button as soon as they discovered an orange cone placed on the hard shoulder.

Between each drive the driver answered survey questions.

## **Effect measurements**

The drivers' subjective experience of driving in the simulator with the different windscreens was collected using questionnaires.

The behavioural data which has been collected in this study refers, above all, to speed, braking, movements of the steering wheel, position on the road and sight length. Average speed was calculated for two stretches, one before each obstacle. This gave the common basic level of speed.

All data were analyzed using T tests. A significance level of 5 percents has consistently been used. Detailed information about data can be found in Bolling and Sørensen (2009).

## **Results**

In order to achieve dazzling from a low lying sun in the driving simulator, a lamp was mounted in front of the windscreen. The angle chosen between the horizon and the lamp was approximately 13 degrees. The glare shields were lowered during the experiment in order to prevent direct dazzling from the lamp. Figure 2 shows dazzling in the simulator from the driver's perspective. Figure 3 shows the halogen lamp throwing a shadow and casting a reflection on the projection screen. The distance between the lamp and the driver was 2.8 metres and the lamp was positioned 0.65 metres to the right of the middle of the driver's field of vision.



**Figure 2. Driver's perspective of dazzling in the simulator.**  
Photo: VTI



**Figure 3. The lamp with shadow and reflection on the screen.** Photo: VTI

The light intensity from the lamp was adjusted before the experiment in such a way that the contrast was perceived realistic. This was mainly done by subjective ratings from VTI researchers. Measurements of illuminance in the simulator, with and without the halogen lamp Halospot 50W 24°, and with the use of windscreen 0, gave the results shown in Table 1a and 1b.

**Table 1a. Illuminance [lx] in the simulator, lamp on, windscreen 0**

Position	Illuminance [lx] lamp on
On the windscreen, outside the cabin in front of the driver's face	260
Driver's eyes, glare shield down	4.4

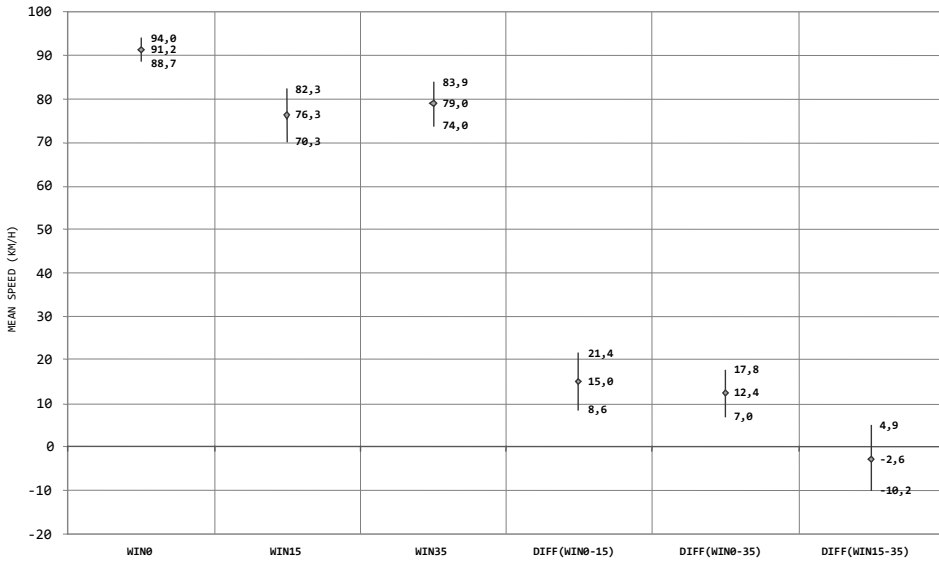
**Table 1b. Illuminance [lx] in the simulator, lamp off, windscreen 0**

Position	Illuminance [lx] lamp off
Driver's eyes, glare shield up, only projector light	2
Light green grass on the projection screen	18
Dark green trees on the projection screen	10
Different road surfaces on the projection screen	16–23
Blue sky on the projection screen – good weather, daylight	60
White clouds on the projection screen – good weather, daylight	90

As can be seen in the two tables the illuminance close to the driver's eyes was 2.0 lx without lamp and glare shield, but 4.4 lx with lamp on and glare shield down. Thus, using a simple fixed halogen lamp an effect of low lying sun was achieved in the driving simulator. Hence, the possibilities to study dazzling and the impact of windscreen wear were given.

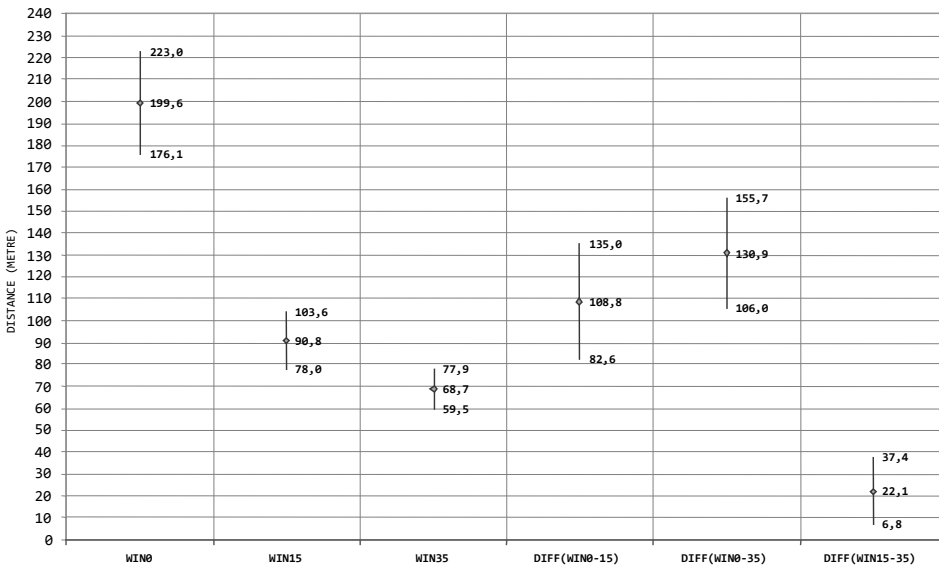
The results of the experiments show that the effect of dazzling varied depending on the degree of windscreen wear. Several driver behavioural variables supported this conclusion. The driving performance deteriorated with the two worn windscreens, compared with the new one. However, the results did not seem to follow a linear function, since the driving performance was rather similar with the two worn windscreens, but differed from the new windscreen, see Figure 4.

For example, the drivers reduced their basic level of speed by 7–21 km/h with worn windscreens. When the driver had to make way for an obstacle on the road, this was more difficult with a worn windscreen, despite the lower speed. When driving with windscreen 35, the drivers on average discovered the excavator 60 ± 37 metres later, started to brake 139 ± 50 metres later, and then used a somewhat harder braking power. They also took a more powerful action to avoid the obstacle. When passing the excavator, the average distance to this obstacle was 1.6 metres with the new windscreen and 0.9 metres with windscreen 35. None of the obstacle passes while driving with the new windscreen led to any collision, whereas two obstacle collisions occurred with windscreen 15 and four with windscreen 35. .



**Figure 4. Average speed and difference in average speed before obstacle B (the excavator) for windscreen 0, 15 and 35, and confidence interval for the average speed and differences**

The sight length to a cone was also measured and was shorter with a worn windscreen (Fig. 5).



**Figure 5. Average values for the distance to the orange cone with windscreen 0, 15 and 35, respectively, and differences in the average value between the windscreens (including the confidence interval for the average values and the differences)**

The average sight length with windscreen 0 was approximately 200 metres when dazzled, whereas the corresponding values with windscreen 15 and 35 were 91 and 69 metres, respectively. The difference in sight length between windscreen 0 and windscreen 35 was on average  $131 \pm 22$  metres, implying a reduction in sight length of approximately 65 percent.

The drivers were asked to grade the level of wear and safety of the windscreens on a 7 grade scale. Mean values and confidence intervals are shown in Table 2. The table shows that windscreen 0 was evaluated to be significantly less worn and significantly safer than the two other windscreens.

**Table 2. Graded level of windscreen wear (1 = not worn, 7 = very worn) and safety (1 = very unsafe, 7 = very safe). Mean value and confidence interval,  $n = 24$**

	Graded level		
	Mean value and confidence interval		
	Windscreen 0	Windscreen 15	Windscreen 35
Wear	$3.5 \pm 0.6$	$6.2 \pm 0.5$	$6.7 \pm 0.2$
Safety	$4.6 \pm 0.7$	$1.4 \pm 0.3$	$1.2 \pm 0.2$

After the last simulator drive, the test subjects had to grade how realistic they experienced the simulator environment to be, on the scale from 1 = very unrealistic to 7 = very realistic. The average grades and the dispersion are presented in Table 3. The results indicate that the test subjects experienced the environment and driving in the simulator as realistic, including the new feature of the artificial sun.

**Table 3. Experienced level of realism. Mean values and confidence interval (on a 7-grade scale from 1 = very unrealistic to 7 = very realistic),  $n = 24$**

	Level of realism
	Mean value and conf. interval
Road environment	$5.6 \pm 0.5$
Artificial sun light	$5.6 \pm 0.5$
Steering function	$6.0 \pm 0.4$
Braking function	$4.9 \pm 0.6$
Driving task	$6.2 \pm 0.3$
Road manners	$5.8 \pm 0.4$

## Discussion

This study has shown that dazzle in a driving simulator can be achieved by directing a lamp towards the windscreen, simulating a low lying sun. The test subjects assessed this artificial sunlight as realistic. Furthermore, the results from the experiment show that when dazzled, driver behaviour deteriorates because of

worn windscreens. This indicates that driving under such difficult conditions entails an increased risk of accidents.

In simulator studies the experimental situation can be experienced as unrealistic and thereby affect driver behaviour in an unwanted way. The test subjects, however, expressed the opinion that the environment and the task was realistic and that the new windscreen was significantly less worn and significantly safer than the two other windscreens. Nevertheless, it should be kept in mind that the measured driver behaviour in a driving simulator not necessarily transfers directly to driving in real traffic environment. Even though the drivers were instructed to drive as they would normally do, they might on one hand have been influenced by the fact that they were being observed while driving, but on the other hand they may also have been influenced by knowing that they were not driving in real traffic.

A within-subjects design was selected because of the expected considerable variation between test subjects. For instance, scanning ability, eye sight and reaction time may vary with age (for an overview see e.g. Levin *et al*, 2009). It could therefore be of interest in connection with a future study to analyze the significance of the age or eyesight of the driver. This experiment included only drivers that did not use glasses or lenses while driving. Hence, on the basis of this study any effect of glasses or lenses on dazzling and driver behaviour can not be commented on.

As the results from the three tested windscreens did not seem to follow a linear function, it would be desirable to conduct corresponding tests also with windscreens driven, for example, 50,000 and 100,000 kilometres, respectively.

In this experiment dazzling of a low lying sun was simulated. Although the artificial sun was fixed in front of the windscreen and the level of luminous intensity was constant, the results indicate that this set-up is satisfactory for this purpose. It would, however, be of interest to further investigate the possibilities of using moving light sources with adjustable brightness. It would furthermore be interesting to study the effect of the eye's adaptation when exposed to sudden glare.

The problems with worn windscreens and dazzle also arise in other situations than in sun light, for example out of the headlight glare from oncoming vehicles during dark hours. It would be of interest to compare the method used in this study with the method proposed by Fullerton and Peli (2009).

Finally, it would be desirable to validate the different simulator methods, using data from real traffic.

## **Conclusions**

The halogen lamp, Halospot 50W 24°, used in this study proved to be sufficient enough to simulate a low lying sun. The test subjects assessed this artificial sunlight as realistic, despite the fact that this lamp was fixed in front of the windscreen and that the lamp light intensity did not vary. However, the light intensity from the lamp must be chosen with care to match the projected images to achieve a realistic impression.



Even if the present study was performed in a simulator environment, instead of in real traffic, the results indicate that driving in dazzling light with a worn windscreen has negative effects on driver behaviour and safety margins. The problem might be even greater in real traffic, since there are other factors, such as dirt and moisture that cause reduced visibility and increases the level of dazzle.

**Keyword:** driver behaviour, driving simulator, windscreen wear, windshield, worn, glare, stray-light, dazzling, sunlight, sight length, speed, scattered light, driver's vision, questionnaire

## **Bibliography**

- Bolling, A., Sörensen, G. (2009) Worn Windscreens. *Swedish National Road and Transport Research Institute (VTI) VTI Rapport 657A, Linköping, Sweden.*
- Fullerton, M., Peli, E., (2009) Development of a system to study the impact of headlight glare in a driving simulator. *Proceedings of the 5th International Driving Symposium on Human Factors in Driver Assessment, Training and Vehicle Design, Montana, USA, 412-418.*
- Levin, L Dukic, T., Henriksson, P., Mårdh, S., Sagberg, F. (2009). Older car drivers in Norway and Sweden – studies of accident involvement, visual search behaviour, attention and hazard perception. *Swedish National Road and Transport Institute. Rapport 656A, Linköping, Sweden.*
- Lundkvist, S.-O., Helters, G., (1993) Sight length to obstacles. (Siktsträcka till hinder vid nedsatt syn och/eller sliten vindruta). *Swedish National Road and Transport Institute. VTI rapport 382, Linköping, Sweden.*
- Mace, D., Garvey, P., Porter, R., Schwab, R., Adrian, W., (2001) Countermeasures for Reducing the Effects of Headlight Glare. *The AAA Foundation for Traffic Safety 1440 New York Avenue, N.W. Washington, D.C.*
- Nordmark, S., Jansson, H., Palmkvist, G., Sehammer, H., (2004) The new VTI Driving Simulator – Multi Purpose Moving Base with High Performance Linear Motion. *In Proceedings of the Driving Simulator Conference 2004 Paris, 45-55.*
- Pronk, N., Fildes, B., Regan, M., Lenné, M., Truedsson, N., Olsson, T., (2001) Windscreens and Safety: A Review. *Report No. 183. Monash University Accident Research Centre.*
- Rompe, K., Engel, G., (1984) Influence of scattered light in windshields on driver's vision during nightdriving. *Society of Automotive Engineers. SAE technical paper 84 03 85, Warrendale, PA.*
- VTI (2010-03-26). *VTI's drivning simulators.* Internet 13:09 2010-03-26 <http://www.vti.se/simulator>



# Flexibility of the cognitive system to use various spatial coding: Implication for driving situation

**Eve Dupierrix, Alain Berthoz**

Laboratoire de Physiologie de la Perception et de l'Action (LPPA),  
CNRS UMR 7152, Collège de France,  
11 place Marcellin Berthelot, 75231 Paris cedex 05  
eve.dupierrix@college-de-France.fr, alain.berthoz@college-de-france.fr

**Abstract** – *Driving is a spatial behaviour that requires fast and accurate spatial coding in order to anticipate and respond appropriately to expected or stunner event. Convergent evidences from animal and human studies support that different reference frames can be used to code our surrounding environment. Although recent works argued in favor of the parallel encoding of space in both egocentric and allocentric coordinates and showed that humans enable to alternate between both these spatial knowledge, the flexibility of the cognitive system to switch between each other remains largely undocumented. The current study aimed to address this issue by investigating, among twenty eight healthy participants, the temporal cost linked to switch from one reference frame to another in memory. Experimental procedure consisted in two stages: (1) a first navigation phase in a virtual town during which participants had to learn the localization of several closed places that we generally encounter in a conventional city (e.g., shops, post office) and, (2) a spatial memory test involving egocentric or allocentric spatial knowledge about these closed places. The methodology of this memory test allowed to estimate the temporal cost needed to switch between egocentric and allocentric knowledge by comparing response times in two conditions: a 'repeat' condition in which the trials involve the same reference frame in memory as the previous trials with an 'alternate' condition in which the trials rely on different spatial memory as the previous trials. As expected, results showed that participants were faster on 'repeat' trials than on 'alternate' trials, revealing a strong temporal switch cost of 585 milliseconds ( $\pm 144.75$ ). This limited flexibility of the cognitive system to switch between various spatial coding in memory could cause some insecurity problems in driving situation that requires very low reaction times.*

**Résumé** - *La conduite automobile nécessite un codage spatial précis et rapide en vue d'anticiper et répondre aux divers événements pouvant survenir. De nombreux résultats issus des travaux chez l'homme et l'animal défendent l'idée selon laquelle différents cadres de référence peuvent être utilisés pour coder*

*l'environnement qui nous entoure. Bien que ces études récentes ont argumenté en faveur de l'encodage simultané de l'espace en coordonnées égocentriques et allocentriques et ont montré que l'homme était capable d'alterner entre ces deux types de connaissances spatiales, la flexibilité du système cognitif pour passer de l'une à l'autre reste peu documentée. Notre étude vise à aborder cette question en examinant parmi vingt huit adultes sains le coût temporel lié au changement de référentiels spatiaux en mémoire. La procédure expérimentale prévoyait deux sessions : (1) une première phase de navigation dans une ville virtuelle au cours de laquelle les participants devaient apprendre la localisation de lieux citadins (e.g., des magasins, la poste) et, (2) un test de mémoire spatial impliquant des connaissances spatiales égocentrées et allocentrées de ces différents lieux. La méthodologie de ce test a permis d'estimer la latence temporelle de changement de référentiel en comparant les temps de réponse dans deux conditions: une condition de répétition dans laquelle les essais impliquaient le même type de référentiel spatial que l'essai précédent avec une condition d'alternance dans laquelle les essais impliquaient un référentiel différent de celui mobilisé par l'essai précédent. Comme attendu, les résultats ont montré des temps de réponse plus rapide pour les essais de répétition par rapport aux essais d'alternance, révélant une latence temporelle importante de changement de référentiel d'environ 585 millisecondes ( $\pm 144.75$ ). Cette flexibilité limitée du système cognitif à changer de codage spatial en mémoire pourrait causer quelques problèmes d'insécurité dans les situations de conduite automobile qui nécessitent des temps de réponse très courts.*

## Introduction

Perceiving our surrounding environment in a rapid manner is essential for driving behaviour that requires low reaction times. Understanding the flexibility of the cognitive system in navigational dynamic situation is thus a crucial issue in this precise context. It is now well establish that different forms of spatial coding and reference frames can be used to code spatial information about our navigational environment (Avraamides & Kelly, 2008; Berthoz, 1991; Trullier, Wiener, Berthoz, & Meyer, 1997). Recent evidences assume that these spatial coding co-exist in memory, suggesting that they may be combined and used simultaneously or sequentially to support spatial behaviour (see Burgess, 2006 for review). Investigating the cognitive flexibility particularly involved in using reference frames could thus have major implications in driving and navigation situations especially when very fast responses are needed.

As evidenced by studies showing that knowledge dependant upon specific viewpoint is maintained in memory (Diwadkar & McNamara, 1997; Schmidt *et al.*, 2007), space can be referenced to the body in an 'egocentric' reference frame. Convergent evidence including the discovery of neurons coding our absolute location in space (Ekstrom *et al.*, 2003; O'Keefe & Dostrovsky, 1971) have demonstrated that spatial information can also be coded by the brain independently of our body's position or orientation, in 'allocentric' coordinates. In expended and complex environment, flexible guidance of behaviour would be

supported by this latter allocentric high-level cognitive comprehension of environment that is supposed to rest upon a 'cognitive map' (Etienne & Jeffery, 2004; O'Keefe & Nadel, 1978).

Although human adults show some general preferences to use a particular reference frame (e.g., Gramann, Muller, Schonebeck, & Debus, 2006), recent works have shown that both egocentric and allocentric reference frames can co-exist in memory (Igloi, Zaoui, Berthoz, & Rondi-Reig, 2009; Waller & Hodgson, 2006): the brain would be able to encode both these forms of spatial coding in parallel, retrieve and switch between them. For example, during a spatial navigation task in a 'starmaze', Igloi and collaborators (2009) have shown that some participants rely on both egocentric and allocentric strategies by shifting from one strategy to another. Importantly, this switching behaviour has been observed during spontaneous as well as imposed behaviour in both directions of switch, showing that both strategies are available at any time during navigation. Although these works support the parallel encoding of space in both egocentric and allocentric coordinates and showed that humans are able to retrieve and switch between both these knowledge, no experimental study has directly investigated the dynamic interaction between the ego- and allocentric reference frames in memory.

Here, we describe a multidisciplinary experiment aiming to investigate the flexibility of the brain to use these two co-existent spatial coding. By combining a virtual reality approach with a task-set switching paradigm, the study focuses upon the time scale of the cost linked to switch between egocentric and allocentric spatial knowledge in memory. We addressed this issue by submitting healthy adults to a spatial memory test that involves the recall of egocentric and allocentric spatial distances between locations previously encountered during navigation in a virtual town.

## **Method**

### **Participants**

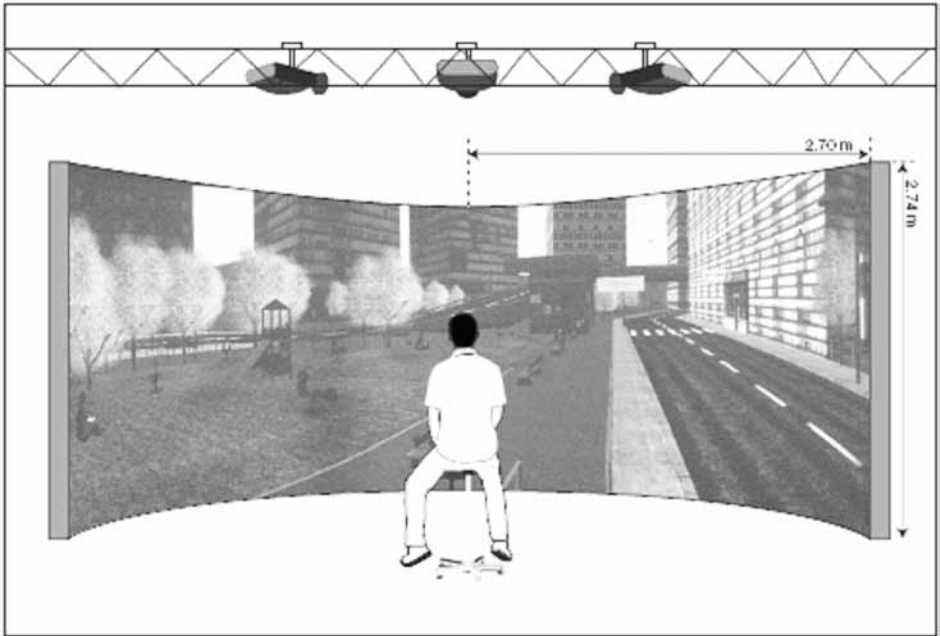
Twelve healthy females and sixteen males volunteered to participate in the study, yielded a total of twenty eight participants. Participants were 23 to 36 years of age (mean age: 28.7 SD: 3.5) and had normal or corrected-to-normal vision. The experiment was approved by the ethic committee of the region (Comity of human protection in experimental research (CPP) of Ile de France VI) and was conducted with the understanding and the written consent of participants who were naive with regard to the precise purpose of the study.

### **Apparatus and procedure**

The procedure was composed of two successive sessions: a learning phase of the virtual reality environment and a spatial memory test phase. The total duration of the experiment was approximately one hour and 40 minutes.

## The navigational virtual environment

The navigational environment was a fully coloured and textured virtual town with buildings, places and roads. It was generated by Virtools™ 4 software and displayed with a high resolution on a large hemicylinder-shaped screen with 185° field of view (270 mm radius and 274 mm height). It was presented in a first-person view and adjusted for the viewpoint height of the participants (Figure 1).



**Figure 1. Schematic representation of the large hemicylinder-shaped screen on which the virtual environment was projected in first-person view**

## The learning phase

After a 5-minutes familiarization phase with the navigational environment and the virtual set-up, the learning session involved navigation through 3 pathways (a, b, c) for approximately one hour and twenty minutes. It simulated a walk path centred on either (left and right) sidewalk in the virtual city. Participants explored each pathway twenty times, yielded a total of sixty exploration trials of the virtual city experienced in a random order. This navigation session allows the participants to explore attentively the virtual city and to learn the position of signs appearing on either side of each of the three pathways. Participants can move forward using the joystick but can not control the navigation trajectory, guarantying that information available during learning was equivalent across participants. There was no overlap between each pathway except the starting place, ensuring that a global allocentric comprehension of the navigational environment can only be developed by integrating those different navigation experiences in memory.

There were thirty distinct closed places in the environment (e.g., butcher shop, pharmacy, bank, police station, museum). Ten closed places appeared on the left

and right sidewalk of each pathway and were identified by fully coloured signs mounted at the top of windows. Those thirty signs were fully coloured large rectangular 3D objects on which the name of the closed place is written. Every time participants encountered signs during navigation on the pathways, participants were stopped for 2 seconds. At each stop, two signs were always apparent, one on the left sidewalk and one the right sidewalk (see Figure 1).

The '*stop distance*' (i.e. the spatial distance between the sign and its respective stop) differed between the different signs of the environment but was maintained strictly constant for a same sign across the different navigation trials.

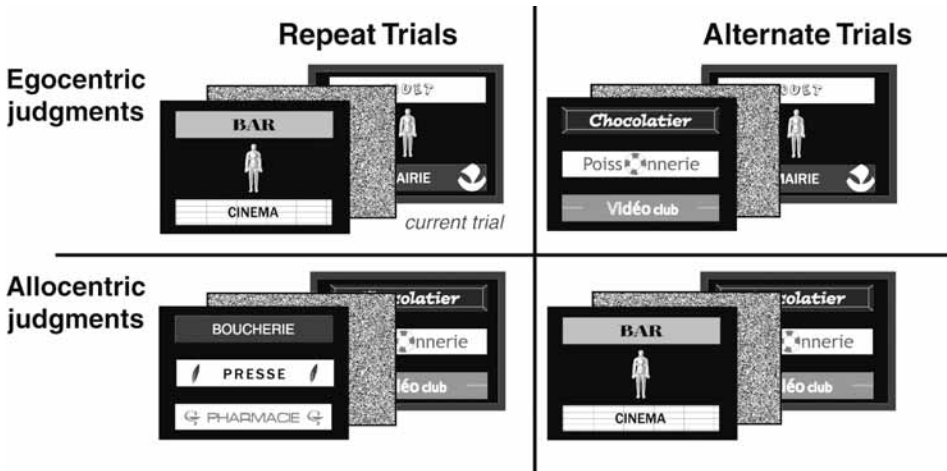
Participants were informed that the learning navigation session is followed by a memory test. They were instructed to learn the position of the thirty distinct close places relative to their position when they were stopped in front of the signs, and relative to the whole environment and the other signs (i.e. independently of their position).

### The test phase

The second session is a spatial memory test performed on a separate standard flat computer screen (19 inch, 1280 x 1024 pixels, 75 Hz). It consisted to retrieve in memory both the "egocentric" and "allocentric" position of the signs. It was composed of two blocks of thirty one stimuli displayed in immediate succession using E-prime2 software.

In each block, half of stimuli intended to involve allocentric spatial memory access. These "allocentric" stimuli consisted to compare spatial distance between signs previously seen during navigation in the virtual city. As shown on the Figure 2, stimuli contained three signs vertically aligned replicating those seen during the navigation. Each one represented a sign appearing on each navigation pathway (a, b, c). Participants had to choose among the bottom and the top signs, which one was closest to the sign displayed at the screen centre. Spatial distances had to be estimated at crow flies on the basis of the spatial knowledge acquired during the learning session in the navigational environment. To the best of our knowledge, the sole way to succeed at that test requires accessing to a global allocentric comprehension of the virtual city formed upon the integration of spatial knowledge acquired from the navigational experience on the three pathways.

The remaining half stimuli intended to involve egocentric spatial memory access. They consisted to compare egocentric spatial distance of signs, namely the spatial position of signs with respect to the participant's position when they were at a specific location in the environment. As illustrated in the Figure 2, "egocentric" stimuli contained two signs at the top and bottom and, a human figure representing the participant in the centre. For these stimuli, participants had to choose among the top and bottom signs, which one was the closest to them when they were stopped in front of those signs during the navigation in the virtual city. They had thus to retrieve in memory both the '*stop distance*' of the top and the bottom signs and compare them in order to decide which one was the shortest.



**Figure 2. Schematic representation of the experimental design. The figure sum up the trial conditions as a function of the Reference frame of the current trial (egocentric vs. allocentric) and the nature of the previous trial, i.e. the Switch variable (repeat vs. alternate)**

The stimuli were displayed until the participants responded by pressing as accurately and quickly as possible one of the two keys corresponding to the top and bottom signs on the screen. Stimuli were then followed by a mask displayed for 200 ms in order to erase the visual previous stimulus.

In order to estimate the eventual temporal cost due to switch from one strategy to another, we manipulated the random order of the “egocentric” and “allocentric” trials in each block. It allows us to compare response time (RT) of trials in two conditions: (1) a first one in which the trials involve the same reference frame in memory as the previous trials (*repeat* trials) with 2) a second one in which the trials rely on different spatial memory as the previous trials (*alternate* trials). Each block thus consisted of a successive set of alternate ‘egocentric’ trials, repeat ‘egocentric’ trials, alternate ‘allocentric’ trials and repeat ‘allocentric’ trials (see Figure 2).

## Data Analysis

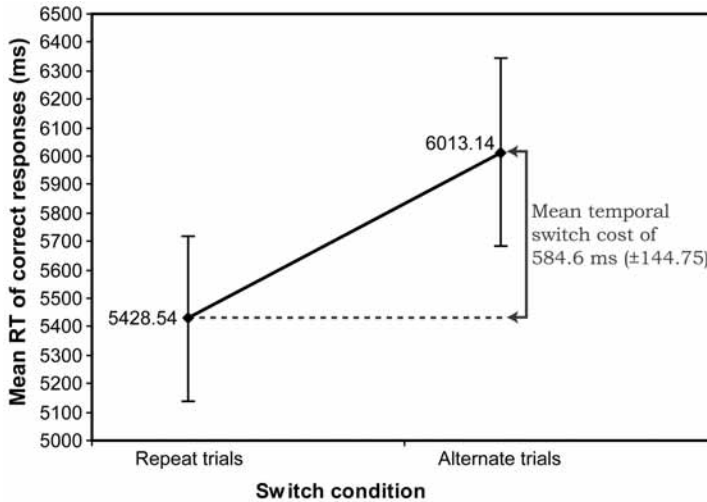
The presence of a temporal switch cost was tested by comparing RTs in alternate and repeat trials. Mean RTs were submitted to a two way ANOVA with Reference frames judgements (egocentric vs. allocentric) and Switch (alternate vs. repeat trials) as within-subject factors. Analyses were performed using STATISTICA v5.5 and 8.0 and the alpha was defined at .05. One participant was excluded from the analysis because his performance in the memory task was below the chance level.

The value of the switch cost was estimated by subtracting mean RT in *repeat* condition from mean RT in *alternate* condition. Positive differences would thus correspond to temporal cost due to switching from a reference frame to another in memory, while negative differences would correspond to switch benefit.



## Results

Participants well succeed to the memory task as shown by the good performance recorded in “egocentric” and “allocentric” trials. The mean percentages of correct egocentric and allocentric judgments were 81.9% (SE = 1.3) and 80.8% (SE = 2.0), respectively.



**Figure 3. Mean RTs in the spatial memory task as a function of the Switch condition (repeat vs. alternate trials). The positive difference of 584.6 ms between both these conditions (alternate trials mean RTs superior to repeat trials mean RTs) indicates a temporal cost due to the switch between both egocentric and allocentric knowledge in memory**

Regarding the temporal cost due to switching from one reference frame to another, the ANOVA on mean RT revealed a main effect of the switch ( $F(1, 26) = 16.90$ ;  $p < .0005$ ). As illustrated in the Figure 3, mean RT were faster in *repeat* trials (5428.54 ms; SE = 291.29) as compared to *alternate* trials (6013.14 ms; SE = 329.05), showing that switching between reference frames in memory takes in average 584.6 milliseconds (SE = 144.75). The analysis revealed also a main effect of the reference frame ( $F(1, 26) = 39.91$ ;  $p < .0001$ ), with longer RT for allocentric judgements (6358.94 ms; SE = 358.42) than for egocentric ones (4676 ms; SE = 225).

## Discussion

The current study aimed to investigate the temporal cost linked to switch between egocentric and allocentric reference frames in memory in the context of complex navigation situation. Firstly, we found high accuracy in both ‘egocentric’ and ‘allocentric’ judgments, demonstrating the human ability to form and use ego- and allocentric knowledge of a complex navigational environment. The time difference in processing ego- and allocentric judgments is not unexpected as the current egocentric and allocentric judgments are not comparable at many levels.

These results may be caused by the material we used in the current experiment: participants had to retrieve spatial knowledge of three signs in allocentric judgments, while they were required to only retrieve those of two signs in egocentric judgments.

Regarding our main issue, we show that alternation between both egocentric and allocentric spatial coding takes a substantial amount of time (in average 585 milliseconds). These results demonstrate the limited flexibility of the cognitive system to use and switch between various spatial coding in memory.

## The underlying process causing the switch cost

Our findings are consistent with the results of Carlson-Radvansky & Jiang (1998) showing that switching between reference frames takes times. The current study significantly extends these previous results by addressing this switching dynamic to the context of navigation and by reporting the time scale of that switch cost.

Regarding the underlying processes causing this switching cost, we could suggest the role of some reconfiguration mechanisms of reference frames in memory via executive control process (Monsell, Sumner, & Waters, 2003; Rogers & Monsell, 1995; Schneider & Logan, 2007). Reconfiguration processes would include reference frame selection, task-set<sup>1</sup> updating and inhibition of the previous reference frame in memory (Sakai, 2008). Reconfiguration processes is assumed to occur only for alternate trials, explaining the longer response times on alternate trials as compared to repeat ones (Monsell *et al.*, 2003; Rogers & Monsell, 1995; Rubinstein, Meyer, & Evans, 2001; Schneider & Logan, 2007).

Interestingly, the current study revealed a strong switch cost of 585 milliseconds as compared to previous study dealing with switching phenomena between other various cognitive processes (Altmann, 2007; Brockmole & Wang, 2002, 2003). For example, switching between different spatial representations has evidenced to require a temporal cost 109.4 milliseconds. In comparable switching paradigm applied to simple (non-spatial) tasks, switch cost was shown to vary between 6 and 201 ms, with an average of 94 ms (Altmann, 2007). This suggests that switching between reference frames involved particular strong cost as compared to switching between other cognitive processes.

## Implication for driving situation

Significant implications can be advanced in driving situation. In particular, using GPS (Global Positioning System) to guide automobile navigation could involve a permanent switch between egocentric and allocentric coordinates: The 'route' perspective experienced by the driver could preferentially involve egocentric spatial coding whereas the spatial information resulting from the map displayed on the GPS could involve allocentric coding (Mellet *et al.*, 2000). Drivers using GPS involving map display could thus suffer from this 'dual' task,

---

<sup>1</sup> A task set is defined as "a configuration of cognitive processes that is actively maintained for subsequent task performance" (Sakai, 2008)

egocentric and allocentric coding, due to the temporal cost linked to permanent switch between them. More generally, this temporal switch cost could involve longer reaction times, thereby leading to some insecurity problems in driving situation. This study suggests that recent GPS using a kind of route perspective are likely to be more compatible with human cognition.

**Keyword:** Spatial memory; reference frame; egocentric; allocentric; temporal switch cost; virtual navigation

## **Bibliography**

- Altmann, E. M. (2007). Comparing switch costs: alternating runs and explicit cuing. *J Exp Psychol Learn Mem Cogn*, 33(3), 475-483.
- Avraamides, M. N., & Kelly, J. W. (2008). Multiple systems of spatial memory and action. *Cogn Process*, 9(2), 93-106.
- Berthoz, A. (1991). Reference frames for the perception and control of movement. In J. paillard (Ed.), *Brain and space* (pp. 81-111). Oxford: Oxford University Press.
- Brockmole, J. R., & Wang, R. F. (2002). Switching between environmental representations in memory. *Cognition*, 83(3), 295-316.
- Brockmole, J. R., & Wang, R. F. (2003). Changing perspective within and across environments. *Cognition*, 87(2), B59-67.
- Burgess, N. (2006). Spatial memory: how egocentric and allocentric combine. *Trends Cogn Sci*, 10(12), 551-557.
- Carlson-Radvansky, L. A., & Jiang, Y. (1998). Inhibition accompanies reference-frame selection. *Psychol Sci*, 9(5), 386-391.
- Diwadkar, V. A., & McNamara, T. P. (1997). Viewpoint dependence in scene recognition. *Psychol Sci*, 8(4), 302-307.
- Ekstrom, A. D., Kahana, M. J., Caplan, J. B., Fields, T. A., Isham, E. A., Newman, E. L., & Fried, I. (2003). Cellular networks underlying human spatial navigation. *Nature*, 425(6954), 184-188.
- Etienne, A. S., & Jeffery, K. J. (2004). Path integration in mammals. *Hippocampus*, 14(2), 180-192.
- Gramann, K., Muller, H. J., Schonebeck, B., & Debus, G. (2006). The neural basis of ego- and allocentric reference frames in spatial navigation: evidence from spatio-temporal coupled current density reconstruction. *Brain Res*, 1118(1), 116-129.
- Igloi, K., Zaoui, M., Berthoz, A., & Rondi-Reig, L. (2009). Sequential egocentric strategy is acquired as early as allocentric strategy: Parallel acquisition of these two navigation strategies. *Hippocampus*.
- Mellet, E., Briscogne, S., Tzourio-Mazoyer, N., Ghaem, O., Petit, L., Zago, L., Etard, O., Berthoz, A., Mazoyer, B., & Denis, M. (2000). Neural

correlates of topographic mental exploration: the impact of route versus survey perspective learning. *Neuroimage*, 12(5), 588-600.

- Monsell, S., Sumner, P., & Waters, H. (2003). Task-set reconfiguration with predictable and unpredictable task switches. *Mem Cognit*, 31(3), 327-342.
- O'Keefe, J., & Dostrovsky, J. (1971). The hippocampus as a spatial map. Preliminary evidence from unit activity in the freely-moving rat. *Brain Res*, 34(1), 171-175.
- O'Keefe, J., & Nadel, L. (Eds.). (1978). *The hippocampus as a cognitive map*: Oxford University Press.
- Rogers, R. D., & Monsell, S. (1995). Costs of a predictable switch between simple cognitive tasks. *J Exp Psychol Gen*, 124(2), 207-231.
- Rubinstein, J. S., Meyer, D. E., & Evans, J. E. (2001). Executive control of cognitive processes in task switching. *J Exp Psychol Hum Percept Perform*, 27(4), 763-797.
- Sakai, K. (2008). Task set and prefrontal cortex. *Annu Rev Neurosci*, 31, 219-245.
- Schmidt, D., Krause, B. J., Weiss, P. H., Fink, G. R., Shah, N. J., Amorim, M. A., Muller, H. W., & Berthoz, A. (2007). Visuospatial working memory and changes of the point of view in 3D space. *Neuroimage*, 36(3), 955-968.
- Schneider, D. W., & Logan, G. D. (2007). Defining task-set reconfiguration: the case of reference point switching. *Psychon Bull Rev*, 14(1), 118-125.
- Trullier, O., Wiener, S. I., Berthoz, A., & Meyer, J. A. (1997). Biologically based artificial navigation systems: review and prospects. *Prog Neurobiol*, 51(5), 483-544.
- Waller, D., & Hodgson, E. (2006). Transient and enduring spatial representations under disorientation and self-rotation. *J Exp Psychol Learn Mem Cogn*, 32(4), 867-882.

# Drivers' perception of simulated loss of adherence in bends

**Thomas Denoual, Franck Mars, Jean-François Petiot, Gilles Reymond, Andras Kemeny**

IRCCyN (Institut de Recherche en Communications et Cybernétique de Nantes)

Renault, Technical Center for Simulation

1 avenue du golf – 78288 Guyancourt, France

thomas.denoual@renault.com, franck.mars@ircsyn.ec-nantes.fr,

jean-francois.petiot@ircsyn.ec-nantes.fr, Gilles.reymond@renault.com,

andras.kemeny@renault.com

**Abstract** - Loss of adherence (LOA) in bends, due to excessive speed or alteration of road grip, can lead to loss of vehicle control, which is a cause for many accidents. This paper presents preliminary results of an experiment studying how drivers perceive and react to vehicle skidding in a fixed-base simulator. Situations of LOA inducing a significant modification on the vehicle trajectory without involving a brutal loss of control or a road departure were chosen. The intensity and the duration of the LOA were manipulated. Naive participants repeated short drives on a track made of a straight road followed by a bend and were asked to answer a questionnaire after each track. To describe the LOA, two types of indicators were used: objective indicators of steering control and subjective indicators based on verbal descriptors scaled after each track. Preliminary results showed that drivers were able to discriminate the different conditions of LOA. The intensity of the perturbation was well perceived, with minimal influence of duration and not apparent relation to the magnitude of the steering correction. By contrast, a distortion of subjective time was observed when the duration of the LOA was assessed. Further analyses will be conducted to determine to what extent objective and subjective indicators were related. This study is the first step to develop an evaluation method that could be applied to the evaluation of ESC system intervention in high performance simulators.

**Résumé** - Les pertes d'adhérence (PA) en virage, dues à une vitesse excessive ou une altération de la tenue de route, peuvent entraîner des pertes de contrôle qui sont la cause de nombreux accidents. Cet article présente les premiers résultats d'une expérience qui étudie comment les conducteurs perçoivent et réagissent face à un dérapage du véhicule. Les situations de PA choisies induisent une modification perceptible de la trajectoire du véhicule sans provoquer une brutale perte de contrôle ou une sortie de route. L'intensité et la durée de la PA ont été manipulées. Des participants naïfs ont répété plusieurs conduites sur parcours simple composé d'une route droite suivie d'un virage.

*Pour décrire les PA, deux types d'indicateurs ont été utilisés: des indicateurs objectifs du contrôle de la trajectoire et des indicateurs subjectifs basés sur des descripteurs verbaux cotés après chaque passage. Les premiers résultats ont montré que les conducteurs sont capables de distinguer les différentes conditions de PA. L'intensité de la perturbation a bien été perçue, avec une influence minimale de la durée, sans relation apparente avec l'amplitude de la correction au volant. En revanche, une distorsion du temps perçu a été observée. Des analyses plus poussées seront menées pour déterminer dans quelle mesure les indicateurs objectifs et subjectifs sont liés. Cette étude est une première étape dans le but de développer une méthode d'évaluation qui pourrait être appliquée à l'évaluation des interventions d'un ESP dans un simulateur haute performance.*

## Introduction

Loss of adherence (LOA) can lead to loss of vehicle control, which causes many accidents. Electronic stability control (ESC) can limit the consequences by correcting the vehicle trajectory according to the driver's intentions and dynamics of lateral acceleration, yaw speed or drift of the vehicle (Liebemann, 2004; Erke, 2008). The calibration and validation processes are time consuming and require physical prototypes and expert drivers on specific grounds, especially for very low adherence situations. Consequently, driving simulators are being used to study LOA episodes and ESC performance (Papelis *et al.*, 2010). Driving simulators are useful tools in vehicle design and perception studies. They allow to safely explore critical situations with naive drivers without environmental bias (Kemeny, 2009). The present study is the first step of a research program aiming at understanding how drivers perceive and react to trajectory perturbations and, further on, to the intervention of an ESC system. This could be useful for the engineering specifications of ESC using driving simulators and to evaluate how actual drivers perceive different system configurations.

During LOA episodes inducing sudden changes in the vehicle trajectory, the driver must perform an appropriate steering response to maintain the vehicle into the lane and avoid road departure. Numerous sensorimotor models have been proposed to explain how drivers use visual, vestibular and haptic information to steer a vehicle in normal conditions (Donges 1978, Raymond *et al.*, 2001, Toffin *et al.*, 2007). However, little is known about sensory cues that are used by the driver to detect LOA episodes and how steering responses are carried out. Besides, hierarchical model of cognitive control applied to driving postulate that steering mainly relies on sensorimotor loops which operate below the level of consciousness (Hollnagel 2004, Michon 1985). Typically, emergence to consciousness arises when external disturbances occur (Hoc and Amalberti 2007). Assessing at the same time steering responses to LOA and the associated subjective experience may be a way to investigate how sensorimotor cues determine the conscious evaluation of driving incidents.

This paper presents a driving simulator experiment in which episodes of LOA were triggered to produce significant modification of the vehicle trajectory without loss of control and road departure. Intensity and duration of the LOA were

manipulated. The first objective was to develop an evaluation method to describe LOA episodes by means of subjective indicators using a non-structured-scaled questionnaire (Strigler, 1998). Objective indicators of the vehicle's dynamic and driver behaviour were also analysed. Another objective was to determine to what extent objective and subjective indicators were related (Mellert, 2007).

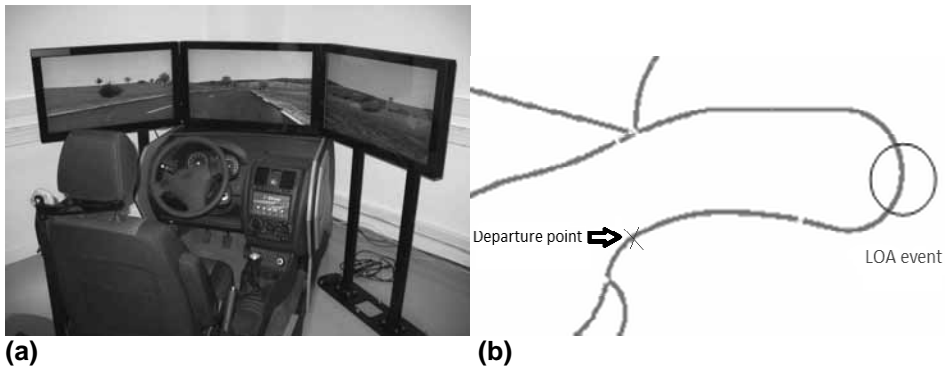
## Method

### Participants

Four female and sixteen male drivers between 20 and 24 years old (mean age of 21.4) participated in the experiment. They had driving licence for 3.4 years on average and drove between 1000 and 25000 km per year (mean = 6325). All of them had normal or corrected-to-normal vision. Fourteen participants declared that they had already faced to a loss of adherence situation on the road, two of them during a specific driving lesson. Two participants had already used a simulator.

### Apparatus

The experiment was conducted on a fixed-base simulator at IRCCyN laboratory (Nantes, France). It consists of a compact size passenger car with actual instrument panel, clutch, brake and accelerator pedals, handbrake, ignition key and an adjustable seat with seat-belt. Transmission is done by an automatic gear box. Vibrators are installed at the bottom of driver seat and upper position of the steering column to render engine noise and vibrations. Active steering force feedback is rendered by a TRW steering wheel. The audio system renders the audio environment for an interactive vehicle. It contains an amplifier, 4 speakers and sub woofer.



**Figure 1. (a) IRCCyN driving simulator. (b) Layout of the country track**

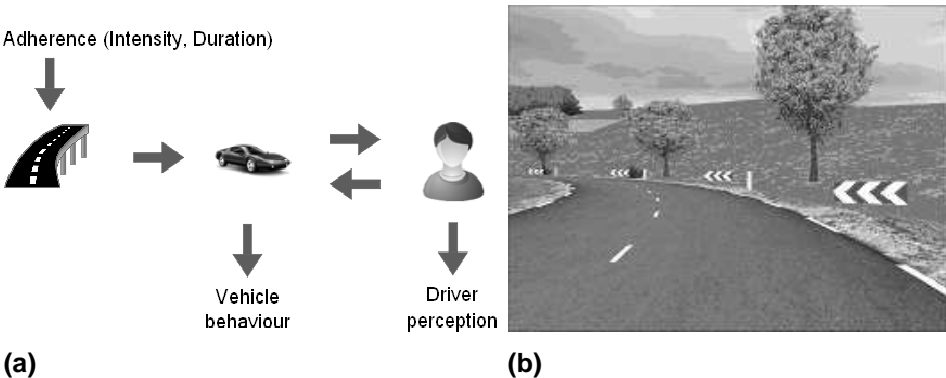
The SCANer<sup>®</sup>Il<sup>2</sup> software package was used with CALLAS<sup>®</sup> dynamic vehicle model (Lechner *et al.*, 1997).

<sup>2</sup> <http://www.scanersimulation.com/>

The visual environment was displayed on three 32 inch LCD monitors with a resolution of 1280 x 720 each, one in front of the driver and two laterals inclined of 45° from the front one, viewed from a distance of about 1 meter and covering 115° of visual angle (Fig. 1a). The graphics database reproduced an open countryside environment. The experiment was performed on a short part of the environment which consisted in a straight line followed by a bend (total distance: 700 m, mean radius in the bend: 111 m) without traffic (Figure 1b).

A simple generic speed regulator was used, consisting of a PID corrector with a nominal speed of 75 km/h, using the automatic gearbox mode in order to reject inter subject velocity bias. This condition also allowed the subject to be only focused on the steering task.

Two type of LOA were simulated in the bend by modifying the adherence under the wheels when the vehicle reached a defined point. The intensity (adherence coefficient) and duration of the simulated LOA in the bend were manipulated as independent variables (IV). An adherence coefficient decrease corresponds to an increase of the intensity of LOA. These values of intensity and duration values were chosen to induce perceptible but controllable LOA. LOA was simulated either on the four wheels (LOA1) or on the rear wheels (LOA2). The LOA1 situation induced a skidding to the outside of the bend comparable to an actual situation of driving on a patch of black ice, a puddle or a pool of oil depending on the independent variables values. The LOA2 induced situations similar to over-steering. The results of the LOA2 are not presented in this paper. After the LOA, coefficient of adherence was set again to 1. The environment was not giving clues about a potential LOA (snow, rain or mark on the road) (Fig. 2b).



**Figure 2. (a) Input and output data. (b) Visual environment in the bend**

## Procedure

The subjects settled themselves in the simulator while preliminary instructions were given. In particular, they were asked to keep their lane without cutting the bend even if there was no oncoming traffic. Then, they were invited to start the simulator and drive a 10 minutes session for training. Next, they drove around the test bend with automatic gearbox and speed regulator on with the repeated instruction to stay in their lane and focus on the trajectory. Four trials without any LOA were performed in order to familiarize the subjects with the bend.



For each type of LOA, a control condition (no LOA) was inserted in the experimental design. The order of presentation of LOA1 and LOA2 was counterbalanced across the subjects. The same Williams Latin Squares design (Williams, 1949) was adopted for each type of LOA to avoid rank and carry-over effects. 20 trials divided into two sequences of each type of LOA preceded by 4 preliminaries trials representing mild and strong LOA episodes were performed. Those 8 preliminaries trials were conducted in order to familiarize the participants to the range of steering perturbations they would encounter during the experiment. They were not analyzed. The two types of LOA induced very different modifications in the vehicle behaviour and situation's perception. Therefore we have chosen this block design to avoid heterogeneous scaling on subjective indicators. Moreover, the experimental design was different for each type of LOA to keep perceptible but controllable situations. A 3\*3 factorial design was used for LOA1 (Intensity: 0.1, 0.3 & 0.5; Duration: 250ms, 500ms & 750ms) (Table 2). A constrained design was used for LOA2 (Intensity: 0.1 to 0.6; Duration: 100 to 500ms). After each trial, a questionnaire was displayed with 13 questions about subjects' perception of the event (Table 1). Answers to the questions were given by the mean of continuous horizontal scroll bars representing two ends of a continuous scale (0: totally disagree to 10: totally agree) (Fig. 3) excepted for 4<sup>th</sup> question (Yes / No). Only LOA1 results are presented in this paper.

Behavioural measures (lateral position, steering angle, lateral acceleration, etc.) were recorded all along the trials at 20 Hz.

**Table 1. Summary of the items corresponding to each question**

Item	Question
Danger	"I perceived a danger during the bend"
Fear feeling	"I was afraid during the bend"
Feeling of control	"I easily kept my vehicle in the lane"
Perturbation perception	"Did you feel a perturbation in the bend?"
Intensity	"The LOA appeared to be weak/strong"
Duration	"The LOA appeared to be short/long"
Visual cue	"I visually perceived the LOA"
Haptic cue	"I perceived the LOA through the steering wheel"
Physical move	"I had the impression of physically moving"
Skid direction	"I felt the vehicle was skidding from the front/rear"
surprise	"I was surprised by the vehicle response"
realism	"Driving the simulator was unrealistic/realistic"
comfort	"I was at ease during the trial"



**Figure 3. Visual answer interface of a question**

## Data analysis

For each condition, the mean and the standard deviation of the subjective answers were computed. When the fourth question was ticked “no”, the following answers were settled to a “default value” depending on the meaning of the question.

For each run, a time to stability (TTS) corresponding to the time taken by the driver after the onset of LOA to bring the vehicle drift speed back into a stability envelope was computed. This envelope is defined as the standard deviation of the mean drift speed and was measured in the control condition. Drift speed was

calculated using the following formula:  $\varphi_{drift} = \frac{d \arctan(\frac{V_y}{V_x})}{dt}$  with  $\varphi_{drift}$  the angular

drift speed,  $V_x$  the longitudinal speed and  $V_y$  the lateral speed. The following objective data were observed in TTS interval: lateral deviation, steering wheel angle, slip angle, yaw speed and lateral acceleration.

Repeated measures analyses of variance (ANOVA,  $\alpha = 0.05$ ) with the intensity and the duration of the LOA as independent variables (IV) were performed on the data. Scheffé tests were performed for post-hoc analyses. A principal component analysis was also performed on the subjective indicators in order to determine if they could be summarized by one or several underlying factors.

## Results

### Subjective data

The principal component analysis of the subjective data showed that all indicators can be represented by a single factor, which means that all variables were highly correlated. The simulation was globally judged as realistic (mean score = 7.64) with no significant effect of intensity and duration.

There was a significant effect of intensity and duration of LOA and a significant interaction between both IV on the duration and danger perception, fear and feeling of control. The effect of intensity and the interaction between both IV on perceived intensity was significant, but the effect of duration was not (Fig. 5 & Tab. 3). Post-hoc tests confirmed that the effect of intensity on duration, danger and intensity perception, fear and feeling of control was significantly higher for longer LOA.

There was no significant effect of the IV on the perceived direction of skidding. Participants could not tell if the vehicle was skidding from the front or the rear side (mean value: 5.11, SD: 2.7).

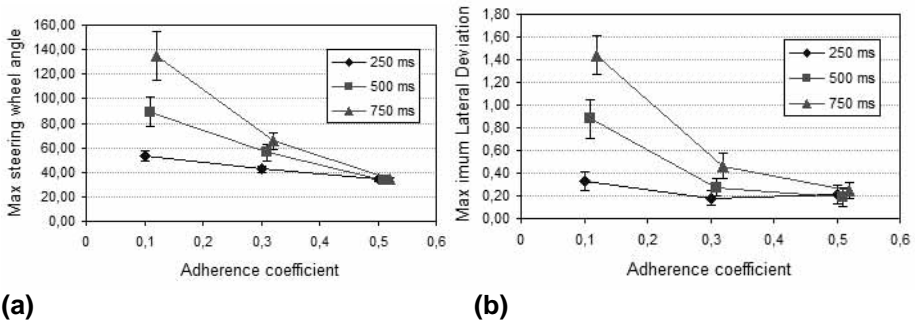
All the LOA situations were clearly perceived through the steering wheel (mean value: 8.13, SD: 2.35) and there was no significantly effect of the IV. Conversely, only the strongest LOA were perceived visually, as shown by the significant effect of the intensity ( $F(2,38) = 62.53$ ,  $p < .05$ ) and duration ( $F(2,38) = 4.79$ ,  $p < .05$ )

## Objective data

Intensity ( $F(2,38) = 200.97, p < .05$ ), duration ( $F(2,38) = 57.65, p < .05$ ) and interaction between both IV ( $F(4,76) = 13.14, p < .05$ ) had significant effects on the TTS. Post-hoc test confirmed that the effect of intensity on TTS was significantly higher for long duration and that there was no significant effect of the duration for lower level of intensity.

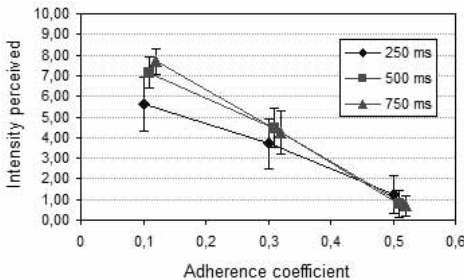
**Table 2. Maximum and mean TTS for each condition**

Conditions	C1	C2	C3	C4	C5	C6	C7	C8	C9
Adherence coefficient	0.1	0.1	0.1	0.3	0.3	0.3	0.5	0.5	0.5
Duration (ms)	250	500	750	250	500	750	250	500	750
TTS max (s)	5.15	5.2	6.15	5.35	5.15	6.15	6.15	2.65	3.55
TTS mean (s)	3.02	4.13	5.55	2.18	3.2	3.93	1.14	1.07	1.44

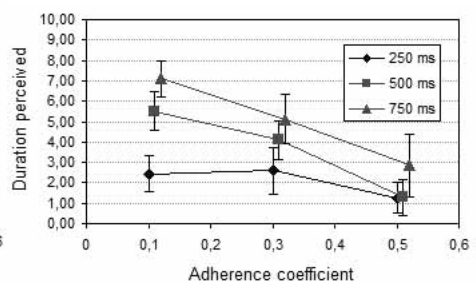


**Figure 4. (a) ANOVA of the maximum steering wheel angle. (b) ANOVA of the maximum lateral deviation from the centre of the road**

The ANOVA performed on the maximum steering wheel angle (Fig. 4a) showed a significant effect of intensity ( $F(2,38) = 136.7, p < .05$ ) and duration ( $F(2,38) = 47.21, p < .05$ ), with a significant interaction between both IV ( $F(4,76) = 23.08, p < .05$ ). Similar results were observed on the maximum lateral deviation (Fig. 4b; intensity:  $F(2,38) = 125.48, p < .05$ , duration:  $F(2,38) = 97.08, p < .05$ ; interaction:  $F(4,76) = 30.08, p < .05$ ).



**Figure 5a. Intensity perception**



**Figure 5b. Duration perception**

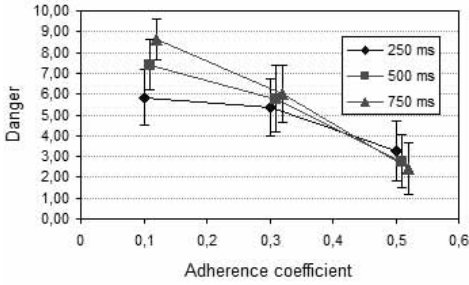


Figure 5c. Danger

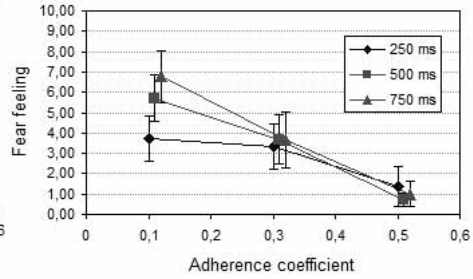


Figure 5d. Fear feeling

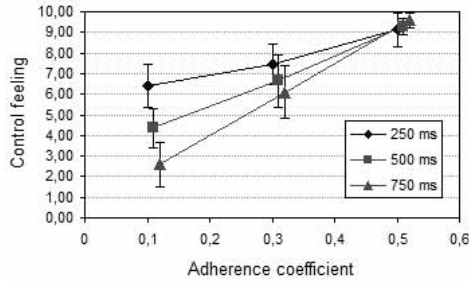


Figure 5e. Control feeling

Table 3. Summary of the statistical analyses performed on the effect of intensity and duration on the selected subjective variables

Subjective Items	IV	F	LoS
Intensity	Intensity	(2,38) = 108.47	<b>p &lt; 0.05</b>
	Duration	(2,38) = 1.97	n.s.
	Intensity*Duration	(4,76) = 5.35	<b>p &lt; 0.05</b>
Duration	Intensity	(2,38) = 34.78	<b>p &lt; 0.05</b>
	Duration	(2,38) = 21	<b>p &lt; 0.05</b>
	Intensity*Duration	(4,76) = 4.47	<b>p &lt; 0.05</b>
Control feeling	Intensity	(2,38) = 89.58	<b>p &lt; 0.05</b>
	Duration	(2,38) = 11.36	<b>p &lt; 0.05</b>
	Intensity*Duration	(4,76) = 8.2	<b>p &lt; 0.05</b>
Danger	Intensity	(2,38) = 63.04	<b>p &lt; 0.05</b>
	Duration	(2,38) = 3.86	<b>p &lt; 0.05</b>
	Intensity*Duration	(4,76) = 7.08	<b>p &lt; 0.05</b>
Fear feeling	Intensity	(2,38) = 50.1	<b>p &lt; 0.05</b>
	Duration	(2,38) = 6.67	<b>p &lt; 0.05</b>
	Intensity*Duration	(4,76) = 7.3	<b>p &lt; 0.05</b>

## **Discussion**

From a general point of view, all subjective answers were correlated and can be described along one dimension, opposed to the adherence coefficient, as revealed by the principal component analysis. This suggests that all subjective ratings were coherent and determined by the intensity of the trajectory perturbation. The question remains now to determine if the participant were able to discriminate the magnitude and duration of the manipulated LOA.

The intensity of the LOA was perceived correctly with only minimal influence of the duration for the higher intensity of LOA. Interestingly, the perceived intensity was neither related to the maximum steering angle nor to the maximum lateral deviation. Since the maximum steering angle can be considered as a good indicator of the intensity of the steering correction, this suggests that subjects were able to evaluate how much adherence the vehicle lost, independently of how long it lasted and how much steering correction was needed.

By contrast, the duration of the LOA was poorly perceived. There was a strong interaction with the intensity of the LOA, revealing that the stronger it was, the longer it was perceived. It could be argued that the participant confused the duration of the LOA with the time needed to stabilize their vehicle, but the clear instructions given prior to the experiment make this assumption hardly believable.

A more plausible explanation is that LOA of high intensity were more stressful than milder one, as showed by the fear and danger ratings. Distortions of time have been observed under stress conditions, especially under life threatening conditions (Hancock, 2005) or during specific critical tasks by paramedics (Jurkovich, 1987). The underlying processes may be the attention. Indeed, Tse *et al.* (2004) proposed that novel or important events run in "slow motion" so that the information may be processed in greater depth per unit of objective time than are casual events.

Further experimentation with more experimented drivers on a high performances simulator with dynamic motion rendering should lead to more consistent results. Indeed, Kemeny *et al.* (2003) highlighted the importance of vestibular cues rendering in speed perception and steering in a simulator.

## **Conclusion**

This study demonstrated that drivers are able to discriminate different conditions of LOA on a fixed-based simulator. Whereas the intensity of LOA episodes could be assessed by the driver with only minor distortions, a subjective expansion of their duration was observed. Further analyses will attempt to more clearly link subjective ratings and steering responses, and also to match the observed data with ESC triggering criteria.

## Bibliography

- Donges, E., (1978) A two-level model of driver steering behaviour. *Human Factors*, 20, 691–707.
- Erke, A., (2008) Effects of electronic stability control (ESC) on accidents: A review of empirical evidence. *Accident analysis and prevention*, vol. 40, n°1, pp. 167-173.
- Hancock P.A. and Weaver J.L., (2005) On time distortion under stress. *Theoretical issues in ergonomics science*, 6:2, 193-211.
- Hoc J.M. & Amalberti R. (2007) *Cognitive control dynamics for reaching a satisficing performance in complex dynamic situations*. *Journal of Cognitive Engineering and Decision Making*, 1, 22-55.
- Hollnagel E. (2004) *A function-centred approach to joint driver-vehicle system design*, Proceedings of the 2004 IEEE international Conference on Systems, Man and Cybernetics, pp. 2548-2551.
- Jurkovich G.J., Campbell D., Padra A. and Luterman A., (1987) Paramedic perception of elapsed time. *Journal of Trauma*, 27, 892-897.
- Kemeny A., (2009) Driving simulation for virtual testing and perception studies. *Proceedings of Driving Simulation Conference Europe 2009*. 15-23.
- Kemeny A., & Panerai F. (2003) Evaluating perception in driving simulation experiments. *Trends in cognitive science*. Vol 7-1, 31-37.
- Land M. F., & Lee D. N., (1994) Where we look when we steer. *Nature*, 369, 742–744.
- Lechner D., Delanne Y., Schaefer G., Schmitt V., (1997) Méthodologie de validation du logiciel de dynamique automobile CALLAS. *SIA 970202*. Congrès SIA Lyon, Avril 1997. Reprinted in *Ingénieurs de l'automobile* N°113, Mai 1997.
- Liebemann E.K., Meder K., Schuh J. and Nenninger G., (2004) Safety and Performance Enhancement: The Bosch Electronic Stability Control (ESP). *SAE Paper No. 2004-21-0060*.
- Mellert V., Baumann I., Freese N. and Weber R., (2007) Impact of sound and vibration on health, travel comfort and performance of flight attendants pilots. *Aerospace Science and Technology*, 12, 18-25.
- Michon J.A. (1985) A critical view of driver behavior models: what do we know, what should we do?. In: L. Evans and R.C. Schwing, Editors, *Human behavior and traffic safety*, Plenum, New York, pp. 485–520.
- Papelis Y.E., Watson G.S. and Brown T.L. (2010) An empirical study of the effectiveness of electronic stability control system in reducing loss of vehicle control. *Accident Analysis and Prevention*, 42, 929-934.

- Reymond G., Kemeny A., Droulez J., Berthoz A. (2001) Role of lateral acceleration in curve driving: Driver model and experiments on a real vehicle and a driving simulator, *Human Factors*, 43, 483-495.
- Strigler F., Touraille C., Sauvageot F., Barthélémy J. and Issanchou S., (1998) « Les épreuves » in *évaluation sensorielle : manuelle méthodologique*, sous la direction de SSHA, Depledt F., Strigler F. Ed. Lavoisier.
- Toffin D., Reymond G., Kemeny A., Droulez J.,(2007) Role of steering wheel feedback on driver performance: driving simulator and modeling analysis, *Vehicle System Dynamics*, 45, 375-388.
- Tse P.U., Intriligator J., Rivest J. and Cavanagh P., (2004) Attention and the subjective expansion of time. *Perception and psychophysics*, 2004,66(7), 1171-1189
- Williams E. J., (1949) Experimental designs balanced for the estimation of residual effects of treatments. *Australian Journal of Scientific Research, Ser. A 2*, 149-168.





# **Simulation design and architectur**



# Heading Towards Eye Limiting Resolution – Display Systems in Driving Simulation

**Alexander Huesmann, Martin Strobl**

BMW Group Research and Technology

BMW Group Research and Technology - 80788 Munich - Germany

alexander.huesmann@bmw.de, martin.strobl@bmw.de

**Abstract** – In driving simulation the driver looks through the windscreen into the virtual world. Besides of the content that is displayed the quality of the display system, i.e. the projector used, plays an important role. It influences the perception of the driver and thereby his behaviour. At BMW Group Research and Technology most recently three new display systems with a wide field of view were installed. Once the requirements were defined detailed tests with various projector types were done. This paper is a summary report of the work done and experience gained over the last years. This summary is independent of specific suppliers and focuses on principle characteristics. Different technologies of projectors as they are relevant for the use in driving simulation are mentioned including their basic properties. Human visual perception and spatial as well as temporal resolution is introduced. The various tests that were done with the projectors and their relevance to the use of driving simulation are addressed as well as experiences and aspects that have to be taken care of are mentioned. Finally the three new display systems for the dynamic driving simulator and the fixed base driving simulators in the Centre of Driving Simulation and Usability at BMW Group Research and Technology are outlined.

## Introduction

In every driving simulator some kind of display system is used to present the image of the environment to the driver, i.e. the view into the virtual world. The type and quality of the display can vary significantly. It is well known that poor display quality can severely increase the nausea feeling of the driver. As well the appropriate judgement of the driver on whether a traffic situation is critical or not depends on the correct visual perception. The judgment e.g. on an oncoming truck which the driver can see when starting the manoeuvre of over taking a slower car depends on whether the driver can identify that there is an object approaching and he can recognise the type of the object. As well the estimation of distance and speed which is linked to the identification of the object itself is influenced by display quality.

In the Centre of Driving Simulation and Usability various kinds of driving simulators are installed fulfilling the demands of different kinds of examinations. In the build-up and renewal of these simulators much care is taken of the quality of the display systems. In order to gain appropriate perception with respect to the requirements of a specific driving simulator BMW Group Research and Technology spends much effort in the testing and selection of display systems.

## **Today's Projector Technologies for Simulation Application**

There are various projectors out there on the market and one can spend from one hundred up to approximately one million Euros. There are various customers asking more and more for high quality projectors. The home cinema is one of these areas leading to high quality products at a comparable low price.

Nevertheless the needs of simulation business are very specific. A high resolution, i.e. lots of pixels, is a clear requirement. This resolution is called spatial resolution. The high resolution image shall be perceived as such even in a dynamic environment. This is referred to as temporal resolution defining the perception of an object or scenery as it changes in time. Only in case of negligible blurring artefacts the visual conditions for static and dynamic sceneries are equivalent and so the temporal resolution is of high quality.

In the following the common technologies of projectors used in a driving simulation environment are listed. These are basic information necessary for the discussion afterwards. Detailed information can be found in internet, e.g. [2] or at the sites of various projector suppliers.

### **CRT (Cathode Ray Tube)**

The CRT projector is a reference since the beginning of driving simulation. The image is composed of a sequence of displayed image points created by a single ray. Every pixel is highlighted only a fraction of the time available for every frame. The overall brightness of the image is very limited. The colour is composed by the three basic components red/green/blue whereas the convergence is done at the surface of the screen and not within the projector. This requires a huge amount of calibration effort which has to be done continuously. An advantage of that technology is that practically there is no delay in displaying the image once the signal is at the projector. Due to the fact that every pixel is highlighted only a very short time there is no visual artefact of blurring, caused neither by the projector technology nor by human perception. This projector type is the standard for issues of temporal resolution.

### **LCOS (Liquid Crystal on Silicon)**

The LCOS technology is a digital full image one, i.e. for every pixel of the image there is a corresponding entity on the chip. LCOS technology is similar to

LCD technology but in contrast to sending light rays through the chip a polarised ray is reflected. The switching of the state of a pixel needs some time and therefore there are transition states between the frames which can be observed as blurring in moving scenery.

Every pixel is highlighted all the time of a frame, i.e. 16.6ms in case of 60 Hz. The brightness is much higher compared to CRT but part of the brightness of the projector lamp is lost due to the fact that polarised light is used in combination with the LCOS chip. Colour convergence is done within the projector. For each of the three basic colours a separate chip is used. Maintenance of the projector is reduced to changing lamps and filters. The LCOS technology has the advantage of extremely low delay which is almost comparable to CRT in case of undistorted images. Once using any warping functionality an additional delay has to be taken into account. This is due to the fact that there is no pixel by pixel relation between the rendering output of the graphics card and the display chip of the projector anymore. Typically it needs information of pixels of several lines of the rendered image to compile a single line of the projector. This algorithm leads in total to a delay according to the number of lines necessary to compile one line of pixels for the projector.

## **DMD (Digital Micro Mirror Device)**

The DMD technology is the basis used in a kind of projectors better known as DLP projectors (Digital Light Processing, trademark owned by Texas Instruments). Similar to LCOS technology there is a chip with reflecting parts for each pixel. In this case there are micro mirrors that are modulated such, that within the period of an image frame the light is partially transmitted through the optics and partially at a light absorber. By this, different light intensities can be created. The switching time of the mirrors is very fast. The modulation frequency is up to 5000Hz. There is a delay of one frame between the time the data arrive at the projector and the image is displayed, i.e. before displaying an image the complete information of the frame has to arrive at the projector.

Colour convergence is done in two different ways. In case of a single chip projector the colour is sequentially combined, i.e. within a frame of display time using a colour wheel or comparable technology (e.g. coloured LEDs) the three basic colours are displayed at the screen, one after the other. In case of a three chip projector the colours are presented at the same time and colour convergence is done inside the projector. Caused by the mirror technology there is more brightness of these projectors compared to LCOS and the maintenance is very similar.

## **GLV (Grating Light Valve)**

The GLV is a micro electro-mechanical system used to reflect light. It is similar to DMD technology. A major difference is that the device covers one column of pixels of an image at once and the image is composed sequentially by the human eye and brain. Creating the sequence of columns at the screen mechanical mirroring devices are typically used. Furthermore laser light sources are used.

Therefore this technology has comparable advantages as single ray laser projectors.

## Single Ray Laser Projector

In case of a single ray laser each single pixel is created by the laser source and, using mirroring devices, sequentially the whole image is projected to the screen. This is very similar to CRT whereas in case of CRT the convergence of colour at the screen requires a high accuracy of adjustment. In case of the laser the colour is created inside the projector and for the single rays no focus is necessary. Laser light provides an extended colour space compared to other light sources.

## Human perception and temporal resolution

Judging the above mentioned characteristics of projector types it is necessary to know some basics about human visual perception of moving objects. The main topic here is whether an image is perceived as having blurring artefacts or not. There are mainly two reasons for blurring due to digital projection.

The first is linked to the ability of a projector to quickly switch between images. Assuming (as an extreme case for better understanding) a video showing a slow moving object (black box on white background) and a display that needs more than one frame switching between black and white (and vice versa) one can easily imagine, that the black box would have a grey and blurred contour at the front with respect to the moving direction and a grey tail at the rear. This perception is only due to the assumed technical capability of the display.

The second reason for perceiving an image as blurred is that human has a high performance sensor, processor and controller for vision. While looking at a moving object in reality it is possible to continuously focus on that object. This is possible because there is a continuous adjustment of the viewing position. The evolution of human being is not tuned to having something digital as 60Hz frame rate.

In case of having a perfect sequence of images at e.g. 60Hz, the result is a jumping image every 16.6ms. Looking at a video there still is a continuous moving of the eye but a discrete jumping of the displayed images. Therefore a moving spot in the video is moving back and forth on few receptors on the retina and not staying on a single position. This is perceived as blurring. This artefact occurs once the image is displayed more or less over the whole time of a frame. In case that the image consists of single light spots, which are displayed in a sequence, the light is seen only a fraction of the frame time and thus no blurring can be seen. This is the case when someone is looking at a CRT projection.

The way to reduce such perceived blurring is to reduce the time of exposure, i.e. to show the image only part of the time of a frame and the remaining time the display is black. In this manner switching times necessary to change a pixel can be hidden as well.

Such options are offered by some companies specialised on simulation projectors based on LCOS and three chip DMD devices. The compromise of this procedure is that the light output of the projector is reduced accordingly.

## **The Test procedures**

At BMW Group Research and Technology various projector technologies were tested and compared. This was done in order to decide on the appropriate projectors for the new display system for the dynamic driving simulator as well as for two systems in fixed base simulators. The procedure that was used to test projectors was developed in a pragmatic way step by step according to the increasing experience. The aim was to judge on projectors using driving simulation situations and scenarios as these give the correct and detailed information with respect to the environment in which the projectors would be used. As part of these tests were done at the facilities of the suppliers a transportable computer configuration was used including SPIDER [3], the driving simulation software of BMW Group Research and Technology.

In the area of flight simulation almost at the same time tests were done with various display technologies focusing on the perception of moving objects. Meanwhile the results are published [4, 5, 6]. Although using different image content and methods the results are quite similar to those gained by the authors.

## **Spatial Resolution**

When replacing projectors the aim always is to increase visibility conditions. In a common sense this is linked to the spatial resolution of a projection system. Taking human perception into account it is clear that spatial resolution is only one criterion amongst others. But definitely the spatial resolution is the basis. As the visibility conditions for moving objects can never be better than for a static image the first step of testing is to look at spatial resolution only.

In order to test other projector technologies and the advantage of increasing the resolution, side by side tests were done. For the first system to be selected which was the projection system of the dynamic simulator, the existing CRT projectors were the reference with a resolution of six arc minutes per optical line pair (6'/OLP). The tests were done with LCOS and DMD projectors of various kinds. The GLV and single ray laser projectors were not tested because on the one side the price for such systems was not within the available budget and on the other hand projectors as they are on the market today were not yet available.

The projectors to be tested were installed with a resolution of 3.5'/OLP to 4'/OLP. Although the final configuration would have a curved screen, the tests were done on a planar screen. In this configuration a dot by dot mapping of the generated image to the projector pixels is done and thus artefacts due to a warping unit are avoided

There are different situations in driving simulation that can be used to judge visibility with respect to resolution. One is to compare the maximum distance between a road sign and an observer so that reading the sign still is possible.

This test was done using an exit sign on the motorway. These kinds of signs can typically be read in a distance of round about 250 m-300 m. In the tests done the sign could be read in a distance of 50 m-80 m using a low resolution CRT and in a distance of 150 m-180 m using a higher resolution projector, no matter of what type.



**Figure 1. Judging visibility condition by reading a road sign**

Another important question is whether an observer is able to identify objects in a far distance. Looking along a road in the city was chosen as a representative situation. The road and the objects along the road such as pedestrians, parking cars and others were compared. A further question was whether it is possible to recognise that there is a T-crossing at the far end. There are several criteria for this assessment. One is to recognise that there is a building at the end of the road. Another is to identify cars (i.e. moving objects) driving in cross direction.



**Figure 2. Judging visibility condition by looking along a road and identifying objects**

The results of these tests showed that increasing the spatial resolution led to a significant increase in visibility. The image was perceived to be clear and sharp with the increased resolution. This result was quite independent of the technology of the projector.

## Temporal Resolution

After conclusion of the tests for spatial resolution it is important to know whether the visual quality is still available if the objects move. In a driving situation moving objects appear once the subject starts driving. In case of longitudinal speed (e.g. driving along a motorway) there occurs different moving of objects on the screen. Objects at the far front move slowly on the screen whereas objects in the vicinity of the driver move quickly and change their size at the same time. This situation is difficult for judging blurring effects. A better situation is the rotational



speed of objects that occurs when turning at a crossing. In this case all objects have the same speed on the screen and the size almost does not change. This is definitively easier to use for judging on temporal resolution.

The set-up used for investigation was a T-crossing of roads. The virtual camera was set in the centre of this junction and a rotation around the vertical axis through the camera was applied. Of course, this scenery is not easy to watch for everyone especially as rotational velocity increases. The tests were done always starting at low speeds. The maximum speed at which it was possible to judge on visual perception and thus on temporal resolution was 25%*s*. This is comparable to a manoeuvre of quickly turning at a crossing.



**Figure 3. Representation of the crossing used to judge on spatial resolution. The upper image is composed of four images in the direction of 0°/90°/180°/270°. The lower part shows details that were used to decide on readability**

The readability of road and traffic signs was one of the criteria to be evaluated. These signs were, as a reference, easy to read as long as the virtual camera was not in motion. The faster the rotation got the more difficult it was to read the text. Besides of the readability other characteristics were monitored, e.g. how vertical edges of houses or the structure of fences appear.

This rotational scenery was used as well to judge on the type of artefacts that a specific display technology would bring up. This was blurring, colour break up or kind of shadows depending on the projector technology. In this case only projectors that reduce the time the image is displayed (as described before) lead to really good results, i.e. the moving scenery was perceived as good as the non moving scene with respect to the criteria mentioned.

## Experience

Besides of the results already mentioned further experiences were made which are important for projector tests and decisions on projection systems.

First of all it is very important to know about the settings of a projector once doing a comparison. As high performance projectors are designed to support various use cases a lot of features modifying the video signal exist. As in case of moving images blurring is something to avoid features that are built in the

projector to increase sharpness or contrast have to be switched off as they lead to wrong results.

For the well being of a subject in a driving simulator the level of spatial and temporal resolution has to be almost equivalent. This was the result of a test that was done with a small number of subjects. Each subject had to sit on a chair in front of a screen and watch a driving scenario as if he was in the driver's seat. The subject had to judge on two different visual configurations. One with a resolution of 6'/OLP and the other with 4'/OLP. Both setups were displayed using a single chip DMD projector with colour wheel.

No matter whom we asked, once entering the test site with an image not in motion the higher resolution image was the really impressive one. But, as soon as motion of the image started there was a significant drop of perceived resolution. Subjects mentioned that everything is getting blurred. This effect was even more dramatic once driving with slightly deviations from the straight line. The blurring resulted from the yaw component of motion. In case of the 6'/OLP configuration the difference in perceived spatial and temporal resolution was less and therefore the overall quality (I'm feeling well) was judged better.

With increasing resolution more and more projectors are necessary to maintain a wide field of view (FoV). The more blending zones there are, the more possibilities exist where mismatches can occur. In order to gain a perfect and continuous image an extremely good edge blending is necessary. The adjustments necessary are of the dimension of a single pixel. In order to reduce the continuous effort necessary to maintain the high accuracy in the blending area an auto-calibration system is helpful.

Software blending, i.e. using continuous grey levels at the blending boundaries is easier to realise than hardware blending and at least for day time driving sceneries a good solution. But care has to be taken in case of DMD technologies as the grey level is a result of different modulation of the micro mirrors. Some chips use synchronised modulation for all equivalent grey levels. This leads to the artefact of flickering bands that human eye can perceive in the blending zone especially in case of saccadic eye movements.

A further issue that comes up with high resolution displays is that synchronisation gets more and more important as minor differences along the blending edges can be perceived. In order to run high resolution perfectly we introduced software synchronisation of the image generators into the driving simulation software SPIDER. Furthermore a hardware synchronisation between the graphic cards was installed.

Looking at the layout of a high resolution display the characteristics of human eye should be taken into account. The eye limiting resolution of approximately 2'/OLP is only available in the fovea of the eye. This is a very limited area of at the maximum a few degrees of angle. In this central area the subject is able to focus and have sharp vision. Thus the high resolution of a display system has to be installed only in the area where the subject is focusing at. In case of driving simulation tasks this is the road and the vicinity around as the driver continuously is scanning this area. Typically this is the area directly in front of the car. One can enhance this area as to be the area that can be seen through the windscreen at

the front which is roughly 30° to left and 50° to the right in case of a left-hand drive. For the peripheral area less resolution is sufficient. As there is a significant increase in perceived resolution once changing from 6'/OLP to 4'/OLP one would expect that the change in resolution can be clearly seen in a projector setup with varying resolution. Our experience is, that once the display is really continuous with respect to geometry, colour and brightness the change in resolution is something that subjects will not be aware of.

Changing from CRT to any digital projector there is a lot of light available. Although the contrast value given for a single projector is in the range of several hundreds to thousands the overall contrast of a wide field of view projection system is in the order of ten. The reason for this is that there is a lot of scattered light which changes the black level to a kind of grey level and thus reduces the available contrast. An approach to increase contrast of a unity gain screen is to reduce the gain, i.e. to change from a white to a grey screen. The effect of increasing the contrast is based on the fact that the scattered light is reduced and although the overall brightness decreases the contrast achieved increases.

This was an issue as well once fine tuning the new display systems at BMW Group Research and Technology. Doing tests with several tiles having different levels of grey the common opinion was that having a brighter image is preferable compared to an image on a grey screen that would have a higher contrast.

## **New Projection Systems in the Centre of Driving Simulation and Usability at BMW Group**

The different kinds of simulators in the Centre of Driving Simulation and Usability as well as the scope of examinations were presented earlier [1]. The projection systems mentioned here are those of the dynamic driving simulator and of two fixed base simulators with a wide FoV.

These projection systems have some of the requirements in common. The horizontal FoV should at least be 220° and the vertical FoV should be 24° to the top and 20° to the bottom based on a height of the driver's eye point of 1.15 m. The eye point distance should be greater than 3 m and the spatial resolution should at least be 6'/OLP and significantly smaller in case of the high resolution systems whereas reasonable placements and amount of blending areas had to be achieved.

### **The Dynamic Driving Simulator**

The dynamic driving simulator was equipped at the start with three CRT projectors presenting a 180° horizontal FoV image to the front at a spatial resolution of 6'/OLP to 7'/OLP. The decision on this projection system was taken once with respect to the excellent temporal resolution of CRT.

The upgrade of this projection system was the first project to start with. The requirements were to increase horizontal FoV to at least 220°, to increase brightness, to increase spatial resolution aiming for 3'/OLP and to get a system with significantly less demand for maintenance. As the blurring artefacts of

moving images displayed by CRT projectors are not recognisable the reference quality was at a very high level. The system to be selected should be on the same level.

The various projector tests showed that the high resolution requirements asked for a projector that would have minimal blurring artefacts in order to guarantee that the high spatial resolution would still be perceived once the objects move and thus fulfil the requirements of temporal resolution as well. Therefore only those projectors came into consideration which are equipped with a kind of a shutter functionality (no matter whether mechanically or electronically) in order to reduce the exposure time of every image of a frame. Best results were gained with a 50% blanking period.

The weight of the projection system was a critical issue as well. As the projectors are mounted on the ceiling of the dome they are critical with respect to the Eigenfrequency of the overall system. The compromise was to select a seven projector configuration (DMD) with a high resolution of 4'/OLP in the front (120° symmetric distributed to the right and left using five projectors in portrait format) and 6'/OLP at the side building in total a horizontal FoV of 240°.

## A New Fixed Base Simulator

After exchanging the projectors in the dynamic driving simulator the next task was to set up a new fixed base driving simulator that should be comparable to the dynamic driving simulator with respect to resolution and FoV.

For this purpose several projectors were tested. The reference was now the high quality projector (DMD technology) used in the dynamic driving simulator. The common requirement was to achieve a resolution of approximately 4'/OLP in the front of the driver and to be able to project on a cylindrical screen. As the budget available was less than for the previous system the question was which compromise had to be made. The tests done showed that if the high resolution to the front is a fixed requirement the projectors to be considered were the same that came into consideration for the dynamic driving simulator. Thus the trade-off was to reduce the high resolution area at the front, slightly reduce resolution and reduce the total horizontal FoV to 220°. The configuration selected consists of three projectors in portrait format to the front and two projectors at the side in landscape format. Once again there is a decrease in resolution from the centre to the side projection.

## The Upgrade of the existing Fixed Base Simulator

The existing fixed base driving simulator is in operation since many years. It had a five channel display system with 225° horizontal FoV using LCOS technology. During the projector tests comparisons were made to these older projectors as well. It could be seen clearly that even without changing the resolution an improvement of visual perception could be gained by exchanging the projection system.

For this projection system the requirements on resolution were less than for the previously mentioned fixed base simulator. The concept of the different driving

simulators in the Centre of Driving Simulation and Usability provides differently equipped driving simulators such that the decision which simulator to use is based on the requirement of the specific examination. This made it possible to exchange the existing projection system although the available budget was significantly less than for the new fixed base simulator mentioned before.

The projection system selected is based on three single chip DMD projectors covering almost 220° horizontal FoV on a cylindrical screen. The spatial resolution is approximately 6'/OLP. A significant higher resolution was not acceptable as the projectors do not have any feature of reducing the exposure time of every image of a frame and thus reduce the perceived blurring of digital projectors. The wide FoV for every projector requires a very flexible warping unit in order to set up the geometry correction. Another issue is that the performance of the image generator i.e. the graphics computer is even more critical than for the other projection systems mentioned as the content to be rendered is larger than for the other systems.

## Conclusion and Acknowledgment

With this paper the authors want to share their experience with others involved in similar tests and decisions. All in all this is the summary of the tests done over several years, starting with the first projector test up to the time all the three simulators were equipped with a new projection system.

It is neither the aim to give an advice on which projector to use nor which supplier to choose as technology and products on the market change continuously. Requirements vary for different simulators and not at last the available budget influences the possibilities. Therefore for any selection individual tests are necessary for which the given information is helpful.

The intensive testing of various projectors would not have been possible without the support of projector suppliers. The authors want to thank those involved in the testing for their intensive support and fruitful discussions.

**Keywords:** Driving Simulation, Projector Technology, Display System, Visual Perception

## Bibliography

Huesmann, A., Ehmanns, D., Wisselmann, D., (2006) Development of ADAS by Means of Driving Simulation. *Proc. Driving Simulation Conf. DSC Europe 2006*, 131-141

[http://en.wikipedia.org/wiki/CRT\\_projector](http://en.wikipedia.org/wiki/CRT_projector), DLP\_projector, Liquid\_crystal\_on\_silicon, Grating\_Light\_Valve

Strobl, M., Huesmann, A., (2004) High Flexibility – An Important Issue for User Studies in Driving Simulation. *Proc. Driving Simulation Conf. DSC Europe 2004*

- Winterbottom, M., Geri, G., Park, L., (2007) Task Validation of Display Temporal-Resolution Measurements. Interservice/Industry Training, Simulation, and Education Conference (I/ITSEC) 2007
- Winterbottom, M., Geri, G., Eidmann, C., Pierce, B., (2007) Perceptual Tests of the Temporal Response of a Shuttered LCoS Projector. SID 07Digest, pp. 334-337(2007)
- Winterbottom, M., Gaska, J., Geri, G., Sweet, B., (2008) Late-News Paper: Evaluation of a Prototype Grating-Light-Valve Laser Projector for Flight Simulation Applications. SID Symposium Digest of Technical Papers, 39(1), 911-914 (2008)

# Impact of Geometric Field Of View on Speed Perception

**Florent Colombet, Damien Paillot, Frédéric Mérienne, Andras Kemeny**

Arts et Metiers Paris Tech, CNRS, Le2i, Institut Image  
2 rue T. Dumorey, 71100 Chalon-sur-Saône, France

Technical Center for Simulation, Renault  
1 avenue du Golf, 78288 Guyancourt

colombet@cluny.ensam.fr, paillot@cluny.ensam.fr, merienne@cluny.ensam.fr,  
andras.kemeny@renault.com

**Abstract** – *This paper deals with changes of the geometric field of view on speed perception. This study has been carried out using the SAAM dynamic driving simulator (Arts et Métiers ParisTech). SAAM provides motion cues thanks to a 6 DOF electromechanical platform and is equipped with a cylindrical screen of 150°. 20 subjects have reproduced 2 speeds (50 km/h and 90 km/h) without knowing the numerical values of these consigns, and with 5 different visual scale factors: 0.70, 0.85, 1.00, 1.15 and 1.30. This visual scale factor correspond to the ratio between the driver's field of view covered by the screen (constant) and the geometric field of view. This study shows that this visual scale factor has a significant impact on the speed reached by the subjects and thus shows that perceived speed increases with this visual scale factor. A 0.15 modification of this factor is enough to obtain a significant effect. The modification of the geometric field of view remained unnoticed by all the subjects, which implies that this technique can be easily used to make drivers reduce their speed in driving simulation conditions. However, this technique may also modify perception of distances.*

**Résumé** - *Cet article présente l'effet du changement du champ de vision géométrique sur la perception de la vitesse. Cette étude a été réalisée sur le simulateur de conduite dynamique SAAM (Arts et Métiers ParisTech). SAAM utilise une plate-forme électromécanique à 6 DDL et est équipé d'un écran cylindrique de 150° pour restituer la sensation de mouvement. 20 sujets ont reproduit 2 vitesses (50 km/h et 90 km/h), sans connaître les valeurs de ces vitesses, et avec 5 facteurs d'échelle visuelle différents : 0.70, 0.85, 1.00, 1.15 et 1.30. Ces facteurs d'échelle correspondent aux rapports entre le champ de vision du conducteur couvert par l'image (constant) et le champ de vision géométrique. Cette étude montre que ce changement visuel a un impact significatif sur la vitesse qu'atteignent les sujets et montre donc que la vitesse perçue augmente avec ce facteur d'échelle visuelle. Un changement de 0.15 de ce facteur suffit pour obtenir un effet significatif. Les changements de champ de vision*

*géométrique n'ont été détectés par aucun des sujets, ce qui implique que cette technique peut facilement être utilisée pour amener les conducteurs à réduire leur vitesse en conditions de simulation de conduite. Cependant, cette technique pourrait aussi modifier la perception des distances.*

## Introduction

Driving simulation allows car manufacturers to develop and test their future cars with digital prototypes and thus reducing the number of physical prototypes. It is thus possible to test the ergonomics, the comfort, the safety, new driving aid systems with drivers in the loop. To ensure the behavior fidelity of the drivers and thus the validity of these studies, drivers have to be provided with motion cues as close as possible with those in real conditions. That's why a large number of human factors studies (Kemeny & Panerai, 2003) (Kennedy *et al.*, 1993) have been carried out with driving simulators to study driver behavior or self-motion perception in driving conditions.

In this paper we will investigate more precisely speed perception. Previous studies (review in Kemeny & Panerai, 2003) show that many factors influence perception of speed, such as optic flow, time-to-contact, field of view, angular declination, image contrast or weather conditions. Perception of speed has been deeply investigated by several authors such as (Lappe *et al.*, 1999) who claim that optic flow is the main factor for perception of self-motion. (Berthoz *et al.*, 1975) have also shown the importance of peripheral vision for the perception of linear horizontal self-motion. According to (Jamson, 2000), the image resolution and the field of view have a significant impact on speed perception. (Panerai *et al.*, 2001) showed the significant influence of the height of the driver viewpoint on perception of speed in comparison to real-world driving.

More recently, (Mourant *et al.*, 2007) studied the influence of the geometric field of view on speed perception. In his experiment, he asked subjects to produce certain speeds (30 and 60 mph) on a static driving simulator with a 45 deg curved screen and with different geometric field of view (GFOV) conditions (25, 55 and 85 deg). He found that produced speed was highly correlated to the GFOV and that produced speed decreased when the GFOV increases. (Diels & Parkes, 2009) made a similar experiment on the TRL driving simulator (visual display covering 210 deg, vibrations rendering, no motion). Subjects were also asked to produce different speeds (20, 30, 50 and 70 mph) with four different GFOV conditions (175, 210, 245 and 280 deg). He obtained similar results.

(Mourant *et al.*, 2007) and (Diels & Parkes, 2009) both claim that perceived speed increases linearly with the size of the GFOV. However in their studies, subjects are asked to produce and not to reproduce vehicle speeds. As speed perception depends on driving conditions (Panerai *et al.*, 2001), in this paper we propose to investigate more precisely the impact of GFOV modifications on speed perception with a speed reproduction task. This experiment has been done with the dynamic driving simulator SAAM (Arts et Métiers ParisTech / Renault, previously referred to as SAM (Colombet *et al.*, 2009)).



## Method

### Participants

Twenty volunteer subjects (3 female and 17 male) external to the lab participated in this study. They ranged in age from 20 to 69 years old (mean 44 years old). They all had 10/10 or corrected to 10/10 vision, held a valid driving license for almost 2 years (mean 25 years) and drove 26 000 km/year on average.

### Driving simulator

This experiment was carried out using the SAAM (referred to previously as SAM (Colombet *et al.*, 2009), see Figure 1) dynamic driving simulator. It is composed of a cockpit based on a Renault Twingo II standard car which has been lightened and instrumented. The inside of the cockpit is unchanged so it is visually identical to the initial car.



**Figure 1. SAAM dynamic driving simulator  
(Arts et Métiers ParisTech / Renault)**

Visual environment is projected thanks to 3 DLP projectors at a 1280x1024 resolution per channel on a 150° cylindrical screen. The screen is high enough for its top not to be seen by the driver. The cockpit and the screen are interdependent thanks to a chassis that also liaise between the cockpit and the upper frame of the electromechanical platform.

Accelerations are rendered thanks to a Gough-Stewart electromechanical platform (MOOG 2000 E) which allows 6 degrees of freedom ( $\pm 20$  deg,  $\pm 0.25$  m,  $\pm 5$  m/s<sup>2</sup>). A classical motion cueing algorithm with anti-backlash filters (Reymond & Kemeny, 2000) is used to compute the simulator displacements. In this algorithm, high-frequency accelerations are rendered by simulator displacements while low-frequency accelerations are rendered by tilt-coordination. Simulated vehicle vibrations are not rendered.

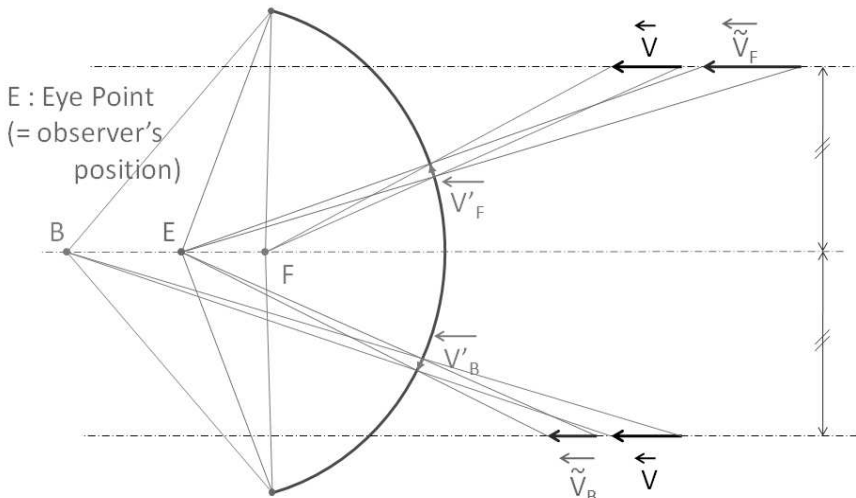
Haptic rendering is done on the steering wheel (active electromechanical system) and on the pedals (passive mechanical system). The gearbox is the original five speed automatic gearbox of the car. Sound of the engine, the road and the traffic is rendered through the cockpit speakers located in the doors. The whole driving simulation is generated by the SCANeR® II software (Oktal, Renault).

Surrounding parasite sounds (such as actuators noise) are cut off thanks to the cockpit which is completely closed. An intercom facility yet allows for communication between the cockpit and the control room.

## Expected results

SAAM dynamic simulator differs from those used by (Mourant *et al.*, 2007) and (Diels & Parkes, 2009) in terms of motion restitution (respectively no motion and only vibrations) and in terms of horizontal field of view cover (respectively 55° and 210°). However we expect the same result: perceived speed will grow up as geometric field of view increases.

To increase the GFOV, the computational point of view is moved forward or backward to decrease the GFOV. As shows Figure 2, modifying geometric field of view will modify optic flow. The same velocity vector  $\vec{V}$  is displayed on the screen in  $\vec{V}'_F$  if display is computed from point F and in  $\vec{V}'_B$  if display is computed from point B. As the driver stays in point E, he will perceive  $\vec{V}_F$  by seeing  $\vec{V}'_F$  and  $\vec{V}_B$  by seeing  $\vec{V}'_B$ . And because  $\vec{V}_F > \vec{V}$  and  $\vec{V}_B < \vec{V}$ , and also because optic flow is one of the main factors for speed perception (Lappe *et al.*, 1999), we can suppose that speed perception will increase (respectively decrease) when the computational point of view is moved forward (respectively backward).

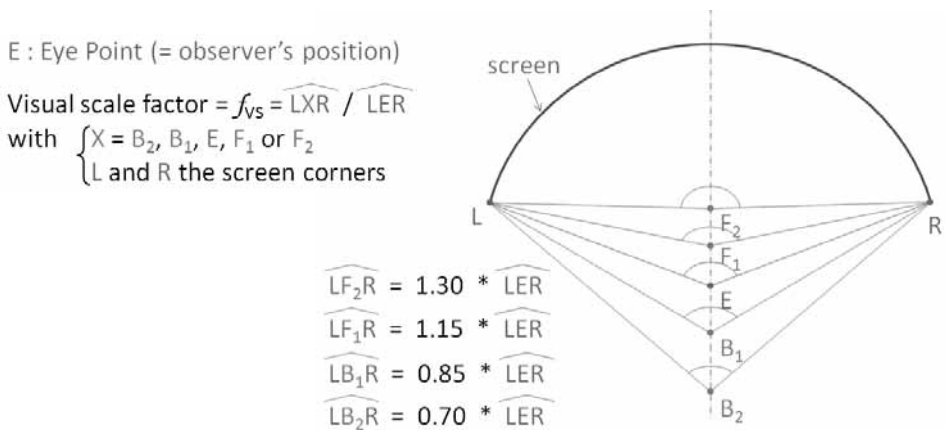


**Figure 2. Influence of computational point of view on both GROV and speed perception**

## Experimental conditions

To verify our hypothesis, five visual conditions were compared (see Figures 3 and 4). The driver's eye-point is situated at point E. Traditionally display is computed from this same point. In our experiment, we varied the point of view used to compute the visual scene. Five different points were used: B<sub>1</sub>, B<sub>2</sub>, E, F<sub>1</sub> and F<sub>2</sub>, all lined up along the longitudinal axis. F<sub>1</sub> and F<sub>2</sub> are located ahead of E, and B<sub>1</sub>, B<sub>2</sub> behind of E.

As driving simulators used by (Mourant *et al.*, 2007) and (Diels & Parkes, 2009) do not provide the same cover of driver's field of view, we cannot compare our results as functions of the GFOV. So we have defined the visual scale factor  $f_{VS}$  as the ratio between the geometric field of view and the field of view covered by the screen. The positions of points B<sub>1</sub>, B<sub>2</sub>, E, F<sub>1</sub> and F<sub>2</sub> have been determined in order to obtain five different visual scale factors: respectively 0.70, 0.85, 1.00, 1.15 and 1.30.



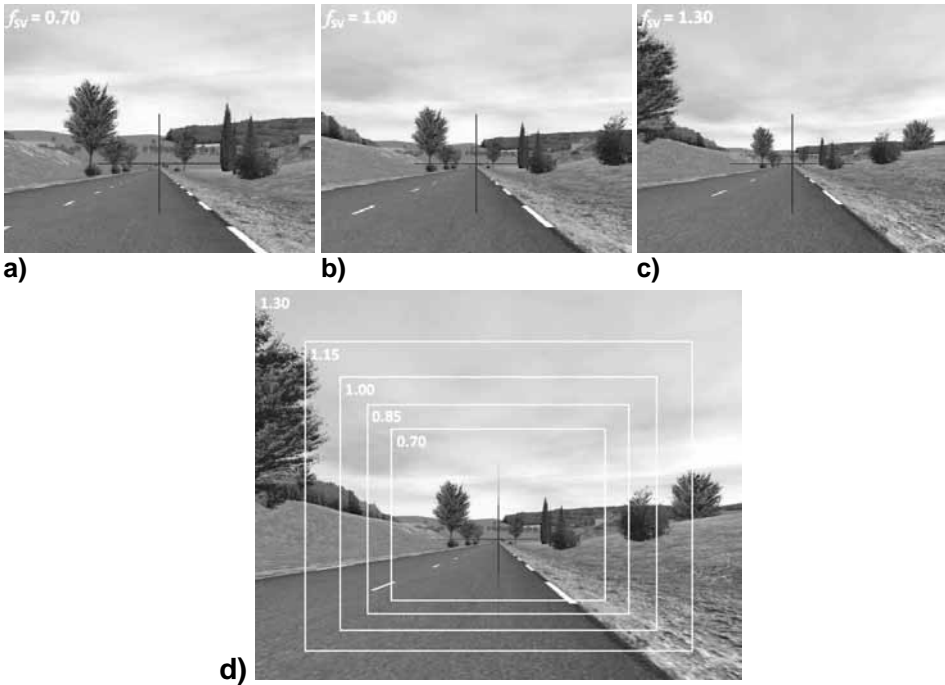
**Figure 3. Schematic presenting the different point of views in relation to the screen. Point E is the eye point, that is to say the observer's point of view. Display should normally be computed from point E. But for the experiment, it was computed from 5 different points: B<sub>1</sub>, B<sub>2</sub>, E, F<sub>1</sub> and F<sub>2</sub>, all lined up along the longitudinal axis**

In every case, the computed image is displayed on the whole screen. In this way the driver's field of view covered by the virtual scene remains identical during all the experiment.

Figure 4 presents screenshots from central display with different visual scale factors, showing the effect on the computed image. The car is always at the same position for all these screenshots.

## Experimental protocol

After a free practice drive to familiarize with the driving simulator, subjects were asked to reproduce two speeds (50 km/h and 90 km/h) in the 5 different visual conditions. The experiment took place on a straight country road (see screenshots in Figure 4).



**Figure 4. Screenshots taken with visual scale factors of 0.70, 1.00 and 1.30 in respectively a), b) and c). In d), 5 screenshots (corresponding to the 5 visual scale factors 0.70, 0.85, 1.00, 1.15 and 1.30) are superposed. All these screenshots correspond to only the center image displayed in the simulator (corresponding to 52° of driver's horizontal field of view)**

For each speed and for each visual condition, subjects drove two times. First they drove with a speed regulator (cruise control) at the consign speed. Speedometer was hidden so they didn't know the numerical value of this speed and thus no bias was introduced. The visual scale factor was then of 1.00. This first driving session lasted about 1 min.

For the second driving session, the speed regulator was disabled and the visual scale factor was randomly changed. Subjects were asked to reach the speed at which they were the first time and then to act the turn signal. The reached speed at which they felt like at consign speed was measured as soon as the turn signal was activated. Besides, as sound plays also an important role in speed perception (Kemeny & Panerai, 2003), it was disabled for this second driving session in order to see more clearly the impact of visual scale factor. Speed perception is analyzed through the speed reached by the subjects. Actually the more the speed perception grows the more the speed reached will decrease for the same perceived speed.

Each participant tested every visual scale factor with every consign speed. The order of treatment of these 10 conditions was random. Table 1 summarizes the simulator configurations for the 2 driving sessions repeated by the subject 10 times (one for each configuration in random order).

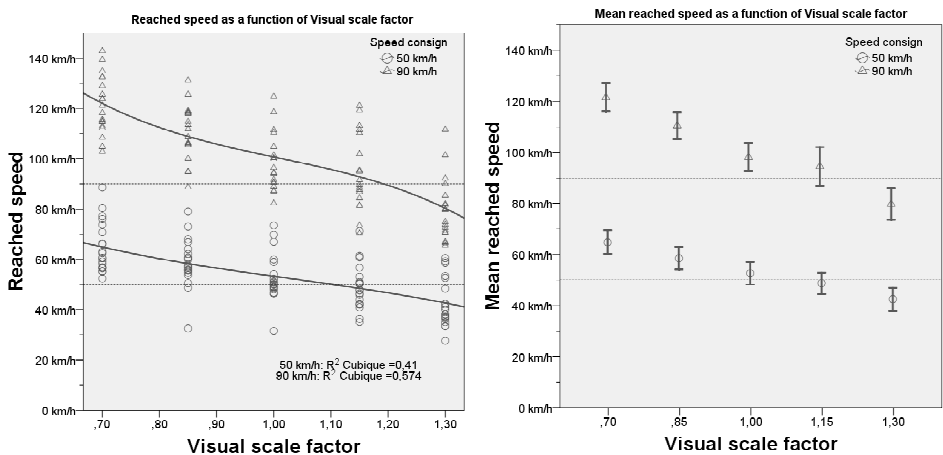
**Table 1. For each of the 10 conditions (2 different consigns of speed and 5 different visual scale factors), subject had to drive 2 times. This table summarizes the simulator configurations for these two driving sessions**

	1 <sup>st</sup> driving session	2 <sup>nd</sup> driving session
<b>Speed consign</b>	50 km/h or 90 km/h	Same as in first driving session
<b>Visual scale factor <math>f_{sv}</math></b>	1.0	0.70, 0.85, 1.00, 1.15 or 1.30 randomly
<b>Speed regulator</b>	Enabled: forced to speed consign (not piloted by driver)	Disabled
<b>Sound</b>	Enabled	Disabled
<b>Speedometer</b>	Hidden	Hidden
<b>Motion rendering / haptic rendering</b>	Enabled	Enabled

After the experiment, subjects were asked if they noticed any change in the simulator settings between the different driving sessions.

## Results

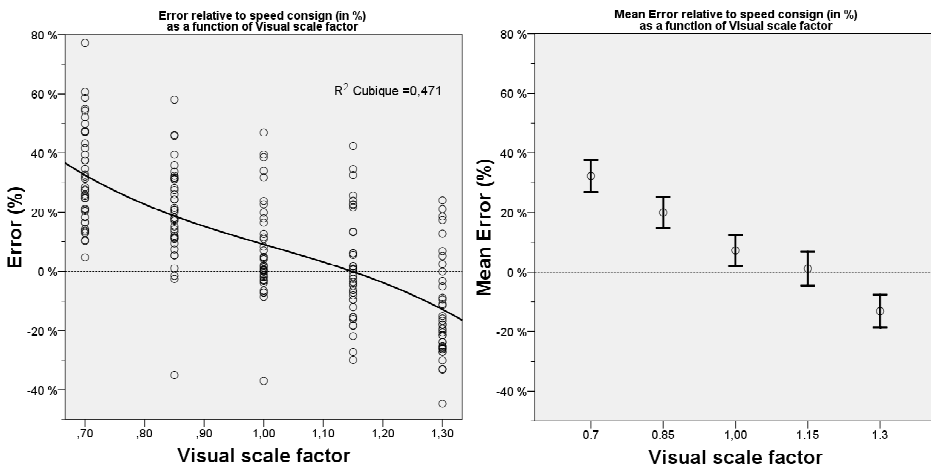
Figure 5 presents the speeds reached by the participants as a function of the visual scale factor. Values are sorted by corresponding speed consign (50 km/h in blue circles and 90 km/h in red triangles). Left graph presents all the values and right graph presents the means and the error bars representing 95% confidence level.



**Figure 5. Reached speed (on the left) and mean reached speed (on the right) as functions of visual scale factor for both speed consigns (50 km/h in circles and 90 km/h in triangles). Vertical error bars represent 95% confidence level**

We can see on these graphs that as expected, speed reached by the participants is decreasing while the visual scale factor is increasing and actually means that perceived speed is increasing with the visual scale factor. This decrease seems to be done along a cubic function. Cubic regressions have been done and the  $R^2$  coefficients' corresponding to the 50 km/h and the 90 km/h consigs are respectively 0.41 and 0.574.

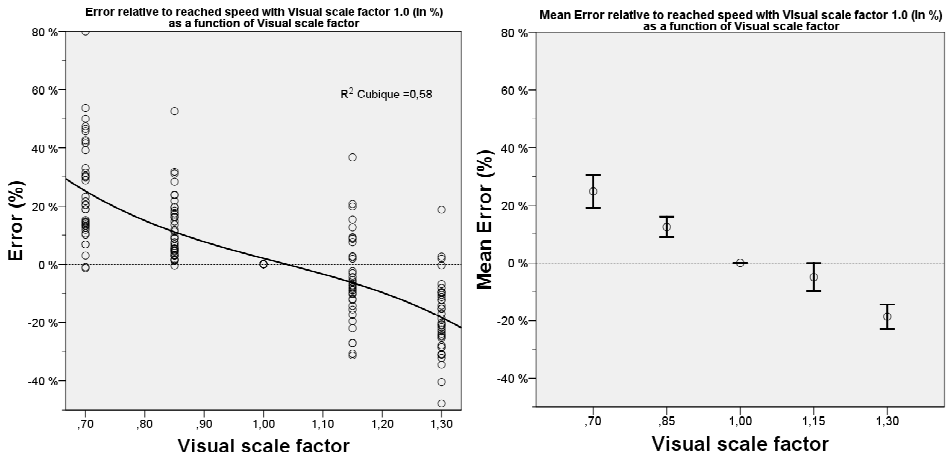
For studying at the same time data corresponding to these 2 different speed consigs, errors relative to speed consigs have been computed. Figure 6 presents the obtained values (on the left) and the corresponding mean errors (on the right) as functions of the visual scale factor. We can see that error is also decreasing along a cubic function ( $R^2 = 0.471$ ) while the visual scale factor is increasing.



**Figure 6. Error (on the left) and mean error (on the right) relative to speed consign displayed as functions of visual scale factor. Vertical error bars represent 95% confidence level**

In order to study individual results, we also computed for each data the error relative to the speed reached by the same subject for the same speed consign with the visual scale factor of 1.0. We obtained the results presented in Figure 7 where we can see that this error is also decreasing along a cubic function ( $R^2 = 0.58$ ). We can also see that there is almost no negative value for 0.70 and 0.85 visual scale factors (respectively 5% and 3%) whereas there are some positive values for 1.15 and 1.30 visual scale factors (respectively 33% and 10%). That means that relatively to the speed that subjects reached with visual scale factor of 1.0, they drove faster in 96% of the case with 0.70 and 0.85 factors. But with 1.15 and 1.30 factors, subjects drive more slowly in only 79% of the case.

A one-factor ANOVA with Tukey post hoc tests was used to analyze these error data. It showed that visual scale factor is highly significant with  $p < 0.001$ . Post hoc results show significant differences between each visual scale factor ( $p < 0.001$ ) except between 1.00 and 1.15 for which we obtain  $p = 0.431$ .



**Figure 7. Error (on the left) and mean error (on the right) relative to speed reached by the same subject with the same speed consign with a visual scale factor of 1.0, as functions of visual scale factor. Vertical error bars represent 95% confidence level**

To the question: “*Did you notice any chagement in the simulator settings between the different driving sessions ?*”, all the subjects answered they did not notice any chagement.

## Discussion and perspectives

We showed that for a speed reproduction task, visual scale factor modifications significantly impacted the speed reached by the subjects, which means that speed perception increases with the visual scale factor. We also showed that a modification of 0.15 of the visual scale factor was enough to obtain a highly significant impact ( $p < 0.001$ ) on speed perception. Furthermore, these visual modifications were subtle enough to remain unnoticed by drivers. So this technique can easily be employed to have drivers reduce or increase their speed in driving simulation conditions.

These first conclusions are consistent with those obtained by (Mourant *et al.*, 2007) and (Diels & Parkes, 2009) though the task (speed reproduction instead of speed production) and the simulation conditions (dynamic with 6 DOF instead of respectively no motion and only vibrations) were different. On the other hand we also found that the variation of speed perception as a function of visual scale factor seems to be stronger when reducing the visual scale factor than when it is increased (see Figure 7). The fact that drivers seem more inclined to raise their speed rather than to reduce it could be one explanation. The absence of audio cues could also explain this result.

On the Figure 6, we can see that the error relative to the speed consign is minimum (in absolute value) for a 1.15 visual scale factor. This value is close to the result of 1.22 that (Diels & Parkes, 2009) obtain with their speed production task. In our experiment, this 1.15 value is hard to explain because the subjects were asked to reproduce a speed, and not to produce it relatively to their own real

experience. So we could have expected to find a result more close to 1.00 than 1.15. Once again, the lack of sound cues can explain this discrepancy.

## Perspectives

We have seen that GFOV modification has an impact on speed perception and seems to remain unnoticed by drivers. And as speed perception is often underestimated in virtual reality applications (Banton *et al.*, 2005), using the visual scale factor could be used for dedicated driving simulators, especially for low cost driving simulators vs. full scale driving simulators. However, the difference between the actual speed and the perceived speed seems also to depend on the speed according to (Mourant *et al.*, 2007). So the GFOV should be dynamically changed as a function of the vehicle speed. Yet effects of dynamic variations of the visual scale factor have not been investigated and knowing the necessary conditions to keep these variations unnoticed by the drivers seems necessary. Furthermore, as acceleration is mathematically the speed derivative, dynamic variations of the GFOV may also have an effect on acceleration perception.

We can also notice that perception of distances may be affected by the visual scale factor (see Figure 2). For the driver,  $\bar{V}_B$  could be perceived "nearer" than  $\bar{V}$  and  $\bar{V}_F$  "farther" than  $\bar{V}$ . We can also see on Figure 11 that e.g. the same tree seems nearer on picture a) than on picture c). As perception of distances is important (Kemeny & Panerai, 2003) to carry out elementary driving tasks such as keeping safety distances or taking a curve, studies to determine the precise effect of the visual scale factor on perception of distances and/or on elementary driving tasks should also be considered. It could then allow concluding on the usability of this technique and to determine the conditions of experimental use.

## Acknowledgements

This work has been done thanks to the support of Le Grand Chalons.

## Bibliography

- Banton, T., Stefanucci, J., Durgin, F., Fass, A., & Proffitt, D. (2005). The perception of walking speed in a virtual environment. *Presence: Teleoperators and Virtual Environments*, 14 (4), 394-406.
- Berthoz, A., Pavard, B., & Young, L. R. (1975). Perception of linear horizontal self-motion induced by peripheral vision (linearvection) basic characteristics and visual-vestibular interactions. *Experimental Brain Research*, 23, 471-489.
- Colombet, F., Kemeny, A., Mérienne, F., & Père, C. (2009). Motion cueing strategies for driving simulators. *Proceedings of the WINVR 09 Conference*. Chalons-sur-Saône, France.
- Diels, C., & Parkes, A. M. (2009). Geometric Field Of View Manipulations Affect Perceived Speed in Driving Simulators. *Proceedings of the Road Safety and Simulation Conference*. Paris, France.



- Jamson, A. H. (2000). Driving Simulator Validity: Issues of Field of View and Resolution. *Proceedings of the Driving Simulation Conference*, 57-64. Paris, France.
- Kemeny, A., & Panerai, F. (2003). Evaluating perception in driving simulation experiments. *TRENDS in Cognitive Science*, 7 (1), 31-37.
- Kennedy, R. S., Lane, N. E., Berbaum, K. S., & Lilienthal, M. G. (1993). Simulator Sickness Questionnaire: An Enhanced Method for Quantifying Simulator Sickness. *The International Journal of Aviation Psychology*, 3, 203-220.
- Lappe, M., Bremmer, F., & van den Berg, A. V. (1999). Perception of self-motion from visual flow. *Trends in Cognitive Sciences*, 3 (9), 329-336.
- Mourant, R. R., Ahmad, N., Jaeger, B. K., & Lin, Y. (2007). Optic flow and geometric field of view in a driving simulator display. *Displays*, 28, 145-149.
- Panerai, F., Droulez, J., Kelada, J. M., Kemeny, A., Balligand, E., & Favre, B. (2001). Speed and safety distance control in truck driving: comparison of simulation and real-world environment. *Proceedings of the Driving Simulation Conference*, 91-108. Sophia Antipolis (Nice), France.
- Reymond, G., & Kemeny, A. (2000). Motion cueing in the Renault driving simulator. *Vehicle System Dynamics*, 34, 249-259.



# Influence of Display Type on Drivers' Performance in a motion-based Driving Simulator

**Volker Grabe, Paolo Pretto, Paolo Robuffo Giordano, Heinrich H. Bühlhoff**

Max Planck Institute For Biological Cybernetics, Department of Human Perception, Cognition and Action  
Spemannstr. 44, 72076 Tübingen, Germany

volker.grabe@tuebingen.mpg.de, paolo.pretto@tuebingen.mpg.de,  
paolor.giordano@tuebingen.mpg.de, heinrichh.buehlhoff@tuebingen.mpg.de

**Abstract** – *Different solutions are used on driving simulators to provide visual feedback. In this study, we investigated the influence of projection technology and field of view on drivers' performance in a slalom driving task. We tested a head mounted display against a curved projection system on our CyberMotion simulator, based on an anthropomorphic robot arm. The results showed that drivers performed significantly better using the projection screen than the HMD. The FoV and the motion simulation did not have a measurable influence on the performance.*

## Introduction

It is well known that large projection screens with wide field of view (FoV) provide motion cues in the periphery of the visual field that can result in a greater sense ofvection (Hettinger & Riccio, 1992; Mohler, Riecke, Thompson, & Bühlhoff, 2005), more accurate navigation abilities (Alfano & Michel, 1990), and more accurate perception of self-motion (Pretto, Ogier, Bühlhoff, & Bresciani, 2009). For instance, in a driving simulation scenario, a wide FoV provides a better estimation of speed (Jamson, 2000; Pretto, Vidal, & Chatziastros, 2008) while in flight simulation a FoV bigger than 60 degrees helps in the cruise phase (Keller, Schnell, Lemos, Glaab, & Parrish, 2003). However, motion-based simulators often lack the space for large projection screens, and therefore small screens or head mounted displays (HMD) are sometimes used.

Traditional HMDs provide a small FoV and create discomfort in the user (Mon-Williams, Warm, & Rushton, 1993). Wide FoV visualization systems may also result in greater simulator sickness compared with more limited FoV devices (Sparto, Whitney, Hodges, Furman, & Redfern, 2004). However, recent lightweight HMDs, combined with head tracking, reduce the users' discomfort and

provide a wide horizontal FoV (Peli, 1998). Yet, these devices influence distance judgments (Willemssen, Colton, Creem-Regehr, & Thompson, 2009). Therefore, the use of HMDs instead of large screens, and the corresponding impacts on driving capabilities, is still an issue but also represents an interesting option for motion-based driving simulators. Moreover, the effects on driving performance of wide FoV in these two types of visualization devices need to be assessed using state-of-the-art setups. To address these issues we used our CyberMotion simulator to compare drivers' performance on a slalom task with different visualization setups and different FoV sizes. Such task was chosen because it requires driving accuracy, which might be influenced by the visual information available from wide FoVs.

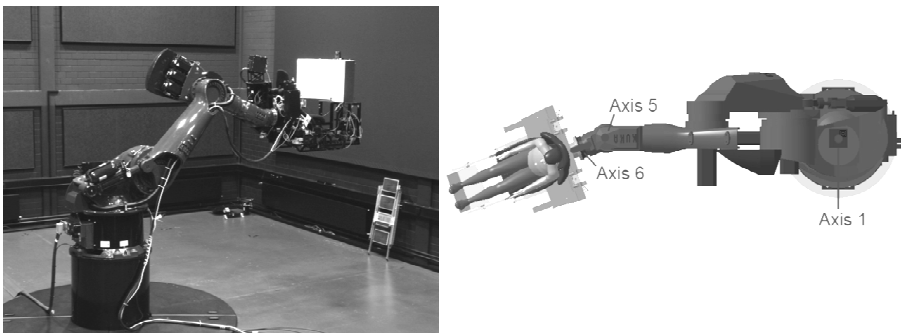
Simulated motion represents also an important factor in driving precision, and depending on the visualization device, this might interfere with drivers' accuracy. Specifically in absence of head tracking, the HMD could create visuo/vestibular conflict due to unintentional head motion induced by the simulator motion. Therefore, we compared drivers' performance also between static conditions in which head motion is minimized.

## Method

### Setup

#### Apparatus

The CyberMotion simulator is based on an anthropomorphic robot manipulator with six degrees of freedom (Figure 1) and derived from an industrial heavy load robot (Kuka AG, 2010; Teufel *et al.*, 2007).



**Figure 1. (a) The CyberMotion Simulator. (b) A sketch of the simulator axis used in the experiment, seen from the top. Axis 1 at the base simulated lateral translations. Heading and roll motions were simulated by axis 5 and 6**

A force feedback steering wheel was used as input device for closed-loop control of the virtual vehicle. As visualization devices, we used a projection screen mounted in front of the seat with a horizontal FoV of  $90^\circ$  and a vertical FoV of  $45^\circ$ . A video projector displayed an image of  $1152 \times 450$  pixels on a curved screen at a distance of approximately 73 cm in front of the subject's eyes (Figure 2a). For

comparison, we used a Sensics xSight 6123 HMD (Sensics Inc., 2010) with a horizontal FoV of  $118^\circ$  and a vertical FoV of  $45^\circ$  (Figure 2b). The low weight of 400 grams limits neck strain and therefore makes it particularly suitable for use on a motion simulator. Each eye piece is rotated outwards off the viewing direction by  $16.75^\circ$  and consists of six individual OLED micro displays. Special lenses are used to overlap all six displays to one seamless image of  $1920 \times 1200$  pixels in each eye. Given a binocular overlap of  $53^\circ$ , the resolution of both eyes combined is  $2664 \times 1200$  pixels. Since no head tracking was used, a similar transport delay for both visual systems can be assumed.



**Figure 2. (a) The projection screen mounted to the CyberMotion Simulator; (b) the Sensics xSight HMD. The optics for both eyes can be moved sidewise to match the user's anatomy**

## Vehicle simulation

Heading and roll motion of the virtual car were simulated according to a simple vehicle model based on Ackermann steering geometry, using axis 5 and 6 respectively (Figure 1b). Lateral translations were mapped into planar circular trajectories with a radius of 3.1 meters. The lateral displacement on the road was simulated by rotating axis 1 at the base of the robot with a scale factor of 0.6. The used vehicle model was validated in a previous study and behaves dynamically in a sensible manner (Pretto, Nusseck, Teufel, & Bülthoff, 2009).

## Visual environment

The visual environment was modeled using the 3D rendering engine OGRE and consisted of a straight road in a forest setting. Trees of different size were placed randomly alongside the road and were repositioned throughout the experiment. A stone wall flanked the textured road to provide a richer visual feedback (Figure 3).

The slalom path was outlined by 15 gates over three consecutive sections. Each gate was 2 meters wide and alternately displaced 3 m to the left and to the right of the center line on a two-lane road. The distance between gates was 62.5 meters in the first and third section, while it varied between 45 and 55 meters, in steps of 2.5 meters, in the middle section. At every run, all five inter-gate distances in the middle section occurred only once, in random order.



**Figure 3. Screenshot of the environment as displayed on the screen in the 90° FoV condition**

## Participants

Ten experienced drivers (1 female, 9 males) were paid to participate in the experiment. They had at least four years of driving experience on a daily basis. The age of the participants was ranging from 22 to 38 with an average of 25.7 years. All subjects had normal or corrected to normal vision using contact lenses. None of them wore glasses. Before entering the simulator they signed an informed consensus.

## Design and procedure

The drivers' task was to complete the slalom course and drive as smooth as possible through each gate. Participants were instructed to rest their head at the back of the seat to minimize involuntary head movements. The simulation started 100 m before the first gate and lasted for 100 more meters after the last gate.

After entering the simulator, participants were provided with a brief training session. First, they saw a video of the optimal driving path; afterwards, they performed once the slalom with the screen setup and 90° FoV to familiarize with the simulator motion and the experimental conditions. The virtual vehicle was traveling at a constant speed of 70 km/h.

Each participant carried out the slalom maneuver with five display settings: I. screen with small FoV (45°); II. HMD with small FoV (45°); III. screen with wide FoV (90°); IV. HMD with wide FoV (90°); V. HMD with very wide FoV (118°). Two additional conditions without physical motion (screen and HMD with 90° FoV) to control for HMD discomfort with static head were added. The vertical FoV was 45° in all conditions.

In a typical driving session, a driver performed four blocks of twelve slalom maneuvers, alternating with another driver after each block. The visualization devices were alternated over the four blocks and between the two drivers. A block

with HMD consisted of four conditions (no motion, 45°, 90° and 118°) repeated three times in random order. In turn, a block with screen consisted of three conditions (no motion, 45° and 90°) repeated four times in random order. Short breaks after four slaloms were allowed to prevent motion sickness. An entire session lasted approximately four hours.

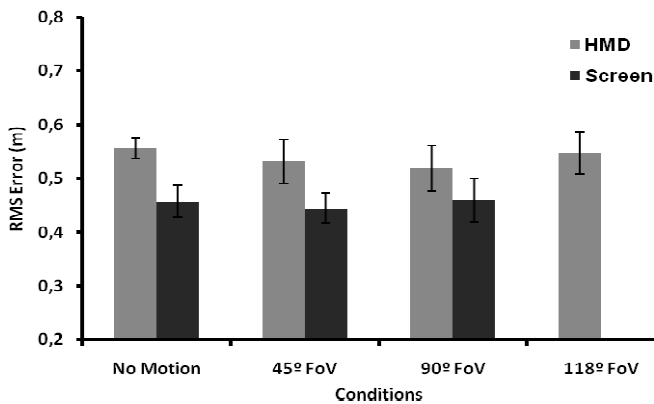
## Measures

A smooth trajectory that passes through the center of each gate was computed using cubic Hermite splines as a flexible estimation of a sinusoid curve (Cossalter & Doria, 2004). Driver's performance was measured in terms of deviation from this path within each two consecutive gates. The Root Mean Square Error (RMSE) from the path was averaged across participants and compared between the tested conditions.

All data was recorded at the rate of 12 ms for the entire experiment. The data from the first and the last gate, as well as from missed gates, were excluded from the analysis.

## Results

We found a significant difference in the performance between the two devices. At a paired-sample t-test the HMD resulted to provide significantly worse results than the screen ( $t_9 = 3.566$ ,  $p < 0.01$ ). This result is supported by the observation that 27 gates were missed when using the HMD, while only one was missed when using the screen. The size of the FoV had no significant effect on driving precision, with both HMD ( $F(2,18) = 0.85$ ,  $p = 0.41$ ) and screen ( $t_9 = 0.593$ ,  $p = 0.568$ ) (Figure 4). Simulated motion did not improve driver's performance in our slalom task ( $F(1,9) = 0.17$ ,  $p = 0.69$ ). Furthermore there was no interaction between motion and the two devices ( $F(1,9) = 0.99$ ,  $p = 0.35$ ).



**Figure 4. Driving performance under different display and motion conditions. Each bar represents data averaged across 10 subjects. The “No Motion” conditions were provided with a FoV of 90°. The error bars indicate standard errors**

## **Discussion and Conclusions**

Our study shows that the deviation from the optimal path in a slalom-driving task is lower when drivers see the virtual environment on a screen rather than on an HMD. This result is consistent with the findings of a previous study in which subjects performed worse with HMD on a self-motion perceptual task (Riecke, Schulte-Pelkum, & Bülthoff, 2005).

Although the resolution, as well as brightness and contrast, were superior in the HMD as compared to the screen, other features of the device might have contributed to its bad performance. A recent study compared HMDs with real world situations and showed that restricted FoV together with high inertial weight on the head results in bad distance judgments (Willemsen, Colton, Creem-Regehr, & Thompson, 2009). However, in our study the HMD had a lower weight and a wider FoV, therefore we might assume that potential effects on perception were reduced.

Other critical factors of the HMD are pincushion and keystone distortion. It has been shown that pincushion distortion does not affect perceptual judgments (Kuhl, Thompson, & Creem-regehr, 2008). In the Sensics HMD, however, the image of each eye is generated by merging the images of six sub-displays, each of them with little pincushion distortion. Moreover, no method to compensate for keystone distortions in the individual displays is provided by the manufacturer and, therefore, it is not possible to set up a perfect transition between the sub-displays in the outer regions of the visual field. How all these optical distortions are perceived is still an issue that needs to be further investigated.

Recent works have shown that a FoV limited to 58° and 42° did not affect humans' abilities in distance judgments (Creem-Regehr, Willemsen, Gooch, & Thompson, 2005; Knapp & Loomis, 2003). In line with this, our study demonstrates that a large FoV does not improve drivers' capabilities to accomplish a slalom task. This result can be explained by the drivers' gaze behavior when driving around a curve. It has been shown, indeed, that drivers look at the inner edge of the road when approaching a curve (Land & Lee, 1994) and therefore, in a slalom task, the driver's gaze is likely to be directed towards the inner side of the approaching gate. In our experiment, the widest visual angle between the heading of the vehicle and the approaching gate was less than 10°. This would indicate that the slalom task is essentially performed in central vision, and additional cues provided by the periphery of the visual field are not taken into account. The smallest (45°) FoV condition of our experiment contained already all the useful information and a slalom path with sharper curves would be necessary to enhance the role of a wide FoV.

In our study physical motion did not affect drivers' performance. In contrast, it has been shown that physical motion improves pilot's performance on a complex helicopter control task (Nieuwenhuizen, Zaal, Teufel, Mulder, & Bülthoff, 2009). This suggests that motion supports the pilot to carry out demanding maneuvers, but it is less important when operating vehicles with more direct control as in our experiment. We assume that experienced drivers could easily carry out our slalom task, resulting in performance saturation. We will address this in future projects by increasing the difficulty of the task.



Finally, the lower performance in the HMD conditions cannot be attributed to the lack of head tracking. In fact, no interaction effect was found between trials with and without physical motion, even within the HMD conditions. This supports the assumption that unintentional head motion was limited and visual/vestibular conflicts were minimal.

## **Bibliography**

- Alfano, P. L., & Michel, G. F. (1990). Restricting the field of view: perceptual and performance effects. *Perceptual & Motor Skills*, 70(1), 35-45.
- Cossalter, V., & Doria, A. (2004). Analysis of motorcycle slalom manoeuvres using the Mozzi axis concept. *Vehicle System Dynamics*, 42(3), 175-194.
- Creem-Regehr, S. H., Willemsen, P., Gooch, A. A., & Thompson, W. B. (2005). The influence of restricted viewing conditions on egocentric distance perception: implications for real and virtual indoor environments. *Perception*, 34(2), 191-204.
- Hettinger, L. J., & Riccio, G. E. (1992). Visually induced motion sickness in virtual environments. *Presence: Teleoperators and Virtual Environments*, 1(3), 306-310.
- Jamson, H. (2000). Driving simulation validity: issues of field of view and resolution. In *Proceedings of the Driving Simulation Conference* (pp. 57-64). Paris, France.
- Keller, M., Schnell, T., Lemos, K., Glaab, L., & Parrish, R. (2003). Pilot performance as a function of display resolution and field of view in a simulated terrain following flight task using a synthetic vision system. In *Digital Avionics Systems Conference* (pp. 9.E.5-91-12).
- Knapp, J. M., & Loomis, J. M. (2003). Limited Field of View of Head-Mounted Displays Is Not the Cause of Distance Underestimation in Virtual. *Presence: Teleoperators and Virtual Environments*, 13(5), 572-577.
- Kuhl, S. A., Thompson, W. B., & Creem-regehr, S. H. (2008). HMD calibration and its effects on distance judgments. In *Proceedings of the 5th Symposium on Applied Perception in Graphics and Visualization* (pp. 15-22). Los Angeles, USA.
- Kuka AG. (2010). <http://www.kuka-entertainment.com/en/>. Retrieved from <http://www.kuka-entertainment.com/en/>.
- Land, M. F., & Lee, D. N. (1994). Where we look when we steer. *Nature*, 369(6483), 742-744.
- Mohler, B. J., Riecke, B. E., Thompson, W. B., & Bülthoff, H. H. (2005). Measuring vection in a large screen virtual environment. In *Proceedings of the 2nd Symposium on Applied Perception in Graphics and Visualization* (pp. 103-109). A Coruña, Spain.

- Mon-Williams, M., Warm, J. P., & Rushton, S. (1993). Binocular vision in a virtual world: visual deficits following the wearing of a head-mounted display. *Ophthalmic and Physiological Optics*, 13(4), 387-391.
- Nieuwenhuizen, F. M., Zaal, P. M., Teufel, H. J., Mulder, M., & Bülthoff, H. H. (2009). The Effect of Simulator Motion on Pilot Control Behaviour for Agile and Inert Helicopter Dynamics. In *Proceedings of the 35th European Rotorcraft Forum* (pp. 1-13). Hamburg, Germany.
- Peli, E. (1998). The visual effects of head-mounted display (HMD) are not distinguishable from those of desk-top computer display. *Vision Research*, 38(13), 2053-2066.
- Pretto, P., Nusseck, H., Teufel, H., & Bülthoff, H. H. (2009). Effect of lateral motion on drivers' performance in the MPI motion simulator. In *Proceedings of the Driving Simulation Conference* (pp. 121-131). Monaco.
- Pretto, P., Ogier, M., Bülthoff, H. H., & Bresciani, J. (2009). Influence of the size of the field of view on motion perception. *Computers & Graphics*, 33(2), 139-146.
- Pretto, P., Vidal, M., & Chatziastros, A. (2008). Why fog increases the perceived speed. In *Proceedings of the Driving Simulation Conference* (pp. 223-235). Monaco.
- Riecke, B. E., Schulte-Pelkum, J., & Bülthoff, H. H. (2005). Perceiving Simulated Ego-Motions in Virtual Reality - Comparing Large Screen Displays with HMDs. In *Proceedings of the International Society for Optical Engineering* (pp. 344-355). San Jose, USA.
- Sensics Inc. (2010). <http://sensics.com/products/xSight/>. Retrieved from <http://sensics.com/products/xSight/>.
- Sparto, P. J., Whitney, S. L., Hodges, L. F., Furman, J. M., & Redfern, M. S. (2004). Simulator sickness when performing gaze shifts within a wide field of view optic flow environment: preliminary evidence for using virtual reality in vestibular rehabilitation. *Journal of NeuroEngineering and Rehabilitation*, 1(14).
- Teufel, H. J., Nusseck, H., Beykirch, K. A., Butler, J. S., Kerger, M., Bülthoff, H. H., *et al.* (2007). MPI Motion Simulator: Development and Analysis of a Novel Motion Simulator. In *Proceedings of the AIAA Modeling and Simulation Technologies Conference and Exhibit* (pp. 1-11). Reston, VA, USA.
- Willemsen, P., Colton, M. B., Creem-Regehr, S. H., & Thompson, W. B. (2009). The effects of head-mounted display mechanical properties and field of view on distance judgments in virtual environments. *ACM Transactions on Applied Perception*, 6(2), 1-14.

# Transport Delay Characterization of SCANeR Driving Simulator

**François Saidi, Guillaume Millet, Gilles Gallée**

Oktal SA,

19, Bd des Nations Unies, 92190 Meudon - France

francois.saidi@oktal.fr, guillaume.millet@oktal.fr, gille.gallee@oktal.fr

**Abstract** – *Considering the high impact of system latency on simulator sickness and fidelity, the overall driving simulator as well as each subsystem must be carefully designed to limit system latency (e.g. system delay or transport delay) and the variation of this latency. This paper first describes improvement done in SCANeR software architecture to reduce and stabilize transport delays values. The most important source of transport delay is identified as being related to the asynchronous architecture of the software. To overcome that problem a scheduler was developed to precisely control the synchronization of the whole software component. In a second part the paper presents the approach used to measure hardware related transport delay in order to specify a suitable configuration for a high performance full scale dynamic driving simulator. This study includes hardware and software instrumentation in which the latency of each subsystem is measured.*

**Résumé** - *Etant donné l'importance des effets de la latence sur la mal du simulateur ainsi que sur la fidélité du rendu, aussi bien le simulateur de conduite au complet que chaque sous-système doivent être soigneusement conçus pour limiter la latence du système et les fluctuations de cette latence. Cet article décrit dans un premier temps l'étude de l'architecture du logiciel de simulation de conduite SCANeR ainsi que les améliorations faites pour réduire et stabiliser la latence du système. L'étude a montré que la source principale de latence est due à l'architecture asynchrone du logiciel. Afin de remédier à problème, un ordonnanceur a été mis au point afin de contrôler finement la synchronisation des différents composants du logiciel. Dans une deuxième partie l'article présente le protocole expérimental ainsi que les résultats des mesures de latences dues aux périphériques matériels du simulateur, dans le but de fournir des spécifications pour un simulateur dynamique de conduite. Cette étude se base sur une instrumentation aussi bien logicielle que matérielle pour fournir des mesures de latence de chaque sous-système.*

## Introduction

Considering the high impact of system latency on simulator sickness and fidelity [5], the overall driving simulator as well as each subsystem must be carefully designed to limit system latency (e.g. system delay or transport delay) and the variation of this latency.

This paper first describes improvement done in SCANeR software architecture to reduce and stabilize transport delays values. In a second part the paper presents the approach used to measure hardware related transport delay in order to specify a suitable configuration for a high performance full scale dynamic driving simulator.

## Background

Simulator transport delay characterization received a lot of attention from simulator operator and manufacturers [1] [2] [3]. Different frameworks have been proposed, most of them relying on real time OS and expensive hardware for inter-host communication.

With the ever-decreasing price of multi-core CPU and high bandwidth Ethernet networks these choices should be reconsidered. Using a different approach, SCANeR™ can run on non real time os and conventional hardware reducing development cost without sacrificing high performance and determinism.

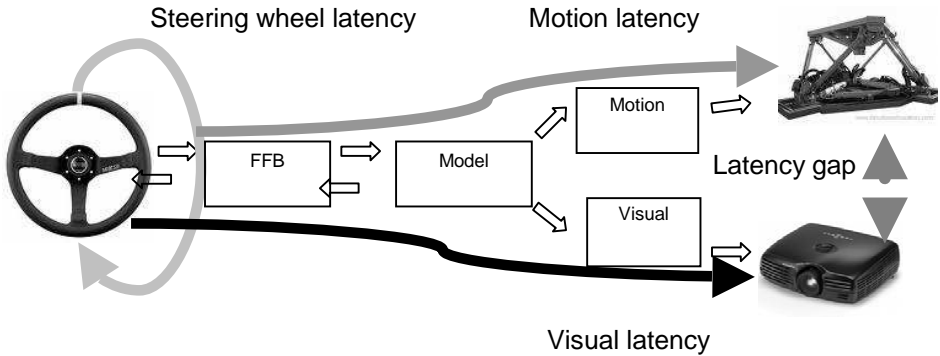
Different sources of delay have been classified [4]:

1. **Off-host delay:** Duration between the occurrence of a physical event and its arrival on the host.
2. **Computational delay:** Time elapsed while the data is in the host system and while the system is doing computations.
3. **Rendering delay:** Time elapsed while the graphics engine is generating the resulting picture.
4. **Display delay:** Time elapsed between sending images to the display and the display actually showing them.
5. **Synchronization delay:** The time in which data is waiting between stages without being processed.
6. **Frame-rate-induced delay:** Between two frames the display is not updated, causing the user to see an outdated image stream.

Each type of latency should be kept as low as possible. This cannot only be achieved by efficient software architecture but a high performance hardware selection and tuning is also necessary.

The system latency is measured between the activation of the steering wheel and the system response (through the visual system or the motion system).

Four latencies define the performance level (Figure 1): The Motion latency, The Visual latency, The Steering wheel latency, and The latency gap between Motion and Visual.



**Figure 1. System latencies**

The latency gap measures the delay between the effect of the steering wheel input on the platform and the effect on the display. In other words this latency gap expresses the asynchronism between vision and motion. This is considered to be the most important latency involved in the simulator sickness and should be kept as small as possible.

## Software architecture measurement and improvement

We undertook extensive studies on transport delay of SCANer™ software. These studies include source code instrumentation and data analysis; they revealed two main areas for improvement:

1. Synchronization between modules
2. Precision of the system timer

The following sections present a brief summary of these results and the solutions and improvement made in each area.

### Synchronization issues

The simulation software relies on a distributed architecture taking advantage of modern multi-cpu hardware. This distributed architecture has nevertheless some complexity drawback and special care must be taken for the synchronization of the various modules. In previous versions of the software, synchronization of the different module was random and a high jittering configuration could happen frequently (Figure 2). In the figures below, M1, M2 and M3 are the critical components involved in the motion latency (we find a similar scheme for the visual latency).

M1 is the Force Feed Back (FFB) module, M2 the Dynamic Model and M3 the Motion module. All modules are running at 500 Hz in these tests.

M1 and M3 modules have a small execution time compared to their time slice, whereas M2 (the dynamic model) can use as much as 80% of its time slice. In such a configuration, the starting time of the module M3 was near the ending time of M2 and the transport delay jittered between 3 and 5 ms (Figure 3).

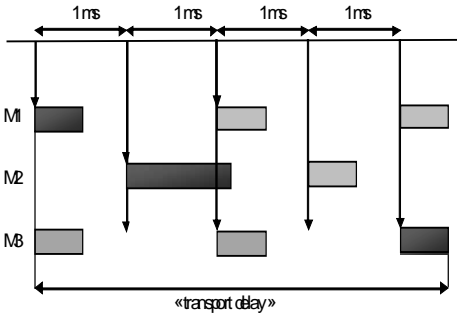


Figure 2. Random synchronization

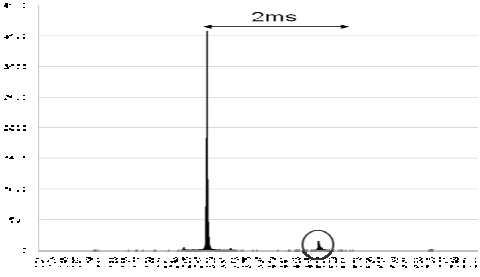


Figure 3. Unscheduled transport delay histogram (horizontal axis in ms, vertical is the number of occurrences)

However, a better synchronization configuration, as shown on Figure 4, could happen but this was also random. Such a configuration provided a transport delay stabilized around 3 ms (Figure 6).

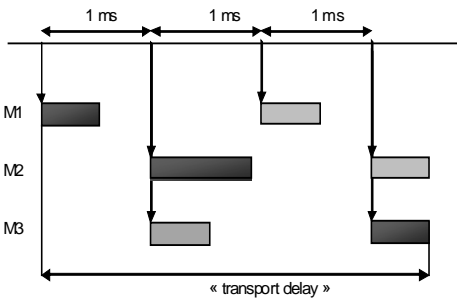


Figure 4. Scheduled synchronization

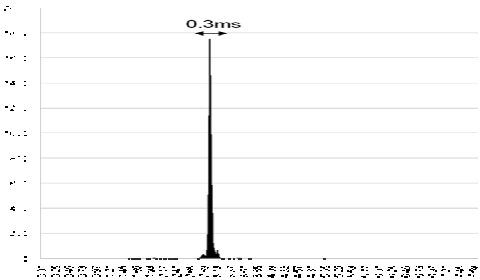


Figure 5. Scheduled transport delay histogram (horizontal axis in ms, vertical is the number of occurrences). The peak is at 3 ms

In order to precisely control the synchronization between the critical modules, a scheduler is needed. This scheduler should guarantee that the user defined synchronization configuration is maintained all over the simulation providing a stabilized transport delay.

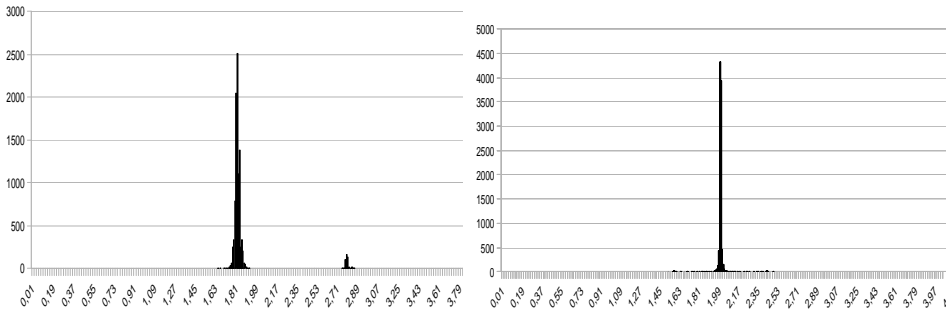
## Precision of the system timer

SCANer™ software and in particular the high frequency scheduler relies on the operating system timing performance.

The histograms below show the frequency stability of the system timer on both Microsoft Windows XP and VISTA/SEVEN.

We notice that the frequency regulation of a 500 Hz timer on windows XP (Figure 7) is less precise (most values are around 1.8 ms and few of them around 2.8 ms). On windows VISTA 99% of the values are around 2 ms. This study

reveals a more precise timer regulation under VISTA OS, similar results are found under windows SEVEN which additionally embed a faster user interface. The use of windows SEVEN is mandatory when running a scheduling component at high frequencies (1000 Hz).

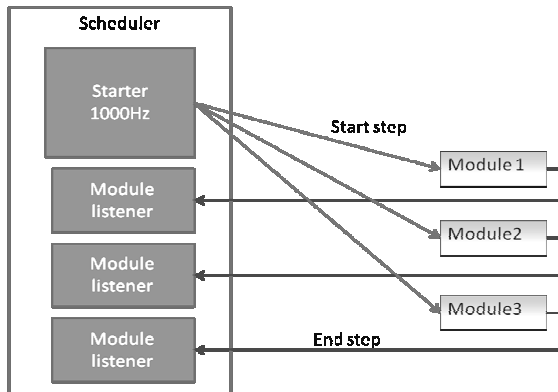


**Figure 7. Frequency histogram of Windows XP timer (left) and VISTA (right) (horizontal axis in ms, vertical is the number of occurrences)**

## Scheduler conception

The scheduler is a software module which should run on the same computer as the FFB, Dynamic Model and Motion module (the critical modules). It controls the starting sequence of each step of the critical modules. The scheduler module runs at 1000 Hz and a configuration file defines the timings between the various modules that must be scheduled.

The scheduler is divided in several threads (Figure 8). A starter thread which sends the start event for each scheduled module and a set of listener threads (one for each scheduled module) to receive the execution end notification of a given module.



**Figure 8. Scheduler architecture**

The evolutions described above led to significant performance improvements of the simulation software which reaches a 3 ms software transport delay with 0.3 ms jittering for the path from FFB through Model and to the Motion module.

# Hardware interfaces subsystem performance evaluation

This section studies the performance of each subsystem of the simulator independently. These tests were done under a Quad-Core Q6600 CPU under Windows VISTA OS. Test were performed using an oscilloscope together with an accelerometer for moving devices (motion platform and steering wheel), photodiodes for projectors, and I/O cards for signaling internal events in the software.

## Steering wheel latency

The first experiment was to measure the steering wheel latency. The force feedback loop architecture is designed to optimize the transport of information from the steering wheel to the vehicle model (angle acquisition) and from the vehicle model to the steering wheel motor (steering torque). The advanced vehicle dynamics model is in charge of the computation of the steering torque according to the driver input and the driving conditions. Experiments were done on a Sensodrive SD-LC with two different kind of CAN interface a USB and PCI with no noticeable performance difference.

A specific version of the FFB module has been used to perform this test. This FFB module periodically sends a high torque value command to the steering wheel controller and simultaneously signaling this event by a 1 value on the pin 0 of the parallel port. This module also reads the speed value of the steering wheel and sets the pin 1 of the parallel port to 1 when a non-zero value is detected. An accelerometer was fixed on the steering wheel and connected to the oscilloscope. Parallel port pin 0 and 1 were connected to the oscilloscope to as described on the Figure 9. The result of this test is shown on Figure 10.

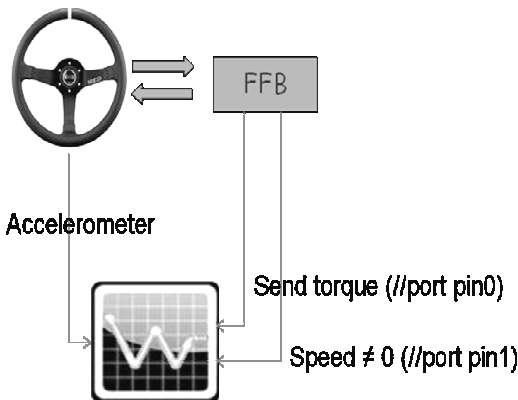


Figure 9. Steering wheel measurement

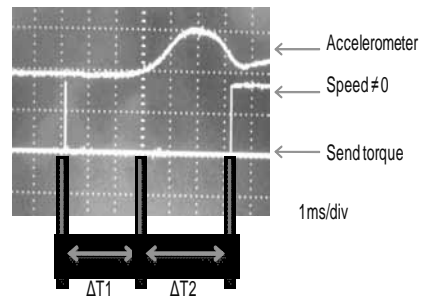


Figure 10. Results with FFB at 500 Hz

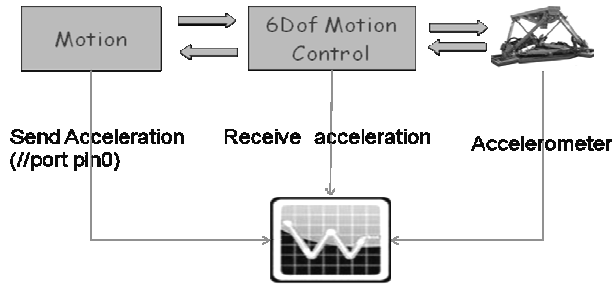
The minimum (6 ms) value has been reached for a FFB frequency of 500 Hz. Over 500 Hz, we did not notice any improvement, the bottleneck being shifted to the steering wheel internal control or the CAN bus communication.



## Motion platform latency

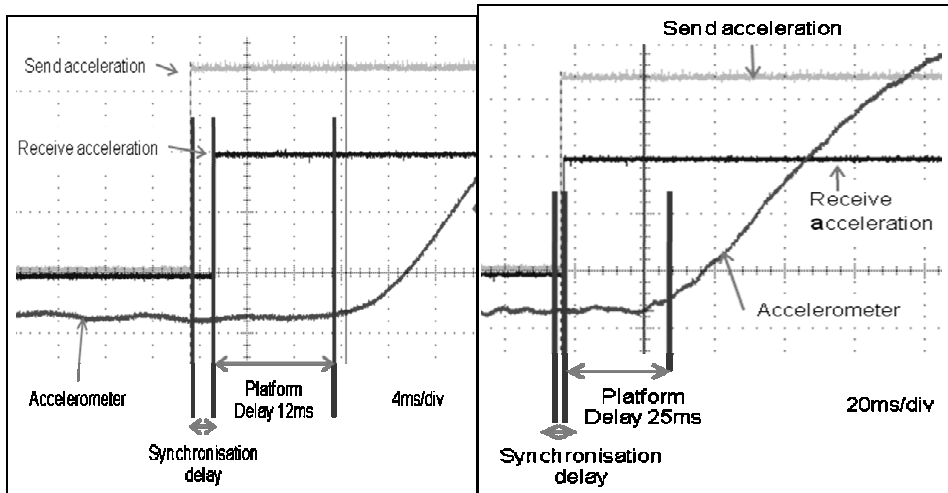
The aim of this second test was to measure the motion platform delay. The tests were done on a Rexroth 6Dof motion platform with a 2500 kg payload.

A specific version of the Motion module has been used to perform this test. This Motion module periodically sends an acceleration value command to the Rexroth control computer and simultaneously signaling this event by a 1 value on the pin 0 of the parallel port. Additionally the Rexroth 6Dof motion control signals the reception of acceleration through an IO card. An accelerometer was fixed on the motion platform and connected to the oscilloscope. Pin 0 and the output of the 6Dof Motion controller IO card were also connected to the oscilloscope as described on Figure 11.



**Figure 11. Motion platform measurement**

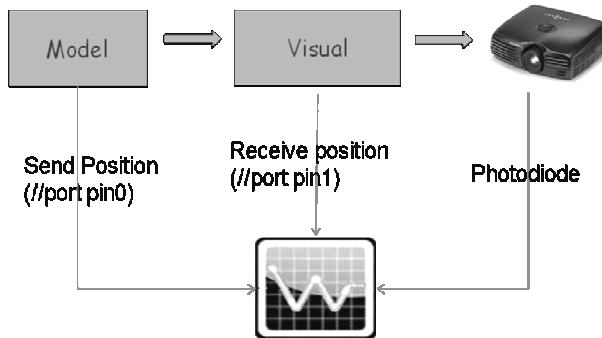
The measured platform delay changes depending on the cueing cut-off filtering value (Figure 12). For a low-pass filter of 5 Hz the transport delay is around 25 ms and for 75 Hz it drops to 12 ms. A series of other experiments were conducted which showed that the platform delay can reach 35 ms. This variation of the platform transport delay does not occur during a simulation but changes only when the cueing settings are modified.



**Figure 12. Motion platform results with a cueing filtering cut-off value at 75 Hz on the left and 5 Hz on the right**

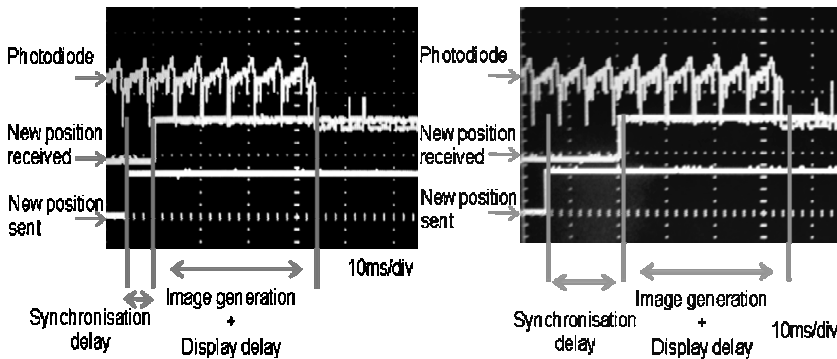
## Visual system

The last test was about measuring the display delay of the video projector. The tests were done with two different DLP projectors. The dynamic model and the visual module were running on two computers. A specific version of the Dynamic Model and the Visual module were used to perform this test. The Model module periodically toggles between a vehicle position corresponding to a bright area of the database and a dark area; this causes a sudden change in the projector intensity easily measurable by a photodiode. Simultaneously the Model module signals the position change by 1 value on the pin 0 of the parallel port. The Visual module is modified to signal a position change by 1 value on the pin 0 of his parallel port. The Visual module frequency (display rate) is 60 Hz. Figure 13 shows the experimental setting, with a photodiode in front of the projector linked to the oscilloscope along with parallel port pin 0 of both computers running Dynamic Model and the Visual module.



**Figure 13. Visual system measurement**

Results showed an important disparity between low cost projectors and high cost, simulation specific, projectors. The display delay vary from one to two frames from the time the frame start to flow out of the VGA connector to the moment where it is fully displayed on the screen. This confirms that the choice of low latency projector is an important issue for high performance simulator.



**Figure 14. Visual transport delay of 2 consecutive measured with a low latency projector**

Another important issue is the synchronization delay (Figure 14) between the model and visual. Because both process run on separated computers, this delay will vary from 0 to 16 ms (the visual module frequency is 60 Hz). A way of generating a synchronization signal from the scheduler to lock the image generation process is under study.

## Conclusion

According to previous results we could estimate the global transport delay of a simulator based on SCANeR™ software and the selected hardware:

1. The average value of the Visual latency is lower or equal to 48.5 ms ( $\pm 8.5$  ms)
2. The average value of the Motion latency can be between 19 ms and 37 ms ( $\pm 1$  ms) depending on the cueing settings.
3. The average value of the latency gap can be between 29.5 and 11.5 ms without delay compensation.
4. The value of the steering wheel latency is around 9 ms.

These values are rather low compared to other simulator, and can easily stand the comparison with simulators based on real time OS. These values show that the bottleneck is the image display and generation frequency leaving some room for improvement.

Ongoing work aims at measuring the end-to-end transport delay of a complete simulator. Moreover an online monitoring of the transport delay is also planned.

The high performance architecture of this simulation software is flexible and optimized, allowing to run the dynamic model and the steering wheel force feedback loop at high frequencies pushing back the frontiers of non real time OS.

**Keyword:** Transport delay, optimization, synchronization

## Bibliography

- Papelis, Y., Qidwai, M., Schwarz, C., Dolan, J., (2005) Characterization of NADS Subsystem Transport Delays. *Proceedings of the Driving Simulation Conference*, DSC USA 2005.
- Worl, R., (2006) Dynamic Measurement of Simulator Transport Delays. *Defense Science and Technology Organization*, Australia.
- Shwarz, C., Gates, T., Papelis, Y., (2003) Motion Characteristics of the National Advanced Driving Simulator *Proceedings of the Driving Simulation Conference*, DSC USA 2003.
- Jacobs, M. C., Livingston, M. A., State, A., Managing Latency in Complex Augmented Reality Systems, *Proceedings of 1997 Symposium on Interactive 3D Graphics*, ACM SIGGRAPH 1997.
- Kemeny, A., Simulation and Perception, *Proceedings of the Driving Simulation Conference*, DSC Europe 2000.



# Software assembly and open standards for driving simulation

Nicolas Filliard<sup>1</sup>, Emmanuel Icart<sup>2</sup>, Jean-Luc Martinez<sup>1</sup>, Sébastien Gérin<sup>1</sup>, Frédéric Mérienne<sup>1</sup>, Andras Kemeny<sup>1,2</sup>

<sup>1</sup> Arts et Métiers Paristech, Le2i, CNRS, Institut Image,  
2 rue Thomas Dumorey - Chalon-sur-Saône, France

<sup>2</sup> Renault, Technical Centre for Simulation

1 avenue du Golf - 78288 Guyancourt

nicolas.filliard@gmail.com, emmanuel.icart@renault.com,  
jean-luc.martinez@cluny.ensam.fr, sebastien.gerin@cluny.ensam.fr,  
frederic.merienne@ensam.eu, andras.kemeny@renault.com

**Abstract** – *Driving simulation systems involve a combination of different computation codes. Although some of these modules are application-specific, their majority is reusable and state-of-the-art implementations are readily available in the open source community. This study investigates whether these open source libraries can combine to build a driving simulation application with reasonable performance. To this end, a component-oriented architecture is proposed, in which modules encapsulate relevant libraries behind a standard interface and exchange simulation data through a message passing interface. By integrating a render engine, a physics library and a simple vehicle dynamics model, we were able to rapidly build a functional minimal simulation application supporting distributed execution over a cluster of computers. As this architecture allows the transparent modification of module code and simplifies the addition of new modules, this kernel represents the foundations of an extensible and reconfigurable open source system dedicated to driving simulation. Details on this kernel application and ongoing development of this platform can found at <http://open-s.sourceforge.net>.*

**Résumé** - *Les logiciels de simulation de conduite reposent sur une combinaison de différents codes de calculs. Bien qu'une partie de ces modules soit extrêmement dépendante d'un usage particulier, leur majorité est réutilisable et certaines implémentations de pointe sont disponibles dans la communauté du logiciel libre. Cette étude vise à déterminer s'il est possible de combiner ces bibliothèques libres afin de construire une application de simulation de conduite atteignant de raisonnables performances. A cette fin, nous proposons une architecture orientée composant, selon laquelle ces bibliothèques sont encapsulées dans des modules s'échangeant des données relatives à la simulation au travers d'une interface d'échange de messages. En intégrant à cette architecture un moteur graphique, une bibliothèque de simulation de*

*physique et un simple modèle de dynamique de véhicule, nous avons pu rapidement mettre en place une application de simulation minimale, pouvant s'exécuter de manière distribuée sur un cluster d'ordinateurs. Cette architecture permettant de modifier le code d'un module de manière transparente et simplifiant l'ajout de nouveaux modules, ce noyau constitue la base d'un logiciel libre extensible et polymorphique dédié à la simulation de conduite dont les détails peuvent être consultés sur le site : <http://open-s.sourceforge.net>.*

## **Introduction**

As suggested a decade ago by the initial authors of VRJuggler, an open-source integration platform for virtual reality, VR developers should “concentrate on the worlds they want to create and not the systems on which they run” [22]. The same remark applies to driving simulation. Building a driving simulation software system implies indeed a complex interplay of different modules based on very different technologies and requires a wide variety of technical skills to build a complete system including image rendering, physics simulation, vehicle dynamics modeling, acquisition of drivers' commands, sound generation, traffic simulation, etc.

Although applications of driving simulation may vary and require specific functionalities, the majority of these components follows exactly the same standardized specifications across implementations and could be reused. In particular, state-of-the-art software libraries are available in the *open source* community to handle graphics rendering, dynamics models, inter-process communication, scenario programming, etc. [1-9]. Yet, these well-known open source libraries have never been assembled to build a complete driving simulator. Particularly, questions about their compatibility and the expected overall performance remain undocumented.

A major interest of studying these solutions is to reduce development costs by taking advantage of mature, often cross-platform, open source projects, which benefit from evolutions required in connected communities (e.g. the game industry for visual rendering). Therefore, this approach enables developers of driving simulators to concentrate their efforts on advanced features or specific to industrial applications. Notably, a number of licenses under which open source libraries are distributed like LGPL (Lesser GNU Public License) [11] allow their use in proprietary products. Moreover, using open source software for driving simulation is particularly adapted to experimental research studies which often require specific adaptation to fit the particular needs of their protocols.

## **Purpose of the current work**

After a brief overview of relevant open-source libraries, we intend to show in this article how these elements can combine to produce a driving simulation application with advanced performance. We present in this article a functioning simulator constructed from a selection of libraries encapsulated into elementary modules. The execution of this application can be distributed over a cluster for

higher performance. The underlying architecture facilitates the addition of new modules and transparent code modification. Inter-module communication layer is based on message passing implemented using a MPI-2<sup>3</sup> standard compliant library. This kernel includes a state-of-the-art real-time image generator used in game design displaying a high quality environment imported from ordinary authoring tools (in our case, Autodesk® Maya®, [www.autodesk.com](http://www.autodesk.com)), and a control module to drive a car through the environment.

## **Software tools for driving simulation and virtual reality**

Proprietary simulation products exist such as Oktal's SCANeRtm simulation engine (<http://www.scannersimulation.com/>), but an alternative open-source equivalent is lacking. Open-source racing games, like TORCS [16], potentially contain all the elementary features required to build a driving simulator, but are hardly re-usable or customizable. Moreover, such systems are often missing support of standard file formats for importing data from usual 3D authoring tools.

Recent surveys have shown the existence of several lower levels for the development of general VR applications which were classified as application programming interfaces (API), frameworks or platforms [18]. APIs are libraries of methods that abstract lower-level resources. Relevant APIs for driving simulation include primarily graphics render engines and/or scene graph management libraries otherwise used in scientific visualization application or game development such as OGRE [1], Irrlicht [2], OpenSceneGraph [3] or OpenSG [4], this latter being additionally able to transparently manage parallel rendering for multi-channel displays. Physics engines handle collisions and are an underlying layer of car dynamics model. ODE [7] and Bullet [8] are two widely supported engines. Proprietary products are also available for free development like nVidia® PhysX® [15] library which enable GPU-accelerated physics simulation. Concerning sound generation OpenAL is a major open source reference [6]. Scripting language such as LUA [9] can also be used for dynamic addition of logic and scenarii in the scenes. Eventually, communication APIs are used to bind together these modules and distribute their execution over computer clusters. MPI standard compliant libraries are suited for this task, such as MPICH [5].

VR development frameworks such as VRJuggler, Delta3D, OpenMASK, OpenSpace3D or FlowVR [18][19] integrate a selection of such APIs and provide a unified development interface. Only low level functionalities are provided and building a driving simulation application would require to program additional custom features, like acquisition of data from steering-wheels or car dynamics model. Moreover, using these integrated frameworks implies to accept the underlying selection of APIs and may have several drawbacks. For instance, FlowVR is not cross-platform, Delta3D does not support cluster management and VRJuggler does not support Microsoft Direct3D rendering. Nevertheless, they guarantee the interoperability between heterogeneous libraries with a controlled

---

<sup>3</sup> MPI: Message Passing Interface. MPI is a normalized interface for managing message exchanges between processes, initially developed for high performance parallel computing [17].

level of performance. These frameworks will not be use in this study in order to concentrate on selection and testing of open source APIs. Yet, the possibility of importing our application in one of these frameworks in the future is not excluded.

In conclusion, open source libraries provide a set of elementary tools that could enter in the composition of a driving simulation application. However, they are rarely integrated in such a finished product. They are mainly currently used in basic immersive visualization platform or integrated games. Building a useable driving simulator from these elements requires an extensive study of their compatibility, of their overall performance when combined and of their ability to import data from most 3D authoring tools. The modularity and the possibility to modify each part of the simulator is also a crucial point.

## Architecture

### Component-oriented design

The proposed architecture follows a component-based approach, which is suited to integrating heterogeneous modules handling parallel computations. Every specific library is encapsulated in a module providing a standard interface that abstracts its functioning. Although this approach adds several communication steps between modules, practical use in the development of other VR platforms has shown that the additional computation overhead remains negligible. Moreover, this design reduces code coupling between modules, favors code reuse and keeps evolution of the code localized, which are critical requirements in the design phase of such composite application. Therefore, the system can easily evolve with newer technologies due its minimal dependency on particular libraries. Notably, modules based on open source libraries can be transparently replaced by in-house developments or proprietary libraries, provided that a SDK (Software Development Kit) is available.

In the proposed version of the software, modules consist in standalone operating system processes, coordinated using MPICH2 [5], a message passing interface following the MPI-2 standard (see footnote 1). The use of an MPI-based inter-module communication layer enables the transparent execution of the simulation software on a variety of hardware architecture ranging from Ethernet-based computer clusters to multi-CPU computers. MPICH2 benefits from an optimized communication channel called *Nemesis* which accelerates communication between processes executed on a single computing node and which supports efficient shared-memory communication. Moreover, MPICH2 has a widely portable implementation and supports different operating systems including Linux and Microsoft® Windows®.

### Kernel-based architecture

The different modules are organized according to a star-shaped design pattern (Figure 1): every module is connected to a central kernel, which manages a database containing all simulation data (e.g. car position, viewpoint, steering wheel angle). Modules can update these data or receive their last value upon request. This architecture is intended to reduce inter-module execution coupling



and to allow the use of heterogeneous module execution frequencies. It also minimizes consequences of module execution failures and facilitates subsequent recovery. This loose coupling enable isolated evolution of modules communication interface, the only constraint being that each module updates and reads the correct shared variables. Moreover, such a centralized data management ensures the coherency of simulation in the whole application and simplifies the implementation of a monitoring tool for message exchanges and data accesses on the server (e.g. for debugging purpose).

This architecture has been preferred over *point-to-point* architecture which arranges modules as a data pipeline, as proposed for instance in FlowVR. Although this latter approach would have optimized inter-module communication speed and simplified inter-module synchronization, the resulting software would have been less robust to a sudden communication loss and a more rigid normalization of messages would have been necessary implying constraints in the evolution of modules.

However, the kernel-based architecture has two main inconveniences that impose constraints on the server dimensioning. First, the central server must be the fastest running process to ensure a correct overall performance. Secondly, central server being busy to handle each incoming messages, its best execution frequencies might drop when the number of modules increases.

## Current state of the software

A basic functional version of this software has been implemented, including four main modules, integrated using a communication layer based on MPICH-2 to enable distributed execution over a computer cluster:

- the visualization module that requests the position and orientation of the camera to display the virtual scene from the driver's viewpoint,
- the vehicle dynamics module that also handles keyboard inputs which generates the car trajectory from the driving commands,
- a camera manager which transforms car position data into camera position,
- the central server which stores and distributes to the different modules the car and camera positions.

The resulting application consists in a simple functioning driving simulator.

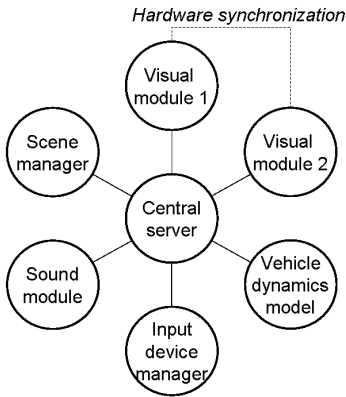
## Interfacing modules and the central server using message passing

The central simulation is primarily a database management system. It stores and distributes upon request the current state of a set of variables. Currently, the central server handles only three types of messages. Modules can order the server to overwrite the current value of some simulation data using "update" messages. "data request" messages are used by modules to fetch the current value of simulation data, in response of which the server releases "send data" messages. Every message used in the application is tagged by a unique identifier which must be declared at the beginning of the application on the server and in

the corresponding modules. This identifier is processed in server-side mechanism to decode the simulation data embedded in the message and trigger the expected behavior.

## Visual rendering

The visual module displays in a graphical window a view of the virtual environment, as seen from the driver's current viewpoint which is fetched before the rendering of each frame using a "data request" message.



**Figure 1. General module organization**

**Figure 2. Virtual view of Guyancourt rendered with our open source simulation software**

The visual scene is rendered using OGRE [1], an object-oriented open-source 3D render engine written in C++, customizable and extensible through the freely available plugins, enabling for instance OpenGL and DirectX support or bindings to multiple physics engines. Moreover, OGRE benefits from an active community. As currently configured, our visual module supports vertex lighting used to render for instance static ambient occlusion. Advanced projected shadows were also implemented using Parallel Split Shadow Mapping method (PSSM) and rendered using Variance Shadow Mapping technique (VSM) implemented in a pixel shader written in HLSL language (Figure 2). More generally, other visual effects can be implemented depending on the application, the performance of the computers and the features provided by the render engine.

Selecting a particular rendering library also implies constraints on the possible readable database description file formats. OGRE only supports its own native binary format, but a number of conversion plugins and exporters exist for main 3D authoring tools, including open source software like Blender. For the purpose of our study, a visual database modeled in Autodesk® Maya® used in typical simulation scenarii at Renault has been exported using one of these plugins.

Eventually, a particularly important aspect visual rendering for driving simulation is the management of multiple visual channels for multi-screens displays. The proposed solution in the current implementation is to launch as many visual processes as rendering channels that are connected to the server.

## Vehicle dynamics module

Vehicle dynamics module takes as input driver commands and calculates the car trajectory using a physics engine. This module sends messages at its own frequency to the central server to update the car position and orientation data. The current implementation uses ODE open-source physics engine and uses the predefined car dynamics model included in the OGREODE open-source library, initially developed for the purpose of binding ODE with OGRE render engine. Therefore, terrain data and car geometry used for calculation must be provided in the OGRE native geometry description format. In this early version, this module is also responsible for drivers' command acquisition through the keyboard. Implementation of this acquisition operation in a separated module and interfacing with more convenient devices like steering wheels is ongoing.

## Defining a new module: the example of the camera manager

Each module essentially consists in an infinite loop sending messages to the central server either to update some simulation data or request their last available value. The camera manager is a very simple module that illustrates this basic mechanism. It transforms the car position and orientation data computed by the car dynamics model into the position and orientation of the viewpoint in the car expressed in the world frame of reference. The following pseudo-code describes this procedure:

```
while not terminate message received from kernel  
  request last car position  
  perform viewpoint position calculations  
  send 'update viewpoint position' message  
  loop frequency regulation instructions  
end while loop
```

In addition, server-side mechanisms that listen to these messages should also be programmed. However, due to the limited number of types of messages and their stereotyped processing on the server, server-side message management can be easily standardized and declaration at runtime of both new messages and new simulation data should be possible. Therefore, opening a communication channel between the server and a module will require a few additional function calls at the module initialization to register the messages on the server.

This procedure shows that the code of the simulation server and modules can evolve separately with minor interactions, provided that the structure of the simulation database is not modified. Therefore, this architecture eases the management of version between modules.

## Execution and practical evaluation

Modules are executed as distinct operating system processes, coordinated using MPICH2 utilities including daemons which ensure message delivery. Modules can be executed on any remote computing node on which this daemon is installed.

Correct execution of the application requires that the central server loops at least faster than the fastest module. MPI being a conservative interface, messages are indeed processed respectively to their reception order. Therefore, a too slow execution frequency of the central server loop results in a lag in the updating of simulation data on the server. Moreover, filling up the incoming message stack of the server blocks the execution of the message sender and eventually results in an overall slow down of the application.

Although experimental evaluation of the performance of the described implementation cannot be precisely documented at this level, this implementation allowed a real-time driving in a typical driving simulation environment (~ 300.000 polygons) on a single desktop computer (Intel Xeon 3GHz, 1Go RAM, nVidia Quadro FX 4800). The generation of two synchronized displays (1280x1024) has also been observed with the same level of performance, using two distinct computers connected through Ethernet network.

## **Discussion**

The functional kernel described in the article validates that open source APIs can be used to build a driving simulation application. The component oriented approach and the kernel based architecture allow reducing the interdependency between the codes of modules and imposing only minimal constraints on message format definition. Therefore, the code of the application can be updated by locally modifying part or integrality of a module, without major influences on the rest of the application. This modular architecture is therefore particularly useful for experimenting different assembly of libraries with the objective of finding an optimal combination. It also provides the foundations of a highly reconfigurable system.

Moreover, the proposed application is scalable thanks to the possible transparent distributed execution over a cluster of computers, and includes strategy for efficient use of memory when running on a single machine, enabled by the use of an MPI-2 compliant library as the communication layer. Preliminary test of the current implementation with low end computers allowed indeed interactive driving. The precise assessment of real-time performance of the application should be addressed in a future study.

Finally, concerning the importation of geometrical information for the visual environment, 3D vehicle models and physics calculation (e.g. collisions, car animation), the application is expecting data in the OGRE native geometry format, for which main 3D modelers have exporters. Yet, an improvement of this importation procedure would be to fully support Collada™, a widely used open standard for 3D information exchange [21]. More generally, as the application may encapsulate heterogeneous libraries, each module may require data in its own format, resulting in a potential multiplication of input file formats necessary to run the simulation, which is a drawback. An advanced implementation of the software should also support emerging open standards for driving simulation data description such as OpenDRIVE® [13] and RoadXML© [14].

## Future directions

Future work will focus on further integration of modules particularly input devices, sound management, and more advanced functionalities like a scenario building interface and traffic management. This latter topic will necessitate to study and select formats for road network specifications, among which new open standards, OpenDRIVE® and RoadXML©, are of particular interest.

## Conclusion

This article presented an ongoing work on the design of an extensible, highly configurable and scalable open-source driving simulation software system. The proposed architecture allows an easy interfacing of third-party libraries to take advantage of existing state-of-the-art functionalities of open-source or commercial products. The implementation also allows efficient distributed execution over multiple computation nodes for higher performance.

This software is currently being written but a running version including communication layer and a few fundamental modules necessary to drive a car in a virtual environment is already being published as Open-S project, licensed under LGPL, available for downloading and testing as of end of June 2010 on <http://open-s.sourceforge.net>.

## Acknowledgements

The virtual environment displayed in the figures of this abstract representing the city of Guyancourt was designed and realized by Jean-François Rivière (Renault, Technical Centre for Simulation).

**Keywords:** Simulation design; open-source software; software engineering; component-based architecture; distributed applications

## Bibliography

- [1] OGRE – Open Source 3D Graphics Engine, <http://www.ogre3d.org>
- [2] Irrlicht Engine - A free open source 3d engine, <http://irrlicht.sourceforge.net>
- [3] OpenSceneGraph, <http://www.openscenegraph.org>
- [4] OpenSG, <http://www.opensg.org>
- [5] MPICH2: High-performance and Widely Portable Message-Passing Interface (MPI), <http://www.mcs.anl.gov/research/projects/mpich2>
- [6] OpenAL: cross-platform 3D audio API, <http://connect.creativelabs.com/openal>
- [7] ODE – Open Dynamics Engine, <http://www.ode.org>
- [8] Bullet Physics, <http://bulletphysics.org>
- [9] The programming language LUA, <http://www.lua.org>

- [10] FlowVR, <http://flowvr.sf.net>
- [11] GNU Lesser General Public License, <http://www.gnu.org/licenses/lgpl.html>
- [12] COLLADA – Digital Asset and FX Exchange Schema, <https://collada.org>
- [13] OpenDRIVE – managing the road ahead, <http://www.opendrive.org>
- [14] RoadXML – The open format road network, <http://www.road-xml.org>
- [15] nVidia PhysX Physics simulation for developers, <http://developer.nvidia.com/object/physx.html>
- [16] TORCS Driver Simulator. <http://torcs.sourceforge.net>.
- [17] MPI specification, <http://www.mpi-forum/docs>
- [18] Wright T.E. and Madey G., A Survey of Technologies for Building Collaborative Virtual Environments, *The International Journal of Virtual Reality*, 2009, 8(1):53-66
- [19] Soares L.P., Raffin B. and Jorge J.A., PC Clusters for Virtual Reality, *The International Journal of Virtual Reality*, 2008, 7(1):67-80
- [20] Morillo P., Bierbaum A., Hartling P., Fernandez M., Cruz-Neira C., Analyzing the performance of a cluster-based architecture for immersive visualization systems, *Journal of Parallel and Distributed Computing*, 2008, 68(2):221-234
- [21] Arnaud R., Parisi T., Developing Web Applications with COLLADA and X3D, White paper, 2007, [khronos.org](http://khronos.org)
- [22] Bierbaum A., Just C., Hartling P., Meinert K., Baker A., Cruz-Neira C., VR Juggler: A Virtual Platform for Virtual Reality Application Development, *IEEE Virtual Reality Conference 2001 (VR 2001)*, 2001, pp 89-96

# **Motion rendering**





# Performance identification and compensation of simulator motion cueing delays

**Zhou Fang, Gilles Reymond, Andras Kemeny**

Renault, Technical Center for Simulation

Technocentre TCR AVA 0 13, 1 avenue du Golf, 78288 Guyancourt, France

zhou.fang@renault.com, gilles.reymond@renault.com,

andras.kemeny@renault.com

**Abstract** – *The lag existing between the command and the resulting cockpit motion in a motion-based simulator, commonly referred to as “transport delay”, is actually the sum of a fixed delay and a frequency-dependent phase delay. A measurement procedure for the identification of the overall transfer function of a motion system is first presented, then is used to design a PID compensator to reduce the apparent simulator lag in usual driving maneuvers. This procedure is carried out on RENAULT’s ULTIMATE high-performance driving simulator. For the reference driving task considered (slalom driving), this filter is shown to bring a 100-200 ms reduction of the phase delay, which is quite perceivable and preferred by test drivers.*

**Résumé** - *Le délai présent entre les commandes et le mouvement résultant du cockpit dans les simulateurs à base mobile, qui est généralement désigné comme “transport delay”, est en réalité la somme d’un délai fixe et d’un retard de phase dépendant de la fréquence. Une procédure d’identification de la fonction de transfert d’un système de mouvement est présentée, puis appliquée à la conception d’un compensateur PID permettant de réduire le délai apparent du simulateur lors de manœuvres de conduites usuelles. Cette procédure est mise en œuvre sur le simulateur de conduite à hautes performances ULTIMATE de RENAULT. Dans la tâche de conduite de référence (conduite en slalom), ce filtre montre une réduction du retard de phase apparent de l’ordre de 100-200 ms, ce qui est tout-à-fait perceptible et préféré par les conducteurs.*

## Introduction

Motion-based simulators rely on hydraulic or electro-mechanical actuators to render motion cues as accurately as possible in terms of amplitude, delay and frequency bandwidth. As for any computer-controlled mechanical system, a

certain lag appears between the command and the resulting motion. In simulators, this lag is commonly referred to as “transport delay”, and is deemed as being a critical factor for the validity of driving simulators (Nordmark, 1994) and virtual reality systems (Bloche *et al.*, 1997). Transport delay creates mismatches between sensory cues, which are considered as a main cause for the occurrence of motion sickness (Oman, 1990), although some level of driver adaptation is possible during active driving (Dagdelen *et al.*, 2002). In any case, simulator designers should aim at reducing this apparent lag as much as possible.

The accurate measurement of this lag is often a practical problem, due to the technical complexity of motion cueing systems, which makes the identification of each individual controller and actuator often impossible for the end user. In this paper, we present a procedure based on external accelerometric measurements and numerical identification of the global transfer function. We then present a pseudo open-loop PID control system to enhance the global response of the motion cueing system and to reduce the apparent motion cueing lag. This algorithm takes advantage of the limited bandwidth of the driver commands, in particular the steering input. The approach chosen here is deliberately software-based, thus allowing a generalization to other motion-based simulators.

This development was carried out on the ULTIMATE high-performance driving simulator developed by RENAULT-Technical Center for Simulation, which is based on a X-Y rail actuator system combined with a hexapod (Bosch-Rexroth Hydraudyne B.V., The Netherlands). This motion system is driven in position mode by the SCANeR© software ([www.scanersimulation.com](http://www.scanersimulation.com)) using a predictive motion cueing algorithm developed internally (Dagdelen *et al.*, 2009). This simulator is being used for vehicle dynamics engineering applications, for which a typical validation scenario is the 1:1 scale simulation of a slalom at moderate speeds (Dagdelen *et al.*, 2006). However, the apparent lag motion feedback was deemed by some expert drivers as being a disturbing factor for the subjective assessment of the transverse dynamics of the simulated vehicle, especially for faster maneuvers (e.g. ESC tests).

## Identification of motion platform response

### Apparent motion cueing delays

The apparent response lag of a computer-controlled actuator system is generally composed of two terms: a ‘pure’ delay and a phase delay.

The *pure delay* corresponds to the time taken by the computer system to transfer an input information into a command for the actuator system. The computation time, data buffering and numerical filters involved in the different algorithms of the simulator can create significant delays. In a typical multi-process architecture, the different cycle times and the communication protocols between processes can also participate in this delay. Depending on the underlying operating system, this delay may be variable (preemptive OS) or fixed (real-time OS). In most simulators, the data path followed by a driver input is complex and involves several sub-systems, which performance is often beyond the control of the simulator designer: data acquisition (digitization hardware, drivers),

communication protocols (e.g. USB, reflective memory, TCP/IP, shared memory etc.), operating system scheduler, etc. This makes the identification of the resulting delay a difficult task without the help of external measurements.

The *phase delay* corresponds to the response time of the motion actuators system, and depends on the technology employed for the motion controllers (frequency and parameters of the control loop) and for the actuators themselves (load, power, damping). In electric motors, the drive electronics and motor coils generally behave as low-pass filters. In hydraulic actuators, the load and internal damping of the actuator also creates a low-pass behavior, not to mention the non-linearity of the valves and pressure supply system. These systems are generally designed to have a global linear response, and as for any linear system, the phase delay will depend on the input signal frequency and on the parameters of

the system. For instance, a first-order low-pass filter  $G(s) = \frac{1}{1 + Ts}$  has a phase delay  $t_\phi = \arctan(T\omega) / \omega$  which varies with the input frequency  $f$  ( $\omega = 2\pi f$ ) and time constant  $T$ , and a gain  $G = (1 + T^2\omega^2)^{-1/2}$ . The performance of motion actuators is often expressed in terms of bandwidth  $f_c$  (cut-off frequency corresponding to -3 dB): for this low-pass filter  $G$ , this frequency is expressed as

$f_c = \frac{1}{2\pi T}$  which gives another expression of the phase lag:

$$t_\phi = \arctan\left(\frac{f}{f_c}\right) / (2\pi f)$$

The practical interpretation of the apparent delay is an ambiguous issue for the simulator designer: which is the delay that drivers are actually sensitive to?

As a comparison, the handling dynamics of a car (vehicle yaw or lateral acceleration response to steering inputs) also exhibit a certain phase delay, due primarily to the dynamics of the tires, suspension and chassis, and to the flexible structure of the steering system. For instance, the rise time (time to reach 90% of steady state value) for the lateral acceleration in response to a sudden step input on the steering wheel was measured for 169 vehicle models (Riede *et al.*, 1984) and shows a typical range of approx 300 to 600 ms. This rise time can be shown to be approximately 2.5-3.5 times greater than the phase delay for a range of sinusoidal steering inputs from 0.2 to 1 Hz. This estimation is the result of a Matlab simulation of a second-order transfer function between the steering angle and lateral acceleration, derived from a classical bicycle model of the vehicle dynamics (Peng *et al.* 1990). Drivers can make the difference between a relatively sluggish and a sporty reactive car, and are therefore sensitive to apparent phase delays between 100-200 ms (although modern cars would be mainly in the lower range). For a reference 0.2 Hz sinusoidal steering input (Norman, 1984), the additional phase delay introduced by a typical large-amplitude simulator motion system would be 32 ms for a relatively fast actuator (5 Hz bandwidth at -3 dB) and 157 ms for a slower one (1.0 Hz bandwidth). For advanced applications involving the assessment of transient responses of the simulated vehicle, a solution for reducing this additional delay is therefore critical.

## Transfer function identification method

In theory, a simple step input is sufficient to estimate both the pure delay and the parameters of a linear transfer function. However, the accuracy of this method is very questionable in practice, due to the limited sampling resolution and the natural presence of noise in the measurements. Although not always perceptible, the position controllers of a motion platform generate a certain level of tremor when holding a set position under load, and accelerometers pick up this vibration quite well. Damping of this background noise would only result in introducing an artificial phase lag in the measurements. Increasing the signal-to-noise ratio is possible by using large platform movements, but this generally leads to reaching its limits in terms of displacement, velocity or acceleration.

Another approach is to design an input signal with sufficient frequency resolution given the expected response bandwidth of the system, while respecting its limits in terms of mechanical travel, speed and acceleration. A balanced frequency distribution is required to avoid biases in the identification procedure of the transfer function, which are generally based on a statistical fit of parameters. The duration of the input signal should also be minimized for practical reasons. The approach chosen here is to use a pseudo-white noise, passed through a low-pass filter to limit the signal to a bandwidth equal to 3-5 Hz for the rails system and 10 Hz for the hexapod system.

As the control algorithms of the motion platform are considered unknown *a priori*, the transfer function of the system  $G$  is being approximated by realistic standard models:

- P1D: first-order model, with pure delay  $G(s) = \exp(-\tau_d \cdot s) \cdot K / (1 + T_{p1} \cdot s)$
- P2D: second-order model with pure delay  $G(s) = \exp(-\tau_d \cdot s) \cdot K / ((1 + T_{p1} \cdot s)(1 + T_{p2} \cdot s))$
- P2UZD: second-order model with pure delay and a zero pole:
- $G(s) = \exp(-\tau_d \cdot s) \cdot K \cdot (1 + T_z \cdot s) / ((1 + T_{p1} \cdot s)(1 + T_{p2} \cdot s))$
- OE: general n-order model  $G(s) = (a_n \cdot s^m + \dots + a_1 \cdot s + a_0) / (s^n + \dots + b_1 \cdot s + b_0)$

For the OE identification, the pure delay term is approximated by a linear transfer function following the classical Padé approximation:

$$\exp(-\tau_d s) \cong (1 - 0,5\tau_d s) / (1 + 0,5\tau_d s)$$

For instance, the P1D model can be approximated by the second-order linear model:

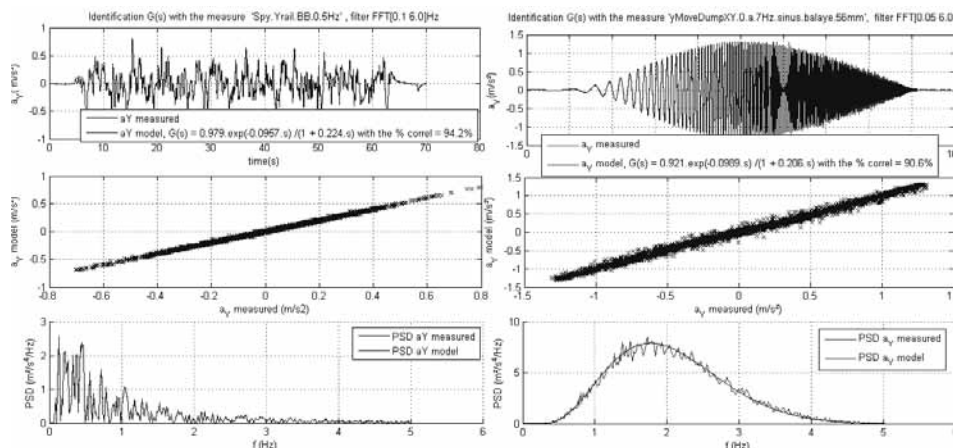
$$G(s) = \exp(-\tau_d \cdot s) \cdot K / (1 + T_{p1} \cdot s) \cong K \cdot (1 - 0,5\tau_d s) / [(1 + 0,5\tau_d s) \cdot (1 + T_{p1} \cdot s)]$$

In this way, the pure delay system is linearized in a LTI system.

The parameters of the transfer functions are identified by means of an optimization method minimizing the errors between the actual measurements and the model outputs. The standard System Identification Toolbox of Matlab was used.

## Data analysis and results

Pre-programmed command signals were injected either at the steering wheel input, or at the platform position input, and the resulting cabin motion was measured simultaneously with a set of accelerometers. Accelerometric measurements were fitted with a simple model composed of a pure delay and a n-order linear low-pass filter. The iterative function identification algorithm minimizes the prediction error of the linear, continuous-time model  $Y(s) = G(s)U(s) + E(s)$ , where the plant model is  $G(s) = e^{-\tau_d s} \cdot H(s)$ . The results obtained with the different models P1D, P2D, P2UZD and OE yield very comparable results, therefore the simplest P1D approximation is sufficient. Non-linearities and higher-order behavior of the actuators are compensated for by the motion platform controllers, which reduce the apparent transfer function of the system to a equivalent filter composed of a low-pass and delay terms.



**Figure 1. Example of identification output signal (top), comparison of model predictions vs. measurements (middle), and acceleration spectral distribution (bottom), for a pseudo-white noise (left) and swept sine (right)**

The measured response of the ULTIMATE X-Y rail and hexapod systems is summarized in Table 1.

**Table 1. Delay identification results for the Ultimate simulator**

	Pure delay	Phase delay at 0.2Hz	Bandwidth (-6 dB)
Hexapod	30~35 ms	35 ms	7 Hz
Rails	15~20 ms	200 ms	1.25 Hz

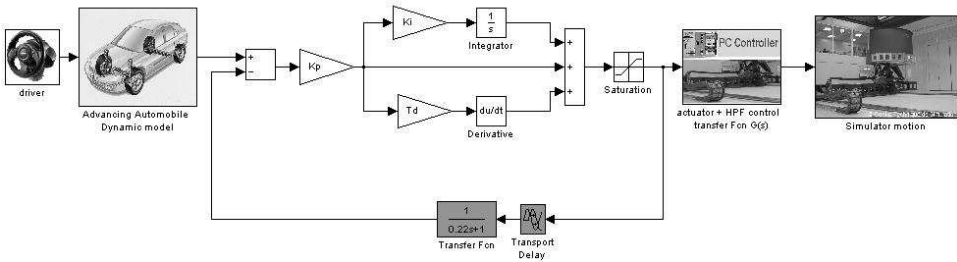
The accurate identification of the pure delay term is critical for the stability of a phase delay correction algorithm presented in the following. As the pure delay term is of lesser amplitude for the rails system, its compensation is of lesser importance and is not considered here (moreover, the correction of pure delays involves specific algorithms with potential stability constraints).

# Correction of the apparent motion cueing delay

The possibility to reduce the phase delay by modifications of the simulation software is analyzed here, as being a flexible and cost-effective alternative to extensive hardware modifications. Advanced methods are available to compensate different sorts of delays (e.g. Smith predictor, fuzzy logic or adaptive models for pure delays; PID for phase delay; others for non-linear and time-varying plant models), but they require a closed-loop control of the system. Their implementation in the simulator would require a substantial modification of the motion system. In the following, a pseudo open-loop solution, which relies on model predictions, is considered.

## Implementation of a PID corrector

A PID corrector is a simple and robust way to shape the response of a given system, by using a negative feedback of its output. In our case, the measurement of the platform motion output entails additional hardware and measurement delays, and a numerical model of the motion system is used instead. The system model, comprising a pure delay and a first-order low pass filter, comes from the identification procedure presented above.



**Figure 2. Structure of the proposed delay compensator**

The performance of a PID corrector is generally assessed by analyzing the deviations from a step input command. Among the variety of available algorithms, the methods of Ziegler-Nichols and Cohen-Coon (De Laminart, 1993; Corriou, 2003) are considered here, as being particularly suitable for first-order systems with a pure delay.

Let us consider the general actuator model as identified for the motion platform:

$$G(s) \cong K_G \cdot \exp(-\tau_d \cdot s) / (1 + T_{P1} \cdot s)$$

The Ziegler-Nichols identification procedure yields the following PID parameters:

$$K_p = 1,2 \cdot T_{P1} / (K_G \cdot \tau_d), \text{ with } T_i = 2\tau_d / K_p \text{ and } T_d = 0,5\tau_d \cdot K_p$$

The Cohen-Coon identification procedure yields the following parameters, with a lesser sensitivity for the delay parameter:

$$K_p = (1/K_G)(T_{P1}/\tau_d)(4/3 + \tau_d/(4.T_{P1}))$$

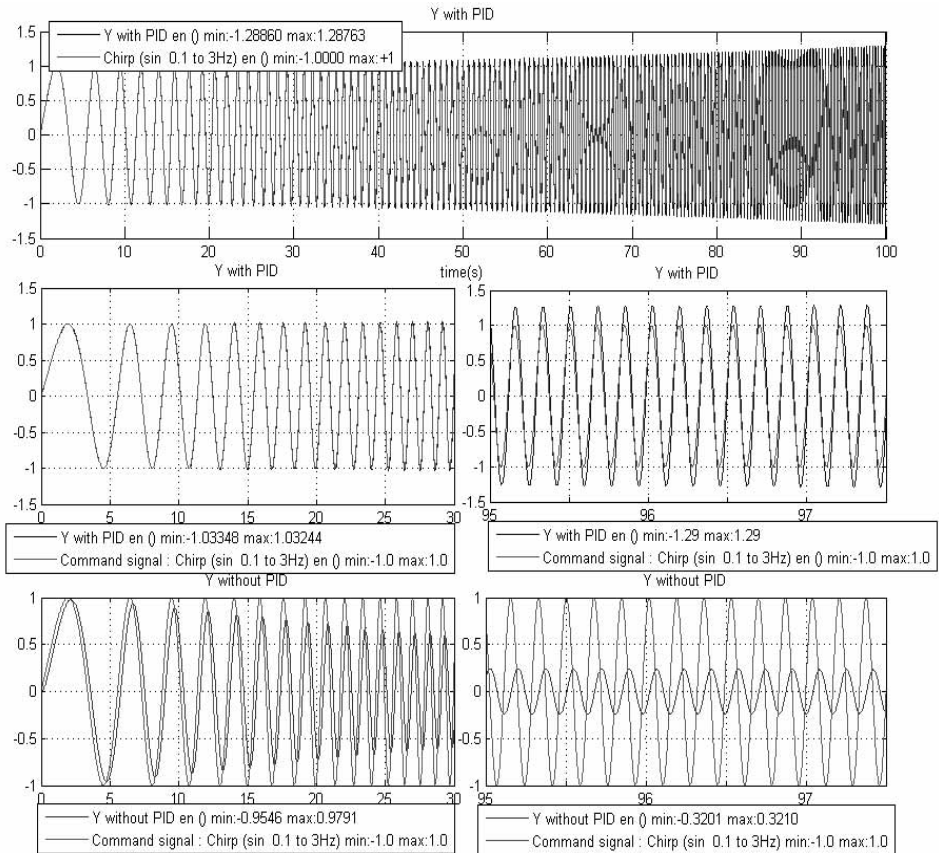
$$T_i = \tau_d(32 + 6(\tau_d/T_{P1})) / (13 + 8(\tau_d/T_{P1})) / K_p$$

$$T_d = 4\tau_d / (11 + 2(\tau_d/T_{P1})) \cdot K_p$$

The accuracy of the model parameters is crucial for the performance of the corrector. In particular, improper values for the pure delay  $\tau_d$  will result in an unstable behavior of the corrector. According to De Laminart (1993), this PID controller gives an excellent result when  $T_{p1}/\tau_d$  is important (i.e. over 5-10), which makes this technique applicable in our case (cf. Table 1).

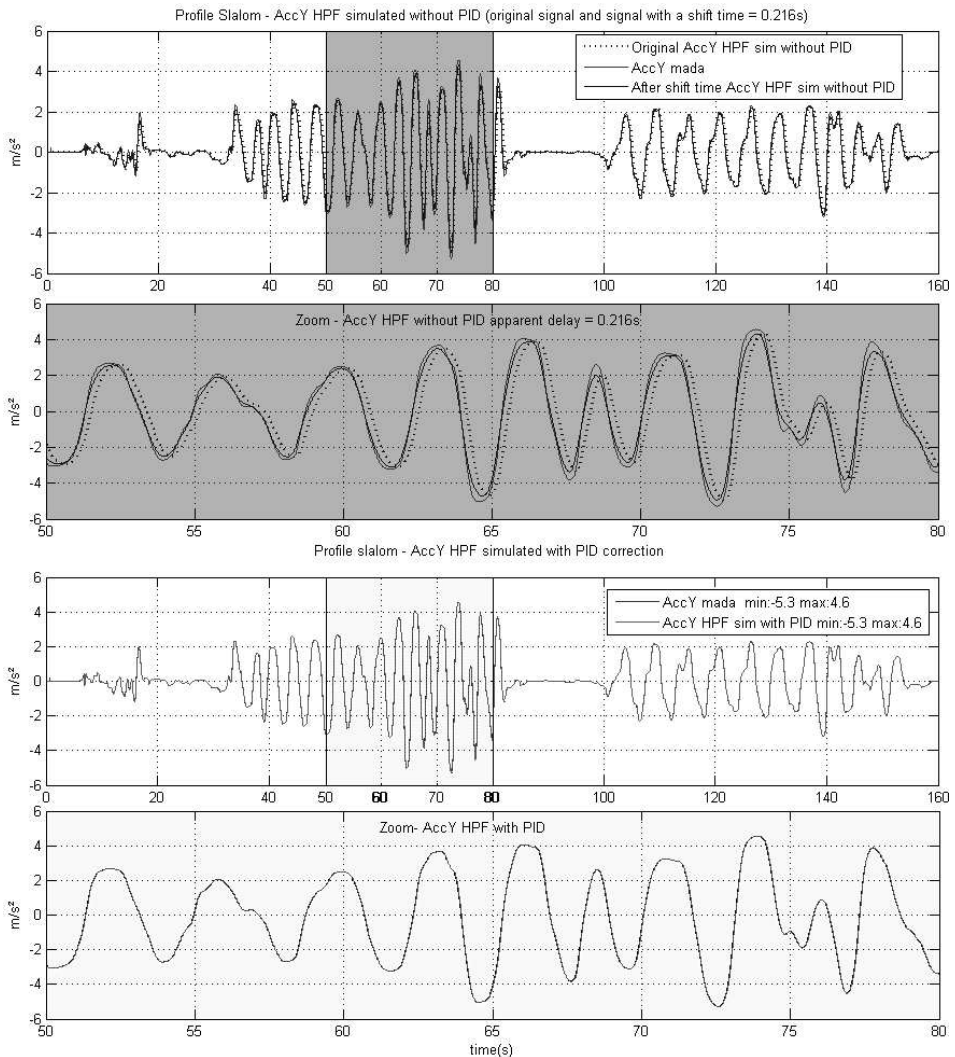
## Results

The simulation of the corrected system for a 0.1-3 Hz swept sine input (Figure 3) confirms the nulling of the phase delay and the correction of low-pass gain loss. Some over-amplification appears at higher frequencies, which is deemed acceptable at this stage, but which could be corrected by an adaptive PID parameter algorithm.



**Figure 3. Simulation of PID compensator performance for a swept sine (top), focus on low frequencies (middle left) and high frequencies (middle right), and comparison without compensator (below)**

This corrector was implemented in the ULTIMATE software by placing it after the vehicle dynamics model (Fig. 2), thus reducing the higher frequencies of the inputs of the filter which may create artifacts such as overshooting. Interactive driving tests were carried out with an accelerometer on the cabin. Despite the simple approximation of the actuator model, the performance of the corrector on the simulator performance is substantial. Figure 4 shows a result of off-line simulation evaluation for a slalom driving (delay reduction of 220 ms), and Figure 5 a real driving measurement with a delay reduction of 230 ms. Pilot subjective tests confirmed that drivers can identify properly (and prefer) the corrected configuration.



**Figure 4. Comparison of off-line simulation of platform lateral motion with and without PID compensation**



The validity of the parameter set chosen for the corrector actually depends on the driving scenario considered. Usual driving maneuvers correspond to steering inputs with a frequency bandwidth of [0-2] Hz, so the tuning described here will produce satisfactory corrections in most of the normal driving situations. However, faster maneuvers will call for a different tuning, with an improved PID parameter algorithm (adaptive, expert control etc.). This tuning may be necessary for instance during the simulation of lateral wind gusts, or for sudden braking maneuvers.

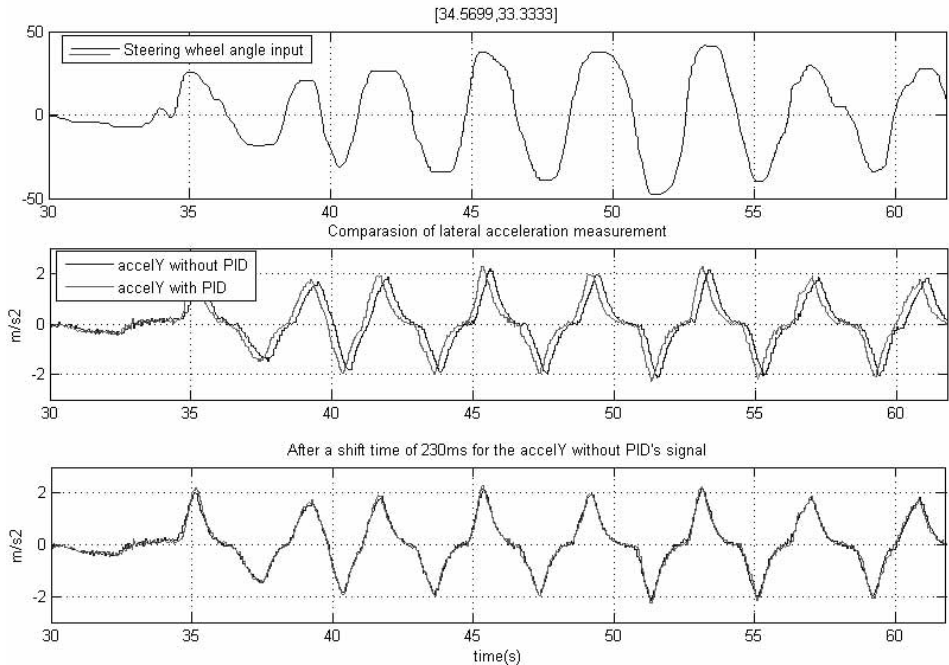


Figure 5. Measurements of a slalom driving session, with an estimation of the delay reduction

## Conclusion

The present study shows that a substantial reduction of the apparent simulator delay is possible using a pseudo open-loop PID corrector tuned from a model of the motion system. This reduction depends on the phase delay of the actuators (which varies with frequency) and on the frequency range of the driver inputs, and typically varies between 100-200 ms. The resulting apparent delay of the simulator is therefore closer to the normal phase delay of the simulated vehicle, which was confirmed by comparative subjective driving tests.

## Bibliography

Dagdelen M., Reymond G., Kemeny A., Bordier M., Maïzi N. 2009. Model-based predictive motion cueing strategy for vehicle driving simulators. *Control Engineering Practice*, 17(9) 995-1003

- Dagdelen M., Reymond G., Kemeny A. (2002) Analysis of the visual compensation in the Renault driving Simulator. Proceedings of the Driving Simulation Conference, Paris, September 2002. pp 109-119
- Bloche S., Kemeny A., Reymond G. (1997) Transport delay analysis in driving simulators with head-mounted displays. Proceedings of Driving Simulation Conference, Sept 8-9 1997, Lyon, France, pp 95-98
- Nordmark S. (1994) Driving simulators: trends and experiences. Proceedings of RTS'94 Driving Simulation Conference, Jan, Paris. pp 5-13
- Oman C.M. (1990). Motion sickness: a synthesis and evaluation of the sensory conflict theory. *Can J Physiol Pharmacol* 68(2), 294-303
- Riede P.M., Leffert Jr. R.L. Cobb W.A. (1984) Typical vehicle parameters for dynamics studies revised for the 1980's, SAE paper N°840561.
- Corriou J.P. (2003) *Commande des Procédés*. Lavoisier : Londres – Paris – New York
- De Larminat P. (1993) *Automatique Commande des systèmes linéaires*. Hermès : Paris
- Norman K.D. (1984) Objective Evaluation of On-Center Handling Performance. SAE paper N°840069
- Peng H., Tomizuka M. (1990) Vehicle lateral control for highway automation. In Proc. American Control Conf., San Diego, CA, USA, 1990, pp. 788-794

# Motion cueing for 3-, 6- and 8-degrees-of-freedom motion systems

**Martin Fischer, Håkan Sehammer, Göran Palmkvist**

Swedish National Road and Transport Research Institute (VTI)

581 95 Linköping, Sweden

[martin.fischer@vti.se](mailto:martin.fischer@vti.se), [hakan.sehammer@vti.se](mailto:hakan.sehammer@vti.se), [goran.palmkvist@vti.se](mailto:goran.palmkvist@vti.se)

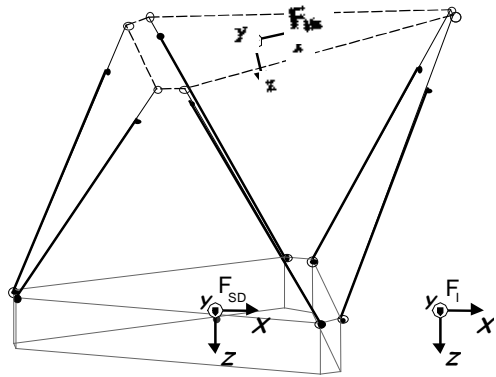
**Abstract** – *Simulators with motion systems are used to give the driver a motion feedback, called motion cue, and thus to increase the realism of the simulation. A motion cueing algorithm defines the movements of the mechanical system based on the current acceleration of the simulator vehicle. The type of the motion system and its related motion envelope is a major factor for the motion cueing which defines both the ability to present certain motion cues as well as their limitations. This paper will describe motion cueing algorithms for three motion system types with a different number of degrees-of-freedom (DOF). The 3-DOF algorithm has been in operation for quite a long time but the described design was not published before, whereas the 6-DOF approach has been reported and this paper gives only an update on the latest results. The motion cueing for the 8-DOF system is newly designed based on experiences with the other two systems. Simulation results promise a high ability to reduce the usage of tilt coordination (common method to present sustained translational accelerations by motion platform tilt, i.e. through gravitational forces) with this system, which a little simplified means to reduce false cues. As new features compared to other algorithms for this type of motion system consequent complementary splitting into low-, mid- and high-frequent signals and cross-system washout compensation are introduced.*

## Introduction

Driving behaviour investigations in dangerous traffic situation, human machine interface research or safety system validation take more and more place in driving simulators. Either the respective type of investigations can not be performed in reality for cost, time or ethical reasons or the repeatability of traffic scenarios and overall test conditions as available in simulation is required.

# Nomenclature

- |                               |  |          |                            |
|-------------------------------|--|----------|----------------------------|
| $\underline{a}_V^{(S)**}$     | - vehicle accelerations  | TC       | - tilt coordination        |
| $\underline{d}_{MC}^{(I)*}$   | - platform displacement<br>$d = [x \ y \ z]^T$   | V        | - vehicle                  |
| $\underline{f}_V^{(S)*}$      | - vehicle specific forces<br>$\underline{f} = \underline{a} - \underline{g}$               | WO       | - washout                  |
| $\underline{\beta}^{(I)*}$    | - platform orientation<br>$\underline{\beta} = [\varphi \ \theta \ \psi]^T$                |          |                            |
| $\underline{\omega}_V^{(S)*}$ | - vehicle angular velocities   |          |                            |
| $L_{jk}$                      | - coordinate transformation from k to j for accelerations<br>$j, k \in \{I, Sd, Hx\}$      |          |                            |
| $T_{jk}$                      | - coordinate transformation from k to j for angular velocities<br>$j, k \in \{I, Sd, Hx\}$ |          |                            |
| CW                            | - classical washout (MCA)  |          |                            |
| DOF                           | - degree-of-freedom  |          |                            |
| FTC                           | - fast tilt coordination (MCA)   |          |                            |
| HP                            | - high-pass filter   |          |                            |
| LP                            | - low-pass filter  | $F_I$    | - inertial reference frame |
| MC                            | - motion cueing  | $F_{Sd}$ | - sled reference frame     |
| MCA                           | - motion cueing algorithm  | $F_{Hx}$ | - hexapod reference frame  |



Simulators with motion systems are used to give the driver a motion feedback, called motion cue, and thus to increase the realism of the simulation. A motion cueing algorithm defines the movements of the mechanical system based on the current acceleration of the simulator vehicle. The type of the motion system and its related motion envelope is a major factor for the motion cueing which defines both the ability to present certain motion cues as well as their limitations. This paper will describe motion cueing algorithms for three motion system types with a different number of degrees-of-freedom (DOF).

# Motion cueing solutions

## 3-DOF motion system

The first motion cueing algorithm is designed for a motion system which has the ability to rotate the simulator cabin in roll and pitch directions and to further move it sideways along a linear sled (e. g. VTI Sim2 and VTI Sim3 - Sim3 additionally has a 4-DOF vibration table and the possibility to present yaw (Nordmark et al., 2004). The basic algorithm for the presentation of longitudinal acceleration, roll and pitch signals is a variation of the classical washout (Reid and Nahon, 1985; Fischer, 2009). The linear sled is mainly used for the presentation of lateral accelerations. To make use of the capabilities of the sled system a road related motion cueing algorithm is implemented which was developed at VTI (Figure 1). An approach reported by Grant et al. (2002) is based on the same general idea but is lacking the upper lane-signal feedback loop and it switches between the classical and a road related algorithm instead of combining both into one algorithm as done for the VTI road related algorithm.

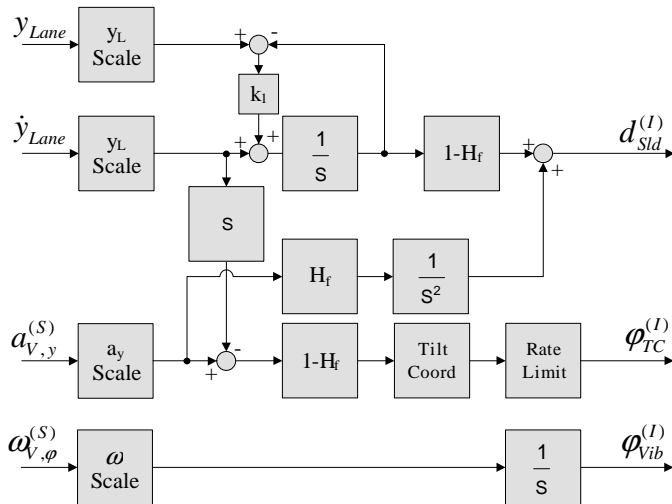


Figure 1. VTI's road related motion cueing algorithm

The main principle of this motion cuing algorithm is to avoid tilting motions caused by lateral accelerations. It is mainly based on the lateral displacement signals  $y_{Lane}$  and  $\dot{y}_{Lane}$ . In the classical washout algorithm the low-frequent lateral accelerations are simulated by a roll rotation (this technique is commonly called tilt coordination). When using the lateral displacement signals the corresponding low-frequent accelerations are introduced by the linear sled instead. Only the difference between these signals and the low-frequent accelerations of the vehicle are presented by roll rotation  $\phi_{RC}^{(I)}$ . The usage of the sled system thus reduces the necessary tilt rotations. The high-pass part of the lateral acceleration is always presented with the sled system. The high-pass

filtered roll velocity of the vehicle is presented separately by the vibration table. Beside the scaling factors, the only tunable parameter is the corner frequency of the high-pass filter  $\omega_0$  as it defines as well the characteristics of the low-pass filter  $L_f = 1 - H_f(\omega_0)$ . This filtering technique (also called complementary filtering) enables an optimal splitting into lower and higher frequencies. The upper lane-signal feedback loop  $y_{Lane}^*(t) = \int (\dot{y}_{Lane}(t) + k_1 \cdot (y_{Lane}(t) - y_{Lane}^*(t)))$  ensures a smooth input signal for the sled system, even if the lane position value "jumps". In this case ( $\dot{y}_{Lane}(t_0) = 0$ ) the feedback loop behaves like a first order low-pass filter with  $k_1^{-1}$  as the time constant (see transfer function in the frequency domain, given in Equation (1)).

$$Y_{Lane}^*(s) = \frac{1}{s} \cdot k_1 \cdot (Y_{Lane}(s) - Y_{Lane}^*(s)) \Rightarrow \frac{Y_{Lane}^*(s)}{Y_{Lane}(s)} = \frac{1}{\frac{1}{k_1}s + 1} \quad (1)$$

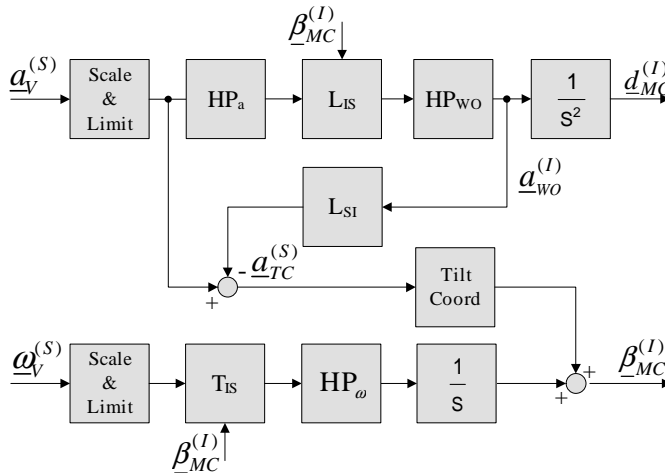
On straight roads nearly all the lateral acceleration is introduced with the sled system whereas in curves a major part is presented via tilt coordination because here a constant lateral acceleration of the vehicle is present without a lateral movement of the vehicle in relation to the centre line of the road. Depending on the scenario design the motion cueing algorithm can be further adapted to the current situation on-line. A usual parameterization is to use scaling factors between 0.5 and 0.6, a feedback-loop factor  $k_1 = 1$ , a 2<sup>nd</sup> order high-pass filter  $H_f$  with a corner frequency of  $\omega_0 = 1.2$  and a damping factor of  $\zeta = 0.7$ .

## 6-DOF motion system

The most common system for a moving-based driving simulator is a hexapod with its 6 degrees-of-freedom. Different aspects of motion cueing algorithms have been generally investigated and a new algorithm for hexapod systems called fast tilt coordination (FTC – s. Figure 2) had been designed based on these investigations (Fischer, 2009). A detailed description of the FTC and the results of a motion cueing evaluation experiment can be also found in earlier publications (Fischer and Werneke, 2008; Fischer et al., 2008).

The FTC is based on the classical washout algorithm using scaling and filtering techniques and the already mentioned tilt coordination. New features are the consideration of the actually presented high-frequent acceleration  $\underline{a}_{WO}^{(t)}$  through a feedback into the tilt coordination path and the avoidance of an additional low-pass filter. This technique has a similar effect as the complementary filtering within the road related MCA. Though, it also takes into account the reduction of the higher frequencies due to the necessary washout filtering. Further, a 6-DOF hexapod motion system enables to choose the point of rotation. The best choice in order to minimize false cues is to use the centre of the drivers head as rotation point. To scale and limit the signal is necessary in order to keep the hexapod within the mechanical restricted motion envelope. This

algorithm introduces higher tilt rotation errors compared to other approaches (e.g. classical washout) due to unrestricted (fast) tilt coordination. However, in an evaluation experiment this turned out to be less important than the achieved reduced timing error (delay between vehicle accelerations and actually presented accelerations).

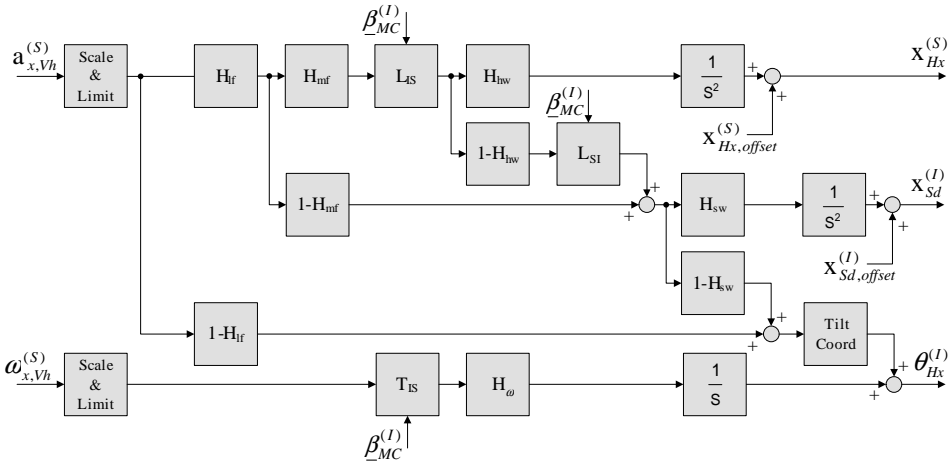


**Figure 2. Fast tilt coordination algorithm**

The referenced parameterization (*Fischer, 2009*) is to choose scaling factors of 0.5 and damping factors of  $\zeta = 1.0$ , 1<sup>st</sup> order high-pass filter  $H_a$  with  $\omega_{0,x} = 2.7$ ,  $\omega_{0,y} = 2.5$  and  $\omega_{0,z} = 6.0$ , 2<sup>nd</sup> order high-pass washout filter  $H_{wO}$  with  $\omega_{0,x} = 0.5$ ,  $\omega_{0,y} = 0.5$  and  $\omega_{0,z} = 1.0$  and 2<sup>nd</sup> order high-pass filter  $H_\omega$  with  $\omega_0 = 2.5$  for all three DOF.

## 8-DOF motion system

A more and more often used motion system is a hexapod built on top of a xy-sled (among others the planned VTI simulator Sim4 (*VTI, 2008*), Renaults Ultimate simulator (*Dagdelen et al., 2004*) and the driving simulator at the University of Leeds (*Jamson, 2007*)). This motion system combines the possibilities of a hexapod motion base with the extended motion envelope in x- and y-direction through the sled. Although it can not move the driver in more than the 6 common DOF (surge, sway, heave, roll, pitch and yaw) it is called 8-DOF system, in order to indicate the redundant possibilities of presenting lateral and longitudinal motion. A new algorithm was designed in order to use the full capabilities of this motion system. It is based on both above described algorithms as well as on previous motion cueing experiences. The design varies for the presentation of the longitudinal, lateral and vertical acceleration signals (including the related rotation signals), thus the different DOF will be explained separately. The basic design principle is shown in Figure 3 for the longitudinal accelerations.

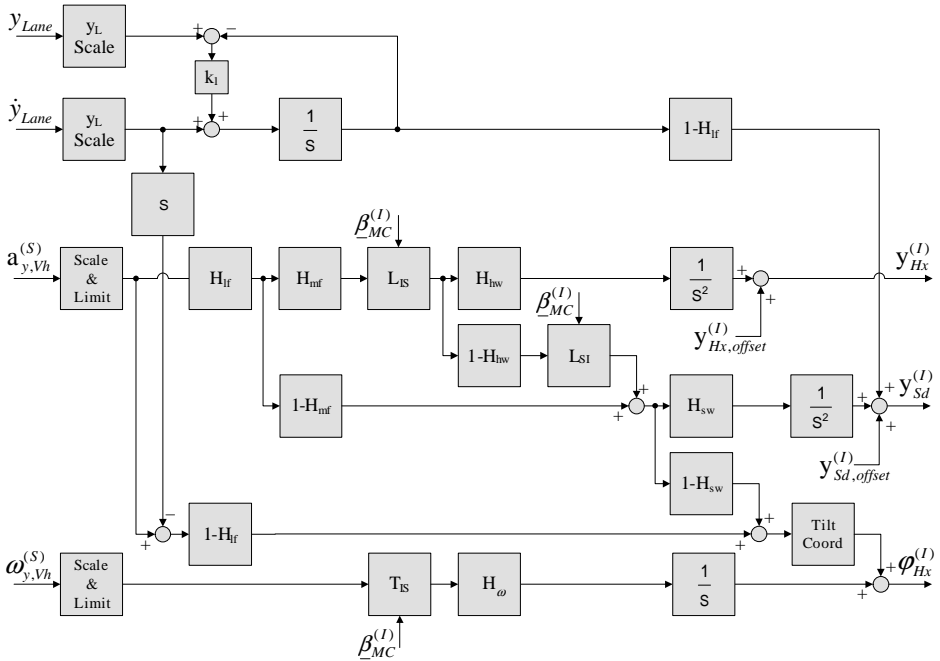


**Figure 3. Presentation of longitudinal acceleration and roll velocity with the 8-DOF MCA**

As in the road related algorithm, complementary high-pass ( $H_i$ ) and low-pass filter ( $L_i = 1 - H_i$ ) are used to split the signals. Basically, the high-frequent longitudinal signals shall be presented with the hexapod (upper path in Figure 3), the mid-frequencies with the sled (middle path) and the lower frequencies via tilt coordination. The choice of presenting the highest frequencies with the hexapod instead of the sled was done because of its higher capability of creating onset cues (up to 0.65g and 0.8g/s) and its higher bandwidth (6 Hz cut-off frequency compared to 3 Hz for the sled). The cut-off frequency of  $H_{mf}$  determines the separation of high- and middle-frequent signals whereas  $H_{hf}$  separates middle- and low-frequencies. The two additional filter ( $H_{hw}$  for the hexapod and  $H_{sw}$  for the sled system) are used to washout the signals, i.e. to make sure that the motion system always returns to its neutral position. This technique is necessary, though it generates false cues. Hence, it is important to find a good trade-off between the two opposing demands: to use a weak washout (which means a low cut-off frequency) and to return to the neutral position rather quick (which requires a higher frequency) in order to guarantee a bigger motion envelope for the next manoeuvre. However, the remaining high-frequent hexapod washout error will be compensated through the sled motion and the sled washout error will be compensated through the tilt coordination (by cross-coupling the different paths with  $1 - H_{hw}$  and  $1 - H_{sw}$ ). The additional offset values for both the hexapod and the sled position allows a pre-positioning of the motion systems according to oncoming events or characteristics of the road ahead.

The motion cueing for the presentation of lateral accelerations has the same basic structure as for the longitudinal signals (see Figure 4). Though, the road related

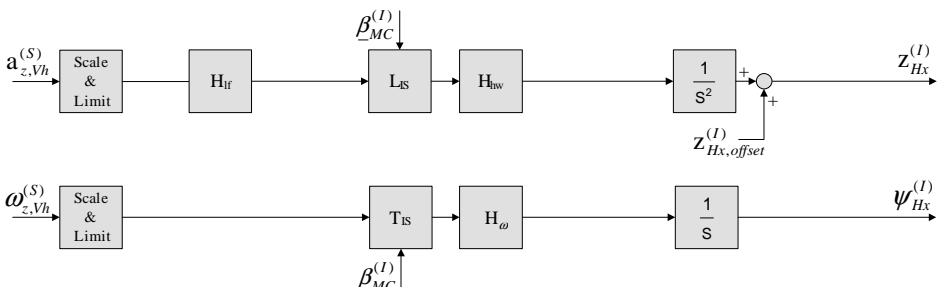




**Figure 4. Presentation of lateral acceleration and pitch velocity with the 8-DOF MCA**

Signals give an additional input to the sled-system (compare section on 3-DOF algorithm). Hence, the sled-system presents all mid- and low-frequent road related motion and the hexapod is mainly used for the high-frequent acceleration onsets. The tilt-coordination technique is only used for remaining low-frequent signals as sustained accelerations during curve driving.

With the used type of 8-DOF motion system, only the high-frequent vertical accelerations and yaw velocities can be presented. Neither the tilt coordination technique nor some other strategy is available to compensate missing or false cues. Thus the motion cueing for these two DOF is rather simple, as shown in Figure 5.



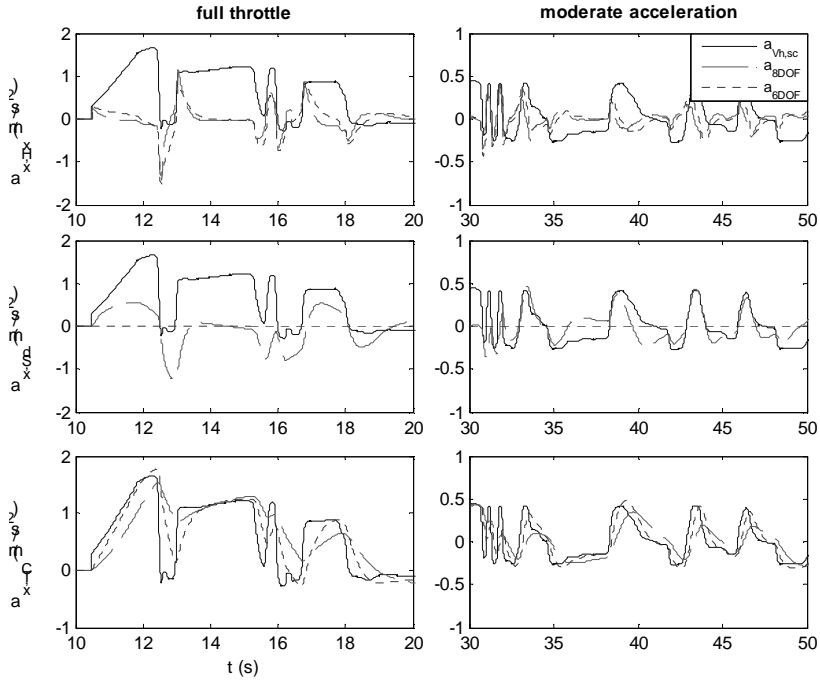
**Figure 5. Presentation of vertical acceleration and yaw velocity with the 8-DOF MCA**

The simulation based parameter tuning resulted in the following set-up: Scaling factors of 0.5 for all DOF, all necessary damping factors set to  $\zeta = 1.0$ , 2<sup>nd</sup> order high-pass filter  $H_{lf}$  with  $\omega_{0,x} = 0.65$ ,  $\omega_{0,y} = 0.85$  and  $\omega_{0,z} = 1.2$ , 1<sup>st</sup> order high-pass filter  $H_{mf}$  with  $\omega_{0,x} = 4.0$  and  $\omega_{0,y} = 6.0$ , 2<sup>nd</sup> order high-pass hexapod washout filter  $H_{hw}$  with  $\omega_{0,x} = 0.5$ ,  $\omega_{0,y} = 0.5$  and  $\omega_{0,z} = 2.0$ , 1<sup>st</sup> order high-pass sled washout filter  $H_{sw}$  with  $\omega_{0,x} = 0.1$  and  $\omega_{0,y} = 0.5$  and 2<sup>nd</sup> order high-pass filter  $H_{\omega}$  with  $\omega_0 = 1.2$  for all 3 DOF.

A similar approach, combining a classical washout based algorithm with the lane-based algorithm presented by *Grant et al.(2002)*, has been already introduced by *Chapron and Colinot (2007)*. However, there are some main differences between their approach and the here presented 8-DOF algorithm: *Chapron and Colinot* chose to use non-linear scaling factors and variable tilt velocity limitation in order to avoid false cues as much as possible. With the here described approach, the same goal shall be achieved through cross-system compensation and a parameterisation that avoids tilt coordination as much as possible. Another algorithm presented by *Grant et al. (2006)*, does not include a lane-based approach but is designed for a motion system which also combines a hexapod with a xy-sled motion system (the NADS simulator). Though, the NADS system further comprehends a yaw turntable and a cab vibration system (as well as a larger stroke in x and y which does not imply any principle difference for the motion cueing algorithm but has a huge influence on the parameter tuning options). Although both algorithms include some similar principles (e. g. using vehicle accelerations as input signals instead of specific forces, (partly) similar frequency splitting strategy, rate limit above 3 deg/s) some bigger differences can be noticed as well (e. g. consequent splitting into low-, mid- and high-frequent signals and washout compensation with the VTI approach vs. hexapod tilt coordination related to turntable position). The extended NADS motion system enables different motion cueing options just as it includes some additional design needs (as the necessity to relate the tilt angle to the yaw table position). Thus a complete design comparison of the two algorithms is not feasible.

## Results

For the comparison of the described algorithms different acceleration characteristics are used: a full throttle and a moderate acceleration phase for the longitudinal direction and steering maneuvers on a straight road and during curve driving for the lateral direction. The following figures show only the results for the 6-DOF and the 8-DOF algorithm, as the main motion cueing signal characteristics of the 3-DOF approach is similar to the 6-DOF for longitudinal accelerations and similar to the 8-DOF for lateral accelerations (except for the high-frequent hexapod motion). Figure 4 shows the contributions of the different motion cueing techniques and motion systems to the presentation of the acceleration signal for both, full throttle acceleration and a more moderate acceleration during driving.

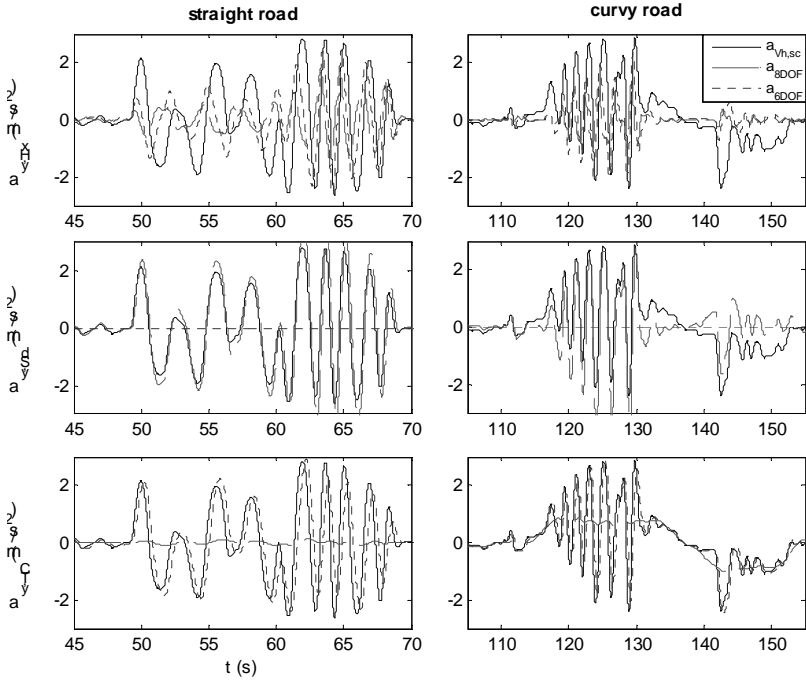


**Figure 4. Full throttle and moderate longitudinal accelerations; Signal presentation split between translational hexapod motion (up), sled motion (middle) and tilt coordination (low)**

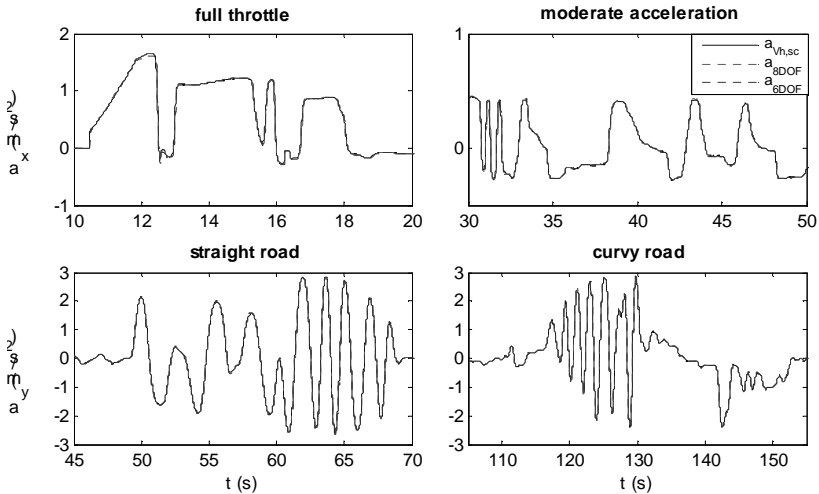
The resulting high-frequent accelerations presented with the hexapod do not differ very much between the two compared approaches. However, the usage of a sled system clearly reduces the necessary tilt coordination. So the 6-DOF approach generates tilt rates up to  $\pm 20$  deg/s, whereas the maximum tilt rate with the 8-DOF algorithm is  $\pm 10$  deg/s during full throttle and strong braking maneuvers and less than  $\pm 4$  deg/s for moderate accelerations. The same effects as for longitudinal acceleration presentation can be observed when looking at the different signals during steering actions (see Figure 5).

The difference between both approaches is even more obvious as here the biggest part of the lateral accelerations is presented with the sled when using the 8-DOF system. Thus, the high frequent hexapod accelerations are noticeable smaller compared to the 6-DOF approach and tilt coordination is nearly completely avoided on straight roads and only used for the very low-frequent, sustained part of the acceleration during curve driving. So, the difference in tilt velocities is even bigger than for the longitudinal accelerations: more than  $\pm 20$  deg/s for the 6-DOF algorithm (peaks up to 30 deg/s) compared to less than  $\pm 2$  deg/s on straight roads and less than  $\pm 5$  deg/s on a curvy road for the 8-DOF approach.

The combination of the two, respectively three signals resemble the scaled vehicle accelerations very well for all discussed approaches (shown for the 6-DOF and the 8-DOF algorithm in Figure 6).



**Figure 5. Lateral accelerations on a straight and a curvy road; Signal presentation split between translational hexapod motion (up), sled motion (middle) and tilt coordination (low)**



**Figure 6. Scaled vehicle accelerations compared to the resulting output signals generated by the 6-DOF and the 8-DOF motion cueing algorithm for different types of roads and manoeuvres**

## **Discussion**

Three motion cueing algorithms designed for different motion systems (3-, 6- and 8-DOF) have been explained. All shown results are based on simulations. However, the first two (3- and 6-DOF) are currently used and approved algorithms and the simulation for the 8-DOF approach takes the actual system limits into account (i.e. motion envelope, maximum velocities and accelerations of the different motion systems) and is based on the experiences with the first two algorithms.

The motion cueing algorithm for the 3-DOF motion system (pitch, roll and y-sled) provides a very good lateral motion feedback, though it lacks the possibility to present strong high frequent longitudinal accelerations and the rotation point is fixed. The shown algorithm for a common 6-DOF hexapod has this opportunity, to use a specified rotation point like e.g. the drivers head and it has a general flexibility to vary the motion cueing strategy according to a given task. However for manoeuvres with a higher dynamic, the necessity to use tilt coordination is immense. Even though it has been shown in the past that this type of motion system is well accepted (at least by non test-drivers) and thus can be very well used for certain types of simulator experiments, the reduction of false cues due to tilt coordination increases the immersion and enables a realistic feedback even for those manoeuvres with higher dynamic demands. This opportunity is provided by 8-DOF systems with linear sleds. They combine the advantages of both above mentioned systems and enable a good reduction in the usage of tilt coordination.

The performance comparison of the three described algorithm as well as previous experiences with the different systems leads to the following general design principles:

1. Avoid tilt coordination as long as possible.
2. If tilt coordination is inevitable, tilt without (or at least a quite unrestrictive) rate limit in order to avoid time lags in signal presentation. Use the drivers head as tilting point.

The mentioned road related motion cueing is clearly one possibility to reduce tilt coordination; the usage of the motion washout technique (i.e. to bring the simulator back into its neutral position) can be another, because it enables a bigger flexibility in presenting motion feedback to fast and unpredictable vehicle movements (independent of the direction of the motion). However, as it can cause false cues (depending on the chosen washout parameter) a weak washout is generally preferable. If redundant cueing options are available (e.g. for lateral acceleration) this leads to the following washout design rules:

1. Chose filter parameter such that the need to washout signals is reduced (i.e. a hexapod has a greater need for a washout than a sled system).
2. Chose a small washout frequency (equals a weak washout).
3. Compensate the washout with another motion system or cueing technique (e. g. tilt coordination) if feasible.

However, there are some open questions which have to be addressed with tests using the real system:

1. What is the best balance between the tilt error (when tilting with a tilt velocity higher than the perception threshold) and false cues due to time lags in the signal presentation (when using strict tilt rate limits) for vehicle signals with huge step-like acceleration changes (e.g. due to an emergency brake)?
2. Is washout compensation always wanted? Can it lead to noticeable counter movements of the hexapod vs. the sled system (e.g. a fast sled move compensated by a fast hexapod move into the opposite direction can theoretically keep the body in place, though practically it can lead to perceivable accelerations or jerks due to the different dynamic characteristics of the different motion systems)? Depending on the road course it maybe is not even necessary to washout a position signal because the current simulator position serves better as a starting point than the neutral position (e.g. during an overtaking manoeuvre)?
3. Another major concern according to the 8-DOF motion system is the introduced false cue when moving the sled system while tilting the hexapod at the same time (i.e. lateral acceleration is not presented exactly in the drivers lateral direction), as done during curve driving (see Figure 5, right). Is this effect perceivable? And if yes, how severe is it experienced, i.e. does it reduce the immersion strongly?

Although simulation results as well as experiences with the described 3-DOF motion cueing approach indicate that the mentioned lateral false cue generally should not have a strong effect on the motion perception, this has to be verified within the 8-DOF system.

After first experiences with the real system the presented strategy will be improved, taking published ideas and experiences as well as the first evaluation results into account. A possible enhancement could be to use an adaptable washout and pre-positioning (especially for the presentation of longitudinal accelerations), to test a vehicle speed and/or simulator position dependent algorithm or use a strategy without fixed filter-frequencies (e.g. adaptive optimal control with frequency-dependant scaling factors (*Tajima et al., 2006*) or tilt limiter settings adapting to linear acceleration levels (*Chapron and Colinot, 2007*). The role of false cues produced through sled movements while the hexapod is tilted (as mentioned above) will be explored as well. Further, the scientific discussion is still ongoing under which conditions the motion perception threshold is at which level (see e.g. *Wentink et al., 2008; Chapron and Colinot, 2007; Nordmark, 1994*) and which perceivable false cues are acceptable when using the tilt coordination method (*Fischer, 2009*).

All these open questions can not be answered by pure computer simulations as the main goal is to create a good illusion of driving a real car, which has to be experienced and finally evaluated by test drivers in the real simulator. Thus, these questions will be (as much as possible) addressed during the initial phase of the new system in order to evaluate the already achieved level of fidelity and to reveal necessary enhancements. However, based on the simulation results, the

developed algorithm and the according parameter choices seem to be a good starting point for the evaluation runs.

**Keywords:** Design and architecture, motion rendering

## **Bibliography**

- Chapron, T., Colinot, J.-P., (2007) The new PSA Peugeot-Citroën Advanced Driving Simulator - Overall design and motion cue algorithm, DSC North America 07 proceedings, Iowa City
- Dagdelen, M., Reymond, G., Kemeny, A., (2004) MPC based Motion Cueing Algorithm - Development and Application to the ULTIMATE Driving Simulator, DSC Europe 04 proceedings, Paris, France
- Fischer, M., (2009) Motion-Cueing-Algorithmen für eine realitätsnahe Bewegungssimulation", Berichte aus dem DLR-Institut für Verkehrssystemtechnik, Band 5, ISSN 1866-721X, PhD thesis, Braunschweig
- Fischer, M., Werneke, J., (2008) The new time-variant motion cueing algorithm for the DLR Dynamic Driving Simulator, DSC Europe 08 proceedings, Monaco
- Fischer, M., Lorenz, T., Wildfeuer, S., Oeltze, K., (2008) The impact of different motion cueing aspects concerning the perceived and subjectively rated motion feedback during longitudinal and lateral vehicle control tasks, DSC Asia/Pacific 08 proceedings, Seoul, Korea
- Grant, P., Artz, B., Blommer, M., Cathey, L., Greenberg, J., (2002) A Paired Comparison Study of Simulator Motion Drive Algorithms, DSC Europe 02 proceedings, Paris
- Grant, P., Clark, A., (2006) Motion Drive Algorithm Development for a Large Displacement Simulator Architecture with Redundant Degrees of Freedom, DSC Asia/Pacific 06 proceedings, Tsukuba, Japan
- Jamson, H., (2007) Driving me Round the Bend – Behavioural Studies Using the New University of Leeds Driving Simulator, 2nd Motion Simulator Conference, Braunschweig, Germany
- Nordmark, S., Jansson, H., Palmkvist, G., Sehammer, H., (2004) The new VTI Driving Simulator - Multi Purpose Moving Base with High Performance Linear Motion, DSC Europe 04 proceedings, Paris, France
- Nordmark, S., (1994) Driving Simulators, Trends and Experiences, VTI särtryck, p. 1-9
- Reid, L. D., Nahon, M. A. (1985) Flight Simulation Motion-Base Drive Algorithms: Part 1 - Developing and Testing the Equations, UTIAS Report 296, University of Toronto, Toronto

Tajima, J., Maruyama, K., Yuhara, N., (2006) Driving Task Adaptive Motion-Cueing Algorithm for Driving Simulator, DSC Asia/Pacific 06 proceedings, Tsukuba, Japan

VTI homepage – news archive ([http://www.vti.se/templates/Page\\_10196.aspx](http://www.vti.se/templates/Page_10196.aspx)):  
“VTI will build an advanced driving simulator in Göteborg”, 12. December 2008

Wentink, M., Valente Pais, R., Mayrhofer, M., Feenstra, P., Bles, W., (2008) First curve driving experiments in the Desdemona simulator, DSC Europe 08 proceedings, Monaco



# SHAKE – an approach for realistic simulation of rough roads in a moving base driving simulator

**Anne Bolling, Jonas Jansson, Anders Genell, Mattias Hjort, Mats Lidström, Staffan Nordmark, Göran Palmqvist, Håkan Sehammar, Leif Sjögren, Mikael Ögren**

Swedish Road and Transport Research Institute  
S581 95 Linköping, Sweden

anne.bolling@vti.se, jonas.jansson@vti.se, anders.genell@vti.se,  
mattias.hjort@vti.se, mats.lidstrom@vti.se, staffan.nordmark@vti.se,  
goran.palmqvist@vti.se, hakan.sehammar@vti.se, leif.sjogren@vti.se,  
mikael.ogren@vti.se

**Abstract** – *With today's advanced measurement equipment for measuring roads, it is possible to measure road geometry at high precision within a large span of wavelengths. Detailed information about the roads longitudinal and lateral profile, including macro texture, would in theory be sufficient for a realistic reproduction of road induced vibration and noise in a driving simulator. Especially, it would be possible to create a direct connection between the visual information of the road condition and the ride experience, which would increase the level of realism in the simulation. VTI has during three years performed an internal project called SHAKE with the aim to develop and implement models in VTI driving simulator III that use measured road data for generating realistic vibrations and audible road noise connected to the visual impression presented on the projection screen. This has indeed resulted in a more realistic driving experience, and a validation study with test persons driving both in the simulator and in the field has been undertaken. The OpenDRIVE standard is used as a framework for describing the road properties (e.g. visual, vibrations and noise). For this purpose some augmentations to the OpenDRIVE standard had to be made. This paper describes the technical implementations in the driving simulator, along with results from test drives on the implemented road sections*

## Introduction

High-fidelity simulation is about creating an as true to life driving experience as possible. To accomplish this several components, such as e.g. visual impression, audible sensation, motion sensation, are required. In each of these fields much work has been done and is still on-going, e.g. (Kawamura, 2004). To achieve a

realistic experience it is also important to synchronise these sensations i.e. the visual impression should be connected to what is felt and heard by the driver. The problems associated with the lack of road irregularities is discussed in (Green, 2005). The purpose of this project has been to achieve better realism of the road surface and to understand how different road surfaces is perceived by the driver.

## Simulator

This work was carried out in VTI's driving simulator 3 (Figure 1). This simulator is particularly well suited for this development due to its unique dedicated vibration table, which is capable of reproducing high frequent road vibrations. Furthermore, it is equipped with a passenger car cabin and an advanced motion system for realistic simulation of forces felt when driving (Nordmark *et al.*, 2004; VTI, 2010-03-26). The surroundings of the driver are shown on a main screen with 120 degrees field of view, as well as in three rear view mirrors. The dedicated vibration table, which simulates road irregularities, is situated under the cabin and provides vibration movement relative to the projection screen. The motion system also provides high performance linear lateral acceleration, as well as roll and pitch movements of the entire platform.

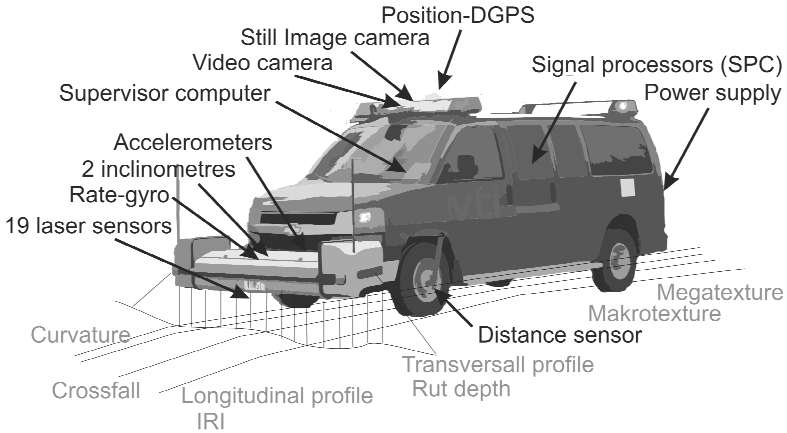


Figure 1. VTI Simulator III

## Vibrations

Driving simulator tests, to study road user behaviour, can be improved by creating a driving experience as close to real life driving as possible. One part of this is to include effects and behaviour that is introduced from a realistic road representation including the road's condition such as ruts, cracks, irregularities etc. Therefore a first test was done to accomplish this. Three sections on real roads were selected. The sections were 3-4000 meter long. They were chosen to cover a spectra of different evenness, one was judge as smooth ( $IRI = 1.1$  mm/m), another as rough ( $1.7$  mm/m) and the third as very rough ( $3.5$  mm/m). The vibrations induced by the unevenness were measured with a personal car, Audi A6 Avant 2006. Accelerometers (3 axes) were mounted in the car chassis, on the driver seat and on the steering wheel. The Audi was driven several times in different speeds over the sections. During the runs data was collected. At least three participants gave, after repeated test runs, their opinion on the sections

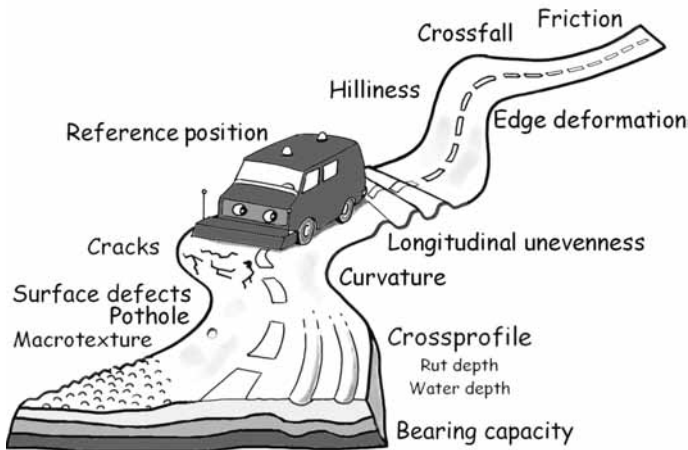
unevenness performance. During the development the same persons was used to subjectively rate the reconstruction in the driving simulator. The geometry and road surface condition was also measured with a dedicated road surface tester system. VTI has at its disposal a special measurement system, VTI Laser RST, (see Figure 2) designed and built to do high precision monitoring of the road surface condition.



**Figure 2. VTI Laser RST**

The VTI Laser RST consists of a data collection system and sensors mounted on a van. The system can measure the road condition in traffic speed (speed independent).

Road condition is defined as a number of measurable indicators; see Figure 3 representing the relevant road surface characteristics, such as transversal unevenness expressed as rut depth, longitudinal unevenness expressed as IRI (International Roughness Index) and the surface texture expressed as MPD (Mean Profile Index).



**Figure 3. Road surface characteristics**

Vibrations from a real road have previously been used in various studies in VTI's driving simulators. The vibrations were generated by modelling each tyre as a vertical spring/mass/damper system, excited by a point following the road envelope. Traditionally, however, the road data input has been in the form of FFT transformed road data, and a longitudinal profile with the same spectral distribution as the measured road had to be created. The resulting longitudinal profile consisted of only one wheel track, leading to vibrations that were purely vertical without any roll or lateral movement.

This vibration model has since then been improved considerably, resulting in a major enhancement in simulation realism. The new vibration model is based on measured road profiles in both wheel tracks. The most important improvements are:

- A new model for representing the wheels has been developed, where a lateral stiffness component of the wheel has been introduced, together with a relaxation length model. This lateral stiffness affects the vertical position of the roll axle, and is needed for realistic roll and lateral movements.
- The movements of the simulator have been optimized with respect to both outer and inner movements of the system.
- Different locations for the center of rotation, of vibrations induced in the vehicles roll behaviour, has been investigated. This research is still ongoing.

The vibration model uses a time step of 0.5 ms for the calculations, while the simulator movements are updated with a frequency of 200 Hz.

The vibration model was developed, and validated by using the following procedure:

1. A passenger car was equipped with accelerometers and rotation sensors, and the vibrations from driving on a few different roads with a roughness varying from smooth to very bumpy were recorded.
2. The recorded vibrations were sent as input signals to the driving simulator movement system, to verify that the simulator was capable of reproducing the vibrations.
3. The road sections used for the vibrations measurements were measured with VTI's sophisticated Road Surface Tester, which measured the road profile with high precision using several laser beams.
4. The new tyre model was developed, and with the measured road geometry as input, vibrations was generated and measured in the driving simulator. These vibrations compared well with those measured on the road.

## Simulated road noise

The most important contributor to the interior sound environment in a car cabin is the tire/road noise. It dominates the interior sound for normal driving speed ranging between 30 - 120 kph. The mechanisms involved in noise generation are very complex and a real time application of a detailed noise generation model that

creates realistic noise and vibrations is a futile approach due to computation cost. In the VTI Simulator III the approach is instead to create a realistic experience for the driver by relatively simple means based on standard road surface roughness measurements available to VTI. The model involves a number of simplifications, and comprises only three main parts: a velocity dependant noise generator, a static global transfer function and a sound effects generator. The noise generator very simply mimics the spectrum variation of the noise due to speed variations by applying an adaptive low-pass filter to a white noise signal. The static transfer function is estimated from road texture data and in-car noise measurements. The sound effects generator creates events such as driving through a pool of water, by filtering and randomly phase-shifting high frequent noise, or driving over a crack in the road, by creating a highly damped sinusoid similar to that from tire cavity resonance or suspension resonance. Modelled and measured road noise levels show reasonably good similarity, and informal listening confirms the adequacy of the simulated road noise.

## OpenDRIVE – Patch augmentation

Since the vehicle position on the road surface or lateral distances relative to road or lane borders are important measures for the new vibration model, a comprehensive definition of the road has been necessary.

Traditionally, most simulator environments have used their own proprietary formats for the logic description of the road system, which has made it impossible to share road data between simulators. In 2006, an initiative to create an open format for the road description was initiated by the Vires company. The format “OpenDRIVE” (OpenDRIVE, 2010) has since then been accepted by several simulators and may become part of a future standard of road description.

VTI has used the OpenDRIVE format since 2007 which has improved the definition of the road and road surface significantly, which greatly facilitated the realization of the SHAKE project. A detailed description of the OpenDRIVE file format can be found at [opendrive.org](http://opendrive.org).

OpenDRIVE is a means for separating a road network into a set of roads, connected by junction areas or directly linked to each other.

A road is described by its geometry, lanes and objects.

The road surface is defined as a material name. VTI has added extensions where the material name is translated to visual appearance, audio and vibration data that describes the surface, see Figure 4. The OpenDRIVE specification of the road surface material indicates what material is used on each specific lane of the road from a start position.

Unfortunately there was no way within OpenDRIVE to specify patches on the road surface – areas where the surface was defect or repaired with a different surface material. The existing object description method was not detailed enough why we had to define a patch method. This defines a minor area, within a lane, where a different surface material is used (see Figure 5). This extension was later included in OpenDRIVE 1.3.

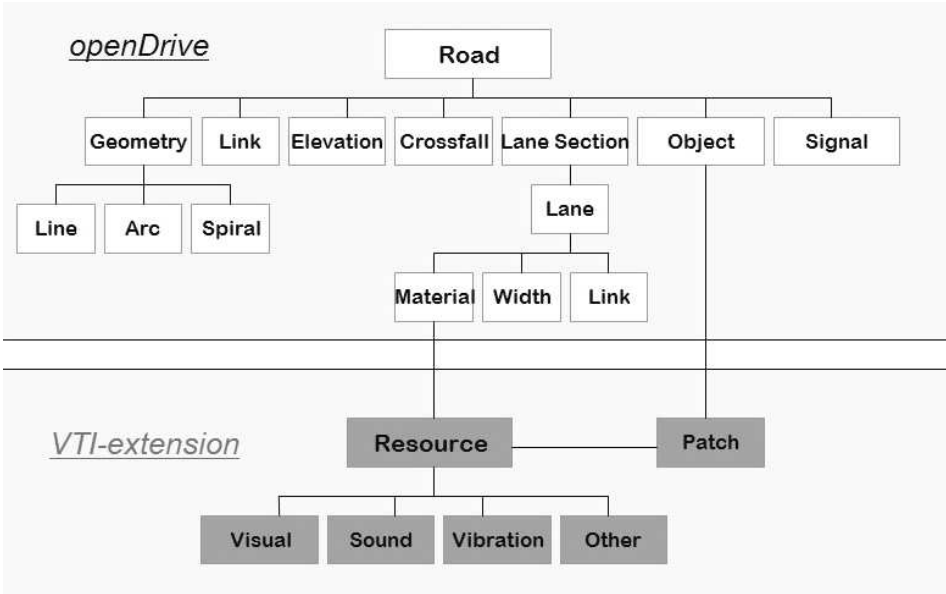


Figure 4. OpenDRIVE and VTI's extension



Figure 5. Example of a road with cracks and patches

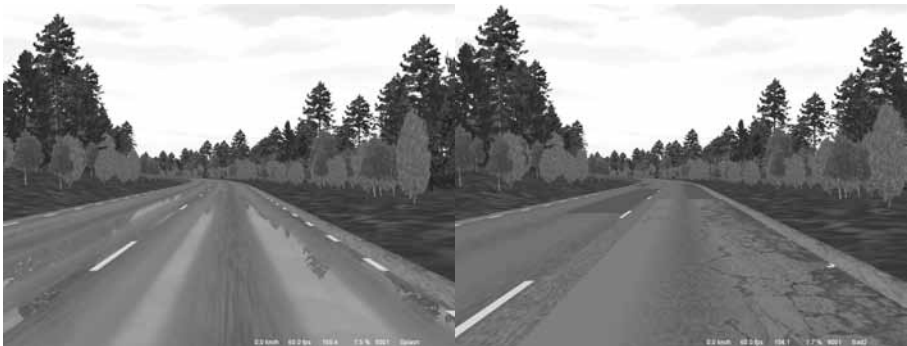
## Evaluation of road realism

During the development several comparisons between real driving and simulator driving were performed. In a larger experiment 32 test participants evaluated eight road surfaces conditions/properties as follows: Patched road, Road with ruts, Ruts with water, Road with rough texture, red, Uneven road 1- medium vibrations (ruts, patches, cracks, edge deformations), Road with cracks in the right wheel track, Road with cracks in the right wheel track and edge deformations, Uneven road 2- greater vibrations (ruts, patches, cracks, edge deformations), Each participant graded the realism of each roadsection between 1 and 7, where 1 is very unrealistic and 7 very realistic.

**Table 1. Perceived realism of the different roads, the number of test participants is 32 for each road**

	Mini- mum	Maxi- mum	Mean	Std. Deviation
Reference road	3.00	7.00	6.0313	.96668
Patched road	2.00	7.00	5.8438	1.11034
Road with ruts	1.00	7.00	5.2188	1.26324
Ruts with water	2.00	7.00	5.8437	1.22104
Road with rough texture, red	2.00	7.00	5.7500	1.21814
Uneven road (medium and heavy) vibrations (ruts, patches, cracks, edge deformations)	5.00	7.00	5.9375	.71561
Road with cracks in the right wheel track	3.00	7.00	5.7500	1.04727
Road with cracks in the right wheel track and edge deformations	4.00	7.00	5.6875	.96512

Overall all roads were judged to be realistic and received high mean values (between 5.2 and 6.0, where 1 represent a very unrealistic impression and 7 a very realistic impression). Figure 6 shows examples from the different roads.



**Figure 6. Example of two of the roads (ruts with water and road with cracks in the right wheel track and edge deformations)**

## Results

This study focuses on the realism of the simulated road surfaces. The development resulted in an augmented version of the OpenDRIVE standard, that facilitated a unified way of describing the roads properties. This description includes how the road appears visually to the driver, the tire to road noise heard by the driver and vibration sensation felt by driver. The proposed extension of a road patch definition was later included in OpenDRIVE 1.3.

The vibration models that were used as well as the tire to road noise model was validated using on road measurements, both using accelerometer measurements and subjective evaluations. These models were then used to implement 8 different roads/surfaces, which were used in a study to evaluate the driver's opinion on road maintenance quality (Ihs *et al.*, 2010).

The general result from 32 test participants was that all roads were perceived as realistic. All roads received high mean values (between 5.2 and 6.0) on scale ranging from 1-7, where 1 is very unrealistic and 7 very realistic. The highest score was assigned to a reference road, that was designed to represent an average road with a normal amount of irregularities and patches.

## Discussion and conclusions

The OpenDRIVE standard was used to specify all properties (i.e. visible, vibrations and audible) of a road surface in a logical road description. This forms the basis for the feed-back generation in the driving simulator. The tire position on road surface activates sound and vibration for each wheel according to road and patch definitions in the OpenDRIVE database. To facilitate this, an extension to the current standard was made. The extension consists of assigning a particular road surface appearance, vibration model and noise model to the description of lane material. Furthermore, the concept of a patch that represents a defined subset of the lane area is also introduced.

Because of its capabilities to reproduce cabin vibrations in the ride comfort range, VTI's Simulator 3 proved to be extremely useful to simulate road irregularities and unevenness.

The introduction of standardized road description provides a good foundation for a unified description of the road network and the road surface properties. The synchronisation of visual, audible and haptic impressions is important to create an overall realistic simulation experience in the simulator. Evaluation of the importance of the roll centre of rotation for the induced vibrations is still on-going.

**Keyword:** OpenDrive, road, vibrations, roadnoise shake

## Bibliographie

Nordmark, S., Jansson, H., Palmkvist, G., Sehammer, H., (2004) The new VTI Driving Simulator – Multi Purpose Moving Base with High Performance Linear Motion. *In Proceedings of the Driving Simulator Conference 2004 Paris, 45-55.*



Green, P (2005); *How Driving Simulator Data Quality Can Be Improved*; In Proceedings of the Driving Simulator Conference 2005 North America, Orlando, USA, November 2005.

VTI (2010-03-26). *VTI's drivning simulators*. Internet 13:09 2010-03-26 <http://www.vti.se/simulator>

OpenDRIVE. Internet 11:39 2010-05-07 <http://www.opendrive.org>

Ihs, A., Andersson, J., Kircher, K., Bolling, A.,(2010); *Trafikanternas krav på vägars tillstånd – en körsimulatorstudie (Road users´ requirements on road surface condition – A driving simulator study)*. Swedish National Road and Traffic Institute. VTI rapport 669.

Kawamura,A., Shirakawa,T. and Maeda,C. (2004); *Applicability of Driving Simulator as a New Tool for the Pavement Surface Evaluation*, Proceedings of the SIV (Italian Society for Transportation Infrastructures) 2004 International Congress, Firenze, Italy, 52-10



# Motion Cueing Algorithm Online Parameter Switching in a Blink of an Eye – A Time-Variant Approach

**Tobias Lorenz, Klaus Jaschke**

German Aerospace Center (DLR)

Institute of Transportation Systems (TS), Lilienthalplatz 7, 38108 Braunschweig,  
Germany

tobias.lorenz@dlr.de, klaus.jaschke@dlr.de

**Abstract** – *The development and evaluation of human centered driver assistance systems is one major research focus within the automotive domain of the Institute of Transportation Systems (TS) at the German Aerospace Center (DLR). To investigate the impact of new driver assistance systems on driver behavior different research facilities from simulations to real car environments are used. One research facility at TS is the dynamic driving simulator with a hexapod structure. Using dynamic driving simulators to reproduce real car motion is a major challenge as the workspace is limited. Within this paper a method of state adaption is presented. This method enables a discrete switching of high-pass filter corner frequencies within one single simulation time step. Thereby discontinuities of the filter output signal as well as in the derivatives of the output signal are avoidable. Thus it is possible to adapt corner frequencies of high-pass filters of a Motion Cueing Algorithm (MCA) according to the current driving situation. The article starts with a description of the MCA currently used for the motion rendering at TS. Afterwards the state adaption method is described including the challenges for adapting this method to the current MCA structure. In the end the new structure for the time-variant MCA as well as the boundary conditions for corner frequency switching and the test results of the new time-variant approach using the state adaption method are outlined.*

## Motivation and Introduction

Research activities at the Institute of Transportation Systems (TS) at the German Aerospace Center (DLR) focus on increasing safety and efficiency of traffic. In particular, this includes development and evaluation of assistance and automation systems within the automotive domain. To evaluate the impact of new driver assistance systems on driver behavior different research facilities are used. One research facility is the dynamic driving simulator with a hexapod structure. Using such motion simulators the representation of real car motion within the limited simulator workspace is a major challenge.

## Nomenclature

$\underline{a}_{FDD}$	$\left[ \frac{m}{s^2} \right]$	vector of translational accelerations calculated by the vehicle dynamics model
$a_n(t)$	$[ ]$	coefficients of the linear time-variant high-pass filter
$\underline{a}_{Sim}$	$\left[ \frac{m}{s^2} \right]$	vector of high-pass filtered translational accelerations commanded by the MCA
$a_y$	$\left[ \frac{m}{s^2} \right]$	translational acceleration in y-direction
$HP$	$[ ]$	time-variant third order high-pass filter in the translational path of the MCA
$HP_a$	$[ ]$	first order high-pass filter in the translational path of the MCA
$HP_{wo}$	$[ ]$	second order high-pass filter in the translational path of the MCA
$L_{IS}$	$[ ]$	transformation matrix from vehicle fixed to inertial coordinate frame
$L_{SI}$	$[ ]$	transformation matrix from inertial to vehicle fixed coordinate frame
$s_y$	$[m]$	position in y-direction
$\underline{sc}_a$	$[ ]$	vector of scaling factors for the input accelerations of the MCA
$t_{switch}$	$[s]$	time when the MCA parameter set is switched
$u(t)$	$[ ]$	input signal of the high-pass filter
$v_y$	$\left[ \frac{m}{s} \right]$	translational velocity in y-direction
$\underline{x}(t)$	$[ ]$	state vector of the high-pass filter
$y(t)$	$[ ]$	output signal of the high-pass filter
$\phi_{tilt}$	$[^\circ]$	rotation angle for the rotation around x-axis for the tilt path
$\omega_{x,tilt}$	$\left[ \frac{^\circ}{s} \right]$	angular velocity for the rotation around x-axis for the tilt path
$\dot{\omega}_{x,tilt}$	$\left[ \frac{^\circ}{s^2} \right]$	angular acceleration for the rotation around x-axis for the tilt path

To improve the motion rendering new and refined Motion Cueing Algorithms (MCA) which map the real car motion to the limited simulator workspace are necessary. Commonly the main elements of these algorithms are scaling blocks, frequency filters and limiters. Usually the parameters of these elements are fixed during a simulator ride. But as outlined in [1, 2, 3] a discrete switching of these parameters according to the current driving situation e.g. city, rural and highway driving could be advantageous. These sets of parameters have to be determined a priori and are used when the respective driving situation occur. The following paper provides a method to discontinuously switch the coefficients of high-pass filters within one single discrete simulation time step. Furthermore the occurring challenges regarding the fast-tilt-coordination (FTC) algorithm [1], which is used for the motion rendering at TS, are presented.

## Challenges of the Time-Variant FTC Algorithm

### The FTC Algorithm

Figure 1 represents the block diagram of the initial FTC structure, which is currently used for motion rendering at TS. The main difference compared to the classical MCA approach [4, 5] is the ideal filter structure which is introduced and discussed in detail by Fischer [1]. There studies proving the validity of the FTC concept were done.

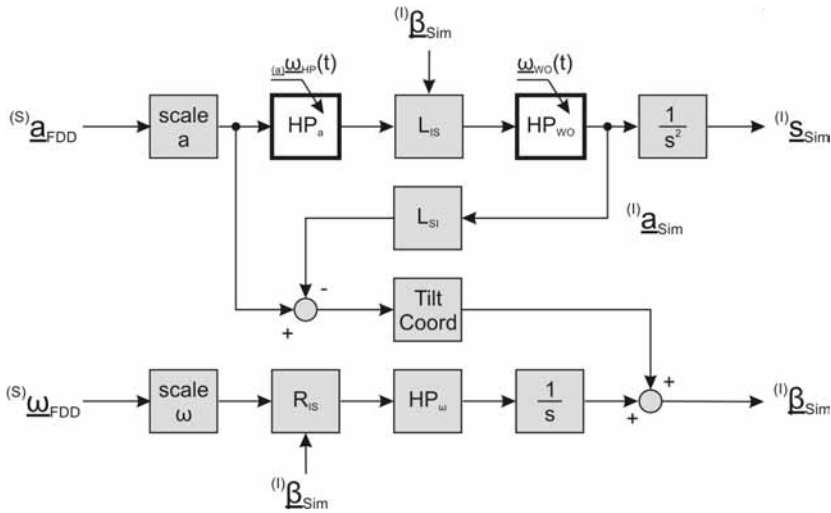


Figure 1. Block diagram of the initial FTC structure

The ideal filter structure is represented by the subtraction of the transformed output signal  $L_{SI} \cdot {}^{(I)}\underline{a}_{Sim}$  of the two high-pass filters ( $HP_a$  and  $HP_{wo}$ ) and the scaled input acceleration  $\underline{sc}_a \cdot {}^{(S)}\underline{a}_{FDD}$ . In the upper path of Figure 1 the high frequent signal components of  $\underline{sc}_a \cdot {}^{(S)}\underline{a}_{FDD}$  are extracted and presented by a linear movement of the simulator platform. Through the ideal filter structure it can

be ensured that no signal components of the scaled input acceleration  $\underline{sC}_a \cdot \overset{(S)}{a}_{FDD}$  get lost caused e.g. by an additional low-pass filter in the tilt coordination path. Thus all parts of the scaled input acceleration, which are not presented by a linear movement of the motion platform, are presented by a tilt movement.

## Switching Effects of Time-Variant High-Pass Filters

Regarding the high-pass filters within the FTC (see Figure 1, white blocks with bold line) according to the discrete online parameter switching of their coefficients  $a_n(t)$  ( $n \in \mathbb{Z}, n \geq 0$ ) undesired switching effects occur. These effects can be explained by considering the time-variant state space description of common high-pass filters. From the linear time-invariant transfer function

$$H(s) = \frac{s^n}{s^n + a_{n-1} \cdot s^{n-1} + \dots + a_1 \cdot s + a_0} \quad (1)$$

the state equation (2) and output equation (3) of the state space description can be derived. There the coefficients of the high-pass filter  $a_n(t)$  are considered as time-variant.

$$\begin{bmatrix} \dot{x}(t) \\ \ddot{x}(t) \\ \cdot \\ \cdot \\ \overset{n}{x}(t) \end{bmatrix} = \begin{bmatrix} 0 & 1 & 0 & \cdot & \cdot & 0 \\ 0 & 0 & 1 & \cdot & \cdot & 0 \\ \cdot & \cdot & \cdot & \cdot & \cdot & \cdot \\ \cdot & \cdot & \cdot & \cdot & 1 & \cdot \\ -a_0(t) & -a_1(t) & \cdot & \cdot & \cdot & -a_{n-1}(t) \end{bmatrix} \cdot \begin{bmatrix} x(t) \\ \dot{x}(t) \\ \cdot \\ \cdot \\ \overset{n-1}{x}(t) \\ x(t) \end{bmatrix} + \begin{bmatrix} 0 \\ \cdot \\ \cdot \\ 0 \\ 1 \end{bmatrix} u(t) \quad (2)$$

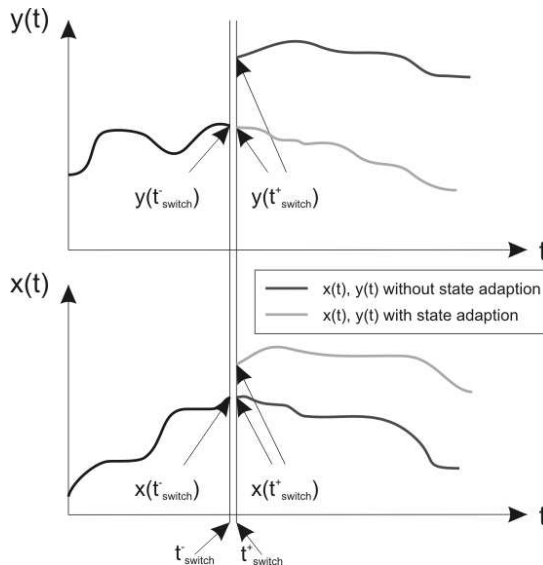
$$y(t) = \begin{bmatrix} -a_0(t) & -a_1(t) & \cdot & \cdot & \cdot & -a_{n-1}(t) \end{bmatrix} \cdot \begin{bmatrix} x(t) \\ \dot{x}(t) \\ \cdot \\ \cdot \\ \overset{n-1}{x}(t) \\ x(t) \end{bmatrix} + u(t) \quad (3)$$

When considering the output equation (3) at a certain time  $t_{switch}$  with the input signal  $u(t_{switch})$  and the state vector  $\underline{x}(t_{switch})$  it is evident that – if one or more of the coefficients  $a_m(t)$  ( $m \in \mathbb{Z}, 0 \leq m \leq n$ ) are changing discontinuously – there will be a discontinuity in the output signal  $y(t)$ . To avoid these discontinuities the method of state adaption is presented in the next section.

# State Adaption Method to Switch the Coefficients of Time-Variant High-Pass Filters

## The Method of State Adaption

To avoid the described output signal discontinuities as described in the former section the idea is to adapt the states of the transfer system in a way that in the moment of coefficients switching the discontinuity will be transferred to the state space. Thus there will be a discontinuity in the system states  $\underline{x}(t)$  but not in the output signal  $y(t)$ . According to the order of the used high-pass filter this method is not limited to avoid discontinuities in the output signal  $y(t)$  but in its derivatives, too. Thus this method is not tied to a type (low pass or high-pass) or a certain order of linear time-variant filters. In Figure 2 the common principle of the state adaption method for the signal flow of the state  $x(t)$  and output  $y(t)$  signal of a first order high-pass filter is outlined schematically.



**Figure 2. Common principle of the state adaption method**

The first step of the state adaption method is the derivation of a system of linear equations based on the output equation (3). There the states of the transfer system are the unknown variables. The order  $n$  ( $n \in \mathbb{Z}, n \geq 0$ ) of the used high-pass filter determines the order of the highest derivative of the output signal  $\frac{d^{n-1}y}{dt^{n-1}}$  where a discontinuity in the signal flow is avoidable. Within the resulting system of linear equations the current values of the output signal and its derivatives, the new coefficients  $a_m(t)$  and the input signal as well as its derivatives are known.

Thus the new states of the time-variant high-pass filter can be calculated to avoid discontinuities in the output signal as well as in the derivatives of the output signal. Because the coefficients of the high-pass filters are piecewise constant its derivatives are zero. So they are not considered in the system of linear equations.

The first equation of the system of linear equations (4) is the output equation of the state space description (3). Considering a high-pass filter with the order  $n > 1$  the equations of the system can be derived step by step. To derive the second equation the first equation has to be differentiated as shown in equation

(4). Caused by the differentiation of the first equation the variable  $x^{(n)}(t)$  occurs in the second equation. This variable has to be replaced by the state equation (2) so that the highest order of the state derivatives is  $(n - 1)$ . If the order of the high-pass is greater than two the second equation of the system of linear equations

has to be differentiated and the occurring  $x^{(n)}(t)$  has to be replaced. These steps

have to be repeated until the highest order of the output derivative  $\frac{d^m y}{dt^m}$  is  $(n - 1)$ .

$$\begin{aligned}
 I. \quad & y(t) = -a_0 \cdot x(t) - \dots - a_{n-1} \cdot x^{(n-1)}(t) + u(t) \\
 II. \quad & \frac{dy}{dt} = -a_0 \cdot \frac{dx}{dt} - \dots - a_{n-1} \cdot x^{(n)}(t) + \dot{u}(t) \\
 & \dots \quad \dots
 \end{aligned} \tag{4}$$

Finally the derived system of linear equations has  $(n - 1)$  equations including  $(n - 1)$  unknown state variables. This system of linear equations can be solved by different methods e.g. Gauss-algorithm, Cramer's rule, etc. and as the equations are not linearly dependent there will be a definite solution.

The state adaption method, to calculate the new system states, is only to be used in the moment of changing high-pass filter coefficients. In this moment the current output signal and its derivatives, the current input signal and its derivatives and the new coefficients are used to calculate the new state variables. Thus it is possible to switch the filter coefficients within a single discrete simulation time step.

## Influence of the State Adaption Method on the Time-Variant FTC Algorithm

In this section the results from the already outlined common method of state adaption are mapped to the FTC algorithm. Considering the block diagram of the FTC algorithm in Figure 1 there are two high-pass filters in the upper path ( $HP_a$  and  $HP_{wO}$ ). There  $HP_a$  is a first order high-pass filter and  $HP_{wO}$  is a second



order high-pass filter. Using the state adaption method separately for both filters will cause points of discontinuity in the angular acceleration signal when the filter coefficients are switched.

Because the highest order of the high-pass filter is two the discontinuities can be avoided for the input signal (accelerations) and the first derivative of the input signal (jerk). This means that in the acceleration signals presented by linear movement of the simulator platform there are no discontinuities. But for the presentation of latent accelerations through the tilt coordination there are discontinuities, because the acceleration signals are transformed to angular values using trigonometric functions. Thus there are no discontinuities in the angular values and the angular velocities but in the angular accelerations. This could be avoided by the new FTC algorithm approach.

In the block diagram of Figure 3 the new structure of the time-variant FTC algorithm is presented. Using the structure of the FTC algorithm presented in Figure 1 discontinuities in the angular acceleration occur in the moment of discrete coefficients switching. To avoid these effects a third order high-pass filter has to be used. Therefore the two high-pass filters in the upper path have to be merged to a third order high-pass filter. This is possible because the time-invariant FTC algorithm almost is a linear time-invariant (LTI) system. Assuming that the time-variant FTC is a piecewise LTI system this method is adaptable. But there is another problem regarding the double integrator in the upper path of the FTC algorithm, because of the discrete switching of parameters by using the state adaption method. In the moment of coefficients switching the wash-out effect of the third order high-pass filter gets lost and the signal flows for the position and velocity signals for linear platform movement are not attracted to the zero position and velocity anymore.

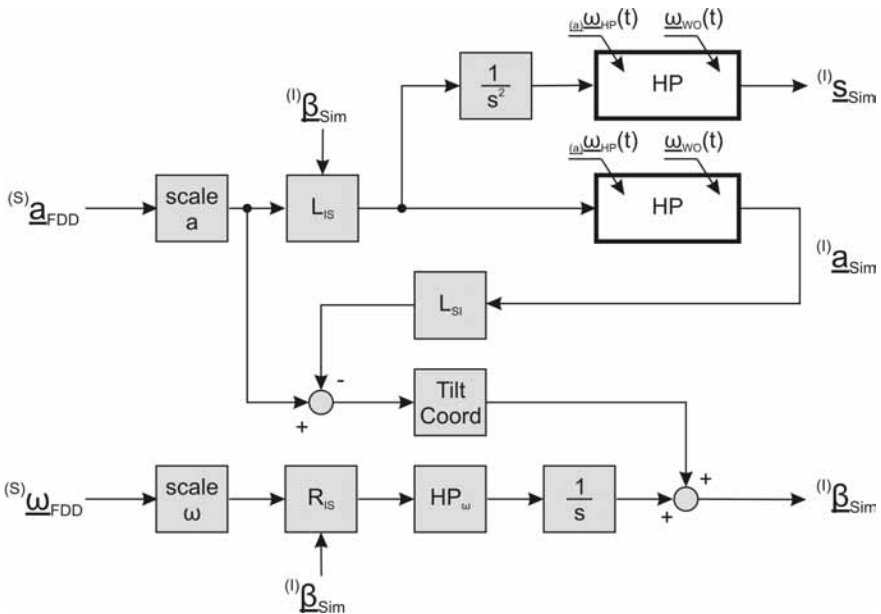
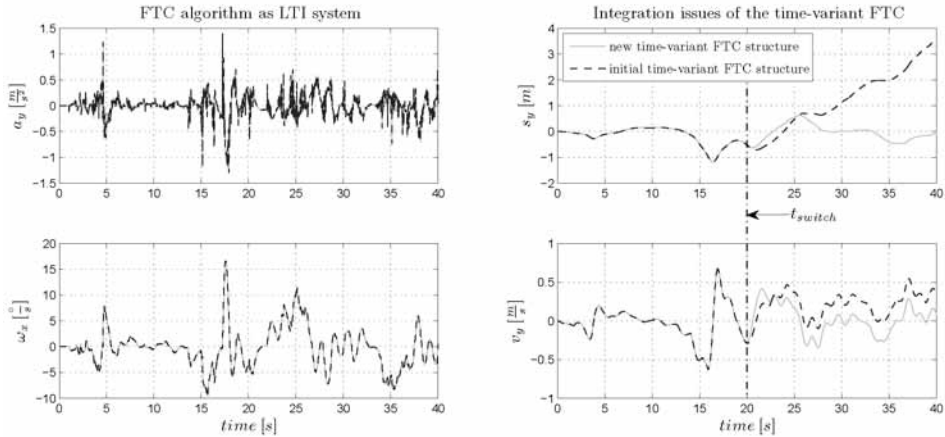


Figure 3. Block diagram of the new structure of time-variant FTC algorithm

In Figure 4 four diagrams are presented dealing with the aforementioned challenges. In the two diagrams on the left side it is shown that the output signals (lateral acceleration and angular velocity of roll movement) of the initial time-variant FTC structure (Figure 1) and the new time-variant FTC structure (Figure 3) are equal for constant filter coefficients. The two plots on the right side present the position and velocity signals in the moment of switching filter coefficients for the initial time-variant FTC structure and the new time-variant FTC structure. In the position signal  $s_y$  and the velocity signal  $v_y$  it is obvious that the wash-out effect of the high-pass filter get lost for the initial time-variant structure.



**Figure 4. Comparison of the initial time-variant FTC structure and the new time-variant FTC structure**

## Constraints and Results for the Discrete Parameter-Switching

### Constraints for the Moment of Parameter-Switching

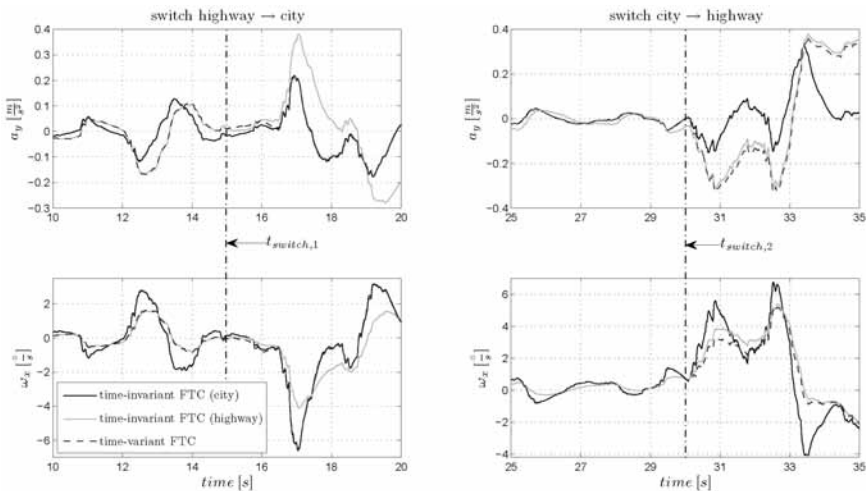
Using the presented method of state adaption it is possible to switch the filter coefficients of high-pass filters within one single discrete simulation time-step. Certainly there is an influence on the signal flow of the output signal which should be kept as low as possible. Therefore it is meaningful to define constraints which have to be fulfilled before initializing the switching process. Considering the change of the filter coefficients for lateral movement the process should not be initialized when currently driving in a curve. Switching the filter coefficients within a curve would cause a movement of the simulator platform although there is a constant lateral acceleration which is presented by a constant tilt angle of the motion platform. In Table 1 the constraints which have to be fulfilled to switch the filter coefficients are outlined for the components of lateral movement. Thereby the perception thresholds for accelerations and angular velocities are taken into account as presented by Benson *et al.* [6,7]. The thresholds for the other motion quantities were gathered by experiments.

**Table 1. Constraints for the discrete parameter switching**

	$ s_y $	$ v_y $	$ a_y $	$ \phi_{tilt} $	$ \omega_{x,tilt} $	$ \dot{\omega}_{x,tilt} $
Limits	$\leq 0,1 \text{ m}$	$\leq 0,1 \frac{\text{m}}{\text{s}}$	$\leq 0,1 \frac{\text{m}}{\text{s}^2}$	$\leq 1^\circ$	$\leq 2 \frac{^\circ}{\text{s}}$	$\leq 2 \frac{^\circ}{\text{s}^2}$

## Presentation of the Results Using the State Adaption Method for Online Parameter-Switching

In Figure 5 the results of the evaluation tests are presented. Within these plots the signal flow of the output signal of the new time-variant FTC structure versus the initial time-invariant FTC structure are presented. In the left plots only very small switching effects are visible while the parameters are switched from highway to city driving.. In the moment of parameter switching  $t_{switch,1}$  there is no discontinuity in the output acceleration or angular velocity. Considering the right plots the switching effects are slightly more clear-cut than in the left plots. Certainly there are no discontinuities in the output signals at the switching time  $t_{switch,2}$ . The difference in the effects is given by comparing the time from the point of parameter switching to the point where the signal flow of the time-variant algorithm equals the signal flow of the time-invariant algorithm. These effects are visible in the presented plots.



**Figure 5. Comparison of the initial time-invariant FTC structure and the new time-variant FTC structure**

## Conclusion

Within this paper an approach to adapt the current set of parameters of a MCA to the current driving situation is presented. Thereby a method to switch the coefficients of a high-pass filter discontinuously without discontinuities in the filter

output signal as well as its derivatives is outlined. The advantage of this method is that the filter coefficients can be switched within one single discrete simulation time step. So the moment of switching is chosen by the fulfillment of constraints regarding the actual motion quantities of the simulator platform.

Certainly it is meaningful to limit the adaption of the current set of parameters to superior driving situations as done in this paper (city, rural and highway driving). Otherwise when running a much more differentiated adaption of parameters the parameter switching can not be ensured because of the constraints for parameter switching.

In the future the method of state adaption should be applied to the lower path of the MCA (see Figure 1) where the high frequent parts of the angular velocities are presented by an angular movement of the simulator platform. A method to online adapt the scaling factors of the FTC algorithm is already presented in reference [2].

**Keywords:** fast tilt coordination, online parameter switching, state adaption, high-pass filter

## Bibliography

- [1] Fischer, M., (2009) Motion-Cueing-Algorithmen: Untersuchung von Mechanismen für eine realitätsnahe Bewegungssimulation, *Dissertation, Braunschweig*
- [2] Lorenz, T., (2008) Implementierung, Test und Bewertung eines zeitvarianten Algorithmus zur Ansteuerung einer Bewegungsplattform, *Diplomarbeit; Braunschweig*
- [3] Grant, P., Blommer, M., Cathey, L., Artz, B. Greenber, J., (2003) Analyzing classes of Motion Drive Algorithms Based on Paired Comparison Techniques, DSC North America, Dearborn (Michigan), October 2003
- [4] Nahon, M.A., Reid, L.D., (1990) Simulator Motion-Drive Algorithms: A Designer's Perspective, *Journal of Guidance Bd. 13, Nr.2, March-April 1990*
- [5] Reymond, G., Kemeny, A., (2000) Motion Cueing in the Renault Driving Simulator, *Vehicle System Dynamics Bd. 34, 249-259*
- [6] Benson, A.J., Spencer, M.B., Stott, J.R., (1989) Thresholds for the detection of the direction of whole-body, linear movement in the horizontal plane, *Aviation, Space and Environmental Medicine Bd. 57, S.1088-1096*
- [7] Benson, A.J., Hutt, E.C., Brown, S.F., (1989) Thresholds for the Perception of Whole Body Angular, *Aviation, Space and Environmental Medicine Bd. 60, 205-213*

**Keynote address**



# Daimler's New Full-Scale, High-dynamic Driving Simulator – A Technical Overview

**Eberhard Zeeb**

Daimler AG

Driving Simulators Dept. GR/ACD, 71059 Sindelfingen-Germany

eberhard.zeeb@daimler.com

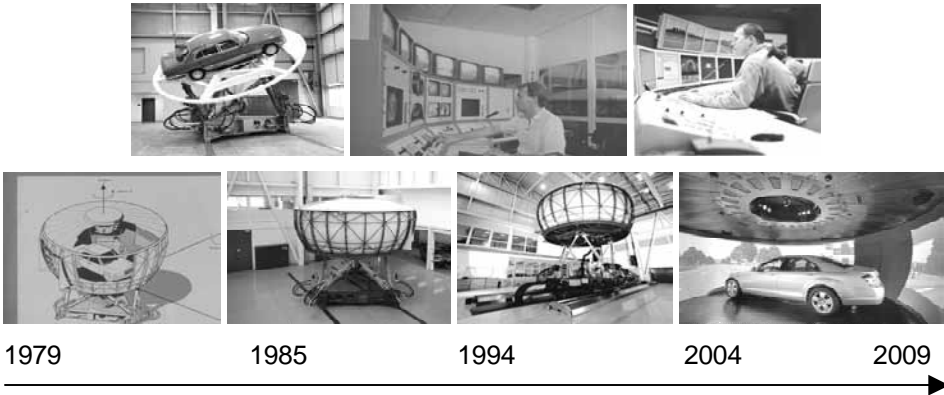
**Abstract** – Based on 25 years experience with the optimization and successful operation of driving simulators as efficient tools for the development and assessment of driver assistant and chassis system for passenger cars, trucks and busses, we have built up a new driving simulator center at Daimler's main research and development location in Sindelfingen. Beside three fixed-based simulators and a ride simulator a completely new designed high dynamic moving-base simulator was constructed. The new driving simulator center was taken into operation in the first half of 2010 and will be officially opened end of September. This paper gives an overview of the hard- and software components as well as of the performance of the new simulators.

## Introduction

Driving simulators are intensively used since several years for the development of driver assistant systems (see e.g. [1,2,3]) and several research institutes and car manufactures have built up new simulator facilities lately (see e.g. [4,5,6]).

Since the first publishing of our moving-base driving simulators in 1985 [7], we have permanently improved and modified the motion system, as shown in Fig. 1.

The driving simulator first was based on a hydraulic hexapod motion system only, which was enhanced by an additional lateral hydraulic cylinder and a lateral rail system of 5.6 m length in 1994 [8]. In 2004 a further soft- and hardware upgrade was done. The simulator thereby more and more had improved in such a way, that it became an accepted efficient tool for drive dynamic assessments of digital prototypes [9]. But the Berlin simulator still has the limitation that typical drive dynamic maneuvers have to be scaled to about 70 % in motion range and dynamic. The hydraulic cylinder system and the aluminum dome structure are also limited to excitation well below 10 Hz.



**Figure 1. History of Daimler’s moving-base driving simulator in Berlin**

To improve the performance of our driving simulator further and to reach the future needs of our car and truck development departments, we started a research and development project to analyze various technologies and possible solutions to realize moving base driving simulators. As a result of this project we built up the driving simulator facility described in the following.

## Driving Simulator Center

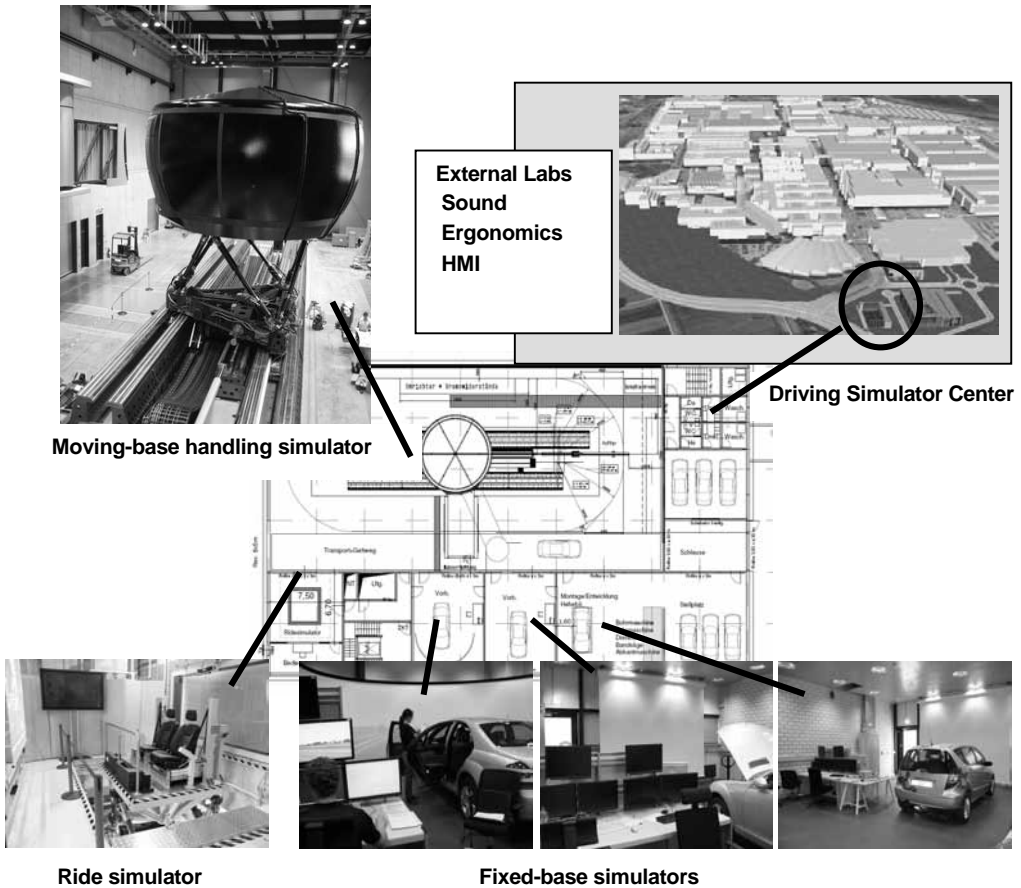
Due to the fact that driving simulators are used within the vehicle development process for a variety of applications – e.g. from simple use studies of control buttons to benefit studies of complex driver assistance systems or drive dynamic assessments - we first had to decide how many (different) driving simulators are necessary and cost efficient. Of course from a basic scientific or technical perspective a simulator with a real car cabin, a photorealistic 360° projection system and a motion system “as big and as dynamic as possible” or in other words a large moving-base simulator on a large x-y-sledge with an additional heave and all rotary degrees of freedom would be the best choice, because it could be used for all possible applications. But such an all-in-one device suitable for every purpose is technically not feasible and by far not cost efficient.

Therefore we

- consequently extrapolated our simulator strategy [1] and decided to build up a simulator center with simulators of different complexity, based - as far as possible - on a common hard- and software structure.
- carefully evaluated the real needs for a motion platform in terms of cost and benefits (see section Motion System).

As shown in Fig. 2, a moving-base handling simulator with a 360° projection, a fixed based simulator with a cylindrical 210 ° front projection and a flat rear projection, two fixed based simulators with flat front projections and a ride simulator are located in the new driving simulator center building. Additionally some further specialized labs within the Mercedes development center are connected to the facility.





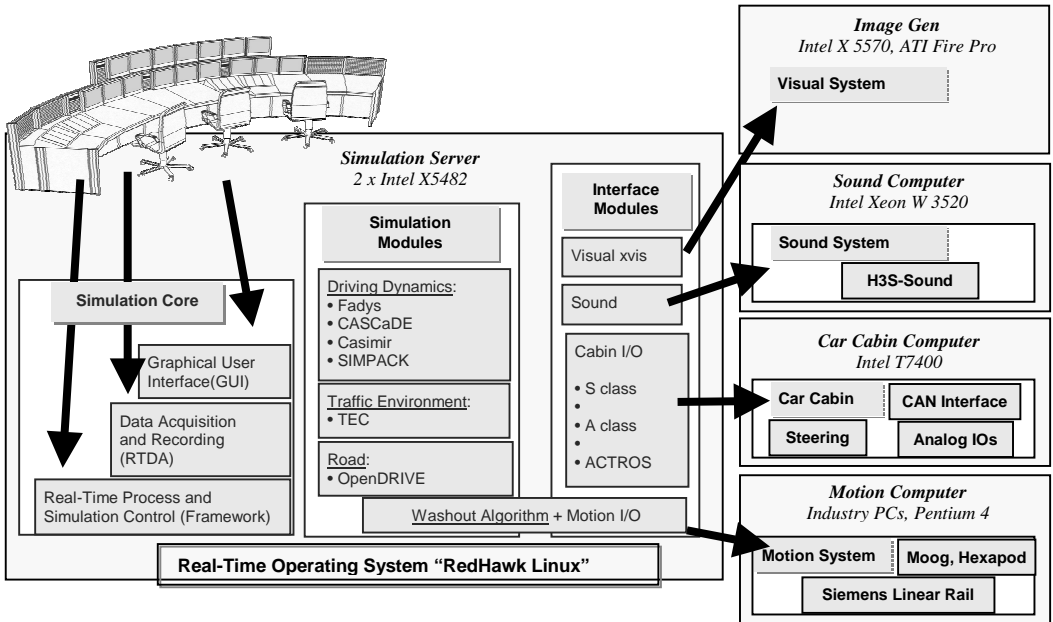
**Figure 2. Schematic of Daimler's new driving simulator center in Sindelfingen**

## Common Simulator Hard- and Software

All driving simulators, except the ride simulator (which is only a comfort shaker without a driver in the loop) are based on the same simulation hard- and software platform as depicted in Figure 3.

As simulation servers we use iHawk 862 G servers with 2 Intel X 5482 Quadcore CPUs, one for each simulator, in sum 10 servers. As real-time operating system ReadHawk Linux is used.

In the past several years, IG technology has undergone significant changes. What was once only possible on large-chassis, special purpose computers, has become increasingly possible on commodity PC's. For our new simulator center, we recognized the need to move to a system non-reliant on special purpose modifications to drivers provided by chip manufactures. Therefore we use commercial-off-the-shelf Intel X 5570 Quadcore CPU with ATI FirePro 8750 Graphics board, one for each graphics channel, in sum 28 Image Generators.



**Figure 3. Schematic of hard- and software structure**

The general software structure already used and optimized for our previous simulators is unchanged and we still use most of the simulation modules, namely the simulation core modules, the drive dynamics modules, OpenDRIVE [10] as road description and the H3S Sound System from Head Acoustics.

Only two new software developments were started, purchased and implemented: a new traffic and experiment control software and a new visual software.

### Traffic and Experiment Control Software TEC

Our in-house developed and for many years successfully used experiment control and traffic simulation software MASTER was originally designed for simulator specialists as users. Additionally it has reached its performance limits, especially considering the realization of autonomous traffic on road networks or inner-city traffic. Therefore we decided to order completely new TEC software from Realtime Technology Inc. based on their existing SimVista Product line [11] and considering our experience with the MASTER software. The interface between TEC and the visual and road modules is realized via OpenFlight and OpenDrive respectively.

The new TEC software allows e.g. the generation of autonomous and deterministic traffic consisting of different kind of vehicles (cars, trucks, bicycles,...), control of all vehicle lights, selection of driver characteristics for the autonomous traffic, placement of obstacles on the road, generation and control of pedestrians, moving objects, traffic signs and traffic lights, chose of environmental conditions like fog or rain and many more. An example of inner-city traffic is shown in Figure 4.

A graphical user interface (GUI) allows controlling and monitoring the TEC-Modules also for e.g. simulator operators or experiment designers without very deep knowledge of the TEC module software itself.



**Figure 4. Example of inner-city traffic generated with TEC**

## Visual Software Pixel Transit

We also implemented a new state-of-the art visual software, Pixel Transit [12] from BlueNewt Software LLC, to enhance the realism of the simulation.

Key features from the user perspective include:

- Dynamic Lighting
- Dynamic Shadows
- High Dynamic Range
- Diffuse, Bump, and Gloss-mapped Objects

With these key features, the implementation of visual system effects associated with realistic driving environments including

- Projected Custom Headlamps
- Articulated Illumination Model (blinkers, brakes, etc)
- Weather Effects (scattered sky attenuation, correct solar/lunar illumination, clouds, rain, snow, layered fog)
- Dynamic Vegetation
- Pedestrians

is realized.

The system software renders the scenes at no less than 60 frames per second without any distracting visible artifacts. This is achieved using Daimler's already existing datasets and the above mentioned commercial-off-the-shelf PC's and graphics hardware. Examples of sceneries generated with Pixel Transit are shown in Fig. 5.



**Figure 5. Example of shadows and brake light generated with Pixel Transit**

## **Projection systems**

The outputs of the image generators are connected via fibre optic dvi links to the video projectors.

For the fixed base simulators we use Viscon projection systems with Canon WUX10 projectors. One simulator is equipped with three front projectors using a cylindrical 210° front screen of 3 m radius and one rear projector. The other fixed-base simulators only have a single channel flat front projection.

The inner surface of the moving-base simulator dome is high gain coated (gain 2.5) and is used as 360° screen, illuminated by a Barco projection system based on 8 Sim7 LCOS projectors.

The exterior mirrors of the simulator car cabins are replaced by LCD displays and the mirror images are displayed directly on these displays.

## **Motion System**

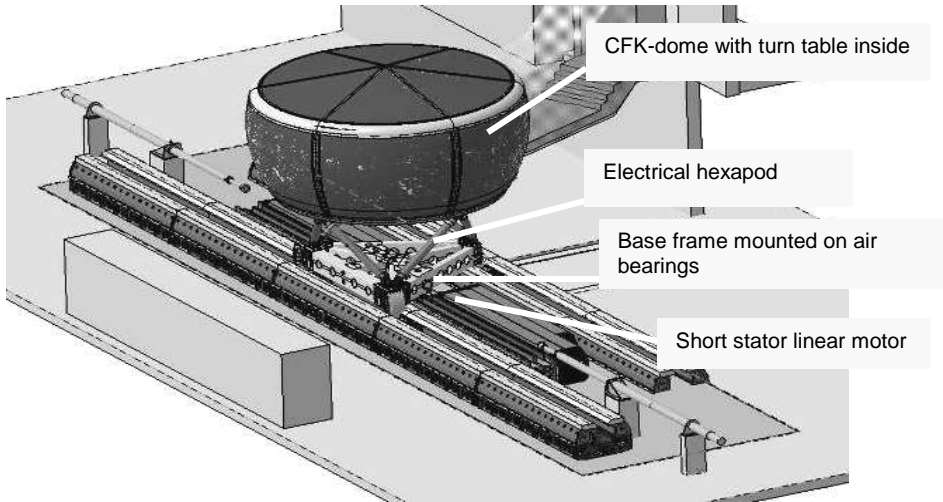
For an optimal and cost efficient design of the motion system we first analyzed the requirements coming from the two main application fields for our moving-base simulator: drive dynamic assessment with expert drivers and driver assistant system evaluation and development with the help of ordinary drivers.

For drive dynamic assessment a very realistic motion simulation without any scaling for e.g. slalom or lane change maneuvers is desirable, resulting in a necessary lateral moving space of about +/- 4 m, lateral acceleration dynamics of 1 g, roll and yaw angles of about 5° and 30°, respectively and a very high motion smoothness.

For experiments with ordinary drivers, motion is only one important topic out of many others (e.g. visual system, sound, realistic car cabin) to dupe a realistic driving feeling. For most of the application, experiments and studies the "old Berlin motion platform" without a linear motion space in longitudinal direction was sufficient both to generate a realistic driving feeling and to achieve an extremely low simulator sickness rate of only 2 % in the last years [13]. To induce a much better longitudinal motion sensation with a scaling factor close to 1:1 for all possible acceleration and deceleration scenarios even a several ten meter long sledge would not be sufficient, but would increase the technical and financial effort tremendously, especially when the above mentioned mandatory requirements for drive dynamic experiments have to be fulfilled.

Therefore we decided to stay with a hexapod platform mounted on a single 12 m long axis for linear motion. Additionally we use a quasi static 90° turn table inside the dome, which allows us to use the linear rail either for lateral (drive dynamic experiments) or longitudinal (e.g. stop and go traffic simulation) motion.

A schematic is shown in Fig. 6. With this configuration we are confident to reach nearly 90 % of the requirements needed for car and truck development with acceptable technical and financial efforts.



**Figure 6. Schematic of motion system**

All mechanical components of the motion system were specially designed and optimized [e.g. 14] together with our construction partner IMTEC GmbH "Innovative Maschinentechnik" and several specific suppliers for the various components.

Essential components and their most important typical values are

- **linear rail system:** high precision machined cast iron elements with a total lengths of 28 m,
- **air bearings** for friction less linear motion, air gap below 40  $\mu\text{m}$ , air pressure below 9 bar, dynamic load bearing capacity between 200 kN and 400 kN
- **short stator linear motor** length 15.5 m, acceleration 1g, max. velocity 10 m/s, force 212 kN, scalable in length
- **electrical hexapod** actuator specs: length 1.5 m, velocity 1.25 m/s, acceleration 1 g platform moving space: + 1.4/-1.3 m longitudinal ,  $\pm 1.3$  m lateral,  $\pm 1.0$  m vertical  $\pm 38^\circ$  yaw,  $+24^\circ$ - $19^\circ$  pitch,  $\pm 20^\circ$  roll
- **Dom** spherical, weight and stiffness optimized CFK structure; inner diameter ca. 7.5 m, height ca. 4.5 m inner surface high gain coating with gain 2.5

## Summary

In summary we have installed a new driving simulator center at the main development facility of Mercedes in Sindelfingen. Within the center several fixed base simulators, a moving-base handling simulator and a ride simulator are installed, all optimized for various use cases within car and truck development.

The high dynamic motion system of the new handling simulator was especially designed to allow the usage of the simulator for a very efficient and realistic

assessment of digital chassis prototypes. In addition to the motion system we also co-developed, purchased and implemented new traffic simulation, new traffic control and new visual system software as well as new high resolution projection systems to improve the realism of the driving simulation further.

The new driving simulator center was completed in July 2010 and currently runs in test operation mode. The regular operation will start end of September.

**Keyword:** moving-base driving simulator, fixed-base simulator, visual system, traffic simulation, drive dynamics assessment, driver assistant systems, car development.

## **Bibliography**

- [1] Käding, W. and J. Breuer, (2006), The use of driving simulators for the evaluation of driving assistance systems, *Conference Proc. DSC 2006 Europe*, pp. 121 – 130, Paris, Oct. 2006.
- [2] T. Brown, B. Dow, D. Marshall, S. Allen (2007) Validation of stopping and turning behavior for novice drivers in the National Advanced Driving Simulator, *Conference Proc. DSC North America, Iowa, September 2007*.
- [3] J.-H. Song, W.-S. Lee, (2008) Evaluation of a Lane Departure Warning System on a Driving Simulator, *Conference Proc. DSC Asia Pacific, Seoul, September 2008*.
- [4] T, Chapron, J.-P. Colinot (2007) The new PSA Peugeot-Citroën Advanced Driving Simulator, Overall design and motion cue algorithm. *Conference Proc. DSC North America, Iowa, September 2007*.
- [5] <http://www.gizmag.com/toyota-driving-simulator/8436/>;  
[http://www.mts.com/stellent/groups/public/documents/library/dev\\_004365.pdf](http://www.mts.com/stellent/groups/public/documents/library/dev_004365.pdf);
- [6] P.J. Feenstra, M. Wentink, Z.C. Roza and W. Bles (2007), Desdemona, an alternative moving base design for driving simulation, , *Conference Proc. DSC North America, Iowa, September 2007*.
- [7] Drosdol, J. and Panik, F. (1985) The Daimler-Benz Driving Simulator: A Tool for Vehicle Development, *SAE Technical Paper Series, no. 850334*.
- [8] Käding, W. and Hoffmeyer, F. (1995) The Advanced Daimler-Benz Driving Simulator, *SAE Technical Paper Series, no. 950175*.
- [9] J. Colditz, L. Dragon, R. Faul, D. Meljnikov, V. Schill, T. Unselt, and E. Zeeb, (2007), Use of Driving Simulators within Car Development., *Conference Proc. DSC North America, Iowa, September 2007*.
- [10] M. Dupuis, M. Strobl, and H. Grezlikowski, (2010) OpenDrive 2010 and beyond-Status and future of the de facto standard for the description of road networks, *to be published in Conference Proc. DSC Europe, Paris, September 2010*.

- [11] M.A. Mollenhauer, M.M. Morrison, R.A. Romano, (2006) Sensor Functionality for Ground Vehicle Simulation Authoring, *Conference Proc. The IMAGE Conference, Scottsdale, AZ, 2006.*
- [12] B. Kuehne, S. Carmody, (2010), Design of a Modern Image Generation Engine for Driving Simulation, *to be published in Conference Proc. DSC Europe, Paris, September 2010.*
- [13] W.Käding, E. Zeeb, (2010), 25 years driving simulator research for active safety, *Conference Proc. International Symposium on Advanced Vehicle Control (AVEC 2010), Loughborough, August 2010.*
- [14] T. Schulz (2006), "Primärteil eines Linearmotors", Deutsches Patent und Markenamt, Patent DE 10 2004 058 369 B4.





# **Virtual prototyping and training**



# Familiarization with a Forward Collision Warning on driving simulator: cost and benefit on driver-system interactions and trust

**Arnaud Koustanai, Arnaud Mas\*, Viola Cavallo, Patricia Delhomme**

INRETS, Laboratory of Driver Psychology, the French national institute for transportation and safety research (INRETS)

Le2i Arts & Métiers ParisTech – CNRS, Technical Center for Simulation Renault  
arnaud.koustanai@inrets.fr, arnaud.mas@renault.com, viola.cavallo@inrets.fr,  
patricia.delhomme@inrets.fr

**Abstract** - *Introducing Advanced Driver Assistance Systems (ADAS) into the vehicle could improve drivers' comfort and reduce road crashes. However, suitable methods are required to study driver/system interactions. In fact, ADAS generate critical use cases, i.e. situations where alarms, or absence of alarms, can be negative for safety. The present study aimed at evaluating the impact of getting familiar, by means of a driving simulator, with critical situations when using the Forward Collision Warning system (FCW). We hypothesized that experiencing the system's function in critical situations would improve drivers' performance and their trust in the FCW. We compared judgments and driving performance of three independent groups: a "control group" where drivers did not use the FCW, an "unfamiliarized group" where drivers used the FCW without having been familiarized with the system, and a "familiarized group" where drivers used the FCW after having been familiarized. Results showed that familiarization made driver/system interactions more effective and safer. Moreover, familiarized drivers rated the system more positively than unfamiliarized drivers. However, familiarization decreased drivers' self-confidence and did not prevent from haste when overtaking slow vehicles. We discussed the relevance of using a driving simulator in FCW's studies and the possibility to transfer skills and knowledge to field operational tests. Finally, we proposed possible improvements to make the familiarization with the system still more effective.*

**Résumé** - *Introduire des systèmes avancés d'aide au conducteur dans le véhicule pourrait augmenter le confort des conducteurs et réduire le nombre d'accidents. Toutefois, des méthodes d'évaluations adaptées sont nécessaires à l'étude des interactions conducteur/système. Les systèmes d'aide génèrent effectivement des cas d'usage critiques, i.e. des situations où les alertes, ou*

*l'absence d'alertes, peuvent être négatives pour la sécurité. L'objectif de la recherche était d'évaluer l'impact de la familiarisation avec les cas critiques d'usage du Forward Collision Warning (FCW) sur simulateur de conduite. Nous avons testé l'hypothèse selon laquelle l'expérience du fonctionnement du FCW dans des situations critiques d'usage augmente la performance de conduite et la confiance des conducteurs dans le système. Nous avons comparé les jugements et la performance de conduite de trois groupes expérimentaux : un groupe contrôle où les conducteurs n'utilisaient pas le FCW, un groupe « non familiarisé » où les conducteurs utilisaient le système sans avoir été familiarisés et un groupe « familiarisé » où les conducteurs utilisaient le système après avoir été familiarisés. Les résultats montrent que la familiarisation rend les interactions conducteur/système plus efficaces et plus sûres. Par ailleurs, les conducteurs familiarisés ont des opinions plus positives sur le FCW comparé aux non familiarisés. Néanmoins, la familiarisation diminue la confiance des participants dans leur capacité de conduite. De plus, elle ne permet pas d'éviter que les conducteurs dépassent de façon trop précipitée les véhicules lents. Nous discutons la pertinence du simulateur pour l'étude du FCW et la possibilité de transfert des connaissances à la conduite sur route réelle. Finalement, nous proposons des améliorations pour rendre la familiarisation avec le système plus efficace.*

## Introduction

The present study forms part of the French MATISS project (Advanced Modeling of Interactive Simulation Techniques for Safety), which objective is to implement valid methodologies to study Advanced Driver Assistance Systems (ADAS) on driving simulators. Introducing ADAS technologies is a major challenge for road safety. In particular, warning devices could help drivers to avoid or limit the impact of a large number of accidents. However, using automation involves behavioral changes which may lead to unsuitable reaction, annoyance, distraction, overreliance, or attentional overload (e.g. Bainbridge, 1987; Kantowitz, 2000; Parasuraman & Riley, 1997). The development of ADAS therefore requires suitable methods to study driver/system cooperation so that their interactions are not negative for road safety.

The Forward Collision Warning system (FCW) well illustrates this point. The system aims at informing drivers of the critical decrease in the distance headway. The FCW has thus a potentially important safety benefit since one accident out of four is a rear-end collision where drivers were distracted. However, drivers are reluctant to use the system because it fails to provide precise information in many occasions. For example, FCW often generates nuisance alarms (NAs) – i.e. alarms triggered by events that do not pose a threat to the drivers (cf. Zador, Krawchuk, & Vaos, 2000). This is typically the case when the lead vehicle slows down in order to change direction or when the driver prepares to overtake another vehicle (e.g. LeBlanc, Eby, Bareket, & Vivoda, 2008). NAs may annoy drivers and lead to inappropriate reactions. On the other hand, some alarms are intentionally suppressed to limit false alarms – i.e. alarms triggered in absence of danger. For

instance, the FCW tested by General Motor Corporation (GMC, 2005) did not trigger alarms when it detects fixed targets because they usually correspond to objects out of the road (e.g. road signs). Furthermore, the system was unavailable below a minimum speed of 50 km/h which usually corresponds to situations where irrelevant targets are numerous (e.g. urban areas, traffic congestion). In addition, the FCW did not trigger alarms when it detects vehicles that do not move in the same direction as the equipped-car since they usually correspond to oncoming vehicles on adjacent lanes or stopping at junctions. However, alarm suppression may delay drivers' reactions and decrease the perceived effectiveness of the system (Parasuraman, 2000).

When using FCW, drivers must adjust their response according to the situation rather than react stereotypically. Consequently, drivers have difficulty to trust the FCW (i.e. to determine whether the system will help them identify hazards in situations characterized by uncertainty and vulnerability, cf. Bliss & Acton, 2003), making less effective drivers/system interactions. Field Operational Test studies (FOT) – where the accuracy of instructions and training are vital – suggested that detailed description of the system's function and training in normal operating situations are not enough for the driver to trust the system (e.g. GMC, 2005; Portouli & Papakostopoulos, 2006; Regan *et al.*, 2006; LeBlanc *et al.*, 2008). GMC (2005) noted that drivers appeared to "probe" the FCW function in extreme conditions to better understand its capabilities and limitations. In the same vein, Cahour and Forzy (2009) assumed that the projection into the use of a cruise control system improves trust and exploration of the device. The authors found that drivers knew more, produced less distorted reconstruction, and had a deeper level of understanding of the system's function after watching video recordings of critical situations than after reading written instructions. Thus, driving simulator studies may be helpful in experiencing such informative-critical situations in safe conditions.

The present research aims at evaluating the impact of the familiarization with some use cases of the FCW on drivers' behavior and trust in the system. We hypothesized that the knowledge of the system's function in critical situations would improve the performance of drivers who use the FCW compared to those who drive without. Furthermore, we expected that drivers' performance and trust in the system would increase more when this knowledge is acquired by practice than by reading a detailed description.

## Method

### Participants

Twenty nine drivers took part in the experiment (21 males, 8 females). Participants were distributed into three independent groups. In a "control group" (10 drivers; mean age = 38.6 years; SD = 10.88), drivers were not familiar and did not use the FCW during the experiment. In an "unfamiliarized group" (12 drivers; mean age = 41.95 years; SD = 9.2), drivers used the FCW without being familiar with the system. In a "familiarized group" (7 drivers; mean age = 43.1 years; SD = 9.5), drivers used the FCW after being familiarized. Participants had more than 5

years of driving experience and drove more than 10 000 km per year. Statistical analyses showed no difference in age and driving experience between groups.

## Apparatus

The experiment was performed on the CARDS2 simulator at RENAULT-Technical Center for Simulation (Guyancourt, France). The simulator cockpit was equipped with a fully functional car dashboard, with force feedback steering wheel, clutch, brake and gas pedal, manual gear lever, and dashboard indicators. The simulator was mounted on a 6-DOF hexapod motion platform, allowing a displacement of  $\pm 20$  cm and a rotation of  $\pm 20^\circ$ . The image was projected on three screens in front of the cabin, providing a visual angle of  $150^\circ$  horizontally and  $40^\circ$  vertically. The rear image was displayed on two LCD screens located in the rear-view mirrors; the image of the inside mirror was incrustated in the front view.

Two additional screens were specifically added for this experiment (Fig.1.): one behind the steering wheel, to display the FCW system interface, and another one on the dashboard, above the gear lever, to display the secondary task interface. A small keyboard was fixed behind the gear lever, in order to interact with the secondary task

The motion platform was deactivated for this experiment. Hexapod motion platforms provide insufficient perception of longitudinal accelerations, especially during braking (Nordmark, Jansson, Palmkvist, & Sehammar, 2004). As time-to-collision perception involves mostly visual components (McLeod & Ross, 1983), it was expected for the present experiment that motion rendering would not provide a crucial cue.



**Figure 1. Illustration of simulator setup, showing the FCW system displaying an alarm (red bar) and the secondary task interface (on the bottom right)**

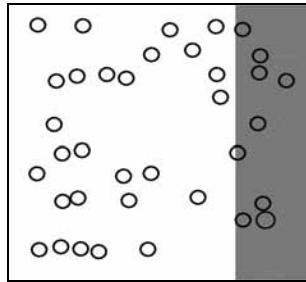
The FCW issued a single visual-plus-tone alert when the distance from the lead vehicle became too short to avoid a collision. The timing was determined by the ISO-recognized Stop-Distance-Algorithm (ISO 15632) defined as following:

$$Dw = VI \times RT + Vf^2 / (2 \times Df) - Vf^2 / (2 \times DI),$$

where  $Dw$  (m) is the warning distance,  $Vf$  (m/s) the speed of following driver,  $VI$  (m/s) the speed of leading vehicle,  $Df$  (m/s<sup>2</sup>) the assumed deceleration of the following vehicle,  $DI$  (m/s<sup>2</sup>) the assumed deceleration of the leading vehicle, and  $RT$  is the assumed driver's reaction time to an event. The  $RT$  value was fixed at 1.25 s, whereas  $DI$  and  $Df$  were fixed at 5 m/s<sup>2</sup>.

The visual interface consisted of a light bar which could be presented in three states: (1) it was yellow below 50km/h when the system was inactive, (2) green above 50 km/h when the system was active, and (3) red when the distance from the lead vehicle became less than the warning distance. A three-bip-tone sounded when the bar changed from green to red; the bar remained red as long as the distance was too short.

The distractive task (Fig. 2.) consisted of locating a target circle (150 mm in diameter, 4 mm in thickness) among 35 distractors (125 mm in diameter, 3 mm in thickness).



**Figure 2. Schematic representation of the distractive task: participants selected the target zone by moving the grey bar**

The participants selected the target zone by pressing two keys which moved a grey vertical bar. The task ended when they pressed a validation key that switched off the device. A new task started when the experimenter switched on the device.

## Design and procedure

The experiment consisted in three sessions: a practice, a familiarization, and a test session. In the practice session, participants were familiarized with the simulator. They drove on a dual carriageway without traffic during 10 min. Then, they practiced the distractive task while following a car.

In the familiarization session, familiarized and unfamiliarized drivers started with reading written instructions about the FCW's functioning. This note specified the different states of the system (unavailable below 50 km/h, available above 50 km/h) and some critical use cases (no detection of vehicles which are stopped, or vehicles that have a differential speed greater than 70 km/h, or those that are

moving in a different direction than the driver). Then, all drivers interacted with traffic in two 8 min runs: the first one in which they were accompanied by the experimenter, who explained how to perform in the encountered situations, and the other one alone. Because control and unfamiliarized drivers did not use the FCW, the session was presented as making them familiar with the virtual environment. For familiarized drivers, the session aimed at becoming familiar with the FCW. All participants experienced situations where the FCW did not give a warning, i.e. they encountered a parked vehicle, a vehicle which started slowly in front of the driver, and an oncoming vehicle in a bend. They also experienced situations that triggered relevant alarms, i.e. they faced a lead vehicle stopping by an emergency braking ( $-5 \text{ m/s}^2$ ). Then, participants encountered situations likely to produce nuisance alarms, i.e. they faced a lead vehicle slowing down smoothly ( $-2 \text{ m/s}^2$ ). The run ended when the participants overtook a slow vehicle that triggered a nuisance alarm. Additionally, familiarized drivers tested freely the FCW by accelerating and slowing down while the lead vehicle moved at a constant speed of 90 km/h. After the drive, participants filled out a self-assessment questionnaire about their driving (self-confidence and self-performance). In addition, familiarized and unfamiliarized drivers filled out a questionnaire about the FCW (trust, performance, and acceptance). The total familiarization session lasted 20 to 25 min.

In the test session, participants were asked to drive a round trip on a rural dual carriageway. They were asked to maintain a speed of 90 km/h while doing the distractive task as fast as possible. However, safety remained their priority, i.e. they could neglect the distractive task if the situation required their attention. They encountered five types of events counterbalanced between the way there and the return. In two "junction scenarios", alarm was not triggered by a vehicle crossing the junction at 3 s from the drivers. In two "merging scenarios", alarms were triggered by a vehicle merging into the lane in front of the driver at a time headway of 1 s. Drivers were not necessarily required to brake to avoid a collision. In two "overtaking scenarios", alarms were triggered when drivers overtook a heavy vehicle moving at 70 km/h. In two "relevant scenarios", alarms were triggered by the lead vehicle braking ( $-3 \text{ m/s}^2$ ). In two "annoying scenarios", alarms were triggered by events which presented the same kinematics than "relevant scenarios", except that the lead vehicle activated the indicator 5 s before turning. Drivers could thus avoid a collision without braking if they started slowing down at the time the lead vehicle signaled its intention to turn. The test session ended with an "emergency scenario" where an alarm was triggered by an emergency braking vehicle ( $-5 \text{ m/s}^2$ ).

The distractive task started 1.5 s before the beginning of the scenarios, in such a way that drivers were always distracted when a danger occurred. To limit the task/event association, 9 distractive tasks were randomly assigned between events.

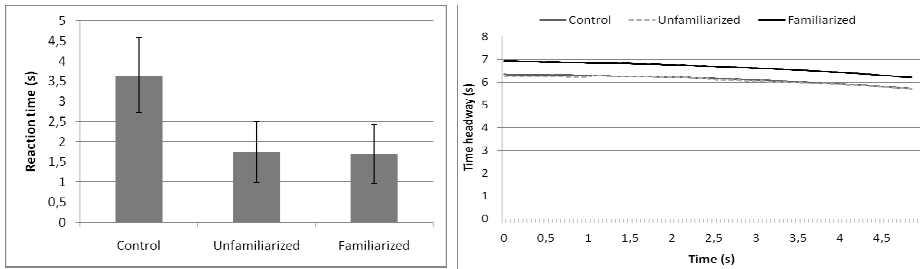
After the drive, participants again filled out self-assessment questionnaires (self-confidence and self-performance). In addition, familiarized and unfamiliarized drivers were asked to fill out questionnaires with regard to the FCW (trust, performance, mental effort, and acceptance). The total test session lasted about 65 min.



## Results and discussion

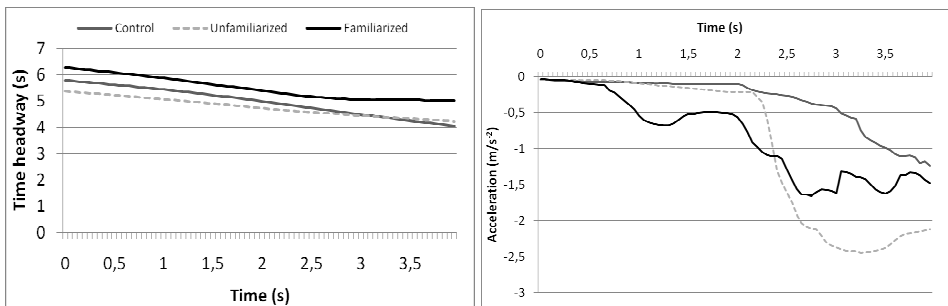
### Behavioral changes

Globally, FCW users (familiarized and unfamiliarized drivers) released accelerator or applied brake faster than control drivers ( $F(2,425) = 31.25$ ;  $p < .000$ ). However, only familiarized drivers kept longer time headways before the beginning of the scenarios ( $F(2,16217) = 59.37$ ;  $p < .000$ ), i.e. they gained time to react even when the FCW could inform them at the time they were distracted. These results are shown in Figures 3a and 3b.



**Figure 3. (a) Reaction time; (b) Time headway for 5 s before the beginning of scenarios**

Between the onset of the scenario and the end of alarms (or when the vehicle left the driver's lane in junction scenarios), mean safety margin was higher ( $F(2,30059) = 39.77$ ;  $p < .000$ ) whereas mean deceleration was lower ( $F(2,31417) = 171.7$ ;  $p < .000$ ) for familiarized than for unfamiliarized drivers. This behavior obviously led to safer driving. In particular, familiarized drivers had no collisions whereas unfamiliarized (20%) and control drivers (40%) collided in the emergency scenario. These results are shown in Figures 4a and 4b.



**Figure 4. (a) Time headway for 4 s after the scenario started; (b) Deceleration for 4 s after the scenario started**

Moreover, FCW users released the accelerator more often than control drivers before the lateral vehicle started crossing their lane in junction scenarios ( $\chi^2_1 = 4.46$ ;  $p < .04$ ). Alarm suppression thus led drivers to better anticipate this event.

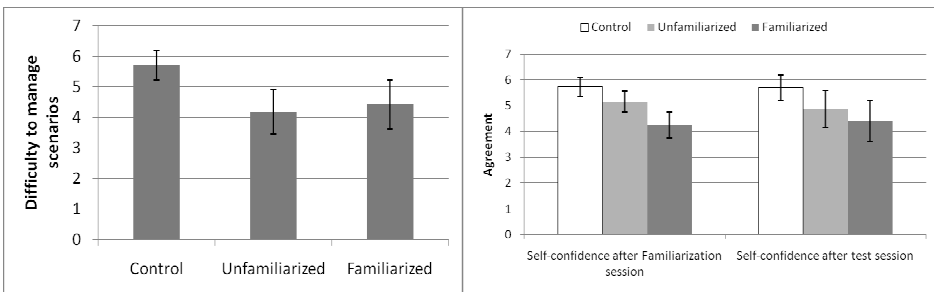
There was no particular change in behavior amongst drivers in relevant and annoying scenarios. In fact, only 20% of the participants released the accelerator before the alert was triggered in annoying scenarios, i.e. few drivers slowed down when the lead vehicle activated the indicator. Because drivers were distracted, we suppose that they had difficulty in anticipating the lead vehicle's braking, thus making alarms relevant.

FCW led to negative effects for safety in overtaking scenarios, since FCW users spent less time behind the vehicle they overtook than control drivers ( $F(2,10369) = 333.88; p < .000$ ). They changed lane about 6 s after the alert began whereas control drivers changed lane after 15.77 s. Hurry in overtaking maneuvers decreases the time to seek for oncoming traffic (e.g. Wilson & Best, 1982). Being familiar with the FCW did not prevent unsafe precipitation of the maneuver.

In merging scenarios, most of control drivers (60%) did not react when the vehicle merged into their lane whereas most of familiarized (82%) and unfamiliarized drivers (72%) released the accelerator or broke (respectively,  $\chi^2_1 = 6.12; p < .02; \chi^2_1 = 5.82; p < .02$ ). However, deceleration was smoother for familiarized than for unfamiliarized or control drivers ( $F(2,1783) = 58.3; p < .000$ ), i.e. being familiarized reduced reaction intensity. Alarms clearly elicited a reaction, but deceleration (between  $-0.06$  and  $-0.16\text{m/s}^2$ ) was not likely to create a threat, even when another vehicle followed closely FCW users.

## Subjective changes

Concerning the drivers' self-assessment (Fig. 5a), familiarized and unfamiliarized drivers were prone to find scenarios easier to manage than did control drivers (respectively,  $t(14) = 2.01; p = .063$  and  $t(20) = 2.84; p < .01$ ). However, familiarized drivers were less confident in their driving performance (Fig. 5b) than unfamiliarized and control drivers after the familiarization session (respectively  $t(15) = 2.16; p < .046$  and  $t(14) = 3.24, p < .005$ ) or the test session (respectively,  $t(15) = 2.01; p = .062$  and  $t(14) = 3.39; p < .04$ ).



**Figure 5. (a) Rating of difficulty to manage scenarios; (b) Rating of self-confidence after familiarization and test session**

This result was expected since the presentation of negative aspects of the system may undermine trust and confidence (Cahour & Forzy, 2009). Also, it is

consistent with Ivancic & Hesketh (2000), who found that “error training” improved driving skills but decreased drivers’ self-confidence. In fact, the familiarization session may have amounted to error training since drivers learned how to deal with the error-prone FCW by reacting/not reacting when an alarm was present/absent. Nevertheless, the decrease in self-confidence is likely to explain that familiarized drivers kept longer time headways and adopted safer behaviors. Actually, familiarized drivers did not estimate that the mental effort was higher than unfamiliarized drivers. On the contrary, they found that the frequency of alarms was not higher than necessary whereas unfamiliarized drivers found that it was slightly too high ( $t(16) = 2.2$ ;  $p < .042$ ). Moreover, familiarized tended to rate the system more useful ( $t(16) = 1.98$ ;  $p = .063$ ), less frustrating ( $t(15) = 1.95$ ;  $p = .069$ ) and were willing to pay more to buy the system ( $t(14) = 2.03$ ;  $p = .061$ ). These results suggest that being familiar with the FCW was likely to have a positive influence on drivers’ trust. However, acceptance did not differ between groups; acceptance increased after the test session and utility became greater than satisfaction ( $F(3,45) = 19.79$ ;  $p < .000$ ).

## Conclusions

FOT studies showed that drivers understood and used better ADAS after probing them in extreme conditions or after being projected into critical situations (cf. GMC, 2005; Cahour & Forzy, 2009). Our findings extended these results to a driving simulator where experiencing critical situations proved to be very relevant for the study of the FCW. First, the familiarization with critical use cases made driver/system interactions more effective and safer. Familiarization had also a positive influence on subjective rating of the system. Changes in behavior and subjective rating were more positive when drivers experienced situations than when they read written description. Thus, a preliminary handling of the system on a driving simulator could be useful in FOT where instructive situations are constrained by the unfolding events or self-created by the drivers. Driving simulators provide the opportunity to create situations where drivers can probe efficiently the capacities and the limitations of the FCW without taking risks. Short- and long-term effects of the knowledge transfer from simulator to real world would be interesting to investigate.

Regarding future applications, the familiarization session could be further improved to make it more effective. For example, our study showed that the FCW encouraged the drivers to escape too quickly from the warning zone indicated when they prepared to overtake a vehicle. A familiarization focused on this use case could counteract its negative effect for safety. Familiarization with the FCW also appeared to decrease drivers’ self-confidence. Further research should determine the real impact of this effect on the behavior adopted by familiarized drivers.

Lastly, our driving simulator study showed that FCW users were more careful towards dangers that were not indicated. This is a positive result since recent studies on driver-centered design recommended the suppression of as most alarms as possible (e.g. LeBlanc *et al.*, 2008). The driving simulator could thus be very useful to assess the effectiveness of such a system and its impact on safety.

**Acknowledgment:** We acknowledge teams of Renault CTS, Renault Ergo/IHM, and OKTAL for their assistance in preparing and running the experiment.

**Keywords:** Familiarization - Forward Collision Warning - Nuisance alarm - Alarm suppression - behavioral changes - subjective rating

## Bibliography

- Bainbridge, L. (1987). *Ironies of automation*. New York: Wiley.
- Bliss, J. P., & Acton, S. A. (2003). Alarm mistrust in automobiles: how collision alarm reliability affects driving. *Appl. Ergon.*, *34*, 499-509.
- General Motors Corporation (2005). *Automotive Collision Avoidance System Field Operational Test (ACAS FOT) (Final program Report No. DOT HS 809 886)*. Washington DC: NHTSA.
- Cahour, B., & Forzy, J.F. (2009) Does projection into use improve trust and exploration? An example with a cruise control system. *Saf. Sci.*, *47*, 1260-1270.
- Ivanic, K., & Hesketh, B. (2000). Learning from errors in a driving simulation: effects on driving skill and self-confidence. *Ergonomics*, *43*, 1966-1984.
- Kantowitz, B. H. (2000). In-vehicle information systems: Premises, promises, and pitfalls. *Transportation Human factors*, *2*, 359-379.
- LeBlanc, D. J., Eby, D. W., Bareket, Z., & Vivoda, J. M. (2008). *On-road Evaluation of the SAVE-IT Vehicle Prototype - Task 14C Final Report for the SAFety VEHICLE using adaptive Interface Technology (SAVE-IT) Project (Vol. 1)*: UMTRI.
- McLeod, R. W., & Ross, H. E. (1983). Optic-flow and cognitive factors in time-to-collision estimates. *Perception*, *12*, 417-423.
- Nordmark, S., Jansson, H., Palmkvist, G., & Sehammar, H. (2004). The new VTI driving simulator. Multipurpose moving base with high performance linear motion. *Proc. Driving Simulation Conf. DSC 2004*, 45-55.
- Panerai, F., Droulez, J., Kelada, J.-M., Kemeny, A., Balligand, E., & Favre, B. (2001). Speed and safety distance control in truck driving: comparison of simulation and real-world environment. *Proc. Driving Simulation Conf. DSC 2001*, 91-107.
- Parasuraman, R. (2000). Designing automation for human use: empirical studies and quantitative models. *Ergonomics*, *43*, 931-951.
- Parasuraman, R., & Riley, V. (1997). Humans and automation: use, misuse, disuse, and abuse. *Hum. Factors*, *39*, 230-253.

- Portouli, V., & Papakostopoulos, V. (2006). *On road study on short-term effects of ADAS on driving behaviour* (No. D1.2.4.): IST Programme.
- Regan, M., Triggs, T. J., Young, K. L., Tomasevic, N., Mitsopoulos, E., Stephan, K., et al. (2006). *On-Road Evaluation of Intelligent Speed Adaptation, Following Distance Warning and Seatbelt Reminder Systems: Final Results of the Australian TAC SafeCar Project*. MUARC.
- Wilson, T., & Best, W. (1982). Driving strategies in overtaking  
*Accid. Anal. & Prev.*, 14, 179-185.
- Zador, P. L., Krawchuck, S. A., & Vaos, R. B. (2000). *Automotive Collision Avoidance (ACAS) Program* (Final Report). Washington, DC: NHTSA.



# Eco-driving performance assessment with in-car visual and haptic feedback assistance

Slim Azzi <sup>1,2</sup>, Gilles Reymond <sup>1</sup>, Frédéric Mérienne <sup>2</sup>, Andras Kemeny <sup>1,2</sup>

<sup>1</sup> Renault, Technical Centre for Simulation

1 Avenue du Golf – 78288 Guyancourt, France

<sup>2</sup> Arts et Métiers ParisTech, Le2i, CNRS, Institut Image

2 Rue Thomas Dumorey – 71100 Chalon sur Saône, France

slim.azzi-renexter@renault.com, gilles.reymond@renault.com,

merienne@cluny.ensam.fr, andras.kemeny@renault.com

**Abstract** – In this experiment, 28 participants completed an urban driving task in the CARDS simulator at Renault's Technical Centre for Simulation. This simulator, based on the SCANeR2<sup>®</sup> software package, provides a 150° field of view in a fully instrumented cockpit. Two different eco-driving assistance devices were added: a 7 inches display on the mid-console, and a force feedback system on the gas pedal. The feedback information was computed by comparing the car's instant acceleration with an optimal acceleration level based on a proprietary consumption model of a Renault diesel engine. Basic eco-driving behaviors, like gear-shifting under 2000 Rpm, allows significant decrease of polluting emissions. Assisting drivers with visual, haptic, or visual-haptic on-board devices, in addition to low engine speed verbal instructions, lead to supplementary significant savings of polluting emissions. There is no significant difference between assistance feedback type; suggesting that haptic feedback provides the same eco-performance as visual feedback. In particular, subjects show good adaptation to the haptic feedback pedal at first utilization of the system. They apparently relied more on haptic modality to achieve the eco-driving task, when they used both visual and haptic assistance.

**Résumé** - Dans cette expérimentation, 28 participants accomplissent une tâche de conduite dans le simulateur CARDS du Centre Technique de Simulation de Renault. Ce simulateur, équipé du logiciel de simulation SCANeR2<sup>®</sup>, délivre un angle de vue de 150° dans un cockpit entièrement instrumenté. Deux interfaces d'assistance à l'éco-conduite complètent le dispositif expérimental : un écran de 7 pouces sur la console centrale et un dispositif appliquant un retour d'effort à la pédale d'accélérateur. Le retour d'information est calculé en comparant l'accélération instantanée du véhicule à un niveau d'accélération optimal, d'après un modèle de consommation de moteur diesel Renault. La pratique de l'éco-

*conduite, comme le changement de rapport sous les 2000 Rpm, permet de réduire significativement les émissions polluantes. L'assistance des conducteurs avec des systèmes d'aide visuel, haptique ou visuo-haptique, permet une réduction supplémentaire significative des émissions polluantes. Aucune différence significative n'a été constatée entre les différents modes d'assistance ; ce qui laisse penser que l'assistance haptique engendre la même éco-performance que l'assistance visuelle. En particulier, les sujets font preuve d'une adaptation satisfaisante à la pédale haptique lors d'une première utilisation du système. Ils accordent apparemment plus de confiance à la modalité haptique pour accomplir leur tâche d'éco-conduite en présence d'une assistance visuo-haptique.*

## Introduction

### Context

Since the early seventies, the European Union has been controlling the polluting emissions of its vehicles by setting more and more drastic ecologic standards. From the early nineties, the development of the collective consciousness for ecology, associated to continuous fuel price increase urges countries to set up sustainable development plans for their vehicle market. In addition to the rules fixed to carmakers, actions have been led to sensitize car holders to eco-driving practicing. In particular, recently, eco-driving has been largely promoted by public organizations. Another way to provide help in eco-driving is to use an on-board assistance system with information on driving eco-efficiency. Feedback may be carried through various perceptive modalities: visual, auditory or haptic.

### Visual assistance feedback

Nowadays, most of the cars are equipped with a digital information display of instant consumption. In order to enhance the visual salience of their consumption aid system, Honda has developed in 2009 a speedometer with changing colors, depending on drivers' instantaneous eco-performance [Honda]. However, drivers' visual attention is mainly focused on the road. By submitting driving participants to other visual on-board detection tasks, it is suggested that visual stimulus detection performance deteriorates, while reaction delay remains unaffected [Recarte & al, 2003]. Moreover, lane keeping and keeping distance to followed car, with the help of peripheral vision, appears to be impaired when watching a visual display on the speedometer, which is otherwise inefficient when the visual display is on the mid-console [Summala & al, 1998].

### Haptic assistance feedback

Haptic stimulation through gas pedal is another way to provide feedback information on eco-performance. Continental has developed an accelerator force feedback pedal AFFP<sup>®</sup> [Continental], which vibrates to inform drivers on optimal



gear-shifting time. Nissan proposes since 2009 an ECO Pedal<sup>®</sup> [Nissan] to provide force feedback information on optimal pedal position, depending on engine state. Both announce fuel savings of between 5 and 10%. Haptic feedback pedal has already been studied in long-term and large field studies for speed limitation requirements. In this particular application, haptic appears to be more efficient than visual assistance. Significant decreases of mean and variation of speed, as well as polluting emissions are observed [Várhelyi & al, 2004]. Haptic feedback pedal acceptance is positively rated by drivers, but there is no willingness to pay for it [Adell & al, 2008].

In car following applications, haptic feedback pedal systems give information on inter-vehicular distance by modifying the gas pedal stiffness proportionally to the distance separating subject to forward car. This system allows significant decrease of standard deviation of inter-vehicle distance and braking reaction time [Kuge & al, 2005; Mulder & al, 2008].

## Problematic

In this study, we aim at evaluating the efficiency of basic eco-driving instructions for polluting emissions reduction. We also try to assess and compare the additional improvements brought by the visual, haptic and coupled visual-haptic eco-driving assistances. Finally, we test whether drivers feel at ease at a first utilization of the force feedback pedal, which intuitively could appear as very intrusive in the control of the car.

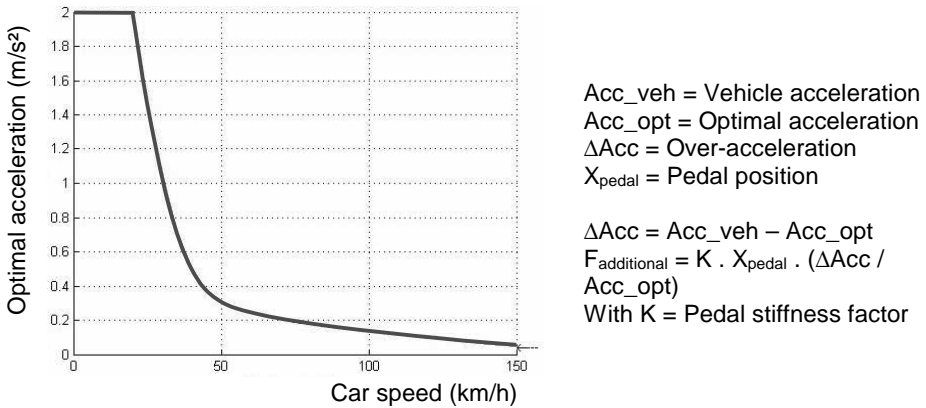
## Method

### Experimental device

This experiment has been conducted on the dynamic driving simulator CARDS at the Technical Center for Simulation of Renault. This simulator based on the SCANeR2<sup>®</sup> simulation software is composed of a modular cockpit, completely instrumented, providing to the driver all the equipments and interactions existing in a real car. The front view is provided by 3 projectors delivering a 150° horizontal field of view image.

For experimental needs, the simulator has been enriched with two eco-driving assistance devices: a visual interface positioned in front of the central console with a progression bar, provides a visual information on  $F_{\text{additional}}$  value; and a gas pedal coupled with an actuator stimulates haptically driver's foot by superposing  $F_{\text{additional}}$  to the initial pedal torque. These two devices provide exactly the same information to drivers through different modalities.

A Renault's proprietary eco-driving model (see Fig 1) compares in real time the longitudinal acceleration of the driven vehicle ( $Acc_{\text{veh}}$ ) to an optimal acceleration level, depending on car speed ( $Acc_{\text{opt}}$ ). This model does not take in account the engine revolution speed. When the drivers' acceleration is over the optimal acceleration, a normalized counter-acting force ( $F_{\text{additional}}$ ), proportional to the gas pedal position ( $X_{\text{pedal}}$ ), is opposed to drivers' foot (see Fig 1). Gas pedal force was equal to 35N when ( $Acc_{\text{veh}}$ ) reached twice ( $Acc_{\text{opt}}$ ).

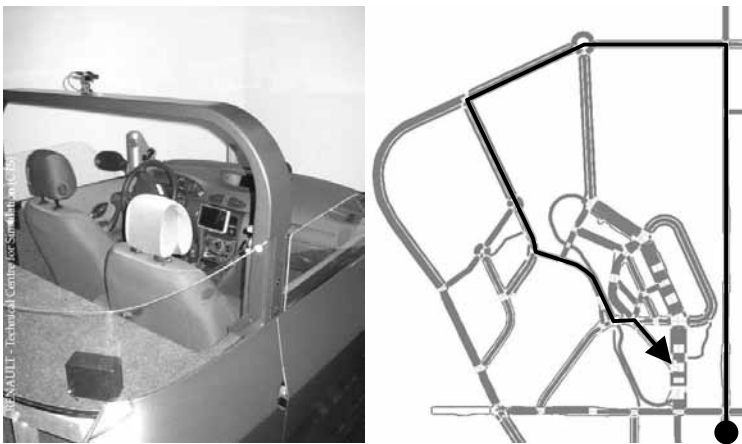


**Figure 1. Schematics of Renault’s proprietary eco-driving model (left); and calculation of  $F_{\text{additional}}$  (right)**

## Protocol

### Task description

The experimental task consists in driving through an urban environment, along a predefined route. No car traffic is present, to facilitate control task repeatability and compare more efficiently eco-driving performances between experimental conditions.



**Figure 2. Picture of the CARDS simulator, with mid-console assistance display (left); experimental database with predefined route (right)**

### Participants

28 subjects aged between 25 and 45 took part in the experiment (7 females and 21 males). All drivers were in possession of a valid driving license. Participants were split into 4 distinct groups of 7 subjects. Three groups were

given assistance feedback at third trial: the visual group ( $S_v$ ) had a visual assistance display; the haptic group ( $S_h$ ), was assisted with the haptic pedal; and the visual-haptic group ( $S_{vh}$ ), had both visual and haptic assistance. Fourth group is the reference group ( $S_n$ ), no assistance was provided, drivers had to accomplish the verbally instructed condition.

## Conditions

Initially, participants had to follow a training session, during which, drivers were asked to accomplish two practice runs in order to get used to drive comfortably with the CARDS simulator and to memorize the experimental task path. Participants in assisted groups drove 1 minute more to understand the functioning of the assistance system to use. After practicing, all participants confirmed that they felt at ease with the whole experimental device.

Participants drove the same route four times in different conditions: ( $T1_{ref}$ ) Normal driving without instructions nor assistance; ( $T2_{eco-behavior}$ ) Driving with the verbal instruction not to exceed 2000 Rpm; ( $T3_{eco-assistance}$ ) Same as condition 2 with the support of an assistance feedback; ( $T4_{eco-behavior}$ ) A repetition of trial ( $T2$ ).

## Data recordings

The following objective data was recorded for each subject:

- Total polluting emissions, calculated on the base of a Renault proprietary model of fuel consumption of a Megane diesel car.
- $Std(X_{pedal})$ , the standard deviation of gas pedal position, calculated on the whole trajectory for each run.
- $Mean(\Delta Acc)$ , the mean of over-acceleration, resulting from the difference between ( $Acc_{veh}$ ), the instantaneous longitudinal acceleration of the car, and ( $Acc_{opt}$ ), the optimal acceleration depending on car speed, given by the Renault proprietary eco-driving rule.

## Results

We performed an ANOVA planned comparison with  $\alpha = 0,05$  on these parameters (see Table 1).

A comparison between  $T1_{ref}$  and  $T2_{eco-behavior}$  was computed among all subjects. A significant decrease was observed on our parameters of interest.

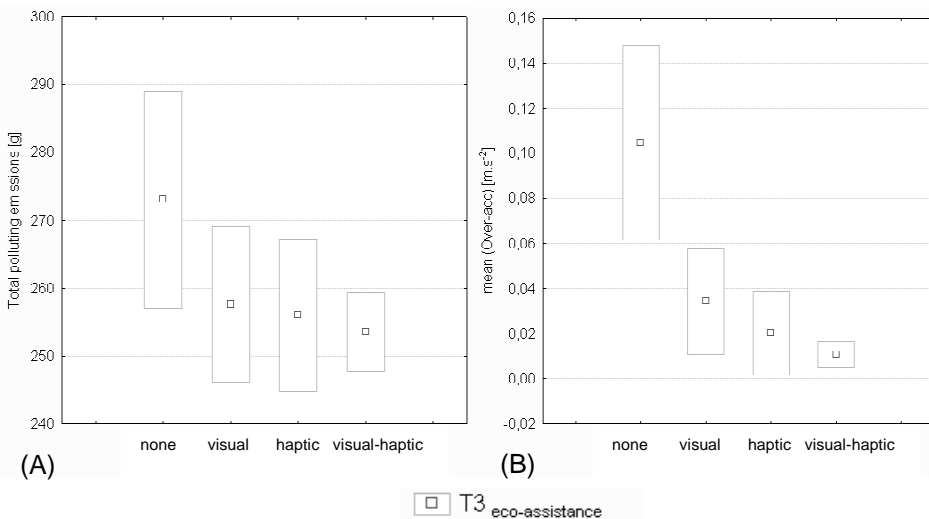
A between group comparison on assisted trial  $T3_{eco-assistance}$  was computed, to evaluate the benefit of each assistance, compared to the reference unassisted group ( $S_n$ ), with verbal instruction to drive at low engine speed. Assistance systems induced a significant decrease. However, there were no significant effects of the type of assistance feedback.

By comparing, into each assisted group, verbally instructed runs (mean of  $T2_{eco-behavior} + T4_{eco-behavior}$ ) to assisted runs  $T3_{eco-assistance}$  ( $T2$  and  $T4$  serves to cancel the bias due to learning effects of low engine speed driving across the three last trials), visual assistance do not lead to significant improvements for

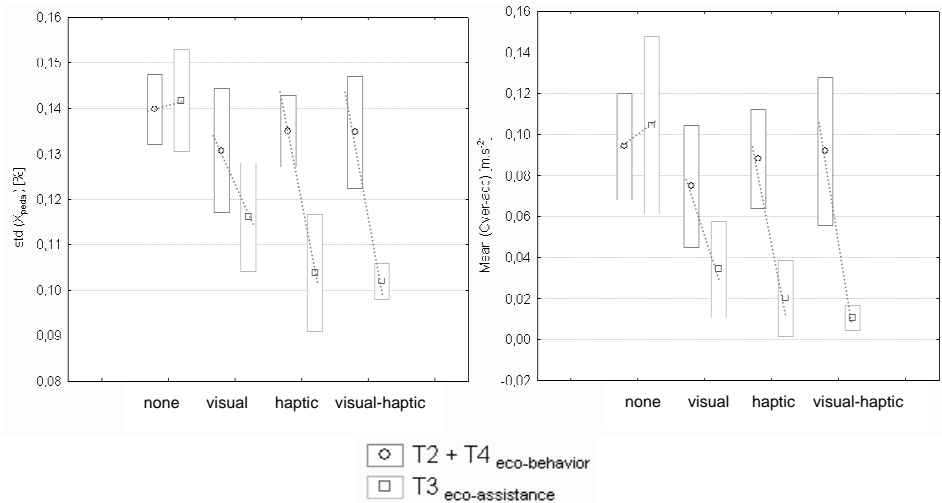
any of the parameters of interest. In the haptically assisted group, total polluting emissions is the only result which is not significantly improved. In visual-haptic group, all the recorded parameters are significantly reduced.

**Table 1. Results of the ANOVA planned comparison analysis**

	<b>Total polluting emissions</b>	<b>Std (<math>X_{pedal}</math>)</b>	<b>Mean (<math>\Delta Acc</math>)</b>
All subjects ( $T1_{ref}$ vs $T2_{eco-behavior}$ )	$F(1.88) = 19,87;$ $p < 0.001$	$F(1.88) = 25,85;$ $p < 0.001$	$F(1.88) = 23,15;$ $p < 0.001$
$S_v$ group ( $T2 + T4$ vs $T3$ )	NS	NS	NS
$S_h$ group ( $T2 + T4$ vs $T3$ )	NS	$F(1.88) = 12,84;$ $p < 0.001$	$F(1.88) = 6,62;$ $p < 0.05$
$S_{vh}$ group ( $T2 + T4$ vs $T3$ )	$F(1.88) = 4,32;$ $p < 0.05$	$F(1.88) = 14,23;$ $p < 0.001$	$F(1.88) = 9,38;$ $p < 0.005$
$T3_{eco-assistance}$ trials ( $S_n$ vs $S_v$ )	$F(1.88) = 4,69;$ $p < 0.05$	$F(1.88) = 5,45;$ $p < 0.05$	$F(1.88) = 4,42;$ $p < 0.05$
$T3_{eco-assistance}$ trials ( $S_n$ vs $S_h$ )	$F(1.88) = 5,74;$ $p < 0.05$	$F(1.88) = 5,68;$ $p < 0.05$	$F(1.88) = 6,35;$ $p < 0.05$
$T3_{eco-assistance}$ trials ( $S_n$ vs $S_{vh}$ )	$F(1.88) = 7,51;$ $p < 0.01$	$F(1.88) = 7,55;$ $p < 0.01$	$F(1.88) = 7,86;$ $p < 0.005$



**Figure 3. Plot by groups of total polluting emissions on T3 eco-assistance trial for (A) total polluting emissions and (B) mean of over-acceleration**



**Figure 4. Plot of (A) standard deviation of pedal position; and (B) mean of over-acceleration, for verbally instructed trials and assisted trials for each group**

## Discussion

This study is a first step to demonstrate the efficiency of a haptic feedback gas pedal on eco-driving, and the ability of drivers to adapt at first use of such an information feedback system. We choose to immerse drivers in a simulated driving context, without traffic to allow performance comparisons between experimental conditions. This choice may give preferential treatment to the visual assistance condition compared to ecological driving condition, because the visual perception of car traffic competes with the visual attention allocated to watching the visual assistance display.

### Contribution of verbal instructions to eco-performance

In this experiment, adopting eco-driving behavior, by limiting engine speed at 2000 Rpm, constitutes a first significant step to reduce total polluting emissions by 5%, compared to driving sessions without instructions. Mean overpass of optimal acceleration, significantly decreases, suggesting that a correlation exists between our optimal acceleration model and eco-driving requirements.

### Additional contribution generated by eco-driving assistances

The three assisted conditions provide significant decreases by 5 to 7% of total polluting emissions (see Fig 3 (A)). This result is consistent with the performance announced for the Continental's accelerator force feedback pedal, or the Nissan's eco pedal. However, there is no significant effect of the type of assistance feedback. This suggests that, haptic stimulation can be as efficient as visual

stimulation, in terms of assisted eco-driving performance. Moreover, in presence of assistance feedback, drivers' over-acceleration level also significantly decrease (see Fig 3 (B)), suggesting that optimizing over-acceleration allows additional polluting emissions improvement, compared to engine speed optimization.

## Drivers' reaction when first using the haptic pedal assistance

Even if haptic devices are newer than visual displays for eco-driving assistance, drivers show a good adaptation to haptic signal modulations. In the groups assisted haptically (haptic and visual-haptic conditions), we notice a significant decrease of the standard deviation of the accelerator pedal in assisted trials, compared to low engine speed verbally instructed trial, without active assistance. In the visual group, this decrease is not significant (see Fig 4 (A)). One could think that pedal stability is enhanced by opposing a counterforce to the foot, which helps guiding it to the position recommended by the system. This result shows a better efficiency of the force feedback pedal on foot stability, for a first usage of the haptic pedal system.

Drivers are able to make fast modifications of their foot admittance, depending on the specificity of the task they are performing. By measuring muscular activity of the leg pressing a car pedal, during "force tasks" (minimize effort variations) and "position task" (resist to perturbations), it appears that drivers use antagonist muscles of the leg to accomplish the various use modes imposed by an active car pedal [Abbink & al, 2004]. In our "force task" experiment, the feedback stimulation provided by the haptic pedal was inhibitory [Mugge & al, 2009], since participants were asked to cancel additional force feedback when it appeared, by releasing accelerator pedal.

This ability to modify the biomechanical admittance has also been highlighted for upper limbs with a steering wheel handling task. Drivers are able to control the trajectory of their car with different steering wheel force feedback strategies, whether they are linear or not, which implies a strong sensorimotor plasticity and a large capacity of quasi-instantaneous adaptation to haptic disturbances [Toffin & al, 2003]. We know furthermore, that the foot and the hand have the same degree of differentiation in haptic modality [Hajnal & al, 2007]. In spite of their neuronal and anatomic differences, the upper and lower limbs seem to have the same perceptive performance in terms of force discrimination ability.

## Visual-haptic merging

When drivers have both visual and haptic assistance for a first use, the decrease in over-acceleration is significant. This decrease is also significant in haptic modality, but not with visual feedback (see Fig 4 (B)). Drivers show better self eco-performance improvement when, at least, haptic feedback is available, in comparison to visual assistance alone: this suggests that haptic is more suited for that particular double task (driving and following the eco-driving indications). This result is otherwise coherent with the higher reliance accorded by participants to the haptic modality, for instance in a visual-haptic size detection task [Ernst & al, 2002].

## Conclusion

This study confirms the efficiency of basic eco-driving behaviors, like gear-shifting under 2000Rpm, on the generated polluting emissions for diesel engines. Adding eco-driving assistances (visual or haptic) allows additional reduction of polluting emissions, but no effect of the type of assistance feedback have been noticed in our experiment. With haptic and visual-haptic assistance, we also observe significant reductions of control activity, measured by standard deviation of gas pedal position, which demonstrates the ease of use of haptic feedback pedal for a first utilization of the system. Moreover, drivers apparently rely more on haptic modality when using both visual and haptic assistance. In this experiment, visual assistance may have an advantage in comparison to ecological driving conditions, because of lack of car traffic. Further studies should analyze the impact of car traffic on the efficiency of visual and haptic assistance, but also drivers' adaptation to haptic feedback pedal in critical situations, when drivers need to accelerate, despite of the increased rigidity of the pedal.

**Acknowledgements:** Research supported by a CIFRE grant (ANRT N°601/2006). We thank A. Daumard (Renault, Energetic Unit) for experienced advices on car consumption models.

## Bibliography

- [Honda] <http://automobiles.honda.com/insight-hybrid/fuel-efficiency.aspx>
- Recarte, M., Nunes, L., (2003) Mental Workload While Driving: Effects on Visual Search, Discrimination, and Decision Making. *Journal of Experimental Psychology: Applied* 9, 119-137
- Summala, H., Lamble, D., Laakso, M., (1998) Driving experience and perception of the lead car's braking when looking at in-car targets. *Accident Analysis and Prevention* 30, 401-407
- [Continental] [http://www.contionline.com/generator/www/com/en/continental/pressportal/themes/press\\_releases/3\\_automotive\\_group/chassis\\_safety/press\\_releases/affp2009\\_21\\_04\\_09\\_en,version=5.html](http://www.contionline.com/generator/www/com/en/continental/pressportal/themes/press_releases/3_automotive_group/chassis_safety/press_releases/affp2009_21_04_09_en,version=5.html)
- [Nissan] [http://www.nissan-global.com/EN/NEWS/2008/\\_STORY/080804-02-e.html](http://www.nissan-global.com/EN/NEWS/2008/_STORY/080804-02-e.html)
- Várhelyi, A., Hjälm Dahl, M., Hydén, C., Draskóczy, M., (2004) Effects of an active accelerator pedal on driver behaviour and traffic safety after long-term use in urban areas. *Accident Analysis & Prevention* 36, 729-737
- Adell, E., Várhelyi, A., (2008) Driver comprehension and acceptance of the active accelerator pedal after long-term use. *Transportation Research Part F: Traffic Psychology and Behaviour* 11, 37-51
- Kuge, N., Boer, E., Yamamura, T., Ward, N., Manser, M., (2005) Study on driver's car following abilities based on an active haptic support function. *SAE transactions* 115, 157-169

- Mulder, M., Mulder, M., van Paassen, M., Abbink, D., (2008) Haptic gas pedal feedback. *Ergonomics* 51, 1710-1720
- Abbink, D., Van Der Helm, F., Boer, E., (2004) Admittance measurements of the foot during 'maintain position' and 'relax' tasks on a gas pedal. *Conference Proceedings - IEEE International Conference on Systems, Man and Cybernetics* 3, 2519-2524
- Mugge, W., Abbink, D., Schouten, A., Dewald, J., van der Helm, F., (2009) A rigorous model of reflex function indicates that position and force feedback are flexibly tuned to position and force tasks. *Experimental Brain Research* 200, Numbers 3-4, 325-340
- Toffin, D., Reymond, G., Kemeny, A., Droulez, J., (2003) Influence of Steering Wheel Torque Feedback in a Dynamic Driving Simulator. *Conference proceedings - Driving Simulation Conference North America*
- Hajnal, A., Fonseca, S., Kinsella-Shaw, J., Silva, P., Carello, C., Turvey, M.T., (2007) Haptic selective attention by foot and by hand. *Neuroscience Letters* 419, 5-9
- Ernst, M.O., Banks, M.S., (2002) Humans integrate visual and haptic information in a statistically optimal fashion. *Nature* 415, 429-433



# Driver performance assessment in driving simulators

Bart Kappé<sup>1</sup>, Leo de Penning<sup>1</sup>, \*Maarten Marsman<sup>2</sup>

<sup>1</sup> TNO

Kampweg 5, Soesterberg,

<sup>2</sup> CITO

Nieuwe Oeverstraat 50, Arnhem

bart.kappe@tno.nl, Leo.depenning@tno.nl, maarten.marsman@cito.nl

**Abstract** – Assessment of driver performance in practical driver training and – testing faces two challenges. First, there is no control of the traffic situations the driver will be presented with, and second, factors other than the performance of the student may play a role in the assessment. Driving simulators allow scripted, deterministic, traffic scenarios to be presented to the driver, and may use automated performance assessment to ensure objective and reliable assessment. In a three year project, we are developing a standardized, interoperable simulator based driver performance assessment. In a field lab of 30 simulators, we will present deterministic traffic scenarios to large groups of students. Using a cognitive model, we will combine scenario background information and performance measures with the assessments made by human observers. This paper presents the project and its goals, and discusses the different approaches we will use to collect assessment data.

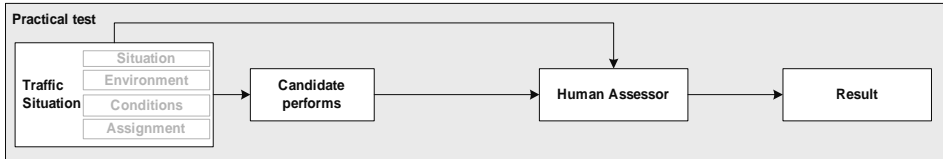
## Introduction

### Performance assessment in practical driving

In both driver training and the formal driving test, driving performance is generally assessed during practical driving. Driving instructors and examiners assess performance while the driver is negotiating a variety of traffic situations. As each and every situation is different, performance is always assessed in relation to the traffic situation at hand. The observed performance does not solely depend on the skill levels of the driver, but on the nature of the encountered situations as well, see Figure 1. As one never knows what situations will be encountered, practical driving assessment is inherently fuzzy.

The variability and unpredictability of traffic situations poses some challenges in the assessment of practical driving skills. First, it may hamper the validity and reliability of the assessment. When only relatively simple situations are met, both

skilled and unskilled drivers will tend to pass. When relatively difficult situations happen to occur during the assessment, both skilled and unskilled drivers may fail. When driving congested highways or city centers, it is difficult to generalize the relatively narrow set of assessed driving skills. Thus, the outcome of the assessment depends to some extent to the traffic situations that are met, which is a factor that is not under full control of the instructor or examiner.



**Figure 1. In practical testing, driver performance is assessed in relation to the traffic situation**

Second, the variability of traffic situations makes it very difficult to define accurate assessment standards. Assessment manuals currently mention vague standards like brake 'in time' or adjust speed 'appropriately' in respect to 'the traffic scenario at hand', without being able to specify when a braking maneuver should be initiated, or what speed should be maintained. Such vague assessment standards allow room for individual differences in the assessment of driver performance. They also obscure a clear understanding of the variables that define a traffic situation, and their relation with performance measures and standards is vague. In other words, we do not know how 'brake in time' and 'adjust to appropriate speed' vary with the characteristics of the situation.

A third issue in practical driving assessment relates to the human nature of the assessment itself. Assessors can be systematically influenced in their judgment by factors other than the performance of the student. Sex, age and other factors may play a role in the assessment, and it is difficult to get a grip on these factors. Also, similar performance may be judged differently due to severity of judgment.

The variability of traffic, and possible systematic biases may hamper adequate assessment in both driver training and -testing. It will be difficult to meet these issues in a practical driving assessment. We feel they can only be met if one is able to control the traffic situations, and is able to assess performance automatically.

## Performance assessment in driving simulators

In a driving simulator, the simulated environment can be deterministic to a large extent. If scripted correctly, a traffic scenario will present a similar traffic situation to the driver, each time it is driven. In our definition, a scenario is a brief 'clip' of a specific traffic situation, such as 'turn left on a signaled intersection with traffic from the left', 'merge onto the highway with a row of trucks on the lane next to you'. In a driving simulator, we may know in advance what traffic situation the driver will be presented during the assessment, and we may allow these situations to be presented in any order.

The traffic situation is not the only aspect that is under control in the simulator. In fact, in the simulator, there is data available on many other aspects that describe a scenario (the 5 Ws: *who* is driving *where*, *what* are they doing *when*, and *why* we should present this scenario).

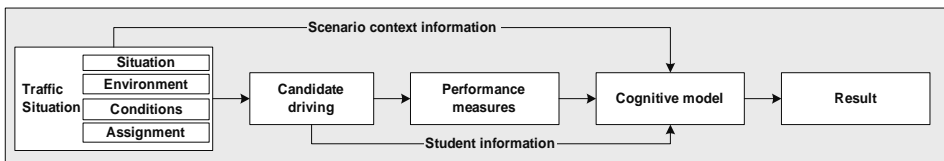
In the simulator, driving performance can be expressed in many different performance measures (e.g. Pauwelussen, Wilschut & Hoedemaeker (2009), FESTA<sup>1</sup>). And, just like practical driving, we can have an instructor or examiner assess the performance of the driver.

The *difficulty* of a scenario is also a relevant factor. Difficulty levels can be determined subjectively, by having assessors rate the difficulty of a scenario. Difficulty can also be determined statistically, if we are able to present such scenarios to large groups of drivers. Then, scenario difficulty can be based on the actual performance of the students.

By combining scenario descriptors, performance data and human assessments, we may be able to solve some of the above mentioned issues of practical driving assessment in a driving simulator. It could allow us to shed some light on the relevant performance measures and their relation with scenario descriptors. If we include driver and assessor background data (age, sex, experience etc.) we may be able to get grip on the subjective aspects that may play a role in practical driving assessment. We believe that this type of research may ultimately lead to the development of a valid and reliable simulator based assessment.

In 2009, TNO has initiated a three year project to develop a driver performance assessment in driving simulators, in cooperation with CITO (an institute for educational measurement), ANWB driver training (a driving school using simulators) and Rozendom Technologies (a driving simulator manufacturer). The simulator based assessment will be developed and evaluated using the driving simulators of ANWB driver training as our field lab (30 systems, 5000 students/y), see Kappé, de Penning, Marsman & Roelofs (2009) for an introduction.

In the first phase, we have made an inventory of scenario descriptors (for the 5 Ws), of standards to describe content and item data, of performance measures in driving simulators, driving and assessor background data and of cognitive models for assessment in simulators.



**Figure 2. In a driving simulator, the traffic situation that will be presented is known. A cognitive model of an assessor may not only be fed with performance data, but with scenario context and student information as well**

<sup>1</sup> See <http://www.its.leeds.ac.uk/festa/>

We developed a prototype of a Neural Symbolic Cognitive Model that may be used to automatically assess driving performance. The model is able to learn the relations between driver performance, scenario descriptors and the observations of a human assessor, see Figure 2. The model can be fed with both formal and behavioral rules, but is also able to elicit new rules from its data (de Penning, Kappé & Bosch van den (2009), Penning, Kappé & Boot (2009); Kappé, de Penning, Marsman & Kuiper, 2010).

## Interoperability through standardization

We realized that a simulator based assessment tend to be developed for simulators of a single manufacturer. As the development of a test is very laborious, we wanted to avoid having to start a new line of research for simulators of a different manufacturer. Thus we try to standardize our scenario data as much as possible. We would like to be able to present identical situations on different simulators, that is, that our simulator based test is *interoperable*. As there is currently no standard scripting language commonly accepted between simulator manufacturers, this can only be done at a meta-level, describing the essentials of a traffic scenario. Therefore, we decided to describe content, results and item specific data in their corresponding standards from the e-learning & e-testing domain (SCORM<sup>2</sup>, QTI<sup>3</sup>, IMS LIP<sup>4</sup>).

By describing test content on a meta-level, in an e-learning environment that is separated from a specific brand of driving simulator, we hope to take a large step in standardization and interoperability.

TNO has developed the SimSCORM platform (de Penning, Boot & Kappé, 2008). SimSCORM allows SCORM compliant content to be played from (open source) Learning and Content Management systems like MOODLE<sup>5</sup>, on any HLA<sup>6</sup> compliant (driving) simulator. (The High Level Architecture (HLA) is the dominant standard for interfacing and connecting simulators). With SimSCORM we can use all the facilities that are offered by modern LCMs, like databases for storing content, results and student data, and use built in provisions like sequencing and navigation of test content, forums, wiki's etc. As it is web-based, we can access individual simulators from the web, add or manipulate test content, and download performance data and instructor observations. Thus, we can remotely access and control the simulators in our field lab at the driving school.

The SimSCORM platform also serves the cognitive model. The cognitive model has access to the meta-data that we use to describe the traffic scenario, to the performance data of each individual student in that scenario, and to the observations made by human assessors that watch the student negotiate that traffic situation in the simulator. Using SimSCORM's data-logging facilities, we are able to use both live assessment as well as post-hoc performance assessments based on replays of recorded performances in the simulator.

---

<sup>2</sup> <http://www.adlnet.gov>

<sup>3</sup> <http://www.imsglobal.org/question/>

<sup>4</sup> <http://www.imspjroject.org/profiles/lipinfo01.html>

<sup>5</sup> <http://moodle.org/>

<sup>6</sup> <http://www.sisostds.org/>

## **Performance assessment methods**

This year a prototype of the assessment module, with a database of about 20 testing scenarios will be installed at the driving school. Using this database we aim to collect assessment data in three different ways.

### **Observer**

We will ask instructors to assess a student's driving performance during and after scenario run-time. With these data, we may be able to discriminate 'acceptable' and 'unacceptable' driving performance. We will ask instructors to assess performance at several pre-defined low- and high order aspects of the driving task (guided and unguided by the assessment module). We know that instructors are likely to be influenced by cognitive biases and factors like gender and age of the driver. Direct observation of the driver negotiating traffic situations in the simulator will allow some room for these subjective aspects giving better insight in the influence these factors have in the assessments of human observers.

We realize that during simulator operation, we cannot expect instructors to assess performance at multiple aspects for all students and all scenarios. Therefore the data will be logged during simulator operation and can be played back afterwards for assessment when the instructor has more time. This will also allow other instructors to assess the same logged scenario, which improves the validity of the assessment and thus the validity of the cognitive model that learns from these assessments.

### **Data only**

A 'data-only' method does not require human observers. It relies solely on scenario descriptors, performance data, and other readily available data. If we accept that more experienced students will perform better than novice students, we may be able to use their driving experience (e.g. number of driving lessons or -hours) as a rough performance measure for their driving skills.

Using a statistical analysis of the data registered in a simulator curriculum, De Winter (2009) has shown that such an approach is able to discriminate different types of drivers in the simulator and that there is a correlation of these groups with the success at the practical driving test.

### **Unbiased assessments**

We realize that assessors can be systematically influenced in their judgment by factors other than the performance of the student. Also, different assessors can judge similar performance differently due to severity of judgment.

The first aspect, systematic influence by factors other than the performance of the student, is problematic if the factor is a characteristic of the student and there is live assessment. This is because the assessor can see the student, and his or her characteristics, while rating the performance. For instance, when an assessor judges men different than women, because they think that men drive better than

women. The assessor then judges similar performance by a male and a female student differently. If a female student is then judged to perform poorer than a male student, it is not possible to disentangle actual performance from a bias in assessment, and it will consequently be addressed to the student. In our system, the simulator records the performance of a student in the simulator. This recorded performance can be displayed elsewhere on a later moment. This makes it possible to display performance in the simulated environment, without displaying the driver, to an assessor at a different location (preferably in a driving simulator). This replaying of recorded behaviour enables the scoring of the behavior of a student, without bias based on student characteristics.

The second aspect pertains to differences in severity of judgment. This is because different assessors have different internal benchmarks to which they compare performance. To handle this there are two possibilities: First, include assessor effects in the IRT model (see for instance Patz, Junker, Johnson & Mariano, 2002), or, second, provide an external benchmark to compare performance to. An external benchmark can be derived by first collecting a small sample of performances of students (say 20). These performances need to be diverse in quality of performance. A group of driver training and examination experts are then asked to individually rank the set of performances on quality of performance. Note that this means that for each task, performance is ranked on a number of sub-domains deemed relevant for competent performance. A statistically optimal ranking of performance can then be provided to a group of experts (possibly the same). The group of experts can then indicate which performance from the ordering can be considered to be on the boundary between sufficient and insufficient. The selected performance can then be used as an external benchmark in scoring performance from a large group of students.

Each of these three assessment methods has its own merits and pitfalls. A data driven approach will be able to use all the performance data that is recorded for training the cognitive model, but will not provide assessment standards. Asking instructors or examiners to rate performance while observing drivers performing the test in the simulator, is relatively simple to realize, be it that they are likely to have cognitive biases in their assessment. Subjective aspects can only be avoided by having instructors perform the unbiased assessment method. This will yield high quality data, but at a cost, as the method is labor intensive. We aim to use all three assessment methods. A comparison of the results may be able to reveal how well a human observer is able to assess true driving performance, and, if present, quantify the nature of their cognitive biases.

## **Concluding remarks**

We believe a simulator based performance assessment may result in more objective assessment of driving performance. By focusing on individual traffic scenarios, deterministic and described in detail, we will be able to take 'situational' aspects of driver performance assessment into account. If we are able to get a grip on subjective and individual biases of human assessors, we will be able to train the cognitive model with high quality assessment data. This will open a way for automated performance assessment in driving simulators. We will learn which

performance measures are the most relevant ones, and how these should be standardized. The data generated in our field lab are not only useful for the present research, but they may also be used for the development and refinement of driver- and traffic models.

## **Bibliography**

- De Winter, J. (2009) Advancing simulation-based driver training. Doctoral dissertation, Technical University Delft.
- Kappé, B., de Penning, L., Marsman, M., Roelofs E. (2009) *Assessment in Driving Simulators: Where we Are and Where we Go*. Proceedings of the Fifth International Driving Symposium on Human Factors in Driver Assessment, Training and Vehicle Design. P 183 – 190.
- Kappé, B., de Penning, L, Marsman, M. Kuiper, H. (2010) Human Performance Assessment In Driving Simulators Phase 1: Theoretical Backgrounds. Report TNO Defence and Safety, in Press.
- Pauwelussen, J. Wilschut, E.S., Hoedemaeker, M. (2009) HMI validation: objective measures & tools. Report TNO-DV 2009 C062, TNO, Soesterberg, The Netherlands.
- Patz, R.J., Junker, B.W., Johnson, M.S., & Mariano, L.T. (2002). The Hierarchical Rater Model for Rated Test Items and its Application to Large-Scale Educational Assessment Data. *Journal of Educational and Behavioral Statistics*, 27(4), p. 341-384.
- Penning, de H.L.H., Boot, E. & Kappé, B. (2008) *Integrating Training Simulations and e-Learning Systems: The SimSCORM platform*. In Proceedings of the Conference on Interservice/Industry Training, Simulation, and Education Conference (I/ITSEC), Orlando, USA.
- Penning, de H.L.H., Kappé, B., Bosch, van den K. (2009a) A Neural-Symbolic System for Automated Assessment in Training Simulators: Position Paper. In Workshop on Neural-Symbolic Learning and Reasoning of the International Joint Conference on Artificial Intelligence (IJCAI), Pasadena, USA.
- Penning, de H.L.H., Kappé, B. & Boot, E.W. (2009b) Automated Performance Assessment and Adaptive Training in Training Simulators with SimSCORM. In Proceedings of the Conference on Interservice/Industry Training, Simulation, and Education Conference (I/ITSEC), Orlando, USA.





# Driver Trust and Reliance on a Navigation System: Effect of Graphical Display

Adrien Barthou<sup>1,2</sup>, Andras Kemeny<sup>2,3</sup>, Gilles Reymond<sup>2</sup>, Frédéric Mérienne<sup>3</sup>  
Alain Berthoz<sup>1</sup>

<sup>1</sup> LPPA, CNRS-Collège de France,  
11, place Marcelin Berthelot, 75005 Paris

<sup>2</sup> CTS, RENAULT,  
1, Avenue du Golf, 78288 Guyancourt

<sup>3</sup> LE2I, CNRS- Arts et Métiers,  
2, rue Thomas Dumoret, 71110 Chalon-sur-Saône

Adrien.barthou@renault.com, Andras.kemeny@renault.com,  
Gilles.reymond@renault.com, frederic.merienne@ensam.eu,  
alain.berthoz@college-de-france.fr

**Abstract** – *The present study investigates the influence of in-car navigation system graphic's appearance on driver trust and reliance on the system. Two navigation systems were used: one with a realistic interface and one with a symbolic interface. During driving sessions on a simulator, the systems committed some guidance incoherencies regarding road signs present in the virtual environment. Subject's trust and reliance on navigation systems were measured and compared between both systems. Result showed a higher level of trust for the realistic appearance system than for the symbolic one during the whole experiment. The presence of incoherencies decreased trust level for both systems but without any significant difference. No difference in system's reliance was found but two groups of subjects were identified. One group is highly relying on both navigation systems' indication when incoherence occurs whereas the other group was not. This study highlights the interaction of subjective items, as system graphical appearance, on user trust. Further experiments using a modified experimental setup may be needed to analyze precisely the influence on user reliance*

**Résumé** - *Cette étude analyse l'influence de l'apparence graphique d'un système d'aide à la navigation sur le niveau de confiance et d'utilisation du système par le conducteur. Deux systèmes d'aide sont utilisés : un avec une interface graphique réaliste, et un avec une interface graphique simpliste. Durant des sessions de conduite réalisées sur simulateur, des incohérences dans le guidage du système vis-à-vis des panneaux présent dans l'environnement routier seront commises. Le niveau de confiance des sujets envers le système et son utilisation sont*

*enregistrés et comparés entre les deux systèmes d'aide à la navigation. Les résultats montrent un niveau de confiance plus élevé tout au long de l'expérience pour le système avec une interface graphique réaliste. La présence d'incohérences de guidage engendre bien une diminution du niveau de confiance mais sans différence notable entre les deux systèmes. Aucune différence du niveau d'utilisation n'est enregistrée mais deux groupes de sujets sont identifiés. Un groupe de sujets se fie largement aux directions indiquées par les deux systèmes lors des incohérences, alors que l'autre groupe non. Cette étude souligne les interactions d'éléments subjectifs, comme l'apparence graphique d'un système, sur le niveau de confiance de l'utilisateur. Une autre phase expérimentale utilisant un protocole modifié serait nécessaire pour analyser en détail l'influence sur le niveau d'utilisation du système.*

## Introduction

Some recent in-car navigation systems display very detailed maps or even present a realistic complex environment or even presenting a realist 3D view of the driving environment. However it is not clear whether this graphical improvement is only an aesthetic benefit or whether it also influences the driver's interaction with the system.

Trust is an important factor to consider when studying human-machine interactions because it mainly determines if the process will be done manually or using the system (1, 2). Trust can be considered as a feeling and is needed when there is a lack of objective clues on the system's global performance (3). In this case, operators can pass through those unknown features by referring to their trust in the system. Trust can be described as composed of three parts: analytic, analogical and affective (4, 5). Trust can be built on objective items known about the system influencing the analytic part (its reliability), on contextual items influencing the analogical part (its data relevancy for the task, designers reputation), or on subjective items influencing the affective part (inclination towards electronic systems, system appearance, etc).

Reliability is a main factor influencing trust which has been largely studied (6, 7, 8, 9). Studies agree on the fact that a decrease of a system's reliability decreases the trust level the operator has in this system. The amplitude of the error committed by the system also plays a role on its impact on operator's trust (10).

Several studies have otherwise analyzed the influence of graphic's appearance on user trust and use of systems. Yeh (11) shows in 2001 an influence of realistic interfaces on user reliance on a target cueing system. Interface aesthetics is also strongly correlated with perceived usability of the computer before and after its use (12). Van Hugt's study (13) shows that interface "beauty" can positively influence user's involvement in the task. We can speculate that the appearance of an in-car navigational system can influence the affect process of driver's trust. A realistic interface could increase trust in the system even if there is no objective evidence confirming this judgment.

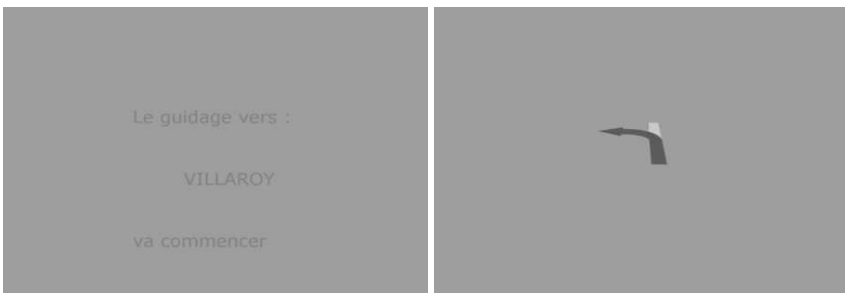
If trust can be influenced by the system's appearance, we can speculate that the system reliance could also be. Reliance is the level of effective usage of the available system while accomplishing the task. Reliance must be well calibrated according to the system objective performance. Over-reliance can lead to failure in accomplishing the task or to accidents. Trust in a system and system reliance seems highly linked (1) but system reliance also depends on other factors than just trust (9, 14) such as personal preferences (15). In other words, it is possible to trust a system but not to rely on it to execute the task. In our case, the question is whether a realistic appearance increases both the trust level in the system and the system reliance comparing to a symbolic appearance system.

When a system's realistic appearance leads to over-reliance, a complacent behavior can be expected, and can be defined as "a psychological state characterized by a low index of suspicion" (16). A simple lack of monitoring is not the origin of a complacent behavior (17). A complacent operator does not see the system's mistake but thinks that the system is correct even if clear evidences are available to demonstrate that the system is not. Being complacent can obviously lead to safety issues if the system asks the driver to act in a dangerous manner (one-way street, closed road...).

The purpose of the present study was to evaluate the influence on trust and reliance of two generic in-car navigation system interfaces using a simulated driving task.



**Figure 1. Realistic navigation system interface. System's starting picture (left) and an example of guidance picture (right)**



**Figure 2. Symbolic navigation system interface. System's starting picture (left) and an example of guidance picture (right), corresponding to the same intersection presenting in Figure 1 for the realistic system**

Two navigation systems have been specifically designed for the study: one with a realistic interface (Fig. 1) and one with a symbolic one (Fig. 2). In order to compare the trust evolution for those two systems in the experiment, both systems have the same working and reliability rate but they will both commit 10 guidance incoherencies in relation to road signs present in the driving environment. The driver's decision to follow the navigation system's indication and not the road sign indication shows driver reliance. A crossroads where the navigation system advises to take a one way street is present in order to reveal complacent behavior and safety issue. From the existing literature, we expect that:

- Trust in the navigation system with the realistic interface will be higher and less impacted by system incoherencies.
- Reliance in the navigation system with the realistic interface will be higher than with the other system and could even support complacent behavior.

## **Materials and Methods**

### **Simulator setup**

The experiment was conducted on a simulator in the LPPA (UMR7152, CNRS Collège-de-France, Paris). It was composed of a Thrustmaster "Ferrari racing wheel", with brake and throttle pedals, placed on a table. The driving simulation software used is SCANeR©II (v 2.22) (<http://www.scannersimulation.com>).

The graphic database reproduces an urban environment. The environment was displayed on a 4 m diameter curved screen with 2.5 m height. The steering wheel was placed on the centre of this screen which provided a wide vision of 180 degrees for the driver. Transmission was set to be an automatic gearbox. Indicator buttons were placed on the left and right back side of the steering wheel. Two speakers placed under the table were rendering the audio environment. The navigation systems were emulated using SCANeR©II software and their indications were displayed on a 15" laptop screen placed on the right side of the steering wheel (Fig. 3).



**Figure 3. Experimental setup**

## Task

The subjects' primary task was to drive from their starting point to a spot in the virtual environment called "Villaroy". To do so, they could either follow the road sign indications present in the virtual environment or follow the indications given by the navigation system. The second task was to put the indicators at each crossroads, but only when they had clearly decided which direction they will take at the crossroads.

During some trials, the indication proposed by the navigation system at a specific crossroads will be incoherent with road signs. The subject will thus have to decide to follow one of the two indications in order to reach their destination.

## Procedure

Fourteen subjects aged 20 to 36 took part in the experiment (one woman and thirteen men). Each subject had to drive 23 different driving sessions in an unknown urban virtual environment. Their mean speed was about 40 km/h. Each driving session lasted between 3 and 4 minutes and was composed of six to nine intersecting roads. After the training session, the first navigation system used was visually presented to the subject (Fig. 1 and 2).

Each subject then drove eleven driving sessions with each system: two sessions of driving without the navigation system, three sessions with a navigation system without incoherence, and six sessions where the system will commit incoherencies. Subjects were not aware of the possible system's incoherencies: The system either asked to take a one way street or an impossible way due to roadwork, or just another direction than those indicated by road signs.

The order of occurrence of incoherence was the same for the two systems. The order of use of the two navigational systems was counterbalanced among subjects, as well for the eleven driving sessions performed with each system

The two navigation systems used were only different for their graphical appearance. The "realistic system" was presenting a screenshot of the incoming crossroad with a red arrow incorporated in the screenshot to show the direction (Fig. 1). The other system, the *symbolic* one, was presenting the same red arrows as the realistic system but on a homogeneous grey background (Fig. 2). As visible in Figure 2, pink lines showed existing roads at the incoming intersection in order to give informations on the structure of the intersection.

## Measurement and questionnaires

The trust level was evaluated using Jian's questionnaire (18). All questions were on a 7 level scale: 1 means "not at all" and 7 "absolutely". Each subject answered to this questionnaire three times for each navigation system. After the system visual presentation (Questionnaire 1, named Q1), after the three sessions without incoherencies (Q2), and after the six sessions containing guidance incoherencies (Q3). The purpose was to assess the evolution of the level of trust through the experiment for the two systems (before and after guidance incoherencies) and compare this level of evolution and value between systems.

Subjects were asked to put their indicators when they have decided on the direction they will follow at the incoming crossroads. The time elapsed between the navigation system's indication display and the indicator was considered as the reaction time for the subject to take their decision of their future direction.

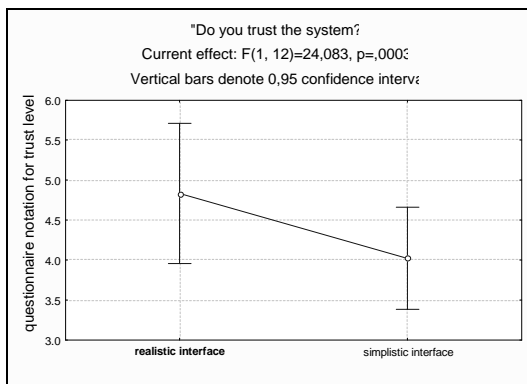
The direction chosen by subject when incoherence occurs were recorded and was used to assess system reliance.

Scores obtained from the questionnaires were analysed with a one way repeated measure ANOVA. Indicators' delay were analysed with a Chi<sup>2</sup> of independence.

## Results

### Subjective data

Results showed a main effect of the appearance on general user trust in the system. Subjects declared that they do trust more the realistic system than the symbolic one (ANOVA  $F = 24$   $df = 2$   $p < 0.001$ ) (Fig. 4).

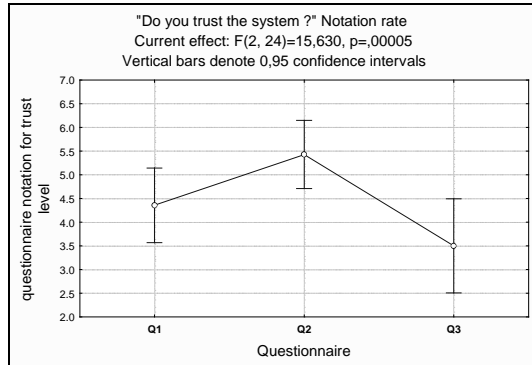


**Figure 4. Mean score of trust level for realistic and symbolic system during the whole experiment. Questionnaire scale is from 1 to 7**

This effect of the system appearance was also visible on other items of the questionnaire: "The system provides safety" ( $F = 7.23$   $df = 2$   $p < 0.05$ ) or "I can rely on the system" ( $F = 23.4$   $df = 2$   $p < 0.001$ ). These positive points associated with an interaction with an automated system obtained a higher scoring with the realistic system than with the symbolic. Data also showed that negative points concerning the interaction between human and automation obtained a lower scoring for the realistic system than for the symbolic one. This effect was significant the following items: "I am suspicious of the system's intent, action or input" ( $F = 6.3$   $df = 2$   $p < 0.05$ ), "The system is deceptive" ( $F = 21.81$   $df = 2$   $p < 0.001$ ) or "The system behave in an underhanded manner" ( $F = 9.7$   $df = 2$   $p < 0.05$ ).

This effect was significant when considering all scoring of each system. However, no significant difference of trust level appeared between the two

systems when comparing the first questionnaire, the second or the third questionnaire (tested with a Tukey HSD test). There was a significant decrease of the level of trust after sessions containing guidance incoherencies (between questionnaire Q2 and Q3, with HSD Tukey test  $p < 0.05$ ), but this decrease was not significantly different between the realistic and symbolic system (Fig. 5).



**Figure 5. Trust level evolution during the experiment, both navigation systems mixed. The score of the three questionnaire (Q1 Q2 and Q3) are displayed. Incoherences are committed in driving sessions between Q2 and Q3**

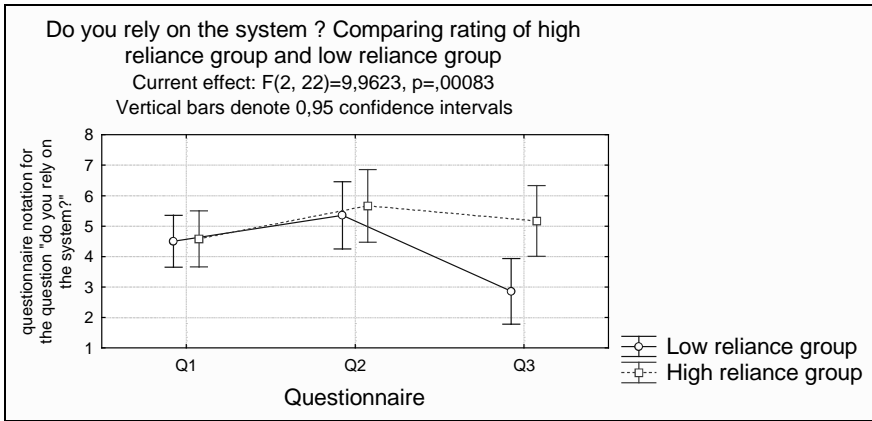
## Objective data

There was no significant effect of system's appearance on subjects' reliance. However, two groups of subjects were easily distinguishable when incoherencies occurred. One group follows 70% of the time the system's indication (high reliance group). The other group was relying less on the systems and followed their indications only 14% of the time (low reliance group). All subjects who had taken the one-way street because the system asked them to do so where in the high reliance group.

There was no significant effect of system's appearance on the reaction time for pressing the indicator's key, as much for crossroads with incoherencies as for crossroads without incoherencies.

## High reliance group and Low reliance group

High reliance subjects declared to rely more on the system than low reliance subjects (ANOVA  $F = 6.2$   $df = 2$   $p < 0.05$ ). Particularly, we have an interaction between questionnaire scores and subjects reliance level ( $F = 9.9$   $df = 2$   $p < 0.001$ ). Post hoc test (HSD Tukey) showed a significantly lower notation for "relying on the system" after sessions with incoherencies for the low reliance group than for the high reliance group ( $p < 0.05$ ) (Fig. 6). For notation before incoherencies (Q1 and Q2), no difference was found. The question "Do you trust the system?" showed a significant decrease of trust after incoherencies (Q3) only for the low reliance group ( $p < 0.001$ ). System reliability was also rated higher in the high reliance group ( $F = 7.7$   $df = 02$   $p < 0.05$ ).



**Figure 6. Reliance level declared in questionnaire Q1, Q2 and Q3 by the high and low reliance group during the experiment. Incoherencies are committed in sessions between Q2 and Q3**

## Discussion

The results showed an effect of system appearance on operator judgment of trust in the system. As indicated in web site studies (19), some graphical items can increase or decrease the level of trust even if they do not refer to a specific intrinsic quality. In our study, a navigation system with a realistic graphical appearance got a higher trust level. Whereas the evolution of trust level was not significantly different between the two systems before and after a decrease of their reliability (presence of incoherencies), the trust level of the realistic system always stayed higher. Other positive items of the questionnaire linked to the interaction with an automated system also had this profile. Consistently, negative items got a lower score for the realistic system than the symbolic system. Although graphic's appearance does not give any objective information about the system quality, it can interfere with the perceived trustworthiness of this system. Indeed, trust is not fully based on objective parameters but is an emotional concept (19) thus has an affective part (4) that can let subjective items interfere with trust. The symbolic system was also providing less visual information, as contextual information. Thus system's appearance may also has interfered with the analogic part of trust by providing different quality of information (4), whereas basic direction indication was present and fully understandable in both systems. The effect of the graphical appearance has thus an effect on those different parts of the judgment of operator on automated systems that are linked with trust.

Contrary to our expectation, the reliance on the system was not affected by the system appearance. This is not incompatible with the effect observed on trust (6, 9). Indeed, trust and reliance are notions that can or must be separated (8). System's appearance may have an effect on trust, but it may be too weak to interact with system reliance during use. Furthermore, as a subjective item, system's appearance may interact firstly with trust which is also an emotional or subjective judgment.



With both systems, some subjects clearly preferred to follow the road sign indications whereas others followed the system's indications. Both systems were concerned. System reliance depends on subject trust of the system but also on other factors as personal preferences (15). We showed here a high difference of reliance that was not clearly based on system trust. Comparing the two groups, trust level for both systems was very close and the significant difference only appeared after navigation system's incoherencies. Trust of subjects of the high reliance group was less impacted after navigation system's incoherencies. Personal preferences concerning automated system could have determined the fact to rely or not on the system and may have modulated the impact of reliability on trust. Subjects of the high reliance group also seemed to be more complacent than the others as they were more likely to take the one-way street, particularly when indicated by the realistic system. They took this way five times out of six with the realistic system. On this specific point, further experiments need to be done to confirm the impact of a realistic system on complacent behavior of high reliance subjects. We may think that reliance may be impacted by the lack of perceived danger during simulated driving sessions, in particular for this one-way street case. Nevertheless, using a simulator with such a complex urban environment seems well adapted for the general trust measure in the navigation system.

## **Conclusion**

Our study reveals the influence of graphical display on the feeling of trust in a navigation system. Trust level is higher in a graphically realistic system than in a simple one whereas their functioning is identical. Unfortunately, we could not clearly distinguish if the system's appearance has here influenced trust via the affective part due to the system's interface presentation or via the analogical part due to the difference of visual information available between both systems. This effect on trust seems also too weak to have a significant influence on the decrease of trust due to the system's decreased reliability.

We did not notice difference in users' reliance in the system comparing the two system appearances. Two groups of users were identified, one highly relying on system indication, and another not. Complacent behavior seems to be found in subjects from the high reliance group, particularly with the graphically realistic system. Further studies are needed to analyze trusting phenomenon in realistic versus symbolic display system while driving.

**Keywords:** trust, reliance, navigation system, graphical appearance.

## **Bibliography**

- 1 - Muir B. (1994) « Trust in automation. Part I: Theoretical issues in the study of trust and human intervention in a process control simulation ». *Ergonomics*, vol. 37 n. 11, 1905-1922.
- 2 - Muir M. (1996) "Trust in automation. Part II. Experimental studies of trust and human intervention in a process control simulation". *Ergonomics*, vol. 39, n 3, 429-460.

- 3 - Rielgelsberger J. (2005) "The mechanics of trust: a frame work for research and design". *Human Computer Study*, 62, 381-422.
- 4 - Lee, J.D. (2004). "Trust in automation: designing for appropriate reliance". *Human Factors*, Vol. 46, n. 1, 50-80.
- 5 - Parasuraman R. (2004) "Trust and etiquette in high-criticality automated systems". *Communication of the ACM*, vol. 47 n. 4.
- 6 - Wiegmann A. (2001) « Automated diagnostic aids: the effect of aid reliability on users' trust and reliance ». *Theo. Issue in Ergonomics*, Vol. 2, n. 4, 352-367.
- 7 - Dzindolet M.T. (2003) « The role of trust in automation reliance ». *Int. Journal of Human Computer Studies*, 58, 697-718.
- 8 - Moray J. Lee, N. (1992) « Trust, control strategies and allocation of function in human-machine systems ». *Ergonomics*, vol. 35, n. 10, 1243-1270.
- 9 - Bisantz M. (2001) « Assessment of operator trust in and utilization of automated decision-aids under different framing conditions ». *Int. Journal of Industrial Ergonomics*, 28, 85-97.
- 10 - de Vries P. (2003) "The effects of errors on system trust, self confidence, and the allocation of control in route planning". *Int. Journal of Human Computer Studies*, 58, 719-735.
- 11 - Yeh M. (2001) "Display signalling in augmented reality: effects of cue reliability and image on attention allocation and trust calibration". *Human Factors*, vol. 43, n. 3, 355-365.
- 12 - Tractinsky N. (2000) "What is beautiful is usable". *interacting with computer*, 13, 137-145.
- 13 - van Vugt H.C. (2007) "Realism is not all! User engagement with task related interface characters". *Interacting with Computer*, 19, 267-280.
- 14 - Lee J.D. (1994) "Trust, self-confidence, and operators' adaptation to automation". *int. journal of Human Computer Studies*, 40, 153-184.
- 15 - Parasuramann R. (1997) "Humans and automation: use, misuse, disuse, abuse". *Human Factors*, 39(2), 230-253.
- 16 - Parasuramann R. (1993) "Performance consequences of automation-Induced "Complacency"". *The Int. Journal of Aviation Psychology*, 3(1), 1-23.
- 17 - Moray N. (2003) "Monitoring, complacency, skepticism and eutectic behaviour". *Int. journal of industrial ergonomics*, 31, 175-178.
- 18 - Jian J. (2000) « Foundation of an empirically determined scale of trust in automated systems ». *Int. Journal of Cognitive Ergonomics*, 4(1), 53-71.
- 19 - Kim J. (1998) "Designing towards emotional usability in customer interfaces-trustworthiness of cyber-banking system interfaces". *Interacting with computers*, 10, 1-29.

# **Product solution & Posters session**



# Toward a standard: RoadXML, the road network database format

**Julien Chaplier, Thomas Nguyen That, Marcus Hewatt, Gilles Gallée**

OKTAL SA, 19, Bd des Nations Unies, 92190 Meudon - France

julien.chaplier@oktal.fr, thomas.nguyen@oktal.fr, marcus.hewatt@oktal.fr,

gilles.gallee@oktal.fr

**Abstract** – *Driving simulator market and the diversity of its applications has been constantly growing for the past 20 years. The number of tools available to describe and produce database followed the same path and there is today a proliferation of applications and formats, usually proprietary, making interoperability difficult. Furthermore the numerous simulation tools and models used in a driving simulator (traffic model, vehicle dynamic model, visual rendering) require road network descriptions with different contents and level of details, depending on the scope of the simulation. Therefore the creation of road network database often require the use of several separate, non-harmonized proprietary tools and processes resulting in several representation of the same network in sometimes incongruous, incomplete and closed database format. Creation and modification of such databases is often a time-consuming labour and may be the source of inconsistencies between simulation modules. Today the actors of the driving simulation market are looking for a more cost-effective and time-saving way to produce and use road network databases. The simulation market is looking for interoperability: database and communication for training, test beds systems for industry. Most of the users want to have simulator contents independent of simulator technology vendors and need the same road environment definition for Software-in-the-loop, hardware-in-the-loop and Driver-in-the-loop systems for testing ADAS. At OKTAL we are involved in simulation and driving simulators since 1989 and had since worked with a number of road description formats. In this context, we propose through RoadXML a new road network description format for driving simulation applications within an open source cooperative approach to ease road database production, improve simulation models consistency, and achieve sharing and interoperability.*

**Résumé** – *Le marché des simulateurs de conduite et la diversité de ses applications a été constamment en croissance durant les 20 dernières années. Le nombre d'outils disponibles pour décrire et produire des bases de données a suivi le même chemin et il y a aujourd'hui une prolifération d'applications et de formats, généralement propriétaires, qui rendent l'interopérabilité difficile. De plus les nombreux outils de simulation et modèles utilisés dans un simulateur de conduite (modèle de trafic, modèle de dynamique véhicule, rendu visuel) requièrent*

*des descriptions de réseaux routiers avec des contenus et niveaux de détails différents, suivant le champ d'application de la simulation. Pour cela, la création de base de données de réseau routier demande souvent l'utilisation de plusieurs outils propriétaires et processus séparés non-harmonisés résultant en de multiples représentations du même réseau dans des formats parfois incongrus, incomplets et fermés. La création et la modification de tels formats est souvent une tâche longue et peut être à l'origine d'incohérences entre les modules de la simulation. Aujourd'hui les acteurs du marché de la simulation de conduite sont à la recherche d'une méthode plus économe et rapide de produire et utiliser des bases de données de réseaux routiers. Le marché de la simulation est à la recherche d'une plus grande interopérabilité : communication des bases de données dans le domaine de la formation, banc de test pour l'industrie. La plupart des utilisateurs souhaite que le contenu des simulateurs soit indépendant des vendeurs de technologie de simulation et demande à avoir la même définition de l'environnement routier pour les systèmes Software-in-the-loop, hardware-in-the-loop et Driver-in-the-loop pour les tests ADAS. Chez Oktal nous sommes impliqués dans la simulation et les simulateurs de conduite depuis 1989 et avons travaillé depuis avec un certain nombre de formats de description routier. Dans ce contexte, nous proposons avec RoadXML un nouveau format de description de réseau routier pour les applications de simulation de conduite dans une approche Open Source et coopérative pour faciliter la production de base de données routières, améliorer la cohérence des modèles de simulation et rendre possible le partage et l'interopérabilité.*

## Background

A few works were made in the direction of a common road network description format for driving simulator in the past years:

- TRAIN-ALL project[3]
- OpenDRIVE™, release in 2007[4].

Other open road network formats like LandXML[5] and OpenStreetMap[6] are already commonly used for geographical needs, but are not dedicated to driving simulator.

The RoadXML format is the outcome of the study of these projects and of the compilation of several proprietary formats developed by different driving simulation actors:

- GRS file format of EVARISTE software product since 1995
  - Tracks version co-developed with PSA Peugeot Citroën
  - Network version co-developed with INRETS [1][2]
- RNS / RS file format (1997) coming from EU TRaCS project with Thales, Renault and Autosim. RNS / RS are the files formats of SCANeRII software [8].

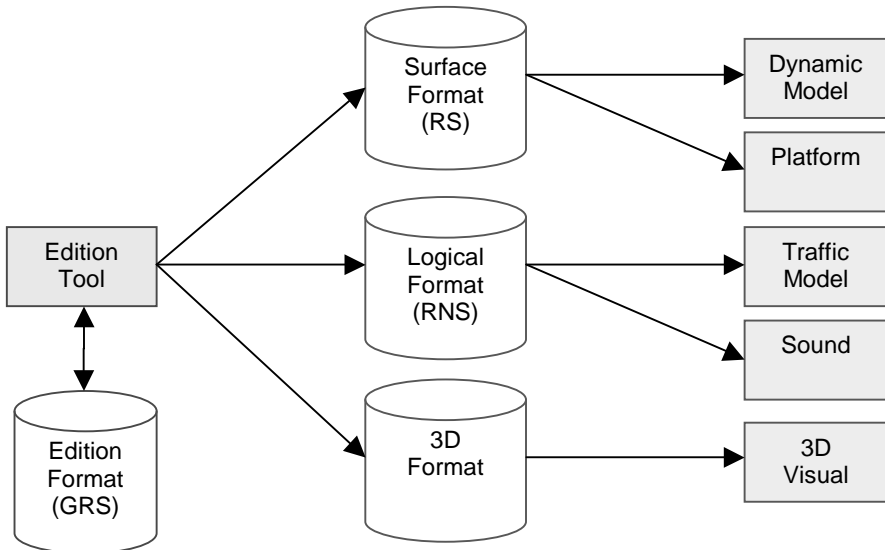
## Former format analysis

RNS file format contains a logical description of the road network dedicated to traffic engine. The axes of the road are simple polylines. Road signs and circulation lanes are attached to them. The format is very simple and therefore accessing data is straight forward. But autonomous vehicle behavior accuracy was limited by the lack of information in the environment description.

RS file format is a road surface description format entirely dedicated to road surface picking tools. It contains an analytic description of the surface (as Bezier patches) but no information on the network.

GRS file format is an edition file format and is the most complete of the 3 formats described here. A 3D representation of the network can be generated from its content, as well as a topological representation. The road surface can also be described analytically from its data [9].

Each file format was specialized according to the needs of the driving simulator modules. The production chain of a database looked like this:

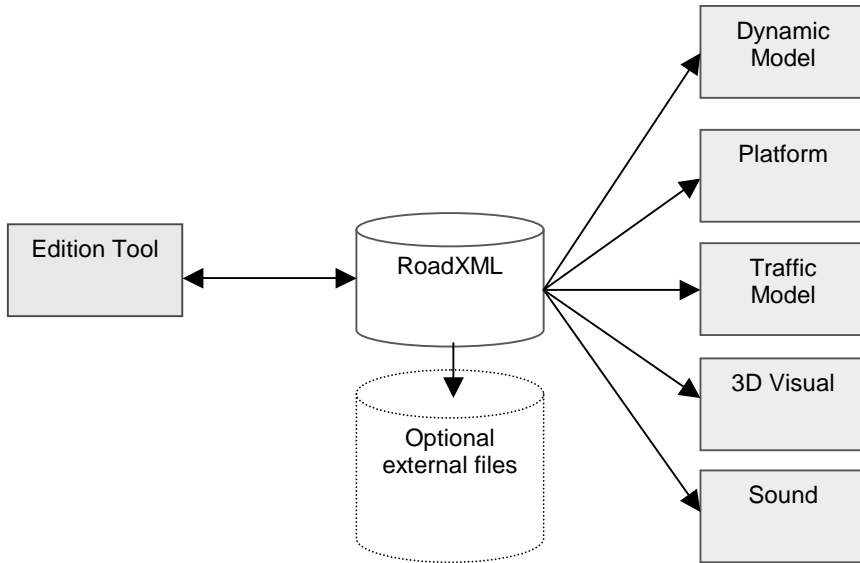


### Former Production Chain

This multiplication of the file formats had several major issues:

- Each file format can be adjusted individually, the consistency between the formats is then broken.
- It's difficult to compare the results of several simulation modules since they don't use the same input data.
- Database handling is not eased: the user need to keep track of all this files.

RoadXML first concept was to have one format for all the driving simulator modules and to give a unique access to the network description. Even when for some reasons another file format is needed, the access is done through the RoadXML file.



**RoadXML production chain**

The second main concept of the format is to be flexible enough to answer future or proprietary driving simulator needs.

RoadXML, previously named RND, has been developed for the past four years. The first version was released in 2006 for Evariste and the traffic model of the PSA Peugeot Citroën SHERPA simulator. In 2007 the version 1.3 is integrated in SCANer™ as an alternative file format for SCANer II traffic[7] and road surface. In 2009 the version 2.0 is the native format of SCANer™studio for road description and is freely available as RoadXML on [www.road-xml.org](http://www.road-xml.org).

## The RoadXML format

### Content

The RoadXML format is a modern XML base file format designed to answer all the needs of road simulators. It has been designed to be flexible and extendable to enable users to enhance the road network description with custom or proprietary data. Because it is XML based, user data can be added at any level of the file tree.

The RoadXML elements and attributes (in the XML sense) are fully readable and don't contain any mysterious tag or magic number. A file can therefore be opened and understood in a text editor.



```

< Track endNode = "Crossroad 1" name = "Main Street" startNode =
"Crossroad 2" >
< XYCurve direction = "0.60562" x = "10" y = "25.5" >
< Segment length = "10"/ >
< ClothoArc endCurvature = "0.02" length = "50 " startCurvature
= "0"/ >
< CircleArc curvature = "0.02" length = "30"/ >
< ClothoArc endCurvature = "0" length = "45" startCurvature =
"0.02"/ >
< PolyLine type = "spline" >
< Vector2d x = "23.0416" y = "0"/ >
< Vector2d x = "128.693" y = "33.9411"/ >
< Vector2d x = "159.265" y = "29.6569"/ >
< Vector2d x = "296.07" y = "-577.832"/ >
< /PolyLine >
< /XYCurve >
...
< /Track >

```

### Extract from a RoadXML file

## Structure

The structure of the format has been organized to ease the creation and the use of networks.

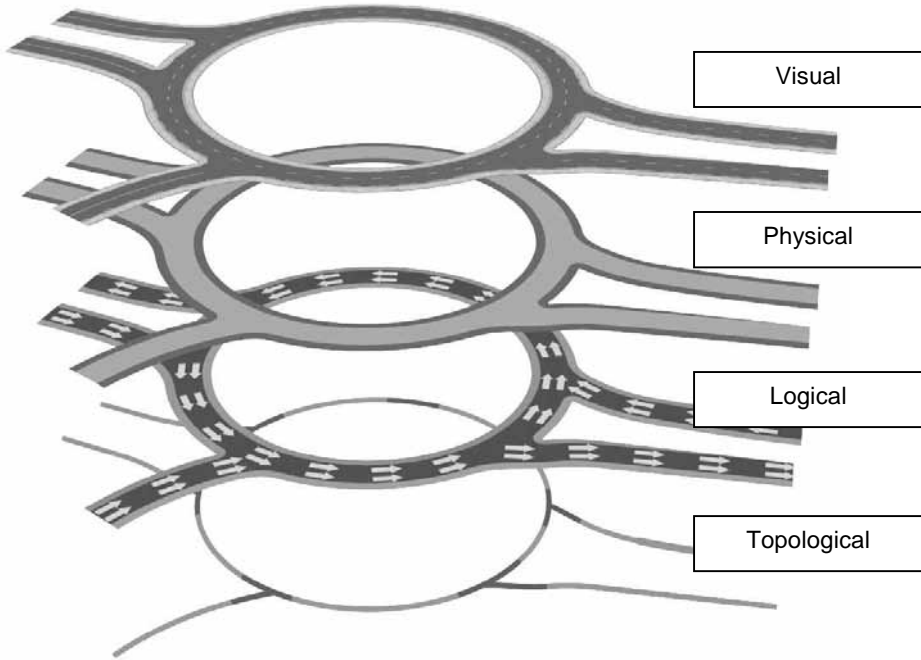
The road network is composed of adjacent tiles, each tile representing a piece of the whole network. Each tile contains a skeleton of the road network, made of axis and intersections, and is connected to its neighbor tiles through specific junction points. An axis is a planar description of the road axis and is made of segments, circle arc, spline and clothoid arcs (also called Cornu spirals or Euler spirals). An Intersection is a connection between axes.

Any other data is then attached to this light skeleton:

- Vertical and horizontal signalization.
- Road surface geometry and properties.
- Large scale data, such as routes and itineraries.
- Small scale data, such as obstacles or local surface properties.
- 3D features.
- Any user defined data.

RoadXML offers a multi layer description of the environment for fast data access for real time applications. Here are the 4 main layers of information:

- **Topological:** element's location and connections with the rest of the network.
- **Logical:** element's signification in a road environment.
- **Physical:** element's properties (road surface or obstacles).
- **Visual:** element's 3D representation.



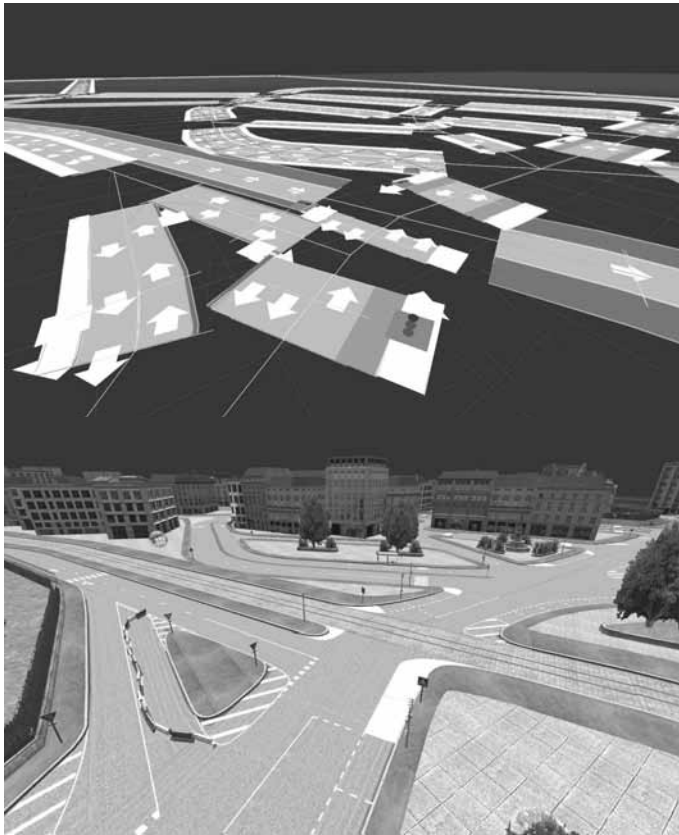
**Four layers representation of a network**

Therefore each element of the RoadXML format is described with 1 to 4 layers of information. Here are a few elements of the format that illustrate this 4 layers representation:

	<b>Topological Layer</b>	<b>Logical Layer</b>	<b>Physical Layer</b>	<b>Visual Layer</b>
Road Marking	Position between 2 lanes	Authorization for the vehicles to cross	Surface properties of the material	Road marking width, dot's length, texture
Road Sign	Position relative to a road axis	Road sign meaning for the traffic	NA	3D object used for its representation.
Cross Profile Lane	Distance to the road axis, width of the lane	Vehicles authorized on the lane, direction way	Road surface properties	Elevation profile, texture

**Data Access**

A driving simulator's component doesn't necessarily need to access all the RoadXML layers of data. But it should always be able to find the information it needs to understand its environment.



### **The network view of the traffic model and the equivalent 3D representation**

#### *Traffic model*

The traffic model access the Topological and Logical layers of the format. The description contains information such as:

- Interconnection between the roads
- Signalization
- Road lanes, with their direction, speed limit and authorized vehicles
- Road marking.

#### *Scenario control*

Like the traffic model, the scenario control needs a topological representation of the network.

#### *Vehicle dynamic models*

Dynamic models have access to an analytic description of the road surface, as well as the ground material. Because a ground material is often specific to the model, the RoadXML ground material contains just a few simple parameters: everything else is defined in a user data element.

### *Platform control model*

Like the dynamic model, the platform control model needs a smooth description of the road surface. It therefore asks an analytic description of the surface.

### *Sound restitution*

Sound engine needs to know a few parameters about the physical properties of the ground surface.

### *3D Viewers*

Viewers need a 3D representation of the network. The RoadXML format contains enough information to build a full 3D representation of the road network and its environment. The format can also reference external files for its representation.

## **Towards an open standard**

### **Open Format**

Since the 6th of October 2009, RoadXML is officially an open file format:

- The community and resources are gathered on a dedicated website: [www.road-xml.org](http://www.road-xml.org)
- Its schema and specification are available
- Schema and specification are free of use for any commercial or non-commercial projects.
- Help and support is available from the website.
- Sample files will be added from time to time on the website.

### **A lively standard**

With time, new needs are emerging from user's applications. RoadXML is therefore in constant evolution and regular updates are released through the website [www.road-xml.org](http://www.road-xml.org).

### **Cooperative approach**

To respond to market needs, not only must a format match technical requirements, but its development and evolutions must also have to be managed in a cooperative approach.

Therefore, the RoadXML format will be managed through an international steering committee constituted by members from the industry and research. The board members will be elected among and by the RoadXML adherent. To become a RoadXML adherent, interested parties may register on the RoadXML website.

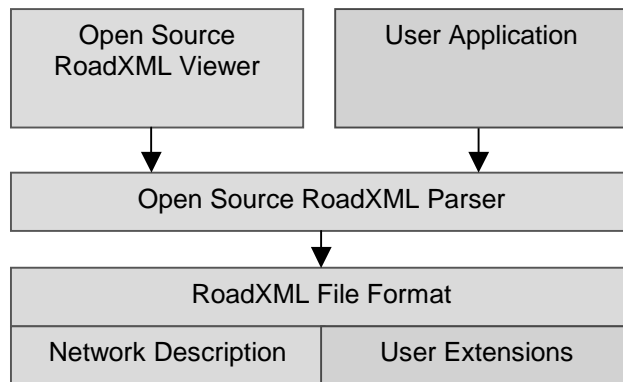
## Open Source Projects

The expansion of a format is often restrained by the lack of free tools to manipulate it. To prevent this, Oktal will soon offer an open source project based on RoadXML to illustrate:

- How to read, write and access data in the XML file.
- How to draw a 3D representation of the road network.
- How to add custom user extensions into the file.

This application will be distributed through sourceforge under the terms of the LGPL license, allowing its use and modification in commercial and non-commercial applications, without restrictions.

Oktal will also offer RoadXML sample databases for download. The objective is to offer all the necessary tools for a newcomer to quickly decide if RoadXML is suited to its project.



**RoadXML Open Format and Source**

## Conclusion

The driving simulation world is seeking an Open Standard on the road network database format. RoadXML is already used in a broad variety of training and research driving simulators. Databases creation and modification was simplified by its use in recent projects. The various modules in these simulators were able to find and use the data they needed within this format.

Opening its specification, making it available for all and constituting a management board is a new step toward the creation of a real international open standard for road network description in simulation.

## Bibliography

- [1] Carles, O. & Espié, S. (1999). Database generation system for road applications. *Proceedings of the Driving Simulation Conference*.

- [2] Carles, O. & Espié, S. (2000) Multi-level environments modeling for road simulations. *Proceedings of the Driving Simulation Conference*.
- [3] The TRAIN-ALL European project, <http://www.trainall-eu.org/>.
- [4] Dupuis, M. & Grezlikowski, H. (2006). OpenDRIVE® – an open standard for the description of roads in driving simulations. *Proceedings of the Driving Simulation Conference*.
- [5] LandXML file format, <http://www.landxml.org/>.
- [6] OpenStreetMap file format, <http://www.openstreetmap.org/>.
- [7] Lacroix, B., Mathieu, P., Rouelle, V., Chaplier, J., Gallée, G. & Kemeny, A. (2007) Towards Traffic Generation with Individual Driver Behavior Model Based Vehicles. *Proceedings of the Driving Simulation Conference*.
- [8] Champion A., Mandiau R., Kolski C., Heidet. and Kemeny A. (1999) Traffic generation with the SCANNER© II simulator: towards a multi-agent architecture *Proceedings of the Driving Simulation Conference*, Paris, July 1999, pp.311-324
- [9] Bruce E. Artz. (1995) An Analytical Road Segment Terrain Database for Driving Simulation. *Proceedings of the Driving Simulation Conference*.

# The Development of a Low Cost Driver Licensing Simulator

**R. Wade Allen, Woon San Joe, George D. Park, John K. Grant**

Systems Technology, Inc.

13766 South Hawthorne Boulevard – Hawthorne - 90250-7083 California USA

rwallen@systemstech.com, wsjoe@systemstech.com,

gdpark@systemstech.com, jkgrant@systemstech.com

**Abstract** – *This paper describes the development of a low cost simulator for the licensing assessment of car and truck drivers. The simulator cabs were set up to be consistent with the ergonomics of either cars or trucks. The simulator was prepared for the Transit Commission in the state of Guyas, Ecuador, so all of the user interfaces were appropriate to Spanish speakers. Furthermore, the driving scenarios and hazard situations were set up to be consistent with the look and feel of the city of Guayaquil, Ecuador where the simulators are located. The assessment criteria were set up to present the licensing examiner with feedback on the occurrence of what were termed minor and fatal errors. The examiner would then base his decision for granting a license on the occurrence of the minor and fatal errors. The paper will describe the development of the simulator and user interface and discuss issues associated with driver assessment for licensing.*

**Résumé** – *Cet article décrit le développement d'un simulateur de faible coût pour l'évaluation de licence de la voiture et de camion. Les cabines de simulation ont été mis en place pour être compatible avec l'ergonomie de l'une des voitures ou des camions. Le simulateur a été préparé pour la Commission de transport en commun dans l'état de Guyas, l'Équateur, de sorte que toutes les interfaces utilisateur ont été appropriées pour haut-parleurs en espagnol. En outre, les scénarios de conduite et de situations de risque ont été mis en place pour être compatible avec l'aspect et la convivialité de la ville de Guayaquil, en Équateur, où les simulateurs sont situés. Les critères d'évaluation ont été créés pour présenter à l'examineur de licence avec les informations sur l'apparition de ce qu'on a appelé mineures et des erreurs fatales. L'examineur alors fonder sa décision d'octroi d'une licence sur la survenue des erreurs mineures et fatale. Le document décrit le développement du simulateur et l'interface utilisateur et de discuter de questions liées à l'évaluation des conducteurs pour les licences.*

## Introduction

Driving simulation has been applied in many areas including research, assessment and training [1]. Assessment involves testing the capability of drivers to handle vehicles in a safe manner. Simulator assessment has been used in a wide variety of applications including patients who's medical condition may impact their driving safety [2], [3], older driver proficiency [4], commercial vehicle driver licensing [5], driver training [6], drug and alcohol impairment [7], [8] and fatigue [9]. This paper describes a simulator developed for a less familiar application, car and truck driver licensing assessment for a transit commission in the state of Guayas, Ecuador. Previously, the commission had used closed course testing to assess drivers for licensing. The use of the simulator is intended to produce a more objective test that includes controlled hazards (vehicles, pedestrians, road profile, etc.).

The closed course testing in Ecuador required not only using available land space but also providing a standardized testing vehicle for a high volume of license applicants. As such, secondary goals of the simulation system included: increased testing efficiency to accommodate the high volume, lowering of licensing costs required of testing vehicles (e.g., gas, vehicle maintenance), and integrating simulator data with existing data infrastructure. Because little work has been done on use of simulator assessment for driver licensing the licensing authority must still work out procedures and protocols for this application to meet the needs of the state of Guayas in Ecuador.

## Background

The simulator components included all of the software and hardware features in Figure 1 except that it was fixed base (no motion) and did not include a head mounted graphics display. The basic software platform has previously been validated for novice driver training [4] and has been applied to a range of other assessment applications (e.g. [2-9]). Assessment of drivers for the purpose of licensing is a relatively new application that has mainly been pursued for commercial truck drivers (e.g. [5]). The hardware was specifically designed to meet the requirements of this application and to accommodate shipping and installation in a distant foreign country as discussed below.

## Design

*Seating Console* - Ergonomics considerations for car and truck versions of the simulator console were addressed as portrayed in Figure 2. The design of the simulator console as illustrated in Figure 3 was governed by ergonomics, cost and shipping requirements (i.e. compact, light weight and rugged). All of the components were common to the car and truck configurations, but the seating and control orientation were dictated by the ergonomic requirements of cabin layout (e.g. truck drivers sit more erect and have a more upright steering angle).



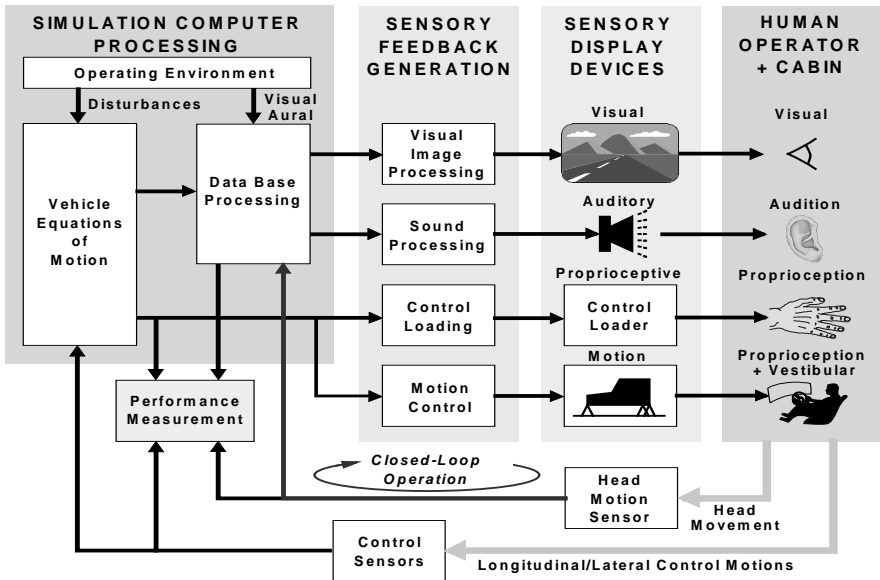


Figure 1. Simulator Components

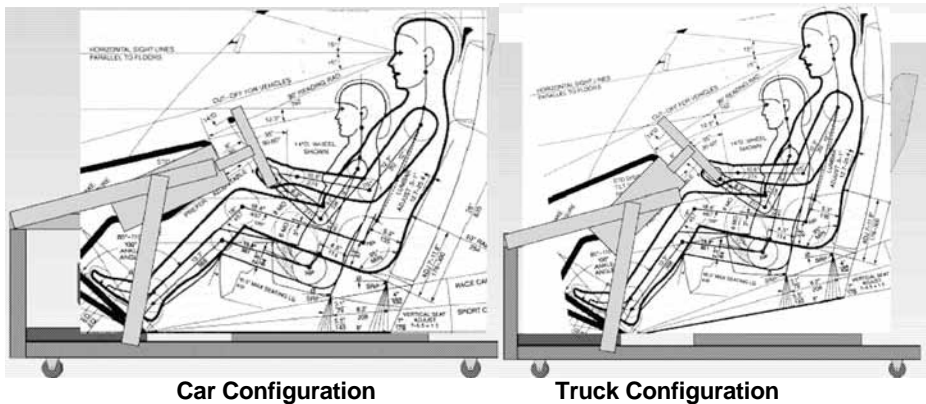


Figure 2. Ergonomic considerations for Simulator Consoles

*Dynamics and Cueing* – The vehicle dynamics and cueing computations were performed on a Dell Vostro Tower computer with a dual core processor running commercially available simulation software (e.g. [1], [10]). The lateral/directional dynamics provided for basic understeer response plus cornering limits of 0.8 g lateral acceleration. The longitudinal dynamics provided for gear shifting based on clutch and shifter inputs and engine torque limits, and also included braking deceleration limits of 0.8 g. Scene graphics were provided by a commercial renderer (Open GVS) that presented the road and environs and specific models that were added at run time from a display list. The display list is used for vehicles, pedestrians and signal timing that are presented relative to the driver's position and speed, and also for various road environment objects such as buildings, flora, and traffic control devices (signs, road markings and delineation) [1], [10].



a) Installation

b) Facility



c) Console Frame

d) Controls

Figure 3. Licensing Simulator Configuration and Installation



Figure 4. The Roadway Environment of Guayaquil, Ecuador

*Driver Cueing Displays* – Visual cueing was provided by a large 42 inch flat panel display with 1080i resolution as illustrated in Figure 3. The auditory cueing was provided by the Dell Vostro Tower sound system that included a low frequency woofer and higher frequency crossover plus tweeters. Sounds included engine, tire road noise and tire squeal at high g's, crash, and wave file commands spoken in Spanish. Steering feel was provided by a torque motor responding to lateral g's.

*Driving Scenarios* - Driving scenarios and models were developed to give the look and feel of the Ecuador capital city of Guayaquil as portrayed in the Figure 4 photographs. These photographs were taken during a drive throughout Guayaquil and environs specifically to capture the essence of the driving environment. Screen shots of the resulting scenarios with different hazard events are shown in Figure 5. The scenarios were prepared using previously published procedures [1], [10]. All traffic control devices (signs, signals and markings) were simulated according to conventions adopted in Ecuador as illustrated in Figure 5. Verbal driving instructions were provided as part of the scenarios (e.g. turn left at the next intersection) and were recorded by a native Ecuadorian speaker in Spanish using local vocabulary and idioms.



a) Car Cabin Configuration



b) Truck Cabin Configuration

**Figure 5. Driving Scenario Scenes with Hazard Situations**

A total of four customized scenarios based on vehicle speed environment were provided. These included:

- 1) Orientation Drive: Designed to familiarize the driver with simulator displays, controls, and virtual environment. Audio warnings were provided for any speed and traffic violations. White fog was provided to help adapt drivers to the simulation environment. Runtime: 5 min.

- 2) Rural Drive: High speeds in a moderate to light traffic environment. Events included: three lane freeway, speed reduction for two signal lights, left turn intersection with oncoming traffic, oncoming head collision, mountain curves, and truck passing task. Runtime: 8 min.
- 3) Suburban Drive: Heavy pedestrian and road obstacle environment with minimal road markings at slow vehicle speeds. Events include: one way streets, stop signs, pedestrian walk outs, vehicle pullouts, vehicles backing into driver's path, oncoming traffic in narrow streets, right/left turn intersections and a construction zone obstacle course. Runtime: 5 min.
- 4) Metro Drive: Heavy pedestrian and traffic in multi-lane urban environment with traffic signals at moderate vehicle speeds. Events include: bridge overpass, vehicle merges, pedestrian walkouts, vehicle pullouts, and right turn intersection. Runtime: 5 min.

**User Interface** - A Graphical User Interface (GUI) illustrated in Figure 6 was designed to allow a licensing examiner to select driving scenarios, and to give feedback on driver performance. The performance feedback includes major errors (accidents and tickets) and minor errors (crossing centerlines and edge lines, turn indicator usage, etc.) as summarized in Table 1. Examiners interpret the performance scores in terms of granting or denying a license (e.g. no fatal errors, a few minor errors).



Figure 6. Licensing Simulator GUI

**Table 1. Drive Summary Provided to License Examiner**

English	Spanish
<p><b>RESULTS SUMMARY</b></p> <p><b>Driver Name:</b></p> <p><b>ID:</b></p> <p><b>Scenario File:</b></p> <p><b>Weather Options:</b></p> <p><b>Run Completion:</b></p> <p><b>Vehicle Options:</b></p> <p><b>Total Runtime:</b></p> <p><b>Date: Time:</b></p> <p><b>Driver Collisions:</b></p> <p>Number of Vehicles: 10</p> <p>Number of Pedestrians: 10</p> <p>Number of Road Obstacles: 10</p> <p><b>Steering &amp; Handling:</b></p> <p>Number of Centerline Crossings: 10</p> <p>Number of Road Edge Excursions: 10</p> <p>Out of Lane (% Time, % Distance): 10.0 % 10.0 %</p> <p>Lane Position (Average, Standard Deviation): 10.0 m 10.0 m</p> <p><b>Vehicle Speed:</b></p> <p>Number of Speeding Tickets: 10</p> <p>Over Speed Limit (% Time, % Distance): 10.0 % 10.0 %</p> <p>Average Vehicle Speed: 10.0 kph</p> <p><b>Traffic Control Compliance:</b></p> <p>Number of Traffic Light Tickets: 10</p> <p>Number of Stop Sign Tickets: 10</p> <p>Number of Turn Signal Tickets: 10</p>	<p><b>RESUME DE RESULTADOS</b></p> <p><b>Nombre del Conductor:</b></p> <p><b>Número de Licencia:</b></p> <p><b>Archivo de Escenario:</b></p> <p><b>Opción del Tiempo:</b></p> <p><b>Porcentaje Completado:</b></p> <p><b>Opción de Vehículo:</b></p> <p><b>Duración Total:</b></p> <p><b>Fecha: Tiempo:</b></p> <p><b>Colisiones del Conductor:</b></p> <p>Número de Vehículos: 10</p> <p>Número de Peatones: 10</p> <p>Número de Obstáculos: 10</p> <p><b>Volante y Manipulación:</b></p> <p>Número de Veces que Cruzó la Línea Central: 10</p> <p>Número de Veces que Cruzo el Borde de la Carretera: 10</p> <p>Fuera del Carril (% Tiempo, % Distancia): 10.0 % 10.0 %</p> <p>Posición del Carril (Promedio, Desviación Estándar): 10.0 m 10.0 m</p> <p><b>Velocidad del Vehículo</b></p> <p>Número de Multas por Exceso de Velocidad: 10</p> <p>Superaciones de la Velocidad (% Tiempo, % Distancia): 10.0 % 10.0 %</p> <p>Promedil de la Velocidad del Vehículo: 10.0 kph</p> <p><b>Cumplimiento de Control de Tráfico:</b></p> <p>Número de Billetes INFRACCIONES en Semáforo: 10</p> <p>Número de Billetes INFRACCIONES en Señal de Pare: 10</p> <p>Número de Multas INFRACCIONES de Luz de Cruce: 10</p>

## Concluding Remarks

The arrival and installation of the simulators was greeted with interest (Figure 3) and they have been officially implemented for driver licensing assessment. As of this writing two applicants have been granted their license, and two applicants have been rejected and cautioned to return prepared to take the simulation assessment. The plan is to use the simulators as a replacement to the current closed course testing in order to present drivers with critical and realistic traffic and road environment situations. Fairly detailed performance feedback is provided to the examiners, but assessment criteria for licensing must still be worked out by examiners and commission authorities. The procedures and passing criteria are still being refined by the Transit Commission as of this writing.

It can be argued that the driving simulator assessment system developed here is assessing completely different metrics of driving behavior and skill than an on-road test may be assessing. But is this really a problem? According to an international literature review by Senserrick and Haworth [11], the relationship between scores of on-road assessments and crash rates once licensed has shown little association. Ecuadorian drivers in addition are required to complete a basic vehicle skills class prior to examination, therefore assessments of vehicle handling and mirror checking may be redundant for licensing

In conclusion, general simulator validation issues for assessment have been extensively dealt with in the literature (e.g. [4], [12] and included references) for specialized driving populations but further work is needed for licensing assessment for the general population. There exists a growing need for cost-effective, reliable and valid driver licensing test procedures. The current system clearly provides some desirable attributes such as safety for the driver and examiner, and the ability to test the applicant in real world situations that are relevant to traffic safety.

## Bibliography

- [1] R. W. Allen, T. J. Rosenthal, B. L. Aponso, and G. D. Park, "Scenarios Produced by Procedural Methods for Driving Research, Assessment and Training Applications," presented at 2003 Driving Simulator Conference North America (DSC-NA), Dearborn, MI, October 8-10, 2003. (STI-P-621)
- [2] T. D. Marcotte, Ph.D., T. J. Rosenthal, E. Roberts, J. C. Scott, R. Meyer, and R. W. Allen, "Driving Simulator Performance Across the Lifespan: A Preliminary Study," presented at 4th International Driving Symposium on Human Factors in Driver Assessment, Training, and Vehicle Design, Stevenson, WA, July 9-12, 2007. (STI-P-692)
- [3] Nyberg, S. L., J. P. Bida, *et al.* (2006). "Cognitive Impairment Predicts Difficulty Driving: A Pilot Study Using HEADS (Hepatic Encephalopathy Assessment Driving Simulator)." *Liver Transplantation* 12(5): C-7.

- [4] G. D. Park, M. L. Cook, T. J. Rosenthal, D. D. Fiorentino, and R. W. Allen, "Simulator Assessment of Older Driver Proficiency," *Advances in Transportation Studies An International Journal*, Special Issue, pp. 75-86, 2006. (STI-P-688)
- [5] Tarr, R., Whitmire, J.D. and Gupta, Kamini, "The Virtual Check Ride as a Diagnostic and Remediation System," *Proceedings of the Driving Simulation Conference, North America 2007*, University of Iowa.
- [6] Allen, R.W., Park, G.D. and Cook, M.L., "Simulator Fidelity and Validity in a Transfer of Training Context," paper presented to the Transportation Research Board Annual Meeting, Washington, DC, January 2010.
- [7] Hiltunen, H., C. Hublin, *et al.* (2000). "The Effects of Zolpidem and Temazepam Taken at 2 A.M. on Driving Starting at 7:30 A. M." *Sleep* 23(Abstract Supplement #2).
- [8] Fillmore, M.T., Harrison, E.L.R., "The impairing effects of alcohol intoxication and speeding on driving precision: analyses of additive and interactive effects," *Advances in Transportation Studies an international Journal* 2007 Special Issue
- [9] Fagbemi, O.S., Pfeffer, K., "The relationship between chronic sleep deficit and distraction in young adult drivers," *Advances in Transportation Studies an international Journal* 2007 Special Issue.
- [10] Park, G., T. J. Rosenthal, *et al.* (2004). "Developing Driving Scenarios for Research, Training and Clinical Applications." *Advances in Transportation Studies An International Journal*(Special Issue).
- [11] Senserrick, T.M. & Haworth, N. (2005). Review of literature regarding national and international young driver training, licensing and regulatory systems (Report No. 239). Clayton, Australia: Monash University, Accident Research Centre.
- [12] H.C. Lee, 2002, "The validity of driving simulator to measure on-road driving performance of older drivers." 24th Conference of Australian Institutes of Transport Research (CAITR), Sydney, AUS.





# OpenDRIVE 2010 and Beyond – Status and Future of the de facto Standard for the Description of Road Networks

Marius Dupuis <sup>1</sup>, Martin Strobl <sup>2</sup>, Hans Grezlikowski <sup>3</sup>

<sup>1</sup> VIRES Simulations technologie GmbH  
83026 Rosenheim, Germany

<sup>2</sup> BMW Group Research and Technology  
80788 Munich, Germany

<sup>3</sup> DAIMLER AG Driving Simulators, Research and Technology  
71059 Sindelfingen, Germany

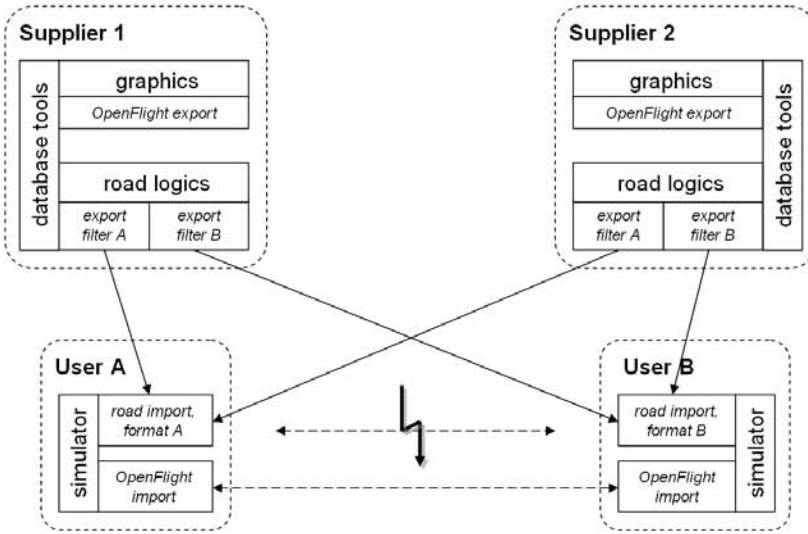
marius@vires.com, martin.strobl@bmw.de, hans.grezlikowski@daimler.com

**Abstract** – *OpenDRIVE was launched in early 2006 and made its first appearance to a broad audience of driving simulation experts at the DSC in September 2006 [1]. Four years later, this paper provides an overview of the project's status and current applications. It will not so much focus on technical details of the data format since these are publicly available via the format specification [2]. Instead, it will take a closer look at the OpenDRIVE project itself, the processes which are implied and the use cases. A detailed user report will show OpenDRIVE's strengths in terms of the exchange of databases. Another open project, based on the ideas of OpenDRIVE and extending its range of applications will be introduced. Finally, an outlook on future developments will be given.*

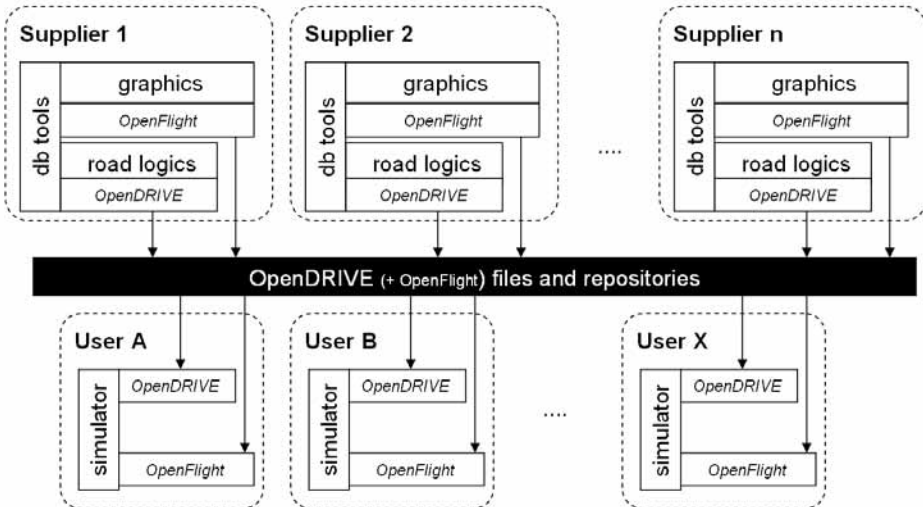
## Background

### Motivation

The idea of OpenDRIVE emerged during the implementation of Daimler's "DRIVE" format by VIRES into several tools for the creation and real-time evaluation of road network databases. Implementing yet another proprietary solution worked well, but it didn't quite provide the perspective of long-term flexibility, especially when it came to identifying additional repositories of road databases, exchanging data within heterogeneous projects etc. The following figure illustrates this situation at the start of the project.



The exchangeability of data that had already been established for visual databases by means of the *OpenFlight* Format [3] was a good benchmark for what had to be done for the logical description of road networks. This initial aim is shown in the following figure:



As the figure illustrates, only the involvement of a broad range of road network creators and users would provide a solid foundation for a successful initiative.

## A Short History of OpenDRIVE

The design of the OpenDRIVE project was laid out as a draft in 2005 and the project itself was made public in 2006 [1]. From the public start, a broad team of simulation professionals was involved in the design of the OpenDRIVE format [2] and the project itself.

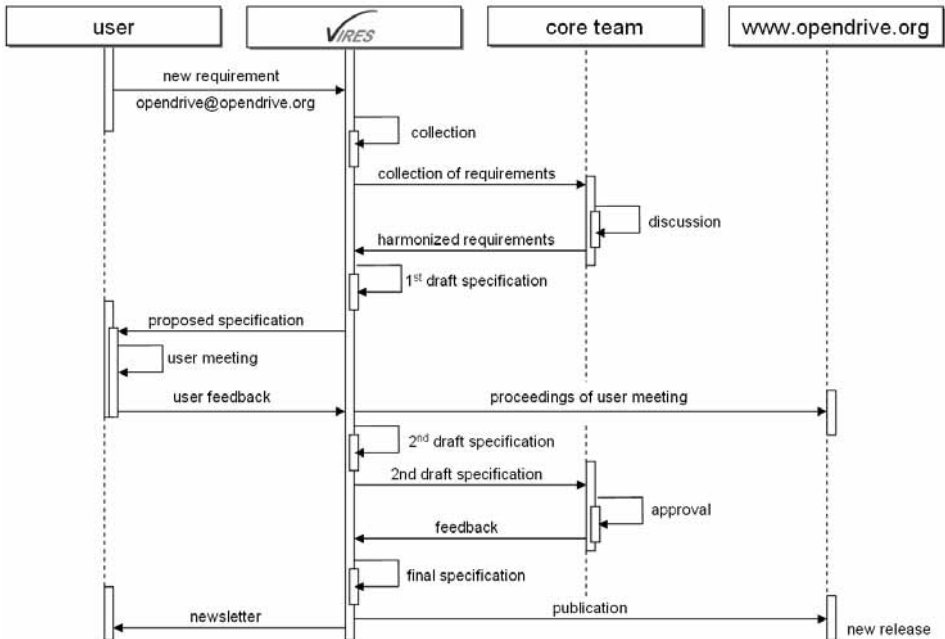
Meanwhile, OpenDRIVE has been in the market for more than four years and can definitely be called a de-facto standard. It is to be considered stable in terms of its design and the procedures of the on-going development process. The format is supported and used by a permanently growing user community worldwide.

## Status Report

### The OpenDRIVE Process

The OpenDRIVE project is managed by a core team of simulation professionals, all of them playing vital roles at research institutes, simulator manufacturers, software suppliers and simulator operators. The management of the core-team and the entire project itself is performed by VIRES.

The real force behind the project is the user base which provides a vast source of new requirements and constant feedback. The following figure illustrates the iterative process of permanently enhancing OpenDRIVE by means of these user inputs.



Proposals for the extension or modification of the format may be submitted by any (potential) user via "opendrive@opendrive.org". VIRES collects these proposals and forwards them to the core-team members for further discussion. Once enough inputs have been collected which justify a new revision of the format, a draft specification is issued which will then be discussed at an OpenDRIVE user meeting.

With the feedback from the user meeting, the specification will be further adapted and finally approved by the core-team members. The final version of the specification will be published on the OpenDRIVE website and users registered in the newsletter distribution list (via newsletter@opendrive.org) will be notified.

## The User Base

The user base of OpenDRIVE can be split into two major groups:

- *Direct users* will typically take care of writing, reading and/or evaluating OpenDRIVE data by means of their own tools. They interface with the OpenDRIVE XML files without any higher level software in-between.
- *Indirect users* are the ones whose simulator software components are also able to interface with OpenDRIVE data. However, the tools for doing so will usually have been written by a supplier who is, again, to be counted as direct user.

Both types of users enjoy the benefits of OpenDRIVE. Whereas formerly there were strong links between road network database customers and their respective suppliers due to the fact that both had to invest into adaptations of tools for proprietary formats, these links are now broken up and both – suppliers and customers – may re-group in an open market.

The total size of the OpenDRIVE user community is unknown since the format specification may be downloaded for free and without prior registration from the OpenDRIVE website. However, a list of users who are willing (and able) to show their support of both the format and the initiative in public is available via the OpenDRIVE website [4]. This list is steadily growing and for every published user there are a couple of others who have at least registered for the OpenDRIVE newsletter.

## Applications

Applications and tools complying with the OpenDRIVE standard are currently confirmed in the following areas:

- database generation
- traffic simulation (automotive and tram)
- vehicle dynamics
- driver assistance systems (e.g. navigation)

User reports presented at the OpenDRIVE meeting in January 2010 gave a good overview of recent developments and actual projects involving the OpenDRIVE data format. These are (among others):

- OpenDRIVE as meta-format for the fusion of navigation and elevation data from different data sources (various users)
- OpenDRIVE as input format for road database generation tools
- OpenDRIVE roads as basis for high quality 3d vehicle dynamics and for vehicle dynamics control systems

- OpenDRIVE as part of additional commercial products (e.g. veDYNA, Modelica)

Another positive message of this recent meeting is that OpenDRIVE is making its way into 3<sup>rd</sup> party applications without any commercial involvement of its “inventors”. Previous concerns that using OpenDRIVE would mean getting into some sort of dependency from key companies (i.e. at the beginning: from VIRES) have been proven wrong. What is more, a data format that is being used in a great variety of applications and by a broad range of users – most of them not commercially linked to each other, many even competing – can really claim to be a de-facto standard.

## Building on OpenDRIVE's Strength: Exchanging Databases

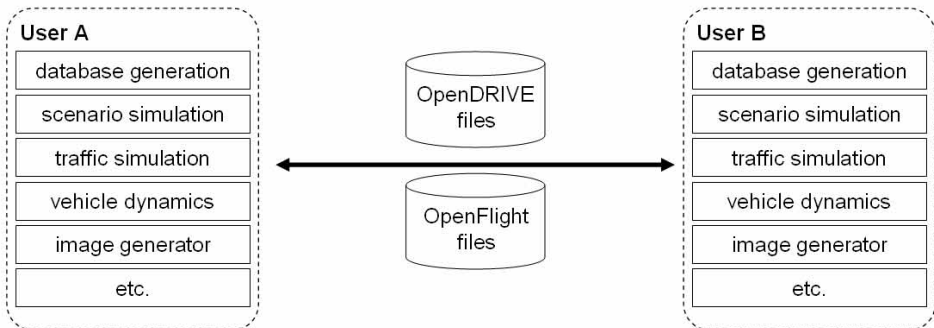
### Overview

With the introduction of OpenDRIVE, users have for the first time been able to exchange road networks between simulators which differ considerably in terms of their core components (framework, vehicle dynamics, traffic/scenario simulation, visual etc.).

Typically, these components are developed by the user or are provided by different suppliers. Therefore, requiring all parties to comply with the OpenDRIVE standard at the level of reading / writing the road network data is the key to the successful database exchange.

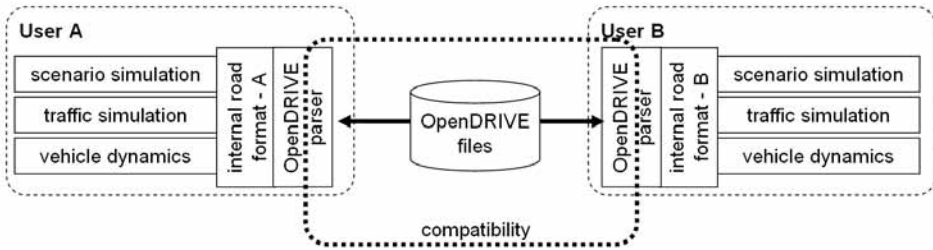
In addition, of course, also the data format of the visual database should be harmonized, but this is considered a minor issue here since quite a number of de-facto standards have been around for these data for a long time already.

The following figure illustrates the very simple interface between otherwise incompatible simulators.



The internal representation of the data within the components may comply with the OpenDRIVE format but is actually independent of OpenDRIVE. The users have to make sure that their file parsers translate the OpenDRIVE data correctly into the established data structures, so that the need for adaptation to

OpenDRIVE remains at a considerably low level (technically and in terms of workforce).



For the design of OpenDRIVE, this implies that the format has to provide all types of data required by the respective components. Therefore, the development process of OpenDRIVE itself has to rely primarily on the user requirements and feedback as noted above.

## BMW Group Research and Technology and Daimler – a Real Use-Case

One example which is to be considered as a proof of these concepts is the database exchange between BMW Group Research and Technology, Munich, and Daimler AG, Sindelfingen, both located in Germany. In 2009 these companies exchanged various databases for use in their respective simulators.

BMW Group Research and Technology had already switched to OpenDRIVE in 2006 because of the obvious advantages of this road description format which are: huge feature set, flexibility, community proven approach and last but not least the possibility to exchange databases with other users of OpenDRIVE.

### Key Concepts and Software Architecture

Both companies use a so-called tile concept. They compose their actual simulation databases - according to the test requirements - of a set of tiles which are drawn from extensive repositories.

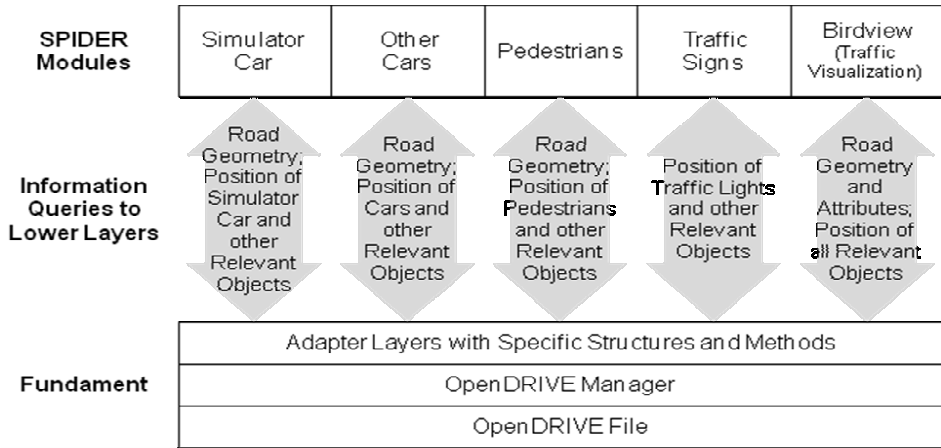
By exchanging tiles, both companies extended their repositories and still stuck to their workflow. Each new tile provided them with new opportunities for creating road networks. In addition, there was no need to disclose any additional information about the actual application of the databases since the composition of the tiles and, therefore, the driving task remains hidden from the other party.

BMW Group Research and Technology decided to switch to the tile concept in 2007. After years of using only complete databases for investigations at the simulators this concept was convincing in terms of flexibility. The databases are built now according to the design of the trials and not vice versa anymore.

The software components interacting with the OpenDRIVE information during run-time (i.e. vehicle dynamics, traffic/scenario etc.) are proprietary solutions developed in-house as well as applications delivered by suppliers. Both companies are using VIRES' OpenDRIVE Manager Real-Time Library for reading

and evaluating OpenDRIVE data. This also means that the subsequent processing of the OpenDRIVE information after reading the OpenDRIVE files may differ considerably.

The driving simulation software of BMW Group Research and Technology is called SPIDER [5]. The following figure shows SPIDER modules that use OpenDRIVE data for different reasons. Due to the fact that these modules can run on different computers each of them reads the OpenDRIVE file independently by means of the OpenDRIVE Manager mentioned above. After reading, most of the OpenDRIVE data are converted to internal data structures.



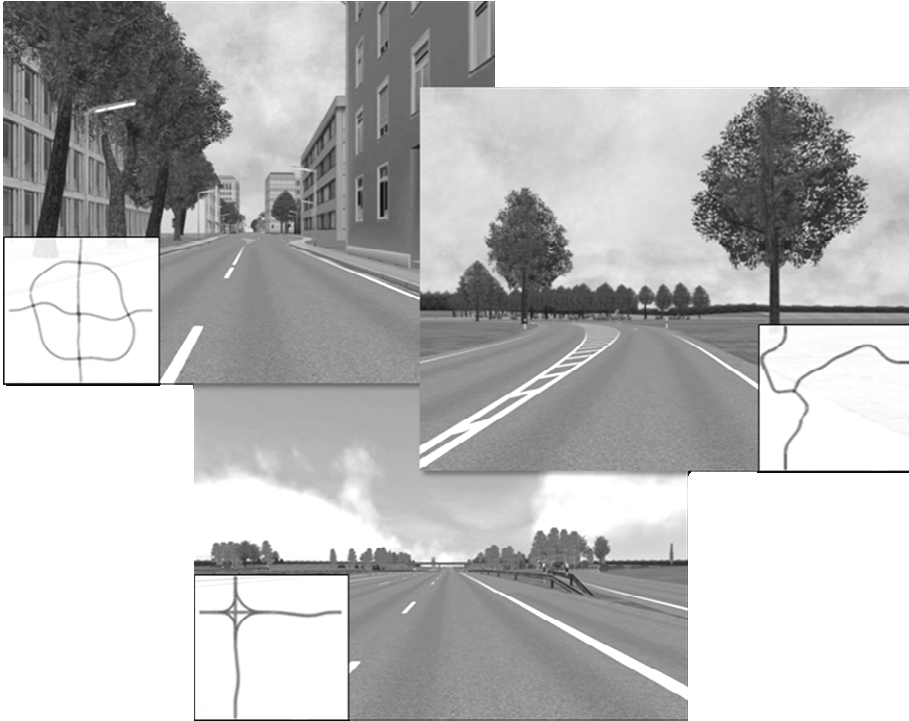
A similar structure of simulation software is used at the Daimler Driving Simulator, however all simulation modules using OpenDRIVE are running on the same simulation server.

### The Exchange in Detail

In detail the exchange of the database tiles between both companies proceeded like this:

- 1) Each company identified tiles that were available for the exchange.
- 2) These tiles were presented to the exchange partner.
- 3) Beside road design additional features like bus stops or zebra crossings were taken into account.
- 4) Each company selected those tiles of the exchange partner which were of most interest and listed them.
- 5) The out-coming lists were compared and an equivalent amount of tiles was identified on both sides.
- 6) The actual exchange of these tiles took place.
- 7) Site-specific modifications were done by each company to receive compatible database tiles without any loss of functionality.

In the figure below a general overview of the exchanged database parts is given. Some snapshots are shown with small insets illustrating the basic road design of the respective tile. Country road, motorway as well as city road tiles were exchanged. Among many others, special constructions like road crossings, highway exit and on-ramp, bus stops, speed bump, park lanes and zebra crossings were part of these tiles.



## Limitations and Conclusions

Concluding from the process described here, the database exchange really took place based on the strength of OpenDRIVE as a de facto standard open format.

One additional thing that has to be noted is that both companies use identical software for creating the databases, i.e. the OpenFlight and OpenDRIVE data. However, for the use case “exchange of road networks”, this does not imply any restrictions since the idea behind OpenDRIVE is to exchange the data based on the results of database generation tools.

During the database exchange the parties came to an important conclusion that has to be addressed: The OpenDRIVE format technically provides all necessary information for the road networks but this information may sometimes be provided in different ways.

In the actual case described here, one point was that traffic lights and signals in junctions may be positioned at various locations (e.g. on tracks leading to a junction or on connecting tracks within junctions). Both ways of positioning these



elements are correct in terms of the OpenDRIVE format but may lead to different interpretation within the respective traffic modules.

Furthermore there is a difference in the usage of OpenDRIVE controllers to group traffic lights. In the software of BMW Group Research and Technology any controllers are ignored because traffic lights are controlled separately via their ID.

From the point of view of BMW Group Research and Technology the exchange of database tiles with Daimler Driving Simulators was very beneficial because of the following reasons:

- 1) Database repositories of both BMW Group Research and Technology and Daimler Driving Simulators were extended by complementary tiles of the other company.
- 2) Namable costs only emerged from the site-specific adaption of the tiles.
- 3) The exchange was a technically uncomplicated procedure.

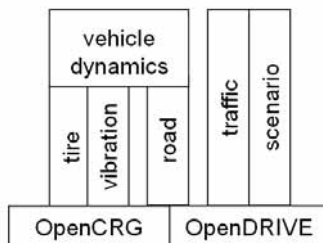
### Lessons Learned

There are two key lessons learned from the database exchange performed by BMW Group Research and Technology and Daimler Driving Simulators regarding OpenDRIVE:

- 1) OpenDRIVE enables users of substantially different simulation software to exchange road networks without major effort.
- 2) OpenDRIVE requires a “style guide” which complements the current technical format description and supports the design of road networks with maximum compatibility.

Having successfully proven the feasibility of exchanging mere road networks, the next challenge will be finding a way for the exchange of complete scenarios. This, however, implies considerably more complexity than the current task.

## From Logics to the Surface: OpenDRIVE and OpenCRG



OpenDRIVE has meanwhile been complemented by another open project, called “OpenCRG” [6]. Where OpenDRIVE concentrates on the macroscopic description of road networks in terms of logics, OpenCRG concentrates on the microscopic description of (selected) road surfaces e.g. for tire and vibration

simulation. The current OpenDRIVE format provides a means to refer to OpenCRG data from within a road network description, so that users may drive on an OpenDRIVE network and use OpenCRG surface descriptions at the same time.

The coherence between OpenDRIVE and OpenCRG data can be guaranteed in two ways: either by providing data along identical reference lines (so-called *genuine* mode, see [2]) or by mapping OpenCRG data along the OpenDRIVE reference line (*attached* mode). The typical use case will be the *attached* mode, for two reasons: first, it would require great effort to match OpenCRG and OpenDRIVE reference lines in *genuine* mode unless they were extracted from the same data source; second, OpenCRG surface data will typically be used for "enhancing" all or parts of OpenDRIVE roads with detailed surface information (e.g. rough road, potholes) not for replacing them.

This leads to a re-use of OpenCRG data sets (or patches) on various sections of a road network and also requires far less physical memory than would otherwise be required for an entire OpenCRG network (example: 10km of an OpenCRG cross-country road with 1cm resolution would require about 4GB of memory, compared with 400kB for a typical OpenDRIVE road of same length but without detailed surface information).

The OpenCRG project is similar in its structure to OpenDRIVE. It provides an open format, is maintained by a team of simulation professionals and involves actual users to a great extent. Beyond the current level of OpenDRIVE, OpenCRG is a full open source project, so that the users are provided with the data format, complemented by the tools necessary to create, modify, manage and evaluate the data.

## 2010 and Beyond: The Future of OpenDRIVE

### User Base

Only a diversified, heterogeneous user base will justify calling OpenDRIVE a de-facto standard. Therefore, efforts are made to further promote the initiative either directly at potential users or via conferences, exhibitions etc. Having established a quite respectable user base since starting from scratch four years ago, the task is now to build on this solid foundation and further "spread the word".

### Removing Barriers

Getting involved with OpenDRIVE currently requires a detailed understanding of the format specification and writing some software for the actual data import and/or export. Commercial tools are available (e.g. by VIREs) but emphasizing the term "open" in OpenDRIVE will be one of the goals of the near future.

This goal shall be achieved by adding more examples to the ones already available via the OpenDRIVE website, complemented by a "style guide" and by providing some pieces of free and – at least partially – open source software.

## The Way to a Formal Standardization

Good ideas spread. So, it's no wonder that as recently as 2009 other initiatives came up to seek what OpenDRIVE had already achieved. For OpenDRIVE– if it wants to stick to its initial aim of providing a common base for the exchange of road networks and if it wants to keep the leading role – this means that the dialog with new initiatives is mandatory.

If multiple initiatives exist for the same subject, it might well make sense to think about bringing them together in order to go all the way to a formal standardization on e.g. European level. This would give the users the certainty of a “real” standard and would also help reaching more users who might today still be (over-) cautious when it comes to making a decision for a road network data format.

With these thoughts in mind, the last OpenDRIVE user group meeting decided to take a closer look at another road data format proposed by a single supplier and to investigate possibilities of further co-operation in terms of formal standardization.

Whatever the outcome of the investigation, which is due to take place until mid 2010 (i.e. after committing the final version of this paper) and which will include an in-depth comparison of technical details of both formats, the following statements of the OpenDRIVE initiative will remain valid:

1. **OpenDRIVE is strong:** its user base is large and growing; OpenDRIVE is supported by the key players in driving simulation; it does not depend on a single supplier; it has been implemented independently by various users.
2. **The users come first:** any decision for the future direction of OpenDRIVE and/or a formal standard must be based on a thorough assessment of the impact on current users; only the solution with minimum overall impact will be acceptable.
3. **Building on OpenDRIVE today is not at risk:** if there was a tbd. format in future, the OpenDRIVE initiative would make sure that migrating from OpenDRIVE to this format would be strongly supported by free software packages.
4. **OpenDRIVE will not** accept any standard of less quality and usability than what is available today.

Beside these arguments, a formal standardization is a long-term process and the OpenDRIVE initiative will remain in place and proceed with no less effort than in the past for the foreseeable future. So, for the distant future, expect either a formal standard with strong involvement of OpenDRIVE, or...OpenDRIVE!

## Bibliography

- [1] Dupuis, M., Grezlikowski, H., (2006) OpenDRIVE – An Open Standard for the Description of Roads in Driving Simulations, M. Dupuis, *Proceedings of the Driving Simulation Conference DSC Europe 2006*, 25-35

- [2] <http://www.opendrive.org/docs/OpenDRIVEFormatSpecRev1.2A.pdf> – OpenDRIVE format specification, VIRES Simulationstechnologie GmbH, *project website 2010*
- [3] <http://www.presagis.com/products/standards/openflight>, Presagis, *company website 2010*
- [4] <http://www.opendrive.org/users.htm>, VIRES Simulationstechnologie GmbH, *project website 2010*
- [5] Huesmann, A., Ehmanns, D., Wisselmann, D., (2006) Development of ADAS by Means of Driving Simulation, *Proceedings of the Driving Simulation Conference DSC Europe 2006*, 131-141
- [6] <http://www.opencrg.org>, VIRES Simulationstechnologie GmbH, *project website 2010*

# Truck Simulator an Instrument for Research and Training

Gianfranco Fancello<sup>a</sup>, Agostino Bruzzone<sup>b</sup>, Maria Grazia Carta<sup>a</sup>, Enrico Bocca<sup>c</sup>, Alberto Tremori<sup>d</sup>, Paolo Fadda<sup>a</sup>

<sup>a</sup> CIREM, University of Cagliari Via Marengo 2, 09127, Cagliari

<sup>b</sup> MISS, Genoa Center via Colombo 68/3 17019 Varazze (SV)

<sup>c</sup> Simulation Team – Laboratory of Logistics - Savona Campus

<sup>d</sup> MAST Srl, Districtpark Tower, P.za Lerda1. 16158 Genoa  
fancello@unica.it, agostino@itim.unige.it, mgcarta@unica.it,  
enrico.bocca@simulationteam.com, alberto.tremori@mastsrl.eu,  
fadda@unica.it,

**Abstract** – *This paper describes the real-time distributed truck simulator developed by University of Cagliari and Genoa. The simulator has been designed and constructed for realizing research about active safety in driving using a physical simulation model. The different situations which involve during driving want to be necessary reproduced with use of simulator. This work describes the main features and components of the simulator, a transportable containerized facility provided with a 6 degrees-of-freedom motion platform. The simulator has been designed to provide a full immersion environment for high performance training, but also and above all for basic and applied research, monitoring and analyzing operator performance by means of electromedical instruments. The specific activities conducted with the truck simulator (training, research, technological advance) aim to reduce the possibility of accident occurrence, which are largely caused by the onset of fatigue. A research simulator as driving simulation to develop many protocols in active safety for sizing fatigue in different context. One of the main objectives of the research in interaction between man-machine is about conditions that caused in man an overload or under-load of work that must produce a reduction quality of the performance. In European and international sphere many researchers have regarded fatigue and influence in quality of driving, many of these are based on using of driving simulator, other studies “naturalistic” contemplate the use of many equipments inside the same vehicle.*

## Introduction

One of the main objectives of the research in man-machine interaction is about conditions that caused an overload or under load of work that must produce a reduction of the performance quality.

The causal factors of accidents in transportation systems can be commonly divided into human, technical and environmental. Human error can be the result of improper task and/or equipment design and ineffective training.

The major contributory factors for reducing accident occurrence are enhanced operator skill development, including periodic refresher training to maintain high truck operators' efficiency, and also performance studies and assessment.

However, actual task performance and fatigue analysis implies some difficulties, that combined with the challenges of virtual reality training, prompted the idea to set up a simulator that was able to record and to analyse performance curves in a virtual environment.

This simulator is also studied to work "on-line" with the "ship to shore gantry crane simulator" of the University of Cagliari (Bruzzone *et al.*, 2008), in the harbour context.

## **Background and State of Art**

Fatigue and in general impaired performance, is as a significant factor in occurring of accidents in transport systems (Fadda 1984a).

Past research conducted on human fatigue prevention has focused on physiological mechanism and methods for measuring fatigue levels (Sherry 2000; Czeisler 1995; Ji, Lan, and Looney 2002). The most common physiological measurements for determining the extent and length of reduced alertness, that are considered as an indicator of increased fatigue and/or drowsiness, make use of the electroencephalogram (EEG) (Lal and Criag 2002). A training manual prepared by the Transportation Development Centre of Canada in November 2002, provides guidelines for analysing fatigue, drowsiness and the resulting performance deterioration of Canadian navy personnel, combining EEG, EOG (eye movement), ECG (heartbeat) and EMG (muscle tone). Behavioural measurements are used for gauging fatigue and are based on frequency of the body movements: the number of movements recorded during task performance over a specific time interval is significantly correlated with the EEG (Bruzzone 1996b).

Fatigue can also be detected observing facial behaviour: changes of facial expression, eye and head movements and gaze are all indicators of fatigue.

As can be observed from the scientific literature no significant in-depth studies have been conducted concerning port operations, specifically truck trailer drivers.

Philip *et al.* (2007) have studied effects on fatigue drivers using driver simulator, the aim of this study was to identify risk factors for performance decadence. Drivers' accidents were the principal cause of death in the modern society and fatigue condition is indicated as the most critical factors.

Test realized with computerized analysis were directed to verify the deviation trajectory from ideal during driving. The software calculates the mean deviation from the centre of the road and the standard deviation of this difference. This standard deviation from the centre of the road (SDS) is one of the studied variables.

Standard deviation of the car steering error from the ideal curve (SDC) is another measure, which represents the ability of the driver in following perfectly the curve with the car. The time taken to identify and respond to the digits, called "reaction time" is measured from the presentation of the digit to the driver's screen display after the signal received from the button. Drivers performed significantly worse than controls on the driving simulator. The main factor affected was the standard deviation steering error from the ideal curve. Many of our vacation drivers had driven for long times with acute sleep loss. The differences observed between drivers and matched controls confirm that fatigue affects long-distance drivers. Sleep debt and none of the variables related to sleep duration influence the regression confirms findings obtained using reaction time tests. There again, duration of driving was the major determinant for performance decrement. Finally, long duration of driving was associated with sleep restriction and cumulative factors may play a role in covering the effects of sleep deprivation, as this factor was almost never observed "alone" in our drivers.

Hanowski *et al.* (2007) have underlined that drivers of commercial vehicles get an average of 5.18 sleep hours per night. The revised hours-of-service (HOS) regulations (in the United States) will provide drivers more opportunities to get sleep. Driver's impairment due to drowsiness is known to be a major contributing factor in many crashes involving commercial-vehicle drivers. Another goal of this research was to assess the association of sleep duration and involvement in critical incidents, including crashes, near-crashes, and crash-relevant conflicts.

Fatigue and sleep deprivation are important factors in the transport industry, fatigue involves loss of attention and decreases individual ability of driving in safety and upgrades risks of human error that can take to fatalities and accidents. Sleepiness delays time of reaction decreases awareness of the judgment. Weakening dues by somnolence is a relevant factor of the involvement in accident with truck vehicles. Trucks drivers' average sleep is good described in literature. Mitler *et al.* (1997) have assessed for commercial driver an average of 5.18 h/day of sleep (during 24 hours) and 4.78 h of sleep electrophysiological verified. The study was conducted during a period of 5 days and has included 4 different scales of driving. To define total amount of sleep it was used an instruments called "actigraph". On sixty-two drivers they have less than seven consecutive days of data (Monday-Sunday), average amount of sleep per day was 6.28 h. They have registered fifty-eight serious accident in the tenth and eleventh hour of driving and analysis results have indicated, besides, as before a serious accident, have a significantly rest less than usually.

In the April 2003 the Federal Motor Carrier Safety Administration (FMCSA) published a revised set of regulations concerning the HOS of commercial-vehicle drivers. These regulations were amended on 30 September 2003 and implemented on 4 January 2004. One central component to the revision was a two hours extension of off-duty time from 8 to 10 h. In this regulation were defined additional 2 h off-duty time which would provide drivers more opportunity to obtain restorative sleep. An additional two off-duty hours were included in the 2003 HOS regulations, but there has been no research conducted to determine if drivers would use those extra hours to sleep. Determining the quantity of sleep that drivers are receiving under the revised regulations was one goal of this study.

A second goal of this research was to assess the association of sleep quantity and involvement in critical incidents, including crashes, near-crashes, and crash-relevant conflicts. This study resulted in an important finding with regard to the revised 2003 HOS regulations. In comparing the mean sleep quantity of drivers in the current study to previously collected data, it appears that drivers may be getting more sleep under the revised HOS regulations.

Long distance driving can be very fatiguing, the task requires long periods of alertness and attention which make considerable demands of the worker. Ample evidence exists to demonstrate that performance deteriorates over time, particularly when the task is monotonous as is the case with driving. Driver errors increase with driving time and performance worsening can be evident after 3 hours of the beginning of the trip. Furthermore, accident risk also increases with driving time.

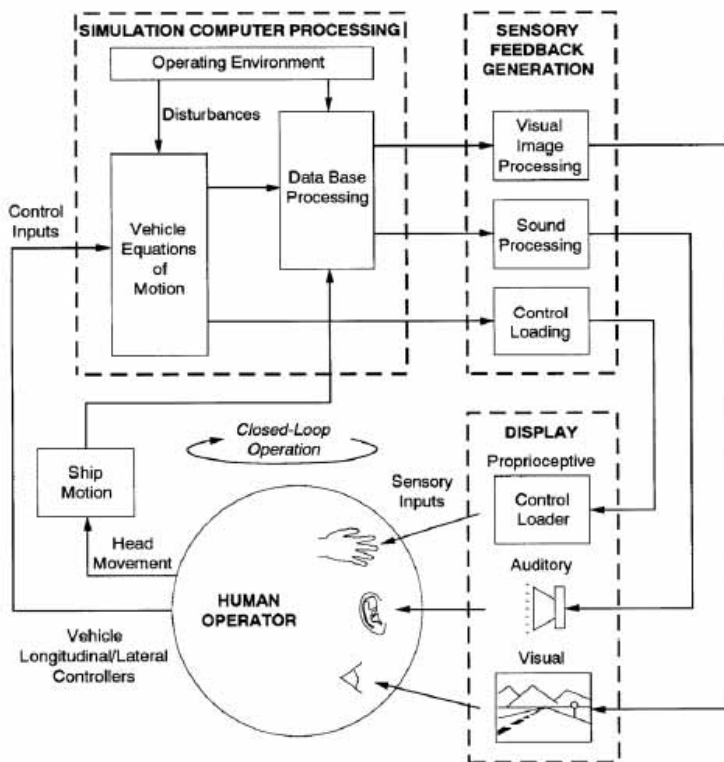
One of the major obstacles to the better management of driver fatigue during long distance in road transport industry can be a lack of practical assessment of the problem which occurs in the industry. The purpose of the present project is to identify possible strategies to manage driver fatigue in the long distance road transport industry in Australia. In the first part of the project, 960 truck drivers were surveyed (Williamson *et al.*, 1992). The results suggested that shorter trips and greater flexibility in arranging the timing and scheduling of trips were related to lower levels of reported fatigue (Feyer and Williamson, 1992; Williamson *et al.*, 1992). When drivers had more flexibility they were more likely to take their rest breaks to coincide with periods of fatigue, and to avoid starting their trips in the early hours of the morning. Drivers who did not have such flexibility but have familiarity with shorter trips also appeared to fare better than drivers who had neither flexibility nor shorter working hours. These findings underscored that operational factors other than working hours are also important in determining the experience of fatigue among truck drivers.

This study was directed towards collecting information about the experience of driver fatigue in the passenger sector. In particular, the relationship between aspects of operational practice and driver fatigue in the long distance coach industry was investigated. Most express drivers (82.5%) were employees of large companies with more than 50 buses. Overall, details of the last long distance trip revealed that express bus drivers covered an average of 1479.5 kilometres (SD = 1576.8) with a mean trip duration of 28.4 hours (SD = 32.6). Virtually all drivers had their trips scheduled for them. Close to one third of the drivers (29%) started their trips in the night hours, between 6.00 p.m. and 6.00 a.m. More than three quarters of the drivers reported that the last trip was typical of trips that they do. Overall, the majority of express drivers did not report fatigue as a major problem for them (20.6%), although 53% reported experiencing fatigue at least occasionally. By far the most common time of day drivers reported experiencing fatigue was between midnight and 6.00 a.m., with approximately half of drivers (50.6%) reporting fatigue as typically occurring at this time. There was consistency, too, in the effects of fatigue: the majority of drivers reported that their driving was adversely affected by fatigue (71.7%), with slowed reactions (78.2%) being the most common outcome reported.



Simulation can play a key role in vehicle design and training, and is more likely to be applied as fidelity increases and cost decreases (Bruzzone *et al.*1997).

A study of Systems Technology, Inc, California investigates in using of "low cost simulation" for research in safety, prototyping and training. Improvements in crash avoidance through vehicle design require methods for prototyping new equipment and exposing drivers to new designs. The central thesis of this study is that low cost PC and related technology can be used to reproduce realistic sensory feedback to the human operator in safety critical driving simulations (Bruzzone *et al.*1997). Processors, display accelerator chips and cards and operating system software advancements over the last few years permit the presentation of virtual environments that can quite adequately simulate visual, auditory and proprioceptive cueing involved in vehicle operation tasks. Furthermore, the feedback can be provided with adequate update rates and minimal transport delays required for simulating the psychomotor and cognitive tasks typically involved in driving in complex environments (Fig. 1).



**Figure 1. Basic Processing Requirements for vehicle operation Simulation**

The visual modality is the most important since it allows the operator to compare the vehicle's path with a desired path in the environment and make appropriate corrections. Proprioceptive feedback can provide added information about the magnitude of control inputs. Auditory feedback can provide some additional information about the aggressiveness of vehicle maneuvering and possible situation awareness.

The sensory feedbacks must reach the operator in a timely fashion, after allowing for delay by the simulation computer processing and sensory feedback generation.

Issues associated with the primary cueing modalities are as follows:

- Proprioceptive (control loading) information must be returned to the human operator at the highest rate and lowest time delay of any sensory feedback in order to give realistic feel characteristics (e.g. Young, 1982). If proprioceptive cueing is dependent on simulation computer processing, update rates of hundreds of times a second with transport delays on the order of a few milliseconds are important here in order to give realistic feel.
- Visual information must be returned to the human operator in less than 100 milliseconds with update motions on the order of 30 Hz or greater to give the appearance of smooth motion (e.g. movie frame rates are 24 Hz). Input sampling and processing can give delays on the order of 2 ½ frames, which result in transport delays of less than 100 milliseconds. Transport delay compensation can also be used to offset the effects of computation delay (Hogema, 1997). Resolution and quality of the visual display must be adequate for the required visual discrimination tasks. It is difficult to achieve resolutions below a few minutes of visual arc with low cost image generators and displays, so high acuity real-world tasks such as highway sign reading are difficult to simulate.
- Motion feedback must correlate closely with visual simulation, so must be returned with a similar time delay (e.g., Allen, Hogue, *et al*, 1991 App. E). Practical, low cost platforms severely restrict motion, and so cueing algorithms have been developed to approximate the cues sensed by the human operator in the real world (e.g., Allen, Hogue, *et al*, 1991 App. F).
- Auditory feedback has the least severe requirement for transport delay, with hundreds of milliseconds probably being acceptable. The frequency content or bandwidth of the auditory stimulus must match the human ear (on the order of 15 KHz), however, in order to produce sounds that are natural and recognizable. Doppler and stereo effects may be of importance in various driving scenarios.

Successful simulation development should include some validation procedures to verify the above response requirements and to ensure correct software implementation (Bruzzone, Kerchoffs 1996a). Validation can include engineering methods applied to various simulator response characteristics (e.g., Allen, Mitchell, *et al.*, 1991; Allen, Rosenthal, *et al.*, 1992; Heydinger, Garrott, *et al.*, 1990). The validation procedures should be designed to verify software coding and the adequate responsiveness of the various cueing dimensions.

Fatigue and impaired performance in general, is regarded as a significant factor in the majority of accidents occurring in transport systems (Fadda 1984).

Past research conducted on human fatigue prevention has focused on both the physiological mechanism and on methods for measuring fatigue levels (Sherry 2000; Czeisler 1995; Ji *et al.* 2002). The most common physiological measurements for determining the extent and length of reduced alertness,

considered as an indicator of increased fatigue and/or drowsiness, employ the electroencephalogram (EEG) (Lal and Criag 2002). A training manual prepared by the Transportation Development Centre of Canada in November 2002, provides guidelines for analyzing fatigue, drowsiness and the resulting performance deterioration of Canadian navy personnel, combining EEG, EOG (eye movement), ECG (heartbeat) and EMG (muscle tone). Behavioral measurements, that have gained credibility recently, are used to gauge fatigue and are based on the frequency of body movements: the number of movements recorded during task performance over a specific time interval is significantly correlated with the EEG (Bruzzone 1996b).

Fatigue can also be readily detected by observing facial behavior: changes of facial expression, eye and head movements, and gaze are all indicators of fatigue.

As can be observed from the state of the art review no significant in-depth studies have been conducted concerning port operations, specifically truck trailer drivers.

## **General description and universal features of simulator**

Like existing training simulators, the truck simulator comprises five main components:

1. Driver cab interface (cockpit): a faithful replica of the truck operator workstation. It is generally fixed to a motion platform, with 2, 3, 4 or 6 degrees of freedom (DOF) depending on load capacity that not only imparts visual and sound stimuli to the operator, but also stimulates sensations of movement. The platform is supported by actuators placed underneath the cab that move the cab in response both to user input and to the tasks performed. The motion system simulates the vibrations and collisions that occur in real operating conditions;
2. Instructor workstation interface: outside the operator cab, it is equipped with special monitors for following the exercise in real time. The instructor can:
  - create innumerable simulation scenarios, in all climatic conditions (wind, rain, sun etc.) and at all times of day (daytime with natural light, night-time with artificial lighting) and for any boundary condition;
  - make trainees repeat a test in the same conditions, in the event he has not performed well in a particular scenario, and can analyze a posteriori any errors made;
  - move on to higher level training, gradually introducing more demanding scenarios as the trainees gradually enhance their skills.
3. Visual display system: recreates through a projection screen the same environment that the operator would actually experience;

4. Audio System: recreates the sound effects generated by vibrations (cab moving during gantry travel), collisions, wind noise;
5. Central operating system: the simulator "brain", controls operations and executes different simulation scenarios (Fig.2).

The innovative conception of this simulator is the portability of the instrument, the simulator inside a container 40' High Cube is easily to transport and to move for training or research scope.



**Figure 2. Simulation Graphic Interface and interactive Board integrated during debriefing activities**

## **Operator fatigue and performance measurements in physical task simulators**

Simulators are increasingly used for researching human factors in transport as these devices allow reproducing and evaluating, also singly, all those factors contributing to fatigue. In a study conducted at the Northeastern University of Boston (Yang, Jaeger, and Mourant 2006) the behavior of 12 novice and 12 experienced drivers, recorded during three right-to-left lane change scenarios was investigated. Each lane change involved:

1. A preparatory period;
2. The actual steering maneuvers from right to left;
3. A post lane change period, accomplished maintaining a specific speed.

Novice drivers were found to be less secure than experienced drivers, showing significantly more variance in lane position during the preparatory and post-lane change phases. They also spent less time looking at the speedometer and mirrors.

The findings of this study suggest that virtual reality driving simulators may be a useful aid for improving novice driver skills in maneuvers such as lane changes.

One particularly interesting area of human factors is the determination of the visual field using specific devices that identify and record operator gaze points during a work cycle. These applications aim to study the field of vision and the information required by the operator to cope with changing conditions, to determine whether any distracter signals exist that alter perception time and consequently the ability to make the right decision.

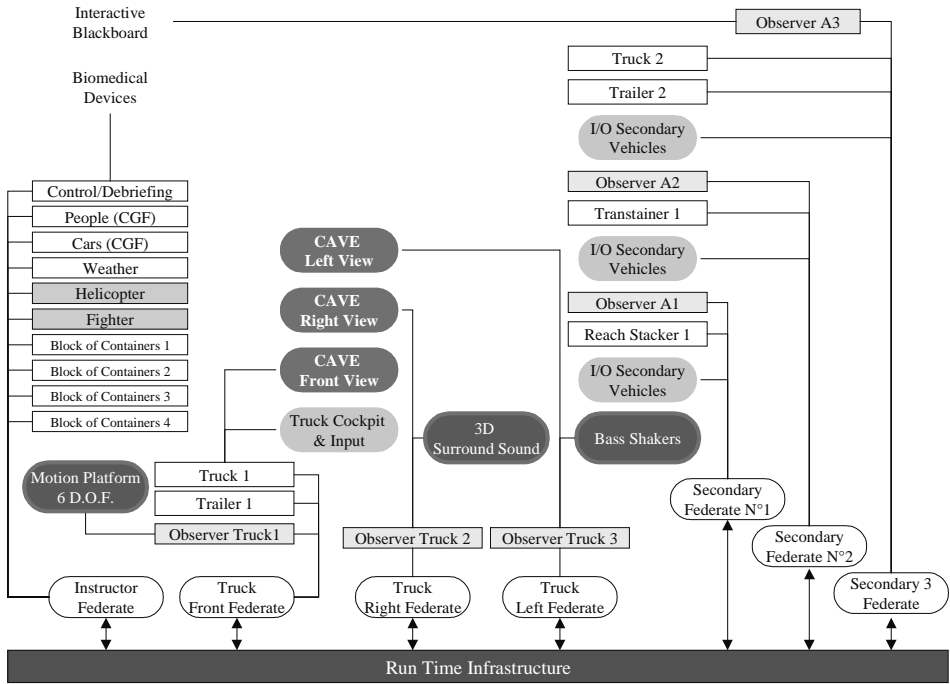
The majority of driving simulators (for example the Drive Safety Simulator at the North Dakota State University) are equipped with an oculometer, a gaze tracker that records fixations points and saccades - from the pupil. In addition, with this device it is possible to evaluate, for example, whether any objects outside the field of vision create sources of distraction, thus impairing performance.

Recent studies conducted by the Universities of Taiwan and San Diego on the assessment of driver performance interpreting EEGs using fuzzy neural networks (Wu, Lin, Liang, and Huang 2004), have shown that accidents caused by sleepy drivers involve a high percentage of fatalities due to a marked impairment in driver ability to control the vehicle; this techniques provide interesting opportunities for being integrated with simulation as already experience by the authors (Giribone, Bruzzone 1995)

## **Simulation architecture**

The development of a truck simulator requires considering all the internal (i.e. engine, suspensions, controls, trailer) and external components (i.e. traffic, environment, road infrastructure) (Bruzzone *et al.*, 2007); the authors are very interested in creating even scenarios that involve multiple vehicle interactions (Bruzzone *et al.*, 2004b). A classical example is provided by in-land or port terminals where the trucks have to interact with cranes and other devices (Bruzzone *et al.*, 1998c). It is evident that the ability to work by this approach strongly enhance the capabilities of the simulator (Bruzzone *et al.*, 1998b); due to these reason the authors decided to adopt an architecture capable to support extensively the interoperability concept (Bruzzone, Giribone 1998); by this approach it is possible to integrate different simulators and to let them to interact dynamically (Bruzzone *et al.*, 2003b); in this case the proposed architecture is presented in the scheme (Fig. 3).

The conceptual model include several objects in addition to trucks and trailers in harbor context, such as bridge cranes, transtainers, reachstackers, People, Cars; several objects are driven by intelligent agents similar to Computer Generated Forces (CGF) and in particular the people and the other cars.



**Figure 3. Example of Simulator Architecture**

The hierarchical structure of the objects integrated in the truck federation is compliant with HLA (1516 IEEE Standard) so the system developed, defined ST\_RT\_1 (Simulation Team, Riding Truck One), resulted as an interoperable real time simulator (Bruzzone *et al.*, 2003a); ST\_RT\_1 operates over a WAN and integrates the different simulators (federates), while object ownership is attributed to the different federates based on the desired configuration and operations dynamics. In fact based on this architecture, ST\_RT\_1 allows a wide range of configurations and operative applications; however it is possible to operate in standing alone mode, obviously with limitation on the I/O (input Output), while the federation allows to control all the different dedicated hardware solution.

The simulator is implemented in C++ for Windows XP™ operating systems; the hardware is based on a set of last generation workstation, while the I/O includes CAVE, motion platform six degree of freedom, truck cockpit, truck driving wheels, etc.

The ST\_RT\_1 support a quick dynamic reconfiguration of each workstation in order to reallocate the equipment and to create different scenarios; obviously this is in some way limited by the availability of proper hardware device on a PC Workstation for driving/operating a specific vehicle.

The key concept for the implementation solution was to fix a full scope simulator (Cave Motion Platform Cockpit, realistic devices) and to set up an instructor position as well as secondary federates devoted to direct other vehicles interacting with the main simulator; in fact the proposed approach allows to install the secondary federate on simple PC/Laptop and to operate in driving other

vehicles or handling device even by using just simple game devices (joysticks, driving wheels) (Bruzzone *et al.*, 2006b).

This approach enables the possibility to create large federation with many secondary operators for analysis or training in complex cooperative scenarios (Bruzzone *et al.* 2004a); in addition it is even possible to activate competitive scenarios where different teams are working concurrently. The architecture was developed in order to support several operative modes such as:

- ST\_RT\_1 supports practice in different scenarios. The operators can virtually works in the same virtual world where different activities and tasks are carried out simultaneously. Several objects can be driven by the intelligent agents directed by the computer
- Control/Debriefing object allows the instructor to control all the boundary conditions during exercises so obviously the trainer control environmental conditions such as rain, fog, wind etc. In addition it is possible to analyze and proceed in debriefing of past operation on-line, while the main simulation is still running, and to jump back to the real-time operation based on instructor control. This represents a pretty innovative approach moving from traditional AAR (After Action Review) to OLR (On-Line Review).

## **Simulator infrastructure for ST\_RT\_1 simulator**

The first implementation of ST\_RT\_1 was installed on a shelter based on a 40 feet high cube container to guarantee maximum mobility to this infrastructure; this solution, tailored for Cagliari needs, include the configuration of the simulation architecture presented in Figure 2 and the following layout of the shelter:

### **Full Scope Simulator**

- Cockpit and Truck Controls
- Driver Seat
- Motion Platform
- Bass Shakers
- 3D Surroundings Sound
- Cave (horizontal amplitude 270°Degrees)
- Camera and intercom for controlling the activities
- Biomedical devices
- Workstation Rack
- UPS
- Transformers

### **Instructor Module**

- Instructor Workstation
- Driving Devices to take control of vehicles, aircrafts or cranes (joysticks, driving wheels, etc.)
- Direct View of Full Scope Truck Front Federate
- Intercom

### **Didactic Area**

- 3 Secondary Federates running on laptops
- Driving Devices to take control of vehicles, aircrafts or cranes (joysticks, driving wheels, etc.)
- Interactive blackboard directed connect to Control/Debriefing Unit or to secondary federates
- Camera for controlling the activities
- Intercom

### **External Connections**

- VGA Connection to Control/Debriefing Unit
- External WAN Connection (Ethernet for Internet activities)
- External LAN Connection for sub-net management

The motion platform as well as the cockpit was prototyped in order to match with the shelter space constraints (Bruzzone *et al.*, 2006a).

The solution proposed is open to both local connection with other simulators such ST\_PT\_1 or with external additional secondary federates (Bruzzone *et al.*, 2008); in addition the ST\_RT\_1 is enable to connect trough the web with other position for blended education and wide area distributed simulation (Bruzzone *et al.*, 1999).

The shelter is equipped with UPS and Transformers in order to be able to operate worldwide with different power supplies.

## **Electromedical instruments and analysis strategies for basic and applied research**

The medical instruments provided for research activities comprise:

- Eye tracker (oculometer), as repeatedly mentioned visibility is a human factor of key importance in driving tasks;
- Integrated polygraph, that allows to record simultaneously EEG, ECG, EMG as well as other parameters specific of drivers tasks;
- Flicker Fusion Unit: for conducting the FLIM test for performance assessment (memory, alertness, speed of reaction).

The research strategy for analyzing visual activities of operators undergoing simulator training will consist in analyzing visual behavior, measuring, using specific analytic tools (Camilli *et al.*, 2007) or trial analysis, "look zones", fixation points and saccades, in other words the movement between consecutive fixation points (once fixation times/points are known the saccades can be easily detected).

A device for determining muscle tone (EMG test) will also be installed. The system comprises electrodes attached to the body parts to be monitored (neck and back). The electrodes record, display and amplify local nerve response to electrical stimulation and detect muscle anomalies and disorders in particular work postures, providing a measure of operator physical performance (Fig. 4).





**Figure 4. Eye Tracker instrument and some results and ME6000 Polygraph and some applications**

Another electromedical instrument is the FLIM unit that provides a measure of central-nervous system activation (arousal) and of the level of performance (memory, attention, reaction time).

The particular simulation architecture of ST\_RT\_1 truck simulator (HLA federation), allows for the inclusion of electromedical equipment as federates. The simulation system provides advanced synchronization functionality ensuring that the psychophysical fatigue measurement systems can be combined with simulated time evolution. The debriefing system matches the operating phases with those portions of the electromedical plots whose spectra coincide with fatigue phases. A model such as a neural network (NN) model will be used for reading and interpreting the complex data based on previous researches (Mosca *et al.*, 1996, Giribone *et al.*, 1998).

In this sense it will be possible to construct performance curves on the simulator along the same lines as for field measurements.

## Conclusions

This paper wants to present the truck simulator created by University of Cagliari and Genoa which will become an instrument for research and training. The purpose of this simulator is to create an instrument set to measure drivers/operator fatigue during his task. The special architecture allows reproducing many particular situations as harbor movements estimated between the most potential dangerous for truck drivers. The versatility of this instrument will allow representing different scenes of driving.

Thus research and training activities conducted with the simulator will be of key importance. Training and refresher courses for drivers that use truck simulator are important for two reasons::in economic terms the proceeds from training package sales to terminal operators will be used to fund research activities. Therefore management strategies need to be created for competitive advantage, offering up-to-date training packages at attractive prices. In this sense one strong point of the truck simulator is its transportability. The infrastructure will make it possible to carry out integrated task training, by means of remote experimentation and tests coordinated by an efficient multimedia network. The integrated training program also envisages the construction of a container trolley simulator. In addition the proposed approach guarantee the possibility reuse and

further develop for the simulator new application areas such as operative and safety policy design, re-engineering and validation, terminal analysis and control etc.

**Keyword:** Truck Simulator, 6 DOF Motion Platforms, Electromedical Instruments for Performance and Fatigue Assessment.

## **Bibliography**

- Allen, R.W., Hogue, J.R., *et al.* (1991)., *National Advanced Driving Simulator (NADS) Requirement Study, Systems Technology, Inc., TR-1256-2;*
- Allen, R.W., Mitchell, D.G., *et al.*, (1991) Validation of Real-Time Man-In-The-Loop Simulations, *Strategic Highway Research Program (SHRP) and Traffic Safety on Two Continents, Gothenburg, Sweden, Sept. 21-24;*
- Allen R.W., Rosenthal T.J., Aponso B.L.,(1998) Low cost simulation for safety research, prototyping and training, *System Technologies, Inc, Presented at the International Technical Conference on the Enhanced Safety of Vehicles (ESV);*
- Bruzzone A.G., Kerckhoffs (1996a), Simulation in Industry, *DIPTTEM Press, Genoa, Vol. I & II, ISBN 1-56555-099-4;*
- Bruzzone A.G. (1996b), Smart Integrated Interface for Evaluating and Supporting Human Performances, *ESPRIT Information Technology: Basic Research Working Group 8467 Simulation for the Future: New Concepts, Tools and Application (SiE-WG), Bruxelles;*
- Bruzzone A.G., M.E., Cotta G., Cerruto M.(1997), Simulation & Virtual Reality To Support The Design Of Safety Procedures In Harbour Environments, *Proceedings of ITEC97, Lausanne (CH);*
- Bruzzone A.G., Bocca E., Longo F., Massei M. (2007), Logistics Node Design and Control over the Whole Life Cycle based on Web Based Simulation, *International Journal of Internet Manufacturing and Services, Vol. 1, Issue 1,pp. 32-50;*
- Bruzzone A.G., S.Poggi, E.Bocca (2008), Framework For Interoperable Operations In Port Facilities, *Proceedings of ECMS2008, June 3rd - 6th, Nicosia, Cyprus;*
- Camilli, M., Nicchia, R., Terenzi, M. and Di Nocera F., (2007), Development of A Simple Tool for Examining Fixations, *Fifth Symposium on Human-Computer Interaction, June 28-30, University of Padua, Department of General Psychology;*
- Czeisler, C.A., (1995), Lecture on fatigue, *Fatigue Symp. Proc.. Tyson Corners, VA: Nat. Transportation Safety Board and NASA Ames Res. Center;*
- Daniel, J., Fabry, R. and Fickova, E., (1985), Changes in activation level during circadian rhythm in shift workers, *Studia Psychologica, 27, pp. 211-217;*

- Dingus, T.A., Neale, V.L., Garness, S.A., Hanowski, R.J., Keisler *et al.*, (2002) Impact of sleeper berth usage on driver fatigue: Final project report, Contract No. DTFH61-96- 00068. U.S. Department of Transportation, Federal Motor Carriers Safety Administration, Washington, DC;
- Fadda, P., (1984), Biomeccanica e Antropometria. In Introduzione al fattore "uomo" nella fenomenologia dei trasporti, *L'Aquila University, Italy: 7-10 (in Italian)*;
- Giribone P. & A.G. Bruzzone (1995), Neural Networks And Fuzzy Control For Bulk Terminal Operating Management, *Proc. of Summer Simulation '95, Ottawa, July 23-26*
- Giribone P., A.G. Bruzzone (1999), Artificial Neural Networks as Adaptive Support for the Thermal Control of Industrial Buildings, *International Journal of Power and Energy Systems, Vol.19, No.1, 75-78 (Proceedings of MIC'97, Innsbruck, Austria, February 17-19, 1997) ISSN 1078-3466*
- Hanowski R.J., Hickman J., Fumero M.C., Olson R.L., Dingus T.A., (2007), The sleep of commercial vehicle under 2003 hours-of-service regulations, *Center for Truck and Bus safety, Virginia Tech Institute, Blacksburg, Virginia*;
- Heydinger, G.J., Garrott, W.R., *et al.* (1990), Validation of Vehicle Stability and Control Simulations, *SAE Paper No. 90-0128, Society of Automotive Engineers, Warrendale, PA*;
- Hogema, J.H., (1997), Compensation for Delay in the Visual Display of a Driving Simulator, *Simulation, pp. 27-34*;
- Ji, Q., Lan, P. and Looney, C. (2006), A Probabilistic Framework for Modeling and Real-Time Monitoring Human Fatigue, *IEEE Transactions on systems, Man and Cybernetics A, 36, 746-754*;
- Lal, S.K.L. and Criag, A. (2002), Driver fatigue: Electroencephalography and psychological assessment, *Psychophysiology, 39, 313-321*;
- Mosca R., Giribone P., Bruzzone A.G. (1996), Study of the Behaviour of Flexible Production Systems using Neural Nets, *International Journal of Production & Control, vol. 7, no.5, 462-470*;
- Sherry, P. (2000), Fatigue Countermeasures in the Railroad Industry: Past and Current Developments, *Washington, D.C.: AAR Press*;
- Young, L (1982), Human Orientation in Space, *AIAA Paper No. 82-0422 presented at the AIAA 20th Aerospace Sciences Meeting, Orlando, FL.*



# Design of a Modern Image Generation Engine for Driving Simulation

**Bob Kuehne, Sean Carmody**

Blue Newt Software, LLC

201 South Main St. Suite 503, Ann Arbor, MI 48103

rpk@blue-newt.com, sean.carmody@blue-newt.com

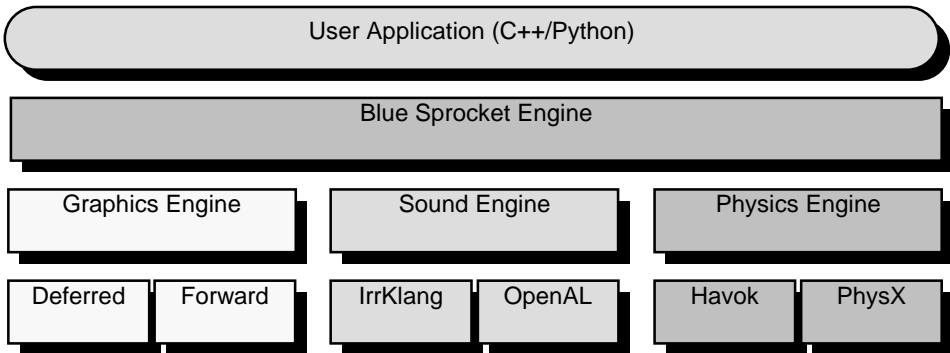
**Abstract** – In 2007 Blue Newt Software began designing and building a new visual rendering system for visual simulation markets. The image generator, called PixelTransit, is built on top of our engine called Blue Sprocket. Our rendering technology has been instrumental in demonstrating to new customers how graphics hardware can be used not just to create better images, but to gain better insight into their simulated environments. Blue Sprocket was designed to address four core goals from a rendering perspective: improved performance, higher-quality, scalability, and improved lighting. The engine additionally was redesigned to use standards wherever possible, and to bring a degree of modularity and scalability not available in this domain. This paper will describe the design and implementation of this system and discuss current problems and future work to be done in this space.

## Design

We built our rendering technology having analyzed and visualization requirements with many different customers. A common refrain was that as new technologies for rendering emerged, customers wanted these advanced graphics features, but were unable to easily adopt them. These new technologies might be newer scenegraphs with different rendering techniques, updates to standard application programming interfaces (APIs) such as OpenGL, or simply the latest algorithms and research from SIGGRAPH. Regardless of the source, adopting these technologies was something that each company addressed every few years to move their simulators forward. We decided a new approach was necessary to help our customers focus on their domains and let us continuously refine, revise, and provide new techniques and algorithms for rendering. We do this through a design which integrates both commercial and open software components, on all platforms. In short, our strategy is to create long-lived interfaces, but with flexible underpinnings allowing future enhancement.

## Architecture

We designed and built the Blue Sprocket Engine (BSE), our rendering and simulation software development kit(SDK) by researching the needs of a variety of customers in this space and studying the many open-source games APIs available. We combined our experience with the simulation market with our research to create an architecture that would allow rapid innovation with stable interfaces. We created a component-object model in which the simulation end-user would create logical objects representing simulation entities and their articulation, then attach components, or 'viewable' aspects to those objects. Viewable components are principally visual, such as 3D models, but can also be sounds, physics, etc. We provide interfaces to the most common of these including sound, physics, and of course, our OpenGL-based graphics. These components are then assigned by the developer to a processing entity we call an Engine. An engine is a specialized processor for turning components into some output, typically imagery, sound, or updated state of the world, as in physics processing. The diagram below shows this overall architecture.



The key architectural decision we made early was to create a simulation object API in the Blue Sprocket Engine to insulate users from changes lower in the API stack. We then were able to create separable instances of Engines which accomplished rendering via various mechanisms. For example, users with the same simulation software can choose to run in a forward rendering environment for ultimate speed or a deferred shading environment for lighting with unlimited numbers of lights. That choice, however, can be made based on the needs of the particular simulation run, and does not constrain the user to only developing their application for one or the other. Mitigating the pain of moving from one rendering interface to another was the key goal of the design of the Blue Sprocket Engine.

Engines are the workhorse of our system, and are individually responsible for two components of how a user creates a simulation. First, they provide components, which are attached to the user Object hierarchy that they describe their simulation world with. Second, engines provide processing capabilities to turn the components that they're managing into some coherent view. The most common view of this is the Graphics Engine which turns Graphics Components containing geometry and rendering state into an image.

## Platform

We began developing our technology with the choice of hardware platform on which to deploy. Based on our experience, we knew many customers had existing Windows installations, however, we wanted to move beyond Windows to ensure both higher code quality, and preserve options for our customers. That decision meant that our tools and code had to be fully cross-platform. This choice of platform directly leads to decisions about which technologies we integrate. Today we build and deploy on 64-bit Windows, Linux, and Mac OS X<sup>7</sup>. This lets our developers and customers both work where they're most productive. Beyond that simple business necessity, we also catch many potential problems early due to compiler differences among vendors.

## Technologies

Our core product focus is clear: to choose and integrate technologies that provide our customers value, while giving those customers programming interfaces which will remain stable, over a highly flexible and high-performance rendering core which can be used to build engines for today's and tomorrow's hardware platforms. This guiding principle informs how we choose among technologies to integrate, build-upon, and deploy.

Given limited resources with which to develop a product, we're always faced with choices about whether to build vs buy technologies. Our core system integrates a variety of commercial external components such as SpeedTree, DIGuy, and more, but also have many open-source components to our system such as Python (scripting), Boost (algorithms, threads, networking), and Bullet (physics). We rely on a rich data import/export toolchain via OpenSceneGraph, however, we expressly do not use any of its rendering capabilities. Having worked with OpenSceneGraph since its inception in 2000, we've found that it's very good for data reading/writing and geometry manipulation, but its rendering is designed for GPUs from a generation ago. This meant we had to take another direction for our graphics engine and so we focused on pure OpenGL 3.3 rendering. We chose OpenGL on over other graphics technology for several reasons. First, OpenGL works on all platforms, from handhelds to desktops, independently of OS. Second, OpenGL has a rich extension mechanism, allowing vendors to expose unique hardware-specific capabilities easily. We use this to gain access to useful vendor features for advanced capabilities such as shader-controlled multisampling. Third, OpenGL is very close to the metal, allowing us to get as close to the absolute maximum performance as possible on a given GPU.

## The Image Generator

In conjunction with development of our simulation engine core, we set about building an application on top of it, an Image Generator (IG) for driving simulation we call PixelTransit. Our focus was to keep the application as simple as possible, and write it the way a customer would write their own application to our engine, Blue Sprocket. This approach allowed us to accomplish the key goal we needed

---

<sup>7</sup> OS X lags OpenGL versions at this point. We handle compatibility through OpenGL extensions.

for one of our most challenging customers - build a new high-performance IG platform on a relatively new commodity graphics hardware GPU. We needed to be able to build the application logic once, but be able to change the graphics rendering underneath as the performance characteristics and quirks of the platform guided us in certain directions and away from others.

This architecture of our Blue Sprocket Engine turned out to be crucial while building the PixelTransit IG. Many times during the process of building the IG, we discovered performance bottlenecks in specific stages of both deferred rendering engine. These were either algorithmic or hardware, but in either case, we needed to rapidly iterate our design. We were able to work around particular problems within several graphics rendering pipelines by applying different deferred rendering techniques, but able to keep the core IG application structure the same.

Our Image Generation platform is compatible with either commodity synchronization solution from either NVIDIA or ATI. These allow frame frame-accurate double-buffering of graphics and GenLock within a frame. For the most part, commodity hardware is a very good choice for a modern platform, however, there are definitely tradeoffs as vendors have moved from a deep integration of hardware, including GPU, to a more integrator/assembly process. We discovered timing quirks due to various OS and hardware interactions on various platforms, necessitating rework several times as platform specifics changed slightly. COTS hardware is very wallet-friendly, but the tradeoff between up-front costs tends to get paid back in software-development time, especially as very timing-critical and bandwidth-stressing operations occur in an application.

The IG networking is built off common components. We use the highly-threaded Boost library to handle asynchronous unicast and multicast network data processing. Boost allows rapid development with a modern, fully C++, peer-reviewed, and open networking stack. We created our own thin packet format for packaging up data and sending it to/from the IGs. One design decision which we made early in the system was that we needed to be able to create data packets and send them from a variety of sources. We wanted to be able to write simulations in Python or in C++ when necessary, so all our data packets have interfaces in both. We begin by writing APIs in C++ and wrapping them in Python. Our system test infrastructure is built in Python atop these wrapped APIs, allowing us to rapidly both test and develop custom capabilities.

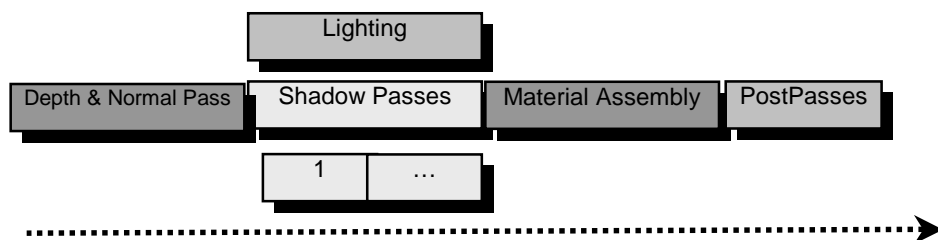
## The Graphics Engine

Early in our development process we thought we'd build our graphics capabilities on standard open-source APIs with which we had extensive experience. As we worked further through our process, various limitations became not just performance-limiting to our end goals, but completely blocked our progress with our primary goal of creating a fully deferred, unlimited-light capable image generator. Shortly thereafter we started development on the current shipping Graphics Engine for the Blue Sprocket Engine. The technologies behind this engine will be detailed next along with a coarse overview of deferred rendering.



The goal of our system was to be able to render hundreds of real in-scene lights at a time. We wanted our launch partner to be able to see actual live lights for all vehicles on-scene, and see dramatically improved lighting in urban settings at night. We quickly narrowed in on the class of techniques known as deferred rendering. Deferred rendering is a style of rendering in which you defer as much of the most expensive rendering workload as long as possible. In many simulations, this expensive work is typically the work that goes into shading pixels and fragments. In a pathologically good case, deferred rendering can mean that you only ever perform lighting and advanced material rendering once per-visible pixel (or per-fragment, if multisampling.) We chose to adapt some of the common deferred techniques to do full floating-point math, end-to-end in our pipeline, then applying a variety of post-processing effects to those floating-point values to re-range them to displayable ranges, and apply effects such as bloom, blur, and depth-of-field.

A user, in this case our graphics team, decides on an algorithm with which they'd like to render results. In our case, this was a floating-point deferred pipeline with post-processing. A user breaks down the tasks into a variety of rendering Passes and combines these through wiring texture outputs to inputs for subsequent stages. We'll presume for the next paragraphs that this pipeline has been assembled and walk through how user data flows through it. A simplified version of the deferred pipeline is represented below.



Our engine begins by taking the user Graphics Components and culling them for visibility. We developed a standalone threaded culling infrastructure so we would have flexibility in how objects were culled. Users directly insert objects to be rendered into Cull Graphs which are then responsible for computing a visible set of results each frame. Cullers are threaded using platform-native threads. Once a culler produces results, we then pass it along to a second set of threaded sort and optimize tasks which order results for rendering. On modern hardware it is particularly important to ensure that like objects are rendered together, to reduce expensive state changes in the hardware. Further, in a modern rendering pipeline, objects contributing to a scene are typically rendered twice or more depending on how many shadow maps, reflection maps, and depth passes are contributing to the scene. For these reasons, culling, sorting, and optimizing those results for display is very important to do effectively and efficiently.

After we've computed results from a variety of cullers, we pass those results to various rendering Passes which produce one or several textures as output. This chain of rendering passes together is known as a *Renderer*. A *Renderer* embodies a particular technique for rendering such as deferred rendering, forward rendering, light-pre-pass rendering, etc. *Renderers* can be relatively

easily interchanged, and user code remains effectively unchanged, with only minor tweaks to end-user materials to take advantage of specific Renderer features.

Renderer passes may be ordered or may be independent, allowing for coarse-threading by combining results on multiple graphics cards. This latter goal, however, remains a difficult task to do well. Core problems in this space remain with low-latency data retrieval and resubmission across graphics hardware. We are hopeful that future generations of graphics cards and APIs will allow better memory and framebuffer access across multiple cards. In the specific case of a deferred rendering pipeline, one could compute the transparent and opaque passes in parallel on separate cards prior to submission of both to the Material Assembly pass.

Finally, after a Renderer has completed its overall scene work, a series of post-processing passes may be performed. In our deferred renderer, for example, we've chosen to compute screen-space fog, water, and snow effects based on depth results, resulting in a very inexpensive fragment operation as these operate only once per-pixel.

## **Results**

Our overall architecture provided benefits almost immediately in that we were able to rapidly iterate our designs. However, for our end-customers results are significantly more valuable. We'll focus on two aspects which allow our customers to derive immediate benefit, in terms of scalability, performance, and capability. These are rapid development of unique features based on our pipeline architecture, and second, dynamic performance tuning based on this same pipeline architecture.

In 2007 we developed capability for true light-lobe rendering for a client. This allowed the client to project arbitrarily-shaped spot lights into a scene and use those in actual experiments surrounding headlight design. Our deferred renderer extends this work to allow effectively unlimited numbers of spot and point lights in a scene. Each spot light can have an arbitrary shape, which means that customers can have hundreds of true-light-lobes active in a scene at any given moment. Each light interacts with the world every frame. That means that not just static objects are lit, but dynamic objects as well.

A related benefit to our customers is the ability to scale performance and quality. In deferred rendering, the performance of the lighting solution directly corresponds to the number of pixels in the final image that are lit. This gives direct control to customers to decide how much lighting realism they desire in any scene, and scale their performance proportionally. So as future hardware with more shader performance arrives, customers can directly create more lights and see improved quality, or simply keep the same number of lights and have performance improve. We strive wherever possible to expose this performance/quality control directly.

Shadows also benefit from this performance/quality control. Our engine was built to allow rapid assembly of multiple rendering passes into an overall

rendering pipeline. In our deferred pipeline, for example, users can have between 1 and 4 shadow maps computed in a directional light shadow pass. This means that as users need more quality, they can add extra shadow maps. However, we've extended this baseline scalability with further controls for users. Shadow resolution can be scaled up or down to improve quality or performance. Further, the number of samples used in filtering the shadows can be increased or decreased creating softer or harder shadows respectively. With creative use of vendor-specific multi-tap sample gathering we can create soft shadows with kernels from 9-25 taps per-result-pixel on screen.

Our engine exposes a few more of these knobs today (post-processing quality, etc) and will expose more in the future. In general we believe this is a very important way to allow customers to 'self-upgrade' as they have requirements or experiments to run which require either more performance or more realism. We believe that the graphics simulation world is only getting more complex and realistic, and customers will require ever-more control to fine-tune their simulation for their specific simulation, hardware, and experiment needs.

## **Conclusion**

In this paper we've described our ground-up development of the PixelTransit IG and the Blue Sprocket Engine for simulation development. Our goal was to design a system that would be easy to maintain by insulating the details of modern graphics from the development of the IG features a modern simulator requires. We have an implementation which is high-dynamic range, fully deferred rendering, unlimited lights, yet with transparency, and anti-aliasing – two difficult tasks for deferred rendering. We approached the task by a rigorous study of the best practices from the games industry combined with the exacting requirements for controllability and quality from the simulation world. We did this by creating a layered architecture which allows rapid development of simulator-specific logic and features, but still allowing efficient evolution of underlying graphics rendering techniques.

## **Appendix: Reference Images**

The images in this section show a variety of effects possible within our flexible pipeline. We demonstrate the dramatic differences in looks for a single car at different times of day, with detailed light modeling. We also show images demonstrating many real-time in-scene lights. Our poster will show more image data, results, detailed antialiasing steps, and live results.



# Approach to Improvement of Realistic Sensation on Universal Driving Simulator

Daisuke Yamaguchi<sup>\*1</sup>, Yoshihiro Suda<sup>\*1</sup>, Masaaki Onuki<sup>\*2</sup>,  
Osamu Shimoyama<sup>\*1</sup>

<sup>1</sup> Institute Of Industrial Science, The University of Tokyo  
4-6-1 Komaba, Meguro-ku, Tokyo 153-8505, Japan  
ymagiis@iis.u-tokyo.ac.jp, suda@iis.u-tokyo.ac.jp  
o-shimoyama@mail.nissan.co.jp

<sup>2</sup> Mitsubishi Precision Co., LTD.

345 Kami-Machiya, Kamakura-shi, Kanagawa 247-8505, Japan  
monuki@mpcnet.co.jp

**Abstract** – "Sustainable ITS Project", an academic-industrial alliance project of the Advanced Mobility Research Center (ITS Center), Institute of Industrial Science, The University of Tokyo has developed "Universal Driving Simulator for Human, Vehicle and Traffic Research"(DS) which is appropriate for studies on ergonomics, automobiles, traffic engineering, etc. To improve realistic sensation and driving feeling on the DS and to suppress a motion sickness, the turntable mechanism which is one of features of the DS has been installed. Recently, approaches for upgrading realistic sensation of the DS such as new visual system with the target projector, modification of a sound system, installation of an automobile navigation system and change of a rotation center were made. The experiments to examine the effectiveness of change of a rotation center were performed and it was considered that this approach would be effective to improve a driving feeling. In this paper, these approaches for upgrading realistic sensation of the DS are introduced and the above examination of change of a rotation center are described.

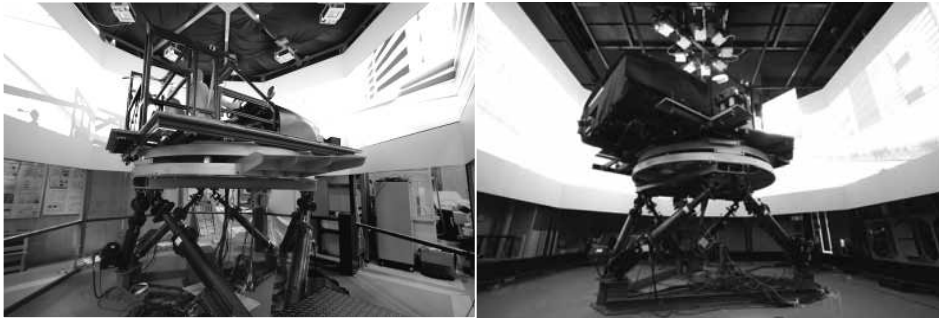
## Introduction

"Sustainable ITS Project", an academic-industrial alliance project of the Advanced Mobility Research Center (ITS Center, ITS stands for Intelligent Transport Systems), Institute of Industrial Science, The University of Tokyo has developed "Universal Driving Simulator for Human, Vehicle and Traffic Research"(DS) which is appropriate for studies on ergonomics, automobiles, traffic engineering, etc. To improve realistic sensation and driving feeling on the DS and to suppress a motion sickness, the turntable mechanism has been

installed. This is one of features of the DS. Recently, the following approaches for upgrading realistic sensation were made; new visual system with the target projector, modification of a sound system, installation of an automobile navigation system and change of a rotation center. The experiments to examine effectiveness of change of a rotation center were performed. In this paper, these approaches and the above examination are described.

## Universal Driving Simulator for Human, Vehicle and Traffic Research

"Universal Driving Simulator for Human, Vehicle and Traffic Research"(DS) is shown in Figure 1. The DS was relocated in the summer 2007. Fig.1(a) is the previous type before relocation and Fig.1(b) is the current type after relocation. Installation area of the DS was expanded from 5 meters square to 6.5 meters square and the size of screen was expanded from 100 inches to 132 inches respectively.



(a) Previous type before relocation

(b) Current type after relocation

**Figure1. Universal driving simulator for human, vehicle and traffic research**

The DS has some features as follows; the 360-degree omni-directional image generation system and a door-mirror image generation system, a 6-DOF motion platform with the turntable mechanism, connection to macroscopic and microscopic traffic simulation systems, etc. The turntable mechanism has been installed to enhance realistic sensation of driving and to suppress a motion sickness. It is particularly effective in the simulated situation that a driver steers to the right or the left at the corner. The above image generation systems were installed because the 360 degree field of view was suitable for complicated situation such as traffic jam or hectic traffic in the urban area including intersections and a rotational motion by the turntable mechanism. The DS connects to a macroscopic traffic simulation system and a microscopic traffic simulation system called "KAKUMO". KAKUMO can generate virtual traffic in the simulator scenario in real time. The DS vehicle runs in the virtual traffic flow. The DS and traffic simulation systems are part of "Mixed Reality Traffic Experiments Space" developed by Sustainable ITS Project. This is a useful tool at an intermediate stage between simulation and pilot program. The DS is used for experiments of drivers' behaviors in the dilemma zone and drivers' characteristics

of steering, distinguishing driver intentions in visual distractions, evaluation on eco-driving skill, evaluation on the dynamics road infrastructure, etc. The main specification of the current type of DS is shown in Table 1.

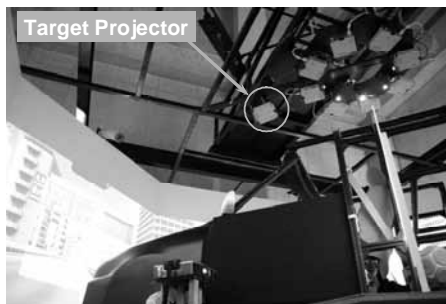
**Table 1. Main specification of the DS (current type)**

<b>Visual System</b>	<ul style="list-style-type: none"> <li>• 8 Liquid-crystal projectors</li> <li>• Calculation frequency: 60Hz</li> <li>• Resolution: XGA (1024 × 768)</li> <li>• Field of view:                             <ul style="list-style-type: none"> <li>Horizontal 360deg, Vertical 30deg</li> </ul> </li> <li>• All-around view screen: 132inch/screen</li> </ul>	<b>6-DOF Motion Platform</b>	<ul style="list-style-type: none"> <li>• Electric actuation</li> <li>• Stewart platform</li> <li>• Payload: 3000kg</li> <li>• Maximum velocity, acceleration: following table</li> </ul>																									
			<table border="1"> <thead> <tr> <th></th> <th>Maximum Displacement</th> <th>Maximum Velocity</th> <th>Maximum Acceleration</th> </tr> </thead> <tbody> <tr> <td>x</td> <td>300→+250mm</td> <td>330mm/s</td> <td>0.5G</td> </tr> <tr> <td>y</td> <td>±260mm</td> <td>350mm/s</td> <td>0.5G</td> </tr> <tr> <td>z</td> <td>-400→+290mm</td> <td>380mm/s</td> <td>0.5G</td> </tr> <tr> <td>Roll</td> <td>±20deg</td> <td>23deg/s</td> <td>-</td> </tr> <tr> <td>Pitch</td> <td>-18→+20deg</td> <td>21deg/s</td> <td>-</td> </tr> <tr> <td>Yaw</td> <td>±17deg</td> <td>22deg/s</td> <td>-</td> </tr> </tbody> </table>		Maximum Displacement	Maximum Velocity	Maximum Acceleration	x	300→+250mm	330mm/s	0.5G	y	±260mm	350mm/s	0.5G	z	-400→+290mm	380mm/s	0.5G	Roll	±20deg	23deg/s	-	Pitch	-18→+20deg	21deg/s	-	Yaw
	Maximum Displacement	Maximum Velocity	Maximum Acceleration																									
x	300→+250mm	330mm/s	0.5G																									
y	±260mm	350mm/s	0.5G																									
z	-400→+290mm	380mm/s	0.5G																									
Roll	±20deg	23deg/s	-																									
Pitch	-18→+20deg	21deg/s	-																									
Yaw	±17deg	22deg/s	-																									
<b>Simulator Cabin</b>	<ul style="list-style-type: none"> <li>• Size: W 3540 × D 3200 × H 3417mm</li> <li>• Automatic car specification</li> <li>• Variable pillars</li> <li>• Simulated vibration by the body sonic</li> </ul>	<b>Turntable Mechanism</b>	<ul style="list-style-type: none"> <li>• Yaw angle velocity: 60deg/s</li> <li>• Yaw angle acceleration: 300deg/s<sup>2</sup></li> </ul>																									
<b>Sound Effects</b>	<ul style="list-style-type: none"> <li>• Engine noise</li> <li>• Road noise</li> <li>• Wind roar etc.</li> </ul>																											
<b>Scenario</b>	<ul style="list-style-type: none"> <li>• Metropolitan / Intercity expressway</li> <li>• City road</li> <li>• Bank course etc.</li> </ul>																											

## Approach to Improvement of Realistic Sensation

### New Visual System with Target Projector

For applications of the DS such as experiments of traffic lights, traffic signs, road information boards, etc., a new visual system with the target projector was installed to the DS. The target projector enhances the visibility of central visual field being deeply-committed to an experiment with the DS. Figure 2 shows the target projector in a 360-degree omni-directional image generation system. The target projector projects a 70-inch image with 2.3 arc-minutes of angular resolution while a normal projector of a 360-degree omni-directional image generation system projects a 132-inch image with 5.3 arc-minutes of angular resolution. Figure 3 shows the image projected onto the front screen of driver seat when the target projector operates. In Fig.3, a boxed part is an image projected by the target projector. The image of target projector is cut out from a normal image and projected onto the screen not to overlap a normal image. Although there is a difference of brightness between both images caused by projection distance, it seems that the target projector is effective for enhancement of visibility.



**Figure 2. Target projector**



**Figure 3. Image projected by target projector**

## Modification of Sound System

The DS makes many sounds such as a road noise, an engine noise, a sound when a car goes by other ones, a window roar, etc. and arranges them on the basis of differences of vehicle velocity or a relative distance between the DS vehicle and other vehicles. The sound system of DS were modified and installed to simulate the sound environment such as boxy listening when a vehicle runs inside the tunnel and to conform a sound output to a rotational motion of a turntable mechanism, etc.

First, for review of an appropriate sound system, the subject experiments were performed in the fully anechoic room where the three dimension acoustic field simulation system was equipped. Subjects evaluated the realistic sensation due to differences in the number of speakers and a layout of them. The appropriate number and layout of speakers were extracted through experimental results.

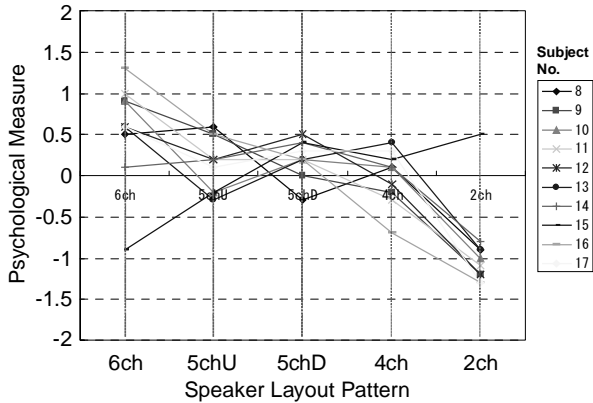
Figure 4 shows psychological measures based on experimental results. Fig.4(a) is for 10 subjects and Fig.4(b) is for 35 subjects total. In each graph, a large value of psychological measure means high realistic sensation. It seems that almost subjects evaluate highest realistic sensation in the 6ch layout. However, actually, it is very difficult to install speakers on the ceiling or under the floor because of the structure of the DS. From these results, it is indicated that evaluation of realistic sensation of the 4ch layout is higher than that of conventional 2ch layout drastically. Therefore, it was judged that four speakers positioned as the 4ch layout are enough to simulate the acoustic situation such as a driver listens many sounds inside a vehicle in view of reverberation. The sound system was modified as shown by Figure 5 on the basis of subject experiment results.

## Installation of Automobile Navigation System

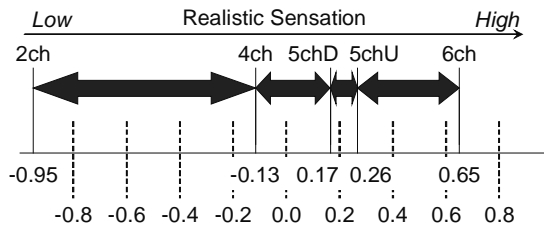
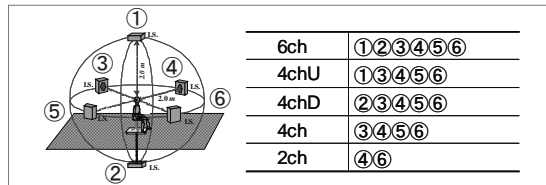
The ITS with information technologies and Advanced Cruise-Assist Highway System (AHS) supporting driving safety with the vehicle infrastructure integration are expected to have great effects in collaboration with an automobile navigation system. However, it is difficult to examine them in the real field. Therefore, the DS seems to be effective for these examinations. For examinations about the collaboration of an automobile navigation system, the appropriate system was



built in the DS shown in Figure 6. The machine indicates a position and a direction of DS vehicle based on the latitude and longitude information. Moreover, the functions of an audio assist and a reminder were added to this system for examinations of them.



(a) 10 subjects



(b) 35 subjects total

Figure 4. Psychological measures of realistic sensation based on experimental results

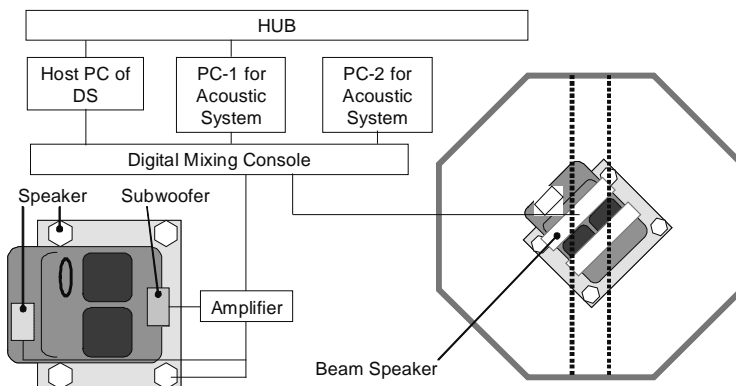


Figure 5. Configuration diagram of modified sound system



Figure 6. Installation of automobile navigation system

## Change of Rotation Center

Detection, analyses and classification of drivers' behaviors were examined through experiments such as driving on a slalom course with the DS. When a subject drives on a slalom course, the turntable mechanism rotates largely corresponding to steering. Turning motion of a vehicle is classified into revolution and rotation. The former is a motion of whole vehicle when a vehicle runs on a circular trajectory. The latter is a motion around a rotation center located within a vehicle. In general, a rotation center is located at the rear of a driver seat. Until now, because a rotation center of the DS was located at a driver seat on the right side and its location was different from an actual vehicle, it seemed that a driver might feel a different driving feeling of the DS from an actual vehicle. Therefore, it was expected that the adjustment of a rotation center would be effective for improvement of a driving feeling of the DS.

The rotation center of the DS was changed such that it became closer to that of an actual vehicle. The cabin imitating an automobile was transferred with 30cm of a lateral direction and 64cm of a longitudinal direction shown in Figure 7 and a rotation center was relocated. The aspect after change of a rotation center is shown in Figure 8 while before transfer is Fig.1(b).

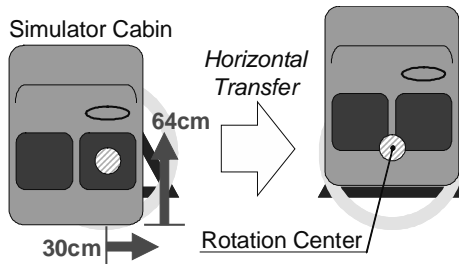


Figure 7. Transfer of cabin



Figure 8. After change of rotation center

## Examination of Effectiveness of Change of Rotation Center

The experiments were performed to examine the effectiveness of the above-mentioned change of a rotation center. Two positions of rotation center shown in Fig.7 were determined in the experiments. The position of before horizontal transfer is pattern I, and that of after horizontal transfer is pattern II. Yaw motion acting to a vehicle body is simulated by the turntable mechanism. The scale factor (SF) was set to 0.5 in the experiments. For instance, when SF and a rotational motion are set to 0.5 and 40 degrees respectively, the turntable mechanism simulates a 20-degree rotational motion and the image generation system simulates a 20-degree rotational motion in the opposite direction from a rotational direction of the turntable mechanism simultaneously. The experimental scenario of a double lane change course shown in Figure 9 was used. A subject drove an experimental route four times. The number of subject was twelve.

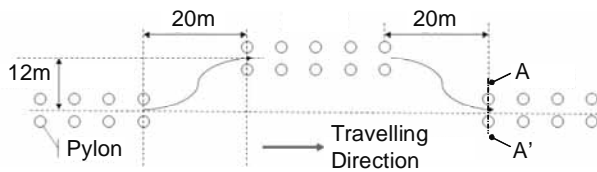


Figure 9. Experimental scenario

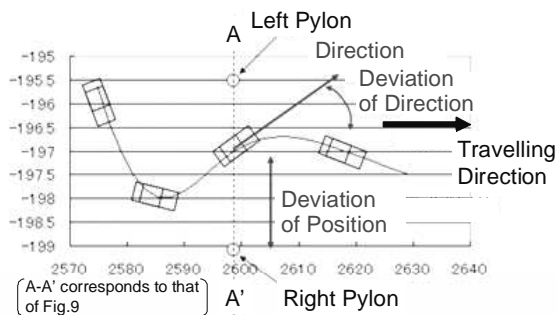


Figure 10. Evaluation item

Deviations of position and direction of the DS vehicle when the DS vehicle reaches at the point A-A' shown in Figures 9 and 10 were determined as the evaluation items, because it was thought that a subject's steering behavior of the second round of lane changes at the point A-A' would be more stable than that of the first round. An approach to the point A-A' such as velocity differs among subjects. Deviations of position and direction are calculated in each subject and converted into the dispersion indicating variability. Finally, the average of dispersion is calculated in each subject.

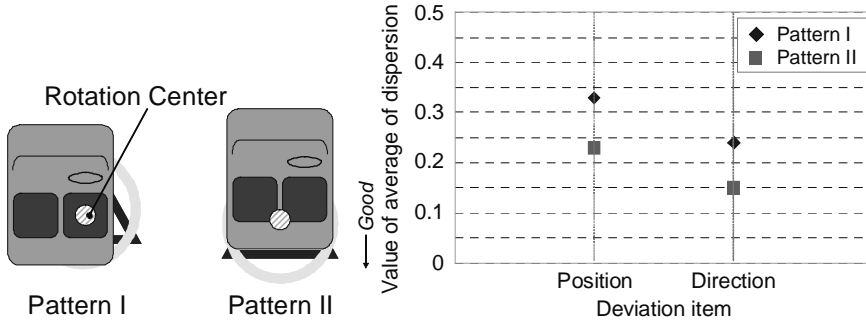


Figure 11. Experimental results

Figure 11 shows experimental results of average of dispersion of deviations of position and direction. A horizontal axis is deviation items and a vertical axis is the value of average of dispersion. A lower value of the average of dispersion means small variability of driving behavior and high drivability of the DS. Both averages of dispersion of position and direction of pattern II are lower than those of pattern I from Fig.11. This suggests that pattern II after change of a rotation center would be easier to drive than pattern I before change. Therefore, it is considered that change of a rotation center would be effective to improve a driving feeling of the DS.

## Conclusions

The approaches for upgrading realistic sensation of "Universal Driving Simulator for Human, Vehicle and Traffic Research" such as a new visual system with the target projector, modification of a sound system, installation of an automobile navigation system and change of a rotation center were made. The experiments were performed to examine the effectiveness of change of a rotation center. From experimental results, it was considered that change of a rotation center would be effective to improve a driving feeling of the DS. The approaches to further improvement of realistic sensation will be examined in the future.

**Acknowledgement:** Authors would like to thank members of "Sustainable ITS Project", an academic-industrial alliance project of the Advanced Mobility Research Center (ITS Center), Institute of Industrial Science, The University of Tokyo. Authors would also like to thank the research support from National Institute for Land and Infrastructure Management.

## **Bibliography**

- Suda, Y., *et al.*, (2005) Development of the Universal Driving Simulator for ITS Researches, *Proc. of 12th World Congress on ITS*, CD-ROM
- Asano, Y., *et al.*, (2004) Improved Driver Sensation by Tilting the Driving Simulator Cabin, *Journal of Japan Automobile Research Institute*, Vol.26, No.9, 487-490
- Shiraishi, T., *et al.*, (2004) Development of a Microscopic Traffic Simulation Model for Interactive Traffic Environment, *Proc. of the 11th World Congress on ITS*, CD-ROM
- Oda, T., *et al.*, (2007) Evaluation of Stopping Behavior of Drivers in Dilemma Zone Using Driving Simulator, *International Journal of ITS Research*, Vol.5, No.1, 47-54
- S. Kumano, *et al.*, (2009) Distinguishing Driver Intentions in Visual Distractions, *Proc. of 16th World Congress on Intelligent Transport Systems*, CD-ROM
- T. Ichihara, *et al.*, (2009) Driver assistance system for eco-driving, *Proc. of 16th World Congress on Intelligent Transport Systems*, CD-ROM
- M. Onuki, *et al.*, (2005) Study on Improving Angular Acceleration Feel on the Driving Simulator and its Effects on Driver's Behavior, *International Journal of ITS Research*, Vol.4, No.1, 47-52



# Pro-SiVIC and Roads, a software suite for sensors simulation and virtual prototyping of adas

Nicolas Hiblot<sup>1</sup>, Dominic Gruyer<sup>2</sup>, Jean-Sébastien Barreiro<sup>1</sup>,  
Bertrand Monnier<sup>1</sup>

<sup>1</sup> CIVITEC

25 allée des Marronniers F-78000 Versailles – France

<sup>2</sup> LIVIC (INRETS/LCPC)

14 route de la minière F-78000 Versailles – France

nicolas.hiblot@civitec.net, gruyer@inrets.fr, jsb@civitec.com,

bertrand.monnier@civitec.net

**Abstract** – *The LIVIC – a research department from INRETS and LCPC – focuses on the development and the evaluation of driving assistance systems. Several years ago, for the needs of its research activity, LIVIC launched the development of a software architecture SiVIC™, which made possible simulation of multi-frequency sensors responses embedded on static or dynamic devices, equipments and vehicles commonly used in ADAS. Raw data from perception systems are then replaced by accurate synthesised data whenever the scenarios for creating these data are too complex, too dangerous to realize or simply because data did not exist. CIVITEC has been created in October 2008 as a spin-out of INRETS and LCPC to focus on industrialisation, development and distribution of Pro-SiVIC – commercial and professional version of SiVIC™ – to the research community and industry. To further streamline the virtual prototyping process, several enhancements have been added including road networks modelling. The ROADS software is owned and developed by LIVIC and based on OpenDRIVE® specifications, an open file format for the logical description of road networks. LIVIC and CIVITEC are currently extending their collaboration in order to add ROADS into the CIVITEC software portfolio.*

**Résumé** - *L'un des thèmes de recherche du LIVIC - laboratoire de recherche commun à l'INRETS et au LCPC - est le développement et l'évaluation des systèmes d'aide à la conduite. Il y a plusieurs années, pour les besoins de son activité de recherche, le LIVIC a lancé le développement du logiciel SiVIC™, qui rend possible la simulation de réponses de capteurs multifréquences intégrés à des appareils statiques ou dynamiques, équipements et véhicules couramment utilisés dans les ADAS. Les données brutes provenant des systèmes de perception sont ensuite remplacées par des données simulées avec précision quand les scénarios sont trop complexes, trop dangereux à réaliser ou tout*

*simplement parce que les données n'existent pas. CIVITEC a été créé en octobre 2008 en tant que jeune-pousse de l'INRETS et du LCPC dans le but d'industrialiser, de développer et de distribuer Pro-SiVIC – version commerciale et professionnelle de SiVIC™ – à la communauté de la recherche et l'industrie. Afin de rationaliser davantage le processus de prototypage virtuel, plusieurs améliorations ont été ajoutées, y compris la gestion des réseaux routiers. Le logiciel ROADS appartient et est développé par le LIVIC. Il est basé sur les spécifications du format OpenDRIVE®, un format de fichier libre permettant la description logique des réseaux routiers. Le LIVIC et CIVITEC sont en train d'élargir leur collaboration en vue d'ajouter ce logiciel dans la gamme de logiciels CIVITEC.*

## Introduction

This paper aims at giving an insight on key challenges related to the development of driver assistance systems and how virtual prototyping with physical simulation of sensors, vehicles, and environments can help in this task. A specific highlight will be made on the emergence of an Open Source offering which addresses graphic and rendering techniques and authoring tools that help to reduce the time for the preparation of road networks and environments.

A quick glance shows that the current offering is essentially divided in two worlds. On one hand, the Driving Simulators that focus primarily on realistic models of vehicles to help the driver to feel the vehicle's behaviour in addition to understanding driver's behaviour in particular situations. The majority of the driving simulators like Racer, Autosim, SIM2, Archisim, Vires, SCANer ... shows some complexity related to their setup, lack of advanced graphic capabilities and are somehow monolithic which make them not suitable for supporting sensors modelling needed for the development, evaluation and validation of Advanced Driving Assistance Systems (ADAS).

On the other hand, Vehicle Simulation software providers such as CarMaker, CarSim, Tesis Dynaware, German truck simulator... carry their effort on vehicle architecture and on accurate vehicle functional performance analysis but generally with standard graphic rendering of the road itself and its surrounding and perfect sensors modelling (no physical models). All these tools require accurate roads and environments descriptions; OKTAL with RoadXML® or Vires with OpenDrive® are initiatives to describe properly road networks and allow data exchange between the communities of simulation software solutions and their users. Finally, advanced modelling of perception sensors is an emerging but promising market where companies like TNO with PreScan or CarSim are trying to position themselves.

However, in order to achieve a realistic sensor simulation, we know that a physical modelling of the environment, of the sensors and of the situations are necessary in order to obtain a behaviour close to the real world; it further allows to reproduce false alarms, and to study the reliability of perception systems.



**ROADS** and **Pro-SiVIC** are software components that help the achievements of virtual prototyping of ADAS, by combining tools to build easily road networks and environments based on OpenDrive® format, and advanced simulation software solutions for the modelling of multi-frequency sensors and vehicle dynamic to feed detection and control/command algorithms early in the development process.

## ROADS – software dedicated to the creation of road networks

Due to the persistent need of an editing tool enabling the creation of roads geometry and topology the LIVIC (a research laboratory for advanced driving assistance systems) decided to develop, two years ago, a new and efficient software dedicated to the creation of road networks: **ROADS**.

A quick glance at the software offering on the market shows that most of the software packages lack of flexibility and suffer of using complexity concerning roads intersection management, roads convergence/separation, road networks sketching...

Moreover, the need of advanced software architecture suitable to easily extend software capabilities is essential. The stability and upgradeability capabilities of such applications are also a guarantee of success. **ROADS** offers these advantages and provides an efficient way to model a road network with the use of specifications accepted by industries and researchers including easy support of Windows and Linux platform.

In fact **ROADS** includes overall specifications from the open file format OpenDRIVE®.

Therefore, **ROADS** helps to dramatically reduce execution time for the creation of simple to complex road networks with an easy-to-use and efficient environment. Figure 1, below, shows the typical incorporation of an OpenDRIVE® file into a simulation application:



© 2006 by 

**Figure 1. Typical incorporation of an OpenDRIVE® file into a simulation application**

Additional information can be founded on the OpenDRIVE® project at the following address: [www.opendrive.org](http://www.opendrive.org). OpenDRIVE® is powered by VIRES Simulationstechnologie GmbH, Rosenheim, Germany.

**ROADS** (Figure 4) creates roads geometry and topology by a combination of straights and curves segments, various intersections shapes and lanes separations, convergences and connections capabilities between these elements. The mathematical formulation for enabling the connections is a combination of straight, arc and clothoid profiles.

Several methods are proposed to build a road network:

- Freehand sketch
- Along a path (defined by a set of points)
- Road connection
- Road extension.



**Figure 2. Road portion shape design with ROADS**

Additional functions help to ease the construction of the road network such as copy, paste, delete and the capability to add a background image.

By combining the methods and the functions available in **ROADS**, it becomes easy and efficient to build a road network and all its complexity (one way, multi-lanes, cross-roads, junctions ...).

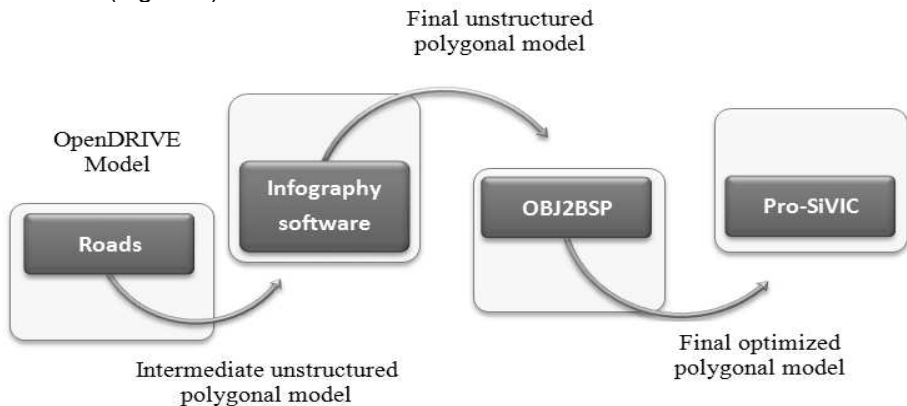
Some original functions are outlined herewith like the freehand sketch, inspired by the work of McCrae, J. and Singh, K. (1). The main idea is to use, as a first step, the freehand drawing in terms of curvature only and to apply the combination of a rotation with a translation to comply, the most faithful way, with the drawn path.

As well as for the road along a path, the work of Hun Shin, Dong and Singh, Sanjiv (2) was used as a foundation combined with a search algorithm of minimum Golden Section.

So far, we have flat roads geometry and topology, **ROADS** allows the edition of OpenDRIVE<sup>®</sup> data to define i.e. the appropriate road transverse profile along the road path. Others information such as terrains can be also added.

The road network and its environment data are then exported straightforward as objects suitable to be use in software simulation tools such as **Pro-SiVIC**.

**ROADS** uses currently standard 3D modelling format such as Wavefront OBJ files and OpenDRIVE<sup>®</sup> v1.2 data model so it can be used with many driving simulators (Figure 3).



**Figure 3. Integration process of roads environmental data in Pro-SiVIC**

The major benefits of **ROADS** lie in its ease of use and its ability to quickly and intuitively get a road network; it allows drawing arbitrary road networks without the need of predefined tiles, neither library of predefined configuration.

**ROADS** will be further extended with several new enhancements and thanks to the collaboration with the LIVIC valued by CIVITEC throughout its software portfolio. Due to its flexibility and capabilities, **ROADS** will be able to be extended to manage scenarios and to support the setup of traffic modelling functionalities.

## Pro-SiVIC: modelling software dedicated to sensors simulation

Many driver assistance systems are studied to improve the safety of road environments. An ego vehicle perception and the corresponding reaction of the vehicle, as braking or accelerating, are generally taken into account. However, an ego perception is not enough in many cases. Risk has to be as low as possible and driving security must be increased by adding information. The resources needed are however time-consuming and expensive. It therefore becomes essential to have a simulation environment (3), (4) allowing prototyping and evaluating extended, enriched and cooperative driving assistance systems in the early stage of the system design. To build a virtual simulation platform, models of road environments, virtual embedded sensors (proprioceptive, exteroceptive), sensors on the infrastructure and communicating devices, have to be pooled according to the laws of physics (5). A vehicle dynamic modelling (physic-based),

combined with actuators (steering wheel angle, torques on each wheel) will allow a realistic vehicle's behaviour.

This is the area where **Pro-SiVIC** acts (4) and meets all these criteria and allows the development and the prototyping of a high level autonomous driving system with cooperative and extended environment perception.

**Pro-SiVIC** is a combination of a dedicated, Open Source, graphic engine and a sensors simulation engine.

## A new 3D Graphic Engine

Position a new 3D graphic engine in a landscape where plenty of Open Source and COTS software exist is indeed challenging. Moreover, virtual reality, games and serious games are a fast growing market where technologies evolved every day.

Nevertheless, for the needs and objectives of the **Pro-SiVIC** simulation software's platform, which target the modelling and simulation of perception sensors, the pre-requisites are at least the following:

- 3D graphic engine, cross platform, programmed in C++
- Dynamic management of user classes as plugins loaded at run-time
- Scripting language with online console, which make easy testing new components
- OpenGL-based graphic rendering for high performance with state-of-the-art video cards
- Ability to run also on low-end machines with a 3D graphics accelerator card
- High-level 3D rendering capabilities
- Support of material data, advanced multi-texturing including HDR, transparency
- Advanced objects shadows
- Ray tracing capabilities for simulation of collision, vehicle/terrain interaction, ...
- Weather conditions: rain, snow, fog

Among others capabilities, the objects animation used an interpolation mechanism, the reflections management used planar reflection and cube maps reflexion.

Given the capabilities and performances of this 3D graphics engine, we think that the field of applications could go beyond the scientific modelling of perception sensors.

Mobile robotic, games and serious games, visual simulations are areas that could benefit of the present 3D graphic engine. In this view, it will be made available as an Open Source project to further extend and accelerate the capabilities. CIVITEC is looking forward to build a core team of industries, research centres, and academics willing to support this initiative.

## Tuning the 3D Graphic Engine for Sensors Modelling and Simulation

To find a way to overcome the constraints related to the modelling of varied perception sensors, specific mechanisms of adapted rendering has been added to the above 3D graphic engine. These mechanisms allow the definition of a “multi-rendering” approach, which suit perfectly to the simulation of sensors. Several rendering’s plugins provide scalable rendering capabilities depending on the requirements for the simulation. For instance a simulation can be used together with a basic graphical rendering of an optical sensor, or RADAR rendering, or a GPS rendering, or switched to a more realistic optical sensor with HDR (High Dynamic Range) textures, shadows, Filters and Tone Mapper.

Among the two current rendering models, one provides a classical 3D graphical engine rendering and the second one gives a better shadows (direct, ambient, occlude, pre processing) and lights management.

Additional enhancements have been provided such as the level of details for a virtual scene (dynamic customization), a set of post processing filters (glow, blur, auto exposition) and the layers management (level of visibility).

## Dynamic Plugins for Road Scenario

**Pro-SiVIC** uses the above simulation engine for the graphical and physical rendering stages. Nowadays, plugins architectures are a must as they offer the flexibility for evolution and scalability including interaction with 3<sup>rd</sup> party applications. Several external modules are taking care of the simulation of all the actors of a road situation.

These modules are naturally included as dynamical elements. A communication protocol allows an access to all the parameters of the sensors and vehicles models. The mechanism used for this communications protocol is thus made adjustable and is distributed on all the **Pro-SiVIC** modules.

### Modelling the Sensors

A set of proprioceptive and exteroceptive sensors are modelled inside **Pro-SiVIC**.

The modelling capabilities enable up-front virtual prototyping of sensors immersed in a dynamic environment taking into account their behaviours as measurements instrument which produce realistic raw data. In addition, enhanced sensors models help to the identification of sensors qualification and validation by the simulation. Currently, the following sensors modules are available:

- A camera module which simulates a set of several cameras. This one is configurable either by using the traditional parameters of a camera (size of matrix, focal distance...) or by using the parameters related to the OpenGL field of view (fovy, Znear, Zfar and aspect ratio),
- An Inertial Navigation System module which simulates an inertial navigation sensor (3-axis accelerometers and 3 axis gyrometers),

- An IR LED transmitter module which emulates, at this moment, a very simple behaviour of an IR transmitter in the eye sight field. Then some filters allow converting the image obtained from the rendering stage in order to match a more realistic IR camera result,
- An odometer module which simulates the optical coder type providing the distance covered (curvilinear X-coordinate) by a vehicle,
- A laser range finder which simulates the behaviour of a laser scanner. Two methods were implemented to carry out this particular simulation. One uses the ray tracing method; unfortunately this one requires a lot of machine resources. The second one, simpler and thus faster, uses the matrix of depth (Z-Buffer) to emulate the distances of the impacts for each beam of the laser scanner.
- A beacon which models a transponder type of sensor. Two sets compose this sensor. The data frames to be sent with the range of the communication are first taken into account by the transmitter. Then, the receiver is attached and embedded into a vehicle. Several transmitters with their own setups and several receivers can be defined and used simultaneously,
- A set of observers provides accurate and reliable references of objects. Four types of reference's sensors have been developed: a car observer, a pedestrian observer, an object observer and finally a road observer which provides road reference information at the vehicle location.

As described above the simulation engine provides the rendering functionalities which are used by the camera model. We will describe here more in details the advanced capabilities for vision sensor modelling, which is among others sensors the most widely used. The mechanism of filters addition is a powerful and efficient capability for a realistic modelling of vision sensors' physic. Indeed, several existing filters can be added during the simulation process to tune the picture rendering in order to produce a realistic image as close as possible to the image produced by a real camera.

The current implementation reproduces the optical system up to the illumination received in the sensor plane as described in the Figure 4 below. Further developments are on going to model the sensor chip behaviour itself in order to reproduce a faithful realism notably for the image capture, integration time and A/D conversion...

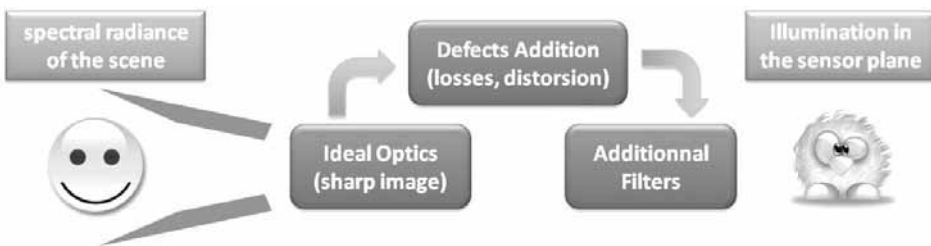


Figure 4. Vision sensors modelling process

The noise, the optical distortion, the depth of field, the glow, the fog, the rain drops, the rain fall, the auto exposure and the auto focus showed below in Figure 5 are some of the filters already available (6).



**Figure 5. Multi-rendering and filters mechanism:**  
a) Noise, b) Depth of field, c) Color, d) Rain drop, e) Auto exposure, f) Fog

### Modelling four wheels vehicle

Using simulation to reproduce realistic measurement's instruments such as a vision sensor implies to take into account the dynamic behaviour of the body where this sensor is attached. Thanks again to the **Pro-SiVIC** plugin architecture;

it becomes possible to couple the sensor to a moving object. This object can be any object as long as its behaviour is described by mathematical equations in order to represent its motion and dynamic. In the case of a four wheels vehicle, the motion of its bodywork on the three axes (roll, pitch and head) is reproduced to provide realistic data for the embedded virtual sensors. Some effects, like the shock absorbers (pumping), have to be taken into account by these movements.

The vehicle model is based on works done by S. Glaser (7) and includes shock absorbers, non linear tire road forces (8), (9). A coupling between longitudinal/lateral axes, the impact of the normal force variations and the moment of the car alignment can also be simulated as described in Figure 6.

A lumped mass at the CG is used to model the weight of the vehicle bodywork. Improvements of this model is possible by adding others components such as a steering column, a differential, etc. It can be replaced also by others vehicle dynamic models thru API defining inputs/outputs allowing an interface with i.e. 3<sup>rd</sup> party software dedicated to car dynamic modelling or C++ coding

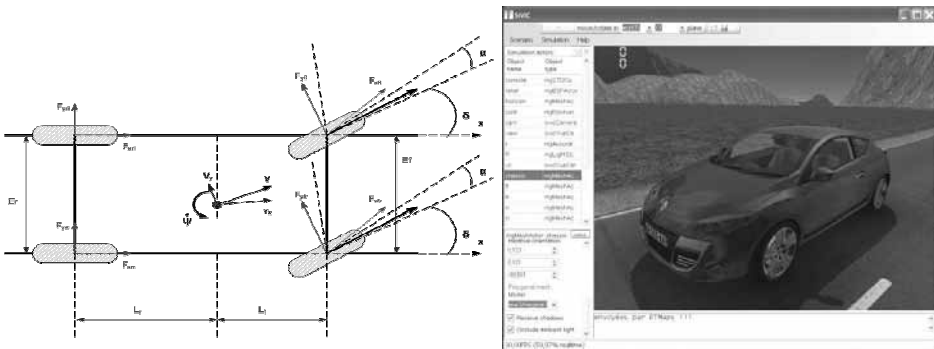


Figure 6. Vehicle modelling

Closing the loop is one of the key challenges when developing an ADAS function, therefore the vehicle model needs to be controlled to enable the complete virtual prototyping such as the one for i.e. obstacle avoidance.

Apart from the vehicle vector states output, the vehicle dynamic model is controlled thanks to actuators input to reproduce precisely the manoeuvres. To achieve these manoeuvres an input torque order independent to each of the wheel allows front wheels drive, rear wheels drive and four wheels drive and is suitable for electrical engine as well. The input for the vehicle orientation is achieved therefore by applying a rotation on the steering wheel. The wheel can be also independently controlled if necessary.

Finally, in order to manage a basic traffic situation, several setups are available to control vehicles' trajectories. With haptic inputs (steering wheel, keyboards, joystick), the vehicle can be controlled by a human driver. Others setups allow basic traffic modelling (vehicle following a trajectory); an extension of the previous one enables to have lateral and longitudinal controllers but also to control the vehicles by orders coming from 3rd party applications.



## Conclusion & future works

The first research release of **ROADS** has been launched in April 2010 and the LIVIC is continuing its effort of development to further increase capabilities. **ROADS** offers an efficient tools to build road networks of different levels of complexity. The compliance of **ROADS** to the OpenDRIVE<sup>®</sup> format combined with its intuitive interface is very attractive but additional developments are needed to further increase capabilities. Among others, the additions of road signs, sidewalks, advanced road marking, buildings, terrains, contents management. Moreover, a new plugin will be added in **ROADS** in order to use road network modelling in support of traffic generation. The traffic outcomes could be use in the **Pro-SiVIC** platform in order to reproduce either urban, peri-urban or motorway conditions. CIVITEC will soon take the distribution of **ROADS** and make it a commercial off-the-shelf (COTS) solution.

Through the Open Source diffusion, the 3D graphic engine of **Pro-SiVIC** should benefit of a larger community and usages. Improvements on render quality with bump mapping techniques or hardware optimisation (Graphics Processing Unit) are indeed some areas of improvements.

**Pro-SiVIC** is currently sold by CIVITEC as a COTS and it offers a large set of functionalities making it possible to model and test various advanced sensors. It can reproduce, in the most faithful way, the reality of a situation, the behaviour of a vehicle and the behaviour of the sensors which can be embedded inside a vehicle.

Concerning the realistic rendering of the scene, we currently use a camera based on the view generated by the OpenGL graphic functions with realistic optical effects. For instance, the current vision sensor model takes into account the optics distortions, the integration time, and noise effects. A weather module (rain, snow...) with effects on the light reflection is also integrated and usable.

Actually, **Pro-SiVIC** allows also to test and to evaluate the perception and control algorithms associated with the perception sensors and this functionality is one of the important advantages of this platform. By changing parameters of the environment (weather, light, traffic, road ...), of the sensors (focal, resolution, distortion, blur ...) it is possible to assess upfront in the design process the robustness of the perception function and the ADAS performances.

**Pro-SiVIC** has been successfully used these years in research projects (ARCOS, LOVE, Safespot and is currently part of the reference platforms for the projects Have-It, Isi-PADAS and E-MOTIVE. The later will help to increase **Pro-SiVIC** capabilities in scenario building and management, traffic computation, sensors and ADAS prototyping, test and evaluation as well as multiplatform's improvement on sensors models, easiness-of-use (GUI), extension in computational capabilities (multiprocessor architectures, GPU).

Keywords: Physic-based Sensors Modelling, ADAS Virtual Prototyping, Perception Sensors Simulation, Vehicle Dynamic Modelling, Road Networks Modelling, Physic-based Immersive Virtual Environment, Real-time 3D Graphic Engine, Environment Rendering & Modelling

## Bibliography

1. Sketching Piecewise Clothoid Curves. McCrae, J. and Singh, K. Copenhagen: SGP'08, 2-4 July 2008.
2. Path Generation for Robot Vehicles Using Composite Clothoid Segments. Hun Shin, Dong and Singh, Sanjiv. CMU-RI-TR-90-31, s.l.: Carnegie Mellon University, Robotics Institute, December 1990, Vol. tech. report.
3. SiVIC™ and RTMaps®, interconnected platforms for the conception and the evaluation of driving assistance systems. Gruyer, Dominique, *et al.* London: ITSC'06, October 2006.
4. Simulation of vehicle automatic speed control by transponder-equipped infrastructure. Gruyer, D., *et al.* Lille: IEEE ITST 2009, 20-22 October 2009.
5. Manoeuvre based trajectory planning for highly autonomous vehicles on real road with traffic. Vanholme, B., *et al.* Budapest: ECC'09, 23-26 August 2009.
6. Pro-SiVIC™, A new way for managing cameras in tunnel. Barreiro, J.-S., *et al.* Limassol: Urban Transport 2010, 5-7 May 2010.
7. Glaser, S. Modélisation et analyse d'un véhicule en trajectoires limites. Application au développement de systèmes d'aide à la conduite. Evry : Thèse de doctorat, January 2004.
8. A new tire model with an application in vehicle dynamics studies. Bakker, E., Pacejka, H.-B. and Lidner, L. 890087, 1989, Vol. SAE.
9. An analysis of tire traction properties and their influence on vehicle dynamic performance. Dugoff, J., Flanches, P. and Segal, L. 700377, 1970, Vol. SAE.