

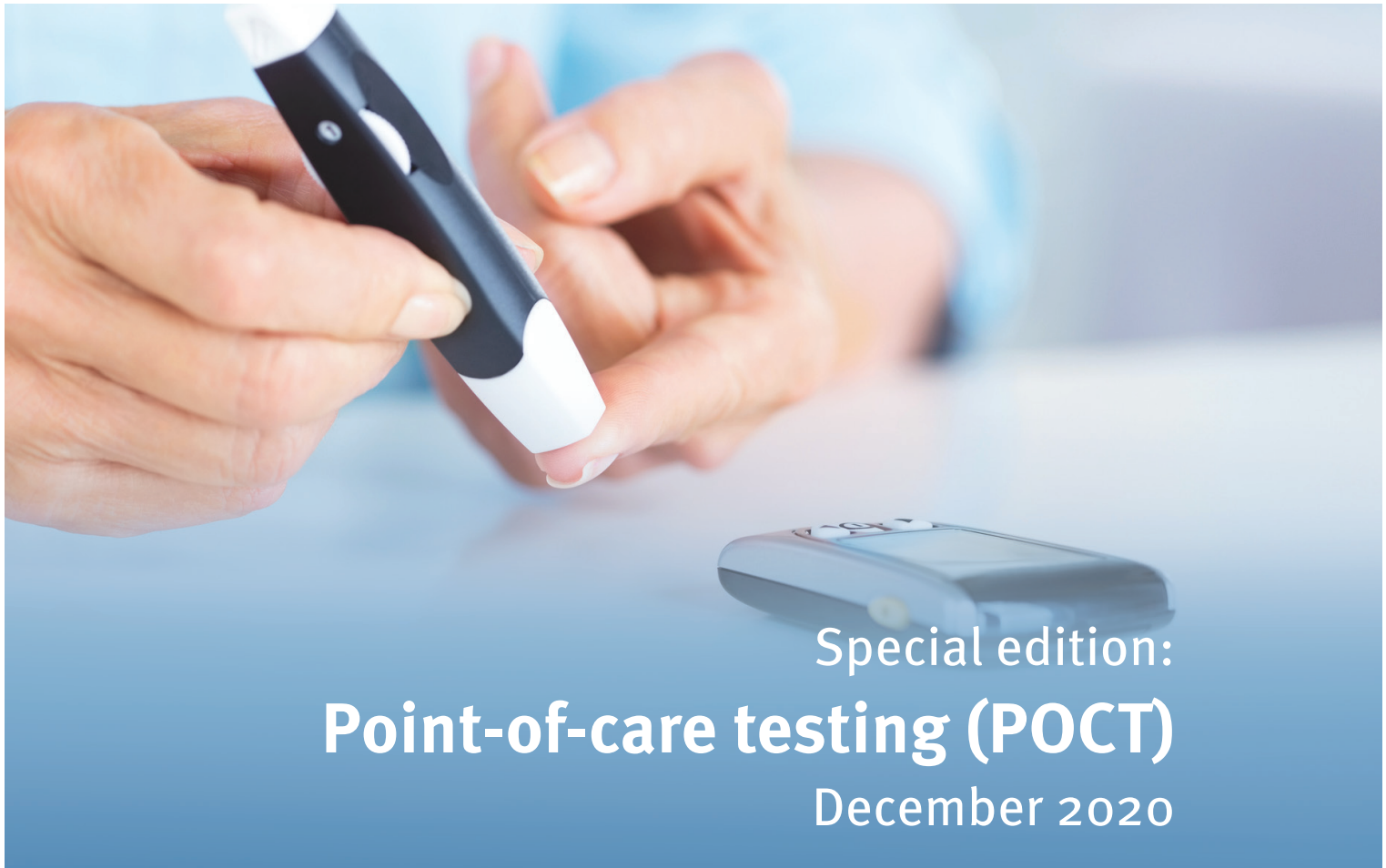

Eurosurveillance

Europe's journal on infectious disease epidemiology, prevention and control



Special edition:

Point-of-care testing (POCT)

December 2020

Guest editor: Nick Phin

Featuring

- Contribution of HIV point-of-care tests in early HIV diagnosis
- Experience of point-of-care testing for influenza in Scotland
- Analysis on confirmation rates for referred positive rotavirus samples in England
- Using rapid POCT to inform antibiotic choice
- Antimicrobial resistance POCT for gonorrhoea treatment
- and more...

Editorial team

Based at the European Centre for Disease Prevention and Control (ECDC),
169 73 Stockholm, Sweden

Telephone number

+46 (0)8 58 60 11 38

E-mail

eurosurveillance@ecdc.europa.eu

Editor-in-chief

Dr Ines Steffens

Senior editor

Kathrin Hagmaier

Scientific editors

Janelle Sandberg

Karen Wilson

Assistant editor

Alina Buzdugan

Associate editors

Tommi Asikainen, Brussels, Belgium

Magnus Boman, Stockholm, Sweden

Mike Catchpole, Stockholm, Sweden

Christian Drosten, Berlin, Germany

Karl Ekdahl, Stockholm, Sweden

Johan Giesecke, Stockholm, Sweden

David Heymann, London, United Kingdom

Irena Klavs, Ljubljana, Slovenia

Karl Kristinsson, Reykjavik, Iceland

Daniel Lévy-Bruhl, Paris, France

Jacob Moran-Gilad, Beer-Sheva, Israel

Chantal Reusken, Bilthoven, the Netherlands

Panayotis T. Tassios, Athens, Greece

Hélène Therre, Paris, France

Henriette de Valk, Paris, France

Sylvie van der Werf, Paris, France

Design/Layout

Fabrice Donguy/Dragos Platon

Online submission system

<https://www.editorialmanager.com/eurosurveillance>

www.eurosurveillance.org

© Eurosurveillance, 2020

Editorial advisors

Albania: Alban Ylli, Tirana

Austria: Maria Paulke-Korinek, Vienna

Belgium: Tinne Lernout, Brussels

Bosnia and Herzegovina: Nina Rodić Vukmir, Banja Luka

Bulgaria: Iva Christova, Sofia

Croatia: Sanja Kurečić Filipović, Zagreb

Cyprus: Maria Koliou, Nicosia

Czech Republic: Jan Kynčl, Prague

Denmark: Peter Henrik Andersen, Copenhagen

Estonia: to be nominated

Finland: Outi Lyytikäinen, Helsinki

France: Valérie Colombani-Cocuron, Paris

Germany: Jamela Seedat, Berlin

Greece: Rengina Vorou, Athens

Hungary: Ágnes Hajdu, Budapest

Iceland: Gudrun Sigmundsdóttir, Reykjavík

Ireland: Joan O'Donnell, Dublin

Italy: Paola De Castro, Rome

Kosovo, under UN Security Council Resolution 1244: to be nominated

Latvia: Dzintars Mozgis, Riga

Lithuania: Nerija Kupreviciene, Vilnius

Luxembourg: Thérèse Staub, Luxembourg

Malta: Tanya Melillo Fenech, Msida

Montenegro: to be nominated

Netherlands: Barbara Schimmer, Bilthoven

North Macedonia: to be nominated

Norway: Emily MacDonald, Oslo

Poland: Malgorzata Sadkowska-Todys, Warsaw

Portugal: Paulo Jorge Nogueira, Lisbon

Romania: Daniela Pitigoi, Bucharest

Serbia: to be nominated

Slovakia: Lukáš Murajda, Bratislava

Slovenia: to be nominated

Spain: Josefa Masa Calle, Madrid

Sweden: Anders Wallensten, Stockholm

Turkey: Fehminaz Temel, Ankara

World Health Organization Regional Office for Europe:

Masoud Dara, Copenhagen

Contents

SPECIAL EDITION: POINT-OF-CARE TESTING (POCT)

EDITORIAL

- The cat is out of the bag – point-of-care testing (POCT) is here to stay
Phin et al. 2

SURVEILLANCE

- The contribution of HIV point-of-care tests in early HIV diagnosis: community-based HIV testing monitoring in Catalonia, 1995 to 2018
Fernández-López et al. 5
- The experience of point-of-care testing for influenza in Scotland in 2017/18 and 2018/19 – no gain without pain
Dickson et al. 16

RESEARCH

- Retrospective analysis on confirmation rates for referred positive rotavirus samples in England, 2016 to 2017: implications for diagnosis and surveillance
Celma et al. 24
- Using rapid point-of-care tests to inform antibiotic choice to mitigate drug resistance in gonorrhoea
Vegvari et al. 32
- Antimicrobial resistance point-of-care testing for gonorrhoea treatment regimens: cost-effectiveness and impact on ceftriaxone use of five hypothetical strategies compared with standard care in England sexual health clinics
Harding-Esch et al. 41
- Effects of primary care C-reactive protein point-of-care testing on antibiotic prescribing by general practice staff: pragmatic randomised controlled trial, England, 2016 and 2017
Eley et al. 53
- Point-of-care tests for influenza A and B viruses and RSV in emergency departments – indications, impact on patient management and possible gains by syndromic respiratory testing, Capital Region, Denmark, 2018
Schneider et al. 64

PERSPECTIVE

- Do point-of-care tests (POCTs) offer a new paradigm for the management of patients with influenza?
Dickson et al. 73

Guest editor: Professor Nick Phin, Deputy Director of the National Infection Service, Public Health England, London, United Kingdom



Professor Nick Phin has been deputy director for Tuberculosis, Acute Respiratory, Gastrointestinal, Emerging/Zoonotic Infections and Travel Health (TARGET), a division of the National Infection Service in Public Health England (PHE) for two and a half years and visiting professor at the University of Chester since 2011. He has also been the International Health Regulations National Focal Point and the European Centre for Disease Prevention and Control (ECDC) Focal Point for several areas. He was acting Director of the Centre for Infectious Disease Surveillance and Control, PHE Colindale London for nearly four years and prior to that acting Head of department for Respiratory Diseases.

Professor Phin joined the Health Protection Agency in 2002 as a Consultant in Communicable Disease Control to pursue an interest in respiratory diseases. After completing his public health training in 1991, he worked as a Director of Public Health in England and Wales for a number of years before joining the Health Protection Agency. He graduated from Glasgow University in medicine.

Professor Phin takes up the position as Director of Public Health Science with Public Health Scotland at the beginning of January 2021.



© Istockphoto

The cat is out of the bag – point-of-care testing (POCT) is here to stay

Nick Phin^{1,2}, Susan M Poutanen^{3,4}

1. Public Health England (PHE), Colindale, London, United Kingdom

2. University of Chester, Chester, United Kingdom

3. University Health Network/Sinai Health Department of Microbiology, Toronto, Canada

4. Department of Laboratory Medicine and Pathobiology, Department of Medicine, University of Toronto, Toronto, Canada

Correspondence: Nick Phin (nick.phin@phe.gov.uk)

Citation style for this article:

Phin Nick, Poutanen Susan M. The cat is out of the bag – point-of-care testing (POCT) is here to stay. *Euro Surveill.* 2020;25(44):pii=2001854. <https://doi.org/10.2807/1560-7917.ES.2020.25.44.2001854>

Article submitted on 03 Nov 2020 / accepted on 05 Nov 2020 / published on 05 Nov 2020

Recently, a friend had to take their cat to the veterinary surgeon as she was out of sorts. After a thorough examination, the veterinarian felt that a haematology and biochemistry screen would be helpful in excluding some of the less obvious conditions that could be present. The friend agreed and asked if they should call back for the results at the end of the week, to which he responded that if they can hold on for 10 minutes, the two of them could discuss the results and any future management coming out of them. We were astonished and wondered why currently such service seemed to be easier to access for animals than for humans.

Point-of-care tests (POCTs) have increased in number in recent years in parallel to other technological advances. And, more than ever before, the current coronavirus disease (COVID-19) pandemic has brought the need for the widespread adoption of sensitive and specific POCTs to the fore. The diagnosis of COVID-19 in the absence of specific symptoms, a robust and consistent clinical syndrome and high rates of asymptomatic infections relies on testing to identify cases and enable the institution of appropriate clinical and public health measures. A POCT performed at, or near the point of patient care, can improve accessibility, provide timely advice, allow for immediate action and increase the likelihood of those infected adopting self-isolation from the start.

The eight articles in this special issue of *Eurosurveillance* highlight the benefits of POCT and identify issues that need to be taken into account when they are introduced into a clinical setting or implemented as part of surveillance that may form the basis for public health action.

The paper by Fernández-López et al. [1] describes an assessment of a community-based HIV testing service in Catalonia, Spain, that used POCT to increase the availability and accessibility of testing, particularly opportunistic testing. During the period of the

assessment, from 1995 to 2018, the researchers were able to show a substantial increase in the number of tests undertaken particularly in people who inject drugs, a group that can be hard to engage with, and many cases were subsequently linked to care. In addition, the increased accessibility and uptake of testing provided some reassurance that the fall in cases seen following the peak in 2014, was likely real, and not a consequence of under-ascertainment.

Celma et al. [2] illustrate the importance of recognising the limitations of POCT and the need to understand the potential for false-positive and false-negative test results, which will vary depending on the characteristics of the POCT and the prevalence of the disease in the population. In their study, POCTs were placed within England's National Health Service hospital laboratories as opposed to near patient care. The positive predictive value of the most commonly used rotavirus immunochromatography-based rapid test in their study varied from only 21.4% from July to November when rotavirus is less prevalent, to 89.6% during January to April, when rotavirus is more prevalent in the temperate northern hemisphere. This illustrates the importance of implementing confirmatory testing given the implications that false-positive rotavirus test results may have on both patient management and national surveillance.

Two articles focus on the use of POCT to tackle the rise in antimicrobial resistance (AMR) in *Neisseria gonorrhoeae*, an increasing public health concern. Vegvari et al. [3] provide a model of using POCT to inform treatment choice for *N. gonorrhoeae* by detecting stepping-stone resistance determinants relevant to the selection of resistance to gepotidacin, a novel antibiotic (type II topoisomerase inhibitor) still used only in clinical trials. The potential for POCT to be used to reduce the potential for selection of resistance is a welcome application in the era of increasing AMR. Knowledge

of baseline resistance-determinant rates and rates of mutations with and without pressure from the antimicrobial of interest are needed to determine the usefulness of this approach and the POCT test characteristics would need to be taken into account.

In a further paper, Harding-Esch et al. [4] analyse the benefits and costs of five antimicrobial resistant *N. gonorrhoeae* POCT strategies and their impact on treatment optimisation, reducing selection pressures on a key antibiotic and cost. They apply a simulation model using a cohort of patients infected with *N. gonorrhoeae*, the majority of whom were men who have sex with men. Primary outcomes were: total costs; percentage of people given optimal treatment; percentage of people given non-ceftriaxone optimal treatment; cost-effectiveness. The authors found that all AMR-POCT strategies can enable correct antibiotic therapy at diagnosis and improve antibiotic stewardship but cost more than standard treatment and would require investment. This has the potential to be mitigated if a small reduction in test costs could be achieved. In addition, the different strategies had differing trade-offs with respect to avoiding suboptimal treatments, costs and ceftriaxone-sparing treatment. This highlights the importance of clearly setting out and agreeing on AMR-POCT programme objectives.

The uptake of recommendations to incorporate C-reactive protein (CRP) POCT in clinical practice was assessed by means of a McNulty–Zelen cluster pragmatic randomised clinical trial by Eley et al. [5]. They noted a non-significant reduction in the odds of prescribing antimicrobials for cough in those with access to CRP POCT, but also noted variable uptake of the POCT in participating practices despite National Institute for Health and Care Excellence (NICE) guidance supporting its use. Furthermore, there was variable uptake of NICE recommendations for delayed treatment for patients with CRP levels between 20 and 100 mg/L. Unlike the potential to implement change within laboratory settings where there is a finite number of laboratories that are accredited and subject to licensing, full impact of POCT, if implemented as part of a national guidance, may not be put in practice given the challenge of influencing adoption by a much large number of independent clinics and clinicians.

Three papers in the special issue are dealing with POCT to detect respiratory viruses, in particular influenza. Schneider et al. [6] report on their experience with POCT for influenza A, influenza B, and respiratory syncytial virus in all hospital emergency departments in the capital region of Denmark. They noted a reduction in antimicrobial use and reduction in hospitalisation days, and an increase in antiviral use in patients with positive POCT results but no difference in mortality or readmission rates. Notwithstanding the limitation of not having a control group of people tested with traditional non-POCT, the authors note the potential for benefit from respiratory syndromic POCT. They ensured

all POCT results were reported into their national microbiology database, but acknowledged the potential for impact on their national surveillance system, given the lack of subtyping available.

In a second paper, Dickson et al. [7] provide an assessment of the impact and effectiveness of national data capture following the use of influenza POCT introduced to aid patient triage during two consecutive influenza seasons. The authors from Scotland found that the areas using POCT increased over the two seasons, the capture of positive POCT results improved between seasons but recording of negative results was incomplete. While there was a clear benefit to patient management, the authors note that the greatest challenge is capturing data for national surveillance. They specifically mention the lack of universal instrument interfaces to laboratory information management systems with the resultant potential for lack of reporting and transcription errors. They also note challenges with documentation of results as belonging to POCT with the potential for misclassification of testing type.

Finally, a perspective paper by Dickson et al. [8] highlights the opportunities and challenges that influenza POCT presents, and describes potential solutions. Challenges highlighted by the authors include integration into clinical workflow, standardisation of protocols, data procurement for surveillance purposes, and characterisation of viral isolates. To address the latter two, the authors specifically recommend consideration of technological solutions to facilitate upload of POCT data to cloud databases to enable data capture in surveillance systems and recommend a national policy for procurement of specimens to enable influenza subtyping, sequencing, and antiviral susceptibility testing.

Molecular and genetic insights and technological advances in computing and miniaturisation have meant that tests with high sensitivity and specificity hitherto considered the domain of reference laboratories are now easily accessible to front-line clinicians and non-traditional settings such as pharmacies. The availability of such tests, at the point of care, are transforming the way medicine is practised. Being able to identify, as part of a consultation, that a patient has a particular infection or condition, allows the clinician to provide the patient tailored treatment and advice in real-time. This has also the potential to achieve a number of other benefits – antibiotic stewardship by only using antibiotics where a bacterial infection is present and only those specific to the infection, patient education with advice specific to the infection, addressing public health issues by advising on contact tracing, cost savings and better utilisation of clinician and patient time by getting treatment right from the start.

However, limitations of POCT need to be recognised. Not all POCTs are equal in performance with some having lower sensitivity and specificity than others. Recognising the potential impact of these test

characteristics on false-positive and false-negative results and the need for confirmatory testing is important. Training POCT users in the correct use and quality oversight of POCT is challenging given the diverse number of clinicians and locations involved with POCT. Integrating POCT data and submitting specimens for surveillance purposes poses additional challenges with public health implications. Policies and regulatory oversight of POCT implementation are important to assure that these limitations are addressed and to ensure that the full benefits of POCT are realised without incurring harm. The cat is already out of the bag – it behoves us to tame it.

Acknowledgements

Nick Phin acted as guest editor for the *Eurosurveillance* special issue on how point-of-care/point of impact testing (POCT/POIT) and self-testing impact surveillance and public health. He was the United Kingdom national editorial advisor of *Eurosurveillance* from 2016 to 31 January 2020. Susan M Poutanen was speaker at the 2019 *Eurosurveillance* seminar: 'Point-of-care testing (POCT) and its impact on surveillance of communicable diseases and public health'.

Conflict of interest

Nick Phin has no declared conflict of interests. Susan M Poutanen reports having received honoraria from Merck related to advisory boards and talks, honoraria from Verity, Cipher, and Paladin Labs related to advisory boards, partial conference travel reimbursement from Copan, and research support from Accelerate Diagnostics and bioMérieux, all outside the submitted work.

References

1. Fernández-López L, Reyes-Urueña J, Conway A, Saz J, Morales A, Quezadas J, et al. The contribution of HIV point-of-care tests in early HIV diagnosis: community-based HIV testing monitoring in Catalonia, 1995 to 2018. *Euro Surveill.* 2020;25(43):1900424. <https://doi.org/10.2807/1560-7917.ES.2020.25.43.1900424> PMID: 33124552
2. Celma CC, Beard S, Douglas A, Wong S, Osafo NK, Hannah M, et al. Retrospective analysis on confirmation rates for referred positive rotavirus samples in England, 2016 to 2017: implications for diagnosis and surveillance. *Euro Surveill.* 2020;25(43):1900375. <https://doi.org/10.2807/1560-7917.ES.2020.25.43.1900375> PMID: 33124554
3. Vegvari C, Grad YH, White PJ, Didelot X, Whittles LK, Scangarella-Oman NE, et al. Using rapid point-of-care tests to inform antibiotic choice to mitigate drug resistance in gonorrhoea. *Euro Surveill.* 2020;25(43):1900210. <https://doi.org/10.2807/1560-7917.ES.2020.25.43.1900210> PMID: 33124551
4. Harding-Esch EM, Huntington SE, Harvey MJ, Weston G, Broad CE, Adams EJ, et al. Antimicrobial resistance point-of-care testing for gonorrhoea treatment regimens: cost-effectiveness and impact on ceftriaxone use of five hypothetical strategies compared with standard care in England sexual health clinics. *Euro Surveill.* 2020;25(43):1900402. <https://doi.org/10.2807/1560-7917.ES.2020.25.43.1900402> PMID: 33124553
5. Eley CV, Sharma A, Lee H, Charlett A, Owens R, McNulty CAM. Effects of primary care C-reactive protein point-of-care testing on antibiotic prescribing by general practice staff: pragmatic randomised controlled trial, England, 2016 and 2017. *Euro Surveill.* 2020;25(44):1900408. <https://doi.org/10.2807/1560-7917.ES.2020.25.44.1900408>
6. Schneider UV, Holm MKA, Bang D, Føns Petersen R, Mortensen S, Trebbien R, et al. Point-of-care tests for influenza A and B viruses and RSV in emergency departments – indications, impact on patient management and possible gains by syndromic respiratory testing, Capital Region, Denmark,

2018. *Euro Surveill.* 2020;25(44):1900430. <https://doi.org/10.2807/1560-7917.ES.2020.25.44.1900430>

7. Dickson EM, Marques DFP, Currie S, Little A, Mangin K, Coyne M, et al. The experience of point-of-care testing for influenza in Scotland in 2017/18 and 2018/19 – no gain without pain. *Euro Surveill.* 2020;25(44):1900419. <https://doi.org/10.2807/1560-7917.ES.2020.25.44.1900419>
8. Dickson EM, Zambon M, Pebody R, de Lusignan S, Elliot AJ, Ellis J, et al. Do point-of-care tests (POCTs) offer a new paradigm for the management of patients with influenza? *Euro Surveill.* 2020;25(44):1900420. <https://doi.org/10.2807/1560-7917.ES.2020.25.44.1900420>

License, supplementary material and copyright

This is an open-access article distributed under the terms of the Creative Commons Attribution (CC BY 4.0) Licence. You may share and adapt the material, but must give appropriate credit to the source, provide a link to the licence and indicate if changes were made.

Any supplementary material referenced in the article can be found in the online version.

This article is copyright of the authors or their affiliated institutions, 2020.

The contribution of HIV point-of-care tests in early HIV diagnosis: community-based HIV testing monitoring in Catalonia, 1995 to 2018

Laura Fernàndez-López^{1,2}, Juliana Reyes-Urueña^{1,2}, Anna Conway^{1,3}, Jorge Saz⁴, Adriana Morales⁵, Jaime Quezadas⁶, Jordi Baroja⁷, Anna Rafel⁸, Ander Pazos⁹, Anna Avellaneda¹⁰, Mercè Meroño¹¹, Lorena Andreo¹², Lluís Romero¹³, Anna Lara¹⁴, Araceli Otón¹⁵, Benet Rifà^{16,17}, Rosa Mansilla^{16,17}, Joan Colom¹⁷, Jordi Casabona^{1,2,18}

1. Centre for Epidemiological Studies on Sexually Transmitted Infections and HIV/AIDS of Catalonia (CEEISCAT), Catalan Health Department, Barcelona, Spain
2. Centros de Investigación Biomédica en Red Epidemiología y Salud Pública (CIBERESP), Spain
3. The Institute for Health Science Research Germans Trias i Pujol (IGTP), Badalona, Spain
4. BCN Checkpoint, Barcelona, Spain
5. Stop Sida, Barcelona, Spain
6. Associació Ciutadana Antisida de Catalunya (ACASC), Barcelona, Spain
7. Centre Jove d'Atenció a les Sexualitats (CJAS), Barcelona, Spain
8. Associació Antisida de Lleida, Lleida, Spain
9. Gaís Positius, Barcelona, Spain
10. Actuavallès, Sabadell, Spain
11. Fundació Àmbit Prevenció, Barcelona, Spain
12. CAS/ARD Lluís Companys, Creu Roja Barcelona, Barcelona, Spain
13. Assexora Tgn (Associació Comunitària de Salut Sexual del Camp de Tarragona), Tarragona, Spain
14. Associació Comunitària Anti Sida de Girona (ACAS), Girona, Spain
15. Creu Roja Tarragona, Tarragona, Spain
16. Section for Surveillance, Prevention and Control of Sexually Transmitted Infections and HIV, Public Health Agency of Catalonia, Barcelona, Spain
17. Programme for Prevention, Control and Treatment of HIV, STIs and Viral Hepatitis, Public Health Agency of Catalonia, Barcelona, Spain
18. Department of Paediatrics, Obstetrics and Gynaecology, and Preventive Medicine, Universitat Autònoma de Barcelona, Bellaterra, Spain

Correspondence: Laura Fernàndez-López (lflopez@iconcologia.net)

Citation style for this article:

Fernàndez-López Laura ORCID icon, Reyes-Urueña Juliana ORCID icon, Conway Anna, Saz Jorge, Morales Adriana, Quezadas Jaime, Baroja Jordi, Rafel Anna, Pazos Ander, Avellaneda Anna, Meroño Mercè, Andreo Lorena, Romero Lluís, Lara Anna, Otón Araceli, Rifà Benet, Mansilla Rosa, Colom Joan, Casabona Jordi. The contribution of HIV point-of-care tests in early HIV diagnosis: community-based HIV testing monitoring in Catalonia, 1995 to 2018. *Euro Surveill.* 2020;25(43):pii=1900424. <https://doi.org/10.2807/1560-7917.ES.2020.25.43.1900424>

Article submitted on 28 Jun 2019 / accepted on 25 Mar 2020 / published on 29 Oct 2020

Background: Community-based HIV testing services combined with the use of point-of-care tests (POCT) have the potential to improve early diagnosis through increasing availability, accessibility and uptake of HIV testing. **Aim:** To describe community-based HIV testing activity in Catalonia, Spain, from 1995 to 2018, and to evaluate the impact of HIV POCT on the HIV continuum of care. **Methods:** A community-based network of voluntary counselling and testing services in Catalonia, Spain has been collecting systematic data on activity, process and results since 1995. A descriptive analysis was performed on pooled data, describing the data in terms of people tested and reactive screening test results. **Results:** Between 1995 and 2018, 125,876 HIV tests were performed (2.1% reactive). Since the introduction of HIV POCT in 2007, a large increase in the number of tests performed was observed, reaching 14,537 tests alone in 2018 (1.3% reactive). Men who have sex with men (MSM), as a proportion of all people tested, has increased greatly over time reaching 74.7% in 2018. The highest percentage of reactive

tests was found in people who inject drugs followed by MSM. The contribution of community-based HIV testing to the overall total notified cases in the Catalonia HIV registry has gradually increased, reaching 37.9% in 2018, and 70% of all MSM cases. In 2018, the percentage of individuals with a reactive screening test who were linked to care was 89.0%. **Conclusion:** Our study reinforces the important role that community-based HIV POCT has on the diagnosis of HIV in key populations.

Introduction

In recent years, efforts to reach the 90–90–90 targets (90% of all people living with HIV knowing their HIV status, 90% of all people diagnosed with HIV receiving antiretroviral therapy and 90% of all people receiving antiretroviral therapy having viral suppression) advocated by the Joint United Nations Programme on HIV/AIDS (UNAIDS), have led to an improvement in accessibility and coverage of testing programmes. This, in turn, has reduced the number of people living with

undiagnosed HIV infection and increased early diagnoses [1]. Monitoring and evaluation (M&E) is an essential component of any effective testing programme. While strategic information should guide the design of testing initiatives, M&E permits continuous evaluation of targets and programme effectiveness, efficiency and impact. Such data can prove invaluable in planning improvements [2].

Catalonia is an autonomous community located in the north-east of Spain. In 2018, it had a population of 7,543,825 inhabitants. This region has a low-level HIV epidemic, where high levels of infection are found only in specific groups, particularly men who have sex with men (MSM). As of 31 December 2017, Catalonia had a rate of 8.1 HIV diagnoses per 100,000 inhabitants, with 53.6% of all diagnoses in 2017 attributed to MSM [3].

In Catalonia, HIV testing M&E forms part of the Integrated AIDS/HIV/STI Surveillance System of Catalonia (SIVES) [4] and is based on two main sources of information: (i) the network of public hospital laboratories, primary healthcare centre laboratories and private laboratories (HIVLABCAT), which have voluntarily reported diagnostic HIV testing and results since 1992; and (ii) the network of community-based voluntary counselling and testing (CBVCT) services, which has offered free, anonymous, voluntary and confidential counselling and testing since 1995 [5]. This report will focus on the data collected by the CBVCT network.

CBVCT services are considered an effective strategy for HIV testing, especially for key populations [6,7], and have expanded in the European Union/European Economic Area (EU/EEA) since 2010 through a variety of service delivery models [8]. This strategy has been proven to increase the availability, accessibility and uptake of HIV testing in order to reduce the number of people who do not know their HIV status or who are diagnosed late [9], impacting the first 90 target set by UNAIDS [10]. In addition, this strategy increases the proportion of first-time testers, increases the proportion of participants who undertook follow-up CD4 tests after diagnosis, detects patients at an earlier stage of infection, increases the number of new HIV diagnoses, and potentially reduces the stigma and discrimination faced by key populations [6].

A systematic review found that the use of HIV point-of-care tests (POCT) as part of CBVCT interventions, combined with behavioural interventions either at individual or community level, has the potential for enormous impact on the HIV epidemic [11]. Scaling up the CBVCT service model was thought to increase the likelihood of achieving the 90–90–90 target by 2020 [12], but the scale up in Europe has been impacted by limited funding, poor integration with national HIV programmes and regulatory barriers. There is a need for guidance to address these implementation challenges, including M&E, and a need to assist countries

in developing, implementing and evaluating national policies [13].

Community-based testing started in Catalonia with only a few sites offering traditional testing, where a nurse was required to perform venepuncture and send the blood sample to a laboratory. Traditional testing was replaced with HIV POCT in 2007, which allowed the expansion of testing programmes in the community. Since 2007, more sites have been offering HIV POCT, and the number of tests performed has increased exponentially [5].

Catalonia has experience in the scaling up of CBVCT interventions using HIV POCT with linkage to care, support and treatment services, within a solid M&E framework. Here, our aims are to describe HIV testing activity among those CBVCT services participating in the DEVO (an abbreviation of ‘voluntary detection’ in Catalan) network from 1995 to 2018 in order to evaluate HIV POCT contribution in the HIV continuum of care.

Methods

Settings

In 1995, the Catalan Health Department (currently, the Public Health Agency of Catalonia, ASPCAT) funded a network of CBVCT services to offer free, voluntary and confidential HIV testing in the region. The purpose of the DEVO network was to complement existing facility-based HIV testing. The DEVO network has since expanded from four CBVCT services in 1995 to the current 12 (becoming six organizations in 2001, seven in 2003, eight in 2004, 10 in 2008 and 12 in 2010), mainly operated by NGOs and serving the general population or, in some cases, key populations: MSM, sex workers (SW), young people (under 30 years old), and people who inject drugs (PWID). The participating organisations of the network are all CBVCT services providing HIV testing by trained lay providers through community and outreach services. In addition to providing HIV testing, most organisations perform syphilis and hepatitis C testing and additional HIV prevention activities. One of the organisations also offers other STI tests. Peers and other lay providers have been trained to perform and interpret rapid diagnostic tests with finger-prick blood samples.

Every person who receives a preliminary reactive test is referred to a laboratory or to an infectious disease specialist who conducts a confirmatory test. The diagnosed clients are then linked with appropriate specialist services.

Data collection

The DEVO network has been collecting systematically standardized data on activity, process and results since 1995. Since 2014, the DEVO network has formed part of the community-based testing (COBATEST) network, a European network of CBVCT services based on the DEVO network experience [8,14]. Since then, all

FIGURE 1

Number of HIV tests performed^a and percentage of reactive tests by year, Catalonia, Spain, 1995–2018 (n = 129,117)

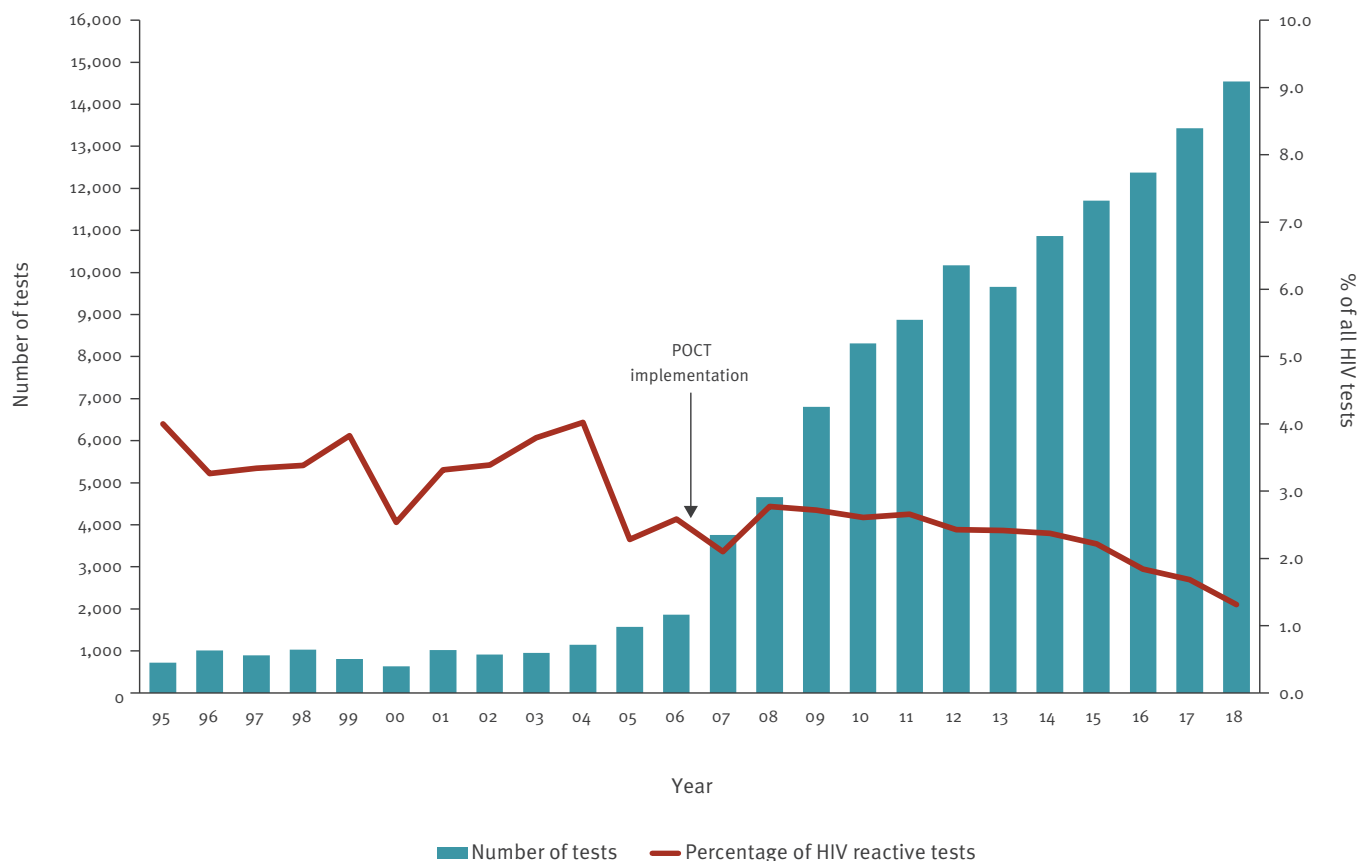

DEVO: voluntary detection; POCT: point-of-care test.

^a Only HIV tests performed within the DEVO network were included.

except one of the CBVCT services use the COBATEST data collection tool (which is based on the DEVO data collection tool) and COBATEST web-based data entry tool through which data can be extracted and analysed in collaboration with the Centre for Epidemiological Studies on Sexually Transmitted Infections and HIV/AIDS of Catalonia (CEEISCAT) as part of the Public Health Agency of Catalonia (ASPCAT). One of the CBVCT services uses their own data collection tool, and shares the minimum agreed data with CEEISCAT. For monitoring and evaluation purposes, the network currently uses the standardised core indicators defined in the COBATEST network [15], aligned with UNAIDS, World Health Organization (WHO) and European Centre for Disease Prevention and Control (ECDC) recommendations [16–18].

Data collected in the DEVO network include basic demographic information on the tester, test location, testing history, risk behaviour and results of HIV, syphilis and hepatitis C testing. Since 2014, services in the DEVO network have used a unique identifier for each client, ensuring anonymity while allowing the identification of

repeat testers and recording the correct number of individuals tested.

Test used

From 1995 to 2007, a conventional laboratory test with phlebotomy was used, from 2007 to 2012 the Determine HIV-1/2 rapid test (Abbott Laboratories, Abbott Park, IL, United States) was used, and since 2012 the new Alere Determine HIV-1/2 Ag/Ab Combo (Abbott Laboratories) test has been used. With both POCTs, the results were obtained in 15–20 min (15 min for Determine HIV-1/2 rapid test and 20 min for Alere Determine HIV-1/2 Ag/Ab Combo), and test accuracy is very high (Determine HIV-1/2 rapid test: sensitivity 99.6% (95% CI: 99.2–99.8), specificity 99.9% (95% CI: 99.8–100.0) [19,20]; Alere Determine HIV-1/2 Ag/Ab Combo: sensitivity 99.9% (95% CI: 99.4–100.0), specificity 99.8% (95% CI: 99.5–99.9) [21].

Data analysis

The descriptive analysis was performed on pooled data from 1995 to 2018 and included: (i) the whole time period 1995–2018; (ii) each year individually; (iii) the percentage of people tested distributed by gender,

TABLE A

Number of HIV tests performed^a, people tested and reactive tests by gender, age group, origin and transmission group, Catalonia, Spain, 1995–2018 (n = 129,117)

Year	1995	1996	1997	1998	1999	2000	2001	2002	2003	2004	2005	2006	2007	2008	2009	2010	2011	2012	2013	2014	2015	2016	2017	2018	Total
All tests																									
Test performed	725	1,011	899	1,034	811	631	1,025	915	949	1,144	1,576	1,858	3,757	4,653	6,806	8,317	8,875	10,168	9,654	10,867	11,705	12,371	13,432	14,537	129,117
People tested	NA	NA	NA	NA	NA	NA	NA	NA	NA	NA	NA	NA	NA	NA	NA	NA	NA	NA	NA	9,197 ^b	10,536 ^b	9,815 ^b	10,076 ^b	10,894 ^b	NA
Gender (n = 112,732)^b																									
Men	423	633	583	615	497	358	581	563	582	734	945	1,162	2,553	3,108	4,690	5,702	6,288	7,275	6,953	7,947	8,091	8,119	8,404	9,117	86,837
Women	292	372	305	417	312	273	442	350	366	403	627	691	1,111	1,420	1,709	1,946	1,772	1,741	1,528	1,436	1,536	1,528	1,524	1,563	24,135
Transgender	0	0	0	0	0	0	0	0	0	0	0	0	77	113	111	115	162	129	120	146	192	182	157	205	1,713
Age group (years) (n = 112,410)^b																									
≤24	265	414	370	466	338	314	434	334	307	354	470	470	794	1,053	1,376	1,644	1,629	1,639	1,580	1,933	2,081	2,057	2,119	2,541	25,209
25–34	304	447	372	399	337	220	433	434	456	527	744	889	1,839	2,210	3,093	3,573	3,681	4,019	3,695	3,939	3,925	3,811	3,910	4,300	48,270
35–44	52	106	119	125	101	78	123	110	144	196	273	360	825	984	1,474	1,793	2,036	2,475	2,355	2,494	2,507	2,514	2,561	2,499	26,625
≥45	36	32	36	44	32	18	35	37	36	67	87	136	287	377	546	760	883	1,013	971	1,163	1,306	1,345	1,387	1,543	12,306
Origin (n = 121,087)^c																									
Local	NA	NA	NA	NA	NA	NA	NA	673	667	755	1,046	1,147	2,341	3,019	4,203	4,976	5,227	5,899	5,576	6,097	6,096	5,851	5,889	6,035	66,346
Foreign national	NA	NA	NA	NA	NA	NA	NA	242	280	389	527	706	1,408	1,615	5,135	5,911	6,121	6,431	5,931	3,390	3,631	3,583	4,123	4,775	54,741
Transmission group (n = 106,992)																									
PWID	42	214	158	115	118	32	160	118	104	141	72	65	131	149	154	159	194	158	121	95	45	49	53	71	2,734
MSW	0	9	7	5	2	1	10	7	18	18	31	64	140	157	208	215	255	238	197	327	384	332	337	221	3,201
MSM	167	218	220	219	167	141	196	172	145	214	219	380	1,201	1,445	2,856	3,687	4,131	5,079	5,060	6,179	6,569	6,853	7,231	7,988	61,154
FSW	1	22	19	21	52	16	114	73	62	64	157	232	247	285	291	401	454	383	278	284	398	382	271	254	4,890
HM	260	260	218	338	231	237	267	220	245	277	404	379	897	900	1,220	1,443	1,426	1,470	1,322	1,510	1,266	1,045	939	1,034	17,929
HW	213	250	231	302	224	177	259	220	235	286	466	466	709	989	1,159	1,292	1,070	1,100	1,042	1,434	1,130	1,136	1,243	1,132	17,084

DEVO: voluntary detection; FSW: female sex worker; HM: heterosexual men; HW: heterosexual women; MSM: men who have sex with men; MSW: male sex worker; NA: not available; PWID: people who inject drugs.

^a Only HIV tests performed within the DEVO network were included.^b From 2014 to 2018 the disaggregated data refer to people tested instead of number of tests performed.^c Foreign national: person born in country other than Spain; local: person born in Spain.

TABLE B

Number of HIV tests performed^a, people tested and reactive tests by gender, age group, origin and transmission group, Catalonia, Spain, 1995–2018 (n = 129,117)

Year	1995	1996	1997	1998	1999	2000	2001	2002	2003	2004	2005	2006	2007	2008	2009	2010	2011	2012	2013	2014	2015	2016	2017	2018	Total	
Reactive tests																										
HIV reactive tests	29	33	30	35	31	16	34	31	36	46	36	48	79	129	185	217	236	247	233	258	259	228	226	191	2,848	
Gender (n = 2,923)																										
Men	25	23	22	30	25	13	27	21	31	40	28	41	68	111	166	204	215	228	224	241	240	210	210	179	2,646	
Women	4	10	8	5	6	3	7	8	8	5	8	7	9	9	11	10	9	12	6	5	4	4	4	4	169	
Transgender	0	0	0	0	0	0	0	0	0	0	0	0	5	9	8	3	12	7	3	12	15	14	12	8	106	
Age group (years) (n = 2,909)																										
≤24	5	2	4	6	5	7	10	6	4	7	8	3	10	16	21	27	32	18	34	44	34	24	24	27	38	394
25–34	13	23	18	18	17	5	19	15	17	21	16	29	31	75	88	111	105	130	97	122	108	111	114	85	1,405	
35–44	4	4	8	8	9	3	5	8	12	14	7	14	29	30	63	55	79	62	81	69	90	61	58	44	823	
≥45	3	1	0	3	0	1	0	2	3	4	5	2	9	7	12	23	20	36	21	23	27	31	27	24	287	
Origin (n = 2,711)																										
Local	NA	NA	NA	NA	NA	NA	NA	14	15	21	18	21	30	59	93	101	114	139	120	123	138	108	83	60	1,272	
Foreign national	NA	NA	NA	NA	NA	NA	NA	17	21	25	18	27	49	70	91	116	122	107	113	135	121	119	143	131	1,439	
Transmission group (n = 2,786)																										
PWID	5	16	12	17	17	8	19	17	15	26	6	11	5	12	14	4	11	9	4	1	4	4	3	1	240	
MSW	0	0	1	2	0	0	0	1	2	4	7	7	9	14	15	15	21	22	19	40	36	34	26	13	288	
MSM	17	9	10	8	7	4	6	5	7	7	7	16	40	70	132	174	180	186	191	205	213	181	191	168	2,050	
FSW	0	0	1	0	2	0	2	0	4	1	4	2	4	4	2	2	2	1	2	3	1	0	0	0	39	
HM	4	3	4	3	1	1	4	2	1	0	1	3	3	3	7	6	6	9	6	2	5	4	3	5	86	
HW	2	4	2	5	4	2	2	2	2	2	2	1	2	4	4	5	3	7	3	7	3	3	3	4	83	

DEVO: voluntary detection; FSW: female sex worker; HM: heterosexual men; HW: heterosexual women; MSM: men who have sex with men; MSW: male sex worker; NA: not available; PWID: people who inject drugs.

^a Only HIV tests performed within the DEVO network were included.

^b From 2014 to 2018 the disaggregated data refer to people tested instead of number of tests performed.

^c Foreign national: person born in country other than Spain; local: person born in Spain.

FIGURE 2

Gender, age, origin and transmission group of (A) all people tested for HIV (n = 112,732^a) and (B) HIV reactive tests (n = 2,848), Catalonia, Spain, 1995–2018

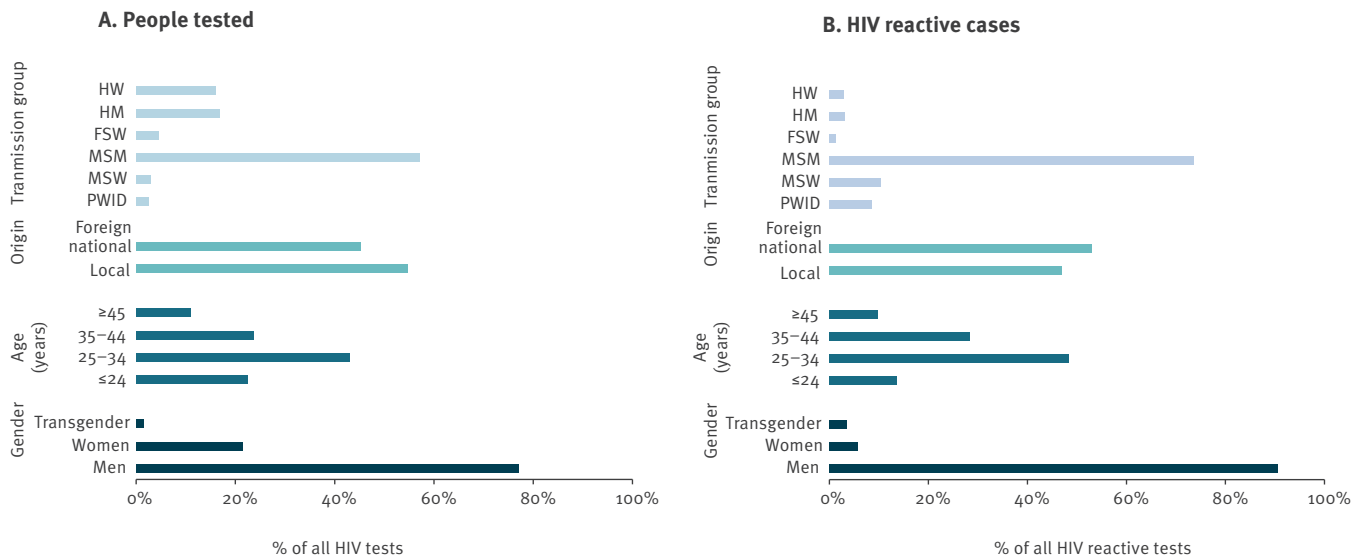

DEVO: voluntary detection; Foreign national: person born in country other than Spain; FSW: female sex worker; HM: heterosexual men; HW: heterosexual women; local: person born in Spain; MSM: men who have sex with men; MSW: male sex worker; PWID: people who inject drugs.

^a Only people tested within the DEVO network were included. Before 2014 disaggregated data refers to number of tests instead of people tested.

age, nationality and transmission group; (iv) the percentage of individuals with a confirmed positive test before 2007 and the percentage of individuals with a reactive screening test after 2017 distributed by gender, age, nationality and transmission group. Variables included: gender (men, women, transgender), age, nationality (foreign national defined as born in a country other than Spain, or local defined as born in Spain) and transmission group (constructed as hierarchical, mutually exclusive risk categories in the following order of priority: PWID, male sex workers (MSW), MSM, female sex workers (FSW), heterosexual women (HW), heterosexual men (HM)).

For Figures 4 and 5 the MSW group was added to the MSM group in order to present all the MSM population together.

The lines in Figure 4 chart the evolution of the percentage of reactive screening tests per year by transmission group and were smoothed using the centred moving average method. Using this method, data points were modified four times, each time the average of raw observations at a given point in time was calculated using that point, the one immediately prior and the one immediately after. This method allows for smoothing out short-term fluctuations and highlights long-term trends or cycles [22]. To test trends in Figures 1 and 4, a Pearson's chi-squared test was used.

Linkage to care was defined as 'entry into healthcare or follow-up by a HIV specialist or a HIV unit after a reactive or confirmatory HIV test at a community testing facility' according to the definition established in the Euro HIV EDAT project, co-funded by the European Commission [23], and all linkage to care information was collected from patient feedback.

In order to evaluate the contribution of community testing to the total number of diagnosed cases in Catalonia, data from the DEVO network and the Catalonia HIV registry were triangulated, considering that reactive tests detected in the DEVO network were linked to care and therefore were noted in the Catalonia HIV registry. The percentage of HIV cases diagnosed in the community and registered in the Catalonia HIV registry was calculated from 2001 to 2017, the period where Catalonia HIV registry data were available.

All percentages were calculated excluding missing values (which represented less than 5%). A p value below 0.001 was considered for statistical significance. Data analysis was performed using PASW Statistics for Windows, version 18.0 (SPSS Inc., Chicago, United States).

Ethical statement

Ethical approval was not needed at the beginning of the project in 1995, as no biological samples were preserved for the study and data collected from the clients were anonymous and part of the routine services

FIGURE 3

Distribution by transmission group of (A) all people HIV tested^a (n=106,992) and (B) HIV reactive tests (n=2,786), Catalonia, Spain, 1995–2018

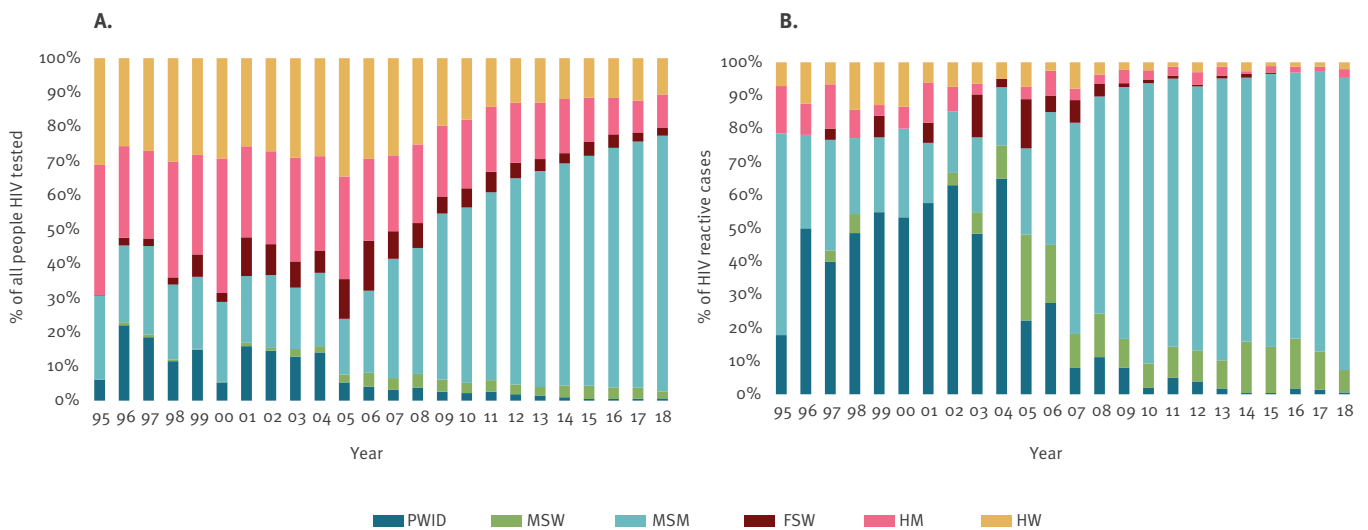

DEVO: voluntary detection; FSW: female sex worker; HM: heterosexual men; HW: heterosexual women; MSM: men who have sex with men; MSW: male sex worker; PWID: people who inject drugs.

^a Only people tested within the DEVO network were included. Before 2014 disaggregated data refers to number of tests instead of people tested.

of CBVCT centres. Since the introduction of POCT, each client taking a POCT gave informed consent stating that they understood the POCT was not a diagnostic test. Since 2014 when the DEVO network joined the COBATEST network, the CBVCT services signed an agreement ensuring they fulfilled the General Data Protection Regulation, where each client has to sign an informed consent explaining the use of the data collected.

Results

Between 1995 and 2018, 129,117 HIV tests were performed by the DEVO network, of which 2.1% were reactive. The increase in the number of tests performed by the CBVCT services by year was relatively low until 2006, ranging from 716 in 1995 to 1,849 in 2006 (Figure 1).

With the introduction of the HIV POCTs at the end of 2006, there was a 102.9% increase in the number of HIV tests performed in 2007 compared to 2006 (analysis published in a previous study [5]). In 2018, the number of HIV tests peaked at 14,537, of which 1.3% (n = 191) were reactive. From 2006 to 2018 there was an increase of 686.2% in number of tests performed (from 1,858 tests performed in 2006 to 14,537 in 2018), with an average annual increase of 21.1%. In the past 10 years, the percentage of reactive tests has been decreasing (statistically significant trend, $p < 0.0001$), from 2.8% (129/4,653) in 2008 to 1.3% (191/14,537) in 2018.

HIV testing activity differed greatly between CBVCT services, with one organisation, which works only with MSM, performing on average more than half of the total number of HIV tests in the DEVO network. The Table shows the evolution by year on tests performed, people tested and number of reactive screening tests disaggregated by gender, age group, origin and transmission group.

Between 1995 and 2018, 77.0% (86,837/112,732) of the total people tested at the community sites were men, and 92.9% (2,646/2,848) of reactive tests were in men. In men and women, the age group with the most people tested and most reactive tests was 25–34 years old (Figure 2). Foreign nationals accounted for 45.2% of the total number of people tested, and 53.1% of the total number of reactive tests. MSM accounted for 57.2% of all people tested, and 73.58% of the total number of reactive tests.

Figure 3 describes the contribution of each transmission group to the total number of people tested, and the total number of reactive tests between 1995 and 2018. It shows that MSM as a proportion of all people tested has increased greatly over time, reaching 74.7% (7,988/10,700) in 2018. The opposite trend is visible among PWID. Each year between 1996 and 2004, PWID were the transmission group with the highest number of reactive tests. Since 2005, the proportion of this group has gradually diminished, reaching the lowest value (0.7%; 71/10,700) in 2018. In the same period, the proportion of all reactive tests for MSM (MSM plus

FIGURE 4

Percentage of HIV reactive tests by transmission group per year, Catalonia, Spain, 1995–2018 (n people tested = 106,992^a; n reactive tests = 2,848^b)

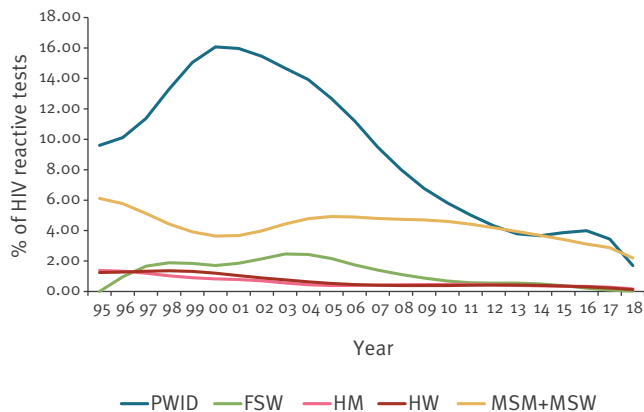

DEVO: voluntary detection; FSW: female sex worker; HM: heterosexual men; HW: heterosexual women; MSM: men who have sex with men; MSW: male sex worker; PWID: people who inject drugs.

^a Only people tested within the DEVO network were included. Before 2014 disaggregated data refers to number of tests instead of people tested.

^b Only HIV reactive tests performed within the DEVO network were included.

The lines were smoothed using the moving average method.

MSW) increased, accounting for 95.0% of the total number of reactive tests detected in 2018.

The highest reactivity rate in each transmission group during the whole period of study was found in PWID (ranging between 1.1% (1/95) in 2014 and 25.0% (8/32) in 2000), followed by MSM plus MSW (ranging between 2.2% (181/8,209) in 2018 and 10.2% (17/167) in 1995) (Figure 4). Nevertheless, in recent years the reactivity rate in the PWID group has gradually decreased. This decrease is not statistically significant, due to the low number of PWID tested. The reactivity rate in MSM plus MSW has shown a statistically significant decrease ($p < 0.001$), especially in the past 10 years, reaching 2.2% (181/8,209) in 2018. For the rest of the groups, no significant trend was observed.

Figure 5 shows the increase of the contribution of HIV POCT in the community to the overall total number of cases registered in the Catalonia HIV registry. The percentage of positive cases in the Catalonia HIV registry which were first detected in the DEVO network has gradually increased, from 4.5% (34/763) in 2001 to 37.9% (219/578) in 2017. In the case of MSM plus MSW, this contribution is higher, reaching 70.0% of total HIV diagnosed cases in the Catalonia HIV registry among MSM in 2018.

In 2018, a total of 14,537 tests were performed in the DEVO network on 10,894 individuals, of which 1.8%

(191/10,894) were reactive. Of these reactive tests, 94.8% (181/191) had a confirmatory test, of which 100% were confirmed as positive. Of the total number confirmed positive, 93.9% (170/181) were linked to care. The percentage of individuals with a reactive screening test who were linked to care was 89.0% (170/191). This percentage has not varied considerably since these data were available (81.7% in 2014, 95.0% in 2015, 89.5% in 2016, and 92.7% in 2017).

Discussion

This study shows the contribution of community-based HIV POCT in improving early HIV diagnosis in Catalonia over time, especially among key populations, and demonstrates that the collected data are an important source of strategic information to be included into the Integrated AIDS/HIV/STI Surveillance System of Catalonia (SIVES).

In Catalonia, community-based HIV testing has been monitored and has formed part of HIV Surveillance since 1995. The DEVO Network has made it possible to collect standardised data on each person tested in CBVCT services. The collected data complement strategic information on key populations and thus make it possible to improve HIV prevention strategies aimed at these key populations. The continual monitoring performed by the DEVO Network has improved public health decision-making at the Public Health Agency of Catalonia by detecting changes in HIV testing uptake, in HIV tester profiles and in HIV test-seeking behaviours [5].

The DEVO Network succeeded in scaling up HIV testing among key populations, with the number of tests performed in the year following the implementation of POCT increasing by 103% from the previous year [5].

HIV POCT have the potential to increase the number of people who know their HIV status [24]. The POCT that meet the WHO's ASSURED (affordability, sensitivity, specificity, user-friendly, rapid and robust, equipment-free and deliverable) criteria [25] follow a simple procedure involving a limited number of steps and are equipment-free, ensuring they can be performed outside traditional laboratory settings by staff with no formal laboratory training [24]. Additionally, both providers and clients prefer rapid tests over traditional tests [26,27]. Several studies have shown the efficacy of CBVCT strategies using HIV POCT to improve HIV testing uptake in populations at higher risk of exposure to HIV [6,7,9]. The DEVO Network has shown to be successful in providing testing to at-risk populations. In the period 1995–2018, 57.2% of tests were performed on MSM, 7.6% on SW (FSW plus MSW), 2.6% on PWID, 1.5% on transgender people and 45.2% on foreign nationals (including migrant population). A recent study showed that in Catalonia, 12.3% of those living with HIV were still undiagnosed, and this proportion was higher in migrants [28]. Therefore, in Catalonia, providing access to HIV POCT in the community is

FIGURE 5

Number of HIV reactive screening tests from the DEVO network, total number of cases registered in the Catalonia HIV registry and the percentage^a of tests recorded in the Catalonia HIV registry first detected in the DEVO network for (A) all people tested (n = 2,483 in DEVO network, n = 13,004 in HIV registry) and (B) men who have sex with men and male sex workers only (n = 2,099 in DEVO network, n = 5,660 in HIV registry), Catalonia, Spain, 2001–2017

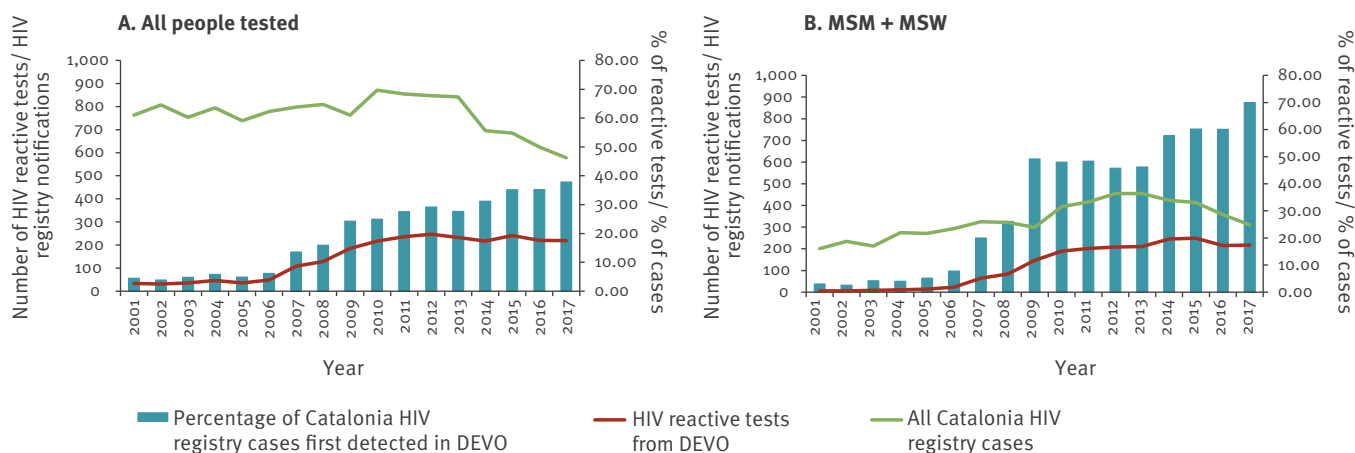

DEVO: voluntary detection; MSM: men who have sex with men; MSW: male sex worker.

^a Percentage calculated as number of reactive tests obtained by DEVO community testing divided by number of total cases recorded in the Catalonia HIV registry.

important, especially for populations facing barriers to accessing the healthcare system, such as the migrant population.

The low number of PWID tested in the DEVO network can be explained by the fact that most PWID are tested in harm reduction centres. In Catalonia there is a network of harm reduction programmes run by mobile units, street teams or facility-based centres. The facility-based centres are located in areas of drug trafficking and drug consumption, or in drug treatment clinics [29].

Linkage to care and treatment for those with a reactive test in the DEVO network is high (89%). A recent systematic review and meta-analysis of studies in the WHO European Region [30] showed a pooled estimate of 85% (95% CI: 75–93) of people with reactive tests linked to care within 3 months. Linkage of those with a reactive test to appropriate specialist services is a key step in the HIV continuum of care, as immediate initiation of treatment has substantial benefits in reducing the risk of patient morbidity, as well as reducing onward transmission [30].

In the past 10 years, a statistically significant decreasing trend has been observed in the percentage of MSM with a HIV reactive test. This trend could be explained by the success of different strategies of combined prevention in this key population, including increased testing frequency and earlier initiation of HIV treatment. BCN Checkpoint (the CBVCT service with the largest HIV testing activity, particularly among MSM) has gone further to promote earlier initiation of HIV treatment by introducing qualitative PCR POCT for the detection of

acute HIV infection [31]. This, coupled with their pre-exposure prophylaxis (PrEP) service in the framework of research studies, has broadened the portfolio of preventive services available to users of the Checkpoint. In England, the incidence of new HIV infections in MSM attending sexual health clinics fell by 55% in 2016 and 2017 [32,33], and was attributed to an increase in HIV testing, earlier initiation of HIV treatment and the scale up of privately purchased generic PrEP in England from late 2017 onwards.

In Catalonia, universal treatment (treatment independent of CD4⁺ cell count for patients newly diagnosed with HIV) has had a positive impact on the dynamics of the viral load in people living with HIV [34]. This, along with increasing testing and linkage to care as part of a combined prevention strategy, can explain the decrease in the percentage of new HIV diagnoses in the DEVO network. The increase in number of sites offering HIV testing thanks to the introduction of HIV POCT has increased the proportion of community detected HIV cases in the overall number of HIV cases reported in Catalonia, increasing from 4.5% in 2001 to 37.9% in 2017. The impact of introducing HIV POCT was even larger for MSM, where 70% of all new HIV diagnoses in 2017 were diagnosed in the community setting. This suggests that CBVCT services are a valuable element of the strategy to increase HIV testing in Catalonia, especially for MSM. These estimations are higher than that presented in a 2019 study showing that in several southern European countries, 0.2–19.7% of total HIV cases and 0.5–37.0% of HIV cases among MSM were diagnosed through CBVCT services [35].

The longstanding experience of the DEVO Network and its results has been used as a basis for establishing the COBATEST Network, a European network of CBVCT services that share standardised data [8,14].

There are a number of limitations to this study. Firstly, the disaggregated data presented in the Table from 1995 to 2013 refers to the number of tests performed, while data from 2014 to 2018 refer to the total number of people tested. This is due to improvements made to the data collection system and its integration into the COBATEST network. After 2013 a unique identifier was assigned to each client, allowing detection of repeat testers, and at the same time ensuring the anonymity of people tested. This could have led to an under-estimation of the number of tests in the period 2014–2018, especially in the MSM group as MSM are more often repeat testers. Secondly, the number of HIV positive cases from 1995 to 2007 refers to HIV confirmed cases only, as the test offered was the conventional laboratory test. Since the introduction of HIV POCT, the number of HIV positive cases refers to reactive cases as in some cases, the information related to referral and confirmation of the diagnosis is not complete. So the number of HIV reactive cases in the period 1995–2006 could be higher. Lastly, regarding the number of cases detected in the DEVO network as a percentage of the total number of Catalonia HIV registry cases - as it was assumed that all reactive cases were linked to care and therefore were added to the Catalonia HIV registry, the contribution could have been overestimated.

Conclusion

In conclusion, our study with a monitoring series of almost 25 years reinforces the important role that community-based HIV POCT has on the improvement of early HIV diagnoses in key populations, and highlights the importance of monitoring these data and including them in a regional or national HIV surveillance system. To ensure sustainability of the community testing services, key stakeholders must commit to including CBVCT services in the design and plan for strategies to achieve the 90–90–90 objectives.

Acknowledgements

We are grateful to all the DEVO network services and their teams for their continuous work collecting and providing HIV testing data: Jorge Saz, Michael Meulbroek, Ferran Pujol, Félix Pérez, Albert Dalmau-Bueno (BCN Checkpoint); Comisión de Prueba Rápida de VIH y otras ITS (Stop Sida); Jaime Quezadas, Gemma Ricomà (ACASC); Jordi Baroja, Mari Paz Oliver, Georgina Picas, Erika Ros, Maria Ferrero Barrio, Jacque Segura I Mireia Aldavert (CJAS); Anna Rafel (Associació Antisida Lleida); Ander Pazos, William Mejías, Joaquim Roqueta (Gais Positius); Anna Avellaneda, Elena Griñán, Júlia Collignon, Alberto Capitán (Actuavallès); Mercè Meroño, Cati Fons, Marisa Cebrián (Àmbit Prevenció); Lorena Andreo, Víctor Navarro, Himalaya Vallejo, Sara Riba (CAS/ARD Lluís Companys, CreuRoja Barcelona); Lluís Romero (ASSEXORAT); Anna Lara, Lluís Franch (ACAS Girona); Araceli Otón, (Creu Roja Tarragona).

Conflict of interest

None declared.

Authors' contributions

LFL led the data analysis and drafting of the manuscript supported by JRU, AC and JCa. JS, AM, JQ, JB, AR, AP, AA, MM, LA, LR, AL, AO provided HIV testing data. BR, RM and JCo contributed to the development of the different drafts. All authors commented on various drafts of the manuscript and approved the final version.

References

1. Tavošči L, Hales D. Monitoring of HIV testing services in the EU/EEA. *Euro Surveill.* 2016;21(48):30410. <https://doi.org/10.2807/1560-7917.ES.2016.21.48.30410> PMID: 27934584
2. World Health Organization (WHO). Consolidated guidelines on person-centred HIV patient monitoring and case surveillance. Geneva: WHO; 2017. Available from: <https://www.who.int/hiv/pub/guidelines/person-centred-hiv-monitoring-guidelines/en/>
3. Centre d'Estudis Epidemiològics sobre les Infeccions de Transmissió Sexual i Sida de Catalunya (CEEISCAT). *Vigilància epidemiològica de la infecció pel VIH i la SIDA a Catalunya. Informe anual 2017.* [Epidemiological surveillance of HIV and AIDS infection in Catalonia. Annual report 2017]. Badalona: CEEISCAT; 2018. Catalan. Available from: https://canalsalut.gencat.cat/web/.content/_A-Z/S/sida/en/lassos/anual_VIH.pdf
4. Centre d'Estudis Epidemiològics sobre les Infeccions de Transmissió Sexual i Sida de Catalunya (CEEISCAT). *Epidemiological Report SIVES 2015.* Technical document nº22, Integrated Surveillance System for STI and HIV in Catalonia. Badalona; CEEISCAT; 2015. Available from: https://salutpublica.gencat.cat/web/.content/minisite/aspacat/vigilancia_salut_publica/vih-sida-its/05_CEEISCAT/publicacions-cientifiques/informes/SIVES/SIVES_2015/sives2015_ENG.pdf
5. Fernández-López L, Rifà B, Pujol F, Becerra J, Pérez M, Meroño M, et al. Impact of the introduction of rapid HIV testing in the Voluntary Counselling and Testing sites network of Catalonia, Spain. *Int J STD AIDS.* 2010;21(6):388–91. PMID: 20606218
6. Suthar AB, Ford N, Bachanas PJ, Wong VJ, Rajan JS, Saltzman AK, et al. Towards universal voluntary HIV testing and counselling: a systematic review and meta-analysis of community-based approaches. *PLoS Med.* 2013;10(8):e1001496. <https://doi.org/10.1371/journal.pmed.1001496> PMID: 23966838
7. Pottie K, Medu O, Welch V, Dahal GP, Tyndall M, Rader T, et al. Effect of rapid HIV testing on HIV incidence and services in populations at high risk for HIV exposure: an equity-focused systematic review. *BMJ Open.* 2014;4(12):e006859. <https://doi.org/10.1136/bmjopen-2014-006859> PMID: 25510889
8. Fernández-López L, Reyes-Urueña J, Agustí C, Kustec T, Klavsl, Casabona C; COBATEST Network group. The COBATEST network: a platform to perform monitoring and evaluation of HIV community-based testing practices in Europe and conduct operational research. *AIDS Care.* 2016;28(February) Suppl 1;32–6. Available from: <http://www.tandfonline.com/doi/full/10.1080/09540121.2016.1146218>
9. Fernández-López L, Reyes-Urueña J, Agustí C, Kustec T, Serdt M, Klavsl, et al. The COBATEST network: monitoring and evaluation of HIV community-based practices in Europe, 2014–2016. *HIV Med.* 2018;19(Suppl 1):21–6. PMID: 29488701
10. European Centre for Disease Prevention and Control (ECDC). Thematic report: continuum of HIV care. Monitoring implementation of the Dublin Declaration on partnership to fight HIV/AIDS in Europe and Central Asia: 2017 progress report. Stockholm: ECDC; 2017. Available from: <https://www.ecdc.europa.eu/sites/default/files/documents/Continuum-of-HIV-care-2017.pdf>
11. Sulat JS, Prabandari YS, Sanusi R, Hapsari ED, Santoso B. The impacts of community-based HIV testing and counselling on testing uptake. *J Heal Res.* 2018;32(2):152–63. <https://doi.org/10.1108/JHR-01-2018-015>
12. Cohen MS, Chen YQ, McCauley M, Gamble T, Hosseinipour MC, Kumarasamy N, et al. Prevention of HIV-1 infection with early antiretroviral therapy. *N Engl J Med.* 2011;365(6):493–505. PMID: 21767103
13. Sullivan AK, Sperle I, Raben D, Amato-Gauci AJ, Lundgren JD, Yazdanpanah Y, et al. HIV testing in Europe: Evaluating the

- impact, added value, relevance and usability of the European Centre for Disease Prevention and Control (ECDC)'s 2010 HIV testing guidance. *Euro Surveill.* 2017;22(48):17-00323. PMID: 29208158
14. Fernández-López L, Reyes-Urueña J, Agustí C, Kustec T, Serdt M, Klavs I, et al. The COBATEST network: monitoring and evaluation of HIV community-based practices in Europe, 2014-2016. *HIV Med.* 2018;19(Suppl 1):21-6. PMID: 29488701
 15. HIV-COBATEST Project. Core indicators to monitor community based voluntary counselling and testing (CBVCT) for HIV Guidelines for CBVCT services. Field-test version. 2012. Available from: https://eurohivedat.eu/arxius/ehe_cdosmenu_cdosmenu_doc_3-CBVCT_core_indicators_field_test_version.pdf
 16. Joint United Nations Programme on HIV/AIDS (UNAIDS). Global AIDS Response progress reporting: monitoring the 2011 political declaration on HIV/AIDS: guidelines on construction of core indicators: 2012 reporting. Geneva: UNAIDS; 2011. Available from: https://unaids-test.unaids.org/sites/default/files/unaids/contentassets/documents/document/2011/JC2215_Global_AIDS_Response_Progress_Reporting_en.pdf
 17. World Health Organization (WHO). Guide for monitoring and evaluating national HIV testing and counselling (HTC) programmes: field-test version. Geneva: WHO; 2011. Available from: https://apps.who.int/iris/bitstream/handle/10665/44558/9789241501347_eng.pdf;jsessionid=2ADC244F085B39203050FA5C20C1A9FE?sequence=1
 18. European Centre for Disease Prevention and Control (ECDC). Implementing the Dublin Declaration on partnership to fight HIV/AIDS in Europe and Central Asia: 2010 progress Report. Stockholm: ECDC; 2010. Available from: https://www.ecdc.europa.eu/sites/default/files/media/en/publications/Publications/100720_implementing_dublin_declaration_hiv_aids_2010_progress_report.pdf
 19. Abbott. ALERE Determine HIV-1/2 package insert. 2011. [Accessed: 23 Jan 2020]. Available from: <https://www.globalpointofcare.abbott/en/product-details/determine-hiv-1-2.html>
 20. Mayhood MK, Afwamba IA, Odhiambo CO, Ndanu E, Thielman NM, Morrissey AB, et al. Validation, performance under field conditions, and cost-effectiveness of Capillus HIV-1/HIV-2 and determine HIV-1/2 rapid human immunodeficiency virus antibody assays using sequential and parallel testing algorithms in Tanzania. *J Clin Microbiol.* 2008;46(12):3946-51. <https://doi.org/10.1128/JCM.01045-08> PMID: 18923015
 21. Abbott. Alere Determine HIV-1/2 Ag/Ab Combo Serum / Plasma Procedure Product Demo (English). Scarborough: Abbott; 2019. [Accessed: 23 Jan 2020]. Available from: <https://www.globalpointofcare.abbott/en/product-details/determine-1-2-ag-ab-combo.html>.
 22. Carlberg C. More predictive analytics: Microsoft Excel. Indianapolis: QUE; 2016.
 23. Dahl A. Optimal linkage to care among MSM: a practical guide for CBVCT's and points of care. Barcelona: Euro HIV EDAT; 2017. Available from: https://eurohivedat.eu/arxius/ehe_docsmenu_docsmenu_doc_128-20131101_Do5_00_OTH_1_EN_PS.pdf
 24. Branson BM. Point-of-Care Rapid Tests for HIV Antibodies. Patientennahe Schnelltests für den Nachweis von HIV-Antikörpern. *Lab Med.* 2003;27(7-8):288-95. Available from: <http://doi.wiley.com/10.1046/j.1439-0477.2003.03049.x>
 25. Peeling RW, Holmes KK, Mabey D, Ronald A. Rapid tests for sexually transmitted infections (STIs): the way forward. *Sex Transm Infect.* 2006;82(Suppl 5):v1-6. <https://doi.org/10.1136/sti.2006.024265> PMID: 17151023
 26. Conway DP, Guy R, Davies SC, Couldwell DL, McNulty A, Smith DE, et al. Rapid HIV testing is highly acceptable and preferred among high-risk gay and bisexual men after implementation in Sydney sexual health clinics. New South Wales. 2015.
 27. Conway DP, Guy R, McNulty A, Couldwell DL, Davies SC, Smith DE, et al. Effect of testing experience and profession on provider acceptability of rapid HIV testing after implementation in public sexual health clinics in Sydney. *HIV Med.* 2015;16(5):280-7. PMID: 25604470
 28. Reyes-Urueña JM, Campbell CNJ, Vives N, Esteve A, Ambrosioni J, Tural C, et al. Estimating the HIV undiagnosed population in Catalonia, Spain: descriptive and comparative data analysis to identify differences in MSM stratified by migrant and Spanish-born population. *BMJ Open.* 2018;8(2):e018533. PMID: 29490955
 29. Fernández-López L, Folch C, Majó X, Gasulla L, Casabona J, Fernandez-Lopez L. Implementation of rapid HIV and HCV testing within harm reduction programmes for people who inject drugs: a pilot study. *AIDS Care.* 2016;28(6):712-6. <https://doi.org/10.1080/09540121.2016.1164290> PMID: 27007000
 30. Croxford S, Yin Z, Burns F, Copas A, Town K, Desai S, et al. Linkage to HIV care following diagnosis in the WHO European Region: A systematic review and meta-analysis, 2006-2017. *PLoS One.* 2018;13(2):e0192403. Available from: <http://www.ncbi.nlm.nih.gov/pubmed/29451875> <https://doi.org/10.1371/journal.pone.0192403> PMID: 29451875
 31. Meulbroek M, Dalmau-Bueno A, Pujol F. Adjusted criteria for point-of-care HIV-RNA testing leads to improved detection of acute HIV infection. *HIV Research for Prevention (HIVR4P)* 2018; 21-25 October 2018, Madrid, Spain. Abstract Po603.
 32. Ogaz D, Miltz AR, Desai S, Saunders J, Charlett A, Gill ON, et al. Preparing for PrEP in England: Prevalence and incidence of HIV and bacterial STIs. Conference on Retroviruses and Opportunistic Infections (CROI); 4-7 March 2019, Seattle, United States. Abstract 48. Available from: <http://www.croiconference.org/sessions/preparing-prep-england-prevalence-and-incidence-hiv-and-bacterial-stis>
 33. Nwokolo N, Hill A, McOwan A, Pozniak A. Rapidly declining HIV infection in MSM in central London. *Lancet HIV.* 2017;4(11):e482-3. [https://doi.org/10.1016/S2352-3018\(17\)30181-9](https://doi.org/10.1016/S2352-3018(17)30181-9) PMID: 29066095
 34. Reyes-Urueña J, Montoliu A, Bruguera A, Miró JM, Podzamczar D, Domingo P, et al. Impact of universal treatment on the dynamics of viral load, Catalonia and the Balearic Islands. PISCIS cohort. 23rd International Workshop on HIV and Hepatitis Observational Databases (IWHOD). 28-30 March 2019, Athens, Greece. Available from: <https://www.researchgate.net/project/PISCIS-Cohort/update/5c9ce9183843b0342433f9af>.
 35. Rocha M, Pujol Roca F, SazBerges J, Chanos S, Polkas G, Mattioli S, et al. High contribution, low public funding: Southern European Checkpoints' role in HIV detection in 4 countries. HepHIV2019 Bucharest Conference: Challenges of Timely and Integrated Testing and Care; 28-30 January 2019, Bucharest, Romania. Available from: https://www.eurotest.org/Portals/0/PS1_1_High%20contribution%2C%20low%20public%20funding%20Southern%20European%20Checkpoints%27%20role%20in%20HIV%20detection%20in%204%20countries.pdf

License, supplementary material and copyright

This is an open-access article distributed under the terms of the Creative Commons Attribution (CC BY 4.0) Licence. You may share and adapt the material, but must give appropriate credit to the source, provide a link to the licence and indicate if changes were made.

Any supplementary material referenced in the article can be found in the online version.

This article is copyright of the authors or their affiliated institutions, 2020.

The experience of point-of-care testing for influenza in Scotland in 2017/18 and 2018/19 – no gain without pain

Elizabeth M Dickson^{1,2}, Diogo FP Marques², Sandra Currie², Annette Little², Kirsty Mangin², Michael Coyne², Arlene Reynolds², Jim McMenamin², David Yirrell^{2,3}

1. European Public Health Microbiology Training Programme (EUPHEM), European Centre for Disease Prevention and Control (ECDC), Stockholm, Sweden
2. Health Protection Scotland, Public Health Scotland, Glasgow, United Kingdom
3. Department of Medical Microbiology, Ninewells Hospital, Dundee, United Kingdom

Correspondence: Elizabeth M Dickson (Elizabeth.Dickson2@nhs.net)

Citation style for this article:

Dickson Elizabeth M, Marques Diogo FP, Currie Sandra, Little Annette, Mangin Kirsty, Coyne Michael, Reynolds Arlene, McMenamin Jim, Yirrell David. The experience of point-of-care testing for influenza in Scotland in 2017/18 and 2018/19 – no gain without pain. *Euro Surveill.* 2020;25(44):pii=1900419. <https://doi.org/10.2807/1560-7917.ES.2020.25.44.1900419>

Article submitted on 27 Jun 2019 / accepted on 06 Jul 2020 / published on 05 Nov 2020

Background: During the 2017/18 and 2018/19 influenza seasons, molecular amplification-based point-of-care tests (mPOCT) were introduced in Scotland to aid triaging respiratory patients for hospital admission, yet communication of results to national surveillance was unaccounted for. **Aim:** This retrospective study aims to describe steps taken to capture mPOCT data and assess impact on influenza surveillance. **Methods:** Questionnaires determined mPOCT usage in 2017/18 and 2018/19. Searches of the Electronic Communication of Surveillance in Scotland (ECOSS) database were performed and compared with information stored in laboratory information management systems. Effect of incomplete data on surveillance was determined by comparing routine against enhanced data and assessing changes in influenza activity levels determined by the moving epidemic method. **Results:** The number of areas employing mPOCT increased over the two seasons (6/14 in 2017/18 and 8/14 in 2018/19). Analysis of a small number of areas (n=3) showed capture of positive mPOCT results in ECOSS improved between seasons and remained high (>94%). However, capture of negative results was incomplete. Despite small discrepancies in weekly activity assessments, routine data were able to identify trend, start, peak and end of both influenza seasons. **Conclusion:** This study has shown an improvement in capture of data from influenza mPOCT and has highlighted issues that need to be addressed for results to be accurately captured in national surveillance. With the clear benefit to patient management we suggest careful consideration should be given to the connectivity aspects of the technology in order to ensure minimal impact on national surveillance.

Introduction

Point-of-care tests (POCT) for influenza have been available since the late 1990s [1]. However, these were relatively insensitive tests relying on the detection of viral antigens. More recently, POCT using molecular nucleic acid amplification (mPOCT), which have increased sensitivity and are comparable to the gold standard laboratory PCR tests (hereafter named as laboratory-derived tests/results), have become available making them an attractive and acceptable option for frontline healthcare services. mPOCT have been implemented and validated within hospital settings [2-8], and community settings [9]. A study performed in 2019 reported that the use of mPOCT in an emergency department in London was associated with reduced nosocomial transmission of influenza [3]. Another study from the Netherlands documented a positive experience with mPOCT in one teaching hospital, reporting reduced turnaround times, improved patient flow and estimated savings of roughly EUR 400,000 [4].

Influenza surveillance is an important public health activity for ensuring that there are adequate health service resources available and appropriate interventions accessible, particularly for those who are at risk of complications of influenza [10,11]. In Scotland, influenza activity is monitored on a weekly basis during the winter period through a wide range of surveillance components. The national influenza surveillance is composed of laboratory results from diagnostic and reference laboratories. These are transferred electronically from individual laboratory information management systems (LIMS) to the Electronic Communication of Surveillance in Scotland (ECOSS) database, managed by Health Protection Scotland (HPS).

During the 2017/18 influenza season, there were moderate to high levels of influenza activity reported

TABLE 1

Completeness of positive and negative influenza mPOCT results transferred from LIMS to ECOSS, Scotland, influenza seasons 2017/18 and 2018/19

mPOCT result	Area	Season 2017/18 ^a			Season 2018/19 ^a			DIFF
		ECOSS mPOCT	LIMS mPOCT	Completeness (%)	ECOSS mPOCT	LIMS mPOCT	Completeness (%) ^b	
Positive	D	164	185	88.6	227	242	93.8	5.2
	F	539	838	64.3	559	578	96.7	32.4
	M	NA	NA	NA	202	199	>100	–
Negative ^c	D	NA	NA	NA	NA	NA	NA	–
	F	86	1,172	7.3	53	1,333	4.0	–3.4
	M	NA	NA	NA	NA	NA	NA	–

DIFF: difference; ECOSS: Electronic Communication of Surveillance in Scotland database; LIMS: laboratory information management system; mPOCT: molecular amplification-based point-of-care tests; NA: not available.

^a Results were obtained from tests carried out from week 40 2017 to week 20 2018 (influenza season 2017/18) and from week 40 2018 to week 20 2019 (influenza season 2018/19).

^b Completeness of data transferred from individual LIMS to the ECOSS database. Completeness calculated as number of ECOSS mPOCT results (positive or negative) / number of LIMS mPOCT results (positive or negative).

^c Negative results were generally not transferred to ECOSS. They were available for area F due to the laboratory in this area having pre-existing data transfer in place for all influenza test results.

across Scotland, putting significant pressure on bed occupancy in an already stretched hospital system (data not shown). mPOCT were rapidly introduced in many of the 14 territorial health boards in Scotland as a means of triaging for hospital admission. The introduction of mPOCT was to supplement and not replace routine testing and therefore resulted in an increase in the total number of patients tested. This had a positive effect on local bed occupancy, treatment and infection control interventions [12]. However, due to the speed of introduction, provision had not necessarily been made to enable capture of the results to ECOSS, and the impact on national influenza surveillance in Scotland was potentially compromised. Prior to the start of the 2018/19 season, HPS attempted to assess and find ways to mitigate the loss of national data as experienced in the previous season. This retrospective study aims to describe the steps taken to capture mPOCT data, assess the impact on influenza surveillance and describe the potential public health challenges resulting from the mPOCT roll-out.

Methods

Setting and study population

Scotland is divided into fourteen territorial health boards (hereafter referred to as areas A-N), which collectively provide healthcare for ca 5.4 million inhabitants. Healthcare can be given at a number of institutions from general practices, community pharmacies, out-of-hours clinics and medical receiving hospitals. Any of these services could potentially offer mPOCT for influenza, but the services that used this technology in the 2017/18 and 2018/19 influenza seasons were acute hospital-based. The population studied was therefore the total number of patients that presented with influenza-like illness to an acute hospital-based service, were tested for influenza using mPOCT and had the results transferred to LIMS.

mPOCT implementation questionnaire

At the end of the 2017/18 influenza season, a questionnaire was developed (Supplement 1) and sent to areas A-N to determine the scale of mPOCT implementation. This was followed by a teleconference with all respondents that reported the use of mPOCT for influenza. Information requested in the questionnaire included the test manufacturer, location of the testing unit, who carried out the tests, how quality assessment was performed, what testing protocols were followed and how the results were reported. This led to the development of a nationally agreed advisory statement in November 2018 on the preferred way to implement mPOCT [12]. In 2018/19, a similar questionnaire (Supplement 2) was distributed to areas A-N before the beginning of the influenza season, but more emphasis was placed on the transfer of mPOCT results to LIMS, whether manual entry of results was required and what codes were assigned to ensure identification of mPOCT.

Analysis of data transfer from LIMS to ECOSS

Influenza laboratory results available in ECOSS were analysed and text fields searched to identify keywords or codes that would indicate that the influenza test was performed using mPOCT (as reported in the mPOCT implementation questionnaire). ECOSS records were then categorised as mPOCT positive or mPOCT negative results and aggregated to obtain weekly counts for each laboratory. Data were aggregated from week 40 2017 to week 20 2018 (season 2017/18) and from week 40 2018 to week 20 2019 (season 2018/19).

Completeness of mPOCT data in ECOSS

Extracts of the equivalent LIMS mPOCT data for the above periods were requested from a small number of participating areas (n = 3) to assess the completeness of both positive and negative ECOSS mPOCT results. Completeness was calculated as:

FIGURE 1

Comparison of rate of positive influenza tests per 100,000 population between the ECOSS routine data and ECOSS enhanced data collection methods for area F during (A) influenza season 2017/18 and (B) influenza season 2018/19, Scotland

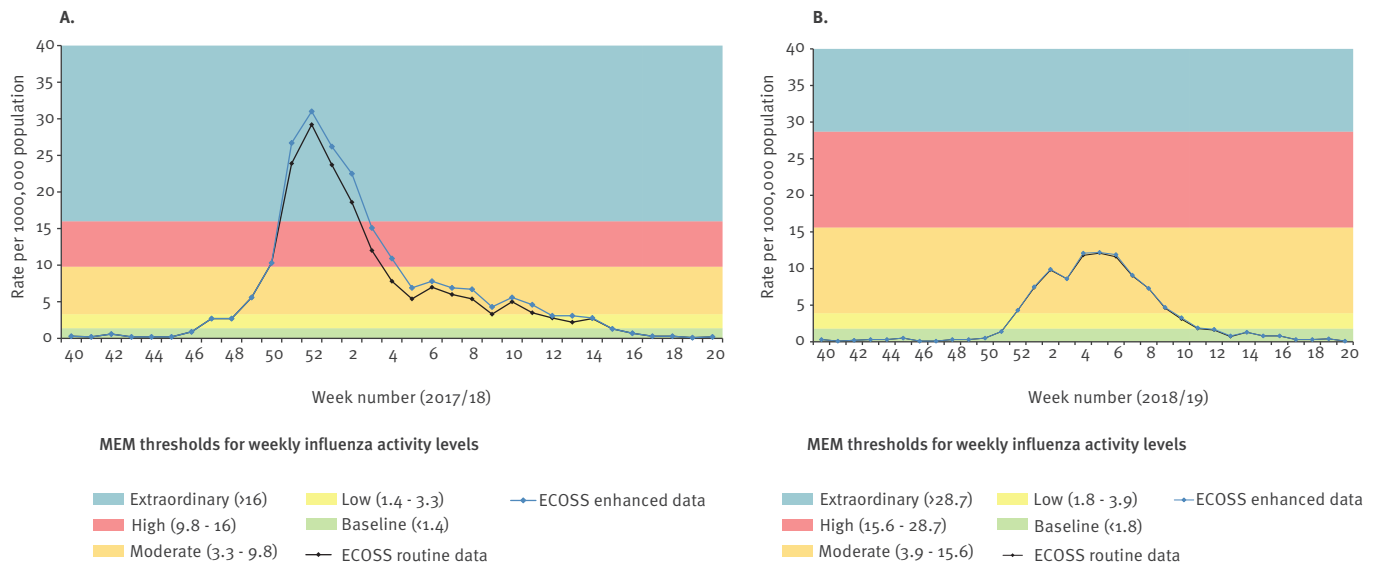

ECOSS: Electronic Communication of Surveillance in Scotland database; MEM: moving epidemic method.

Results were obtained from tests carried out from week 40 2017 to week 20 2018 (influenza season 2017/18) and from week 40 2018 to week 20 2019 (influenza season 2018/19).

Pearson correlation coefficient between ECOSS routine and ECOSS enhanced data was (A) ($r=0.996$) and (B) ($r=0.999$).

number of ECOSS mPOCT results (positive or negative) / number of LIMS mPOCT results (positive or negative).

Impact of mPOCT on microbiological surveillance data

For each participating area, the impact of incomplete or lacking mPOCT data in the Scottish influenza surveillance was assessed by comparing ECOSS routine data (nationally agreed data electronically transferred from the local laboratory (LIMS), which may or may not include all mPOCT local laboratory-derived results) to ECOSS enhanced data (ECOSS data with mPOCT results identified through text searches were removed and replaced by the LIMS extracted mPOCT data to avoid double counting). In order to compare these data, we calculated two indicators: (i) proportion of positives (number of positive results divided by the number of tests performed) and (ii) rate of positives (number of positive results expressed per 100,000 population).

Proportion of mPOCT vs laboratory-derived positive results and tests

We estimated mPOCT usage between the two seasons as a proportion of all positive test results i.e. laboratory-derived plus mPOCT (ECOSS enhanced data). For this calculation we divided the mPOCT figure provided by LIMS by the figure provided by ECOSS enhanced data.

Statistical analysis

For each indicator value we calculated the Pearson correlation coefficient (r -value) and compared the respective influenza activity levels to investigate whether having complete mPOCT data would change our interpretation of influenza weekly activity. Weekly influenza activity level was defined using the moving epidemic method (MEM) [13]. MEM is a standardised method for reporting influenza activity adopted by the European Centre for Disease Prevention and Control that allows intra- and inter-country comparisons. We used MEM to calculate intensity thresholds and identify influenza activity levels based on the two indicators mentioned above (proportion of positives and rate of positives). The MEM thresholds were calculated using the 'mem' R package (R software version 3.5.1 (R Foundation, Vienna, Austria), and the package 'mem' version 2.14) using the predefined configuration, i.e. fixed criterium method and a slope parameter of 2.8. For each indicator, and based on historical data since the 2010/11 season, MEM defined the following weekly influenza activity levels [14]: baseline (data below epidemic threshold); low (data between epidemic and low thresholds); moderate (data between low and medium thresholds); high (data between medium and high thresholds); extraordinary (data above high threshold).

Ethical statement

This study used only aggregate and non-identifiable data, therefore no ethical approval was necessary.

FIGURE 2

Comparison of proportion of positive^a influenza tests between the ECOSS routine data and ECOSS enhanced data collection methods for area F during (A) influenza season 2017/18 and (B) influenza season 2018/19, Scotland

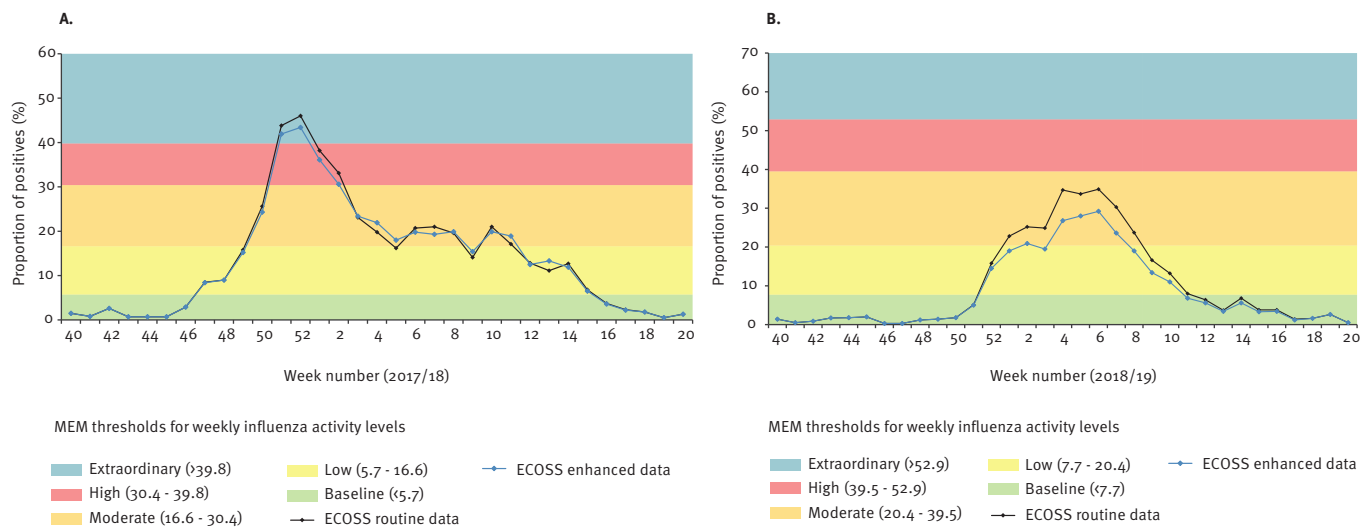

ECOSS: Electronic Communication of Surveillance in Scotland database; MEM: moving epidemic method.

^a Proportion of positives calculated as number of positive tests / number of total tests.

Results were obtained from tests carried out from week 40 2017 to week 20 2018 (influenza season 2017/18) and from week 40 2018 to week 20 2019 (influenza season 2018/19).

Pearson correlation coefficient between ECOSS routine and ECOSS enhanced data was (A) ($r=0.996$) and (B) ($r=0.998$).

Results

mPOCT implementation questionnaire

During the 2017/18 influenza season, six of 14 areas reported use of influenza mPOCT compared with eight of 14 in the 2018/19 season (Supplement 3). The majority of mPOCT were used at acute hospital admissions or emergency departments during the 2017/18 season, with more specialised departments (e.g. oncology and paediatric ICU) using mPOCT during the 2018/19 season. With the exception of outlying hospitals where testing was performed by laboratory staff, the majority of mPOCT were performed by ward staff.

According to additional comments received in the questionnaires, training in the first instance was usually performed by the mPOCT manufacturers, with some departments supplementing this with training by laboratory staff. Quality assessment was minimal due to time and cost restraints, which led to shorter verification processes and general acceptance of the manufacturer's sensitivity and specificity claims. All areas agreed a local protocol with clinicians as to who should be tested and under what circumstances. It was noted that during the 2017/18 season this was not always adhered to and an increase in number of tests was reported due to testing of asymptomatic individuals, contacts or members of staff. In all cases, patient management decisions were based entirely on the result of the mPOCT, including use of personal protective

equipment (PPE), antiviral treatment, admission and transfer.

In the 2017/18 influenza season, none of the areas had direct transfer of test results from the mPOCT machine to their LIMS, thus data transfer was performed manually (frequency variable). In the 2018/19 influenza season, despite differences between areas, manual entry of mPOCT results was required at some stage of the data transfer process. Of note, two areas used a central computational system (middleware), which received data from multiple mPOCT machines before transferring to LIMS. However, this link did not work and manual data extraction from the middleware was required. In addition, information received from the 2018/19 questionnaire showed there was no consistent use of identifiable mPOCT codes across areas.

Analysis of data transfer from LIMS to national database

The analysis of ECOSS data only identified a small number of areas that had records categorised as mPOCT based on text searches (two of six in 2017/18: areas D and F; and three of eight in 2018/19: areas D, F and M). Due to this, only these areas were further analysed and investigated for completeness. The weekly aggregated counts for the 2017/18 and 2018/19 seasons were then requested from these areas. Among areas D, F and M, only area F had negative results available through ECOSS, but this was due to the laboratory in this area

TABLE 2

Proportion of influenza mPOCT among all influenza tests^a performed in area F by influenza season, and proportion of positive influenza mPOCT among all positive influenza tests^a for areas F, M and D by season, Scotland, influenza seasons 2017/18 and 2018/19

Tests	Area	Season 2017/18					Season 2018/19				
		ECOSS mPOCT tests	LIMS mPOCT tests	ECOSS routine tests ^a	ECOSS enhanced tests ^b	Proportion of mPOCT tests (%) ^c	ECOSS mPOCT tests	LIMS mPOCT tests	ECOSS routine tests ^a	ECOSS enhanced tests ^b	Proportion of mPOCT tests (%) ^c
All tests	F	625	2,010	11,571	12,956	15.5	612	1,911	9,511	10,810	17.7
Positive tests	F	539	838	2,166	2,465	34.0	559	578	1,191	1,210	47.8
	M	NA	NA	NA	NA	NA	202	199	443	440	45.2
	D	164	185	939	960	19.3	227	242	567	582	41.6

ECOSS: Electronic Communication of Surveillance in Scotland database; LIMS: laboratory information management system; mPOCT: molecular amplification-based point-of-care tests; NA: not available.

^a Laboratory-derived + mPOCT.

^b (ECOSS routine – ECOSS mPOCT) + LIMS mPOCT.

^c LIMS mPOCT tests divided by ECOSS enhanced tests.

Results were obtained from tests carried out from week 40 2017 to week 20 2018 (influenza season 2017/18) and from week 40 2018 to week 20 2019 (influenza season 2018/19).

Proportion of mPOCT tests are a potential proportion due to not all LIMS mPOCT results being reported to ECOSS.

having pre-existing data transfer in place for all influenza test results.

Completeness of mPOCT data in ECOSS

The results presented in Table 1 show the proportion of mPOCT positive results captured by ECOSS i.e. completeness increased between the 2017/18 and 2018/19 seasons for areas D and F by 5.2% and 32.4%, respectively. In the 2018/19 season, a very high proportion of mPOCT positive results was captured by ECOSS (93.8%, 96.7% and >100% for areas D, F and M, respectively). The proportion of mPOCT negative results captured by ECOSS for area F was very low in both seasons (7.3% and 4% in 2017/18 and 2018/19, respectively). It was not possible to calculate the completeness of mPOCT negative results in ECOSS for areas D and M as influenza negative results from laboratories in these areas were not routinely captured by ECOSS. Discrepancies in mPOCT results between ECOSS and LIMS, as seen in area M, were determined to be a result of differences in coding, subsequent incorrect data entry into text fields, and the code not being recognised by the software during data extraction.

Impact of mPOCT on influenza surveillance data

Data obtained from area F were used to assess the impact of mPOCT in influenza surveillance as it enabled the analysis of both positivity rate and proportion of positives (required negative results). In terms of rate of positives, the weekly influenza activity level based on ECOSS enhanced data was similar to that of ECOSS routine data (Figure 1). Both seasons' data showed a very high correlation coefficient (0.996 and 0.999 in season 2017/18 and 2018/19, respectively). This is in line with the high proportion of positives being captured by ECOSS in both seasons (Table 1). The low proportion of mPOCT negatives being captured by ECOSS meant an overestimation of the proportion of positives

calculated during the two seasons (Figure 2), i.e. the ECOSS routine data showed an artificially higher proportion of positives than the ECOSS enhanced data. However, the overall trends remained similar and influenza activity level interpretation was similar for both ECOSS datasets for most weeks. There was one week in the 2017/18 season (Figure 2A) where level interpretation would have been moderate instead of low if we were using ECOSS enhanced data (week 5 2018). In the 2018/19 season, if we were using the ECOSS enhanced data there would have been 3 weeks where activity level would have been low instead of moderate (weeks 1, 3, and 8 in 2019) and one week where activity level would have been baseline instead of low (week 11 2019) (Figure 2B). Despite these sporadic discrepancies, the data available in ECOSS for area F allowed the identification of the start, peak and end of both influenza seasons. The intensity of the peak and the timing of the start and end of the seasons were the same regardless of using ECOSS routine or ECOSS enhanced data.

Proportion of mPOCT vs laboratory-derived positive results and tests

There was an increase in the proportion of mPOCT among all tests performed (laboratory-derived and mPOCT together) in area F from 15.5% to 17.7% in the 2017/18 and 2018/19 season, respectively (Table 2). In addition, the proportion of mPOCT positive results among all positive results increased from 34% (2017/18 season) to 48% (2018/19 season). An increase in the proportion of mPOCT positive results among all positive results was also seen in area D (19% to 42% in the 2017/18 and 2018/19 season, respectively), and in the 2018/19 season the proportion of mPOCT positive results for area M was 45.2% (Table 2).

Discussion

The 2017/18 influenza season was dominated by influenza A(H3N2) which is more likely to affect the elderly

population [15], but with a noticeable tail of Influenza B cases which affects both the young and the elderly [16]. mPOCTs were rapidly introduced by health boards across Scotland and this study reports the consequential difficulties of this technology for the national microbiological surveillance of influenza.

Although different mPOCT systems were used in the different areas, the principal technology is the same and therefore does not affect the results. Most hospitals wanted to link the mPOCT machines directly to their LIMS. However this is technically difficult, requires time and local IT support, and is often expensive as LIMS providers charge for changes to their systems. Inevitably, in almost all cases an mPOCT machine to LIMS link was not established. Following the 2017/18 season, areas were encouraged to include a code in their mPOCT results and report this to HPS in order to enable differentiation between mPOCT generated results from laboratory results. However, this failed to be achieved in the 2018/19 season, possibly be due to the speed at which mPOCT were implemented, and compatibility issues between the different systems used.

Data from a small number of areas suggest that in most instances the positive cases of influenza are being captured by the national database (ECOSS). This is in contrast with the negative results where there is a sizeable gap between local and national figures. Incomplete mPOCT negative results data in the national surveillance system will overestimate the proportion of positives and potentially overestimate the weekly influenza activity levels. Despite this, data for area F showed that the differences in weekly influenza activity level were minimal and the existing microbiological surveillance was able to identify the trend, start, peak and end of the influenza epidemics in the 2017/18 and 2018/19 seasons. mPOCT accounted for ca 18% of all tests undertaken in area F, and up to 48% of all influenza positive results. The increased use of mPOCT and increased number of positive results reinforces the need for accurate data capture at national level. Work is ongoing and HPS along with the Scottish Microbiology and Virology Network (SMVN) are working with laboratories to standardise and improve data collection. However, the decision on which mPCOT machine to choose, and how to transfer the data is both laboratory and resource dependent.

It is important to note that, in addition to the microbiological surveillance, the national influenza surveillance is composed of other components such as calls concerning respiratory problems to the National Health Service (NHS) 24 helpline, GP consultation rates for influenza-like illness, outbreaks, severe acute respiratory illness and mortality surveillance. These are essential not only to capture the influenza burden in different parts of the population/healthcare but also to complement each other when there are changes in

the surveillance system, such as the introduction of mPOCT.

The data presented here are the first that we are aware of that attempt to quantify the impact that mPOCT for influenza has had on the information being received by public health authorities. We have shown the importance of recognising what mPOCT results should be recorded. All users need to be aware of the impact that each of the variables will have on the estimation of proportion of positives, and how the data are used to assess influenza activity both at local and national level. The main challenge is capturing the mPOCT negative results within ECOSS in order to have an accurate denominator and to avoid overestimating the proportion of positives indicator. With this evidence now available, it is hoped that many of these issues can be addressed for future influenza seasons. While reporting from a Scottish perspective we anticipate that our observations are likely to reflect common issues found in other European countries in which the introduction of mPOCT for influenza pose a challenge for data recording, and as a consequence, the accuracy and completeness of surveillance information.

Limitations

There are a number of caveats to our data and it is important to highlight them as a way of suggesting areas for consideration and improvement when planning implementation of mPOCT. This study covered only a sample of areas in Scotland therefore the total impact of incomplete or lack of mPOCT data in the national surveillance system (ECOSS) is still unknown. The impact is likely to be larger if the use of mPOCT increases dramatically and accounts for the majority of influenza tests. It is also important to stress that front-line users, e.g. nursing staff, may not always recognise the critical nature of recording and reporting every mPOCT result. Further work is required to quantify this and to identify laboratory-specific challenges that will need to be addressed. While ECOSS enhanced data were calculated to avoid double counting any mPOCT results, there may still be some instances of duplication in which identifiers were close, but not exactly matching. It was noted that during the 2017/18 season, adherence to local protocols was not always evident and some testing was performed on asymptomatic individuals, contacts or members of staff, although this number was minimal. There were a number of areas that were subject to manual data entry, which carries a risk of transcription errors. In order to minimise this risk, we recommend that all steps are automated and linked to the LIMS and ECOSS. The method of identifying an mPOCT via text searches in ECOSS is suboptimal and there is the potential for misclassification. The use of MEM applied to microbiological surveillance data depends on historical data as described elsewhere [17]. The lack of reliable and complete microbiological data (including mPOCT) can therefore limit the potential application of this methodology to assess influenza activity at local level where data might be limited.

In order to address some of the issues that have been discussed, a separate programme to improve all microbiology data received at HPS is currently underway. The ECOSS Data Roll Out Improvement Project (EDRIP) will review all data received from all NHS clinical microbiology laboratories in Scotland, including mPOCT data, over a two-year period. It is hoped that any issues identified will be addressed quickly to result in a continuous improvement to the quality of all data held within ECOSS. This will ensure that the impact of the influenza mPOCT programme in Scotland can be reliably assessed, and effectiveness of any interventions monitored.

Conclusion

Through close liaison with the Scottish territorial health boards and respective laboratories, we have shown there was an improvement in mPOCT data collection between the 2017/18 and 2018/19 influenza seasons. Further work is needed to ensure accurate numbers of positive and negative mPOCT results are collected in ECOSS, including set up of direct LIMS connectivity, education of frontline users on the impact of missing results, and continued development and audit of local protocols. Due to the benefits for patient management, the use of mPOCT for influenza is likely to continue and implementation of these systems should be carefully managed in order to reduce the impact on national microbiological surveillance.

empirical study and modelling is required to optimise their use for public health benefit.

Acknowledgements

We would like to thank all the laboratory staff that responded to the questionnaires and requests for data. We would like to thank Professor Rory Gunson for his expert opinion on the laboratory data.

Conflict of interest

None declared.

Authors' contributions

EMD, DFPM, JM and DY developed the research idea. DFPM carried out the body of the analysis with SC, AL, KM and DY providing additional results. EMD, DFPM and DY wrote the manuscript. All other authors contributed to the discussion and comments on the manuscript.

References

- Public Health England (PHE). Point of care tests for influenza and other respiratory viruses. London: PHE; 2018. Available from: <https://www.gov.uk/government/publications/point-of-care-tests-for-influenza-and-other-respiratory-viruses>
- Maignan M, Viglino D, Hablot M, Termoz Masson N, Lebeugle A, Collomb Muret R, et al. Diagnostic accuracy of a rapid RT-PCR assay for point-of-care detection of influenza A/B virus at emergency department admission: A prospective evaluation during the 2017/2018 influenza season. *PLoS One*. 2019;14(5):e0216308. <https://doi.org/10.1371/journal.pone.0216308> PMID: 31063477
- Youngs J, Marshall B, Farragher M, Whitney L, Glass S, Pope C, et al. Implementation of influenza point-of-care testing and patient cohorting during a high-incidence season: a retrospective analysis of impact on infection prevention and control and clinical outcomes. *J Hosp Infect*. 2019;101(3):276-84. <https://doi.org/10.1016/j.jhin.2018.11.010> PMID: 30471317
- Lankelma JM, Hermans MHA, Hazenberg EHL, Macken T, Dautzenberg PLJ, Koeijvoets KCMC, et al. Implementation of point-of-care testing and a temporary influenza ward in a Dutch hospital. *Neth J Med*. 2019;77(3):109-15. PMID: 31012428
- Brendish NJ, Malachira AK, Clark TW. Molecular point-of-care testing for respiratory viruses versus routine clinical care in adults with acute respiratory illness presenting to secondary care: a pragmatic randomised controlled trial protocol (ResPOC). *BMC Infect Dis*. 2017;17(1):128. <https://doi.org/10.1186/s12879-017-2219-x> PMID: 28166743
- Rogan DT, Kochar MS, Yang S, Quinn JV. Impact of Rapid Molecular Respiratory Virus Testing on Real-Time Decision Making in a Pediatric Emergency Department. *J Mol Diagn*. 2017;19(3):460-7. <https://doi.org/10.1016/j.jmoldx.2017.01.009> PMID: 28341587
- Brotons P, Nogueras M-M, Valls A, Larrauri A, Dominguez A, Launes C, et al. Impact of Rapid On-demand Molecular Diagnosis of Pediatric Seasonal Influenza on Laboratory Workflow and Testing Costs: A Retrospective Study. *Pediatr Infect Dis J*. 2019;38(6):559-63. <https://doi.org/10.1097/INF.0000000000002224> PMID: 31117115
- You JHS, Tam LP, Lee NLS. Cost-effectiveness of molecular point-of-care testing for influenza viruses in elderly patients at ambulatory care setting. *PLoS One*. 2017;12(7):e0182091. <https://doi.org/10.1371/journal.pone.0182091> PMID: 28750092
- Klepser DG, Klepser ME, Smith JK, Dering-Anderson AM, Nelson M, Pohlen LE. Utilization of influenza and streptococcal pharyngitis point-of-care testing in the community pharmacy practice setting. *Res Social Adm Pharm*. 2018;14(4):356-9. <https://doi.org/10.1016/j.sapharm.2017.04.012> PMID: 28479019
- Rakocevic B, Grgurevic A, Trajkovic G, Mugosa B, Sipetic Grujicic S, Medenica S, et al. Influenza surveillance: determining the epidemic threshold for influenza by using the Moving Epidemic Method (MEM), Montenegro, 2010/11 to 2017/18 influenza seasons. *Euro Surveill*. 2019;24(12):1800042. <https://doi.org/10.2807/1560-7917.ES.2019.24.12.1800042> PMID: 30914080
- Green HK, Charlett A, Moran-Gilad J, Fleming D, Durnall H, Thomas DR, et al. Harmonizing influenza primary-care surveillance in the United Kingdom: piloting two methods to assess the timing and intensity of the seasonal epidemic across several general practice-based surveillance schemes. *Epidemiol Infect*. 2015;143(1):1-12. <https://doi.org/10.1017/S0950268814001757> PMID: 25023603
- Health Protection Scotland (HPS). SBAR: Joint SMVN/SHPN public health microbiology advisory. Statement for influenza point of care tests. Glasgow: HPS; 21 Nov 2018. Available from: <https://www.hps.scot.nhs.uk/web-resources-container/sbar-joint-smvnshpn-public-health-microbiology-advisory-statement-for-influenza-point-of-care-tests/>
- Vega T, Lozano JE, Meerhoff T, Snacken R, Mott J, Ortiz de Lejarazu R, et al. Influenza surveillance in Europe: establishing epidemic thresholds by the moving epidemic method. *Influenza Other Respir Viruses*. 2013;7(4):546-58. <https://doi.org/10.1111/j.1750-2659.2012.00422.x> PMID: 22897919
- Vega T, Lozano JE, Meerhoff T, Snacken R, Beauté J, Jørgensen P, et al. Influenza surveillance in Europe: comparing intensity levels calculated using the moving epidemic method. *Influenza Other Respir Viruses*. 2015;9(5):234-46. <https://doi.org/10.1111/irv.12330> PMID: 26031655
- Wong KC, Luscombe GM, Hawke C. Influenza infections in Australia 2009-2015: is there a combined effect of age and sex on susceptibility to virus subtypes? *BMC Infect Dis*. 2019;19(1):42. <https://doi.org/10.1186/s12879-019-3681-4> PMID: 30630435
- Lemaitre M, Carrat F. Comparative age distribution of influenza morbidity and mortality during seasonal influenza epidemics and the 2009 H1N1 pandemic. *BMC Infect Dis*. 2010;10(1):162. <https://doi.org/10.1186/1471-2334-10-162> PMID: 20534113
- Murray JLK, Marques DFP, Cameron RL, Potts A, Bishop J, von Wissmann B, et al. Moving epidemic method (MEM) applied to virology data as a novel real time tool to predict peak in seasonal influenza healthcare utilisation. The Scottish experience of the 2017/18 season to date. *Euro Surveill*. 2018;23(11):11-8. <https://doi.org/10.2807/1560-7917.ES.2018.23.11.18-00079> PMID: 29560854

License, supplementary material and copyright

This is an open-access article distributed under the terms of the Creative Commons Attribution (CC BY 4.0) Licence. You may share and adapt the material, but must give appropriate credit to the source, provide a link to the licence and indicate if changes were made.

Any supplementary material referenced in the article can be found in the online version.

This article is copyright of the authors or their affiliated institutions, 2020.

Retrospective analysis on confirmation rates for referred positive rotavirus samples in England, 2016 to 2017: implications for diagnosis and surveillance

Cristina C Celma^{1,2}, Stuart Beard^{1,2}, Amy Douglas³, Shan Wong¹, Nana-Kwame Osafo¹, Matthew Hannah⁴, Ashleigh Hale¹, Gabrielle Huggins¹, Shamez Ladhani⁵, Jake Dunning^{4,3}

1. Enteric Virus Unit, National Infection Service Laboratories, Public Health England, London, United Kingdom

2. These authors contributed equally to this work

3. Gastrointestinal Pathogens Unit, National Infection Service Laboratories, Public Health England, London, United Kingdom

4. High Containment Microbiology, National Infection Service Laboratories, Public Health England, London, United Kingdom

5. Immunisations and Countermeasures, National Infection Service, Public Health England, London, United Kingdom

Correspondence: Jake Dunning (jake.dunning@phe.gov.uk)

Citation style for this article:

Celma Cristina C, Beard Stuart, Douglas Amy, Wong Shan, Osafo Nana-Kwame, Hannah Matthew, Hale Ashleigh, Huggins Gabrielle, Ladhani Shamez, Dunning Jake. Retrospective analysis on confirmation rates for referred positive rotavirus samples in England 2016 to 2017: implications for diagnosis and surveillance. *Euro Surveill.* 2020;25(43):pii=1900375. <https://doi.org/10.2807/1560-7917.ES.2020.25.43.1900375>

Article submitted on 10 Jun 2019 / accepted on 01 Mar 2020 / published on 29 Oct 2020

Background: Rapid diagnostic tests are commonly used by hospital laboratories in England to detect rotavirus (RV), and results are used to inform clinical management and support national surveillance of the infant rotavirus immunisation programme since 2013. In 2017, the Public Health England (PHE) national reference laboratory for enteric viruses observed that the presence of RV could not be confirmed by PCR in a proportion of RV-positive samples referred for confirmatory detection. **Aim:** We aimed to compare the positivity rate of detection methods used by hospital laboratories with the PHE confirmatory test rate.

Methods: Rotavirus specimens testing positive at local hospital laboratories were re-tested at the PHE national reference laboratory using a PCR test. Confirmatory results were compared to original results from the PHE laboratory information management system. **Results:** Hospital laboratories screened 70.1% (2,608/3,721) of RV samples using immunochromatographic assay (IC) or rapid tests, 15.5% (578/3,721) using enzyme immunoassays (EIA) and 14.4% (535/3,721) using PCR. Overall, 1,011/3,721 (27.2%) locally RV-positive samples referred to PHE in 2016 and 2017 failed RV detection using the PHE reference laboratory PCR test. Confirmation rates were 66.9% (1,746/2,608) for the IC tests, 87.4% (505/578) for the EIA and 86.4% (465/535) for the PCR assays. Seasonal confirmation rate discrepancies were also evident for IC tests. **Conclusions:** This report highlights high false positive rates with the most commonly used RV screening tests and emphasises the importance of implementing verified confirmatory tests for RV detections. This has implications for clinical diagnosis and national surveillance.

Introduction

Rotavirus (RV) infection is a common cause of severe watery diarrhoea in young individuals around the world [1]. In healthy individuals, the disease is usually mild and self-limiting, with symptoms lasting between 3 and 8 days. However, in very young or immunocompromised patients, RV infection can cause more severe manifestations including fever, vomiting, abdominal pain and dehydration. There is no specific treatment for RV infection; oral rehydration and intravenous fluid supplementation can be administered to prevent or treat severe dehydration.

Prior to routine RV vaccination in the United Kingdom (UK), the burden of RV disease was estimated to be 750,000 diarrhoea episodes [2], and 14,300 diarrhoea-related hospital admissions of children under the age of five [3] every year, representing a considerable healthcare cost. In 2013, a monovalent live-attenuated RV vaccine was introduced into the UK infant immunisation programme as a two-dose schedule at 8 and 16 weeks of age. The programme resulted in a 77% reduction of laboratory-reported RV infections [4,5], and a 26% decrease in gastroenteritis-associated hospitalisation in young children [4,6]. It is estimated that the RV immunisation programme was associated with a GBP 12.5 million (EUR 13.7 million converted on 9 Sep 2020) saving in RV-associated healthcare costs within a year of implementation [6].

RV episodes are typically seasonal with most cases occurring during the winter and spring months (January to April in the temperate northern hemisphere). Following the introduction of RV immunisation, seasonal patterns have shifted, with shorter and more delayed periods of RV disease activity observed in

TABLE

Rotavirus referred positive samples and confirmation rates, England, 2016–2017 (n = 3,721)

Test	Samples		Confirmed		SE	95% CI	
	n	Use (%)	n	PPV (%)		Lower	Upper
RORT 1	34	0.9	5	14.7	6.2	6.2	31.1
RORT 2	187	5.0	166	88.8	2.3	83.4	92.6
RORT 3	1,165	31.3	774	66.4	1.4	63.7	69.1
RORT 4	117	3.1	69	59.0	4.6	49.8	67.5
RORT 5	6	0.2	2	33.3	21.1	7.2	76.3
RORT 6	26	0.7	9	34.6	9.5	18.8	54.7
RART 7	5	0.1	4	80.0	20	25.6	97.9
RART 8	111	3.0	101	91.0	2.7	84	95.1
RART 9	48	1.3	43	89.6	4.5	77.1	95.6
RART 10	56	1.5	44	78.6	5.5	65.8	87.5
RART 11	244	6.6	189	77.5	2.7	71.8	82.3
RART 12	130	3.5	98	75.4	3.8	67.2	82.1
RART 13	16	0.4	12	75.0	11.2	48.2	90.6
RART 14	14	0.4	12	85.7	9.7	55.9	96.6
RART 15	29	0.8	21	72.4	8.4	53.4	85.7
RART 16	115	3.1	65	56.5	4.6	47.3	65.3
RART 17	305	8.2	132	43.3	2.8	37.8	48.9
EIA Commercial 1	248	6.7	230	92.7	1.7	88.8	95.4
EIA Commercial 2	233	6.3	199	85.4	2.3	80.3	89.4
EIA Other	97	2.6	76	78.4	4.2	69	85.5
PCR Commercial 1	80	2.1	37	46.3	5.6	35.6	57.3
PCR Commercial 2	44	1.2	27	61.4	7.4	46.2	74.6
PCR Commercial 3	6	0.2	6	100.0	0	NA	NA
PCR In-house	405	10.9	395	97.5	0.8	95.5	98.7
Total	3,721	100	2,716	73.0	NA	NA	NA

CI: confidence interval; EIA: enzyme immunoassay; NA: not applicable; PPV: positive predictive value; RART: rotavirus and adenovirus rapid test; RORT: rotavirus only rapid test; RV: rotavirus; SE: standard error.

some countries such as the United States (US) and Belgium [7-9].

In England, National Health Service (NHS) hospital laboratories routinely test stool samples from patients with gastroenteritis for a number of viruses including RV in order to confirm the diagnosis and inform clinical management. A variety of detection methods are used by NHS hospital laboratories for RV screening [10], such as immunoassay-based methods (i.e. enzyme-linked immunosorbent assay and immunochromatographic) and molecular assay-based methods (i.e. reverse transcription and PCR).

As part of national surveillance of the RV immunisation programme in England, NHS hospital laboratories are actively requested to submit all positive RV stool samples to the Public Health England (PHE) Virus Reference Department (VRD) Enteric Virus Unit (EVU) reference laboratory for confirmation and additional characterisation to support the molecular surveillance of circulating RV strains. In recent years, an increasing number of positive RV samples submitted by NHS hospital laboratories failed molecular characterisation.

Therefore, a confirmatory PCR detection test was implemented at the PHE reference laboratory for all RV samples received; this PCR test is performed before attempting molecular characterisation. The PHE reference laboratory confirmatory PCR detection test identified a considerable proportion of RV-negative samples, suggesting a high rate of false positive results at some local NHS hospital laboratories.

The aim of this study was to determine the proportion of samples that tested positive for RV in local NHS hospital laboratories, were submitted to the PHE reference laboratory and were also positive using the PHE reference laboratory confirmatory PCR test. The study also aimed to compare the results of the PHE reference laboratory confirmatory PCR test with the results from the original RV testing method used by the NHS hospital laboratory. Variations in performance of the different tests during and outside the RV season were also assessed as part of the analysis.

FIGURE 1

Positive predictive values of (A) rapid tests vs EIA and PCR and (B) individual testing method for rotavirus infection, England, 2016–2017 (n = 3,721)

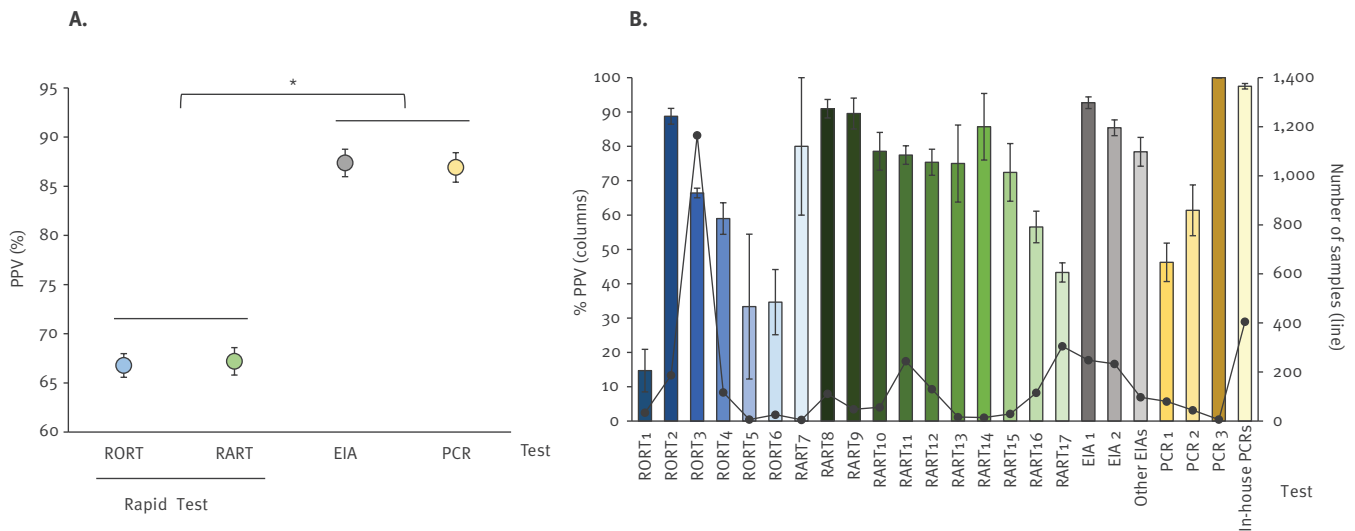

EIA: enzyme immunoassay; PPV: positive predictive values; RART: rotavirus and adenovirus rapid test; RORT: rotavirus only rapid test; *: significant difference ($p < 0.001$).

Methods

Data source

Samples received at the PHE reference laboratory from 5 January 2016 to 28 December 2017 were included in the analysis. Data were extracted from the PHE reference laboratory information management system, which contains all the information provided in the laboratory request form, along with the results of the PHE reference laboratory confirmatory PCR test. For samples where the RV screening method was not stated on the laboratory request form, the individual laboratories were contacted directly.

Segregation of tests and methodologies

Commercial rapid tests, enzyme immunoassays (EIA) and PCR tests were identified in this study. Of the seventeen types of commercial rapid tests used, six targeted RV only (RORT1 to RORT6) and 11 were designed for dual detection of RV and adenovirus (RART7 to RART17). For EIA, three subgroups were created: two commercially available kits (commercial EIA1 and commercial EIA2) and one group including other commercial or in-house tests (other EIAs). The PCR category was subdivided into four groups, including commercial (PCR1 to PCR3) and PCR assays developed in-house (in-house PCRs).

Rotavirus detection–PHE reference laboratory confirmatory PCR test targeting VP6 gene

Patients' stool samples received from referring laboratories across England were tested using real-time PCR (PHE reference laboratory confirmatory PCR) to determine the presence of RV RNA (n=3,729). Partial

amplification of the VP6 gene was performed as previously described [11,12] with modifications. Briefly, nucleic acid was extracted from 200µl of 10% faecal suspensions by automatic RNA extraction platform (MP96, Roche, Almere, the Netherlands or Qiasymphony, Qiagen, Hilden, Germany). A reverse transcription step was carried out with random hexamers (Invitrogen) followed by PCR amplification using primers VP6-F: 5'-GAC GGV GCR ACT ACA TGG T-3'; VP6-R: 5'-GTC CAA TTC ATN CCT GGT GG-3'; and probe VP6P: FAM5'-CCA CCR AAY ATG ACR CCA GCN GTA -3' MGB. cDNA was initially heated at 50°C for two minutes and 95°C for 2 min, followed by 35 PCR cycles at 95°C for 15 s and 60°C for one minute. Mengovirus was used as an internal process control (added before the nucleic acid extraction step) and detected using primers MengoF: 5'-GCG GGT CCT GCC GAA AGT-3', MengoR5'-GAA GTA ACA TAT AGA CAG ACG CAC AC-3' and probe: MengoP5'-VIC-ATC ACA TTA CTG GCC GAA GC-MGB-3'.

The limit of detection of the PHE reference laboratory confirmatory PCR test was determined by 10-fold serial dilutions of in vitro transcribed single stranded RNA derived from simian rhesus rotavirus (RRV) segment S6 as template. Copy number was calculated using the formula:

$$\text{copy number (molecules/}\mu\text{L)} = \frac{[\text{concentration (ng/}\mu\text{L)} \times 6.022 \times 10^{23} \text{ (molecules/mol)}]}{[\text{length of amplicon} \times 650 \text{ (g/mol)} \times 10^9 \text{ (ng/g)}]}$$

The limit of detection of 3.4×10^3 copies of target RNA was determined as the lowest copy number that produced positive results in duplicates for two independent tests.

FIGURE 2

Positive predictive values by month and (A) testing methods and (B) rotavirus only rapid test, for rotavirus infection and month, England, 2016–2017 (n = 3,721)

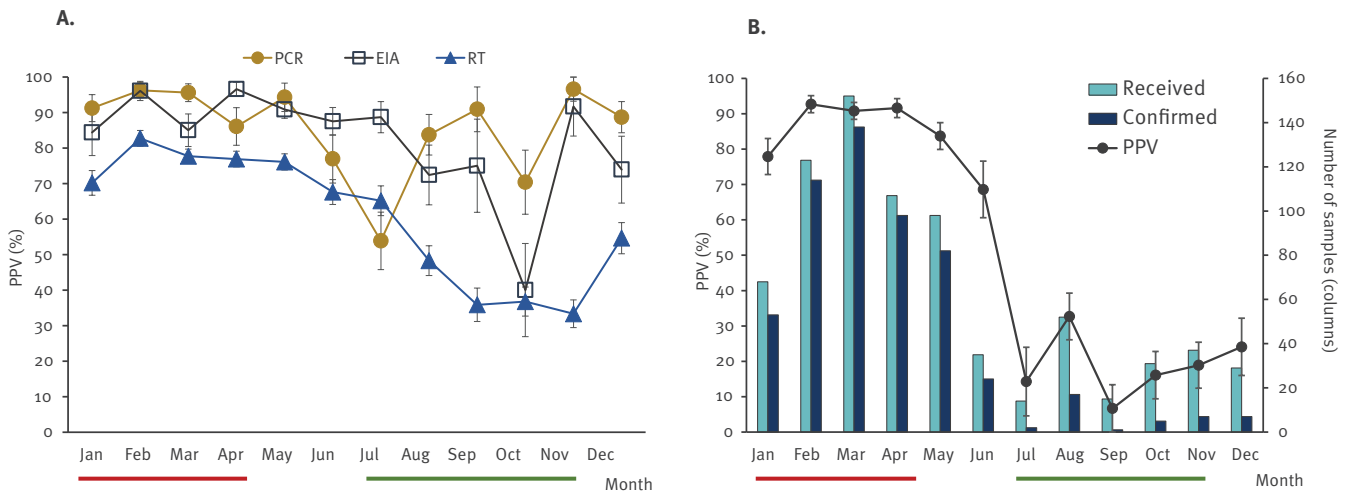

EIA: enzyme immunoassay; PPV: positive predictive value; RORT: rotavirus only rapid test; RT: rapid test.

^a Most commonly used test, data for 2017 only. High and low RV seasons are indicated by red and green lines, respectively.

Specific PCRs targeting NSP3 gene

A subset of 59 samples was identified for further testing. Criteria for selection were based on: (i) samples with a positive result by rapid tests but negative by PHE reference laboratory confirmatory PCR; (ii) samples received in the current (at the time) RV season to mitigate sample degradation. A specific PCR targeting NSP3 gene was performed as described elsewhere [13]. Briefly, after the reverse transcription step with random primers, PCR was performed using primers NVP3-Fdeg, NVP3-R1 and probe NVP3-Probe. The reaction mixture consisted of 1 × TaqMan Universal master mix (Invitrogen), 0.2 μM each primer, 0.15 μM probe and 0.05 μl ROX dye. Amplification conditions were two minutes at 50 °C and one minute at 95 °C, followed by 45 cycles of 15 s at 95 °C and one minute at 60 °C.

Electron microscopy

Clinical material for electron microscopy was selected based on: (i) the rapid test method and positive result; (ii) PHE reference laboratory confirmatory PCR result; (iii) availability of material; (iv) most recent specimens to minimise sample degradation. Specimens (19 samples) screened by RORT2 (n = 4), RORT3 (n = 5), RORT4 (n = 5) or RART11 (n = 5) were included. Two positive samples and at least two negatives for the PHE reference laboratory confirmatory PCR per rapid test group were tested. Detailed methods are provided in Supplementary Materials and methods.

Statistical analysis

Data analysis was performed by calendar year based on sample receipt date at the PHE reference laboratory. Statistical analysis was performed using MS Excel and Stata v14.1 software (StataCorp, Texas, US).

Confirmation rates or positive predictive values (PPV), standard errors (SE) and 95% confidence intervals (95% CI) were calculated for all methods. PPV is the probability that the individuals with a positive screening result will truly have the disease. To test if there were any significant differences ($p < 0.001$) in PPV between the different testing methodologies and individual tests, chi-squared tests were performed.

Ethical statement

PHE has legal permission, provided by Regulation 3 of The Health Service (Control of Patient Information) Regulations 2002 [14], to process patient confidential information for national surveillance of communicable diseases and includes PHE's responsibility to monitor the safety and effectiveness of vaccines.

Results

Rotavirus confirmed-positive samples

During the two-year surveillance period, 3,729 RV samples that tested positive at local NHS hospital laboratories were received by PHE reference laboratory for confirmation and additional characterisation. Of those 3,729 samples, 3,721 were included in this data analysis based on the completeness of information required and the statistical value. Eight samples were excluded from this study because they did not meet the criteria: seven samples lacked information on the screening methodology used by the local NHS hospital laboratories and one sample had been tested using a commercial PCR test, putting it in a PCR₄ category of n = 1.

All samples were subjected to the PHE reference laboratory confirmatory PCR test targeting VP6 gene before

attempting strain characterisation. The PHE reference laboratory confirmatory PCR test was positive in 73% (2,716/3,721) of referred samples (Table).

Use of primary screening tests

For the purpose of this analysis, local testing methods were grouped in three categories: immunochromatography-based or rapid test, enzyme immunoassays (EIA) and PCR tests. Most samples (2,608/3,721, 70.1%) had been tested with rapid tests locally, while 15.5% (578/3,721) had been tested by EIA and 14.4% (535/3,721) by PCR.

RORT₃ was the most commonly used test with 1,165 (31.3%) samples followed by in-house PCRs (405 samples, 10.9%). RART₁₇ (305, 8.2%), commercial EIA₁ (248, 6.7%), RART₁₁ (244, 6.6%) and commercial EIA₂ (233, 6.3%) were less frequently used, while RORT₅ (6, 0.2%), RART₇ (5, 0.1%), RART₁₃ (16, 0.4%), RART₁₄ (14, 0.4%) and commercial PCR₃ categories (6, 0.2%) were each represented with less than 20 samples (Table).

PHE reference laboratory confirmation rates and positive predictive value

Of the 2,608 specimens with a positive rapid test result, the PHE reference laboratory confirmatory PCR test was positive in 1,746 (66.9%) of cases. Analysis of the positive predictive value (PPV) by testing method showed a clear difference between the rapid tests when compared with the EIA and PCR methods (Figure 1A). PPVs were significantly higher ($p < 0.001$) for PCR (86.8%) and EIA (87.4%) methods compared with the RORT (66.8%) and RART (67.1%) rapid test methods. PPVs for individual tests ranged from 14.7% (5/34) for RORT₁ to 91% (101/111) for RART₈ (Table and Figure 1B). RV RNA was detected in less than 50% of samples initially tested with RORT₁, RORT₅, RORT₆ or RART₁₇. For the most commonly used rapid test, RORT₃ ($n = 1,165$ specimens), RV RNA was confirmed in only 774 (66.4%) samples.

Within the EIA group, results were more consistent and less variable, with PHE reference laboratory confirmation rates ranging from 78.4% (76/97) for the other EIAs group to 92.7% (230/248) and 85.4% (199/233) for the two commercial EIA tests (EIA₁ and EIA₂, respectively). Of the commercial PCRs used by local NHS hospital laboratories, there was variable and suboptimal performance overall, with PHE confirmation of 61.4% (27/44) for commercial PCR₂ and 46.3% (37/80) for commercial PCR₁. By contrast, 97.5% (395/405) of in-house PCR and six of six commercial PCR₃ assays were confirmed as positive by the PHE reference laboratory PCR test.

Seasonal variation

In order to assess whether the seasonal nature of RV activity may impact on PPV of screening tests, an analysis of the performance by methodology was conducted across each month. The rate of samples confirmed positive showed inconsistent variation per month (Figure 2A and Table S1). All methodologies

showed a decrease in confirmation rates during low-season months (July to November) with lowest PPV for PCR occurring in July (21/39, 53.8%, 95% CI: 38.1%–68.9), for EIA in October (6/15, 40%, 95% CI: 18.6%–66.1) and for rapid tests in November (50/150, 33.3%, 95% CI: 26.2%–41.3). The PPVs of the rapid tests were the lowest of all methodologies for both high (January to April) and low seasons.

Analysis of seasonal variation on confirmation rates for RORT₃, the rapid test with the highest number of specimens, showed a similar pattern but with greater variation (Figure 2B and Table S2). The greatest proportion of samples confirmed as positive was observed in February (114/123, 92.7%), with 89.6% (403/450) for the complete peak RV season (January to April). Outside the RV season, the confirmation rate was only 21.4% (32/149) with the lowest percentage observed during September (1/15, 6.7%).

Detection of rotavirus NSP3 gene and electron microscopy

To further confirm our findings, selected samples were subjected to two additional detection assays. A subset of 59 specimens initially screened positive by rapid tests but negative by the PHE reference laboratory confirmatory PCR test, was tested by PCR amplification of the NSP₃ gene. Only two samples (2/59, 3.4%) were positive indicating that 96.6% of the samples were true negatives. Cycle threshold (Ct) values for NSP₃ tests for the two samples (Ct: 34.9 and 37.0) suggested the presence of RV at a very low genome content.

Electron microscopy (EM) was also performed on 19 samples to visualise any viral particles. Eight samples found positive by both rapid test and PHE reference laboratory confirmatory PCR test were all confirmed as positive by virus particle visualisation (data not shown), while eleven specimens with a negative PHE reference laboratory confirmatory PCR test result also failed particle detection under EM (Table S3).

Discussion

Our results highlight the importance of validating screening results for RV diagnosis. The strong reproducibility of the results for referred samples that were screened by in-house PCR tests supports this methodology for RV detection. However, only 10.9% (405/3,721) of the samples were screened using this methodology. The commercial PCR tests PCR₁ and PCR₂ performed less well in comparison to in-house PCRs (confirmation rate of 46.3% and 61.4% for PCR₁ and PCR₂, respectively, compared with 97.5% for the in-house PCR). In addition, a greater proportion of PCR₁ and PCR₂ samples failed to be confirmed as positive at the PHE reference laboratory: 53.8% (43/80) of PCR₁; 38.6% (17/44) of PCR₂ and 2.5% (10/405) of in-house PCR samples failed. Commercial PCR detection kits are marketed as very specific and sensitive tests for RV detection but remarkably, the commercial PCR tests included in our analysis revealed a variable confirmation rate. It is

unclear why in-house PCR assays out-performed commercial PCR assays. One possible explanation may be differences in assay validation, since the development of in-house assays could include more stringent local validation steps as part of the assay development process. Although the number of samples in the PCR category was relatively low (535/3,721, 14.4%), our results suggest that additional local verification of commercial tests may be required before routine use.

Performance of assays within the EIA group was very high and consistent overall. This finding is supported by previous reports highlighting the suitability of this testing method for surveillance programmes [15]. All three EIA groups in this analysis, consisting of both commercial and in-house assays, had very high confirmation rates. However, only a relatively small proportion (578/3,721, 15.5%) of total NHS hospital laboratory samples was tested using EIA.

Most NHS hospital laboratories prefer to use rapid tests for RV screening, rather than alternative methodologies. Cost and resources are likely to play an important part in this decision, since rapid tests are relatively inexpensive and easy to use compared with EIA and PCR assays that require dedicated equipment and trained staff. In contrast, rapid tests for RV are designed as point-of-care tests (POCT), which allow fast screening for rapid diagnosis, need no specialised equipment and can be performed by personnel with minimal or no specific laboratory training. In general, benefits of a POC testing approach are clear in terms of rapid administration of rehydration therapy, isolation or no admission into particular settings (i.e. hospital wards) and reduction in the use of ineffective treatments such as antibiotics. However, POCT for RV detection have limitations. Our analysis indicates that this popular screening method performs poorly, with only 66.9% (1,746/2,608) of locally positive samples being confirmed as positive by PHE. The overall PPV for IC tests in this study is also lower than recent reports [15-18]. Similar discrepancies for screening tests have been described in the literature. A high proportion of false positive results in Australia was reported after an unexplained surge in RV cases [19], and an excessive number of false positive results by IC tests was also reported in Spain [20].

To confirm our findings and support the PHE RV confirmation strategy, additional tests were performed on positive rapid test samples that failed PHE reference laboratory confirmatory PCR test detection. The rationale for this approach was to use two independent assays to confirm VP6 negative samples as true negatives. Results for the NSP3 detection confirmed that of the 59 samples available for retesting (with negative results by VP6 detection test), 57 specimens were true negatives, and two samples failed VP6 detection because of very low RV nucleic acid content. The second methodology undertaken was EM, which has conventionally been used as a reference method for

RV detection [21]. The results of both these additional assays support the VP6 detection strategy as appropriate for RV confirmation. The limitations of these results are the low number of samples available or included for testing and the possibility of degradation of samples due to the time between the initial PHE reference laboratory confirmatory PCR tests and later NSP3 PCR and EM tests.

Our results suggest that out-of-season false positive results are more common for screening tests compared with tests performed during the RV season, particularly when rapid tests are used. For the most commonly used rapid test, RORT3, the confirmation rate was 92.7% (114/123) in February 2017, but only 1 in 15 in September 2017. A lower PPV can be expected during months when RV activity decreases and this will have an impact on PHE confirmation rates regardless of the screening methodology used by the NHS hospital laboratories. The higher proportion of false positive rapid test results when RV activity is lower will also have considerable implications for national RV surveillance because RV infections have fallen dramatically since the introduction of the infant immunisation programme [4,5]. The high rates of false positives, especially out-of-season, will underestimate the true impact and effectiveness of the current immunisation programme. More importantly, false positive results could have important implications for patient diagnosis and subsequent clinical management, and may divert efforts to investigate and identify the true cause of illness, which could delay the administration of appropriate treatment.

There are also cost implications in processing referred samples for molecular characterisation if a large proportion of samples are false positive. At the PHE reference laboratory, characterisation and typing is based on analysis and sequencing of RV VP4 and VP7 gene amplicons, which are both labour-intensive and resource-intensive assays.

The strength of this study lies in the availability of a single national reference centre for processing RV samples across England for the purpose of national surveillance. Consistent surveillance has been in place since the infant RV immunisation programme began more than 5 years ago, and large numbers of samples are processed using the same reference laboratory protocol every year. A limitation is the different number of samples analysed within the different categories, which limits the statistical power for tests with relatively small numbers of samples submitted to PHE. Our data, however, include results from every sample submitted from patients across England over a two-year period and, therefore, represents the state of RV testing at local and national level during 2016 and 2017. Another limitation is that there may be several reasons why local testing may be positive for RV but negative with the PHE reference laboratory confirmatory PCR test, such as small sample volumes, low RV

concentrations or sample degradation. This, however, is likely to represent only a small proportion of the PHE confirmed negative samples, as supported by the results of the two additional detection assays performed on a subset of PHE confirmed positive and confirmed negative samples.

Conclusion

A review of the methodologies used for RV initial detection showed a clear preference for rapid tests among NHS hospital laboratories. Rapid tests can be highly unreliable if used as the sole diagnostic method; even the best performing assays should be considered for screening only and should be confirmed using a more reliable, confirmatory test. Inconsistencies in confirmation rates for IC and other commercial assays, such as commercial PCRs, demonstrate the importance of a verification process before implementation into clinical settings. Furthermore, this report emphasises the need for a confirmatory result to support all screening tests for diagnosis of RV because the results may have implications for both the clinical management of patients and national surveillance. A reactive RV detection result using screening tests should be interpreted with caution if used to direct clinical management. Surveillance programmes monitoring the effectiveness of RV immunisation should be aware of high false positive rates with commonly used RV screening tests since they may underestimate vaccine effectiveness if reference laboratory confirmation rates are not considered alongside.

Acknowledgements

The authors would like to thank Professor Polly Roy, London School of Hygiene and Tropical Medicine, for providing ss-RNA segment S6 RRV strain used to determine the limit of detection for the confirmatory PHE reference laboratory confirmatory PCR assay, and Natalie Adams (formerly of Public Health England) for her assistance regarding rotavirus reporting system.

Conflict of interest

None declared.

Authors' contributions

CCC, SB, SW, N-KO, AH and GH were involved in data collection, molecular testing and analysis and interpretation of results. AD performed statistical analysis. MH performed electron microscopy studies. SL and JD coordinated the study and reviewed the manuscript. All authors reviewed and approved the final version of the manuscript.

References

1. Tate JE, Burton AH, Boschi-Pinto C, Parashar UD, World Health Organization–Coordinated Global Rotavirus Surveillance Network. Global, Regional, and National Estimates of Rotavirus Mortality in Children <5 Years of Age, 2000–2013. *Clin Infect Dis.* 2016;62(Suppl 2):S96–105. <https://doi.org/10.1093/cid/civ1013>
2. Tam CC, Rodrigues LC, Viviani L, Dodds JP, Evans MR, Hunter PR, et al. Longitudinal study of infectious intestinal disease in the UK (IID2 study): incidence in the community and presenting to general practice. *Gut.* 2012;61(1):69–77. <https://doi.org/10.1136/gut.2011.238386>
3. Harris JP, Jit M, Cooper D, Edmunds WJ. Evaluating rotavirus vaccination in England and Wales. Part I. Estimating the burden of disease. *Vaccine.* 2007;25(20):3962–70. <https://doi.org/10.1016/j.vaccine.2007.02.072>
4. Atchison CJ, Stowe J, Andrews N, Collins S, Allen DJ, Nawaz S, et al. Rapid Declines in Age Group-Specific Rotavirus Infection and Acute Gastroenteritis Among Vaccinated and Unvaccinated Individuals Within 1 Year of Rotavirus Vaccine Introduction in England and Wales. *J Infect Dis.* 2016;213(2):243–9. <https://doi.org/10.1093/infdis/jiv398>
5. Marlow R, Muir P, Vipond B, Lyttle M, Trotter C, Finn A. Assessing the impacts of the first year of rotavirus vaccination in the United Kingdom. *Euro Surveill.* 2015;20(48):30077. <https://doi.org/10.2807/1560-7917.ES.2015.20.48.30077>
6. Thomas SL, Walker JL, Fenty J, Atkins KE, Elliot AJ, Hughes HE, et al. Impact of the national rotavirus vaccination programme on acute gastroenteritis in England and associated costs averted. *Vaccine.* 2017;35(4):680–6. <https://doi.org/10.1016/j.vaccine.2016.11.057>
7. Zeller M, Rahman M, Heylen E, De Coster S, De Vos S, Arijis I, et al. Rotavirus incidence and genotype distribution before and after national rotavirus vaccine introduction in Belgium. *Vaccine.* 2010;28(47):7507–13. <https://doi.org/10.1016/j.vaccine.2010.09.004>
8. Tate JE, Panozzo CA, Payne DC, Patel MM, Cortese MM, Fowlkes AL, et al. Decline and change in seasonality of US rotavirus activity after the introduction of rotavirus vaccine. *Pediatrics.* 2009;124(2):465–71. <https://doi.org/10.1542/peds.2008-3528>
9. Tate JE, Patel MM, Steele AD, Gentsch JR, Payne DC, Cortese MM, et al. Global impact of rotavirus vaccines. *Expert Rev Vaccines.* 2010;9(4):395–407. <https://doi.org/10.1586/erv.10.17>
10. World Health Organization (WHO). Manual of rotavirus detection and characterization methods. Geneva: WHO; 2009. Available from: https://apps.who.int/iris/bitstream/handle/10665/70122/WHO_IVB_08.17_eng.pdf;jsessionid=28249D098F26CE65FA1A88D21987A63B?sequence=1
11. Iturriza Gómara M, Wong C, Blome S, Desselberger U, Gray J. Molecular characterization of VP6 genes of human rotavirus isolates: correlation of genogroups with subgroups and evidence of independent segregation. *J Virol.* 2002;76(13):6596–601. <https://doi.org/10.1128/JVI.76.13.6596-6601.2002>
12. Iturriza Gómara M, Wong C, Blome S, Desselberger U, Gray J. Rotavirus subgroup characterisation by restriction endonuclease digestion of a cDNA fragment of the VP6 gene. *J Virol Methods.* 2002;105(1):99–103. [https://doi.org/10.1016/S0166-0934\(02\)00087-3](https://doi.org/10.1016/S0166-0934(02)00087-3)
13. Freeman MM, Kerin T, Hull J, McCaustland K, Gentsch J. Enhancement of detection and quantification of rotavirus in stool using a modified real-time RT-PCR assay. *J Med Virol.* 2008;80(8):1489–96. <https://doi.org/10.1002/jmv.21228>
14. National Health Service (England and Wales). The Health Service (Control of Patient Information) Regulations 2002. The National Archives; 23 May 2002. Available from: <https://www.legislation.gov.uk/uksi/2002/1438/made>
15. Gautam R, Lyde F, Esona MD, Quaye O, Bowen MD. Comparison of PremierRotaclone, ProSpecT and RIDASCREEN rotavirus enzyme immunoassay kits for detection of rotavirus antigen in stool specimens. *J Clin Virol.* 2013;58(1):292–4. <https://doi.org/10.1016/j.jcv.2013.06.022>
16. Lagare A, Moumouni A, Kaplon J, Langendorf C, Pothier P, Grais RF, et al. Diagnostic accuracy of VIKIA® Rota-Adeno and Premier™ Rotaclone® tests for the detection of rotavirus in Niger. *BMC Res Notes.* 2017;10(1):505. <https://doi.org/10.1186/s13104-017-2832-1>
17. Khamrin P, Tran DN, Chan-it W, Thongprachum A, Okitsu S, Maneekarn N, et al. Comparison of the rapid methods for screening of group A rotavirus in stool samples. *J Trop Pediatr.* 2011;57(5):375–7. <https://doi.org/10.1093/tropej/fmq101>
18. Kaplon J, Frey C, Pillet S, Mendes Martins L, Ambert-Balay K, Aho SL, et al. Diagnostic Accuracy of Seven Commercial Assays for Rapid Detection of Group A Rotavirus Antigens. *J Clin Microbiol.* 2015;53(11):3670–3. <https://doi.org/10.1128/JCM.01984-15>
19. Ye S, Roczo-Farkas S, Whitley DM, Lambert SB, Robson J, Heney C, et al. Evidence of false-positive results in a commercially available rotavirus assay in the vaccine era, Australia, 2011 to 2012. *Euro Surveill.* 2013;18(21):20483.
20. Lopez-Lacort M, Collado S, Díez-Gandía A, Díez-Domingo J. Rotavirus, vaccine failure or diagnostic error?

Vaccine. 2016;34(48):5912-5. <https://doi.org/10.1016/j.vaccine.2016.10.032>

21. Brandt CD, Kim HW, Rodriguez WJ, Thomas L, Yolken RH, Arrobio JO, et al. Comparison of direct electron microscopy, immune electron microscopy, and rotavirus enzyme-linked immunosorbent assay for detection of gastroenteritis viruses in children. *J Clin Microbiol.* 1981;13(5):976-81. <https://doi.org/10.1128/JCM.13.5.976-981.1981>

License, supplementary material and copyright

This is an open-access article distributed under the terms of the Creative Commons Attribution (CC BY 4.0) Licence. You may share and adapt the material, but must give appropriate credit to the source, provide a link to the licence and indicate if changes were made.

Any supplementary material referenced in the article can be found in the online version.

This article is copyright of the authors or their affiliated institutions, 2020.

Using rapid point-of-care tests to inform antibiotic choice to mitigate drug resistance in gonorrhoea

Carolin Vegvari¹, Yonatan H Grad^{2,3}, Peter J White^{1,4,5}, Xavier Didelot^{1,4,6}, Lilith K Whittles^{1,4}, Nicole E Scangarella-Oman⁷, Fanny S Mitrani-Gold^{7*}, Etienne Dumont⁷, Caroline R Perry⁷, Kim Gilchrist^{7,8}, Mohammad Hossain⁷, Tatum D Mortimer², Roy M Anderson¹, David Gardiner⁷

1. Department of Infectious Disease Epidemiology, School of Public Health, Imperial College London, London, United Kingdom
2. Department of Immunology and Infectious Diseases, Harvard T.H. Chan School of Public Health, Boston, United States
3. Division of Infectious Diseases, Brigham and Women's Hospital, Harvard Medical School, Boston, United States
4. MRC Centre for Global Infectious Disease Analysis and NIHR Health Protection Research Unit in Modelling and Health Economics, School of Public Health, Imperial College London, London, United Kingdom
5. Modelling and Economics Unit, National Infection Service, Public Health England, London, United Kingdom
6. Current affiliation: School of Life Sciences and Department of Statistics, University of Warwick, United Kingdom
7. GlaxoSmithKline, Collegeville, Pennsylvania, United States
8. Current affiliation: Pfizer, Inc, Pennsylvania, United States

Correspondence: Carolin Vegvari (c.vegvari@imperial.ac.uk)

Citation style for this article:

Vegvari Carolin, Grad Yonatan H, White Peter J, Didelot Xavier, Whittles Lilith K, Scangarella-Oman Nicole E, Mitrani-Gold Fanny S, Dumont Etienne, Perry Caroline R, Gilchrist Kim, Hossain Mohammad, Mortimer Tatum D, Anderson Roy M, Gardiner David. Using rapid point-of-care tests to inform antibiotic choice to mitigate drug resistance in gonorrhoea. *Euro Surveill.* 2020;25(43):pii=1900210. <https://doi.org/10.2807/1560-7917.ES.2020.25.43.1900210>

Article submitted on 27 Mar 2019 / accepted on 01 May 2020 / published on 29 Oct 2020

Background: The first cases of extensively drug resistant gonorrhoea were recorded in the United Kingdom in 2018. There is a public health need for strategies on how to deploy existing and novel antibiotics to minimise the risk of resistance development. As rapid point-of-care tests (POCTs) to predict susceptibility are coming to clinical use, coupling the introduction of an antibiotic with diagnostics that can slow resistance emergence may offer a novel paradigm for maximising antibiotic benefits. Gepotidacin is a novel antibiotic with known resistance and resistance-predisposing mutations. In particular, a mutation that confers resistance to ciprofloxacin acts as the 'stepping-stone' mutation to gepotidacin resistance. **Aim:** To investigate how POCTs detecting *Neisseria gonorrhoeae* resistance mutations for ciprofloxacin and gepotidacin can be used to minimise the risk of resistance development to gepotidacin. **Methods:** We use individual-based stochastic simulations to formally investigate the aim. **Results:** The level of testing needed to reduce the risk of resistance development depends on the mutation rate under treatment and the prevalence of stepping-stone mutations. A POCT is most effective if the mutation rate under antibiotic treatment is no more than two orders of magnitude above the mutation rate without treatment and the prevalence of stepping-stone mutations is 1–13%. **Conclusion:** Mutation frequencies and rates should be considered when estimating the POCT usage required to reduce the risk of resistance development in a given population. Molecular POCTs for resistance mutations and stepping-stone mutations to resistance are likely to become important tools in antibiotic stewardship.

Introduction

Neisseria gonorrhoeae, the causal agent of the sexually transmitted infection (STI) gonorrhoea, is becoming increasingly resistant to available antibiotic treatment options [1,2]. The most widely recommended treatment for gonorrhoea is a combination therapy of ceftriaxone plus azithromycin, administered empirically without bacterial culture or point-of-care testing [3]. In isolates collected across Europe, the proportion of isolates with decreased susceptibility to ceftriaxone increased from 15% to 17.7% from 2015 to 2016. At the same time azithromycin resistance across Europe was stable at about 7% but was much higher in individual countries (34.5% in Portugal) [4]. The first treatment failure of this dual therapy was reported in the United Kingdom (UK) in 2014 [5]. Azithromycin resistance in combination with reduced susceptibility to ceftriaxone has been well-studied [4]. Resistance to previous recommended treatments, such as ciprofloxacin, is generally high (30–70% in Europe, above 70% in East Asia) [2]. As ceftriaxone is at the same time the first-line and last-resort treatment, the World Health Organization (WHO) in 2017 declared the possible evolution of untreatable gonorrhoea a global public health emergency [6].

In an attempt to spare ceftriaxone as a last-resort treatment, rapid point-of-care tests (POCTs) detecting ciprofloxacin resistance mutations have been developed. Thus, even though ciprofloxacin is no longer recommended for gonorrhoea treatment, it could still be used when a POCT detects no resistance mutations [7]. Such tests could easily be expanded to include known resistance markers for other antibiotics.

TABLE 1

Genotypes of isolates at baseline and test-of-cure from gepotidacin treatment failures with emergence of resistance, phase II clinical trial, 2017 [11]

Participant number	Visit	Genotype <i>gyrA</i>	Genotype <i>parC</i>	MIC gepotidacin (mg/L)	MIC ciprofloxacin (mg/L)
4	Baseline	S91F D95G	D86N	1	8
	Test-of-cure	S91F A92T D95G	D86N	>32	8
6	Baseline	S91F D95G	D86N	1	4
	Test-of-cure	S91F A92T D95G	D86N	32	4

MIC: minimum inhibitory concentration.

Mutation *gyrA* A92T leading to gepotidacin resistance is displayed in bold.

Gepotidacin is a novel topoisomerase IIA inhibitor currently under development and in phase III clinical trials with activity against *N. gonorrhoeae* [8]. Its mechanism of action differs from that of fluoroquinolones, and it has demonstrated activity against most ciprofloxacin-resistant gonococcal strains [9]. Ciprofloxacin inhibits bacterial DNA gyrase and topoisomerase IV. The main ciprofloxacin resistance mutations in genes coding for DNA gyrase subunit A (GyrA) and topoisomerase IV subunit A (ParC) in *N. gonorrhoeae* are presented in the Supplementary Material 1, Supplementary Table 1. In a recent phase II clinical trial on the efficacy of gepotidacin against uncomplicated genitourinary gonorrhoea, emergence of resistance was observed for *N. gonorrhoeae* isolates from two treatment failures following use of a single dose of 3g gepotidacin. This resistance is likely to have emerged due to the combination of a pre-existing ciprofloxacin resistance mutation (D86N) in the *parC* gene and de novo within-host emergence of an A92T mutation in the *gyrA* gene (Table 1). Additional experiments suggest that the gepotidacin minimum inhibitory concentration (MIC) is only significantly increased if both mutations are present together [10]. See Supplementary Material 1, Supplementary Text 1 for more details on the microbiological analysis of the phase II clinical trial. Structural analysis of the interaction of gepotidacin with GyrA suggests that gepotidacin does not interact with the two quinolone binding sites in GyrA at amino acid positions 91 and 95 [9]. Therefore, it was assumed that the S91F and D95G mutations in *gyrA* were not critical for the evolution of gepotidacin resistance. There may be other mutations that can cause resistance to gepotidacin, but they were not observed in the phase II clinical trial.

Novel post-treatment mutations occurred in isolates from two subjects that were treated with a single dose of 3g gepotidacin [11]. The mutations S91F and D95G in *gyrA* and D86N in *parC* on their own confer different levels of resistance to ciprofloxacin.

Here, we consider the novel paradigm of introducing an antibiotic together with a POCT to control gonococcal infections and slow down resistance development. A POCT for gepotidacin resistance would determine if the known stepping-stone mutations, *gyrA* A92T

or *parC* D86N, were present. If neither were detected, then gepotidacin could be used without substantial risk of treatment failure, based on current evidence, as there are no other known clinically relevant target-specific resistance mutations for gepotidacin in *N. gonorrhoeae*. If one or both mutations were present, treatment with another antibiotic would be indicated. Determining the frequencies of resistance mutations requires surveillance systems such as the data recorded in the European Gonococcal Antimicrobial Surveillance Programme (Euro-GASP, data collection since 2009) and the US Gonococcal Isolate Surveillance Project database (GISP, data collection since 1986). Euro-GASP monitors *N. gonorrhoeae* antimicrobial susceptibility trends by phenotypically characterising isolates from male and female patients. GISP samples isolates from male patients attending STD clinics. Each participating country contributes 100 cultured and characterised isolates per year.

Our study aims to answer several questions using a theoretical modelling framework: can a molecular POCT that detects known stepping-stone mutations prevent the spread of gepotidacin-resistant strains? Under what conditions is a POCT most effective at reducing the risk of resistance development, and how frequently would such a test need to be used to reduce this risk by at least 50% over five years? These questions have broader implications for designing antibiotic stewardship strategies and prolonging the life span of novel and existing antibiotics.

Methods

Model framework

We developed a compartmental deterministic model framework of gonorrhoea transmission building on previous models [12,13]. As in Whittles et al. [14] our model uses transmission parameter values derived from men who have sex with men (MSM) populations in London. The model has three compartments, susceptible (S), infected (I) and treated (T) individuals (Figure 1, Supplementary Material 1, Supplementary Text 2). Individuals in the infected class are infected but not currently treated. Individuals in the treated class are infected and currently receiving treatment. The time

FIGURE 1
Two-locus gonorrhoea antibiotic resistance model

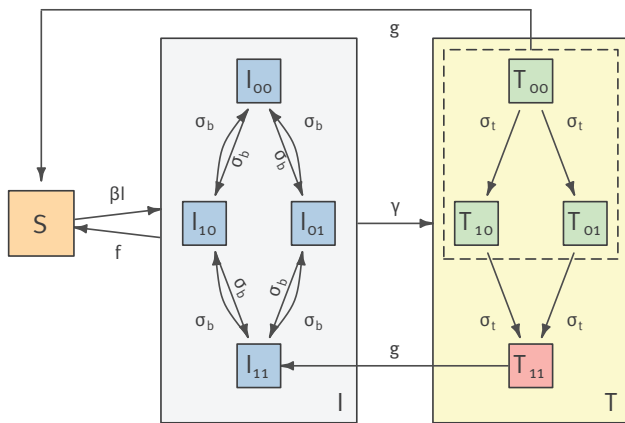

S: susceptible individuals; I: infected, untreated individuals; T: infected, treated individuals.

The basic model has three main compartments, susceptible, infected and treated individuals (i.e. infected individuals that are undergoing treatment). Individuals can be infected with one of four gonococcal strains that differ in the combination of resistance ('stepping-stone') mutations they carry (00, 10, 01 or 11). Only strains with both gepotidacin resistance mutations (11) are considered resistant to gepotidacin. Strains with one resistance mutation (10 and 01) are resistant to ciprofloxacin, but sensitive to gepotidacin. First subscript: state of resistance for the first locus (0 – sensitive, 1 – resistant); second subscript: state of resistance for the second locus (0 – sensitive, 1 – resistant); β : infection rate parameter (product of sexual contact rate and infection probability per contact); f : spontaneous recovery rate from infection without treatment ($1/f$ – duration of natural infection); g : Cure rate in individuals currently being treated ($1/g$ – duration of treatment); γ : treatment seeking rate ($1/\gamma$ – time from start of infection to start of treatment); σ_b : locus-specific mutation rate in untreated individuals (no selection pressure); σ_t : locus-specific mutation rate in treated individuals (under selection pressure).

that individuals spend in the treated class is the duration for which the within-host antibiotic concentration is great enough to clear the infection.

The key novel feature of our model is that we explicitly consider different resistance genotypes of relevance to gepotidacin. Given that there are two known stepping-stone mutations that together cause elevated MICs, susceptible individuals can be infected by one of four strains. If 0 signifies the sensitive allele and 1 the resistant allele, these strains are: 00, 10, 01 and 11. Based on the observations from the phase II clinical study [15], we assume that only the 11 genotype is resistant to both ciprofloxacin and gepotidacin, whereas 10 and 01 are resistant to ciprofloxacin only. The model also allows for the possibility that both resistance mutations can arise de novo over the course of an infection.

Model parameters and transitions

Susceptible individuals become infected at rate β , which in our modelling framework is population-specific and depends on the sexual contact rate and the infection probability per contact (Table 2). Infected individuals seek treatment at rate γ and can recover

spontaneously at rate f . Treated individuals recover at rate g if they are not resistant, and return to the susceptible class. Individuals with treatment failures are reclassified as infected. For more details on the model processes see Supplementary Material 1, Supplementary Text 2. To assess the impact of uncertainty in model parameters, we performed sensitivity analyses by varying model parameters across a range of measured values from the literature. We assume an annual incidence rate of gonorrhoea of 22,000 cases in a total population of 1.5 million individuals, approximating the MSM population in the UK [16]. We varied the starting conditions for each of the simulation scenarios described below. For model parameter and variable values used in the simulations see Table 2.

Resistance evolution

Sensitive strains can acquire resistance to antibiotics by de novo mutations. The mutation rate in *N. gonorrhoeae* has been determined from phylogenetic studies [17]. Several studies indicate that the mutation rate under treatment may be increased due to the SOS DNA damage response [18-20]. A DNA damage response system in *N. gonorrhoeae* has been described by Schook et al. [21]. Other topoisomerase II inhibitors are known to increase the mutation rate by interfering with DNA replication [22,23]. However, as the mechanism of action of gepotidacin differs from that of conventional topoisomerase II inhibitors, it may not increase the mutation rate to the same extent. There are no estimates for mutation rates in *N. gonorrhoeae* under antibiotic pressure. We therefore performed simulations for a range of mutation rate parameters under treatment based on estimates obtained from other bacterial species (Table 2).

N. gonorrhoeae is known to have a high rate of homologous recombination [24]. Recombination between different gonococcal strains can only occur in mixed infections at the same anatomical site. Thus, the effective recombination rate can be calculated as:

$$\text{coinfection frequency} \times \text{ratio of recombination to mutation} \times \text{base mutation rate}$$

The coinfection frequency with different gonococcal strains at the same anatomical site is unknown, but we can use the frequency of infections with different gonococcal strains at different anatomical sites as a proxy upper-bound estimate for the frequency of mixed infections (13%) at the same anatomical site [25]. The ratio of recombination to mutation events has been estimated from whole genome sequence data (genome-wide average) [17,26,27]. If we assume a mutation rate of 2.45×10^{-8} substitutions per nt per day and a recombination-to-mutation ratio of 2.2 [27], we obtain an effective recombination rate of 7×10^{-9} . Since this would lead to an increase in the rate of resistance acquisition that is smaller than the increased mutation rates that we tested, we do not explicitly consider recombination in the model.

TABLE 2

Parameter values used in simulation model

Model parameter (unit)	Values used in individual simulations
Infection rate (per day)	5.56×10^{-8} , 1.67×10^{-8} , 6.02×10^{-8} , 2.28×10^{-7} , 2.29×10^{-7}
Recovery rate f (inverse of duration of natural infection) (per day)	1/84, 1/160, 1/185, 1/240, 1/365
Treatment rate γ (inverse of time in days until patients first seek treatment) (per day)	1/3, 1/12, 1/13, 1/52
Cure rate for gepotidacin treatment, assuming double dose (inverse of treatment duration, i.e. time over MIC) (per day)	1.778 (=1/13.5h)
Cure rate for ciprofloxacin treatment, assuming single dose (inverse of treatment duration) (per day)	6 (=1/4h)
Proportion of patients that return for second round treatment p	1, 0.8, 0.6, 0.5
Mutation rate without treatment σ_b (substitutions per nt per day)	3.12×10^{-9} , 2.45×10^{-8}
Mutation rate with treatment σ_t (substitutions per nt per day)	3.12×10^{-9} , 2.45×10^{-8} , 4.9×10^{-8} , 1.23×10^{-7} , 2.45×10^{-7} , 2.45×10^{-6} , 2.45×10^{-5} , 7.95×10^{-5} , 9.66×10^{-4}
Point-of-care test usage (%)	0, 10, 20, 30, 40, 50, 60, 70, 80, 90, 100
Total simulated population	1.5×10^6
Initial number of infected individuals/equilibrium incidence rate	22,000
Initial prevalence of <i>parC</i> D86N (%)	0, 0.06, 0.18, 0.462, 0.669, 1.5, 2, 2.9, 3, 5.9, 6.5, 8.6, 13, 19.3, 38.6
Initial prevalence of <i>gyrA</i> A92T (%)	0, 1
Initial prevalence of double mutant (<i>parC</i> D86N/ <i>gyrA</i> A92T) (%)	0

MIC: minimum inhibitory concentration.

All rates are per day. If more than one value is given, the whole range of values has been tested in different simulations. See Supplementary Material 2 for parameter combinations used in individual simulations. References and the basis of assumptions are included in the Supplementary Material 1, Supplementary Table 2.

Treatment scenarios and outcome measure

In our numerical evaluations of the model of a POCT detecting resistance mutations we varied the use of the POCT as a proportion of treated gonorrhoea infections from 0% to 100% and the assumed sensitivity and specificity of the test from 80 to 100%. If a POCT was used then gepotidacin was only used as a treatment if no resistance mutations were detected. If no POCT was used then gepotidacin was used as a first-line treatment.

We used stochastic simulations based on the deterministic structure defined in Supplementary Material 1, Supplementary Text 2, Figure S1, Equations 2, Table S1, and a Gillespie algorithm to analyse model behaviour and predictions. We recorded the number of simulations out of 100 replications in which the 5% resistance threshold was reached at any time point over a five-year timeframe. (This corresponds to the WHO recommendation that when resistance to a specific antibiotic exceeds 5%, alternative antibiotics should be used [28].) Table 2 lists parameter values used in simulations. A full list of parameter combinations used in each simulation scenario together with the results can be found in Supplementary Material 2.

Determining the prevalence of *parC* D86N in Europe and the United States

We obtained publicly available *N. gonorrhoeae* whole genome sequencing (WGS) data from the National

Center for Biotechnology Information (NCBI) Sequence Read Archive deposited as part of the studies in Supplementary Material 1, Supplementary Table 3. We ran FastQC [29] to assess WGS data quality and removed accessions with insufficient or poor-quality reads. We mapped reads to *N. gonorrhoeae* NCCP11945 (NC_011035.1) using BWA-MEM vs 0.7.17-r1188 [30]. Duplicates were marked using Picard vs 2.8.0 (<https://github.com/broadinstitute/picard>). We called variants using Pilon vs 1.23 [31] with minimum depth of 10X and minimum mapping quality of 20. We removed accessions where more than 15% of sites were unable to be called by Pilon due to insufficient coverage or poor mapping quality. We identified variants in *gyrA* and *parC* corresponding to the amino acid mutations *gyrA* A92T and *parC* D86N.

Currently, no published genomic databases report frequencies for the *gyrA* A92T mutation. The highest reported prevalence of the *parC* D86N mutation was 38.6% of ciprofloxacin-resistant isolates [12]. We genotyped 10,259 unique accessions that passed our quality control filters. The frequencies of *parC* D86N and *gyrA* A92T mutations are low in Europe and in the United States (Euro-GASP: *parC* D86N 1.8%, *gyrA* A92T 0% of all gonococcal isolates analysed September–November 2013 [32], GISP: *parC* D86N 0.635%, *gyrA* A92T 0%, of all gonococcal isolates analysed 2000–2013 [33]). This means that in Europe

FIGURE 2

Proportion of simulations in which the frequency of gepotidacin-resistant strains reaches 5% with different mutation rates, prevalence of *parC* D86N and POCT usage levels

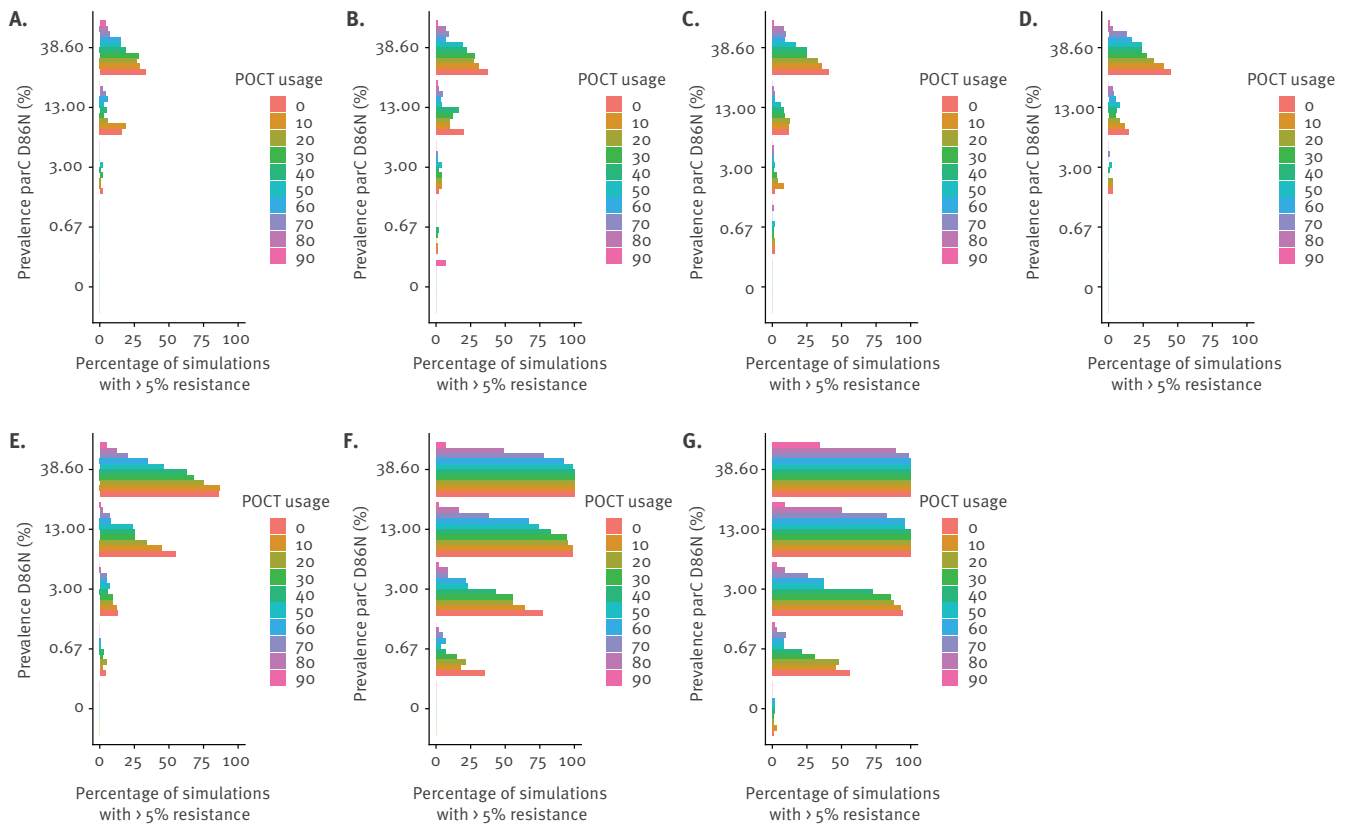

POCT: point-of-care testing.

The initial prevalence of *gyrA* A92T was 0 in all simulations. Mutation rates (substitutions per nt per day): A. 2.45×10^{-8} , B. 4.9×10^{-8} , C. 1.23×10^{-7} , D. 2.45×10^{-7} , E. 2.45×10^{-6} , F. 2.45×10^{-5} , G. 7.95×10^{-5} . Total number of simulations 100.

and the US simulation assuming 0.6–6.5% initial prevalence of *parC* D86N are the most applicable.

Ethical statement

No ethical approval was required for this study because no new data have been collected as part of the study.

Results

If the mutation rate with treatment is the same as without treatment, then even a POCT usage of 20–30% can reduce the risk of resistance development (Figure 2A). With assumptions of complete testing and perfect sensitivity and specificity, resistance did not develop in our simulations. If the initial prevalence of the stepping-stone mutations was lower than 6%, stochastic effects were important, so that even high POCT usage had little impact on the emergence of resistant strains (Supplementary Material 1, Supplementary Figure 1). In populations with an initial frequency of more than 6% of the *parC* D86N mutation, a POCT had a potential to reduce the risk of resistance reaching 5%. The effect of the POCT was roughly proportional to the usage level.

The greater the mutation rate during treatment and the higher the population prevalence of stepping-stone mutations, the higher the POCT usage needed to reduce the risk of resistance development (Figure 2). With an initial frequency of the *parC* D86N greater than 10% and a mutation rate during treatment of more than 1,000 times the baseline mutation rate, POCT usage had to be 80–90% to halve the risk of resistance development (Figure 2G). An increase in mutation rate during treatment of this order of magnitude is rarely observed in laboratory experiments (Supplementary Material 1, Supplementary Table 4). If the initial prevalence of *gyrA* A92T is 1%, rather than 0%, more resistance emerges, especially if mutation rates under treatment are high (Supplementary Material 1, Supplementary Figure 2). If the mutation rate under treatment is less than 1,000 times the baseline mutation rate, the added risk of resistance development from *gyrA* A92T prevalence of 1% stays below 10%.

If there were no stepping-stone mutations in a population, the risk of resistance development was generally

low (< 5% if the prevalence of *parC* D86N was < 13% and only exceeding 25% if the prevalence of *parC* D86N was 38.6%), and a POCT was only required if the mutation rate during treatment was very high (9.66×10^{-4} per site per day) (Supplementary Material 1, Supplementary Figures 1, 3). The sensitivity and specificity of the test did not have a great influence on the risk of resistance development in the range tested. With high POCT usage (70–90%), a higher sensitivity (99% compared to 80%) of the test slightly decreases the probability of resistance spreading (Supplementary Material 1, Supplementary Figure 4).

parC D86N prevalence

We did not observe any isolates with *gyrA* A92T. We found that across all datasets 6.1% (626/10,259) of isolates encoded the *parC* D86N mutation. *parC* D86N was observed in 17 of 20 datasets.

If the mutation rate is not increased under treatment, the risk of resistance emergence is less than 5% in scenarios assuming 0.6 – 6.5% initial prevalence of *parC* D86N.

Discussion

Our results indicate that a molecular POCT detecting the two known stepping-stone mutations implicated in gepotidacin resistance could help reduce the risk of resistance development to gepotidacin, a novel antibiotic undergoing phase III trials, by *N. gonorrhoeae*. The ability to do so would depend on the population prevalence of stepping-stone mutations and the mutation rate under treatment. If both are low, then most strains will be sensitive to gepotidacin and a POCT would have a negligible effect on the risk of resistance development. If the mutation rate under treatment is very high and a large proportion of strains already have one stepping-stone mutation, a POCT would not be able to prevent resistance spreading, because resistance would arise too frequently after testing in previously sensitive infections. A high rate of horizontal gene transfer between coinfecting strains could equally lead to increased rates of resistance emergence [34]. It is possible that other fluoroquinolone resistance mutations affect the MIC for gepotidacin in *N. gonorrhoeae*, but none have so far been identified.

This suggests that a POCT would be most valuable if the increase in mutation rate under treatment is moderate (no more than 100 times above the baseline mutation rate) and the prevalence of pre-existing resistance mutations is at least 1%. In this case and if the prevalence of resistance mutations is not too high (maximum 13% in our analyses), even a 20–30% usage of the POCT could, given our assumptions, halve the risk of resistance development. This would be the case for all publicly available datasets we surveyed, where 6.1% of all *N. gonorrhoeae* genomes carry *parC* D86N. However, due to stochastic variability, 50% usage would be preferable to reliably halve the risk of resistance development. The prevalence of *parC* D86N is

expected to vary among different countries. Therefore, optimum POCT usage values will be country-specific.

These results are in good agreement with a recent study which found that a POCT that detects resistance to three antibiotics used to treat gonorrhoea can prevent resistant strains from spreading, if its usage is at least 37%, and that test sensitivity and specificity have a minor effect on resistance development [35]. Our study also agrees with results from Fingerhuth et al. according to which a POCT test with resistance detection prevents more cases of antibiotic-resistant gonorrhoea than a NAAT test without resistance detection, unless the POCT sensitivity is lower than 80% [36].

Since gepotidacin resistance only arises when both known stepping-stone mutations occur in the same strain, the relationship between the mutation rate under treatment and the risk of resistance development is not linear. Small increases in mutation rate of up to 10-fold did not increase the risk of resistance development in our simulations, unless the initial prevalence of *parC* D86N was assumed to be greater than 30%. If the mutation rate under treatment increased 1,000 times or more, resistance almost always developed within 5 years.

Mutation rates during antibiotic exposure of this magnitude are rare according to the literature on other bacterial species (Supplementary Material 1, Supplementary Table 4). Moreover, mutation rate measurements from in vitro experiments are prone to overestimation [37]. Our results suggest that estimates of the mutation rate under antibiotic exposure should be taken into account when evaluating treatment strategies. For example, Obolski and Hadany use a simulation model to show that in hospitals antibiotic mixing and cycling are superior to combination therapy, if bacterial mutagenesis is stress-induced [38].

We did not consider fitness costs of antibiotic resistance mutations, because there is no population-level data on potential fitness costs of gepotidacin resistance mutations. As fluoroquinolone-resistant strains persist in the population, we can assume that fitness costs associated with fluoroquinolone-resistance mutations are small or absent [33]. Our model represents a worst-case scenario regarding the speed of spread of gepotidacin resistance. If there were sufficiently high fitness costs associated with one or both known stepping-stone mutations leading to gepotidacin resistance and a POCT could ensure that only infections without stepping-stone mutations were treated with gepotidacin, then newly-arising gepotidacin-resistant strains would potentially quickly become extinct [14].

Since some of the data for this study came from a relatively small sample (a phase II clinical trial), the evaluation may have to be updated when more data becomes available. In the case of treatment failure, the sequence in which alternative antibiotics are

prescribed can matter, especially if there is evidence for cross-resistance or resistance mutations to different antibiotics for the same strains. Therapies with multiple targets, or antibiotics that require multiple mutations before they lose their efficacy, should be preferred as first-line treatments.

The main limitation of this study is the lack of empirical information on key model parameters. For example, estimates for the duration of natural infection are based on limited observational studies from before 1980. Similarly, the duration from infection to when patients seek treatment may vary among different populations. The population we model approximates an MSM population and likely overestimates treatment rates for women who are more frequently asymptomatic. However, as long as we compare simulation scenarios with the same sets of parameters, the qualitative outcome of our analysis is unlikely to change. Another limitation is that potentially we do not know all mechanisms of resistance to gepotidacin and we acknowledge the need for genomic surveillance to determine if other resistance mutations can arise.

Simulation studies can inform us on what data should be collected to improve treatment strategies. In the case of gepotidacin, molecular surveillance data to estimate the frequency of known stepping-stone mutations is required. More generally, whole-genome surveillance data in combination with phenotypic antimicrobial susceptibility data can inform us about the frequency of resistance genes to other antimicrobials used for gonorrhoea treatment. In vitro or animal model experiments could help to estimate the mutation rate under gepotidacin exposure. Mutation prevalence and rate should be considered when estimating the POCT usage required to reduce the risk of resistance development in a given population. Molecular POCTs for resistance mutations and stepping-stone mutations are likely to become important tools in antibiotic stewardship and surveillance in the coming years, and a combination of empirical study and modelling is required to optimise their use for public health benefit.

* Erratum

The affiliation of Fanny S Mitrani-Gold was corrected on 6 Nov 2020, after publication of the article.

Disclaimer

The views expressed are those of the authors and not necessarily those of the Department of Health and Social Care; the Foreign, Commonwealth & Development Office; MRC; NIHR; NHS; or Public Health England.

Acknowledgements

The authors would like to thank Brian Spratt for helpful discussions on the work presented in this manuscript.

Funding

This study was supported by GlaxoSmithKline and was funded in part with Federal funds from the Office of the Assistant Secretary for Preparedness and Response, Biomedical Advanced Research and Development Authority (BARDA), under agreement # HHSO100201300011C.

CV was funded by a research grant (3000032222) and YHG by consulting fees from GlaxoSmithKline (GSK). PJW and XD were funded by the UK National Institute for Health Research (NIHR) Health Protection Research Unit (HPRU) in Modelling Methodology at Imperial College London in partnership with Public Health England (PHE) (grant HPRU-2012-10080). PJW and LKW acknowledge funding from the UK Medical Research Council (MRC) Centre for Global Infectious Disease Analysis (MR/R015600/1); this award is jointly funded by the MRC and the UK Foreign, Commonwealth & Development Office (FCDO) under the MRC/FCDO Concordat agreement and is also part of the EDCTP2 programme supported by the European Union (EU). TDM was funded by the Smith Family Foundation and NIH NIAID grant (F32AI145157). GSK authors contributed to study design, provided data and were involved in the interpretation of data and results. The Department of Health and Social Care; Foreign, Commonwealth & Development Office; MRC; NIHR; Public Health England; NIH and the Smith Family Foundation had no role in study design, data collection and analysis, decision to publish, or preparation of the manuscript.

Conflict of interest

PJW, XD, LKW and TDM have no competing interests and have received no funding from GSK for this work. CV received funding from GSK for this work. NESO, FSMG, ED, CRP, MH, DG are employees of GSK. RMA was a non-executive board member of GSK till June 2018. YHG has consulted for GSK. KG is an employee for Pfizer and was formerly an employee of GSK.

Authors' contributions

Study conceptualisation and design: CV, YHG, PJW, XD, LKW, NESO, FSMG, ED, CRP, KG, MH, RMA, DG.

Conducting the analyses: CV, YHG, TDM.

Writing the original manuscript: CV.

Providing data for the analysis: NESO, FSMG, ED, CRP, KG, MH, DG, YHG, TDM.

Editing and approving the manuscript: CV, YHG, PJW, XD, LKW, NESO, FSMG, ED, CRP, KG, MH, TDM, RMA, DG.

References

1. Unemo M. Current and future antimicrobial treatment of gonorrhoea - the rapidly evolving *Neisseria gonorrhoeae* continues to challenge. *BMC Infect Dis.* 2015;15(1):364. <https://doi.org/10.1186/s12879-015-1029-2> PMID: 26293005
2. Wi T, Lahra MM, Ndowa F, Bala M, Dillon JR, Ramon-Pardo P, et al. Antimicrobial resistance in *Neisseria gonorrhoeae*: Global surveillance and a call for international collaborative action. *PLoS Med.* 2017;14(7):e1002344. <https://doi.org/10.1371/journal.pmed.1002344> PMID: 28686231
3. World Health Organization (WHO). WHO Guidelines for the Treatment of *Neisseria gonorrhoeae*. Geneva: WHO. 2016. Available from: <https://www.who.int/reproductivehealth/publications/rtis/gonorrhoea-treatment-guidelines/en/>

4. Day MJ, Spiteri G, Jacobsson S, Woodford N, Amato-Gauci AJ, Cole MJ, et al. Stably high azithromycin resistance and decreasing ceftriaxone susceptibility in *Neisseria gonorrhoeae* in 25 European countries, 2016. *BMC Infect Dis.* 2018;18(1):609. <https://doi.org/10.1186/s12879-018-3528-4> PMID: 30509194
5. Fifer H, Natarajan U, Jones L, Alexander S, Hughes G, Golparian D, et al. Failure of Dual Antimicrobial Therapy in Treatment of Gonorrhoea. *N Engl J Med.* 2016;374(25):2504-6. <https://doi.org/10.1056/NEJMc1512757> PMID: 27332921
6. World Health Organization (WHO). Global priority list of antibiotic-resistant bacteria to guide research, discovery, and development of new antibiotics. Geneva: WHO. 27 Feb 2017. Available from: <https://www.who.int/medicines/publications/global-priority-list-antibiotic-resistant-bacteria/en/>
7. Allan-Blitz LT, Humphries RM, Hemarajata P, Bhatti A, Pandori MW, Siedner MJ, et al. Implementation of a Rapid Genotypic Assay to Promote Targeted Ciprofloxacin Therapy of *Neisseria gonorrhoeae* in a Large Health System. *Clin Infect Dis.* 2017;64(9):1268-70. PMID: 28034887
8. Farrell DJ, Sader HS, Rhomberg PR, Scangarella-Oman NE, Flamm RK. In Vitro Activity of Gepotidacin (GSK2140944) against *Neisseria gonorrhoeae*. *Antimicrob Agents Chemother.* 2017;61(3):e02047-16. <https://doi.org/10.1128/AAC.02047-16> PMID: 28069643
9. Bax BD, Chan PF, Eggleston DS, Fosberry A, Gentry DR, Gorrec F, et al. Type IIA topoisomerase inhibition by a new class of antibacterial agents. *Nature.* 2010;466(7309):935-40. <https://doi.org/10.1038/nature09197> PMID: 20686482
10. Scangarella-Oman NE, Hossain M, Dixon PB, Ingraham K, Min S, Tiffany CA, et al. Microbiological Analysis from a Phase 2 Randomized Study in Adults Evaluating Single Oral Doses of Gepotidacin in the Treatment of Uncomplicated Urogenital Gonorrhoea Caused by *Neisseria gonorrhoeae*. *Antimicrob Agents Chemother.* 2018;62(12):e01221-18. <https://doi.org/10.1128/AAC.01221-18> PMID: 30249694
11. Scangarella-Oman N, Hossain M, Dixon P, Ingraham K, Min S, Tiffany C, et al. P2.38 Microbiological analysis from a phase ii study in adults evaluating single doses of gepotidacin (GSK2140944) in the treatment of uncomplicated urogenital gonorrhoea caused by *Neisseria gonorrhoeae*. *Sex Transm Infect.* 2017;93(Suppl 2):A84.
12. Garnett GP, Mertz KJ, Finelli L, Levine WC, St Louis ME. The transmission dynamics of gonorrhoea: modelling the reported behaviour of infected patients from Newark, New Jersey. *Philos Trans R Soc Lond B Biol Sci.* 1999;354(1384):787-97. <https://doi.org/10.1098/rstb.1999.0431> PMID: 10365404
13. Hethcote H, Yorke J. *Gonorrhoea transmission dynamics and control.* Berlin: Springer. 1984.
14. Whittles LK, White PJ, Didelot X. Estimating the fitness cost and benefit of cefixime resistance in *Neisseria gonorrhoeae* to inform prescription policy: A modelling study. *PLoS Med.* 2017;14(10):e1002416. <https://doi.org/10.1371/journal.pmed.1002416> PMID: 29088226
15. Taylor SN, Morris DH, Avery AK, Workowski KA, Batteiger BE, Tiffany CA, et al. Gepotidacin for the Treatment of Uncomplicated Urogenital Gonorrhoea: A Phase 2, Randomized, Dose-Ranging, Single-Oral Dose Evaluation. *Clin Infect Dis.* 2018;67(4):504-12. <https://doi.org/10.1093/cid/ciy145> PMID: 29617982
16. Office for National Statistics (ONS). United Kingdom population mid-year estimate 2016. London: ONS. [Accessed: 25 Nov 2017]. Available from: www.ons.gov.uk/peoplepopulationandcommunity/populationandmigration/populationestimates/timeseries/ukpop/pop
17. Didelot X, Dordel J, Whittles LK, Collins C, Bilek N, Bishop CJ, et al. Genomic Analysis and Comparison of Two Gonorrhoea Outbreaks. *MBio.* 2016;7(3):e00525-16. <https://doi.org/10.1128/mBio.00525-16> PMID: 27353752
18. Brittain C, Childs M, Duley L, Harding J, Hepburn T, Meakin G, et al. Gentamicin versus ceftriaxone for the treatment of gonorrhoea (G-TOG trial): study protocol for a randomised trial. *Trials.* 2016;17(1):558. <https://doi.org/10.1186/s13063-016-1683-8> PMID: 27881151
19. Bjedov I, Tenailon O, Gérard B, Souza V, Denamur E, Radman M, et al. Stress-induced mutagenesis in bacteria. *Science.* 2003;300(5624):1404-9. <https://doi.org/10.1126/science.1082240> PMID: 12775833
20. Yang J, Annamalai T, Cheng B, Banda S, Tyagi R, Tse-Dinh YC. Antimicrobial Susceptibility and SOS-Dependent Increase in Mutation Frequency Are Impacted by *Escherichia coli* Topoisomerase I C-Terminal Point Mutation. *Antimicrob Agents Chemother.* 2015;59(10):6195-202. <https://doi.org/10.1128/AAC.00855-15> PMID: 26248366
21. Schook PO, Stohl EA, Criss AK, Seifert HS. The DNA-binding activity of the *Neisseria gonorrhoeae* LexA orthologue NG1427 is modulated by oxidation. *Mol Microbiol.* 2011;79(4):846-60. <https://doi.org/10.1111/j.1365-2958.2010.07491.x> PMID: 21299643
22. Nagel M, Reuter T, Jansen A, Szekat C, Bierbaum G. Influence of ciprofloxacin and vancomycin on mutation rate and transposition of IS256 in *Staphylococcus aureus*. *Int J Med Microbiol.* 2011;301(3):229-36. <https://doi.org/10.1016/j.ijmm.2010.08.021> PMID: 21115395
23. Vestergaard M, Paulander W, Marvig RL, Clasen J, Jochumsen N, Molin S, et al. Antibiotic combination therapy can select for broad-spectrum multidrug resistance in *Pseudomonas aeruginosa*. *Int J Antimicrob Agents.* 2016;47(1):48-55. <https://doi.org/10.1016/j.ijantimicag.2015.09.014> PMID: 26597931
24. Spratt BG, Bowler LD, Zhang QY, Zhou J, Smith JM. Role of interspecies transfer of chromosomal genes in the evolution of penicillin resistance in pathogenic and commensal *Neisseria* species. *J Mol Evol.* 1992;34(2):115-25. <https://doi.org/10.1007/BF00182388> PMID: 1556747
25. De Silva D, Peters J, Cole K, Cole MJ, Cresswell F, Dean G, et al. Whole-genome sequencing to determine transmission of *Neisseria gonorrhoeae*: an observational study. *Lancet Infect Dis.* 2016;16(11):1295-303. [https://doi.org/10.1016/S1473-3099\(16\)30157-8](https://doi.org/10.1016/S1473-3099(16)30157-8) PMID: 27427203
26. Grad YH, Kirkcaldy RD, Trees D, Dordel J, Harris SR, Goldstein E, et al. Genomic epidemiology of *Neisseria gonorrhoeae* with reduced susceptibility to cefixime in the USA: a retrospective observational study. *Lancet Infect Dis.* 2014;14(3):220-6. [https://doi.org/10.1016/S1473-3099\(13\)70693-5](https://doi.org/10.1016/S1473-3099(13)70693-5) PMID: 24462211
27. Ezewudo MN, Joseph SJ, Castillo-Ramirez S, Dean D, Del Rio C, Didelot X, et al. Population structure of *Neisseria gonorrhoeae* based on whole genome data and its relationship with antibiotic resistance. *PeerJ.* 2015;3:e806. <https://doi.org/10.7717/peerj.806> PMID: 25780762
28. World Health Organization (WHO). Global action plan to control the spread and impact of antimicrobial resistance in *Neisseria gonorrhoeae*. Geneva: WHO; 2012. Available from: <https://apps.who.int/iris/handle/10665/44863>
29. Babraham Institute. Babraham Bioinformatics. FastQC. Cambridge: Babraham Institute. 2012. Available from: <http://www.bioinformatics.babraham.ac.uk/projects/fastqc/>
30. Li H. Aligning sequence reads, clone sequences and assembly contigs with BWA-MEM. *ArXiv13033997 Q-Bio.* 2013. Available from: <https://arxiv.org/abs/1303.3997>
31. Walker BJ, Abeel T, Shea T, Priest M, Abouelliel A, Sakthikumar S, et al. Pilon: an integrated tool for comprehensive microbial variant detection and genome assembly improvement. *PLoS One.* 2014;9(11):e112963. <https://doi.org/10.1371/journal.pone.0112963> PMID: 25409509
32. Harris SR, Cole MJ, Spiteri G, Sánchez-Busó L, Golparian D, Jacobsson S, et al. Public health surveillance of multidrug-resistant clones of *Neisseria gonorrhoeae* in Europe: a genomic survey. *Lancet Infect Dis.* 2018;18(7):758-68. [https://doi.org/10.1016/S1473-3099\(18\)30225-1](https://doi.org/10.1016/S1473-3099(18)30225-1) PMID: 29776807
33. Grad YH, Harris SR, Kirkcaldy RD, Green AG, Marks DS, Bentley SD, et al. Genomic Epidemiology of Gonococcal Resistance to Extended-Spectrum Cephalosporins, Macrolides, and Fluoroquinolones in the United States, 2000-2013. *J Infect Dis.* 2016;214(10):1579-87. <https://doi.org/10.1093/infdis/jiw420> PMID: 27638945
34. Levin BR, Bonten MJ. Cycling antibiotics may not be good for your health. *Proc Natl Acad Sci USA.* 2004;101(36):13101-2. <https://doi.org/10.1073/pnas.0404970101> PMID: 15340145
35. Tuite AR, Gift TL, Chesson HW, Hsu K, Salomon JA, Grad YH. Impact of Rapid Susceptibility Testing and Antibiotic Selection Strategy on the Emergence and Spread of Antibiotic Resistance in Gonorrhoea. *J Infect Dis.* 2017;216(9):1141-9. <https://doi.org/10.1093/infdis/jix450> PMID: 28968710
36. Fingerhuth SM, Low N, Bonhoeffer S, Althaus CL. Detection of antibiotic resistance is essential for gonorrhoea point-of-care testing: a mathematical modelling study. *BMC Med.* 2017;15(1):142. <https://doi.org/10.1186/s12916-017-0881-x> PMID: 28747205
37. Frénoy A, Bonhoeffer S. Death and population dynamics affect mutation rate estimates and evolvability under stress in bacteria. *bioRxiv.* 2017. <https://doi.org/10.1101/224675>
38. Obolski U, Hadany L. Implications of stress-induced genetic variation for minimizing multidrug resistance in bacteria. *BMC Med.* 2012;10(1):89. <https://doi.org/10.1186/1741-7015-10-89> PMID: 22889082

This is an open-access article distributed under the terms of the Creative Commons Attribution (CC BY 4.0) Licence. You may share and adapt the material, but must give appropriate credit to the source, provide a link to the licence and indicate if changes were made.

Any supplementary material referenced in the article can be found in the online version.

This article is copyright of the authors or their affiliated institutions, 2020.

Antimicrobial resistance point-of-care testing for gonorrhoea treatment regimens: cost-effectiveness and impact on ceftriaxone use of five hypothetical strategies compared with standard care in England sexual health clinics

Emma M Harding-Esch^{1,2}, Susie E Huntington³, Michael J Harvey³, Georgie Weston³, Claire E Broad¹, Elisabeth J Adams³, S Tariq Sadiq^{1,2,4}

1. Applied Diagnostic Research and Evaluation Unit, Institute for Infection and Immunity, St George's University of London, London, United Kingdom

2. National Infection Service, Public Health England, London, United Kingdom

3. Aquarius Population Health, London, United Kingdom

4. St George's University Hospitals NHS Foundation Trust, London, United Kingdom

Correspondence: S Tariq Sadiq (ssadiq@sgul.ac.uk)

Citation style for this article:

Harding-Esch Emma M, Huntington Susie E, Harvey Michael J, Weston Georgie, Broad Claire E, Adams Elisabeth J, Sadiq S Tariq. Antimicrobial resistance point-of-care testing for gonorrhoea treatment regimens: cost-effectiveness and impact on ceftriaxone use of five hypothetical strategies compared with standard care in England sexual health clinics. *Euro Surveill.* 2020;25(43):pii=1900402. <https://doi.org/10.2807/1560-7917.ES.2020.25.43.1900402>

Article submitted on 21 Jun 2019 / accepted on 22 Apr 2020 / published on 29 Oct 2020

Background: Widespread ceftriaxone antimicrobial resistance (AMR) threatens *Neisseria gonorrhoeae* (NG) treatment, with few alternatives available. AMR point-of-care tests (AMR POCT) may enable alternative treatments, including abandoned regimens, sparing ceftriaxone use. We assessed cost-effectiveness of five hypothetical AMR POCT strategies: A-C included a second antibiotic alongside ceftriaxone; and D and E consisted of a single antibiotic alternative, compared with standard care (SC: ceftriaxone and azithromycin). **Aim:** Assess costs and effectiveness of AMR POCT strategies that optimise NG treatment and reduce ceftriaxone use. **Methods:** The five AMR POCT treatment strategies were compared using a decision tree model simulating 38,870 NG-diagnosed England sexual health clinic (SHC) attendees; A micro-costing approach, representing cost to the SHC (for 2015/16), was employed. Primary outcomes were: total costs; percentage of patients given optimal treatment (regimens curing NG, without AMR); percentage of patients given non-ceftriaxone optimal treatment; cost-effectiveness (cost per optimal treatment gained). **Results:** All strategies cost more than SC. Strategy B (azithromycin and ciprofloxacin (azithromycin preferred); dual therapy) avoided most suboptimal treatments (n = 48) but cost most to implement (GBP 4,093,844 (EUR 5,474,656)). Strategy D (azithromycin AMR POCT; monotherapy) was most cost-effective for both cost per optimal treatments gained (GBP 414.67 (EUR 554.53)) and per ceftriaxone-sparing treatment (GBP 11.29

(EUR 15.09)) but with treatment failures (n = 34) and suboptimal treatments (n = 706). **Conclusions:** AMR POCT may enable improved antibiotic stewardship, but require net health system investment. A small reduction in test cost would enable monotherapy AMR POCT strategies to be cost-saving.

Introduction

Antimicrobial resistance (AMR) has developed to every class of antibiotic used for treatment of the bacterial sexually transmitted infection (STI) *Neisseria gonorrhoeae* (NG) [1], with increasing reports of multidrug-resistant strains [2]. NG, the second most prevalent bacterial STI globally [3], is associated with serious long-term reproductive health complications if left untreated.

World Health Organization (WHO) guidelines [4] recommend a treatment regimen that treats at least 95% of circulating NG strains, as monitored through antibiotic surveillance programmes such as Public Health England's national Gonococcal Resistance to Antimicrobials Surveillance Programme (GRASP) [1]. Dual therapy with ceftriaxone and azithromycin is recommended in Europe [5], and was in the United Kingdom (UK) until 2019 [6] when it was replaced with 1 g ceftriaxone monotherapy due to the emergence of azithromycin resistance [7]. AMR to ceftriaxone, an extended-spectrum cephalosporin, is the most urgent

Standard care

Standard care with dual therapy of intramuscular ceftriaxone (500 mg) and oral azithromycin (1 g single dose).

Dual therapy, including ceftriaxone

A) AMR POCT for ciprofloxacin resistance only. Infections identified as not resistant to ciprofloxacin are given oral ciprofloxacin (500 mg) plus ceftriaxone (500 mg). Infections identified as ciprofloxacin resistant are given SC.

B) Dual AMR POCT for azithromycin and ciprofloxacin resistance. If no azithromycin resistance is identified, SC is given. If azithromycin resistant, ciprofloxacin (500 mg) and ceftriaxone (500 mg) are given unless there is ciprofloxacin resistance, in which case ceftriaxone (500 mg) is given alone.

C) Dual AMR POCT for ciprofloxacin and azithromycin resistance. If no ciprofloxacin resistance is identified, ciprofloxacin (500 mg) and ceftriaxone (500 mg) are given. If ciprofloxacin resistant, SC is given, unless there is also azithromycin resistance, when ceftriaxone (500 mg) is given alone.

Monotherapy optimisation

D) AMR POCT for azithromycin resistance. If no azithromycin resistance is identified, azithromycin (2 g) is given. If azithromycin resistant, ceftriaxone (500 mg) and ciprofloxacin (500 mg) dual therapy is given. If the AMR POCT incorrectly shows no resistance (false negative for AMR), it is assumed the treatment fails. The treatment failure would be identified in the test-of-cure and the patient would then receive 500 mg ceftriaxone.

E) AMR POCT for ciprofloxacin. If no ciprofloxacin resistance is identified, 500 mg ciprofloxacin monotherapy is given. If ciprofloxacin resistant, SC is given. If the AMR POCT incorrectly shows no resistance, monotherapy is assumed to fail, the patient returns and receives 500 mg ceftriaxone alone.

AMR: antimicrobial resistance; POCT: point-of-care test; SC: standard care.

threat [8,9] with few practical alternatives immediately available if widespread resistance develops.

Rapid diagnostics have been identified as a key approach to tackling AMR [10]. Rapid tests are those that have a two-hour turnaround, whereas point-of-care tests (POCTs) enable the test to be conducted, results obtained and treatment performed in the same clinical visit [11]. A principal feature of an NG AMR diagnostic is to assess antibiotic susceptibility at the time of NG diagnosis. A test that combines both NG diagnosis and AMR prediction at the point-of-care (AMR POCT) would allow the selection of appropriate treatment regimens for considerable numbers of NG infections, including safe use of antimicrobials which have been abandoned for widespread use due to circulating resistance, but which would be effective for a substantial proportion of infections [12]. For example, in the UK in 2018, 60% of NG infections were susceptible to ciprofloxacin, 90% to azithromycin and 88% to penicillin [1]. The ability to use these antibiotics to treat NG may in turn reduce AMR selection pressure on ceftriaxone [13].

Rapid tests are already being used for NG in some sexual health clinics (SHC) [14]. While laboratory-based NG fluoroquinolone susceptibility tests exist [15], rapid NG AMR tests are in development and being clinically evaluated. One such test is an NG fluoroquinolone susceptibility AMR POCT, developed within the Precise Study [16] using the io platform (Binx Health Limited (formerly Atlas Genetics), Boston, United States (US)) already CE-marked for *Chlamydia trachomatis* (CT)

detection [12,17]. Costs and short-term clinical impacts of these tests are used in procuring sexual health services provision for a region (known as sexual health commissioning in England) and adoption into SHC decisionmaking [18].

In this analysis, we assessed the cost-effectiveness in English SHC of five hypothetical AMR POCT strategies for the treatment of NG, which enable use of ciprofloxacin and/or azithromycin, either alongside, or as an alternative to, ceftriaxone. Potential diagnostic resistance-determinants of these antibiotics are small in number (*gyrA* for ciprofloxacin; *23S rRNA* and *mtrCDE* transporter for azithromycin), are relatively well-understood, and their absence predictive of susceptibility (particularly for ciprofloxacin). The development of molecular AMR POCTs for detection of these determinants are thus technically feasible and therefore more likely to be immediately available [19-21].

Methods**Model structure**

We compared standard care (SC) for NG treatment in the UK (at the time of investigation, ceftriaxone 500 mg and azithromycin 1 g dual therapy [6]) with five different AMR POCT strategies (Box, Supplementary Figure S1), where the AMR POCT was used as a reflex test to inform antibiotic selection irrespective of which test was used to diagnose NG initially. The AMR POCT strategies were chosen to either facilitate optimised choice

of a second antibiotic alongside ceftriaxone (dual therapy), or enable a single antibiotic alternative to ceftriaxone (monotherapy) (Box and Table 1).

The rationale for dual therapy strategies is based on the assumption that combination therapy is more effective at preventing emergence or spread of AMR and thereby preserves the use of ceftriaxone. The rationale for the monotherapy strategies is that an AMR POCT enables effective treatment of the known resistance profile, sparing the use of ceftriaxone [22].

Each strategy consisted of a series of intended treatment regimens, contingent on the results of the AMR POCT used. For example, in strategy B, the earliest intended treatment regimen was SC, where the AMR POCT indicated azithromycin resistance; the second intended treatment regimen was ceftriaxone and ciprofloxacin, where the AMR POCT then indicated ciprofloxacin resistance; the third intended treatment regimen was ceftriaxone monotherapy.

A decision tree model was constructed using TreeAge Pro version 2017 (TreeAge Software, Williamstown, United States (US)) to simulate a hypothetical cohort of 38,870 NG-diagnosed SHC attendees (21,915 men who have sex with men (MSM), 8,488 women and 8,467 men who have sex with women (MSW)), representing the total number of NG diagnoses in England SHC in 2015, obtained from the genitourinary medicine clinical activity dataset national surveillance data (GUMCAD) [23]. Our assumptions regarding AMR POCT use meant the model could not be used when considering presumptive treatment, e.g. for sexual contacts of NG-positive patients initially negative by microscopy but subsequently positive by nucleic acid amplification testing (NAAT). Approximately 10% of individuals diagnosed with NG are in contacts [24] but the epidemiological breakdown of these patients (e.g. women, MSW, MSM) and the nature of their NG diagnoses (e.g. microscopy negative and NAAT positive) is not reported. Therefore, contacts could not be removed from the hypothetical cohort.

Key model assumptions include: 100% compliance with test protocols; all patients entering the model are NG true-positives; dual AMR POCT results are available simultaneously; and there is no ceftriaxone resistance data (supported by England's GRASP [1]) so patients with monotherapy treatment failure would return and be successfully treated with ceftriaxone only. Model assumptions are provided in Supplementary Table S1.

Outcomes

We aimed to assess the costs and effectiveness of these AMR POCT strategies to optimise treatment regimen choice and reduce selection pressure on ceftriaxone. The primary outcomes were the total costs (2015/16 GBP(EUR)), the percentage of people given optimal treatment, and the percentage of people given non-ceftriaxone optimal treatment. Optimal treatment

was defined as one which cured NG and did not contain an antibiotic against which there was resistance. Model definitions are provided in Supplementary Table S2. These data were used to calculate incremental cost-effectiveness ratios (ICER, see equation) for the cost per additional optimal treatment gained and the cost per additional ceftriaxone treatment avoided. This was chosen as the measure of cost-effectiveness rather than other measures, such as cost per Quality Adjusted Life Years (QALY), because little data exist on the consequence of optimal vs suboptimal NG treatment on long-term outcomes, such as mortality or life-time costs.

$$ICER = \frac{Cost_B - Cost_A}{Effectiveness_B - Effectiveness_A}$$

A: standard care; B: antimicrobial resistance point-of-care test strategy; ICER: incremental cost-effectiveness ratio.

ICERs were calculated for two types of effectiveness: optimal treatments and ceftriaxone treatments avoided.

Secondary outcomes were the percentage of people given a missed earlier intended treatment regimen (MEITR), and the percentage of people failing treatment due to resistance. MEITR was defined as the use of a treatment regimen which cured NG, but where an earlier intended treatment regimen would have provided optimal treatment because susceptible infections had been misclassified as resistant by the AMR POCT. MEITRs were independent of treatment effectiveness.

Treatment

AMR POCT strategy treatment regimens were developed with input from three senior clinicians at St George's University Hospitals NHS Foundation Trust, London, who outlined current and hypothetical AMR POCT patient pathways (Supplementary Figure S1). The purpose of the work was to determine AMR POCT strategy for short-term clinical impacts, because these are the data used for sexual health service provision and decisionmaking for adoption into SHC [18]. Furthermore, progression to longer-term clinical impacts from suboptimally treated infection is poorly defined [25]. Therefore, the time horizon was that of initial patient treatment. Complications associated with STIs, such as pelvic inflammatory disease (PID) in women, and adverse drug events associated with treatment were not considered.

Model parameters

Model epidemiology parameters are presented in Table 2, and cost parameters in Table 3 and Supplementary Table S3. The hypothetical AMR POCT sensitivity and specificity were based on other NAAT-based rapid and POC tests [26-28], and altered in sensitivity analyses. Antibiotic resistance prevalences were obtained from national surveillance of SHC attendees (GRASP, 2017)

TABLE 1
Summary of antimicrobial point-of-care test strategies

Strategy	Antibiotic(s) for which resistance is tested			Intended treatment regimen based on test result						
	A	+	B	No resistance to A			Resistance to A			Resistance to A+B
Strategy A	Ciprofloxacin	NA	NA	Ciprofloxacin	+	Ceftriaxone	Azithromycin	+	Ceftriaxone	NA
Strategy B	Azithromycin	+	Ciprofloxacin	Azithromycin	+	Ceftriaxone	Ciprofloxacin	+	Ceftriaxone	Ceftriaxone
Strategy C	Ciprofloxacin	+	Azithromycin	Ciprofloxacin	+	Ceftriaxone	Azithromycin	+	Ceftriaxone	Ceftriaxone
Strategy D	Azithromycin	NA	NA	Azithromycin ^{a,b}	NA	NA	Ciprofloxacin	+	Ceftriaxone	NA
Strategy E	Ciprofloxacin	NA	NA	Ciprofloxacin ^b	NA	NA	Azithromycin	+	Ceftriaxone	NA
Standard care	No resistance testing is done. Standard care is ceftriaxone 500 mg and azithromycin 1 g dual therapy [6].									

NA: not applicable.

^a Dose given: 2 g.

^b If incorrect test result and treatment fails, ceftriaxone is given.

Bold font indicates standard care antibiotics, i.e. azithromycin and ceftriaxone dual therapy.

Unless otherwise stated, doses are: ceftriaxone 500 mg; azithromycin 1 g; ciprofloxacin 500 mg.

[29]. GRASP is England's national sentinel surveillance system that detects and monitors AMR in NG and records potential treatment failures. As the time horizon was that of initial patient treatment, discounting rates were not applied.

A micro-costing approach was employed, considering only costs incurred to the healthcare provider (i.e. SHC). Costs to those procuring sexual health services provision, or to health systems as a whole, were not considered. Costs were estimated by adapting an existing model [30] and included: laboratory equipment; POCTs and antibiotics; AMR POCTs; and NG treatment implementation (e.g. staff time and consumables, including partner notification and health promotion) (Supplementary Table S3). It was assumed the AMR POCTs produced results in 30 min (maximum acceptable POCT run-time for service users [31,32]) and that in all strategies, NG-positive samples would still be sent to the laboratory for culture and phenotypic resistance testing. Costs are given in 2015/16 prices (GBP (EUR)) and inflated when based on old estimates [33]. Antibiotic prices were extracted from the British National Formulary (BNF) website (September 2016), with the cheapest formulation being used including non-proprietary costs where available [34]. Initial costs of diagnosing NG were not considered as people only entered the model after an NG diagnosis. The cost of implementing a change to clinical practice was also not considered.

Sensitivity analyses

We conducted one-way analyses using TreeAge Pro version 2017 (TreeAge Software) and R software version 3.5.0 (R Foundation, Vienna, Austria), for each of the model parameters by varying them independently at the ends of their ranges to examine the effect on the primary outcome (Table 2). These analyses identified which model parameters results were most sensitive to. Each sensitivity analysis compared one of the five

AMR POCT strategies with SC, across three population groups (women, MSW, and MSM). Probabilistic sensitivity analyses (PSA) were not performed because our analysis was a cost-effectiveness analysis with the outcome as cost per event avoided, rather than a cost acceptability or cost utility analysis exploring the likelihood that the technology is cost-effective at different willingness to pay (WTP) thresholds. There is no commonly agreed WTP for our outcome, and therefore presenting PSA results would likely not have yielded additional beneficial information.

This report was written following the Consolidated Health Economic Evaluation Reporting Standards (CHEERS) checklist [35].

Ethical statement

As the only data included for this study were nationally published surveillance data from PHE, and no patient data were used, ethical approval was not required.

Results

Overall AMR POCT strategy costs, treatments used, and treatment outcomes compared with SC in all groups are presented in Table 4. Breakdowns by population group are presented in Supplementary Tables S4, S5 and S6.

Costs

The cost of SC NG management was GBP 2,856,168 (EUR 3,819,524) for the total cohort (Table 4). All AMR POCT strategies cost more than SC, with dual therapy AMR POCT strategies more expensive than monotherapy strategies. Strategy D was the least expensive AMR POCT strategy, costing GBP 3,271,684 (EUR 4,375,189), 14.5% more than SC. Strategy B was the most expensive, costing GBP 4,093,844 (EUR 5,474,656), 43% more than SC. This was consistent across all population groups (Supplementary Tables S4, S5 and S6).

TABLE 2
Epidemiology parameters used in the model for antimicrobial point-of-care test strategies

Variable		Percentage (%)						Number						Comments and references
		MSM		W		MSW		MSM		W		MSW		
		Base case value	Range (low, high)	Base case value	Range (low, high)	Base case value	Range (low, high)	Base case value	Range (low, high)	Base case value	Range (low, high)	Base case value	Range (low, high)	
1	Initial clinic attendances	56.4	NA	21.8	NA	21.8	NA	21,915	NA	8,488	NA	8,467	NA	GUMCAD, 2015 [23]
2	Resistance to azithromycin ^a	4.7	3.3–6.1	2.7	1.9–3.5	5.3	3.7–6.9	1,030	723–1,337	229	161–297	449	313–584	GRASP, 2017 [29]
3	Resistance to ceftriaxone	0	0–0	0	0–0	0	0–0	0	0–0	0	0–0	0	0–0	GRASP, 2017 [29]
4	Resistance to ciprofloxacin ^b	36.2	25.3–47.1	20.1	14.1–26.1	32.5	22.8–42.3	7,933	5,544–10,322	1,706	1,197–2,215	2,752	1,930–3,582	GRASP, 2017 [29]
5	Sensitivity of AMR POCT	98	90–100	98	90–100	98	90–100	NA	NA	NA	NA	NA	NA	Assumption
6	Specificity of AMR POCT	99	90–100	99	90–100	99	90–100	NA	NA	NA	NA	NA	NA	Assumption

AMR: antimicrobial resistance; GUMCAD: genitourinary medicine clinical activity dataset; GRASP: gonococcal resistance to antimicrobial surveillance programme; MSM: men who have sex with men; MSW: men who have sex with women; NA: not applicable; POCT: point-of-care test; W: women.

^a The azithromycin resistance ranges were extended further to 1–10% for all population groups in one-way azithromycin resistance analysis so that the effect of more extreme values could be explored.

^b The ciprofloxacin resistance ranges were extended further to 0–50% in one-way ciprofloxacin resistance analysis so that the effect of more extreme values could be explored.

Optimal treatment

All AMR POCT strategies provided more optimal treatments than SC, in all population groups. Strategy B provided most optimal ($n = 38,822$) and least suboptimal ($n = 48$) treatments. Strategies A and E equally provided the least optimal treatments and the most suboptimal ($n = 813$) (see Table 4 and Supplementary Tables S4, S5 and S6).

Ceftriaxone-sparing treatments given

Since all dual therapy strategies used ceftriaxone, only monotherapy strategies provided ceftriaxone-sparing options. Strategy D reduced ceftriaxone use by 95% compared with SC (Table 4).

MEITRs given

A MEITR refers to a treatment regimen being used when an earlier intended treatment regimen would have provided optimal treatment. In all population groups, the fewest were in Strategies A and E ($n = 265$), and B ($n = 267$), and the most were in Strategy C ($n = 912$) (Table 4, Supplementary Tables S4, S5 and S6).

Treatment failures

There were some treatment failures in each monotherapy strategy due to false-susceptible AMR POCT results: strategy D had 34/38,870 (0.09% of treatments) and Strategy E had 248/38,870 (0.64% of treatments) (Table 4). There were no treatment failures with SC or dual therapy strategies (A, B and C) because they all included ceftriaxone. This was consistent across all population groups (Supplementary Tables S4, S5 and S6).

Cost-effectiveness analysis

The cost-effectiveness analysis (CEA) results are presented in Table 5. When avoidance of suboptimal treatments was considered, Strategy D was most cost-effective relative to SC, costing GBP 414.67 (EUR

554.53) per optimal treatment gained. Strategy A was least cost-effective overall, whereas Strategy B was the most-cost effective dual therapy strategy.

When avoidance of ceftriaxone use was considered, Strategy D was most cost-effective relative to SC, costing GBP 11.29 (EUR 15.09) per ceftriaxone-sparing treatment gained. These findings were consistent across all population groups.

Sensitivity analyses

In one-way sensitivity analyses, the following four parameters had the greatest impact on cost-effectiveness per optimal treatment gained for all AMR POCT strategies and across all population groups: prevalence of azithromycin resistance; AMR POCT sensitivity; prevalence of ciprofloxacin resistance; and the cost of single detection AMR POCT. In monotherapy strategies, the cost-effectiveness model was additionally sensitive to cost of clinical management (both with and without injection), cost of ceftriaxone, and AMR POCT specificity (for strategy D). The cost multiplier for a dual detection AMR POCT impacted on AMR POCT cost-effectiveness for Strategies B and C. Tornado plots from these analyses are presented in Supplementary Figure S2.

For all strategies, variation of ICER in relation to azithromycin resistance prevalence was minimal until prevalence fell to or below 3%, at which point it increased (Supplementary Figure S3). These rises in ICER were least for strategies B and D. With the exception of strategy B where ICER were consistent for all population groups, these increases in ICER were most limited in women.

Variation in AMR POCT accuracy also showed similar patterns across all population groups. Apart from Strategy D, variation in specificity had very little effect on cost per optimal treatment gained. In contrast, as

TABLE 3

Cost parameters used in the model for antimicrobial point-of-care test strategies

Cost input	Cost ^a		Comments and references
	Base case value	Range (low–high)	
Management of NG (oral medication/IM injection)	GBP 53.00/ GBP 62.74 (EUR 70.88 / EUR 83.90)	GBP 37.10–68.90 / GBP 43.92–81.56 (EUR 49.6–92.1 / EUR 58.73–109.07)	^b Adapted from previous model. Adams, 2014 [30]
Return visit due to treatment failure	GBP 48.01 (EUR 64.20)	GBP 33.61–62.41 (EUR 44.95–83.46)	^{b,c} Adapted from previous model. Adams, 2014 [30]
Single AMR POCT	GBP 29.00 (EUR 38.78)	GBP 20.00–40.00 (EUR 26.75–53.49)	Estimate [47]
Dual AMR POCT	GBP 31.90 (EUR 42.66)	GBP 29.00–58.00 (EUR 38.78–77.56)	Estimate – 10% more than price of single AMR POCT (multiplier 1.1, range 1.0–2.0)
Dual AMR POCT	GBP 31.90 (EUR 42.66)	GBP 22.00–44.00 (EUR 29.42–58.84)	Estimate – single AMR POCT is varied, multiplier remains at 1.1 (10% more than price of single AMR POCT)
Azithromycin 1 g ^d	GBP 1.16 (EUR 1.55)	GBP 0.81–1.51 (EUR 1.08–2.02)	BNF, 2016 [34]
Azithromycin 2 g ^d	GBP 2.32 (EUR 3.10)	GBP 1.62–3.02 (EUR 2.17–4.04)	BNF, 2016 [34]
Ceftriaxone 500 mg ^e	GBP 9.58 (EUR 12.81)	GBP 6.71–12.45 (EUR 8.97–16.65)	BNF, 2016 [34]
Ciprofloxacin 500 mg ^d	GBP 0.07 (EUR 0.09)	GBP 0.05–0.09 (EUR 0.07–0.12)	BNF, 2016 [34]

AMR: antimicrobial resistance; BNF: British National Formulary; IM: intramuscular; NG: *Neisseria gonorrhoeae*; POCT: point-of-care test.

^a GBP costs were converted to EUR using a historic currency conversion of an average of 366 days from 1 July 2015 to 30 June 2016 [48]. For this time period, GBP 1 = EUR 1.34, and EUR 1 = GBP 0.75.

^b Includes staff time and consumables but not antibiotic costs. Costs were inflated to 2015/16 costs using the Hospital and Community Health Services (HCHS) Inflation Indices 2015 produced by the Personal Social Services Research Unit [33]. No data were available for inflation from 2014/15 to 2015/16 so it was assumed to be the same as between 2013/2014 and 2014/15. The United Kingdom hospital consumer price index for health services shows similar annual growth in this sector from 2014 (93.2 in 2013, 97.1 in 2014 and 100 in 2015), which validates this assumption [49]. GBP costs were converted to EUR using a historic currency conversion of an average of 366 days from 1 July 2015 to 30 June 2016 [48]. For this time period, GBP 1 = EUR 1.34, and EUR 1 = GBP 0.75. A further breakdown of cost data are provided in Supplementary Table S3.

^c Within the context of this model, treatment failure due to resistance to a monotherapy would result in a return visit. No repeat culture would be taken and no repeat diagnostic tests would occur. The patient would be successfully treated using ceftriaxone, administered via injection.

^d Oral medication.

^e Administered via intramuscular injection. The price quoted is for 1 g vial of ceftriaxone, the smallest non-proprietary vial available [34] - the remaining 500 mg is then discarded.

sensitivity decreased to a minimum of 90%, particularly towards the lower range, the cost per optimal treatment gained increased exponentially, except for strategy B where the relationship was linear. Strategy B also had the smallest change in ICER between maximum (100%) and minimum (90%) sensitivity (maximum difference of GBP 169.21 (EUR 226.28) per optimal treatment gained in women) compared with other strategies where the difference was in the thousands. For Strategy D, change in sensitivity had little impact on cost per optimal treatment gained, whereas when specificity decreased to below around 95.5%, the cost per optimal treatment gained started to increase exponentially. The sensitivity analyses are presented in Supplementary Figure S4.

The prevalence of ciprofloxacin resistance had very little effect on cost per optimal treatment gained in Strategies B, C and D (Supplementary Figure S5). For Strategies A and E, as ciprofloxacin resistance increased from ca 20%, there was an exponential increase in cost per optimal treatment gained for women only.

The relationship between ICER and cost of a single target AMR POCT was linear. Interestingly, as the cost of the single target AMR POCT increased, the two dual-target AMR POCTs diverged, with strategy B costing less per optimal treatment gained relative to strategy C.

For the three single target AMR POCTs (A, D and E), reducing the cost of the test had the greatest impact

TABLE 4

Total costs, treatments used and treatment outcomes for standard care and antimicrobial resistance point-of-care test strategies: all groups (n = 38,870)

Strategy	Total cost ^a	Number of antibiotics used to treat NG			Number of optimal treatments ^b	Number of suboptimal treatments ^c	Number of MEITR ^d	Number of treatment failures ^e
		Ceftriaxone	Azithromycin	Ciprofloxacin				
Standard care	GBP 2,856,168 (EUR 3,819,524)	38,870	38,870	0	37,162	1,708	NA	NA
A: Single POCT for ciprofloxacin; dual therapy	GBP 3,954,554 (EUR 5,288,385)	38,870	12,408	26,462	38,057	813	265	NA
B: Dual POCT for azithromycin and ciprofloxacin; dual therapy	GBP 4,093,844 (EUR 5,474,656)	38,870	36,825	1,373	38,822	48	267	NA
C: Dual POCT for ciprofloxacin and azithromycin; dual therapy	GBP 4,066,498 (EUR 5,438,086)	38,870	11,736	26,462	38,611	259	912	NA
D: Single POCT for azithromycin; monotherapy	GBP 3,271,684 (EUR 4,375,189)	2,080	36,825	2,045	38,164	706	372	34
E: Single POCT for ciprofloxacin; monotherapy	GBP 3,457,581 (EUR 4,623,788)	12,656	12,408	26,462	38,057	813	265	248

AMR: antimicrobial resistance; MEITR: missed earlier intended treatment regimen; NG: *Neisseria gonorrhoeae*; POCT: point-of-care test.

^a GBP costs were converted to EUR using a historic currency conversion of an average of 366 days from 1 July 2015 to 30 June 2016 [48]. For this time period, GBP 1 = EUR 1.34, and EUR 1 = GBP 0.75.

^b 'Optimal' refers to a treatment regimen which cures the NG infection and does not contain any antibiotic against which there is resistance.

^c 'Suboptimal' refers to a treatment regimen which contains antibiotics against which there is NG resistance - if the treatment is a monotherapy it will result in treatment failure.

^d 'Missed earlier intended treatment regimen' (MEITR) refers to a treatment regimen which cures the NG infection and does not contain any antibiotic against which there is resistance, but a treatment regimen was used when an earlier intended treatment regimen would have provided optimal treatment – a MEITR is due to a false-resistant AMR POCT result.

^e 'Treatment failure' refers to failure to cure an NG infection due to resistance to an antibiotic given as monotherapy and is due to a false-susceptible AMR POCT result.

on cost per treatment gained. Monotherapy strategies became cost-saving (ICER < 0) for all population groups when AMR POCT cost was ≤ GBP 18 (24.07 EUR) for Strategy D, and ≤ GBP 16 (EUR 21.40) for Strategy E (Supplementary Figure S6). Strategy B had lowest costs per additional optimal treatment for dual therapy strategies.

Discussion

We assessed the cost-effectiveness and impacts of deploying AMR POCTs for *N. gonorrhoeae*. All AMR POCT strategies assessed resulted in more optimal treatments compared with SC. Monotherapy AMR POCT strategies provided ceftriaxone-sparing options, with Strategy D reducing the use of ceftriaxone by 95%. Both outcomes are important in promoting antibiotic stewardship by minimising risks of breakthrough with ceftriaxone-resistant circulating strains, and reducing selection pressure for resistance developing to ceftriaxone, respectively.

Our cost-effectiveness analysis adapted a previously published cost-effectiveness model of introducing a dual CT/NG POCT into a SHC [28,30], and was populated using available published data, and where unavailable, using unpublished data and expert opinion.

By employing a decision tree model approach we could account for sufficient complexity without over-building. However, this approach is, in contrast to using a transmission dynamic model [36], unable to assess outcomes such as the impact AMR POCTs could have on re-infection in a previously treated patient, on population prevalence or burden of disease, or on AMR evolution.

Turner et al. have adapted the same CT/NG POCT cost-effectiveness model we used for our analysis [28,30] to analyse the potential clinical and overall economic impact of an NG AMR POCT [37]. While theirs was not a cost-effectiveness analysis, and different model assumptions and parameters from ours were used, they also demonstrated that AMR POCTs could lead to overall reductions in ceftriaxone use, but that introduction of AMR POCTs incurred increased costs. Using an individual-based dynamic transmission model that incorporated partner treatment and which was applied to a London MSM population, Zienkiewicz et al. [38] also demonstrated that AMR POCTs for NG ciprofloxacin sensitivity reduced ceftriaxone use, by 70% compared with the reference scenario. An individual-based model of molecular NG AMR test use compared with culture within an NG surveillance system in remote settings

TABLE 5
Cost effectiveness analysis for standard care and antimicrobial resistance point-of-care test strategies

Subgroup	Comparison	Total additional cost ^a	Additional cost per patient ^a	Number of optimal treatments gained	Additional cost per optimal treatment gained ^a	Number of ceftriaxone treatments avoided	Additional cost per ceftriaxone-sparing treatment ^a
All	AMR POCT A vs SC	GBP 1,098,386.00 (EUR 1,468,860.00)	GBP 28.26 (EUR 37.79)	895	GBP 1,226.97 (EUR 1,640.81)	0	Dominated
	AMR POCT B vs SC	GBP 1,237,676.00 (EUR 1,655,131.00)	GBP 31.84 (EUR 42.58)	1,660	GBP 745.44 (EUR 996.87)	0	Dominated
	AMR POCT C vs SC	GBP 1,210,330.00 (EUR 1,618,562.00)	GBP 31.14 (EUR 41.64)	1,449	GBP 835.39 (EUR 1,117.16)	0	Dominated
	AMR POCT D vs SC	GBP 415,516.00 (EUR 555,665.30)	GBP 10.69 (EUR 14.30)	1,002	GBP 414.67 (EUR 554.53)	36,790	GBP 11.29 (EUR 15.09)
	AMR POCT E vs SC	GBP 601,414.00 (EUR 804,264.80)	GBP 15.47 (EUR 20.69)	895	GBP 671.82 (EUR 898.42)	26,214	GBP 22.94 (EUR 30.68)
MSM	AMR POCT A vs SC	GBP 620,274.00 (EUR 829,486.10)	GBP 28.30 (EUR 37.85)	499	GBP 1,242.13 (EUR 1,661.09)	0	Dominated
	AMR POCT B vs SC	GBP 697,730.00 (EUR 933,067.20)	GBP 31.84 (EUR 42.58)	1,001	GBP 697.32 (EUR 932.52)	0	Dominated
	AMR POCT C vs SC	GBP 683,317.00 (EUR 913,792.80)	GBP 31.18 (EUR 41.70)	864	GBP 790.97 (EUR 1,057.76)	0	Dominated
	AMR POCT D vs SC	GBP 235,532.00 (EUR 314,974.50)	GBP 10.75 (EUR 14.38)	568	GBP 414.38 (EUR 554.15)	20,676	GBP 11.39 (EUR 15.23)
	AMR POCT E vs SC	GBP 358,920.00 (EUR 479,980.00)	GBP 16.38 (EUR 21.90)	499	GBP 718.75 (EUR 961.18)	13,842	GBP 25.93 (EUR 34.68)
MSW	AMR POCT A vs SC	GBP 239,316.00 (EUR 320,034.80)	GBP 28.26 (EUR 37.79)	248	GBP 965.92 (EUR 1,291.72)	0	Dominated
	AMR POCT B vs SC	GBP 269,519.00 (EUR 360,425.00)	GBP 31.83 (EUR 42.57)	436	GBP 617.60 (EUR 825.91)	0	Dominated
	AMR POCT C vs SC	GBP 263,674.00 (EUR 352,608.50)	GBP 31.14 (EUR 41.64)	391	GBP 674.71 (EUR 902.28)	0	Dominated
	AMR POCT D vs SC	GBP 91,956.00 (EUR 122,971.80)	GBP 10.86 (EUR 14.52)	271	GBP 339.59 (EUR 454.13)	7,938	GBP 11.58 (EUR 15.49)
	AMR POCT E vs SC	GBP 132,108.00 (EUR 176,666.70)	GBP 15.60 (EUR 20.86)	248	GBP 533.21 (EUR 713.06)	5,658	GBP 23.35 (EUR 31.23)
Women	AMR POCT A vs SC	GBP 238,796.00 (EUR 319,339.40)	GBP 28.13 (EUR 37.62)	148	GBP 1,612.62 (EUR 2,156.54)	0	Dominated
	AMR POCT B vs SC	GBP 270,428.00 (EUR 361,640.60)	GBP 31.86 (EUR 42.61)	223	GBP 1,210.74 (EUR 1,619.11)	0	Dominated
	AMR POCT C vs SC	GBP 263,339.00 (EUR 352,160.50)	GBP 31.02 (EUR 41.48)	194	GBP 1,356.61 (EUR 1,814.18)	0	Dominated
	AMR POCT D vs SC	GBP 88,028.00 (EUR 117,718.90)	GBP 10.37 (EUR 13.87)	163	GBP 540.55 (EUR 722.87)	8,176	GBP 10.77 (EUR 14.40)
	AMR POCT E vs SC	GBP 110,386.00 (EUR 147,618.10)	GBP 13.00 (EUR 17.38)	148	GBP 745.45 (EUR 996.88)	6,714	GBP 16.44 (EUR 21.99)

AMR: antimicrobial resistance; MSM: men who have sex with men; MSW: men who have sex with women; POCT: point-of-care test; SC: standard care.

^a GBP costs were converted to EUR using a historic currency conversion of an average of 366 days from 1 July 2015 to 30 June 2016 [48]. For this time period, GBP 1 = EUR 1.34, and EUR 1 = GBP 0.75.

A strategy is 'dominated' if it is more expensive and provides fewer/equivalent benefits.

found that they substantially improved the timeliness of NG AMR detection, facilitating a faster change in recommended treatment, with potential for decreasing NG AMR impact on the wider population [39]. Fingerhuth et al. [36] developed a compartmental transmission model of antibiotic-sensitive and antibiotic-resistant NG to look at proportion of resistant infections and cases averted. They showed that the clinical pathway that included an AMR POCT resulted in the lowest proportion of resistant infections after 30 years, whereas the clinical pathway with a POCT that did not test for AMR resulted in the highest. They also noted that test diagnostic performance is key for AMR POCTs to have a beneficial public health impact. The potential public health impact of AMR POCTs was confirmed by Tuite et al., with AMR POCTs delaying the proportion of isolates reaching > 5% resistance compared with empirical treatment [40]. However, it was highlighted that the AMR POCT should test for resistance to multiple antimicrobials, otherwise non-tested, resistant, strains will be selected for. Thus, continued surveillance, including culture, should be continued. Together, these health economic and modelling evaluations highlight the possible beneficial impacts of implementing AMR POCTs on reducing ceftriaxone use and decreasing NG AMR prevalence at the population level, but the design and implementation of the tests should also be carefully considered.

As with all mathematical models, several assumptions were made (Supplementary Table S1), including AMR POCT diagnostic accuracy - a necessity as these tests are currently in early phases of development [16,41]. Future performance estimates will need to consider two elements: predictive accuracies of any biomarkers used to detect AMR; the performance of platforms and chemistries used to detect them. Variations in both may independently affect outcomes.

Our analysis had some limitations. We used the most recent NG AMR data available from GRASP at the time [29], but AMR rates constantly change and, in the sensitivity analyses, AMR prevalence alterations had the greatest impact on AMR POCT cost-effectiveness (Supplementary Figure S2). This may limit the generalisability of our results as it is not possible to know future resistance profiles. However, the results should be generalisable to the ranges used in the sensitivity analyses. In addition, as AMR POCTs are still in development, some of the model's other epidemiological parameters will have changed by the time the AMR POCTs are available for use in routine practice, which may further limit the analyses' applicability in the longer term. This highlights the need to continually conduct analyses such as these, to enhance our ability to predict and understand future trends. Our analyses are also limited to data from England, with results perhaps less generalisable to other countries. This will be exacerbated by the 2019 change to 1 g ceftriaxone monotherapy, further setting it aside from guidelines in other European countries [7]. Our model also did not

consider NG-positive patients coinfecting with another organisms, such as CT, which would affect patient pathways and treatment options. Additional factors not considered were costs associated with treating long-term NG infection sequelae [42], costs incurred outside of the SHC, and costs or cost-savings associated with changing clinical pathways in order to accommodate the AMR POCTs. Thus the time horizon for the costs and consequences was of initial patient treatment only.

Strategy B was most effective for avoiding suboptimal treatments but the most costly to implement. Strategy D was the most cost-effective for both effectiveness outcomes (optimal treatments gained and ceftriaxone avoidance), but resulted in treatment failures, as well as nearly 15-fold higher suboptimal treatments compared with Strategy B. Both strategies B and D enabled the re-use of ciprofloxacin, previously abandoned for the treatment of NG in the UK [6].

All AMR POCT strategies were more expensive than SC, with dual therapy AMR POCT strategies more expensive than monotherapy strategies, suggesting that short-term net financial investments in AMR POCT adoption are required to gain long-term antimicrobial stewardship benefits. The O'Neill review of AMR [10] noted that accepting the initial expense of new test introduction may enable longer-term societal pay-offs by reducing infection rates and maintaining effective NG treatments. Interestingly, our sensitivity analysis suggested that even if AMR POCT costs were notably reduced, perhaps through production scale-up, dual therapy AMR POCT strategies would still not be cost-saving. However, a relatively small reduction to less than GBP 18 (EUR 24.07) per test would enable the monotherapy AMR POCT strategies to be cost-saving.

The monotherapy strategies resulted in treatment failures due to false susceptible AMR POCT results, although minimal relative to SC. Since we assumed ceftriaxone treated 100% of NG infections, there were no treatment failures for SC or dual therapy strategies. The most recent GRASP data suggest that ceftriaxone resistance remains low (no ceftriaxone resistance reported, although there is a reduction in susceptibility with 24.6% of isolates with minimum inhibitory concentrations (MICs) \geq 0.03 mg/L in 2018 compared with 16.6% in 2017 [1]), but there are increasing concerns regarding international ceftriaxone-resistant strains [43-45]. This potentially undermines our assumption and the resulting lack of treatment failures from dual therapy AMR POCT strategies.

Most MEITRs (treatment regimen used when an earlier intended treatment regimen would have provided optimal treatment) were in Strategy C, and the least in Strategies A, B and E. Avoiding MEITRs is important because it maximises the ability to use ciprofloxacin (in Strategies A, C and E), or reduces the need for ceftriaxone use (Strategies B and D). These numbers were small compared with actual patient numbers in whom

a MEITR might be used if these AMR POCTs were available more generally. For example, using national surveillance data [23,46], we estimated that over 25,000 of the 38,870 NG-diagnosed SHC patients assumed to have been treated with SC in 2015 would have had ciprofloxacin-susceptible NG. Strategies A and E would have enabled all, except 265 (Table 4), of these patients to be treated with ciprofloxacin, a 100-fold reduction in these missed opportunities.

Since a MEITR is due to susceptible infections misclassified as resistant by the AMR POCT, test specificity is key. In sensitivity analyses of AMR POCT accuracy, Strategy D was the only strategy where cost per optimal treatment gained was affected by changes in specificity. In all other strategies, cost per optimal treatment gained increased as sensitivity decreased. This is because these strategies contained an AMR POCT that included ciprofloxacin testing, so resistance (20–36%, dependent on population group [29]) was detected and optimal treatment could be given. In contrast, if AMR POCT sensitivity in these strategies fell, true ciprofloxacin-resistant cases were missed and the patient suboptimally treated. Strategy D, where the AMR POCT was for azithromycin only, was the only strategy where ciprofloxacin was given without resistance-testing - as the specificity decreased, more patients received false-positive azithromycin resistance results and were treated with ciprofloxacin. Due to high ciprofloxacin resistance prevalence, this treatment was suboptimal in a large number of cases. Following the logic of the other strategies, if azithromycin resistance prevalence increased, cost per optimal treatment gained in Strategy D would become sensitive to both AMR POCT specificity and sensitivity.

Thus, prevalence of resistance has important implications for AMR POCT accuracy requirements and ICER of optimal treatments gained. In the azithromycin resistance sensitivity analyses, ICER increased when resistance fell below ca 3% (well below current UK azithromycin resistance prevalence, reported at ca 9.7% [1]), primarily because when azithromycin resistance is low, there is little value in testing for it (Strategies B, C and D) and there will be few treatment failures from background resistance (Strategies A and E). In the ciprofloxacin resistance sensitivity analysis, an effect on ICER was only seen in women in strategies A and E (because of lower baseline ciprofloxacin resistance prevalence).

From a population-level antimicrobial stewardship public health perspective, increasing the number of suboptimal treatments may eventually lead to an increased number of resistant infections [36]. The relative public health importance of a smaller total number of suboptimal treatments with a few treatment failures vs a higher number of suboptimal treatments with no failures warrants further investigation, and could be included in future transmission model analyses. Furthermore, the long-term public health impact

of preserving ceftriaxone use while increasing the risk of treatment failures from monotherapy strategies (vs maintaining ceftriaxone in the earlier intended treatment regimen with an increase in suboptimal treatments and no adequate treatment alternative), should also be investigated.

Conclusion

Once developed, AMR POCTs could have wide-ranging implications for clinical decisionmaking globally, including the potential re-use of antibiotics previously abandoned for the treatment of NG, ensuring the right treatment is given to the right person at the right time (precision medicine). Although it may be necessary to accept net health system investment to enable longer-term societal pay-offs by reducing infection rates and maintaining effective NG treatments, a relatively small reduction in test cost could enable some AMR POCT strategies to be cost-saving.

empirical study and modelling is required to optimise their use for public health benefit.

Acknowledgements

Funding statement: This work was supported by the National Institute for Health Research (NIHR) i4i Programme (<https://www.nihr.ac.uk/about-us/how-we-are-managed/boards-and-panels/programme-boards436and-panels/invention-for-innovation/>) [grant number II-LB-0214-20005]. The funder had no role in study design, data collection and analysis, decision to publish, or preparation of the manuscript.

Conflict of interest

SEH, MJH, GW and EJA are employees of Aquarius Population Health (APH) which reports grants on STI and POC research outside the submitted work from Innovate UK, Cepheid, St Georges University of London, Enigma Diagnostics, and AstraZeneca. EHE, CEB and STS are members of the Applied Diagnostic Research and Evaluation Unit at St George's, University of London, which has received funding from Binx Health, Alere, Cepheid, Speedx and Sekisui.

Authors' contributions

EMHE, SEH, MJH, CEB, EJA and STS designed the model. MJH and GW ran the model. EMHE, SHE, MJH and STS wrote the first draft of the paper. All authors edited the manuscript and read and approved the final version of the paper.

References

1. Public Health England (PHE). Antimicrobial resistance in *Neisseria gonorrhoeae* in England and Wales. Key findings from the Gonococcal Resistance to Antimicrobials Surveillance Programme (GRASP 2018). London: PHE; Oct 2019. Available from: https://assets.publishing.service.gov.uk/government/uploads/system/uploads/attachment_data/file/834924/GRASP__2018_report.pdf
2. Abbraha M, Egli-Gany D, Low N. Epidemiological, behavioural, and clinical factors associated with antimicrobial-resistant gonorrhoea: a review. *F1000 Res*. 2018;7:400. <https://doi.org/10.12688/f1000research.13600.1> PMID: 29636908
3. Rowley J, Vander Hoorn S, Korenromp E, Low N, Unemo M, Abu-Raddad LJ, et al. Chlamydia, gonorrhoea, trichomoniasis

- and syphilis: global prevalence and incidence estimates, 2016. *Bull World Health Organ.* 2019;97(8):548-562P. <https://doi.org/10.2471/BLT.18.228486> PMID: 31384073
4. World Health Organization (WHO). Global action plan to control the spread and impact of antimicrobial resistance in *Neisseria gonorrhoeae*. Geneva: WHO; 2012. Available from: http://apps.who.int/iris/bitstream/10665/44863/1/9789241503501_eng.pdf
 5. Bignell C, Unemo M, Radcliffe K, Jensen JS, Babayan K, Barton S, et al. , European STI Guidelines Editorial Board. 2012 European guideline on the diagnosis and treatment of gonorrhoea in adults. *Int J STD AIDS.* 2013;24(2):85-92. <https://doi.org/10.1177/0956462412472837> PMID: 24400344
 6. Bignell C, Fitzgerald M, Guideline Development Group. British Association for Sexual Health and HIV UK. UK national guideline for the management of gonorrhoea in adults, 2011. *Int J STD AIDS.* 2011;22(10):541-7. <https://doi.org/10.1258/ijisa.2011.011267> PMID: 21998172
 7. Fifer H, Saunders J, Soni S, Sadiq ST, FitzGerald M. 2019. British Association for Sexual Health and HIV national guideline for the management of infection with *Neisseria gonorrhoeae* (2019). British London: Association for Sexual Health and HIV. 2019. Available from: <https://www.bashguidelines.org/media/1208/gc-2019.pdf>
 8. Fifer H, Natarajan U, Jones L, Alexander S, Hughes G, Golparian D, et al. Failure of Dual Antimicrobial Therapy in Treatment of Gonorrhoea. *N Engl J Med.* 2016;374(25):2504-6. <https://doi.org/10.1056/NEJMc1512757> PMID: 27332921
 9. Low N, Unemo M. Molecular tests for the detection of antimicrobial resistant *Neisseria gonorrhoeae*: when, where, and how to use? *Curr Opin Infect Dis.* 2016;29(1):45-51. <https://doi.org/10.1097/QCO.0000000000000230> PMID: 26658656
 10. O'Neill J. Rapid Diagnostics: stopping unnecessary use of antibiotics. London: Review on Antimicrobial Resistance; Oct 2015. Available from: <http://amr-review.org/sites/default/files/Rapid%20Diagnostics%20-%20Stopping%20Unnecessary%20use%20of%20Antibiotics.pdf>
 11. World Health Organization (WHO). Simple / Rapid tests. Geneva: WHO. [Accessed: Jul 2016]. Available from: http://www.who.int/diagnostics_laboratory/faq/simple_rapid_tests/en/
 12. Sadiq ST, Mazzaferrri F, Unemo M. Rapid accurate point-of-care tests combining diagnostics and antimicrobial resistance prediction for *Neisseria gonorrhoeae* and *Mycoplasma genitalium*. *Sex Transm Infect.* 2017;93(54):S65-8. <https://doi.org/10.1136/sextrans-2016-053072> PMID: 28684610
 13. Sadiq ST, Dave J, Butcher PD. Point-of-care antibiotic susceptibility testing for gonorrhoea: improving therapeutic options and sparing the use of cephalosporins. *Sex Transm Infect.* 2010;86(6):445-6. <https://doi.org/10.1136/sti.2010.044230> PMID: 20940156
 14. Herbst de Cortina S, Bristow CC, Joseph Davey D, Klausner JD. A Systematic Review of Point of Care Testing for Chlamydia trachomatis, *Neisseria gonorrhoeae*, and *Trichomonas vaginalis*. *Infect Dis Obstet Gynecol.* 2016;2016:4386127. <https://doi.org/10.1155/2016/4386127> PMID: 27313440
 15. SpeedX. ResistancePlus GC.Australia: SpeedX. [Accessed: 1 Mar 2020]. Available from: <https://plexpcr.com/resistanceplus-gc/>
 16. National Institute for Health Research (NIHR). Invention for Innovation grant: A Point of Care Antimicrobial Resistance test for *Neisseria gonorrhoeae* and *Mycoplasma genitalium* infection. Ensuring accurate therapy and antibiotic stewardship in sexual health medicine. Reference: IL-LB-0214-20005. Available from: https://nihr.opendatasoft.com/explore/dataset/infonihr-open-dataset/table/?disjunctive.programme_type&disjunctive.project_status&disjunctive.programme&disjunctive.rgn17nm&disjunctive.pcon17nm&disjunctive.ccg18nm&disjunctive.ctry17cd&disjunctive.funder&disjunctive.acronym&disjunctive.ctry17nm&disjunctive.ccg19nm&disjunctive.lad19nm&disjunctive.pcon18nm&q=antimicrobial+resistance
 17. Harding-Esch EM, Cousins EC, Chow SC, Phillips LT, Hall CL, Cooper N, et al. A 30-minute nucleic acid amplification point-of-care test for genital Chlamydia trachomatis infection in women: a prospective, multi-centre study of diagnostic accuracy. *EBioMedicine.* 2018;28:120-7. <https://doi.org/10.1016/j.ebiom.2017.12.029> PMID: 29396306
 18. Public Health England (PHE). Making it work. A guide to whole system commissioning for sexual health, reproductive health and HIV. London: PHE; Mar 2015. Available from: https://www.gov.uk/government/uploads/system/uploads/attachment_data/file/408357/Making_it_work_revised_March_2015.pdf
 19. Pond MJ, Hall CL, Miari VF, Cole M, Laing KG, Jagatia H, et al. Accurate detection of *Neisseria gonorrhoeae* ciprofloxacin susceptibility directly from genital and extragenital clinical samples: towards genotype-guided antimicrobial therapy. *J Antimicrob Chemother.* 2016;71(4):897-902. <https://doi.org/10.1093/jac/dkv432> PMID: 26817487
 20. Allan-Blitz LT, Humphries RM, Hemarajata P, Bhatti A, Pandori MW, Siedner MJ, et al. Implementation of a Rapid Genotypic Assay to Promote Targeted Ciprofloxacin Therapy of *Neisseria gonorrhoeae* in a Large Health System. *Clin Infect Dis.* 2017;64(9):1268-70. PMID: 28034887
 21. Eyre DW, De Silva D, Cole K, Peters J, Cole MJ, Grad YH, et al. WGS to predict antibiotic MICs for *Neisseria gonorrhoeae*. *J Antimicrob Chemother.* 2017;72(7):1937-47. <https://doi.org/10.1093/jac/dkx067> PMID: 28333355
 22. Unemo M, Bradshaw CS, Hocking JS, de Vries HJC, Francis SC, Mabey D, et al. Sexually transmitted infections: challenges ahead. *Lancet Infect Dis.* 2017;17(8):e235-79. [https://doi.org/10.1016/S1473-3099\(17\)30310-9](https://doi.org/10.1016/S1473-3099(17)30310-9) PMID: 28701272
 23. Public Health England (PHE). Sexually transmitted infections (STIs): annual data tables, 2006-2015. London: PHE. [Accessed: 1 Mar 2020]. Available from: <https://www.gov.uk/government/statistics/sexually-transmitted-infections-stis-annual-data-tables>
 24. Public Health England (PHE). Table 7: STI diagnoses & partner notification, 2012 - 2015. London: PHE. [Accessed: 1 Mar 2020]. Available from: https://assets.publishing.service.gov.uk/government/uploads/system/uploads/attachment_data/file/534562/2015_Table_7_STI_diagnoses___partner_notification__2012-2015.pdf
 25. Herzog SA, Heijne JC, Althaus CL, Low N. Describing the progression from Chlamydia trachomatis and *Neisseria gonorrhoeae* to pelvic inflammatory disease: systematic review of mathematical modeling studies. *Sex Transm Dis.* 2012;39(8):628-37. <https://doi.org/10.1097/OLQ.0b013e31825159ff> PMID: 22801346
 26. Gaydos CA, Van Der Pol B, Jett-Goheen M, Barnes M, Quinn N, Clark C, et al. , CT/NG Study Group. Performance of the Cepheid CT/NG Xpert Rapid PCR Test for Detection of Chlamydia trachomatis and *Neisseria gonorrhoeae*. *J Clin Microbiol.* 2013;51(6):1666-72. <https://doi.org/10.1128/JCM.03461-12> PMID: 23467600
 27. Harding-Esch EM, Fuller SS, Christine Chow SL, Nori AV, Harrison MA, Parker M, et al. Diagnostic accuracy of a prototype rapid chlamydia and gonorrhoea recombinase polymerase amplification assay: a multi-centre cross-sectional pre-clinical evaluation. *Clin Microbiol Infect.* 2019;25(3):380e1-380.e7. <http://dx.doi.org/https://doi.org/10.1016/j.cmi.2018.06.003> PMID: 29906594
 28. Turner KM, Round J, Horner P, Macleod J, Goldenberg S, Deol A, et al. An early evaluation of clinical and economic costs and benefits of implementing point of care NAAT tests for Chlamydia trachomatis and *Neisseria gonorrhoeae* in genitourinary medicine clinics in England. *Sex Transm Infect.* 2014;90(2):104-11. <https://doi.org/10.1136/sextrans-2013-051147> PMID: 24273127
 29. Public Health England (PHE). Surveillance of antimicrobial resistance in *Neisseria gonorrhoeae* in England and Wales. Key findings from the Gonococcal Resistance to Antimicrobials Surveillance Programme (GRASP). London: PHE; 2017. Available from: https://assets.publishing.service.gov.uk/government/uploads/system/uploads/attachment_data/file/651636/GRASP_Report_2017.pdf
 30. Adams EJ, Ehrlich A, Turner KM, Shah K, Macleod J, Goldenberg S, et al. Mapping patient pathways and estimating resource use for point of care versus standard testing and treatment of chlamydia and gonorrhoea in genitourinary medicine clinics in the UK. *BMJ Open.* 2014;4(7):e005322. <https://doi.org/10.1136/bmjopen-2014-005322> PMID: 25056977
 31. Harding-Esch EM, Nori AV, Hegazi A, Pond MJ, Okolo O, Nardone A, et al. Impact of deploying multiple point-of-care tests with a 'sample first' approach on a sexual health clinical care pathway. A service evaluation. *Sex Transm Infect.* 2017;93(6):424-9. <https://doi.org/10.1136/sextrans-2016-052988> PMID: 28159916
 32. Atkinson LM, Vijeratnam D, Mani R, Patel R. 'The waiting game': are current chlamydia and gonorrhoea near-patient/point-of-care tests acceptable to service users and will they impact on treatment? *Int J STD AIDS.* 2016;27(8):650-5. <https://doi.org/10.1177/0956462415591414> PMID: 26092579
 33. Personal Social Services Research Unit (PSSRU). Unit Costs of Health and Social Care 2015. Kent: PSSRU; 2015. Available from: <http://www.pssru.ac.uk/project-pages/unit-costs/2015/2015> [
 34. National Institute for Health and Care Excellence (NICE) British National Formulary. (BNF). London: NICE. [Accessed 29 Sept 2016]. Available from: <https://www.evidence.nhs.uk/formulary/bnf/current>

35. Husereau D, Drummond M, Petrou S, Carswell C, Moher D, Greenberg D, et al. Consolidated Health Economic Evaluation Reporting Standards (CHEERS) statement. *BMJ*. 2013;346(mar25 1):f1049. PMID: 23529982
36. Fingerhuth SM, Low N, Bonhoeffer S, Althaus CL. Detection of antibiotic resistance is essential for gonorrhoea point-of-care testing: a mathematical modelling study. *BMC Med*. 2017;15(1):142. <https://doi.org/10.1186/s12916-017-0881-x> PMID: 28747205
37. Turner KM, Christensen H, Adams EJ, McAdams D, Fifer H, McDonnell A, et al. Analysis of the potential for point-of-care test to enable individualised treatment of infections caused by antimicrobial-resistant and susceptible strains of *Neisseria gonorrhoeae*: a modelling study. *BMJ Open*. 2017;7(6):e015447. <https://doi.org/10.1136/bmjopen-2016-015447> PMID: 28615273
38. Zienkiewicz AK, Verschuere van Rees N, Homer M, Ong JJ, Christensen H, Hill D, et al. Agent-based modelling study of antimicrobial-resistant *Neisseria gonorrhoeae* transmission in men who have sex with men: towards individualised diagnosis and treatment. *Sex Health*. 2019;16(5):514-22. <https://doi.org/10.1071/SH18235> PMID: 31476277
39. Hui BB, Ryder N, Su JY, Ward J, Chen MY, Donovan B, et al. Exploring the Benefits of Molecular Testing for Gonorrhoea Antibiotic Resistance Surveillance in Remote Settings. *PLoS One*. 2015;10(7):e0133202. <https://doi.org/10.1371/journal.pone.0133202> PMID: 26181042
40. Tuite AR, Gift TL, Chesson HW, Hsu K, Salomon JA, Grad YH. Impact of Rapid Susceptibility Testing and Antibiotic Selection Strategy on the Emergence and Spread of Antibiotic Resistance in Gonorrhoea. *J Infect Dis*. 2017;216(9):1141-9. <https://doi.org/10.1093/infdis/jix450> PMID: 28968710
41. Toskin I, Govender V, Blondeel K, Murtagh M, Unemo M, Zemouri C, et al. Call to action for health systems integration of point-of-care testing to mitigate the transmission and burden of sexually transmitted infections. *Sex Transm Infect*. 2020;96(5):342-7. <https://doi.org/10.1136/sextrans-2019-054358> PMID: 32241905
42. Davies B, Turner KME, Frølund M, Ward H, May MT, Rasmussen S, et al. , Danish Chlamydia Study Group. Risk of reproductive complications following chlamydia testing: a population-based retrospective cohort study in Denmark. *Lancet Infect Dis*. 2016;16(9):1057-64. [https://doi.org/10.1016/S1473-3099\(16\)30092-5](https://doi.org/10.1016/S1473-3099(16)30092-5) PMID: 27289389
43. Golparian D, Rose L, Lynam A, Mohamed A, Bercot B, Ohnishi M, et al. Multidrug-resistant *Neisseria gonorrhoeae* isolate, belonging to the internationally spreading Japanese FC428 clone, with ceftriaxone resistance and intermediate resistance to azithromycin, Ireland, August 2018. *Euro Surveill*. 2018;23(47). <https://doi.org/10.2807/1560-7917.ES.2018.23.47.1800617> PMID: 30482267
44. Eyre DW, Sanderson ND, Lord E, Regisford-Reimmer N, Chau K, Barker L, et al. Gonorrhoea treatment failure caused by a *Neisseria gonorrhoeae* strain with combined ceftriaxone and high-level azithromycin resistance, England, February 2018. *Euro Surveill*. 2018;23(27). <https://doi.org/10.2807/1560-7917.ES.2018.23.27.1800323> PMID: 29991383
45. European Centre for Disease Prevention and Control (ECDC). Extensively drug-resistant (XDR) *Neisseria gonorrhoeae* in the United Kingdom and Australia. Stockholm: ECDC. 7 May 2018. Available from: <https://ecdc.europa.eu/sites/portal/files/documents/RRA-Gonorrhoea%2C%20Antimicrobial%20resistance-United%20Kingdom%2C%20Australia.pdf>
46. Public Health England (PHE). Surveillance of antimicrobial resistance in *Neisseria gonorrhoeae*. Key findings from the 'Gonococcal resistance to antimicrobials surveillance programme' (GRASP) and related surveillance data. London: PHE; 2015. Available from: https://www.gov.uk/government/uploads/system/uploads/attachment_data/file/476582/GRASP_2014_report_final_11115.pdf
47. Huntington SE, Burns RM, Harding-Esch E, Harvey MJ, Hill-Tout R, Fuller SS, et al. Modelling-based evaluation of the costs, benefits and cost-effectiveness of multipathogen point-of-care tests for sexually transmitted infections in symptomatic genitourinary medicine clinic attendees. *BMJ Open*. 2018;8(9):e020394. <https://doi.org/10.1136/bmjopen-2017-020394> PMID: 30201794
48. Monthly Average Rates London OFX. UKForex Limited. [Accessed: 9 Mar 2020]. Available from: <https://www.ofx.com/en-gb/forex-news/historical-exchange-rates/monthly-average-rates/>
49. Office for National Statistics (ONS). Consumer price inflation time series. London: ONS. [Accessed: 9 Mar 2020]. Available from: <https://www.ons.gov.uk/economy/inflationandpriceindices/datasets/consumerpriceindices>

License, supplementary material and copyright

This is an open-access article distributed under the terms of the Creative Commons Attribution (CC BY 4.0) Licence. You may share and adapt the material, but must give appropriate credit to the source, provide a link to the licence and indicate if changes were made.

Any supplementary material referenced in the article can be found in the online version.

This article is copyright of the authors or their affiliated institutions, 2020.

Effects of primary care C-reactive protein point-of-care testing on antibiotic prescribing by general practice staff: pragmatic randomised controlled trial, England, 2016 and 2017

Charlotte Victoria Eley¹, Anita Sharma², Hazel Lee², Andre Charlett³, Rebecca Owens¹, Clodna Ann Miriam McNulty¹

1. Primary Care Unit, Public Health England, Gloucester, United Kingdom

2. An NHS Clinical Commissioning Group, Greater Manchester, United Kingdom

3. Statistics Unit, Public Health England, London, United Kingdom

Correspondence: Charlotte Eley (Charlotte.Eley@nhs.uk)

Citation style for this article:

Eley Charlotte Victoria, Sharma Anita, Lee Hazel, Charlett Andre, Owens Rebecca, McNulty Clodna Ann Miriam. Effects of primary care C-reactive protein point-of-care testing on antibiotic prescribing by general practice staff: pragmatic randomised controlled trial, England, 2016 and 2017. *Euro Surveill.* 2020;25(44):pii=1900408. <https://doi.org/10.2807/1560-7917.ES.2020.25.44.1900408>

Article submitted on 24 Jun 2019 / accepted on 21 Apr 2020 / published on 05 Nov 2020

Background: C-reactive protein (CRP) testing can be used as a point-of-care test (POCT) to guide antibiotic use for acute cough. **Aim:** We wanted to determine feasibility and effect of introducing CRP POCT in general practices in an area with high antibiotic prescribing for patients with acute cough and to evaluate patients' views of the test. **Methods:** We used a McNulty–Zelen cluster pragmatic randomised controlled trial design in general practices in Northern England. Eight intervention practices accepted CRP testing and eight control practices maintained usual practice. Data collection included process evaluation, patient questionnaires, practice audit and antibiotic prescribing data. **Results:** Eight practices with over 47,000 patient population undertook 268 CRP tests over 6 months: 78% of patients had a CRP <20 mg/L, 20% CRP 20–100 mg/L and 2% CRP >100 mg/L, where 90%, 22% and 100%, respectively, followed National Institute for Health and Care Excellence (NICE) antibiotic prescribing guidance. Patients reported that CRP testing was comfortable (88%), convenient (84%), useful (92%) and explained well (85%). Patients believed CRP POCT aided clinical diagnosis, provided quick results and reduced unnecessary antibiotic use. Intervention practices had an estimated 21% reduction (95% confidence interval: 0.46–1.35) in the odds of prescribing for cough compared with the controls, a non-significant but clinically relevant reduction. **Conclusions:** In routine general practice, CRP POCT use was variable. Non-significant reductions in antibiotic prescribing may reflect small sample size due to non-use of tests. While CRP POCT may be useful, primary care staff need clearer CRP guidance and action planning according to NICE guidance.

Introduction

Seventy to eighty per cent of all antibiotics in the United Kingdom (UK) are prescribed in the community [1] and 60% of these antibiotics are issued for respiratory tract infections (RTI) [2]; 20% are thought to be unnecessary or inappropriate [3] as research suggests that acute RTI are often viral and do not require an antibiotic [2,4,5]. Reducing inappropriate antibiotic prescribing is fundamental to tackling antimicrobial resistance and The UK Five Year Antimicrobial Resistance Strategy aims to optimise prescribing practice by promoting better use of existing diagnostics [6].

The Lord O'Neill report, tackling drug-resistant infections globally, recommends that by 2020 it should be mandatory that the prescription of antibiotics is informed by data and testing technology, such as a diagnostic test, wherever available and effective to support clinical judgment to prescribe [7].

The National Institute for Health and Care Excellence (NICE) incorporated C-reactive protein (CRP) point-of-care tests (POCT) into the diagnosis of pneumonia guidelines CG 191 (Box 1) [8] and CRP POCT is also included in the NICE acute cough summary for antimicrobial prescribing [9]. The NICE recommends that CRP POCT should be considered when a patient presents with symptoms of lower RTI, clinical assessment is inconclusive and there is uncertainty whether antibiotics should be prescribed [8]. Even though CRP POCT is recommended by NICE and has the potential to improve patient care, the uptake of CRP POCT across England has been very variable and CRP POCT is not extensively used in primary care [10].

Box 1

NICE Guidance CG 191: Pneumonia in adults: diagnosis and management [8]

Presentation with lower respiratory tract infection

For people presenting with symptoms of lower respiratory tract infection in primary care, consider a point-of-care C-reactive protein test if after clinical assessment a diagnosis of pneumonia has not been made and it is not clear whether antibiotics should be prescribed. Use the results of the C-reactive protein test to guide antibiotic prescribing in people without a clinical diagnosis of pneumonia as follows:

- Do not routinely offer antibiotic therapy if the C-reactive protein concentration is less than 20 mg/L.
- Consider a delayed antibiotic prescription (a prescription for use at a later date if symptoms worsen) if the C-reactive protein concentration is between 20 mg/L and 100 mg/L.
- Offer antibiotic therapy if the C-reactive protein concentration is greater than 100 mg/L.

NICE: National Institute for Health and Care Excellence.

Systematic reviews, for RTI in general and lower RTI specifically, show the value of CRP POCT on reducing antibiotic prescriptions for RTI [11–14]. Huang et al. reported that CRP POCT significantly reduced antibiotic prescribing at the index consultation for patients with RTI [11]. A randomised control trial found that general practitioners (GPs) in the CRP test group prescribed significantly fewer antibiotics compared with the control group [15] and that patients in the CRP test group used fewer antibiotics than the control [16]. This research was conducted in research practices in the Netherlands and results may not be replicated in a non-research setting with normal primary care service provision in England. A small pilot study with 94 patients conducted within a single GP surgery in Wales found that the practice using CRP POCT had significantly reduced their antibiotic prescribing compared with other practices in the health board [17].

The use of CRP POCT for acute cough may be particularly valuable in areas with high antibiotic prescribing, but there is inconsistent CRP test use in such areas (e.g. Northern England) [18]. Therefore, the present study aimed to determine if the introduction of CRP POCT into non-research practices in a Clinical Commissioning Group (CCG) with high antibiotic prescribing was feasible, to explore whether CRP POCT was acceptable to patients, and whether provision of CRP POCT reduced prescribing for acute cough compared with controls. The study aimed to measure antibiotic use via enhanced retrospective audit using Read codes in intervention and control practices. The main difference between our study and previous CRP POCT research is that our study was based in real-life patient populations found in non-research clinical practices, aiming to reflect the true potential use of CRP POCT and their impact in primary care in England.

FIGURE 1

Recruitment flow chart, C-reactive protein point-of-care testing, Northern England, 2016–17 (n = 16 practices)

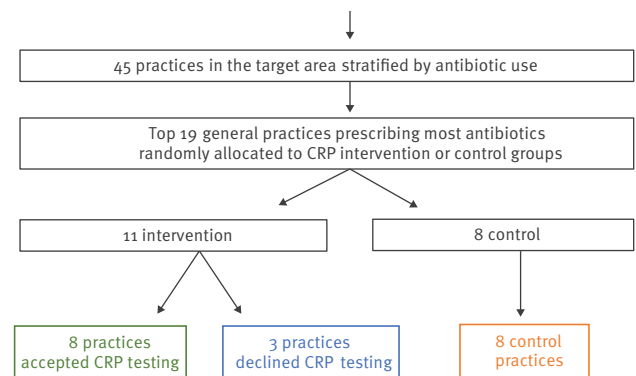

CRP: C-reactive protein; POCT: point-of-care test.

Methods

Design and setting

We performed a service evaluation using the McNulty–Zelen clustered randomised controlled trial (RCT) design [19] in practices within a high-prescribing CCG in Northern England. A CCG is a clinically led statutory National Health Service (NHS) body responsible for the planning and commissioning of healthcare services for their local area. In this design, practices were not aware that they were taking part in an RCT or that they had been randomly assigned to an intervention or control group; they only knew that they were being part of a pilot of CRP POC testing in their CCG. Control practices were not told about the trial. Consent was given by the CCG on the practices' behalf. The study was not registered as a trial to keep the study masked to practices.

Stratification and randomisation

Forty-five general practices within a Northern England CCG were stratified by total antibiotic dispensing per 1,000 patients for 2016. The top 19 prescribers were randomly (using computer generated pseudo-random numbers) allocated to the intervention (offering CRP POCT) or control group (usual provision by the practice) (Figure 1).

In 2016, practices allocated to the intervention arm were offered a CRP POCT machine and up to 100 CRP tests to use over 6 months by a letter from the local GP antimicrobial stewardship (AMS) lead and follow-up phone call. Practices used the CRP POCT machine for 6 months between 1 August 2016 and 31 July 2017; start date was dependent on when the practices had received training. The study aimed for the use of 800 CRP POCTs to contribute to statistically significant results. Practices that agreed to take part in the study were visited by the AMS lead to promote the CRP POCT and received standard CRP POCT training by Alere Ltd (Stockport UK) which is usual practice when a

Box 2

Study inclusion and exclusion criteria, C-reactive protein point-of-care testing, Northern England, 2016–17

Inclusion criteria

- The patient is between 18 and 64 years inclusive.
- The patient has undergone clinical assessment (ideally using diagnostic score).
- The patient has given oral consent for the CRP test and understands the rationale for the test and process according to the clinician.
- The patient has a lower respiratory tract infection presenting diagnostic uncertainty.
- The presentation is acute (21 days or less from symptom onset).
- The patient has a primary complaint of cough.

Exclusion criteria

- The patient has a definitive indication for antibiotics (without diagnostic uncertainty), i.e. pneumonia.
- The patient is severely ill and definitely requiring antibiotics or hospital admission.

diagnostic test is introduced into a laboratory or primary care setting. Alere was selected for this study as it was the most readily available CRP test in the UK at that time, had been reviewed by a Medtech innovation briefing [20] and was being used in other CCGs across England at that time [21]. The CRP testing kits were provided by Alere at cost to the CCG and were free to the healthcare staff. They comprised of the Alere Afinion CRP POCT manufactured by Alere Ltd. The test has a total assay time of 4 min on a sample volume of 1.5 µL capillary blood [22]. Alere were not involved in the planning of the study or interpretation of results, they only helped deliver the training to practices.

Patient inclusion/exclusion criteria

Practice staff were asked to offer patients over 18 years and under 65 years with acute cough a CRP POCT after clinical assessment and in accordance with national guidelines as appropriate [8] using patient selection criteria (Box 2). To avoid overuse of the test, clinicians using the CRP POCT were advised to use a diagnostic score to help them decide whether a CRP test was needed. The diagnostic score comprised: breathlessness, pulse >100 bpm, temperature >37.8 °C, crackles on the chest and diminished vesicular breathing and each symptom scored 1 point. A diagnostic score of at least 1 was advised before a CRP POCT should be considered. The controls did not use the diagnostic score as they did not know they were in the trial, this diagnostic score was only used by intervention practices. Use of the CRP POCT in practices stopped after a 6-month period or when the practice had used their allocated 100 CRP tests. Practices were asked not to use CRP testing for other clinical scenarios.

Figure 2

Data inclusion flow chart, C-reactive protein point-of-care testing, Northern England, 2016–17 (n = 8 practices)

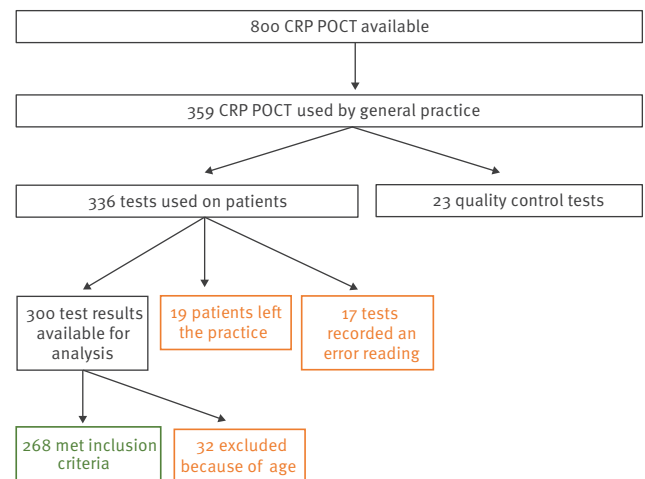

CRP: C-reactive protein; POCT: point-of-care test.

Data collection

Patient descriptive data

We asked GP clinical staff to record on the clinical computer system routine clinical assessment, diagnosis, diagnostic score, CRP test result, antibiotic prescriptions (delayed if within 7 days of consultation or immediate). Patient re-consultations in the next 4 weeks and hospitalisation data were taken from routinely collected data on the practice clinical system. The patient descriptive data enabled us to determine if management of acute cough following a CRP POCT was in line with NICE guidance but was dependent on accurate inputting of patient records by staff. A medicine optimisation technician (author HL) visited each intervention practice to download this information from the EMIS Health general practice clinical data management system (<https://www.emishealth.com>). The EMIS Health clinical data management system supplies electronic patient record systems and software used in primary care, acute care and community pharmacy in the UK. Entry of NHS code/patient identifier was obligatory on the CRP POCT machine before each test and used to check patient computer records against NICE CRP guidelines.

Patient questionnaire

Patients were invited to complete a satisfaction questionnaire (Supplement S1) immediately after the CRP test or at home. Non-returns were reminded by letter and telephone call.

Management of acute cough, bronchitis, chest and lower respiratory tract infection, and C-reactive protein test use in the practice using a Read code search

The Data Quality Team for Greater Manchester Shared Services hosted by an NHS CCG in Greater Manchester undertook an EMIS GP clinical system search to obtain diagnostic Read code and antibiotic prescribing data

TABLE 1

Use of C-reactive protein point-of-care testing in intervention practices, Northern England, 2016–17 (n = 268)

Practice	IA	IB	IC	ID	IE	IF	IG	IH	Totals
Usage rate (total CRP tests/registered patients)	1.5%	0.3%	0.05%	1.5%	0.6%	0.7%	0.6%	0%	0.6%
Pre-CRP assessment diagnostic score used ^a	41	9	1	62	0	10	93	NA	216
Number of CRP tests conducted that met inclusion criteria	70	5	3	61	21	14	94	0	268
Main CRP POCT user	GP	GP	GP/nurse	GP/nurse	Practice nurse	GP	Prescribing pharmacist	NA	NA
CRP POCT machine location	Nurses room	GP room	Nurses room	GP room	Clean store	Portable on a trolley	Pharmacist room	NA	NA
Number of consultations of 18–64 year-olds with LRTI, bronchitis, acute cough, chest infection ^b	182	84	292	40	204	100	284	Merged with intervention practice IC	1,186
CRP/100 consultations with LRTI, bronchitis, acute cough and chest infection	38.5	6.0	1.0	152.5 ^c	10.3	14.0	33.1		22.6
Number of antibiotics ^d prescribed on day of CRP test	110	43	169	19	104	74	118		637

CRP: C-reactive protein; GP: general practitioner; LRTI: lower respiratory tract infection; NA: not applicable; POCT: point-of-care test.

^a Clinical assessment score pre-CRP: breathlessness, pulse >100, temperature >37.8, crackles on the chest and diminished vesicular breathing.

^b Excludes upper respiratory tract infections, sinusitis, pharyngitis, laryngitis, tonsillitis, rhinitis/common cold, sore throat.

^c This figure is >100 suggesting that CRP has been used for diagnoses outside of the four eligible diagnoses.

^d Total antibiotics (amoxicillin, amoxicillin/clavulanic acid, phenoxymethylpenicillin, doxycycline, tetracycline, oxytetracycline, clarithromycin, erythromycin and azithromycin).

Most CRP test results were <20 mg/L (78%; 209/268) and the management of these patients mainly followed NICE guidance to self-care and no antibiotics (90%; 188/209) (Box 1). All patients with a CRP >100 mg/L were treated with immediate antibiotics (5/5) in line with NICE. However, only 12 of 54 with a CRP result between 20 and 100 mg/L were managed in line with NICE guidance which states that a delayed antibiotic prescription should be considered by the clinician (Figure 3).

from intervention and control practices. The Read code search aimed to capture all patients presenting with acute cough, aged between 18 and 64 years inclusive, during the study period (1 August 2016–31 July 2017). To capture comparative data for the same 6 months in the previous year, the Read code data also included 12 months before the study (1 August 2015–31 July 2016). Patients presenting with acute cough as the main symptom fulfilled the inclusion criteria. However as clinicians have different clinical computer coding habits, to make sure all potential patients who had an acute cough were captured in the study, the data search included patients with acute cough, bronchitis, chest infection or lower RTI, which may all present with acute cough. The antibiotics included in this data collection were: amoxicillin, amoxicillin/clavulanic acid (search term used: co-amoxiclav), phenoxymethylpenicillin, doxycycline, tetracycline, oxytetracycline, clarithromycin, erythromycin and azithromycin.

There was an administrative merger between two of the intervention practices during the study. The consultation and prescribing data for these two practices were available as from a single provider, therefore in these analyses there are total of practices is only seven in the intervention arm.

Data analysis

Descriptive analysis was conducted to describe: the total patient population, patients with acute cough, bronchitis, chest infection or lower RTI, GP trends in dispensing data for each GP practice in the period before and during the study, CRP data, practice Read code searches and closed patient questions. Authors CE and AC used Stata version 13.1 (StataCorp., College Station, United States) and visual graphs to represent the findings. Author CE analysed open-ended patient questions using NVivo software version 10 (Q S R International UK Ltd, Warrington, UK) to organise and code the data for thematic analysis. The main qualitative themes derived from the open-ended patient questions were discussed and agreed by the research team.

The primary objective was to determine if the intervention practices had reduced odds of prescribing antibiotics for lower RTI, bronchitis, chest infection and acute cough consultations compared with their prescribing practice during the same period in the previous year and compared with the controls during the same time periods. We used mixed-effects logistic regression models with the binary outcome of whether an antibiotic was dispensed or not. In each analysis, GP practice was included as a random intercept and dispensing in the same 6 months in the previous year, month, age and sex were included as fixed effects.

FIGURE 3

Summary of management actions following C-reactive protein point-of-care testing in line with NICE guidance [8], Northern England, 2016–17 (n = 268)

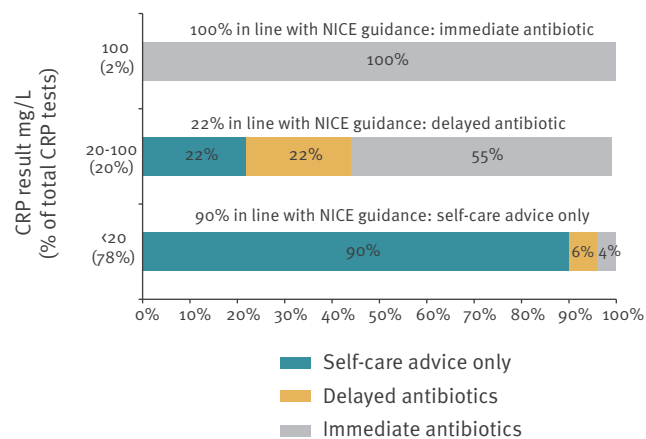

CRP: C-reactive protein; NICE: National Institute for Health and Care Excellence.

To assess the impact of the intervention, a mixed effects logistic regression model was conducted, with practice number and patient number as random effects; the random effect for patient was statistically unimportant, so only practice number was used as a random intercept. When there were multiple prescriptions for a single consultation these were combined such that the unit of analysis was a consultation, defined by practice code, EMIS number and date, and the binary outcome of no or at least one prescription for a consultation was used in the statistical model. Age, sex, proportion prescribed in the same 6 months in the previous year, month of prescription, diagnosis category, viral diagnosis, bacterial diagnosis and intervention were used as fixed effects in the regression model. An interaction between diagnosis category and intervention was also fitted to assess if there was any evidence that the intervention effect differed between the diagnosis categories.

Ethical statement

National Research Ethics Committee approval was not required as the study did not recruit NHS patients, through the NHS. This decision is in accordance with the NHS 'defining research' guidelines [23]. The trial was approved by National Institute for Health Research Clinical Research Network Greater Manchester where the trial was taking place. Data were collected in line with the Data Protection Act 1998 and Caldicott 1999 regulations on handling and distributing sensitive participant information. All general practices provided written informed consent for their practice data to be extracted. Oral consent was obtained from patients for the CRP POCT and assumed for the patient questionnaire.

Results

Of the 19 randomised practices, 11 were randomised to receive the CRP POCT machine; eight practices accepted and three declined. Following acceptance, eight practices were trained and six requested a second practice training visit. The number of CRP tests used in the eight practices ranged from 0 to 100 CRP POCT in the 6 months (median: 19.5).

Study process evaluation

Out of 800 tests allocated, 336 were used for patient testing and 23 were used as quality controls. Nineteen of the 336 patients tested left their practice so there were no patient data available, 17 had data input errors and 32 tests were undertaken in patients outside the age criteria in Box 2. Therefore, we included 268 of 336 patient CRP tests in the analysis (Figure 2).

The main presenting conditions were acute cough (57%; 153/268) or chest infection (24%; 64/268); other RTI presented included cold (6%; 16/268), sore throat (4%; 11/268), viral infection (1%; 3/268), ear pain (1%; 3/268), not recorded/other conditions (7%; 18/268). Overall CRP POCT uptake in the eight general practices ranged considerably dependent on number of consultations for 18–64-year-olds with lower RTI, bronchitis, acute cough and chest infection (Table 1).

Patients with a higher CRP test result were significantly more likely to re-consult in the next month: >100 mg/L (2/5), 20–100 mg/L (8/55) and <20 mg/L (23/208). The number of hospital admissions did not follow the same pattern. Of nine patients with a hospital admission (or complication that warranted further clinical examinations), five had a CRP test result <20 mg/L, four had a CRP test result of 20–100 mg/L and none were >100 mg/L.

A higher diagnostic score was associated with fewer patients with a CRP reading <20mg/L. Among the 193 patients who had a diagnostic risk classification score before the CRP test, 106 (55%) had a diagnostic score of 0, 51 (26%) a score of 1, 26 (13%) a score of 2, eight (4%) a score of 3, two (1%) a score of 4, and none had a score of 5. A CRP result <20 mg/L was seen in 92 of the 106 with score 0, in 41 of 51 with score 1, in 17 of 26 with score 2, in two of eight with score 3, and in none of the patients with a score of 4.

Patient views

The patient satisfaction questionnaires were returned by 53% (134 of 251 distributed); 48 respondents were men (36%) and 82 women (61%), and 46 were completed on the day of the CRP test. For the individual questions, 48% (59/122) respondents described the CRP test as very comfortable, 44% (54/124) as very convenient, 60% (72/121) as very useful, 67% (78/116) reported that it prolonged their visit to the doctor by only 5 min, and 83% (102/123) reported that the explanation of the purpose of the test was very good (Figure 4).

FIGURE 4

Patient feedback on C-reactive protein point-of-care testing, Northern England, 2016–17 (n = 134)

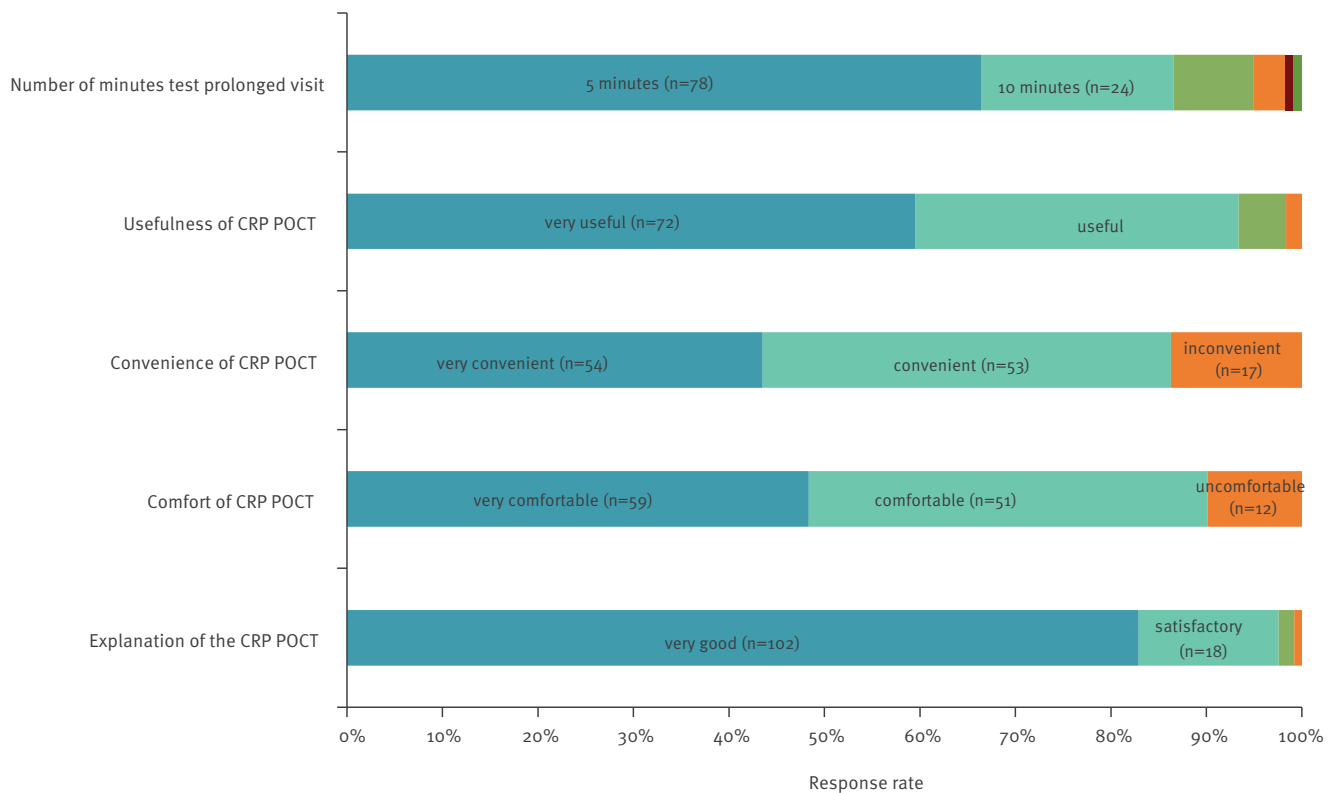

Of the 122 patients who responded to this question, half reported that the test was conducted by prescribing pharmacists in the practice (60/122), 28% (34/122) by a GP, 18% (22/122) by a nurse and 5% (6/122) did not know. In the open ended questions, the most common comments were that the CRP test aids clinical diagnosis, provides quick results and reduces unnecessary antibiotic use (Table 2).

Only four patients made negative comments about the CRP POCT: unsure if CRP test result was correct as they had to re-consult at the practice with worsening symptoms (n = 2), and the finger prick blood test was uncomfortable (n = 2). Most patients (78%; 101/130) stated they would definitely recommend that others who present with a cough should have a CRP test. Most would expect a CRP test when they next presented with an acute cough but it would depend on their symptoms (54%; 68/125), 93% (116/125) would accept a CRP test if their GP offered it and 78% (95/122) would be happy for a CRP test to be done at a local community pharmacy.

Descriptive analysis: 6-month study trial

During the 6-month intervention there were 2,934 consultations (2,297 patients) for lower RTI, bronchitis, acute cough or chest infection, with 1,186 consultations (981 patients) in the intervention group and 1,748 (1,316 patients) in the control group. Nearly all antibiotics were prescribed on the consultation day (97%), with 12 deferred scripts Read-coded. A total of 654 (55.1%) of the consultations in the intervention

arm had at least one antibiotic prescription, compared with 941 (53.8%) of consultations in the control arm that had at least one antibiotic prescription during the 6-month trial period.

In intervention and control practices, there was no evidence that prescribing differed between men and women, nor by the age of the patient. There were differences in the prescribing rate in both intervention and controls across the diagnosis categories, with a significantly higher prescribing rate for chest infections (n = 898), lower RTI (n = 456) and bronchitis (n = 39) compared with cough alone (n = 1,541) over the 6-month study period, chi square test of association 20.04, 1 degree of freedom $p < 0.001$ (Table 3).

Statistical analysis: intervention versus control

Figure 5 shows that three intervention practices (IC, ID and IG) and two control practices (CD and CH) had significantly reduced antibiotic prescribing during the 6-month trial period compared with the same 6 months in the previous year. There were no practices that had significantly increased antibiotic prescribing; all other practices were similar during the 6-month trial period compared with the same 6 months in the previous year.

Respiratory tract infection diagnoses

A total of 2,934 consultations were used in the mixed-effects logistic regression analysis. There was an estimated 12% reduction in the odds of prescribing for these RTI diagnoses (including lower RTI, bronchitis, chest/respiratory infection and cough) in the

TABLE 2

Qualitative patient views on what they liked about the C-reactive protein point-of-care tests, Northern England, 2016–17 (n = 122)

Theme	Patient quotes
Aids clinical diagnosis	<p>“Helps diagnosis and treatment”</p> <p>“Helped the doctor know whether I needed an antibiotic”</p> <p>“Diagnosed the problem there and then”</p>
Provides quick results	<p>I like that you “get an informative answer straight away”</p> <p>“It was good because it gave me immediate feedback”</p> <p>“Something quick and simple, easy to do and gave instant results”</p>
Reduces unnecessary antibiotic use	<p>“Saves issuing antibiotics when not needed”</p> <p>“Good for not giving antibiotics out if not needed”</p> <p>“Decides whether you need antibiotics or not, which is good if you need antibiotics and if you don’t need antibiotics. At least you know!”</p>

TABLE 3

Percentage of consultations with an antibiotic prescription, by diagnosis category, Northern England, 2016–17 (n = 1,595)

Diagnosis category	Practice					
	Control (n = 941)		Intervention (n = 654)		Total (n = 1,595)	
	n	%	n	%	n	%
Lower respiratory tract infection	229	65.5	227	71.7	456	68.4
Bronchitis	22	59.1	17	76.5	39	66.7
Chest/respiratory infection	550	78.5	348	82.2	898	80.0
Cough	947	36.5	594	32.9	1,541	35.0

intervention practices (95% confidence interval (CI): –34% to +16%) compared with the control practices, the model results are presented in Table 4.

Cough diagnoses

There were a total of 1,541 consultations with a diagnosis of cough over the 6-month trial. When considering just the cough diagnoses, there was a 21% reduction in the odds of prescribing in the intervention practices (estimated OR = 0.79; 95% CI: 0.46–1.35), however, the result was not statistically significant and could be due to chance alone (noted in Table 4 intervention; p = 0.4).

Statistical analysis: high- versus low-fidelity practices

Three of the intervention practices, A, D and G, performed more than 60% of the tests available and more than 30 CRP tests per 100 consultations with lower RTI, bronchitis, acute cough and chest infection, and were classified as high-fidelity practices. The other, low-fidelity, practices undertook fewer than 15 tests per 100 consultations with lower RTI, bronchitis, acute cough and chest infection. In additional analyses, we further classified the binary variable of intervention or control into intervention (high fidelity), intervention (low fidelity) and control. After allowing for the other variables in the regression model, there was an estimated 19%

reduction (95% CI: –17 to 34) in the odds of prescribing in the three high-fidelity practices (p = 0.26). In the intervention practices considered not to be high users of CRP POCT (low fidelity), there was an estimated 7% reduction (95% CI: –30 to 33) in the odds of prescribing (p = 0.7). Diagnoses relating to only cough saw a larger clinical reduction of 31% in the odds of prescribing (total antibiotics) in high-fidelity practices (Table 5).

Table 5 shows an estimated 19% reduction (95% CI: –17 to 34) in the odds of prescribing in the three high-fidelity intervention practices compared to non-intervention practices when considering the four diagnoses and a 31% reduction (95% CI: –38 to 65) when considering just cough diagnoses; both failed to reach statistical significance. Overall and for most subgroup of diagnoses, there were estimated reductions in the odds of prescribing in those three practices (high-fidelity) that performed most CRP POCT, particularly when considering just the cough diagnosis which was the intended patient group for this study. However, for none of these analyses did the reduction reach levels that would be considered as being of statistical significance.

FIGURE 5

Antibiotic prescribing rate before and during the intervention period, C-reactive protein point-of-care testing, England, 2016–17 (n = 16 practices^a)

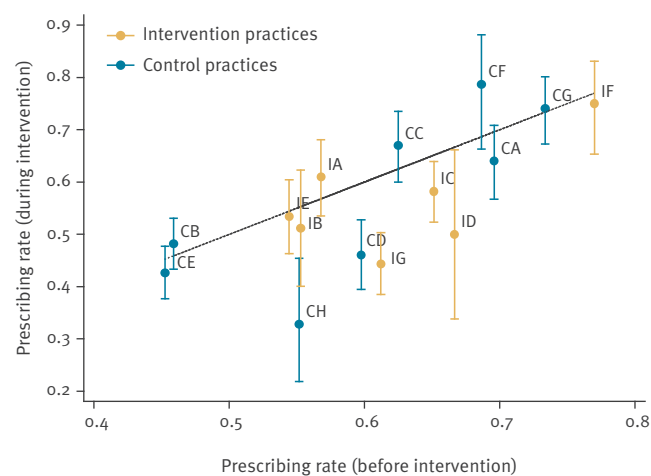

^a Intervention practice IH was merged with IC during the study period.

Discussion

This study did not find any evidence that the use of CRP POCT in RTI (lower RTI, bronchitis, chest/respiratory infection and cough) leads to a statistically significant decrease in the total antibiotic prescribing rate in adults older than 18 and younger than 65 years in practices with high antibiotic prescribing rates. However, it did find evidence of a clinically important reduction in total antibiotic prescriptions administered during the trial in several intervention practices; in consultations where the diagnoses mentioned cough, intervention practices had an estimated 21% reduction in the odds of prescribing, and this was increased to 31% in the three high-fidelity practices.

The study found that even in these high-antibiotic-prescribing practices, there were only a small number of consultations and patients who had acute cough as their main symptom and therefore benefitted from CRP POCT. Our data indicate that in these high-prescribing practices, CRP POCTs were not used in line with NICE guidance as about half of the eligible patients received immediate antibiotics rather than delayed antibiotic prescriptions and may have been using the tests outside the recommended indications. Diagnostic scores are useful tools as a higher diagnostic score was associated with fewer patients with a CRP reading of < 20 mg/L.

Our study confirmed that patients were generally happy about CRP POCT, reporting that the tests can give clinical staff a better basis for treatment decisions, and that the finger prick should be of little concern.

A main strength of our study is that the practices involved were non-research practices in the usual NHS

non-trial setting. This means that the patient views were of routine general practice, providing a true representation of the current pressures CCG and the NHS face today.

While only one CCG with an ethnically diverse patient population was included in the study, which may compromise the representativeness for the whole UK, we took every effort that a range of practices, patients and general practice staff were included in the study. This study's sample reflects an example of England NHS, with varying acceptance and use of diagnostic tools. Practices varied in size and methods of implementation. Main users of the machine included GPs, prescribing pharmacists and practice nurses, reflecting the real environment of POCT in routine general practice and the variety of staff involved. More patients were involved in this present study than in the other research practice-based studies [17], reflecting the true behaviour in a busy service with high prescribing.

Given the considerable variation in prescribing between practices, the study sample size would need to be about four times larger to provide sufficient statistical power to detect a relative reduction in the odds of dispensing of 0.88, which equates to an absolute 5% reduction for the observed levels of dispensing. It should be noted that as high-prescribing practices were included in the study, they would have reduced prescribing because of the regression to the mean; however this has been considered by including data from intervention and control practices both before and after the trial.

A further limitation is that the EMIS data are only as reliable as the data that are inputted by clinicians.

It should be considered that it was impossible to blind practices to the intervention to use CRP POCT, they knew that their antibiotic use was routinely monitored, would continue to be monitored, and that this was an evaluation to determine if CRP POCT could help reduce antibiotic use in acute cough as part of a national antimicrobial stewardship programme.

An RCT in the Netherlands with 40 GPs from 20 general practices reported that GPs in the CRP test group prescribed significantly fewer antibiotics than in the control group (31% vs 53%; $p=0.02$) [15]; our study did not see this significant reduction, using non-research practices and routine general practice. Cals et al. also found that family physicians trained in enhanced communication skills prescribed significantly fewer antibiotics during episodes of RTI in the 3.5 years following the Dutch trial [24], something which our study did not focus on specifically. A communication-based CRP POCT intervention may be better placed in England to attempt to educate patients and increase awareness around antibiotics. Also a recent systematic review including 15 studies across the world, including Denmark, Germany, the Netherlands and Norway, reported that the use of CRP-driven antibiotic therapy

TABLE 4

Estimated effect of C-reactive protein point-of-care testing on antibiotic use, mixed-effects logistic regression model including lower respiratory tract infection, bronchitis, chest/respiratory infection and cough, Northern England, 2016–17 (n = 2,934)

Predictor	Estimated OR	95% CI	p value
Intervention ^a	0.88	0.66–1.16	0.4
Baseline prescribing rate ^{b,c}	17.29	3.53–84.60	< 0.001
Age (per year) ^{b,d}	0.9935	0.9870–1.000	0.05
Sex (female) ^e	1.04	0.88–1.22	0.7
Diagnosis category			
Lower respiratory tract infection		Reference	
Bronchitis	0.83	0.40–1.70	0.6
Chest/respiratory infection	1.79	1.36–2.35	< 0.001
Cough	0.25	0.21–0.32	< 0.001

CI: confidence interval; OR: odds ratio.

^a Reference: control.

^b Continuous predictor in the range zero to one. The estimated OR is the relative change in odds for a theoretical unit change in the predictor.

^c Predictor included to account for baseline differences in pre-intervention prescribing.

^d Predictor included to account for change of one year of age.

^e Reference: male.

TABLE 5

Estimated reduction in the odds of prescribing (total antibiotics) in intervention practices, compared to non-intervention practices, C-reactive protein point-of-care testing, Northern England, 2016–17 (n = 1,186)

Diagnosis included	Estimated reduction in the odds of prescribing: total antibiotics (OR, 95% CI)		
	All intervention practices	High-fidelity intervention practices	Low-fidelity intervention practices
Lower respiratory tract infection, bronchitis, chest/respiratory infection, cough (n = 1,186)	–12% (0.88; 95% CI: 0.66–1.16)	–19% (0.81; 95% CI: 0.66–1.17)	–7% (0.93; 95% CI: 0.67–1.30)
Cough (n = 594)	–21% (0.79; 95% CI: 0.46–1.35)	–31% (0.69; 95% CI: 0.35–1.38)	–13% (0.87; 95% CI: 0.46–1.65)

CI: confidence interval; OR: odds ratio.

was associated with a decreased duration of antibiotic use in neonatal and adult patients [14].

Qualitative interviews and focus groups with the general practice staff involved in the present study was conducted in 2017 and 2018 [18] and support our understanding of existing barriers and facilitators to successful implementation of CRP POCT in routine primary care.

Our study reports that only 22% of patients with a CRP result between 20 and 100 mg/L were managed in line with NICE guidance to consider a delayed antibiotic prescription. However, no known qualitative or quantitative studies on the diagnosis management of patients with CRP reading of 20–100 mg/L have been published to understand why treatment is not managed in line with NICE guidance. Previous research reported that general practice staff are familiar with CRP POCT NICE guidance but some would prefer to use clinical judgement and be safe and prescribe [18].

A multi-country study in research practices across Europe found that almost all patients would be happy to be managed with the addition of a POCT for lower RTI and patients with experience of POCT accepted it as part of routine care [25]. Our study adds patient views that CRP POCT aid clinical diagnosis, provided quick results and reduced unnecessary antibiotic use. Another European study reported that most patients who received a CRP POCT were satisfied with their consultation although many did not receive an antibiotic [26]. Patient feedback was also positive in a small study in Wales which supports patients' views in our study that CRP POCT was useful, convenient and comfortable [17].

In the Nordic countries and Switzerland, trained staff undertake diagnostic tests in the GP offices and there is no extra work or cost for GPs when requesting a CRP POC test [27,28]. Under such conditions, implementing CRP POCT is no problem. However, CRP testing is more difficult when the clinician or other practice staff have to undertake the POCT themselves.

Primary care commissioners are those who work for the CCG to directly commission primary medical services and performance manage practices, in the UK. The variability in use of CRP testing in line with NICE guidance indicates that national and local guidance, and training on the use and interpretation of CRP POCT, needs to be clear and readily available for general practice staff in CCG considering using the test. As there were limited opportunities to use CRP POCT across practices, the machines will be most beneficial in larger GP practices with more patients. More work is needed in the group of patients with intermediate CRP results of 20–100 mg/L to establish how management of these patients in line with NICE guidance could be attained; learning from other European studies would be helpful. Adopting CRP POCT into routine care in the UK needs a clear CCG and practice action plan, guidance, training and an individual who sees most patients eligible for a CRP POCT.

Practice managers, general practice staff and commissioners are all influenced by the cost of diagnostic tools. Economic evaluations show cost-effectiveness of CRP POCT over existing management of RTI in primary care [28]. However, the upfront costs to general practices still needs to be established. It would be useful to evaluate CRP POCTs in larger practices (>20,000 patients) for feasibility, efficiency and cost-effectiveness.

Our study identified examples showing that it is feasible for practices to adopt CRP POCT into routine general practice in line with O'Neill's suggestion that a test should be mandatory before an antibiotic is prescribed [7], and their success should be shared with other CCG.

Acknowledgements

We would like to thank staff at Oldham CCG, especially Nigel Dunkerley, Locality Medicine Optimisation Lead and the Karen Dunn from the GM Shared Services Team. Further thanks to staff at Public Health England, Primary Care Unit for support on the project in particular Donna Lecky and Leah Jones. Many thanks to the practices and general practice staff who took part in this research.

Funding: The research was funded by PHE Primary Care Unit and the CRP POCTs were supplied by Alere Ltd at 50% of the price.

Availability of data and material: Unpublished data from the study can be availed upon request from CE. EMIS data is not available as can be patient identifiable.

The views expressed are those of the authors and not necessarily those of Oldham CCG or Public Health England.

Conflict of interest

None declared.

Authors' contributions

CVE managed the project during data collection and data analysis, analysed patient descriptive data and patient questionnaire data, wrote the descriptive analysis report and patient questionnaire report, lead on the qualitative study, co-ordinated the collection of antibiotic prescribing data collection and analysis, and wrote the manuscript. AS led the project throughout the study, developed the protocol, led on practice recruitment and provided comments on the manuscript. HL collected all patient descriptive data and assisted with the collection of the patient questionnaire data and contributed to manuscript revisions. AC conducted statistical and descriptive analysis on the antibiotic prescribing data and audits, and provided statistical reports, made comments on the manuscript. RO managed the project during the preliminary stages of the project; protocol development and practice recruitment and made final comments on the manuscript. CAMM participated in the design of the study, commented on the protocol, reviewed the data, made final comments on the manuscript and oversaw the project. All authors read and approved the final manuscript.

References

1. Public Health England (PHE). English surveillance programme for antimicrobial utilisation and resistance (ESPAUR). Report 2018. London: PHE; 2018. Available from: https://allcatsrgrey.org.uk/wp/download/public_health/ESPAUR_2018_report.pdf
2. National Institute for Health and Care Excellence (NICE). Respiratory tract infections (self-limiting): prescribing antibiotics. Clinical guideline [CG69]. London: NICE; 23 Jul 2008. Available from: <https://www.nice.org.uk/guidance/cg69>
3. Smieszek T, Pouwels KB, Dolk FCK, Smith DRM, Hopkins S, Sharland M, et al. Potential for reducing inappropriate antibiotic prescribing in English primary care. *J Antimicrob Chemother.* 2018;73(suppl_2):ii36-43. <https://doi.org/10.1093/jac/dkx500> PMID: 29490058
4. Little P, Stuart B, Moore M, Coenen S, Butler CC, Godycki-Cwirko M, et al. Amoxicillin for acute lower-respiratory-tract infection in primary care when pneumonia is not suspected: a 12-country, randomised, placebo-controlled trial. *Lancet Infect Dis.* 2013;13(2):123-9. [https://doi.org/10.1016/S1473-3099\(12\)70300-6](https://doi.org/10.1016/S1473-3099(12)70300-6) PMID: 23265995
5. Smith SM, Fahey T, Smucny J, Becker LA. Antibiotics for acute bronchitis. *Cochrane Database Syst Rev.* 2014;3(3):CD000245. <https://doi.org/10.1002/14651858.CD000245.pub3> PMID: 24585130
6. Department of Health. UK five-year antimicrobial resistance strategy 2013 to 2018. London: Department of Health; 2013. Available from: https://www.gov.uk/government/uploads/system/uploads/attachment_data/file/244058/20130902_UK_5_year_AMR_strategy.pdf
7. O'Niell J. 2016. Review on antimicrobial resistance. London: UK Department of Health; May 2016. Available from: https://amr-review.org/sites/default/files/160518_Final%20paper_with%20cover.pdf
8. National Institute for Health and Care Excellence (NICE). Pneumonia in adults: diagnosis and management. Clinical guideline [CG191]. London: NICE; 2014. Available from: <https://www.nice.org.uk/guidance/cg191/resources/pneumonia-in-adults-diagnosis-and-management-35109868127173>
9. National Institute for Health and Care Excellence (NICE). Cough (acute): antimicrobial prescribing. London: NICE; Feb 2019. Available from: <https://www.nice.org.uk/guidance/ng120/resources/visual-summary-pdf-6664861405>
10. Oppong R, Coast J, Hood K, Nuttall J, Smith RD, Butler CC, et al. Resource use and costs of treating acute cough/lower respiratory tract infections in 13 European countries: results and challenges. *Eur J Health Econ.* 2011;12(4):319-29. <https://doi.org/10.1007/s10198-010-0239-1> PMID: 20364288
11. Huang Y, Chen R, Wu T, Wei X, Guo A. Association between point-of-care CRP testing and antibiotic prescribing in respiratory tract infections: a systematic review and meta-analysis of primary care studies. *Br J Gen Pract.* 2013;63(616):e787-94. <https://doi.org/10.3399/bjgp13X674477> PMID: 24267862
12. Joshi A, Perin DP, Gehle A, Nsiah-Kumi PA. Feasibility of using C-reactive protein for point-of-care testing. *Technol Health Care.* 2013;21(3):233-40. <https://doi.org/10.3233/THC-130720> PMID: 23792796

13. Engel MF, Paling FP, Hoepelman AI, van der Meer V, Oosterheert JJ. Evaluating the evidence for the implementation of C-reactive protein measurement in adult patients with suspected lower respiratory tract infection in primary care: a systematic review. *Fam Pract.* 2012;29(4):383-93. <https://doi.org/10.1093/fampra/cm119> PMID: 22159030
14. Petel D, Winters N, Gore GC, Papenburg J, Beltempo M, Lacroix J, et al. Use of C-reactive protein to tailor antibiotic use: a systematic review and meta-analysis. *BMJ Open.* 2018;8(12):e022133. <https://doi.org/10.1136/bmjopen-2018-022133> PMID: 30580258
15. Cals JW, Butler CC, Hopstaken RM, Hood K, Dinant GJ. Effect of point of care testing for C reactive protein and training in communication skills on antibiotic use in lower respiratory tract infections: cluster randomised trial. *BMJ.* 2009;338(may05 1):b1374. <https://doi.org/10.1136/bmj.b1374> PMID: 19416992
16. Cals JW, Chappin FH, Hopstaken RM, van Leeuwen ME, Hood K, Butler CC, et al. C-reactive protein point-of-care testing for lower respiratory tract infections: a qualitative evaluation of experiences by GPs. *Fam Pract.* 2010;27(2):212-8. <https://doi.org/10.1093/fampra/cm088> PMID: 20022909
17. Hughes A, Gwyn L, Harris S, Clarke C. Evaluating a point-of-care C reactive protein test to support antibiotic prescribing decisions in a general practice. *Clin Pharm.* 2016;8(10):309-8.
18. Eley CV, Sharma A, Lecky DM, Lee H, McNulty CAM. Qualitative study to explore the views of general practice staff on the use of point-of-care C reactive protein testing for the management of lower respiratory tract infections in routine general practice in England. *BMJ Open.* 2018;8(10):e023925. <https://doi.org/10.1136/bmjopen-2018-023925> PMID: 30361406
19. McNulty C, Ricketts EJ, Rugman C, Hogan A, Charlett A, Campbell R, et al. A qualitative study exploring the acceptability of the McNulty-Zelen design for randomised controlled trials evaluating educational interventions. *BMC Fam Pract.* 2015;16(69):169. <https://doi.org/10.1186/s12875-015-0356-0> PMID: 26577832
20. National Institute for Health and Care Excellence (NICE). Alere Afinion CRP for C-reactive protein testing in primary care. London: NICE; 14 Sep 2016. Available from: <https://www.nice.org.uk/advice/mib81/resources/alere-afinion-crp-for-c-reactive-protein-testing-in-primary-care-pdf-63499402887109>
21. Ward C. Point-of-care C-reactive protein testing to optimise antibiotic use in a primary care urgent care centre setting. *BMJ Open Qual.* 2018;7(4):e000391. <https://doi.org/10.1136/bmjopen-2018-000391> PMID: 30397661
22. Abbott. Alere Afinion CRP. Warrington: Abbott. [Accessed: Sep 2018]. Available from: <https://www.alere.com/en/home/product-details/afinion-crp.html>
23. NHS Health Research Authority. Is my study research?. London: NHS Health Research Authority. [Accessed: 28 Apr 2017]. Available from: <http://www.hra.nhs.uk/documents/2016/06/defining-research.pdf>
24. Cals JW, de Bock L, Beckers PJHW, Francis NA, Hopstaken RM, Hood K, et al. Enhanced communication skills and C-reactive protein point-of-care testing for respiratory tract infection: 3.5-year follow-up of a cluster randomized trial. *Ann Fam Med.* 2013;11(2):157-64. <https://doi.org/10.1370/afm.1477> PMID: 23508603
25. Wood F, Brookes-Howell L, Hood K, Cooper L, Verheij T, Goossens H, et al. A multi-country qualitative study of clinicians' and patients' views on point of care tests for lower respiratory tract infection. *Fam Pract.* 2011;28(6):661-9. <https://doi.org/10.1093/fampra/cm031> PMID: 21653924
26. Tonkin-Crine S, Anthierens S, Francis NA, Brugman C, Fernandez-Vandellos P, Krawczyk J, et al. Exploring patients' views of primary care consultations with contrasting interventions for acute cough: a six-country European qualitative study. *NPJ Prim Care Respir Med.* 2014;24(1):14026. <https://doi.org/10.1038/npjpcrm.2014.26> PMID: 25030621
27. Rebnord IK, Hunskaar S, Gjesdal S, Hetlevik Ø. Point-of-care testing with CRP in primary care: a registry-based observational study from Norway. *BMC Fam Pract.* 2015;16(170):170. <https://doi.org/10.1186/s12875-015-0385-8> PMID: 26585447
28. Cooke J, Butler C, Hopstaken R, Dryden MS, McNulty C, Hurding S, et al. Narrative review of primary care point-of-care testing (POCT) and antibacterial use in respiratory tract infection (RTI). *BMJ Open Respir Res.* 2015;2(1):e000086. <https://doi.org/10.1136/bmjresp-2015-000086> PMID: 25973210

License, supplementary material and copyright

This is an open-access article distributed under the terms of the Creative Commons Attribution (CC BY 4.0) Licence. You may share and adapt the material, but must give appropriate credit to the source, provide a link to the licence and indicate if changes were made.

Any supplementary material referenced in the article can be found in the online version.

This article is copyright of the authors or their affiliated institutions, 2020.

Point-of-care tests for influenza A and B viruses and RSV in emergency departments – indications, impact on patient management and possible gains by syndromic respiratory testing, Capital Region, Denmark, 2018

Uffe Vest Schneider¹, Mona Katrine Alberthe Holm¹, Didi Bang², Randi Føns Petersen², Shila Mortensen², Ramona Trebbien², Jan Gorm Lisby¹

1. Department of Clinical Microbiology, Copenhagen University Hospital Hvidovre, Hvidovre, Denmark

2. Department of Virus & Microbiological Special Diagnostics, Statens Serum Institut, Copenhagen, Denmark

Correspondence: Uffe Vest Schneider (Uffe.Vest.Schneider@regionh.dk)

Citation style for this article:

Schneider Uffe Vest, Holm Mona Katrine Alberthe, Bang Didi, Petersen Randi Føns, Mortensen Shila, Trebbien Ramona, Lisby Jan Gorm. Point-of-care tests for influenza A and B viruses and RSV in emergency departments – indications, impact on patient management and possible gains by syndromic respiratory testing, Capital Region, Denmark, 2018. *Euro Surveill.* 2020;25(44):pii=1900430. <https://doi.org/10.2807/1560-7917.ES.2020.25.44.1900430>

Article submitted on 30 Jun 2019 / accepted on 06 Jul 2020 / published on 05 Nov 2020

Background: Point-of-care tests (POCT) for influenza A and B viruses and respiratory syncytial virus (RSV) were implemented in emergency departments of all hospitals in the Capital Region of Denmark in 2018.

Aim: To establish whether POC testing for influenza viruses or RSV is based on a valid respiratory symptom indication, whether changes in patient management based on a positive result are safe and whether syndromic POC testing may benefit patients with influenza or RSV. **Methods:** Samples from 180 children (< 18 years) and 375 adults tested using POCT between February and July 2018 were retested for 26 respiratory pathogens. Diagnosis, indication for POC testing, hospitalisation time, antimicrobial therapy and readmission or death within one month of testing were obtained from patient records. **Results:** A valid indication for POC testing was established in 168 (93.3%) of children and 334 (89.1%) of adults. A positive POCT result significantly reduced antibiotic prescription and median hospitalisation time by 44.3 hours for adults and 14.2 hours for children, and significantly increased antiviral treatment in adults. Risk of readmission or death was not significantly altered by a positive result. Testing for 26 respiratory pathogens established that risk of coinfection is lower with increasing age and that POCT for adults should be restricted to the influenza and RSV season. **Conclusion:** Positive POCT resulted in changed patient management for both children and adults, and was deemed safe. POCT for additional pathogens may be beneficial in children below 5 years of age and outside the influenza and RSV season.

Introduction

Over a dozen different platforms for target amplification-based point-of-care tests (POCT) are now available through several different companies [1]. Studies have evaluated the benefits of POC testing for respiratory pathogens on patient management [2-13], but their conclusions are conflicting and the benefits for patient management are therefore not fully understood. Several studies found that POC testing may improve patient management by deferring hospital admission [3], reducing hospitalisation time [4,5], improving targeted use of antiviral treatment [4,6-9,12], reducing prescription [10] and duration of antibiotic treatment [5], reducing in-hospital isolation time [8], improving use of side room isolation facilities [6] and decreasing overall costs of hospitalisation [3,5,12,13]. In contrast, other studies reported that POC testing for respiratory pathogens does not significantly reduce prescription or duration of antibiotics [4,7-9,11], do not reduce hospitalisation time or defer admissions [7-9] and do not reduce the risk of death or readmission [4,7,8].

In January 2018, routine POC testing for influenza A and B viruses and human orthopneumovirus (formerly respiratory syncytial virus, RSV) was implemented at all hospital emergency departments in the Capital Region of Denmark. Quality assurance was established by retesting the POCT samples for 20 viral and six bacterial respiratory targets at the National World Health Organization (WHO) Influenza Laboratory, Department of Virus and Microbiological Special Diagnostics, Statens Serum Institut (SSI), Copenhagen, Denmark. Accuracy and error rates of the POCT were determined for bedside use by emergency department clinical personnel or laboratory technicians (under review). Several concerns were raised [14] in connection with

the implementation of POC testing for influenza A and B viruses and RSV [14]. It has been suggested that indication for POCT would increase as clinicians got access to a fast and low-complexity bedside test, which could lead to unnecessary testing and added expense without any added clinical benefit. Questions have also been raised as to whether clinicians would act on a positive test result and change patient management, and whether such changes would be safe for patients [14].

It is also unknown whether testing for additional respiratory pathogens using POCT would benefit patients and if so, which patients should be offered this testing. We aim to evaluate data for the first 6 months following the introduction of POCT in the Capital Region of Denmark to establish whether such testing is conducted based on a valid respiratory symptom indication. We also aim to examine whether clinicians safely use positive POCT results to change patient management by comparing treatment of POCT positive patients with POCT negative patients. Additionally, we identify which other viral and bacterial pathogens can be detected in the patient samples, and whether a positive syndromic test result for these pathogens could potentially influence patient management. Finally, we consider scenarios in which syndromic POCT may be of added benefit to POC testing for influenza A and B viruses and RSV in order to improve patient management.

Methods

Study design

This clinical impact study compared positive POCT results with negative POCT results. Consecutive patient samples ($n = 555$) tested for influenza A and B viruses and RSV using the cobas Liat system (Roche Diagnostics, Hvidovre, Denmark) between February and July 2018 were included in the study. The test period was restricted to the first 6 months after POCT implementation to ensure a fast assessment and allow necessary changes in instructions for clinical personnel to be implemented, and allow access to the cobas Liat instruments prior to the following influenza and RSV season from week 40 2018 to week 20 2019.

Patients were tested for influenza A and B viruses and RSV by POCT if the attending physician found the patient to be likely to have influenza A or B or RSV infection based on the clinical presentation of the patient.

Demographics

Data regarding age at sampling, sex, sample date, time and date for admission to and discharge from hospital, initiation and type of antibacterial or antiviral treatment on admittance to hospital, readmission or death within 1 month of previous hospitalisation, lung X-ray within 24 hours of a POCT and clinical diagnosis were extracted from the patients' electronic record. Patients were considered children if they were under 18 years of age at time of sampling.

For some patients, clinical diagnosis was established retrospectively as no diagnosis had been registered in the electronic patient record. A clinical diagnosis was established by one of the medical doctors authoring this manuscript and verified by another medical doctor. This was done by accessing the POCT result and reviewing additional clinical results documented in the electronic patient record including: lung X-ray, lung stethoscopy, temperature, oxygenation, clinical respiratory symptoms, reported pain, leucocytosis and C-reactive protein level. Other diagnostic relevant information recorded for individuals >18 years of age was the CURB-65 score (confusion, blood urea nitrogen, respiratory rate, blood pressure and age 65 or older). For one child, no clinical diagnosis had been reported and data in their electronic patient record were limited and indicated other or no infection. Their diagnosis was therefore registered as not available.

Clinical diagnosis was recorded either as: a viral respiratory tract infection (RTI); bacterial RTI; a RTI that could not be differentiated as either bacterial or viral; another infection not originating from a respiratory focus; or no infection at all based on the clinical diagnosis in the electronic patient record.

Indication for point-of-care testing

Indication for POC testing was considered valid if any respiratory symptoms were reported in the electronic patient record either as a patient-reported symptom or established as part of an objective examination e.g. by inspection of cavum oris or lung stethoscopy of the patient or by X-ray of the thorax.

Point-of-care testing

Samples were collected and tested locally by emergency department clinical personnel or laboratory technicians at all four hospitals (three emergency departments and one paediatric emergency department), in the Capital Region of Denmark. After testing, the remaining sample material was sent to the Department of Clinical Microbiology at Hvidovre University Hospital and forwarded to the Danish National World Health Organization (WHO) Influenza Laboratory, Department of Virus and Microbiological Special Diagnostics, Statens Serum Institut (SSI), Copenhagen, Denmark.

Retesting at Statens Serum Institut

At SSI, samples were tested in single real-time PCR assays targeting: *Bordetella parapertussis*, *Bordetella pertussis*, *Chlamydia pneumoniae*, *Chlamydia psittaci*, *Legionella* spp., *Mycoplasma pneumoniae*, enterovirus, human coronavirus 229E, human coronavirus HKU1, human coronavirus NL63, human coronavirus OC43, human mastadenovirus A-G (formerly adenovirus), human metapneumovirus (hMPV), human polyomavirus 3, human polyomavirus 4, human respirovirus 1 (formerly parainfluenzavirus 1), human respirovirus 3 (formerly parainfluenzavirus 3), human orthorubulavirus 2 (formerly parainfluenzavirus 2), human orthorubulavirus 4 (formerly parainfluenzavirus 4), influenza

TABLE 1

Characteristics of patients tested for influenza A and B viruses and RSV using point-of-care tests at hospital emergency departments, and indication for testing, Capital Region of Denmark, February–July 2018 (n = 555)

Characteristics	Number of children (n = 180)	%	Number of adults (n = 375)	%
Age (years)				
<2	122	67.8	NA	NA
2–5	29	16.1	NA	NA
6–17	29	16.1	NA	NA
18–65	NA	NA	210	56
>65	NA	NA	165	44
Sex				
Female	68	37.8	213	56.8
Number of POCT by month				
February	1	0.6	39	10.4
March	66	36.7	189	50.4
April	75	41.7	102	27.2
May	15	8.3	31	8.3
June	11	6.1	10	2.7
July	12	6.7	4	1.1
Valid indication for POCT				
February to July	168	93.3	334	89.1
February to April	135	95.1	294	89.1
May to July	33	86.8	40	88.9
Clinical diagnosis				
Viral RTI	124	68.9	142	37.9
Bacterial RTI	9	5.0	95	25.3
Viral or bacterial RTI	9	5.0	27	7.2
Other infection	27	15.0	58	15.5
No infection	10	5.6	53	14.1
Not available	1	0.6	0	0.0
Antibacterial or viral treatment				
Only oseltamir treatment	0	0.0	15	4.0
Only antibacterial treatment	33	18.3	194	51.7
Oseltamir and antibacterial treatment	0	0.0	12	3.2
Outcome				
Median hospitalisation time – hours (IQR)	13.5	0.0–39.7	44.7	6.8–131.7
Readmission within 30 days	43	23.9	108	28.8
Death within 30 days of discharge	0	0.0	51	13.6
Median age for death (IQR)	NA	NA	77.5	66.8–84.0

IQR: interquartile range; NA: not applicable; POCT: point-of-care test; RTI: respiratory tract infection. Children were defined as patients under 18 years at time of presentation.

A virus either as non-typeable, subtype A(H1N1)pdm09 or A(H3N2), influenza B virus, influenza C virus, parvovirus, primate bocaparvovirus 1+2 (formerly bocavirus), rhinovirus and RSV. Assays are laboratory-developed tests quality assured according to the quality programme provided by the WHO. Total nucleic acids were extracted from 200 µL of patient sample after the addition of PolyA (0.05 mg/mL) as a carrier (Roche Diagnostics) by a MagNa Pure 96 extraction robot using the MagNa Pure 96 DNA Viral NA small volume kit, the 'plasma small volume protocol', and an elution volume of 100 µL (Roche Diagnostics). Real-time PCR was performed using either an MX3005P (Stratagene,

Agilent Technologies, Glostrup, Denmark) or an ABI 7500 (Applied Biosystems, ThermoFisher Scientific, Slangerup, Denmark) real-time system. For each assay, 5 µL of extracted nucleic acids was used in a total reaction volume of 25 µL.

Statistical analysis

Statistical analysis was performed using MS Excel, MedCalc online version (MedCalc software, Ostend, Belgium) and Social Science Statistics (socsistatistics.com). Descriptive data are reported as number and percentage of individuals. Age in years and hospitalisation

TABLE 2

Effect of a positive influenza A and B viruses and RSV point-of-care test result on patient management, Capital Region of Denmark, February–July 2018 (n = 555)

Children (n = 180)	POCT positive		POCT negative		Difference		p value
	Total n	%	Total n	%	z-score	95% CI	
Hospitalisation time, hours (IQR)	1.0	0.0–27.1	15.2	(1.4–42.2)	2.4	NA	0.017
Antibacterial treatment	2	3.8	31	24.4	20.6	9.5 to 29.2	0.0011
Readmission within one month	13	24.5	30	23.6	0.9	–11.6 to 15.5	0.897
Lung X-ray within 24 hours	2	3.8	15	11.8	8.0	–2.0 to 15.3	0.094
Viral or viral/bacterial RTI	53	100.0	80	63.0	37.0	26.6 to 45.7	<0.0001
Bacterial RTI	0	0.0	9	7.1	7.1	–0.4 to 12.9	0.047
Adults (n = 375)	POCT positive		POCT negative		Difference		p value
	Total n	%	Total n	%	z-score	95% CI	
Hospitalisation time, hours (IQR)	16.3	2.6–75.3	60.6	11.3–142.2	3.9	NA	<0.0001
Antibacterial treatment	33	28.4	161	62.2	33.7	23.0 to 43.1	<0.0001
Oseltamir	21	18.1	6	2.3	15.8	9.3 to 23.9	<0.0001
Readmission within one month	30	25.9	78	30.1	4.2	–5.9 to 13.4	0.403
Death within one month of hospitalisation	14	12.1	37	14.3	2.2	–5.9 to 9.0	0.563
Lung X-ray within 24 hours	70	60.3	156	60.2	0.1	–10.7 to 10.5	0.984
Viral or viral/bacterial RTI	108	93.1	61	23.6	69.6	61.3 to 75.4	<0.0001
Bacterial RTI	6	5.2	89	34.4	29.2	21.3 to 35.8	<0.0001

CI: confidence interval; IQR: interquartile range; NA: not applicable; POCT: point-of-care test; RSV: respiratory syncytial virus; RTI: respiratory tract infection.

Children were defined as patients under 18 years at time of presentation.

time in hours are reported as median with interquartile range (IQR).

Comparison of proportions was performed by ‘N-1’ chi-squared test and comparison of medians was performed by two-tailed Mann–Whitney U test, with level of significance at $p < 0.05$.

Ethical statement

Collection of patient data for quality assurance and development of treatment was granted according to Danish legislation by the board of directors at Hvidovre University Hospital (application WZ19001024–2019–30) and data were anonymised and used for statistical analysis according to the regulation.

Results

Basic patient characteristics and indication for point-of-care testing

Of the tested individuals, children below 18 years accounted for 32.4% (180/555), adults between 18 and 65 years accounted for 37.8% (210/555), and elderly patients above 65 years accounted for 29.7% (165/555) (Table 1).

Patients were primarily tested in March and April 2018, and most patients (both children and adults) were found to have a viral or mixed viral and bacterial RTI. Median hospitalisation time for children was 13.5 hours (IQR: 0.0–39.7) and 33 (18.3%) of the children were treated with antimicrobial therapy initiated during

hospital admission (Table 1). Median hospitalisation time for adults was 44.7 hours (IQR: 6.8–131.7) and 206 (54.9%) of adults were treated with antimicrobial therapy initiated during hospital admission. Twenty-seven (7.2%) of adult patients received oseltamir treatment for influenza due to a positive POCT result, and 12 of these patients were also treated with antibiotics. Approximately one quarter of all children and adults were readmitted to hospital within 30 days of the previous discharge. Fifty-one adult patients (13.6%), median age 77.5 years (IQR: 66.8–84.0), died under hospitalisation or within 30 days of discharge (Table 1). Nine of the patients who died were below 65 years of age and all had underlying conditions. Three had cancer, two had liver cirrhosis, two had Down syndrome, one had chronic obstructive pulmonary disease (COPD) and diabetes and one had severe COPD.

One hundred and sixty eight (93.3%) children and 334 (89.1%) adults were found to have a valid indication for POC testing, leaving 12 (6.7%) children and 41 (10.9%) adults tested for influenza A and B viruses and RSV using a POCT without any respiratory symptomatology recorded in their electronic patient record.

Effects of a positive point-of-care test result on patient management

A positive POCT result for influenza A or B viruses or RSV was significantly associated with a viral or mixed

TABLE 3

Viral and bacterial targets detected, by age group, among patients who took an influenza A and B virus and RSV point-of-care test at a hospital emergency department, Capital Region of Denmark, February–July 2018 (n = 312)

Pathogen detected	Age (years)				
	0–1	2–5	6–17	18–65	>65
<i>Bordetella pertussis</i>	1	0	0	0	0
Enterovirus	13	2	1	1	0
Human coronavirus 229E	1	0	0	0	1
Human coronavirus HKU1	0	0	0	2	0
Human coronavirus NL63	6	0	2	2	0
Human coronavirus OC43	0	0	0	1	0
Human mastadenovirus A-G	15	5	2	6	1
Human metapneumovirus	7	2	0	12	10
RSV	30	1	0	8	10
Human polyomavirus 3	1	1	0	0	0
Human polyomavirus 4	5	1	0	0	0
Human respirovirus 1	1	0	0	0	0
Human respirovirus 3	10	2	0	3	2
Influenza A virus (non-typeable)	1	0	1	4	1
Influenza A(H1N1)pdm09 virus	3	4	1	9	2
Influenza A(H3N2) virus	1	1	3	13	15
Influenza B virus	1	1	1	26	28
<i>Mycoplasma pneumoniae</i>	0	0	1	6	0
Parechovirus	1	0	0	0	0
Primate bocaparvovirus 1+2	3	0	0	1	0
Rhinovirus	36	2	3	12	8
Total number of detected viruses	135	22	14	100	78
Total number of detected bacteria	1	0	1	6	0
Total number of samples with detection of one pathogen	74	15	13	98	76
Total number of samples with co-detection of pathogens	28	2	1	4	1
Total number of samples tested negative for all pathogens	20	12	15	108	88
Single target detection rate %	60.7	51.7	44.8	46.7	46.1
Coinfection rate %	23.0	6.9	3.4	1.9	0.6

RSV: respiratory syncytial virus.

All samples were negative for *Bordetella parapertussis*, *Chlamydia pneumoniae*, *Chlamydia psittaci*, human orthorubulavirus 2 and 4, influenza C virus and *Legionella* spp.

viral/bacterial RTI diagnosis in both children and adults ($p < 0.0001$) (Table 2).

Significantly more adult patients with a positive POCT result were treated with oseltamir ($p < 0.0001$) and significantly fewer with antibiotics ($p < 0.0001$) than those adults with a negative POCT result (Table 2). An added benefit was significantly reduced hospitalisation time for adults ($p < 0.0001$) and children ($p < 0.017$) with a positive POCT result compared to a negative POCT result (a median of 16.3 hours (IQR: 2.6–75.3) vs 60.6 hours (IQR: 11.3–142.2) for adults, respectively, and a median of 1 hour (IQR: 0.0–27.1) vs 15.2 hours (IQR: 1.4–42.2) for children, respectively). Risk of readmission or death within 1 month of discharge and the likelihood of having a lung X-ray performed within 24 hours of a POCT was almost equally distributed between POCT-positive and -negative patients (Table 2).

Additional pathogen findings by syndromic respiratory testing

When tested for the 20 viral and six bacterial pathogens included in Table 3, 56.2% (312/555) of all POCT samples were positive for one or more pathogen.

In children below 2 years of age, 60.7% (74/122) were positive for one pathogen, whereas 23.0% (28/122) were positive for multiple pathogens (23 for two pathogens, four for three pathogens and one for four pathogens). The rate of coinfection of pathogens diminished with age. Among 2–5 year olds, two children were found to be positive for either three or four pathogens. From 6 years of age and older, all coinfections were caused by two pathogens (Table 3). In children below 2 years of age, the most prevalent findings were rhinovirus, RSV, human mastadenovirus A-G, enterovirus and human respirovirus 3, whereas influenza A virus and influenza B virus were only rarely detected in this age group (Table 3). Influenza B virus was predominately detected in adults and influenza A(H1N1)pdm09

TABLE 4

Viral and bacterial pathogens detected among patients who took an influenza A and B virus and RSV point-of-care test at a hospital emergency department, by sampling month, Capital Region of Denmark, February–July 2018 (n = 312)

Pathogen detected	Month (2018)					
	February	March	April	May	June	July
<i>Bordetella pertussis</i>	0	0	0	0	0	1
Enterovirus	0	8	3	3	1	2
Human coronavirus 229E	0	0	2	0	0	0
Human coronavirus HKU1	1	0	1	0	0	0
Human coronavirus NL63	1	6	3	0	0	0
Human coronavirus OC43	0	1	0	0	0	0
Human mastadenovirus A-G	1	12	7	5	0	4
Human metapneumovirus	0	15	16	0	0	0
RSV	1	21	27	0	0	0
Human polyomavirus 3	0	0	2	0	0	0
Human polyomavirus 4	0	2	2	1	0	1
Human respirovirus 1	0	0	1	0	0	0
Human respirovirus 3	0	3	5	7	0	2
Influenza A virus (non-typeable)	0	4	3	0	0	0
Influenza A(H1N1)pdm09 virus	1	14	3	0	0	0
Influenza A(H3N2) virus	2	23	8	0	0	0
Influenza B virus	8	41	8	0	0	0
<i>Mycoplasma pneumoniae</i>	1	3	2	1	0	0
Parechovirus	0	0	0	0	0	1
Primate bocaparvovirus 1+2	1	2	1	0	0	0
Rhinovirus	0	17	27	8	4	5
Total number of detected viruses	16	169	120	24	5	15
Total number of detected bacteria	1	3	2	1	1	1
Total number of samples with detection of one pathogen	17	140	88	18	5	8
Total number of samples with co-detection of pathogens	0	15	15	3	0	3
Total number of samples tested negative for all pathogens	23	100	74	25	16	5
Single target detection rate %	42.5	54.9	49.7	39.1	23.8	50.0
Coinfection rate %	0	5.9	8.5	6.5	0	18.8

RSV: respiratory syncytial virus.

All samples were negative for *Bordetella parapertussis*, *Chlamydia pneumoniae*, *Chlamydia psittaci*, human orthorubulavirus 2 and 4, influenza C virus and *Legionella* spp.

virus was most prevalent in children aged 2–5 years, with a declining prevalence in the older age groups and among the children below 2 years. Influenza A(H3N2) virus predominated in children above 5 years of age and in adults (Table 3). Seven influenza A virus-positive samples were non-typeable after amplification and sequencing at SSI. No further attempts were conducted to identify the influenza A virus subtype. The most prevalent pathogens detected between February and April were influenza B virus, influenza A virus, RSV and hMPV, all of which were not detected in May to July 2018 (Table 4).

Rhinovirus, human respirovirus 3, human mastadenovirus A-G and enterovirus were detected most frequently in May to July indicating the season differences between different respiratory pathogens (Table 4).

How syndromic respiratory testing may impact patient management

Syndromic testing for 26 other respiratory pathogens was compared with POC testing for influenza A and B viruses and RSV and is presented in Table 5. A significantly shorter hospitalisation time (1.0 vs 16.0 hours, $p=0.024$) and significantly fewer antibiotics (3.8% vs 17.1%, $p=0.020$) were observed for children with a positive POCT result for influenza A and B viruses and RSV compared to children positive for other respiratory viruses (Table 5). A similar effect on hospitalisation time in adults was not observed, even though those with a positive POCT result for influenza A and B viruses and RSV received significantly fewer antibiotics ($p<0.0001$) compared with adults positive for other viruses (Table 5).

Discussion

The risk of excessive use of POCT for detecting respiratory pathogens is frequently mentioned as a concern when considering placing POCT for bedside use by

TABLE 5

Potential effect of point-of-care testing for influenza A and B viruses and RSV, and syndromic testing for 26 other respiratory viruses on patient management, Capital Region of Denmark, February–July 2018 (n = 312)

Children (n = 133)	Influenza A and B and RSV POCT positive		Positive for other respiratory viruses		Difference		p value
	Total n	%	Total n	%	z-score	95% CI	
Hospitalisation time, hours (IQR)	0.7	(0.0–37.0)	15.7	(1.5–36.1)	2.52	NA	0.012
Antibacterial treatment	2	4.1	14	16.7	12.6	1.0 to 22.4	0.032
Readmission within one month	12	24.5	18	21.4	3.1	–10.9 to 18.6	0.685
Lung X-ray within 24 hours	2	4.1	11	13.1	9.0	–2.1 to 18.3	0.093
Viral or viral / bacterial RTI	49	100.0	65	77.4	22.6	12.1 to 32.6	0.0003
Bacterial RTI	0	0.0	4	4.8	4.8	–3.1 to 11.6	0.122
Adults (n = 179)	Influenza A and B and RSV POCT positive		Positive for other respiratory viruses ^a		Difference		p value
	Total n	%	Total n	%	z-score	95% CI	
Hospitalisation time, hours (IQR)	17.5	(3.6–76.7)	41.6	(3.4–105.5)	–2.03	NA	0.042
Antibacterial treatment	35	31.5	40	58.8	27.3	12.3 to 40.8	0.0003
Antiviral treatment	20	18.0	0	0.0	18.0	10.0 to 26.2	0.0002
Readmission within one month	27	24.3	19	27.9	3.6	–9.1 to 17.2	0.592
Death within one month of hospitalisation	14	12.6	8	11.8	0.8	–10.1 to 10.2	0.867
Lung X-ray within 24 hours	64	57.7	43	63.2	5.6	–9.2 to 19.6	0.461
Viral or viral / bacterial RTI	100	90.1	29	42.6	47.4	33.7 to 59.3	<0.0001
Bacterial RTI	8	7.2	24	35.3	28.1	16.0 to 40.5	<0.0001

IQR: interquartile range; NA: not applicable; POCT: point-of-care test; RSV: respiratory syncytial virus; RTI: respiratory tract infection.

^a Patients positive for other respiratory viruses that are typically included in syndromic POCT platforms excluding influenza A virus, influenza B virus and RSV.

Children were defined as patients under 18 years at time of presentation.

clinical personnel in emergency departments. To our knowledge, no studies have previously looked at the indications for POC testing when implemented for routine clinical patient management. In our study, 93.3% of tested children and 89.1% of tested adults had clinical signs of a respiratory infection and thereby a valid indication for POC testing. Interestingly, 33 children (18.3%) and 40 adults (10.7%) were tested in May to July 2018 even though no influenza A virus-, influenza B virus- or RSV-positive patients were detected after week 20 2018. It is therefore recommended to restrict the use of POCT for respiratory testing to relevant time periods based on the seasonal variation of the pathogens included in the assay used for the POCT [15]. It may also be beneficial to introduce an electronic prompt question for clinical signs of respiratory infection when ordering the POCT to increase the likelihood of a valid indication for POCT.

Previous studies agree that POCT for respiratory infections improve the targeted use of antiviral treatment [4,6,8,9,12], which is also supported by the present study. In contrast, the effect on prescription and duration of antibiotic treatment and hospitalisation time is debatable [4,5,7–11]. Most studies support that prescription and duration of antibiotic treatment is not significantly reduced by POC testing [4,7–9], and three studies found no reduction in duration of hospitalisation [7–9]. These studies looked at the effect of a POCT

intervention using the Biofire FilmArray PCR system (Biomerieux, Saint-Louis, US), which analyses samples in central laboratories [4,7–9]. This method is in contrast to the present study, where POC testing was conducted bedside using the much faster cobas Liat influenza A and B viruses and RSV assay. In addition, the present study compared the effect of POCT on antibiotic prescription and duration of hospitalisation.

The present study showed that clinicians do take the POCT result into account when diagnosing the patient and deciding treatment strategy. Even though hospitalisation time was shortened and antibiotic use was decreased, we found no difference in readmission or mortality between POCT-positive and -negative patients, indicating that the use of a POCT for clinical decisions regarding hospital admission and initiation of antibiotic therapy is safe for the patient. Other studies have reported that a general introduction of syndromic POCT for multiple respiratory pathogens without taking the result of the POCT into account does not alter prescription and duration of antibiotic treatment or duration of hospitalisation [4,7–9,11]. One may speculate that a fast and positive result for other respiratory pathogens will also impact prescription of antibiotics and duration of hospitalisation, as is suggested by our data, as these lesser pathogenic viruses are often treated with antibiotics and patients are admitted even

though they are diagnosed with viral or mixed viral and bacterial RTI.

Coinfections with several respiratory pathogens have frequently been found in younger children and have been shown to reduce with increasing age [15,16], which is in line with the present study. The use of syndromic POCT should therefore be considered in children below 5 years of age and may also be beneficial outside the appropriate season for targeted POCT for influenza A and B viruses and RSV. Further randomised controlled trials are needed to clarify whether positive syndromic POCT for respiratory viruses can significantly reduce antibiotic prescription and duration of hospitalisation compared to targeted testing for influenza A and B viruses and RSV. Such studies are relevant as 322 patients, or 58.0% of all patients tested by POCT in the present study, were positive for one or more of the 26 tested respiratory pathogens.

The present study has several limitations including that patients were only tested if the treating physician suspected the patient to be positive for influenza viruses or RSV based on clinical evaluation. The prevalence of respiratory viruses is therefore expected to be higher in our sample than in the general population. Samples were collected consecutively, but only from the middle of the RSV and influenza season, which may have influenced patient handling and the detection of other viral and bacterial pathogens. This study compares POCT-positive and -negative samples and cannot be used to evaluate whether patient management was changed by the introduction of POCT compared to centralised laboratory testing. In addition, we can only hypothesise whether syndromic POC testing may result in changed patient management compared with POC testing for influenza A and B viruses and RSV.

It is still unknown how the introduction of POCT will influence influenza and RSV surveillance in Denmark. As results are reported directly into the national microbiology database, it may impact surveillance data if testing frequency and indication for testing changes over time. As the present POC testing for influenza A and B viruses and RSV does not subtype influenza A virus-positive isolates, it may influence national surveillance as most centralised microbiology laboratories report influenza A virus subtypes. Most POCT samples will not be subtyped as only a fraction of samples will be subtyped by SSI in the future. Further studies are therefore needed to establish how POCT for influenza A and B viruses and RSV are changing our national surveillance data.

Conflict of interest

Jan Gorm Lisby and Uffe Vest Schneider have both received honorarium for presenting papers at Roche Diagnostics sponsored events / conferences.

Authors' contributions

Uffe Vest Schneider, Didi Bang and Jan Gorm Lisby conceived the project. Uffe Vest Schneider and Jan Gorm Lisby initiated the collection of the clinical samples. Didi Bang, Randi Føns Petersen, Shila Mortensen and Ramona Trebbien oversaw the testing of samples at Statens Serum Institut. Uffe Vest Schneider, Mona Katrine Alberthe Holm and Jan Gorm Lisby received clearance to and collected the clinical data. Uffe Vest Schneider performed the data analysis and drafted the manuscript with input from all authors. All authors approved the final manuscript.

References

1. Banerjee D, Kanwar N, Hassan F, Essmyer C, Selvarangan R. Comparison of six sample-to-answer influenza A/B and respiratory syncytial virus nucleic acid amplification assays using respiratory specimens from children. *J Clin Microbiol*. 2018;56(11):e00930-18. <https://doi.org/10.1128/JCM.00930-18> PMID: 30185508
2. Egilmezer E, Walker GJ, Bakthavathsalam P, Peterson JR, Gooding JJ, Rawlinson W, et al. Systematic review of the impact of point-of-care testing for influenza on the outcomes of patients with acute respiratory tract infection. *Rev Med Virol*. 2018;28(5):e1995. <https://doi.org/10.1002/rmv.1995> PMID: 30101552
3. Hansen GT, Moore J, Herding E, Gooch T, Hirigoyen D, Hanson K, et al. Clinical decision making in the emergency department setting using rapid PCR: Results of the CLADE study group. *J Clin Virol*. 2018;102:42-9. <https://doi.org/10.1016/j.jcv.2018.02.013> PMID: 29494950
4. Brendish NJ, Malachira AK, Armstrong L, Houghton R, Aitken S, Nyimbili E, et al. Routine molecular point-of-care testing for respiratory viruses in adults presenting to hospital with acute respiratory illness (ResPOC): a pragmatic, open-label, randomised controlled trial. *Lancet Respir Med*. 2017;5(5):401-11. [https://doi.org/10.1016/S2213-2600\(17\)30120-0](https://doi.org/10.1016/S2213-2600(17)30120-0) PMID: 28392237
5. Duan S, Gu X, Fan G, Sun R, Wang Y, Yu D, et al. Evaluation of a molecular point of care testing for viral and atypical pathogens on intravenous antibiotic duration in hospitalized adults with lower respiratory tract infection: A randomized clinical trial. *Clin Microbiol Infect*. <https://doi.org/10.1016/j.cmi.2019.06.012>
6. Pedersen CJ, Rogan DT, Yang S, Quinn JV. Using a novel rapid viral test to improve triage of emergency department patients with acute respiratory illness during flu season. *J Clin Virol*. 2018;108:72-6. <https://doi.org/10.1016/j.jcv.2018.09.008> PMID: 30261422
7. Andrews D, Chetty Y, Cooper BS, Virk M, Glass SK, Letters A, et al. Multiplex PCR point of care testing versus routine, laboratory-based testing in the treatment of adults with respiratory tract infections: a quasi-randomised study assessing impact on length of stay and antimicrobial use. *BMC Infect Dis*. 2017;17(1):671. <https://doi.org/10.1186/s12879-017-2784-z> PMID: 29017451
8. Vos LM, Weehuizen JM, Hoepelman AIM, Kaasjager KHAH, Riezebos-Brilman A, Oosterheert JJ. More targeted use of oseltamivir and in-hospital isolation facilities after implementation of a multifaceted strategy including a rapid molecular diagnostic panel for respiratory viruses in immunocompromised adult patients. *J Clin Virol*. 2019;116:11-7. <https://doi.org/10.1016/j.jcv.2019.04.003> PMID: 30999234
9. Busson L, Bartiaux M, Brahim S, Konopnicki D, Dauby N, Gérard M, et al. Contribution of the FilmArray Respiratory Panel in the management of adult and pediatric patients attending the emergency room during 2015-2016 influenza epidemics: An interventional study. *Int J Infect Dis*. 2019;83:32-9. <https://doi.org/10.1016/j.ijid.2019.03.027> PMID: 30926539
10. Kaku N, Hashiguchi K, Iwanaga Y, Akamatsu N, Matsuda J, Kosai K, et al. Evaluation of FilmArray respiratory panel multiplex polymerase chain reaction assay for detection of pathogens in adult outpatients with acute respiratory tract infection. *J Infect Chemother*. 2018;24(9):734-8. <https://doi.org/10.1016/j.jiac.2018.05.006> PMID: 29895452
11. Sakata KK, Azadeh N, Brighton A, Temkit M, Klassen CL, Grys TE, et al. Impact of nasopharyngeal FilmArray respiratory panel results on antimicrobial decisions in hospitalized patients. *Can Respir J*. 2018;2018:9821426. <https://doi.org/10.1155/2018/9821426> PMID: 30008977
12. Vecino-Ortiz AI, Goldenberg SD, Douthwaite ST, Cheng CY, Glover RE, Mak C, et al. Impact of a multiplex PCR

- point-of-care test for influenza A/B and respiratory syncytial virus on an acute pediatric hospital ward. *Diagn Microbiol Infect Dis*. 2018;91(4):331-5. <https://doi.org/10.1016/j.diagmicrobio.2018.03.013> PMID: 29706478
13. Rahamat-Langendoen J, Groenewoud H, Kuijpers J, Melchers WJG, van der Wilt GJ. Impact of molecular point-of-care testing on clinical management and in-hospital costs of patients suspected of influenza or RSV infection: a modeling study. *J Med Virol*. 2019;91(8):1408-14. <https://doi.org/10.1002/jmv.25479> PMID: 30950066
 14. Lisby G, Andersen DT, Chen M, Dreyer A, Greve T, Hansen D, et al. Anbefalinger vedrørende implementering og anvendelse af Point-of-Care teknologi til diagnostik af infektionssygdomme. [Recommendations regarding the implementation and use of point-of-care technology for diagnosis of infectious diseases]. Odense: Dansk Selskab for Klinisk Mikrobiologi (DSKM); 2017. (Danish). Available from: <https://dskm.dk/wp-content/uploads/2016/08/POC-Rapport-fra-DSKMs-Udvalg.pdf>
 15. Arbefeville S, Ferrieri P. Epidemiologic analysis of respiratory viral infections mainly in hospitalized children and adults in a Midwest university medical center after the implementation of a 14-virus multiplex nucleic acid amplification test. *Am J Clin Pathol*. 2017;147(1):43-9. PMID: 28028115
 16. Tsagarakis NJ, Sideri A, Makridis P, Triantafyllou A, Stamoulakatou A, Papadogeorgaki E. Age-related prevalence of common upper respiratory pathogens, based on the application of the FilmArray Respiratory panel in a tertiary hospital in Greece. *Medicine (Baltimore)*. 2018;97(22):e10903. <https://doi.org/10.1097/MD.00000000000010903> PMID: 29851817

License, supplementary material and copyright

This is an open-access article distributed under the terms of the Creative Commons Attribution (CC BY 4.0) Licence. You may share and adapt the material, but must give appropriate credit to the source, provide a link to the licence and indicate if changes were made.

Any supplementary material referenced in the article can be found in the online version.

This article is copyright of the authors or their affiliated institutions, 2020.

Do point-of-care tests (POCTs) offer a new paradigm for the management of patients with influenza?

Elizabeth M Dickson^{1,2}, Maria Zambon³, Richard Pebody⁴, Simon de Lusignan⁵, Alex J Elliot⁶, Joanna Ellis³, Angie Lackenby³, Gillian Smith⁶, Jim McMenamin²

1. European Programme for Public Health Microbiology (EUPHEM), European Centre for Disease Prevention and Control (ECDC), Stockholm, Sweden
2. Health Protection Scotland, Public Health Scotland, Glasgow, United Kingdom
3. Reference Microbiology, National Infection Service, Public Health England, London, United Kingdom
4. Centre for Infectious Disease Surveillance and Control, Public Health England, London, United Kingdom
5. Nuffield Department of Primary Care, Oxford, United Kingdom
6. Real-time Syndromic Surveillance Team, Field Service, National Infection Service, Public Health England, Birmingham, United Kingdom

Correspondence: Elizabeth M Dickson (Elizabeth.Dickson2@nhs.net)

Citation style for this article:

Dickson Elizabeth M, Zambon Maria, Pebody Richard, de Lusignan Simon, Elliot Alex J, Ellis Joanna, Lackenby Angie, Smith Gillian, McMenamin Jim. Do point-of-care tests (POCTs) offer a new paradigm for the management of patients with influenza?. *Euro Surveill.* 2020;25(44):pii=1900420. <https://doi.org/10.2807/1560-7917.ES.2020.25.44.1900420>

Article submitted on 27 Jun 2019 / accepted on 22 Jun 2020 / published on 05 Nov 2020

The introduction of point-of-care tests (POCTs) has presented new opportunities for the management of patients presenting to healthcare providers with acute respiratory symptoms. This Perspective article is based on the experiences of national infection teams/those managing acute respiratory infections across the United Kingdom in terms of the challenges and opportunities that this may present for public health. This Perspective article was conceived and written pre-coronavirus disease (COVID-19), however the principles we outline here for influenza can also be translated to COVID-19 and some key points are made throughout the article. The greatest challenge for intergrating POCTs into non-traditional environments is the capture of data and samples for surveillance purposes which provides information for public health action. However, POCTs together with measures outlined in this article, offer a new paradigm for the management and public health surveillance of patients with influenza.

Background

Although point-of-care tests (POCTs) for influenza have been available for 20 years, the implementation of this technology in the United Kingdom (UK) has been slow due to problems with the sensitivity of the tests and how to integrate them into the care pathways. However, with the more recent expansion of the second generation nucleic acid amplification POC technologies, with improved sensitivity to the comparable 'gold standard' PCR laboratory tests, the implementation of these has become more acceptable in clinical settings.

While theoretically POCTs themselves could be performed at home, this application is not within the

scope of this article. The definition of POCTs here is restricted to platforms with the potential to be used within 20 metres of patients and operated by a wide range of staff, including those without a laboratory background. The time to result may vary from 10 to 90 minutes [1]. This article will not cover the various tests that are available or diagnostic accuracies of these compared with the 'gold standard', as other published studies have covered this in depth [2,3].

From the literature, there has been successful use of the POCTs within hospital settings [4,5], paediatric emergency departments [6], community pharmacy settings [7] and outpatient departments [8]. This evidence and (more recent) experiences of others [9] suggest that there now may be an opportunity to change the way patients who present with acute respiratory symptoms are managed and to use POCTs as part of a healthcare pathway. This Perspective article aims to explore the opportunities and challenges of their introduction with a public health focus and provides an opinion on how they can be successfully and thoughtfully implemented into routine healthcare.

Opportunities

Opportunity exists for the evaluation of the use of POCTs in primary care (Table). In the UK, there have already been moves towards the establishment of large primary care practices which could enable this targeted triaging of patients away from hospital. POCTs might influence the care pathways, providing reassurance that antibiotics are not needed and may create an opportunity for potential greater use of antiviral medication earlier in the course of the illness, thus maximising potential therapeutic effectiveness. POCTs may

TABLE

Opportunities and challenges presented by influenza (and multiplex) POCTs for primary and secondary healthcare settings and public health

Settings	Opportunities	Challenges
Primary and secondary healthcare	<ul style="list-style-type: none"> • Enable targeted treatment in a timely manner reducing the risk of spread of influenza and other respiratory pathogens; • Early activation could provide data on vaccine effectiveness; • May assist with reduction of inappropriate antibiotic use in line with AMR strategy; • Allow greater segregation of acutely ill patients from those with chronic problems; • Reduce onward risk of transmission of influenza and other respiratory pathogens to others and reduced associated morbidity and mortality; • Allow release of single rooms through triaging patients in cohorts; • Potentially reduce length of hospital stay and nosocomial transmission of influenza and other respiratory pathogens; • Personalised medicine. 	<ul style="list-style-type: none"> • Only large practices/practice federations likely to engage and need to be cost neutral/cost saving; • Integrating POCT process into clinical workflow (many of the POCT machines require 20 min operation time and GP consultation is 10 min); • Standardising protocols and harmonising technologies across authorities; • Higher demands on the services when patients present with viral illness to general practices or hospital front door; • Potentially increase transmission within community.
Public health	<ul style="list-style-type: none"> • Could increase testing of particular risk groups and generate better intelligence from surveillance; • Quicker time to result helping to inform action; • Improving data availability at community level. 	<ul style="list-style-type: none"> • Capturing of data for surveillance from the laboratory systems; • Impact on surveillance data (proportion positives) and indicators (e.g. Goldstein for MEM) [20]; • Ensuring good quality surveillance data; • Reduced availability of samples for genetic and phenotypic testing in reference (public health) laboratories for analysis of strain distribution, vaccine effectiveness analysis.

AMR: antimicrobial resistance; GP: general practitioner; MEM: moving epidemic method; POCT: point-of-care test.

also enable the more timely use of antivirals in communal settings such as care homes, for example, where a rapid diagnosis of influenza can facilitate effective prescribing of antivirals based upon current National Institute for Health and Care Excellence (NICE) recommendations [10].

In the UK, the management of patients presenting with acute respiratory symptoms varies depending on the healthcare service they are presenting to, and which guideline(s) is/are being followed in each healthcare administrative region. However, the general principles are that (i) the patient will be triaged and, where appropriate, clinically assessed in community primary or secondary care, (ii) a presumptive diagnosis will be given (e.g. influenza-like illness) and if indicated, (iii) samples will be taken to be sent to the laboratory for confirmatory testing. The laboratory performs subtyping, sequencing and tests of antiviral susceptibility on all or subsets of samples and this information can subsequently be used by epidemiologists to follow disease trends, subtype and strain distribution and to provide estimates of vaccine effectiveness.

Dependant on clinical assessment, the patient will be sent home to recover or referred to hospital/admitted

for further investigation and management with or without antibiotics/antivirals. The most obvious opportunity for the use of POCTs would be for more rapid triaging of patients at the hospital front door, putting them into appropriate care pathways thereby reducing the risk of onward transmission and consequent burden within hospitals and on the health service. Once at hospital, POCTs enable patient cohorting in bays of general wards or on designated influenza wards with reduced consequent risk of nosocomial transmission of influenza and improved patient flow [4]. On a larger scale, this could become the normal pathway associated with this group of patients in which POCTs may be cost saving by avoiding nosocomial hospital infections and ensuring appropriate targeted prescribing of antivirals/antibiotics. This latter may be of particular importance in an era of antimicrobial stewardship to minimise antimicrobial resistance. Post hoc analysis of a larger parent study has shown that reducing the turnaround time (TAT) of a test to less than 1.6 hours (such as those achievable by POCT), leads to a higher rate of early hospital discharge compared to longer TAT [5]. The authors surmise that this early discharge suggests that even a modestly more expensive diagnostic strategy is likely to be a cost saving compared to routine clinical care.

Impact on antimicrobial treatment

The same post hoc analysis as mentioned above showed that the reduced TAT led to an earlier discontinuation of antibiotics compared with a longer TAT [5]. A large randomised controlled trial (RCT) in the UK was undertaken over two winter seasons in order to provide an insight into the clinical applicability of POC testing and the impact that it may have on a number of outcomes [6]. Although there was no reduction in the duration of antibiotics given overall, the patients in the POCT group received single doses or reduced courses of antibiotics compared with those in the control group, with a reduced length of stay, improved influenza detection and antiviral use. A more recent RCT from China measured the impact of POCTs for viral and atypical pathogens on intravenous antibiotic treatment duration in hospitalised adults with lower respiratory tract infection and saw a significant reduction in the duration of intravenous antibiotic treatment ($p < 0.001$) when POCTs were used [11].

While POCTs for influenza may increase antiviral treatment, their effect on morbidity and mortality are still being assessed [3].

Personalised medicine

Recently, 46% of antibiotic prescriptions in England that could be mapped to a body system and/or clinical condition, were mapped to respiratory tract and ear, nose, throat infections [12]. Linked to this is a major seasonal variation in acute general practice consultations due to influenza and respiratory syncytial virus infections [13]. As mentioned earlier, some work has been done to assess the impact of POCTs on antibiotic use in secondary care [6,10]. However, to impact on antimicrobial prescribing, allow antibiotic sparing and contribute to reducing antimicrobial resistance, the appropriate and optimised use of antiviral agents needs to be evaluated [14,15]. An additional prospect of having antiviral resistance detection as part of POCTs would provide further rationale for appropriate clinical management of cases at the hospital front door (or earlier).

Vulnerable populations such as children and those aged 65 years or more are also worth considering when contemplating POCTs for personalised medicine. Children tend to have a higher viral load when infected with influenza which is advantageous for a POCT, however, those aged 65 years or more might have a reduced viral load and present late to care which may render the POCT falsely negative.

New potential third generation POCTs are in development which include host biomarkers as targets such as C-reactive protein as a non-specific marker for bacterial infection and the myxovirus-resistance A (MxA) protein, a derivative of interferon type I α/β which is indicative of the presence of a viral infection [16]. These tests offer another way for guiding treatment or stratifying management of presenting patients.

Challenges

A number of assumptions are being made on the quality assurance and quality control of influenza POCTs and it may need to be clarified what their real-life sensitivity and specificity is. A study in a paediatric emergency department in Australia found that although a positive influenza POCT result led to a quicker diagnosis and reduced length of hospital stay, a negative POCT delayed diagnosis. The authors concluded that if influenza is still suspected, then further investigations should be performed to take account of the diagnostic uncertainty surrounding negative POCT results [17]. This can have important cost implications and delay the administration of antivirals, with negative therapeutic consequences.

Capture of data and samples for surveillance

Integration of a new technology into clinical workflows is always challenging and may have unintended consequences. The principal challenge for integrating POCTs into non-traditional environments is the capture of data and samples for surveillance purposes to provide information for public health action. Current influenza surveillance relies upon the collection of data from multiple sources and the monitoring of individual surveillance components to provide a comprehensive record for analysis. The POCT results need to be captured by the Laboratory Information Management Systems (LIMS) to allow the inclusion of these data for surveillance.

Assuming high sensitivity and specificity (confirmed by local quality assurance of the testing systems used) there are residual important questions regarding data capture from POCTs. Do we get the timely results of positive tests and for the negative tests, do we get these results too (and thus may deduce the denominator and percentage positive)? Further, how do we deal with any step change in ascertainment bias from the widespread use of POCTs e.g. impact on the results of the laboratory positive or Goldstein/composite moving epidemic method [18,19] indicators? Finally, if POCTs only give an influenza A or an influenza B result, rather than H1N1, H3N2 subtype, etc. how do we get a representative picture of the circulating viral strains? This latter is particularly important to genetically characterise circulating influenza viruses and their relationship to the seasonal vaccine viruses, antiviral susceptibility and disease severity.

The experiences of a recent Scottish study undertaken during a season with increased pressure on hospital services from influenza A(H3N2) are illustrative of the practical problems for surveillance and short-term prediction based on the number of positive samples and the proportions of patients testing positive [20]. Our own observation is that the emergence of COVID-19 and the response to the global pandemic has led to an increased use of devices in non-standard environments such as schools. This means there will be more difficulties unless there is a concerted effort to assimilate the

POCT results into routine reporting systems, requiring local system support.

Discussion

In order to answer whether POCTs contribute to a new paradigm in the management of patients with acute respiratory symptoms, we first have to look at the opportunities and challenges that this technology presents. One of the main obstacles to evaluate the potential for influenza POCTs used outside the laboratory setting is the lack of published studies on the utilisation of the second generation nucleic acid amplification (PCR-based) technologies in clinical settings. The majority of POCT studies available to support this Perspective article were reporting on antigen tests which are known to have poorer sensitivity compared with the PCR-based tests.

Many aspects of influenza POCTs require to be addressed before implementation can be fully considered. Technological solutions, such as uploading data from POCT machines to cloud databases, or statistical techniques are available to overcome timely positive and negative tests as well as the ascertainment bias from widespread POCT use. The last one, obtaining information at influenza subtype level, may be addressed by a national policy to inform procurement. Consideration of the added benefit to surveillance of subtype data, as already outlined, can be justified in such a policy should the testing system be more expensive than that giving just influenza A or B result.

It has been shown that the potential benefit to patients and the healthcare systems that they present to may be considerable. The study by Youngs et al. suggests reduced number of hospital-acquired laboratory-confirmed influenza cases per day (0.66 cases vs 0.95 cases), a shorter median length of stay (5.5 days vs 7.5 days) and increased antiviral prescribing (80% vs 64.1%) [4]. In addition to this, the authors note that by cohorting the influenza-positive patients, trusts were able to collectively release 779 single rooms for use with other patients. The cost saving and opportunity created for alternative management of the freed resource may be substantial in each hospital particularly when scaled to a national basis. More studies are required on the cost-effectiveness of influenza POCTs in clinical settings in terms of clinical outcome and antibiotic use, as well as the more efficient use of isolation facilities resulting in reduced transmission and ultimately cost savings.

With influenza POCTs it is important to note that there is the further opportunity for taking the testing out of the laboratory and into non-traditional environments, e.g. care homes. There is already documented use of these tests in community pharmacies [7] which was shown to improve access to care as many patients visited outside clinic hours. This could potentially reduce the number of patients visiting out-of-hours, medical centres, emergency departments and hospital admission

thereby reducing the number of exposure risks to other patients. On the back of this, there is an opportunity to investigate smart technologies that some devices coming on to the market now have, allowing results to be fed wirelessly into cloud-based systems for data capture. This may not yet be a feature of influenza POCT devices but is a likely direction of future development. With recent developments following the emergence of SARS-CoV-2, the COVID-19 National Diagnostic Research and Evaluation Platform (CONDOR) is evaluating diagnostics in settings such as GP surgeries, care homes or hospitals, and accelerating how these technologies can be used in the real-world [21].

Given the experiences so far with COVID-19 and the overlap in symptoms with influenza, it is therefore vital that the distinction is made between these two serious infections and that rapid diagnosis is key. The ideal situation for the management of patients with acute respiratory symptoms would be that the POCT is performed early enough in the system to allow the patient to be triaged according to the test result and therefore minimising the subsequent exposure risks and potential for healthcare-associated infections. One of the key developments to come from the COVID-19 pandemic is that there is much greater interest in multiplex for several respiratory pathogens as was detailed by Brendish et al. prior to the pandemic [22]. POCT could therefore become much more informative for dealing with patients with severe respiratory symptoms. Indeed, Brendish et al. have since published on the use of POCT for the detection of COVID-19. Their evidence further supports the implementation of POCT into emergency departments and admission units prior to the next phase of the pandemic [23].

It is likely that POCTs could become part of a larger package for reducing influenza virus and SARS-CoV-2 infection challenges which would also include (i) hand washing policies, (ii) timely administration of antivirals and (iii) proper respiratory precautions when managing symptomatic patients. This should involve close scrutiny of health economic data on impact. The broader societal antimicrobial resistance agenda is also important to consider. The World Health Organization (WHO) global action plan on antimicrobial resistance includes the objectives to strengthen knowledge through surveillance and research, and optimise the use of antimicrobial agents [14]. These are key elements for the management of patients with influenza that we are proposing here.

The opportunities that are presented here with these new technologies are welcome. There will undoubtedly be many technology developments in the coming years to help meet the public health challenges and these need to be proactively adopted, with challenges worked through, to progress to improvement in healthcare delivery in different settings. The concurrent benefits of progress in digital technology and personalised methods should also be considered to bring in wider

societal perspectives. It is our belief that POCTs taken together with the above measures offer a new paradigm for the management and public health surveillance of patients with influenza. In short, the potential of POCTs needs to be recognised and the existing ways of doing things need to be changed; all this will take time and careful handling.

Acknowledgements

We would like to thank all the laboratory staff who responded to the questionnaires and requests for data. We would like to thank Professor Rory Gunson for his expert opinion on the laboratory data.

Conflict of interest

None declared.

Authors' contributions

EMD, MZ, RP, SdeL, GS and JM developed the concept of this Perspective article. EMD and JM wrote the manuscript and all authors discussed and commented on the manuscript.

References

1. Public Health England (PHE). Point of care tests for influenza and other respiratory viruses. London: PHE; 27 Nov 2018. Available from: https://assets.publishing.service.gov.uk/government/uploads/system/uploads/attachment_data/file/846008/Point_of_care_tests_for_influenza_and_other_respiratory_viruses.pdf
2. Merckx J, Wali R, Schiller I, Caya C, Gore GC, Chartrand C, et al. Diagnostic Accuracy of Novel and Traditional Rapid Tests for Influenza Infection Compared With Reverse Transcriptase Polymerase Chain Reaction: A Systematic Review and Meta-analysis. *Ann Intern Med*. 2017;167(6):394-409. <https://doi.org/10.7326/M17-0848> PMID: 28869986
3. Lee JJ, Verbakel JY, Goyder CR, Ananthakumar T, Tan PS, Turner PJ, et al. The Clinical Utility of Point-of-Care Tests for Influenza in Ambulatory Care: A Systematic Review and Meta-analysis. *Clin Infect Dis*. 2019;69(1):24-33. <https://doi.org/10.1093/cid/ciy837> PMID: 30285232
4. Youngs J, Marshall B, Farragher M, Whitney L, Glass S, Pope C, et al. Implementation of influenza point-of-care testing and patient cohorting during a high-incidence season: a retrospective analysis of impact on infection prevention and control and clinical outcomes. *J Hosp Infect*. 2019;101(3):276-84. <https://doi.org/10.1016/j.jhin.2018.11.010> PMID: 30471317
5. Brendish NJ, Malachira AK, Beard KR, Ewings S, Clark TW. Impact of turnaround time on outcome with point-of-care testing for respiratory viruses: a post hoc analysis from a randomised controlled trial. *Eur Respir J*. 2018;52:1800555. 13993003.00555-2018
6. Rogan DT, Kochar MS, Yang S, Quinn JV. Impact of Rapid Molecular Respiratory Virus Testing on Real-Time Decision Making in a Pediatric Emergency Department. *J Mol Diagn*. 2017;19(3):460-7. <https://doi.org/10.1016/j.jmoldx.2017.01.009> PMID: 28341587
7. Klepser DG, Klepser ME, Smith JK, Dering-Anderson AM, Nelson M, Pohlen LE. Utilization of influenza and streptococcal pharyngitis point-of-care testing in the community pharmacy practice setting. *Res Social Adm Pharm*. 2018;14(4):356-9. <https://doi.org/10.1016/j.sapharm.2017.04.012> PMID: 28479019
8. You JHS, Tam LP, Lee NLS. Cost-effectiveness of molecular point-of-care testing for influenza viruses in elderly patients at ambulatory care setting. *PLoS One*. 2017;12(7):e0182091. <https://doi.org/10.1371/journal.pone.0182091> PMID: 28750092
9. Evans C, Raza M, Zaidi SK. Influenza point of care testing: a Sheffield Teaching Hospital experience. *Royal College of Pathologists The Bulletin*. 2018; (184):241-3.
10. National Institute for Health and Care Excellence (NICE). Oseltamivir, amantadine (review) and zanamivir for the prophylaxis of influenza. London: NICE; 24 Sep 2008. Available from: <https://www.nice.org.uk/guidance/ta158/resources/oseltamivir-amantadine-review-and-zanamivir-for-the-prophylaxis-of-influenza-pdf-82598321461957>
11. Shengchen D, Gu X, Fan G, Sun R, Wang Y, Yu D, et al. Evaluation of a molecular point-of-care testing for viral and atypical pathogens on intravenous antibiotic duration in hospitalized adults with lower respiratory tract infection: a randomized clinical trial. *Clin Microbiol Infect*. 2019;25(11):1415-21. <https://doi.org/10.1016/j.cmi.2019.06.012> PMID: 31229593
12. Dolk FCK, Pouwels KB, Smith DRM, Robotham JV, Smieszek T. Antibiotics in primary care in England: which antibiotics are prescribed and for which conditions? *J Antimicrob Chemother*. 2018;73(suppl_2):ii2-10. PMID: 29490062
13. Bou-Antoun S, Costelloe C, Honeyford K, Mazidi M, Hayhoe BWJ, Holmes A, et al. Age-related decline in antibiotic prescribing for uncomplicated respiratory tract infections in primary care in England following the introduction of a national financial incentive (the Quality Premium) for health commissioners to reduce use of antibiotics in the community: an interrupted time series analysis. *J Antimicrob Chemother*. 2018;73(10):2883-92. <https://doi.org/10.1093/jac/dky237> PMID: 29955785
14. World Health Organization (WHO). Global Action Plan on Antimicrobial Resistance. Geneva: WHO; 2015. Available from: https://apps.who.int/iris/bitstream/handle/10665/193736/9789241509763_eng.pdf?sequence=1
15. Department of Health. Department for Environment Food and Rural Affairs. UK Five Year Antimicrobial Resistance Strategy 2013 to 2018. London: Department of Health; 2013. Available from: https://assets.publishing.service.gov.uk/government/uploads/system/uploads/attachment_data/file/244058/20130902_UK_5_year_AMR_strategy.pdf
16. Shapiro NI, Self WH, Rosen J, Sharp SC, Filbin MR, Hou PC, et al. A prospective, multi-centre US clinical trial to determine accuracy of FebriDx point-of-care testing for acute upper respiratory infections with and without a confirmed fever. *Ann Med*. 2018;50(5):420-9. <https://doi.org/10.1080/07853890.2018.1474002> PMID: 29775092
17. Li-Kim-Moy J, Dastouri F, Rashid H, Khandaker G, Kesson A, McCaskill M, et al. Utility of early influenza diagnosis through point-of-care testing in children presenting to an emergency department. *J Paediatr Child Health*. 2016;52(4):422-9. <https://doi.org/10.1111/jpc.13092> PMID: 27145506
18. Murray JLK, Marques DFP, Cameron RL, Potts A, Bishop J, von Wissmann B, et al. Moving epidemic method (MEM) applied to virology data as a novel real time tool to predict peak in seasonal influenza healthcare utilisation. The Scottish experience of the 2017/18 season to date. *Euro Surveill*. 2018;23(11):11-8. <https://doi.org/10.2807/1560-7917.ES.2018.23.11.18-00079> PMID: 29560854
19. Vega T, Lozano JE, Meerhoff T, Snacken R, Mott J, Ortiz de Lejarazu R, et al. Influenza surveillance in Europe: establishing epidemic thresholds by the moving epidemic method. *Influenza Other Respir Viruses*. 2013;7(4):546-58. <https://doi.org/10.1111/j.1750-2659.2012.00422.x> PMID: 22897919
20. Dickson EM, Marques DFP, Currie S, Little A, Mangin K, Coyne M, et al. The experience of point of care testing for influenza in Scotland in 2017/18 and 2018/19 - no gain without pain. *Euro Surveill*. 2020;25(44):1900419. <https://doi.org/10.2807/1560-7917.ES.2020.25.44.1900419>
21. COVID-19 National Diagnostic Research and Evaluation Platform (CONDOR). A single route to evaluate new diagnostic tests for COVID-19. Oxford: University of Oxford; 2020. Available from: <https://www.condor-platform.org/>
22. Brendish NJ, Mills S, Ewings S, Clark TW. Impact of point-of-care testing for respiratory viruses on antibiotic use in adults with exacerbation of airways disease. *J Infect*. 2019;79(4):357-62. <https://doi.org/10.1016/j.jinf.2019.06.010> PMID: 31233809
23. Brendish NJ, Poole S, Naidu VV, Mansbridge CT, Norton NJ, Wheeler H, et al. Clinical impact of molecular point-of-care testing for suspected COVID-19 in hospital (COV-19POC): a prospective, interventional, non-randomised, controlled study. *Lancet Respir Med*. 2020; S2213-2600(20)30454-9. PMID: 33038974

License, supplementary material and copyright

This is an open-access article distributed under the terms of the Creative Commons Attribution (CC BY 4.0) Licence. You may share and adapt the material, but must give appropriate credit to the source, provide a link to the licence and indicate if changes were made.

Any supplementary material referenced in the article can be found in the online version.

This article is copyright of the authors or their affiliated institutions, 2020.

National bulletins

ALBANIA

Health bulletin
Institute of Public Health
Quarterly, online. In English.
<http://www.ishp.gov.al/rreth-buletinit-te-institutit-te-shendetit-publik>

AUSTRIA

Public Health Newsletter - Mitteilungen für das österreichische Gesundheitswesen
Bundesministerium für Gesundheit/ Ministry of Health, Vienna
Published monthly, via email. In German.
Link to past editions: http://www.bmg.gv.at/home/Schwerpunkte/Krankheiten/Newsletter_Public_Health
Link to registration: <http://bmg.gv.at/home/Service/Newsletter>

BELGIUM

Vlaams Infectieziektebulletin
Department of Infectious Diseases Control, Flanders
Bimonthly, online. In Dutch, with summaries in English.
<http://www.infectieziektebulletin.be>
Newsflash Infectious Diseases
Scientific Institute of Public Health, Brussels
Monthly, online. In French.
<https://epidemiowiv-isp.be/ID/Pages/flashes.aspx?lcid=1036>
Monthly, online. In Dutch.
<https://epidemiowiv-isp.be/ID/Pages/flashes.aspx?lcid=1043>

BOSNIA AND HERZEGOVINA

Institute for Public Health of the Federation of Bosnia and Herzegovina
Monthly bulletin.
<http://www.zzjfbih.ba/epidemioloski-bilteni/>
Institute of Public Health of the Republic of Srpska
<http://www.phi.rs.ba/>

BULGARIA

Bulletin of the National Centre of Infectious and Parasitic Diseases, Sofia
Print version. In Bulgarian.
<http://www.ncipd.org/>

CYPRUS

Newsletter of the Network for Surveillance and Control of Communicable Diseases in Cyprus
Medical and Public Health Services, Ministry of Health, Nicosia
Biannual, print and online. In Greek.
<http://www.moh.gov.cy>

CZECH REPUBLIC

Zprávy CEM (The Bulletin of Centre for Epidemiology and Microbiology)
Státní zdravotní ústav (National Institute of Public Health), Prague
Monthly, print and online (6 months after print version). In Czech, with abstracts in English.
<http://www.szu.cz/publications-and-products/zpravy-epidemiologie-a-mikrobiologie>
Infekce v ČR - EPIDAT (Notifications of infectious diseases in the Czech Republic)
Státní zdravotní ústav (National Institute of Public Health), Prague
<http://www.szu.cz/publikace/data/infekce-v-cr>

DENMARK

EPI-NEWS
Department of Infectious Disease Epidemiology and Prevention, Statens Serum Institut, Copenhagen.
Weekly, via email subscription and online. In Danish and English (one week later).
<https://en.ssi.dk/news/epi-news>

ESTONIA

Health Board, Tallinn
Estonian Communicable Disease Bulletin
Monthly, online. In English.
<https://www.terviseamet.ee/en/communicable-diseases/communicable-disease-bulletins>

FINLAND

National Institute for Health and Welfare (THL), Department of Health Security
In Finnish.
<https://thl.fi/fi/web/infektioaudit>

FRANCE

Bulletin épidémiologique hebdomadaire (BEH)
Santé publique France, Saint-Maurice
Bimonthly, online. In French, with abstracts in English.
<https://www.santepubliquefrance.fr/revues/beh/bulletin-epidemiologique-hebdomadaire>

GERMANY

Epidemiologisches Bulletin
Robert Koch-Institut, Berlin
Weekly, print and online. In German.
www.rki.de/epidbull

GREECE

National Public Health Organization
Updates, online. In Greek.
<https://eody.gov.gr/e-enimerosi-ioynios-2019/>

HUNGARY

Epinfo (az Országos Epidemiológiai Központ epidemiológiai információs hetilapja)
National Center For Epidemiology, Budapest
Weekly, online. In Hungarian.
<http://www.oek.hu/oek.web?to=839&nid=41&pid=7&lang=hun>

ICELAND

EPI-ICE
Landlknisembtti, Directorate Of Health, Seltjarnarnes
Monthly to quarterly, online. In Icelandic and English.
<https://www.landlaeknir.is/english/epi-ice/>

IRELAND

EPI-INSIGHT
Health Protection Surveillance Centre, Dublin
Monthly, online. In English.
<http://www.hpsc.ie/epi-insight/>

ITALY

Notiziario dell'Istituto Superiore di Sanita
Istituto Superiore di Sanita, Reparto di Malattie Infettive, Rome
Monthly, online. In Italian.
<http://www.iss.it/publ/noti/index.php?lang=1&tipo=4>
Bolletino Epidemiologico Nazionale (BEN)
Istituto Superiore di Sanita, Reparto di Malattie Infettive, Rome
Monthly, online. In Italian.
<http://www.epicentro.iss.it/ben>

LATVIA

Epidemioloģijas Biļeteni
Sabiedrības veselības aģentūra
Public Health Agency, Riga
Online. In Latvian.
<http://www.sva.lv/epidemioloģija/bileteni>

LITHUANIA

Epidemioloģijos žinios
Užkrečiamųjų ligų profilaktikos ir kontrolės centras
Center for Communicable Disease Prevention and Control, Vilnius
Online. In Lithuanian.
<http://www.ulac.lt/index.php?pl=26>

MALTA

IDCU notifiable infectious disease tables
Infectious Disease Prevention and Control Unit, Department of Health
Promotion and Disease Prevention
Monthly and annually, online. In English.
https://ehealth.gov.mt/HealthPortal/public_health/idcu/library/library_menu.aspx

NETHERLANDS

Infectieziekten Bulletin
Rijksinstituut voor Volksgezondheid en Milieu
National Institute of Public Health and the Environment, Bilthoven
Monthly, online. In Dutch.
<http://www.infectieziektenbulletin.nl>

NORWAY

Nytt om smittevern
Folkehelseinstituttet, Oslo
Online. In Norwegian.
<http://www.fhi.no/tema/smittevern-og-overvaaking>

POLAND

Meldunki o zachorowaniach na choroby zakaźne i zatruciach w Polsce
Państwowy Zakład Higieny
National Institute of Hygiene, Warsaw
Fortnightly, online. In Polish and English.
http://www.pzh.gov.pl/epimeld/index_p.html#o1

PORTUGAL

Portugal Saúde em Números / Health by Numbers Portugal
Ministério da Saúde,
Direcção-Geral da Saúde, Lisbon
Digital only. In Portuguese and English.
<https://www.dgs.pt/publicacoes/revista-cientifica-da-dgs.aspx>

ROMANIA

Centrul pentru Prevenirea și Controlul Bolilor Transmisibile, National Centre
of Communicable Diseases Prevention and Control, Institute of Public Health,
Bucharest
Print only. In Romanian.
<http://www.cnscbt.ro/>

SLOVENIA

eNboz - Elektronske novice s področja nalezljivih bolezní in okoljskega
zdravja /
Inštitut za varovanje zdravja, Center za nalezljive bolezni
Institute of Public Health, Center for Infectious Diseases, Ljubljana
Monthly, online. In Slovene.
<http://www.nijz.si/sl/e-nboz-o/>

SPAIN

Boletín Epidemiológico Semanal
Centro Nacional de Epidemiología, Instituto de Salud Carlos III, Madrid
Fortnightly, print and online. In Spanish.
<http://revista.isciii.es/index.php/bes/issue/current>

SWEDEN

Nyheter och press
Folkhälsomyndigheten, Stockholm
Weekly, online. In Swedish.
<https://www.folkhalsomyndigheten.se/nyheter-och-press/>

EUROPEAN UNION

Europa is the official portal of the European Union. It provides up-to-date
coverage of main events and information on activities and institutions of the
European Union.
<http://europa.eu>

EUROPEAN COMMISSION - PUBLIC HEALTH

The website of the European Commission Directorate General for Health and
Consumer Protection (DG SANCO).
<http://ec.europa.eu/health/>

HEALTH-EU PORTAL

The Health-EU Portal (the official public health portal of the European Union)
includes a wide range of information and data on health-related issues and
activities at both European and international levels.
<http://ec.europa.eu/health-eu/>

EUROPEAN CENTRE FOR DISEASE PREVENTION AND CONTROL

European Centre for Disease Prevention and Control (ECDC)
The European Centre for Disease Prevention and Control (ECDC) was
established in 2005. It is an EU agency that aims to strengthen Europe's
defences against infectious diseases. It is located in Stockholm, Sweden.
<http://www.ecdc.europa.eu>

All material in *Eurosurveillance* is in the public domain and may be used and reprinted without special permission. However, the source should be cited properly and we suggest adding a link to the exact page on the *Eurosurveillance* website.

Articles published in *Eurosurveillance* are indexed in PubMed/Medline.

Eurosurveillance print editions are selections of short and long articles previously published on the *Eurosurveillance* website. The full listing of all *Eurosurveillance* articles can be found in the Archives section of the website.

The opinions expressed by authors contributing to *Eurosurveillance* do not necessarily reflect the opinions of the European Centre for Disease Prevention and Control (ECDC) or the editorial team or the institutions with which the authors are affiliated. Neither ECDC nor any person acting on behalf of ECDC is responsible for the use that might be made of the information in this journal. The information provided in *Eurosurveillance* is designed to support, not replace, the relationship that exists between a patient/reader and his/her physician.



Visit our website at www.eurosurveillance.org

Eurosurveillance print editions are selections of short and long articles previously published on the *Eurosurveillance* website.

All the articles in this issue are available online. Individual articles and whole issues can be downloaded in PDF format.

The website archives all articles since 1995, and offers a search facility.

To receive *Eurosurveillance's* free electronic releases and e-alerts by email, please subscribe on our website.

Papers published in the former monthly release are indexed in MEDLINE since January 2001, and papers published in the weekly release from January 2005 (with the exception of short, non-scientific notices) are also indexed in MEDLINE.

The Index Medicus abbreviation for *Eurosurveillance* is Euro Surveill.

Follow us on Twitter : #eurosurveillanc

Contributions to *Eurosurveillance* are welcomed. Full instructions for authors are available on our website: www.eurosurveillance.org

Paper TQ-AD-20-002-EN-C ISSN 1025-496X

PDF TQ-AD-20-002-EN-N ISSN 1560-7917

Graphic design © ECDC, Stockholm



Publications Office