

ETSI TS 138 101-1 V15.3.0 (2018-10)



**5G;
NR;
User Equipment (UE) radio transmission and reception;
Part 1: Range 1 Standalone
(3GPP TS 38.101-1 version 15.3.0 Release 15)**



Reference

RTS/TSGR-0438101-1v30

Keywords

5G

ETSI

650 Route des Lucioles
F-06921 Sophia Antipolis Cedex - FRANCE

Tel.: +33 4 92 94 42 00 Fax: +33 4 93 65 47 16

Siret N° 348 623 562 00017 - NAF 742 C
Association à but non lucratif enregistrée à la
Sous-Préfecture de Grasse (06) N° 7803/88

Important notice

The present document can be downloaded from:

<http://www.etsi.org/standards-search>

The present document may be made available in electronic versions and/or in print. The content of any electronic and/or print versions of the present document shall not be modified without the prior written authorization of ETSI. In case of any existing or perceived difference in contents between such versions and/or in print, the only prevailing document is the print of the Portable Document Format (PDF) version kept on a specific network drive within ETSI Secretariat.

Users of the present document should be aware that the document may be subject to revision or change of status.

Information on the current status of this and other ETSI documents is available at

<https://portal.etsi.org/TB/ETSIDeliverableStatus.aspx>

If you find errors in the present document, please send your comment to one of the following services:

<https://portal.etsi.org/People/CommiteeSupportStaff.aspx>

Copyright Notification

No part may be reproduced or utilized in any form or by any means, electronic or mechanical, including photocopying and microfilm except as authorized by written permission of ETSI.

The content of the PDF version shall not be modified without the written authorization of ETSI.

The copyright and the foregoing restriction extend to reproduction in all media.

© ETSI 2018.

All rights reserved.

DECT™, **PLUGTESTS™**, **UMTS™** and the ETSI logo are trademarks of ETSI registered for the benefit of its Members.

3GPP™ and **LTE™** are trademarks of ETSI registered for the benefit of its Members and of the 3GPP Organizational Partners.

oneM2M logo is protected for the benefit of its Members.

GSM® and the GSM logo are trademarks registered and owned by the GSM Association.

Intellectual Property Rights

Essential patents

IPRs essential or potentially essential to normative deliverables may have been declared to ETSI. The information pertaining to these essential IPRs, if any, is publicly available for **ETSI members and non-members**, and can be found in ETSI SR 000 314: *"Intellectual Property Rights (IPRs); Essential, or potentially Essential, IPRs notified to ETSI in respect of ETSI standards"*, which is available from the ETSI Secretariat. Latest updates are available on the ETSI Web server (<https://ipr.etsi.org/>).

Pursuant to the ETSI IPR Policy, no investigation, including IPR searches, has been carried out by ETSI. No guarantee can be given as to the existence of other IPRs not referenced in ETSI SR 000 314 (or the updates on the ETSI Web server) which are, or may be, or may become, essential to the present document.

Trademarks

The present document may include trademarks and/or tradenames which are asserted and/or registered by their owners. ETSI claims no ownership of these except for any which are indicated as being the property of ETSI, and conveys no right to use or reproduce any trademark and/or tradename. Mention of those trademarks in the present document does not constitute an endorsement by ETSI of products, services or organizations associated with those trademarks.

Foreword

This Technical Specification (TS) has been produced by ETSI 3rd Generation Partnership Project (3GPP).

The present document may refer to technical specifications or reports using their 3GPP identities, UMTS identities or GSM identities. These should be interpreted as being references to the corresponding ETSI deliverables.

The cross reference between GSM, UMTS, 3GPP and ETSI identities can be found under <http://webapp.etsi.org/key/queryform.asp>.

Modal verbs terminology

In the present document "**shall**", "**shall not**", "**should**", "**should not**", "**may**", "**need not**", "**will**", "**will not**", "**can**" and "**cannot**" are to be interpreted as described in clause 3.2 of the [ETSI Drafting Rules](#) (Verbal forms for the expression of provisions).

"**must**" and "**must not**" are **NOT** allowed in ETSI deliverables except when used in direct citation.

Contents

Intellectual Property Rights	2
Foreword.....	2
Modal verbs terminology.....	2
Foreword.....	10
1 Scope	11
2 References	11
3 Definitions, symbols and abbreviations	11
3.1 Definitions	11
3.2 Symbols.....	12
3.3 Abbreviations	14
4 General	15
4.1 Relationship between minimum requirements and test requirements	15
4.2 Applicability of minimum requirements	15
4.3 Specification suffix information.....	15
5 Operating bands and channel arrangement.....	16
5.1 General	16
5.2 Operating bands.....	16
5.2A Operating bands for CA	17
5.2A.1 Intra-band CA	17
5.2A.2 Inter-band CA	17
5.2B Operating bands for DC	18
5.2B.1 General.....	18
5.2C Operating band combination for SUL	18
5.3 UE channel bandwidth	19
5.3.1 General.....	19
5.3.2 Maximum transmission bandwidth configuration	19
5.3.3 Minimum guardband and transmission bandwidth configuration.....	19
5.3.4 RB alignment with different numerologies.....	20
5.3.5 UE channel bandwidth per operating band	21
5.3.6 Asymmetric channel bandwidths	24
5.3A UE channel bandwidth for CA	25
5.3A.1 General.....	25
5.3A.2 Maximum transmission bandwidth configuration for CA	25
5.3A.3 Minimum guardband and transmission bandwidth configuration for CA	25
5.3A.4 RB alignment with different numerologies for CA.....	27
5.3A.5 UE channel bandwidth per operating band for CA.....	27
5.4 Channel arrangement.....	27
5.4.1 Channel spacing.....	27
5.4.1.1 Channel spacing for adjacent NR carriers	27
5.4.2 Channel raster	28
5.4.2.1 NR-ARFCN and channel raster.....	28
5.4.2.2 Channel raster to resource element mapping.....	28
5.4.2.3 Channel raster entries for each operating band	28
5.4.3 Synchronization raster	29
5.4.3.1 Synchronization raster and numbering.....	29
5.4.3.3 Synchronization raster entries for each operating band.....	30
5.4A Channel arrangement for CA.....	32
5.4A.1 Channel spacing for CA.....	32
5.4A.2 Channel raster for CA.....	32
5.4A.3 Synchronization raster for CA	32
5.4A.4 Tx-Rx frequency separation for CA.....	32
5.5 Configurations	33
5.5A Configurations for CA.....	33
5.5A.1 Configurations for intra-band contiguous CA.....	33

5.5A.2	Configurations for intra-band non-contiguous CA	35
5.5A.3	Configurations for inter-band CA	36
5.5B	Configurations for DC	38
5.5C	Configurations for SUL	38
6	Transmitter characteristics	39
6.1	General	39
6.2	Transmitter power	39
6.2.1	UE maximum output power	39
6.2.2	UE maximum output power reduction	40
6.2.3	UE additional maximum output power reduction	41
6.2.3.1	General	41
6.2.3.2	A-MPR for NS_04	44
6.2.3.3	A-MPR for NS_10	46
6.2.3.4	A-MPR for NS_05	47
6.2.3.5	A-MPR for NS_40	48
6.2.3.6	A-MPR for NS_08	48
6.2.3.7	A-MPR for NS_03	50
6.2.3.8	A-MPR for NS_37	50
6.2.3.9	A-MPR for NS_38	51
6.2.3.10	A-MPR for NS_39	51
6.2.3.11	A-MPR for NS_41	52
6.2.3.12	A-MPR for NS_42	52
6.2.4	Configured transmitted power	53
6.2A	Transmitter power for CA	54
6.2A.1	UE maximum output power for CA	54
6.2A.1.1	UE maximum output power for Intra-band contiguous CA	54
6.2A.1.1	UE maximum output power for Intra-band non-contiguous CA	54
6.2A.1.3	UE maximum output power for Inter-band CA	54
6.2A.2	UE maximum output power reduction for CA	55
6.2A.2.1	UE maximum output power reduction for Intra-band contiguous CA	55
6.2A.2.2	UE maximum output power reduction for Intra-band non-contiguous CA	55
6.2A.2.3	UE maximum output power reduction for Inter-band CA	55
6.2A.3	UE additional maximum output power reduction for CA	55
6.2A.3.1.1	UE additional maximum output power reduction for Intra-band contiguous CA	55
6.2A.3.1.2	UE additional maximum output power reduction for Intra-band non-contiguous CA	55
6.2A.3.1.3	UE additional maximum output power reduction for Inter-band CA	55
6.2A.4	Configured output power for CA	55
6.2A.4.1	Configured transmitted power level	55
6.2A.4.1.1	Configured transmitted power for Intra-band contiguous CA	55
6.2A.4.1.2	Configured transmitted power for Intra-band non-contiguous CA	55
6.2A.4.1.3	Configured transmitted power for Inter-band CA	55
6.2A.4.2	$\Delta T_{IB,c}$ for CA	57
6.2A.4.2.1	$\Delta T_{IB,c}$ for Intra-band contiguous CA	57
6.2A.4.2.2	$\Delta T_{IB,c}$ for Intra-band non-contiguous CA	57
6.2A.4.2.3	$\Delta T_{IB,c}$ for Inter-band CA	57
6.2B	Transmitter power for DC	58
6.2C	Transmitter power for SUL	58
6.2C.1	Configured transmitted power for SUL	58
6.2C.2	$\Delta T_{IB,c}$	58
6.2D	Transmitter power for UL-MIMO	59
6.2D.1	UE maximum output power for UL-MIMO	59
6.2D.2	UE maximum output power reduction for UL-MIMO	59
6.2D.3	UE additional maximum output power reduction for UL-MIMO	59
6.2D.4	Configured transmitted power for UL-MIMO	59
6.3	Output power dynamics	60
6.3.1	Minimum output power	60
6.3.2	Transmit OFF power	61
6.3.3	Transmit ON/OFF time mask	61
6.3.3.1	General	61
6.3.3.2	General ON/OFF time mask	62
6.3.3.3	Transmit power time mask for slot and short or subslot boundaries	62

6.3.3.4	PRACH time mask.....	62
6.3.3.5	Void.....	63
6.3.3.6	SRS time mask.....	63
6.3.3.7	PUSCH-PUCCH and PUSCH-SRS time masks.....	65
6.3.3.8	Transmit power time mask for consecutive slot or long subslot transmission and short subslot transmission boundaries.....	65
6.3.3.9	Transmit power time mask for consecutive short subslot transmissions boundaries.....	65
6.3.4	Power control.....	66
6.3.4.1	General.....	66
6.3.4.2	Absolute power tolerance.....	66
6.3.4.3	Relative power tolerance.....	66
6.3.4.4	Aggregate power tolerance.....	67
6.3A	Output power dynamics for CA.....	67
6.3A.1	Minimum output power for CA.....	67
6.3A.1.1	Minimum output power for intra-band contiguous CA.....	67
6.3A.1.2	Minimum output power for intra-band non-contiguous CA.....	67
6.3A.1.3	Minimum output power for inter-band CA.....	67
6.3A.2	Transmit OFF power for CA.....	67
6.3A.2.1	Transmit OFF power for intra-band contiguous CA.....	67
6.3A.2.2	Transmit OFF power for intra-band non-contiguous CA.....	67
6.3A.2.3	Transmit OFF power for inter-band CA.....	67
6.3A.3	Transmit ON/OFF time mask for CA.....	68
6.3A.3.1	Transmit ON/OFF time mask for intra-band contiguous CA.....	68
6.3A.3.2	Transmit ON/OFF time mask for intra-band non-contiguous CA.....	68
6.3A.3.3	Transmit ON/OFF time mask for inter-band CA.....	68
6.3A.4	Power control for CA.....	68
6.3A.4.1	Power control for intra-band contiguous CA.....	68
6.3A.4.2	Power control for intra-band non-contiguous CA.....	68
6.3A.4.3	Power control for inter-band CA.....	68
6.3D	Output power dynamics for UL-MIMO.....	68
6.3D.1	Minimum output power for UL-MIMO.....	68
6.3D.2	Transmit OFF power for UL-MIMO.....	68
6.3D.3	Transmit ON/OFF time mask for UL-MIMO.....	68
6.3D.4	Power control for UL-MIMO.....	68
6.4	Transmit signal quality.....	69
6.4.1	Frequency error.....	69
6.4.2	Transmit modulation quality.....	69
6.4.2.1	Error Vector Magnitude.....	69
6.4.2.2	Carrier leakage.....	70
6.4.2.3	In-band emissions.....	70
6.4.2.4	EVM equalizer spectrum flatness.....	71
6.4.2.4.1	Requirements for pi/2 BPSK modulation.....	72
6.4A	Transmit signal quality for CA.....	73
6.4A.1	Frequency error for CA.....	73
6.4A.1.1	Frequency error for intra-band contiguous CA.....	73
6.4A.1.2	Frequency error for intra-band non-contiguous CA.....	73
6.4A.1.3	Frequency error for inter-band CA.....	73
6.4A.2	Transmit modulation quality for CA.....	73
6.4A.2.1	Frequency error for intra-band contiguous CA.....	73
6.4A.2.2	Frequency error for intra-band non-contiguous CA.....	73
6.4A.2.3	Frequency error for inter-band CA.....	73
6.4D	Transmit signal quality for UL-MIMO.....	74
6.4D.1	Frequency error for UL-MIMO.....	74
6.4D.2	Transmit modulation quality for UL-MIMO.....	74
6.4D.3	Time alignment error for UL-MIMO.....	74
6.4D.4	Requirements for coherent UL MIMO.....	75
6.5	Output RF spectrum emissions.....	75
6.5.1	Occupied bandwidth.....	75
6.5.2	Out of band emission.....	75
6.5.2.1	General.....	75
6.5.2.2	Spectrum emission mask.....	76
6.5.2.3	Additional spectrum emission mask.....	76

6.5.2.3.1	Requirements for network signalled value "NS_35"	76
6.5.2.3.2	Requirements for network signalled value "NS_04"	77
6.5.2.3.3	Requirements for network signalled value "NS_03"	78
6.5.2.3.4	Requirements for network signalled value "NS_06"	78
6.5.2.3.5	Requirements for network signalled value "NS_40"	79
6.5.2.3.6	Requirements for network signalled value "NS_41"	79
6.5.2.3.7	Requirements for network signalled value "NS_42"	79
6.5.2.4	Adjacent channel leakage ratio	80
6.5.2.4.1	NR ACLR	80
6.5.2.4.2	UTRA ACLR	80
6.5.3	Spurious emissions	81
6.5.3.1	General spurious emissions	81
6.5.3.2	Spurious emissions for UE co-existence	82
6.5.3.3	Additional spurious emissions	88
6.5.3.3.1	Requirement for network signalled value "NS_04"	88
6.5.3.3.3	Requirement for network signalled value "NS_18"	89
6.5.3.3.5	Requirement for network signalled value "NS_08"	89
6.5.3.3.6	Requirement for network signalled value "NS_37"	89
6.5.3.3.7	Requirement for network signalled value "NS_38"	90
6.5.3.3.8	Requirement for network signalled value "NS_39"	90
6.5.4	Transmit intermodulation	90
6.5A	Output RF spectrum emissions for CA	91
6.5A.1	Occupied bandwidth for CA	91
6.5A.1.1	Occupied bandwidth for Intra-band contiguous CA	91
6.5A.1.2	Occupied bandwidth for Intra-band non-contiguous CA	91
6.5A.1.3	Occupied bandwidth for Inter-band CA	91
6.5A.2	Out of band emission for CA	91
6.5A.2.1	General	91
6.5A.2.2	Spectrum emission mask	91
6.5A.2.2.1	Spectrum emission mask for Intra-band contiguous CA	91
6.5A.2.2.2	Spectrum emission mask for Intra-band non-contiguous CA	91
6.5A.2.2.3	Spectrum emission mask for Inter-band CA	91
6.5A.2.3	Additional spectrum emission mask	92
6.5A.2.3.1	Additional spectrum emission mask for Intra-band contiguous CA	92
6.5A.2.3.2	Additional spectrum emission mask for Intra-band non-contiguous CA	92
6.5A.2.3.3	Additional spectrum emission mask for Inter-band CA	92
6.5A.2.4	Adjacent channel leakage ratio	92
6.5A.2.4.1	NR ACLR	92
6.5A.2.4.1.1	NR ACLR for Intra-band contiguous CA	92
6.5A.2.4.1.2	NR ACLR for Intra-band non-contiguous CA	92
6.5A.2.4.1.3	NR ACLR for Inter-band CA	92
6.5A.2.4.2	UTRA ACLR	92
6.5A.2.4.2.1	UTRA ACLR for Intra-band contiguous CA	92
6.5A.2.4.2.2	UTRA ACLR for Intra-band non-contiguous CA	92
6.5A.2.4.2.3	UTRA ACLR for Inter-band CA	92
6.5A.3	Spurious emission for CA	92
6.5A.3.1	General spurious emissions	92
6.5A.3.2	Spurious emissions for UE co-existence	92
6.5A.3.2.1	Spurious emissions for UE co-existence for Intra-band contiguous CA	92
6.5A.3.2.2	Spurious emissions for UE co-existence for Intra-band non-contiguous CA	92
6.5A.3.2.3	Spurious emissions for UE co-existence for Inter-band CA	92
6.5A.4	Transmit intermodulation for CA	93
6.5A.3.2.1	Transmit intermodulation for Intra-band contiguous CA	93
6.5A.3.2.2	Transmit intermodulation for Intra-band non-contiguous CA	93
6.5A.3.2.3	Transmit intermodulation for Inter-band CA	93
6.5D	Output RF spectrum emissions for UL-MIMO	93
6.5D.1	Occupied bandwidth for UL-MIMO	93
6.5D.2	Out of band emission for UL-MIMO	94
6.5D.3	Spurious emission for UL-MIMO	94
6.5D.4	Transmit intermodulation for UL-MIMO	94
7	Receiver characteristics	95

7.1	General	95
7.2	Diversity characteristics	95
7.3	Reference sensitivity	95
7.3.1	General.....	95
7.3.2	Reference sensitivity power level	95
7.3.3	$\Delta R_{IB,c}$	102
7.3A	Reference sensitivity for CA	102
7.3A.1	General.....	102
7.3A.2	Reference sensitivity power level for CA	102
7.3A.2.1	Reference sensitivity power level for Intra-band contiguous CA	102
7.3A.2.2	Reference sensitivity power level for Intra-band non-contiguous CA	102
7.3A.2.3	Reference sensitivity power level for Inter-band CA	102
7.3A.3	$\Delta R_{IB,c}$ for CA	102
7.3A.3.1	General	102
7.3A.3.2	$\Delta R_{IB,c}$ for Inter-band CA.....	102
7.3A.3.2.1	$\Delta R_{IB,c}$ for two bands	103
7.3A.3.2.2	$\Delta R_{IB,c}$ for three bands	103
7.3A.4	Reference sensitivity exceptions due to UL harmonic interference for CA.....	103
7.3A.5	Reference sensitivity exceptions due to intermodulation interference due to 2UL CA.....	105
7.3B	Reference sensitivity for DC	106
7.3C	Reference sensitivity for SUL	106
7.3C.1	General.....	106
7.3C.2	Reference sensitivity power level for SUL	106
7.3C.3	$\Delta R_{IB,c}$ for SUL	107
7.3C.3.1	General	107
7.3C.3.2	SUL band combination	108
7.3C.3.2.1	$\Delta R_{IB,c}$ for two bands	108
7.3D	Reference sensitivity for UL-MIMO.....	108
7.4	Maximum input level	108
7.4A	Maximum input level for CA	108
7.4A.1	Maximum input level for Intra-band contiguous CA.....	108
7.4A.2	Maximum input level for Intra-band non-contiguous CA	109
7.4A.3	Maximum input level for Inter-band CA	109
7.4D	Maximum input level for UL-MIMO.....	109
7.5	Adjacent channel selectivity.....	109
7.5A	Adjacent channel selectivity for CA.....	113
7.5A.1	Adjacent channel selectivity for Intra-band contiguous CA	113
7.5A.2	Adjacent channel selectivity Intra-band non-contiguous CA	114
7.5A.3	Adjacent channel selectivity Inter-band CA	114
7.5D	Adjacent channel selectivity for UL-MIMO	114
7.6	Blocking characteristics	114
7.6.1	General.....	114
7.6.2	In-band blocking.....	115
7.6.3	Out-of-band blocking.....	117
7.6.4	Narrow band blocking	119
7.6A	Blocking characteristics for CA	120
7.6A.1	General.....	120
7.6A.2	In-band blocking for CA.....	120
7.6A.2.1	In-band blocking for Intra-band contiguous CA.....	120
7.6A.2.2	In-band blocking for Intra-band non-contiguous CA	121
7.6A.2.3	In-band blocking for Inter-band CA.....	121
7.6A.3	Out-of-band blocking for CA.....	122
7.6A.3.1	Out-of-band blocking for Intra-band contiguous CA	122
7.6A.3.2	Out-of-band blocking for Intra-band non-contiguous CA	123
7.6A.3.3	Out-of-band blocking for Inter-band CA.....	123
7.6A.4	Narrow band blocking for CA	123
7.6A.4.1	Narrow band blocking for Intra-band contiguous CA	123
7.6A.4.2	Narrow band blocking for Intra-band non-contiguous CA.....	123
7.6A.4.3	Narrow band blocking for Inter-band CA.....	123
7.6D	Blocking characteristics for UL-MIMO	123
7.7	Spurious response.....	123
7.7A	Spurious response for CA.....	125

7.7A.1	Spurious response for Intra-band contiguous CA	125
7.7A.2	Spurious response for Intra-band non-contiguous CA	125
7.7A.3	Spurious response for Inter-band CA	125
7.7D	Spurious response for UL-MIMO	125
7.8	Intermodulation characteristics	125
7.8.1	General	125
7.8.2	Wide band Intermodulation	126
7.8A	Intermodulation characteristics for CA	128
7.8A.1	General	128
7.8A.2	Wide band intermodulation for CA	128
7.8A.2.1	Wide band intermodulation for Intra-band contiguous CA	128
7.8A.2.2	Wide band intermodulation for Intra-band non-contiguous CA	128
7.8A.2.3	Wide band intermodulation for Inter-band CA	128
7.8D	Intermodulation characteristics for UL-MIMO	128
7.9	Spurious emissions	129
7.9A	Spurious emissions for CA	129
7.9A.1	Spurious emissions for Intra-band contiguous CA	129
7.9A.2	Spurious emissions for Intra-band non-contiguous CA	129
7.9A.3	Spurious emissions for Inter-band CA	129
Annex A (normative): Measurement channels		130
A.1	General	130
A.2	UL reference measurement channels	130
A.2.1	General	130
A.2.2	Reference measurement channels for FDD	131
A.2.2.1	DFT-s-OFDM Pi/2-BPSK	131
A.2.2.2	DFT-s-OFDM QPSK	134
A.2.2.3	DFT-s-OFDM 16QAM	137
A.2.2.4	DFT-s-OFDM 64QAM	140
A.2.2.5	DFT-s-OFDM 256QAM	143
A.2.2.6	CP-OFDM QPSK	146
A.2.2.7	CP-OFDM 16QAM	149
A.2.2.8	CP-OFDM 64QAM	152
A.2.2.9	CP-OFDM 256QAM	155
A.2.3	Reference measurement channels for TDD	158
A.2.3.1	DFT-s-OFDM Pi/2-BPSK	158
A.2.3.2	DFT-s-OFDM QPSK	161
A.2.3.3	DFT-s-OFDM 16QAM	164
A.2.3.4	DFT-s-OFDM 64QAM	167
A.2.3.5	DFT-s-OFDM 256QAM	170
A.2.3.6	CP-OFDM QPSK	173
A.2.3.7	CP-OFDM 16QAM	176
A.2.3.8	CP-OFDM 64QAM	179
A.2.3.9	CP-OFDM 256QAM	182
A.3	DL reference measurement channels	185
A.3.1	General	185
A.3.2	DL reference measurement channels for FDD	185
A.3.2.1	General	185
A.3.2.2	FRC for receiver requirements for QPSK	186
A.3.2.3	FRC for maximum input level for 64QAM	189
A.3.2.4	FRC for maximum input level for 256 QAM	192
A.3.3	DL reference measurement channels for TDD	195
A.3.3.1	General	195
A.3.3.2	FRC for receiver requirements for QPSK	195
A.3.3.3	FRC for maximum input level for 64QAM	198
A.3.3.4	FRC for maximum input level for 256 QAM	201
A.4	CSI reference measurement channels	203
A.5	OFDMA Channel Noise Generator (OCNG)	203
A.5.1	OCNG Patterns for FDD	203

A.5.1.1	OCNG FDD pattern 1: Generic OCNG FDD Pattern for all unused REs.....	203
A.5.2	OCNG Patterns for TDD.....	204
A.5.2.1	OCNG TDD pattern 1: Generic OCNG TDD Pattern for all unused REs	204
A.6	Void.....	204
Annex B (informative):	Void	205
Annex C (informative):	Downlink physical channels	206
C.1	General	206
C.2	Setup.....	206
C.3	Connection	206
C.3.1	Measurement of Receiver Characteristics.....	206
Annex D (informative):	Void	207
Annex E (normative):	Environmental conditions	208
E.1	General	208
E.2	Environmental	208
E.2.1	Temperature	208
E.2.2	Voltage	208
E.2.3	Vibration.....	209
Annex F (normative):	Transmit modulation.....	210
F.1	Measurement Point.....	210
F.2	Basic Error Vector Magnitude measurement	210
F.3	Basic in-band emissions measurement.....	210
F.4	Modified signal under test.....	211
F.5	Window length	213
F.5.1	Timing offset.....	213
F.5.2	Window length	213
F.5.3	Window length for normal CP	213
F.5.4	Window length for Extended CP.....	213
F.5.5	Window length for PRACH	213
F.6	Averaged EVM	213
F.7	Spectrum Flatness	214
Annex G (informative):	Void	215
Annex H (informative):	Void	215
Annex I (informative):	Void	215
Annex J (informative):	Change history	216
History		222

Foreword

This Technical Specification has been produced by the 3rd Generation Partnership Project (3GPP).

The contents of the present document are subject to continuing work within the TSG and may change following formal TSG approval. Should the TSG modify the contents of the present document, it will be re-released by the TSG with an identifying change of release date and an increase in version number as follows:

Version x.y.z

where:

- x the first digit:
 - 1 presented to TSG for information;
 - 2 presented to TSG for approval;
 - 3 or greater indicates TSG approved document under change control.
- y the second digit is incremented for all changes of substance, i.e. technical enhancements, corrections, updates, etc.
- z the third digit is incremented when editorial only changes have been incorporated in the document.

1 Scope

The present document establishes the minimum RF requirements for NR User Equipment (UE) operating on frequency Range 1.

2 References

The following documents contain provisions which, through reference in this text, constitute provisions of the present document.

References are either specific (identified by date of publication, edition number, version number, etc.) or non-specific.

For a specific reference, subsequent revisions do not apply.

For a non-specific reference, the latest version applies. In the case of a reference to a 3GPP document (including a GSM document), a non-specific reference implicitly refers to the latest version of that document in the same Release as the present document.

- [1] 3GPP TR 21.905: "Vocabulary for 3GPP Specifications".
- [2] 3GPP TS 38.101-2: "NR; User Equipment (UE) radio transmission and reception; Part 2: Range 2 Standalone".
- [3] 3GPP TS 38.101-3: "NR; User Equipment (UE) radio transmission and reception; Part 3: Range 1 and Range 2 Interworking operation with other radios".
- [4] 3GPP TS 38.521-1: "NR; User Equipment (UE) conformance specification; Radio transmission and reception; Part 1: Range 1 Standalone".
- [5] Recommendation ITU-R M.1545: "Measurement uncertainty as it applies to test limits for the terrestrial component of International Mobile Telecommunications-2000".
- [6] 3GPP TS 38.211: "NR; Physical channels and modulation".
- [7] 3GPP TS 38.331: "Radio Resource Control (RRC) protocol specification".
- [8] 3GPP TS 38.213: "NR; Physical layer procedures for control".

3 Definitions, symbols and abbreviations

3.1 Definitions

For the purposes of the present document, the terms and definitions given in 3GPP TR 21.905 [1] and the following apply. A term defined in the present document takes precedence over the definition of the same term, if any, in 3GPP TR 21.905 [1].

Aggregated Channel Bandwidth: The RF bandwidth in which a UE transmits and receives multiple contiguously aggregated carriers.

Carrier aggregation: Aggregation of two or more component carriers in order to support wider transmission bandwidths.

Carrier aggregation band: A set of one or more operating bands across which multiple carriers are aggregated with a specific set of technical requirements.

Carrier aggregation bandwidth class: A class defined by the aggregated transmission bandwidth configuration and maximum number of component carriers supported by a UE.

Carrier aggregation configuration: A combination of CA operating band(s) and CA bandwidth class(es) supported by a UE.

Contiguous carriers: A set of two or more carriers configured in a spectrum block where there are no RF requirements based on co-existence for un-coordinated operation within the spectrum block.

Contiguous resource allocation: A resource allocation of consecutive resource blocks within one carrier or across contiguously aggregated carriers. The gap between contiguously aggregated carriers due to the nominal channel spacing is allowed.

Contiguous spectrum: Spectrum consisting of a contiguous block of spectrum with no sub-block gaps.

Inter-band carrier aggregation: Carrier aggregation of component carriers in different operating bands.

NOTE: Carriers aggregated in each band can be contiguous or non-contiguous.

Intra-band contiguous carrier aggregation: Contiguous carriers aggregated in the same operating band.

Intra-band non-contiguous carrier aggregation: Non-contiguous carriers aggregated in the same operating band.

Sub-block: This is one contiguous allocated block of spectrum for transmission and reception by the same UE. There may be multiple instances of sub-blocks within an RF bandwidth.

Sub-block bandwidth: The bandwidth of one sub-block.

Sub-block gap: A frequency gap between two consecutive sub-blocks within an RF bandwidth, where the RF requirements in the gap are based on co-existence for un-coordinated operation.

3.2 Symbols

For the purposes of the present document, the following symbols apply:

ΔF_{Global}	Granularity of the global frequency raster
ΔF_{Raster}	Band dependent channel raster granularity
Δf_{OOB}	Δ Frequency of Out Of Band emission
$\Delta F_{\text{TX-RX}}$	Δ Frequency of default TX-RX separation of the FDD <i>operating band</i>
$\Delta P_{\text{PowerClass}}$	Adjustment to maximum output power for a given power class
ΔR_{B}	The starting frequency offset between the allocated RB and the measured non-allocated RB $\Delta R_{\text{IB},c}$
	Allowed reference sensitivity relaxation due to support for inter-band CA operation, for serving cell c
$\Delta R_{\text{IB},4\text{R}}$	Reference sensitivity adjustment due to support for 4 antenna ports
Δ_{Shift}	Channel raster offset for SUL
ΔT_{C}	Allowed operating band edge transmission power relaxation
$\Delta T_{\text{C},c}$	Allowed operating band edge transmission power relaxation for serving cell c
$\Delta T_{\text{IB},c}$	Allowed maximum configured output power relaxation due to support for inter-band CA operation, for serving cell c
$\Delta T_{\text{IB},c}$	Allowed maximum configured output power relaxation due to support for inter-band CA operation, for serving cell c
BW_{Channel}	Channel bandwidth
$BW_{\text{Channel,block}}$	Sub-block bandwidth, expressed in MHz. $BW_{\text{Channel,block}} = F_{\text{edge,block,high}} - F_{\text{edge,block,low}}$
$BW_{\text{Channel_CA}}$	Aggregated channel bandwidth, expressed in MHz
$BW_{\text{Channel,max}}$	Maximum channel bandwidth supported among all bands in a release
BW_{GB}	$\max(BW_{\text{GB,Channel}(k)})$
$BW_{\text{GB,block,low}}$	The minimum guardband for the lowest assigned component carrier within a <i>sub-block</i>
$BW_{\text{GB,block,high}}$	The minimum guardband for the highest assigned component carrier within a <i>sub-block</i>
$BW_{\text{GB,Channel}(k)}$	Minimum guard band defined in sub-clause 5.3A.1 of carrier k
BW_{DL}	Channel bandwidth for DL
BW_{UL}	Channel bandwidth for UL
$BW_{\text{interferer}}$	Bandwidth of the interferer
$\text{Ceil}(x)$	Rounding upwards; $\text{ceil}(x)$ is the smallest integer such that $\text{ceil}(x) \geq x$
$\text{Floor}(x)$	Rounding downwards; $\text{floor}(x)$ is the greatest integer such that $\text{floor}(x) \leq x$
F_{C}	<i>RF reference frequency</i> on the channel raster, given in table 5.4.2.2-1
$F_{\text{C,block,high}}$	F_{C} of the highest transmitted/received carrier in a <i>sub-block</i>
$F_{\text{C,block,low}}$	F_{C} of the lowest transmitted/received carrier in a <i>sub-block</i>
$F_{\text{C,low}}$	The F_{C} of the lowest carrier, expressed in MHz
$F_{\text{C,high}}$	The F_{C} of the highest carrier, expressed in MHz

F_{DL_low}	The lowest frequency of the downlink <i>operating band</i>
F_{DL_high}	The highest frequency of the downlink <i>operating band</i>
F_{UL_low}	The lowest frequency of the uplink <i>operating band</i>
F_{UL_high}	The highest frequency of the uplink <i>operating band</i>
$F_{edge,block,low}$	The lower <i>sub-block</i> edge, where $F_{edge,block,low} = F_{C,block,low} - F_{offset,low}$.
$F_{edge,block,high}$	The upper <i>sub-block</i> edge, where $F_{edge,block,high} = F_{C,block,high} + F_{offset,high}$.
F_{edge_low}	The <i>lower edge of aggregated channel bandwidth</i> , expressed in MHz. $F_{edge,low} = F_{C,low} - F_{offset,low}$.
F_{edge_high}	The <i>higher edge of aggregated channel bandwidth</i> , expressed in MHz. $F_{edge,high} = F_{C,high} + F_{offset,high}$.
$F_{interferer}$ (offset)	Frequency offset of the interferer (between the center frequency of the interferer and the carrier frequency of the carrier measured)
$F_{interferer}$	Frequency of the interferer
$F_{ioffset}$	Frequency offset of the interferer (between the center frequency of the interferer and the closest edge of the carrier measured)
F_{offset}	Frequency offset from $F_{C,high}$ to the <i>higher edge</i> or $F_{C,low}$ to the <i>lower edge</i> .
$F_{offset,block,low}$	Separation between lower edge of a <i>sub-block</i> and the center of the lowest component carrier within the <i>sub-block</i>
$F_{offset,block,high}$	Separation between higher edge of a <i>sub-block</i> and the center of the highest component carrier within the <i>sub-block</i>
$F_{offset,high}$	Frequency offset from $F_{C,high}$ to the upper <i>UE RF Bandwidth edge</i> ,
$F_{offset,low}$	Frequency offset from $F_{C,low}$ to the lower <i>UE RF Bandwidth edge</i> ,
F_{OOB}	The boundary between the NR out of band emission and spurious emission domains
F_{REF}	RF reference frequency
$F_{REF-Offs}$	Offset used for calculating F_{REF}
$F_{REF,Shift}$	RF reference frequency for Supplementary Uplink (SUL) bands
F_{uw} (offset)	The frequency separation of the center frequency of the carrier closest to the interferer and the center frequency of the interferer
$GB_{channel}$	Minimum guard band defined in sub-clause 5.3.3
L_{CRB}	Transmission bandwidth which represents the length of a contiguous resource block allocation expressed in units of resources blocks
Max()	The largest of given numbers
Min()	The smallest of given numbers
n_{PRB}	Physical resource block number
NR_{ACLR}	NR ACLR
N_{RB}	Transmission bandwidth configuration, expressed in units of resource blocks
$N_{RB,block,low}$	The transmission bandwidth configurations for the lowest assigned component carrier within the <i>sub-block</i>
$N_{RB,block,high}$	The transmission bandwidth configurations for the highest assigned component carrier within the <i>sub-block</i>
$N_{RB,low}$	The transmission bandwidth configurations according to Table 5.3.2-1 for the lowest assigned component carrier in section 5.3A.1
$N_{RB,high}$	The transmission bandwidth configurations according to Table 5.3.2-1 for the highest assigned component carrier in section 5.3A.1
N_{REF}	NR Absolute Radio Frequency Channel Number (NR-ARFCN)
$N_{REF-Offs}$	Offset used for calculating N_{REF}
P_{CMAX}	The configured maximum UE output power
$P_{CMAX,c}$	The configured maximum UE output power for serving cell c
$P_{CMAX,f,c}$	The configured maximum UE output power for carrier f of serving cell c in each slot
P_{EMAX}	Maximum allowed UE output power signalled by higher layers
$P_{EMAX,c}$	Maximum allowed UE output power signalled by higher layers for serving cell c
$P_{interferer}$	Modulated mean power of the interferer
$P_{PowerClass}$	$P_{PowerClass}$ is the nominal UE power (i.e., no tolerance)
$P-MPR_c$	Maximum allowed UE output power reduction for serving cell c
P_{RB}	The transmitted power per allocated RB, measured in dBm
P_{UMAX}	The measured configured maximum UE output power
P_{uw}	Power of an unwanted DL signal
P_w	Power of a wanted DL signal
RB_{start}	Indicates the lowest RB index of transmitted resource blocks
$SCS_{block,low}$	SCS for the lowest assigned component carrier within the <i>sub-block</i>
$SCS_{block,high}$	SCS for the highest assigned component carrier within the <i>sub-block</i>
SCS_{low}	SCS for the lowest assigned component carrier in section 5.3A.1
SCS_{high}	SCS for the highest assigned component carrier in section 5.3A.1

$T(P_{\text{CMAX},f,c})$	Tolerance for applicable values of $P_{\text{CMAX},f,c}$ for configured maximum UE output power for carrier f of serving cell c
$T_{L,c}$	Absolute value of the lower tolerance for the applicable <i>operating band</i> as specified in section 6.2.1
SS_{REF}	SS block reference frequency position
$UTRA_{\text{ACLR}}$	UTRA ACLR

3.3 Abbreviations

For the purposes of the present document, the abbreviations given in 3GPP TR 21.905 [1] and the following apply. An abbreviation defined in the present document takes precedence over the definition of the same abbreviation, if any, in 3GPP TR 21.905 [1].

Abbreviation format (EW)

ACLR	Adjacent Channel Leakage Ratio
ACS	Adjacent Channel Selectivity
A-MPR	Additional Maximum Power Reduction
BS	Base Station
BW	Bandwidth
BWP	Bandwidth Part
CA	Carrier Aggregation
CA_nX-nY	Inter-band CA of component carrier(s) in one sub-block within Band X and component carrier(s) in one sub-block within Band Y where X and Y are the applicable NR <i>operating band</i>
CC	Component Carriers
CP-OFDM	Cyclic Prefix-OFDM
CW	Continuous Wave
DC	Dual Connectivity
DFT-s-OFDM	Discrete Fourier Transform-spread-OFDM
DM-RS	Demodulation Reference Signal
DTX	Discontinuous TransmissionE-UTRA Evolved UTRA
EVM	Error Vector Magnitude
FR	Frequency Range
FRC	Fixed Reference Channel
GSCN	Global Synchronization Channel Number
IBB	In-band Blocking
IDFT	Inverse Discrete Fourier Transformation
ITU-R	Radiocommunication Sector of the International Telecommunication Union
MBW	Measurement bandwidth defined for the protected band
MOP	Maximum Output Power
MPR	Allowed maximum power reduction
MSD	Maximum Sensitivity Degradation
NR	New Radio
NR-ARFCN	NR Absolute Radio Frequency Channel Number
NS	Network Signalling
OCNG	OFDMA Channel Noise Generator
OOB	Out-of-band
P-MPR	Power Management Maximum Power Reduction
PRB	Physical Resource Block
QAM	Quadrature Amplitude Modulation
RE	Resource Element
REFSENS	Reference Sensitivity
RF	Radio Frequency
RMS	Root Mean Square (value)
RSRP	Reference Signal Receiving PowerRx Receiver
SC	Single Carrier
SCS	Subcarrier spacing
SDL	Supplementary Downlink
SEM	Spectrum Emission Mask
SNR	Signal-to-Noise Ratio
SRS	Sounding Reference SymbolSUL Supplementary uplink

SS	Synchronization Symbol
TAE	Time Alignment Error
Tx	Transmitter
UL-MIMO	Uplink Multiple Antenna transmission

4 General

4.1 Relationship between minimum requirements and test requirements

The present document is a Single-RAT specification for NR UE, covering RF characteristics and minimum performance requirements. Conformance to the present specification is demonstrated by fulfilling the test requirements specified in the conformance specification 3GPP TS 38.521-1 [4].

The Minimum Requirements given in this specification make no allowance for measurement uncertainty. The test specification TS 38.521-1 [4] defines test tolerances. These test tolerances are individually calculated for each test. The test tolerances are used to relax the minimum requirements in this specification to create test requirements. For some requirements, including regulatory requirements, the test tolerance is set to zero.

The measurement results returned by the test system are compared - without any modification - against the test requirements as defined by the shared risk principle.

The shared risk principle is defined in Recommendation ITU-R M.1545 [5].

4.2 Applicability of minimum requirements

- In this specification the Minimum Requirements are specified as general requirements and additional requirements. Where the Requirement is specified as a general requirement, the requirement is mandated to be met in all scenarios
- For specific scenarios for which an additional requirement is specified, in addition to meeting the general requirement, the UE is mandated to meet the additional requirements.
- The spurious emissions power requirements are for the long-term average of the power. For the purpose of reducing measurement uncertainty it is acceptable to average the measured power over a period of time sufficient to reduce the uncertainty due to the statistical nature of the signal

4.3 Specification suffix information

Unless stated otherwise the following suffixes are used for indicating at 2nd level subclause, shown in Table 4.3-1.

Table 4.3-1: Definition of suffixes

Clause suffix	Variant
None	Single Carrier
A	Carrier Aggregation (CA)
B	Dual-Connectivity (DC)
C	Supplement Uplink (SUL)
D	UL MIMO

A terminal which supports the above features needs to meet both the general requirements and the additional requirement applicable to the additional subclause (suffix A, B, C and D) in clauses 5, 6 and 7. Where there is a difference in requirement between the general requirements and the additional subclause requirements (suffix A, B, C and D) in clauses 5, 6 and 7, the tighter requirements are applicable unless stated otherwise in the additional subclause.

A terminal which supports more than one feature in clauses 5, 6 and 7 shall meet all of the separate corresponding requirements.

For a terminal that supports SUL for the band combination specified in Table 5.2C-1, the current version of the specification assumes the terminal is configured with active transmission either on UL carrier or SUL carrier at any

time in one serving cell and the UE requirements for single carrier shall apply for the active UL or SUL carrier accordingly.

5 Operating bands and channel arrangement

5.1 General

The channel arrangements presented in this clause are based on the operating bands and channel bandwidths defined in the present release of specifications.

NOTE: Other operating bands and channel bandwidths may be considered in future releases.

Requirements throughout the RF specifications are in many cases defined separately for different frequency ranges (FR). The frequency ranges in which NR can operate according to this version of the specification are identified as described in Table 5.1-1.

Table 5.1-1: Definition of frequency ranges

Frequency range designation	Corresponding frequency range
FR1	450 MHz – 6000 MHz
FR2	24250 MHz – 52600 MHz

The present specification covers FR1 operating bands.

5.2 Operating bands

NR is designed to operate in the FR1 operating bands defined in Table 5.2-1.

Table 5.2-1: NR operating bands in FR1

NR operating band	Uplink (UL) operating band BS receive / UE transmit F _{UL_low} – F _{UL_high}	Downlink (DL) operating band BS transmit / UE receive F _{DL_low} – F _{DL_high}	Duplex Mode
n1	1920 MHz – 1980 MHz	2110 MHz – 2170 MHz	FDD
n2	1850 MHz – 1910 MHz	1930 MHz – 1990 MHz	FDD
n3	1710 MHz – 1785 MHz	1805 MHz – 1880 MHz	FDD
n5	824 MHz – 849 MHz	869 MHz – 894 MHz	FDD
n7	2500 MHz – 2570 MHz	2620 MHz – 2690 MHz	FDD
n8	880 MHz – 915 MHz	925 MHz – 960 MHz	FDD
n12	699 MHz – 716 MHz	729 MHz – 746 MHz	FDD
n20	832 MHz – 862 MHz	791 MHz – 821 MHz	FDD
n25	1850 MHz – 1915 MHz	1930 MHz – 1995 MHz	FDD
n28	703 MHz – 748 MHz	758 MHz – 803 MHz	FDD
n34	2010 MHz – 2025 MHz	2010 MHz – 2025 MHz	TDD
n38	2570 MHz – 2620 MHz	2570 MHz – 2620 MHz	TDD
n39	1880 MHz – 1920 MHz	1880 MHz – 1920 MHz	TDD
n40	2300 MHz – 2400 MHz	2300 MHz – 2400 MHz	TDD
n41	2496 MHz – 2690 MHz	2496 MHz – 2690 MHz	TDD
n50	1432 MHz – 1517 MHz	1432 MHz – 1517 MHz	TDD ¹
n51	1427 MHz – 1432 MHz	1427 MHz – 1432 MHz	TDD
n66	1710 MHz – 1780 MHz	2110 MHz – 2200 MHz	FDD
n70	1695 MHz – 1710 MHz	1995 MHz – 2020 MHz	FDD
n71	663 MHz – 698 MHz	617 MHz – 652 MHz	FDD
n74	1427 MHz – 1470 MHz	1475 MHz – 1518 MHz	FDD
n75	N/A	1432 MHz – 1517 MHz	SDL
n76	N/A	1427 MHz – 1432 MHz	SDL
n77	3300 MHz – 4200 MHz	3300 MHz – 4200 MHz	TDD
n78	3300 MHz – 3800 MHz	3300 MHz – 3800 MHz	TDD
n79	4400 MHz – 5000 MHz	4400 MHz – 5000 MHz	TDD
n80	1710 MHz – 1785 MHz	N/A	SUL
n81	880 MHz – 915 MHz	N/A	SUL
n82	832 MHz – 862 MHz	N/A	SUL
n83	703 MHz – 748 MHz	N/A	SUL
n84	1920 MHz – 1980 MHz	N/A	SUL
n86	1710 MHz – 1780MHz	N/A	SUL

NOTE 1: UE that complies with the NR Band n50 minimum requirements in this specification shall also comply with the NR Band n51 minimum requirements.

5.2A Operating bands for CA

5.2A.1 Intra-band CA

NR intra-band contiguous carrier aggregation is designed to operate in the operating bands defined in Table 5.2A.1-1, where all operating bands are within FR1.

Table 5.2A.1-1: Intra-band contiguous CA operating bands in FR1

NR CA Band	NR Band (Table 5.2-1)
CA_n77	n77
CA_n78	n78
CA_n79	n79

5.2A.2 Inter-band CA

NR inter-band carrier aggregation is designed to operate in the operating bands defined in Table 5.2A.2-1, where all operating bands are within FR1.

Table 5.2A.2-1: Inter-band CA operating bands involving FR1 (two bands)

NR CA Band	NR Band (Table 5.2-1)
CA_n3A-n77A	n3, n77
CA_n3A-n78A	n3, n78
CA_n3A-n79A	n3, n79
CA_n8A-n75A	n8, n75
CA_n8-n78A	n8, n78
CA_n8A-n79A	n8, n79
CA_n28A-n75A ²	n28, n75
CA_n28A_n78A	n28, n78
CA_n41A-n78A	n41, n78
CA_n75A-n78A ¹	n75, n78
CA_n77A-n79A	n77, n79
CA_n78A-n79A	n78, n79
NOTE 1: Applicable for UE supporting inter-band carrier aggregation with mandatory simultaneous Rx/Tx capability.	
NOTE 2: The frequency range in band n28 is restricted for this band combination to 703-733 MHz for the UL and 758-788 MHz for the DL.	

5.2B Operating bands for DC

5.2B.1 General

NR dual connectivity is designed to operate in the operating bands defined in Table 5.2B-1, where all operating bands are within FR1.

Table 5.2B-1: Inter-band DC operating bands involving FR1 (two bands)

NR DC Band	NR Band (Table 5.2-1)
NOTE: Applicable for UE supporting inter-band dual connectivity with mandatory simultaneous Rx/Tx capability.	

5.2C Operating band combination for SUL

NR operation is designed to operate in the operating band combination defined in Table 5.2C-1, where all operating bands are within FR1.

Table 5.2C-1: Operating band combination for SUL in FR1

NR Band combination for SUL	NR Band (Table 5.2-1)
SUL_n78-n80 ²	n78, n80
SUL_n78-n81 ²	n78, n81
SUL_n78-n82 ²	n78, n82
SUL_n78-n83 ²	n78, n83
SUL_n78-n84 ²	n78, n84
SUL_n78-n86 ²	n78, n86
SUL_n79-n80 ²	n79, n80
SUL_n79-n81 ²	n79, n81
NOTE 1: If a UE is configured with both NR UL and NR SUL carriers in a cell, the switching time between NR UL carrier and NR SUL carrier is 0us.	
NOTE 2: For UE supporting SUL band combination simultaneous Rx/Tx capability is mandatory.	

5.3 UE channel bandwidth

5.3.1 General

The UE channel bandwidth supports a single NR RF carrier in the uplink or downlink at the UE. From a BS perspective, different UE channel bandwidths may be supported within the same spectrum for transmitting to and receiving from UEs connected to the BS. Transmission of multiple carriers to the same UE (CA) or multiple carriers to different UEs within the BS channel bandwidth can be supported.

From a UE perspective, the UE is configured with one or more BWP / carriers, each with its own UE channel bandwidth. The UE does not need to be aware of the BS channel bandwidth or how the BS allocates bandwidth to different UEs.

The placement of the UE channel bandwidth for each UE carrier is flexible but can only be completely within the BS channel bandwidth.

5.3.2 Maximum transmission bandwidth configuration

The maximum transmission bandwidth configuration N_{RB} for each UE channel bandwidth and subcarrier spacing is specified in Table 5.3.2-1.

Table 5.3.2-1: Maximum transmission bandwidth configuration N_{RB}

SCS (kHz)	5MHz	10MHz	15MHz	20 MHz	25 MHz	30 MHz	40 MHz	50MHz	60 MHz	80 MHz	90 MHz	100 MHz
	N_{RB}	N_{RB}	N_{RB}	N_{RB}	N_{RB}	N_{RB}	N_{RB}	N_{RB}	N_{RB}	N_{RB}	N_{RB}	N_{RB}
15	25	52	79	106	133	160	216	270	N/A	N/A	N/A	N/A
30	11	24	38	51	65	78	106	133	162	217	245	273
60	N/A	11	18	24	31	38	51	65	79	107	121	135

5.3.3 Minimum guardband and transmission bandwidth configuration

The minimum guardband for each UE channel bandwidth and SCS is specified in Table 5.3.3-1,

Table 5.3.3-1: Minimum guardband for each UE channel bandwidth and SCS (kHz)

SCS (kHz)	5 MHz	10 MHz	15 MHz	20 MHz	25 MHz	30 MHz	40 MHz	50MHz	60 MHz	80 MHz	90 MHz	100 MHz
15	242.5	312.5	382.5	452.5	522.5	592.5	552.5	692.5	N/A	N/A	N/A	N/A
30	505	665	645	805	785	945	905	1045	825	925	885	845
60	N/A	1010	990	1330	1310	1290	1610	1570	1530	1450	1410	1370

NOTE: The minimum guardbands have been calculated using the following equation: $(CHBW \times 1000 \text{ (kHz)} - RB \text{ value} \times SCS \times 12) / 2 - SCS/2$, where RB values are from Table 5.3.2-1.

Figure 5.3.3-1: Void

The number of RBs configured in any channel bandwidth shall ensure that the minimum guardband specified in this clause is met.

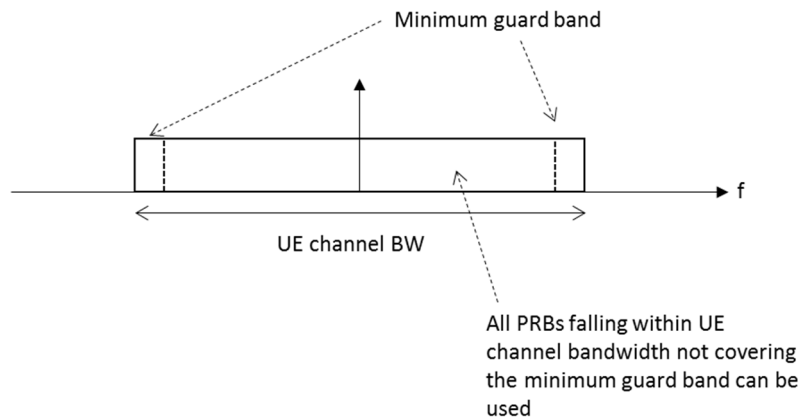

Figure 5.3.3-2: UE PRB utilization

In the case that multiple numerologies are multiplexed in the same symbol due to BS transmission of SSB, the minimum guardband on each side of the carrier is the guardband applied at the configured channel bandwidth for the numerology that is received immediately adjacent to the guard.

If multiple numerologies are multiplexed in the same symbol and the UE channel bandwidth is >50 MHz, the minimum guardband applied adjacent to 15 kHz SCS shall be the same as the minimum guardband defined for 30 kHz SCS for the same UE channel bandwidth.

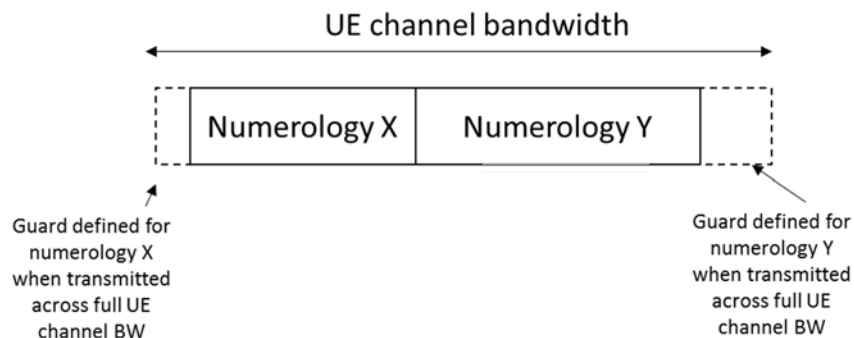

Figure 5.3.3-3 Guard band definition when transmitting multiple numerologies

NOTE: Figure 5.3.3-3 is not intended to imply the size of any guard between the two numerologies. Inter-numerology guard band within the carrier is implementation dependent.

5.3.4 RB alignment with different numerologies

For each numerology, its common resource blocks are specified in Section 4.4.4.3 in [9], and the starting point of its transmission bandwidth configuration on the common resource block grid for a given channel bandwidth is indicated by an offset to "Reference point A" in the unit of the numerology. The indicated transmission bandwidth configuration must fulfil the minimum guardband requirement specified in Section 5.3.3.

5.3.5 UE channel bandwidth per operating band

The requirements in this specification apply to the combination of channel bandwidths, SCS and operating bands shown in Table 5.3.5-1. The transmission bandwidth configuration in Table 5.3.2-1 shall be supported for each of the specified channel bandwidths. The channel bandwidths are specified for both the TX and RX path.

Table 5.3.5-1 Channel bandwidths for each NR band

NR Band	NR band / SCS / UE Channel bandwidth												
	SCS kHz	5 MHz	10 ^{1,2} MHz	15 ² MHz	20 ² MHz	25 ² MHz	30 MHz	40 MHz	50 MHz	60 MHz	80 MHz	90 MHz	100 MHz
n1	15	Yes	Yes	Yes	Yes								
	30		Yes	Yes	Yes								
	60		Yes	Yes	Yes								
n2	15	Yes	Yes	Yes	Yes								
	30		Yes	Yes	Yes								
	60		Yes	Yes	Yes								
n3	15	Yes	Yes	Yes	Yes	Yes	Yes						
	30		Yes	Yes	Yes	Yes	Yes						
	60		Yes	Yes	Yes	Yes	Yes						
n5	15	Yes	Yes	Yes	Yes								
	30		Yes	Yes	Yes								
	60												
n7	15	Yes	Yes	Yes	Yes								
	30		Yes	Yes	Yes								
	60		Yes	Yes	Yes								
n8	15	Yes	Yes	Yes	Yes								
	30		Yes	Yes	Yes								
	60												
n12	15	Yes	Yes	Yes									
	30		Yes	Yes									
	60												
n20	15	Yes	Yes	Yes	Yes								
	30		Yes	Yes	Yes								
	60												
n25	15	Yes	Yes	Yes	Yes								
	30		Yes	Yes	Yes								
	60		Yes	Yes	Yes								
n28	15	Yes	Yes	Yes	Yes								
	30		Yes	Yes	Yes								
	60												
n34	15	Yes	Yes	Yes									
	30		Yes	Yes									
	60		Yes	Yes									
n38	15	Yes	Yes	Yes	Yes								
	30		Yes	Yes	Yes								
	60		Yes	Yes	Yes								
n39	15	Yes	Yes	Yes	Yes	Yes	Yes	Yes					
	30		Yes	Yes	Yes	Yes	Yes	Yes					
	60		Yes	Yes	Yes	Yes	Yes	Yes					
n40	15	Yes	Yes	Yes	Yes	Yes	Yes	Yes	Yes				
	30		Yes	Yes	Yes	Yes	Yes	Yes	Yes	Yes	Yes		
	60		Yes	Yes	Yes	Yes	Yes	Yes	Yes	Yes	Yes		
n41	15		Yes	Yes	Yes			Yes	Yes				
	30		Yes	Yes	Yes			Yes	Yes	Yes	Yes	Yes	Yes
	60		Yes	Yes	Yes			Yes	Yes	Yes	Yes	Yes	Yes
n50	15	Yes	Yes	Yes	Yes			Yes	Yes				
	30		Yes	Yes	Yes			Yes	Yes	Yes	Yes ³		
	60		Yes	Yes	Yes			Yes	Yes	Yes	Yes ³		
n51	15	Yes											
	30												
	60												
n66	15	Yes	Yes	Yes	Yes			Yes					
	30		Yes	Yes	Yes			Yes					
	60		Yes	Yes	Yes			Yes					
n70	15	Yes	Yes	Yes	Yes ³	Yes ³							
	30		Yes	Yes	Yes ³	Yes ³							
	60		Yes	Yes	Yes ³	Yes ³							

NR Band	NR band / SCS / UE Channel bandwidth												
	SCS kHz	5 MHz	10 ^{1,2} MHz	15 ² MHz	20 ² MHz	25 ² MHz	30 MHz	40 MHz	50 MHz	60 MHz	80 MHz	90 MHz	100 MHz
n71	15	Yes	Yes	Yes	Yes								
	30		Yes	Yes	Yes								
	60												
n74	15	Yes	Yes	Yes	Yes								
	30		Yes	Yes	Yes								
	60		Yes	Yes	Yes								
n75	15	Yes	Yes	Yes	Yes								
	30		Yes	Yes	Yes								
	60		Yes	Yes	Yes								
n76	15	Yes											
	30												
	60												
n77	15		Yes	Yes	Yes			Yes	Yes				
	30		Yes	Yes	Yes			Yes	Yes	Yes	Yes	Yes	Yes
	60		Yes	Yes	Yes			Yes	Yes	Yes	Yes	Yes	Yes
n78	15		Yes	Yes	Yes			Yes	Yes				
	30		Yes	Yes	Yes			Yes	Yes	Yes	Yes	Yes	Yes
	60		Yes	Yes	Yes			Yes	Yes	Yes	Yes	Yes	Yes
n79	15							Yes	Yes				
	30							Yes	Yes	Yes	Yes		Yes
	60							Yes	Yes	Yes	Yes		Yes
n80	15	Yes	Yes	Yes	Yes	Yes	Yes						
	30		Yes	Yes	Yes	Yes	Yes						
	60		Yes	Yes	Yes	Yes	Yes						
n81	15	Yes	Yes	Yes	Yes								
	30		Yes	Yes	Yes								
	60												
n82	15	Yes	Yes	Yes	Yes								
	30		Yes	Yes	Yes								
	60												
n83	15	Yes	Yes	Yes	Yes								
	30		Yes	Yes	Yes								
	60												
n84	15	Yes	Yes	Yes	Yes								
	30		Yes	Yes	Yes								
	60		Yes	Yes	Yes								
n86	15	Yes	Yes	Yes	Yes			Yes					
	30		Yes	Yes	Yes			Yes					
	60		Yes	Yes	Yes			Yes					

NOTE 1: 90% spectrum utilization may not be achieved for 30kHz SCS.
 NOTE 2: 90% spectrum utilization may not be achieved for 60kHz SCS.
 NOTE 3: This UE channel bandwidth is applicable only to downlink.

5.3.6 Asymmetric channel bandwidths

The UE channel bandwidth can be asymmetric in downlink and uplink. In asymmetric channel bandwidth operation, the narrower carrier shall be confined within the frequency range of the wider channel bandwidth.

In FDD, the confinement is defined as a deviation to the default Tx-Rx carrier center frequency separation (defined in table 5.4.4-1) as following:

$$\Delta F_{TX-RX} = |(BW_{DL} - BW_{UL})/2|$$

The operating bands and supported asymmetric channel bandwidth combinations are defined in table 5.3.6-1.

Table 5.3.6-1: FDD asymmetric UL and DL channel bandwidth combinations

NR Band	Channel bandwidths for UL (MHz)	Channel bandwidths for DL (MHz)
n66	5, 10	20, 40
	20	40
n70	5	10, 15
	5, 10, 15	20, 25

In TDD, the operating bands and supported asymmetric channel bandwidth combinations are defined in table 5.3.6-2.

Table 5.3.6-2: TDD asymmetric UL and DL channel bandwidth combinations

NR Band	Channel bandwidths for UL (MHz)	Channel bandwidths for DL (MHz)
n50	60	80

5.3A UE channel bandwidth for CA

5.3A.1 General

Figure 5.3A.1-1: Void

Figure 5.3A.1-2: Void

5.3A.2 Maximum transmission bandwidth configuration for CA

For carrier aggregation, the maximum transmission bandwidth configuration is defined per component carrier and the requirement is specified in subclause 5.3.2.

5.3A.3 Minimum guardband and transmission bandwidth configuration for CA

For intra-band contiguous carrier aggregation, *Aggregated Channel Bandwidth* and *Guard Bands* are defined as follows, see Figure 5.3A.3-1.

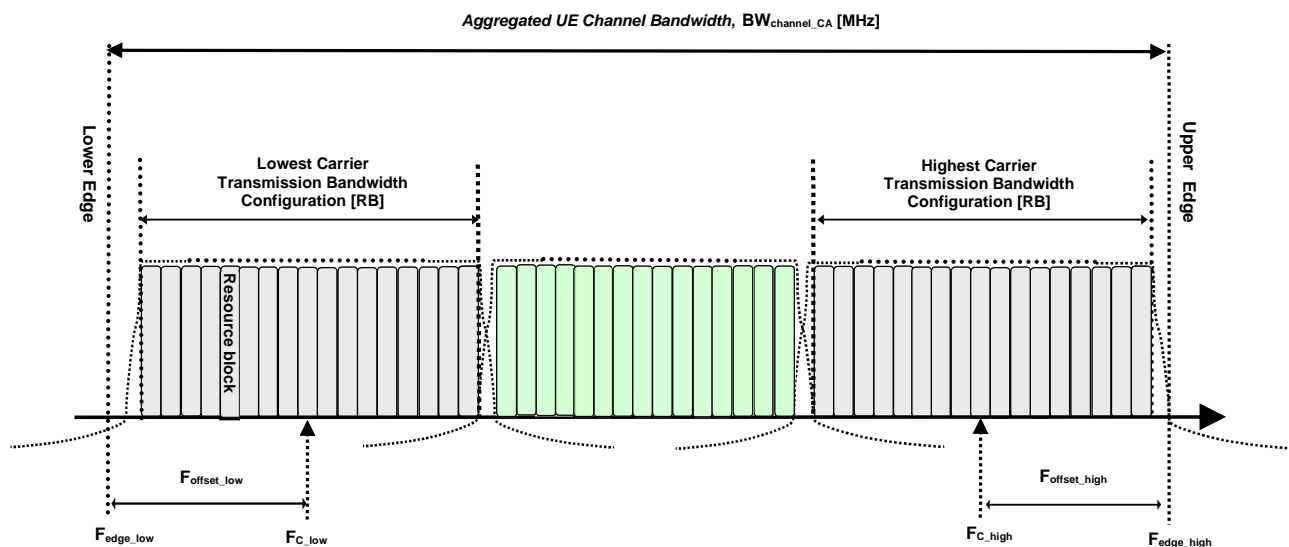

Figure 5.3A.3-1: Definition of *Aggregated Channel Bandwidth* for intra-band carrier aggregation

The *aggregated channel bandwidth*, $BW_{Channel_CA}$, is defined as

$$BW_{Channel_CA} = F_{edge,high} - F_{edge,low} \text{ (MHz)}.$$

The lower bandwidth edge $F_{edge,low}$ and the upper bandwidth edge $F_{edge,high}$ of the aggregated channel bandwidth are used as frequency reference points for transmitter and receiver requirements and are defined by

$$F_{edge,low} = F_{C,low} - F_{offset,low}$$

$$F_{edge,high} = F_{C,high} + F_{offset,high}$$

The lower and upper frequency offsets depend on the transmission bandwidth configurations of the lowest and highest assigned edge component carrier and are defined as

$$F_{offset,low} = (N_{RB,low} * 12 + 1) * SCS_{low} / 2 + BW_{GB} \text{ (MHz)}$$

$$F_{offset,high} = (N_{RB,high} * 12 - 1) * SCS_{high} / 2 + BW_{GB} \text{ (MHz)}$$

$$BW_{GB} = \max(BW_{GB,Channel(k)})$$

$BW_{GB,Channel(k)}$ is the minimum guard band defined in sub-clause 5.3.3 of carrier k , while $N_{RB,low}$ and $N_{RB,high}$ are the transmission bandwidth configurations according to Table 5.3.2-1 for the lowest and highest assigned component carrier, respectively.

For intra-band non-contiguous carrier aggregation *Sub-block Bandwidth* and *Sub-block edges* are defined as follows, see Figure 5.3A.3-2.

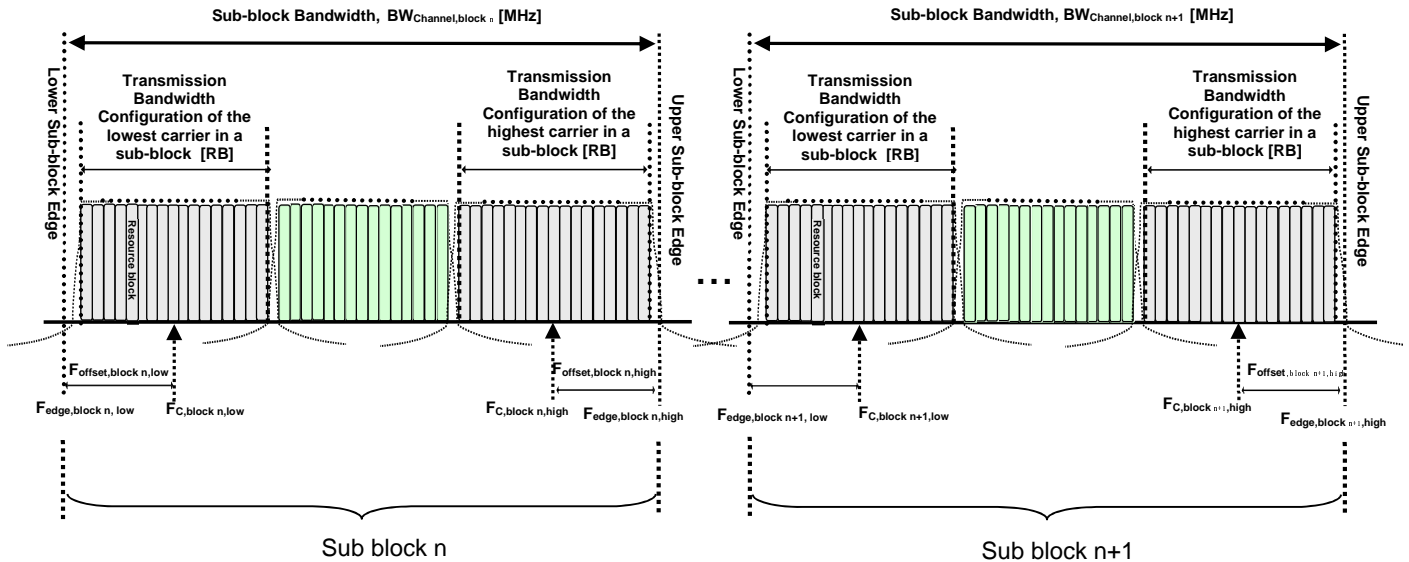

Figure 5.3A.3-2: Definition of sub-block bandwidth for intra-band non-contiguous spectrum

The lower sub-block edge of the Sub-block Bandwidth ($BW_{Channel,block}$) is defined as

$$F_{edge,block,low} = F_{C,block,low} - F_{offset,block,low}.$$

The upper sub-block edge of the Sub-block Bandwidth is defined as

$$F_{edge,block,high} = F_{C,block,high} + F_{offset,block,high}.$$

The Sub-block Bandwidth, $BW_{Channel,block}$, is defined as follows:

$$BW_{Channel,block} = F_{edge,block,high} - F_{edge,block,low} \text{ (MHz)}$$

The lower and upper frequency offsets $F_{offset,block,low}$ and $F_{offset,block,high}$ depend on the transmission bandwidth configurations of the lowest and highest assigned edge component carriers within a sub-block and are defined as

$$F_{offset,block,low} = (N_{RB,low} * 12 + 1) * SCS_{low} / 2 + BW_{GB,low} \text{ (MHz)}$$

$$F_{offset,block,high} = (N_{RB,high} * 12 - 1) * SCS_{high} / 2 + BW_{GB,high} \text{ (MHz)}$$

where $N_{RB,low}$ and $N_{RB,high}$ are the transmission bandwidth configurations according to Table 5.3.2-1 for the lowest and highest assigned component carrier within a sub-block, respectively. $BW_{GB,low}$, $BW_{GB,high}$ are the minimum guard band defined in sub-clause 5.3.3 for the lowest and highest assigned component carrier respectively

The sub-block gap size between two consecutive sub-blocks W_{gap} is defined as

$$W_{gap} = F_{edge,block\ n+1,low} - F_{edge,block\ n,high} \text{ (MHz)}$$

5.3A.4 RB alignment with different numerologies for CA

5.3A.5 UE channel bandwidth per operating band for CA

The requirements for carrier aggregation in this specification are defined for carrier aggregation configurations.

For intra-band contiguous carrier aggregation, a carrier aggregation configuration is a single operating band supporting a carrier aggregation bandwidth class with associated bandwidth combination sets specified in clause 5.5A.1. For each carrier aggregation configuration, requirements are specified for all aggregated channel bandwidths contained in a bandwidth combination set, A UE can indicate support of several bandwidth combination sets per carrier aggregation configuration. For intra-band non-contiguous carrier aggregation, a carrier aggregation configuration is a single operating band supporting two or more sub-blocks, each supporting a carrier aggregation bandwidth class.

For inter-band carrier aggregation, a carrier aggregation configuration is a combination of operating bands, each supporting a carrier aggregation bandwidth class.

Table 5.3A.5-1: CA bandwidth classes

NR CA bandwidth class	Aggregated channel bandwidth	Number of contiguous CC	Fallback group
A	$BW_{Channel_CA} \leq BW_{Channel,max}$	1	
B	$20 \text{ MHz} \leq BW_{Channel_CA} \leq 50 \text{ MHz}$	2	
C	$100 \text{ MHz} < BW_{Channel_CA} \leq 2 \times BW_{Channel,max}$	2	1
D	$200 \text{ MHz} < BW_{Channel_CA} \leq 3 \times BW_{Channel,max}$	3	
E	$300 \text{ MHz} < BW_{Channel_CA} \leq 4 \times BW_{Channel,max}$	4	
F	$50 \text{ MHz} < BW_{Channel_CA} \leq 100 \text{ MHz}$	2	2
G	$100 \text{ MHz} < BW_{Channel_CA} \leq 150 \text{ MHz}$	3	
H	$150 \text{ MHz} < BW_{Channel_CA} \leq 200 \text{ MHz}$	4	
I	$200 \text{ MHz} < BW_{Channel_CA} \leq 250 \text{ MHz}$	5	
J	$250 \text{ MHz} < BW_{Channel_CA} \leq 300 \text{ MHz}$	6	
K	$300 \text{ MHz} < BW_{Channel_CA} \leq 350 \text{ MHz}$	7	
L	$350 \text{ MHz} < BW_{Channel_CA} \leq 400 \text{ MHz}$	8	

NOTE: $BW_{Channel,max}$ is maximum channel bandwidth supported among all bands in a release

5.4 Channel arrangement

5.4.1 Channel spacing

5.4.1.1 Channel spacing for adjacent NR carriers

The spacing between carriers will depend on the deployment scenario, the size of the frequency block available and the channel bandwidths. The nominal channel spacing between two adjacent NR carriers is defined as following:

- For NR operating bands with 100 kHz channel raster,

$$\text{Nominal Channel spacing} = (BW_{Channel(1)} + BW_{Channel(2)})/2$$

- For NR operating bands with 15 kHz channel raster,

$$\text{Nominal Channel spacing} = (BW_{Channel(1)} + BW_{Channel(2)})/2 + \{-5\text{kHz}, 0\text{kHz}, 5\text{kHz}\}$$

where $BW_{\text{Channel}(1)}$ and $BW_{\text{Channel}(2)}$ are the channel bandwidths of the two respective NR carriers. The channel spacing can be adjusted depending on the channel raster to optimize performance in a particular deployment scenario.

5.4.2 Channel raster

5.4.2.1 NR-ARFCN and channel raster

The global frequency channel raster defines a set of RF reference frequencies F_{REF} . The RF reference frequency is used in signalling to identify the position of RF channels, SS blocks and other elements.

The global frequency raster is defined for all frequencies from 0 to 100 GHz. The granularity of the global frequency raster is ΔF_{Global} .

RF reference frequencies are designated by an NR Absolute Radio Frequency Channel Number (NR-ARFCN) in the range (0.. 2016666) on the global frequency raster. The relation between the NR-ARFCN and the RF reference frequency F_{REF} in MHz is given by the following equation, where $F_{\text{REF-Offs}}$ and $N_{\text{Ref-Offs}}$ are given in table 5.4.2.1-1 and N_{REF} is the NR-ARFCN.

$$F_{\text{REF}} = F_{\text{REF-Offs}} + \Delta F_{\text{Global}} (N_{\text{REF}} - N_{\text{REF-Offs}})$$

Table 5.4.2.1-1: NR-ARFCN parameters for the global frequency raster

Frequency range (MHz)	ΔF_{Global} (kHz)	$F_{\text{REF-Offs}}$ (MHz)	$N_{\text{REF-Offs}}$	Range of N_{REF}
0 – 3000	5	0	0	0 – 599999
3000 – 24250	15	3000	600000	600000 – 2016666

The channel raster defines a subset of RF reference frequencies that can be used to identify the RF channel position in the uplink and downlink. The RF reference frequency for an RF channel maps to a resource element on the carrier. For each operating band, a subset of frequencies from the global frequency raster are applicable for that band and forms a channel raster with a granularity ΔF_{Raster} , which may be equal to or larger than ΔF_{Global} .

For SUL bands and Bands n1, n2, n3, n5, n7, n8, n20, n28, n66 and n71 defined in Table 5.2-1.

$$F_{\text{REF_shift}} = F_{\text{REF}} + \Delta_{\text{shift}}, \Delta_{\text{shift}} = 0\text{kHz or } 7.5\text{kHz}.$$

where Δ_{shift} is signalled by the network in higher layer parameter *frequencyShift7p5khz* [7].

The mapping between the channel raster and corresponding resource element is given in Section 5.4.2.2. The applicable entries for each operating band are defined in Section 5.4.2.3

5.4.2.2 Channel raster to resource element mapping

The mapping between the RF reference frequency on the channel raster and the corresponding resource element is given in Table 5.4.2.2-1 and can be used to identify the RF channel position. The mapping depends on the total number of RBs that are allocated in the channel and applies to both UL and DL. The mapping must apply to at least one numerology supported by the UE.

Table 5.4.2.2-1: Channel raster to resource element mapping

	$N_{\text{RB}} \bmod 2 = 0$	$N_{\text{RB}} \bmod 2 = 1$
Resource element index k	0	6
Physical resource block number n_{PRB}	$n_{\text{PRB}} = \left\lfloor \frac{N_{\text{RB}}}{2} \right\rfloor$	$n_{\text{PRB}} = \left\lfloor \frac{N_{\text{RB}}}{2} \right\rfloor$

k , n_{PRB} , N_{RB} are as defined in TS 38.211[6].

5.4.2.3 Channel raster entries for each operating band

The RF channel positions on the channel raster in each NR operating band are given through the applicable NR-ARFCN in Table 5.4.2.3-1, using the channel raster to resource element mapping in subclause 5.4.2.2.

For NR operating bands with 100 kHz channel raster, $\Delta F_{\text{Raster}} = 20 \times \Delta F_{\text{Global}}$. In this case every 20th NR-ARFCN within the operating band are applicable for the channel raster within the operating band and the step size for the channel raster in Table 5.4.2.3-1 is given as <20>.

For NR operating bands with 15 kHz channel raster below 3GHz, $\Delta F_{\text{Raster}} I \times \Delta F_{\text{Global}}$, where $I \in \{3,6\}$. Every I^{th} NR-ARFCN within the operating band are applicable for the channel raster within the operating band and the step size for the channel raster in Table 5.4.2.3-1 is given as <I>.

For NR operating bands with 15 kHz channel raster above 3GHz, $\Delta F_{\text{Raster}} I \times \Delta F_{\text{Global}}$, where $I \in \{1,2\}$. Every I^{th} NR-ARFCN within the operating band are applicable for the channel raster within the operating band and the step size for the channel raster in table 5.4.2.3-1 is given as <I>.

In frequency bands with two ΔF_{Raster} , the higher ΔF_{Raster} applies to channels using only the SCS that equals the higher ΔF_{Raster} .

Table 5.4.2.3-1: Applicable NR-ARFCN per operating band

NR Operating Band	ΔF_{Raster} (kHz)	Uplink Range of N_{REF} (First – <Step size> – Last)	Downlink Range of N_{REF} (First – <Step size> – Last)
n1	100	384000 – <20> – 396000	422000 – <20> – 434000
n2	100	370000 – <20> – 382000	386000 – <20> – 398000
n3	100	342000 – <20> – 357000	361000 – <20> – 376000
n5	100	164800 – <20> – 169800	173800 – <20> – 178800
n7	100	500000 – <20> – 514000	524000 – <20> – 538000
n8	100	176000 – <20> – 183000	185000 – <20> – 192000
n12	100	139800 – <20> – 143200	145800 – <20> – 149200
n20	100	166400 – <20> – 172400	158200 – <20> – 164200
n25	100	370000 – <20> – 383000	386000 – <20> – 399000
n28	100	140600 – <20> – 149600	151600 – <20> – 160600
n34	100	402000 – <20> – 405000	402000 – <20> – 405000
n38	100	514000 – <20> – 524000	514000 – <20> – 524000
n39	100	376000 – <20> – 384000	376000 – <20> – 384000
n40	100	460000 – <20> – 480000	460000 – <20> – 480000
n41	15	499200 – <3> – 537999	499200 – <3> – 537999
	30	499200 – <6> – 537996	499200 – <6> – 537996
n50	100	286400 – <20> – 303400	286400 – <20> – 303400
n51	100	285400 – <20> – 286400	285400 – <20> – 286400
n66	100	342000 – <20> – 356000	422000 – <20> – 440000
n70	100	339000 – <20> – 342000	399000 – <20> – 404000
n71	100	132600 – <20> – 139600	123400 – <20> – 130400
n74	100	285400 – <20> – 294000	295000 – <20> – 303600
n75	100	N/A	286400 – <20> – 303400
n76	100	N/A	285400 – <20> – 286400
n77	15	620000 – <1> – 680000	620000 – <1> – 680000
n77	30	620000 – <2> – 680000	620000 – <2> – 680000
n78	15	620000 – <1> – 653333	620000 – <1> – 653333
n78	30	620000 – <2> – 653332	620000 – <2> – 653332
n79	15	693334 – <1> – 733333	693334 – <1> – 733333
n79	30	693334 – <2> – 733332	693334 – <2> – 733332
n80	100	342000 – <20> – 357000	N/A
n81	100	176000 – <20> – 183000	N/A
n82	100	166400 – <20> – 172400	N/A
n83	100	140600 – <20> – 149600	N/A
n84	100	384000 – <20> – 396000	N/A
n86	100	342000 – <20> – 356000	N/A

5.4.3 Synchronization raster

5.4.3.1 Synchronization raster and numbering

The synchronization raster indicates the frequency positions of the synchronization block that can be used by the UE for system acquisition when explicit signalling of the synchronization block position is not present.

A global synchronization raster is defined for all frequencies. The frequency position of the SS block is defined as SS_{REF} with corresponding number GSCN. The parameters defining the SS_{REF} and GSCN for all the frequency ranges are in Table 5.4.3.1-1.

The resource element corresponding to the SS block reference frequency SS_{REF} is given in subclause 5.4.3.2. The synchronization raster and the subcarrier spacing of the synchronization block is defined separately for each band.

Table 5.4.3.1-1: GSCN parameters for the global frequency raster

Frequency range	SS Block frequency position SS_{REF}	GSCN	Range of GSCN
0 – 3000 MHz	$N * 1200\text{kHz} + M * 50\text{ kHz}$, $N=1:2499$, $M \in \{1,3,5\}$ (Note 1)	$3N + (M-3)/2$	2 – 7498
3000-24250 MHz	$3000\text{ MHz} + N * 1.44\text{ MHz}$ $N = 0:14756$	$7499 + N$	7499 – 22255
NOTE 1: The default value for operating bands with SCS spaced channel raster is $M=3$.			

5.4.3.2 Synchronization raster to synchronization block resource element mapping

The mapping between the synchronization raster and the corresponding resource element of the SS block is given in Table 5.4.3.2-1. The mapping depends on the total number of RBs that are allocated in the channel and applies to both UL and DL.

Table 5.4.3.2-1: Synchronization raster to SS block resource element mapping

Resource element index k	0
Physical resource block number n_{PRB} of the SS block	$n_{PRB} = 10$

k , n_{PRB} , are as defined in TS 38.211[6].

5.4.3.3 Synchronization raster entries for each operating band

The synchronization raster for each band is give in Table 5.4.3.3-1. The distance between applicable GSCN entries is given by the <Step size> indicated in Table 5.4.3.3-1.

Table 5.4.3.3-1: Applicable SS raster entries per operating band

NR Operating Band	SS Block SCS	SS Block pattern ¹	Range of GSCN (First – <Step size> – Last)
n1	15kHz	Case A	5279 – <1> – 5419
n2	15kHz	Case A	4829 – <1> – 4969
n3	15kHz	Case A	4517 – <1> – 4693
n5	15kHz	Case A	2177 – <1> – 2230
	30kHz	Case B	2183 – <1> – 2224
n7	15kHz	Case A	6554 – <1> – 6718
n8	15kHz	Case A	2318 – <1> – 2395
n12	15kHz	Case A	1828 – <1> – 1858
n20	15kHz	Case A	1982 – <1> – 2047
n25	15 kHz	Case A	4829 – <1> – 4981
n28	15kHz	Case A	1901 – <1> – 2002
n34	15kHz	Case A	5030 – <1> – 5056
n38	15kHz	Case A	6431 – <1> – 6544
n39	15kHz	Case A	4706 – <1> – 4795
n40	15kHz	Case A	5756 – <1> – 5995
n41	15kHz	Case A	6246 – <3> – 6717
	30 kHz	Case C	6252 – <3> – 6714
n50	15kHz	Case A	3584 – <1> – 3787
n51	15kHz	Case A	3572 – <1> – 3574
n66	15kHz	Case A	5279 – <1> – 5494
	30kHz	Case B	5285 – <1> – 5488
n70	15kHz	Case A	4993 – <1> – 5044
n71	15kHz	Case A	1547 – <1> – 1624
n74	15kHz	Case A	[3692 – <1> – 3790]
n75	15kHz	Case A	3584 – <1> – 3787
n76	15kHz	Case A	3572 – <1> – 3574
n77	30kHz	Case C	7711 – <1> – 8329
n78	30kHz	Case C	7711 – <1> – 8051
n79	30kHz	Case C	8480 – <16> – 8880

NOTE 1: SS Block pattern is defined in section 4.1 in TS 38.213 [8]

5.4.4 TX–RX frequency separation

The default TX channel (carrier centre frequency) to RX channel (carrier centre frequency) separation for operating bands is specified in Table 5.4.4-1.

Table 5.4.4-1: Default UE TX-RX frequency separation

NR Operating Band	TX – RX carrier centre frequency separation
n1	190 MHz
n2	80 MHz
n3	95 MHz
n5	45 MHz
n7	120 MHz
n8	45 MHz
n12	30 MHz
n20	-41 MHz
n25	80 MHz
n28	55 MHz
n66	400 MHz
n70	295,300 ¹ MHz
n71	-46 MHz
n74	48 MHz

NOTE 1: Default TX-RX carrier centre frequency separation.

5.4A Channel arrangement for CA

5.4A.1 Channel spacing for CA

For intra-band contiguous carrier aggregation with two or more component carriers, the nominal channel spacing between two adjacent NR component carriers is defined as the following unless stated otherwise:

For NR operating bands with 100 kHz channel raster:

$$\text{Nominal channel spacing} = \left\lfloor \frac{BW_{\text{Channel (1)}} + BW_{\text{Channel (2)}} - 2|GB_{\text{Channel (1)}} - GB_{\text{Channel (2)}}|}{0.6} \right\rfloor 0.3 \text{ [MHz]}$$

For NR operating bands with 15 kHz channel raster:

$$\text{Nominal channel spacing} = \left\lfloor \frac{BW_{\text{Channel (1)}} + BW_{\text{Channel (2)}} - 2|GB_{\text{Channel (1)}} - GB_{\text{Channel (2)}}|}{0.015 * 2^{n+1}} \right\rfloor 0.015 * 2^n \text{ [MHz]}$$

with

$$n = \max(\mu_1, \mu_2)$$

where $BW_{\text{Channel(1)}}$ and $BW_{\text{Channel(2)}}$ are the channel bandwidths of the two respective NR component carriers according to Table 5.3.2-1 with values in MHz. and the $GB_{\text{Channel(i)}}$ is the minimum guard band defined in sub-clause 5.3.3, while μ_1 and μ_2 are the subcarrier spacing configurations of the component carriers as defined in TS 38.211. The channel spacing for intra-band contiguous carrier aggregation can be adjusted to any multiple of least common multiple of channel raster and sub-carrier spacing less than the nominal channel spacing to optimize performance in a particular deployment scenario.

For intra-band non-contiguous carrier aggregation the channel spacing between two NR component carriers in different sub-blocks shall be larger than the nominal channel spacing defined in this subclause.

5.4A.2 Channel raster for CA

For inter-band carrier aggregation, the channel raster requirements in subclause 5.4.2 apply for each operating band.

5.4A.3 Synchronization raster for CA

For inter-band carrier aggregation, the synchronization raster requirements in subclause 5.4.3 apply for each operating band.

5.4A.4 Tx-Rx frequency separation for CA

For inter-band carrier aggregation, the Tx-Rx frequency separation requirements in subclause 5.4.4 apply for each operating band.

5.5 Configurations

5.5A Configurations for CA

5.5A.1 Configurations for intra-band contiguous CA

Table 5.5A.1-1: NR CA configurations and bandwidth combination sets defined for intra-band contiguous CA

E-UTRA CA configuration / Bandwidth combination set								
NR CA configuration	Uplink CA configurations	Component carriers in order of increasing carrier frequency					Aggregated bandwidth (MHz)	Bandwidth combination set
		Channel bandwidths for carrier (MHz)	Channel bandwidths for carrier (MHz)	Channel bandwidths for carrier (MHz)	Channel bandwidths for carrier (MHz)	Channel bandwidths for carrier (MHz)		
CA_n77C CA_n78C CA_n79C		50	60				110	0
		60	60				120	
		50	80				130	
		60	80				140	
		50	100				150	
		60	100				160	
		80	80				180	
		80	100				200	
CA_n77D, CA_n78D, CA_n79D		50	60	100			210	
		60	60	100			220	
		50	80	100			230	
		60	80	100			240	
		50	100	100			250	
		80	80	100			260	
		80	90	100			270	
		80	100	100			280	
		90	100	100			290	
100	100	100			300			
CA_n77E, CA_n78E, CA_n79E		50	60	100	100		310	
		60	60	100	100		320	
		50	80	100	100		330	
		60	80	100	100		340	
		50	100	100	100		350	
		80	80	100	100		360	
		80	90	100	100		370	
		80	100	100	100		380	
		90	100	100	100		390	
100	100	100	100		400			

Table 5.5A.1-2: NR CA configurations and bandwidth combination sets defined for intra-band contiguous CA for fallback group 2

NR CA configuration	Uplink CA configurations	E-UTRA CA configuration / Bandwidth combination set				
		Component carriers in order of increasing carrier frequency			aggregated bandwidth (MHz)	Bandwidth combination set
		Channel bandwidths for carrier (MHz)	Channel bandwidths for carrier (MHz)	Channel bandwidths for the other carrier (MHz)		
CA_n77F, CA_n78F, CA_n79F		40	20		60	0
		50	20		70	
		40	40		80	
		40	50		90	
		50	50		100	
CA_n77G, CA_n78G, CA_n79G		40	20	50	110	
		50	20	50	120	
		40	40	50	130	
		40	50	50	140	
		50	50	50	150	
CA_n77H, CA_n78H, CA_n79H		40	20	50x2	160	
		50	20	50x2	170	
		40	40	50x2	180	
		40	50	50x2	190	
		50	50	50x2	200	
CA_n77I, CA_n78I, CA_n79I		40	20	50x3	210	
		50	20	50x3	220	
		40	40	50x3	230	
		40	50	50x3	240	
		50	50	50x3	250	
CA_n77J, CA_n78J, CA_n79J		40	20	50x4	260	
		50	20	50x4	270	
		40	40	50x4	280	
		40	50	50x4	290	
		50	50	50x4	300	
CA_n77K, CA_n78K, CA_n79K		40	20	50x5	310	
		50	20	50x5	320	
		40	40	50x5	330	
		40	50	50x5	340	
		50	50	50x5	350	
CA_n77L, CA_n78L, CA_n79L		40	20	50x6	360	
		50	20	50x6	370	
		40	40	50x6	380	
		40	50	50x6	390	
		50	50	50x6	400	

5.5A.2 Configurations for intra-band non-contiguous CA

Detailed structure of the subclause is TBD.

5.5A.3 Configurations for inter-band CA

Table 5.5A.3-1: NR CA configurations and bandwidth combinations sets defined for inter-band CA (two bands)

NR CA configuration	Uplink CA configuration	NR Band	SCS (kHz)	5 MHz	10 MHz	15 MHz	20 MHz	25 MHz	30 MHz	40 MHz	50 MHz	60 MHz	80 MHz	90 MHz	100 MHz	Bandwidth combination set	
CA_n3A-n77A	-	n3	15	Yes	Yes	Yes	Yes	Yes	Yes							0	
			30		Yes	Yes	Yes	Yes	Yes								
			60		Yes	Yes	Yes	Yes	Yes								
		n77	15		Yes	Yes	Yes			Yes	Yes						
			30		Yes	Yes	Yes			Yes	Yes	Yes	Yes	Yes	Yes		Yes
			60		Yes	Yes	Yes			Yes	Yes	Yes	Yes	Yes	Yes		Yes
CA_n3A-n78A	CA_n3A-n78A	n3	15	Yes	Yes	Yes	Yes	Yes	Yes							0	
			30		Yes	Yes	Yes	Yes	Yes								
			60		Yes	Yes	Yes	Yes	Yes								
		n78	15		Yes	Yes	Yes			Yes	Yes						
			30		Yes	Yes	Yes			Yes	Yes	Yes	Yes	Yes	Yes		Yes
			60		Yes	Yes	Yes			Yes	Yes	Yes	Yes	Yes	Yes		Yes
CA_n3A-n79A	-	n3	15	Yes	Yes	Yes	Yes	Yes	Yes							0	
			30		Yes	Yes	Yes	Yes	Yes								
			60		Yes	Yes	Yes	Yes	Yes								
		n79	15		Yes	Yes	Yes			Yes	Yes						
			30		Yes	Yes	Yes			Yes	Yes	Yes	Yes		Yes		
			60		Yes	Yes	Yes			Yes	Yes	Yes	Yes		Yes		
CA_n8A-n75A	-	n8	15	Yes	Yes	Yes	Yes									0	
			30		Yes	Yes	Yes										
			60														
		n75	15	Yes	Yes	Yes	Yes										
			30		Yes	Yes	Yes										
			60		Yes	Yes	Yes										
CA_n8A-n78A	CA_n8A-n78A	n8	15	Yes	Yes	Yes	Yes									0	
			30		Yes	Yes	Yes										
			60														
		n78	15		Yes	Yes	Yes			Yes	Yes						
			30		Yes	Yes	Yes			Yes	Yes	Yes	Yes	Yes	Yes		Yes
			60		Yes	Yes	Yes			Yes	Yes	Yes	Yes	Yes	Yes		Yes
CA_n8A-n79A	-	n8	15	Yes	Yes	Yes	Yes									0	
			30		Yes	Yes	Yes										
			60														
		n79	15		Yes	Yes	Yes			Yes	Yes						
			30		Yes	Yes	Yes			Yes	Yes	Yes	Yes		Yes		
			60		Yes	Yes	Yes			Yes	Yes	Yes	Yes		Yes		
CA_n28A-n75A	-	N28	15	Yes	Yes	Yes	Yes									0	
			30		Yes	Yes	Yes										
			60														
		n75	15	Yes	Yes	Yes	Yes										
			30		Yes	Yes	Yes										
			60		Yes	Yes	Yes										
CA_n28A-n78A	-	n28	15	Yes	Yes	Yes	Yes									0	
			30		Yes	Yes	Yes										
			60														
		n78	15		Yes	Yes	Yes			Yes	Yes						
			30		Yes	Yes	Yes			Yes	Yes	Yes	Yes	Yes	Yes		Yes
			60		Yes	Yes	Yes			Yes	Yes	Yes	Yes	Yes	Yes		Yes
CA_n41A-n78A	-	n41	15		Yes	Yes	Yes			Yes	Yes					0	
			30		Yes	Yes	Yes			Yes	Yes	Yes	Yes		Yes		
			60		Yes	Yes	Yes			Yes	Yes	Yes	Yes		Yes		
		n78	15		Yes	Yes	Yes			Yes	Yes						
			30		Yes	Yes	Yes			Yes	Yes	Yes	Yes	Yes	Yes		Yes
			60		Yes	Yes	Yes			Yes	Yes	Yes	Yes	Yes	Yes		Yes
CA_n75A-n78A	-	n75	15	Yes	Yes	Yes	Yes									0	
			30		Yes	Yes	Yes										
			60		Yes	Yes	Yes										
		n78	15		Yes	Yes	Yes			Yes	Yes						
			30		Yes	Yes	Yes			Yes	Yes	Yes	Yes	Yes	Yes		Yes
			60		Yes	Yes	Yes			Yes	Yes	Yes	Yes	Yes	Yes		Yes

CA n76A- n78A	-	n76	15	Yes												0
			30													
			60													
		n78	15		Yes	Yes	Yes			Yes	Yes					
			30		Yes	Yes	Yes			Yes	Yes	Yes	Yes	Yes	Yes	
			60		Yes	Yes	Yes			Yes	Yes	Yes	Yes	Yes	Yes	
CA_n77A -n79A	-	n77	15		Yes	Yes	Yes			Yes	Yes					0
			30		Yes	Yes	Yes			Yes	Yes	Yes	Yes	Yes	Yes	
			60		Yes	Yes	Yes			Yes	Yes	Yes	Yes	Yes	Yes	
		n79	15							Yes	Yes					
			30							Yes	Yes	Yes	Yes		Yes	
			60							Yes	Yes	Yes	Yes		Yes	
CA_n78A -n79A	-	n78	15		Yes	Yes	Yes			Yes	Yes				0	

5.5B Configurations for DC

5.5C Configurations for SUL

Table 5.5C-1: Supported channel bandwidths per SUL band combination

SUL configuration	NR Band	Subcarrier spacing (kHz)	5 MHz	10 MHz	15 MHz	20 MHz	25 MHz	30 MHz	40 MHz	50 MHz	60 MHz	80 MHz	90 MHz	100 MHz
SUL_n78A-n80A	n78	15		Yes	Yes	Yes			Yes	Yes				
		30		Yes	Yes	Yes			Yes	Yes	Yes	Yes	Yes	Yes
		60		Yes	Yes	Yes			Yes	Yes	Yes	Yes	Yes	Yes
	n80	15	Yes	Yes	Yes	Yes	Yes	Yes						
SUL_n78A-n81A	n78	15		Yes	Yes	Yes			Yes	Yes				
		30		Yes	Yes	Yes			Yes	Yes	Yes	Yes	Yes	Yes
		60		Yes	Yes	Yes			Yes	Yes	Yes	Yes	Yes	Yes
	n81	15	Yes	Yes	Yes	Yes								
SUL_n78A-n82A	n78	15		Yes	Yes	Yes			Yes	Yes				
		30		Yes	Yes	Yes			Yes	Yes	Yes	Yes	Yes	Yes
		60		Yes	Yes	Yes			Yes	Yes	Yes	Yes	Yes	Yes
	n82	15	Yes	Yes	Yes	Yes								
SUL_n78A-n83A	n78	15		Yes	Yes	Yes			Yes	Yes				
		30		Yes	Yes	Yes			Yes	Yes	Yes	Yes	Yes	Yes
		60		Yes	Yes	Yes			Yes	Yes	Yes	Yes	Yes	Yes
	n83	15	Yes	Yes	Yes	Yes								
SUL_n78A-n84A	n78	15		Yes	Yes	Yes			Yes	Yes				
		30		Yes	Yes	Yes			Yes	Yes	Yes	Yes	Yes	Yes
		60		Yes	Yes	Yes			Yes	Yes	Yes	Yes	Yes	Yes
	n84	15	Yes	Yes	Yes	Yes								
SUL_n78A-n86A	n78	15		Yes	Yes	Yes			Yes	Yes				
		30		Yes	Yes	Yes			Yes	Yes	Yes	Yes	Yes	Yes
		60		Yes	Yes	Yes			Yes	Yes	Yes	Yes	Yes	Yes
	n86	15	Yes	Yes	Yes	Yes								
SUL_n79A-n80A	n79	15							Yes	Yes				
		30							Yes	Yes	Yes	Yes		Yes
		60							Yes	Yes	Yes	Yes		Yes
	n80	15	Yes	Yes	Yes	Yes	Yes	Yes						
SUL_n79A-n81A	n79	15							Yes	Yes				
		30							Yes	Yes	Yes	Yes		Yes
		60							Yes	Yes	Yes	Yes		Yes
	n81	15	Yes	Yes	Yes	Yes								

6 Transmitter characteristics

6.1 General

Unless otherwise stated, the transmitter characteristics are specified at the antenna connector of the UE with a single or multiple transmit antenna(s). For UE with integral antenna only, a reference antenna with a gain of 0 dBi is assumed.

6.2 Transmitter power

6.2.1 UE maximum output power

The following UE Power Classes define the maximum output power for any transmission bandwidth within the channel bandwidth of NR carrier unless otherwise stated. The period of measurement shall be at least one sub frame (1ms).

Table 6.2.1-1: UE Power Class

NR band	Class 1 (dBm)	Tolerance (dB)	Class 2 (dBm)	Tolerance (dB)	Class 3 (dBm)	Tolerance (dB)
n1					23	± 2
n2					23	± 2 ³
n3					23	± 2 ³
n5					23	± 2
n7					23	± 2 ³
n8					23	± 2 ³
n12					23	± 2 ³
n20					23	± 2 ³
n25					23	± 2
n28					23	+2 / - 2.5
n34					23	± 2
n38					23	± 2
n39					23	± 2
n40					23	± 2
n41			26	+2/-3 ³	23	± 2 ³
n50					23	± 2
n51					23	± 2
n66					23	± 2
n70					23	± 2
n71					23	+2 / - 2.5
n74					23	± 2
n77			26	+2/-3	23	+2/-3
n78			26	+2/-3	23	+2/-3
n79			26	+2/-3	23	+2/-3
n80					23	± 2
n81					23	± 2
n82					23	± 2
n83					23	± 2/-2.5
n84					23	± 2
n86					23	± 2
NOTE 1: P _{PowerClass} is the maximum UE power specified without taking into account the tolerance						
NOTE 2: Power class 3 is default power class unless otherwise stated						
NOTE 3: Refers to the transmission bandwidths (Figure 5.3.3-1) confined within F _{UL_low} and F _{UL_low} + 4 MHz or F _{UL_high} – 4 MHz and F _{UL_high} , the maximum output power requirement is relaxed by reducing the lower tolerance limit by 1.5 dB						

If a UE supports a different power class than the default UE power class for the band and the supported power class enables the higher maximum output power than that of the default power class:

- if the field of UE capability maxUplinkDutyCycle is absent and the percentage of uplink symbols transmitted in a certain evaluation period is larger than 50% (The exact evaluation period is no less than one radio frame); or

- if the field of UE capability *maxUplinkDutyCycle* is not absent and the percentage of uplink symbols transmitted in a certain evaluation period is larger than *maxUplinkDutyCycle* as defined in TS 38.331 (The exact evaluation period is no less than one radio frame); or
- [may] apply all requirements for the default power class to the supported power class and set the configured transmitted power as specified in sub-clause 6.2.4;
- if the IE P-Max as defined in TS 38.331 [7] is not provided; or
- if the IE P-Max as defined in TS 38.331 [7] is provided and set to the maximum output power of the default power class or lower;
- shall apply all requirements for the default power class to the supported power class and set the configured transmitted power as specified in sub-clause 6.2.4;
- else (i.e the IE *P-Max* as defined in TS 38.331 [7] is provided and set to the higher value than the maximum output power of the default power class and the percentage of uplink symbols transmitted in a certain evaluation period is less than or equal to *maxUplinkDutyCycle* as defined in TS 38.331; or the IE *P-Max* as defined in TS 38.331 [7] is provided and set to the higher value than the maximum output power of the default power class and the percentage of uplink symbols transmitted in a certain evaluation period is less than or equal to 50% when *maxUplinkDutyCycle* is absent. (The exact evaluation period is no less than one radio frame):
- shall apply all requirements for the supported power class and set the configured transmitted power class as specified in sub-clause 6.2.4;

6.2.2 UE maximum output power reduction

UE is allowed to reduce the maximum output power due to higher order modulations and transmit bandwidth configurations. For UE Power Class [2] and 3, the allowed maximum power reduction (MPR) is defined in Table 6.2.2-2 and Table 6.2.2-1, respectively for channel bandwidths that meets both following criteria:

Channel bandwidth ≤ 100 MHz.

Relative channel bandwidth $\leq 4\%$ for TDD bands and $\leq 3\%$ for FDD bands

Where relative channel bandwidth = $2 \cdot BW_{\text{Channel}} / (F_{\text{UL_low}} + F_{\text{UL_high}})$

Table 6.2.2-1 Maximum power reduction (MPR) for power class 3

Modulation	MPR (dB)		
	Edge RB allocations	Outer RB allocations	Inner RB allocations
DFT-s-OFDM PI/2 BPSK	$\leq 3.5^1$	$\leq 1.2^1$	$\leq 0.2^1$
	0.5^2	0.5^2	0^2
DFT-s-OFDM QPSK	≤ 1		0
DFT-s-OFDM 16 QAM	≤ 2		≤ 1
DFT-s-OFDM 64 QAM	≤ 2.5		
DFT-s-OFDM 256 QAM	4.5		
CP-OFDM QPSK	≤ 3		≤ 1.5
CP-OFDM 16 QAM	≤ 3		≤ 2
CP-OFDM 64 QAM	≤ 3.5		
CP-OFDM 256 QAM	≤ 6.5		

NOTE 1: Applicable for UE operating in TDD mode with PI/2 BPSK modulation and if the IE [P-Boost-BPSK] is set to 1 and 40% or less slots in radio frame are used for UL transmission for bands n40, n77, n78 and n79.

NOTE 2: Applicable for UE operating in FDD mode, or in TDD mode in bands other than n40, n77, n78 and n79 and if the IE [P-Boost-BPSK] is set to 0 and if more than 40% of slots in radio frame are used for UL transmission for bands n40, n77, n78 and n79.

Table 6.2.2-2 Maximum power reduction (MPR) for power class 2

Modulation	MPR (dB)		
	Edge RB allocations	Outer RB allocations	Inner RB allocations

DFT-s-OFDM PI/2 BPSK	≤ 3.5	≤ 0.5	0
DFT-s-OFDM QPSK	≤ 3.5	≤ 1	0
DFT-s-OFDM 16 QAM	≤ 3.5	≤ 2	≤ 1
DFT-s-OFDM 64 QAM	≤ 3.5	≤ 2.5	
DFT-s-OFDM 256 QAM		≤ 4.5	
CP-OFDM QPSK	≤ 3.5	≤ 3	≤ 1.5
CP-OFDM 16 QAM	≤ 3.5	≤ 3	≤ 2
CP-OFDM 64 QAM		≤ 3.5	
CP-OFDM 256 QAM		≤ 6.5	

Where the following parameters are defined to specify valid RB allocation ranges for Outer and Inner RB allocations:

N_{RB} is the maximum number of RBs for a given Channel bandwidth and sub-carrier spacing defined in Table 5.3.2-1.

$$RB_{Start,Low} = \max(1, \text{floor}(L_{CRB}/2))$$

where $\max()$ indicates the largest value of all arguments and $\text{floor}(x)$ is the greatest integer less than or equal to x .

$$RB_{Start,High} = N_{RB} - RB_{Start,Low} - L_{CRB}$$

The RB allocation is an Inner RB allocation if the following conditions are met

$$RB_{Start,Low} \leq RB_{Start} \leq RB_{Start,High}, \text{ and}$$

$$L_{CRB} \leq \text{ceil}(N_{RB}/2)$$

where $\text{ceil}(x)$ is the smallest integer greater than or equal to x .

An Edge RB allocation is one for which the RB's are allocated at the lowermost or uppermost edge of the channel with $L_{CRB} \leq 2$ RB's.

The RB allocation is an Outer RB allocation for all other allocations which are not an Inner RB allocation or Edge RB allocation.

If CP-OFDM allocation satisfies following conditions it is considered as almost contiguous allocation

$$N_{RB_gap} / (N_{RB_alloc} + N_{RB_gap}) \leq 0.25$$

and $N_{RB_alloc} + N_{RB_gap}$ is larger than 106, 51 or 24 RBs for 15 kHz, 30 kHz or 60 kHz respectively where N_{RB_gap} is number of unallocated RBs between allocated RBs and N_{RB_alloc} is number of allocated RBs. For these almost contiguous signals in power class 3, the allowed maximum power reduction defined in Table 6.2.2-1 is increased by

$$\text{CEIL}(10 \log_{10}(1 + N_{RB_gap} / N_{RB_alloc}), 0.5) \text{ dB.}$$

For the UE maximum output power modified by MPR, the power limits specified in subclause 6.2.4 apply.

6.2.3 UE additional maximum output power reduction

6.2.3.1 General

Additional emission requirements can be signalled by the network. Each additional emission requirement is associated with a unique network signalling (NS) value indicated in RRC signalling by a frequency band number of the applicable operating band [in the field *frequencyBandList*] and an associated value in the field *additionalSpectrumEmission*. Throughout this specification, the notion of indication or signalling of an NS value refers to the corresponding indication of a frequency band [in the field *frequencyBandList*] and an associated value of *additionalSpectrumEmission* in the relevant RRC information elements [7].

To meet the additional requirements, additional maximum power reduction (A-MPR) is allowed for the maximum output power as specified in Table 6.2.1-1. Unless stated otherwise, an A-MPR of 0 dB shall be used.

Table 6.2.3-1 specifies for UE Power Class 3 the additional requirements with their associated network signalling values and the allowed A-MPR and applicable operating band(s) for each NS value. The mapping between network signalling labels and the *additionalSpectrumEmission* IE defined in TS 38.331 [7] is specified in Table 6.2.3-1A. Unless otherwise stated, the allowed A-MPR is in addition to the allowed MPR specified in subclause 6.2.2.

Table 6.2.3-1: Additional maximum power reduction (A-MPR)

Network Signalling label	Requirements (subclause)	NR Band	Channel bandwidth (MHz)	Resources Blocks (N_{RB})	A-MPR (dB)	Value of additional Spectrum Emission
NS_01					N/A	1
NS_03	6.5.2.3.3	n2, n25, n66, n70			Table 6.2.3.7-1	3
NS_03U	6.5.2.3.3, 6.5.2.4.2	n2, n25, n66			FFS	
NS_04	6.5.2.3.1	n41	10, 15, 20, 40, 50, 60 80, 100		Subclause 6.2.3.2	4
NS_05	6.5.3.3.4	n1, n84	5, 10, 15, 20 ⁵		Subclause 6.2.3.4	
NS_05U	6.5.3.3.4, 6.5.2.4.2	n1, n84	5, 10, 15, 20		FFS	
NS_06	6.5.2.3.4	n12	5, 10, 15	5.3.5	N/A	2
NS_08	6.5.3.3.5	n8, n81	5, 10, 15		Subclause 6.2.3.6	NS_08
NS_08U	6.5.3.3.5, 6.5.2.4.2	n8, n81	5, 10, 15		FFS	NS_08U
NS_10		n20, n82	15, 20	Table 6.2.3.3-1	Table 6.2.3.3-1	NS_xx
NS_17	6.5.3.3.2	n28, n83	5,10	Table 5.3.2-1	[1] ^{3,4}	
NS_18	6.5.3.3.3	n28, n83	5	≥ 2	$\leq 2^4$	
			10, 15, 20	≥ 1	$\leq 5^4$	
NS_35	6.5.2.3.1	n71	5, 10, 15, 20	Table 5.3.2-1	N/A	2
NS_37	6.5.3.3.6	n74(NOTE6)	10, 15	Table 6.2.3.8-1	Table 6.2.3.8-1	1
NS_38	6.5.3.3.7	n74	5, 10, 15, 20	Table 6.2.3.9-1	Table 6.2.3.9-1	2
NS_39	6.5.3.3.8	n74	10, 15, 20	Table 6.2.3.10-1	Table 6.2.3.10-1	3
NS_40	6.5.2.3.7	n51	5		Table 6.2.3.5-1	
NS_41	6.5.2.3.6	n50	5, 10, 15, 20, 40, 50, 60		Table 6.2.3.11-1	
NS_42	6.5.2.3.7	n50	5, 10, 15, 20, 40, 50, 60		Table 6.2.3.12-1	
NS_100	6.5.2.4.2	n1, n2, n3, n5, n8, n20, n25, n66, n80, n81, n82, n84, NOTE 1			Table 6.2.3-2	

NOTE 1: This NS can be signalled for NR bands that have UTRA services deployed

NOTE 2: The total maximum output power reduction for NS_17 and NS_18 is obtained by taking the maximum value of MPR + A-MPR specified in Table 6.2.3-1 and Table 6.2.4-1 in TS 36.101 and A-MPR specified in Table 6.2.3-1.

NOTE 3: The A-MPR is 0dB for inner RB allocations for DFT-s-OFDM PI/2 BPSK and QPSK.

NOTE 4: The A-MPR for CP-OFDM shall also add the corresponding MPR specified in Table 6.2.2-1.

NOTE 5: No A-MPR is applied for 5MHz CBW where the lower channel edge is ≥ 1930 MHz, 10MHz CBW where the lower channel edge is ≥ 1950 MHz and 15MHz CBW where the lower channel edge is ≥ 1955 MHz.

NOTE 6: Applicable when the NR carrier is within 1447.9 – 1462.9 MHz

Table 6.2.3-1A: Mapping of Network Signaling label

NR band	Value of additionalSpectrumEmission							
	0	1	2	3	4	5	6	7
n1	NS_01	NS_100	NS_05	NS_05U				
n2	NS_01	NS_100	NS_03	NS_03U				
n3	NS_01	NS_100						
n5	NS_01	NS_100						
n7	NS_01							
n8	NS_01	NS_100	NS_08	NS_08U				
n12	NS_01	NS_06						
n20	NS_01	NS_100	NS_10					
n25	NS_01	NS_100	NS_03	NS_03U				
n28	NS_01	NS_17	NS_18					
n34	NS_01							
n38	NS_01							
n39	NS_01							
n40	NS_01	NS_40						
n41	NS_01	NS_04						
n51	NS_01							
n66	NS_01	NS_100	NS_03	NS_03U				
n70	NS_01	NS_03						
n71	NS_01	NS_35						
n75	NS_01							
n76	NS_01							
n77	NS_01							
n78	NS_01							
n79	NS_01							
n80	NS_01	NS_100						
n81	NS_01	NS_100	NS_08	NS_08U				
n82	NS_01	NS_100	NS_10					
n83	NS_01	NS_17	NS_18					
n84	NS_01	NS_100	NS_05	NS_05U				
n86	NS_01							
NOTE:	additionalSpectrumEmission corresponds to an information element of the same name defined in sub-clause 6.3.2 of TS 38.331 [7].							

Table 6.2.3-2: A-MPR for UTRA protections

Modulation	A-MPR	
	Outer RB allocations	Inner RB allocations
DFT-s-OFDM PI/2 BPSK	≤ 1.5	0
DFT-s-OFDM QPSK	≤ 1	0
DFT-s-OFDM 16 QAM	≤ 0.5	0
DFT-s-OFDM 64 QAM	≤ 0.5	0
DFT-s-OFDM 256 QAM	0	0
CP-OFDM QPSK	≤ 1	0
CP-OFDM 16 QAM	≤ 1	0
CP-OFDM 64 QAM	≤ 0.5	0
CP-OFDM 256 QAM	0	0

NOTE 1: A-MPR defined in this Table is additive to MPR defined in Table 6.2.2-1
NOTE 2: Outer and inner allocations are defined in clause 6.2.2

6.2.3.2 A-MPR for NS_04

If a UE is configured for n41 on the uplink and it receives IE NS_04 the allowed maximum power reduction applied to transmissions on n41 is defined as follows. For NS_04, A-MPR is not added to MPR. Also, when NS_04 is signalled, MPR shall be set to zero in the P_{CMAX} equations to avoid double-counting MPR.

Allowed maximum power reduction is defined as $A-MPR = \max(MPR, A-MPR')$,

Note that $A-MPR' = 0$ dB means only MPR is applied,

where $A-MPR'$ is defined as

```

if  $RB_{start} \leq f_{start,max,IMD3} / (12 \cdot SCS)$  and  $L_{CRB} \leq AW_{max,IMD3} / (12 \cdot SCS)$  and  $F_c - BW_{channel}/2 < F_{UL,low} + offset_{IMD3}$ ,
then
    the  $A-MPR'$  is defined according to Table 6.2.3.2-2 PC3_A2 for Power Class 3 and PC2 A4 for Power
    Class 2,
else,
if  $RB_{start} \leq L_{CRB}/2 + \Delta_{start} / (12 \cdot SCS)$  and  $L_{CRB} \leq AW_{max,regrowth} / (12 \cdot SCS)$  and  $F_c - BW_{channel}/2 < F_{UL,low} +$ 
 $offset_{regrowth}$ ,
then
    the  $A-MPR'$  is defined according to Table 6.2.3.2-2 PC3_A1 for Power Class 3 and PC2 A3 for Power
    Class 2,
else
     $A-MPR' = 0$  dB and apply MPR.

```

With the parameters defined in Table 6.2.3.2-1.

Table 6.2.3.2-1: Parameters for region edges and frequency offsets

Parameter	Symbol	Value		Related condition
		OFDM	DFT-S-OFDM	
Max allocation start in IMD3 region	$f_{\text{start,max,IMD3}}$	0.33 BW_{Channel}		$RB_{\text{start}} \leq f_{\text{start,max,IMD3}} / (12\text{SCS})$
Max allocation BW in IMD3 region	$AW_{\text{max,IMD3}}$	4 MHz		$LCRB \leq AW_{\text{max,IMD3}} / (12\text{SCS})$
Max freq. offset for IMD3 region	$\text{offset}_{\text{max,IMD3}}$	$BW_{\text{Channel}} - 6\text{MHz}$		
Freq. offset required to avoid A-MPR in IMD3 region	$\text{offset}_{\text{IMD3}}$	$\text{offset}_{\text{max,IMD3}}$		$F_C - BW_{\text{Channel}}/2 \geq F_{\text{UL_low}} + \text{offset}_{\text{IMD3}}$
Right edge of regrowth region	Δ_{start}	0.08 BW_{Channel}		$RB_{\text{start}} \leq LCRB/2 + \Delta_{\text{start}} / (12\text{SCS})$
Max allocation BW in regrowth region	$AW_{\text{max,regrowth}}$	100 MHz		$LCRB \leq \text{Min}(LCRB_{\text{Max}}, AW_{\text{max,regrowth}} / (12\text{SCS}))$
Freq. offset required to avoid A-MPR in regrowth region	$\text{offset}_{\text{regrowth}}$	Max (10 MHz, $0.25 * BW_{\text{Channel}}$ MHz)	Max (10 MHz, $0.45 * BW_{\text{Channel}}$ MHz)	$F_C - BW_{\text{Channel}}/2 \geq F_{\text{UL_low}} + \text{offset}_{\text{regrowth}}$

Table 6.2.3.2-2: A-MPR' valuesAccess	Modulation	MPR' (dB)			
		PC3_A1	PC3_A2	PC2_A3	PC2_A4
DFT-S-OFDM	pi/2-BPSK	3.5	3.5	3.5	[5.5]
	QPSK	4	4	4.5	[6]
	16-QAM	4	4	5	[6]
	64-QAM		4.5	5	[6.5]
	256-QAM	4.5	6	6.5	[8]
CP-OFDM	QPSK	5.5	5.5	6.5	[7.5]
	16-QAM	5.5	5.5	6.5	[7.5]
	64-QAM	5.5	5.5	6.5	[7.5]
	256-QAM	6.5	8	7.5	[10]

NOTE: The A-MPR' values in this table apply for both A-MPR relative to 23 dBm for PC3 and A-MPR relative to 26 dBm for PC2

6.2.3.3 A-MPR for NS_10

Table 6.2.3.3-1: A-MPR for "NS_10"

Channel bandwidth [MHz]	Parameters	Region A
15	RB _{start}	[0 – 10]
	L _{CRB} [RBs]	[1 -20]
	A-MPR [dB]	≤ 3 ⁶
20	RB _{start}	[0 – 15]
	L _{CRB} [RBs]	[1 -20]
	A-MPR [dB]	≤ 6 ⁶
<p>NOTE 1: RB_{start} indicates the lowest RB index of transmitted resource blocks</p> <p>NOTE 2: L_{CRB} is the length of a contiguous resource block allocation</p> <p>NOTE 3: For intra-subframe frequency hopping which intersects Region A, notes 1 and 2 apply on a per slot basis. For intra-slot or intra-subslot frequency hopping which intersects Region A, notes 1 and 2 apply on a T_{no_hopping} basis.</p> <p>NOTE 4: For intra-subframe frequency hopping which intersect Region A, the larger A-MPR value may be applied for both slots in the subframe. For intra-slot frequency hopping which intersects Region A, the larger A-MPR value may be applied for the slot. For intra-subslot frequency hopping which intersects Region A, the larger A-MPR value may be applied for the subslot.</p> <p>NOTE 5: The total maximum output power reduction for NS_10 is obtained by taking the maximum value of MPR + A-MPR specified in Table 6.2.3-1 and Table 6.2.4-1 in TS 36.101 and A-MPR specified in Table 6.2.3.3-1.</p> <p>NOTE 6: The A-MPR for CP-OFDM shall also add the corresponding MPR specified in Table 6.2.2-1.</p>		

6.2.3.4 A-MPR for NS_05

Table 6.2.3.4-1: A-MPR for NS_05

Channel Bandwidth, MHz	Carrier Centre Frequency, F_c , MHz	Region A			Region B			Region C		
		Rbstart	LCRB	A-MPR	Rbstart	LCRB	A-MPR	Rbstart	LCRB	A-MPR
5MHz	$1922.5 \leq F_c < 1927.5$	$<1.62\text{MHz}/12/\text{SCS}$	$>2.52\text{MHz}/12/\text{SCS}$	A3						
10MHz	$1920 \leq F_c < 1935$	$<1.62\text{MHz}/12/\text{SCS}$	>0	A1	$>1.62\text{MHz}/12/\text{SCS}$ $\leq 3.60\text{MHz}/12/\text{SCS}$	$>5.4\text{MHz}/12/\text{SCS}$	A7	$>7.74\text{MHz}/12/\text{SCS}$	$\leq 1.08\text{MHz}/12/\text{SCS}$	A2
10MHz	$1935 \leq F_c < 1945$		$>4.5\text{MHz}/12/\text{SCS}$	A4						
15MHz	$1927.5 \leq F_c < 1932.5$	$<3.24\text{MHz}/12/\text{SCS}$	>0	A1	$>3.24\text{MHz}/12/\text{SCS}$ $\leq 5.40\text{MHz}/12/\text{SCS}$	$>8.1\text{MHz}/12/\text{SCS}$	A7	$>10.9\text{MHz}/12/\text{SCS}$	$\leq 1.08\text{MHz}/12/\text{SCS}$	A2
15MHz	$1932.5 \leq F_c < 1942.5$	$<1.62\text{MHz}/12/\text{SCS}$	>0	A1				$>12.6\text{MHz}/12/\text{SCS}$	$\leq 1.08\text{MHz}/12/\text{SCS}$	A2
15MHz	$1942.5 \leq F_c < 1947.5$		$>7.2\text{MHz}/12/\text{SCS}$	A5						
20MHz	$1930 \leq F_c < 1950$	$<4.86\text{MHz}/12/\text{SCS}$	>0	A1	$>4.86\text{MHz}/12/\text{SCS}$ $\leq 7.20\text{MHz}/12/\text{SCS}$	$>9.0\text{MHz}/12/\text{SCS}$	A7	$>14.22\text{MHz}/12/\text{SCS}$	$\leq 1.08\text{MHz}/12/\text{SCS}$	A2
20MHz	$1950 \leq F_c < 1960$		$>9.0\text{MHz}/12/\text{SCS}$	A6						

NOTE 1: The A-MPR values are listed in Table 6.2.3.4-1 and 6.2.3.4-2.
NOTE 2: For any undefined region, MPR applies

Table 6.2.3.4-2: A-MPR for modulation and waveform type

Modulation/Waveform	A1	A2	A3	
	Outer/Inner	Outer/Inner	Outer	Inner
DFT-s-OFDM PI/2 BPSK	≤ 10	≤ 5	≤ 4	N/A
DFT-s-OFDM QPSK	≤ 10	≤ 5	≤ 4.5	N/A
DFT-s-OFDM 16 QAM	≤ 10	≤ 5	≤ 6	N/A
DFT-s-OFDM 64 QAM	≤ 11	≤ 5	≤ 6	N/A
DFT-s-OFDM 256 QAM	≤ 13	≤ 5	≤ 7	N/A
CP-OFDM QPSK	≤ 10	≤ 5	≤ 7.5	≤ 2
CP-OFDM 16 QAM	≤ 10	≤ 5	≤ 7.5	N/A
CP-OFDM 64 QAM	≤ 11	≤ 5	≤ 8	N/A
CP-OFDM 256 QAM	≤ 13	N/A	≤ 10	N/A

NOTE 1: The backoff applied is max (MPR, A-MPR) where MPR is defined in Table 6.2.2-1
NOTE 2: Outer and inner allocations are defined in clause 6.2.2

Table 6.2.3.4-3: A-MPR for modulation and waveform type

Modulation/Waveform	A4		A5		A6		A7
	Outer	Inner	Outer	Inner	Outer	Inner	Outer/Inner
DFT-s-OFDM PI/2 BPSK	≤ 1	N/A	≤ 1	N/A	≤ 1	N/A	≤ 6
DFT-s-OFDM QPSK	N/A		≤ 1.5	N/A	≤ 1.5		≤ 6
DFT-s-OFDM 16 QAM	N/A		N/A	N/A	N/A		≤ 6
DFT-s-OFDM 64 QAM	N/A		N/A	N/A	N/A		≤ 6
DFT-s-OFDM 256 QAM	N/A		N/A	N/A	N/A		≤ 6
CP-OFDM QPSK	≤ 3.5		≤ 3.5	N/A	≤ 3.5		≤ 6
CP-OFDM 16 QAM	≤ 3.5		≤ 3.5	N/A	≤ 3.5		≤ 6
CP-OFDM 64 QAM	N/A		N/A	≤ 4	N/A		≤ 6
CP-OFDM 256 QAM	N/A		N/A	N/A	N/A		≤ 6
NOTE 1: The backoff applied is max (MPR, A-MPR) where MPR is defined in Table 6.2.2-1							
NOTE 2: Outer and inner allocations are defined in clause 6.2.2							

Table 6.2.3.4-4 - Table 6.2.3.4-9: Void

6.2.3.5 A-MPR for NS_40

Table 6.2.3.5-1: A-MPR for "NS_40"

Modulation	A-MPR	
	Channel bandwidth (MHz): 5 MHz	
	Outer RB allocations	Inner RB allocations
DFT-s-OFDM QPSK	15.5	12
DFT-s-OFDM 16 QAM	14.5	11
DFT-s-OFDM 64 QAM	14.5	10
DFT-s-OFDM 256 QAM	12.5	7.5
CP-OFDM QPSK	14.5	10
CP-OFDM 16 QAM	14.5	10
CP-OFDM 64 QAM	14	8
CP-OFDM 256 QAM	11	5.5
NOTE 1: The total maximum output power reduction for NS_40 is obtained by taking the maximum value of MPR + A-MPR specified in Table 6.2.3-1 and Table 6.2.4-30a in TS 36.101 and MPR+A-MPR specified in Table 6.2.2-1 and Table 6.2.3.5-1.		

6.2.3.6 A-MPR for NS_08

Table 6.2.3.6-1: A-MPR for NS_08 for 5 MHz CBW

Modulation	A-MPR		Configurations for A-MPR (NOTE 3)
	Outer RB allocations	Inner RB allocations	
DFT-s-OFDM PI/2 BPSK	0	0	
DFT-s-OFDM QPSK	≤ 2	0	L _{CRB} > 15 for 15kHz SCS
DFT-s-OFDM 16 QAM	0	0	
DFT-s-OFDM 64 QAM	0	0	
DFT-s-OFDM 256 QAM	0	0	
CP-OFDM QPSK	≤ 3.5	0	L _{CRB} > 15 for 15kHz SCS
CP-OFDM 16 QAM	≤ 3.5	0	L _{CRB} > 15 for 15kHz SCS
CP-OFDM 64 QAM	0	0	
CP-OFDM 256 QAM	0	0	
NOTE 1: The total backoff applied is max(MPR, A-MPR) where MPR is defined in Table 6.2.2-1			
NOTE 2: Outer and inner allocations are defined in clause 6.2.2			
NOTE 3: When configurations are specified, A-MPR is only applied for the conditions and zero A-MPR is applied for the rest of RB allocations.			

Table 6.2.3.6-2: A-MPR for NS_08 for 10 MHz CBW

Modulation	A-MPR		Configurations for A-MPR (NOTE 3)
	Outer RB allocations	Inner RB allocations	
DFT-s-OFDM PI/2 BPSK	≤ 1.5	0	LCRB > 40 for 15kHz SCS
DFT-s-OFDM QPSK	≤ 2.5	0	LCRB > 30 for 15kHz SCS LCRB > 15 for 30kHz SCS
DFT-s-OFDM 16 QAM	≤ 2.5	0	LCRB > 40 for 15kHz SCS LCRB > 20 for 30kHz SCS
DFT-s-OFDM 64 QAM	≤ 2.5	0	LCRB > 45 for 15kHz SCS
DFT-s-OFDM 256 QAM	0	0	LCRB > 40 for 15kHz SCS LCRB > 20 for 30kHz SCS
CP-OFDM QPSK	≤ 4	0	LCRB > 40 for 15kHz SCS LCRB > 20 for 30kHz SCS
CP-OFDM 16 QAM	≤ 4	0	LCRB > 40 for 15kHz SCS LCRB > 20 for 30kHz SCS
CP-OFDM 64 QAM	≤ 4	0	LCRB > 45 for 15kHz SCS
CP-OFDM 256 QAM	0	0	

NOTE 1: The total backoff applied is max(MPR, A-MPR) where MPR is defined in Table 6.2.2-1
NOTE 2: Outer and inner allocations are defined in clause 6.2.2
NOTE 3: When configurations are specified, A-MPR is only applied for the conditions and zero A-MPR is applied for the rest of RB allocations.

Table 6.2.3.6-3: A-MPR for NS_08 for 15 MHz CBW

Modulation	A-MPR		Configurations for A-MPR (NOTE 3)
	Outer RB allocations	Inner RB allocations	
DFT-s-OFDM PI/2 BPSK	≤ 9	≤ 9	NOTE 4
1DFT-s-OFDM QPSK	≤ 9	≤ 9	NOTE 4
DFT-s-OFDM 16 QAM	≤ 9	≤ 9	NOTE 4
DFT-s-OFDM 64 QAM	≤ 9	≤ 9	NOTE 4
DFT-s-OFDM 256 QAM	≤ 9	≤ 9	NOTE 4
CP-OFDM QPSK	≤ 9	≤ 9	NOTE 4
CP-OFDM 16 QAM	≤ 9	≤ 9	NOTE 4
CP-OFDM 64 QAM	≤ 9	≤ 9	NOTE 4
CP-OFDM 256 QAM	≤ 9	≤ 9	NOTE 4

NOTE 1: The total backoff applied is max(MPR, A-MPR) where MPR is defined in Table 6.2.2-1
NOTE 2: Outer and inner allocations are defined in clause 6.2.2
NOTE 3: When configurations are specified, A-MPR is only applied for the conditions and zero A-MPR is applied for the rest of RB allocations.
NOTE 4: For 15kHz SCS, applicable for $RB_{START} < 10$ or > 68 and $LCRB > 0$, or $10 \leq RB_{START} < 34$ and $LCRB > 40$. For 30kHz SCS, applicable for $RB_{START} < 5$ or > 34 and $LCRB > 0$, or $5 \leq RB_{START} < 17$ and $LCRB > 12$.

6.2.3.7 A-MPR for NS_03

Table 6.2.3.7-1 A-MPR for NS_03

Modulation	Channel BW / Transmission BW in MHz					A-MPR	
	5	10	15	20	40	Outer RB allocations	Inner RB allocations
DFT-s-OFDM PI/2 BPSK, DFT-s-OFDM QPSK, DFT-s-OFDM 16 QAM	1.44	1.44 – 2.16	1.44 – 2.88	2.16 – 3.24	2.88 – 4.32	N/A	≤1
	> 1.44	> 2.16	> 2.88	> 3.24	> 4.32	≤1	≤2
DFT-s-OFDM 64 QAM	1.44	1.44 – 2.16	1.44 – 2.88	2.16 – 3.24	2.88 – 4.32	≤0.5	≤0.5
	> 1.44	> 2.16	> 2.88	> 3.24	> 4.32	≤1.5	≤1.5
DFT-s-OFDM 256 QAM	<1.44					≤0.5	≤0.5
	≥1.44					≤1.5	≤1.5
CP-OFDM QPSK	1.44	1.44 – 2.16	1.44 – 2.88	2.16 – 3.24	2.88 – 4.32	N/A	≤1
	> 1.44	> 2.16	> 2.88	> 3.24	> 4.32	≤1	≤2
CP-OFDM 16 QAM	1.44	1.44 – 2.16	1.44 – 2.88	2.16 – 3.24	2.88 – 4.32	N/A	≤2
	> 1.44	> 2.16	> 2.88	> 3.24	> 4.32	≤1	≤2
CP-OFDM 64 QAM	> 1.08	> 1.08	> 1.44	> 1.8	> 2.88	≤1	≤1
CP-OFDM 256 QAM	> 1.08	> 1.08	> 1.44	> 1.8	> 2.88	≤1	≤1

NOTE 1: A-MPR defined in this Table is additive to MPR defined in Table 6.2.2-1
NOTE 2: Inner and outer allocations are defined in clause 6.2.2

6.2.3.8 A-MPR for NS_37

Table 6.2.3.8-1: A-MPR for B11/B21 protection (NS_37) for 10MHz, 15MHz (1447.9-1462.9MHz)

Channel Bandwidth, MHz	Carrier Centre Frequency, F _c , MHz	Region A (Outer/Inner)			Region B (Outer/Inner)			Region C (Outer/Inner)		
		RBstart, (MHz/12/SCS)	LCRB (MHz/12/SCS)	A-MPR	RBstart (MHz/12/SCS)	LCRB (MHz/12/SCS)	A-MPR	RBstart (MHz/12/SCS)	LCRB (MHz/12/SCS)	A-MPR
10MHz	1452.9 < F _c ≤ 1457.9	≥0	>40	≤ A1	N/A	N/A	N/A	N/A	N/A	N/A
15MHz	F _c = 1455.4	≥0	>55	≤ A1	<[0.54]	< [1.08]	[≤ A2]	>[13.86]	< [1.08]	[≤ A2]

NOTE 1: A-MPR values in Table 6.2.3.8-2.

NOTE 2: The backoff applied is max (MPR, A-MPR) where MPR is defined in Table 6.2.2-1

NOTE 3: For any undefined region, MPR applies

NOTE 4: No A-MPR for SCS=60 kHz.

Table 6.2.3.8-2: A-MPR for modulation and waveform type

Modulation/Waveform	A1		A2
	Outer	Inner	Outer/Inner
DFT-s-OFDM PI/2 BPSK	≤ 1	N/A	[≤ 3]
DFT-s-OFDM QPSK	≤ 1.5	N/A	[≤ 3]
DFT-s-OFDM 16 QAM	≤ 2.5	N/A	[≤ 3]
DFT-s-OFDM 64 QAM	≤ 3	N/A	[≤ 3]
DFT-s-OFDM 256 QAM	N/A	N/A	[N/A]
CP-OFDM QPSK	≤ 3.5	N/A	[≤ 3]
CP-OFDM 16 QAM	≤ 3.5	N/A	[≤ 3]
CP-OFDM 64 QAM	N/A	N/A	[N/A]
CP-OFDM 256 QAM	N/A	N/A	[N/A]

NOTE 1: The backoff applied is max(MPR, A-MPR) where MPR is defined in Table 6.2.2-1
NOTE 2: Outer and inner allocations are defined in clause 6.2.2

6.2.3.9 A-MPR for NS_38

Table 6.2.3.9-1: A-MPR for EESS (NS_38) Protection (1430-1470MHz)

Channel Bandwidth, MHz	Carrier Centre Frequency, F_c , MHz	Region A (Outer/Inner)			Region B (Outer/Inner)	
		Rbstart,	LCRB	A-MPR	Rbstart+LCRB(MHz/12/SCS)	A-MPR
10MHz	$[1435 \leq F_c < 1442]$	$[\leq -1.8 \text{ MHz}/12/\text{SCS} + \text{LCRB}/2]$	$[>3.6]$	$[\leq 12]$	$[\leq 2.16]$	$[\leq 9]$
15MHz	$[1437.5 \leq F_c < 1447.5]$	$[\leq -1.8 \text{ MHz}/12/\text{SCS} + \text{LCRB}/2]$	$[>3.6]$	$[\leq 13]$	$[\leq 3.6]$	$[\leq 10]$
20MHz	$[1440 \leq F_c < 1450]$	$[\leq -1.8 \text{ MHz}/12/\text{SCS} + \text{LCRB}/2]$	$[>3.6]$	$[\leq 13]$	$[\leq 5.4]$	$[\leq 10]$

NOTE 1: The backoff applied is max(MPR, A-MPR) where MPR is defined in Table 6.2.2-1
NOTE 2: Outer and inner allocations are defined in clause 6.2
NOTE 3: For any undefined region, MPR applies
NOTE 4: A-MPR applies to all modulation and waveform types.

6.2.3.10 A-MPR for NS_39

Table 6.2.3.10-1: A-MPR for own RX (NS_39) Protection for 10MHz,15MHz, 20MHz (1440-1470MHz)

Channel Bandwidth, MHz	Carrier Centre Frequency, F_c , MHz	Region A (Outer/Inner)	
		Rbstart+LCRB(MHz/12/SCS)	A-MPR
10MHz	$[1462 < F_c \leq 1465]$	$[>7.9]$	$[\leq 6]$
15MHz	$[1456.3 < F_c \leq 1462.5]$	$[>11.2]$	$[\leq 6]$
20MHz	$[1450.8 < F_c \leq 1460]$	$[>14.4]$	$[\leq 6]$

NOTE 1: The backoff applied is max(MPR, A-MPR) where MPR is defined in Table 6.2.2-1
NOTE 2: Outer and inner allocations are defined in clause 6.2
NOTE 3: For any undefined region, MPR applies
NOTE 4: A-MPR applies to all modulation and waveform types.

6.2.3.11 A-MPR for NS_41

Table 6.2.3.11-1: A-MPR for "NS_41"

Channel Bandwidth, MHz	Carrier Centre Frequency, F _c , MHz	Region A (Outer/Inner)			Region B (Outer/Inner)		
		Rbstart	LCRB	A-MPR [dB]	Rbstart	LCRB	A-MPR [dB]
5MHz	-	-	-	NA	-	-	NA
10MHz	$1437 \leq F_c < 1442$	$\leq -4.5\text{MHz}/12/\text{SCS} + \text{LCRB}$	$>4.5\text{MHz}/12/\text{SCS}$	≤ 9	$\text{LCRB} < 1.7\text{MHz}/12/\text{SCS}$	$\leq 2.7 \text{MHz}/12/\text{SCS}$	≤ 9
15MHz	$1439.5 \leq F_c < 1447.5$	$\leq -5.4\text{MHz}/12/\text{SCS} + \text{LCRB}$	$>5.4\text{MHz}/12/\text{SCS}$	≤ 11	$\text{LCRB} < 3.42\text{MHz}/12/\text{SCS}$	$\leq 3.6 \text{MHz}/12/\text{SCS}$	≤ 9
20MHz	$1442 \leq F_c < 1450$	$\leq -5.4\text{MHz}/12/\text{SCS} + \text{LCRB}$	$>5.4\text{MHz}/12/\text{SCS}$	≤ 12	$\text{LCRB} < 5.04\text{MHz}/12/\text{SCS}$	$\leq 5 \text{MHz}/12/\text{SCS}$	≤ 9
40MHz	$1452 \leq F_c < 1497$	$\leq -7.2\text{MHz}/12/\text{SCS} + \text{LCRB}$	$>7.2\text{MHz}/12/\text{SCS}$	≤ 13.5	$\text{LCRB} < 11.7\text{MHz}/12/\text{SCS}$	$\leq 18 \text{MHz}/12/\text{SCS}$	≤ 10.5
50MHz	$1457 \leq F_c < 1492$	$\leq -7.2\text{MHz}/12/\text{SCS} + \text{LCRB}$	$>7.2\text{MHz}/12/\text{SCS}$	≤ 13.5	$\text{LCRB} < 15.12\text{MHz}/12/\text{SCS}$	$\leq 18 \text{MHz}/12/\text{SCS}$	≤ 10.5
60MHz	$1462 \leq F_c < 1487$	$\leq -7.2\text{MHz}/12/\text{SCS} + \text{LCRB}$	$>7.2\text{MHz}/12/\text{SCS}$	≤ 13.5	$\text{LCRB} < 18.72\text{MHz}/12/\text{SCS}$	$\leq 18.72 \text{MHz}/12/\text{SCS}$	≤ 10.5

NOTE 1: The backoff applied is max(MPR, A-MPR) where MPR is defined in Table 6.2.2-1
NOTE 2: Outer and inner allocations are defined in clause 6.2.2
NOTE 3: For any undefined region, MPR applies
NOTE 4: A-MPR applies to all modulation and waveform types.

6.2.3.12 A-MPR for NS_42

Table 6.2.3.12-1: A-MPR for "NS_42"

Channel Bandwidth, MHz	Carrier Centre Frequency, F _c , MHz	Region A		Region B		
		RBend	A-MPR (Outer/Inner)	Rbstart	A-MPR (Inner)	A-MPR (Outer)
5MHz	$1512 \leq F_c \leq 1514.5$	$>3.1\text{MHz} / 12 / \text{SCS}$	≤ 7	$<0.9\text{MHz}/12/\text{SCS}$	≤ 1.5	≤ 4
10MHz	$1497 \leq F_c \leq 1512$	$>6.2\text{MHz} / 12 / \text{SCS}$	≤ 8	$<0.9\text{MHz}/12/\text{SCS}$	≤ 1.5	≤ 5
15MHz	$1502 \leq F_c \leq 1509.5$	$>9.3\text{MHz} / 12 / \text{SCS}$	≤ 8	$<3.06\text{MHz}/12/\text{SCS}$	≤ 1.5	≤ 5
20MHz	$1497 \leq F_c \leq 1507$	$>12.4\text{MHz} / 12 / \text{SCS}$	≤ 8	$<4.5\text{MHz}/12/\text{SCS}$	≤ 1.5	≤ 5
40MHz	$1477 \leq F_c \leq 1497$	$>24.8\text{MHz} / 12 / \text{SCS}$	≤ 8	$<5.4\text{MHz}/12/\text{SCS}$	≤ 1.5	≤ 5
50MHz	$1467 \leq F_c \leq 1492$	$>31\text{MHz} / 12 / \text{SCS}$	≤ 8	$<7.2\text{MHz}/12/\text{SCS}$	≤ 1.5	≤ 5
60MHz	$1462 \leq F_c \leq 1487$	$>37.2\text{MHz} / 12 / \text{SCS}$	≤ 8	$<7.2\text{MHz}/12/\text{SCS}$	≤ 1.5	≤ 5

NOTE 1: The backoff applied is max(MPR, A-MPR) where MPR is defined in Table 6.2.2-1
NOTE 2: Outer and inner allocations are defined in clause 6.2.2
NOTE 3: For any undefined region, MPR applies
NOTE 4: A-MPR applies to all modulation and waveform types.

6.2.4 Configured transmitted power

The UE is allowed to set its configured maximum output power $P_{\text{CMAX},f,c}$ for carrier f of serving cell c in each slot. The configured maximum output power $P_{\text{CMAX},f,c}$ is set within the following bounds:

$$P_{\text{CMAX},L,f,c} \leq P_{\text{CMAX},f,c} \leq P_{\text{CMAX},H,f,c} \text{ with}$$

$$P_{\text{CMAX},L,f,c} = \text{MIN} \{ P_{\text{EMAX},c} - \Delta T_{C,c}, (P_{\text{PowerClass}} - \Delta P_{\text{PowerClass}}) - \text{MAX}(M\text{PR}_c + A\text{-M}\text{PR}_c + \Delta T_{\text{IB},c} + \Delta T_{C,c} + \Delta T_{\text{RxSRS}}, P\text{-M}\text{PR}_c) \}$$

$$P_{\text{CMAX},H,f,c} = \text{MIN} \{ P_{\text{EMAX},c}, P_{\text{PowerClass}} - \Delta P_{\text{PowerClass}} \}$$

where

$P_{\text{EMAX},c}$ is the value given by IE P-Max for serving cell c , defined in TS 38.331[7];

$P_{\text{PowerClass}}$ is the maximum UE power specified in Table 6.2.1-1 without taking into account the tolerance specified in the Table 6.2.1-1;

When the IE [P-Boost-BPSK] is set to 1, $P_{\text{EMAX},c}$ is increased by +3 dB for a power class 3 capable UE operating in TDD bands n40, n77, n78, and n79 with PI/2 BPSK modulation and 40% or less slots in radio frame are used for UL transmission when $P_{\text{EMAX},c} \geq 20$ dBm.

When the IE [P-Boost-BPSK] is set to 1, $\Delta P_{\text{PowerClass}} = -3$ dB for a power class 3 capable UE operating in TDD bands n40, n77, n78, and n79 with PI/2 BPSK modulation and 40% or less slots in radio frame are used for UL transmission.

$\Delta P_{\text{PowerClass}} = 3$ dB for a power class 2 capable UE operating in Band n41, n77, n78 and n79, when P-max of 23 dBm or lower is indicated; or when the field of UE capability *maxUplinkDutyCycle* is absent and the percentage of uplink symbols transmitted in a certain evaluation period is larger than 50%; or when the field of UE capability *maxUplinkDutyCycle* is not absent and the percentage of uplink symbols transmitted in a certain evaluation period is larger than *maxUplinkDutyCycle* as defined in TS 38.331 (The exact evaluation period is no less than one radio frame); or if P-Max is not indicated in the cell, otherwise $\Delta P_{\text{PowerClass}} = 0$ dB;

$\Delta T_{\text{IB},c}$ is the additional tolerance for serving cell c as specified in TS 38.101-3 subclause 6.2A.4.2 and 6.2B.4.2; $\Delta T_{\text{IB},c} = 0$ dB otherwise;

$\Delta T_{C,c}$ is TBD;

$M\text{PR}_c$ and $A\text{-M}\text{PR}_c$ for serving cell c are specified in subclause 6.2.2 and subclause 6.2.3, respectively;

ΔT_{RxSRS} is 3 dB and is applied when UE transmits SRS to the antenna port that is designated as Rx port. For other SRS transmissions ΔT_{RxSRS} is zero

$P\text{-M}\text{PR}_c$ is the allowed maximum output power reduction for

- ensuring compliance with applicable electromagnetic energy absorption requirements and addressing unwanted emissions / self desense requirements in case of simultaneous transmissions on multiple RAT(s) for scenarios not in scope of 3GPP RAN specifications;
- ensuring compliance with applicable electromagnetic energy absorption requirements in case of proximity detection is used to address such requirements that require a lower maximum output power.

The UE shall apply $P\text{-M}\text{PR}_c$ for serving cell c only for the above cases. For UE conducted conformance testing $P\text{-M}\text{PR}_c$ shall be 0 dB

NOTE 1: $P\text{-M}\text{PR}_c$ was introduced in the $P_{\text{CMAX},f,c}$ equation such that the UE can report to the eNB the available maximum output transmit power. This information can be used by the eNB for scheduling decisions.

NOTE 2: $P\text{-M}\text{PR}_c$ may impact the maximum uplink performance for the selected UL transmission path.

T_{REF} and T_{eval} are specified in Table 6.2.4-1. For each T_{REF} , the $P_{\text{CMAX},L,c}$ for serving cell c are evaluated per T_{eval} and given by the minimum value taken over the transmission(s) within the T_{eval} ; the minimum $P_{\text{CMAX},L,f,c}$ over one or more T_{eval} is then applied for the entire T_{REF}

Table 6.2.4-1: Evaluation and reference periods for P_{CMAX}

T _{REF}	T _{eval}	T _{eval} with frequency hopping
Physical channel length	Physical channel length	Min(T _{no_hopping} , Physical Channel Length)

The measured configured maximum output power P_{UMAX,f,c} shall be within the following bounds:

$$P_{CMAX_L,f,c} - \text{MAX}\{T_{L,c}, T(P_{CMAX_L,f,c})\} \leq P_{UMAX,f,c} \leq P_{CMAX_H,f,c} + T(P_{CMAX_H,f,c}).$$

where the tolerance T(P_{CMAX,f,c}) for applicable values of P_{CMAX,f,c} is specified in Table 6.2.4-1. The tolerance T_{L,c} is the absolute value of the lower tolerance for the applicable operating band as specified in Table 6.2.1-1.

Table 6.2.4-1: P_{CMAX} tolerance

P _{CMAX,f,c} (dBm)	Tolerance T(P _{CMAX,f,c}) (dB)
23 < P _{CMAX,c} ≤ 33	2.0
21 ≤ P _{CMAX,c} ≤ 23	2.0
20 ≤ P _{CMAX,c} < 21	2.5
19 ≤ P _{CMAX,c} < 20	3.5
18 ≤ P _{CMAX,c} < 19	4.0
13 ≤ P _{CMAX,c} < 18	5.0
8 ≤ P _{CMAX,c} < 13	6.0
-40 ≤ P _{CMAX,c} < 8	7.0

6.2A Transmitter power for CA

6.2A.1 UE maximum output power for CA

6.2A.1.1 UE maximum output power for Intra-band contiguous CA

6.2A.1.1 UE maximum output power for Intra-band non-contiguous CA

6.2A.1.3 UE maximum output power for Inter-band CA

For inter-band carrier aggregation with one uplink carrier assigned to one NR band, the transmitter power requirements in subclause 6.2 apply.

For inter-band carrier aggregation with uplink assigned to two NR bands, UE maximum output power shall be measured over all component carriers from different bands. If each band has separate antenna connectors, maximum output power is measured as the sum of maximum output power at each UE antenna connector. The period of measurement shall be at least one sub frame (1ms). The maximum output power is specified in Table 6.2A.1.3-1.

Table 6.2A.1.3-1 UE Power Class for uplink inter-band CA (two bands)

NR CA Configuration	Class 1 (dBm)	Tolerance (dB)	Class 2 (dBm)	Tolerance (dB)	Class 3 (dBm)	Tolerance (dB)	Class 4 (dBm)	Tolerance (dB)
CA_XA-YA					23	TBD		
NOTE 1: Void								
NOTE 2: 2 refers to the transmission bandwidths (Figure 5.3.2-1) confined within FUL _{low} and FUL _{low} + 4 MHz or FUL _{high} – 4 MHz and FUL _{high} , the maximum output power requirement is relaxed by reducing the lower tolerance limit by 1.5 dB								
NOTE 3: PPowerClass is the maximum UE power specified without taking into account the tolerance								
NOTE 4: For inter-band carrier aggregation the maximum power requirement should apply to the total transmitted power over all component carriers (per UE).								

6.2A.2 UE maximum output power reduction for CA

6.2A.2.1 UE maximum output power reduction for Intra-band contiguous CA

6.2A.2.2 UE maximum output power reduction for Intra-band non-contiguous CA

6.2A.2.3 UE maximum output power reduction for Inter-band CA

For inter-band carrier aggregation with uplink assigned to two NR bands, the requirements in subclause 6.2.2 apply for each uplink component carrier.

6.2A.3 UE additional maximum output power reduction for CA

6.2A.3.1.1 UE additional maximum output power reduction for Intra-band contiguous CA

6.2A.3.1.2 UE additional maximum output power reduction for Intra-band non-contiguous CA

6.2A.3.1.3 UE additional maximum output power reduction for Inter-band CA

6.2A.4 Configured output power for CA

6.2A.4.1 Configured transmitted power level

6.2A.4.1.1 Configured transmitted power for Intra-band contiguous CA

6.2A.4.1.2 Configured transmitted power for Intra-band non-contiguous CA

6.2A.4.1.3 Configured transmitted power for Inter-band CA

For uplink carrier aggregation the UE is allowed to set its configured maximum output power $P_{\text{CMAX},c}$ for serving cell c and its total configured maximum output power P_{CMAX} .

The configured maximum output power $P_{\text{CMAX},c}$ on serving cell c shall be set as specified in subclause 6.2.4.

For uplink inter-band carrier aggregation, MPR_c and A-MPR_c apply per serving cell c and are specified in subclause 6.2.2 and subclause 6.2.3, respectively. P-MPR_c accounts for power management for serving cell c . $P_{\text{CMAX},c}$ is calculated under the assumption that the transmit power is increased independently on all component carriers.

The total configured maximum output power P_{CMAX} shall be set within the following bounds:

$$P_{\text{CMAX}_L} \leq P_{\text{CMAX}} \leq P_{\text{CMAX}_H}$$

For uplink inter-band carrier aggregation with one serving cell c per operating band when same slot symbol pattern is used in all aggregated serving cells,

$$P_{\text{CMAX}_L} = \text{MIN} \{ 10 \log_{10} \sum \text{MIN} [p_{\text{EMAX},c} / (\Delta t_{C,c}), p_{\text{PowerClass}} / (\text{mpr}_c \cdot \text{a-mpr}_c \cdot \Delta t_{C,c} \cdot \Delta t_{\text{IB},c} \cdot \Delta t_{\text{RxSRS},c}), p_{\text{PowerClass}} / \text{pmpr}_c], p_{\text{PowerClass}} \}$$

$$P_{\text{CMAX}_H} = \text{MIN} \{ 10 \log_{10} \sum p_{\text{EMAX},c}, P_{\text{PowerClass}} \}$$

where

- $p_{\text{EMAX},c}$ is the linear value of $P_{\text{EMAX},c}$ which is given by IE *P-Max* for serving cell c in [7];
- $P_{\text{PowerClass}}$ is the maximum UE power specified in Table 6.2A.1.3-1 without taking into account the tolerance specified in the Table 6.2A.1.3-1; $p_{\text{PowerClass}}$ is the linear value of $P_{\text{PowerClass}}$;
- mpr_c and a-mpr_c are the linear values of MPR_c and A-MPR_c as specified in subclause 6.2.2 and subclause 6.2.3, respectively;
- pmpr_c is the linear value of P-MPR_c ;
- $\Delta T_{\text{RxSRS},c}$ is 3 dB and is applied when UE transmits SRS to the antenna port that is designated as Rx port. For other SRS transmissions ΔT_{RxSRS} is zero;

- $\Delta t_{C,c}$ is the linear value of $\Delta T_{C,c}$. $\Delta t_{C,c} = 1.41$ when NOTE 2 in Table 6.2A.1.3-1 applies for a serving cell c , otherwise $\Delta t_{C,c} = 1$;
- $\Delta t_{IB,c}$ is the linear value of the inter-band relaxation term $\Delta T_{IB,c}$ of the serving cell c as specified in Table 6.2A.4.2.3-1; otherwise $\Delta t_{IB,c} = 1$;

For uplink inter-band carrier aggregation with one serving cell c per operating band when at least one different numerology/slot pattern is used in aggregated cells, the UE is allowed to set its configured maximum output power $P_{CMAX,c(i),i}$ for serving cell $c(i)$ of slot numerology type i , and its total configured maximum output power P_{CMAX} .

The configured maximum output power $P_{CMAX,c(i),i}(p)$ in slot p of serving cell $c(i)$ on slot numerology type i shall be set within the following bounds:

$$P_{CMAX_L,f,c(i),i}(p) \leq P_{CMAX,f,c(i),i}(p) \leq P_{CMAX_H,f,c(i),i}(p)$$

where $P_{CMAX_L,f,c(i),i}(p)$ and $P_{CMAX_H,f,c(i),i}(p)$ are the limits for a serving cell $c(i)$ of slot numerology type i as specified in subclause 6.2.4.

The total UE configured maximum output power $P_{CMAX}(p,q)$ in a slot p of slot numerology or symbol pattern i , and a slot q of slot numerology or symbol pattern j that overlap in time shall be set within the following bounds unless stated otherwise:

$$P_{CMAX_L}(p,q) \leq P_{CMAX}(p,q) \leq P_{CMAX_H}(p,q)$$

When slots p and q have different transmissions lengths and belong to different cells on different bands:

$$P_{CMAX_L}(p,q) = \text{MIN} \{ 10 \log_{10} [P_{CMAX_L,f,c(i),i}(p) + P_{CMAX_L,f,c(i),j}(q)], P_{PowerClass} \}$$

$$P_{CMAX_H}(p,q) = \text{MIN} \{ 10 \log_{10} [P_{CMAX_H,f,c(i),i}(p) + P_{CMAX_H,f,c(i),j}(q)], P_{PowerClass} \}$$

where $P_{CMAX_L,f,c(i),i}$ and $P_{CMAX_H,f,c(i),i}$ are the respective limits $P_{CMAX_L,f,c(i),i}$ and $P_{CMAX_H,f,c(i),i}$ are expressed in linear scale.

T_{REF} and T_{eval} are specified in Table 6.2A.4.1.3-0 when same and different slot patterns are used in aggregated carriers. For each T_{REF} , the P_{CMAX_L} is evaluated per T_{eval} and given by the minimum value taken over the transmission(s) within the T_{eval} ; the minimum P_{CMAX_L} over the one or more T_{eval} is then applied for the entire T_{REF} . $P_{PowerClass}$ shall not be exceeded by the UE during any period of time.

Table 6.2A.4.1.3-0: P_{CMAX} evaluation window for different Slot and Channel durations

T_{REF}	T_{eval}	T_{eval} with frequency hopping
T_{REF} of largest slot duration over both UL CCs	Physical channel length	Min($T_{no_hopping}$, Physical Channel Length)

If the UE is configured with multiple TAGs and transmissions of the UE on slot i for any serving cell in one TAG overlap some portion of the first symbol of the transmission on slot $i + 1$ for a different serving cell in another TAG, the UE minimum of P_{CMAX_L} for slots i and $i + 1$ applies for any overlapping portion of slots i and $i + 1$. $P_{PowerClass}$ shall not be exceeded by the UE during any period of time.

The measured maximum output power P_{UMAX} over all serving cells with same slot pattern shall be within the following range:

$$P_{CMAX_L} - \text{MAX}\{T_L, T_{LOW}(P_{CMAX_L})\} \leq P_{UMAX} \leq P_{CMAX_H} + T_{HIGH}(P_{CMAX_H})$$

$$P_{UMAX} = 10 \log_{10} \sum P_{UMAX,c}$$

where $P_{UMAX,c}$ denotes the measured maximum output power for serving cell c expressed in linear scale. The tolerances $T_{LOW}(P_{CMAX})$ and $T_{HIGH}(P_{CMAX})$ for applicable values of P_{CMAX} are specified in Table 6.2A.4.1.3-1. The tolerance T_L is the absolute value of the lower tolerance for applicable NR CA configuration as specified in Table 6.2.2A-2 for inter-band carrier aggregation.

The measured maximum output power P_{UMAX} over all serving cells, when at least one slot has a different transmission numerology or symbol pattern, shall be within the following range:

$$P'_{CMAX_L} - \text{MAX}\{T_L, T_{LOW}(P'_{CMAX_L})\} \leq P'_{UMAX} \leq P'_{CMAX_H} + T_{HIGH}(P'_{CMAX_H})$$

$$P'_{UMAX} = 10 \log_{10} \sum p'_{UMAX,c}$$

where $p'_{UMAX,c}$ denotes the average measured maximum output power for serving cell c expressed in linear scale over T_{REF} . The tolerances $T_{LOW}(P'_{CMAX})$ and $T_{HIGH}(P'_{CMAX})$ for applicable values of P'_{CMAX} are specified in Table Table 6.2A.4.1.3-1 for inter-band carrier aggregation. The tolerance T_L is the absolute value of the lower tolerance for applicable NR CA configuration as specified in Table 6.2A.1.3-1 for inter-band carrier aggregation.

where:

$$P'_{CMAX_L} = \text{MIN}\{ \text{MIN}\{ 10\log_{10}\sum(p_{CMAX_L,f,c}(i,i)), P_{PowerClass} \} \text{ over all overlapping slots in } T_{REF}\}$$

$$P'_{CMAX_H} = \text{MAX}\{ \text{MIN}\{ 10 \log_{10} \sum p_{EMAX,c}, P_{PowerClass} \} \text{ over all overlapping Tslots in } T_{REF}\}$$

Table 6.2A.4.1.3-1: PCMAX tolerance for uplink inter-band CA (two bands)

PCMAX (dBm)	Tolerance TLOW(PCMAX) (dB)	Tolerance THIGH(PCMAX) (dB)
$P_{CMAX} = 23$	3.0	2.0
$22 \leq P_{CMAX} < 23$	5.0	2.0
$21 \leq P_{CMAX} < 22$	5.0	3.0
$20 \leq P_{CMAX} < 21$	6.0	4.0
$16 \leq P_{CMAX} < 20$	5.0	
$11 \leq P_{CMAX} < 16$	6.0	
$-40 \leq P_{CMAX} < 11$	7.0	

6.2A.4.2 $\Delta T_{IB,c}$ for CA

6.2A.4.2.1 $\Delta T_{IB,c}$ for Intra-band contiguous CA

6.2A.4.2.2 $\Delta T_{IB,c}$ for Intra-band non-contiguous CA

6.2A.4.2.3 $\Delta T_{IB,c}$ for Inter-band CA

$\Delta T_{IB,c}$ for NR CA For the UE which supports inter-band NR CA configuration, $\Delta T_{IB,c}$ in Tables below applies. Unless otherwise stated, $\Delta T_{IB,c}$ is set to zero.

Table 6.2A.4.2.3-1: $\Delta T_{IB,c}$ due to NR CA (two bands)

Inter-band CA configuration	NR Band	$\Delta T_{IB,c}$ (dB)
CA_n3-n77	n3	0.6
	n77	0.8
CA_n3A-n78A	n3	0.6
	n78	0.8
CA_n3-n79	n3	0.3
	n79	0.8
CA_n8-n75	n8	0.3
CA_n8A-n78A	n8	0.6
	n78	0.8
CA_n8-n79	n8	0.3
	n79	0.8
CA_n28-n75	n28	0.3
CA_n28A-n78A	n28	0.5
	n78	0.8
CA_n41A-n78A ¹	n41	0.3
	n78	0.8
CA_n75-n78	n78	0.8
CA_n76-n78	n78	0.8
CA_n77-n79A	n77	0.5
	n79	0.5
CA_n78A-n79A	n78	0.5
	n79	0.5

NOTE: The requirements only apply when the sub-frame and Tx-Rx timings are synchronized between the component carriers. In the absence of synchronization, the requirements are not within scope of these specifications.

6.2B Transmitter power for DC

6.2C Transmitter power for SUL

6.2C.1 Configured transmitted power for SUL

For single carrier configured transmit power, as the UL carrier and SUL carrier is a same cell, the configured transmit power is specified for each UL carrier in a serving cell. The configured transmit power requirement for serving cell is applied for each UL carrier.

6.2C.2 $\Delta T_{IB,c}$

For the UE which supports SUL band combination, $\Delta T_{IB,c}$ in Tables below applies. Unless otherwise stated, $\Delta T_{IB,c}$ is set to zero.

Table 6.2C.2-1: $\Delta T_{IB,c}$ due to SUL

Band combination for SUL	NR Band	$\Delta T_{IB,c}$ (dB)
SUL_n78-n80	n78	0.8
	n80	0.6
SUL_n78-n81	n78	0.8
	n81	0.6
SUL_n78-n82	n78	0.8
	n82	0.6
SUL_n78-n83	n78	0.8
	n83	0.5
SUL_n78-n84	n78	0.8
	n84	0.3
SUL_n78-n86	n78	0.8
	n86	0.6

6.2D Transmitter power for UL-MIMO

6.2D.1 UE maximum output power for UL-MIMO

For PC2 UE with two transmit antenna connectors in closed-loop spatial multiplexing scheme, the maximum output power for any transmission bandwidth within the channel bandwidth is specified in Table 6.2D.1-1. The requirements shall be met with the UL-MIMO configurations specified in Table 6.2D.1-2. For UE supporting UL-MIMO, the maximum output power is measured as the sum of the maximum output power at each UE antenna connector. The period of measurement shall be at least one sub frame (1ms).

The requirements shall be met with the UL-MIMO configurations of using 2-layer UL-MIMO transmission with codebook of $\frac{1}{\sqrt{2}} \begin{bmatrix} 1 & 0 \\ 0 & 1 \end{bmatrix}$. DCI Format for UE configured in PUSCH transmission mode for uplink single-user MIMO shall be used.

Table 6.2D.1-1: UE Power Class for UL-MIMO in closed loop spatial multiplexing scheme

NR band	Class 1 (dBm)	Tolerance (dB)	Class 2 (dBm)	Tolerance (dB)	Class 3 (dBm)	Tolerance (dB)	Class 4 (dBm)	Tolerance (dB)
n41			26	+2/-3 ¹	23	+2/-3 ¹		
n77			26	+2/-3	23	+2/-3		
n78			26	+2/-3	23	+2/-3		
n79			26	+2/-3	23	+2/-3		

NOTE 1: ¹ refers to the transmission bandwidths confined within F_{UL_low} and $F_{UL_low} + 4$ MHz or $F_{UL_high} - 4$ MHz and F_{UL_high} , the maximum output power requirement is relaxed by reducing the lower tolerance limit by 1.5 dB

Table 6.2D.1-2: UL-MIMO configuration in closed-loop spatial multiplexing scheme

Transmission scheme	DCI format	Codebook Index
Codebook based uplink	DCI format 0_1	Codebook index 0

If UE is configured for transmission on single-antenna port, the requirements in subclause 6.2.1 apply.

6.2D.2 UE maximum output power reduction for UL-MIMO

For UE with two transmit antenna connectors in closed-loop spatial multiplexing scheme, the allowed Maximum Power Reduction (MPR) for the maximum output power in Table 6.2D.1-1 is specified in Table 6.2.2-1. The requirements shall be met with UL-MIMO configurations defined in Table 6.2D.1-2. For UE supporting UL-MIMO, the maximum output power is measured as the sum of the maximum output power at each UE antenna connector.

For the UE maximum output power modified by MPR, the power limits specified in subclause 6.2D.4 apply.

If UE is configured for transmission on single-antenna port, the requirements in subclause 6.2.2 apply.

6.2D.3 UE additional maximum output power reduction for UL-MIMO

For UE with two transmit antenna connectors in closed-loop spatial multiplexing scheme, the A-MPR values specified in subclause 6.2.3 shall apply to the maximum output power specified in Table 6.2D.1-1. The requirements shall be met with the UL-MIMO configurations specified in Table 6.2D.1-2. For UE supporting UL-MIMO, the maximum output power is measured as the sum of the maximum output power at each UE antenna connector. Unless stated otherwise, an A-MPR of 0 dB shall be used.

For the UE maximum output power modified by A-MPR, the power limits specified in subclause 6.2D.4 apply.

If UE is configured for transmission on single-antenna port, the requirements in subclause 6.2.3 apply.

6.2D.4 Configured transmitted power for UL-MIMO

For UE supporting UL-MIMO, the transmitted power is configured per each UE.

The definitions of configured maximum output power $P_{\text{CMAX},c}$, the lower bound $P_{\text{CMAX}_L,c}$, and the higher bound $P_{\text{CMAX}_H,c}$ specified in subclause 6.2.4 shall apply to UE supporting UL-MIMO, where

$P_{\text{PowerClass}}$, $\Delta P_{\text{PowerClass}}$ and $\Delta T_{C,c}$ are specified in subclause 6.2D.1;

MPR_c is specified in subclause 6.2D.2;

A- MPR_c is specified in subclause 6.2D.3.

The measured configured maximum output power $P_{\text{UMAX},c}$ for serving cell c shall be within the following bounds:

$$P_{\text{CMAX}_L,c} - \text{MAX}\{T_L, T_{\text{LOW}}(P_{\text{CMAX}_L,c})\} \leq P_{\text{UMAX},c} \leq P_{\text{CMAX}_H,c} + T_{\text{HIGH}}(P_{\text{CMAX}_H,c})$$

where $T_{\text{LOW}}(P_{\text{CMAX}_L,c})$ and $T_{\text{HIGH}}(P_{\text{CMAX}_H,c})$ are defined as the tolerance and applies to $P_{\text{CMAX}_L,c}$ and $P_{\text{CMAX}_H,c}$ separately, while T_L is the absolute value of the lower tolerance in Table 6.2D.1-1 for the applicable operating band.

For UE with two transmit antenna connectors in closed-loop spatial multiplexing scheme, the tolerance is specified in Table 6.2D.4-1. The requirements shall be met with UL-MIMO configurations specified in Table 6.2D.1-2.

Table 6.2D.4-1: $P_{\text{CMAX},c}$ tolerance in closed-loop spatial multiplexing scheme

$P_{\text{CMAX},c}$ (dBm)	Tolerance $T_{\text{LOW}}(P_{\text{CMAX}_L,c})$ (dB)	Tolerance $T_{\text{HIGH}}(P_{\text{CMAX}_H,c})$ (dB)
$P_{\text{CMAX},c} = 26$	3.0	2.0
$23 \leq P_{\text{CMAX},c} < 26$	3.0	2.0
$22 \leq P_{\text{CMAX},c} < 23$	5.0	2.0
$21 \leq P_{\text{CMAX},c} < 22$	5.0	3.0
$20 \leq P_{\text{CMAX},c} < 21$	6.0	4.0
$16 \leq P_{\text{CMAX},c} < 20$	5.0	
$11 \leq P_{\text{CMAX},c} < 16$	6.0	
$-40 \leq P_{\text{CMAX},c} < 11$	7.0	

If UE is configured for transmission on single-antenna port, the requirements in subclause 6.2.4 apply.

6.3 Output power dynamics

Detailed structure of the subclause is TBD.

6.3.1 Minimum output power

The minimum controlled output power of the UE is defined as the power in the channel bandwidth for all transmit bandwidth configurations (resource blocks), when the power is set to a minimum value.

The minimum output power is defined as the mean power in one sub-frame TBD ms. The minimum output power shall not exceed the values specified in Table 6.3.1-1.

Table 6.3.1-1: Minimum output power

Channel bandwidth (MHz)	Minimum output power (dBm)	Measurement bandwidth (MHz)
5	-40	4.515
10	-40	9.375
15	-40	14.235
20	-40	19.095
25	-39	23.955
30	-38.2	28.815
40	-37	38.895
50	-36	48.615
60	-35.2	58.35
80	-34	78.15
90	-33.5	88.23
100	-33	98.31

6.3.2 Transmit OFF power

Transmit OFF power is defined as the mean power in the channel bandwidth when the transmitter is OFF. The transmitter is considered OFF when the UE is not allowed to transmit or during periods when the UE is not transmitting a sub-frame. During DTX and measurements gaps, the transmitter is not considered OFF.

The transmit OFF power is defined as the mean power in a duration of at least one sub-frame (1ms) excluding any transient periods. The transmit OFF power shall not exceed the values specified in Table 6.3.2-1.

Table 6.3.2-1: Transmit OFF power

Channel bandwidth (MHz)	Transmit OFF power (dBm)	Measurement bandwidth (MHz)
5	-50	4.515
10	-50	9.375
15	-50	14.235
20	-50	19.095
25	-50	23.955
30	-50	28.815
40	-50	38.895
50	-50	48.615
60	-50	58.35
80	-50	78.15
90	-50	88.23
100	-50	98.31

6.3.3 Transmit ON/OFF time mask

6.3.3.1 General

The transmit power time mask defines the transient period(s) allowed

between transmit OFF power as defined in sub-clause 6.3.2 and transmit ON power symbols (transmit ON/OFF) between continuous ON-power transmissions with powerchange or RB hopping is applied.

In case of RB hopping, transition period is shared symmetrically.

Unless otherwise stated the requirements in clause 6.5 apply also in transient periods.

In the following sub-clauses, following definitions apply:

A slot transmission is a Type A transmission.

A long subslot transmission is a Type B transmission with more than 2 symbols.

A short subslot transmission is a Type B transmission with 1 or 2 symbols.

6.3.3.2 General ON/OFF time mask

The general ON/OFF time mask defines the observation period between transmit OFF and ON power and between transmit ON and OFF power for each SCS. ON/OFF scenarios include; the beginning or end of DTX, measurement gap, contiguous, and non-contiguous transmission, etc

The OFF power measurement period is defined in a duration of at least one slot excluding any transient periods. The ON power is defined as the mean power over one slot excluding any transient period.

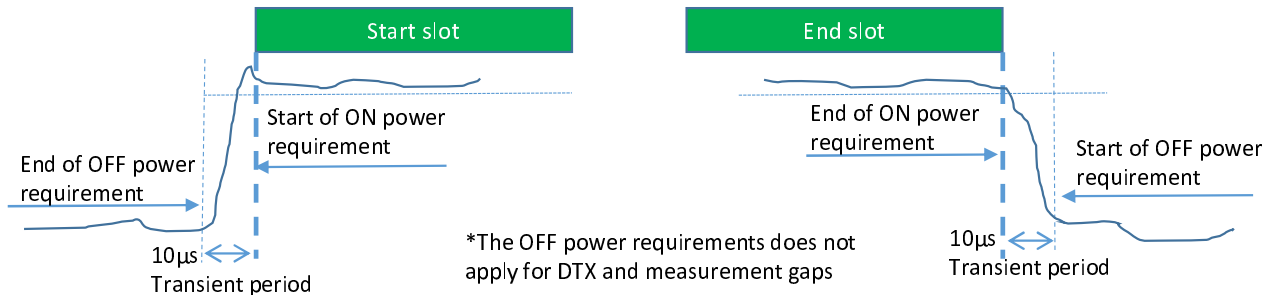

Figure 6.3.3.2-1: General ON/OFF time mask for NR UL transmission in FR1

6.3.3.3 Transmit power time mask for slot and short or subslot boundaries

The transmit power time mask for slot and a long subslot transmission boundaries defines the transient periods allowed between slot and long subslot PUSCH transmissions. For PUSCH-PUCCH and PUSCH-SRS transitions and multiplexing the time masks in sub-clause 6.3.3.7 apply.

The transmit power time mask for slot or long subslot and short subslot transmission boundaries defines the transient periods allowed between slot or long subslot and short subslot transmissions. The time masks in sub-clause 6.3.3.8 apply.

The transmit power time mask for short subslot transmission boundaries defines the transient periods allowed between short subslot transmissions. The time masks in sub-clause 6.3.3.9 apply.

6.3.3.4 PRACH time mask

The PRACH ON power is specified as the mean power over the PRACH measurement period excluding any transient periods as shown in Figure 6.3.3.4-1. The measurement period for different PRACH preamble format is specified in Table 6.3.3.4-1.

Table 6.3.3.4-1: PRACH ON power measurement period

PRACH preamble format	SCS (kHz)	Measurement period (ms)
0	1.25	0.903125
1	1.25	2.284375
2	1.25	3.352604
3	5	0.903125
A1	15	0.142708
	30	0.071354
A2	15	0.285417
	30	0.142708
A3	15	0.428125
	30	0.2140625
B1	15	0.140365
	30	0.070182
B4	15	0.83046875
	30	0.415234375
A1/B1	15	0.142708 ms for first six occasion 0.140365 ms for the last occasion
	30	0.071354 ms for first six occasion 0.070182 ms for the last occasion
A2/B2	15	0.285417 ms for first two occasion 0.278385 ms for the third occasion
	30	0.142708 ms for first two occasion 0.1391925 ms for the third occasion
A3/B3	15	0.428125 ms for the first occasion 0.41640625 ms for the second occasion
	30	0.2140625 ms for the first occasion 0.208203125 ms for the second occasion
C0	15	0.10703125
	30	0.053515625
C2	15	0.333333
	30	0.166667

NOTE: For PRACH on PRACH occasion start from the beginning of 0.5ms or span the boundary of 0.5ms of the subframe, the measurement period will plus 0.032552µs

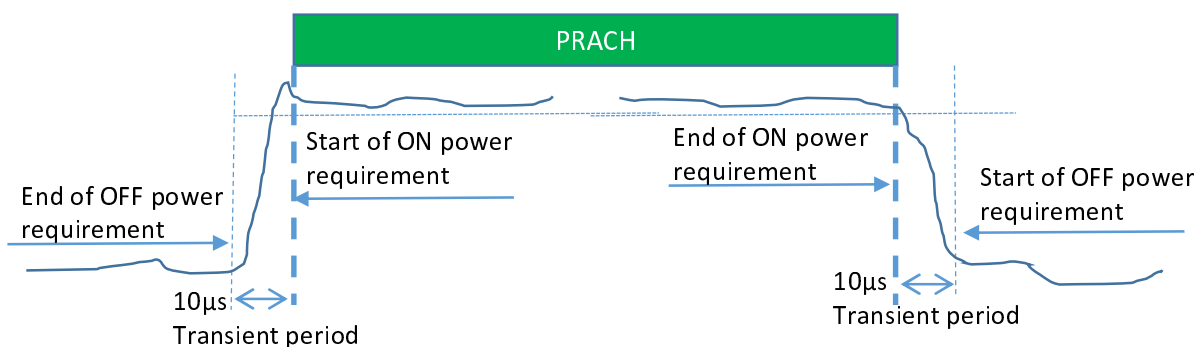

Figure 6.3.3.4-1: PRACH ON/OFF time mask

6.3.3.5 Void

6.3.3.6 SRS time mask

For SRS transmission mapped to one OFDM symbol, the ON power is defined as the mean power over the symbol duration excluding any transient period; Figure 6.3.3.6-1

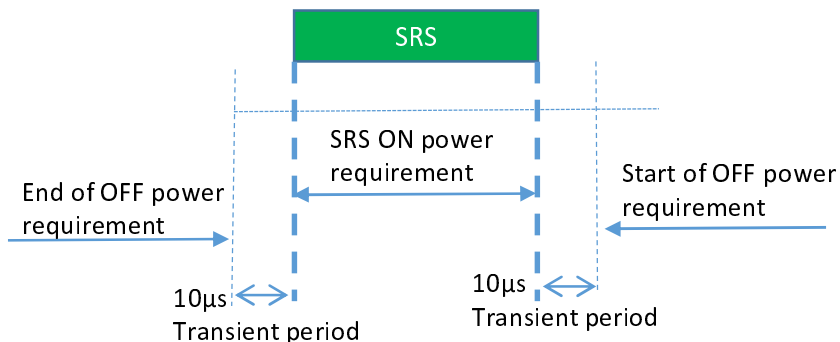

Figure 6.3.3.6-1: Single SRS time mask for NR UL transmission

For SRS transmission mapped to two OFDM symbols the ON power is defined as the mean power for each symbol duration excluding any transient period. See Figure 6.3.3.6-2

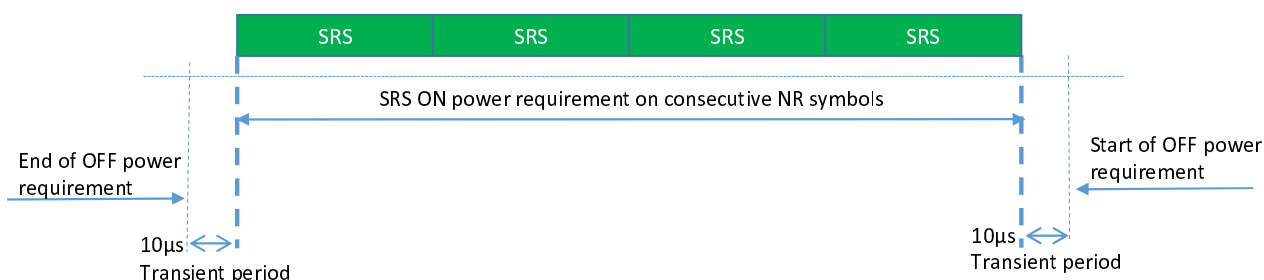

Figure 6.3.3.6-2: Consecutive SRS time mask for the case when no power change is required

When power change between consecutive SRS transmissions is required, then Figure 6.3.3.6-3 and Figure 6.3.3.6-4 apply.

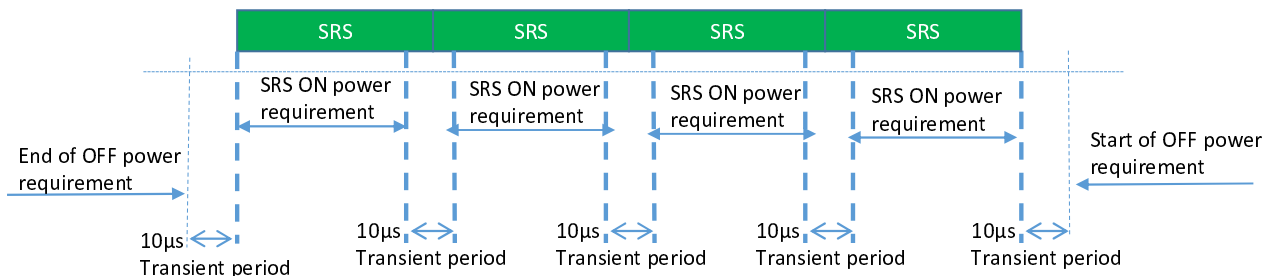

Figure 6.3.3.6-3: Consecutive SRS time mask for the case when power change is required and when 15kHz and 30kHz SCS is used in FR1

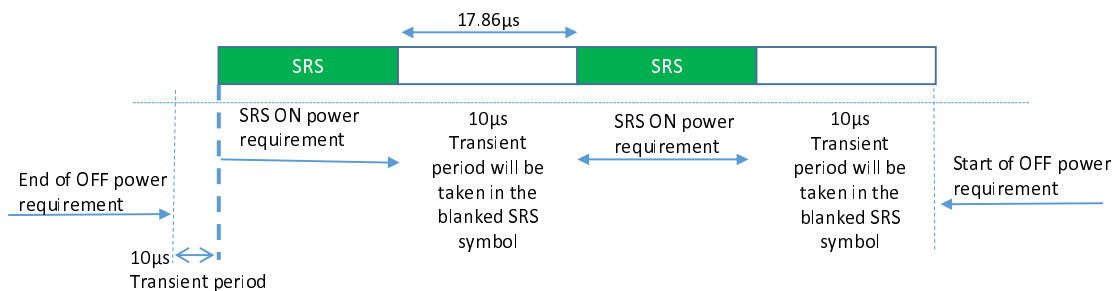

Figure 6.3.3.6-4: Consecutive SRS time mask for the case when power change is required and when 60kHz SCS is used in FR1

6.3.3.7 PUSCH-PUCCH and PUSCH-SRS time masks

The PUCCH/PUSCH/SRS time mask defines the observation period between sounding reference symbol (SRS) and an adjacent PUSCH/PUCCH symbol and subsequent UL transmissions. The time masks apply for all types of frame structures and their allowed PUCCH/PUSCH/SRS transmissions unless otherwise stated.

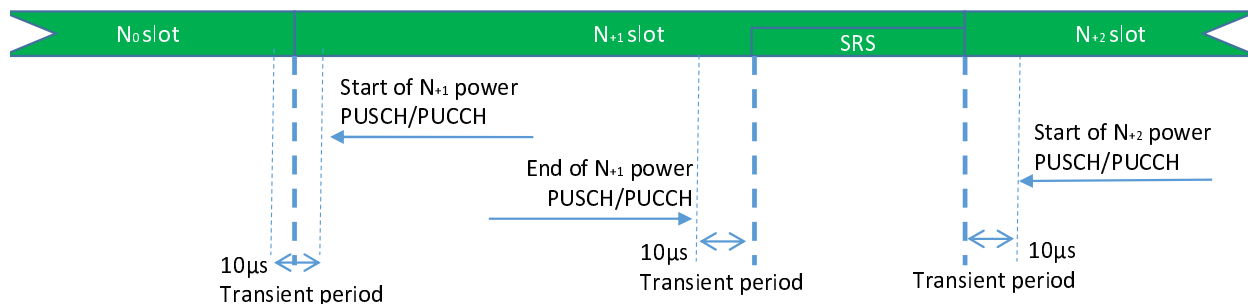

Figure 6.3.3.7-1: PUCCH/PUSCH/SRS time mask when there is a transmission before or after or both before and after SRS

When there is no transmission preceding SRS transmission or succeeding SRS transmission, then the same time mask applies as shown in Figure 6.3.3.7-1.

6.3.3.8 Transmit power time mask for consecutive slot or long subslot transmission and short subslot transmission boundaries

The transmit power time mask for consecutive slot or long subslot transmission and short slot transmission boundaries defines the transient periods allowed between such transmissions.

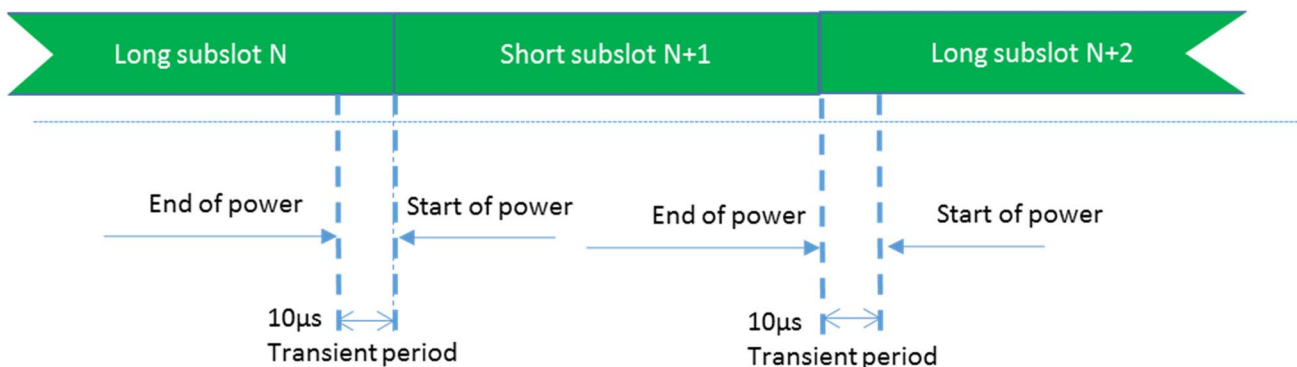

Figure 6.3.3.8-1: Consecutive slot or long subslot transmission and short subslot transmission time mask

6.3.3.9 Transmit power time mask for consecutive short subslot transmissions boundaries

The transmit power time mask for consecutive short subslot transmission boundaries defines the transient periods allowed between short subslot transmissions.

The transient period shall be equally shared as shown on Figure 6.3.3.9-2.

Figure 6.3.3.9-1: Void

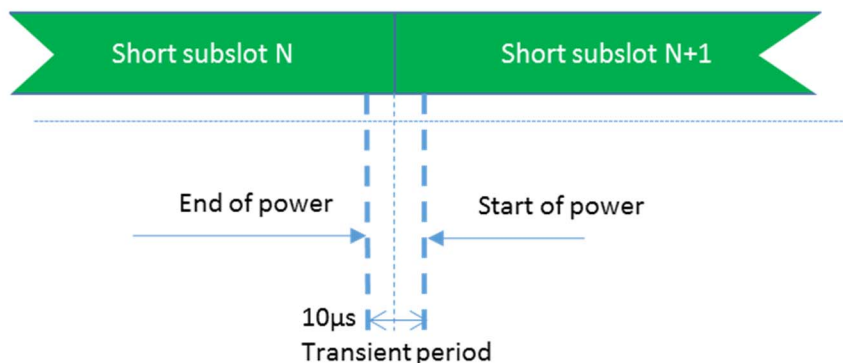

Figure 6.3.3.9-2: Consecutive short subslot transmissions time mask

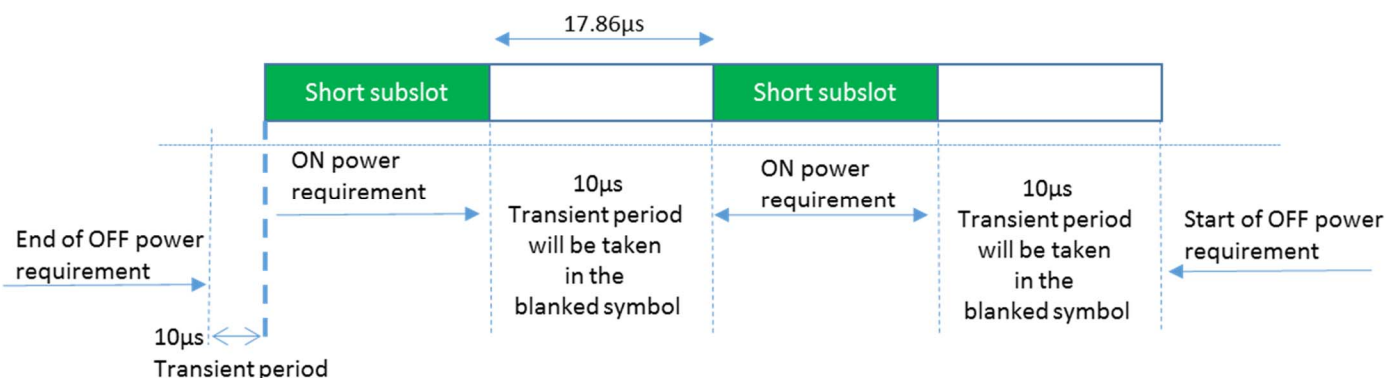

Figure 6.3.3.9-3: Consecutive short subslot (1 symbol gap) time mask for the case when transient period is required on both sides of the symbol and when 60kHz SCS is used in FR1

6.3.4 Power control

6.3.4.1 General

The requirements on power control accuracy apply under normal conditions.

6.3.4.2 Absolute power tolerance

The absolute power tolerance is the ability of the UE transmitter to set its initial output power to a specific value for the first sub-frame at the start of a contiguous transmission or non-contiguous transmission with a transmission gap larger than 20ms. The tolerance includes the channel estimation error.

The minimum requirement specified in Table 6.3.4.2-1 apply in the power range bounded by the minimum output power as specified in sub-clause 6.3.1 and the maximum output power as specified in sub-clause 6.2.1.

Table 6.3.4.2-1: Absolute power tolerance

Conditions	Tolerance
Normal	± 9.0 dB

6.3.4.3 Relative power tolerance

The relative power tolerance is the ability of the UE transmitter to set its output power in a target sub-frame relatively to the power of the most recently transmitted reference sub-frame if the transmission gap between these sub-frames is larger than 20ms.

The minimum requirements specified in Table 6.3.4.3-1 apply when the power of the target and reference sub-frames are within the power range bounded by the minimum output power as defined in sub-clause 6.3.1 and the measured PUMAX as defined in sub-clause 6.2.1.

Table 6.3.4.3-1: Relative power tolerance

Power step ΔP (Up or down) (dB)	All combinations of PUSCH and PUCCH transitions (dB)	All combinations of PUSCH/PUCCH and SRS transitions between sub- frames (dB)	PRACH (dB)
$\Delta P < 2$	[± 2.5] (NOTE)	[± 3.0]	[± 2.5]
$2 \leq \Delta P < 3$	[± 3.0]	[± 4.0]	[± 3.0]
$3 \leq \Delta P < 4$	[± 3.5]	[± 5.0]	[± 3.5]
$4 \leq \Delta P \leq 10$	[± 4.0]	[± 6.0]	[± 4.0]
$10 \leq \Delta P < 15$	[± 5.0]	[± 8.0]	[± 5.0]
$15 \leq \Delta P$	[± 6.0]	[± 9.0]	[± 6.0]
NOTE:	For PUSCH to PUSCH transitions with the allocated resource blocks fixed in frequency and no transmission gaps other than those generated by downlink subframes, DwPTS fields or Guard Periods: for a power step $\Delta P \leq 1$ dB, the relative power tolerance for transmission is ± 0.7 dB.		

6.3.4.4 Aggregate power tolerance

The aggregate power control tolerance is the ability of the UE transmitter to maintain its power during non-contiguous transmissions within 21 ms in response to 0 dB commands with respect to the first UE transmission and all other power control parameters as specified in 38.213 kept constant.

The minimum requirement specified in Table 6.3.4.4-1 apply in the power range bounded by the minimum output power as specified in sub-clause 6.3.1 and the maximum output power as specified in sub-clause 6.2.2.

Table 6.3.4.4-1: Aggregate power tolerance

TPC command	UL channel	Aggregate power tolerance within 21ms
0 dB	PUCCH	± 2.5 dB
0 dB	PUSCH	± 3.5 dB

6.3A Output power dynamics for CA

For inter-band carrier aggregation with one uplink carrier assigned to one NR band, the output power dynamics requirements in subclause 6.3 apply.

6.3A.1 Minimum output power for CA

6.3A.1.1 Minimum output power for intra-band contiguous CA

6.3A.1.2 Minimum output power for intra-band non-contiguous CA

6.3A.1.3 Minimum output power for inter-band CA

For inter-band carrier aggregation with uplink assigned to two NR bands, the minimum output power is defined per carrier and the requirement is specified in subclause 6.3.1.

6.3A.2 Transmit OFF power for CA

6.3A.2.1 Transmit OFF power for intra-band contiguous CA

6.3A.2.2 Transmit OFF power for intra-band non-contiguous CA

6.3A.2.3 Transmit OFF power for inter-band CA

For inter-band carrier aggregation with uplink assigned to two NR bands, the transmit OFF power specified in subclause 6.3.2.1 is applicable for each component carrier when the transmitter is OFF on all component carriers. The

transmitter is considered to be OFF when the UE is not allowed to transmit or during periods when the UE is not transmitting a sub-frame. During measurements gaps, the UE is not considered to be OFF.

6.3A.3 Transmit ON/OFF time mask for CA

6.3A.3.1 Transmit ON/OFF time mask for intra-band contiguous CA

6.3A.3.2 Transmit ON/OFF time mask for intra-band non-contiguous CA

6.3A.3.3 Transmit ON/OFF time mask for inter-band CA

For inter-band carrier aggregation with uplink assigned to two NR bands, the general output power ON/OFF time mask specified in subclause 6.3.3.1 is applicable for each component carrier during the ON power period and the transient periods. The OFF period as specified in subclause 6.3.3.1 shall only be applicable for each component carrier when all the component carriers are OFF.

6.3A.4 Power control for CA

6.3A.4.1 Power control for intra-band contiguous CA

6.3A.4.2 Power control for intra-band non-contiguous CA

6.3A.4.3 Power control for inter-band CA

No requirements unique to CA operation are defined.

6.3D Output power dynamics for UL-MIMO

6.3D.1 Minimum output power for UL-MIMO

For UE with two transmit antenna connectors in closed-loop spatial multiplexing scheme, the minimum output power is defined as the sum of the mean power at each transmit connector in one sub-frame (1ms). The minimum output power shall not exceed the values specified in Table 6.3.1-1.

If UE is configured for transmission on single-antenna port, the requirements in subclause 6.3.1 apply

6.3D.2 Transmit OFF power for UL-MIMO

The transmit OFF power is defined as the mean power at each transmit antenna connector in a duration of at least one sub-frame (1ms) excluding any transient periods.

The transmit OFF power at each transmit antenna connector shall not exceed the values specified in Table 6.3.2-1.

6.3D.3 Transmit ON/OFF time mask for UL-MIMO

For UE supporting UL-MIMO, the ON/OFF time mask requirements in subclause 6.3.3 apply at each transmit antenna connector.

For UE with two transmit antenna connectors in closed-loop spatial multiplexing scheme, the general ON/OFF time mask requirements specified in subclause 6.3.3.1 apply to each transmit antenna connector. The requirements shall be met with the UL-MIMO configurations described in sub-clause 6.2D.1.

If UE is configured for transmission on single-antenna port, the requirements in subclause 6.3.3 apply.

6.3D.4 Power control for UL-MIMO

For UE supporting UL-MIMO, the power control tolerance applies to the sum of output power at each transmit antenna connector.

The power control requirements specified in subclause 6.3.4 apply to UE with two transmit antenna connectors in closed-loop spatial multiplexing scheme. The requirements shall be met with UL-MIMO configurations described in sub-clause 6.2D.1.

If UE is configured for transmission on single-antenna port, the requirements in subclause 6.3.4 apply

6.4 Transmit signal quality

6.4.1 Frequency error

The UE modulated carrier frequency shall be accurate to within ± 0.1 PPM observed over a period of 1 ms compared to the carrier frequency received from the NR Node B.

6.4.2 Transmit modulation quality

Transmit modulation quality defines the modulation quality for expected in-channel RF transmissions from the UE. The transmit modulation quality is specified in terms of:

Error Vector Magnitude (EVM) for the allocated resource blocks (RBs)

EVM equalizer spectrum flatness derived from the equalizer coefficients generated by the EVM measurement process

Carrier leakage

In-band emissions for the non-allocated RB

All the parameters defined in subclause 6.4.2 are defined using the measurement methodology specified in Annex F.

6.4.2.1 Error Vector Magnitude

The Error Vector Magnitude is a measure of the difference between the reference waveform and the measured waveform. This difference is called the error vector. Before calculating the EVM the measured waveform is corrected by the sample timing offset and RF frequency offset. Then the carrier leakage shall be removed from the measured waveform before calculating the EVM.

The measured waveform is further equalised using the channel estimates subjected to the EVM equaliser spectrum flatness requirement specified in sub-clause 6.4.2.4. For DFT-s-OFDM waveforms, the EVM result is defined after the front-end FFT and IDFT as the square root of the ratio of the mean error vector power to the mean reference power expressed as a %. For CP-OFDM waveforms, the EVM result is defined after the front-end FFT as the square root of the ratio of the mean error vector power to the mean reference power expressed as a %.

The basic EVM measurement interval in the time domain is one preamble sequence for the PRACH and the duration of PUCCH/PUSCH channel, or one hop, if frequency hopping is enabled for PUCCH and PUSCH in the time domain. The EVM measurement interval is reduced by any symbols that contains an allowable power transient as defined in subclause 6.3.3.

The RMS average of the basic EVM measurements for 10 sub-frames excluding any transient period for the average EVM case, and 60 sub-frames excluding any transient period for the reference signal EVM case, for the different modulations schemes shall not exceed the values specified in Table 6.4.2.1-1 for the parameters defined in Table 6.4.2.1-2. For EVM evaluation purposes, all PRACH preamble formats 0-4 and all PUCCH formats 1, 1a, 1b, 2, 2a and 2b are considered to have the same EVM requirement as QPSK modulated.

Table 6.4.2.1-1: Requirements for Error Vector Magnitude

Parameter	Unit	Average EVM Level
Pi/2-BPSK	%	30
QPSK	%	17.5
16 QAM	%	12.5
64 QAM	%	8
256 QAM	%	3.5

Table 6.4.2.1-2: Parameters for Error Vector Magnitude

Parameter	Unit	Level
UE Output Power	dBm	\geq Table 6.3.1-1
UE Output Power for 256 QAM	dBm	\geq TBD
Operating conditions		Normal conditions

6.4.2.2 Carrier leakage

Carrier leakage is an additive sinusoid waveform whose frequency is the same as the modulated waveform carrier frequency. The measurement interval is one slot in the time domain.

In the case that uplink sharing, the carrier leakage may have 7.5 kHz shift with the carrier frequency.

The relative carrier leakage power is a power ratio of the additive sinusoid waveform and the modulated waveform. The relative carrier leakage power shall not exceed the values specified in Table 6.4.2.2-1.

Table 6.4.2.2-1: Requirements for Carrier Leakage

Parameter	Relative Limit [dBc]
Output power > 10 dBm	-28
0 dBm ≤ Output power ≤ 10 dBm	-25
-30 dBm ≤ Output power ≤ 0 dBm	-20
-40 dBm ≤ Output power < -30 dBm	-10

6.4.2.3 In-band emissions

The in-band emission is defined as the average emission across 12 sub-carriers and as a function of the RB offset from the edge of the allocated UL transmission bandwidth. The in-band emission is measured as the ratio of the UE output power in a non-allocated RB to the UE output power in an allocated RB.

The basic in-band emissions measurement interval is defined over one slot in the time domain, however, the minimum requirement applies when the in-band emission measurement is averaged over 10 sub-frames. When the PUSCH or PUCCH transmission slot is shortened due to multiplexing with SRS, the in-band emissions measurement interval is reduced by one or more symbols, accordingly.

The average of the basic in-band emission measurement over 10 sub-frames shall not exceed the values specified in Table 6.4.2.3-1.

Table 6.4.2.3-1: Requirements for in-band emissions

Parameter description	Unit	Limit (NOTE 1)		Applicable Frequencies
General	dB	$\max \left\{ -25 - 10 \cdot \log_{10} (N_{RB} / L_{CRB}), \right.$ $20 \cdot \log_{10} EVM - 3 - 5 \cdot (\Delta_{RB} - 1) / L_{CRB},$ $\left. -57 \text{ dBm} + 10 \log_{10} (SCS / 15 \text{ kHz}) - P_{RB} \right\}$		Any non-allocated (NOTE 2)
IQ Image	dB	-28	Image frequencies when output power > 10 dBm	Image frequencies (NOTES 2, 3)
		-25	Image frequencies when output power ≤ 10 dBm	
Carrier leakage	dBc	-28	Output power > 10 dBm	Carrier leakage frequency (NOTES 4, 5)
		-25	0 dBm ≤ Output power ≤ 10 dBm	
		-20	-30 dBm ≤ Output power ≤ 0 dBm	
		-10	-40 dBm ≤ Output power < -30 dBm	

- NOTE 1: An in-band emissions combined limit is evaluated in each non-allocated RB. For each such RB, the minimum requirement is calculated as the higher of $P_{RB} - 30$ dB and the power sum of all limit values (General, IQ Image or Carrier leakage) that apply. P_{RB} is defined in NOTE 10.
- NOTE 2: The measurement bandwidth is 1 RB and the limit is expressed as a ratio of measured power in one non-allocated RB to the measured average power per allocated RB, where the averaging is done across all allocated RBs.
- NOTE 3: The applicable frequencies for this limit are those that are enclosed in the reflection of the allocated bandwidth, based on symmetry with respect to the carrier leakage frequency, but excluding any allocated RBs.
- NOTE 4: The measurement bandwidth is 1 RB and the limit is expressed as a ratio of measured power in one non-allocated RB to the measured total power in all allocated RBs.
- NOTE 5: The applicable frequencies for this limit are those that are enclosed in the RBs containing the carrier leakage frequency if N_{RB} is odd, or in the two RBs immediately adjacent to the carrier leakage frequency if N_{RB} is even but excluding any allocated RB.
- NOTE 6: L_{CRL} is the Transmission Bandwidth (see Figure 5.3.3).
- NOTE 7: N_{RB} is the Transmission Bandwidth Configuration (see Figure 5.3.3).
- NOTE 8: EVM is the limit specified in Table 6.4.2.1-1 for the modulation format used in the allocated RBs.
- NOTE 9: Δ_{RB} is the starting frequency offset between the allocated RB and the measured non-allocated RB (e.g. $\Delta_{RB}=1$ or $\Delta_{RB}=-1$ for the first adjacent RB outside of the allocated bandwidth).
- NOTE 10: P_{RL} is the transmitted power normalized by the number of allocated RBs, measured in dBm.

6.4.2.4 EVM equalizer spectrum flatness

The zero-forcing equalizer correction applied in the EVM measurement process (as described in Annex F) must meet a spectral flatness requirement for the EVM measurement to be valid. The EVM equalizer spectrum flatness is defined in terms of the maximum peak-to-peak ripple of the equalizer coefficients (dB) across the allocated uplink block. The basic measurement interval is the same as for EVM.

The peak-to-peak variation of the EVM equalizer coefficients contained within the frequency range of the uplink allocation shall not exceed the maximum ripple specified in Table 6.4.2.4-1 for normal conditions. For uplink allocations contained within both Range 1 and Range 2, the coefficients evaluated within each of these frequency ranges shall meet the corresponding ripple requirement and the following additional requirement: the relative difference between the maximum coefficient in Range 1 and the minimum coefficient in Range 2 must not be larger than 5 dB, and the relative difference between the maximum coefficient in Range 2 and the minimum coefficient in Range 1 must not be larger than 7 dB (see Figure 6.4.2.4-1).

The EVM equalizer spectral flatness shall not exceed the values specified in Table 6.4.2.4-2 for extreme conditions. For uplink allocations contained within both Range 1 and Range 2, the coefficients evaluated within each of these frequency ranges shall meet the corresponding ripple requirement and the following additional requirement: the relative difference between the maximum coefficient in Range 1 and the minimum coefficient in Range 2 must not be larger than 6 dB, and the relative difference between the maximum coefficient in Range 2 and the minimum coefficient in Range 1 must not be larger than 10 dB (see Figure 6.4.2.4-1).

Table 6.4.2.4-1: Requirements for EVM equalizer spectrum flatness (normal conditions)

Frequency range	Maximum ripple [dB]
$F_{UL_Meas} - F_{UL_Low} \geq 3$ MHz and $F_{UL_High} - F_{UL_Meas} \geq 3$ MHz (Range 1)	4 (p-p)
$F_{UL_Meas} - F_{UL_Low} < 3$ MHz or $F_{UL_High} - F_{UL_Meas} < 3$ MHz (Range 2)	8 (p-p)
NOTE 1: F_{UL_Meas} refers to the sub-carrier frequency for which the equalizer coefficient is evaluated	
NOTE 2: F_{UL_Low} and F_{UL_High} refer to each E-UTRA frequency band specified in Table 5.5-1	

Table 6.4.2.4-2: Minimum requirements for EVM equalizer spectrum flatness f (extreme conditions)

Frequency range	Maximum Ripple [dB]
$F_{UL_Meas} - F_{UL_Low} \geq 5 \text{ MHz}$ and $F_{UL_High} - F_{UL_Meas} \geq 5 \text{ MHz}$ (Range 1)	4 (p-p)
$F_{UL_Meas} - F_{UL_Low} < 5 \text{ MHz}$ or $F_{UL_High} - F_{UL_Meas} < 5 \text{ MHz}$ (Range 2)	12 (p-p)
NOTE 1: F_{UL_Meas} refers to the sub-carrier frequency for which the equalizer coefficient is evaluated	
NOTE 2: F_{UL_Low} and F_{UL_High} refer to each E-UTRA frequency band specified in Table 5.5-1	

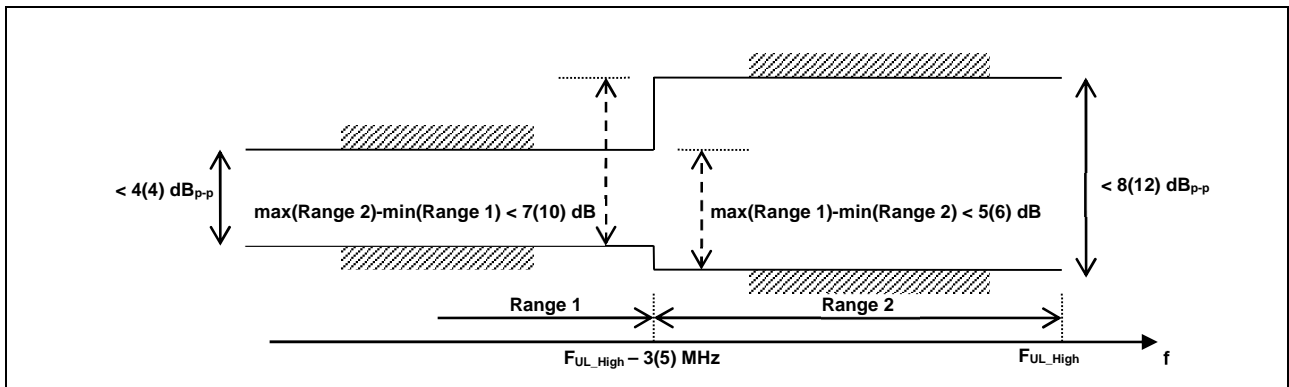

Figure 6.4.2.4-1: The limits for EVM equalizer spectral flatness with the maximum allowed variation of the coefficients indicated (the ETC minimum requirement are within brackets).

6.4.2.4.1 Requirements for pi/2 BPSK modulation

These requirements apply if the IE [P-Boost-BPSK] is set to 1 for power class 3 capable UE operating in TDD bands n40, n77, n78 and n79 with pi/2 BPSK modulation and 40% or less slots in radio frame are used for UL transmission. Otherwise the requirements for EVM equalizer spectrum flatness defined in clause 6.4.2.4 apply.

The EVM equalizer coefficients across the allocated uplink block shall be modified to fit inside the mask specified in Table 6.4.2.4.1-1 for normal conditions, prior to the calculation of EVM.

Table 6.4.2.4.1-1: Mask for EVM equalizer coefficients for pi/2 BPSK, normal conditions

Frequency range	Parameter	Maximum ripple [dB]
$F_{meas} - F_{center} \leq X \text{ MHz}$ or $F_{center} - F_{meas} \leq X \text{ MHz}$ (Range 1)	X1	6 (p-p)
$F_{meas} - F_{center} > X \text{ MHz}$ or $F_{center} - F_{meas} > X \text{ MHz}$ (Range 2)	X2	14 (p-p)
NOTE 1: F_{meas} refers to the sub-carrier frequency for which the equalizer coefficient is evaluated		
NOTE 2: F_{center} refers to the center frequency of an allocated block of PRBs		
NOTE 3: X, in MHz, is equal to 25% of the bandwidth of the PRB allocation		
NOTE 4: See Figure 6.4.2.4-1 for description of X1, X2		

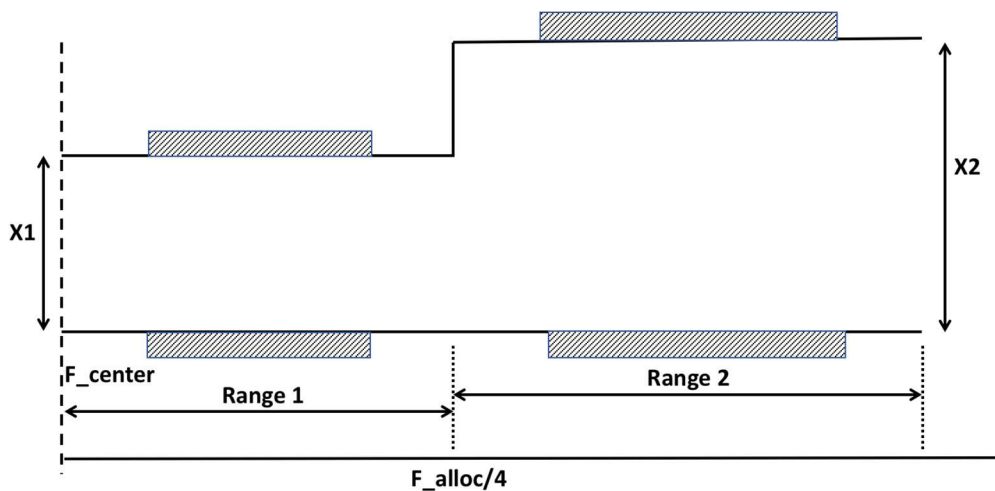

Figure 6.4.2.4.1-1: The limits for EVM equalizer spectral flatness with the maximum allowed variation. F_center denotes the center frequency of the allocated block of PRBs. F_alloc denotes the bandwidth of the PRB allocation.

For $\pi/2$ BPSK modulation the UE shall be allowed to employ spectral shaping and the shaping filter shall be restricted so that the impulse response of the shaping filter itself shall meet

$$|\tilde{a}_i(t,0)| \geq |\tilde{a}_i(t,\tau)| \quad \forall \tau \neq 0$$

$$20\log_{10} |\tilde{a}_i(t,\tau)| < -15 \text{ dB} \quad 1 < \tau < M - 1,$$

where, $|\tilde{a}_i(t,\tau)| = \text{IDFT}\{|\tilde{a}_i(t,f)| e^{j\varphi(t,f)}\}$, f is the frequency of the M allocated subcarriers, $\tilde{a}_i(t,f)$ and $\varphi(t,f)$ are the amplitude and phase response.

0dB reference is defined as $20\log_{10} |\tilde{a}_i(t,0)|$.

6.4A Transmit signal quality for CA

For inter-band carrier aggregation with one uplink carrier assigned to one NR band, the transmit signal quality requirements in subclause 6.4 apply.

6.4A.1 Frequency error for CA

6.4A.1.1 Frequency error for intra-band contiguous CA

6.4A.1.2 Frequency error for intra-band non-contiguous CA

6.4A.1.3 Frequency error for inter-band CA

For inter-band carrier aggregation with uplink assigned to two NR bands, the frequency error requirements defined in subclause 6.4.1 shall apply on each component carrier with all component carriers active.

6.4A.2 Transmit modulation quality for CA

6.4A.2.1 Frequency error for intra-band contiguous CA

6.4A.2.2 Frequency error for intra-band non-contiguous CA

6.4A.2.3 Frequency error for inter-band CA

For inter-band carrier aggregation with uplink assigned to two NR bands, the requirements shall apply on each component carrier as defined in clause 6.4.2 with all component carriers active.

6.4D Transmit signal quality for UL-MIMO

6.4D.1 Frequency error for UL-MIMO

For UE(s) supporting UL-MIMO, the UE modulated carrier frequency at each transmit antenna connector shall be accurate to within ± 0.1 PPM observed over a period of one sub-frame (1 ms) compared to the carrier frequency received from the NR Node B.

6.4D.2 Transmit modulation quality for UL-MIMO

For UE supporting UL-MIMO, the transmit modulation quality requirements are specified at each transmit antenna connector.

If UE is configured for transmission on single-antenna port, the requirements specified for single carrier apply.

The transmit modulation quality is specified in terms of:

- Error Vector Magnitude (EVM) for the allocated resource blocks (RBs)
- EVM equalizer spectrum flatness derived from the equalizer coefficients generated by the EVM measurement process
- Carrier leakage (caused by IQ offset)
- In-band emissions for the non-allocated RB

6.4D.2.1 Error Vector Magnitude

For UE with two transmit antenna connectors in closed-loop spatial multiplexing scheme, the Error Vector Magnitude requirements specified in Table 6.4.2.1-1 which is defined in subclause 6.4.2.1 apply at each transmit antenna connector. The requirements shall be met with the UL-MIMO configurations specified in Table 6.2D.1-2

6.4D.2.2 Carrier leakage

For UE with two transmit antenna connectors in closed-loop spatial multiplexing scheme, the Relative Carrier Leakage Power requirements specified in Table 6.4.2.2-1 which is defined in subclause 6.4.2.2 apply at each transmit antenna connector. The requirements shall be met with the UL-MIMO configurations specified in Table 6.2D.1-2

6.4D.2.3 In-band emissions

For UE with two transmit antenna connectors in closed-loop spatial multiplexing scheme, the In-band Emission requirements specified in Table 6.4.2.3-1 which is defined in subclause 6.4.2.3 apply at each transmit antenna connector. The requirements shall be met with the uplink MIMO configurations specified in Table 6.2D.1-2

6.4D.2.4 EVM equalizer spectrum flatness for UL-MIMO

For UE with two transmit antenna connectors in closed-loop spatial multiplexing scheme, the EVM Equalizer Spectrum Flatness requirements specified in Table 6.4.2.4-1 and Table 6.4.2.4-2 which are defined in subclause 6.4.2.4 apply at each transmit antenna connector. The requirements shall be met with the UL-MIMO configurations specified in Table 6.2D.1-2

6.4D.3 Time alignment error for UL-MIMO

For UE(s) with multiple transmit antenna connectors supporting UL-MIMO, this requirement applies to frame timing differences between transmissions on multiple transmit antenna connectors in the closed-loop spatial multiplexing scheme.

The time alignment error (TAE) is defined as the average frame timing difference between any two transmissions on different transmit antenna connectors.

For UE(s) with multiple transmit antenna connectors, the Time Alignment Error (TAE) shall not exceed 130 ns.

6.4D.4 Requirements for coherent UL MIMO

For coherent UL MIMO, Table 6.4D.4-1 lists the maximum allowable difference between the measured relative power and phase errors between different antenna ports in any slot within the specified time window from the last transmitted SRS on the same antenna ports, for the purpose of uplink transmission (codebook or non-codebook usage) and those measured at that last SRS. The requirements in Table 6.4D.4-1 apply when the UL transmission power at each antenna port is larger than 0 dBm for SRS transmission and for the duration of time window.

Table 6.4D.4-1: Maximum allowable difference of relative phase and power errors in a given slot compared to those measured at last SRS transmitted

Difference of relative phase error	Difference of relative power error	Time window
40 degrees	4 dB	20 msec

The above requirements when all the following conditions are met within the specified time window:

- UE is not signaled with a change in number of SRS ports in SRS-config, or a change in PUSCH-config
- UE remains in DRX active time (UE does not enter DRX OFF time)
- No measurement gap occurs
- No instance of SRS transmission with the usage antenna switching occurs
- Active BWP remains the same
- EN-DC and CA configuration is not changed for the UE (UE is not configured or de-configured with PScell or SCell(s))

6.5 Output RF spectrum emissions

6.5.1 Occupied bandwidth

Occupied bandwidth is defined as the bandwidth containing 99 % of the total integrated mean power of the transmitted spectrum on the assigned channel. The occupied bandwidth for all transmission bandwidth configurations (Resources Blocks) shall be less than the channel bandwidth specified in Table 6.5.1-1.

Table 6.5.1-1: Occupied channel bandwidth

	NR Channel bandwidth											
	5 MHz	10 MHz	15 MHz	20 MHz	25 MHz	30 MHz	40 MHz	50 MHz	60 MHz	80 MHz	90 MHz	100 MHz
Occupied channel bandwidth (MHz)	5	10	15	20	25	30	40	50	60	80	90	100

6.5.2 Out of band emission

6.5.2.1 General

The Out of band emissions are unwanted emissions immediately outside the assigned channel bandwidth resulting from the modulation process and non-linearity in the transmitter but excluding spurious emissions. This out of band emission limit is specified in terms of a spectrum emission mask and an adjacent channel leakage power ratio.

To improve measurement accuracy, sensitivity and efficiency, the resolution bandwidth may be smaller than the measurement bandwidth. When the resolution bandwidth is smaller than the measurement bandwidth, the result should be integrated over the measurement bandwidth in order to obtain the equivalent noise bandwidth of the measurement bandwidth.

6.5.2.2 Spectrum emission mask

The spectrum emission mask of the UE applies to frequencies (Δf_{OoB}) starting from the \pm edge of the assigned NR channel bandwidth. For frequencies offset greater than F_{OoB} , the spurious requirements in subclause 6.5.3 are applicable.

NOTE: For measurement conditions at the edge of each frequency range, the lowest frequency of the measurement position in each frequency range should be set at the lowest boundary of the frequency range plus MBW/2. The highest frequency of the measurement position in each frequency range should be set at the highest boundary of the frequency range minus MBW/2. MBW denotes the measurement bandwidth defined for the protected band.

The power of any UE emission shall not exceed the levels specified in Table 6.5.2.2-1 for the specified channel bandwidth.

Table 6.5.2.2-1: NR General spectrum emission mask

Spectrum emission limit (dBm) / Channel bandwidth													
Δf_{OoB} (MHz)	5 MHz	10 MHz	15 MHz	20 MHz	25 MHz	30 MHz	40 MHz	50 MHz	60 MHz	80 MHz	90 MHz	100 MHz	Measurement bandwidth
$\pm 0-1$	-13	-13	-13	-13	-13	-13	-13						1 % channel bandwidth
$\pm 0-1$								-24	-24	-24	-24	-24	30 kHz
$\pm 1-5$	-10	-10	-10	-10	-10	-10	-10	-10	-10	-10	-10	-10	1 MHz
$\pm 5-6$	-13	-13	-13	-13	-13	-13	-13	-13	-13	-13	-13	-13	
$\pm 6-10$	-25												
$\pm 10-15$		-25											
$\pm 15-20$			-25										
$\pm 20-25$				-25									
$\pm 25-30$					-25								
$\pm 30-35$						-25							
$\pm 35-40$										-13			
$\pm 40-45$							-25						
$\pm 45-50$													
$\pm 50-55$								-25					
$\pm 55-60$													
$\pm 60-65$									-25				
$\pm 65-80$													
$\pm 80-90$										-25			
$\pm 90-95$											-25		
$\pm 95-100$													
$\pm 100-105$												-25	

6.5.2.3 Additional spectrum emission mask

Additional spectrum emission requirements are signalled by the network with network signalling value indicated by the field *additionalSpectrumEmission*.

6.5.2.3.1 Requirements for network signalled value "NS_35"

Additional spectrum emission requirements are signalled by the network to indicate that the UE shall meet an additional requirement for a specific deployment scenario as part of the cell handover/broadcast message.

When "NS_35" is indicated in the cell, the power of any UE emission shall not exceed the levels specified in Table 6.5.2.3.1-1.

Table 6.5.2.3.1-1: Additional requirements for "NS_35"

Spectrum emission limit (dBm) / Channel bandwidth					
Δf_{OoB} (MHz)	5 MHz	10 MHz	15 MHz	20 MHz	Measurement bandwidth (unless otherwise stated)
$\pm 0-0.1$	-15	-18	-20	-21	30 kHz
$\pm 0.1-6$	-13	-13	-13	-13	100 kHz
$\pm 6-10$	-25 ¹	-13	-13	-13	100 kHz
$\pm 10-15$		-25 ¹	-13	-13	100 kHz
$\pm 15-20$			-25 ¹	-13	100 kHz
$\pm 20-25$				-25	1 MHz
NOTE 1: The measurement bandwidth shall be 1 MHz					

NOTE: As a general rule, the resolution bandwidth of the measuring equipment should be equal to the measurement bandwidth. However, to improve measurement accuracy, sensitivity and efficiency, the resolution bandwidth may be smaller than the measurement bandwidth. When the resolution bandwidth is smaller than the measurement bandwidth, the result should be integrated over the measurement bandwidth in order to obtain the equivalent noise bandwidth of the measurement bandwidth.

6.5.2.3.2 Requirements for network signalled value "NS_04"

Additional spectrum emission requirements are signalled by the network to indicate that the UE shall meet an additional requirement for a specific deployment scenario as part of the cell handover/broadcast message.

The n41 SEM transition point from -13 dBm/MHz to -25 dBm/MHz is based on the emission bandwidth. The emission bandwidth is defined as the width of the signal between two points, one below the carrier center frequency and one above the carrier center frequency, outside of which all emissions are attenuated at least 26 dB below the transmitter power. Since the 26-dB emission bandwidth is implementation dependent, the transmission bandwidths occupied by RBs is used for the SEM.

Table 6.5.2.3.2-1: n41 transmission bandwidths for CP-OFDM

SCS (kHz)	Channel bandwidths (MHz)								
	10	15	20	40	50	60	80	90	100
15	9.36	14.22	19.08	38.88	48.6	N.A	N.A	N.A	N.A
30	8.64	13.68	18.36	38.16	47.88	58.32	78.12	88.02	98.28
60	7.92	12.96	17.28	36.72	46.8	56.88	77.04	87.12	97.20

Table 6.5.2.3.2-2: n41 transmission bandwidths for DFT-S-OFDM

SCS (kHz)	Channel bandwidths (MHz)								
	10	15	20	40	50	60	80	90	100
15	9.00	13.50	18.00	38.88	48.60	N/A	N/A	N/A	N/A
30	8.64	12.96	18.00	36.00	46.08	58.32	77.76	87.48	97.20
60	7.20	12.96	17.28	36.00	46.08	54.00	72.00	86.40	97.20

When "NS_04" is indicated in the cell, the power of any UE emission shall not exceed the levels specified in Table 6.5.2.3.2-3.

Table 6.5.2.3.2-3: n41 SEM with “NS_04”

Δf_{OOB} MHz	Spectrum emission limit (dBm) / measurement bandwidth for each channel bandwidth										
	10 MHz	15 MHz	20 MHz	40 MHz	50 MHz	60 MHz	80 MHz	90 MHz	100 MHz	Measurement bandwidth	
$\pm 0 - 1$	-10	-10	-10	-10						2 % channel bandwidth	
					-10					1 MHz	
$\pm 1 - 5$	-10										1 MHz
$\pm 5 - X$	-13										
$\pm X - (BW_{Channel} + 5$ MHz)	-25										
NOTE: X is defined in Table 6.5.2.3.2-1 for CP-OFDM and 6.5.2.3.2-2 for DFT-S-OFDM											

6.5.2.3.3 Requirements for network signalled value "NS_03"

Additional spectrum emission requirements are signalled by the network to indicate that the UE shall meet an additional requirement for a specific deployment scenario as part of the cell handover/broadcast message.

When "NS_03", is indicated in the cell, the power of any UE emission shall not exceed the levels specified in Table 6.5.2.3.3-1.

Table 6.5.2.3.3-1: Additional requirements for “NS_03”

Δf_{OOB} (MHz)	Spectrum emission limit (dBm)/ Channel bandwidth					
	5 MHz	10 MHz	15 MHz	20 MHz	40 MHz	Measurement bandwidth
$\pm 0-1$	-13	-13	-13	-13	-13	1 % of channel BW
$\pm 1-6$	-13	-13	-13	-13	-13	1 MHz
$\pm 6-10$	-25	-13	-13	-13	-13	1 MHz
$\pm 10-15$		-25	-13	-13	-13	1 MHz
$\pm 15-20$			-25	-13	-13	1 MHz
$\pm 20-25$				-25	-13	1 MHz
$\pm 25-40$					-13	1 MHz
$\pm 40-45$					-25	1 MHz

NOTE: As a general rule, the resolution bandwidth of the measuring equipment should be equal to the measurement bandwidth. However, to improve measurement accuracy, sensitivity and efficiency, the resolution bandwidth may be smaller than the measurement bandwidth. When the resolution bandwidth is smaller than the measurement bandwidth, the result should be integrated over the measurement bandwidth in order to obtain the equivalent noise bandwidth of the measurement bandwidth.

Table 6.5.2.3.3-2: Void

6.5.2.3.4 Requirements for network signalled value "NS_06"

Additional spectrum emission requirements are signalled by the network to indicate that the UE shall meet an additional requirement for a specific deployment scenario as part of the cell handover/broadcast message.

When "NS_06" is indicated in the cell, the power of any UE emission shall not exceed the levels specified in Table 6.5.2.3.4-1.

Table 6.5.2.3.4-1: Additional requirements for "NS_06"

Spectrum emission limit (dBm) / Channel bandwidth				
Δf_{OOB} (MHz)	5 MHz	10 MHz	15 MHz	Measurement bandwidth
$\pm 0 - 0.1$	-15	-18	-20	30 kHz
$\pm 0.1 - 1$	-13	-13	-13	100 kHz
$\pm 1 - 6$	-13	-13	-13	1 MHz
$\pm 6 - 10$	-25			
$\pm 10 - 15$		-25		
$\pm 15 - 20$		-25		

6.5.2.3.5 Requirements for network signalled value "NS_40"

Additional spectrum emission requirements are signalled by the network to indicate that the UE shall meet an additional requirement for a specific deployment scenario as part of the cell handover/broadcast message.

When "NS_40" is indicated in the cell, the power of any UE emission shall not exceed the levels specified in Table 6.5.2.3.5-1.

Table 6.5.2.3.5-1: Additional requirements for NR channels are assigned within 1427-1452MHz

Frequency band (MHz)	Channel bandwidth / Spectrum emission limit (dBm)	Measurement bandwidth
	27 MHz	
$1400 \leq f \leq 1427$	-32	27 MHz
NOTE 1: This requirement shall be verified with UE transmission power of 15 dBm.		

NOTE: As a general rule, the resolution bandwidth of the measuring equipment should be equal to the measurement bandwidth. However, to improve measurement accuracy, sensitivity and efficiency, the resolution bandwidth may be smaller than the measurement bandwidth. When the resolution bandwidth is smaller than the measurement bandwidth, the result should be integrated over the measurement bandwidth in order to obtain the equivalent noise bandwidth of the measurement bandwidth.

6.5.2.3.6 Requirements for network signalled value "NS_41"

Additional spectrum emission requirements are signalled by the network to indicate that the UE shall meet an additional requirement for a specific deployment scenario as part of the cell handover/broadcast message.

When "NS_41" is indicated in the cell, the power of any UE emission shall not exceed the levels specified in Table 6.5.2.3.6-1.

Table 6.5.2.3.6-1: Additional requirements for NR channels assigned within 1427-1452MHz

Frequency band (MHz)	Channel bandwidth / Spectrum emission limit (dBm)	Measurement bandwidth
	27 MHz	
$1400 \leq f \leq 1427$	-32	27 MHz
NOTE 1: This requirement shall be verified with UE transmission power of 15 dBm.		

NOTE: As a general rule, the resolution bandwidth of the measuring equipment should be equal to the measurement bandwidth. However, to improve measurement accuracy, sensitivity and efficiency, the resolution bandwidth may be smaller than the measurement bandwidth. When the resolution bandwidth is smaller than the measurement bandwidth, the result should be integrated over the measurement bandwidth in order to obtain the equivalent noise bandwidth of the measurement bandwidth.

6.5.2.3.7 Requirements for network signalled value "NS_42"

Additional spectrum emission requirements are signalled by the network to indicate that the UE shall meet an additional requirement for a specific deployment scenario as part of the cell handover/broadcast message.

When "NS_42" is indicated in the cell, the power of any UE emission shall not exceed the levels specified in Table 6.5.2.3.7-1.

Table 6.5.2.3.7-1: Additional requirements for NR channels assigned within 1492-1517MHz

Frequency band (MHz)	Channel bandwidth / Spectrum emission limit (dBm)	Measurement bandwidth
	1 MHz	
1518 ≤ f ≤ 1520	-0.8	1 MHz
1520 < f ≤ 1559	-30	1 MHz

NOTE: As a general rule, the resolution bandwidth of the measuring equipment should be equal to the measurement bandwidth. However, to improve measurement accuracy, sensitivity and efficiency, the resolution bandwidth may be smaller than the measurement bandwidth. When the resolution bandwidth is smaller than the measurement bandwidth, the result should be integrated over the measurement bandwidth in order to obtain the equivalent noise bandwidth of the measurement bandwidth.

6.5.2.4 Adjacent channel leakage ratio

Adjacent Channel Leakage power Ratio (ACLR) is the ratio of the filtered mean power centred on the assigned channel frequency to the filtered mean power centred on an adjacent channel frequency.

To improve measurement accuracy, sensitivity and efficiency, the resolution bandwidth may be smaller than the measurement bandwidth. When the resolution bandwidth is smaller than the measurement bandwidth, the result should be integrated over the measurement bandwidth in order to obtain the equivalent noise bandwidth of the measurement bandwidth.

6.5.2.4.1 NR ACLR

NR Adjacent Channel Leakage power Ratio (NR_{ACLR}) is the ratio of the filtered mean power centred on the assigned NR channel frequency to the filtered mean power centred on an adjacent NR channel frequency at nominal channel spacing.

The assigned NR channel power and adjacent NR channel power are measured with rectangular filters with measurement bandwidths specified in Table 6.5.2.4.1-1.

If the measured adjacent channel power is greater than -50 dBm then the NR_{ACLR} shall be higher than the value specified in Table 6.5.2.4.1-2.

Table 6.5.2.4.1-1: NR ACLR measurement bandwidth

NR channel bandwidth / NR ACLR measurement bandwidth												
	5 MHz	10 MHz	15 MHz	20 MHz	25 MHz	30 MHz	40 MHz	50 MHz	60 MHz	80 MHz	90 MHz	100 MHz
NR ACLR measurement bandwidth	4.515	9.375	14.235	19.095	23.955	28.815	38.895	48.615	58.35	78.15	88.23	98.31

Table 6.5.2.4.1-2: NR ACLR requirement

	Power class 1	Power class 2	Power class 3
NR ACLR		31 dB	30 dB

6.5.2.4.2 UTRA ACLR

UTRA adjacent channel leakage power ratio ($UTRA_{ACLR}$) is the ratio of the filtered mean power centred on the assigned NR channel frequency to the filtered mean power centred on an adjacent(s) UTRA channel frequency.

UTRA_{ACLR} is specified for the first adjacent UTRA channel (UTRA_{ACLR1}) which center frequency is ± 2.5 MHz from NR channel edge and for the 2nd adjacent UTRA channel (UTRA_{ACLR2}) which center frequency is ± 7.5 MHz from NR channel edge.

The UTRA channel power is measured with a RRC filter with roll-off factor $\alpha = 0.22$ and bandwidth of 3.84 MHz. The assigned NR channel power is measured with a rectangular filter with measurement bandwidth specified in Table 6.5.2.4.2-1.

If the measured adjacent channel power is greater than - 50dBm then the UTRA_{ACLR1} and UTRA_{ACLR2} shall be higher than the value specified in Table 6.5.2.4.2-1.

Table 6.5.2.4.2-1: UTRA ACLR requirement

	Power class 3
UTRA _{ACLR1}	33 dB
UTRA _{ACLR2}	36 dB

UTRA ACLR requirement is applicable when signalled by the network with network signalling value indicated by the field *additionalSpectrumEmission*.

6.5.3 Spurious emissions

Spurious emissions are emissions which are caused by unwanted transmitter effects such as harmonics emission, parasitic emissions, intermodulation products and frequency conversion products, but exclude out of band emissions unless otherwise stated. The spurious emission limits are specified in terms of general requirements in line with SM.329 and NR operating band requirement to address UE co-existence.

To improve measurement accuracy, sensitivity and efficiency, the resolution bandwidth may be smaller than the measurement bandwidth. When the resolution bandwidth is smaller than the measurement bandwidth, the result should be integrated over the measurement bandwidth in order to obtain the equivalent noise bandwidth of the measurement bandwidth.

NOTE: For measurement conditions at the edge of each frequency range, the lowest frequency of the measurement position in each frequency range should be set at the lowest boundary of the frequency range plus MBW/2. The highest frequency of the measurement position in each frequency range should be set at the highest boundary of the frequency range minus MBW/2. MBW denotes the measurement bandwidth defined for the protected band.

6.5.3.1 General spurious emissions

Unless otherwise stated, the spurious emission limits apply for the frequency ranges that are more than F_{OOB} (MHz) in Table 6.5.3.1-1 from the edge of the channel bandwidth. The spurious emission limits in Table 6.5.3.1-2 apply for all transmitter band configurations (N_{RB}) and channel bandwidths.

NOTE: For measurement conditions at the edge of each frequency range, the lowest frequency of the measurement position in each frequency range should be set at the lowest boundary of the frequency range plus MBW/2. The highest frequency of the measurement position in each frequency range should be set at the highest boundary of the frequency range minus MBW/2. MBW denotes the measurement bandwidth defined for the protected band.

Table 6.5.3.1-1: Boundary between NR out of band and general spurious emission domain

Channel bandwidth	OOB boundary F_{OOB} (MHz)
$BW_{Channel}$	$BW_{Channel} + 5$

Table 6.5.3.1-2: Requirement for general spurious emissions limits

Frequency Range	Maximum Level	Measurement bandwidth	NOTE
$9 \text{ kHz} \leq f < 150 \text{ kHz}$	-36 dBm	1 kHz	
$150 \text{ kHz} \leq f < 30 \text{ MHz}$	-36 dBm	10 kHz	
$30 \text{ MHz} \leq f < 1000 \text{ MHz}$	-36 dBm	100 kHz	
$1 \text{ GHz} \leq f < 12.75 \text{ GHz}$	-30 dBm	1 MHz	
	-25 dBm	1 MHz	
$12.75 \text{ GHz} \leq f < 5^{\text{th}}$ harmonic of the upper frequency edge of the UL operating band in GHz	-30 dBm	1 MHz	1
$12.75 \text{ GHz} < f < 26 \text{ GHz}$	-30 dBm	1 MHz	2
NOTE 1: Applies for Band that the upper frequency edge of the UL Band more than 2.69 GHz			
NOTE 2: Applies for Band that the upper frequency edge of the UL Band more than 5.2 GHz			
NOTE 3: Applies for EN-DC combinations that include n41 when NS_04 is signalled.			

6.5.3.2 Spurious emissions for UE co-existence

This clause specifies the requirements for NR bands for coexistence with protected bands.

Table 6.5.3.2-1: Requirements for spurious emissions for UE co-existence

NR Band	Spurious emission for UE co-existence						
	Protected band	Frequency range (MHz)			Maximum Level (dBm)	MBW (MHz)	NOTE
n1, n84	E-UTRA Band 1, 5, 7, 8, 11, 18, 19, 20, 21, 22, 26, 27, 28, 31, 32, 38, 40, 41, 42, 43, 44, 45, 50, 51, 65, 67, 68, 69, 72, 73, 74, 75, 76, NR Band n78, n79	F _{DL_low}	-	F _{DL_high}	-50	1	
	NR Band n77	F _{DL_low}	-	F _{DL_high}	-50	1	2
	E-UTRA Band 3, 34	F _{DL_low}	-	F _{DL_high}	-50	1	15
	Frequency range	1880	-	1895	-40	1	15, 27
	Frequency range	1895	-	1915	-15.5	5	15, 26, 27
	Frequency range	1915	-	1920	+1.6	5	15, 26, 27
n2	E-UTRA Band 4, 5, 10, 12, 13, 14, 17, 24, 26, 27, 28, 29, 30, 41, 42, 48, 50, 51, 66, 70, 71, 74	F _{DL_low}	-	F _{DL_high}	-50	1	
	E-UTRA Band 2, 25	F _{DL_low}	-	F _{DL_high}	-50	1	15
	E-UTRA Band 43	F _{DL_low}	-	F _{DL_high}	-50	1	2
n3, n80	E-UTRA Band 1, 5, 7, 8, 20, 26, 27, 28, 31, 32, 33, 34, 38, 39, 40, 41, 43, 44, 45, 50, 51, 65, 67, 68, 69, 72, 73, 74, 75, 76. NR Band n79	F _{DL_low}	-	F _{DL_high}	-50	1	
	E-UTRA Band 3	F _{DL_low}	-	F _{DL_high}	-50	1	15
	E-UTRA Band 11, 18, 19, 21	F _{DL_low}	-	F _{DL_high}	-50	1	13
	E-UTRA Band 22, 42, NR Band n77, n78	F _{DL_low}	-	F _{DL_high}	-50	1	2
	Frequency range	1884.5	-	1915.7	-41	0.3	13
n5	E-UTRA Band 1, 2, 3, 4, 5, 7, 8, 10, 12, 13, 14, 17, 18, 19, 24, 25, 26, 28, 29, 30, 31, 34, 38, 40, 42, 43, 45, 48, 50, 51, 65, 66, 70, 71, 73, 74, 85	F _{DL_low}	-	F _{DL_high}	-50		
	E-UTRA Band 41, 52	F _{DL_low}	-	F _{DL_high}	-50	1	2
	E-UTRA Band 11, 21	F _{DL_low}	-	F _{DL_high}	-50	1	39
	Frequency range	1884.5	-	1915.7	-41	0.3	8,39
n7	E-UTRA Band 1, 2, 3, 4, 5, 7, 8, 10, 12, 13, 14, 17, 20, 22, 26, 27, 28, 29, 30, 31, 32, 33, 34, 40, 42, 43, 50, 51, 65, 66, 67, 68, 72, 74, 75, 76, NR Band n77, n78	F _{DL_low}	-	F _{DL_high}	-50	1	
	Frequency range	2570	-	2575	+1.6	5	15, 21, 26
	Frequency range	2575	-	2595	-15.5	5	15, 21, 26
	Frequency range	2595	-	2620	-40	1	15, 21
n8, n81	E-UTRA Band 1, 20, 28, 31, 32, 33, 34, 38, 39, 40, 45, 50, 51, 65, 67, 68, 69, 72, 73, 74, 75, 76	F _{DL_low}	-	F _{DL_high}	-50	1	
	E-UTRA band 3, 7, 22, 41, 42, 43, NR Band n77, n78, n79	F _{DL_low}	-	F _{DL_high}	-50	1	2
	E-UTRA 8	F _{DL_low}	-	F _{DL_high}	-50	1	15
	E-UTRA Band 11, 21	F _{DL_low}	-	F _{DL_high}	-50	1	
	Frequency range	1884.5	-	1915.7	-41	0.3	8
n12	E-UTRA Band 2, 5, 13, 14, 17, 24, 25, 26, 27, 30, 41, 48, 50, 51, 71, 74	F _{DL_low}	-	F _{DL_high}	-50	1	
	E-UTRA Band 4, 10, 66, 70	F _{DL_low}	-	F _{DL_high}	-50	1	2

NR Band	Spurious emission for UE co-existence						
	Protected band	Frequency range (MHz)			Maximum Level (dBm)	MBW (MHz)	NOTE
	E-UTRA Band 12, 85	FDL_low	-	FDL_high	-50	1	15
n20, n82	E-UTRA Band 1, 3, 7, 8, 22, 31, 32, 33, 34, 40, 43, 50, 51, 65, 67, 68, 72, 74, 75, 76	FDL_low	-	FDL_high	-50	1	
	E-UTRA Band 20	FDL_low	-	FDL_high	-50	1	15
	E-UTRA Band 38, 42, 69, NR Band n77, n78	FDL_low	-	FDL_high	-50	1	2
	Frequency range	758	-	788	-50	1	
n25	E-UTRA Band 4, 5, 10, 12, 13, 14, 17, 24, 26, 27, 28, 29, 30, 41, 42, 48, 66, 70, 71, 85	FDL_low	-	FDL_high	-50	1	
	E-UTRA Band 2	FDL_low	-	FDL_high	-50	1	15
	E-UTRA Band 25	FDL_low	-	FDL_high	-50	1	15
	E-UTRA Band 43	FDL_low	-	FDL_high	-50	1	2
n28, n83	E-UTRA Band 1, 4, 10, 22, 42, 43, 50, 51, 65, 73, 74, 75, 76, NR Band n77, n78	FDL_low	-	FDL_high	-50	1	2
	E-UTRA Band 1	FDL_low	-	FDL_high	-50	1	19, 25
	E-UTRA Band 2, 3, 5, 7, 8, 18, 19, 20, 25, 26, 27, 31, 34, 38, 40, 41, 66, 72, NR Band n79	FDL_low	-	FDL_high	-50	1	
	E-UTRA Band 11, 21	FDL_low	-	FDL_high	-50	1	19, 24
	Frequency range	470	-	694	-42	8	15, 35
	Frequency range	470	-	710	-26.2	6	34
	Frequency range	662	-	694	-26.2	6	15
	Frequency range	758	-	773	-32	1	15
	Frequency range	773	-	803	-50	1	
	Frequency range	1884.5	-	1915.7	-41	0.3	8, 19
n34	E-UTRA Band 1, 3, 7, 8, 11, 18, 19, 20, 21, 22, 26, 28, 31, 32, 33, 38, 39, 40, 41, 42, 43, 44, 45, 50, 51, 65, 67, 69, 72, 74, 75, 76, NR Band n78, n79	FDL_low	-	FDL_high	-50	1	5
	NR Band n77	FDL_low	-	FDL_high	-50	1	2
	Frequency range	1884.5	-	1915.7	-41	0.3	8
n38	E-UTRA Band 1, 2, 3, 4, 5, 8, 10, 12, 13, 14, 17, 20, 22, 27, 28, 29, 30, 31, 32, 33, 34, 40, 42, 43, 50, 51, 65, 66, 67, 68, 72, 74, 75, 76	FDL_low	-	FDL_high	-50	1	
	Frequency range	2620	-	2645	-15.5	5	15, 22, 26
	Frequency range	2645	-	2690	-40	1	15, 22
n39	E-UTRA Band 1, 8, 22, 26, 34, 40, 41, 42, 44, 45, 50, 51, 74, NR Band n79	FDL_low	-	FDL_high	-50	1	
	NR Band n77, n78	FDL_low	-	FDL_high	-50	1	2
	Frequency range	1805	-	1855	-40	1	33
	Frequency range	1855	-	1880	-15.5	5	15, 26, 33
n40	E-UTRA Band 1, 3, 5, 7, 8, 20, 22, 26, 27, 28, 31, 32, 33, 34, 38, 39, 41, 42, 43, 44, 45, 50, 51, 65, 67, 68, 69, 72, 74, 75, 76, NR Band n77, n78	FDL_low	-	FDL_high	-50	1	
	NR Band n79	FDL_low	-	FDL_high	-50	1	2

NR Band	Spurious emission for UE co-existence						
	Protected band	Frequency range (MHz)			Maximum Level (dBm)	MBW (MHz)	NOTE
n41	E-UTRA Band 1, 2, 3, 4, 5, 8, 10, 12, 13, 14, 17, 24, 25, 26, 27, 28, 29, 30, 34, 39, 40, 42, 44, 45, 48, 50, 51, 65, 66, 70, 71, 73, 74, NR Band n77, n78	F _{DL_low}	-	F _{DL_high}	-50	1	
	NR Band n79	F _{DL_low}	-	F _{DL_high}	-50	1	2
	E-UTRA Band 9, 11, 18, 19, 21	F _{DL_low}	-	F _{DL_high}	-50	1	30
	Frequency range	1884.5	-	1915.7	-41	0.3	8, 30
n50	E-UTRA Band 1, 2, 3, 4, 5, 7, 8, 12, 13, 17, 20, 26, 28, 29, 31, 34, 38, 39, 40, 41, 42, 43, 48, 65, 66, 67, 68	F _{DL_low}	-	F _{DL_high}	-50	1	
n51	E-UTRA Band 1, 2, 3, 4, 5, 7, 8, 12, 13, 17, 20, 26, 28, 29, 31, 34, 38, 39, 40, 41, 42, 43, 48, 65, 66, 67, 68	F _{DL_low}	-	F _{DL_high}	-50	1	
n66, n86	E-UTRA Band 1, 2, 3, 4, 5, 7, 8, 12, 13, 17, 20, 26, 28, 29, 31, 34, 38, 39, 40, 41, 42, 43, 48, 65, 66, 67, 68, 70, 71	F _{DL_low}	-	F _{DL_high}	-50	1	
	E-UTRA Band 42, 48	F _{DL_low}	-	F _{DL_high}	-50	1	2
n70	E-UTRA Band 2, 4, 5, 10, 12, 13, 14, 17, 24, 25, 29, 30, 41, 48, 66, 70, 71	F _{DL_low}	-	F _{DL_high}	-50	1	2
n71	E-UTRA Band 4, 5, 12, 13, 14, 17, 24, 26, 30, 48, 66, 85	F _{DL_low}	-	F _{DL_high}	-50	1	
	E-UTRA Band 2, 25, 41, 70	F _{DL_low}	-	F _{DL_high}	-50	1	2
	E-UTRA Band 29	F _{DL_low}	-	F _{DL_high}	-38	1	15
	E-UTRA Band 71	F _{DL_low}	-	F _{DL_high}	-50	1	15
n74	E-UTRA Band 1, 2, 3, 4, 5, 7, 8, 12, 13, 17, 18, 19, 20, 26, 28, 29, 31, 34, 38, 39, 40, 41, 42, 43, 48, 65, 66, 67, 68	F _{DL_low}	-	F _{DL_high}	-50	1	
	Frequency range	1884.5	-	1915.7	-41	0.3	8
	Frequency range	1400	-	1427	-32	27	15, 41
	Frequency range	1475	-	1488	-50	1	42
	Frequency range	1488	-	1518	-50	1	15
n77, n78	E-UTRA Band 1, 3, 5, 7, 8, 11, 18, 19, 20, 21, 26, 28, 34, 39, 40, 41, 65	F _{DL_low}	-	F _{DL_high}	-50	1	
	Frequency range	1884.5	-	1915.7	-41	0.3	8
	NR Band n257	26500	-	29500	-5	100	
n79	E-UTRA Band 1, 3, 5, 8, 11, 18, 19, 21, 28, 34, 39, 40, 41, 42, 65	F _{DL_low}	-	F _{DL_high}	-50	1	
	Frequency range	1884.5	-	1915.7	-41	0.3	8
	NR Band n257	26500	-	29500	-5	100	
n80	See n3						
n81	See n8						
n82	See n20						
n83	See n28						
n84	See n1						
n86	See n66						

- NOTE 1: F_{DL_low} and F_{DL_high} refer to each frequency band specified in Table 5.2-1 or Table 5.5-1 in TS 36.101
- NOTE 2: As exceptions, measurements with a level up to the applicable requirements defined in Table 6.5.3.1-2 are permitted for each assigned NR carrier used in the measurement due to 2nd, 3rd, 4th or 5th harmonic spurious emissions. Due to spreading of the harmonic emission the exception is also allowed for the first 1 MHz frequency range immediately outside the harmonic emission on both sides of the harmonic emission. This results in an overall exception interval centred at the harmonic emission of $(2\text{MHz} + N \times \text{LCRB} \times 180\text{kHz})$, where N is 2, 3, 4, 5 for the 2nd, 3rd, 4th or 5th harmonic respectively. The exception is allowed if the measurement bandwidth (MBW) totally or partially overlaps the overall exception interval.
- NOTE 3: 15 kHz SCS is assumed when RB is mentioned in the note.
- NOTE 4: N/A
- NOTE 5: For non-synchronised TDD operation to meet these requirements some restriction will be needed for either the operating band or protected band
- NOTE 6: N/A
- NOTE 7: Applicable when co-existence with PHS system operating in 1884.5 - 1919.6 MHz.
- NOTE 8: Applicable when co-existence with PHS system operating in 1884.5 - 1915.7 MHz.
- NOTE 9: N/A
- NOTE 10: N/A
- NOTE 11: Whether the applicable frequency range should be 793-805MHz instead of 799-805MHz is TBD
- NOTE 12: The emissions measurement shall be sufficiently power averaged to ensure a standard deviation < 0.5 dB
- NOTE 13: This requirement applies for 5, 10, 15 and 20 MHz NR channel bandwidth allocated within 1744.9MHz and 1784.9MHz.
- NOTE 14: N/A
- NOTE 15: These requirements also apply for the frequency ranges that are less than F_{OoB} (MHz) in Table 6.5.3.1-1 and Table 6.5A.3.1-1 from the edge of the channel bandwidth.
- NOTE 16: N/A
- NOTE 17: N/A
- NOTE 18: N/A
- NOTE 19: Applicable when the assigned NR carrier is confined within 718 MHz and 748 MHz and when the channel bandwidth used is 5 or 10 MHz.
- NOTE 20: N/A
- NOTE 21: This requirement is applicable for any channel bandwidths within the range 2500 - 2570 MHz with the following restriction: for carriers of 15 MHz bandwidth when carrier centre frequency is within the range 2560.5 - 2562.5 MHz and for carriers of 20 MHz bandwidth when carrier centre frequency is within the range 2552 - 2560 MHz the requirement is applicable only for an uplink transmission bandwidth less than or equal to 54 RB.
- NOTE 22: This requirement is applicable for power class 3 UE for any channel bandwidths within the range 2570 - 2615 MHz with the following restriction: for carriers of 15 MHz bandwidth when carrier centre frequency is within the range 2605.5 - 2607.5 MHz and for carriers of 20 MHz bandwidth when carrier centre frequency is within the range 2597 - 2605 MHz the requirement is applicable only for an uplink transmission bandwidth less than or equal to 54 RB. For power class 2 UE for any channel bandwidths within the range 2570 - 2615 MHz, NS_44 shall apply. For power class 2 or 3 UE for carriers with channel bandwidth overlapping the frequency range 2615 - 2620 MHz the requirement applies with the maximum output power configured to +19 dBm in the IE P-Max.
- NOTE 23: Void
- NOTE 24: As exceptions, measurements with a level up to the applicable requirement of -38 dBm/MHz is permitted for each assigned NR carrier used in the measurement due to 2nd harmonic spurious emissions. An exception is allowed if there is at least one individual RB within the transmission bandwidth (see Figure 5.3.3-1) for which the 2nd harmonic totally or partially overlaps the measurement bandwidth (MBW).
- NOTE 25: As exceptions, measurements with a level up to the applicable requirement of -36 dBm/MHz is permitted for each assigned NR carrier used in the measurement due to 3rd harmonic spurious emissions. An exception is allowed if there is at least one individual RB within the transmission bandwidth (see Figure 5.3.3-1) for which the 3rd harmonic totally or partially overlaps the measurement bandwidth (MBW).
- NOTE 26: For these adjacent bands, the emission limit could imply risk of harmful interference to UE(s) operating in the protected operating band.
- NOTE 27: This requirement is applicable for any channel bandwidths within the range 1920 - 1980 MHz with the following restriction: for carriers of 15 MHz bandwidth when carrier centre frequency is within the range 1927.5 - 1929.5 MHz and for carriers of 20 MHz bandwidth when carrier centre frequency is within the range 1930 - 1938 MHz the requirement is applicable only for an uplink transmission bandwidth less than or equal to 54 RB.
- NOTE 28: N/A
- NOTE 29: N/A
- NOTE 30: This requirement applies when the NR carrier is confined within 2545-2575MHz or 2595-2645MHz and the channel bandwidth is 10 or 20 MHz

NR Band	Spurious emission for UE co-existence				
	Protected band	Frequency range (MHz)	Maximum Level (dBm)	MBW (MHz)	NOTE
NOTE 31: N/A					
NOTE 32: Void					
NOTE 33: This requirement is only applicable for carriers with bandwidth confined within 1885-1920 MHz (requirement for carriers with at least 1RB confined within 1880 - 1885 MHz is not specified). This requirement applies for an uplink transmission bandwidth less than or equal to 54 RB for carriers of 15 MHz bandwidth when carrier center frequency is within the range 1892.5 - 1894.5 MHz and for carriers of 20 MHz bandwidth when carrier center frequency is within the range 1895 - 1903 MHz.					
NOTE 34: This requirement is applicable for 5 and 10 MHz NR channel bandwidth allocated within 718-728MHz. For carriers of 10 MHz bandwidth, this requirement applies for an uplink transmission bandwidth less than or equal to 30 RB with RBstart > 1 and RBstart<48.					
NOTE 35: This requirement is applicable in the case of a 10 MHz NR carrier confined within 703 MHz and 733 MHz, otherwise the requirement of -25 dBm with a measurement bandwidth of 8 MHz applies.					
NOTE 36: This requirement is applicable for NR channel bandwidth allocated within 1920-1980 MHz.					
NOTE 37: Applicable when the upper edge of the channel bandwidth frequency is greater than 1980MHz.					
NOTE 38: Applicable when NS_33 or NS_34 is configured by the pre-configured radio parameters.					
NOTE 39: Void.					
NOTE 40: In the frequency range x-5950MHz, SE requirement of -30dBm/MHz should be applied; where x = max (5925, fc + 15), where fc is the channel centre frequency.					
NOTE 41: Applicable for 1.4 MHz bandwidth, and when the lower edge of the assigned NR UL channel bandwidth frequency is greater than or equal to 1427 MHz + the channel BW assigned for 3, 5 and 10 MHz bandwidth, and when the lower edge of the assigned E-UTRA UL channel bandwidth frequency is greater than or equal to 1440 MHz for 15 and 20 MHz bandwidth.					
NOTE 42: Applicable for 1.4 , 3 and 5 MHz bandwidth, and when the upper edge of the assigned NR UL channel bandwidth frequency is less than or equal to 1467 MHz assigned for 10 MHz bandwidth, and when the upper edge of the assigned NR UL channel bandwidth frequency is less than or equal to 1463.8 MHz for 15 MHz bandwidth, and when the upper edge of the assigned NR UL channel bandwidth frequency is less than or equal to 1460.8 MHz for 20 MHz bandwidth.					

NOTE: To simplify Table 6.5.3.2-1, E-UTRA band numbers are listed for bands which are specified only for E-UTRA operation or both E-UTRA and NR operation. NR band numbers are listed for bands which are specified only for NR operation.

6.5.3.3 Additional spurious emissions

These requirements are specified in terms of an additional spectrum emission requirement. Additional spurious emission requirements are signalled by the network to indicate that the UE shall meet an additional requirement for a specific deployment scenario as part of the cell handover/broadcast message.

NOTE: For measurement conditions at the edge of each frequency range, the lowest frequency of the measurement position in each frequency range should be set at the lowest boundary of the frequency range plus MBW/2. The highest frequency of the measurement position in each frequency range should be set at the highest boundary of the frequency range minus MBW/2. MBW denotes the measurement bandwidth defined for the protected band.

6.5.3.3.1 Requirement for network signalled value "NS_04"

When "NS 04" is indicated in the cell, the power of any UE emission shall not exceed the levels specified in Table 6.6.3.3.1-1. This requirement also applies for the frequency ranges that are less than F_{OOB} (MHz) in Table 6.5.3.1-1 from the edge of the channel bandwidth.

Table 6.5.3.3.1-1: Additional requirements

Frequency range (MHz)	Channel bandwidth / Spectrum emission limit (dBm)	Measurement bandwidth
	10, 15, 20, 40, 50, 60, 80, 90, 100 MHz	
$2495 \leq f < 2496$	-13	1% of Channel BW
$2490.5 \leq f < 2495$	-13	1 MHz
$0 < f < 2490.5$	-25	1 MHz

6.5.3.3.2 Requirement for network signalled value “NS_17”

When “NS_17” is indicated in the cell, the power of any UE emission shall not exceed the levels specified in Table 6.5.3.3.2-1. This requirement also applies for the frequency ranges that are less than F_{OOB} (MHz) in Table 6.5.3.1-1 from the edge of the channel bandwidth.

Table 6.5.3.3.2-1: Additional requirements

Frequency range (MHz)	Channel bandwidth / Spectrum emission limit (dBm)		Measurement bandwidth	NOTE
	5, 10 MHz			
$470 \leq f \leq 710$	-26.2		6 MHz	1
NOTE 1: Applicable when the assigned E-UTRA carrier is confined within 718 MHz and 748 MHz and when the channel bandwidth used is 5 or 10 MHz.				

6.5.3.3.3 Requirement for network signalled value “NS_18”

When “NS_18” is indicated in the cell, the power of any UE emission shall not exceed the levels specified in Table 6.5.3.3.3-1. This requirement also applies for the frequency ranges that are less than F_{OOB} (MHz) in Table 6.5.3.1-1 from the edge of the channel bandwidth.

Table 6.5.3.3.3-1: Additional requirements

Frequency range (MHz)	Channel bandwidth / Spectrum emission limit (dBm)		Measurement bandwidth	NOTE
	5, 10, 15, 20 MHz			
692-698	-26.2		6 MHz	

6.5.3.3.4 Requirement for network signalled value “NS_05”

When “NS_05” is indicated in the cell, the power of any UE emission shall not exceed the levels specified in Table 6.5.3.3.4-1. This requirement also applies for the frequency ranges that are less than F_{OOB} (MHz) in Table 6.5.3.1-1 from the edge of the channel bandwidth.

Table 6.5.3.3.4-1: Additional requirements

Frequency band (MHz)	Channel bandwidth / Spectrum emission limit (dBm)				Measurement bandwidth	NOTE
	5MHz	10MHz	15MHz	20MHz		
$1884.5 \leq f \leq 1915.7$	-41	-41	-41	-41	300 KHz	

6.5.3.3.5 Requirement for network signalled value “NS_08”

When “NS08” is indicated in the cell, the power of any UE emission shall not exceed the levels specified in Table 6.5.3.3.5-1. This requirement also applies for the frequency ranges that are less than F_{OOB} (MHz) in Table 6.5.3.1-1 from the edge of the channel bandwidth.

Table 6.5.3.3.5-1: Additional requirement

Frequency range (MHz)	Channel bandwidth / Spectrum emission limit (dBm)			Measurement bandwidth
	5 MHz	10 MHz	15 MHz	
$860 \leq f \leq 890$	-40	-40	-40	1 MHz

6.5.3.3.6 Requirement for network signalled value “NS_37”

When “NS 37” is indicated in the cell, the power of any UE emission shall not exceed the levels specified in Table 6.5.3.3.6-1. This requirement also applies for the frequency ranges that are less than F_{OOB} (MHz) in Table 6.5.3.1-1 from the edge of the channel bandwidth.

Table 6.5.3.3.6-1: Additional requirement

Frequency band (MHz)	Channel bandwidth / Spectrum emission limit (dBm)				Measurement bandwidth
	5MHz	10MHz	15MHz	20MHz	
$1475.9 \leq f \leq 1510.9$	-35	-35	-35	-35	1 MHz

6.5.3.3.7 Requirement for network signalled value “NS_38”

When “NS 38” is indicated in the cell, the power of any UE emission shall not exceed the levels specified in Table 6.5.3.3.7-1. This requirement also applies for the frequency ranges that are less than FOOB (MHz) in Table 6.5.3.1-1 from the edge of the channel bandwidth.

Table 6.5.3.3.7-1: Additional requirements

Frequency band (MHz)	Channel bandwidth / Spectrum emission limit (dBm)	Measurement bandwidth
	5 MHz, 10 MHz, 15 MHz, 20 MHz	
$1400 \leq f \leq 1427$	-32	27MHz
NOTE 1: This requirement shall be verified with UE transmission power of 15 dBm.		

6.5.3.3.8 Requirement for network signalled value “NS_39”

When “NS 39” is indicated in the cell, the power of any UE emission shall not exceed the levels specified in Table 6.5.3.3.8-1. This requirement also applies for the frequency ranges that are less than FOOB (MHz) in Table 6.5.3.1-1 from the edge of the channel bandwidth.

Table 6.5.3.3.8-1: Additional requirements

Frequency band (MHz)	Channel bandwidth / Spectrum emission limit (dBm)	Measurement bandwidth
	5 MHz, 10 MHz, 15 MHz, 20 MHz	
$1475 \leq f \leq 1488$	-28	1MHz

6.5.4 Transmit intermodulation

The transmit intermodulation performance is a measure of the capability of the transmitter to inhibit the generation of signals in its non linear elements caused by presence of the wanted signal and an interfering signal reaching the transmitter via the antenna.

UE transmit intermodulation is defined by the ratio of the mean power of the wanted signal to the mean power of the intermodulation product when an interfering CW signal is added at a level below the wanted signal at each transmitter antenna port with the other antenna port(s) if any terminated. Both the wanted signal power and the intermodulation product power are measured through NR rectangular filter with measurement bandwidth shown in Table 6.5.4-1.

The requirement of transmit intermodulation is specified in Table 6.5.4-1.

Table 6.5.4-1: Transmit Intermodulation

Wanted signal channel bandwidth	BW_{Channel}	
Interference signal frequency offset from channel center	BW_{Channel}	$2 \cdot BW_{\text{Channel}}$
Interference CW signal level	-40dBc	
Intermodulation product	< -29dBc	< -35dBc
Measurement bandwidth	The maximum transmission bandwidth configuration among the different SCSs for the channel BW as defined in Table 6.5.2.1.1-1	
Measurement offset from channel center	BW_{Channel} and $2 \cdot BW_{\text{Channel}}$	$2 \cdot BW_{\text{Channel}}$ and $4 \cdot BW_{\text{Channel}}$

6.5A Output RF spectrum emissions for CA

For inter-band carrier aggregation with one uplink carrier assigned to one NR band, the output RF spectrum emissions requirements in subclause 6.5 apply.

6.5A.1 Occupied bandwidth for CA

6.5A.1.1 Occupied bandwidth for Intra-band contiguous CA

6.5A.1.2 Occupied bandwidth for Intra-band non-contiguous CA

6.5A.1.3 Occupied bandwidth for Inter-band CA

For inter-band carrier aggregation with uplink assigned to two NR bands, the occupied bandwidth is defined per component carrier. Occupied bandwidth is the bandwidth containing 99 % of the total integrated mean power of the transmitted spectrum on assigned channel bandwidth on the component carrier. The occupied bandwidth shall be less than the channel bandwidth specified in Table 6.5.1-1.

6.5A.2 Out of band emission for CA

6.5A.2.1 General

Detailed structure of the subclause is TBD

6.5A.2.2 Spectrum emission mask

6.5A.2.2.1 Spectrum emission mask for Intra-band contiguous CA

6.5A.2.2.2 Spectrum emission mask for Intra-band non-contiguous CA

6.5A.2.2.3 Spectrum emission mask for Inter-band CA

For inter-band carrier aggregation with uplink assigned to two NR bands, the spectrum emission mask of the UE is defined per component carrier while both component carriers are active and the requirements are specified in subclauses 6.5.2.1 and 6.5.2.2. If for some frequency spectrum emission masks of component carriers overlap then spectrum emission mask allowing higher power spectral density applies for that frequency. If for some frequency a component carrier spectrum emission mask overlaps with the channel bandwidth of another component carrier, then the emission mask does not apply for that frequency.

6.5A.2.3 Additional spectrum emission mask

6.5A.2.3.1 Additional spectrum emission mask for Intra-band contiguous CA

6.5A.2.3.2 Additional spectrum emission mask for Intra-band non-contiguous CA

6.5A.2.3.3 Additional spectrum emission mask for Inter-band CA

6.5A.2.4 Adjacent channel leakage ratio

6.5A.2.4.1 NR ACLR

6.5A.2.4.1.1 NR ACLR for Intra-band contiguous CA

6.5A.2.4.1.2 NR ACLR for Intra-band non-contiguous CA

6.5A.2.4.1.3 NR ACLR for Inter-band CA

For inter-band carrier aggregation with uplink assigned to two NR bands, the NR Adjacent Channel Leakage power Ratio (NRACLR) is defined per component carrier while both component carriers are active and the requirement is specified in subclause 6.5.2.4.1.

6.5A.2.4.2 UTRA ACLR

6.5A.2.4.2.1 UTRA ACLR for Intra-band contiguous CA

6.5A.2.4.2.2 UTRA ACLR for Intra-band non-contiguous CA

6.5A.2.4.2.3 UTRA ACLR for Inter-band CA

For inter-band carrier aggregation with uplink assigned to two NR bands, the UTRA Adjacent Channel Leakage power Ratio (UTRAACLR) is defined per component carrier while both component carrier are active and the requirement is specified in subclause 6.5.2.4.2.

6.5A.3 Spurious emission for CA

6.5A.3.1 General spurious emissions

For inter-band carrier aggregation with uplink assigned to two NR bands, the spurious emission requirement Table 6.5.3.1-2 apply for the frequency ranges that are more than F_{OOB} as defined in Table 6.5.3.1-1 away from edges of the assigned channel bandwidth on a component carrier. If for some frequency a spurious emission requirement of individual component carrier overlaps with the spectrum emission mask or channel bandwidth of another component carrier then it does not apply.

6.5A.3.2 Spurious emissions for UE co-existence

6.5A.3.2.1 Spurious emissions for UE co-existence for Intra-band contiguous CA

6.5A.3.2.2 Spurious emissions for UE co-existence for Intra-band non-contiguous CA

6.5A.3.2.3 Spurious emissions for UE co-existence for Inter-band CA

For inter-band carrier aggregation with the uplink assigned to two NR bands, the requirements in Table 6.5A.3.2-1 apply on each component carrier with all component carriers are active.

NOTE: For inter-band carrier aggregation with uplink assigned to two NR bands the requirements in Table 6.5A.3.2-1 could be verified by measuring spurious emissions at the specific frequencies where second and third order intermodulation products generated by the two transmitted carriers can occur; in that case, the requirements for remaining applicable frequencies in Table 6.5A.3.2-1 would be considered to be verified by the measurements verifying the one uplink inter-band CA UE to UE co-existence requirements.

Table 6.5A.3.2.3-1: Requirements for uplink inter-band carrier aggregation (two bands)

NR CA Configuration	Spurious emission						
	Protected Band	Frequency range (Mhz)			Maximum Level (dBm)	MBW (MHz)	NOTE
CA_n3A-n78A	E-UTRA Band 1, 3, 5, 7, 8, 11, 18, 19, 20, 21, 26, 28, 34, 39, 40, 41, 65	F _{DL_low}	-	F _{DL_high}	-50	1	
	Frequency range	1884.5	-	1915.7	-41	0.3	3
	NR Band n257	26500	-	29500	-5	100	
CA_n8A-n78A	E-UTRA Band 1,8, 20, 28, 34, 39, 40,65	F _{DL_low}	-	F _{DL_high}	-50	1	
	E-UTRA Band 3, 7,41	F _{DL_low}	-	F _{DL_high}	-50	1	2
	E-UTRA Band 11, 21	F _{DL_low}	-	F _{DL_high}	-50	1	5
	Frequency range	860	-	890	-40	1	4,5
	Frequency range	1884.5	-	1915.7	-41	0.3	3
	NR Band n257	26500	-	29500	-5	100	
	NR Band n258	24250	-	27500	-5	100	
NOTE 1: FDL_low and FDL_high refer to each frequency band specified in Table 5.2-1 or Table 5.5-1 in TS 36.101							
NOTE 2: As exceptions, measurements with a level up to the applicable requirements defined in Table 6.5.3.1-2 are permitted for each assigned NR carrier used in the measurement due to 2nd, 3rd, 4th or 5 th harmonic spurious emissions. Due to spreading of the harmonic emission the exception is also allowed for the first 1 MHz frequency range immediately outside the harmonic emission on both sides of the harmonic emission. This results in an overall exception interval centred at the harmonic emission of (2MHz + N x LCRB x 180kHz), where N is 2, 3, 4, 5 for the 2nd, 3rd, 4th or 5th harmonic respectively. The exception is allowed if the measurement bandwidth (MBW) totally or partially overlaps the overall exception interval.							
NOTE 3: Applicable when co-existence with PHS system operating in 1884.5 -1915.7MHz							
NOTE 4: These requirements also apply for the frequency ranges that are less than F _{OOB} (MHz) in Table 6.5.3.1-1 and Table 6.5A.3.1-1 from the edge of the channel bandwidth.							
NOTE 5: This requirement is applicable only for the following cases: - for carriers of 5 MHz channel bandwidth when carrier centre frequency (Fc) is within the range 902.5 MHz ≤ Fc < 907.5 MHz with an uplink transmission bandwidth less than or equal to 20 RB - for carriers of 5 MHz channel bandwidth when carrier centre frequency (Fc) is within the range 907.5 MHz ≤ Fc ≤ 912.5 MHz without any restriction on uplink transmission bandwidth. - for carriers of 10 MHz channel bandwidth when carrier centre frequency (Fc) is Fc = 910 MHz with an uplink transmission bandwidth less than or equal to 32 RB with RBstart > 3.							

NOTE: To simplify Table 6.5A.3.2.3-1, E-UTRA band numbers are listed for bands which are specified only for E-UTRA operation or both E-UTRA and NR operation. NR band numbers are listed for bands which are specified only for NR operation.

6.5A.4 Transmit intermodulation for CA

6.5A.3.2.1 Transmit intermodulation for Intra-band contiguous CA

6.5A.3.2.2 Transmit intermodulation for Intra-band non-contiguous CA

6.5A.3.2.3 Transmit intermodulation for Inter-band CA

For inter-band carrier aggregation with uplink assigned to two NR bands, the transmit intermodulation requirement is specified in Table 6.5.4-1 which shall apply on each component carrier with both component carriers active.

6.5D Output RF spectrum emissions for UL-MIMO

6.5D.1 Occupied bandwidth for UL-MIMO

For UE supporting UL-MIMO, the requirements for occupied bandwidth is specified at each transmit antenna connector. The occupied bandwidth is defined as the bandwidth containing 99 % of the total integrated mean power of the transmitted spectrum on the assigned channel at each transmit antenna connector.

For UE with two transmit antenna connectors in closed-loop spatial multiplexing scheme, the occupied bandwidth at each transmitter antenna shall be less than the channel bandwidth specified in table 6.5.1-1. The requirements shall be met with UL-MIMO configurations described in sub-clause 6.2D.1.

If UE is configured for transmission on single-antenna port, the requirements in subclause 6.5.1 apply

6.5D.2 Out of band emission for UL-MIMO

For UE supporting UL-MIMO, the requirements for Out of band emissions resulting from the modulation process and non-linearity in the transmitters are specified at each transmit antenna connector.

For UEs with two transmit antenna connectors in closed-loop spatial multiplexing scheme, the requirements in subclause 6.5.2 apply to each transmit antenna connector. The requirements shall be met with UL-MIMO configurations described in sub-clause 6.2D.1.

If UE is configured for transmission on single-antenna port, the requirements in subclause 6.5.2 apply.

6.5D.3 Spurious emission for UL-MIMO

For UE supporting UL-MIMO, the requirements for Spurious emissions which are caused by unwanted transmitter effects such as harmonics emission, parasitic emissions, intermodulation products and frequency conversion products are specified at each transmit antenna connector.

For UEs with two transmit antenna connectors in closed-loop spatial multiplexing scheme, the requirements specified in subclause 6.5.3 apply to each transmit antenna connector. The requirements shall be met with the UL-MIMO configurations described in sub-clause 6.2D.1.

If UE is configured for transmission on single-antenna port, the requirements in subclause 6.5.3 apply.

6.5D.4 Transmit intermodulation for UL-MIMO

For UE supporting UL-MIMO, the transmit intermodulation requirements are specified at each transmit antenna connector and the wanted signal is defined as the sum of output power at each transmit antenna connector.

For UEs with two transmit antenna connectors in closed-loop spatial multiplexing scheme, the requirements specified in subclause 6.5.4 apply to each transmit antenna connector. The requirements shall be met with the UL-MIMO configurations described in sub-clause 6.2D.1.

If UE is configured for transmission on single-antenna port, the requirements in subclause 6.5.4 apply.

7 Receiver characteristics

7.1 General

Unless otherwise stated the receiver characteristics are specified at the antenna connector(s) of the UE. For UE(s) with an integral antenna only, a reference antenna(s) with a gain of 0 dBi is assumed for each antenna port(s). UE with an integral antenna(s) may be taken into account by converting these power levels into field strength requirements, assuming a 0 dBi gain antenna. For UEs with more than one receiver antenna connector, identical interfering signals shall be applied to each receiver antenna port if more than one of these is used (diversity).

The levels of the test signal applied to each of the antenna connectors shall be as defined in the respective sections below.

With the exception of subclause 7.3, the requirements shall be verified with the network signalling value NS_01 configured (Table 6.2.3-1).

All the parameters in clause 7 are defined using the UL reference measurement channels specified in Annexes A.2.2 and A.2.3, the DL reference measurement channels specified in Annex A.3.2 and using the set-up specified in Annex C.3.1.

7.2 Diversity characteristics

The UE is required to be equipped with a minimum of two Rx antenna ports in all operating bands except for the bands n7, n38, n41, n77, n78, n79 where the UE is required to be equipped with a minimum of four Rx antenna ports. This requirement applies when the band is used as a standalone band or as part of a band combination.

For the requirements in Section 7, the UE shall be verified with two Rx antenna ports in all supported frequency bands. Additional requirements for four Rx ports shall be verified in operating bands where the UE is equipped with four Rx antenna ports.

The above rules apply for all subclauses with the exception of subclause 7.9.

7.3 Reference sensitivity

7.3.1 General

The reference sensitivity power level REFSENS is the minimum mean power applied to each one of the UE antenna ports for all UE categories, at which the throughput shall meet or exceed the requirements for the specified reference measurement channel.

In later subclauses of Section 7 where the value of REFSENS is used as a reference to set the corresponding requirement:

in all bands, the UE shall be verified against those requirements by applying the REFSENS value in Table 7.3.2-1 with 2 Rx antenna ports tested;

for bands where the UE is required to be equipped with 4 Rx antenna ports, the UE shall additionally be verified against those requirements by applying the resulting REFSENS value derived from the requirement in Table 7.3.2-2 with 4 Rx antenna ports tested.

7.3.2 Reference sensitivity power level

The throughput shall be $\geq 95\%$ of the maximum throughput of the reference measurement channels as specified in Annexes A.2.2, A.2.3 and A.3.2 (with one sided dynamic OCNG Pattern OP.1 FDD/TDD for the DL-signal as described in Annex A.5.1.1/A.5.2.1) with parameters specified in Table 7.3.2-1 and Table 7.3.2-2.

Table 7.3.2-1: Two antenna port reference sensitivity QPSK PREFSENS

Operating band / SCS / Channel bandwidth / Duplex-mode														
Operating Band	SCS kHz	5 MHz (dBm)	10 MHz (dBm)	15 MHz (dBm)	20 MHz (dBm)	25 MHz (dBm)	30 MHz (dBm)	40 MHz (dBm)	50 MHz (dBm)	60 MHz (dBm)	80 MHz (dBm)	90 MHz (dBm)	100 MHz (dBm)	Duplex Mode
n1	15	-100.0	-96.8	-95.0	-93.8									FDD
	30		-97.1	-95.1	-94.0									
	60		-97.5	-95.4	-94.2									
n2	15	-98.0	-94.8	-93.0	-91.8									FDD
	30		-95.1	-93.1	-92.0									
	60		-95.5	-93.4	-92.2									
n3	15	-97.0	-93.8	-92.0	-90.8	-89.7	-88.9							FDD
	30		-94.1	-92.1	-91.0	-89.8	-89.0							
	60		-94.5	-92.4	-91.2	-90.0	-89.1							
n5	15	-98.0	-94.8	-93.0	-90.8									FDD
	30		-95.1	-93.1	-91.0									
	60													
n7 ¹	15	-98.0	-94.8	-93.0	-91.8									FDD
	30		-95.1	-93.1	-92.0									
	60		-95.5	-93.4	-92.2									
n8	15	-97.0	-93.8	-92.0	-90.0									FDD
	30		-94.1	-92.1	-90.2									
	60													
n12	15	-97.0	-93.8	-92.0										FDD
	30		-94.1	-92.1										
	60													
n20	15	-97.0	-93.8	-91.0	-89.8									FDD
	30		-94.1	-91.1	-90.0									
	60													
n25	15	-96.5	-93.3	-91.5	-90.3									FDD
	30		-93.6	-91.6	-90.5									
	60		-94.0	-91.9	-90.7									
n28	15	-98.5	-95.5	-93.5	-90.8									FDD
	30		-95.6	-93.6	-91.0									
	60													
n34	15	-100.0	-96.8	-95.0										TDD
	30		-97.1	-95.1										
	60		-97.5	-95.4										
n38	15	-100.0	-96.8	-95.0	-93.8									TDD
	30		-97.1	-95.1	-94.0									
	60		-97.5	-95.4	-94.2									
n39	15	-100.0	-96.8	-95.0	-93.8	-92.7	-91.9	-90.6						TDD
	30		-97.1	-95.1	-94.0	-92.8	-92.0	-90.7						
	60		-97.5	-95.4	-94.2	-93.0	-92.1	-90.9						
n40	15	-100.0	-96.8	-95.0	-93.8	-92.7	-91.9	-90.6	-89.6					TDD
	30		-97.1	-95.1	-94.0	-92.8	-92.0	-90.7	-89.7	-88.9	-87.6			
	60		-97.5	-95.4	-94.2	-93.0	-92.1	-90.9	-89.8	-89.1	-87.6			
n41 ¹	15		-94.8	-93.0	-91.8			-88.6	-87.6					TDD
	30		-95.1	-93.1	-92.0			-88.7	-87.7	-86.9	-85.6	-85.1	-84.7	
	60		-95.5	-93.4	-92.2			-88.9	-87.8	-87.1	-85.6	-85.1	-84.7	
n50	15	-100.0	-96.8	-95.0	-93.8			-90.6	-89.6					TDD
	30		-97.1	-95.1	-94.0			-90.7	-89.7	-88.9	-87.6			
	60		-97.5	-95.4	-94.2			-90.9	-89.8	-89.1	-87.6			
n51	15	-100.0												TDD
	30													

Operating band / SCS / Channel bandwidth / Duplex-mode														
Operating Band	SCS kHz	5 MHz (dBm)	10 MHz (dBm)	15 MHz (dBm)	20 MHz (dBm)	25 MHz (dBm)	30 MHz (dBm)	40 MHz (dBm)	50 MHz (dBm)	60 MHz (dBm)	80 MHz (dBm)	90 MHz (dBm)	100 MHz (dBm)	Duplex Mode
	60													
n66	15	-99.5	-96.3	-94.5	-93.3			-90.1						FDD
	30		-96.6	-94.6	-93.5			-90.2						
	60		-97.0	-94.9	-93.7			-90.4						
n70	15	-100.0	-96.8	-95.0	-93.8	-92.7								FDD
	30		-97.1	-95.1	-94.0	-92.8								
	60		-97.5	-95.4	-94.2	-93.0								
n71	15	-97.2	-94.0	-91.6	-86.0									FDD
	30		-94.3	-91.9	-87.4									
	60	-												
n74	15	-99.5 ³	-96.3 ³	-94.5 ³	-93.3 ³									FDD
	30		-96.6 ³	-94.6 ³	-93.5 ³									
	60		-97.0 ³	-94.9 ³	-93.7 ³									
n77 (3.3 to 3.8 GHz) ¹	15		-95.8	-94.0	-92.7			-89.6	-88.6					TDD
	30		-96.1	-94.1	-92.9			-89.7	-88.7	-87.9	-86.6	-86.1	-85.6	
	60	-	-96.5	-94.4	-93.1			-89.9	-88.8	-88.0	-86.7	-86.2	-85.7	
n77 ¹	15		-95.3	-93.5	-92.2			-89.1	-88.1					TDD
	30		-95.6	-93.6	-92.4			-89.2	-88.2	-87.4	-86.1	-85.6	-85.1	
	60	-	-96.0	-93.9	-92.6			-89.4	-88.3	-87.5	-86.2	-85.7	-85.2	
n78 ¹	15		-95.8	-94.0	-92.7			-89.6	-88.6					TDD
	30		-96.1	-94.1	-92.9			-89.7	-88.7	-87.9	-86.6	-86.1	-85.6	
	60		-96.5	-94.4	-93.1			-89.9	-88.8	-88.0	-86.7	-86.2	-85.7	
n79 ¹	15							-89.6	-88.6					TDD
	30							-89.7	-88.7	-87.9	-86.6		-85.6	
	60							-89.9	-88.8	-88.0	-86.7		-85.7	

NOTE 1: Four Rx antenna ports shall be the baseline for this operating band
NOTE 2: The transmitter shall be set to P_{UMAX} as defined in subclause 6.2.4
NOTE 3: ³ indicates that the requirement is modified by -0.5 dB when the assigned NR channel bandwidth is confined within 1475.9-1510.9 MHz.

For UE(s) equipped with 4 Rx antenna ports, reference sensitivity for 2Rx antenna ports in Table 7.3.2-1 shall be modified by the amount given in $\Delta R_{IB,4R}$ in Table 7.3.2-2 for the applicable operating bands.

Table 7.3.2-2: Four antenna port reference sensitivity allowance $\Delta R_{IB,4R}$

Operating band	$\Delta R_{IB,4R}$ (dB)
n7, n38, n41	-2.7
n77, n78, n79	-2.2

The reference receive sensitivity (REFSENS) requirement specified in Table 7.3.2-1 and Table 7.3.2-2 shall be met for an uplink transmission using QPSK DFT-s-OFDM waveforms and for uplink transmission bandwidth less than or equal to that specified in Table 7.3.2-3.

Table 7.3.2-3: Uplink configuration for reference sensitivity

Operating band / SCS / Channel bandwidth / Duplex mode														
Operating Band	SCS kHz	5 MHz	10 MHz	15 MHz	20 MHz	25 MHz	30 MHz	40 MHz	50 MHz	60 MHz	80 MHz	90 MHz	100 MHz	Duplex Mode
n1	15	25	50 ¹	75 ¹	100 ¹									FDD
	30		24	36 ¹	50 ¹									
	60		10 ¹	18	24									
n2	15	25	50 ¹	50 ¹	50 ¹									FDD
	30	10 ¹	24	24 ¹	24 ¹									
	60		10 ¹	10 ¹	10 ¹¹									
n3	15	25	50 ¹	50 ¹	50 ¹	50 ¹	50 ¹							FDD
	30		24	24 ¹	24 ¹	24 ¹	24 ¹							
	60		10 ¹	10 ¹	10 ¹	10 ¹	10 ¹							
n5	15	25	25 ¹	25 ¹	25 ¹									FDD
	30		10 ¹	10 ¹	10 ¹									
	60													
n7	15	25	50 ¹	75 ¹	75 ¹									FDD
	30		24	36 ¹	36 ¹									
	60		10 ¹	18	18 ¹									
n8	15	25	25 ¹	25 ¹	25 ¹									FDD
	30		10 ¹	10 ¹	10 ¹									
	60													
n12	15	20 ¹	20 ¹	20 ¹										FDD
	30		10 ¹	10 ¹										
	60													
n20	15	25	20 ¹	20 ²	20 ²									FDD
	30		10 ¹	10 ²	10 ²									
	60													
n25	15	25	50	50 ¹	50 ¹									FDD
	30		24	24 ¹	24 ¹									
	60		10	10 ¹	10 ¹									
n28	15	25	25 ¹	25 ¹	25 ¹									FDD
	30		10 ¹	10 ¹	10 ¹									
	60													
n34	15	25	50 ¹	75 ¹										TDD
	30		24	36 ¹										
	60		10 ¹	18										
n38	15	25	50 ¹	75 ¹	100 ¹									TDD
	30		24	36 ¹	50 ¹									
	60		10 ¹	18	24									
n39	15	25	50 ¹	75 ¹	100 ¹	128 ¹	160	216						TDD
	30		24	36 ¹	50 ¹	64 ¹	75 ¹	100 ¹						
	60		10 ¹	18	24	30 ¹	36 ¹	50 ¹						
n40	15	25	50 ¹	75 ¹	100 ¹	128 ¹	160	216	270					TDD
	30		24	36 ¹	50 ¹	64 ¹	75 ¹	100 ¹	128 ¹	162	216 ¹			
	60		10 ¹	18	24	30 ¹	36 ¹	50 ¹	64 ¹	75 ¹	100 ¹			
n41	15		50 ¹	75 ¹	100 ¹			216	270					TDD
	30		24	36 ¹	50 ¹			100 ¹	128 ¹	162	216 ¹	243 ¹	270 ¹	
	60		10 ¹	18	24			50 ¹	64 ¹	75 ¹	100 ¹	120 ¹	135	
n50	15	25	50 ¹	75 ¹	100 ¹			216	270					TDD
	30		24	36 ¹	50 ¹			100 ¹	128 ¹	162	NOTE 3			
	60		10 ¹	18	24			50 ¹	64 ¹	75 ¹	NOTE 3			
n51	15	25												TDD
	30													

Operating band / SCS / Channel bandwidth / Duplex mode														
Operating Band	SCS kHz	5 MHz	10 MHz	15 MHz	20 MHz	25 MHz	30 MHz	40 MHz	50 MHz	60 MHz	80 MHz	90 MHz	100 MHz	Duplex Mode
	60													
n66	15	25	50 ¹	75 ¹	100 ¹			216						FDD
	30		24	36 ¹	50 ¹			100 ¹						
	60		10 ¹	18	24			50 ¹						
n70	15	25	50 ¹	75 ¹	NOTE 3	NOTE 3								FDD
	30		24	36 ¹	NOTE 3	NOTE 3								
	60		10 ¹	18	NOTE 3	NOTE 3								
n71	15	25	25 ¹	20 ¹	20 ¹									FDD
	30		12 ¹	10 ¹	10 ¹									
	60													
N74	15	25	25 ¹	25 ¹	25 ¹									FDD
	30		10 ¹	10 ¹	10 ¹									
	60		5 ¹	5 ¹	5 ¹									
n77	15		50 ¹	75 ¹	100 ¹			216	270					TDD
	30		24	36 ¹	50 ¹			100 ¹	128 ¹	162	216 ¹	243 ¹	270 ¹	
	60	-	10 ¹	18	24			50 ¹	64 ¹	75 ¹	100 ¹	120 ¹	135	
n77 (3.8 to 4.2 GHz)	15		50 ¹	75 ¹	100 ¹			216	270					TDD
	30		24	36 ¹	50 ¹			100 ¹	128 ¹	162	216 ¹	243 ¹	270 ¹	
	60		10 ¹	18	24			50 ¹	64 ¹	75 ¹	100 ¹	120 ¹	135	
n78	15		50 ¹	75 ¹	100 ¹			216	270					TDD
	30		24	36 ¹	50 ¹			100 ¹	128 ¹	162	216 ¹	243 ¹	270 ¹	
	60		10 ¹	18	24			50 ¹	64 ¹	75 ¹	100 ¹	120 ¹	135	
n79	15							216	270					TDD
	30							100 ¹	128 ¹	162	216 ¹		270 ¹	
	60							50 ¹	64 ¹	75 ¹	100 ¹		135	

NOTE 1: ¹ Refers to the UL resource blocks shall be located as close as possible to the downlink operating band but confined within the transmission bandwidth configuration for the channel bandwidth (Table 5.3.2-1).

NOTE 2: ² refers to Band 20; for 15kHz SCS, in the case of 15MHz channel bandwidth, the UL resource blocks shall be located at RBstart 11 and in the case of 20MHz channel bandwidth, the UL resource blocks shall be located at RBstart 16; for 30kHz SCS, in the case of 15MHz channel bandwidth, the UL resource blocks shall be located at RBstart 6 and in the case of 20MHz channel bandwidth, the UL resource blocks shall be located at RBstart 8; for 60kHz SCS, in the case of 15MHz channel bandwidth, the UL resource blocks shall be located at RBstart 3 and in the case of 20MHz channel bandwidth, the UL resource blocks shall be located at RBstart 4;

NOTE 3: For DL channel bandwidths that do not have symmetric UL channel bandwidth, highest valid UL configuration with lowest duplex distance shall be used.

Unless given by Table 7.3.2-4, the minimum requirements specified in Tables 7.3.2-1 and 7.3.2-2 shall be verified with the network signalling value NS_01 (Table 6.2.3-1) configured.

Table 7.3.2-4: Network signaling value for reference sensitivity

Operating band	Network Signalling value
n2	NS_03
n12	NS_06
n25	NS_03
n66	NS_03
n70	NS_03
n71	NS_35

7.3.3 $\Delta R_{IB,c}$

<Editor's note: Text to be added >

7.3A Reference sensitivity for CA

7.3A.1 General

The reference sensitivity power level REFSENS is the minimum mean power applied to each one of the UE antenna ports for all UE categories, at which the throughput shall meet or exceed the requirements for the specified reference measurement channel.

7.3A.2 Reference sensitivity power level for CA

7.3A.2.1 Reference sensitivity power level for Intra-band contiguous CA

For intra-band contiguous carrier aggregation, the throughput of each component carrier shall be $\geq 95\%$ of the maximum throughput of the reference measurement channels as specified in Annex A (with one sided dynamic OCNG Pattern OP.1 FDD/TDD for the DL-signal) with peak reference sensitivity specified in Table 7.3.2-1.

7.3A.2.2 Reference sensitivity power level for Intra-band non-contiguous CA

7.3A.2.3 Reference sensitivity power level for Inter-band CA

For inter-band carrier aggregation with one component carrier per operating band and the uplink assigned to one NR band the throughput shall be $\geq 95\%$ of the maximum throughput of the reference measurement channels as specified in Annex A (with one sided dynamic OCNG Pattern OP.1 FDD/TDD for the DL-signal) with parameters specified in Table 7.3.2-1, Table 7.3.2-2 and Table 7.3.2-3 modified in accordance with sub-clause 7.3A.3.2. The reference sensitivity is defined to be met with all downlink component carriers active and one of the uplink carriers active. Exceptions to reference sensitivity are allowed in accordance with sub-clause 7.3A.4.

7.3A.3 $\Delta R_{IB,c}$ for CA

7.3A.3.1 General

For a UE supporting a CA configuration, the $\Delta R_{IB,c}$ applies for both SC and CA operation.

7.3A.3.2 $\Delta R_{IB,c}$ for Inter-band CA

For the UE which supports inter-band carrier aggregation, the minimum requirement for reference sensitivity in Table 7.3A.3.2-1 shall be increased by the amount given by $\Delta R_{IB,c}$ defined in subclause 7.3A.3.2 for the applicable operating bands.

7.3A.3.2.1 $\Delta R_{IB,c}$ for two bandsTable 7.3A.3.2.1-1: $\Delta R_{IB,c}$ due to CA (two bands)

Inter-band CA configuration	NR Band	$\Delta R_{IB,c}$ (dB)
CA_n3-n77	n3	0.2
	n77	0.5
CA_n3A-n78A	n3	0.2
	n78	0.5
CA_n3-n79	n79	0.5
CA_n8A-n78A	n8	0.2
	n78	0.5
CA_n8-n79	n79	0.5
CA_n28-n75	n28	0.2
CA_n28A-n78A	n28	0.2
	n78	0.5
CA_n41A-n78A ¹	n78	0.5
CA_n75A-n78A	n78	0.5
CA_n76A-n78A	n78	0.5
NOTE 1: The requirements only apply when the sub-frame and Tx-Rx timings are synchronized between the component carriers. In the absence of synchronization, the requirements are not within scope of these specifications.		

7.3A.3.2.2 $\Delta R_{IB,c}$ for three bandsTable 7.3A.3.2.2-1: $\Delta R_{IB,c}$ due to CA (three bands)

Inter-band CA configuration	NR Band	$\Delta R_{IB,c}$ (dB)

7.3A.4 Reference sensitivity exceptions due to UL harmonic interference for CA

Sensitivity degradation is allowed for a band in frequency range 1 if it is impacted by UL harmonic interference from another band in frequency range 1 of the same CA configuration. Reference sensitivity exceptions are specified in Table 7.3A.4-1 with uplink configuration specified in Table 7.3A.4-2.

Table 7.3A.4-1: Reference sensitivity exceptions due to UL harmonic for NR CA FR1

MSD due to harmonic exception for the DL band													
UL band	DL band	5 MHz	10 MHz	15 MHz	20 MHz	25 MHz	30 MHz	40 MHz	50 MHz	60 MHz	80 MHz	90 MHz	100 MHz
		dB	dB	dB	dB	dB	dB	dB	dB	dB	dB	dB	dB
n3	n77 ^{1,2}		23.9	22.1	20.9			17.9	16.9	16.1			
	n77 ³		1.1	0.8	0.3								
n3	n78 ^{1,2}		23.9	22.1	20.9			17.9	16.9	16.1			
	n78 ³		1.1	0.8	0.3								
n8	n78 ^{4,5}		10.8	9.1	8.0			5.1	4.2	3.5	2.3		1.4
n8	n78 ^{1,2}		10.8	9.1	8			3.5	2.3	1.4			
n8	n79 ^{1,2}							[6.8]	6.2	[5.6]	4.9		4.4
n28	n75 ^{1,2}	28.1	25.3	24.0	22.8								
	n78 ^{1,2}		[10.4]	[8.9]	[7.8]			[4.7]	[3.7]	[3]	[1.7]	[1.2]	[0.7]

NOTE 1: These requirements apply when there is at least one individual RE within the uplink transmission bandwidth of the aggressor (lower) band for which the 2nd transmitter harmonic is within the downlink transmission bandwidth of a victim (higher) band.

NOTE 2: The requirements should be verified for UL NR-ARFCN of the aggressor (lower) band (superscript LB) such that $f_{UL}^{LB} = \lfloor f_{DL}^{HB} / 0.2 \rfloor \cdot 0.1$ in MHz and $F_{UL_low}^{LB} + BW_{Channel}^{LB} / 2 \leq f_{UL}^{LB} \leq F_{UL_high}^{LB} - BW_{Channel}^{LB} / 2$ with f_{DL}^{HB} carrier frequency in the victim (higher) band in MHz and $BW_{Channel}^{LB}$ the channel bandwidth configured in the lower band.

NOTE 3: The requirements are only applicable to channel bandwidths with a carrier frequency at $\pm (20 + BW_{Channel}^{HB} / 2)$ MHz offset from $2f_{UL}^{LB}$ in the victim (higher band) with $F_{UL_low}^{LB} + BW_{Channel}^{LB} / 2 \leq f_{UL}^{LB} \leq F_{UL_high}^{LB} - BW_{Channel}^{LB} / 2$, where $BW_{Channel}^{LB}$ and $BW_{Channel}^{HB}$ are the channel bandwidths configured in the aggressor (lower) and victim (higher) bands in MHz, respectively.

NOTE 4: These requirements apply when there is at least one individual RE within the uplink transmission bandwidth of a low band for which the 4th transmitter harmonic is within the downlink transmission bandwidth of a high band.

NOTE 5: The requirements should be verified for UL NR-ARFCN of a low band (superscript LB) such that $f_{UL}^{LB} = \lfloor f_{DL}^{HB} / 0.4 \rfloor \cdot 0.1$ in MHz and $F_{UL_low}^{LB} + BW_{Channel}^{LB} / 2 \leq f_{UL}^{LB} \leq F_{UL_high}^{LB} - BW_{Channel}^{LB} / 2$ with f_{DL}^{HB} the carrier frequency of a high band in MHz and $BW_{Channel}^{LB}$ the channel bandwidth configured in the low band.

Table 7.3A.4-2: Uplink configuration for reference sensitivity exceptions due to UL harmonic interference for NR CA, FR1

NR Band / Channel bandwidth of the high band													
UL band	DL band	5 MHz	10 MHz	15 MHz	20 MHz	25 MHz	30 MHz	40 MHz	50 MHz	60 MHz	80 MHz	90 MHz	100 MHz
n3	n77		26	39	53			106	133	160			
n3	n78		26	39	53			106	133	160		25	
n8	n78		16	25	25			25	25	25	25	25	25
n8	n79							25	25	25	25		25
n28	n75	12	25	36	50								
n28	n78	5	10	15	20								

NOTE: 15kHz SCS is assumed for UL band.

For unsynchronized operation, Rx de-sensing in one band will be caused by another band due to lack of isolation in the band filters. Reference sensitivity exceptions for cross band are specified in Table 7.3A.4-3 with uplink configuration specified in Table 7.3A.4-4.

Table 7.3A.4-3: MSD for the CA configuration for asynchronous operation and cross band isolation for CA

Channel bandwidth												
NR CA Configuration	NR band	5 MHz	10 MHz	15 MHz	20 MHz	40 MHz	50 MHz	60 MHz	80 MHz	90 MHz	100 MHz	Duplex mode
CA_n41A-n78A	n41		90.3	88.5	87.3	84.1	83.1					TDD

Table 7.3A.4-3a: Uplink configuration for reference sensitivity exceptions due to cross band isolation for CA

NR Band / Channel bandwidth of the high band														
UL band	DL band	SCS (kHz)	5 MHz	10 MHz	15 MHz	20 MHz	25 MHz	30 MHz	40 MHz	50 MHz	60 MHz	80 MHz	90 MHz	100 MHz
n78	n41	30	N/A	273	273	273	N/A	N/A	273	273	273	273	273	273

Table 7.3A.4-4: Reference sensitivity exceptions due to harmonic mixing for CA in NR FR1

UL band	DL band	5 MHz (dB)	10 MHz (dB)	15 MHz (dB)	20 MHz (dB)	25 MHz (dB)	40 MHz (dB)	50 MHz (dB)	60 MHz (dB)	80 MHz (dB)	90 MHz (dB)	100 MHz (dB)
n41	n78 ¹	N/A	8.3	8.0	6.9	N/A	3.9	3	2.3	1.2		0.4
n78	n41 ²	N/A	10.4	10.4	10.4	N/A	7.2	6.2	5.5	4.5		4.5

NOTE 1: The requirements should be verified for UL EARFCN of the aggressor (lower) band (superscript LB) such that $f_{UL}^{LB} = \lfloor f_{DL}^{HB} / 0.15 \rfloor \cdot 0.1$ in MHz and $F_{UL_low}^{LB} + BW_{Channel}^{LB} / 2 \leq f_{UL}^{LB} \leq F_{UL_high}^{LB} - BW_{Channel}^{LB} / 2$ with f_{DL}^{HB} carrier frequency in the victim (higher) band in MHz and $BW_{Channel}^{LB}$ the channel bandwidth configured in the lower band.

NOTE 2: The requirements should be verified for UL EARFCN of the aggressor (high) band (superscript HB) such that $f_{UL}^{LB} = \lfloor 15 * f_{DL}^{HB} \rfloor \cdot 0.1$ in MHz and $F_{UL_low}^{HB} + BW_{Channel}^{HB} / 2 \leq f_{UL}^{HB} \leq F_{UL_high}^{HB} - BW_{Channel}^{HB} / 2$ with f_{DL}^{LB} carrier frequency in the victim (lower) band in MHz and $BW_{Channel}^{LB}$ the channel bandwidth configured in the higher band.

Table 7.3A.4-4a: Uplink configuration for reference sensitivity exceptions due to receiver harmonic mixing for CA in NR FR1

UL band	DL band	SCS (kHz)	5 MHz	10 MHz	15 MHz	20 MHz	25 MHz	40 MHz	50 MHz	60 MHz	80 MHz	90 MHz	100 MHz
n41	n78	30	N/A	24	24	24	N/A	24	24	24	24	24	24
n78	n41	30	N/A	50	50	50	N/A	50	50	50	50	50	50

7.3A.5 Reference sensitivity exceptions due to intermodulation interference due to 2UL CA

For inter-band carrier aggregation with uplink assigned to two NR bands given in Table 7.3A.5-1 the reference sensitivity is defined only for the specific uplink and downlink test points specified in Table 7.3A.5-1. For these test points the reference sensitivity requirement specified in Table 7.3.2-1 and Table 7.3.2-2 are relaxed by the amount of the corresponding parameter MSD given in Table 7.3A.5-1.

Table 7.3A.5-1: 2DL/2UL interband Reference sensitivity QPSK P_{REFSENS} and uplink/downlink configurations

Band / Channel bandwidth / N _{RB} / Duplex mode								Source of IMD
NR CA Configuration	NR band	UL F _c (MHz)	UL/DL BW (MHz)	UL C _{LRB}	DL F _c (MHz)	MSD (dB)	Duplex mode	
CA_n3A-n78A	n3	1740	5	25	1835	[26] [28.7 ⁵]	FDD	IMD2 ⁴
	n78	3575	10	25	3575	N/A	TDD	N/A
CA_n3A-n78A	n3	1765	5	25	1860	[8.0] [10.7 ⁵]	FDD	IMD4 ⁴
	n78	3435	10	25	3435	N/A	TDD	N/A
CA_n8A-n78A	n8	897.5	5	25	942.5	8.3	FDD	IMD4
	n78	3635	10	52	3635	N/A	TDD	N/A

NOTE 1: Both of the transmitters shall be set min(+20 dBm, P_{C_{MAX}L,f,c}) as defined in subclause 6.2A.4
 NOTE 2: RB_{START} = 0, 15kHz SCS is assumed.
 NOTE 3: No requirements apply when there is at least one individual RE within the intermodulation generated by the dual uplink is within the downlink transmission bandwidth of the FDD band. The reference sensitivity should only be verified when this is not the case (the requirements specified in clause 7.3 apply).
 NOTE4: This band is subject to IMD5 also which MSD is not specified.
 NOTE 5: Applicable only if operation with 4 antenna ports is supported in the band with carrier aggregation configured.

7.3B Reference sensitivity for DC

7.3C Reference sensitivity for SUL

7.3C.1 General

The reference sensitivity power level REFSENS is the minimum mean power applied to each one of the UE antenna ports for all UE categories, at which the throughput shall meet or exceed the requirements for the specified reference measurement channel.

7.3C.2 Reference sensitivity power level for SUL

For SUL operation, the reference receive sensitivity (REFSENS) requirement for downlink bands specified in Table 7.3.2-1 shall be met for an uplink transmission bandwidth less than or equal to that specified in Table 7.3.2-3 or supplementary uplink transmission bandwidth less than or equal to that specified in Table 7.3C.2-1.

Table 7.3C.2-1: Supplementary Uplink configuration for reference sensitivity

Downlink band/ Uplink band / Channel bandwidth / N _{RB}					
Downlink band	Uplink band	5 MHz	10 MHz	15 MHz	20 MHz
n78	n80	25	52	79	106
n78	n81	25	52	79	106
n78	n82	25	52	79	106
n78	n83	25	52	79	106
n78	n84	25	52	79	106
n78	n86	25	52	79	106
n79	n80	25	52	79	106
n79	n81	25	52	79	106

For the UE that supports any of the SUL operation given in Table 7.3C.2-2, exceptions to the requirements specified in Table 7.3.2-1 are allowed when the uplink is active in a lower frequency band and is within a specified frequency range such that transmitter harmonics fall within the downlink transmission bandwidth assigned in a higher band as noted in Table 7.3C.2-2. For these exceptions, the UE shall meet the requirements specified in Table 7.3C.2-2 and Table 7.3C.2-3.

Table 7.3C.2-2: Reference sensitivity for SUL operation (exceptions due to harmonic issue)

UL band	DL band	5 MHz	10 MHz	15 MHz	20 MHz	25 MHz	30 MHz	40 MHz	50 MHz	60 MHz	80 MHz	90 MHz	100 MHz
		dB	dB	dB	dB	dB	dB	dB	dB	dB	dB	dB	dB
n80	n78 ^{1,2}		23.9	22.1	20.9			17.9					
	n78 ³		1.1	0.8	0.3								
n82	n78 ^{4,5}		10.8	9.1	8			6					
n81	n78 ^{1,2}		10.8	9.1	8			5.1	4.2	3.5	2.3		1.4
n81	n78 ^{6,7}		10.4	8.9	7.8			4.7	3.7	3	1.7	1.2	0.7
n86	n78 ^{1,2}		23.9	22.1	20.9			17.9					
	n78 ³		1.1	0.8	0.3								
n81	n79 ^{6,7}							[6.8]	6.2	[5.6]	4.9		4.4

NOTE 1: These requirements apply when there is at least one individual RE within the uplink transmission bandwidth of the aggressor (lower) band for which the 2nd transmitter harmonic is within the downlink transmission bandwidth of a victim (higher) band.

NOTE 2: The requirements should be verified for UL EARFCN of the aggressor (lower) band (superscript LB) such that $f_{UL}^{LB} = \lfloor f_{DL}^{HB} / 0.2 \rfloor \cdot 0.1$ in MHz and $F_{UL_low}^{LB} + BW_{Channel}^{LB} / 2 \leq f_{UL}^{LB} \leq F_{UL_high}^{LB} - BW_{Channel}^{LB} / 2$ with f_{DL}^{HB} carrier frequency in the victim (higher) band in MHz and $BW_{Channel}^{LB}$ the channel bandwidth configured in the lower band.

NOTE 3: The requirements are only applicable to channel bandwidths with a carrier frequency at $\pm (20 + BW_{Channel}^{HB} / 2)$ MHz offset from $2f_{UL}^{LB}$ in the victim (higher band) with $F_{UL_low}^{LB} + BW_{Channel}^{LB} / 2 \leq f_{UL}^{LB} \leq F_{UL_high}^{LB} - BW_{Channel}^{LB} / 2$, where $BW_{Channel}^{LB}$ and $BW_{Channel}^{HB}$ are the channel bandwidths configured in the aggressor (lower) and victim (higher) bands in MHz, respectively.

NOTE 4: These requirements apply when there is at least one individual RE within the uplink transmission bandwidth of the aggressor (lower) band for which the 4th transmitter harmonic is within the downlink transmission bandwidth of a victim (higher) band.

NOTE 5: The requirements should be verified for UL EARFCN of the aggressor (lower) band (superscript LB) such that $f_{UL}^{LB} = \lfloor f_{DL}^{HB} / 0.4 \rfloor \cdot 0.1$ in MHz and $F_{UL_low}^{LB} + BW_{Channel}^{LB} / 2 \leq f_{UL}^{LB} \leq F_{UL_high}^{LB} - BW_{Channel}^{LB} / 2$ with f_{DL}^{HB} carrier frequency in the victim (higher) band in MHz and $BW_{Channel}^{LB}$ the channel bandwidth configured in the lower band.

NOTE 6: The requirements should be verified for UL EARFCN of the aggressor (lower) band (superscript LB) such that $f_{UL}^{LB} = \lfloor f_{DL}^{HB} / 0.5 \rfloor \cdot 0.1$ in MHz and $F_{UL_low}^{LB} + BW_{Channel}^{LB} / 2 \leq f_{UL}^{LB} \leq F_{UL_high}^{LB} - BW_{Channel}^{LB} / 2$ with f_{DL}^{HB} carrier frequency in the victim (higher) band in MHz and $BW_{Channel}^{LB}$ the channel bandwidth configured in the lower band.

NOTE 7: These requirements apply when there is at least one individual RE within the uplink transmission bandwidth of the aggressor (lower) band for which the 4th transmitter harmonic is within the downlink transmission bandwidth of a victim (higher) band.

Table 7.3C.2-3: Supplementary Uplink configuration (exceptions due to harmonic issue)

NR Band / Channel bandwidth of the high band													
UL band	DL band	5 MHz (N _{RB})	10 MHz (N _{RB})	15 MHz (N _{RB})	20 MHz (N _{RB})	25 MHz (N _{RB})	30 MHz (N _{RB})	40 MHz (N _{RB})	50 MHz (N _{RB})	60 MHz (N _{RB})	80 MHz (N _{RB})	90 MHz (N _{RB})	100 MHz (N _{RB})
n80	n78		25	36	50			100					
n81	n78		16	25	25			25	25	25	25	25	25
n81	n79							25	25	25	25	25	25
n83	n78		10	15	20			25	25	25	25	25	25
n86	n78		26	39	53			100					

7.3C.3 ΔR_{IB,c} for SUL

7.3C.3.1 General

For a UE supporting a SUL configuration, the ΔR_{IB,c} applies for both SC and SUL operation.

7.3C.3.2 SUL band combination

For the UE which supports SUL band combination, the minimum requirement for reference sensitivity in Table 7.3C.2-1 shall be increased by the amount given in $\Delta R_{IB,c}$ defined in subclause 7.3C.3.2 for the applicable operating bands.

7.3C.3.2.1 $\Delta R_{IB,c}$ for two bands

Table 7.3C.3.2.1-1: $\Delta R_{IB,c}$ due to SUL (two bands)

Band combination for SUL	NR Band	$\Delta R_{IB,c}$ (dB)
SUL_n78-n80	n78	0.5
	n80	0.2
SUL_n78-n81	n78	0.2
	n81	0.2
SUL_n78-n82	n78	0.5
SUL_n78-n83	n78	0.5
	n83	0.2
SUL_n78-n84	n78	0.5
SUL_n78-n86	n78	0.5
	n86	0.2

7.3D Reference sensitivity for UL-MIMO

For UE with two transmitter antenna connectors in closed-loop spatial multiplexing scheme, the minimum requirements specified in subclause 7.3 shall be met with the UL-MIMO configurations described in sub-clause 6.2D.1. For UL-MIMO, the parameter P_{UMAX} is the total transmitter power over the two transmits power over the two transmit antenna connectors.

7.4 Maximum input level

Maximum input level is defined as the maximum mean power received at the UE antenna port, at which the specified relative throughput shall meet or exceed the minimum requirements for the specified reference measurement channel. The throughput shall be $\geq 95\%$ of the maximum throughput of the reference measurement channels as specified in Annex A.3.2 (with one sided dynamic OCNG Pattern OP.1 FDD/TDD as described in Annex A.5.1.1/A.5.2.1) with parameters specified in Table 7.4-1.

Table 7.4-1: Maximum input level

Rx Parameter	Units	Channel bandwidth											
		5 MHz	10 MHz	15 MHz	20 MHz	25 MHz	30 MHz	40 MHz	50 MHz	60 MHz	80 MHz	90 MHz	100 MHz
Power in Transmission Bandwidth Configuration	dBm	-25 ²			-24 ²	-23 ²	-22 ²	-21 ²	-20 ²				
		-27 ³			-26 ³	-25 ³	-24 ³	-23 ³	-22 ³				
NOTE 1: The transmitter shall be set to 4dB below $P_{CMAX,L}$ at the minimum uplink configuration specified in Table 7.3-3 with $P_{CMAX,L}$ as defined in subclause 6.2.4.													
NOTE 2: Reference measurement channel is [TBD] for 64-QAM.													
NOTE 3: Reference measurement channel is [TBD] for 256-QAM.													

7.4A Maximum input level for CA

7.4A.1 Maximum input level for Intra-band contiguous CA

For carrier aggregation maximum input level is defined as the exact wording TBD, over the aggregated receiver bandwidth, at which the specified relative throughput shall meet or exceed the minimum requirements for the specified reference measurement channel over each component carrier. The minimum requirement is the same as the one specified in Table 7.4-1.

7.4A.2 Maximum input level for Intra-band non-contiguous CA

7.4A.3 Maximum input level for Inter-band CA

For inter-band carrier aggregation with one component carrier per operating band and the uplink assigned to one NR band, the maximum input level is defined with the uplink active on the band(s) other than the band whose downlink is being tested. The UE shall meet the requirements specified in subclause 7.4 for each component carrier while all downlink carriers are active.

7.4D Maximum input level for UL-MIMO

For UE with two transmitter antenna connectors in closed-loop spatial multiplexing, the minimum requirements specified in sub-clause 7.4 shall be met with the UL-MIMO configurations described in sub-clause 6.2D.1. For UL-MIMO, the parameter $P_{\text{CMAX,L}}$ is defined as the total transmitter power over the two transmit antenna connectors.

7.5 Adjacent channel selectivity

Adjacent channel selectivity (ACS) is a measure of a receiver's ability to receive an NR signal at its assigned channel frequency in the presence of an adjacent channel signal at a given frequency offset from the centre frequency of the assigned channel. ACS is the ratio of the receive filter attenuation on the assigned channel frequency to the receive filter attenuation on the adjacent channel(s).

The UE shall fulfil the minimum requirements specified in Table 7.5-1 for NR bands with $F_{\text{DL,high}} < 2700$ MHz and $F_{\text{UL,high}} < 2700$ MHz and the minimum requirements specified in Table 7.5-2. for NR bands with $F_{\text{DL,low}} \geq 3300$ MHz and $F_{\text{UL,low}} \geq 3300$ MHz. These requirements apply for all values of an adjacent channel interferer up to -25 dBm and for any SCS specified for the channel bandwidth of the wanted signal. However, it is not possible to directly measure the ACS; instead the lower and upper range of test parameters are chosen as in Table 7.5-3 and Table 7.5-4 for verification of the requirements specified in Table 7.5-1 and as in Table 7.5-5, and Table 7.5-6 for verification of the requirements specified in Table 7.5-2. For these test parameters, the throughput shall be $\geq 95\%$ of the maximum throughput of the reference measurement channels as specified in [Annexes A.2.2, A.2.3 and A.3.2 (with one sided dynamic OCNG Pattern OP.1 FDD/TDD for the DL-signal as described in Annex A.5.1.1/A.5.2.1)]. For operating bands with an unpaired DL part (as noted in [Table 5.5-1]), the requirements only apply for carriers assigned in the paired part.

Table 7.5-1: ACS for NR bands with $F_{\text{DL,high}} < 2700$ MHz and $F_{\text{UL,high}} < 2700$ MHz

RX parameter	Units	Channel bandwidth				
		5 MHz	10 MHz	15 MHz	20 MHz	25 MHz
ACS	dB	[33]	[33]	[30]	[27]	[26]
RX parameter	Units	Channel bandwidth				
		30 MHz	40 MHz	50 MHz	60 MHz	80 MHz
ACS	dB	[25.5]	[24]	[23]	[22.5]	[21]
RX parameter	Units	Channel bandwidth				
		90 MHz	100 MHz			
ACS	dB	[20.5]	[20]			

Table 7.5-2: ACS for NR bands with $F_{\text{DL,low}} \geq 3300$ MHz and $F_{\text{UL,low}} \geq 3300$ MHz

RX parameter	Units	Channel bandwidth				
		10 MHz	15 MHz	20 MHz	40 MHz	50 MHz
ACS	dB	[33]	[33]	[33]	[33]	[33]
RX parameter	Units	Channel bandwidth				
		60 MHz	80 MHz	90 MHz	100 MHz	
ACS	dB	[33]	[33]	[33]	[33]	

Table 7.5-3: Test parameters for NR bands with $F_{DL_high} < 2700$ MHz and $F_{UL_high} < 2700$ MHz, case 1

RX parameter	Units	Channel bandwidth				
		5 MHz	10 MHz	15 MHz	20 MHz	25 MHz
Power in transmission bandwidth configuration	dBm	REFSENS + 14 dB				
$P_{interferer}$	dBm	REFSENS + [45.5] dB	REFSENS + [45.5] dB	REFSENS + [42.5] dB	REFSENS + [39.5] dB	REFSENS + [38.5] dB
$BW_{interferer}$	MHz	5	5	5	5	5
$F_{interferer}$ (offset)	MHz	5 / -5	7.5 / -7.5	10 / -10	12.5 / -12.5	15 / -15
RX parameter	Units	Channel bandwidth				
		30 MHz	40 MHz	50 MHz	60 MHz	80 MHz
Power in transmission bandwidth configuration	dBm	REFSENS + 14 dB				
$P_{interferer}$	dBm	REFSENS + [38] dB	REFSENS + [36.5] dB	REFSENS + [35.5] dB	REFSENS + [35] dB	REFSENS + [33.5] dB
$BW_{interferer}$	MHz	5	5	5	5	5
$F_{interferer}$ (offset)	MHz	17.5 / -17.5	22.5 / -22.5	27.5 / -27.5	32.5 / -32.5	42.5 / -42.5
RX parameter	Units	Channel bandwidth				
		90 MHz	100 MHz			
Power in transmission bandwidth configuration	dBm	REFSENS + 14 dB				
$P_{interferer}$	dBm	REFSENS + [33] dB	REFSENS + [32.5] dB			
$BW_{interferer}$	MHz	5	5			
$F_{interferer}$ (offset)	MHz	47.5 / -47.5	52.5 / -52.5			
NOTE 1: The transmitter shall be set to 4dB below [...].						
NOTE 2: The absolute value of the interferer offset $F_{interferer}$ (offset) shall be further adjusted to $(\lceil F_{interferer} / SCS \rceil + 0.5) SCS$ MHz with SCS the sub-carrier spacing of the wanted signal in MHz. The interferer is an NR signal with an SCS equal to that of the wanted signal.						
NOTE 3: The interferer consists of the NR interferer RMC specified in [...]						

Table 7.5-4: Test parameters for NR bands with $F_{DL_high} < 2700$ MHz and $F_{UL_high} < 2700$ MHz, case 2

RX parameter	Units	Channel bandwidth				
		5 MHz	10 MHz	15 MHz	20 MHz	25 MHz
Power in transmission bandwidth configuration	dBm	[-56.5]	[-56.5]	[-53.5]	[-50.5]	[-49.5]
$P_{interferer}$	dBm	-25				
$BW_{interferer}$	MHz	5	5	5	5	5
$F_{interferer}$ (offset)	MHz	5 / -5	7.5 / -7.5	10 / -10	12.5 / -12.5	15 / -15
RX parameter	Units	Channel bandwidth				
		30 MHz	40 MHz	50 MHz	60 MHz	80 MHz
Power in transmission bandwidth configuration	dBm	[-49]	[-47]	[-46.5]	[-46]	[-44.5]
$P_{interferer}$	dBm	-25				
$BW_{interferer}$	MHz	5	5	5	5	5
$F_{interferer}$ (offset)	MHz	17.5 / -17.5	22.5 / -22.5	27.5 / -27.5	32.5 / -32.5	42.5 / -42.5
RX parameter	Units	Channel bandwidth				
		90 MHz	100 MHz			
Power in transmission bandwidth configuration	dBm	[-44]	[-43.5]			
$P_{interferer}$	dBm	-25				
$BW_{interferer}$	MHz	5	5			
$F_{interferer}$ (offset)	MHz	47.5 / -47.5	52.5 / -52.5			
NOTE 1: The transmitter shall be set to 24 dB below [...].						
NOTE 2: The absolute value of the interferer offset $F_{interferer}$ (offset) shall be further adjusted to $(\lceil F_{interferer} / SCS \rceil + 0.5) SCS$ MHz with SCS the sub-carrier spacing of the wanted signal in MHz. The interferer is an NR signal with an SCS equal to that of the wanted signal.						
NOTE 3: The interferer consists of the RMC specified in [...].						

Table 7.5-5: Test parameters for NR bands with $F_{DL_low} \geq 3300$ MHz and $F_{UL_low} \geq 3300$ MHz, case 1

RX parameter	Units	Channel bandwidth				
		10 MHz	15 MHz	20 MHz	40 MHz	50 MHz
Power in transmission bandwidth configuration	dBm	REFSENS + 14 dB				
$P_{interferer}$	dBm	REFSENS + [45.5] dB				
$BW_{interferer}$	MHz	10	15	20	40	50
$F_{interferer}$ (offset)	MHz	10 / -10	15 / -15	20 / -20	40 / -40	50 / -50
RX parameter	Units	Channel bandwidth				
		60 MHz	80 MHz	90 MHz	100 MHz	
Power in transmission bandwidth configuration	dBm	REFSENS + 14 dB				
$P_{interferer}$	dBm	REFSENS + [45.5] dB	REFSENS + [45.5] dB	REFSENS + [45.5] dB	REFSENS + [45.5] dB	
$BW_{interferer}$	MHz	60	80	90	100	
$F_{interferer}$ (offset)	MHz	60 / -60	80 / -80	90 / -90	100 / -100	
NOTE 1: The transmitter shall be set to 4dB below [...].						
NOTE 2: The absolute value of the interferer offset $F_{interferer}$ (offset) shall be further adjusted to $(\lceil F_{interferer} / SCS \rceil + 0.5) SCS$ MHz with SCS the sub-carrier spacing of the wanted signal in MHz. The interferer is an NR signal with an SCS equal to that of the wanted signal.						
NOTE 3: The interferer consists of the RMC specified in [...]						

Table 7.5-6: Test parameters for NR bands with $F_{DL_low} \geq 3300$ MHz and $F_{UL_low} \geq 3300$ MHz, case 2

RX parameter	Units	Channel bandwidth				
		10 MHz	15 MHz	20 MHz	40 MHz	50 MHz
Power in transmission bandwidth configuration	dBm	[-56.5]				
$P_{interferer}$	dBm	-25				
$BW_{interferer}$	MHz	10	15	20	40	50
$F_{interferer}$ (offset)	MHz	10 / -10	15 / -15	20 / -20	40 / -40	50 / -50
RX parameter	Units	Channel bandwidth				
		60 MHz	80 MHz	90 MHz	100 MHz	
Power in transmission bandwidth configuration	dBm	[-56.5]				
$P_{interferer}$	dBm	-25	-25	-25	-25	
$BW_{interferer}$	MHz	60	80	90	100	
$F_{interferer}$ (offset)	MHz	60 / -60	80 / -80	90 / -90	100 / -100	
NOTE 1: The transmitter shall be set to 24 dB below [...].						
NOTE 2: The absolute value of the interferer offset $F_{interferer}$ (offset) shall be further adjusted to $(\lceil F_{interferer} / SCS \rceil + 0.5) SCS$ MHz with SCS the sub-carrier spacing of the wanted signal in MHz. The interferer is an NR signal with an SCS equal to that of the wanted signal.						
NOTE 3: The interferer consists of the RMC specified in [...]						

7.5A Adjacent channel selectivity for CA

7.5A.1 Adjacent channel selectivity for Intra-band contiguous CA

For intra-band contiguous carrier aggregation with two component carriers and aggregated bandwidth BWChannel_CA shall be configured at nominal channel spacing to the PCC. The UE shall fulfil the minimum requirement specified in Table 7.5A.1-1 for an adjacent channel interferer on either side of the aggregated downlink signal at a specified frequency offset and for an interferer power up to -25 dBm.

The throughput of each carrier shall be $\geq 95\%$ of the maximum throughput of the reference measurement channels as specified in Annexes A.X.X (with one sided dynamic OCNG Pattern for the DL-signal as described in Annex A.X.X.X) with parameters specified in Tables 7.5A.1-2 and 7.5A.1-3.

Table 7.5A.1-1: ACS for intra-band contiguous CA with $F_{DL_low} \geq 3300$ MHz and $F_{UL_low} \geq 3300$ MHz

RX parameter	Units	Channel bandwidth				
		110 MHz	120 MHz	130 MHz	140 MHz	150 MHz
ACS	dB	[33]	[33]	[33]	[33]	[33]
RX parameter	Units	Channel bandwidth				
		160 MHz	180 MHz	200 MHz		
ACS	dB	[33]	[33]	[33]		

Table 7.5A.1-2: Test parameters for intra-band contiguous CA with $F_{DL_low} \geq 3300$ MHz and $F_{UL_low} \geq 3300$ MHz, case 1

RX parameter	Units	Channel bandwidth				
		110 MHz	120 MHz	130 MHz	140 MHz	150 MHz
Power in transmission bandwidth configuration	dBm	REFSENS + 14 dB				
$P_{interferer}$	dBm	REFSENS + [45.5] dB				
$BW_{interferer}$	MHz	110	120	130	140	150
$F_{interferer}$ (offset)	MHz	110 / -110	120 / -120	130 / -130	140 / -140	150 / -150
RX parameter	Units	Channel bandwidth				
		160 MHz	180 MHz	200 MHz		
Power in transmission bandwidth configuration	dBm	REFSENS + 14 dB	REFSENS + 14 dB	REFSENS + 14 dB		
$P_{interferer}$	dBm	REFSENS + [45.5] dB	REFSENS + [45.5] dB	REFSENS + [45.5] dB		
$BW_{interferer}$	MHz	160	180	200		
$F_{interferer}$ (offset)	MHz	160 / -160	180 / -180	200 / -200		
NOTE 1: The transmitter shall be set to 4dB below [...].						
NOTE 2: The absolute value of the interferer offset $F_{interferer}$ (offset) shall be further adjusted to $(\lceil F_{interferer} / SCS \rceil + 0.5) SCS$ MHz with SCS the sub-carrier spacing of the wanted signal in MHz. The interferer is an NR signal with an SCS equal to that of the wanted signal.						
NOTE 3: The interferer consists of the RMC specified in [...].						

Table 7.5A.1-3: Test parameters for intra-band contiguous CA with $F_{DL_low} \geq 3300$ MHz and $F_{UL_low} \geq 3300$ MHz, case 2

RX parameter	Units	Channel bandwidth				
		110 MHz	120 MHz	130 MHz	140 MHz	150 MHz
Power in transmission bandwidth configuration	dBm	[-56.5]				
$P_{interferer}$	dBm	-25				
$BW_{interferer}$	MHz	110	120	130	140	150
$F_{interferer}$ (offset)	MHz	110 / -110	120 / -120	130 / -130	140 / -140	150 / -150
RX parameter	Units	Channel bandwidth				
		160 MHz	180 MHz	200 MHz		
Power in transmission bandwidth configuration	dBm	[-56.5]	[-56.5]	[-56.5]		
$P_{interferer}$	dBm	-25	-25	-25		
$BW_{interferer}$	MHz	160	180	200		
$F_{interferer}$ (offset)	MHz	160 / -160	180 / -180	200 / -200		
NOTE 1: The transmitter shall be set to 4dB below [...].						
NOTE 2: The absolute value of the interferer offset $F_{interferer}$ (offset) shall be further adjusted to $(\lceil F_{interferer} / SCS \rceil + 0.5) SCS$ MHz with SCS the sub-carrier spacing of the wanted signal in MHz. The interferer is an NR signal with an SCS equal to that of the wanted signal.						
NOTE 3: The interferer consists of the RMC specified in [...].						

7.5A.2 Adjacent channel selectivity Intra-band non-contiguous CA

Detailed structure of the subclause is TBD.

7.5A.3 Adjacent channel selectivity Inter-band CA

For inter-band carrier aggregation with one component carrier per operating band and the uplink assigned to one NR band, the adjacent channel requirements are defined with the uplink active on the band(s) other than the band whose downlink is being tested. The UE shall meet the requirements specified in subclause 7.5 for each component carrier while all downlink carriers are active.

The throughput of each carrier shall be $\geq 95\%$ of the maximum throughput of the reference measurement channels as specified in Annexes A.X.X (with one sided dynamic OCNG Pattern for the DL-signal as described in Annex A.X.X.X).

7.5D Adjacent channel selectivity for UL-MIMO

For UE(s) with two transmitter antenna connectors in closed-loop spatial multiplexing scheme, the minimum requirements specified in sub-clause 7.5 shall be met with the UL-MIMO configurations described in sub-clause 6.2D.1. For UL-MIMO, the parameter P_{CMAX_L} is defined as the total transmitter power over the two transmit antenna connectors.

7.6 Blocking characteristics

7.6.1 General

The blocking characteristic is a measure of the receiver's ability to receive a wanted signal at its assigned channel frequency in the presence of an unwanted interferer on frequencies other than those of the spurious response or the adjacent channels, without this unwanted input signal causing a degradation of the performance of the receiver beyond a specified limit. The blocking performance shall apply at all frequencies except those at which a spurious response occurs.

7.6.2 In-band blocking

For NR bands with $F_{DL_high} < 2700$ MHz and $F_{UL_high} < 2700$ in-band blocking (IBB) is defined for an unwanted interfering signal falling into the UE receive band or into the first 15 MHz below or above the UE receive band. The throughput of the wanted signal shall be $\geq 95\%$ of the maximum throughput of the reference measurement channels as specified in Annexes A.2.2, A.2.3 and A.3.2 (with one sided dynamic OCNG Pattern OP.1 FDD/TDD for the DL-signal as described in Annex A.5.1.1/A.5.2.1) with parameters specified in Table 7.6.2-1 and Table 7.6.2-2. The said relative throughput requirement shall be met for any SCS specified for the channel bandwidth of the wanted signal. For operating bands with an unpaired DL part (as noted in Table 5.5-1), the requirements only apply for carriers assigned in the paired part.

Table 7.6.2-1: In-band blocking parameters for NR bands with $F_{DL_high} < 2700$ MHz and $F_{UL_high} < 2700$ MHz

RX parameter	Units	Channel bandwidth				
		5 MHz	10 MHz	15 MHz	20 MHz	25 MHz
Power in transmission bandwidth configuration	dBm	REFSENS + channel specific value below				
	dB	6	6	7	9	10
$BW_{interferer}$	MHz	5				
$F_{offset, case 1}$	MHz	7.5				
$F_{offset, case 2}$	MHz	12.5				
RX parameter	Units	Channel bandwidth				
		30 MHz	40 MHz	50 MHz	60 MHz	80 MHz
Power in transmission bandwidth configuration	dBm	REFSENS + channel specific value below				
	dB	11	12	13	14	15
$BW_{interferer}$	MHz	5				
$F_{offset, case 1}$	MHz	7.5				
$F_{offset, case 2}$	MHz	12.5				
RX parameter	Units	Channel bandwidth				
		90 MHz	100 MHz			
Power in transmission bandwidth configuration	dBm	REFSENS + channel specific value below				
	dB	15.5	16			
$BW_{interferer}$	MHz	5				
$F_{offset, case 1}$	MHz	7.5				
$F_{offset, case 2}$	MHz	12.5				

NOTE 1: The transmitter shall be set to 4dB below [...].
 NOTE 2: The interferer consists of the RMC specified in [...]

Table 7.6.2-2: In-band blocking for NR bands with $F_{DL_high} < 2700$ MHz and $F_{UL_high} < 2700$ MHz

NR band	Parameter	Unit	Case 1	Case 2	Case 3
	$P_{interferer}$	dBm	-56	-44	-15
n1, n2, n3, n5, n7, n8, n12, n20, n25, n28, n34, n38, n39, n40, n41, n50, n51, n66, n70, n74, n75, n76	$F_{interferer}$ (offset)	MHz	$-CBW/2 - F_{offset, case 1}$ and $CBW/2 + F_{offset, case 1}$	$\leq -CBW/2 - F_{offset, case 2}$ and $\geq CBW/2 + F_{offset, case 2}$	
	$F_{interferer}$	MHz	NOTE 2	$F_{DL_low} - 15$ to $F_{DL_high} + 15$	
n71	$F_{interferer}$	MHz	NOTE 2	$F_{DL_low} - 12$ to $F_{DL_high} + 15$	$F_{DL_low} - 12$
NOTE 1: The absolute value of the interferer offset $F_{interferer}$ (offset) shall be further adjusted to $(\lceil F_{interferer} / SCS \rceil + 0.5) SCS$ MHz with SCS the sub-carrier spacing of the wanted signal in MHz. The interferer is an NR signal with an SCS equal to that of the wanted signal. NOTE 2: For each carrier frequency, the requirement applies for two interferer carrier frequencies: a: $-CBW/2 - F_{offset, case 1}$; b: $CBW/2 + F_{offset, case 1}$					

For NR bands with $F_{DL_low} \geq 3300$ MHz and $F_{UL_low} \geq 3300$ MHz in-band blocking (IBB) is defined for an unwanted interfering signal falling into the UE receive band or into an immediately adjacent frequency range up 3CBW below or above the UE receive band with CBW is the bandwidth of the wanted signal. The throughput of the wanted signal shall be $\geq 95\%$ of the maximum throughput of the reference measurement channels as specified in [Annexes A.2.2, A.2.3 and A.3.2 (with one sided dynamic OCNNG Pattern OP.1 FDD/TDD for the DL-signal as described in Annex A.5.1.1/A.5.2.1)] with parameters specified in Table 7.6.2-3 and Table 7.6.2-4. The said relative throughput requirement shall be met for any SCS specified for the channel bandwidth of the wanted signal.

Table 7.6.2-3: In-band blocking parameters for NR bands with $F_{DL_low} \geq 3300$ MHz and $F_{UL_low} \geq 3300$ MHz

RX parameter	Units	Channel bandwidth				
		10 MHz	15 MHz	20 MHz	40 MHz	50 MHz
Power in transmission bandwidth configuration	dBm	REFSENS + channel specific value below				
	dB	6				
$BW_{interferer}$	MHz	10	15	20	40	50
$F_{offset, case 1}$	MHz	15	22.5	30	60	75
$F_{offset, case 2}$	MHz	25	37.5	50	100	125
RX parameter	Units	Channel bandwidth				
		60 MHz	80 MHz	90 MHz	100 MHz	
Power in transmission bandwidth configuration	dBm	REFSENS + channel specific value below				
	dB	6				
$BW_{interferer}$	MHz	60	80	90	100	
$F_{offset, case 1}$	MHz	90	120	135	150	
$F_{offset, case 2}$	MHz	150	200	225	250	
NOTE 1: The transmitter shall be set to 4dB below [...].						
NOTE 2: The interferer consists of the RMC specified in [...]						

Table 7.6.2-4: In-band blocking for NR bands with $F_{DL_low} \geq 3300$ MHz and $F_{UL_low} \geq 3300$ MHz

NR band	Parameter	Unit	Case 1	Case 2
	n77, n78, n79	$P_{interferer}$	dBm	-56
$F_{interferer}$ (offset)		MHz	$-\text{CBW}/2 - F_{\text{offset, case 1}}$ and $\text{CBW}/2 + F_{\text{offset, case 1}}$	$\leq -\text{CBW}/2 - F_{\text{offset, case 2}}$ and $\geq \text{CBW}/2 + F_{\text{offset, case 2}}$
	$F_{interferer}$		NOTE 2	$F_{DL_low} - 3\text{CBW}$ to $F_{DL_high} + 3\text{CBW}$
NOTE 1: The absolute value of the interferer offset $F_{interferer}$ (offset) shall be further adjusted to $(\lceil F_{interferer} / \text{SCS} \rceil + 0.5) \text{SCS}$ MHz with SCS the sub-carrier spacing of the wanted signal in MHz. The interferer is an NR signal with an SCS equal to that of the wanted signal.				
NOTE 2: For each carrier frequency, the requirement applies for two interferer carrier frequencies: a: $-\text{CBW}/2 - F_{\text{offset, case 1}}$; b: $\text{CBW}/2 + F_{\text{offset, case 1}}$				
NOTE 3: CBW denotes the channel bandwidth of the wanted signal				

7.6.3 Out-of-band blocking

For NR bands with $F_{DL_high} < 2700$ MHz and $F_{UL_high} < 2700$ MHz out-of-band band blocking is defined for an unwanted CW interfering signal falling outside a frequency range 15 MHz below or above the UE receive band. The throughput of the wanted signal shall be $\geq 95\%$ of the maximum throughput of the reference measurement channels as specified in Annexes A.2.2, A.2.3 and A.3.2 (with one sided dynamic OCNG Pattern OP.1 FDD/TDD for the DL-signal as described in Annex A.5.1.1/A.5.2.1) with parameters specified in Table 7.6.3-1 and Table 7.6.3-2. The said relative throughput requirement shall be met for any SCS specified for the channel bandwidth of the wanted signal. For operating bands with an unpaired DL part (as noted in Table 5.5-1), the requirements only apply for carriers assigned in the paired part.

Table 7.6.3-1: Out-of-band blocking parameters for NR bands with $F_{DL_high} < 2700$ MHz and $F_{UL_high} < 2700$ MHz

RX parameter	Units	Channel bandwidth				
		5 MHz	10 MHz	15 MHz	20 MHz	25 MHz
Power in transmission bandwidth configuration	dBm	REFSENS + channel specific value below				
	dB	6	6	7	9	10
RX parameter	Units	Channel bandwidth				
		30 MHz	40 MHz	50 MHz	60 MHz	80 MHz
Power in transmission bandwidth configuration	dBm	REFSENS + channel specific value below				
	dB	11	12	13	14	15
RX parameter	Units	Channel bandwidth				
		90 MHz	100 MHz			
Power in transmission bandwidth configuration	dBm	REFSENS + channel specific value below				
	dB	15.5	16			
NOTE: The transmitter shall be set to 4dB below						

Table 7.6.3-2: Out of-band blocking for NR bands with $F_{DL_high} < 2700$ MHz and $F_{UL_high} < 2700$ MHz

NR band	Parameter	Unit	Range 1	Range 2	Range 3
n1, n2, n3, n5, n7, n8, n12, n20, n25, n28, n34, n38, n39, n40, n41, n50, n51, n66, n70, n71, n74, n75, n76	$P_{interferer}$	dBm	-44	-30	-15
	$F_{interferer}$ (CW)	MHz	$-60 < f - F_{DL_low} < -15$ or $15 < f - F_{DL_high} < 60$	$-85 < f - F_{DL_low} \leq -60$ or $60 \leq f - F_{DL_high} < 85$	$1 \leq f \leq F_{DL_low} - 85$ or $F_{DL_high} + 85 \leq f \leq 12750$
NOTE: The power level of the interferer ($P_{interferer}$) for Range 3 shall be modified to -20 dBm for $F_{interferer} > 6000$ MHz.					

For interferer frequencies across ranges 1, 2 and 3 in Table 7.6.3-2, a maximum of

$$\lfloor \max\{24,6 \cdot \lceil n \cdot N_{RB} / 6 \rceil / \min\{\lfloor n \cdot N_{RB} / 10 \rfloor, 5\}\} \rfloor$$

exceptions are allowed for spurious response frequencies in each assigned frequency channel when measured using a step size of $\min(\lfloor CBW / 2 \rfloor, 5)$ MHz with N_{RB} the number of resource blocks in the downlink transmission bandwidth configuration, CBW the bandwidth of the frequency channel in MHz and $n = 1,2,3$ for SCS = 15,30,60 kHz, respectively. For these exceptions, the requirements in sub-clause 7.7 apply.

For NR bands with $F_{DL_low} \geq 3300$ MHz and $F_{UL_low} \geq 3300$ MHz out-of-band band blocking is defined for an unwanted CW interfering signal falling outside a frequency range up to 3CBW below or from 3CBW above the UE receive band, where CBW is the channel bandwidth. The throughput of the wanted signal shall be $\geq 95\%$ of the maximum throughput of the reference measurement channels as specified in Annexes A.2.2, A.2.3 and A.3.2 (with one sided dynamic OCN Pattern OP.1 FDD/TDD for the DL-signal as described in Annex A.5.1.1/A.5.2.1) with parameters specified in Table 7.6.3-3 and Table 7.6.3-4. The said relative throughput requirement shall be met for any SCS specified for the channel bandwidth of the wanted signal.

Table 7.6.3-3: Out-of-band blocking parameters for NR bands with $F_{DL_low} \geq 3300$ MHz and $F_{UL_low} \geq 3300$ MHz

RX parameter	Units	Channel bandwidth				
		10 MHz	15 MHz	20 MHz	40 MHz	50 MHz
Power in transmission bandwidth configuration	dBm	REFSENS + channel specific value below				
	dB	6	7	9	9	9
RX parameter	Units	Channel bandwidth				
		60 MHz	80 MHz	90 MHz	100 MHz	
Power in transmission bandwidth configuration	dBm	REFSENS + channel specific value below				
	dB	9	9	9	9	
NOTE: The transmitter shall be set to 4dB below						

Table 7.6.3-4: Out of-band blocking for NR bands with $F_{DL_low} \geq 3300$ MHz and $F_{UL_low} \geq 3300$ MHz

NR band	Parameter	Unit	Range 1	Range 2	Range 3
n77, n78 (NOTE 3)	$P_{interferer}$	dBm	-44	-30	-15
	$F_{interferer}$ (CW)	MHz	$-60 < f - F_{DL_low} \leq -3CBW$ or $3CBW \leq f - F_{DL_high} < 60$	$-200 < f - F_{DL_low} \leq -MAX(60,3CBW)$ or $MAX(60,3CBW) \leq f - F_{DL_high} < 200$	$1 \leq f \leq F_{DL_low} - MAX(200,3CBW)$ or $F_{DL_high} + MAX(200,3CBW) \leq f \leq 12750$
n79 (NOTE 4)	$F_{interferer}$ (CW)	MHz	N/A	$-150 < f - F_{DL_low} \leq -MAX(60,3CBW)$ or $MAX(60,3CBW) \leq f - F_{DL_high} < 150$	$1 \leq f \leq F_{DL_low} - MAX(150,3CBW)$ or $F_{DL_high} + MAX(150,3CBW) \leq f \leq 12750$
<p>NOTE 1: The power level of the interferer ($P_{interferer}$) for Range 3 shall be modified to -20 dBm for $F_{interferer} > 6000$ MHz.</p> <p>NOTE 2: CBW denotes the channel bandwidth of the wanted signal</p> <p>NOTE 3: The power level of the interferer ($P_{interferer}$) for Range 3 shall be modified to -20 dBm, for $F_{interferer} > 2700$ MHz and $F_{interferer} < 4800$ MHz. For $CBW > 15$ MHz, the requirement for Range 1 is not applicable and Range 2 applies from the frequency offset of 3CBW from the band edge. For CBW larger than 60 MHz, the requirement for Range 2 is not applicable and Range 3 applies from the frequency offset of 3CBW from the band edge.</p> <p>NOTE 4: The power level of the interferer ($P_{interferer}$) for Range 3 shall be modified to -20 dBm, for $F_{interferer} > 3650$ MHz and $F_{interferer} < 5750$ MHz. For $CBW \geq 40$ MHz, the requirement for Range 2 is not applicable and Range 3 applies from the frequency offset of 3CBW from the band edge.</p>					

For interferer frequencies across ranges 1, 2 and 3 in Table 7.6.3-4, a maximum of

$$\lfloor \max\{24,6 \cdot \lceil n \cdot N_{RB} / 6 \rceil / \min\{\lfloor n \cdot N_{RB} / 10 \rfloor, 5\}\} \rfloor$$

exceptions are allowed for spurious response frequencies in each assigned frequency channel when measured using a step size of $\min(\lfloor CBW / 2 \rfloor, 5)$ MHz with N_{RB} the number of resource blocks in the downlink transmission bandwidth configuration, CBW the bandwidth of the frequency channel in MHz and $n = 1, 2, 3$ for $SCS = 15, 30, 60$ kHz, respectively. For these exceptions, the requirements in sub-clause 7.7 apply.

7.6.4 Narrow band blocking

This requirement is measure of a receiver's ability to receive a NR signal at its assigned channel frequency in the presence of an unwanted narrow band CW interferer at a frequency, which is less than the nominal channel spacing.

The relative throughput shall be $\geq 95\%$ of the maximum throughput of the reference measurement channels as specified in Annexes A.2.2, A.2.3 and A.3.2 (with one sided dynamic OCNG Pattern OP.1 FDD/TDD for the DL-signal as described in Annex A.5.1.1/A.5.2.1) with parameters specified in Table 7.6.2-1. For operating bands with an unpaired DL part (as noted in Table 5.5-1), the requirements only apply for carriers assigned in the paired part.

Table 7.6.4-1: Narrow Band Blocking

NR band	Parameter	Unit	Channel Bandwidth										
			5 MHz	10 MHz	15 MHz	20 MHz	25 MHz	40 MHz	50 MHz	60 MHz	80 MHz	90 MHz	100 MHz
n1,n2, n3, n5, n7, n8, n12, n20, n25, n28, n34, n38, n39, n40, n41, n50, n51, n66, n70, n71, n74, n75, n76	P _w	dBm	P _{PREFSENS} + channel-bandwidth specific value below										
			16	13	14	16	16	16	16	16	16	16	16
	P _{uw} (CW)	dBm	-55	-55	-55	-55	-55	-55	-55	-55	-55	-55	-55
	F _{uw} (offset SCS= 15 kHz)	MHz	2.7075	5.2125	7.7025	10.2075	13.0275	20.5575	NA	NA	NA	NA	NA
	F _{uw} (offset SCS= 30 kHz)	MHz	NA	NA	NA	NA			TBD	TBD			

NOTE 1: The transmitter shall be set a 4 dB below PCMAX_L at the minimum uplink configuration specified in Table 7.3.1-2 with PCMAX_L as defined in subclause 6.2.5.
 NOTE 2: Reference measurement channel is specified in Annex A.3.2 with one sided dynamic OCNG Pattern OP.1 FDD/TDD as described in Annex A.5.1.1/A.5.2.1.
 NOTE 3: The PREFSENS power level is specified in Table 7.3.1-1 and Table 7.3.1-1a for two and four antenna ports, respectively.

7.6A Blocking characteristics for CA

7.6A.1 General

7.6A.2 In-band blocking for CA

7.6A.2.1 In-band blocking for Intra-band contiguous CA

For intra-band contiguous carrier aggregation with two component carriers and aggregated bandwidth BW_{Channel_CA}, the SCC(s) shall be configured at nominal channel spacing to the PCC. The UE shall fulfil the minimum requirement specified in Table 7.6A.2.1-1 for an adjacent channel interferer on either side of the aggregated downlink signal at a specified frequency offset and for an interferer power up to -25 dBm. The throughput of each carrier shall be ≥ 95% of the maximum throughput of the reference measurement channels as specified in Annexes A.X.X (with one sided dynamic OCNG Pattern for the DL-signal as described in Annex A.X.X.X).

Table 7.6A.2.1-1: In-band blocking parameters for intra-band contiguous CA with $F_{DL_low} \geq 3300$ MHz and $F_{UL_low} \geq 3300$ MHz

RX parameter	Units	Channel bandwidth				
		110 MHz	120 MHz	130 MHz	140 MHz	150 MHz
Power in transmission bandwidth configuration	dBm	REFSENS + channel specific value below				
	dB	6				
$BW_{interferer}$	MHz	110	120	130	140	150
$F_{offset, case 1}$	MHz	165	180	195	210	225
$F_{offset, case 2}$	MHz	275	300	325	350	375
RX parameter	Units	Channel bandwidth				
		160 MHz	180 MHz	200 MHz		
Power in transmission bandwidth configuration	dBm	REFSENS + channel specific value below				
	dB	6	6	6		
$BW_{interferer}$	MHz	160	180	200		
$F_{offset, case 1}$	MHz	240	270	300		
$F_{offset, case 2}$	MHz	400	450	500		
NOTE 1: The transmitter shall be set to 4dB below [...].						
NOTE 2: The interferer consists of the RMC specified in [...]						

Table 7.6A.2.1-2: In-band blocking for intra-band contiguous CA with $F_{DL_low} \geq 3300$ MHz and $F_{UL_low} \geq 3300$ MHz

NR band	Parameter	Unit	Case 1	Case 2
		$P_{interferer}$	dBm	[-56]
n77, n78, n79	$F_{interferer}$ (offset)	MHz	$-CBW/2 - F_{offset, case 1}$ and $BW/2 + F_{offset, case 1}$	$\leq -CBW/2 - F_{offset, case 2}$ and $\geq CBW/2 + F_{offset, case 2}$
	$F_{interferer}$		NOTE 2	$F_{DL_low} - 3CBW$ to $F_{DL_high} + 3CBW$
NOTE 1: The absolute value of the interferer offset $F_{interferer}$ (offset) shall be further adjusted to $(\lceil F_{interferer} / SCS \rceil + 0.5) SCS$ MHz with SCS the sub-carrier spacing of the wanted signal in MHz. The interferer is an NR signal with an SCS equal to that of the wanted signal.				
NOTE 2: For each carrier frequency, the requirement applies for two interferer carrier frequencies: a: $-CBW/2 - F_{offset, case 1}$; b: $CBW/2 + F_{offset, case 1}$				
NOTE 3: CBW denotes the channel bandwidth of the wanted signal				

7.6A.2.2 In-band blocking for Intra-band non-contiguous CA

Detailed structure of the subclause is TBD

7.6A.2.3 In-band blocking for Inter-band CA

For inter-band carrier aggregation with one component carrier per operating band and the uplink assigned to one NR band, the in-band blocking requirements are defined with the uplink active on the band(s) other than the band whose downlink is being tested. The UE shall meet the requirements specified in subclause 7.6.2 for each component carrier while all downlink carriers are active.

For the UE which supports inter-band CA configuration in Table 7.3A.3.2, $P_{interferer}$ power defined in Table 7.6.2-2 and 7.6.2-4 is increased by the amount given by $\Delta R_{IB,c}$ in Table 7.3A.3.2.

The throughput of each carrier shall be $\geq 95\%$ of the maximum throughput of the reference measurement channels as specified in Annexes A.X.X (with one sided dynamic OCNG Pattern for the DL-signal as described in Annex A.X.X.X).

7.6A.3 Out-of-band blocking for CA

7.6A.3.1 Out-of-band blocking for Intra-band contiguous CA

For intra-band contiguous carrier aggregations the downlink SCC(s) shall be configured at nominal channel spacing to the PCC. For FDD, the PCC shall be configured closest to the uplink band. All downlink carriers shall be active throughout the test. The uplink output power shall be set as specified in Table 7.6.X with the uplink configuration set according to Table 7.3A-1 for the applicable carrier aggregation configuration. For UE(s) supporting one uplink carrier, the uplink configuration of the PCC shall be in accordance with Table 7.3-2.

The UE shall fulfil the minimum requirement in presence of an interfering signal specified in Tables 7.6.X and Tables 7.6.Y being on either side of the aggregated signal. The throughput of each carrier shall be $\geq 95\%$ of the maximum throughput of the reference measurement channels as specified in Annexes.

Details for exceptions are TBD.

Table 7.6A.3-1: Out-of-band blocking parameters for intra-band contiguous CA with $F_{DL_low} \geq 3300$ MHz and $F_{UL_low} \geq 3300$ MHz

RX parameter	Units	Channel bandwidth				
		110 MHz	120 MHz	130 MHz	140 MHz	150 MHz
Power in transmission bandwidth configuration	dBm	REFSENS + channel specific value below				
	dB	9	9	9	9	9
RX parameter	Units	Channel bandwidth				
		160 MHz	180 MHz	200 MHz		
Power in transmission bandwidth configuration	dBm	REFSENS + channel specific value below	REFSENS + channel specific value below	REFSENS + channel specific value below		
	dB	9	9	9		

NOTE 1: The transmitter shall be set to 4dB below

Table 7.6A.3-2: Out of-band blocking for intra-band contiguous CA with $F_{DL_low} \geq 3300$ MHz and $F_{UL_low} \geq 3300$ MHz

NR band	Parameter	Unit	Range1	Range 2	Range 3
n77, n78 (NOTE 3)	$P_{interferer}$	dBm	-45	-30	-15
	$F_{interferer}$ (CW)	MHz	N/A	N/A	$1 \leq f \leq F_{DL_low} - \text{MAX}(200,3\text{CBW})$ or $F_{DL_high} + \text{MAX}(200,3\text{CBW})$ $\leq f \leq 12750$
n79 (NOTE 4)	$F_{interferer}$ (CW)	MHz	N/A	N/A	$1 \leq f \leq F_{DL_low} - \text{MAX}(150,3\text{CBW})$ or $F_{DL_high} + \text{MAX}(150,3\text{CBW})$ $\leq f \leq 12750$

NOTE 1: The power level of the interferer ($P_{interferer}$) for Range 3 shall be modified to -20 dBm for $F_{interferer} > 6000$ MHz.

NOTE 2: CBW denotes the channel bandwidth of the wanted signal

NOTE 3: The power level of the interferer ($P_{interferer}$) for Range 3 shall be modified to -20 dBm, for $F_{interferer} > 2700$ MHz and $F_{interferer} < 4800$ MHz. For CBW > 15 MHz, the requirement for Range 1 is not applicable and Range 2 applies from the frequency offset of 3CBW from the band edge. For CBW larger than 60 MHz, the requirement for Range 2 is not applicable and Range 3 applies from the frequency offset of 3CBW from the band edge.

NOTE 4: The power level of the interferer ($P_{interferer}$) for Range 3 shall be modified to -20 dBm, for $F_{interferer} > 3650$ MHz and $F_{interferer} < 5750$ MHz. For CBW ≥ 40 MHz, the requirement for Range 2 is not applicable and Range 3 applies from the frequency offset of 3CBW from the band edge.

7.6A.3.2 Out-of-band blocking for Intra-band non-contiguous CA

Detailed structure of the subclause is TBD

7.6A.3.3 Out-of-band blocking for Inter-band CA

For inter-band carrier aggregation with one component carrier per operating band and the uplink assigned to one NR band, the out-of-band blocking requirements are defined with the uplink active on the band(s) other than the band whose downlink is being tested. The UE shall meet the requirements specified in subclause 7.6.3 for each component carrier while all downlink carriers are active.

For inter-band carrier aggregation with uplink assigned to two NR bands, the out-of-band blocking requirements specified in subclause 7.6.3 shall be met with the transmitter power for the uplink set to 7 dB below $P_{\text{CMAX_L,f,c}}$ for each serving cell c .

For the UE which supports inter-band CA configuration in Table 7.3A.3.2, $P_{\text{interferer}}$ power defined in Table 7.6.3-2 and 7.6.3-4 is increased by the amount given by $\Delta R_{\text{IB,c}}$ in Table 7.3A.3.2.

The throughput of each carrier shall be $\geq 95\%$ of the maximum throughput of the reference measurement channels as specified in Annexes A.X.X (with one sided dynamic OCNG Pattern for the DL-signal as described in Annex A.X.X.X).

7.6A.4 Narrow band blocking for CA

7.6A.4.1 Narrow band blocking for Intra-band contiguous CA

Detailed structure of the subclause is TBD

7.6A.4.2 Narrow band blocking for Intra-band non-contiguous CA

Detailed structure of the subclause is TBD

7.6A.4.3 Narrow band blocking for Inter-band CA

For inter-band carrier aggregation with one component carrier per operating band and the uplink assigned to one NR band, the narrow band blocking requirements are defined with the uplink active on the band(s) other than the band whose downlink is being tested. The UE shall meet the requirements specified in subclause 7.6.4 for each component carrier while all downlink carriers are active.

For the UE which supports inter-band CA configuration in Table 7.3A.3.2, P_{UW} power defined in Table 7.6.4-1 is increased by the amount given by $\Delta R_{\text{IB,c}}$ in Table 7.3A.3.2.

The throughput of each carrier shall be $\geq 95\%$ of the maximum throughput of the reference measurement channels as specified in Annexes A.X.X (with one sided dynamic OCNG Pattern for the DL-signal as described in Annex A.X.X.X).

7.6D Blocking characteristics for UL-MIMO

For UE with two transmitter antenna connectors in closed-loop spatial multiplexing scheme, the minimum requirements specified in subclause 7.6 shall be met with the UL-MIMO configurations described in sub-clause 6.2D.1. For UL-MIMO, the parameter $P_{\text{CMAX_L}}$ is defined as the total transmitter power over the two transmit antenna connectors.

7.7 Spurious response

Spurious response is a measure of the ability of the receiver to receive a wanted signal on its assigned channel frequency without exceeding a given degradation due to the presence of an unwanted CW interfering signal at any other frequency for which a response is obtained, i.e. for which the out-of-band blocking limit as specified in subclause 7.6.3 is not met.

The throughput shall be $\geq 95\%$ of the maximum throughput of the reference measurement channels as specified in Annexes A.2.2, A.2.3 and A.3.2 (with one sided dynamic OCNG Pattern OP.1 FDD/TDD for the DL-signal as described in Annex A.5.1.1/A.5.2.1) with parameters for the wanted signal as specified in Table 7.7-1 for NR bands

with $F_{DL_high} < 2700$ MHz and $F_{UL_high} < 2700$ MHz and in Table 7.7-1a for NR bands with $F_{DL_high} \geq 3300$ MHz and $F_{UL_high} \geq 3300$ MHz and for the interferer as specified in Table 7.7-2. The said relative throughput requirement shall be met for any SCS specified for the channel bandwidth of the wanted signal. For operating bands with an unpaired DL part (as noted in Table 5.5-1), the requirements only apply for carriers assigned in the paired part.

Table 7.7-1: Spurious response parameters for NR bands with $F_{DL_high} < 2700$ MHz and $F_{UL_high} < 2700$ MHz

RX parameter	Units	Channel bandwidth				
		5 MHz	10 MHz	15 MHz	20 MHz	25 MHz
Power in transmission bandwidth configuration	dBm	REFSENS + channel specific value below				
	dB	6	6	7	9	10
RX parameter	Units	Channel bandwidth				
		30 MHz	40 MHz	50 MHz	60 MHz	80 MHz
Power in transmission bandwidth configuration	dBm	REFSENS + channel specific value below				
	dB	11	12	13	14	15
RX parameter	Units	Channel bandwidth				
		90 MHz	100 MHz			
Power in transmission bandwidth configuration	dBm	REFSENS + channel specific value below				
	dB	15.5	16			

NOTE 1: The transmitter shall be set to 4dB below

Table 7.7.1-1a: Spurious response parameters for NR bands with $F_{DL_low} \geq 3300$ MHz and $F_{UL_low} \geq 3300$ MHz

RX parameter	Units	Channel bandwidth				
		10 MHz	15 MHz	20 MHz	40 MHz	50 MHz
Power in transmission bandwidth configuration	dBm	REFSENS + channel specific value below				
	dB	6	7	9	9	9
RX parameter	Units	Channel bandwidth				
		60 MHz	80 MHz	90 MHz	100 MHz	
Power in transmission bandwidth configuration	dBm	REFSENS + channel specific value below				
	dB	9	9	9	9	

NOTE 1: The transmitter shall be set to 4dB below

Table 7.7-2: Spurious response

Parameter	Unit	Level
$P_{Interferer}$ (CW)	dBm	-44
$F_{Interferer}$	MHz	Spurious response frequencies

7.7A Spurious response for CA

7.7A.1 Spurious response for Intra-band contiguous CA

Table 7.7A-1: Spurious response parameters for intra-band contiguous CA with $F_{DL_low} \geq 3300$ MHz and $F_{UL_low} \geq 3300$ MHz

RX parameter	Units	Channel bandwidth				
		110 MHz	120 MHz	130 MHz	140 MHz	150 MHz
Power in transmission bandwidth configuration	dBm	REFSENS + channel specific value below				
	dB	9	9	9	9	9
RX parameter	Units	Channel bandwidth				
Power in transmission bandwidth configuration	dBm	160 MHz	180 MHz	200 MHz		
		REFSENS + channel specific value below	REFSENS + channel specific value below	REFSENS + channel specific value below		
	dB	9	9	9		

NOTE 1: The transmitter shall be set to 4dB below

Table 7.7A-2: Spurious response for CA

Parameter	Unit	Level
$P_{Interferer}$ (CW)	dBm	-44
$F_{Interferer}$	MHz	Spurious response frequencies

7.7A.2 Spurious response for Intra-band non-contiguous CA

Detailed structure of the subclause is TBD

7.7A.3 Spurious response for Inter-band CA

For inter-band carrier aggregation with one component carrier per operating band and the uplink assigned to one NR band, the spurious response are defined with the uplink active on the band(s) other than the band whose downlink is being tested. The UE shall meet the requirements specified in subclause 7.7 for each component carrier while all downlink carriers are active.

For the UE which supports inter-band CA configuration in Table 7.3A.3.2, $P_{interferer}$ power defined in Table 7.7-2 is increased by the amount given by $\Delta R_{IB,c}$ in Table 7.3A.3.2.

The throughput of each carrier shall be $\geq 95\%$ of the maximum throughput of the reference measurement channels as specified in Annexes A.X.X (with one sided dynamic OCNG Pattern for the DL-signal as described in Annex A.X.X.X).

7.7D Spurious response for UL-MIMO

For UE with two transmitter antenna connectors in closed-loop spatial multiplexing scheme, the minimum requirements specified in subclause 7.7 shall be met with the UL-MIMO configurations described in sub-clause 6.2D.1. For UL-MIMO, the parameter P_{CMAX_L} is defined as the total transmitter power over the two transmit antenna connectors.

7.8 Intermodulation characteristics

7.8.1 General

Intermodulation response rejection is a measure of the capability of the receiver to receive a wanted signal on its assigned channel frequency in the presence of two or more interfering signals which have a specific frequency relationship to the wanted signal

7.8.2 Wide band Intermodulation

The wide band intermodulation requirement is defined using a CW carrier and modulated NR signal as interferer 1 and interferer 2 respectively.

The throughput shall be $\geq 95\%$ of the maximum throughput of the reference measurement channels as specified in Annexes A.2.2, A.2.3 and A.3.2 (with one sided dynamic OCNG Pattern OP.1 FDD/TDD for the DL-signal as described in Annex A.5.1.1/A.5.2.1) with parameters specified in Table 7.8.2-1 for NR bands with $F_{DL_high} < 2700$ MHz and $F_{UL_high} < 2700$ MHz and Table 7.8.2-2 for NR bands with $F_{DL_low} \geq 3300$ MHz and $F_{UL_low} \geq 3300$ MHz. The said relative throughput requirement shall be met for any SCS specified for the channel bandwidth of the wanted signal. For operating bands with an unpaired DL part (as noted in Table 5.5-1), the requirements only apply for carriers assigned in the paired part.

Table 7.8.1-1: Wide band intermodulation parameters for NR bands with $F_{DL_high} < 2700$ MHz and $F_{UL_high} < 2700$ MHz

Rx parameter	Units	Channel bandwidth											
		5 MHz	10 MHz	15 MHz	20 MHz	25 MHz	30 MHz	40 MHz	50 MHz	60 MHz	80 MHz	90 MHz	100 MHz
P_w in Transmission Bandwidth Configuration, per CC	dBm	REFSENS + channel bandwidth specific value below											
		6	6	7	9	10	11	12	13	14	15	15	16
$P_{Interferer\ 1}$ (CW)	dBm	-46											
$P_{Interferer\ 2}$ (Modulated)	dBm	-46											
$BW_{Interferer\ 2}$	MHz	5											
$F_{Interferer\ 1}$ (Offset)	MHz	-BW/2 – 7.5 / +BW/2 + 7.5											
$F_{Interferer\ 2}$ (Offset)	MHz	$2 * F_{Interferer\ 1}$											
NOTE 1: The transmitter shall be set to 4dB below $P_{CMAX_L,c}$ or P_{CMAX_L} as defined in TBD.													
NOTE 2: Reference measurement channel is TBD.													
NOTE 3: The modulated interferer consists of the Reference measurement channel specified in TBD.													
NOTE 4: The $F_{interferer\ 1}$ (offset) is the frequency separation of the center frequency of the carrier closest to the interferer and the center frequency of the CW interferer and $F_{interferer\ 2}$ (offset) is the frequency separation of the center frequency of the carrier closest to the interferer and the center frequency of the modulated interferer.													

Table 7.8.2-2: Wide band intermodulation parameters for NR bands with $F_{DL_low} \geq 3300$ MHz and $F_{UL_low} \geq 3300$ MHz

Rx parameter	Units	Channel bandwidth								
		10 MHz	20 MHz	40 MHz	50 MHz	60 MHz	80 MHz	90 MHz	100 MHz	
P_w in Transmission Bandwidth Configuration, per CC	dBm									REFSENS + 6
$P_{Interferer\ 1}$ (CW)	dBm									-46
$P_{Interferer\ 2}$ (Modulated)	dBm									-46
$BW_{Interferer\ 2}$	MHz									BW
$F_{Interferer\ 1}$ (Offset)	MHz									-2BW / +2BW
$F_{Interferer\ 2}$ (Offset)	MHz									$2 * F_{Interferer\ 1}$
<p>NOTE 1: The transmitter shall be set to 4dB below $P_{CMAX_L,C}$ or P_{CMAX_L} as defined in TBD.</p> <p>NOTE 2: Reference measurement channel is TBD.</p> <p>NOTE 3: The modulated interferer consists of the Reference measurement channel specified in TBD.</p> <p>NOTE 4: The $F_{interferer\ 1}$ (offset) is the frequency separation of the center frequency of the carrier closest to the interferer and the center frequency of the CW interferer and $F_{interferer\ 2}$ (offset) is the frequency separation of the center frequency of the carrier closest to the interferer and the center frequency of the modulated interferer.</p>										

7.8A Intermodulation characteristics for CA

7.8A.1 General

7.8A.2 Wide band intermodulation for CA

7.8A.2.1 Wide band intermodulation for Intra-band contiguous CA

Table 7.8A.2.1-1: Wide band intermodulation parameters for intra-band contiguous CA with $F_{DL_low} \geq 3300$ MHz and $F_{UL_low} \geq 3300$ MHz

Rx parameter	Units	Channel bandwidth									
		110 MHz	120 MHz	130 MHz	140 MHz	150 MHz	160 MHz	180 MHz		200 MHz	
$P_{w \text{ in Transmission Bandwidth Configuration, per CC}}$	dBm										REFSENS + 6
$P_{\text{Interferer 1 (CW)}}$	dBm										-46
$P_{\text{Interferer 2 (Modulated)}}$	dBm										-46
$BW_{\text{Interferer 2}}$	MHz										BW
$F_{\text{Interferer 1 (Offset)}}$	MHz										-2BW / +2BW
$F_{\text{Interferer 2 (Offset)}}$	MHz										$2 * F_{\text{Interferer 1}}$
NOTE 1: The transmitter shall be set to 4dB below $P_{\text{CMAX_L,c}}$ or $P_{\text{CMAX_L}}$ as defined in TBD. NOTE 2: Reference measurement channel is TBD. NOTE 3: The modulated interferer consists of the Reference measurement channel specified in TBD. NOTE 4: The $F_{\text{interferer 1}}$ (offset) is the frequency separation of the center frequency of the carrier closest to the interferer and the center frequency of the CW interferer and $F_{\text{interferer 2}}$ (offset) is the frequency separation of the center frequency of the carrier closest to the interferer and the center frequency of the modulated interferer.											

7.8A.2.2 Wide band intermodulation for Intra-band non-contiguous CA

Detailed structure of the subclause is TBD

7.8A.2.3 Wide band intermodulation for Inter-band CA

For inter-band carrier aggregation with one component carrier per operating band and the uplink assigned to one NR band, the wide band intermodulation requirements are defined with the uplink active on the band(s) other than the band whose downlink is being tested. The UE shall meet the requirements specified in subclause 7.8 for each component carrier while all downlink carriers are active.

For the UE which supports inter-band CA configuration in Table 7.3A.3.2, $P_{\text{interferer}}$ power defined in Table 7.8.2-1 and 7.8.2-2 is increased by the amount given by $\Delta R_{\text{IB,c}}$ in Table 7.3A.3.2.

The throughput of each carrier shall be $\geq 95\%$ of the maximum throughput of the reference measurement channels as specified in Annexes A.X.X (with one sided dynamic OCNG Pattern for the DL-signal as described in Annex A.X.X.X).

7.8D Intermodulation characteristics for UL-MIMO

For UE(s) with two transmitter antenna connectors in closed-loop spatial multiplexing scheme, the minimum requirements in subclause 7.8 shall be met with the UL-MIMO configurations described in sub-clause 6.2D.1. For UL-MIMO, the parameter $P_{\text{CMAX_L}}$ is defined as the total transmitter power over the two transmit antenna connectors.

7.9 Spurious emissions

The spurious emissions power is the power of emissions generated or amplified in a receiver that appear at the UE antenna connector.

The power of any narrow band CW spurious emission shall not exceed the maximum level specified in Table 7.9-1

Table 7.9-1: General receiver spurious emission requirements

Frequency range	Measurement bandwidth	Maximum level	NOTE
$30 \text{ MHz} \leq f < 1 \text{ GHz}$	100 kHz	-57 dBm	
$1 \text{ GHz} \leq f \leq 12.75 \text{ GHz}$	1 MHz	-47 dBm	
$12.75 \text{ GHz} \leq f \leq 5^{\text{th}}$ harmonic of the upper frequency edge of the DL operating band in GHz	1 MHz	-47 dBm	2
12.75 GHz – 26 GHz	1 MHz	-47dBm	3
NOTE 1: Unused PDCCH resources are padded with resource element groups with power level given by PDCCH_RA/RB as defined in Annex C.3.1.			
NOTE 2: Applies for Band that the upper frequency edge of the DL Band more than 2.69 GHz.			
NOTE 3: Applies for Band that the upper frequency edge of the DL Band more than 5.2 GHz.			

7.9A Spurious emissions for CA

7.9A.1 Spurious emissions for Intra-band contiguous CA

Table 7.9A-1: General receiver spurious emission requirements for CA

Frequency range	Measurement bandwidth	Maximum level	NOTE
$30 \text{ MHz} \leq f < 1 \text{ GHz}$	100 kHz	-57 dBm	
$1 \text{ GHz} \leq f \leq 12.75 \text{ GHz}$	1 MHz	-47 dBm	
$12.75 \text{ GHz} \leq f \leq 5^{\text{th}}$ harmonic of the upper frequency edge of the DL operating band in GHz	1 MHz	-47 dBm	2
12.75 GHz – 26 GHz	1 MHz	-47dBm	3
NOTE 1: Unused PDCCH resources are padded with resource element groups with power level given by PDCCH_RA/RB as defined in Annex C.3.1.			
NOTE 2: Applies for Band that the upper frequency edge of the DL Band more than 2.69 GHz.			
NOTE 3: Applies for Band that the upper frequency edge of the DL Band more than 5.2 GHz.			

7.9A.2 Spurious emissions for Intra-band non-contiguous CA

Detailed structure of the subclause is TBD

7.9A.3 Spurious emissions for Inter-band CA

For inter-band carrier aggregation with one component carrier per operating band and the uplink assigned to one NR band, the UE shall meet the Rx spurious emissions requirements specified in subclause 7.9 for each component carrier while all downlink carriers are active.

Annex A (normative): Measurement channels

A.1 General

The throughput values defined in the measurement channels specified in Annex A, are calculated and are valid per datastream (codeword). For multi-stream (more than one codeword) transmissions, the throughput referenced in the minimum requirements is the sum of throughputs of all datastreams (codewords).

The UE category entry in the definition of the reference measurement channel in Annex A is only informative and reveals the UE categories, which can support the corresponding measurement channel. Whether the measurement channel is used for testing a certain UE category or not is specified in the individual minimum requirements.

A.2 UL reference measurement channels

A.2.1 General

The measurement channels in the following subclauses are defined to derive the requirements in clause 6 (Transmitter Characteristics) and clause 7 (Receiver Characteristics). The measurement channels represent example configurations of physical channels for different data rates.

A.2.2 Reference measurement channels for FDD

A.2.2.1 DFT-s-OFDM Pi/2-BPSK

Table A.2.2.1-1: Reference Channels for DFT-s-OFDM Pi/2-BPSK for 15kHz SCS

Parameter	Channel bandwidth	Subcarrier Spacing	Allocated resource blocks	DFT-s-OFDM Symbols per slot (Note 1)	Modulation	MCS Index (Note 2)	Target Coding Rate	Payload size	Transport block CRC	LDPC Base Graph	Number of code blocks per slot (Note 3)	Total number of bits per slot	Total modulated symbols per slot
Unit	MHz	KHz						Bits	Bits			Bits	
	5-50	15	1	11	pi/2 BPSK	0	1/4	32	16	2	1	132	132
	5	15	12	11	pi/2 BPSK	0	1/4	384	16	2	1	1584	1584
	5	15	25	11	pi/2 BPSK	0	1/4	808	16	2	1	3300	3300
	10	15	25	11	pi/2 BPSK	0	1/4	808	16	2	1	3300	3300
	10	15	50	11	pi/2 BPSK	0	1/4	1544	16	2	1	6600	6600
	15	15	36	11	pi/2 BPSK	0	1/4	1128	16	2	1	4752	4752
	15	15	75	11	pi/2 BPSK	0	1/4	2408	16	2	1	9900	9900
	20	15	50	11	pi/2 BPSK	0	1/4	1544	16	2	1	6600	6600
	20	15	100	11	pi/2 BPSK	0	1/4	3104	16	2	1	13200	13200
	25	15	64	11	pi/2 BPSK	0	1/4	2024	16	2	1	8448	8448
	25	15	128	11	pi/2 BPSK	0	1/4	3976	24	2	2	16896	16896
	30	15	80	11	pi/2 BPSK	0	1/4	2472	16	2	1	10560	10560
	30	15	160	11	pi/2 BPSK	0	1/4	4872	24	2	2	21120	21120
	40	15	108	11	pi/2 BPSK	0	1/4	3368	16	2	1	14256	14256
	40	15	216	11	pi/2 BPSK	0	1/4	6664	24	2	2	28512	28512
	50	15	135	11	pi/2 BPSK	0	1/4	4104	24	2	2	17820	17820
	50	15	270	11	pi/2 BPSK	0	1/4	8448	24	2	3	35640	35640

NOTE 1: PUSCH mapping Type-A and single-symbol DM-RS configuration Type-1 with 2 additional DM-RS symbols, such that the DM-RS positions are set to symbols 2, 7, 11. DMRS is [TDM'ed] with PUSCH data.

NOTE 2: MCS Index is based on MCS table 6.1.4.1-1 defined in 38.214.

NOTE 3: If more than one Code Block is present, an additional CRC sequence of L = 24 Bits is attached to each Code Block (otherwise L = 0 Bit)

Table A.2.2.1-2: Reference Channels for DFT-s-OFDM Pi/2-BPSK for 30kHz SCS

Parameter	Channel bandwidth	Subcarrier Spacing	Allocated resource blocks	DFT-s-OFDM Symbols per slot (Note 1)	Modulation	MCS Index (Note 2)	Target Coding Rate	Payload size	Transport block CRC	LDPC Base Graph	Number of code blocks per slot (Note 3)	Total number of bits per slot	Total modulated symbols per slot
Unit	MHz	KHz						Bits	Bits			Bits	
	5-50	30	1	11	pi/2 BPSK	0	1/4	32	16	2	1	132	132
	5	30	5	11	pi/2 BPSK	0	1/4	160	16	2	1	660	660
	5	30	10	11	pi/2 BPSK	0	1/4	320	16	2	1	1320	1320
	10	30	12	11	pi/2 BPSK	0	1/4	384	16	2	1	1584	1584
	10	30	24	11	pi/2 BPSK	0	1/4	768	16	2	1	3168	3168
	15	30	18	11	pi/2 BPSK	0	1/4	576	16	2	1	2376	2376
	15	30	36	11	pi/2 BPSK	0	1/4	1128	16	2	1	4752	4752
	20	30	25	11	pi/2 BPSK	0	1/4	808	16	2	1	3300	3300
	20	30	50	11	pi/2 BPSK	0	1/4	1544	16	2	1	6600	6600
	25	30	32	11	pi/2 BPSK	0	1/4	1032	16	2	1	4224	4224
	25	30	64	11	pi/2 BPSK	0	1/4	2024	16	2	1	8448	8448
	30	30	36	11	pi/2 BPSK	0	1/4	1128	16	2	1	4752	4752
	30	30	75	11	pi/2 BPSK	0	1/4	2408	16	2	1	9900	9900
	40	30	50	11	pi/2 BPSK	0	1/4	1544	16	2	1	6600	6600
	40	30	100	11	pi/2 BPSK	0	1/4	3104	16	2	1	13200	13200
	50	30	64	11	pi/2 BPSK	0	1/4	2024	16	2	1	8448	8448
	50	30	128	11	pi/2 BPSK	0	1/4	3976	24	2	2	16896	16896
	60	30	81	11	pi/2 BPSK	0	1/4	2536	16	2	1	10692	10692
	60	30	162	11	pi/2 BPSK	0	1/4	5000	24	2	2	21384	21384
	80	30	108	11	pi/2 BPSK	0	1/4	3368	16	2	1	14256	14256
	80	30	216	11	pi/2 BPSK	0	1/4	6664	24	2	2	28512	28512
	90	30	120	11	pi/2 BPSK	0	1/4	3752	16	2	1	15840	15840
	90	30	243	11	pi/2 BPSK	0	1/4	7560	24	2	2	32076	32076
	100	30	135	11	pi/2 BPSK	0	1/4	4104	24	2	2	17820	17820
	100	30	270	11	pi/2 BPSK	0	1/4	8448	24	2	3	35640	35640

NOTE 1: PUSCH mapping Type-A and single-symbol DM-RS configuration Type-1 with 2 additional DM-RS symbols, such that the DM-RS positions are set to symbols 2, 7, 11. DMRS is [TDM'ed] with PUSCH data.

NOTE 2: MCS Index is based on MCS table 6.1.4.1-1 defined in 38.214.

NOTE 3: If more than one Code Block is present, an additional CRC sequence of L = 24 Bits is attached to each Code Block (otherwise L = 0 Bit)

Table A.2.2.1-3: Reference Channels for DFT-s-OFDM Pi/2-BPSK for 60kHz SCS

Parameter	Channel bandwidth	Subcarrier Spacing	Allocated resource blocks	DFT-s-OFDM Symbols per slot (Note 1)	Modulation	MCS Index (Note 2)	Target Coding Rate	Payload size	Transport block CRC	LDPC Base Graph	Number of code blocks per slot (Note 3)	Total number of bits per slot	Total modulated symbols per slot
Unit	MHz	KHz						Bits	Bits			Bits	
	10-100	60	1	11	pi/2 BPSK	0	1/4	32	16	2	1	132	132
	10	60	5	11	pi/2 BPSK	0	1/4	160	16	2	1	660	660
	10	60	10	11	pi/2 BPSK	0	1/4	320	16	2	1	1320	1320
	15	60	9	11	pi/2 BPSK	0	1/4	288	16	2	1	1188	1188
	15	60	18	11	pi/2 BPSK	0	1/4	576	16	2	1	2376	2376
	20	60	12	11	pi/2 BPSK	0	1/4	384	16	2	1	1584	1584
	20	60	24	11	pi/2 BPSK	0	1/4	768	16	2	1	3168	3168
	25	60	15	11	pi/2 BPSK	0	1/4	480	16	2	1	1980	1980
	25	60	30	11	pi/2 BPSK	0	1/4	984	16	2	1	3960	3960
	30	60	18	11	pi/2 BPSK	0	1/4	576	16	2	1	2376	2376
	30	60	36	11	pi/2 BPSK	0	1/4	1128	16	2	1	4752	4752
	40	60	25	11	pi/2 BPSK	0	1/4	808	16	2	1	3300	3300
	40	60	50	11	pi/2 BPSK	0	1/4	1544	16	2	1	6600	6600
	50	60	32	11	pi/2 BPSK	0	1/4	1032	16	2	1	4224	4224
	50	60	64	11	pi/2 BPSK	0	1/4	2024	16	2	1	8448	8448
	60	60	36	11	pi/2 BPSK	0	1/4	1128	16	2	1	4752	4752
	60	60	75	11	pi/2 BPSK	0	1/4	2408	16	2	1	9900	9900
	80	60	50	11	pi/2 BPSK	0	1/4	1544	16	2	1	6600	6600
	80	60	100	11	pi/2 BPSK	0	1/4	3104	16	2	1	13200	13200
	90	60	60	11	pi/2 BPSK	0	1/4	1864	16	2	1	7920	7920
	90	60	120	11	pi/2 BPSK	0	1/4	3752	16	2	1	15840	15840
	100	60	64	11	pi/2 BPSK	0	1/4	2024	16	2	1	8448	8448
	100	60	135	11	pi/2 BPSK	0	1/4	4104	24	2	2	17820	17820

NOTE 1: PUSCH mapping Type-A and single-symbol DM-RS configuration Type-1 with 2 additional DM-RS symbols, such that the DM-RS positions are set to symbols 2, 7, 11. DMRS is [TDM'ed] with PUSCH data.

NOTE 2: MCS Index is based on MCS table 6.1.4.1-1 defined in 38.214.

NOTE 3: If more than one Code Block is present, an additional CRC sequence of L = 24 Bits is attached to each Code Block (otherwise L = 0 Bit)

A.2.2.2 DFT-s-OFDM QPSK

Table A.2.2.2-1: Reference Channels for DFT-s-OFDM QPSK for 15kHz SCS

Parameter	Channel bandwidth	Subcarrier Spacing	Allocated resource blocks	DFT-s-OFDM Symbols per slot (Note 1)	Modulation	MCS Index (Note 2)	Target Coding Rate	Payload size	Transport block CRC	LDPC Base Graph	Number of code blocks per slot (Note 3)	Total number of bits per slot	Total modulated symbols per slot
Unit	MHz	KHz						Bits	Bits			Bits	
	5-50	15	1	11	QPSK	2	1/6	56	16	2	1	264	132
	5	15	12	11	QPSK	2	1/6	608	16	2	1	3168	1584
	5	15	20	11	QPSK	2	1/6	1032	16	2	1	5280	2640
	5	15	25	11	QPSK	2	1/6	1256	16	2	1	6600	3300
	10	15	20	11	QPSK	2	1/6	1032	16	2	1	5280	2640
	10	15	25	11	QPSK	2	1/6	1256	16	2	1	6600	3300
	10	15	50	11	QPSK	2	1/6	2472	16	2	1	13200	6600
	15	15	20	11	QPSK	2	1/6	1032	16	2	1	5280	2640
	15	15	25	11	QPSK	2	1/6	1256	16	2	1	6600	3300
	15	15	36	11	QPSK	2	1/6	1800	16	2	1	9504	4752
	15	15	50	11	QPSK	2	1/6	2472	16	2	1	13200	6600
	15	15	75	11	QPSK	2	1/6	3752	16	2	1	19800	9900
	20	15	20	11	QPSK	2	1/6	1032	16	2	1	5280	2640
	20	15	25	11	QPSK	2	1/6	1256	16	2	1	6600	3300
	20	15	50	11	QPSK	2	1/6	2472	16	2	1	13200	6600
	20	15	100	11	QPSK	2	1/6	5000	24	2	2	26400	13200
	25	15	50	11	QPSK	2	1/6	2472	16	2	1	13200	6600
	25	15	64	11	QPSK	2	1/6	3240	16	2	1	16896	8448
	25	15	128	11	QPSK	2	1/6	6408	24	2	2	33792	16896
	30	15	50	11	QPSK	2	1/6	2472	16	2	1	13200	6600
	30	15	80	11	QPSK	2	1/6	3976	24	2	2	21120	10560
	30	15	160	11	QPSK	2	1/6	7944	24	2	3	42240	21120
	40	15	108	11	QPSK	2	1/6	5384	24	2	2	28512	14256
	40	15	216	11	QPSK	2	1/6	10752	24	2	3	57024	28512
	50	15	135	11	QPSK	2	1/6	6664	24	2	2	35640	17820
	50	15	270	11	QPSK	2	1/6	13320	24	2	4	71280	35640

NOTE 1: PUSCH mapping Type-A and single-symbol DM-RS configuration Type-1 with 2 additional DM-RS symbols, such that the DM-RS positions are set to symbols 2, 7, 11. DMRS is [TDM'ed] with PUSCH data.

NOTE 2: MCS Index is based on MCS table 6.1.4.1-1 defined in 38.214.

NOTE 3: If more than one Code Block is present, an additional CRC sequence of L = 24 Bits is attached to each Code Block (otherwise L = 0 Bit)

Table A.2.2-2: Reference Channels for DFT-s-OFDM QPSK for 30kHz SCS

Parameter	Channel bandwidth	Subcarrier Spacing	Allocated resource blocks	DFT-s-OFDM Symbols per slot (Note 1)	Modulation	MCS Index (Note 2)	Target Coding Rate	Payload size	Transport block CRC	LDPC Base Graph	Number of code blocks per slot (Note 3)	Total number of bits per slot	Total modulated symbols per slot
Unit	MHz	KHz						Bits	Bits			Bits	
	5-50	30	1	11	QPSK	2	1/6	56	16	2	1	264	132
	5	30	5	11	QPSK	2	1/6	256	16	2	1	1320	660
	5	30	10	11	QPSK	2	1/6	504	16	2	1	2640	1320
	10	30	12	11	QPSK	2	1/6	608	16	2	1	3168	1584
	10	30	24	11	QPSK	2	1/6	1192	16	2	1	6336	3168
	15	30	18	11	QPSK	2	1/6	928	16	2	1	4752	2376
	15	30	36	11	QPSK	2	1/6	1800	16	2	1	9504	4752
	20	30	25	11	QPSK	2	1/6	1256	16	2	1	6600	3300
	20	30	50	11	QPSK	2	1/6	2472	16	2	1	13200	6600
	25	30	32	11	QPSK	2	1/6	1608	16	2	1	8448	4224
	25	30	64	11	QPSK	2	1/6	3240	16	2	1	16896	8448
	30	30	36	11	QPSK	2	1/6	1800	16	2	1	9504	4752
	30	30	75	11	QPSK	2	1/6	3752	16	2	1	19800	9900
	40	30	50	11	QPSK	2	1/6	2472	16	2	1	13200	6600
	40	30	100	11	QPSK	2	1/6	5000	24	2	2	26400	13200
	50	30	64	11	QPSK	2	1/6	3240	16	2	1	16896	8448
	50	30	128	11	QPSK	2	1/6	6408	24	2	2	33792	16896
	60	30	81	11	QPSK	2	1/6	4040	24	2	2	21384	10692
	60	30	162	11	QPSK	2	1/6	8064	24	2	3	42768	21384
	80	30	108	11	QPSK	2	1/6	5384	24	2	2	28512	14256
	80	30	216	11	QPSK	2	1/6	10752	24	2	3	57024	28512
	90	30	120	11	QPSK	2	1/6	5896	24	2	2	31680	15840
	90	30	243	11	QPSK	2	1/6	12040	24	2	4	64152	32076
	100	30	135	11	QPSK	2	1/6	6664	24	2	2	35640	17820
	100	30	270	11	QPSK	2	1/6	13320	24	2	4	71280	35640

NOTE 1: PUSCH mapping Type-A and single-symbol DM-RS configuration Type-1 with 2 additional DM-RS symbols, such that the DM-RS positions are set to symbols 2, 7, 11. DMRS is [TDM'ed] with PUSCH data.

NOTE 2: MCS Index is based on MCS table 6.1.4.1-1 defined in 38.214.

NOTE 3: If more than one Code Block is present, an additional CRC sequence of L = 24 Bits is attached to each Code Block (otherwise L = 0 Bit)

Table A.2.2-3: Reference Channels for DFT-s-OFDM QPSK for 60kHz SCS

Parameter	Channel bandwidth	Subcarrier Spacing	Allocated resource blocks	DFT-s-OFDM Symbols per slot (Note 1)	Modulation	MCS Index (Note 2)	Target Coding Rate	Payload size	Transport block CRC	LDPC Base Graph	Number of code blocks per slot (Note 3)	Total number of bits per slot	Total modulated symbols per slot
Unit	MHz	KHz						Bits	Bits			Bits	
	10-100	60	1	11	QPSK	2	1/6	56	16	2	1	264	132
	10	60	5	11	QPSK	2	1/6	256	16	2	1	1320	660
	10	60	10	11	QPSK	2	1/6	504	16	2	1	2640	1320
	15	60	9	11	QPSK	2	1/6	456	16	2	1	2376	1188
	15	60	18	11	QPSK	2	1/6	928	16	2	1	4752	2376
	20	60	12	11	QPSK	2	1/6	608	16	2	1	3168	1584
	20	60	24	11	QPSK	2	1/6	1192	16	2	1	6336	3168
	25	60	15	11	QPSK	2	1/6	768	16	2	1	3960	1980
	25	60	30	11	QPSK	2	1/6	1544	16	2	1	7920	3960
	30	60	18	11	QPSK	2	1/6	928	16	2	1	4752	2376
	30	60	36	11	QPSK	2	1/6	1800	16	2	1	9504	4752
	40	60	25	11	QPSK	2	1/6	1256	16	2	1	6600	3300
	40	60	50	11	QPSK	2	1/6	2472	16	2	1	13200	6600
	50	60	32	11	QPSK	2	1/6	1608	16	2	1	8448	4224
	50	60	64	11	QPSK	2	1/6	3240	16	2	1	16896	8448
	60	60	36	11	QPSK	2	1/6	1800	16	2	1	9504	4752
	60	60	75	11	QPSK	2	1/6	3752	16	2	1	19800	9900
	80	60	50	11	QPSK	2	1/6	2472	16	2	1	13200	6600
	80	60	100	11	QPSK	2	1/6	5000	24	2	2	26400	13200
	90	60	60	11	QPSK	2	1/6	3104	16	2	1	15840	7920
	90	60	120	11	QPSK	2	1/6	5896	24	2	2	31680	15840
	100	60	64	11	QPSK	2	1/6	3240	16	2	1	16896	8448
	100	60	135	11	QPSK	2	1/6	6664	24	2	2	35640	17820

NOTE 1: PUSCH mapping Type-A and single-symbol DM-RS configuration Type-1 with 2 additional DM-RS symbols, such that the DM-RS positions are set to symbols 2, 7, 11. DMRS is [TDM'ed] with PUSCH data.

NOTE 2: MCS Index is based on MCS table 6.1.4.1-1 defined in 38.214.

NOTE 3: If more than one Code Block is present, an additional CRC sequence of L = 24 Bits is attached to each Code Block (otherwise L = 0 Bit)

A.2.2.3 DFT-s-OFDM 16QAM

Table A.2.2.3-1: Reference Channels for DFT-s-OFDM 16QAM for 15kHz SCS

Parameter	Channel bandwidth	Subcarrier Spacing	Allocated resource blocks	DFT-s-OFDM Symbols per slot (Note 1)	Modulation	MCS Index (Note 2)	Target Coding Rate	Payload size	Transport block CRC	LDPC Base Graph	Number of code blocks per slot (Note 3)	Total number of bits per slot	Total modulated symbols per slot
Unit	MHz	KHz						Bits	Bits			Bits	
	5-50	15	1	11	16QAM	10	1/3	176	16	2	1	528	132
	5	15	12	11	16QAM	10	1/3	2088	16	2	1	6336	1584
	5	15	25	11	16QAM	10	1/3	4352	24	1	1	13200	3300
	10	15	25	11	16QAM	10	1/3	4352	24	1	1	13200	3300
	10	15	50	11	16QAM	10	1/3	8712	24	1	2	26400	6600
	15	15	36	11	16QAM	10	1/3	6272	24	1	1	19008	4752
	15	15	75	11	16QAM	10	1/3	13064	24	1	2	39600	9900
	20	15	50	11	16QAM	10	1/3	8712	24	1	2	26400	6600
	20	15	100	11	16QAM	10	1/3	17424	24	1	3	52800	13200
	25	15	64	11	16QAM	10	1/3	11272	24	1	2	33792	8448
	25	15	128	11	16QAM	10	1/3	22536	24	1	3	67584	16896
	30	15	80	11	16QAM	10	1/3	14088	24	1	2	42240	10560
	30	15	160	11	16QAM	10	1/3	28168	24	1	4	84480	21120
	40	15	108	11	16QAM	10	1/3	18960	24	1	3	57024	14256
	40	15	216	11	16QAM	10	1/3	37896	24	1	5	114048	28512
	50	15	135	11	16QAM	10	1/3	23568	24	1	3	71280	17820
	50	15	270	11	16QAM	10	1/3	47112	24	1	6	142560	35640

NOTE 1: PUSCH mapping Type-A and single-symbol DM-RS configuration Type-1 with 2 additional DM-RS symbols, such that the DM-RS positions are set to symbols 2, 7, 11. DMRS is [TDM'ed] with PUSCH data.

NOTE 2: MCS Index is based on MCS table 6.1.4.1-1 defined in 38.214.

NOTE 3: If more than one Code Block is present, an additional CRC sequence of L = 24 Bits is attached to each Code Block (otherwise L = 0 Bit)

Table A.2.2.3-2: Reference Channels for DFT-s-OFDM 16QAM for 30kHz SCS

Parameter	Channel bandwidth	Subcarrier Spacing	Allocated resource blocks	DFT-s-OFDM Symbols per slot (Note 1)	Modulation	MCS Index (Note 2)	Target Coding Rate	Payload size	Transport block CRC	LDPC Base Graph	Number of code blocks per slot (Note 3)	Total number of bits per slot	Total modulated symbols per slot
Unit	MHz	KHz						Bits	Bits			Bits	
	5-50	30	1	11	16QAM	10	1/3	176	16	2	1	528	132
	5	30	5	11	16QAM	10	1/3	888	16	2	1	2640	660
	5	30	10	11	16QAM	10	1/3	1800	16	2	1	5280	1320
	10	30	12	11	16QAM	10	1/3	2088	16	2	1	6336	1584
	10	30	24	11	16QAM	10	1/3	4224	24	1	1	12672	3168
	15	30	18	11	16QAM	10	1/3	3240	16	2	1	9504	2376
	15	30	36	11	16QAM	10	1/3	6272	24	1	1	19008	4752
	20	30	25	11	16QAM	10	1/3	4352	24	1	1	13200	3300
	20	30	50	11	16QAM	10	1/3	8712	24	1	2	26400	6600
	25	30	32	11	16QAM	10	1/3	5632	24	1	1	16896	4224
	25	30	64	11	16QAM	10	1/3	11272	24	1	2	33792	8448
	30	30	36	11	16QAM	10	1/3	6272	24	1	1	19008	4752
	30	30	75	11	16QAM	10	1/3	13064	24	1	2	39600	9900
	40	30	50	11	16QAM	10	1/3	8712	24	1	2	26400	6600
	40	30	100	11	16QAM	10	1/3	17424	24	1	3	52800	13200
	50	30	64	11	16QAM	10	1/3	11272	24	1	2	33792	8448
	50	30	128	11	16QAM	10	1/3	22536	24	1	3	67584	16896
	60	30	81	11	16QAM	10	1/3	14088	24	1	2	42768	10692
	60	30	162	11	16QAM	10	1/3	28168	24	1	4	85536	21384
	80	30	108	11	16QAM	10	1/3	18960	24	1	3	57024	14256
	80	30	216	11	16QAM	10	1/3	37896	24	1	5	114048	28512
	90	30	120	11	16QAM	10	1/3	21000	24	1	3	63360	15840
	90	30	243	11	16QAM	10	1/3	43032	24	1	6	128304	32076
	100	30	135	11	16QAM	10	1/3	23568	24	1	3	71280	17820
	100	30	270	11	16QAM	10	1/3	47112	24	1	6	142560	35640

NOTE 1: PUSCH mapping Type-A and single-symbol DM-RS configuration Type-1 with 2 additional DM-RS symbols, such that the DM-RS positions are set to symbols 2, 7, 11. DMRS is [TDM'ed] with PUSCH data.

NOTE 2: MCS Index is based on MCS table 6.1.4.1-1 defined in 38.214.

NOTE 3: If more than one Code Block is present, an additional CRC sequence of L = 24 Bits is attached to each Code Block (otherwise L = 0 Bit)

Table A.2.2.3-3: Reference Channels for DFT-s-OFDM 16QAM for 60kHz SCS

Parameter	Channel bandwidth	Subcarrier Spacing	Allocated resource blocks	DFT-s-OFDM Symbols per slot (Note 1)	Modulation	MCS Index (Note 2)	Target Coding Rate	Payload size	Transport block CRC	LDPC Base Graph	Number of code blocks per slot (Note 3)	Total number of bits per slot	Total modulated symbols per slot
Unit	MHz	KHz						Bits	Bits			Bits	
	10-100	60	1	11	16QAM	10	1/3	176	16	2	1	528	132
	10	60	5	11	16QAM	10	1/3	888	16	2	1	2640	660
	10	60	10	11	16QAM	10	1/3	1800	16	2	1	5280	1320
	15	60	9	11	16QAM	10	1/3	1608	16	2	1	4752	1188
	15	60	18	11	16QAM	10	1/3	3240	16	2	1	9504	2376
	20	60	12	11	16QAM	10	1/3	2088	16	2	1	6336	1584
	20	60	24	11	16QAM	10	1/3	4224	24	1	1	12672	3168
	25	60	15	11	16QAM	10	1/3	2664	16	2	1	7920	1980
	25	60	30	11	16QAM	10	1/3	5248	24	1	1	15840	3960
	30	60	18	11	16QAM	10	1/3	3240	16	2	1	9504	2376
	30	60	36	11	16QAM	10	1/3	6272	24	1	1	19008	4752
	40	60	25	11	16QAM	10	1/3	4352	24	1	1	13200	3300
	40	60	50	11	16QAM	10	1/3	8712	24	1	2	26400	6600
	50	60	32	11	16QAM	10	1/3	5632	24	1	1	16896	4224
	50	60	64	11	16QAM	10	1/3	11272	24	1	2	33792	8448
	60	60	36	11	16QAM	10	1/3	6272	24	1	1	19008	4752
	60	60	75	11	16QAM	10	1/3	13064	24	1	2	39600	9900
	80	60	50	11	16QAM	10	1/3	8712	24	1	2	26400	6600
	80	60	100	11	16QAM	10	1/3	17424	24	1	3	52800	13200
	90	60	60	11	16QAM	10	1/3	10504	24	1	2	31680	7920
	90	60	120	11	16QAM	10	1/3	21000	24	1	3	63360	15840
	100	60	64	11	16QAM	10	1/3	11272	24	1	2	33792	8448
	100	60	135	11	16QAM	10	1/3	23568	24	1	3	71280	17820

NOTE 1: PUSCH mapping Type-A and single-symbol DM-RS configuration Type-1 with 2 additional DM-RS symbols, such that the DM-RS positions are set to symbols 2, 7, 11. DMRS is [TDM'ed] with PUSCH data.

NOTE 2: MCS Index is based on MCS table 6.1.4.1-1 defined in 38.214.

NOTE 3: If more than one Code Block is present, an additional CRC sequence of L = 24 Bits is attached to each Code Block (otherwise L = 0 Bit)

A.2.2.4 DFT-s-OFDM 64QAM

Table A.2.2.4-1: Reference Channels for DFT-s-OFDM 64QAM for 15kHz SCS

Parameter	Channel bandwidth	Subcarrier Spacing	Allocated resource blocks	DFT-s-OFDM Symbols per slot (Note 1)	Modulation	MCS Index (Note 2)	Target Coding Rate	Payload size	Transport block CRC	LDPC Base Graph	Number of code blocks per slot (Note 3)	Total number of bits per slot	Total modulated symbols per slot
Unit	MHz	KHz						Bits	Bits			Bits	
	5	15	25	11	64QAM	18	1/2	9992	24	1	2	19800	3300
	10	15	50	11	64QAM	18	1/2	19968	24	1	3	39600	6600
	15	15	75	11	64QAM	18	1/2	30216	24	1	4	59400	9900
	20	15	100	11	64QAM	18	1/2	39936	24	1	5	79200	13200
	25	15	128	11	64QAM	18	1/2	51216	24	1	7	101376	16896
	30	15	160	11	64QAM	18	1/2	63528	24	1	8	126720	21120
	40	15	216	11	64QAM	18	1/2	86040	24	1	11	171072	28512
	50	15	270	11	64QAM	18	1/2	108552	24	1	13	213840	35640

NOTE 1: PUSCH mapping Type-A and single-symbol DM-RS configuration Type-1 with 2 additional DM-RS symbols, such that the DM-RS positions are set to symbols 2, 7, 11. DMRS is [TDM'ed] with PUSCH data.

NOTE 2: MCS Index is based on MCS table 6.1.4.1-1 defined in 38.214.

NOTE 3: If more than one Code Block is present, an additional CRC sequence of L = 24 Bits is attached to each Code Block (otherwise L = 0 Bit)

Table A.2.2.4-2: Reference Channels for DFT-s-OFDM 64QAM for 30kHz SCS

Parameter	Channel bandwidth	Subcarrier Spacing	Allocated resource blocks	DFT-s-OFDM Symbols per slot (Note 1)	Modulation	MCS Index (Note 2)	Target Coding Rate	Payload size	Transport block CRC	LDPC Base Graph	Number of code blocks per slot (Note 3)	Total number of bits per slot	Total modulated symbols per slot
Unit	MHz	KHz						Bits	Bits			Bits	
	5	30	10	11	64QAM	18	1/2	3968	24	1	1	7920	1320
	10	30	24	11	64QAM	18	1/2	9480	24	1	2	19008	3168
	15	30	36	11	64QAM	18	1/2	14344	24	1	2	28512	4752
	20	30	50	11	64QAM	18	1/2	19968	24	1	3	39600	6600
	25	30	64	11	64QAM	18	1/2	25608	24	1	4	50688	8448
	30	30	75	11	64QAM	18	1/2	30216	24	1	4	59400	9900
	40	30	100	11	64QAM	18	1/2	39936	24	1	5	79200	13200
	50	30	128	11	64QAM	18	1/2	51216	24	1	7	101376	16896
	60	30	162	11	64QAM	18	1/2	64552	24	1	8	128304	21384
	80	30	216	11	64QAM	18	1/2	86040	24	1	11	171072	28512
	90	30	243	11	64QAM	18	1/2	96264	24	1	12	192456	32076
	100	30	270	11	64QAM	18	1/2	108552	24	1	13	213840	35640

NOTE 1: PUSCH mapping Type-A and single-symbol DM-RS configuration Type-1 with 2 additional DM-RS symbols, such that the DM-RS positions are set to symbols 2, 7, 11. DMRS is [TDM'ed] with PUSCH data.

NOTE 2: MCS Index is based on MCS table 6.1.4.1-1 defined in 38.214.

NOTE 3: If more than one Code Block is present, an additional CRC sequence of L = 24 Bits is attached to each Code Block (otherwise L = 0 Bit)

Table A.2.2.4-3: Reference Channels for DFT-s-OFDM 64QAM for 60kHz SCS

Parameter	Channel bandwidth	Subcarrier Spacing	Allocated resource blocks	DFT-s-OFDM Symbols per slot (Note 1)	Modulation	MCS Index (Note 2)	Target Coding Rate	Payload size	Transport block CRC	LDPC Base Graph	Number of code blocks per slot (Note 3)	Total number of bits per slot	Total modulated symbols per slot
Unit	MHz	KHz						Bits	Bits			Bits	
	10	60	10	11	64QAM	18	1/2	3968	24	1	1	7920	1320
	15	60	18	11	64QAM	18	1/2	7168	24	1	1	14256	2376
	20	60	24	11	64QAM	18	1/2	9480	24	1	2	19008	3168
	25	60	30	11	64QAM	18	1/2	12040	24	1	2	23760	3960
	30	60	36	11	64QAM	18	1/2	14344	24	1	2	28512	4752
	40	60	50	11	64QAM	18	1/2	19968	24	1	3	39600	6600
	50	60	64	11	64QAM	18	1/2	25608	24	1	4	50688	8448
	60	60	75	11	64QAM	18	1/2	30216	24	1	4	59400	9900
	80	60	100	11	64QAM	18	1/2	39936	24	1	5	79200	13200
	90	60	120	11	64QAM	18	1/2	48168	24	1	6	95040	15840
	100	60	135	11	64QAM	18	1/2	54296	24	1	7	106920	17820

NOTE 1: PUSCH mapping Type-A and single-symbol DM-RS configuration Type-1 with 2 additional DM-RS symbols, such that the DM-RS positions are set to symbols 2, 7, 11. DMRS is [TDM'ed] with PUSCH data.

NOTE 2: MCS Index is based on MCS table 6.1.4.1-1 defined in 38.214.

NOTE 3: If more than one Code Block is present, an additional CRC sequence of L = 24 Bits is attached to each Code Block (otherwise L = 0 Bit)

A.2.2.5 DFT-s-OFDM 256QAM

Table A.2.2.5-1: Reference Channels for DFT-s-OFDM 256QAM for 15kHz SCS

Parameter	Channel bandwidth	Subcarrier Spacing	Allocated resource blocks	DFT-s-OFDM Symbols per slot (Note 1)	Modulation	MCS Index (Note 2)	Target Coding Rate	Payload size	Transport block CRC	LDPC Base Graph	Number of code blocks per slot (Note 3)	Total number of bits per slot	Total modulated symbols per slot
Unit	MHz	KHz						Bits	Bits			Bits	
	5	15	25	11	256QAM	20	2/3	17424	24	1	3	26400	3300
	10	15	50	11	256QAM	20	2/3	34816	24	1	5	52800	6600
	15	15	75	11	256QAM	20	2/3	53288	24	1	7	79200	9900
	20	15	100	11	256QAM	20	2/3	69672	24	1	9	105600	13200
	25	15	128	11	256QAM	20	2/3	90176	24	1	11	135168	16896
	30	15	160	11	256QAM	20	2/3	112648	24	1	14	168960	21120
	40	15	216	11	256QAM	20	2/3	151608	24	1	18	228096	28512
	50	15	270	11	256QAM	20	2/3	188576	24	1	23	285120	35640

NOTE 1: PUSCH mapping Type-A and single-symbol DM-RS configuration Type-1 with 2 additional DM-RS symbols, such that the DM-RS positions are set to symbols 2, 7, 11. DMRS is [TDM'ed] with PUSCH data.

NOTE 2: MCS Index is based on MCS table 5.1.3.1-2 defined in 38.214.

NOTE 3: If more than one Code Block is present, an additional CRC sequence of L = 24 Bits is attached to each Code Block (otherwise L = 0 Bit)

Table A.2.2.5-2: Reference Channels for DFT-s-OFDM 256QAM for 30kHz SCS

Parameter	Channel bandwidth	Subcarrier Spacing	Allocated resource blocks	DFT-s-OFDM Symbols per slot (Note 1)	Modulation	MCS Index (Note 2)	Target Coding Rate	Payload size	Transport block CRC	LDPC Base Graph	Number of code blocks per slot (Note 3)	Total number of bits per slot	Total modulated symbols per slot
Unit	MHz	KHz						Bits	Bits			Bits	
	5	30	10	11	256QAM	20	2/3	7040	24	1	1	10560	1320
	10	30	24	11	256QAM	20	2/3	16896	24	1	3	25344	3168
	15	30	36	11	256QAM	20	2/3	25104	24	1	3	38016	4752
	20	30	50	11	256QAM	20	2/3	34816	24	1	5	52800	6600
	25	30	64	11	256QAM	20	2/3	45096	24	1	6	67584	8448
	30	30	75	11	256QAM	20	2/3	53288	24	1	7	79200	9900
	40	30	100	11	256QAM	20	2/3	69672	24	1	9	105600	13200
	50	30	128	11	256QAM	20	2/3	90176	24	1	11	135168	16896
	60	30	162	11	256QAM	20	2/3	114776	24	1	14	171072	21384
	80	30	216	11	256QAM	20	2/3	151608	24	1	18	228096	28512
	90	30	243	11	256QAM	20	2/3	172176	24	1	21	256608	32076
	100	30	270	11	256QAM	20	2/3	188576	24	1	23	285120	35640

NOTE 1: PUSCH mapping Type-A and single-symbol DM-RS configuration Type-1 with 2 additional DM-RS symbols, such that the DM-RS positions are set to symbols 2, 7, 11. DMRS is [TDM'ed] with PUSCH data.

NOTE 2: MCS Index is based on MCS table 5.1.3.1-2 defined in 38.214.

NOTE 3: If more than one Code Block is present, an additional CRC sequence of L = 24 Bits is attached to each Code Block (otherwise L = 0 Bit)

Table A.2.2.5-3: Reference Channels for DFT-s-OFDM 256QAM for 60kHz SCS

Parameter	Channel bandwidth	Subcarrier Spacing	Allocated resource blocks	DFT-s-OFDM Symbols per slot (Note 1)	Modulation	MCS Index (Note 2)	Target Coding Rate	Payload size	Transport block CRC	LDPC Base Graph	Number of code blocks per slot (Note 3)	Total number of bits per slot	Total modulated symbols per slot
Unit	MHz	KHz						Bits	Bits			Bits	
	10	60	10	11	256QAM	20	2/3	7040	24	1	1	10560	1320
	15	60	18	11	256QAM	20	2/3	12552	24	1	2	19008	2376
	20	60	24	11	256QAM	20	2/3	16896	24	1	3	25344	3168
	25	60	30	11	256QAM	20	2/3	21000	24	1	3	31680	3960
	30	60	36	11	256QAM	20	2/3	25104	24	1	3	38016	4752
	40	60	50	11	256QAM	20	2/3	34816	24	1	5	52800	6600
	50	60	64	11	256QAM	20	2/3	45096	24	1	6	67584	8448
	60	60	75	11	256QAM	20	2/3	53288	24	1	7	79200	9900
	80	60	100	11	256QAM	20	2/3	69672	24	1	9	105600	13200
	90	60	120	11	256QAM	20	2/3	83976	24	1	10	126720	15840
	100	60	135	11	256QAM	20	2/3	94248	24	1	12	142560	17820

NOTE 1: PUSCH mapping Type-A and single-symbol DM-RS configuration Type-1 with 2 additional DM-RS symbols, such that the DM-RS positions are set to symbols 2, 7, 11. DMRS is [TDM'ed] with PUSCH data.

NOTE 2: MCS Index is based on MCS table 5.1.3.1-2 defined in 38.214.

NOTE 3: If more than one Code Block is present, an additional CRC sequence of L = 24 Bits is attached to each Code Block (otherwise L = 0 Bit)

A.2.2.6 CP-OFDM QPSK

Table A.2.2.6-1: Reference Channels for CP-OFDM QPSK for 15kHz SCS

Parameter	Channel bandwidth	Subcarrier Spacing	Allocated resource blocks	CP-OFDM Symbols per slot (Note 1)	Modulation	MCS Index (Note 2)	Target Coding Rate	Payload size	Transport block CRC	LDPC Base Graph	Number of code blocks per slot (Note 3)	Total number of bits per slot	Total modulated symbols per slot
Unit	MHz	KHz						Bits	Bits			Bits	
	5-50	15	1	11	QPSK	2	1/6	56	16	2	1	264	132
	5	15	13	11	QPSK	2	1/6	672	16	2	1	3432	1716
	5	15	25	11	QPSK	2	1/6	1256	16	2	1	6600	3300
	10	15	26	11	QPSK	2	1/6	1288	16	2	1	6864	3432
	10	15	52	11	QPSK	2	1/6	2600	16	2	1	13728	6864
	15	15	40	11	QPSK	2	1/6	2024	16	2	1	10560	5280
	15	15	79	11	QPSK	2	1/6	3912	24	2	2	20856	10428
	20	15	53	11	QPSK	2	1/6	2664	16	2	1	13992	6996
	20	15	106	11	QPSK	2	1/6	5256	24	2	2	27984	13992
	25	15	67	11	QPSK	2	1/6	3368	16	2	1	17688	8844
	25	15	133	11	QPSK	2	1/6	6664	24	2	2	35112	17556
	30	15	80	11	QPSK	2	1/6	3976	24	2	2	21120	10560
	30	15	160	11	QPSK	2	1/6	7944	24	2	3	42240	21120
	40	15	108	11	QPSK	2	1/6	5384	24	2	2	28512	14256
	40	15	216	11	QPSK	2	1/6	10752	24	2	3	57024	28512
	50	15	135	11	QPSK	2	1/6	6664	24	2	2	35640	17820
	50	15	270	11	QPSK	2	1/6	13320	24	2	4	71280	35640

NOTE 1: PUSCH mapping Type-A and single-symbol DM-RS configuration Type-1 with 2 additional DM-RS symbols, such that the DM-RS positions are set to symbols 2, 7, 11. DMRS is [TDM'ed] with PUSCH data.

NOTE 2: MCS Index is based on MCS table 5.1.3.1-1 defined in 38.214.

NOTE 3: If more than one Code Block is present, an additional CRC sequence of L = 24 Bits is attached to each Code Block (otherwise L = 0 Bit)

Table A.2.2.6-2: Reference Channels for CP-OFDM QPSK for 30kHz SCS

Parameter	Channel bandwidth	Subcarrier Spacing	Allocated resource blocks	CP-OFDM Symbols per slot (Note 1)	Modulation	MCS Index (Note 2)	Target Coding Rate	Payload size	Transport block CRC	LDPC Base Graph	Number of code blocks per slot (Note 3)	Total number of bits per slot	Total modulated symbols per slot
Unit	MHz	KHz						Bits	Bits			Bits	
	5-50	30	1	11	QPSK	2	1/6	56	16	2	1	264	132
	5	30	6	11	QPSK	2	1/6	304	16	2	1	1584	792
	5	30	11	11	QPSK	2	1/6	552	16	2	1	2904	1452
	10	30	12	11	QPSK	2	1/6	608	16	2	1	3168	1584
	10	30	24	11	QPSK	2	1/6	1192	16	2	1	6336	3168
	15	30	19	11	QPSK	2	1/6	984	16	2	1	5016	2508
	15	30	38	11	QPSK	2	1/6	1928	16	2	1	10032	5016
	20	30	26	11	QPSK	2	1/6	1288	16	2	1	6864	3432
	20	30	51	11	QPSK	2	1/6	2536	16	2	1	13464	6732
	25	30	33	11	QPSK	2	1/6	1672	16	2	1	8712	4356
	25	30	65	11	QPSK	2	1/6	3240	16	2	1	17160	8580
	30	30	39	11	QPSK	2	1/6	2024	16	2	1	10296	5148
	30	30	78	11	QPSK	2	1/6	3848	24	2	2	20592	10296
	40	30	53	11	QPSK	2	1/6	2664	16	2	1	13992	6996
	40	30	106	11	QPSK	2	1/6	5256	24	2	2	27984	13992
	50	30	67	11	QPSK	2	1/6	3368	16	2	1	17688	8844
	50	30	133	11	QPSK	2	1/6	6664	24	2	2	35112	17556
	60	30	81	11	QPSK	2	1/6	4040	24	2	2	21384	10692
	60	30	162	11	QPSK	2	1/6	8064	24	2	3	42768	21384
	80	30	109	11	QPSK	2	1/6	5384	24	2	2	28776	14388
	80	30	217	11	QPSK	2	1/6	10752	24	2	3	57288	28644
	90	30	123	11	QPSK	2	1/6	6152	24	2	2	32472	16236
	90	30	245	11	QPSK	2	1/6	12296	24	2	4	64680	32340
	100	30	137	11	QPSK	2	1/6	6792	24	2	2	36168	18084
	100	30	273	11	QPSK	2	1/6	13576	24	2	4	72072	36036

NOTE 1: PUSCH mapping Type-A and single-symbol DM-RS configuration Type-1 with 2 additional DM-RS symbols, such that the DM-RS positions are set to symbols 2, 7, 11. DMRS is [TDM'ed] with PUSCH data.

NOTE 2: MCS Index is based on MCS table 5.1.3.1-1 defined in 38.214.

NOTE 3: If more than one Code Block is present, an additional CRC sequence of L = 24 Bits is attached to each Code Block (otherwise L = 0 Bit)

Table A.2.2.6-3: Reference Channels for CP-OFDM QPSK for 60kHz SCS

Parameter	Channel bandwidth	Subcarrier Spacing	Allocated resource blocks	CP-OFDM Symbols per slot (Note 1)	Modulation	MCS Index (Note 2)	Target Coding Rate	Payload size	Transport block CRC	LDPC Base Graph	Number of code blocks per slot (Note 3)	Total number of bits per slot	Total modulated symbols per slot
Unit	MHz	KHz						Bits	Bits			Bits	
	10-100	60	1	11	QPSK	2	1/6	56	16	2	1	264	132
	10	60	6	11	QPSK	2	1/6	304	16	2	1	1584	792
	10	60	11	11	QPSK	2	1/6	552	16	2	1	2904	1452
	15	60	9	11	QPSK	2	1/6	456	16	2	1	2376	1188
	15	60	18	11	QPSK	2	1/6	928	16	2	1	4752	2376
	20	60	12	11	QPSK	2	1/6	608	16	2	1	3168	1584
	20	60	24	11	QPSK	2	1/6	1192	16	2	1	6336	3168
	25	60	16	11	QPSK	2	1/6	808	16	2	1	4224	2112
	25	60	31	11	QPSK	2	1/6	1544	16	2	1	8184	4092
	30	60	19	11	QPSK	2	1/6	984	16	2	1	5016	2508
	30	60	38	11	QPSK	2	1/6	1928	16	2	1	10032	5016
	40	60	26	11	QPSK	2	1/6	1288	16	2	1	6864	3432
	40	60	51	11	QPSK	2	1/6	2536	16	2	1	13464	6732
	50	60	33	11	QPSK	2	1/6	1672	16	2	1	8712	4356
	50	60	65	11	QPSK	2	1/6	3240	16	2	1	17160	8580
	60	60	40	11	QPSK	2	1/6	2024	16	2	1	10560	5280
	60	60	79	11	QPSK	2	1/6	3912	24	2	2	20856	10428
	80	60	54	11	QPSK	2	1/6	2664	16	2	1	14256	7128
	80	60	107	11	QPSK	2	1/6	5256	24	2	2	28248	14124
	90	60	61	11	QPSK	2	1/6	3104	16	2	1	16104	8052
	90	60	121	11	QPSK	2	1/6	6024	24	2	2	31944	15972
	100	60	68	11	QPSK	2	1/6	3368	16	2	1	17952	8976
	100	60	135	11	QPSK	2	1/6	6664	24	2	2	35640	17820

NOTE 1: PUSCH mapping Type-A and single-symbol DM-RS configuration Type-1 with 2 additional DM-RS symbols, such that the DM-RS positions are set to symbols 2, 7, 11. DMRS is [TDM'ed] with PUSCH data.

NOTE 2: MCS Index is based on MCS table 5.1.3.1-1 defined in 38.214.

NOTE 3: If more than one Code Block is present, an additional CRC sequence of L = 24 Bits is attached to each Code Block (otherwise L = 0 Bit)

A.2.2.7 CP-OFDM 16QAM

Table A.2.2.7-1: Reference Channels for CP-OFDM 16QAM for 15kHz SCS

Parameter	Channel bandwidth	Subcarrier Spacing	Allocated resource blocks	CP-OFDM Symbols per slot (Note 1)	Modulation	MCS Index (Note 2)	Target Coding Rate	Payload size	Transport block CRC	LDPC Base Graph	Number of code blocks per slot (Note 3)	Total number of bits per slot	Total modulated symbols per slot
Unit	MHz	KHz						Bits	Bits			Bits	
	5-50	15	1	11	16QAM	10	1/3	176	16	2	1	528	132
	5	15	13	11	16QAM	10	1/3	2280	16	2	1	6864	1716
	5	15	25	11	16QAM	10	1/3	4352	24	1	1	13200	3300
	10	15	26	11	16QAM	10	1/3	4480	24	1	1	13728	3432
	10	15	52	11	16QAM	10	1/3	9224	24	1	2	27456	6864
	15	15	40	11	16QAM	10	1/3	7040	24	1	1	21120	5280
	15	15	79	11	16QAM	10	1/3	13832	24	1	2	41712	10428
	20	15	53	11	16QAM	10	1/3	9224	24	1	2	27984	6996
	20	15	106	11	16QAM	10	1/3	18432	24	1	3	55968	13992
	25	15	67	11	16QAM	10	1/3	11784	24	1	2	35376	8844
	25	15	133	11	16QAM	10	1/3	23040	24	1	3	70224	17556
	30	15	80	11	16QAM	10	1/3	14088	24	1	2	42240	10560
	30	15	160	11	16QAM	10	1/3	28168	24	1	4	84480	21120
	40	15	108	11	16QAM	10	1/3	18960	24	1	3	57024	14256
	40	15	216	11	16QAM	10	1/3	37896	24	1	5	114048	28512
	50	15	135	11	16QAM	10	1/3	23568	24	1	3	71280	17820
	50	15	270	11	16QAM	10	1/3	47112	24	1	6	142560	35640

NOTE 1: PUSCH mapping Type-A and single-symbol DM-RS configuration Type-1 with 2 additional DM-RS symbols, such that the DM-RS positions are set to symbols 2, 7, 11. DMRS is [TDM'ed] with PUSCH data.

NOTE 2: MCS Index is based on MCS table 5.1.3.1-1 defined in 38.214.

NOTE 3: If more than one Code Block is present, an additional CRC sequence of L = 24 Bits is attached to each Code Block (otherwise L = 0 Bit)

Table A.2.2.7-2: Reference Channels for CP-OFDM 16QAM for 30kHz SCS

Parameter	Channel bandwidth	Subcarrier Spacing	Allocated resource blocks	CP-OFDM Symbols per slot (Note 1)	Modulation	MCS Index (Note 2)	Target Coding Rate	Payload size	Transport block CRC	LDPC Base Graph	Number of code blocks per slot (Note 3)	Total number of bits per slot	Total modulated symbols per slot
Unit	MHz	KHz						Bits	Bits			Bits	
	5-50	30	1	11	16QAM	10	1/3	176	16	2	1	528	132
	5	30	6	11	16QAM	10	1/3	1064	16	2	1	3168	792
	5	30	11	11	16QAM	10	1/3	1928	16	2	1	5808	1452
	10	30	12	11	16QAM	10	1/3	2088	16	2	1	6336	1584
	10	30	24	11	16QAM	10	1/3	4224	24	1	1	12672	3168
	15	30	19	11	16QAM	10	1/3	3368	16	2	1	10032	2508
	15	30	38	11	16QAM	10	1/3	6656	24	1	1	20064	5016
	20	30	26	11	16QAM	10	1/3	4480	24	1	1	13728	3432
	20	30	51	11	16QAM	10	1/3	8968	24	1	2	26928	6732
	25	30	33	11	16QAM	10	1/3	5760	24	1	1	17424	4356
	25	30	65	11	16QAM	10	1/3	11272	24	1	2	34320	8580
	30	30	39	11	16QAM	10	1/3	6784	24	1	1	20592	5148
	30	30	78	11	16QAM	10	1/3	13576	24	1	2	41184	10296
	40	30	53	11	16QAM	10	1/3	9224	24	1	2	27984	6996
	40	30	106	11	16QAM	10	1/3	18432	24	1	3	55968	13992
	50	30	67	11	16QAM	10	1/3	11784	24	1	2	35376	8844
	50	30	133	11	16QAM	10	1/3	23040	24	1	3	70224	17556
	60	30	81	11	16QAM	10	1/3	14088	24	1	2	42768	10692
	60	30	162	11	16QAM	10	1/3	28168	24	1	4	85536	21384
	80	30	109	11	16QAM	10	1/3	18960	24	1	3	57552	14388
	80	30	217	11	16QAM	10	1/3	37896	24	1	5	114576	28644
	90	30	123	11	16QAM	10	1/3	21504	24	1	3	64944	16236
	90	30	245	11	16QAM	10	1/3	43032	24	1	6	129360	32340
	100	30	137	11	16QAM	10	1/3	24072	24	1	3	72336	18084
	100	30	273	11	16QAM	10	1/3	48168	24	1	6	144144	36036

NOTE 1: PUSCH mapping Type-A and single-symbol DM-RS configuration Type-1 with 2 additional DM-RS symbols, such that the DM-RS positions are set to symbols 2, 7, 11. DMRS is [TDM'ed] with PUSCH data.

NOTE 2: MCS Index is based on MCS table 5.1.3.1-1 defined in 38.214.

NOTE 3: If more than one Code Block is present, an additional CRC sequence of L = 24 Bits is attached to each Code Block (otherwise L = 0 Bit)

Table A.2.2.7-3: Reference Channels for CP-OFDM 16QAM for 60kHz SCS

Parameter	Channel bandwidth	Subcarrier Spacing	Allocated resource blocks	CP-OFDM Symbols per slot (Note 1)	Modulation	MCS Index (Note 2)	Target Coding Rate	Payload size	Transport block CRC	LDPC Base Graph	Number of code blocks per slot (Note 3)	Total number of bits per slot	Total modulated symbols per slot
Unit	MHz	KHz						Bits	Bits			Bits	
	10-100	60	1	11	16QAM	10	1/3	176	16	2	1	528	132
	10	60	6	11	16QAM	10	1/3	1064	16	2	1	3168	792
	10	60	11	11	16QAM	10	1/3	1928	16	2	1	5808	1452
	15	60	9	11	16QAM	10	1/3	1608	16	2	1	4752	1188
	15	60	18	11	16QAM	10	1/3	3240	16	2	1	9504	2376
	20	60	12	11	16QAM	10	1/3	2088	16	2	1	6336	1584
	20	60	24	11	16QAM	10	1/3	4224	24	1	1	12672	3168
	25	60	16	11	16QAM	10	1/3	2792	16	2	1	8448	2112
	25	60	31	11	16QAM	10	1/3	5376	24	1	1	16368	4092
	30	60	19	11	16QAM	10	1/3	3368	16	2	1	10032	2508
	30	60	38	11	16QAM	10	1/3	6656	24	1	1	20064	5016
	40	60	26	11	16QAM	10	1/3	4480	24	1	1	13728	3432
	40	60	51	11	16QAM	10	1/3	8968	24	1	2	26928	6732
	50	60	33	11	16QAM	10	1/3	5760	24	1	1	17424	4356
	50	60	65	11	16QAM	10	1/3	11272	24	1	2	34320	8580
	60	60	40	11	16QAM	10	1/3	7040	24	1	1	21120	5280
	60	60	79	11	16QAM	10	1/3	13832	24	1	2	41712	10428
	80	60	54	11	16QAM	10	1/3	9480	24	1	2	28512	7128
	80	60	107	11	16QAM	10	1/3	18960	24	1	3	56496	14124
	90	60	61	11	16QAM	10	1/3	10760	24	1	2	32208	8052
	90	60	121	11	16QAM	10	1/3	21000	24	1	3	63888	15972
	100	60	68	11	16QAM	10	1/3	11784	24	1	2	35904	8976
	100	60	135	11	16QAM	10	1/3	23568	24	1	3	71280	17820

NOTE 1: PUSCH mapping Type-A and single-symbol DM-RS configuration Type-1 with 2 additional DM-RS symbols, such that the DM-RS positions are set to symbols 2, 7, 11. DMRS is [TDM'ed] with PUSCH data.

NOTE 2: MCS Index is based on MCS table 5.1.3.1-1 defined in 38.214.

NOTE 3: If more than one Code Block is present, an additional CRC sequence of L = 24 Bits is attached to each Code Block (otherwise L = 0 Bit)

A.2.2.8 CP-OFDM 64QAM

Table A.2.2.8-1: Reference Channels for CP-OFDM 64QAM for 15kHz SCS

Parameter	Channel bandwidth	Subcarrier Spacing	Allocated resource blocks	CP-OFDM Symbols per slot (Note 1)	Modulation	MCS Index (Note 2)	Target Coding Rate	Payload size	Transport block CRC	LDPC Base Graph	Number of code blocks per slot (Note 3)	Total number of bits per slot	Total modulated symbols per slot
Unit	MHz	KHz						Bits	Bits			Bits	
	5	15	25	11	64QAM	19	1/2	9992	24	1	2	19800	3300
	10	15	52	11	64QAM	19	1/2	21000	24	1	3	41184	6864
	15	15	79	11	64QAM	19	1/2	31752	24	1	4	62568	10428
	20	15	106	11	64QAM	19	1/2	42016	24	1	5	83952	13992
	25	15	133	11	64QAM	19	1/2	53288	24	1	7	105336	17556
	30	15	160	11	64QAM	19	1/2	63528	24	1	8	126720	21120
	40	15	216	11	64QAM	19	1/2	86040	24	1	11	171072	28512
	50	15	270	11	64QAM	19	1/2	108552	24	1	13	213840	35640

NOTE 1: PUSCH mapping Type-A and single-symbol DM-RS configuration Type-1 with 2 additional DM-RS symbols, such that the DM-RS positions are set to symbols 2, 7, 11. DMRS is [TDM'ed] with PUSCH data.

NOTE 2: MCS Index is based on MCS table 5.1.3.1-1 defined in 38.214.

NOTE 3: If more than one Code Block is present, an additional CRC sequence of L = 24 Bits is attached to each Code Block (otherwise L = 0 Bit)

Table A.2.2.8-2: Reference Channels for CP-OFDM 64QAM for 30kHz SCS

Parameter	Channel bandwidth	Subcarrier Spacing	Allocated resource blocks	CP-OFDM Symbols per slot (Note 1)	Modulation	MCS Index (Note 2)	Target Coding Rate	Payload size	Transport block CRC	LDPC Base Graph	Number of code blocks per slot (Note 3)	Total number of bits per slot	Total modulated symbols per slot
Unit	MHz	KHz						Bits	Bits			Bits	
	5	30	11	11	64QAM	19	1/2	4352	24	1	1	8712	1452
	10	30	24	11	64QAM	19	1/2	9480	24	1	2	19008	3168
	15	30	38	11	64QAM	19	1/2	15112	24	1	2	30096	5016
	20	30	51	11	64QAM	19	1/2	20496	24	1	3	40392	6732
	25	30	65	11	64QAM	19	1/2	26120	24	1	4	51480	8580
	30	30	78	11	64QAM	19	1/2	31240	24	1	4	61776	10296
	40	30	106	11	64QAM	19	1/2	42016	24	1	5	83952	13992
	50	30	133	11	64QAM	19	1/2	53288	24	1	7	105336	17556
	60	30	162	11	64QAM	19	1/2	64552	24	1	8	128304	21384
	80	30	217	11	64QAM	19	1/2	86040	24	1	11	171864	28644
	90	30	245	11	64QAM	19	1/2	98376	24	1	12	194040	32340
	100	30	273	11	64QAM	19	1/2	108552	24	1	13	216216	36036

NOTE 1: PUSCH mapping Type-A and single-symbol DM-RS configuration Type-1 with 2 additional DM-RS symbols, such that the DM-RS positions are set to symbols 2, 7, 11. DMRS is [TDM'ed] with PUSCH data.

NOTE 2: MCS Index is based on MCS table 5.1.3.1-1 defined in 38.214.

NOTE 3: If more than one Code Block is present, an additional CRC sequence of L = 24 Bits is attached to each Code Block (otherwise L = 0 Bit)

Table A.2.2.8-3: Reference Channels for CP-OFDM 64QAM for 60kHz SCS

Parameter	Channel bandwidth	Subcarrier Spacing	Allocated resource blocks	CP-OFDM Symbols per slot (Note 1)	Modulation	MCS Index (Note 2)	Target Coding Rate	Payload size	Transport block CRC	LDPC Base Graph	Number of code blocks per slot (Note 3)	Total number of bits per slot	Total modulated symbols per slot
Unit	MHz	KHz						Bits	Bits			Bits	
	10	60	11	11	64QAM	19	1/2	4352	24	1	1	8712	1452
	15	60	18	11	64QAM	19	1/2	7168	24	1	1	14256	2376
	20	60	24	11	64QAM	19	1/2	9480	24	1	2	19008	3168
	25	60	31	11	64QAM	19	1/2	12296	24	1	2	24552	4092
	30	60	38	11	64QAM	19	1/2	15112	24	1	2	30096	5016
	40	60	51	11	64QAM	19	1/2	20496	24	1	3	40392	6732
	50	60	65	11	64QAM	19	1/2	26120	24	1	4	51480	8580
	60	60	79	11	64QAM	19	1/2	31752	24	1	4	62568	10428
	80	60	107	11	64QAM	19	1/2	43032	24	1	6	84744	14124
	90	60	121	11	64QAM	19	1/2	48168	24	1	6	95832	15972
	100	60	135	11	64QAM	19	1/2	54296	24	1	7	106920	17820

NOTE 1: PUSCH mapping Type-A and single-symbol DM-RS configuration Type-1 with 2 additional DM-RS symbols, such that the DM-RS positions are set to symbols 2, 7, 11. DMRS is [TDM'ed] with PUSCH data.

NOTE 2: MCS Index is based on MCS table 5.1.3.1-1 defined in 38.214.

NOTE 3: If more than one Code Block is present, an additional CRC sequence of L = 24 Bits is attached to each Code Block (otherwise L = 0 Bit)

A.2.2.9 CP-OFDM 256QAM

Table A.2.2.9-1: Reference Channels for CP-OFDM 256QAM for 15kHz SCS

Parameter	Channel bandwidth	Subcarrier Spacing	Allocated resource blocks	CP-OFDM Symbols per slot (Note 1)	Modulation	MCS Index (Note 2)	Target Coding Rate	Payload size	Transport block CRC	LDPC Base Graph	Number of code blocks per slot (Note 3)	Total number of bits per slot	Total modulated symbols per slot
Unit	MHz	KHz						Bits	Bits			Bits	
	5	15	25	11	256QAM	20	2/3	17424	24	1	3	26400	3300
	10	15	52	11	256QAM	20	2/3	36896	24	1	5	54912	6864
	15	15	79	11	256QAM	20	2/3	55304	24	1	7	83424	10428
	20	15	106	11	256QAM	20	2/3	73776	24	1	9	111936	13992
	25	15	133	11	256QAM	20	2/3	94248	24	1	12	140448	17556
	30	15	160	11	256QAM	20	2/3	112648	24	1	14	168960	21120
	40	15	216	11	256QAM	20	2/3	151608	24	1	18	228096	28512
	50	15	270	11	256QAM	20	2/3	188576	24	1	23	285120	35640

NOTE 1: PUSCH mapping Type-A and single-symbol DM-RS configuration Type-1 with 2 additional DM-RS symbols, such that the DM-RS positions are set to symbols 2, 7, 11. DMRS is [TDM'ed] with PUSCH data.

NOTE 2: MCS Index is based on MCS table 5.1.3.1-2 defined in 38.214.

NOTE 3: If more than one Code Block is present, an additional CRC sequence of L = 24 Bits is attached to each Code Block (otherwise L = 0 Bit)

Table A.2.2.9-2: Reference Channels for CP-OFDM 256QAM for 30kHz SCS

Parameter	Channel bandwidth	Subcarrier Spacing	Allocated resource blocks	CP-OFDM Symbols per slot (Note 1)	Modulation	MCS Index (Note 2)	Target Coding Rate	Payload size	Transport block CRC	LDPC Base Graph	Number of code blocks per slot (Note 3)	Total number of bits per slot	Total modulated symbols per slot
Unit	MHz	KHz						Bits	Bits			Bits	
	5	30	11	11	256QAM	20	2/3	7680	24	1	1	11616	1452
	10	30	24	11	256QAM	20	2/3	16896	24	1	3	25344	3168
	15	30	38	11	256QAM	20	2/3	26632	24	1	4	40128	5016
	20	30	51	11	256QAM	20	2/3	35856	24	1	5	53856	6732
	25	30	65	11	256QAM	20	2/3	46104	24	1	6	68640	8580
	30	30	78	11	256QAM	20	2/3	55304	24	1	7	82368	10296
	40	30	106	11	256QAM	20	2/3	73776	24	1	9	111936	13992
	50	30	133	11	256QAM	20	2/3	94248	24	1	12	140448	17556
	60	30	162	11	256QAM	20	2/3	114776	24	1	14	171072	21384
	80	30	217	11	256QAM	20	2/3	151608	24	1	18	229152	28644
	90	30	245	11	256QAM	20	2/3	172176	24	1	21	258720	32340
	100	30	273	11	256QAM	20	2/3	192624	24	1	23	288288	36036

NOTE 1: PUSCH mapping Type-A and single-symbol DM-RS configuration Type-1 with 2 additional DM-RS symbols, such that the DM-RS positions are set to symbols 2, 7, 11. DMRS is [TDM'ed] with PUSCH data.

NOTE 2: MCS Index is based on MCS table 5.1.3.1-2 defined in 38.214.

NOTE 3: If more than one Code Block is present, an additional CRC sequence of L = 24 Bits is attached to each Code Block (otherwise L = 0 Bit)

Table A.2.2.9-3: Reference Channels for CP-OFDM 256QAM for 60kHz SCS

Parameter	Channel bandwidth	Subcarrier Spacing	Allocated resource blocks	CP-OFDM Symbols per slot (Note 1)	Modulation	MCS Index (Note 2)	Target Coding Rate	Payload size	Transport block CRC	LDPC Base Graph	Number of code blocks per slot (Note 3)	Total number of bits per slot	Total modulated symbols per slot
Unit	MHz	KHz						Bits	Bits			Bits	
	10	60	11	11	256QAM	20	2/3	7680	24	1	1	11616	1452
	15	60	18	11	256QAM	20	2/3	12552	24	1	2	19008	2376
	20	60	24	11	256QAM	20	2/3	16896	24	1	3	25344	3168
	25	60	31	11	256QAM	20	2/3	22032	24	1	3	32736	4092
	30	60	38	11	256QAM	20	2/3	26632	24	1	4	40128	5016
	40	60	51	11	256QAM	20	2/3	35856	24	1	5	53856	6732
	50	60	65	11	256QAM	20	2/3	46104	24	1	6	68640	8580
	60	60	79	11	256QAM	20	2/3	55304	24	1	7	83424	10428
	80	60	107	11	256QAM	20	2/3	75792	24	1	9	112992	14124
	90	60	121	11	256QAM	20	2/3	86040	24	1	11	127776	15972
	100	60	135	11	256QAM	20	2/3	94248	24	1	12	142560	17820

NOTE 1: PUSCH mapping Type-A and single-symbol DM-RS configuration Type-1 with 2 additional DM-RS symbols, such that the DM-RS positions are set to symbols 2, 7, 11. DMRS is [TDM'ed] with PUSCH data.

NOTE 2: MCS Index is based on MCS table 5.1.3.1-2 defined in 38.214.

NOTE 3: If more than one Code Block is present, an additional CRC sequence of L = 24 Bits is attached to each Code Block (otherwise L = 0 Bit)

A.2.3 Reference measurement channels for TDD

TDD slot patterns defined for reference sensitivity tests will be used for UL RMCs defined below.

A.2.3.1 DFT-s-OFDM Pi/2-BPSK

Table A.2.3.1-1: Reference Channels for DFT-s-OFDM Pi/2-BPSK for 15kHz SCS

Parameter	Channel bandwidth	Subcarrier Spacing	Allocated resource blocks	DFT-s-OFDM Symbols per slot (Note 1)	Modulation	MCS Index (Note 2)	Target Coding Rate	Payload size for slots 4 and 9	Transport block CRC	LDPC Base Graph	Number of code blocks per slot for slots 4 and 9 (Note 3)	Total number of bits per slot for slots 4 and 9	Total modulated symbols per slot for slots 4 and 9
Unit	MHz	KHz						Bits	Bits			Bits	
	5-50	15	1	11	pi/2 BPSK	0	1/4	32	16	2	1	132	132
	5	15	12	11	pi/2 BPSK	0	1/4	384	16	2	1	1584	1584
	5	15	25	11	pi/2 BPSK	0	1/4	808	16	2	1	3300	3300
	10	15	25	11	pi/2 BPSK	0	1/4	808	16	2	1	3300	3300
	10	15	50	11	pi/2 BPSK	0	1/4	1544	16	2	1	6600	6600
	15	15	36	11	pi/2 BPSK	0	1/4	1128	16	2	1	4752	4752
	15	15	75	11	pi/2 BPSK	0	1/4	2408	16	2	1	9900	9900
	20	15	50	11	pi/2 BPSK	0	1/4	1544	16	2	1	6600	6600
	20	15	100	11	pi/2 BPSK	0	1/4	3104	16	2	1	13200	13200
	25	15	64	11	pi/2 BPSK	0	1/4	2024	16	2	1	8448	8448
	25	15	128	11	pi/2 BPSK	0	1/4	3976	24	2	2	16896	16896
	30	15	80	11	pi/2 BPSK	0	1/4	2472	16	2	1	10560	10560
	30	15	160	11	pi/2 BPSK	0	1/4	4872	24	2	2	21120	21120
	40	15	108	11	pi/2 BPSK	0	1/4	3368	16	2	1	14256	14256
	40	15	216	11	pi/2 BPSK	0	1/4	6664	24	2	2	28512	28512
	50	15	135	11	pi/2 BPSK	0	1/4	4104	24	2	2	17820	17820
	50	15	270	11	pi/2 BPSK	0	1/4	8448	24	2	3	35640	35640

NOTE 1: PUSCH mapping Type-A and single-symbol DM-RS configuration Type-1 with 2 additional DM-RS symbols, such that the DM-RS positions are set to symbols 2, 7, 11. DMRS is [TDM'ed] with PUSCH data.

NOTE 2: MCS Index is based on MCS table 6.1.4.1-1 defined in 38.214.

NOTE 3: If more than one Code Block is present, an additional CRC sequence of L = 24 Bits is attached to each Code Block (otherwise L = 0 Bit)

Table A.2.3.1-2: Reference Channels for DFT-s-OFDM Pi/2-BPSK for 30kHz SCS

Parameter	Channel bandwidth	Subcarrier Spacing	Allocated resource blocks	DFT-s-OFDM Symbols per slot (Note 1)	Modulation	MCS Index (Note 2)	Target Coding Rate	Payload size for slots 8, 9, 18 and 19	Transport block CRC	LDPC Base Graph	Number of code blocks per slot for slots 8, 9, 18 and 19 (Note 3)	Total number of bits per slot for slots 8, 9, 18 and 19	Total modulated symbols per slot for slots 8, 9, 18 and 19
Unit	MHz	KHz						Bits	Bits			Bits	
	5-50	30	1	11	pi/2 BPSK	0	1/4	32	16	2	1	132	132
	5	30	5	11	pi/2 BPSK	0	1/4	160	16	2	1	660	660
	5	30	10	11	pi/2 BPSK	0	1/4	320	16	2	1	1320	1320
	10	30	12	11	pi/2 BPSK	0	1/4	384	16	2	1	1584	1584
	10	30	24	11	pi/2 BPSK	0	1/4	768	16	2	1	3168	3168
	15	30	18	11	pi/2 BPSK	0	1/4	576	16	2	1	2376	2376
	15	30	36	11	pi/2 BPSK	0	1/4	1128	16	2	1	4752	4752
	20	30	25	11	pi/2 BPSK	0	1/4	808	16	2	1	3300	3300
	20	30	50	11	pi/2 BPSK	0	1/4	1544	16	2	1	6600	6600
	25	30	32	11	pi/2 BPSK	0	1/4	1032	16	2	1	4224	4224
	25	30	64	11	pi/2 BPSK	0	1/4	2024	16	2	1	8448	8448
	30	30	36	11	pi/2 BPSK	0	1/4	1128	16	2	1	4752	4752
	30	30	75	11	pi/2 BPSK	0	1/4	2408	16	2	1	9900	9900
	40	30	50	11	pi/2 BPSK	0	1/4	1544	16	2	1	6600	6600
	40	30	100	11	pi/2 BPSK	0	1/4	3104	16	2	1	13200	13200
	50	30	64	11	pi/2 BPSK	0	1/4	2024	16	2	1	8448	8448
	50	30	128	11	pi/2 BPSK	0	1/4	3976	24	2	2	16896	16896
	60	30	81	11	pi/2 BPSK	0	1/4	2536	16	2	1	10692	10692
	60	30	162	11	pi/2 BPSK	0	1/4	5000	24	2	2	21384	21384
	80	30	108	11	pi/2 BPSK	0	1/4	3368	16	2	1	14256	14256
	80	30	216	11	pi/2 BPSK	0	1/4	6664	24	2	2	28512	28512
	90	30	120	11	pi/2 BPSK	0	1/4	3752	16	2	1	15840	15840
	90	30	243	11	pi/2 BPSK	0	1/4	7560	24	2	2	32076	32076
	100	30	135	11	pi/2 BPSK	0	1/4	4104	24	2	2	17820	17820
	100	30	270	11	pi/2 BPSK	0	1/4	8448	24	2	3	35640	35640

NOTE 1: PUSCH mapping Type-A and single-symbol DM-RS configuration Type-1 with 2 additional DM-RS symbols, such that the DM-RS positions are set to symbols 2, 7, 11. DMRS is [TDM'ed] with PUSCH data.

NOTE 2: MCS Index is based on MCS table 6.1.4.1-1 defined in 38.214.

NOTE 3: If more than one Code Block is present, an additional CRC sequence of L = 24 Bits is attached to each Code Block (otherwise L = 0 Bit)

Table A.2.3.1-3: Reference Channels for DFT-s-OFDM Pi/2-BPSK for 60kHz SCS

Parameter	Channel bandwidth	Subcarrier Spacing	Allocated resource blocks	DFT-s-OFDM Symbols per slot (Note 1)	Modulation	MCS Index (Note 2)	Target Coding Rate	Payload size for slots 4, 9, 14, 19, 24, 29, 34 and 39	Transport block CRC	LDPC Base Graph	Number of code blocks per slot for slots 4, 9, 14, 19, 24, 29, 34 and 39 (Note 3)	Total number of bits per slot for slots 4, 9, 14, 19, 24, 29, 34 and 39	Total modulated symbols per slot for slots 4, 9, 14, 19, 24, 29, 34 and 39
Unit	MHz	KHz						Bits	Bits			Bits	
	10-100	60	1	11	pi/2 BPSK	0	1/4	32	16	2	1	132	132
	10	60	5	11	pi/2 BPSK	0	1/4	160	16	2	1	660	660
	10	60	10	11	pi/2 BPSK	0	1/4	320	16	2	1	1320	1320
	15	60	9	11	pi/2 BPSK	0	1/4	288	16	2	1	1188	1188
	15	60	18	11	pi/2 BPSK	0	1/4	576	16	2	1	2376	2376
	20	60	12	11	pi/2 BPSK	0	1/4	384	16	2	1	1584	1584
	20	60	24	11	pi/2 BPSK	0	1/4	768	16	2	1	3168	3168
	25	60	15	11	pi/2 BPSK	0	1/4	480	16	2	1	1980	1980
	25	60	30	11	pi/2 BPSK	0	1/4	984	16	2	1	3960	3960
	30	60	18	11	pi/2 BPSK	0	1/4	576	16	2	1	2376	2376
	30	60	36	11	pi/2 BPSK	0	1/4	1128	16	2	1	4752	4752
	40	60	25	11	pi/2 BPSK	0	1/4	808	16	2	1	3300	3300
	40	60	50	11	pi/2 BPSK	0	1/4	1544	16	2	1	6600	6600
	50	60	32	11	pi/2 BPSK	0	1/4	1032	16	2	1	4224	4224
	50	60	64	11	pi/2 BPSK	0	1/4	2024	16	2	1	8448	8448
	60	60	36	11	pi/2 BPSK	0	1/4	1128	16	2	1	4752	4752
	60	60	75	11	pi/2 BPSK	0	1/4	2408	16	2	1	9900	9900
	80	60	50	11	pi/2 BPSK	0	1/4	1544	16	2	1	6600	6600
	80	60	100	11	pi/2 BPSK	0	1/4	3104	16	2	1	13200	13200
	90	60	60	11	pi/2 BPSK	0	1/4	1864	16	2	1	7920	7920
	90	60	120	11	pi/2 BPSK	0	1/4	3752	16	2	1	15840	15840
	100	60	64	11	pi/2 BPSK	0	1/4	2024	16	2	1	8448	8448
	100	60	135	11	pi/2 BPSK	0	1/4	4104	24	2	2	17820	17820

NOTE 1: PUSCH mapping Type-A and single-symbol DM-RS configuration Type-1 with 2 additional DM-RS symbols, such that the DM-RS positions are set to symbols 2, 7, 11. DMRS is [TDM'ed] with PUSCH data.

NOTE 2: MCS Index is based on MCS table 6.1.4.1-1 defined in 38.214.

NOTE 3: If more than one Code Block is present, an additional CRC sequence of L = 24 Bits is attached to each Code Block (otherwise L = 0 Bit)

A.2.3.2 DFT-s-OFDM QPSK

Table A.2.3.2-1: Reference channels for DFT-s-OFDM QPSK for 15kHz SCS

Parameter	Channel bandwidth	Subcarrier Spacing	Allocated resource blocks	DFT-s-OFDM Symbols per slot (Note 1)	Modulation	MCS Index (Note 2)	Target Coding Rate	Payload size for slots 4 and 9	Transport block CRC	LDPC Base Graph	Number of code blocks per slot for slots 4 and 9 (Note 3)	Total number of bits per slot for slots 4 and 9	Total modulated symbols per slot for slots 4 and 9
Unit	MHz	KHz						Bits	Bits			Bits	
	5-50	15	1	11	QPSK	2	1/6	56	16	2	1	264	132
	5	15	12	11	QPSK	2	1/6	608	16	2	1	3168	1584
	5	15	20	11	QPSK	2	1/6	1032	16	2	1	5280	2640
	5	15	25	11	QPSK	2	1/6	1256	16	2	1	6600	3300
	10	15	20	11	QPSK	2	1/6	1032	16	2	1	5280	2640
	10	15	25	11	QPSK	2	1/6	1256	16	2	1	6600	3300
	10	15	50	11	QPSK	2	1/6	2472	16	2	1	13200	6600
	15	15	20	11	QPSK	2	1/6	1032	16	2	1	5280	2640
	15	15	25	11	QPSK	2	1/6	1256	16	2	1	6600	3300
	15	15	36	11	QPSK	2	1/6	1800	16	2	1	9504	4752
	15	15	50	11	QPSK	2	1/6	2472	16	2	1	13200	6600
	15	15	75	11	QPSK	2	1/6	3752	16	2	1	19800	9900
	20	15	20	11	QPSK	2	1/6	1032	16	2	1	5280	2640
	20	15	25	11	QPSK	2	1/6	1256	16	2	1	6600	3300
	20	15	50	11	QPSK	2	1/6	2472	16	2	1	13200	6600
	20	15	100	11	QPSK	2	1/6	5000	24	2	2	26400	13200
	25	15	50	11	QPSK	2	1/6	2472	16	2	1	13200	6600
	25	15	64	11	QPSK	2	1/6	3240	16	2	1	16896	8448
	25	15	128	11	QPSK	2	1/6	6408	24	2	2	33792	16896
	30	15	50	11	QPSK	2	1/6	2472	16	2	1	13200	6600
	30	15	80	11	QPSK	2	1/6	3976	24	2	2	21120	10560
	30	15	160	11	QPSK	2	1/6	7944	24	2	3	42240	21120
	40	15	108	11	QPSK	2	1/6	5384	24	2	2	28512	14256
	40	15	216	11	QPSK	2	1/6	10752	24	2	3	57024	28512
	50	15	135	11	QPSK	2	1/6	6664	24	2	2	35640	17820
	50	15	270	11	QPSK	2	1/6	13320	24	2	4	71280	35640

NOTE 1: PUSCH mapping Type-A and single-symbol DM-RS configuration Type-1 with 2 additional DM-RS symbols, such that the DM-RS positions are set to symbols 2, 7, 11. DMRS is [TDM'ed] with PUSCH data.

NOTE 2: MCS Index is based on MCS table 6.1.4.1-1 defined in 38.214.

NOTE 3: If more than one Code Block is present, an additional CRC sequence of L = 24 Bits is attached to each Code Block (otherwise L = 0 Bit)

Table A.2.3.2-2: Reference channels for DFT-s-OFDM QPSK for 30kHz SCS

Parameter	Channel bandwidth	Subcarrier Spacing	Allocated resource blocks	DFT-s-OFDM Symbols per slot (Note 1)	Modulation	MCS Index (Note 2)	Target Coding Rate	Payload size for slots 8, 9, 18 and 19	Transport block CRC	LDPC Base Graph	Number of code blocks per slot for slots 8, 9, 18 and 19 (Note 3)	Total number of bits per slot for slots 8, 9, 18 and 19	Total modulated symbols per slot for slots 8, 9, 18 and 19
Unit	MHz	KHz						Bits	Bits			Bits	
	5-50	30	1	11	QPSK	2	1/6	56	16	2	1	264	132
	5	30	5	11	QPSK	2	1/6	256	16	2	1	1320	660
	5	30	10	11	QPSK	2	1/6	504	16	2	1	2640	1320
	10	30	12	11	QPSK	2	1/6	608	16	2	1	3168	1584
	10	30	24	11	QPSK	2	1/6	1192	16	2	1	6336	3168
	15	30	18	11	QPSK	2	1/6	928	16	2	1	4752	2376
	15	30	36	11	QPSK	2	1/6	1800	16	2	1	9504	4752
	20	30	25	11	QPSK	2	1/6	1256	16	2	1	6600	3300
	20	30	50	11	QPSK	2	1/6	2472	16	2	1	13200	6600
	25	30	32	11	QPSK	2	1/6	1608	16	2	1	8448	4224
	25	30	64	11	QPSK	2	1/6	3240	16	2	1	16896	8448
	30	30	36	11	QPSK	2	1/6	1800	16	2	1	9504	4752
	30	30	75	11	QPSK	2	1/6	3752	16	2	1	19800	9900
	40	30	50	11	QPSK	2	1/6	2472	16	2	1	13200	6600
	40	30	100	11	QPSK	2	1/6	5000	24	2	2	26400	13200
	50	30	64	11	QPSK	2	1/6	3240	16	2	1	16896	8448
	50	30	128	11	QPSK	2	1/6	6408	24	2	2	33792	16896
	60	30	81	11	QPSK	2	1/6	4040	24	2	2	21384	10692
	60	30	162	11	QPSK	2	1/6	8064	24	2	3	42768	21384
	80	30	108	11	QPSK	2	1/6	5384	24	2	2	28512	14256
	80	30	216	11	QPSK	2	1/6	10752	24	2	3	57024	28512
	90	30	120	11	QPSK	2	1/6	5896	24	2	2	31680	15840
	90	30	243	11	QPSK	2	1/6	12040	24	2	4	64152	32076
	100	30	135	11	QPSK	2	1/6	6664	24	2	2	35640	17820
	100	30	270	11	QPSK	2	1/6	13320	24	2	4	71280	35640

NOTE 1: PUSCH mapping Type-A and single-symbol DM-RS configuration Type-1 with 2 additional DM-RS symbols, such that the DM-RS positions are set to symbols 2, 7, 11. DMRS is [TDM'ed] with PUSCH data.

NOTE 2: MCS Index is based on MCS table 6.1.4.1-1 defined in 38.214.

NOTE 3: If more than one Code Block is present, an additional CRC sequence of L = 24 Bits is attached to each Code Block (otherwise L = 0 Bit)

Table A.2.3.2-3: Reference channels for DFT-s-OFDM QPSK for 60kHz SCS

Parameter	Channel bandwidth	Subcarrier Spacing	Allocated resource blocks	DFT-s-OFDM Symbols per slot (Note 1)	Modulation	MCS Index (Note 2)	Target Coding Rate	Payload size for slots 4, 9, 14, 19, 24, 29, 34 and 39	Transport block CRC	LDPC Base Graph	Number of code blocks per slot for slots 4, 9, 14, 19, 24, 29, 34 and 39 (Note 3)	Total number of bits per slot for slots 4, 9, 14, 19, 24, 29, 34 and 39	Total modulated symbols per slot for slots 4, 9, 14, 19, 24, 29, 34 and 39
Unit	MHz	KHz						Bits	Bits			Bits	
	10-100	60	1	11	QPSK	2	1/6	56	16	2	1	264	132
	10	60	5	11	QPSK	2	1/6	256	16	2	1	1320	660
	10	60	10	11	QPSK	2	1/6	504	16	2	1	2640	1320
	15	60	9	11	QPSK	2	1/6	456	16	2	1	2376	1188
	15	60	18	11	QPSK	2	1/6	928	16	2	1	4752	2376
	20	60	12	11	QPSK	2	1/6	608	16	2	1	3168	1584
	20	60	24	11	QPSK	2	1/6	1192	16	2	1	6336	3168
	25	60	15	11	QPSK	2	1/6	768	16	2	1	3960	1980
	25	60	30	11	QPSK	2	1/6	1544	16	2	1	7920	3960
	30	60	18	11	QPSK	2	1/6	928	16	2	1	4752	2376
	30	60	36	11	QPSK	2	1/6	1800	16	2	1	9504	4752
	40	60	25	11	QPSK	2	1/6	1256	16	2	1	6600	3300
	40	60	50	11	QPSK	2	1/6	2472	16	2	1	13200	6600
	50	60	32	11	QPSK	2	1/6	1608	16	2	1	8448	4224
	50	60	64	11	QPSK	2	1/6	3240	16	2	1	16896	8448
	60	60	36	11	QPSK	2	1/6	1800	16	2	1	9504	4752
	60	60	75	11	QPSK	2	1/6	3752	16	2	1	19800	9900
	80	60	50	11	QPSK	2	1/6	2472	16	2	1	13200	6600
	80	60	100	11	QPSK	2	1/6	5000	24	2	2	26400	13200
	90	60	60	11	QPSK	2	1/6	3104	16	2	1	15840	7920
	90	60	120	11	QPSK	2	1/6	5896	24	2	2	31680	15840
	100	60	64	11	QPSK	2	1/6	3240	16	2	1	16896	8448
	100	60	135	11	QPSK	2	1/6	6664	24	2	2	35640	17820

NOTE 1: PUSCH mapping Type-A and single-symbol DM-RS configuration Type-1 with 2 additional DM-RS symbols, such that the DM-RS positions are set to symbols 2, 7, 11. DMRS is [TDM'ed] with PUSCH data.

NOTE 2: MCS Index is based on MCS table 6.1.4.1-1 defined in 38.214.

NOTE 3: If more than one Code Block is present, an additional CRC sequence of L = 24 Bits is attached to each Code Block (otherwise L = 0 Bit)

A.2.3.3 DFT-s-OFDM 16QAM

Table A.2.3.3-1: Reference channels for DFT-s-OFDM 16QAM for 15kHz SCS

Parameter	Channel bandwidth	Subcarrier Spacing	Allocated resource blocks	DFT-s-OFDM Symbols per slot (Note 1)	Modulation	MCS Index (Note 2)	Target Coding Rate	Payload size for slots 4 and 9	Transport block CRC	LDPC Base Graph	Number of code blocks per slot for slots 4 and 9 (Note 3)	Total number of bits per slot for slots 4 and 9	Total modulated symbols per slot for slots 4 and 9
Unit	MHz	KHz						Bits	Bits			Bits	
	5-50	15	1	11	16QAM	10	1/3	176	16	2	1	528	132
	5	15	12	11	16QAM	10	1/3	2088	16	2	1	6336	1584
	5	15	25	11	16QAM	10	1/3	4352	24	1	1	13200	3300
	10	15	25	11	16QAM	10	1/3	4352	24	1	1	13200	3300
	10	15	50	11	16QAM	10	1/3	8712	24	1	2	26400	6600
	15	15	36	11	16QAM	10	1/3	6272	24	1	1	19008	4752
	15	15	75	11	16QAM	10	1/3	13064	24	1	2	39600	9900
	20	15	50	11	16QAM	10	1/3	8712	24	1	2	26400	6600
	20	15	100	11	16QAM	10	1/3	17424	24	1	3	52800	13200
	25	15	64	11	16QAM	10	1/3	11272	24	1	2	33792	8448
	25	15	128	11	16QAM	10	1/3	22536	24	1	3	67584	16896
	30	15	80	11	16QAM	10	1/3	14088	24	1	2	42240	10560
	30	15	160	11	16QAM	10	1/3	28168	24	1	4	84480	21120
	40	15	108	11	16QAM	10	1/3	18960	24	1	3	57024	14256
	40	15	216	11	16QAM	10	1/3	37896	24	1	5	114048	28512
	50	15	135	11	16QAM	10	1/3	23568	24	1	3	71280	17820
	50	15	270	11	16QAM	10	1/3	47112	24	1	6	142560	35640

NOTE 1: PUSCH mapping Type-A and single-symbol DM-RS configuration Type-1 with 2 additional DM-RS symbols, such that the DM-RS positions are set to symbols 2, 7, 11. DMRS is [TDM'ed] with PUSCH data.

NOTE 2: MCS Index is based on MCS table 6.1.4.1-1 defined in 38.214.

NOTE 3: If more than one Code Block is present, an additional CRC sequence of L = 24 Bits is attached to each Code Block (otherwise L = 0 Bit)

Table A.2.3.3-2: Reference channels for DFT-s-OFDM 16QAM for 30kHz SCS

Parameter	Channel bandwidth	Subcarrier Spacing	Allocated resource blocks	DFT-s-OFDM Symbols per slot (Note 1)	Modulation	MCS Index (Note 2)	Target Coding Rate	Payload size for slots 8, 9, 18 and 19	Transport block CRC	LDPC Base Graph	Number of code blocks per slot for slots 8, 9, 18 and 19 (Note 3)	Total number of bits per slot for slots 8, 9, 18 and 19	Total modulated symbols per slot for slots 8, 9, 18 and 19
Unit	MHz	KHz						Bits	Bits			Bits	
	5-50	30	1	11	16QAM	10	1/3	176	16	2	1	528	132
	5	30	5	11	16QAM	10	1/3	888	16	2	1	2640	660
	5	30	10	11	16QAM	10	1/3	1800	16	2	1	5280	1320
	10	30	12	11	16QAM	10	1/3	2088	16	2	1	6336	1584
	10	30	24	11	16QAM	10	1/3	4224	24	1	1	12672	3168
	15	30	18	11	16QAM	10	1/3	3240	16	2	1	9504	2376
	15	30	36	11	16QAM	10	1/3	6272	24	1	1	19008	4752
	20	30	25	11	16QAM	10	1/3	4352	24	1	1	13200	3300
	20	30	50	11	16QAM	10	1/3	8712	24	1	2	26400	6600
	25	30	32	11	16QAM	10	1/3	5632	24	1	1	16896	4224
	25	30	64	11	16QAM	10	1/3	11272	24	1	2	33792	8448
	30	30	36	11	16QAM	10	1/3	6272	24	1	1	19008	4752
	30	30	75	11	16QAM	10	1/3	13064	24	1	2	39600	9900
	40	30	50	11	16QAM	10	1/3	8712	24	1	2	26400	6600
	40	30	100	11	16QAM	10	1/3	17424	24	1	3	52800	13200
	50	30	64	11	16QAM	10	1/3	11272	24	1	2	33792	8448
	50	30	128	11	16QAM	10	1/3	22536	24	1	3	67584	16896
	60	30	81	11	16QAM	10	1/3	14088	24	1	2	42768	10692
	60	30	162	11	16QAM	10	1/3	28168	24	1	4	85536	21384
	80	30	108	11	16QAM	10	1/3	18960	24	1	3	57024	14256
	80	30	216	11	16QAM	10	1/3	37896	24	1	5	114048	28512
	90	30	120	11	16QAM	10	1/3	21000	24	1	3	63360	15840
	90	30	243	11	16QAM	10	1/3	43032	24	1	6	128304	32076
	100	30	135	11	16QAM	10	1/3	23568	24	1	3	71280	17820
	100	30	270	11	16QAM	10	1/3	47112	24	1	6	142560	35640

NOTE 1: PUSCH mapping Type-A and single-symbol DM-RS configuration Type-1 with 2 additional DM-RS symbols, such that the DM-RS positions are set to symbols 2, 7, 11. DMRS is [TDM'ed] with PUSCH data.
 NOTE 2: MCS Index is based on MCS table 6.1.4.1-1 defined in 38.214.
 NOTE 3: If more than one Code Block is present, an additional CRC sequence of L = 24 Bits is attached to each Code Block (otherwise L = 0 Bit)

Table A.2.3.3-3: Reference channels for DFT-s-OFDM 16QAM for 60kHz SCS

Parameter	Channel bandwidth	Subcarrier Spacing	Allocated resource blocks	DFT-s-OFDM Symbols per slot (Note 1)	Modulation	MCS Index (Note 2)	Target Coding Rate	Payload size for slots 4, 9, 14, 19, 24, 29, 34 and 39	Transport block CRC	LDPC Base Graph	Number of code blocks per slot for slots 4, 9, 14, 19, 24, 29, 34 and 39 (Note 3)	Total number of bits per slot for slots 4, 9, 14, 19, 24, 29, 34 and 39	Total modulated symbols per slot for slots 4, 9, 14, 19, 24, 29, 34 and 39
Unit	MHz	KHz						Bits	Bits			Bits	
	10-100	60	1	11	16QAM	10	1/3	176	16	2	1	528	132
	10	60	5	11	16QAM	10	1/3	888	16	2	1	2640	660
	10	60	10	11	16QAM	10	1/3	1800	16	2	1	5280	1320
	15	60	9	11	16QAM	10	1/3	1608	16	2	1	4752	1188
	15	60	18	11	16QAM	10	1/3	3240	16	2	1	9504	2376
	20	60	12	11	16QAM	10	1/3	2088	16	2	1	6336	1584
	20	60	24	11	16QAM	10	1/3	4224	24	1	1	12672	3168
	25	60	15	11	16QAM	10	1/3	2664	16	2	1	7920	1980
	25	60	30	11	16QAM	10	1/3	5248	24	1	1	15840	3960
	30	60	18	11	16QAM	10	1/3	3240	16	2	1	9504	2376
	30	60	36	11	16QAM	10	1/3	6272	24	1	1	19008	4752
	40	60	25	11	16QAM	10	1/3	4352	24	1	1	13200	3300
	40	60	50	11	16QAM	10	1/3	8712	24	1	2	26400	6600
	50	60	32	11	16QAM	10	1/3	5632	24	1	1	16896	4224
	50	60	64	11	16QAM	10	1/3	11272	24	1	2	33792	8448
	60	60	36	11	16QAM	10	1/3	6272	24	1	1	19008	4752
	60	60	75	11	16QAM	10	1/3	13064	24	1	2	39600	9900
	80	60	50	11	16QAM	10	1/3	8712	24	1	2	26400	6600
	80	60	100	11	16QAM	10	1/3	17424	24	1	3	52800	13200
	90	60	60	11	16QAM	10	1/3	10504	24	1	2	31680	7920
	90	60	120	11	16QAM	10	1/3	21000	24	1	3	63360	15840
	100	60	64	11	16QAM	10	1/3	11272	24	1	2	33792	8448
	100	60	135	11	16QAM	10	1/3	23568	24	1	3	71280	17820

NOTE 1: PUSCH mapping Type-A and single-symbol DM-RS configuration Type-1 with 2 additional DM-RS symbols, such that the DM-RS positions are set to symbols 2, 7, 11. DMRS is [TDM'ed] with PUSCH data.

NOTE 2: MCS Index is based on MCS table 6.1.4.1-1 defined in 38.214.

NOTE 3: If more than one Code Block is present, an additional CRC sequence of L = 24 Bits is attached to each Code Block (otherwise L = 0 Bit)

A.2.3.4 DFT-s-OFDM 64QAM

Table A.2.3.4-1: Reference channels for DFT-s-OFDM 64QAM for 15kHz SCS

Parameter	Channel bandwidth	Subcarrier Spacing	Allocated resource blocks	DFT-s-OFDM Symbols per slot (Note 1)	Modulation	MCS Index (Note 2)	Target Coding Rate	Payload size for slots 4 and 9	Transport block CRC	LDPC Base Graph	Number of code blocks per slot for slots 4 and 9 (Note 3)	Total number of bits per slot for slots 4 and 9	Total modulated symbols per slot for slots 4 and 9
Unit	MHz	KHz						Bits	Bits			Bits	
	5	15	25	11	64QAM	18	1/2	9992	24	1	2	19800	3300
	10	15	50	11	64QAM	18	1/2	19968	24	1	3	39600	6600
	15	15	75	11	64QAM	18	1/2	30216	24	1	4	59400	9900
	20	15	100	11	64QAM	18	1/2	39936	24	1	5	79200	13200
	25	15	128	11	64QAM	18	1/2	51216	24	1	7	101376	16896
	30	15	160	11	64QAM	18	1/2	63528	24	1	8	126720	21120
	40	15	216	11	64QAM	18	1/2	86040	24	1	11	171072	28512
	50	15	270	11	64QAM	18	1/2	108552	24	1	13	213840	35640

NOTE 1: PUSCH mapping Type-A and single-symbol DM-RS configuration Type-1 with 2 additional DM-RS symbols, such that the DM-RS positions are set to symbols 2, 7, 11. DMRS is [TDM'ed] with PUSCH data.

NOTE 2: MCS Index is based on MCS table 6.1.4.1-1 defined in 38.214.

NOTE 3: If more than one Code Block is present, an additional CRC sequence of L = 24 Bits is attached to each Code Block (otherwise L = 0 Bit)

Table A.2.3.4-2: Reference channels for DFT-s-OFDM 64QAM for 30kHz SCS

Parameter	Channel bandwidth	Subcarrier Spacing	Allocated resource blocks	DFT-s-OFDM Symbols per slot (Note 1)	Modulation	MCS Index (Note 2)	Target Coding Rate	Payload size for slots 8, 9, 18 and 19	Transport block CRC	LDPC Base Graph	Number of code blocks per slot for slots 8, 9, 18 and 19 (Note 3)	Total number of bits per slot for slots 8, 9, 18 and 19	Total modulated symbols per slot for slots 8, 9, 18 and 19
Unit	MHz	KHz						Bits	Bits			Bits	
	5	30	10	11	64QAM	18	1/2	3968	24	1	1	7920	1320
	10	30	24	11	64QAM	18	1/2	9480	24	1	2	19008	3168
	15	30	36	11	64QAM	18	1/2	14344	24	1	2	28512	4752
	20	30	50	11	64QAM	18	1/2	19968	24	1	3	39600	6600
	25	30	64	11	64QAM	18	1/2	25608	24	1	4	50688	8448
	30	30	75	11	64QAM	18	1/2	30216	24	1	4	59400	9900
	40	30	100	11	64QAM	18	1/2	39936	24	1	5	79200	13200
	50	30	128	11	64QAM	18	1/2	51216	24	1	7	101376	16896
	60	30	162	11	64QAM	18	1/2	64552	24	1	8	128304	21384
	80	30	216	11	64QAM	18	1/2	86040	24	1	11	171072	28512
	90	30	243	11	64QAM	18	1/2	96264	24	1	12	192456	32076
	100	30	270	11	64QAM	18	1/2	108552	24	1	13	213840	35640

NOTE 1: PUSCH mapping Type-A and single-symbol DM-RS configuration Type-1 with 2 additional DM-RS symbols, such that the DM-RS positions are set to symbols 2, 7, 11. DMRS is [TDM'ed] with PUSCH data.

NOTE 2: MCS Index is based on MCS table 6.1.4.1-1 defined in 38.214.

NOTE 3: If more than one Code Block is present, an additional CRC sequence of L = 24 Bits is attached to each Code Block (otherwise L = 0 Bit)

Table A.2.3.4-3: Reference channels for DFT-s-OFDM 64QAM for 60kHz SCS

Parameter	Channel bandwidth	Subcarrier Spacing	Allocated resource blocks	DFT-s-OFDM Symbols per slot (Note 1)	Modulation	MCS Index (Note 2)	Target Coding Rate	Payload size for slots 4, 9, 14, 19, 24, 29, 34 and 39	Transport block CRC	LDPC Base Graph	Number of code blocks per slot for slots 4, 9, 14, 19, 24, 29, 34 and 39 (Note 3)	Total number of bits per slot for slots 4, 9, 14, 19, 24, 29, 34 and 39	Total modulated symbols per slot for slots 4, 9, 14, 19, 24, 29, 34 and 39
Unit	MHz	KHz						Bits	Bits			Bits	
	10	60	10	11	64QAM	18	1/2	3968	24	1	1	7920	1320
	15	60	18	11	64QAM	18	1/2	7168	24	1	1	14256	2376
	20	60	24	11	64QAM	18	1/2	9480	24	1	2	19008	3168
	25	60	30	11	64QAM	18	1/2	12040	24	1	2	23760	3960
	30	60	36	11	64QAM	18	1/2	14344	24	1	2	28512	4752
	40	60	50	11	64QAM	18	1/2	19968	24	1	3	39600	6600
	50	60	64	11	64QAM	18	1/2	25608	24	1	4	50688	8448
	60	60	75	11	64QAM	18	1/2	30216	24	1	4	59400	9900
	80	60	100	11	64QAM	18	1/2	39936	24	1	5	79200	13200
	90	60	120	11	64QAM	18	1/2	48168	24	1	6	95040	15840
	100	60	135	11	64QAM	18	1/2	54296	24	1	7	106920	17820

NOTE 1: PUSCH mapping Type-A and single-symbol DM-RS configuration Type-1 with 2 additional DM-RS symbols, such that the DM-RS positions are set to symbols 2, 7, 11. DMRS is [TDM'ed] with PUSCH data.

NOTE 2: MCS Index is based on MCS table 6.1.4.1-1 defined in 38.214.

NOTE 3: If more than one Code Block is present, an additional CRC sequence of L = 24 Bits is attached to each Code Block (otherwise L = 0 Bit)

A.2.3.5 DFT-s-OFDM 256QAM

Table A.2.3.5-1: Reference channels for DFT-s-OFDM 256QAM for 15kHz SCS

Parameter	Channel bandwidth	Subcarrier Spacing	Allocated resource blocks	DFT-s-OFDM Symbols per slot (Note 1)	Modulation	MCS Index (Note 2)	Target Coding Rate	Payload size for slots 4 and 9	Transport block CRC	LDPC Base Graph	Number of code blocks per slot for slots 4 and 9 (Note 3)	Total number of bits per slot for slots 4 and 9	Total modulated symbols per slot for slots 4 and 9
Unit	MHz	KHz						Bits	Bits			Bits	
	5	15	25	11	256QAM	20	2/3	17424	24	1	3	26400	3300
	10	15	50	11	256QAM	20	2/3	34816	24	1	5	52800	6600
	15	15	75	11	256QAM	20	2/3	53288	24	1	7	79200	9900
	20	15	100	11	256QAM	20	2/3	69672	24	1	9	105600	13200
	25	15	128	11	256QAM	20	2/3	90176	24	1	11	135168	16896
	30	15	160	11	256QAM	20	2/3	112648	24	1	14	168960	21120
	40	15	216	11	256QAM	20	2/3	151608	24	1	18	228096	28512
	50	15	270	11	256QAM	20	2/3	188576	24	1	23	285120	35640

NOTE 1: PUSCH mapping Type-A and single-symbol DM-RS configuration Type-1 with 2 additional DM-RS symbols, such that the DM-RS positions are set to symbols 2, 7, 11. DMRS is [TDM'ed] with PUSCH data.

NOTE 2: MCS Index is based on MCS table 5.1.3.1-2 defined in 38.214.

NOTE 3: If more than one Code Block is present, an additional CRC sequence of L = 24 Bits is attached to each Code Block (otherwise L = 0 Bit)

Table A.2.3.5-2: Reference channels for DFT-s-OFDM 256QAM for 30kHz SCS

Parameter	Channel bandwidth	Subcarrier Spacing	Allocated resource blocks	DFT-s-OFDM Symbols per slot (Note 1)	Modulation	MCS Index (Note 2)	Target Coding Rate	Payload size for slots 8, 9, 18 and 19	Transport block CRC	LDPC Base Graph	Number of code blocks per slot for slots 8, 9, 18 and 19 (Note 3)	Total number of bits per slot for slots 8, 9, 18 and 19	Total modulated symbols per slot for slots 8, 9, 18 and 19
Unit	MHz	KHz						Bits	Bits			Bits	
	5	30	10	11	256QAM	20	2/3	7040	24	1	1	10560	1320
	10	30	24	11	256QAM	20	2/3	16896	24	1	3	25344	3168
	15	30	36	11	256QAM	20	2/3	25104	24	1	3	38016	4752
	20	30	50	11	256QAM	20	2/3	34816	24	1	5	52800	6600
	25	30	64	11	256QAM	20	2/3	45096	24	1	6	67584	8448
	30	30	75	11	256QAM	20	2/3	53288	24	1	7	79200	9900
	40	30	100	11	256QAM	20	2/3	69672	24	1	9	105600	13200
	50	30	128	11	256QAM	20	2/3	90176	24	1	11	135168	16896
	60	30	162	11	256QAM	20	2/3	114776	24	1	14	171072	21384
	80	30	216	11	256QAM	20	2/3	151608	24	1	18	228096	28512
	90	30	243	11	256QAM	20	2/3	172176	24	1	21	256608	32076
	100	30	270	11	256QAM	20	2/3	188576	24	1	23	285120	35640

NOTE 1: PUSCH mapping Type-A and single-symbol DM-RS configuration Type-1 with 2 additional DM-RS symbols, such that the DM-RS positions are set to symbols 2, 7, 11. DMRS is [TDM'ed] with PUSCH data.

NOTE 2: MCS Index is based on MCS table 5.1.3.1-2 defined in 38.214.

NOTE 3: If more than one Code Block is present, an additional CRC sequence of L = 24 Bits is attached to each Code Block (otherwise L = 0 Bit)

Table A.2.3.5-3: Reference channels for DFT-s-OFDM 256QAM for 60kHz SCS

Parameter	Channel bandwidth	Subcarrier Spacing	Allocated resource blocks	DFT-s-OFDM Symbols per slot (Note 1)	Modulation	MCS Index (Note 2)	Target Coding Rate	Payload size for slots 4, 9, 14, 19, 24, 29, 34 and 39	Transport block CRC	LDPC Base Graph	Number of code blocks per slot for slots 4, 9, 14, 19, 24, 29, 34 and 39 (Note 3)	Total number of bits per slot for slots 4, 9, 14, 19, 24, 29, 34 and 39	Total modulated symbols per slot for slots 4, 9, 14, 19, 24, 29, 34 and 39
Unit	MHz	KHz						Bits	Bits			Bits	
	10	60	10	11	256QAM	20	2/3	7040	24	1	1	10560	1320
	15	60	18	11	256QAM	20	2/3	12552	24	1	2	19008	2376
	20	60	24	11	256QAM	20	2/3	16896	24	1	3	25344	3168
	25	60	30	11	256QAM	20	2/3	21000	24	1	3	31680	3960
	30	60	36	11	256QAM	20	2/3	25104	24	1	3	38016	4752
	40	60	50	11	256QAM	20	2/3	34816	24	1	5	52800	6600
	50	60	64	11	256QAM	20	2/3	45096	24	1	6	67584	8448
	60	60	75	11	256QAM	20	2/3	53288	24	1	7	79200	9900
	80	60	100	11	256QAM	20	2/3	69672	24	1	9	105600	13200
	90	60	120	11	256QAM	20	2/3	83976	24	1	10	126720	15840
	100	60	135	11	256QAM	20	2/3	94248	24	1	12	142560	17820

NOTE 1: PUSCH mapping Type-A and single-symbol DM-RS configuration Type-1 with 2 additional DM-RS symbols, such that the DM-RS positions are set to symbols 2, 7, 11. DMRS is [TDM'ed] with PUSCH data.

NOTE 2: MCS Index is based on MCS table 5.1.3.1-2 defined in 38.214.

NOTE 3: If more than one Code Block is present, an additional CRC sequence of L = 24 Bits is attached to each Code Block (otherwise L = 0 Bit)

A.2.3.6 CP-OFDM QPSK

Table A.2.3.6-1: Reference channels for CP-OFDM QPSK for 15kHz SCS

Parameter	Channel bandwidth	Subcarrier Spacing	Allocated resource blocks	CP-OFDM Symbols per slot (Note 1)	Modulation	MCS Index (Note 2)	Target Coding Rate	Payload size for slots 4 and 9	Transport block CRC	LDPC Base Graph	Number of code blocks per slot for slots 4 and 9 (Note 3)	Total number of bits per slot for slots 4 and 9	Total modulated symbols per slot for slots 4 and 9
Unit	MHz	KHz						Bits	Bits			Bits	
	5-50	15	1	11	QPSK	2	1/6	56	16	2	1	264	132
	5	15	13	11	QPSK	2	1/6	672	16	2	1	3432	1716
	5	15	25	11	QPSK	2	1/6	1256	16	2	1	6600	3300
	10	15	26	11	QPSK	2	1/6	1288	16	2	1	6864	3432
	10	15	52	11	QPSK	2	1/6	2600	16	2	1	13728	6864
	15	15	40	11	QPSK	2	1/6	2024	16	2	1	10560	5280
	15	15	79	11	QPSK	2	1/6	3912	24	2	2	20856	10428
	20	15	53	11	QPSK	2	1/6	2664	16	2	1	13992	6996
	20	15	106	11	QPSK	2	1/6	5256	24	2	2	27984	13992
	25	15	67	11	QPSK	2	1/6	3368	16	2	1	17688	8844
	25	15	133	11	QPSK	2	1/6	6664	24	2	2	35112	17556
	30	15	80	11	QPSK	2	1/6	3976	24	2	2	21120	10560
	30	15	160	11	QPSK	2	1/6	7944	24	2	3	42240	21120
	40	15	108	11	QPSK	2	1/6	5384	24	2	2	28512	14256
	40	15	216	11	QPSK	2	1/6	10752	24	2	3	57024	28512
	50	15	135	11	QPSK	2	1/6	6664	24	2	2	35640	17820
	50	15	270	11	QPSK	2	1/6	13320	24	2	4	71280	35640

NOTE 1: PUSCH mapping Type-A and single-symbol DM-RS configuration Type-1 with 2 additional DM-RS symbols, such that the DM-RS positions are set to symbols 2, 7, 11. DMRS is [TDM'ed] with PUSCH data.

NOTE 2: MCS Index is based on MCS table 5.1.3.1-1 defined in 38.214.

NOTE 3: If more than one Code Block is present, an additional CRC sequence of L = 24 Bits is attached to each Code Block (otherwise L = 0 Bit)

Table A.2.3.6-2: Reference channels for CP-OFDM QPSK for 30kHz SCS

Parameter	Channel bandwidth	Subcarrier Spacing	Allocated resource blocks	CP-OFDM Symbols per slot (Note 1)	Modulation	MCS Index (Note 2)	Target Coding Rate	Payload size for slots 8, 9, 18 and 19	Transport block CRC	LDPC Base Graph	Number of code blocks per slot for slots 8, 9, 18 and 19 (Note 3)	Total number of bits per slot for slots 8, 9, 18 and 19	Total modulated symbols per slot for slots 8, 9, 18 and 19
Unit	MHz	KHz						Bits	Bits			Bits	
	5-50	30	1	11	QPSK	2	1/6	56	16	2	1	264	132
	5	30	6	11	QPSK	2	1/6	304	16	2	1	1584	792
	5	30	11	11	QPSK	2	1/6	552	16	2	1	2904	1452
	10	30	12	11	QPSK	2	1/6	608	16	2	1	3168	1584
	10	30	24	11	QPSK	2	1/6	1192	16	2	1	6336	3168
	15	30	19	11	QPSK	2	1/6	984	16	2	1	5016	2508
	15	30	38	11	QPSK	2	1/6	1928	16	2	1	10032	5016
	20	30	26	11	QPSK	2	1/6	1288	16	2	1	6864	3432
	20	30	51	11	QPSK	2	1/6	2536	16	2	1	13464	6732
	25	30	33	11	QPSK	2	1/6	1672	16	2	1	8712	4356
	25	30	65	11	QPSK	2	1/6	3240	16	2	1	17160	8580
	30	30	39	11	QPSK	2	1/6	2024	16	2	1	10296	5148
	30	30	78	11	QPSK	2	1/6	3848	24	2	2	20592	10296
	40	30	53	11	QPSK	2	1/6	2664	16	2	1	13992	6996
	40	30	106	11	QPSK	2	1/6	5256	24	2	2	27984	13992
	50	30	67	11	QPSK	2	1/6	3368	16	2	1	17688	8844
	50	30	133	11	QPSK	2	1/6	6664	24	2	2	35112	17556
	60	30	81	11	QPSK	2	1/6	4040	24	2	2	21384	10692
	60	30	162	11	QPSK	2	1/6	8064	24	2	3	42768	21384
	80	30	109	11	QPSK	2	1/6	5384	24	2	2	28776	14388
	80	30	217	11	QPSK	2	1/6	10752	24	2	3	57288	28644
	90	30	123	11	QPSK	2	1/6	6152	24	2	2	32472	16236
	90	30	245	11	QPSK	2	1/6	12296	24	2	4	64680	32340
	100	30	137	11	QPSK	2	1/6	6792	24	2	2	36168	18084
	100	30	273	11	QPSK	2	1/6	13576	24	2	4	72072	36036

NOTE 1: PUSCH mapping Type-A and single-symbol DM-RS configuration Type-1 with 2 additional DM-RS symbols, such that the DM-RS positions are set to symbols 2, 7, 11. DMRS is [TDM'ed] with PUSCH data.

NOTE 2: MCS Index is based on MCS table 5.1.3.1-1 defined in 38.214.

NOTE 3: If more than one Code Block is present, an additional CRC sequence of L = 24 Bits is attached to each Code Block (otherwise L = 0 Bit)

Table A.2.3.6-3: Reference channels for CP-OFDM QPSK for 60kHz SCS

Parameter	Channel bandwidth	Subcarrier Spacing	Allocated resource blocks	CP-OFDM Symbols per slot (Note 1)	Modulation	MCS Index (Note 2)	Target Coding Rate	Payload size for slots 4, 9, 14, 19, 24, 29, 34 and 39	Transport block CRC	LDPC Base Graph	Number of code blocks per slot for slots 4, 9, 14, 19, 24, 29, 34 and 39 (Note 3)	Total number of bits per slot for slots 4, 9, 14, 19, 24, 29, 34 and 39	Total modulated symbols per slot for slots 4, 9, 14, 19, 24, 29, 34 and 39
Unit	MHz	KHz						Bits	Bits			Bits	
	10-100	60	1	11	QPSK	2	1/6	56	16	2	1	264	132
	10	60	6	11	QPSK	2	1/6	304	16	2	1	1584	792
	10	60	11	11	QPSK	2	1/6	552	16	2	1	2904	1452
	15	60	9	11	QPSK	2	1/6	456	16	2	1	2376	1188
	15	60	18	11	QPSK	2	1/6	928	16	2	1	4752	2376
	20	60	12	11	QPSK	2	1/6	608	16	2	1	3168	1584
	20	60	24	11	QPSK	2	1/6	1192	16	2	1	6336	3168
	25	60	16	11	QPSK	2	1/6	808	16	2	1	4224	2112
	25	60	31	11	QPSK	2	1/6	1544	16	2	1	8184	4092
	30	60	19	11	QPSK	2	1/6	984	16	2	1	5016	2508
	30	60	38	11	QPSK	2	1/6	1928	16	2	1	10032	5016
	40	60	26	11	QPSK	2	1/6	1288	16	2	1	6864	3432
	40	60	51	11	QPSK	2	1/6	2536	16	2	1	13464	6732
	50	60	33	11	QPSK	2	1/6	1672	16	2	1	8712	4356
	50	60	65	11	QPSK	2	1/6	3240	16	2	1	17160	8580
	60	60	40	11	QPSK	2	1/6	2024	16	2	1	10560	5280
	60	60	79	11	QPSK	2	1/6	3912	24	2	2	20856	10428
	80	60	54	11	QPSK	2	1/6	2664	16	2	1	14256	7128
	80	60	107	11	QPSK	2	1/6	5256	24	2	2	28248	14124
	90	60	61	11	QPSK	2	1/6	3104	16	2	1	16104	8052
	90	60	121	11	QPSK	2	1/6	6024	24	2	2	31944	15972
	100	60	68	11	QPSK	2	1/6	3368	16	2	1	17952	8976
	100	60	135	11	QPSK	2	1/6	6664	24	2	2	35640	17820

NOTE 1: PUSCH mapping Type-A and single-symbol DM-RS configuration Type-1 with 2 additional DM-RS symbols, such that the DM-RS positions are set to symbols 2, 7, 11. DMRS is [TDM'ed] with PUSCH data.

NOTE 2: MCS Index is based on MCS table 5.1.3.1-1 defined in 38.214.

NOTE 3: If more than one Code Block is present, an additional CRC sequence of L = 24 Bits is attached to each Code Block (otherwise L = 0 Bit)

A.2.3.7 CP-OFDM 16QAM

Table A.2.3.7-1: Reference channels for CP-OFDM 16QAM for 15kHz SCS

Parameter	Channel bandwidth	Subcarrier Spacing	Allocated resource blocks	CP-OFDM Symbols per slot (Note 1)	Modulation	MCS Index (Note 2)	Target Coding Rate	Payload size for slots 4 and 9	Transport block CRC	LDPC Base Graph	Number of code blocks per slot for slots 4 and 9 (Note 3)	Total number of bits per slot for slots 4 and 9	Total modulated symbols per slot for slots 4 and 9
Unit	MHz	KHz						Bits	Bits			Bits	
	5-50	15	1	11	16QAM	10	1/3	176	16	2	1	528	132
	5	15	13	11	16QAM	10	1/3	2280	16	2	1	6864	1716
	5	15	25	11	16QAM	10	1/3	4352	24	1	1	13200	3300
	10	15	26	11	16QAM	10	1/3	4480	24	1	1	13728	3432
	10	15	52	11	16QAM	10	1/3	9224	24	1	2	27456	6864
	15	15	40	11	16QAM	10	1/3	7040	24	1	1	21120	5280
	15	15	79	11	16QAM	10	1/3	13832	24	1	2	41712	10428
	20	15	53	11	16QAM	10	1/3	9224	24	1	2	27984	6996
	20	15	106	11	16QAM	10	1/3	18432	24	1	3	55968	13992
	25	15	67	11	16QAM	10	1/3	11784	24	1	2	35376	8844
	25	15	133	11	16QAM	10	1/3	23040	24	1	3	70224	17556
	30	15	80	11	16QAM	10	1/3	14088	24	1	2	42240	10560
	30	15	160	11	16QAM	10	1/3	28168	24	1	4	84480	21120
	40	15	108	11	16QAM	10	1/3	18960	24	1	3	57024	14256
	40	15	216	11	16QAM	10	1/3	37896	24	1	5	114048	28512
	50	15	135	11	16QAM	10	1/3	23568	24	1	3	71280	17820
	50	15	270	11	16QAM	10	1/3	47112	24	1	6	142560	35640

NOTE 1: PUSCH mapping Type-A and single-symbol DM-RS configuration Type-1 with 2 additional DM-RS symbols, such that the DM-RS positions are set to symbols 2, 7, 11. DMRS is [TDM'ed] with PUSCH data.

NOTE 2: MCS Index is based on MCS table 5.1.3.1-1 defined in 38.214.

NOTE 3: If more than one Code Block is present, an additional CRC sequence of L = 24 Bits is attached to each Code Block (otherwise L = 0 Bit)

Table A.2.3.7-2: Reference channels for CP-OFDM 16QAM for 30kHz SCS

Parameter	Channel bandwidth	Subcarrier Spacing	Allocated resource blocks	CP-OFDM Symbols per slot (Note 1)	Modulation	MCS Index (Note 2)	Target Coding Rate	Payload size for slots 8, 9, 18 and 19	Transport block CRC	LDPC Base Graph	Number of code blocks per slot for slots 8, 9, 18 and 19 (Note 3)	Total number of bits per slot for slots 8, 9, 18 and 19	Total modulated symbols per slot for slots 8, 9, 18 and 19
Unit	MHz	KHz						Bits	Bits			Bits	
	5-50	30	1	11	16QAM	10	1/3	176	16	2	1	528	132
	5	30	6	11	16QAM	10	1/3	1064	16	2	1	3168	792
	5	30	11	11	16QAM	10	1/3	1928	16	2	1	5808	1452
	10	30	12	11	16QAM	10	1/3	2088	16	2	1	6336	1584
	10	30	24	11	16QAM	10	1/3	4224	24	1	1	12672	3168
	15	30	19	11	16QAM	10	1/3	3368	16	2	1	10032	2508
	15	30	38	11	16QAM	10	1/3	6656	24	1	1	20064	5016
	20	30	26	11	16QAM	10	1/3	4480	24	1	1	13728	3432
	20	30	51	11	16QAM	10	1/3	8968	24	1	2	26928	6732
	25	30	33	11	16QAM	10	1/3	5760	24	1	1	17424	4356
	25	30	65	11	16QAM	10	1/3	11272	24	1	2	34320	8580
	30	30	39	11	16QAM	10	1/3	6784	24	1	1	20592	5148
	30	30	78	11	16QAM	10	1/3	13576	24	1	2	41184	10296
	40	30	53	11	16QAM	10	1/3	9224	24	1	2	27984	6996
	40	30	106	11	16QAM	10	1/3	18432	24	1	3	55968	13992
	50	30	67	11	16QAM	10	1/3	11784	24	1	2	35376	8844
	50	30	133	11	16QAM	10	1/3	23040	24	1	3	70224	17556
	60	30	81	11	16QAM	10	1/3	14088	24	1	2	42768	10692
	60	30	162	11	16QAM	10	1/3	28168	24	1	4	85536	21384
	80	30	109	11	16QAM	10	1/3	18960	24	1	3	57552	14388
	80	30	217	11	16QAM	10	1/3	37896	24	1	5	114576	28644
	90	30	123	11	16QAM	10	1/3	21504	24	1	3	64944	16236
	90	30	245	11	16QAM	10	1/3	43032	24	1	6	129360	32340
	100	30	137	11	16QAM	10	1/3	24072	24	1	3	72336	18084
	100	30	273	11	16QAM	10	1/3	48168	24	1	6	144144	36036

NOTE 1: PUSCH mapping Type-A and single-symbol DM-RS configuration Type-1 with 2 additional DM-RS symbols, such that the DM-RS positions are set to symbols 2, 7, 11. DMRS is [TDM'ed] with PUSCH data.

NOTE 2: MCS Index is based on MCS table 5.1.3.1-1 defined in 38.214.

NOTE 3: If more than one Code Block is present, an additional CRC sequence of L = 24 Bits is attached to each Code Block (otherwise L = 0 Bit)

Table A.2.3.7-3: Reference channels for CP-OFDM 16QAM for 60kHz SCS

Parameter	Channel bandwidth	Subcarrier Spacing	Allocated resource blocks	CP-OFDM Symbols per slot (Note 1)	Modulation	MCS Index (Note 2)	Target Coding Rate	Payload size for slots 4, 9, 14, 19, 24, 29, 34 and 39	Transport block CRC	LDPC Base Graph	Number of code blocks per slot for slots 4, 9, 14, 19, 24, 29, 34 and 39 (Note 3)	Total number of bits per slot for slots 4, 9, 14, 19, 24, 29, 34 and 39	Total modulated symbols per slot for slots 4, 9, 14, 19, 24, 29, 34 and 39
Unit	MHz	KHz						Bits	Bits			Bits	
	10-100	60	1	11	16QAM	10	1/3	176	16	2	1	528	132
	10	60	6	11	16QAM	10	1/3	1064	16	2	1	3168	792
	10	60	11	11	16QAM	10	1/3	1928	16	2	1	5808	1452
	15	60	9	11	16QAM	10	1/3	1608	16	2	1	4752	1188
	15	60	18	11	16QAM	10	1/3	3240	16	2	1	9504	2376
	20	60	12	11	16QAM	10	1/3	2088	16	2	1	6336	1584
	20	60	24	11	16QAM	10	1/3	4224	24	1	1	12672	3168
	25	60	16	11	16QAM	10	1/3	2792	16	2	1	8448	2112
	25	60	31	11	16QAM	10	1/3	5376	24	1	1	16368	4092
	30	60	19	11	16QAM	10	1/3	3368	16	2	1	10032	2508
	30	60	38	11	16QAM	10	1/3	6656	24	1	1	20064	5016
	40	60	26	11	16QAM	10	1/3	4480	24	1	1	13728	3432
	40	60	51	11	16QAM	10	1/3	8968	24	1	2	26928	6732
	50	60	33	11	16QAM	10	1/3	5760	24	1	1	17424	4356
	50	60	65	11	16QAM	10	1/3	11272	24	1	2	34320	8580
	60	60	40	11	16QAM	10	1/3	7040	24	1	1	21120	5280
	60	60	79	11	16QAM	10	1/3	13832	24	1	2	41712	10428
	80	60	54	11	16QAM	10	1/3	9480	24	1	2	28512	7128
	80	60	107	11	16QAM	10	1/3	18960	24	1	3	56496	14124
	90	60	61	11	16QAM	10	1/3	10760	24	1	2	32208	8052
	90	60	121	11	16QAM	10	1/3	21000	24	1	3	63888	15972
	100	60	68	11	16QAM	10	1/3	11784	24	1	2	35904	8976
	100	60	135	11	16QAM	10	1/3	23568	24	1	3	71280	17820

NOTE 1: PUSCH mapping Type-A and single-symbol DM-RS configuration Type-1 with 2 additional DM-RS symbols, such that the DM-RS positions are set to symbols 2, 7, 11. DMRS is [TDM'ed] with PUSCH data.

NOTE 2: MCS Index is based on MCS table 5.1.3.1-1 defined in 38.214.

NOTE 3: If more than one Code Block is present, an additional CRC sequence of L = 24 Bits is attached to each Code Block (otherwise L = 0 Bit)

A.2.3.8 CP-OFDM 64QAM

Table A.2.3.8-1: Reference channels for CP-OFDM 64QAM for 15kHz SCS

Parameter	Channel bandwidth	Subcarrier Spacing	Allocated resource blocks	CP-OFDM Symbols per slot (Note 1)	Modulation	MCS Index (Note 2)	Target Coding Rate	Payload size for slots 4 and 9	Transport block CRC	LDPC Base Graph	Number of code blocks per slot for slots 4 and 9 (Note 3)	Total number of bits per slot for slots 4 and 9	Total modulated symbols per slot for slots 4 and 9
Unit	MHz	KHz						Bits	Bits			Bits	
	5	15	25	11	64QAM	19	1/2	9992	24	1	2	19800	3300
	10	15	52	11	64QAM	19	1/2	21000	24	1	3	41184	6864
	15	15	79	11	64QAM	19	1/2	31752	24	1	4	62568	10428
	20	15	106	11	64QAM	19	1/2	42016	24	1	5	83952	13992
	25	15	133	11	64QAM	19	1/2	53288	24	1	7	105336	17556
	30	15	160	11	64QAM	19	1/2	63528	24	1	8	126720	21120
	40	15	216	11	64QAM	19	1/2	86040	24	1	11	171072	28512
	50	15	270	11	64QAM	19	1/2	108552	24	1	13	213840	35640

NOTE 1: PUSCH mapping Type-A and single-symbol DM-RS configuration Type-1 with 2 additional DM-RS symbols, such that the DM-RS positions are set to symbols 2, 7, 11. DMRS is [TDM'ed] with PUSCH data

NOTE 2: MCS Index is based on MCS table 5.1.3.1-1 defined in 38.214.

NOTE 3: If more than one Code Block is present, an additional CRC sequence of L = 24 Bits is attached to each Code Block (otherwise L = 0 Bit)

Table A.2.3.8-2: Reference channels for CP-OFDM 64QAM for 30kHz SCS

Parameter	Channel bandwidth	Subcarrier Spacing	Allocated resource blocks	CP-OFDM Symbols per slot (Note 1)	Modulation	MCS Index (Note 2)	Target Coding Rate	Payload size for slots 8, 9, 18 and 19	Transport block CRC	LDPC Base Graph	Number of code blocks per slot for slots 8, 9, 18 and 19 (Note 3)	Total number of bits per slot for slots 8, 9, 18 and 19	Total modulated symbols per slot for slots 8, 9, 18 and 19
Unit	MHz	KHz						Bits	Bits			Bits	
	5	30	11	11	64QAM	19	1/2	4352	24	1	1	8712	1452
	10	30	24	11	64QAM	19	1/2	9480	24	1	2	19008	3168
	15	30	38	11	64QAM	19	1/2	15112	24	1	2	30096	5016
	20	30	51	11	64QAM	19	1/2	20496	24	1	3	40392	6732
	25	30	65	11	64QAM	19	1/2	26120	24	1	4	51480	8580
	30	30	78	11	64QAM	19	1/2	31240	24	1	4	61776	10296
	40	30	106	11	64QAM	19	1/2	42016	24	1	5	83952	13992
	50	30	133	11	64QAM	19	1/2	53288	24	1	7	105336	17556
	60	30	162	11	64QAM	19	1/2	64552	24	1	8	128304	21384
	80	30	217	11	64QAM	19	1/2	86040	24	1	11	171864	28644
	90	30	245	11	64QAM	19	1/2	98376	24	1	12	194040	32340
	100	30	273	11	64QAM	19	1/2	108552	24	1	13	216216	36036

NOTE 1: PUSCH mapping Type-A and single-symbol DM-RS configuration Type-1 with 2 additional DM-RS symbols, such that the DM-RS positions are set to symbols 2, 7, 11. DMRS is [TDM'ed] with PUSCH data.

NOTE 2: MCS Index is based on MCS table 5.1.3.1-1 defined in 38.214.

NOTE 3: If more than one Code Block is present, an additional CRC sequence of L = 24 Bits is attached to each Code Block (otherwise L = 0 Bit)

Table A.2.3.8-3: Reference channels for CP-OFDM 64QAM for 60kHz SCS

Parameter	Channel bandwidth	Subcarrier Spacing	Allocated resource blocks	CP-OFDM Symbols per slot (Note 1)	Modulation	MCS Index (Note 2)	Target Coding Rate	Payload size for slots 4, 9, 14, 19, 24, 29, 34 and 39	Transport block CRC	LDPC Base Graph	Number of code blocks per slot for slots 4, 9, 14, 19, 24, 29, 34 and 39 (Note 3)	Total number of bits per slot for slots 4, 9, 14, 19, 24, 29, 34 and 39	Total modulated symbols per slot for slots 4, 9, 14, 19, 24, 29, 34 and 39
Unit	MHz	KHz						Bits	Bits			Bits	
	10	60	11	11	64QAM	19	1/2	4352	24	1	1	8712	1452
	15	60	18	11	64QAM	19	1/2	7168	24	1	1	14256	2376
	20	60	24	11	64QAM	19	1/2	9480	24	1	2	19008	3168
	25	60	31	11	64QAM	19	1/2	12296	24	1	2	24552	4092
	30	60	38	11	64QAM	19	1/2	15112	24	1	2	30096	5016
	40	60	51	11	64QAM	19	1/2	20496	24	1	3	40392	6732
	50	60	65	11	64QAM	19	1/2	26120	24	1	4	51480	8580
	60	60	79	11	64QAM	19	1/2	31752	24	1	4	62568	10428
	80	60	107	11	64QAM	19	1/2	43032	24	1	6	84744	14124
	90	60	121	11	64QAM	19	1/2	48168	24	1	6	95832	15972
	100	60	135	11	64QAM	19	1/2	54296	24	1	7	106920	17820

NOTE 1: PUSCH mapping Type-A and single-symbol DM-RS configuration Type-1 with 2 additional DM-RS symbols, such that the DM-RS positions are set to symbols 2, 7, 11. DMRS is [TDM'ed] with PUSCH data.

NOTE 2: MCS Index is based on MCS table 5.1.3.1-1 defined in 38.214.

NOTE 3: If more than one Code Block is present, an additional CRC sequence of L = 24 Bits is attached to each Code Block (otherwise L = 0 Bit)

A.2.3.9 CP-OFDM 256QAM

Table A.2.3.9-1: Reference channels for CP-OFDM 256QAM for 15kHz SCS

Parameter	Channel bandwidth	Subcarrier Spacing	Allocated resource blocks	CP-OFDM Symbols per slot (Note 1)	Modulation	MCS Index (Note 2)	Target Coding Rate	Payload size for slots 4 and 9	Transport block CRC	LDPC Base Graph	Number of code blocks per slot for slots 4 and 9 (Note 3)	Total number of bits per slot for slots 4 and 9	Total modulated symbols per slot for slots 4 and 9
Unit	MHz	KHz						Bits	Bits			Bits	
	5	15	25	11	256QAM	20	2/3	17424	24	1	3	26400	3300
	10	15	52	11	256QAM	20	2/3	36896	24	1	5	54912	6864
	15	15	79	11	256QAM	20	2/3	55304	24	1	7	83424	10428
	20	15	106	11	256QAM	20	2/3	73776	24	1	9	111936	13992
	25	15	133	11	256QAM	20	2/3	94248	24	1	12	140448	17556
	30	15	160	11	256QAM	20	2/3	112648	24	1	14	168960	21120
	40	15	216	11	256QAM	20	2/3	151608	24	1	18	228096	28512
	50	15	270	11	256QAM	20	2/3	188576	24	1	23	285120	35640

NOTE 1: PUSCH mapping Type-A and single-symbol DM-RS configuration Type-1 with 2 additional DM-RS symbols, such that the DM-RS positions are set to symbols 2, 7, 11. DMRS is [TDM'ed] with PUSCH data.

NOTE 2: MCS Index is based on MCS table 5.1.3.1-2 defined in 38.214.

NOTE 3: If more than one Code Block is present, an additional CRC sequence of L = 24 Bits is attached to each Code Block (otherwise L = 0 Bit)

Table A.2.3.9-2: Reference channels for CP-OFDM 256QAM for 30kHz SCS

Parameter	Channel bandwidth	Subcarrier Spacing	Allocated resource blocks	CP-OFDM Symbols per slot (Note 1)	Modulation	MCS Index (Note 2)	Target Coding Rate	Payload size for slots 8, 9, 18 and 19	Transport block CRC	LDPC Base Graph	Number of code blocks per slot for slots 8, 9, 18 and 19 (Note 3)	Total number of bits per slot for slots 8, 9, 18 and 19	Total modulated symbols per slot for slots 8, 9, 18 and 19
Unit	MHz	KHz						Bits	Bits			Bits	
	5	30	11	11	256QAM	20	2/3	7680	24	1	1	11616	1452
	10	30	24	11	256QAM	20	2/3	16896	24	1	3	25344	3168
	15	30	38	11	256QAM	20	2/3	26632	24	1	4	40128	5016
	20	30	51	11	256QAM	20	2/3	35856	24	1	5	53856	6732
	25	30	65	11	256QAM	20	2/3	46104	24	1	6	68640	8580
	30	30	78	11	256QAM	20	2/3	55304	24	1	7	82368	10296
	40	30	106	11	256QAM	20	2/3	73776	24	1	9	111936	13992
	50	30	133	11	256QAM	20	2/3	94248	24	1	12	140448	17556
	60	30	162	11	256QAM	20	2/3	114776	24	1	14	171072	21384
	80	30	217	11	256QAM	20	2/3	151608	24	1	18	229152	28644
	90	30	245	11	256QAM	20	2/3	172176	24	1	21	258720	32340
	100	30	273	11	256QAM	20	2/3	192624	24	1	23	288288	36036

NOTE 1: PUSCH mapping Type-A and single-symbol DM-RS configuration Type-1 with 2 additional DM-RS symbols, such that the DM-RS positions are set to symbols 2, 7, 11. DMRS is [TDM'ed] with PUSCH data.

NOTE 2: MCS Index is based on MCS table 5.1.3.1-2 defined in 38.214.

NOTE 3: If more than one Code Block is present, an additional CRC sequence of L = 24 Bits is attached to each Code Block (otherwise L = 0 Bit)

Table A.2.3.9-3: Reference channels for CP-OFDM 256QAM for 60kHz SCS

Parameter	Channel bandwidth	Subcarrier Spacing	Allocated resource blocks	CP-OFDM Symbols per slot (Note 1)	Modulation	MCS Index (Note 2)	Target Coding Rate	Payload size for slots 4, 9, 14, 19, 24, 29, 34 and 39	Transport block CRC	LDPC Base Graph	Number of code blocks per slot for slots 4, 9, 14, 19, 24, 29, 34 and 39 (Note 3)	Total number of bits per slot for slots 4, 9, 14, 19, 24, 29, 34 and 39	Total modulated symbols per slot for slots 4, 9, 14, 19, 24, 29, 34 and 39
Unit	MHz	KHz						Bits	Bits			Bits	
	10	60	11	11	256QAM	20	2/3	7680	24	1	1	11616	1452
	15	60	18	11	256QAM	20	2/3	12552	24	1	2	19008	2376
	20	60	24	11	256QAM	20	2/3	16896	24	1	3	25344	3168
	25	60	31	11	256QAM	20	2/3	22032	24	1	3	32736	4092
	30	60	38	11	256QAM	20	2/3	26632	24	1	4	40128	5016
	40	60	51	11	256QAM	20	2/3	35856	24	1	5	53856	6732
	50	60	65	11	256QAM	20	2/3	46104	24	1	6	68640	8580
	60	60	79	11	256QAM	20	2/3	55304	24	1	7	83424	10428
	80	60	107	11	256QAM	20	2/3	75792	24	1	9	112992	14124
	90	60	121	11	256QAM	20	2/3	86040	24	1	11	127776	15972
	100	60	135	11	256QAM	20	2/3	94248	24	1	12	142560	17820

NOTE 1: PUSCH mapping Type-A and single-symbol DM-RS configuration Type-1 with 2 additional DM-RS symbols, such that the DM-RS positions are set to symbols 2, 7, 11. DMRS is [TDM'ed] with PUSCH data.

NOTE 2: MCS Index is based on MCS table 5.1.3.1-2 defined in 38.214.

NOTE 3: If more than one Code Block is present, an additional CRC sequence of L = 24 Bits is attached to each Code Block (otherwise L = 0 Bit)

A.3 DL reference measurement channels

A.3.1 General

Unless otherwise stated, Tables A.3.2.2-1, A.3.2.2-2, A.3.2.2-3, A.3.3.2-1, A.3.3.2-2 and A.3.3.2-3 are applicable for measurements of the Receiver Characteristics (clause 7) with the exception of subclauses 7.4 (Maximum input level).

Unless otherwise stated, Tables A.3.2.3-1, A.3.2.3-2, A.3.2.3-3, A.3.3.3-1, A.3.3.3-2 and A.3.3.3-3 are applicable for subclauses 7.4 (Maximum input level) and for UE not supporting PDSCH 256QAM,

Unless otherwise stated, Tables A.3.2.4-1, A.3.2.4-2, A.3.2.4-3, A.3.3.4-1, A.3.3.4-2 and A.3.3.4-3 are applicable for subclauses 7.4 (Maximum input level) and for UE supporting PDSCH 256QAM,

Unless otherwise stated, Tables A.3.2.2-1, A.3.2.2-2, A.3.2.2-3, A.3.3.2-1, A.3.3.2-2 and A.3.3.2-3 also apply for the modulated interferer used in Clauses 7.5, 7.6 and 7.8 with test specific bandwidths.

Table A.3.1-1. Common reference channel parameters

Parameter	Unit	Value
CORESET frequency domain allocation		Full BW
CORESET time domain allocation		2 OFDM symbols at the begin of each slot
PDSCH mapping type		Type A
PDSCH start symbol index (S)		2
Number of consecutive PDSCH symbols (L)		12
PDSCH PRB bundling	PRBs	2
Dynamic PRB bundling		false
Overhead value for TBS determination		0
First DMRS position for Type A PDSCH mapping		2
DMRS type		Type 1
Number of additional DMRS		2
FDM between DMRS and PDSCH		Disable
TRS configuration		1 slot, periodicity 10 ms, offset 0
PTRS configuration		PTRS is not configured

A.3.2 DL reference measurement channels for FDD

A.3.2.1 General

Table A.3.2.1-1 Additional reference channels parameters for FDD

Parameter	Unit	Value
Number of HARQ Processes		4
K1 value		2 for all slots

A.3.2.2 FRC for receiver requirements for QPSK

Table A.3.2.2-1 Fixed reference channel for receiver requirements (SCS 15 kHz, FDD, QPSK 1/3)

Parameter	Unit	Value							
		5	10	15	20	25	30	40	50
Channel bandwidth	MHz	5	10	15	20	25	30	40	50
Subcarrier spacing	kHz	15	15	15	15	15	15	15	15
Subcarrier spacing configuration μ		0	0	0	0	0	0	0	0
Allocated resource blocks		25	52	79	106	133	160	216	270
Subcarriers per resource block		12	12	12	12	12	12	12	12
Allocated slots per Frame		9	9	9	9	9	9	9	9
MCS Index		4	4	4	4	4	4	4	4
MCS Table for TBS determination		64QAM							
Modulation		QPSK	QPSK	QPSK	QPSK	QPSK	QPSK	QPSK	QPSK
Target Coding Rate		1/3	1/3	1/3	1/3	1/3	1/3	1/3	1/3
Maximum number of HARQ transmissions		1	1	1	1	1	1	1	1
Information Bit Payload per Slot									
For Slot 0	Bits	N/A	N/A	N/A	N/A	N/A	N/A	N/A	N/A
For Slots 1,2,3,4,5,6,7,8,9	Bits	1672	3368	5120	6912	8712	10504	14088	17424
Transport block CRC	Bits	16	16	24	24	24	24	24	24
LDPC base graph		2	2	1	1	1	1	1	1
Number of Code Blocks per Slot									
For Slot 0	CBs	N/A	N/A	N/A	N/A	N/A	N/A	N/A	N/A
For Slots 1,2,3,4,5,6,7,8,9	CBs	1	1	1	1	2	2	2	3
Binary Channel Bits per Slot									
For Slot 0	Bits	N/A	N/A	N/A	N/A	N/A	N/A	N/A	N/A
For Slots 1,2,3,4,5,6,7,8,9	Bits	5400	11232	17064	22896	28728	34560	46656	58320
Max. Throughput averaged over 1 frame	Mbps	1.504	3.031	4.608	6.220	7.841	9.454	12.67 9	15.68 2
NOTE 1: Additional parameters are specified in Table A.3.1-1 and Table A.3.2.1-1..									
NOTE 2: If more than one Code Block is present, an additional CRC sequence of L = 24 Bits is attached to each Code Block (otherwise L = 0 Bit).									
NOTE 3: SS/PBCH block is transmitted in slot #0 of each frame									
NOTE 4: Slot i is slot index per frame, QPSK 1/3									

Table A.3.2.2-2 Fixed reference channel for receiver requirements (SCS 30 kHz, FDD, QPSK 1/3)

Parameter	Unit	Value									
		5	10	15	20	25	30	40	50	60	80
Carrier frequency configuration μ	MHz	1	1	1	1	1	1	1	1	1	1
Number of subcarriers per block		11	24	38	51	65	78	106	133	162	217
Number of subcarriers per source block		12	12	12	12	12	12	12	12	12	12
Number of subcarriers per frame		19	19	19	19	19	19	19	19	19	19
Number of subcarriers per slot		4	4	4	4	4	4	4	4	4	4
Modulation scheme		64QAM									
Code rate		QPSK	QPSK	QPSK	QPSK	QPSK	QPSK	QPSK	QPSK	QPSK	QPSK
Number of HARQ transmissions		1/3	1/3	1/3	1/3	1/3	1/3	1/3	1/3	1/3	1/3
Number of HARQ transmissions per Slot		1	1	1	1	1	1	1	1	1	1
Number of HARQ transmissions per Slot	Bits	N/A	N/A	N/A	N/A	N/A	N/A	N/A	N/A	N/A	N/A
Number of HARQ transmissions per Slot	Bits	736	1608	2472	3368	4224	4992	6912	8712	10504	14088
Number of HARQ transmissions per Slot	Bits	16	16	16	16	24	24	24	24	24	24
Number of HARQ transmissions per Slot		2	2	2	2	1	1	1	1	1	1
Number of HARQ transmissions per Slot	CBs	N/A	N/A	N/A	N/A	N/A	N/A	N/A	N/A	N/A	N/A
Number of HARQ transmissions per Slot	CBs	1	1	1	1	1	1	1	2	2	2
Number of HARQ transmissions per Slot	Bits	N/A	N/A	N/A	N/A	N/A	N/A	N/A	N/A	N/A	N/A
Number of HARQ transmissions per Slot	Bits	2376	5184	8208	11016	14040	16848	22896	28728	34992	46872
Average throughput per Slot	Mbps	1.398	3.055	4.697	6.399	8.025	9.485	13.133	16.553	19.958	26.767

All parameters are specified in Table A.3.1-1 and Table A.3.2.1-1.

When one Code Block is present, an additional CRC sequence of L = 24 Bits is attached to each Code Block (otherwise L = 0 Bit).

One Code Block is transmitted in slot #0 of each frame

Slot index per frame

Table A.3.2.2-3 Fixed reference channel for receiver requirements (SCS 60 kHz, FDD, QPSK 1/3)

Parameter	Unit	Value									
		10	15	20	25	30	40	50	60	80	
Bandwidth	MHz	10	15	20	25	30	40	50	60	80	
Subcarrier spacing configuration μ		2	2	2	2	2	2	2	2	2	
Number of resource blocks		11	18	24	31	38	51	65	79	107	
Number of resource blocks per Frame		12	12	12	12	12	12	12	12	12	
		38	38	38	38	38	38	38	38	38	
		4	4	4	4	4	4	4	4	4	
TBS Determination		64QAM									
Modulation		QPSK	QPSK	QPSK	QPSK	QPSK	QPSK	QPSK	QPSK	QPSK	QPSK
Code Rate		1/3	1/3	1/3	1/3	1/3	1/3	1/3	1/3	1/3	1/3
Number of HARQ transmissions		1	1	1	1	1	1	1	1	1	1
Payload per Slot											
	Bits	N/A	N/A	N/A	N/A	N/A	N/A	N/A	N/A	N/A	N/A
Number of bits per Slot	Bits	736	1192	1608	2024	2472	3368	4224	5120	6912	
Number of CRC bits	Bits	16	16	16	16	16	16	24	24	24	
Number of bits per Slot		2	2	2	2	2	2	1	1	1	
Number of Code Blocks per Slot											
	CBs	N/A	N/A	N/A	N/A	N/A	N/A	N/A	N/A	N/A	N/A
Number of Code Blocks per Slot	CBs	1	1	1	1	1	1	1	1	1	1
Number of bits per Slot											
	Bits	N/A	N/A	N/A	N/A	N/A	N/A	N/A	N/A	N/A	N/A
Number of bits per Slot	Bits	2376	3888	5184	6696	8208	11016	14040	17064	23112	23112
Throughput averaged over 1 frame	Mbps	2.870	4.649	6.271	7.894	9.641	13.135	16.474	19.968	26.957	26.957

Additional parameters are specified in Table A.3.1-1 and Table A.3.2.1-1.

If more than one Code Block is present, an additional CRC sequence of L = 24 Bits is attached to each Code Block (otherwise L = 0 Bit).

The PBCH block is transmitted in slot #0 of each frame

i is slot index per frame

A.3.2.3 FRC for maximum input level for 64QAM

Table A.3.2.3-1 Fixed reference channel for maximum input level receiver requirements (SCS 15 kHz, FDD, 64QAM)

Parameter	Unit	Value							
		5	10	15	20	25	30	40	50
Channel bandwidth	MHz	5	10	15	20	25	30	40	50
Subcarrier spacing	kHz	15	15	15	15	15	15	15	15
Subcarrier spacing configuration μ		0	0	0	0	0	0	0	0
Allocated resource blocks		25	52	79	106	133	[160]	216	270
Subcarriers per resource block		12	12	12	12	12	12	12	12
Allocated slots per Frame		9	9	9	9	9	9	9	9
MCS Index		24	24	24	24	24	24	24	24
MCS Table for TBS determination		64QAM							
Modulation		64 QAM	64 QAM	64 QAM	64 QAM	64 QAM	64 QAM	64 QAM	64 QAM
Target Coding Rate		3/4	3/4	3/4	3/4	3/4	3/4	3/4	3/4
Maximum number of HARQ transmissions		1	1	1	1	1	1	1	1
Information Bit Payload per Slot									
For Slot 0	Bits	N/A	N/A	N/A	N/A	N/A	N/A	N/A	N/A
For Slots 1,2,3,4,5,6,7,8,9	Bits	12296	25608	38936	52224	64552	77896	106576	131176
Transport block CRC	Bits	24	24	24	24	24	24	24	24
LDPC base graph		1	1	1	1	1	1	1	1
Number of Code Blocks per Slot									
For Slot 0	CBs	N/A	N/A	N/A	N/A	N/A	N/A	N/A	N/A
For Slots 1,2,3,4,5,6,7,8,9	CBs	2	4	5	7	8	10	13	16
Binary Channel Bits per Slot									
For Slot 0	Bits	N/A	N/A	N/A	N/A	N/A	N/A	N/A	N/A
For Slots 1,2,3,4,5,6,7,8,9	Bits	16200	33696	51192	68688	86184	103680	139968	174960
Max. Throughput averaged over 1 frame	Mbps	11.066	23.047	35.042	47.002	58.097	70.106	95.918	118.058

NOTE 1: Additional parameters are specified in Table A.3.1-1 and Table A.3.2.1-1.
NOTE 2: If more than one Code Block is present, an additional CRC sequence of L = 24 Bits is attached to each Code Block (otherwise L = 0 Bit).
NOTE 3: SS/PBCH block is transmitted in slot 0 of each frame
NOTE 4: Slot i is slot index per frame

Table A.3.2.3-2 Fixed reference channel for maximum input level receiver requirements (SCS 30 kHz, FDD, 64QAM)

Parameter	Unit	Value										
		5	10	15	20	25	30	40	50	60	80	100
Channel bandwidth	MHz	5	10	15	20	25	30	40	50	60	80	100
Subcarrier spacing configuration μ		1	1	1	1	1	1	1	1	1	1	1
Allocated resource blocks		11	24	38	51	65	[78]	106	133	162	217	273
Subcarriers per resource block		12	12	12	12	12	12	12	12	12	12	12
Allocated slots per Frame		19	19	19	19	19	19	19	19	19	19	19
MCS Index		24	24	24	24	24	24	24	24	24	24	24
MCS Table for TBS determination		64QAM										
Modulation		64 QAM	64 QAM	64 QAM	64 QAM	64 QAM	64 QAM	64 QAM	64 QAM	64 QAM	64 QAM	64 QAM
Target Coding Rate		3/4	3/4	3/4	3/4	3/4	3/4	3/4	3/4	3/4	3/4	3/4
Maximum number of HARQ transmissions		1	1	1	1	1	1	1	1	1	1	1
Information Bit Payload per Slot												
For Slot 0	Bits	N/A	N/A	N/A	N/A	N/A	N/A	N/A	N/A	N/A	N/A	N/A
For Slots 1,...,19	Bits	5376	11784	18432	25104	31752	37896	52224	64552	79896	106576	135296
Transport block CRC	Bits	24	24	24	24	24	24	24	24	24	24	24
LDPC base graph		1	1	1	1	1	1	1	1	1	1	1
Number of Code Blocks per Slot												
For Slot 0	CBs	N/A	N/A	N/A	N/A	N/A	N/A	N/A	N/A	N/A	N/A	N/A
For Slots 1,...,19	CBs	1	2	3	3	4	5	7	8	10	13	17
Binary Channel Bits per Slot												
For Slot 0	Bits	N/A	N/A	N/A	N/A	N/A	N/A	N/A	N/A	N/A	N/A	N/A
For Slots 1,...,19	Bits	7128	15552	24624	33048	42120	50544	68688	86184	104976	140616	176904
Max. Throughput averaged over 1 frame	Mbps	10.214	22.390	35.021	47.698	60.329	72.002	99.226	122.64 9	151.80 2	202.49 4	257.06 2
NOTE 1: Additional parameters are specified in Table A.3.1-1 and Table A.3.2.1-1.												
NOTE 2: If more than one Code Block is present, an additional CRC sequence of L = 24 Bits is attached to each Code Block (otherwise L = 0 Bit).												
NOTE 3: SS/PBCH block is transmitted in slot 0 of each frame												
NOTE 4: Slot i is slot index per frame												

Table A.3.2.3-3 Fixed Reference Channel for Maximum input level receiver requirements (SCS 60 kHz, FDD, 64QAM)

Parameter	Unit	Value										
		10	15	20	25	30	40	50	60	80	100	
Channel bandwidth	MHz											
Subcarrier spacing configuration μ		2	2	2	2	2	2	2	2	2	2	2
Allocated resource blocks		11	18	24	31	[38]	51	65	79	107	135	
Subcarriers per resource block		12	12	12	12	12	12	12	12	12	12	12
Allocated slots per Frame		38	38	38	38	38	38	38	38	38	38	38
MCS Index		24	24	24	24	24	24	24	24	24	24	24
MCS Table for TBS determination		64QAM										
Modulation		64 QAM	64 QAM	64 QAM	64 QAM	64 QAM	64 QAM	64 QAM	64 QAM	64 QAM	64 QAM	64 QAM
Target Coding Rate		3/4	3/4	3/4	3/4	3/4	3/4	3/4	3/4	3/4	3/4	3/4
Maximum number of HARQ transmissions		1	1	1	1	1	1	1	1	1	1	1
Information Bit Payload per Slot												
For Slot 0,1	Bits	N/A	N/A	N/A	N/A	N/A	N/A	N/A	N/A	N/A	N/A	N/A
For Slots 2,...,39	Bits	5376	8712	11784	15112	18432	25104	31752	38936	52224	65576	
Transport block CRC	Bits	24	24	24	24	24	24	24	24	24	24	24
LDPC base graph		1	1	1	1	1	1	1	1	1	1	1
Number of Code Blocks per Slot												
For Slot 0,1	CBs	N/A	N/A	N/A	N/A	N/A	N/A	N/A	N/A	N/A	N/A	N/A
For Slots 2,...,39	CBs	1	2	2	2	3	3	4	5	7	8	
Binary Channel Bits per Slot												
For Slot 0,1	Bits	N/A	N/A	N/A	N/A	N/A	N/A	N/A	N/A	N/A	N/A	N/A
For Slots 2,...,39	Bits	7128	11664	15552	20088	24624	33048	42120	51192	69336	87480	
Max. Throughput averaged over 1 frame	Mbps	20.429	33.106	44.779	57.426	70.042	95.395	120.65 8	147.95 7	198.45 1	249.18 9	
NOTE 1: Additional parameters are specified in Table A.3.1-1 and Table A.3.2.1-1.												
NOTE 2: If more than one Code Block is present, an additional CRC sequence of L = 24 Bits is attached to each Code Block (otherwise L = 0 Bit).												
NOTE 3: SS/PBCH block is transmitted in slot #0 of each frame												
NOTE 4: Slot i is slot index per frame												

A.3.2.4 FRC for maximum input level for 256 QAM

Table A.3.2.4-1 Fixed reference channel for maximum input level receiver requirements (SCS 15 kHz, FDD, 256QAM)

Parameter	Unit	Value							
		5	10	15	20	25	30	40	50
Channel bandwidth	MHz	5	10	15	20	25	30	40	50
Subcarrier spacing	kHz	15	15	15	15	15	15	15	15
Subcarrier spacing configuration μ		0	0	0	0	0	0	0	0
Allocated resource blocks		25	52	79	106	133	[160]	216	270
Subcarriers per resource block		12	12	12	12	12	12	12	12
Allocated slots per Frame		9	9	9	9	9	9	9	9
MCS Index		23	23	23	23	23	23	23	23
MCS Table for TBS determination		64QAM							
Modulation		256 QAM	256 QAM	256 QAM	256 QAM	256 QAM	256 QAM	256 QAM	256 QAM
Target Coding Rate		4/5	4/5	4/5	4/5	4/5	4/5	4/5	4/5
Maximum number of HARQ transmissions		1	1	1	1	1	1	1	1
Information Bit Payload per Slot									
For Slot 0	Bits	N/A	N/A	N/A	N/A	N/A	N/A	N/A	N/A
For Slots 1,2,3,4,5,6,7,8,9	Bits	16896	34816	53288	71688	90176	108552	143400	180376
Transport block CRC	Bits	24	24	24	24	24	24	24	24
LDPC base graph		1	1	1	1	1	1	1	1
Number of Code Blocks per Slot									
For Slot 0	CBs	N/A	N/A	N/A	N/A	N/A	N/A	N/A	N/A
For Slots 1,2,3,4,5,6,7,8,9	CBs	3	5	7	9	12	14	18	23
Binary Channel Bits per Slot									
For Slot 0	Bits	N/A	N/A	N/A	N/A	N/A	N/A	N/A	N/A
For Slots 1,2,3,4,5,6,7,8,9	Bits	21600	44928	68256	91584	114912	138240	186624	233280
Max. Throughput averaged over 1 frame	Mbps	15.206	31.334	47.959	64.519	81.158	97.697	129.060	162.338
NOTE 1: Additional parameters are specified in Table A.3.1-1 and Table A.3.2.1-1.									
NOTE 2: If more than one Code Block is present, an additional CRC sequence of L = 24 Bits is attached to each Code Block (otherwise L = 0 Bit).									
NOTE 3: SS/PBCH block is transmitted in slot 0 of each frame									
NOTE 4: Slot i is slot index per frame									

Table A.3.2.4-2 Fixed reference channel for maximum input level receiver requirements (SCS 30 kHz, FDD, 256QAM)

Parameter	Unit	Value											
		5	10	15	20	25	30	40	50	60	80	100	
Channel bandwidth	MHz												
Subcarrier spacing configuration μ		1	1	1	1	1	1	1	1	1	1	1	1
Allocated resource blocks		11	24	38	51	65	[78]	106	133	162	217	273	
Subcarriers per resource block		12	12	12	12	12	12	12	12	12	12	12	
Allocated slots per Frame		19	19	19	19	19	19	19	19	19	19	19	
MCS Index		23	23	23	23	23	23	23	23	23	23	23	
MCS Table for TBS determination		256QAM											
Modulation		256 QAM	256 QAM	256 QAM	256 QAM	256 QAM	256 QAM	256 QAM	256 QAM	256 QAM	256 QAM	256 QAM	
Target Coding Rate		4/5	4/5	4/5	4/5	4/5	4/5	4/5	4/5	4/5	4/5	4/5	
Maximum number of HARQ transmissions		1	1	1	1	1	1	1	1	1	1	1	
Information Bit Payload per Slot													
For Slot 0	Bits	N/A	N/A	N/A	N/A	N/A	N/A	N/A	N/A	N/A	N/A	N/A	
For Slots 1,...,19	Bits	7424	16136	25608	33816	44040	52224	71688	90176	108552	147576	184424	
Transport block CRC	Bits	24	24	24	24	24	24	24	24	24	24	24	
LDPC base graph		1	1	1	1	1	1	1	1	1	1	1	
Number of Code Blocks per Slot													
For Slot 0	CBs	N/A	N/A	N/A	N/A	N/A	N/A	N/A	N/A	N/A	N/A	N/A	
For Slots 1,...,19	CBs	1	3	4	5	6	7	9	12	14	19	23	
Binary Channel Bits per Slot													
For Slot 0	Bits	N/A	N/A	N/A	N/A	N/A	N/A	N/A	N/A	N/A	N/A	N/A	
For Slots 1,...,19	Bits	9504	20736	32832	44064	56160	67392	91584	114912	139968	187488	235872	
Max. Throughput averaged over 1 frame	Mbps	14.106	30.658	48.655	64.250	83.676	99.226	136.20 7	171.33 4	206.24 9	280.39 4	350.40 6	
Note 1:	Additional parameters are specified in Table A.3.1-1 and Table A.3.2.1-1.												
Note 2:	If more than one Code Block is present, an additional CRC sequence of L = 24 Bits is attached to each Code Block (otherwise L = 0 Bit).												
Note 3:	SS/PBCH block is transmitted in slot 0 of each frame												
Note 4:	Slot i is slot index per frame												

Table A.3.2.4-3 Fixed reference channel for maximum input level receiver requirements (SCS 60 kHz, FDD, 256QAM)

Parameter	Unit	Value									
		10	15	20	25	30	40	50	60	80	100
Channel bandwidth	MHz	10	15	20	25	30	40	50	60	80	100
Subcarrier spacing configuration μ		2	2	2	2	2	2	2	2	2	2
Allocated resource blocks		11	18	24	31	[38]	51	65	79	107	135
Subcarriers per resource block		12	12	12	12	12	12	12	12	12	12
Allocated slots per Frame		38	38	38	38	38	38	38	38	38	38
MCS Index		23	23	23	23	23	23	23	23	23	23
MCS Table for TBS determination		256QAM									
Modulation		256 QAM	256 QAM	256 QAM	256 QAM	256 QAM	256 QAM	256 QAM	256 QAM	256 QAM	256 QAM
Target Coding Rate		4/5	4/5	4/5	4/5	4/5	4/5	4/5	4/5	4/5	4/5
Maximum number of HARQ transmissions		1	1	1	1	1	1	1	1	1	1
Information Bit Payload per Slot											
For Slot 0,1	Bits	N/A	N/A	N/A	N/A	N/A	N/A	N/A	N/A	N/A	N/A
For Slots 2,...,39	Bits	7424	12040	16136	21000	25608	33816	44040	53288	71688	90176
Transport block CRC	Bits	24	24	24	24	24	24	24	24	24	24
LDPC base graph		1	1	1	1	1	1	1	1	1	1
Number of Code Blocks per Slot											
For Slot 0,1	CBs	N/A	N/A	N/A	N/A	N/A	N/A	N/A	N/A	N/A	N/A
For Slots 2,...,39	CBs	1	2	3	3	4	5	6	7	9	12
Binary Channel Bits per Slot											
For Slot 0,1	Bits	N/A	N/A	N/A	N/A	N/A	N/A	N/A	N/A	N/A	N/A
For Slots 2,...,39	Bits	9504	15552	20736	26784	32832	44064	56160	68256	92448	116640
Max. Throughput averaged over 1 frame	Mbps	28.211	45.752	61.317	79.800	97.310	128.50 1	167.35 2	202.49 4	272.41 4	342.66 9
NOTE 1: Additional parameters are specified in Table A.3.1-1 and Table A.3.2.1-1.											
NOTE 2: If more than one Code Block is present, an additional CRC sequence of L = 24 Bits is attached to each Code Block (otherwise L = 0 Bit).											
NOTE 3: SS/PBCH block is transmitted in slot #0 of each frame											
NOTE 4: Slot i is slot index per frame											

A.3.3 DL reference measurement channels for TDD

A.3.3.1 General

Table A.3.3.1-1 Additional reference channels parameters for TDD

Parameter		Value		
		SCS 15 kHz ($\mu=0$)	SCS 30 kHz ($\mu=1$)	SCS 60 kHz ($\mu=2$)
UL-DL configuration	<i>referenceSubcarrierSpacing</i>	15 kHz	30 kHz	60 kHz
	<i>dl-UL-TransmissionPeriodicity</i>	5 ms	5 ms	1.25 ms
	<i>nrofDownlinkSlots</i>	3	7	3
	<i>nrofDownlinkSymbols</i>	10	6	6
	<i>nrofUplinkSlot</i>	1	2	1
	<i>nrofUplinkSymbols</i>	2	4	4
Number of HARQ Processes		8	8	8
K1 value		K1 = 4 if mod(i,5) = 0 K1 = 3 if mod(i,5) = 1 K1 = 2 if mod(i,5) = 2 where i is slot index per frame; i = {0,...,9}	K1 = 8 if mod(i,10) = 0 K1 = 7 if mod(i,10) = 1 K1 = 6 if mod(i,10) = 2 K1 = 5 if mod(i,10) = 3 K1 = 4 if mod(i,10) = 4 K1 = 3 if mod(i,10) = 5 K1 = 2 if mod(i,10) = 6 where i is slot index per frame; i = {0,...,19}	K1 = 4 if mod(i,5) = 0 K1 = 3 if mod(i,5) = 1 K1 = 2 if mod(i,5) = 2 where i is slot index per frame; i = {0,...,39}

A.3.3.2 FRC for receiver requirements for QPSK

Table A.3.3.2-1 Fixed reference channel for receiver requirements (SCS 15 kHz, TDD, QPSK 1/3)

Parameter	Unit	Value							
		5	10	15	20	25	30	40	50
Channel bandwidth	MHz	5	10	15	20	25	30	40	50
Subcarrier spacing	kHz	15	15	15	15	15	15	15	15
Subcarrier spacing configuration μ		0	0	0	0	0	0	0	0
Allocated resource blocks		25	52	79	106	133	[160]	216	270
Subcarriers per resource block		12	12	12	12	12	12	12	12
Allocated slots per Frame		5	5	5	5	5	5	5	5
MCS Index		4	4	4	4	4	4	4	4
MCS Table for TBS determination		64QAM							
Modulation		QPSK	QPSK	QPSK	QPSK	QPSK	QPSK	QPSK	QPSK
Target Coding Rate		1/3	1/3	1/3	1/3	1/3	1/3	1/3	1/3
Maximum number of HARQ transmissions		1	1	1	1	1	1	1	1
Information Bit Payload per Slot									
For Slots 0,3,4,8,9	Bits	N/A	N/A	N/A	N/A	N/A	N/A	N/A	N/A
For Slots 1,2,5,6,7	Bits	1672	3368	5120	6912	8712	10504	14088	17424
Transport block CRC	Bits	16	16	24	24	24	24	24	24
LDPC base graph		2	2	1	1	1	1	1	1
Number of Code Blocks per Slot									
For Slots 0,3,4,8,9	CBs	N/A	N/A	N/A	N/A	N/A	N/A	N/A	N/A
For Slots 1,2,5,6,7	CBs	1	1	1	1	2	2	2	3
Binary Channel Bits per Slot									
For Slots 0,3,4,8,9	Bits	N/A	N/A	N/A	N/A	N/A	N/A	N/A	N/A
For Slots 1,2,5,6,7	Bits	5400	11232	17064	22896	28728	34560	46656	58320
Max. Throughput averaged over 1 frame	Mbps	0.836	1.684	2.560	3.456	4.356	5.252	7.044	8.712
Note 1: Additional parameters are specified in Table A.3.1-1 and Table A.3.3.1-1.									
Note 2: If more than one Code Block is present, an additional CRC sequence of L = 24 Bits is attached to each Code Block (otherwise L = 0 Bit).									
Note 3: SS/PBCH block is transmitted in slot 0 of each frame									
Note 4: Slot i is slot index per frame									

Table A.3.3.2-2 Fixed reference channel for receiver requirements (SCS 30 kHz, TDD, QPSK 1/3)

Parameter	Unit	Value										
		5	10	15	20	25	30	40	50	60	80	100
Channel bandwidth	MHz	5	10	15	20	25	30	40	50	60	80	100
Subcarrier spacing configuration μ		1	1	1	1	1	1	1	1	1	1	1
Allocated resource blocks		11	24	38	51	65	78	106	133	162	217	273
Subcarriers per resource block		12	12	12	12	12	12	12	12	12	12	12
Allocated slots per Frame		13	13	13	13	13	13	13	13	13	13	13
MCS Index		4	4	4	4	4	4	4	4	4	4	4
MCS Table for TBS determination		64QAM										
Modulation		QPSK	QPSK	QPSK	QPSK	QPSK	QPSK	QPSK	QPSK	QPSK	QPSK	QPSK
Target Coding Rate		1/3	1/3	1/3	1/3	1/3	1/3	1/3	1/3	1/3	1/3	1/3
Maximum number of HARQ transmissions		1	1	1	1	1	1	1	1	1	1	1
Information Bit Payload per Slot												
For Slots 0 and Slot i, if $\text{mod}(i, 10) = \{7,8,9\}$ for i from $\{0, \dots, 19\}$	Bits	N/A	N/A	N/A	N/A	N/A	N/A	N/A	N/A	N/A	N/A	N/A
For Slot i, if $\text{mod}(i, 10) = \{0,1,2,3,4,5,6\}$ for i from $\{1, \dots, 19\}$	Bits	736	1608	2472	3368	4224	4992	6912	8712	10504	14088	17928
Transport block CRC	Bits	16	16	16	16	24	24	24	24	24	24	24
LDPC base graph		2	2	2	2	1	1	1	1	1	1	1
Number of Code Blocks per Slot												
For Slots 0 and Slot i, if $\text{mod}(i, 10) = \{7,8,9\}$ for i from $\{0, \dots, 19\}$	CBs	N/A	N/A	N/A	N/A	N/A	N/A	N/A	N/A	N/A	N/A	N/A
For Slot i, if $\text{mod}(i, 10) = \{0,1,2,3,4,5,6\}$ for i from $\{1, \dots, 19\}$	CBs	1	1	1	1	1	1	1	2	2	2	3
Binary Channel Bits per Slot												
For Slots 0 and Slot i, if $\text{mod}(i, 10) = \{7,8,9\}$ for i from $\{0, \dots, 19\}$	Bits	N/A	N/A	N/A	N/A	N/A	N/A	N/A	N/A	N/A	N/A	N/A
For Slot i, if $\text{mod}(i, 10) = \{0,1,2,3,4,5,6\}$ for i from $\{1, \dots, 19\}$	Bits	2376	5184	8208	11016	14040	16848	22896	28728	34992	46872	58968
Max. Throughput averaged over 1 frame	Mbps	0.957	2.090	3.214	4.378	5.491	6.490	8.986	11.326	13.655	18.314	23.306
NOTE 1: Additional parameters are specified in Table A.3.1-1 and Table A.3.3.1-1.												
NOTE 2: If more than one Code Block is present, an additional CRC sequence of L = 24 Bits is attached to each Code Block (otherwise L = 0 Bit).												
NOTE 3: SS/PBCH block is transmitted in slot #0 of each frame												
NOTE 4: Slot i is slot index per frame												

Table A.3.3.2-3 Fixed reference channel for receiver requirements (SCS 60 kHz, TDD, QPSK 1/3)

Parameter	Unit	Value										
		10	15	20	25	30	40	50	60	80	100	
Channel bandwidth	MHz											
Subcarrier spacing configuration μ		2	2	2	2	2	2	2	2	2	2	2
Allocated resource blocks		11	18	24	31	38	51	65	79	107	135	
Subcarriers per resource block		12	12	12	12	12	12	12	12	12	12	12
Allocated slots per Frame		22	22	22	22	22	22	22	22	22	22	22
MCS Index		4	4	4	4	4	4	4	4	4	4	4
MCS Table for TBS determination		64QAM										
Modulation		QPSK	QPSK	QPSK	QPSK	QPSK	QPSK	QPSK	QPSK	QPSK	QPSK	QPSK
Target Coding Rate		1/3	1/3	1/3	1/3	1/3	1/3	1/3	1/3	1/3	1/3	1/3
Maximum number of HARQ transmissions		1	1	1	1	1	1	1	1	1	1	1
Information Bit Payload per Slot												
For Slots 0,1 and Slot i, if $\text{mod}(i, 5) = \{3,4\}$ for i from $\{0, \dots, 39\}$	Bits	N/A	N/A	N/A	N/A	N/A	N/A	N/A	N/A	N/A	N/A	N/A
For Slot i, if $\text{mod}(i, 5) = \{0,1,2\}$ for i from $\{2, \dots, 39\}$	Bits	736	1192	1608	2024	2472	3368	4224	5120	6912	8712	
Transport block CRC	Bits	16	16	16	16	16	16	24	24	24	24	24
LDPC base graph		2	2	2	2	2	2	1	1	1	1	1
Number of Code Blocks per Slot												
For Slots 0,1 and Slot i, if $\text{mod}(i, 5) = \{3,4\}$ for i from $\{0, \dots, 39\}$	CBs	N/A	N/A	N/A	N/A	N/A	N/A	N/A	N/A	N/A	N/A	N/A
For Slot i, if $\text{mod}(i, 5) = \{0,1,2\}$ for i from $\{2, \dots, 39\}$	CBs	1	1	1	1	1	1	1	1	1	1	2
Binary Channel Bits per Slot												
For Slots 0,1 and Slot i, if $\text{mod}(i, 5) = \{3,4\}$ for i from $\{0, \dots, 39\}$	Bits	N/A	N/A	N/A	N/A	N/A	N/A	N/A	N/A	N/A	N/A	N/A
For Slot i, if $\text{mod}(i, 5) = \{0,1,2\}$ for i from $\{2, \dots, 39\}$	Bits	2376	3888	5184	6696	8208	11016	14040	17064	23112	29160	
Max. Throughput averaged over 1 frame	Mbps	1.619	2.622	3.538	4.453	5.438	7.410	9.293	11.264	15.206	19.166	
NOTE 1: Additional parameters are specified in Table A.3.1-1 and Table A.3.3.1-1.												
NOTE 2: If more than one Code Block is present, an additional CRC sequence of L = 24 Bits is attached to each Code Block (otherwise L = 0 Bit).												
NOTE 3: SS/PBCH block is transmitted in slot #0 of each frame												
NOTE 4: Slot i is slot index per frame												

A.3.3.3 FRC for maximum input level for 64QAM

Table A.3.3-1 Fixed reference channel for maximum input level receiver requirements (SCS 15 kHz, TDD, 64QAM)

Parameter	Unit	Value							
		5	10	15	20	25	30	40	50
Channel bandwidth	MHz	5	10	15	20	25	30	40	50
Subcarrier spacing	kHz	15	15	15	15	15	15	15	15
Subcarrier spacing configuration μ		0	0	0	0	0	0	0	0
Allocated resource blocks		25	52	79	106	133	[160]	216	270
Subcarriers per resource block		12	12	12	12	12	12	12	12
Allocated slots per Frame		5	5	5	5	5	5	5	5
MCS Index		24	24	24	24	24	24	24	24
MCS Table for TBS determination		64QAM							
Modulation		64 QAM	64 QAM	64 QAM	64 QAM	64 QAM	64 QAM	64 QAM	64 QAM
Target Coding Rate		3/4	3/4	3/4	3/4	3/4	3/4	3/4	3/4
Maximum number of HARQ transmissions		1	1	1	1	1	1	1	1
Information Bit Payload per Slot									
For Slots 0,3,4,8,9	Bits	N/A	N/A	N/A	N/A	N/A	N/A	N/A	N/A
For Slots 1,2,5,6,7	Bits	12296	25608	38936	52224	64552	77896	106576	131176
Transport block CRC	Bits	24	24	24	24	24	24	24	24
LDPC base graph		1	1	1	1	1	1	1	1
Number of Code Blocks per Slot									
For Slots 0,3,4,8,9	CBs	N/A	N/A	N/A	N/A	N/A	N/A	N/A	N/A
For Slots 1,2,5,6,7	CBs	2	4	5	7	8	10	13	16
Binary Channel Bits per Slot									
For Slots 0,3,4,8,9	Bits	N/A	N/A	N/A	N/A	N/A	N/A	N/A	N/A
For Slots 1,2,5,6,7	Bits	16200	33696	51192	68688	86184	103680	139968	174960
Max. Throughput averaged over 1 frame	Mbps	6.148	12.804	19.468	26.112	32.276	38.948	53.288	65.588

NOTE 1: Additional parameters are specified in Table A.3.1-1 and Table A.3.3.1-1.
NOTE 2: If more than one Code Block is present, an additional CRC sequence of L = 24 Bits is attached to each Code Block (otherwise L = 0 Bit).
NOTE 3: SS/PBCH block is transmitted in slot 0 of each frame
NOTE 4: Slot i is slot index per frame

Table A.3.3.3-2 Fixed reference channel for maximum input level receiver requirements (SCS 30 kHz, TDD, 64QAM)

Parameter	Unit	Value										
		5	10	15	20	25	30	40	50	60	80	100
Channel bandwidth	MHz	5	10	15	20	25	30	40	50	60	80	100
Subcarrier spacing configuration μ		1	1	1	1	1	1	1	1	1	1	1
Allocated resource blocks		11	24	38	51	65	78	106	133	162	217	273
Subcarriers per resource block		12	12	12	12	12	12	12	12	12	12	12
Allocated slots per Frame		13	13	13	13	13	13	13	13	13	13	13
MCS Index		24	24	24	24	24	24	24	24	24	24	24
MCS Table for TBS determination		64QAM										
Modulation		64 QAM	64 QAM	64 QAM	64 QAM	64 QAM	64 QAM	64 QAM	64 QAM	64 QAM	64 QAM	64 QAM
Target Coding Rate		3/4	3/4	3/4	3/4	3/4	3/4	3/4	3/4	3/4	3/4	3/4
Maximum number of HARQ transmissions		1	1	1	1	1	1	1	1	1	1	1
Information Bit Payload per Slot												
For Slots 0 and Slot i, if $\text{mod}(i, 10) = \{7,8,9\}$ for i from $\{0, \dots, 19\}$	Bits	N/A	N/A	N/A	N/A	N/A	N/A	N/A	N/A	N/A	N/A	N/A
For Slot i, if $\text{mod}(i, 10) = \{0,1,2,3,4,5,6\}$ for i from $\{1, \dots, 19\}$	Bits	5376	11784	18432	25104	31752	37896	52224	64552	79896	106576	135296
Transport block CRC	Bits	24	24	24	24	24	24	24	24	24	24	24
LDPC base graph		1	1	1	1	1	1	1	1	1	1	1
Number of Code Blocks per Slot												
For Slots 0 and Slot i, if $\text{mod}(i, 10) = \{7,8,9\}$ for i from $\{0, \dots, 19\}$	CBs	N/A	N/A	N/A	N/A	N/A	N/A	N/A	N/A	N/A	N/A	N/A
For Slot i, if $\text{mod}(i, 10) = \{0,1,2,3,4,5,6\}$ for i from $\{1, \dots, 19\}$	CBs	1	2	3	3	4	5	7	8	10	13	17
Binary Channel Bits per Slot												
For Slots 0 and Slot i, if $\text{mod}(i, 10) = \{7,8,9\}$ for i from $\{0, \dots, 19\}$	Bits	N/A	N/A	N/A	N/A	N/A	N/A	N/A	N/A	N/A	N/A	N/A
For Slot i, if $\text{mod}(i, 10) = \{0,1,2,3,4,5,6\}$ for i from $\{1, \dots, 19\}$	Bits	7128	15552	24624	33048	42120	50544	68688	86184	104976	140616	176904
Max. Throughput averaged over 1 frame	Mbps	6.989	15.319	23.962	32.635	41.278	49.265	67.891	83.918	103.86 5	138.54 9	175.88 5
NOTE 1: Additional parameters are specified in Table A.3.1-1 and Table A.3.3.1-1.												
NOTE 2: If more than one Code Block is present, an additional CRC sequence of L = 24 Bits is attached to each Code Block (otherwise L = 0 Bit).												
NOTE 3: SS/PBCH block is transmitted in slot #0 of each frame												
NOTE 4: Slot i is slot index per frame												

Table A.3.3.3-3. Fixed reference channel for maximum input level receiver requirements (SCS 60 kHz, TDD, 64QAM)

Parameter	Unit	Value										
		10	15	20	25	30	40	50	60	80	100	
Channel bandwidth	MHz											
Subcarrier spacing configuration μ		2	2	2	2	2	2	2	2	2	2	2
Allocated resource blocks		11	18	24	31	38	51	65	79	107	135	
Subcarriers per resource block		12	12	12	12	12	12	12	12	12	12	12
Allocated slots per Frame		22	22	22	22	22	22	22	22	22	22	22
MCS Index		24	24	24	24	24	24	24	24	24	24	24
MCS Table for TBS determination		64QAM										
Modulation		64 QAM	64 QAM	64 QAM	64 QAM	64 QAM	64 QAM	64 QAM	64 QAM	64 QAM	64 QAM	64 QAM
Target Coding Rate		3/4	3/4	3/4	3/4	3/4	3/4	3/4	3/4	3/4	3/4	3/4
Maximum number of HARQ transmissions		1	1	1	1	1	1	1	1	1	1	1
Information Bit Payload per Slot												
For Slots 0,1 and Slot i, if mod(i, 5) = {3,4} for i from {0,...,39}	Bits	N/A	N/A	N/A	N/A	N/A	N/A	N/A	N/A	N/A	N/A	N/A
For Slot i, if mod(i, 5) = {0,1,2} for i from {2,...,39}	Bits	5376	8712	11784	15112	18432	25104	31752	38936	52224	65576	
Transport block CRC	Bits	24	24	24	24	24	24	24	24	24	24	24
LDPC base graph		1	1	1	1	1	1	1	1	1	1	1
Number of Code Blocks per Slot												
For Slots 0,1 and Slot i, if mod(i, 5) = {3,4} for i from {0,...,39}	CBs	N/A	N/A	N/A	N/A	N/A	N/A	N/A	N/A	N/A	N/A	N/A
For Slot i, if mod(i, 5) = {0,1,2} for i from {2,...,39}	CBs	1	2	2	2	3	3	4	5	7	8	
Binary Channel Bits per Slot												
For Slots 0,1 and Slot i, if mod(i, 5) = {3,4} for i from {0,...,39}	Bits	N/A	N/A	N/A	N/A	N/A	N/A	N/A	N/A	N/A	N/A	N/A
For Slot i, if mod(i, 5) = {0,1,2} for i from {2,...,39}	Bits	7128	11664	15552	20088	24624	33048	42120	51192	69336	87480	
Max. Throughput averaged over 1 frame	Mbps	11.827	19.166	25.925	33.246	40.550	55.229	69.854	85.659	114.89 3	144.26 7	
NOTE 1: Additional parameters are specified in Table A.3.1-1 and Table A.3.3.1-1. NOTE 2: If more than one Code Block is present, an additional CRC sequence of L = 24 Bits is attached to each Code Block (otherwise L = 0 Bit). NOTE 3: SS/PBCH block is transmitted in slot #0 of each frame NOTE 4: Slot i is slot index per frame												

A.3.3.4 FRC for maximum input level for 256 QAM

Table A.3.3.4-1 Fixed reference channel for maximum input level receiver requirements (SCS 15 kHz, TDD, 256QAM)

Parameter	Unit	Value							
		5	10	15	20	25	30	40	50
Channel bandwidth	MHz	5	10	15	20	25	30	40	50
Subcarrier spacing	kHz	15	15	15	15	15	15	15	15
Subcarrier spacing configuration μ		0	0	0	0	0	0	0	0
Allocated resource blocks		25	52	79	106	133	[160]	216	270
Subcarriers per resource block		12	12	12	12	12	12	12	12
Allocated slots per Frame		5	5	5	5	5	5	5	5
MCS Index		23	23	23	23	23	23	23	23
MCS table for TBS determination		256QAM							
Modulation		256 QAM	256 QAM	256 QAM	256 QAM	256 QAM	256 QAM	256 QAM	256 QAM
Target Coding Rate		4/5	4/5	4/5	4/5	4/5	4/5	4/5	4/5
Maximum number of HARQ transmissions		1	1	1	1	1	1	1	1
Information Bit Payload per Slot									
For Slots 0,3,4,8,9	Bits	N/A	N/A	N/A	N/A	N/A	N/A	N/A	N/A
For Slots 1,2,5,6,7	Bits	16896	34816	53288	71688	90176	108552	143400	180376
Transport block CRC	Bits	24	24	24	24	24	24	24	24
LDPC base graph		1	1	1	1	1	1	1	1
Number of Code Blocks per Slot									
For Slots 0,3,4,8,9	CBs	N/A	N/A	N/A	N/A	N/A	N/A	N/A	N/A
For Slots 1,2,5,6,7	CBs	3	5	7	9	12	14	18	23
Binary Channel Bits per Slot									
For Slots 0,3,4,8,9	Bits	N/A	N/A	N/A	N/A	N/A	N/A	N/A	N/A
For Slots 1,2,5,6,7	Bits	21600	44928	68256	91584	114912	138240	186624	233280
Max. Throughput averaged over 1 frame	Mbps	8.448	17.408	26.644	35.844	45.088	54.276	71.700	90.188
NOTE 1: Additional parameters are specified in Table A.3.1-1 and Table A.3.3.1-1.									
NOTE 2: If more than one Code Block is present, an additional CRC sequence of L = 24 Bits is attached to each Code Block (otherwise L = 0 Bit).									
NOTE 3: SS/PBCH block is transmitted in slot 0 of each frame									
NOTE 4: Slot i is slot index per frame									

Table A.3.3.4-3 Fixed reference channel for maximum input level receiver requirements (SCS 60 kHz, TDD, 256QAM)

Parameter	Unit	Value								
		10	15	20	25	30	40	50	60	80
Bandwidth	MHz	10	15	20	25	30	40	50	60	80
Subcarrier spacing configuration μ		2	2	2	2	2	2	2	2	2
Number of resource blocks		11	18	24	31	38	51	65	79	107
Number of subcarriers per resource block		12	12	12	12	12	12	12	12	12
Number of slots per Frame		22	22	22	22	22	22	22	22	22
Number of subcarriers		23	23	23	23	23	23	23	23	23
Modulation scheme for TBS determination		256QAM								
Modulation order		256 QAM	256 QAM	256 QAM	256 QAM	256 QAM	256 QAM	256 QAM	256 QAM	256 QAM
Coding Rate		4/5	4/5	4/5	4/5	4/5	4/5	4/5	4/5	4/5
Number of HARQ transmissions		1	1	1	1	1	1	1	1	1
Number of Bits per Slot										
Number of bits for Slot i, if mod(i, 5) = {3,4} for i from {0,...,39}	Bits	N/A	N/A	N/A	N/A	N/A	N/A	N/A	N/A	N/A
Number of bits for Slot i, if mod(i, 5) = {0,1,2} for i from {0,...,39}	Bits	7424	12040	16136	21000	25608	33816	44040	53288	71688
Number of bits for CRC	Bits	24	24	24	24	24	24	24	24	24
Number of bits for PBCH		1	1	1	1	1	1	1	1	1
Number of Code Blocks per Slot										
Number of Code Blocks for Slot i, if mod(i, 5) = {3,4} for i from {0,...,39}	CBs	N/A	N/A	N/A	N/A	N/A	N/A	N/A	N/A	N/A
Number of Code Blocks for Slot i, if mod(i, 5) = {0,1,2} for i from {0,...,39}	CBs	1	2	3	3	4	5	6	7	9
Number of bits per Slot										
Number of bits for Slot i, if mod(i, 5) = {3,4} for i from {0,...,39}	Bits	N/A	N/A	N/A	N/A	N/A	N/A	N/A	N/A	N/A
Number of bits for Slot i, if mod(i, 5) = {0,1,2} for i from {0,...,39}	Bits	9504	15552	20736	26784	32832	44064	56160	68256	92448
Throughput averaged over 1 frame	Mbps	16.333	26.488	35.499	46.200	56.338	74.395	96.888	117.234	157.714

Additional parameters are specified in Table A.3.1-1 and Table A.3.3.1-1.

If more than one Code Block is present, an additional CRC sequence of L = 24 Bits is attached to each Code Block (otherwise L = 0 Bit).

SS/PBCH block is transmitted in slot #0 of each frame

Slot i is slot index per frame

A.4 CSI reference measurement channels

A.5 OFDMA Channel Noise Generator (OCNG)

A.5.1 OCNG Patterns for FDD

A.5.1.1 OCNG FDD pattern 1: Generic OCNG FDD Pattern for all unused REs

Table A.5.1.1-1: OP.1 FDD: Generic OCNG FDD Pattern for all unused REs

OCNG Appliance	Control Region (Core Set)	Data Region
OCNG Parameters		
Resources allocated	All unused REs (Note 1)	All unused REs (Note 2)

Structure	PDCCH	PDSCH
Content	Uncorrelated pseudo random QPSK modulated data	Uncorrelated pseudo random QPSK modulated data
Transmission scheme for multiple antennas ports transmission	Single Tx port transmission	Spatial multiplexing using any precoding matrix with dimensions same as the precoding matrix for PDSCH
Subcarrier Spacing	Same as for RMC PDCCH in the active BWP	Same as for RMC PDSCH in the active BWP
Power Level	Same as for RMC PDCCH	Same as for RMC PDSCH
Note 1: All unused REs in the active CORESETS appointed by the search spaces in use.		
Note 2: Unused available REs refer to REs in PRBs not allocated for any physical channels, CORESETs, synchronization signals or reference signals in channel bandwidth.		

A.5.2 OCNG Patterns for TDD

A.5.2.1 OCNG TDD pattern 1: Generic OCNG TDD Pattern for all unused REs

Table A.5.2.1-1: OP.1 TDD: Generic OCNG TDD Pattern for all unused REs

OCNG Appliance OCNG Parameters	Control Region (Core Set)	Data Region
Resources allocated	All unused REs (Note 1)	All unused REs (Note 2)
Structure	PDCCH	PDSCH
Content	Uncorrelated pseudo random QPSK modulated data	Uncorrelated pseudo random QPSK modulated data
Transmission scheme for multiple antennas ports transmission	Single Tx port transmission	Spatial multiplexing using any precoding matrix with dimensions same as the precoding matrix for PDSCH
Subcarrier Spacing	Same as for RMC PDCCH in the active BWP	Same as for RMC PDSCH in the active BWP
Power Level	Same as for RMC PDCCH	Same as for RMC PDSCH
Note 1: All unused REs in the active CORESETS appointed by the search spaces in use.		
Note 2: Unused available REs refer to REs in PRBs not allocated for any physical channels, CORESETs, synchronization signals or reference signals in channel bandwidth.		

A.6 Void

Annex B (informative): Void

Annex C (informative): Downlink physical channels

C.1 General

The following clauses, describes the downlink Physical Channels that are transmitted during a connection i.e., when measurements are done.

C.2 Setup

Table C.2-1 describes the downlink Physical Channels that are required for connection set up.

Table C.2-1: Downlink Physical Channels required for connection set-up

Physical Channel
PBCH
SSS
PSS
PDCCH
PDSCH
PBCH DMRS
PDCCH DMRS
PDSCH DMRS
CSI-RS

C.3 Connection

C.3.1 Measurement of Receiver Characteristics

Unless otherwise stated, Table C.3.1-1 is applicable for measurements on the Receiver Characteristics (clause 7).

Table C.3.1-1: Downlink Physical Channels transmitted during a connection (FDD and TDD)

Parameter	Unit	Value
SSS transmit power	W	Test specific
EPRE ratio of PSS to SSS	dB	0
EPRE ratio of PBCH DMRS to SSS	dB	0
EPRE ratio of PBCH to PBCH DMRS	dB	0
EPRE ratio of PDCCH DMRS to SSS	dB	0
EPRE ratio of PDCCH to PDCCH DMRS	dB	0
EPRE ratio of PDSCH DMRS to SSS (Note 1)	dB	3
EPRE ratio of PDSCH to PDSCH DMRS (Note 1)	dB	-3
EPRE ratio of CSI-RS to SSS	dB	0
EPRE ratio of PTRS to PDSCH	dB	Test specific
EPRE ratio of OCNG DMRS to SSS	dB	0
EPRE ratio of OCNG to OCNG DMRS (Note 1)	dB	0
NOTE 1: No boosting is applied to any of the channels except PDSCH DMRS. For PDSCH DMRS, 3 dB power boosting is applied assuming DMRS Type 1 configuration when DMRS and PDSCH are TDM'ed and only half of the DMRS REs are occupied.		
NOTE 2: Number of DMRS CDM groups without data for PDSCH DMRS configuration for OCNG is set to 1.		

Annex D (informative): Void

Annex E (normative): Environmental conditions

E.1 General

This normative annex specifies the environmental requirements of the UE. Within these limits the requirements of the present documents shall be fulfilled.

E.2 Environmental

The requirements in this clause apply to all types of UE(s).

E.2.1 Temperature

The UE shall fulfil all the requirements in the full temperature range of:

Table E.2.1-1: Temperature conditions

+15°C to +35°C	For normal conditions (with relative humidity of 25 % to 75 %)
-10°C to +55°C	For extreme conditions (see IEC publications 68-2-1 and 68-2-2)

Outside this temperature range the UE, if powered on, shall not make ineffective use of the radio frequency spectrum. In no case shall the UE exceed the transmitted levels as defined in clause 6.2 for extreme operation.

E.2.2 Voltage

The UE shall fulfil all the requirements in the full voltage range, i.e. the voltage range between the extreme voltages.

The manufacturer shall declare the lower and higher extreme voltages and the approximate shutdown voltage. For the equipment that can be operated from one or more of the power sources listed below, the lower extreme voltage shall not be higher, and the higher extreme voltage shall not be lower than that specified below.

Table E.2.2-1: Voltage conditions

Power source	Lower extreme voltage	Higher extreme voltage	Normal conditions voltage
AC mains	0,9 * nominal	1,1 * nominal	nominal
Regulated lead acid battery	0,9 * nominal	1,3 * nominal	1,1 * nominal
Non regulated batteries:			
Leclanché	0,85 * nominal	Nominal	Nominal
Lithium	0,95 * nominal	1,1 * Nominal	1,1 * Nominal
Mercury/nickel & cadmium	0,90 * nominal		Nominal

Outside this voltage range the UE if powered on, shall not make ineffective use of the radio frequency spectrum. In no case shall the UE exceed the transmitted levels as defined in clause 6.2 for extreme operation. In particular, the UE shall inhibit all RF transmissions when the power supply voltage is below the manufacturer declared shutdown voltage.

E.2.3 Vibration

The UE shall fulfil all the requirements when vibrated at the following frequency/amplitudes.

Table E.2.3-1: Vibration conditions

Frequency	ASD (Acceleration Spectral Density) random vibration
5 Hz to 20 Hz	0,96 m ² /s ³
20 Hz to 500 Hz	0,96 m ² /s ³ at 20 Hz, thereafter –3 dB/Octave

Outside the specified frequency range the UE, if powered on, shall not make ineffective use of the radio frequency spectrum. In no case shall the UE exceed the transmitted levels as defined in TS 38.101-1 for extreme operation.

Annex F (normative): Transmit modulation

F.1 Measurement Point

Figure F.1-1 shows the measurement point for the unwanted emission falling into non-allocated RB(s) and the EVM for the allocated RB(s).

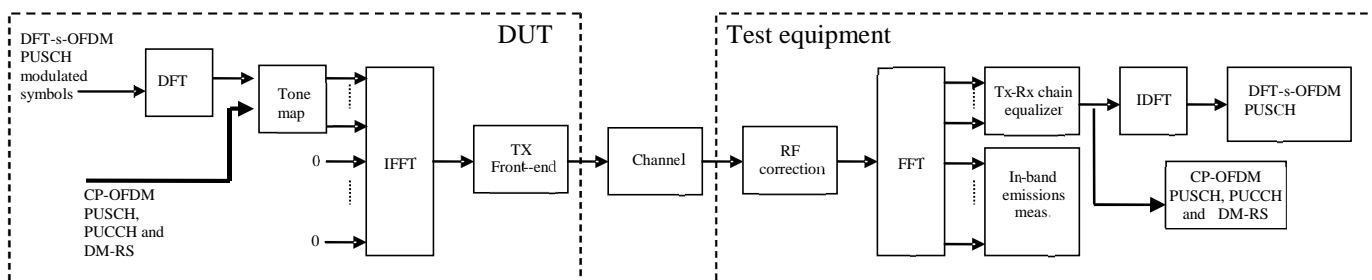

Figure F.1-1: EVM measurement points

F.2 Basic Error Vector Magnitude measurement

The EVM is the difference between the ideal waveform and the measured waveform for the allocated RB(s)

$$EVM = \sqrt{\frac{\sum_{v \in T_m} |z'(v) - i(v)|^2}{|T_m| \cdot P_0}}$$

where

T_m is a set of $|T_m|$ modulation symbols with the considered modulation scheme being active within the measurement period,

$z'(v)$ are the samples of the signal evaluated for the EVM,

$i(v)$ is the ideal signal reconstructed by the measurement equipment, and

P_0 is the average power of the ideal signal. For normalized modulation symbols P_0 is equal to 1.

The basic EVM measurement interval is defined over one slot in the time domain for PUCCH and PUSCH and over one preamble sequence for the PRACH.

F.3 Basic in-band emissions measurement

The in-band emissions are a measure of the interference falling into the non-allocated resources blocks. The in-band emission requirement is evaluated for PUCCH and PUSCH transmissions. The in-band emission requirement is not evaluated for PRACH transmissions.

The in-band emissions are measured as follows

$$Emissions_{absolute}(\Delta_{RB}) = \begin{cases} \frac{1}{|T_s|} \sum_{t \in T_s} \sum_{f_l + (12 \cdot \Delta_{RB} + 11) \cdot \Delta f}^{\max(f_{\min}, f_l + 12 \cdot \Delta_{RB} \cdot \Delta f)} |Y(t, f)|^2, \Delta_{RB} < 0 \\ \frac{1}{|T_s|} \sum_{t \in T_s} \sum_{f_h + (12 \cdot \Delta_{RB} - 11) \cdot \Delta f}^{\min(f_{\max}, f_h + 12 \cdot \Delta_{RB} \cdot \Delta f)} |Y(t, f)|^2, \Delta_{RB} > 0 \end{cases},$$

where

T_s is a set of $|T_s|$ OFDM symbols with the considered modulation scheme being active within the measurement period,

Δ_{RB} is the starting frequency offset between the allocated RB and the measured non-allocated RB (e.g. $\Delta_{RB} = 1$ or $\Delta_{RB} = -1$ for the first adjacent RB),

f_{\min} (resp. f_{\max}) is the lower (resp. upper) edge of the UL system BW,

f_l and f_h are the lower and upper edge of the allocated BW, and

$Y(t, f)$ is the frequency domain signal evaluated for in-band emissions as defined in the subsection (ii)

The relative in-band emissions are, given by

$$Emissions_{relative}(\Delta_{RB}) = \frac{Emissions_{absolute}(\Delta_{RB})}{\frac{1}{|T_s| \cdot N_{RB}} \sum_{t \in T_s} \sum_{f_l}^{f_l + (12 \cdot N_{RB} - 1) \Delta f} |Y(t, f)|^2}$$

where

N_{RB} is the number of allocated RBs

The basic in-band emissions measurement interval is defined over one slot in the time domain. When the PUSCH or PUCCH transmission slot is shortened due to multiplexing with SRS, the in-band emissions measurement interval is reduced by one OFDM symbol, accordingly.

In the evaluation of in-band emissions, the timing is set according to $\Delta \tilde{t} = \Delta \tilde{c}$, where sample time offsets $\Delta \tilde{t}$ and $\Delta \tilde{c}$ are defined in subclause F.4.

F.4 Modified signal under test

Implicit in the definition of EVM is an assumption that the receiver is able to compensate a number of transmitter impairments.

The PUSCH data or PRACH signal under test is modified and, in the case of PUSCH data signal, decoded according to:

$$Z'(t, f) = IDFT \left\{ \frac{FFT \left\{ z(v - \Delta \tilde{t}) \cdot e^{-j2\pi \Delta \tilde{t} v} \right\} e^{j2\pi f \Delta \tilde{t}}}{\tilde{a}(t, f) \cdot e^{j\tilde{\varphi}(t, f)}} \right\}$$

where

$z(v)$ is the time domain samples of the signal under test.

The PUCCH or PUSCH demodulation reference signal or PUCCH data signal under test is equalised and, in the case of PUCCH data signal decoded according to:

$$Z'(t, f) = \frac{FFT \left\{ z(v - \Delta \tilde{t}) \cdot e^{-j2\pi \Delta \tilde{t} v} \right\} e^{j2\pi f \Delta \tilde{t}}}{\tilde{a}(t, f) \cdot e^{j\tilde{\varphi}(t, f)}}$$

where

$z(v)$ is the time domain samples of the signal under test.

To minimize the error, the signal under test should be modified with respect to a set of parameters following the procedure explained below.

Notation:

$\Delta\tilde{t}$ is the sample timing difference between the FFT processing window in relation to nominal timing of the ideal signal.

$\Delta\tilde{f}$ is the RF frequency offset.

$\tilde{\varphi}(t, f)$ is the phase response of the TX chain.

$\tilde{a}(t, f)$ is the amplitude response of the TX chain.

In the following $\Delta\tilde{c}$ represents the middle sample of the EVM window of length W (defined in the next subsections) or the last sample of the first window half if W is even.

The EVM analyser shall

- detect the start of each slot and estimate $\Delta\tilde{t}$ and $\Delta\tilde{f}$,
- determine $\Delta\tilde{c}$ so that the EVM window of length W is centred
 - on the time interval determined by the measured cyclic prefix minus 16κ samples of the considered OFDM symbol for symbol l for subcarrier spacing configuration μ in a subframe, with $l = 0$ or $l = 7 \cdot 2^\mu$ for normal CP, i.e. the first 16κ samples of the CP should not be taken into account for this step. In the determination of the number of excluded samples, a sampling rate of $1/T_c$ is assumed. If a different sampling rate is used, the number of excluded samples is scaled linearly.
 - on the measured cyclic prefix of the considered OFDM symbol for all other symbols for normal CP and for symbol 0 to 11 for extended CP.
 - on the measured preamble cyclic prefix for the PRACH

To determine the other parameters a sample timing offset equal to $\Delta\tilde{c}$ is corrected from the signal under test. The EVM analyser shall then

- correct the RF frequency offset $\Delta\tilde{f}$ for each time slot, and
- apply an FFT of appropriate size. The chosen FFT size shall ensure that in the case of an ideal signal under test, there is no measured inter-subcarrier interference.

The carrier leakage shall be removed from the evaluated signal before calculating the EVM and the in-band emissions; however, the removed relative carrier leakage power also has to satisfy the applicable requirement.

At this stage the allocated RBs shall be separated from the non-allocated RBs. In the case of PUCCH and PUSCH EVM, the signal on the non-allocated RB(s), $Y(t, f)$, is used to evaluate the in-band emissions.

Moreover, the following procedure applies only to the signal on the allocated RB(s).

- In the case of PUCCH and PUSCH, the UL EVM analyzer shall estimate the TX chain equalizer coefficients $\tilde{a}(t, f)$ and $\tilde{\varphi}(t, f)$ used by the ZF equalizer for all subcarriers by time averaging at each signal subcarrier of the amplitude and phase of the reference and data symbols. The time-averaging length is 1 slot. This process creates an average amplitude and phase for each signal subcarrier used by the ZF equalizer. The knowledge of data modulation symbols may be required in this step because the determination of symbols by demodulation is not reliable before signal equalization.

- In the case of PRACH, the UL EVM analyzer shall estimate the TX chain coefficients $\tilde{a}(t)$ and $\tilde{\varphi}(t)$ used for phase and amplitude correction and are selected so as to minimize the resulting EVM. The TX chain coefficients are not dependent on frequency, i.e. $\tilde{a}(t, f) = \tilde{a}(t)$ and $\tilde{\varphi}(t, f) = \tilde{\varphi}(t)$. The TX chain coefficients are chosen independently for each preamble transmission and for each $\Delta\tilde{f}$.

At this stage estimates of $\Delta\tilde{f}$, $\tilde{a}(t, f)$, $\tilde{\varphi}(t, f)$ and $\Delta\tilde{c}$ are available. $\Delta\tilde{f}$ is one of the extremities of the window W , i.e. $\Delta\tilde{f}$ can be $\Delta\tilde{c} + \alpha - \left\lfloor \frac{W}{2} \right\rfloor$ or $\Delta\tilde{c} + \left\lfloor \frac{W}{2} \right\rfloor$, where $\alpha = 0$ if W is odd and $\alpha = 1$ if W is even. The EVM analyser shall then

- calculate EVM_l with $\Delta\tilde{f}$ set to $\Delta\tilde{c} + \alpha - \left\lfloor \frac{W}{2} \right\rfloor$,
- calculate EVM_h with $\Delta\tilde{f}$ set to $\Delta\tilde{c} + \left\lfloor \frac{W}{2} \right\rfloor$.

F.5 Window length

F.5.1 Timing offset

As a result of using a cyclic prefix, there is a range of $\Delta\tilde{f}$, which, at least in the case of perfect Tx signal quality, would give close to minimum error vector magnitude. As a first order approximation, that range should be equal to the length of the cyclic prefix. Any time domain windowing or FIR pulse shaping applied by the transmitter reduces the $\Delta\tilde{f}$ range within which the error vector is close to its minimum.

F.5.2 Window length

The window length W affects the measured EVM, and is expressed as a function of the configured cyclic prefix length. In the case where equalization is present, as with frequency domain EVM computation, the effect of FIR is reduced. This is because the equalization can correct most of the linear distortion introduced by the FIR. However, the time domain windowing effect can't be removed.

F.5.3 Window length for normal CP

Contents in this section are FFS.

F.5.4 Window length for Extended CP

Contents in this section are FFS.

F.5.5 Window length for PRACH

Contents in this section are FFS.

F.6 Averaged EVM

The general EVM is averaged over basic EVM measurements for n slots in the time domain.

$$\overline{EVM} = \sqrt{\frac{1}{n} \sum_{i=1}^n EVM_i^2},$$

where n is

$$n = \begin{cases} 10, & \text{for 15 kHz SCS} \\ 20, & \text{for 30 kHz SCS} \\ 40, & \text{for 60 kHz SCS} \end{cases}$$

for PUCCH, PUSCH.

The EVM requirements shall be tested against the maximum of the RMS average at the window W extremities of the EVM measurements:

Thus \overline{EVM}_l is calculated using $\Delta\tilde{t} = \Delta\tilde{t}_l$ in the expressions above and \overline{EVM}_h is calculated using $\Delta\tilde{t} = \Delta\tilde{t}_h$.

Thus we get:

$$EVM = \max(\overline{EVM}_l, \overline{EVM}_h)$$

The calculation of the EVM for the demodulation reference signal, EVM_{DMRS} , follows the same procedure as calculating the general EVM, with the exception that the modulation symbol set T_m defined in clause F.2 is restricted to symbols containing uplink demodulation reference signals.

The basic EVM_{DMRS} measurements are first averaged over n slots in the time domain to obtain an intermediate average \overline{EVM}_{DMRS} .

$$\overline{EVM}_{DMRS} = \sqrt{\frac{1}{n} \sum_{i=1}^n EVM_{DMRS,i}^2}$$

In the determination of each $EVM_{DMRS,i}$, the timing is set to $\Delta\tilde{t} = \Delta\tilde{t}_l$ if $\overline{EVM}_l > \overline{EVM}_h$, and it is set to $\Delta\tilde{t} = \Delta\tilde{t}_h$ otherwise, where \overline{EVM}_l and \overline{EVM}_h are the general average EVM values calculated in the same n slots over which the intermediate average \overline{EVM}_{DMRS} is calculated. Note that in some cases, the general average EVM may be calculated only for the purpose of timing selection for the demodulation reference signal EVM.

Then the results are further averaged to get the EVM for the demodulation reference signal, EVM_{DMRS} ,

$$EVM_{DMRS} = \sqrt{\frac{1}{6} \sum_{j=1}^6 \overline{EVM}_{DMRS,j}^2}$$

The PRACH EVM, EVM_{PRACH} , is averaged over TBD preamble sequence measurements for all preamble formats.

The EVM requirements shall be tested against the maximum of the RMS average at the window W extremities of the EVM measurements:

Thus $\overline{EVM}_{PRACH,l}$ is calculated using $\Delta\tilde{t} = \Delta\tilde{t}_l$ and $\overline{EVM}_{PRACH,h}$ is calculated using $\Delta\tilde{t} = \Delta\tilde{t}_h$.

Thus we get:

$$EVM_{PRACH} = \max(\overline{EVM}_{PRACH,l}, \overline{EVM}_{PRACH,h})$$

F.7 Spectrum Flatness

The data shall be taken from FFT coded data symbols and the demodulation reference symbols of the allocated resource block.

Annex G (informative): Void

Annex H (informative): Void

Annex I (informative): Void

Annex J (informative): Change history

Change history							
Date	Meeting	TDoc	CR	Rev	Cat	Subject/Comment	New version
2017-08	RAN4#84	R4-1708909				Initial Skeleton	0.0.1
2017-10	RAN4#84 Bis	R4-1709958				Added approved TPs in RAN4-NR-AH#3 R4-1709948, TP for TS 38.101-1: minimum output power, Huawei R4-1709454, TP for TS 38.101-1:UE Tx spurious emission for range 1, ZTE Corporation	0.1.0
2017-10	RAN4#84 Bis	R4-1711978				Embedded approved TPs in RAN4#84Bis R4-1711556, "TP to TS 38.101: Draft CR to Transmitter power clause", Nokia R4-1710962, "TP to TS 38.101-1: Draft CR to Output RF spectrum emissions" Nokia R4-1711608, "TP for TS38.101-1 on conducted UE transmitter intermodulation for FR1(section 6.5)" ZTE Corporation Number of TPs by editors	0.2.0
2017-12	RAN4#85	R4-1713805				Approved TPs in RAN4#85 R4-1713204, TP on general parts for 38.101-1 NR FR1, Ericsson R4-1714047, WF on MPR for sub6GHz, NTT DOCOMO, INC. R4-1714052, TP for TS 38.101-1 introduction of band n71 for transmitter characteristics, T-Mobile USA Inc. R4-1714162, TP to 38.101-1: ACS, Ericsson R4-1714163, TP to 36.101-1: In-band blocking, Ericsson R4-1714446, TP to 36.101-1: Out-of-band blocking and exceptions for spurious response, Ericsson R4-1714369, TP for NBB requirement for FR1, Intel Corporation R4-1714529, TP on introducing operating bands for NR-LTE DC including SUL band combinations in 38.101-1, Huawei R4-1714097, TP for TS 38.101-1: UE RF requirements for standalone SUL, Huawei R4-1714536, TP for TS 38.101-1: Channel Bandwidth Definition, Qualcomm Incorporated (Note, this TP was further discussed and edited in the reflector) R4-1714114, TP for TS 38.101-1: Channel Arrangement, Qualcomm Incorporated (Note, this TP was further discussed and edited in the reflector) R4-1714029, Sub6 Reference Sensitivity, Qualcomm Incorporated R4-1714329, TP to TR 38.101-01 v0.2.0: ON/OFF mask design for NR UE transmissions for FR1, Ericsson Band list according to R4-1714542, List of bands and band combinations to be introduced into RAN4 NR core requirements by December 2017, RAN4 Chairmen Input from: R4-1714479, TP for TR 38.817-01 NR channel bandwidth, Huawei, HiSilicon	0.3.0
2017-12	RAN4#85	R4-1714569				Further corrections and alignments with 38.104 after email review	0.4.0
2017-12	RAN#78	RP-172475				v1.0.0 submitted for plenary approval. Contents same as 0.4.0	1.0.0
2017-12	RAN#78					Approved by plenary – Rel-15 spec under change control	15.0.0

2018-03	RAN#79	RP-180264	0003		F	<p>Implementation of endorsed CRs to 38.101-1</p> <p>Endorsed draft CRs</p> <p>F: R4-1800400, Editorial corrections for 38.101-1, Qualcomm</p> <p>B: R4-1801102, Draft CR for 30 MHz CBW support, Huawei</p> <p>F: R4-1800032, 38.101-1 n71 draft CR for section 6.2.3 - UE A-MPR - NS values, T-Mobile USA Inc.</p> <p>B: R4-1801121, Draft pCR for TS 38.101-1 version 15.0.0: Remaining ON/OFF masks for FR1 NR UE transmissions, Ericsson</p> <p>F: R4-1800417, Correction of NR SEM table and additional requirements table, vivo</p> <p>F: R4-1800033, 38.101-1 n71 draft CR for section 6.5.3.2 Spurious emissions for UE co-existence, T-Mobile USA Inc.</p> <p>F: R4-1801114, Proposal on protected band numbering in UE specs, Sprint Corporation</p> <p>F: R4-1800407, Draft CR for TS 38.101-1: Mandatory 4Rx antenna performance for NR UE, Vodafone Group Plc</p> <p>F: R4-1800451 Draft CR for TS 38.101-1: Clarification of 4Rx NR bands, Huawei, HiSilicon</p> <p>F: R4-1801136, Draft CR for TS 38.101-1: REFSENS for NR bands, Huawei, HiSilicon</p> <p>F: R4-1801137, Draft CR: n71 REFSENS, Dish Network</p> <p>F: R4-1800395, Draft CR to 38.101-1: corrections to ACS and in-band blocking, Ericsson</p> <p>F: R4-1800396, Draft CR to 38.101-1: corrections to out-of-band blocking, Ericsson</p> <p>F: R4-1800397, Draft CR to 38.101-1: corrections to spurious response, Ericsson</p> <p>F: R4-1800305, Draft CR for NR FR1 wide band intermodulation requirements, MediaTek Inc.</p> <p>F: R4-1800320, Draft CR to 38.101-1: Rx Spurious emission for NR FR1 (section 7.9), ZTE Corporation</p> <p>F: R4-1800473, Draft CR on UE RF requirements for SUL in TS 38.101-1, Huawei</p> <p>F: R4-1800965, Draft CR to TS 38.101-1: Asymmetric CH BW operation, Dish Network</p> <p>F: R4-1800882, Draft CR for correction of UE channel bandwidth for Bands n77 and n78 for TS 38.101-1, Orange UK</p> <p>F: R4-1801012, Draft CR to 38.101-1: Clarifications to UE spectrum utilization section 5.3, Ericsson</p> <p>F: R4-1800030, 38.101-1 n71 draft CR for section 5.4.4 - TX-RX frequency separation, T-Mobile USA Inc</p> <p>F: R4-1801228, Draft CR to 38.101-1: Channel spacing for CA for NR FR1(section 5.4.1.2), ZTE Corporation</p> <p>F: R4-1801231, Correction CR for channel spacing:38.101-1, Samsung</p> <p>F: R4-1801235, Draft CR to TS 38.101-1: Corrections on channel raster calculation in section 5.4.2, ZTE Corporation</p> <p>F: R4-1801318, Draft CR on synchronization raster, Huawei</p> <p>RAN4#86:</p> <p>R4-1803053, Draft CR for new spec structure of 38.101-1, Ericsson</p> <p>R4-1801479, Draft CR to 38.101-1: Default Tx-RX frequency separation for NR FR1(section 5.4.4), ZTE</p> <p>R4-1801581, Draft CR for TS 38.101-1 update of 4Rx bands, Huawei Technologies France</p> <p>R4-1802211, draft CR TS 38.101-1 Uplink configuration for FR1 NR REFSENS, Skyworks Solutions Inc.</p> <p>R4-1802342, Draft CR for NR FR1 ACS case 2 transmitter power setting correction (Note 1), MediaTek Inc.</p> <p>R4-1802509, Draft CR on 38.101-1 v15.0.0: Remaining ON/OFF masks for FR1 NR UE transmissions, Ericsson</p> <p>R4-1802566, Draft CR to TS 38.101-1: Clarification of mixed numerology guardband size, Ericsson</p> <p>R4-1802978, Draft CR to TS 38.101-1: Corrections on channel raster in Section 5.4.2.3, Intel Corporation</p> <p>R4-1803064, Draft CR for 38.101-1: Correction of errors, Sprint Corporation</p> <p>R4-1803065, Draft CR for 38.101-1 Introduction of n41requirements, Sprint Corporation</p> <p>R4-1803242, Draft CR to 38.101-1: Corrections to n66, Dish Network</p> <p>R4-1803285, Draft CR to 38.101-1: Correction to CH BWs without symmetric uplink Dish Network, Skyworks Solutions Inc.</p> <p>R4-1803436, Introduction of UL subcarrier alignment for additional bands, AT&T</p> <p>R4-1803456, Draft CR for 38.101-1: Spurious Emissions for UE Coexistence, Sprint Corporation</p>	15.1.0
---------	--------	-----------	------	--	---	---	--------

						R4-1803461, CR on configured transmitted power for TS 38.101-1, Huawei R4-1803452, draft CR for introduction of completed band combinations from 37.865-01-01 into 38.101-1, Ericsson R4-1803567, Draft CR for TS 38.101-1: Sync raster offset in re-farming bands (5.4.3), Ericsson R4-1803365, CR to introduce MPR for PC2 and PC3 and A-MPR for UTRA protection, Nokia	
2018-06	RAN#80	RP-181262	0011		F	CR to TS 38.101-1: Implementation of endorsed draft CRs from RAN4 #86bis and RAN4 #87	15.2.0

2018-09	RAN#81	RP-181896	0025		F	<p>Big CR for 38.101-1</p> <p>Endorced draft CRs from RAN4#NR-AH-1807 R4-1809335, Draft CR on UL RMC for FR1 RF tests, Qualcomm Incorporated R4-1809337, Draft CR on NR UE REFSSENS SNR FRC for FR1, Intel Corporation R4-1809339, Draft CR on measurement of receiver characteristics for FR1 RF Tests, Qualcomm Incorporated R4-1809396, Draft CR on NR UE maximum input level FRC for FR1, Intel R4-1809567, Draft CR on OCNNG pattern for FR1 REFSSENS tests, Qualcomm Incorporated, Rohde & Schwarz</p> <p>Endoirced draft CRs from RAN4#88</p> <p>R4-1809714, Draft CR to correct in-band blocking parameters for FR1, Anritsu Corporation R4-1809784, Draft CR to 38.101-1: Corrections on CA bandwidth classes for FR1, ZTE Corporation R4-1809785, Draft CR to TS 38.101-1 for Corrections on UE transmitter power, ZTE Corporation R4-1809793, Draft CR to 38.101-1: Corrections on additional spectrum emission mask, ZTE Corporation R4-1809919, Correction on UE receiver requirement for FR1, CATT R4-1810091, Draft CR TS 38.101-1 - UE ON-OFF mask clean up, Ericsson R4-1810210, Draft CR for TS 38.101-1: MPR inner and outer RB allocations formula correction, MediaTek, Inc. R4-1810229, Draft CR for TS 38.101-1: Spurious emission for UE coexistence table corrections, MediaTek, Inc. R4-1810230, Draft CR for TS38.101-1 to correct 90MHz UE CBW, LG Electronics, Inc. R4-1810232, Draft CR for TS 38.101-1: Table 7.3.2-1 n77 reference sensitivity corrections, MediaTek, Inc. R4-1810369, Draft CR to 38.101-1: Corrections on symbols and abbreviations in section 3, ZTE Corporation R4-1810376, Draft CR: General corrections to n71 requirements, Dish Network R4-1810428, Draft CR on TS38.101-1 for UE maximum output power for UL-MIMO, OPPO R4-1810552, Correction of reference tables, OPPO R4-1810729, Draft CR for introduction of Band n74 for TS 38.101-1, NTT DOCOMO, Inc. R4-1810862, Draft CR to 38.101-1: Updates to Transmit Modulation Annex, Rohde & Schwarz R4-1810892, CR to update Table 6.2D.1-2 for FR1, Qualcomm Incorporated R4-1810961, CR on ACS minimum requirement, Intel Corporation R4-1810965, CR on Out-of-Band Blocking minimum requirement, Intel Corporation R4-1810967, CR on Rx Intermodulation characteristics for CA, Intel Corporation R4-1810974, Annex lettering change for 38.101-1, Qualcomm Incorporated R4-1811189, CR to add more details to Coherent UL MIMO spec for FR1, Qualcomm Incorporated R4-1811280, Corrections of NR receiver characteristics titles, Vivo R4-1811455, Draft CR on DL Physical Channel for FR1 RF tests, Qualcomm Europe Inc. (Spain) R4-1811457, NS numbering, Qualcomm Incorporated R4-1811459, Correction on UE transmitter requirement for FR1, CATT R4-1811463, Draft CR for 38.101-1: Addition of missing NR CA configurations n8-n75 and n28-n75, VodafoneItalia SpA R4-1811472, Addition parameters about n51 in TS 38.101-1, Huawei, Hisilicon, Etisalat R4-1811474, CR CP- OFDM almost contiguous allocation, Nokia, Nokia Shanghai Bell R4-1811477, Draft CR to 38.101-1: FR1 Power Control, Qualcomm Incorporated R4-1811478, A-MPR correction for n20 and n28, Huawei, HiSilicon R4-1811490, Draft CR to 38.101-1: Addition of Carrier Leakage table, Rohde & Schwarz R4-1811491, Draft CR for TS38.101-1 on transmit signal quality, OPPO</p>	15.3.0
---------	--------	-----------	------	--	---	--	--------

					<p>R4-1811493, CR to TS 38.101-1: pi/2 BPSK with Spectrum Shaping, Indian Institute of Tech (M), Indian Institute of Tech (H), CEWIT, Nokia</p> <p>R4-1811513, A proposal on 2UL co-ex table modification, SoftBank Corp.</p> <p>R4-1811514, Draft CR to TS 38.101-1: Clarification on OCNG, Keysight Technologies UK Ltd</p> <p>R4-1811516, Draft CR on NR DL FRCs for FR1 UE RF requirements, Intel Corporation</p> <p>R4-1811550, Draft CR to TS 38.101-1 on channel bandwidth and spacing descriptions, Ericsson</p> <p>R4-1811553, Draft CR to 38.101-1: Corrections on description of channel raster entries, ZTE Corporation</p> <p>R4-1811783, Measurement period of PRACH time mask, CATT</p> <p>R4-1811792, Draft CR for A-MPR revision for n1, NTT DOCOMO, INC.</p> <p>R4-1811798, Draft CR for P_{cm}ax for FR1, Qualcomm Incorporated</p> <p>R4-1811799, P_{cm}ax for inter-band NR CA FR1 draft CR, InterDigital, Inc.</p> <p>R4-1811812, Draft CR to 38.101-1: On FR1 AMPR Band n41 NS_04, Qualcomm Incorporated</p> <p>R4-1811816, CR to update the definition of Long and Short subslot for FR1, Qualcomm</p> <p>R4-1811894, Addition parameters about n50 in TS 38.101-1, Huawei</p> <p>R4-1811896, Draft CR for TS 38.101-1: n41 GSCN range modification, MediaTek Inc.</p> <p>R4-1811285, Draft CR TS 38.101-1: NS_04 A-MPR' and spurious emisison corrections, Sprint</p>	
--	--	--	--	--	--	--

History

Document history		
V15.2.0	July 2018	Publication
V15.3.0	October 2018	Publication