

**HIGHLIGHTS OF PRESCRIBING INFORMATION**

These highlights do not include all the information needed to use BRIXADI safely and effectively. See full prescribing information for BRIXADI.

**BRIXADI™ (buprenorphine) extended-release injection for subcutaneous use CIII**  
Initial U.S. Approval: 2002

**WARNING: RISK OF SERIOUS HARM OR DEATH WITH INTRAVENOUS ADMINISTRATION; BRIXADI RISK EVALUATION AND MITIGATION STRATEGY**

See full prescribing information for complete boxed warning.

- **Serious harm or death could result if administered intravenously. (5.1)**
- **BRIXADI is only available through a restricted program called the BRIXADI REMS. Healthcare settings and pharmacies that order and dispense BRIXADI must be certified in this program and comply with the REMS requirements. (5.2)**

**INDICATIONS AND USAGE**

BRIXADI contains buprenorphine, a partial opioid agonist. BRIXADI is indicated for the treatment of moderate to severe opioid use disorder in patients who have initiated treatment with a single dose of a transmucosal buprenorphine product or who are already being treated with buprenorphine. (1)  
BRIXADI should be used as part of a complete treatment plan that includes counseling and psychosocial support. (1)

**DOSAGE AND ADMINISTRATION**

- Only healthcare providers should prepare and administer BRIXADI. (2.1)
- BRIXADI (weekly) and BRIXADI (monthly) are different formulations. Doses of BRIXADI (weekly) cannot be combined to yield an equivalent BRIXADI (monthly) dose. (2.1)
- BRIXADI should be injected slowly, into the subcutaneous tissue of the buttock, thigh, abdomen, or upper arm (2.1)
- Strongly consider prescribing naloxone at the time BRIXADI is initiated or renewed because patients being treated for opioid use disorder have the potential for relapse, putting them at risk for opioid overdose. (2.2)
- Injection sites for BRIXADI (weekly) should be alternated/rotated for each injection. (2.7)

See Full Prescribing Information for administration instructions. (2.7)

**DOSAGE FORMS AND STRENGTHS**

BRIXADI is a weekly and monthly injection provided in a pre-filled single-dose syringe with a 23 gauge ½ inch needle. (3)

- BRIXADI (weekly) is available in 8 mg/0.16 mL, 16 mg/0.32 mL, 24 mg/0.48 mL, and 32 mg/0.64 mL;
- BRIXADI (monthly) is available in 64 mg/0.18 mL, 96 mg/0.27 mL, and 128 mg/0.36 mL.

**CONTRAINDICATIONS**

Hypersensitivity to buprenorphine or any other ingredients in BRIXADI. (4)

**WARNINGS AND PRECAUTIONS**

- **Addiction, Abuse, and Misuse:** Buprenorphine can be abused in a manner similar to other opioids. Monitor patients for conditions indicative of diversion or progression of opioid dependence and addictive behaviors. (5.3)
- **Respiratory Depression:** Life-threatening respiratory depression and death have occurred in association with buprenorphine. Warn patients of the potential danger of self-administration of benzodiazepines or other CNS depressants while under treatment with BRIXADI. (5.4, 5.5)
- **Neonatal Opioid Withdrawal Syndrome:** Neonatal opioid withdrawal syndrome (NOWS) is an expected and treatable outcome of prolonged use of opioids during pregnancy. (5.6)
- **Adrenal Insufficiency:** If diagnosed, treat with physiologic replacement of corticosteroids, and wean patient off of the opioid. (5.7)
- **Risk of Opioid Withdrawal with Abrupt Discontinuation:** If treatment with BRIXADI is discontinued, monitor patients for withdrawal and treat appropriately. (5.8)
- **Risk of Hepatitis, Hepatic Events:** Monitor liver function tests prior to and during treatment. (5.9)
- **Latex Allergy:** The packaging of this product contains natural rubber latex which may cause allergic reactions. (5.10)
- **Risk of Withdrawal in Patients Dependent on Full Agonist Opioids:** Administer a test dose of transmucosal buprenorphine and monitor for precipitated withdrawal before injecting BRIXADI. (5.11)
- **Treatment of Emergent Acute Pain:** Treat pain with a non-opioid analgesic whenever possible. If opioid therapy is required, monitor patients closely because higher doses may be required for analgesic effect. (5.12)

**ADVERSE REACTIONS**

Adverse reactions commonly associated with BRIXADI administration (in ≥5% of patients) were injection site pain, headache, constipation, nausea, injection site erythema, injection site pruritus, insomnia, and urinary tract infection. (6.1)

**To report SUSPECTED ADVERSE REACTIONS, contact Braeburn at 1-833-274-9234 or FDA at 1-800-FDA-1088 or [www.fda.gov/medwatch](http://www.fda.gov/medwatch).**

**DRUG INTERACTIONS**

- **CYP3A4 Inhibitors and Inducers:** Monitor patients starting or ending CYP3A4 inhibitors or inducers for potential over or under dosing. (7)
- **Serotonergic Drugs:** If concomitant use is warranted, monitor for serotonin syndrome, particularly during treatment initiation, and during dose adjustment of the serotonergic drug. (7)

**USE IN SPECIFIC POPULATIONS**

- **Lactation:** Buprenorphine passes into the mother's milk. (8.2)
- **Geriatric Patients:** Monitor for sedation or respiratory depression. (8.5)
- **Moderate to Severe Hepatic Impairment:** Not recommended. (5.14, 8.6)

See 17 for PATIENT COUNSELING INFORMATION and Medication Guide.

Revised: 05/2023

**FULL PRESCRIBING INFORMATION: CONTENTS\***

**WARNING: RISK OF SERIOUS HARM OR DEATH WITH INTRAVENOUS ADMINISTRATION; BRIXADI RISK EVALUATION AND MITIGATION STRATEGY**

**1 INDICATIONS AND USAGE**

**2 DOSAGE AND ADMINISTRATION**

- 2.1 Important Dosage and Administration Instructions
- 2.2 Patient Access to Naloxone for the Emergency Treatment of Opioid Overdose
- 2.3 Recommended Dosing
- 2.4 Patient Selection
- 2.5 Clinical Supervision
- 2.6 Instructions for Use
- 2.7 Limits on Distribution
- 2.8 Removal of BRIXADI

**3 DOSAGE FORMS AND STRENGTHS**

**4 CONTRAINDICATIONS**

**5 WARNINGS AND PRECAUTIONS**

- 5.1 Risk of Serious Harm or Death with Intravenous Administration
- 5.2 BRIXADI Risk Evaluation and Mitigation Strategy (REMS)
- 5.3 Addiction, Abuse, and Misuse
- 5.4 Risk of Life-Threatening Respiratory and Central Nervous System (CNS) Depression
- 5.5 Managing Risks From Concomitant Use of Benzodiazepines or Other CNS Depressants with Buprenorphine
- 5.6 Neonatal Opioid Withdrawal Syndrome
- 5.7 Adrenal Insufficiency
- 5.8 Risk of Opioid Withdrawal with Abrupt Discontinuation of BRIXADI Treatment
- 5.9 Risk of Hepatitis, Hepatic Events
- 5.10 Hypersensitivity Reactions
- 5.11 Precipitation of Opioid Withdrawal Signs and Symptoms
- 5.12 Risks Associated with Treatment of Emergent Acute Pain

- 5.13 Use in Opioid Naïve Patients
- 5.14 Use in Patients with Impaired Hepatic Function
- 5.15 QTc Prolongation
- 5.16 Impairment of Ability to Drive and Operate Machinery
- 5.17 Orthostatic Hypotension
- 5.18 Elevation of Cerebrospinal Fluid Pressure
- 5.19 Elevation of Intrahepatic Pressure
- 5.20 Effects in Acute Abdominal Conditions
- 5.21 Unintentional Pediatric Exposure

**6 ADVERSE REACTIONS**

- 6.1 Clinical Trials Experience
- 6.2 Postmarketing Experience

**7 DRUG INTERACTIONS**

**8 USE IN SPECIFIC POPULATIONS**

- 8.1 Pregnancy
- 8.2 Lactation
- 8.3 Females and Males of Reproductive Potential
- 8.4 Pediatric Use
- 8.5 Geriatric Use
- 8.6 Hepatic Impairment
- 8.7 Renal Impairment

**9 DRUG ABUSE AND DEPENDENCE**

- 9.1 Controlled Substance
- 9.2 Abuse
- 9.3 Dependence

**10 OVERDOSAGE**

**11 DESCRIPTION**

**12 CLINICAL PHARMACOLOGY**

- 12.1 Mechanism of Action
- 12.2 Pharmacodynamics
- 12.3 Pharmacokinetics

**13 NONCLINICAL TOXICOLOGY**

- 13.1 Carcinogenesis, Mutagenesis, Impairment of Fertility

**14 CLINICAL STUDIES**

- 14.1 Opioid Blockade Study, NCT02611752
- 14.2 Phase 3 Double-Blind Study, NCT02651584

**16 HOW SUPPLIED/STORAGE AND HANDLING**

**17 PATIENT COUNSELING INFORMATION**

\* Sections or subsections omitted from the full prescribing information are not listed.

## FULL PRESCRIBING INFORMATION

### **WARNING: RISK OF SERIOUS HARM OR DEATH WITH INTRAVENOUS ADMINISTRATION; BRIXADI RISK EVALUATION AND MITIGATION STRATEGY**

- **Serious harm or death could result if administered intravenously. BRIXADI forms a liquid crystalline gel upon contact with body fluids and may cause occlusion, local tissue damage, and thrombo-embolic events, including life-threatening pulmonary emboli, if administered intravenously. (5.1)**
- **Because of the risk of serious harm or death that could result from intravenous self-administration, BRIXADI is only available through a restricted program called the BRIXADI REMS. Healthcare settings and pharmacies that order and dispense BRIXADI must be certified in this program and comply with the REMS requirements. (5.2)**

## 1 INDICATIONS AND USAGE

BRIXADI is indicated for the treatment of moderate to severe opioid use disorder in patients who have initiated treatment with a single dose of a transmucosal buprenorphine product or who are already being treated with buprenorphine.

BRIXADI should be used as part of a complete treatment plan that includes counseling and psychosocial support.

## 2 DOSAGE AND ADMINISTRATION

### 2.1 Important Dosage and Administration Instructions

FOR SUBCUTANEOUS INJECTION ONLY. DO NOT ADMINISTER BRIXADI INTRAVENOUSLY, INTRAMUSCULARLY, OR INTRADERMALLY [see *Warnings and Precautions (5.1), Instructions for Use (2.6)*].

- BRIXADI exists in two formulations.
- Doses of BRIXADI (weekly) cannot be combined to yield a monthly dose.
- Only healthcare providers should prepare and administer BRIXADI.
- Administer BRIXADI as a single injection. Do not divide.
- BRIXADI should be injected slowly, into the subcutaneous tissue of the buttock, thigh, abdomen, or upper arm.
  - In patients who are not currently receiving buprenorphine treatment, for BRIXADI (weekly), the upper arm site should only be used after steady-state has been achieved (4 consecutive doses) [see *Instructions for Use (2.6)*]. Injection in the arm site was associated with approximately 10% lower plasma levels than other sites.
- Injection sites should be alternated/rotated between injections for BRIXADI (weekly) [see *Instructions for Use (2.6)*].

- For all patients, the dose of BRIXADI must be individualized based on patient tolerability and/or efficacy.
- BRIXADI (weekly) should be administered in 7-day intervals.
- BRIXADI (monthly) should be administered in 28-day intervals.
- For patients not currently receiving buprenorphine treatment, begin with a test dose of 4 mg transmucosal buprenorphine to establish that buprenorphine is tolerated without precipitated withdrawal, and then transition to BRIXADI (weekly). Initiating treatment with BRIXADI as the first buprenorphine product has not been studied. Initiating treatment with BRIXADI (monthly) in new entrants to treatment has not been studied [see *Dosage and Administration (2.3)*].
- Patients who are currently being treated with other buprenorphine-containing products can start treatment with either BRIXADI (weekly) or BRIXADI (monthly) [see *Dosage and Administration (2.3)*].
- Administer each injection using only the syringe and safety needle included with the product [see *Instructions for Use (2.6)*]. Caution: The BRIXADI needle cap is synthetically derived from natural rubber latex which may cause allergic reactions in latex-sensitive individuals [see *Warnings and Precautions (5.10)*].

To avoid missed doses, the weekly dose may be administered up to 2 days before or after the weekly time point, and the monthly dose may be administered up to 1 week before or after the monthly time point.

If a dose is missed, the next dose should be administered as soon as practically possible.

## **2.2 Patient Access to Naloxone for the Emergency Treatment of Opioid Overdose**

Discuss the availability of naloxone for the emergency treatment of opioid overdose with the patient and caregiver. Because patients being treated for opioid use disorder have the potential for relapse, putting them at risk for opioid overdose, strongly consider prescribing naloxone for the emergency treatment of opioid overdose, both when initiating and renewing treatment with BRIXADI. Also consider prescribing naloxone if the patient has household members (including children) or other close contacts at risk for accidental ingestion or opioid overdose [see *Warnings and Precautions (5.4)*].

Advise patients and caregivers that naloxone may also be administered for a known or suspected overdose with buprenorphine itself. Higher than normal doses and repeated administration of naloxone may be necessary due to the long duration of action of buprenorphine and its affinity for the mu receptor [see *Overdosage (10)*].

Inform patients and caregivers of their options for obtaining naloxone as permitted by individual state naloxone dispensing and prescribing requirements or guidelines (e.g., by prescription, directly from a pharmacist, or as part of a community-based program) [see *Patient Counseling Information (17)*].

## 2.3 Recommended Dosing

### Patients Not Currently Receiving Buprenorphine Treatment

The recommended weekly dose in patients not currently receiving buprenorphine treatment is 24 mg of BRIXADI (weekly) titrated up over the first week of treatment as follows:

1. To avoid precipitating an opioid withdrawal syndrome, administer a test dose of transmucosal buprenorphine 4 mg when objective signs of mild to moderate withdrawal appear.
2. If the dose of transmucosal buprenorphine is tolerated without precipitated withdrawal, administer the first dose of BRIXADI (weekly), 16 mg.
3. Administer an additional dose of 8 mg BRIXADI (weekly) within 3 days of the first dose to achieve the recommended 24 mg BRIXADI (weekly) dose.

If needed, during this first week of treatment, administer an additional 8 mg dose of BRIXADI (weekly), waiting at least 24 hours after the previous injection, for a total weekly dose of 32 mg BRIXADI (weekly).

Administer subsequent BRIXADI (weekly) injections based on the total weekly dose that was established during Week One. Dosage adjustments can be made at weekly appointments with the maximum BRIXADI (weekly) dose being 32 mg.

A patient who misses a dose of BRIXADI (weekly) should receive the next dose as soon as possible. BRIXADI (weekly) should be administered in 7-day intervals.

### Patients Switching from Transmucosal Buprenorphine-containing Products to BRIXADI

Patients currently being treated with a transmucosal buprenorphine-containing product may be switched directly to either BRIXADI (weekly) or BRIXADI (monthly).

Table 1 identifies the corresponding dose of BRIXADI when switching a patient from transmucosal buprenorphine to BRIXADI (weekly) or BRIXADI (monthly), expressing the transmucosal dose equivalents in terms of Subutex or Suboxone doses.

**Table 1: Daily doses of sublingual buprenorphine (Subutex, Suboxone, or generic product equivalents) and suggested corresponding BRIXADI (weekly) or BRIXADI (monthly) doses**

Daily dose of sublingual buprenorphine	BRIXADI (weekly)	BRIXADI (monthly)
≤ 6 mg	8 mg	--
8-10 mg	16 mg	64 mg
12-16 mg	24 mg	96 mg
18-24 mg	32 mg	128 mg

Note: One SUBOXONE® (buprenorphine and naloxone) 8 mg/2 mg sublingual tablet provides equivalent buprenorphine exposure to one SUBUTEX® (buprenorphine HCl) 8 mg sublingual tablet or one Zubsolv® (buprenorphine and naloxone) 5.7 mg/1.4 mg sublingual tablet.

### Patients Transitioning Between BRIXADI (weekly) and BRIXADI (monthly)

Patients may be transitioned from weekly to monthly or from monthly to weekly dosing of BRIXADI based on clinical judgment (see Table 2).

**Table 2: Recommended dose when transitioning between BRIXADI (weekly) and BRIXADI (monthly)**

BRIXADI (weekly)	BRIXADI (monthly)
16 mg	64 mg
24 mg	96 mg
32 mg	128 mg

A patient who misses a dose of BRIXADI should receive the next dose as soon as possible. BRIXADI (weekly) should be administered in 7-day intervals. BRIXADI (monthly) should be administered in 28-day intervals.

#### Dose Adjustments of BRIXADI

An additional BRIXADI (weekly) 8 mg injection may be administered, based on clinical judgment during a dosing interval, up to a maximum dose of 32 mg per week of BRIXADI (weekly) or 128 mg per month of BRIXADI (monthly).

## **2.4 Patient Selection**

Patients appropriate for BRIXADI (weekly) are:

1. adults who have tolerated a single 4 mg dose of a transmucosal buprenorphine-containing product. The test dose of transmucosal buprenorphine-containing product should be administered based on instructions in the appropriate product label.
2. adults who are currently being treated with a transmucosal buprenorphine-containing product.

Patients appropriate for BRIXADI (monthly) are adults who are currently being treated with a transmucosal buprenorphine-containing product. BRIXADI (monthly) is not intended for patients who are not currently receiving buprenorphine treatment.

## **2.5 Clinical Supervision**

Periodic assessment is necessary to determine effectiveness of the treatment plan and overall patient progress. When evaluating the patient, examine the injection site for signs of infection or evidence of tampering or attempts to remove the depot.

Due to the chronic nature of opioid use disorder, the need for continuing medication-assisted treatment should be re-evaluated periodically. There is no maximum recommended duration of maintenance treatment. For some patients, treatment may continue indefinitely. If considering stopping treatment, the clinical status of the patient should be considered.

If BRIXADI is discontinued, its extended-release characteristics should be considered, and the patient should be monitored for several months for signs and symptoms of withdrawal and treated appropriately. After steady-state has been achieved, which is 4 weeks for BRIXADI (weekly) and 4 months for BRIXADI (monthly), patients discontinuing BRIXADI may have

detectable plasma levels of buprenorphine for approximately 1 month for BRIXADI (weekly) and for approximately 4 months for BRIXADI (monthly). The correlation between plasma concentrations of buprenorphine and those detectable in urine is not known.

## 2.6 Instructions for Use

Prior to injecting BRIXADI, carefully read the instructions as well as the full prescribing information.

### IMPORTANT INFORMATION:

- For subcutaneous injection only [*see Warnings and Precautions (5.1)*].
- To be prepared and administered by a healthcare provider only.
- Read the instructions carefully before handling the product.
- As a universal precaution, always wear gloves and inject BRIXADI under aseptic conditions.
- BRIXADI should be injected slowly, into the subcutaneous tissue of the buttock, thigh, abdomen, or upper arm.
- In patients who are not currently receiving buprenorphine treatment, for BRIXADI (weekly), the upper arm site should only be used after steady-state has been achieved (4 consecutive doses). Injection in the arm site was associated with approximately 10% lower plasma levels than other sites.
- Discard BRIXADI if the liquid contains visible particles or is cloudy. Discard BRIXADI after the expiration date shown on the carton or on the safety syringe label.

**SAFETY SYRINGE PARTS** (see Figures 1, 2, and 3 below)

Figure 1.

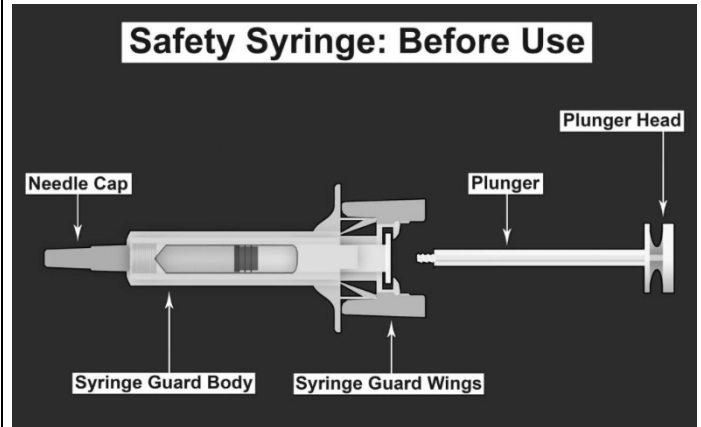

Figure 2.

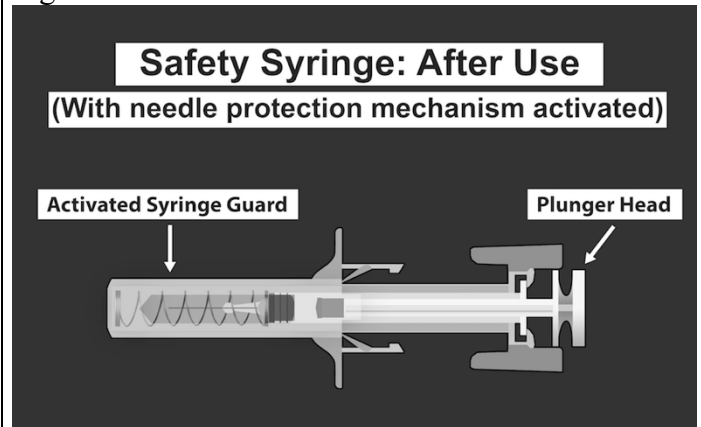
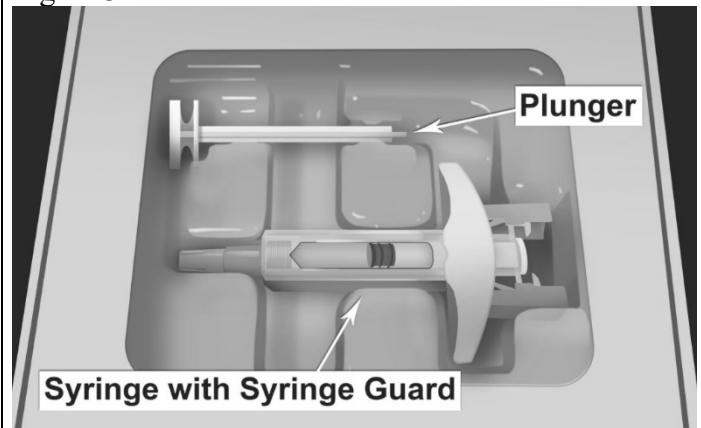

Figure 3.





### MATERIALS NEEDED FOR INJECTION

Illustrated in Figure 4.

- Alcohol wipe
- Cotton ball
- Sharps disposal container

Figure 4.



### SELECTING AN INJECTION SITE

The areas for subcutaneous injection are highlighted in Figure 5. **BRXADI should not be administered to the same site of injection for at least 8 weeks for BRXADI (weekly). No injection site rotation is required for BRXADI (monthly).**

**BRXADI should be injected slowly, into the subcutaneous tissue of the buttock, thigh, abdomen, or upper arm.**

In patients who are not currently receiving buprenorphine treatment, for BRXADI (weekly), the upper arm site should only be used after steady-state has been achieved (after 4 consecutive doses) [see *Dosage and Administration (2.1)*].

Figure 5.

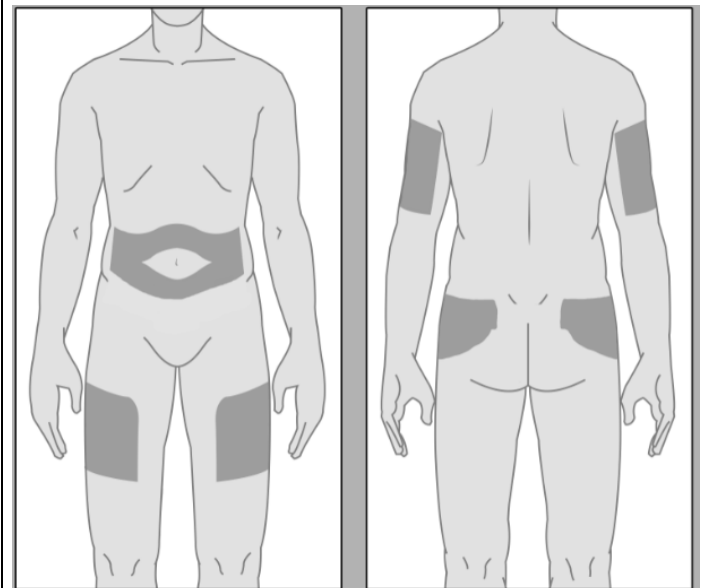

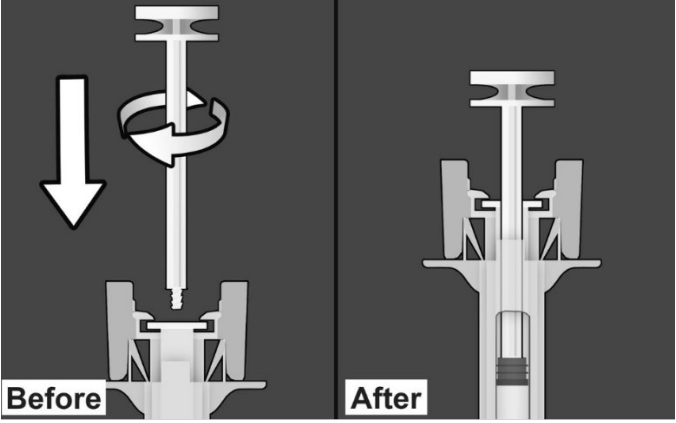
<p><b>PREPARE THE SAFETY SYRINGE</b></p> <p><i>Step 1:</i></p> <p>Wash hands thoroughly with soap and water prior to handling the safety syringe.</p> <p><i>Step 2:</i></p> <p>Remove the safety syringe components from the carton. Assemble the safety syringe. While holding the syringe guard body, insert the plunger into the body of the syringe and rotate clockwise until it is attached to the stopper inside the syringe as illustrated in Figure 6.</p>	<p>Figure 6.</p>  <p>The figure consists of two side-by-side diagrams labeled 'Before' and 'After'. The 'Before' diagram shows a plunger being inserted into the syringe body. A large white arrow points downwards, and a circular arrow indicates clockwise rotation. The 'After' diagram shows the plunger fully seated and locked into the stopper inside the syringe body.</p>
<p><i>Step 3:</i></p> <p>Inspect the safety syringe closely:</p> <p>Do not use the safety syringe after the expiration date shown on the carton or on the safety syringe label.</p> <ul style="list-style-type: none"><li>• The liquid should be clear and yellowish to yellow in color.</li><li>• A small air bubble may be visible.</li></ul> <p>Do not use the safety syringe if the liquid contains visible particles or is cloudy.</p>	
<p><b>PREPARATION OF SITE</b></p> <p><i>Step 4:</i></p> <ul style="list-style-type: none"><li>• Put on gloves.</li><li>• Clean the injection site with an alcohol wipe using a circular motion.</li></ul> <p>Do not touch the cleaned area again before injecting.</p>	

## ADMINISTERING INJECTION

### Step 5:

- Grasp the safety syringe by the syringe, as shown (see Figure 7).
- Carefully pull the needle cap straight off.
- Immediately dispose of the needle cap (Never try to recap the needle).

It is normal to see a small drop of liquid at the tip of the needle.

Figure 7.



### Step 6:

Pinch the skin at the injection site between your thumb and index finger as shown in Figure 8.

Figure 8.

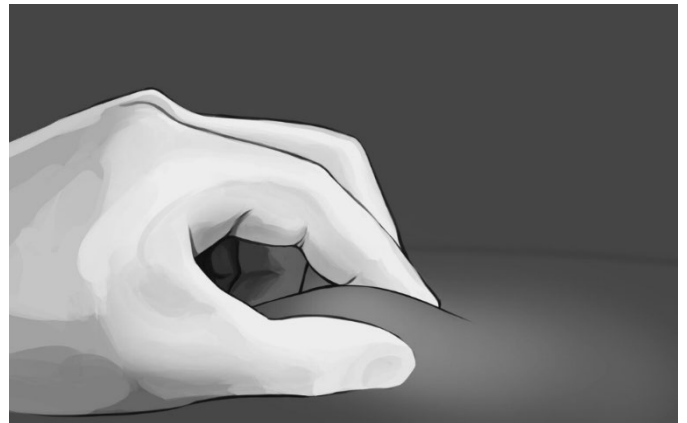

### Step 7:

Hold the syringe, as shown, and insert the needle at an angle of approximately 90° (see Figure 9). The needle is designed to inject into the subcutaneous space. It is important to fully insert the needle.

Figure 9.

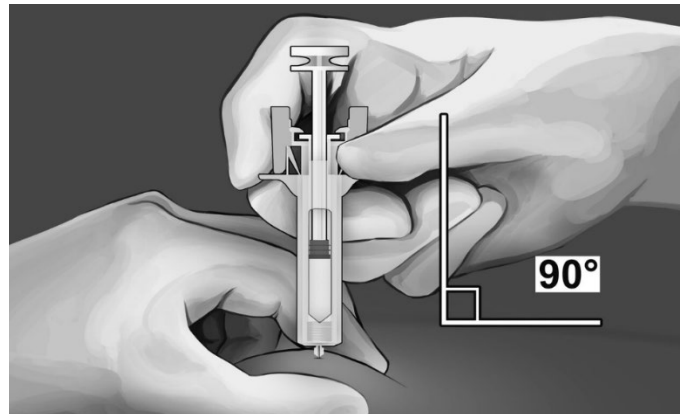

*Step 8:*

- After the needle is completely inserted into the subcutaneous tissue, release the skin that you are grasping. Slowly press down the plunger head until it latches in the safety device 'wings' (see Figure 10). This will ensure that all of the medication has been injected.
- **Keep the plunger pressed fully down while you hold the safety syringe in place for an additional 2 seconds.**

Figure 10.

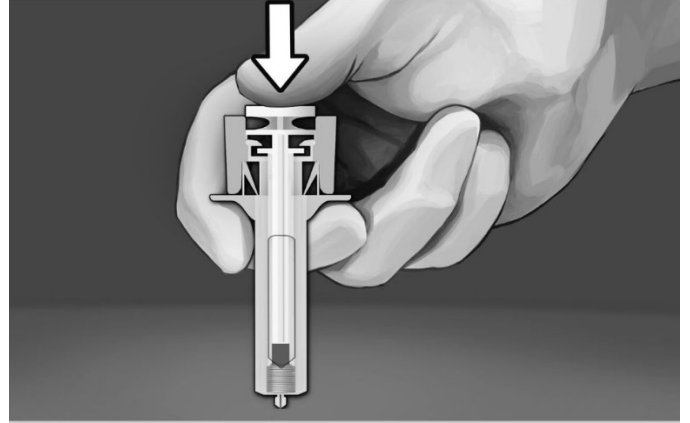

*Step 9:*

- Gently pull the needle out of the skin.
- Keep the plunger fully depressed while you carefully lift the needle straight out from the injection site (see Figure 11).

Figure 11.

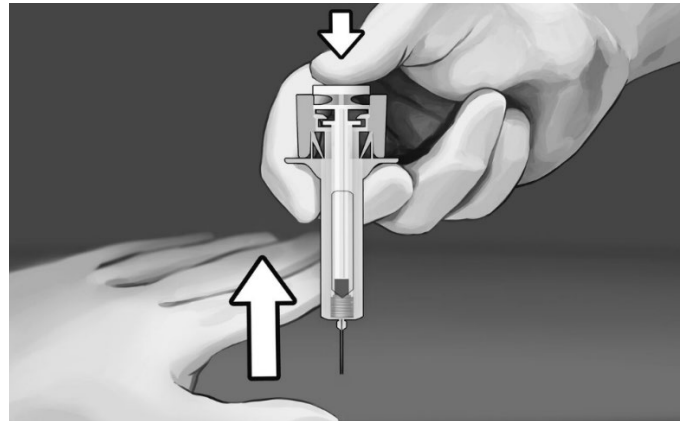

*Step 10:*

- As soon as you have completely removed the needle from the skin, slowly take your thumb off the plunger.
- Allow the syringe guard to automatically cover the exposed needle (see Figure 12).
- There may be a small amount of blood at the injection site. If needed, wipe with a cotton ball or gauze.

Figure 12.

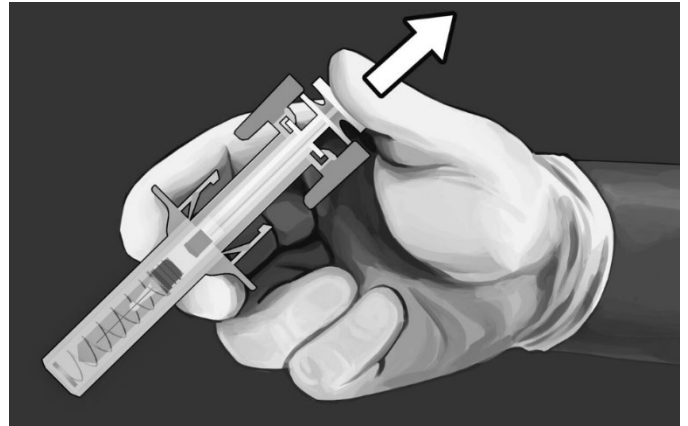

**DISPOSAL OF USED SAFETY SYRINGE**

*Step 11:*

Put the used safety syringe immediately into a sharps container (see Figure 13).

**POST INJECTION CARE**

- Examine the injection site.
- If there is blood, press a cotton ball or gauze pad on the injection site.
- Do not rub the injection site.
- Apply an adhesive bandage if needed.
- Patient should be instructed to notify you immediately if excessive swelling, redness, heat or drainage develops at the injection site.

Figure 13.



## 2.7 Limits on Distribution

BRIXADI is subject to a risk evaluation and mitigation strategy (REMS) program that includes, among other elements, a restricted distribution program. The purpose of the restricted distribution program is to ensure that BRIXADI is only administered by a healthcare provider [see *Warnings and Precautions (5.2)*].

## 2.8 Removal of BRIXADI

BRIXADI forms a biodegradable liquid crystalline gel upon injection that is not always palpable and may not be conducive to surgical removal. Therefore, removal is not recommended.

## 3 DOSAGE FORMS AND STRENGTHS

BRIXADI is a sterile, yellowish to yellow-clear liquid solution and is provided as two different formulations, one for weekly and one for monthly administration in pre-filled, single-dose, syringes, with 23 gauge ½ inch needles, available in the following dosage strengths.

**Table 3: BRIXADI (weekly) Strengths**

BRIXADI (weekly) 50 mg/mL buprenorphine	
Dosage Strength	Dosage Volume
8 mg	0.16 mL
16 mg	0.32 mL
24 mg	0.48 mL
32 mg	0.64 mL

**Table 4: BRIXADI (monthly) Strengths**

BRIXADI (monthly) 356 mg/mL buprenorphine	
Dosage Strength	Dosage Volume
64 mg	0.18 mL
96 mg	0.27 mL
128 mg	0.36 mL

## 4 CONTRAINDICATIONS

BRIXADI is contraindicated in patients with hypersensitivity (e.g., anaphylactic shock) to buprenorphine, or any other ingredients in the solution for injection [see *Warnings and Precautions (5.10)*].

## 5 WARNINGS AND PRECAUTIONS

### 5.1 Risk of Serious Harm or Death with Intravenous Administration

Intravenous injection presents significant risk of serious harm or death as BRIXADI forms a liquid crystalline gel upon contact with body fluids. Occlusion, local tissue damage, and

thrombo-embolic events, including life-threatening pulmonary emboli, could result if administered intravenously [see *Warnings and Precautions (5.2), Drug Abuse and Dependence (9.2)*]. Do not administer intravenously, intramuscularly, or intradermally.

## 5.2 BRIXADI Risk Evaluation and Mitigation Strategy (REMS)

BRIXADI is available only through a restricted program called the BRIXADI REMS because of the risk of serious harm or death that could result from intravenous self-administration. The goal of the REMS is to mitigate serious harm or death that could result from intravenous self-administration by ensuring that healthcare settings and pharmacies are certified and only dispense BRIXADI directly to a healthcare provider for administration by a healthcare provider.

Notable requirements of the BRIXADI REMS include the following:

- Healthcare Settings and Pharmacies that order and dispense BRIXADI must be certified in the BRIXADI REMS.
- Certified Healthcare Settings and Pharmacies must establish processes and procedures to verify BRIXADI is provided directly to a healthcare provider for administration by a healthcare provider, and the drug is not dispensed to the patient.
- Certified Healthcare Settings and Pharmacies must not distribute, transfer, loan, or sell BRIXADI.

Further information is available at [www.BRIXADIREMS.com](http://www.BRIXADIREMS.com) or by calling **1-833-274-9234**.

## 5.3 Addiction, Abuse, and Misuse

BRIXADI contains buprenorphine, a Schedule III controlled substance that can be abused in a manner similar to other opioids. Buprenorphine is sought by people with opioid use disorder and is subject to criminal diversion. Monitor all patients for progression of opioid use disorder and addictive behaviors [see *Drug Abuse and Dependence (9.2)*].

## 5.4 Risk of Life-Threatening Respiratory and Central Nervous System (CNS) Depression

Buprenorphine has been associated with life-threatening respiratory depression and death. Many, but not all, postmarketing reports regarding coma and death involved misuse by self-injection or were associated with the concomitant use of buprenorphine and benzodiazepines or other CNS depressant drugs including alcohol. Warn patients of the potential danger of self-administration of benzodiazepines or other CNS depressants while under treatment with BRIXADI [see *Drug Interactions (7), Warnings and Precautions (5.5), Patient Counseling Information (17)*].

Use BRIXADI with caution in patients with compromised respiratory function (e.g., chronic obstructive pulmonary disease, cor pulmonale, decreased respiratory reserve, hypoxia, hypercapnia, or pre-existing respiratory depression).

Due to its extended-release characteristics, if BRIXADI is discontinued as a result of compromised respiratory function, monitor patients for ongoing buprenorphine effects for approximately 1 month for BRIXADI (weekly) and for approximately 4 months for BRIXADI (monthly).

Educate patients and caregivers on how to recognize respiratory depression and emphasize the importance of calling 911 or getting emergency medical help right away in the event of a known or suspected overdose [*see Patient Counseling Information (17)*].

Opioids can cause sleep-related breathing disorders including central sleep apnea (CSA) and sleep related hypoxemia. Opioid use increases the risk of CSA in a dose-dependent fashion. In patients who present with CSA, monitor patient during treatment and consider dose reduction using best practices for opioid taper. [*see Clinical Supervision (2.5)*].

#### Patient Access to Naloxone for the Emergency Treatment of Opioid Overdose

Discuss the availability of naloxone for the emergency treatment of opioid overdose with the patient and caregiver.

Because patients being treated for opioid use disorder have the potential for relapse, putting them at risk for opioid overdose, strongly consider prescribing naloxone for the emergency treatment of opioid overdose, both when initiating and renewing treatment with BRIXADI. Also consider prescribing naloxone if the patient has household members (including children) or other close contacts at risk for accidental ingestion or opioid overdose [*see Dosage and Administration (2.2)*].

Advise patients and caregivers that naloxone may also be administered for a known or suspected overdose with buprenorphine itself. Higher than normal doses and repeated administration of naloxone may be necessary due to the long duration of action of buprenorphine and its affinity for the mu receptor [*see Overdosage (10)*].

Inform patients and caregivers of their options for obtaining naloxone as permitted by individual state naloxone dispensing and prescribing requirements or guidelines (e.g., by prescription, directly from a pharmacist, or as part of a community-based program).

Educate patients and caregivers on how to recognize respiratory depression and, if naloxone is prescribed, how to treat with naloxone. Emphasize the importance of calling 911 or getting emergency medical help, even if naloxone is administered [*see Patient Counseling Information (17)*].

### **5.5 Managing Risks From Concomitant Use of Benzodiazepines or Other CNS Depressants with Buprenorphine**

Concomitant use of buprenorphine and benzodiazepines or other CNS depressants increases the risk of adverse reactions including respiratory depression, overdose, and death. Medication-assisted treatment of opioid use disorder, however, should not be categorically denied to patients taking these drugs. Prohibiting or creating barriers to treatment can pose an even greater risk of morbidity and mortality due to the opioid use disorder alone.

As a routine part of orientation to buprenorphine treatment, educate patients about the risks of concomitant use of benzodiazepines sedatives, opioid analgesics, and alcohol.

Develop strategies to manage use of prescribed or illicit benzodiazepines or other CNS depressants at initiation of buprenorphine treatment, or if it emerges as a concern during treatment. Adjustments to induction procedures and additional monitoring may be required. There is no evidence to support dose limitations or arbitrary caps of buprenorphine as a strategy to address benzodiazepine use in buprenorphine-treated patients. However, if a patient is sedated at the time of buprenorphine dosing, delay or omit the buprenorphine dose if appropriate.



Cessation of benzodiazepines or other CNS depressants is preferred in most cases of concomitant use with buprenorphine. In some cases, monitoring in a higher level of care for taper may be appropriate. In others, gradually tapering a patient off of a prescribed benzodiazepine or other CNS depressant or decreasing to the lowest effective dose may be appropriate.

For patients in buprenorphine treatment, benzodiazepines are not the treatment of choice for anxiety or insomnia. Before co-prescribing benzodiazepines, ensure that patients are appropriately diagnosed and consider alternative medications and non-pharmacologic treatments to address anxiety or insomnia. Ensure that other healthcare providers prescribing benzodiazepines or other CNS depressants are aware of the patients' buprenorphine treatment and coordinate care to minimize the risks associated with concomitant use.

If concomitant use is warranted, strongly consider prescribing naloxone for the emergency treatment of opioid overdose, as is recommended for all patients in buprenorphine treatment for opioid use disorder [see *Warnings and Precautions (5.4)*].

In addition, take measures to confirm that patients are taking their medications as prescribed and are not diverting or supplementing with illicit drugs. Toxicology screening should test for prescribed and illicit benzodiazepines [see *Drug Interactions (7)*].

## 5.6 Neonatal Opioid Withdrawal Syndrome

Neonatal opioid withdrawal syndrome (NOWS) is an expected and treatable outcome of prolonged use of opioids during pregnancy, whether that use is medically-authorized or illicit. Unlike opioid withdrawal syndrome in adults, NOWS may be life-threatening if not recognized and treated in the neonate. Healthcare providers should observe newborns for signs of NOWS and manage accordingly [see *Use in Specific Populations (8.1)*].

Advise pregnant women receiving opioid addiction treatment with BRIXADI of the risk of neonatal opioid withdrawal syndrome and ensure that appropriate treatment will be available [see *Use in Specific Populations (8.1)*]. This risk must be balanced against the risk of untreated opioid addiction which often results in continued or relapsing illicit opioid use and is associated with poor pregnancy outcomes. Therefore, prescribers should discuss the importance and benefits of management of opioid addiction throughout pregnancy.

## 5.7 Adrenal Insufficiency

Cases of adrenal insufficiency have been reported with opioid use, more often following greater than one month of use. Presentation of adrenal insufficiency may include non-specific symptoms and signs including nausea, vomiting, anorexia, fatigue, weakness, dizziness, and low blood pressure. If adrenal insufficiency is suspected, confirm the diagnosis with diagnostic testing as soon as possible. If adrenal insufficiency is diagnosed, treat with physiologic replacement doses of corticosteroids. Wean the patient off of the opioid to allow adrenal function to recover and continue corticosteroid treatment until adrenal function recovers. Other opioids may be tried as some cases reported use of a different opioid without recurrence of adrenal insufficiency. The information available does not identify any particular opioids as being more likely to be associated with adrenal insufficiency.

## 5.8 Risk of Opioid Withdrawal with Abrupt Discontinuation of BRIXADI Treatment

Buprenorphine is a partial agonist at the mu-opioid receptor and chronic administration produces physical dependence of the opioid type, characterized by withdrawal signs and symptoms upon

abrupt discontinuation or rapid taper. The withdrawal syndrome is milder than that seen with full agonists and may be delayed in onset [see *Drug Abuse and Dependence (9.2, 9.3)*].

Patients who elect to discontinue BRIXADI treatment should be monitored for withdrawal signs and symptoms with consideration given to the product's extended-release characteristics [See *Clinical Pharmacology (12.3)*].

Consider transmucosal buprenorphine if needed to treat withdrawal after discontinuing BRIXADI.

## 5.9 Risk of Hepatitis, Hepatic Events

Cases of cytolytic hepatitis and hepatitis with jaundice have been observed in individuals receiving buprenorphine for the treatment of opioid use disorder, both in clinical trials and through postmarketing adverse event reports.

The spectrum of abnormalities ranges from transient asymptomatic elevations in hepatic transaminases to case reports of death, hepatic failure, hepatic necrosis, hepatorenal syndrome, and hepatic encephalopathy. In many cases, the presence of pre-existing liver enzyme abnormalities, infection with hepatitis B or hepatitis C virus, concomitant usage of other potentially hepatotoxic drugs, and ongoing injection drug abuse may have played a causative or contributory role. In other cases, insufficient data were available to determine the etiology of the abnormality. Withdrawal of buprenorphine has resulted in amelioration of acute hepatitis in some cases; however, in other cases no dose reduction was necessary. The possibility exists that buprenorphine had a causative or contributory role in the development of the hepatic abnormality in some cases.

Liver function tests are recommended prior to initiation of treatment to establish a baseline. Periodic monitoring of liver function during treatment is also recommended. A biological and etiological evaluation is recommended when a hepatic event is suspected. Monitor patients with declining hepatic function for side effects resulting from increased exposure to buprenorphine.

## 5.10 Hypersensitivity Reactions

Cases of hypersensitivity to buprenorphine containing products have been reported both in clinical trials and in the postmarketing experience. Cases of bronchospasm, angioneurotic edema, and anaphylactic shock have been reported. The most common signs and symptoms include rashes, hives, and pruritus. A history of hypersensitivity to buprenorphine or other components is a contraindication to the use of BRIXADI [see *Contraindications (4)*].

Latex Allergies: The BRIXADI needle cap is synthetically derived from natural rubber latex which may cause allergic reactions in latex-sensitive individuals.

## 5.11 Precipitation of Opioid Withdrawal Signs and Symptoms

Because of the partial agonist properties of buprenorphine, BRIXADI injection may precipitate opioid withdrawal signs and symptoms in individuals physically dependent on full opioid agonists such as heroin, morphine, or methadone before the effects of the full opioid agonist have subsided.

In patients who are new entrants to treatment, administer a test dose of transmucosal buprenorphine and monitor for precipitated withdrawal and treat appropriately [see *Dosage and Administration (2.3)*].

## 5.12 Risks Associated with Treatment of Emergent Acute Pain

While on BRIXADI, situations may arise where patients need acute pain management, or may require anesthesia. Treat patients receiving BRIXADI with non-opioid analgesic whenever possible. Patients requiring opioid therapy for analgesia may be treated with a high-affinity full opioid analgesic under the supervision of a healthcare provider, with particular attention to respiratory function. Higher doses may be required for analgesic effect. Therefore, a higher potential for toxicity exists with opioid administration. If opioid therapy is required as part of anesthesia, patients should be continuously monitored in an anesthesia care setting by persons not involved in the conduct of the surgical or diagnostic procedure. The opioid therapy should be provided by individuals specifically trained in the use of anesthetic drugs and the management of the respiratory effects of potent opioids, specifically the establishment and maintenance of a patent airway and assisted ventilation.

Advise patients of the importance of instructing their family members, in the event of emergency, to inform the treating healthcare provider or emergency room staff that the patient is physically dependent on an opioid and that the patient is being treated with BRIXADI [*see Patient Counseling Information (17)*].

Please refer to Section 2.5 for further details on duration of exposure following discontinuation for both weekly and monthly BRIXADI formulations [*see Clinical Supervision (2.5)*].

## 5.13 Use in Opioid Naïve Patients

There have been reported deaths of opioid naïve individuals who received a 2 mg dose of buprenorphine as a sublingual tablet. BRIXADI is not appropriate for use in opioid naïve patients.

## 5.14 Use in Patients With Impaired Hepatic Function

In a pharmacokinetic study with transmucosal buprenorphine, buprenorphine plasma levels were found to be higher and the half-life was found to be longer in subjects with moderate and severe hepatic impairment, but not in subjects with mild hepatic impairment. The effect of hepatic impairment on the pharmacokinetics of BRIXADI, has not been studied.

Because of the long-acting nature of the product, adjustments to dosages of BRIXADI are not rapidly reflected in plasma buprenorphine levels. Because buprenorphine levels cannot be rapidly decreased, patients with pre-existing moderate to severe hepatic impairment are not candidates for treatment with BRIXADI.

Patients who develop moderate to severe hepatic impairment while being treated with BRIXADI should be monitored for several months for signs and symptoms of toxicity or overdose caused by increased levels of buprenorphine and patients may require a dose adjustment [*see Use in Specific Populations (8.6)*].

## 5.15 QTc Prolongation

Thorough QT studies with buprenorphine products have demonstrated QT prolongation  $\leq 15$  msec. This QTc prolongation effect does not appear to be mediated by hERG channels. Based on these two findings, buprenorphine is unlikely to be pro-arrhythmic when used alone in patients without risk factors. The risk of combining buprenorphine with other QT- prolonging agents is not known.

Consider these observations in clinical decisions when prescribing BRIXADI to patients with

risk factors such as hypokalemia, bradycardia, recent conversion from atrial fibrillation, congestive heart failure, digitalis therapy, baseline QT prolongation, subclinical long-QT syndrome, or severe hypomagnesemia. [see *Clinical Pharmacology (12.2)*].

### **5.16 Impairment of Ability to Drive and Operate Machinery**

BRIXADI may impair the mental or physical abilities required for the performance of potentially dangerous tasks such as driving a car or operating machinery, especially for the first few days following treatment and dose adjustment. Buprenorphine plasma levels accumulate during the BRIXADI (weekly) or BRIXADI (monthly) injections, which achieves steady-state at the fourth weekly or monthly injection. Caution patients about driving or operating hazardous machinery until they are reasonably certain that BRIXADI does not adversely affect their ability to engage in such activities. [see *Clinical Pharmacology (12.3)*].

### **5.17 Orthostatic Hypotension**

Buprenorphine may produce orthostatic hypotension in ambulatory patients.

### **5.18 Elevation of Cerebrospinal Fluid Pressure**

Buprenorphine may elevate cerebrospinal fluid pressure and should be used with caution in patients with head injury, intracranial lesions, and other circumstances where cerebrospinal pressure may be increased. Buprenorphine can produce miosis and changes in the level of consciousness that may interfere with patient evaluation.

### **5.19 Elevation of Intracholedochal Pressure**

Buprenorphine has been shown to increase intracholedochal pressure, as do other opioids, and thus should be administered with caution to patients with dysfunction of the biliary tract.

### **5.20 Effects in Acute Abdominal Conditions**

Buprenorphine may obscure the diagnosis or clinical course of patients with acute abdominal conditions.

### **5.21 Unintentional Pediatric Exposure**

Buprenorphine can cause severe, possibly fatal, respiratory depression in children who are accidentally exposed to it.

## **6 ADVERSE REACTIONS**

The following adverse reactions are discussed in more detail in other sections of the labeling:

- Addiction, Abuse, and Misuse [see *Warnings and Precautions (5.3)*]
- Respiratory and CNS Depression [see *Warnings and Precautions (5.4)*]
- Neonatal Opioid Withdrawal Syndrome [see *Warnings and Precautions (5.6)*]
- Adrenal Insufficiency [see *Warnings and Precautions (5.7)*]
- Opioid Withdrawal [see *Warnings and Precautions (5.8, 5.11)*]
- Hepatitis, Hepatic Events [see *Warnings and Precautions (5.9)*]
- Hypersensitivity Reactions [see *Warnings and Precautions (5.10)*]

- Orthostatic Hypotension [*see Warnings and Precautions (5.17)*]
- Elevation of Cerebrospinal Fluid Pressure [*see Warnings and Precautions (5.18)*]
- Elevation of Intracholedochal Pressure [*see Warnings and Precautions (5.19)*]

## 6.1 Clinical Trials Experience

Because clinical trials are conducted under widely varying conditions, adverse reaction rates observed in the clinical trials of a drug cannot be directly compared to rates in the clinical trials of another drug and may not reflect the rates observed in practice.

The safety of BRIXADI was evaluated in 440 opioid-dependent patients across two, Phase 3 clinical studies: one double-blind, active-control (n=213) and one open-label (n=227). In these studies, a total of 305 patients were exposed to BRIXADI for at least 24 weeks and 132 patients were exposed for at least 48 weeks.

In the first 12-week phase of the double-blind, double-dummy, active-controlled study, patients received BRIXADI (weekly) (16, 24, 32 mg) or matching placebo injections after a one-week titration. In the second 12-week phase of the study, patients remaining in the study received BRIXADI (monthly) (64, 96, 128, or 160 mg) or matching placebo injections. The 160 mg monthly dose is not an approved dose. Those randomized to receiving placebo injections were the active control groups and received sublingual buprenorphine/naloxone tablets at corresponding doses to BRIXADI. Patients receiving active BRIXADI injections also received placebo sublingual tablets.

Adverse reactions led to premature discontinuation in 10 (4.7%) patients in the group receiving BRIXADI compared to 5 (2.3%) patients in the sublingual buprenorphine/naloxone group, during the double-blind study.

Adverse reactions commonly reported after BRIXADI administration ( $\geq 5\%$ , regardless of dose and regimen) in the double-blind study, were injection site pain (9.9%), headache (7.5%), constipation (7.5%), nausea (7.0%), injection site erythema (6.6%), injection site pruritus (6.1%), Insomnia (5.6%), and urinary tract infection (5.2%).

Table 5 shows the adverse reactions for BRIXADI compared with the active-control group (SL BPN/NX) in the double-blind study.

**Table 5: Adverse Reactions in the Phase 3 Double-Blind Study:  $\geq 2\%$  of Patients Receiving BRIXADI (Excluding Injection Site Reactions).**

System Organ Class (SOC) Preferred Term (PT) <sup>a</sup>	BRIXADI Total <sup>b</sup> (N=213) n(%)	SL BPN/NX <sup>c</sup> (N=215) n(%)
<b>Cardiac disorders</b>	<b>6 (2.8%)</b>	<b>9 (4.2%)</b>
Tachycardia	5 (2.3)	5 (2.3)
<b>Gastrointestinal disorders</b>	<b>43 (20.2%)</b>	<b>45 (20.9%)</b>
Constipation	16 (7.5)	16 (7.4)
Diarrhea	6 (2.8)	7 (3.3)
Nausea	15 (7.0)	17 (7.9)
Vomiting	9 (4.2)	8 (3.7)
<b>Infections and infestations</b>	<b>42 (19.7%)</b>	<b>50 (23.3%)</b>
Urinary tract infection	11 (5.2)	10 (4.7)
Upper respiratory tract infection	9 (4.2)	9 (4.2)
<b>Musculoskeletal and connective tissue disorders</b>	<b>20 (9.4%)</b>	<b>22 (10.2%)</b>
Arthralgia	7 (3.3)	3 (1.4)
<b>Nervous system disorders</b>	<b>27 (12.7%)</b>	<b>27 (12.6%)</b>
Headache	16 (7.5)	17 (7.9)
<b>Psychiatric disorders</b>	<b>20 (9.4%)</b>	<b>20 (9.3%)</b>
Anxiety	6 (2.8)	7 (3.3)
Insomnia	12 (5.6)	6 (2.8)

a = report of adverse reactions that occurred in  $\geq 2\%$  of the patients randomized to BRIXADI in Study HS-11-421. Patients are represented once per PT

b = This group includes all subjects exposed to varying doses of both the BRIXADI (weekly) and BRIXADI (monthly) formulations.

c = SL BPN/NX denotes the active comparator: patients assigned to daily buprenorphine with sham (placebo) injections. Patients randomized to this group could also receive a 'booster' injection of BRIXADI (weekly), 8mg, per protocol. All patients in Study 421 received a single test dose of 4mg SL BPN/NX before randomization into either arm.

Injection site reactions in the double-blind study are presented in Table 6 below. The majority of injection site-related adverse events were mild or moderate in severity. No injection site reactions were reported as severe intensity.

**Table 6: Injection site reactions in the Double-Blind Phase 3 Study:  $\geq 2\%$  of Patients Receiving BRIXADI**

Preferred Term (PT) <sup>a</sup>	BRIXADI Total <sup>b</sup> (N=213) n(%)	SL BPN/NX <sup>c</sup> (N=215) n(%)
<b>Administration site reactions<sup>d</sup></b>	<b>44 (20.7%)</b>	<b>49 (22.8%)</b>
Injection site pain	21 (9.9%)	17 (7.9%)
Injection site erythema	14 (6.6%)	12 (5.6%)
Injection site pruritus	13 (6.1%)	13 (6.0%)
Injection site swelling	10 (4.7%)	7 (3.3%)
Injection site reaction	9 (4.2%)	7 (3.3%)

a = Injection site reactions (ISR) that occurred in  $\geq 2\%$  of patients receiving BRIXADI, in the controlled trial, HS-11-421. Patients are represented once per PT.

b = This group includes patients exposed to varying doses of both the BRIXADI weekly and monthly formulations.

c = SL BPN/NX denotes the active comparator: subjects assigned to daily buprenorphine with sham (placebo) injections. Patients randomized to this group could also receive a supplemental 'booster' injection of BRIXADI (weekly), 8mg, per protocol.

d = The ISRs that occurred in  $\geq 2\%$  of the patients randomized to BRIXADI were reported under the HGLT of Administration site reactions. However, ISRs were also identified under the Bacterial infectious disorders HGLT (of which, there were three injection site related cellulitis reactions in the BRIXADI group and one in the SL BPN/NX group, respectively) but those numbers did not rise to level of reporting. Tabulation included all events coded as treatment emergent *and* injection site reactions, regardless of treatment emergent flags.

## 6.2 Postmarketing Experience

The following adverse reactions have been identified during post-approval use of buprenorphine. Because these reactions are reported voluntarily from a population of uncertain size, it is not always possible to reliably estimate their frequency or establish a causal relationship to drug exposure.

The most frequently reported postmarketing adverse event observed with buprenorphine sublingual tablets, excluding drug exposure during pregnancy, was drug misuse or abuse.

Serotonin syndrome: Cases of serotonin syndrome, a potentially life-threatening condition, have been reported during concomitant use of opioids with serotonergic drugs.

Adrenal insufficiency: Cases of adrenal insufficiency have been reported with opioid use, more often following greater than one month of use.

Anaphylaxis: Anaphylaxis has been reported with buprenorphine [see *Contraindications (4)*].

Androgen deficiency: Cases of androgen deficiency have occurred with chronic use of opioids [see *Clinical Pharmacology (12.2)*].

The following adverse reactions have been identified during post-approval use of an identical buprenorphine extended-release injection for subcutaneous use outside of the United States and are not described elsewhere in the label. Because these reactions are reported voluntarily from a population of uncertain size, it is not always possible to reliably estimate their frequency or establish a causal relationship to drug exposure.

Injection site mass, abscess, ulceration, and necrosis: Cases of injection site abscess, ulceration and necrosis have been reported after treatment initiation. Some cases have required debridement

and antibiotic treatment. The likelihood of serious injection site reactions may be increased with inadvertent intramuscular or intradermal administration.

Insufficient dosing: Cases of drug withdrawal reactions consistent with insufficient drug dosing have been reported, often occurring at or after two weeks of treatment initiation and resolving upon dose increase.

## 7 DRUG INTERACTIONS

<b>Benzodiazepines and other Central Nervous System (CNS) Depressants</b>	
<i>Clinical Impact:</i>	Due to additive pharmacologic effects, the concomitant use of benzodiazepines or other CNS depressants, including alcohol, increases the risk of respiratory depression, profound sedation, coma, and death.
<i>Intervention:</i>	<p>Cessation of benzodiazepines or other CNS depressants is preferred in most cases of concomitant use. In some cases, monitoring in a higher level of care for taper may be appropriate. In others, gradually tapering a patient off a prescribed benzodiazepine or CNS depressant or decreasing to the lowest effective dose may be appropriate. Similarly, cessation of other CNS depressants is preferred when possible.</p> <p>Before co-prescribing benzodiazepines for anxiety or insomnia, ensure that patients are appropriately diagnosed and consider alternative medications and non-pharmacologic treatment [see <i>Warnings and Precautions (5.5)</i>].</p> <p>If concomitant use is warranted, strongly consider prescribing naloxone for the emergency treatment of opioid overdose, as is recommended for all patients in treatment for opioid use disorder [see <i>Warnings and Precautions (5.4)</i>].</p>
<i>Examples:</i>	Alcohol, non-benzodiazepine sedatives/hypnotics, anxiolytics, tranquilizers, muscle relaxants, general anesthetics, antipsychotics, and other opioids.
<b>Inhibitors of CYP3A4</b>	
<i>Clinical Impact:</i>	<p>The effects on buprenorphine exposure in patients treated with BRIXADI have not been studied, and the effects may be dependent on the route of administration.</p> <p>Buprenorphine is metabolized to norbuprenorphine primarily by CYP3A4; therefore, potential interactions may occur when BRIXADI is given concurrently with agents that affect CYP3A4 activity [see <i>Clinical Pharmacology (12.3)</i>].</p> <p>The concomitant use of buprenorphine and CYP3A4 inhibitors can increase the plasma concentration of buprenorphine, resulting in increased or prolonged opioid effects, particularly when an inhibitor is added after a stable dose of BRIXADI is achieved.</p>
<i>Intervention:</i>	<u>Patients Converted to BRIXADI Treatment from a Regimen of Transmucosal Buprenorphine used Concomitantly with</u>



	<p><u>CYP3A4 Inhibitors:</u> Monitor to ensure that the plasma buprenorphine level provided by BRIXADI is adequate.</p> <p><u>Patients Already on BRIXADI who Require Newly-Initiated Treatment with a CYP3A4 Inhibitor:</u> Monitor for signs and symptoms of over-medication. If signs and symptoms of buprenorphine toxicity or overdose occur but the concomitant medication cannot be reduced or discontinued, reduce the dose of BRIXADI. If available doses do not permit achievement of the desired dose, it may be necessary to discontinue treatment with BRIXADI and treat the patient with a formulation of buprenorphine that permits more precise dose adjustments.</p> <p><u>Patients Stabilized on BRIXADI in the Setting of Concomitant Medication That is a CYP3A4 Inhibitor, and the Concomitant Medication is Discontinued:</u> Monitor for withdrawal and consider a dosage adjustment of BRIXADI. If the dose of BRIXADI cannot be adjusted to an adequate level in the absence of the concomitant medication, transition the patient back to a formulation of buprenorphine that permits more precise dose adjustments.</p>
<p><i>Examples:</i></p>	<p>azole antifungals (e.g., ketoconazole), macrolide antibiotics (e.g., erythromycin), and protease inhibitors (e.g., ritonavir, indinavir, and saquinavir)</p>
<p><b>CYP3A4 Inducers</b></p>	
<p><i>Clinical Impact:</i></p>	<p>The effects of co-administered CYP3A4 inducers on buprenorphine exposure in patients treated with BRIXADI have not been studied.</p> <p>Buprenorphine is metabolized to norbuprenorphine primarily by CYP3A4; therefore, potential interactions may occur when BRIXADI is given concurrently with agents that affect CYP3A4 activity [<i>see Clinical Pharmacology (12.3)</i>].</p> <p>CYP3A4 inducers may induce metabolism of buprenorphine and, therefore, may cause increased clearance of the drug which could lead to a decrease in buprenorphine plasma concentrations, lack of efficacy or, possibly, development of an abstinence syndrome.</p>
<p><i>Intervention:</i></p>	<p><u>Patients Converted to BRIXADI Treatment from a Regimen of Transmucosal Buprenorphine used Concomitantly with CYP3A4 Inducers:</u> Monitor to ensure that the plasma buprenorphine level provided by BRIXADI is adequate.</p> <p><u>Patients Already on BRIXADI who Require Newly-Initiated Treatment with a CYP3A4 Inducer:</u> Monitor for withdrawal. If the dose of BRIXADI is not adequate in the presence of the concomitant medication, and the concomitant medication cannot be reduced or discontinued, adjust the dose of BRIXADI. If the dose of BRIXADI cannot be adjusted to an adequate level, transition the patient back to a formulation of buprenorphine that permits more precise dose adjustments.</p>

	<p><u>Patients Stabilized on BRIXADI in the setting of Concomitant Medication that is a CYP3A4 Inducer, and the Concomitant Medication is Discontinued:</u> Monitor for signs and symptoms of over-medication. If the dose provided by BRIXADI is excessive in the absence of the concomitant inducer, consider reducing the dose of BRIXADI.</p> <p>If the dose of BRIXADI cannot be adjusted to an adequate level, transition the patient back to a formulation of buprenorphine that permits more precise dose adjustments [see <i>Clinical Pharmacology (12.3)</i>].</p>
<i>Examples:</i>	Rifampin, carbamazepine, phenytoin, phenobarbital
<b>Antiretrovirals: Non-nucleoside reverse transcriptase inhibitors (NNRTIs)</b>	
<i>Clinical Impact:</i>	Non-nucleoside reverse transcriptase inhibitors (NNRTIs) are metabolized principally by CYP3A4. Efavirenz, nevirapine, and etravirine are known CYP3A4 inducers, whereas delavirdine is a CYP3A4 inhibitor. Significant pharmacokinetic interactions between NNRTIs (e.g., efavirenz and delviradine) and buprenorphine have been shown in clinical studies, but these pharmacokinetic interactions did not result in any significant pharmacodynamics effects.
<i>Intervention:</i>	It is recommended that patients who are on BRIXADI treatment have their dose monitored for increase or decrease in therapeutic effects if NNRTIs are added to their treatment regimen.
<i>Examples:</i>	Efavirenz, nevirapine, etravirine, delavirdine
<b>Antiretrovirals: Protease Inhibitors (PIs)</b>	
<i>Clinical Impact:</i>	Studies have shown some antiretroviral protease inhibitors (PIs) with CYP3A4 inhibitory activity (e.g., nelfinavir, lopinavir/ritonavir, ritonavir) have little effect on buprenorphine pharmacokinetics and no significant pharmacodynamics effects. Other PIs with CYP3A4 inhibitory activity (e.g., atazanavir and atazanavir/ritonavir) resulted in elevated levels of buprenorphine and norbuprenorphine and patients in one study reported increased sedation. Symptoms of opioid excess have been found in postmarketing reports of patients receiving buprenorphine and atazanavir with and without ritonavir concomitantly.
<i>Intervention:</i>	If treatment with atazanavir with and without ritonavir must be initiated in a patient already treated with BRIXADI, the patient should be monitored for signs and symptoms of over-medication. It may be necessary to discontinue treatment with BRIXADI and treat the patient with a sublingual buprenorphine product that permits rapid dose adjustments.
<i>Examples:</i>	Atazanavir, ritonavir
<b>Antiretrovirals: Nucleoside reverse transcriptase inhibitors (NRTIs)</b>	
<i>Clinical impact:</i>	Nucleoside reverse transcriptase inhibitors (NRTIs) do not appear to induce or inhibit the P450 enzyme pathway, thus no interactions with buprenorphine are expected.

<i>Intervention:</i>	None
<b>Serotonergic Drugs</b>	
<i>Clinical Impact:</i>	The concomitant use of opioids with other drugs that affect the serotonergic neurotransmitter system has resulted in serotonin syndrome.
<i>Intervention:</i>	If concomitant use is warranted, carefully observe the patient, particularly during treatment initiation, and during dose adjustment of the serotonergic drug. Discontinue BRIXADI if serotonin syndrome is suspected.
<i>Examples:</i>	Selective serotonin reuptake inhibitors (SSRIs), serotonin and norepinephrine reuptake inhibitors (SNRIs), tricyclic antidepressants (TCAs), triptans, 5-HT <sub>3</sub> receptor antagonists, drugs that affect serotonin neurotransmitter system (e.g., mirtazapine, trazodone, tramadol), certain muscle relaxants (i.e. cyclobenzaprine, metaxalone), and monoamine oxidase (MAO) inhibitors (those intended to treat psychiatric disorders and also others, such as linezolid and intravenous methylene blue).
<b>Monoamine Oxidase Inhibitors (MAOIs)</b>	
<i>Clinical Impact:</i>	MAOI interactions with opioids may manifest as serotonin syndrome or opioid toxicity (e.g., respiratory depression, coma).
<i>Intervention:</i>	The use of BRIXADI is not recommended for patients taking MAOIs or within 14 days of stopping such treatment.
<i>Examples:</i>	Phenelzine, tranylcypromine, linezolid
<b>Muscle Relaxants</b>	
<i>Clinical Impact:</i>	Buprenorphine may enhance the neuromuscular blocking action of skeletal muscle relaxants and produce an increased degree of respiratory depression.
<i>Intervention:</i>	Monitor patients receiving muscle relaxants and BRIXADI for signs of respiratory depression that may be greater than otherwise expected and decrease the dosage of the muscle relaxant as necessary. Due to the risk of respiratory depression with concomitant use of skeletal muscle relaxants and opioids, strongly consider prescribing naloxone for the emergency treatment of opioid overdose [see <i>Dosage and Administration (2.3)</i> , <i>Warnings and Precautions (5.4, 5.5)</i> ].
<b>Diuretics</b>	
<i>Clinical Impact:</i>	Opioids can reduce the efficacy of diuretics by inducing the release of antidiuretic hormone.
<i>Intervention:</i>	Monitor patients for signs of diminished diuresis and/or effects on blood pressure and increase the dosage of the diuretic needed.
<b>Anticholinergic Drugs</b>	
<i>Clinical Impact:</i>	The concomitant use of anticholinergic drugs may increase the risk of urinary retention and/or severe constipation, which may lead to paralytic ileus.

<i>Intervention:</i>	Monitor patients for signs of urinary retention or reduced gastric motility when BRIXADI is used concomitantly with anticholinergic drugs.
----------------------	--

## 8 USE IN SPECIFIC POPULATIONS

### 8.1 Pregnancy

#### Risk Summary

The data on use of buprenorphine, the active ingredient in BRIXADI in pregnancy, are limited; however, these data do not indicate an increased risk of major malformations specifically due to buprenorphine exposure. There are limited data from randomized clinical trials in women maintained on sublingual buprenorphine that were not designed appropriately to assess the risk of major malformations [see Data].

Embryofetal death was observed in both rats and rabbits administered buprenorphine during the period of organogenesis at doses 21 times and equal to, respectively, the mean daily dose of 4.6 mg buprenorphine delivered by either 32 mg BRIXADI (weekly) or 128 mg BRIXADI (monthly). Pre- and post-natal development studies in rats demonstrated increased neonatal deaths at doses approximately equal to and above and dystocia at 11 times the mean daily dose of 4.6 mg buprenorphine. No clear teratogenic effects were seen when buprenorphine was administered during organogenesis with a range of doses 4 times and greater than the mean daily dose of 4.6 mg of buprenorphine. However, increases in skeletal abnormalities were noted in rats and rabbits administered buprenorphine daily during organogenesis at doses 2 and 21 times the mean daily dose of 4.6 mg of buprenorphine, respectively. In a few studies, some events such as acephalus and omphalocele were also observed but these findings were not clearly treatment-related [see Data]. Based on animal data, advise pregnant women of the potential risk to a fetus.

The estimated background risk of major birth defects and miscarriage for the indicated population are unknown. In the U.S. general population, the estimated background risk of major birth defects and miscarriage in clinically recognized pregnancies is 2-4% and 15-20%, respectively.

BRIXADI should be used during pregnancy only if the potential benefit justifies the potential risk to the fetus.

#### Clinical Considerations

##### *Disease-associated maternal and embryo-fetal risk*

Untreated opioid addiction in pregnancy is associated with adverse obstetrical outcomes such as low birth weight, preterm birth, and fetal death. In addition, untreated opioid addiction often results in continued or relapsing illicit opioid use.

##### *Dose Adjustment during Pregnancy and the Postpartum Period*

Dosage adjustments of buprenorphine may be required during pregnancy, even if the patient was maintained on a stable dose prior to pregnancy. Withdrawal signs and symptoms should be monitored closely, and the dose adjusted as necessary.

##### *Fetal/neonatal adverse reactions*

Neonatal opioid withdrawal syndrome may occur in newborn infants of mothers who are receiving treatment with BRIXADI.

Neonatal opioid withdrawal syndrome presents as irritability, hyperactivity, and abnormal sleep pattern, high pitched cry, tremor, vomiting, diarrhea, and/or failure to gain weight. Signs of neonatal withdrawal usually occur in the first days after birth. The duration and severity of neonatal opioid withdrawal syndrome may vary. Observe newborns for signs of neonatal opioid withdrawal syndrome and manage accordingly [*see Warnings and Precautions (5.6)*].

#### *Labor or Delivery*

Opioid-dependent women on buprenorphine maintenance therapy may require additional analgesia during labor.

As with all opioids, use of buprenorphine prior to delivery may result in respiratory depression in the newborn. Closely monitor neonates for signs of respiratory depression. An opioid antagonist such as naloxone should be available for reversal of opioid induced respiratory depression in the neonate.

#### Data

##### *Human Data*

Studies have been conducted to evaluate neonatal outcomes in women exposed to buprenorphine during pregnancy. Limited data from trials, observational studies, case series, and case reports on buprenorphine use in pregnancy do not indicate an increased risk of major malformations specifically due to buprenorphine. Several factors may complicate the interpretation of investigations of the children of women who take buprenorphine during pregnancy, including maternal use of illicit drugs, late presentation for prenatal care, infection, poor compliance, poor nutrition, and psychosocial circumstances. Interpretation of data is complicated further by the lack of information on untreated opioid-dependent pregnant women, who would be the most appropriate group for comparison. Rather, women on another form of opioid medication-assisted treatment, or women in the general population are generally used as the comparison group. However, women in these comparison groups may be different from women prescribed buprenorphine-containing products with respect to maternal factors that may lead to poor pregnancy outcomes.

In a multicenter, double-blind, randomized, controlled trial (Maternal Opioid Treatment: Human Experimental Research [MOTHER]) designed primarily to assess neonatal opioid withdrawal effects, opioid-dependent pregnant women were randomized to buprenorphine (n=86) or methadone (n=89) treatment, with enrollment at an average gestational age of 18.7 weeks in both groups. A total of 28 of the 86 women in the buprenorphine group (33%) and 16 of the 89 women in the methadone group (18%) discontinued treatment before the end of pregnancy.

Among women who remained in treatment until delivery, there was no difference between buprenorphine-treated and methadone-treated groups in the number of neonates requiring NOWS treatment or in the peak severity of NOWS. Buprenorphine-exposed neonates required less morphine (mean total dose, 1.1 mg vs 10.4 mg), had shorter hospital stays (10.0 days vs 17.5 days), and shorter duration of treatment for NOWS (4.1 days vs 9.9 days) compared to the methadone-exposed group. There were no differences between groups in other primary outcomes (neonatal head circumference) or secondary outcomes (weight and length at birth, preterm birth, gestational age at delivery, and 1-minute and 5-minute Apgar scores), or in the rates of maternal or neonatal adverse events. The outcomes among mothers who discontinued treatment before

delivery and may have relapsed to illicit opioid use are not known. Because of the imbalance in discontinuation rates between the buprenorphine and methadone groups, the study findings are difficult to interpret.

#### *Animal Data*

The exposure margins below are based on the mean daily dose of 4.6 mg buprenorphine delivered by 32 mg BRIXADI (weekly) or 128 mg BRIXADI (monthly) on body surface area comparisons, unless otherwise noted.

No definitive drug-related teratogenic effects were observed in rats and rabbits at IM doses up to 30 mg/kg/day (64 times and 127 times, respectively, on a mg/m<sup>2</sup> basis). Maternal toxicity resulting in mortality was noted in these studies in both rats and rabbits. Acephalus was observed in one rabbit fetus from the low-dose group and omphalocele was observed in two rabbit fetuses from the same litter in the mid-dose group; no findings were observed in fetuses from the high-dose group. Maternal toxicity was seen in the high-dose group but not at the lower doses where the findings were observed. Following oral administration of buprenorphine to rats, dose-related post-implantation losses, evidenced by increases in the numbers of early resorptions with consequent reductions in the numbers of fetuses, were observed at doses of 10 mg/kg/day or greater (21 times on a mg/m<sup>2</sup> basis). In the rabbit, increased post-implantation losses occurred at an oral dose of 40 mg/kg/day (169 times on a mg/m<sup>2</sup> basis). Following IM administration in the rat and the rabbit, post-implantation losses, as evidenced by decreases in live fetuses and increases in resorptions, occurred at 30 mg/kg/day (64 times and 127 times, respectively, on a mg/m<sup>2</sup> basis).

Buprenorphine was not teratogenic in rats and rabbits after subcutaneous (SC) doses of up to 5 mg/kg/day (9 and 5 times in rat, and 12 and 7 times in rabbit the highest daily exposure from 32 mg BRIXADI (weekly) or 128 mg BRIXADI (monthly), respectively, on an AUC basis), after intramuscular (IM) doses of up to 5 mg/kg/day (11 and 21 times on a mg/m<sup>2</sup> basis), after IV doses up to 0.8 mg/kg/day (2 and 3 times on a mg/m<sup>2</sup> basis), or after oral doses up to 160 mg/kg/day in rats (338 times on a mg/m<sup>2</sup> basis) and 25 mg/kg/day in rabbits (106 times on a mg/m<sup>2</sup> basis). Significant increases in skeletal abnormalities (e.g., extra thoracic vertebra or thoraco-lumbar ribs) were noted in rats after SC administration of 1 mg/kg/day and up (2.4 or 1.5 times the highest daily exposure from 32 mg BRIXADI (weekly) or 128 mg BRIXADI (monthly), respectively, on an AUC basis), but were not observed at oral doses up to 160 mg/kg/day (338 times on a mg/m<sup>2</sup> basis).

Increases in skeletal abnormalities in rabbits after IM administration of 5 mg/kg/day (21 times on a mg/m<sup>2</sup> basis) in the absence of maternal toxicity or oral administration of 1 mg/kg/day or greater (4 times on a mg/m<sup>2</sup> basis) were not statistically significant. In rabbits, buprenorphine produced statistically significant pre-implantation losses at oral doses of 1 mg/kg/day or greater (4 times on a mg/m<sup>2</sup> basis) and post-implantation losses that were statistically significant at IV doses of 0.2 mg/kg/day or greater (approximately equal on a mg/m<sup>2</sup> basis). No maternal toxicity was noted at doses causing post-implantation loss in this study.

Dystocia was noted in pregnant rats treated intramuscularly with buprenorphine from Gestation Day 14 through Lactation Day 21 at 5 mg/kg/day (11 times on a mg/m<sup>2</sup> basis). Fertility and pre- and post-natal development studies with buprenorphine in rats indicated increases in neonatal mortality after oral doses of 0.8 mg/kg/day and up (2 times on a mg/m<sup>2</sup> basis), after IM doses of 0.5 mg/kg/day and up (approximately equal on a mg/m<sup>2</sup> basis), and after SC doses of 0.1 mg/kg/day and up (0.4 or 0.3 times the highest daily exposure from 32 mg BRIXADI (weekly)

or 128 mg BRIXADI (monthly), respectively, on an AUC basis). An apparent lack of milk production during these studies likely contributed to the decreased pup viability and lactation indices. Delays in the occurrence of righting reflex and startle response were noted in rat pups at an oral dose of 80 mg/kg/day (169 times on a mg/m<sup>2</sup> basis).

## 8.2 Lactation

### Risk Summary

Based on two studies in 13 lactating women maintained on sublingual buprenorphine treatment, buprenorphine and its metabolite norbuprenorphine were present in low levels in human milk. Available data have not shown adverse reactions in breastfed infants. The development and health benefits of breastfeeding should be considered along with the mother's clinical need for buprenorphine treatment and any potential adverse effects on the breastfed child from the drug or from the underlying maternal condition.

### Clinical Considerations

Advise the nursing mother taking buprenorphine to monitor the infant for increased drowsiness and breathing difficulties.

### Data

Data were consistent from two studies (N=13) of breastfeeding infants whose mothers were maintained on sublingual doses of buprenorphine ranging from 2.4 to 24 mg/day, showing that the infants were exposed to less than 1% of the maternal daily dose.

In a study of six lactating women who were taking a median sublingual buprenorphine dose of 0.29 mg/kg/day 5 to 8 days after delivery, breast milk provided a median infant dose of 0.42 mcg/kg/day of buprenorphine and 0.33 mcg/kg/day of norbuprenorphine, equal to 0.2% and 0.12% respectively, of the maternal weight-adjusted dose (relative dose/kg [%] of norbuprenorphine was calculated from the assumption that buprenorphine and norbuprenorphine are equipotent).

Data from a study of seven lactating women who were taking a median (sublingual buprenorphine) dose of 7 mg/day an average of 1.12 months after delivery indicated that the mean milk concentrations ( $C_{avg}$ ) of buprenorphine and norbuprenorphine were 3.65 mcg/L and 1.94 mcg/L respectively. Based on the study data, and assuming milk consumption of 150 mL/kg/day, an exclusively breastfed infant would receive an estimated mean absolute infant dose (AID) of 0.55 mcg/kg/day of buprenorphine and 0.29 mcg/kg/day of norbuprenorphine, or a mean relative infant dose (RID) of 0.38% and 0.18%, respectively, of the maternal weight-adjusted dose.

## 8.3 Females and Males of Reproductive Potential

### Infertility

Chronic use of opioids may cause reduced fertility in females and males of reproductive potential. It is not known whether these effects on fertility are reversible [see *Adverse Reactions (6.2)*, *Clinical Pharmacology (12.2)*, *Nonclinical Toxicology (13.1)*].

## 8.4 Pediatric Use

The safety and effectiveness of BRIXADI have not been established in pediatric patients.

## 8.5 Geriatric Use

Clinical studies of BRIXADI did not include sufficient numbers of subjects aged 65 or older to determine whether they respond differently to the drug than younger patients. Other reported clinical experience with buprenorphine has not identified differences in responses between the geriatric and younger patients.

Due to possible decreased hepatic, renal, or cardiac function and of concomitant disease or other drug therapy in geriatric patients, the decision to prescribe BRIXADI should be made cautiously in individuals 65 years of age or older and these patients should be monitored for signs and symptoms of toxicity or overdose.

## 8.6 Hepatic Impairment

The effect of hepatic impairment on the pharmacokinetics of BRIXADI has not been studied.

The effect of hepatic impairment on the pharmacokinetics of sublingual buprenorphine has been evaluated in a pharmacokinetic study. While no clinically significant changes were observed in subjects with mild hepatic impairment, the plasma levels have been shown to be higher and half-life values have been shown to be longer for buprenorphine in subjects with moderate and severe hepatic impairment.

Because of the long-acting nature of the product, adjustments to dosages of BRIXADI are not rapidly reflected in plasma buprenorphine levels. Therefore, patients with pre-existing moderate to severe hepatic impairment are not candidates for treatment with BRIXADI.

Patients who develop moderate to severe hepatic impairment while being treated with BRIXADI should be monitored for signs and symptoms of toxicity or overdose caused by increased levels of buprenorphine [*see Warnings and Precautions (5.14), Clinical Pharmacology (12.3)*].

## 8.7 Renal Impairment

Clinical studies of BRIXADI did not include subjects with renal impairment. No differences in buprenorphine pharmacokinetics were observed between 9 dialysis-dependent and 6 normal patients following IV administration of 0.3 mg buprenorphine.



## 9 DRUG ABUSE AND DEPENDENCE

### 9.1 Controlled Substance

BRIXADI contains buprenorphine, a Schedule III substance under the Controlled Substances Act.

### 9.2 Abuse

Abuse is the intentional, non-therapeutic use of a drug, even once, for its desirable psychological or physiological effects. Misuse is the intentional use, for therapeutic purposes, of a drug by an individual in a way other than prescribed by a healthcare provider or for whom it was not prescribed.

BRIXADI contains buprenorphine, a Schedule III controlled substance that can be abused similar to other opioids. Patients who continue to misuse, abuse, or divert buprenorphine products or other opioids should be provided with or referred for more intensive and structured treatment. Abuse of buprenorphine poses a risk of overdose and death. This risk is increased with the abuse of buprenorphine and alcohol and other substances, especially benzodiazepines [*see Warnings and Precautions (5.5)*].

BRIXADI is distributed through a restricted distribution program, which is intended to prevent the direct distribution to a patient. BRIXADI should only be dispensed directly to a healthcare provider for administration by a healthcare provider. It is supplied in prefilled syringes and is intended for administration only by subcutaneous injection by a healthcare provider. The entire contents of the prefilled syringe should be administered. After administration, a small amount of BRIXADI may remain in the needle. Properly dispose of the needle and syringe [*see How Supplied/Storage and Handling (16)*].

Upon injection, BRIXADI spontaneously transforms from a low viscous solution to a liquid crystalline gel that encapsulates buprenorphine and releases it at a steady rate as the depot biodegrades [*see Warnings and Precautions (5.1)*]. Clinical monitoring for evidence at the injection site of tampering or attempting to remove the depot should be ongoing throughout treatment. No attempts to remove BRIXADI have been reported in clinical trials.

### 9.3 Dependence

Physical dependence is a state that develops as a result of physiological adaptation in response to repeated drug use, manifested by withdrawal signs and symptoms after abrupt discontinuation or a significant dose reduction of a drug.

Buprenorphine is a partial agonist at the mu-opioid receptor and chronic administration produces physical dependence of the opioid type, characterized by moderate withdrawal signs and symptoms upon abrupt discontinuation or rapid taper. The withdrawal syndrome is typically milder than seen with full agonists and may be delayed in onset. Monitor patients during discontinuation of BRIXADI for symptoms of withdrawal [*see Warnings and Precautions (5.9)*].

Due to the long-acting nature of BRIXADI, withdrawal signs and symptoms may not be evident immediately following the discontinuation of treatment.

Neonatal opioid withdrawal syndrome (NOWS) is an expected and treatable outcome of prolonged use of opioids during pregnancy [*see Warnings and Precautions (5.6)*].

## 10 OVERDOSAGE

### Clinical Presentation

The manifestations of acute buprenorphine overdose include pinpoint pupils, sedation, hypotension, respiratory depression, and death.

### Treatment of Overdose

In the event of overdose, the respiratory and cardiac status of the patient should be monitored carefully. When respiratory or cardiac functions are depressed, primary attention should be given to the re-establishment of adequate respiratory exchange through provision of a patent airway and institution of assisted or controlled ventilation. Oxygen, IV fluids, vasopressors, and other supportive measures should be considered as indicated. Naloxone may be of value for the management of buprenorphine overdose. Higher than normal doses and repeated administration may be necessary.

Clinicians should consider the potential role and contribution of buprenorphine, other opioids, and other CNS depressant drugs in a patient's clinical presentation.

## 11 DESCRIPTION

BRIXADI (buprenorphine) extended-release injection is a sterile, yellowish to yellow clear liquid provided in a single-dose, pre-filled syringe intended for subcutaneous injection only. BRIXADI is designed to deliver buprenorphine at a controlled rate over either one week or one month.

The active ingredient in BRIXADI is buprenorphine free base, a partial opioid agonist.

BRIXADI is provided in multiple doses with two durations (weekly and monthly).

- BRIXADI (weekly; 8, 16, 24, 32 mg) consists of 50 mg/mL buprenorphine base, 10% w/w anhydrous ethanol and soybean phosphatidylcholine/glycerol dioleate in a weight ratio 50/50 to final volume.
- BRIXADI (monthly; 64, 96, 128 mg) consists of 356 mg/mL buprenorphine base, 30% w/w N-methyl pyrrolidine and soybean phosphatidylcholine/glycerol dioleate in weight ratio 40/60 to final volume.

Upon injection, BRIXADI spontaneously transforms from a low viscous solution to a liquid crystalline gel that encapsulates buprenorphine and releases it at a steady rate as the depot biodegrades.

Different drug product strengths, or doses, are accomplished by different syringe fill volumes [see *Dosage Forms and Strengths (3)*].

The molecular weight of buprenorphine free base is 467.65 g/mol, and its molecular formula is C<sub>29</sub>H<sub>41</sub>NO<sub>4</sub>. Chemically, buprenorphine is: (2S)-2-[17-(Cyclopropylmethyl)-4,5α-epoxy-3-hydroxy-6α,14-ethano-14α-morphinan-7α-yl]-3,3-dimethylbutan-2-ol.

The structural formula is:

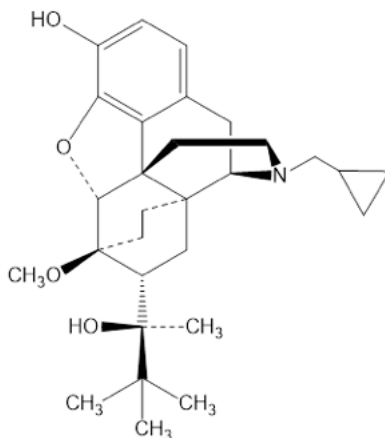

## 12 CLINICAL PHARMACOLOGY

### 12.1 Mechanism of Action

BRIXADI contains buprenorphine, a partial agonist at the mu-opioid receptor and an antagonist at the kappa-opioid receptor.

### 12.2 Pharmacodynamics

#### Opioid Blockade

The opioid blockade study assessed the blockade of subjective opioid drug-liking effects and pharmacokinetics (PK) of BRIXADI (weekly) in 47 patients with moderate or severe opioid dependence. The primary endpoint was the maximum rating ( $E_{max}$ ) on the visual analogue scale (VAS) for drug-liking. After stabilization on immediate-release morphine, all patients completed a 3-day qualification/baseline hydromorphone challenge session consisting of 3 intramuscular doses of hydromorphone (0 mg, [placebo], 6 mg, and 18 mg) once daily for 3 consecutive days in a randomized, double-blind, crossover manner. Following the qualification phase, eligible patients received 2 injections of BRIXADI (weekly) for two weeks at either the 24 mg or 32 mg level. Two hydromorphone challenge sessions (3 consecutive days each) were conducted throughout the week after each weekly injection of BRIXADI (weekly).

On average, the subjective effects (e.g., drug liking [ $E_{max}$ ]) of 6 mg or 18 mg hydromorphone was blocked following injections of BRIXADI (weekly) at the 24 mg or 32 mg levels. The variability in drug-liking scores was wider for the 18 mg than the 6 mg hydromorphone dose level. In addition, for the 18 mg hydromorphone dose challenge, the drug-liking score variability was wider towards the end of the BRIXADI (weekly) dosing interval compared to earlier in the interval (e.g. Days 4-6 versus Days 1-3; Day 11-13 versus Day 8-10). Drug-liking score variability was wider for the 24 mg BRIXADI (weekly) dose level compared to 32 mg [*see Clinical Studies (14.1)*].

Figure 14 illustrates the relationship between buprenorphine plasma level and drug liking after 18 mg hydromorphone where data from the 24 mg BRIXADI (weekly) arm is pooled with data from the 32 mg BRIXADI (weekly) arm. The observed plateau for maximal response of drug-liking was reached at buprenorphine concentrations of approximately 1.5-2 ng/mL plasma levels.

**Figure 14: Placebo-Corrected Drug Liking VAS vs. Plasma Buprenorphine Concentration Following 18 mg Hydromorphone Challenges for Pooled 24 mg and 32 mg Arms**

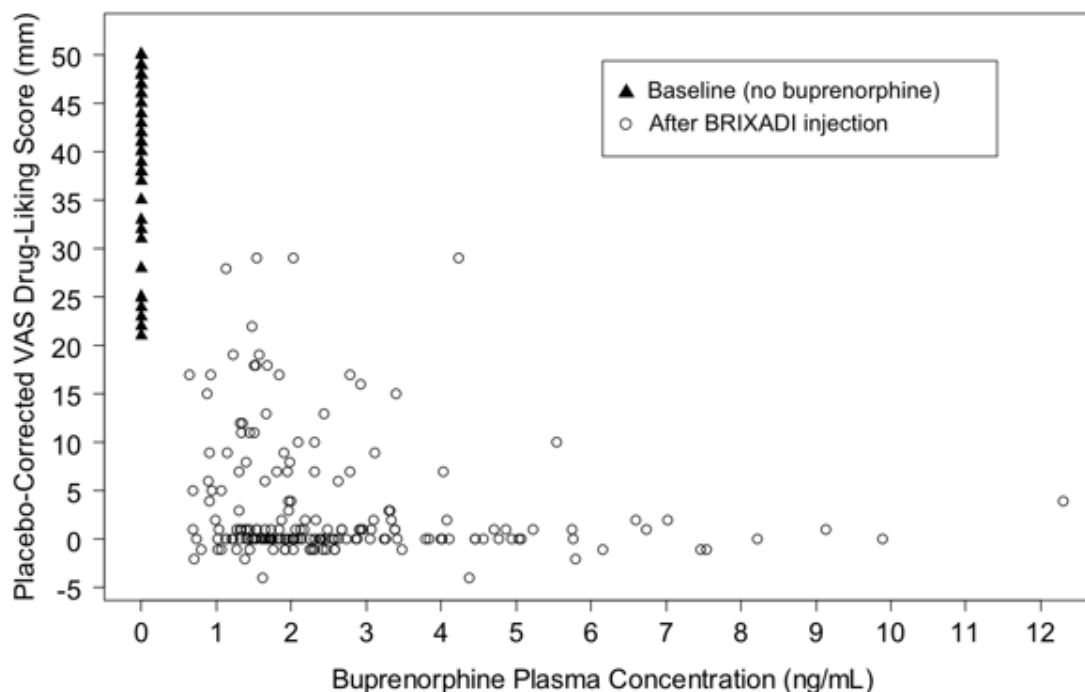

### Androgen Deficiency

Chronic use of opioids may influence the hypothalamic-pituitary-gonadal axis, leading to androgen deficiency that may manifest as low libido, impotence, erectile dysfunction, amenorrhea, or infertility.

The causal role of opioids in the clinical syndrome of hypogonadism is unknown because the various medical, physical, lifestyle, and psychological stressors that may influence gonadal hormone levels have not been adequately controlled for in studies conducted to date. Patients presenting with symptoms of androgen deficiency should undergo laboratory evaluation.

### Cardiac Electrophysiology

Thorough QT studies with buprenorphine products have demonstrated modest QT prolongation  $\leq 15$  msec. Two categorical analyses of cardiovascular-specific adverse events among patients exposed to buprenorphine demonstrated no proarrhythmic potential. One Holter monitoring study demonstrated no arrhythmia. An analysis of medical literature provided no evidence for causal association between buprenorphine and Torsades de Pointes.

### Physiological Effects

Buprenorphine in IV (2, 4, 8, 12 and 16 mg) and sublingual (12 mg) doses have been administered to opioid-experienced subjects who were not physically dependent to examine cardiovascular, respiratory, and subjective effects at doses comparable to those used for treatment of opioid use disorder. Compared to placebo, there were no statistically significant differences among any of the treatment conditions for blood pressure, heart rate, respiratory rate, O<sub>2</sub> saturation, or skin temperature across time. Systolic BP was higher in the 8 mg group than placebo (3-hour AUC values). Minimum and maximum effects were similar across all

treatments. Subjects remained responsive to low voice and responded to computer prompts. Some subjects showed irritability, but no other changes were observed.

The respiratory effects of sublingual buprenorphine were compared with the effects of methadone in a double-blind, parallel group, dose ranging comparison of single doses of buprenorphine sublingual solution (1, 2, 4, 8, 16, or 32 mg) and oral methadone (15, 30, 45, or 60 mg) in non-dependent, opioid-experienced volunteers. In this study, hypoventilation not requiring medical intervention was reported more frequently after buprenorphine doses of 4 mg and higher than after methadone. Both drugs decreased O<sub>2</sub> saturation to the same degree.

In clinical studies conducted with BRIXADI at doses ranging from 7.5 to 32 mg for weekly BRIXADI and 64 to 192 mg for monthly BRIXADI, no incidences of temperature elevations, or clinically significant lowering of oxygen saturation were observed.

### 12.3 Pharmacokinetics

#### Absorption

BRIXADI is an extended-release formulation of buprenorphine designed for subcutaneous administration. BRIXADI is available in two regimens: weekly and monthly. Following single doses of BRIXADI (weekly) or BRIXADI (monthly), the buprenorphine C<sub>max</sub> and AUC<sub>inf</sub> increase dose-proportionally.

The steady-state PK of buprenorphine following BRIXADI (weekly), BRIXADI (monthly) and their comparison to sublingual SUBUTEX across three studies are shown in Table 7. In these studies, BRIXADI (weekly) was administered for 4 or 4 to 7 weekly doses, BRIXADI (monthly) was administered for 4 monthly doses, and SUBUTEX was administered for 7 daily doses.

After BRIXADI subcutaneous injection, the buprenorphine plasma concentration increases with a median time to maximum plasma concentration (t<sub>max</sub>) of about 24 hours for BRIXADI (weekly) and 6-10 hours for BRIXADI (monthly). Based on trough levels after each dose, steady-state exposure is reached at administration of the fourth weekly or monthly dose.

After four repeated doses of BRIXADI (weekly) (16 mg) AUC<sub>τ</sub> (0-7d), C<sub>max</sub> and C<sub>trough</sub> values are ~40% higher exposure compared to the first dose. Based on cross-study comparisons, four repeated doses of BRIXADI (monthly) (128 mg) results in 68%, 65%, and 124% higher AUC<sub>τ</sub> (0-28d), C<sub>max</sub> and C<sub>trough</sub> values, respectively compared to the first dose.

**Table 7: Summary of steady-state PK parameters of buprenorphine after subcutaneous buttock injections of BRIXADI (weekly) and BRIXADI (monthly) and sublingual (SL) administration of SUBUTEX**

Drug product dose			C <sub>av</sub> (ng/mL)			C <sub>max</sub> (ng/mL)			C <sub>trough</sub> <sup>a</sup> (ng/mL)		
SL BPN	Brixadi (weekly)	Brixadi (monthly)	SL BPN *	Brixadi (weekly)	Brixadi (monthly)	SL BPN *	Brixadi (weekly)	Brixadi (monthly)	SL BPN *	Brixadi (weekly)	Brixadi (monthly)
8 mg	16 mg	64 mg	1.2	2.1	2.0 <sup>§</sup>	4.7	4.3	4.0 <sup>§</sup>	0.7	0.8	1.3 <sup>§</sup>
16 mg	24 mg	96 mg	1.8	2.9 <sup>§</sup>	2.9 <sup>§</sup>	6.5	5.5 <sup>§</sup>	6.0 <sup>§</sup>	1.0	1.4 <sup>§</sup>	2.0 <sup>§</sup>
24 mg	32 mg	128 mg	2.5	4.2	3.9	8.2	6.9	11.1	1.4	2.6	2.1

\* Average value of two studies

<sup>§</sup> Simulated

<sup>a</sup> C<sub>168h</sub> after 4<sup>th</sup> dose for BRIXADI (weekly), C<sub>28d</sub> after 4<sup>th</sup> dose for BRIXADI (monthly) and C<sub>24h</sub> after 7<sup>th</sup> daily dose for Subutex

### Effect of injection Site on PK of BRIXADI

After multiple dose subcutaneous injections of 32 mg BRIXADI weekly product at different injection sites (abdomen, thigh, buttock or upper arm), a comparable PK exposure was observed. However, injection in the arm site was associated with approximately 10% lower plasma levels than other sites.

### Distribution:

Buprenorphine is approximately 96% protein bound, primarily to alpha and beta globulin.

### Elimination:

Buprenorphine is metabolized and eliminated in urine and feces. The apparent terminal plasma half-life of buprenorphine following subcutaneous injection of BRIXADI ranged between 3 to 5 days for BRIXADI (weekly) and 19 to 26 days for BRIXADI (monthly) as a result of the slow release of buprenorphine from the subcutaneous depot.

### *Metabolism:*

Buprenorphine undergoes both N-dealkylation to norbuprenorphine and glucuronidation. The N-dealkylation pathway is mediated primarily by the CYP3A4. Norbuprenorphine, the major metabolite, can further undergo glucuronidation. Norbuprenorphine has been found to bind opioid receptors in vitro; however, it has not been studied clinically for opioid-like activity.

Norbuprenorphine steady-state plasma concentrations in humans after subcutaneous injection of BRIXADI (weekly or monthly) are low compared to buprenorphine (AUC norbuprenorphine/buprenorphine ratio of 0.35).

### *Excretion:*

A mass balance study of buprenorphine showed complete recovery of radiolabel in urine (30%) and feces (69%) collected up to 11 days after dosing. Almost all of the dose was accounted for in terms of buprenorphine, norbuprenorphine, and two unidentified buprenorphine metabolites. In urine, most of the buprenorphine and norbuprenorphine was conjugated (buprenorphine, 1% free and 9.4% conjugated; norbuprenorphine, 2.7% free and 11% conjugated). In feces, almost all of the buprenorphine and norbuprenorphine were free (buprenorphine, 33% free and 5% conjugated; norbuprenorphine, 21% free and 2% conjugated).

### Drug Interaction Studies:

#### *CYP3A4 Inhibitors and Inducers*

The effects of co-administered CYP3A4 inhibitors and inducers on buprenorphine exposure in subjects treated with BRIXADI have not been studied; however, such interactions have been established in studies using transmucosal buprenorphine. The effects of buprenorphine may be dependent on the route of administration.

Buprenorphine is metabolized to norbuprenorphine primarily by cytochrome CYP3A4; therefore, potential interactions may occur when BRIXADI is given concurrently with agents that affect CYP3A4 activity. The effects of co-administered CYP3A4 inducers or inhibitors have been established in studies using transmucosal buprenorphine. Patients who switch to BRIXADI treatment from a regimen for transmucosal buprenorphine used concomitantly with CYP3A4 inhibitors (e.g., ketoconazole, macrolide antibiotics (e.g., erythromycin) or HIV protease inhibitors, or CYP3A4 inducer (e.g., phenobarbital, carbamazepine, phenytoin, rifampicin)

should be monitored to ensure that the plasma buprenorphine level provided by BRIXADI is adequate and not excessive [see *Drug Interactions (7)*].

Buprenorphine has been found to be a CYP2D6 and CYP3A4 inhibitor and its major metabolite, norbuprenorphine, has been found to be a moderate CYP2D6 inhibitor in in vitro studies employing human liver microsomes. However, plasma concentrations of buprenorphine and norbuprenorphine resulting from therapeutic BRIXADI doses are not expected to significantly affect the metabolism (systemic exposure) of other concomitantly administered medications [see *Drug Interactions (7)*].

### Specific Populations

Based on population pharmacokinetic analyses, age, sex and race do not have a clinically meaningful effect on PK of BRIXADI.

#### *Hepatic Impairment*

The effect of hepatic impairment on the pharmacokinetics of BRIXADI has not been studied.

In a pharmacokinetic study, the disposition of buprenorphine was determined after administering a 2.0/0.5 mg Suboxone (buprenorphine/naloxone) sublingual tablet in subjects with varied degrees of hepatic impairment as indicated by Child-Pugh criteria. The disposition of buprenorphine in patients with hepatic impairment was compared to disposition in subjects with normal hepatic function.

In subjects with mild hepatic impairment, the changes in mean  $C_{max}$ ,  $AUC_{0-last}$ , and half-life values of buprenorphine were not clinically significant.

For subjects with moderate and severe hepatic impairment, mean  $C_{max}$ ,  $AUC_{0-last}$ , and half-life values of buprenorphine were increased [see *Warnings and Precautions (5.14)* and *Use in Specific Populations (8.6)*].

#### *Renal Impairment*

The effect of renal impairment on the pharmacokinetics of BRIXADI has not been studied.

Clinical studies of BRIXADI did not include subjects with severe renal impairment. Less than 1% is excreted as unchanged buprenorphine in urine following IV buprenorphine administration. No differences in buprenorphine pharmacokinetics were observed between 9 dialysis-dependent and 6 normal patients following IV administration of 0.3 mg buprenorphine [see *Use in Specific Populations (8.7)*].

Population PK analyses indicated no notable relationship between creatinine clearance and steady-state buprenorphine plasma concentrations.

#### *HCV infection*

In subjects with HCV infection but no sign of hepatic impairment, the changes in the mean  $C_{max}$ ,  $AUC_{0-last}$ , and half-life values of buprenorphine were not clinically significant in comparison to healthy subjects without HCV infection.

## 13 NONCLINICAL TOXICOLOGY

### 13.1 Carcinogenesis, Mutagenesis, Impairment of Fertility

#### Carcinogenicity

Carcinogenicity studies of buprenorphine were conducted in Sprague-Dawley rats and CD-1 mice. Buprenorphine was administered in the diet to rats for 27 months at doses of 0.6, 5.5, and 56 mg/kg/day (0.3, 1.4 and 11.3 times the highest daily exposure from 32 mg BRIXADI (weekly) on an AUC basis and 0.2, 0.9 and 6.9 times the highest daily exposure from 128 mg BRIXADI (monthly) on an AUC basis). A statistically significant dose-related increase in Leydig cell tumors occurred. In an 86-week study in CD-1 mice, buprenorphine was not carcinogenic at dietary doses up to 100 mg/kg/day (7 and 4 times the highest daily exposure from 32 mg BRIXADI (weekly) or 128 mg BRIXADI (monthly), respectively, on an AUC basis).

NMP, an excipient in BRIXADI (monthly) produced an increase in hepatocellular adenomas and carcinomas in male and female mice at 47 and 60 times, respectively, the maximum daily dose (MDD) of NMP via 128 mg BRIXADI (monthly) on a mg/m<sup>2</sup> basis. The clinical significance of these findings is unclear. No tumors were noted in male or female mice at 7.4 and 9.5 times the MDD on a mg/m<sup>2</sup> basis. In 2-year inhalation and dietary studies in rats, NMP did not result in evidence of carcinogenicity.

#### Mutagenicity

Buprenorphine was studied in a series of tests utilizing gene, chromosome, and DNA interactions in both prokaryotic and eukaryotic systems. Results were negative in yeast (*S. cerevisiae*) for recombinant, gene convertant, or forward mutations; negative in *Bacillus subtilis* “rec” assay; negative for clastogenicity in CHO cells, Chinese hamster bone marrow and spermatogonia cells, and negative in the mouse lymphoma L5178Y assay.

Results were equivocal in the Ames test: negative in studies in two laboratories, but positive for frame shift mutation at a high dose (5 mg/plate) in a third study. Results were positive in the Green-Tweets (*E. coli*) survival test, positive in a DNA synthesis inhibition (DSI) test with testicular tissue from mice, for both in vivo and in vitro incorporation of [<sup>3</sup>H]thymidine, and positive in unscheduled DNA synthesis test using testicular cells from mice.

#### Impairment of Fertility

Reproduction studies of buprenorphine in rats demonstrated no evidence of impaired fertility at daily oral doses up to 80 mg/kg/day (169 times the mean daily dose of 4.6 mg buprenorphine as delivered by 32 mg BRIXADI (weekly) or 128 mg BRIXADI (monthly) on a mg/m<sup>2</sup> basis) or up to 5 mg/kg/day IM (11 times the mean daily dose of 4.6 mg buprenorphine as delivered by 32 mg BRIXADI (weekly) or 128 mg BRIXADI (monthly) on a mg/m<sup>2</sup> basis) or 5 mg/kg/day SC (16 or 10 times the highest daily exposure from 32 mg BRIXADI (weekly) or 128 mg BRIXADI (monthly), respectively, on an AUC basis).

## 14 CLINICAL STUDIES

The key studies from the BRIXADI clinical development program that support its use in the treatment of moderate to severe opioid use disorder are a Phase 3, double-blind, active control (sublingual buprenorphine/naloxone), efficacy and safety study (NCT02651584), and an opioid blockade study (NCT02611752). Additionally, a Phase 3, open-label safety study (NCT0267211)



provides data to support the safety of converting from daily transmucosal buprenorphine, buprenorphine/naloxone or generic equivalents.

### **14.1 Opioid Blockade Study, NCT02611752**

The opioid blockade study assessed the blockade of subjective opioid effects, PK, and safety of BRIXADI weekly in 47 patients with moderate or severe opioid use disorder. Forty-six patients completed the study. Subjects were randomized to receive two injections of BRIXADI (weekly) once weekly for 2 weeks either at a 24 mg or 32 mg dose level.

After stabilization on immediate-release morphine, all patients completed a 3-day qualification/baseline hydromorphone (HM) challenge session, which included intramuscular administration of 3 doses of HM (0 mg [placebo], 6 mg and 18 mg) once daily for 3 consecutive days. Patients were not exposed to buprenorphine during the baseline/qualification phase.

Following the qualification phase, eligible patients were randomly assigned to receive 2 doses of either 24 mg (22 patients) or 32 mg (24 patients) BRIXADI (weekly) with each dose administered one week apart. Two HM challenge sessions (Days 1-3 and 4-6 for the first session and Days 8-10 and 11-13 for the second session, respectively) were conducted after each dose of BRIXADI (weekly).

The primary endpoint was the peak effect ( $E_{max}$ ) on a 100-mm bipolar (i.e., 50=neutral response) “Drug Liking” Visual Analog Scale (VAS). The pre-defined upper bound of the 95% CI for complete blockade of drug liking was an 11 mm difference between VAS  $E_{max}$  scores obtained for HM doses compared with placebo.

During the qualification/baseline phase, mean  $E_{max}$  scores for placebo were neutral while intramuscular hydromorphone 6 and 18 mg produced dose-related increases in the scores. Beginning with the first injection of BRIXADI (weekly) 24 mg or 32 mg weekly, no active intramuscular hydromorphone dose resulted in a mean drug liking VAS  $E_{max}$  score of 11 mm or greater when compared to placebo, which demonstrated complete blockade that was sustained throughout the first and second dosing intervals (see Figure 15). Individual subject scores are shown in Figure 16.

**Figure 15: Mean Difference in Placebo-Corrected Peak Drug Liking**

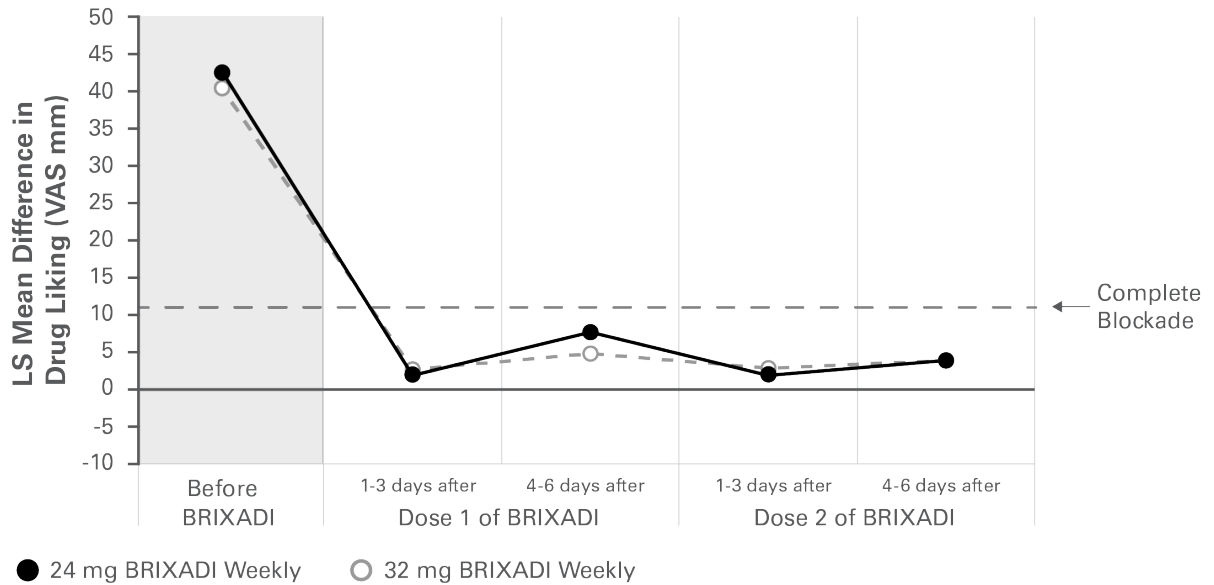

**Figure 16: Mean Difference in Placebo-Corrected Peak Drug Liking with Individual Scores**

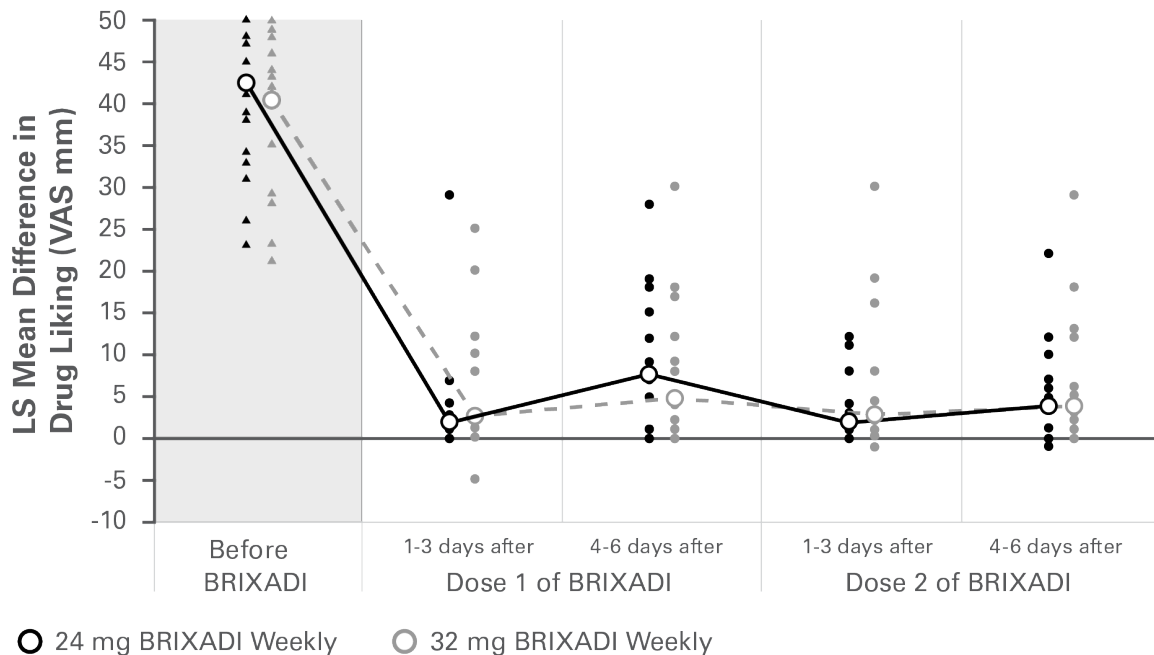

### 14.2 Phase 3 Double-Blind Study, NCT02651584

The efficacy and safety of BRIXADI for the treatment of opioid use disorder was evaluated in a Phase 3, 24-Week, randomized, double-blind, double-dummy, active controlled, multicenter study in patients who met the DSM-5 criteria for moderate or severe opioid use disorder and who were actively seeking but not currently receiving buprenorphine treatment. Patients were randomized to receive either BRIXADI injections with placebo sublingual tablets or sublingual buprenorphine/naloxone (SL BPN/NX) tablets with placebo injections. All patients received individual drug counseling for the duration of the study.

On the first day of treatment patients received an open-label 4 mg test dose of sublingual buprenorphine. Patients who tolerated the test dose (two patients did not tolerate the test dose) were randomized and given a 16 mg injection of BRIXADI (weekly) or matched placebo. During the next 6 days patients were allowed up to two further 8 mg injections as needed. Patients received an injection of 16, 24, or 32 mg on Day 8 matched to the dose they received in the previous seven days. Patients received injections weekly (every 7 days +/- 2-day window) for twelve weeks total and then transitioned to an equivalent dose of BRIXADI (monthly) (every 28 days, +/- 7-day window) for the remaining twelve weeks. Dose adjustments were permitted for the duration of the study. Supplemental 8 mg BRIXADI (weekly) injections were allowed during the second phase of the study and were also used in the active-controlled group. Overall, supplemental 8 mg injections were given to 14 patients (6.6%) in the BRIXADI arm and 17 patients (7.9%) in the SL BPN/NX arm. Table 8 shows the doses of BRIXADI (weekly) administered following the initial titration period and at the final visit before transition to BRIXADI (monthly) was allowed. Table 9 shows the first and final BRIXADI (monthly) dose administered to each patient.

**Table 8: Number of patients receiving each BRIXADI (weekly) dose at selected time points**

BRIXADI (weekly) Dose	Following Titration Period	End of Weekly Phase
16 mg	2	6
24 mg	128	84
32 mg	54	64

**Table 9: Number of patients receiving each BRIXADI (monthly) dose at selected time points**

BRIXADI (monthly) Dose	First BRIXADI (monthly) dose	Final BRIXADI (monthly) dose
64 mg	8	11
96 mg	84	83
128 mg	66	56
160 mg*	0	8

\*not an approved strength

For the first twelve weeks patients completed weekly visits. For the final twelve weeks patients were transitioned to monthly visits. Patients were also required to complete three additional randomly scheduled visits during the final twelve weeks. Efficacy was evaluated using urine drug screens combined with self-reported use of illicit opioid use. Missing urine drug screen samples and/or self-reports were counted as positive for illicit opioids.

A total of 428 patients were randomized equally (215 patients in the SL BPN/NX group and 213 in the BRIXADI group). Of the randomized patients, 69.0% (147/213) of the patients in BRIXADI treatment group and 72.6% (156/215) of the patients in the SL BPN/NX treatment group completed the 24-week period. Patient demographics and baseline characteristics are provided in Table 10.

**Table 10: Patient Demographics and Baseline Characteristics**

	<b>BRIXADI (N=213)</b>	<b>SL BPN/NX (N=215)</b>
<b>Mean Age (Years)</b>	38.7	38.0
<b>Sex %</b>		
Male	56.8	66.0
Female	43.2	34.0
<b>Race or Ethnicity %</b>		
White	74.6	76.3
Black or African American	22.1	22.3
American Indian or Alaska Native	0.9	0.5
Asian	0.5	0
Native Hawaiian or Other Pacific Islander	0.5	0
Other	1.4	0.9
<b>Primary Opioid of Use at Initiation %</b>		
Heroin	71.4	70.2
Prescription Pain Reliever	28.6	29.8
<b>Injectable Route %</b>	53.5	51.2
<b>Substance Use by Urine Toxicology Prior to Randomization %</b>		
Amphetamines	22.1	18.6
Barbiturates	1.4	0.5
Benzodiazepine	21.1	21.9
Cocaine	30.5	32.6
Cannabinoids	34.3	36.3
Fentanyl	29.1	22.8
Phencyclidine	1.9	0.5
<b>Medical History %</b>		
Anxiety	14.1	18.6
Back Pain	15.5	18.6
Depression	11.7	13.0

Table 11 below illustrates the proportion of patients who were considered to be responders. A patient was a responder if they met all of the following criteria:

- Negative opioid assessment (urinalysis and self-report) during week 12 (evaluated during week 13 visit).

- No more than one positive opioid assessment in the three illicit opioid use assessments performed during week 9 to 11 (evaluated during visits at weeks 10 to 12).
- Negative opioid assessment during the final month of the study.
- No more than one positive opioid assessment at the three scheduled monthly visits and three random site visits.

This responder definition was designed to identify patients who were successfully treated with both BRIXADI (weekly) (administered in the first 12 weeks of treatment) and BRIXADI (monthly) (administered in the second 12 weeks of treatment). Therefore, patients were required to have negative opioid assessments at the end of each treatment phase. Each phase also included an allowable grace period (an initial period of time when positive opioid assessments were not taken into account) and the definition also allowed for sporadic positive assessments. Based on the results of this trial, the efficacy of BRIXADI was demonstrated. Table 11 shows the response rate for each treatment arm along with the associated 95% confidence interval for their difference.

**Table 11: Number (Percentage) of Patients who met the Responder Definition**

<b>BRIXADI Injection with placebo sublingual tablets (N=213)</b>	<b>SL BPN/NX Tablets with Placebo Injections (N=215)</b>	<b>Treatment Difference (95% CI)</b>
36 (16.9%)	30 (14.0%)	2.9% (-3.9%, 9.8%)*

\* The lower bound of the confidence interval was within the agreed upon noninferiority threshold of -10%.

The cumulative distribution function (CDF) of the percentage of negative opioid assessments (urine samples negative for illicit opioid use combined with self-reports negative for illicit opioid use) from Week 4 through Week 24 are shown in Figure 17 and Table 12. The figure and table are cumulative, so that a patient whose percentage of opioid-free assessments is, for example 50%, is also included at every level of negative opioid assessments below 50%. Missing values and values after premature discontinuation were considered positive. Based on the CDF of the percentage of negative opioid assessments, superiority was demonstrated with BRIXADI with statistical significance compared with SL BPN/NX. However, on the right-hand side of the curves where patients were reporting mostly negative opioid assessments (80% or greater) there was little to no difference between BRIXADI and SL BPN/NX.

**Figure 17: Patients Achieving Varying Percentages of Negative Opioid Assessments (urine and self-report) in weeks 4 through 24**

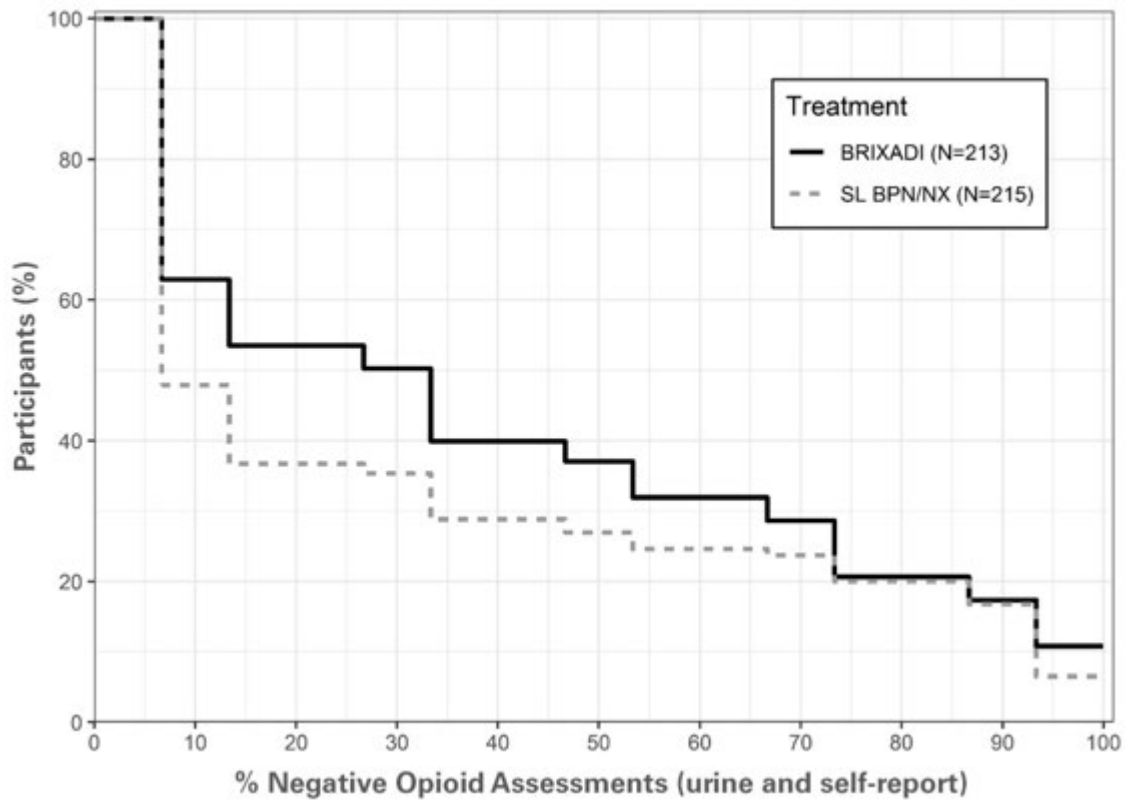

**Table 12: Patients Achieving Varying Percentage of Opioid-Negative Assessments (urine and self report) (Weeks 4-24)**

Percentage of Opioid-Negative Assessments (Urine and Self Report)	Number (%) of Patients	
	BRIXADI N=213	SL BPN/NX N=215
≥ 0%	213 (100.0)	215 (100.0)
≥ 10%	121 (56.8)	87 (40.5)
≥ 20%	114 (53.5)	79 (36.7)
≥ 30%	95 (44.6)	67 (31.2)
≥ 40%	85 (39.9)	62 (28.8)
≥ 50%	74 (34.7)	56 (26.0)
≥ 60%	68 (31.9)	53 (24.7)
≥ 70%	51 (23.9)	49 (22.8)
≥ 80%	44 (20.7)	43 (20.0)
≥ 90%	28 (13.1)	27 (12.6)
≥ 100%	23 (10.8)	14 (6.5)

## 16 HOW SUPPLIED/STORAGE AND HANDLING

Weekly and monthly BRIXADI is available as a sterile, yellowish to yellow clear liquid solution in a single dose, prefilled safety syringe.

The BRIXADI needle cap is synthetically derived from natural rubber latex, which may cause allergic reactions in latex sensitive individuals.

Store BRIXADI at room temperature at 20°C to 25°C (68°F to 77° F); with excursions permitted at 15°C to 30° C (59°F to 86°F) [see USP Controlled Room Temperature].

BRIXADI is a Schedule III drug product. Handle with adequate security and accountability. After administration, syringes should be properly disposed, per facility procedure for a Schedule III drug product, and per applicable federal, state, and local regulations.

<b>BRIXADI Weekly</b> <b>50 mg/mL buprenorphine</b>		
<b>Dosage</b>	<b>Volume</b>	<b>NDC</b>
8 mg	0.16 mL	58284-208-01 58284-208-91
16 mg	0.32 mL	58284-216-01 58284-216-91
24 mg	0.48 mL	58284-224-01 58284-224-91
32 mg	0.64 mL	58284-232-01 58284-232-91

<b>BRIXADI Monthly</b> <b>356 mg/mL buprenorphine</b>		
<b>Dosage</b>	<b>Volume</b>	<b>NDC</b>
64 mg	0.18 mL	58284-264-01 58284-264-91
96 mg	0.27 mL	58284-296-01 58284-296-91
128 mg	0.36 mL	58284-228-01 58284-228-91

## 17 PATIENT COUNSELING INFORMATION

Advise the patient to read the FDA-approved patient labeling (Medication Guide).

Instruct patients to read the Medication Guide each time BRIXADI is administered because new information may be available.

## Safe Use

Before initiating treatment with BRIXADI, explain the points listed below to patients and caregivers.

### BRIXADI Risk Evaluation and Mitigation Strategy (REMS)

Advise patients that because of the risk of serious harm or death due to intravenous self-administration, BRIXADI is available only through a restricted distribution program called the BRIXADI REMS. Healthcare settings and pharmacies are certified and only dispense BRIXADI directly to a healthcare provider for administration by a healthcare provider [*see Warnings and Precautions (5.2)*].

### Life Threatening Respiratory Depression

Educate patients and caregivers on how to recognize respiratory depression and emphasize the importance of calling 911 or getting emergency medical help right away in the event of a known or suspected overdose [*see Warnings and Precautions 5.4*].

#### *Patient Access to Naloxone for the Emergency Treatment of Opioid Overdose*

Because patients being treated for opioid use disorder are at risk for relapse, discuss the importance of having access to naloxone with the patient and caregiver. Also discuss the importance of having access to naloxone if there are household members (including children) or other close contacts at risk for accidental ingestion or opioid overdose.

Inform patients and caregivers of the options for obtaining naloxone as permitted by individual state naloxone dispensing and prescribing requirements or guidelines (e.g., by prescription, directly from a pharmacist, or as part of a community-based program).

Educate patients and caregivers on how to recognize the signs and symptoms of an opioid overdose.

Explain to patients and caregivers that naloxone's effects are temporary, and that they must call 911 or get emergency medical help right away in all cases of known or suspected opioid overdose, even if naloxone is administered.

Repeat administration may be necessary, particularly for overdose involving buprenorphine, because naloxone is often not effective at the doses available for patient access [*Dosage and Administration (2.3), Warnings and Precautions (5.4), Overdosage (10)*].

If naloxone is prescribed, also advise patients and caregivers:

- How to treat with naloxone in the event of an opioid overdose
- To tell family and friends about their naloxone and to keep it in a place where family and friends can easily access it in an emergency
- To read the Patient Information (or other educational material) that will come with their naloxone. Emphasize the importance of doing this before an opioid emergency happens, so the patient and



caregiver will know what to do.

#### Interaction with Benzodiazepines and other CNS Depressants

Inform patients and caregivers that potentially fatal additive effects may occur if BRIXADI is used with benzodiazepines or other CNS depressants, including alcohol, and not to use these concomitantly unless supervised by a healthcare provider [see *Warnings and Precautions (5.5) and Drug Interactions (7)*].

#### Serotonin Syndrome

Inform patients that BRIXADI could cause a rare but potentially life-threatening condition resulting from concomitant administration of serotonergic drugs. Warn patients of the symptoms of serotonin syndrome and to seek medical attention right away if symptoms develop. Instruct patients to inform their physicians if they are taking, or plan to take serotonergic medications [see *Drug Interactions (7)*].

#### Adrenal Insufficiency

Inform patients that BRIXADI could cause adrenal insufficiency, a potentially life-threatening condition. Adrenal insufficiency may present with non-specific symptoms and signs such as nausea, vomiting, anorexia, fatigue, weakness, dizziness, and low blood pressure. Advise patients to seek medical attention if they experience a constellation of these symptoms [see *Warnings and Precautions (5.7)*].

#### Anaphylaxis

Inform patients that anaphylaxis has been reported with buprenorphine. Advise patients how to recognize such a reaction and when to seek medical attention [see *Warnings and Precautions (5.10)*].

#### Latex Allergy

The BRIXADI needle cap is synthetically derived from natural rubber latex which may cause allergic reactions in latex-sensitive individuals [see *Warnings and Precautions (5.10)*].

#### Dependence and Withdrawal

Inform patients that BRIXADI can cause drug dependence and that withdrawal signs and symptoms may occur when the medication is discontinued [see *Warnings and Precautions (5.11)*].

#### Driving or Operating Heavy Machinery

Caution patients that BRIXADI may impair the mental or physical abilities required for the performance of potentially dangerous tasks such as driving or operating hazardous machinery.

Instruct patients not to drive or operate hazardous machinery until they are reasonably certain that BRIXADI therapy does not adversely affect their ability to engage in such activities [see *Warnings and Precautions (5.16)*].

#### Orthostatic Hypotension

Inform patients that, like other opioids, BRIXADI may produce orthostatic hypotension in ambulatory individuals [see *Warnings and Precautions (5.17)*].

### Long Duration of Action

Inform patients that they may have detectable levels of buprenorphine for a prolonged period of time after treatment with BRIXADI. Considerations of drug-drug interactions, buprenorphine effects, and analgesia may continue to be relevant for several months after the last injection [see *Clinical Pharmacology (12.3)*].

### Drug Interactions

Instruct patients to inform their healthcare providers of any other prescription medications, over-the-counter medications, or herbal preparations that are prescribed or currently being used [see *Drug Interactions (7)*].

### Pregnancy

#### *Neonatal Opioid Withdrawal Syndrome*

Advise women that if they are pregnant while being treated with BRIXADI, the baby may have signs of withdrawal at birth and that withdrawal is treatable [see *Warnings and Precautions (5.6)*, *Use in Specific Populations (8.1)*].

#### *Embryofetal Toxicity*

Advise women of childbearing potential who become pregnant or are planning to become pregnant to consult their healthcare provider regarding the possible effects of using BRIXADI during pregnancy [see *Use in Specific Populations (8.1)*].

### Lactation

Warn patients that buprenorphine passes into breast milk. Advise the nursing mother taking buprenorphine to monitor the infant for increased drowsiness and breathing difficulties [see *Use in Specific Populations (8.2)*].

### Infertility

Inform patients that chronic use of opioids may cause reduced fertility. It is not known whether these effects on fertility are reversible [see *Infertility (8.3)*].

### Emergency Analgesia

Advise patients to instruct their family members to, in the event of emergency, inform the treating physician or emergency room staff that the patient is physically dependent on an opioid and that the patient is being treated with BRIXADI [see *Warnings and Precautions (5.12)*].

### Clinical Monitoring

Tell your patients to seek emergency attention if they have signs or symptoms of respiratory or CNS depression or overdose [see *Warnings and Precautions (5.4, 5.5)*].

Tell your patients not to tamper with or try to remove their depot [see *Dosage and Administration (2.5)*].

© 2023 Braeburn, Inc. BRIXADI™ is a trademark of Braeburn Inc.

Distributed by:  
Braeburn Inc.  
Plymouth Meeting, PA 19462

Manufactured by:  
Pharmaceuticals International, Inc. (Pii)  
Cockeysville, MD 21030

05/2023

## Medication Guide

### **BRIXADI™ (brix-a-dee) (buprenorphine) extended-release injection, for subcutaneous use (CIII)**

#### **What is the most important information I should know about BRIXADI?**

- Because of the serious risk of potential harm or death from self-injecting BRIXADI into a vein (intravenously), it is only available through a restricted program called the BRIXADI REMS Program.
  - BRIXADI is not available in retail pharmacies.
  - Your BRIXADI injection will only be given to you by a healthcare provider.
- BRIXADI contains a medicine called buprenorphine. Buprenorphine is an opioid that can cause serious and life-threatening breathing problems, especially if you take or use certain other medicines or drugs.
- Talk to your healthcare provider about naloxone. Naloxone is a medicine that is available to patients for the emergency treatment of an opioid overdose. If naloxone is given, you must call 911 or get emergency medical help right away to treat an overdose or accidental use of an opioid.
- **BRIXADI can cause serious and life-threatening breathing problems. Get emergency help right away if you:**
  - feel faint
  - feel dizzy
  - are confused
  - feel sleepy or uncoordinated
  - have blurred vision
  - have slurred speech
  - are breathing slower than normal
  - cannot think well or clearly
- **Do not take BRIXADI with certain medicines. Taking BRIXADI with other opioid medicines, benzodiazepines, alcohol, other central nervous system depressants (including street drugs) can cause severe drowsiness, decreased awareness, breathing problems, coma, and death.**
- In an emergency, have family members tell the emergency department staff that you are physically dependent on an opioid and are being treated with BRIXADI.
- You may have detectable levels of BRIXADI in your body for several months after stopping treatment with BRIXADI.

#### **What is BRIXADI?**

BRIXADI is a prescription medicine used to treat moderate to severe opioid addiction (dependence) to opioid drugs (prescription or illegal) in people:

- who have started treatment with a single dose of a buprenorphine medicine in the form of a sublingual tablet or buccal film (transmucosal), OR
- who are already being treated with buprenorphine

BRIXADI should be used as part of a complete treatment plan that also includes counseling and behavioral therapy.

It is not known if BRIXADI is safe and effective in children.

#### **Who should not receive BRIXADI?**

**Do not receive BRIXADI** if you are allergic to buprenorphine or any ingredients in BRIXADI. See the end of this Medication Guide for a list of ingredients in BRIXADI .

#### **Before receiving BRIXADI, tell your healthcare provider about all of your medical conditions, including if you have:**

- |   |  |   |
|---|--|---|
| • trouble breathing or lung problems                | • an enlarged prostate (men)             | • a head injury or brain problem                          |
| • a curve in your spine that affects your breathing | • problems urinating                     | • mental health problems                                  |
| • Addison's disease                                 | • liver, kidney, or gallbladder problems | • adrenal gland or thyroid gland problems                 |
|   | • a history of alcoholism                | • a latex allergy. The BRIXADI needle cap contains latex. |

#### **Tell your healthcare provider if you are:**

- **pregnant or plan to become pregnant.** If you receive BRIXADI while pregnant, your baby may have symptoms of opioid withdrawal at birth that could be life-threatening if not recognized and treated. Talk to your healthcare provider if you are pregnant or become pregnant.
- **breastfeeding.** BRIXADI can pass into your breast milk and may harm your baby. Talk to your healthcare provider about the best way to feed your baby during treatment with BRIXADI. Monitor your baby for increased drowsiness and breathing problems if you breastfeed during treatment with BRIXADI.

**Tell your healthcare provider about all the medicines you take, including** prescription and over-the-counter medicines, vitamins and herbal supplements. Talk with your healthcare provider before starting any new medicines during or after stopping treatment with BRIXADI.

### How will I receive BRIXADI?

- You will receive BRIXADI by your healthcare provider as an injection just under the skin (subcutaneous) of your buttock, thigh, stomach (abdomen), or upper arm. If you are new to buprenorphine treatment, the upper arm should only be used after 4 doses of BRIXADI.
- If you are not currently receiving buprenorphine treatment, your healthcare provider will give you a test dose of buprenorphine first to see if you are able to tolerate it, and then switch you over to BRIXADI.
- You will receive BRIXADI 1 time every week or 1 time every month.
- BRIXADI is injected as a liquid. After the injection, BRIXADI changes to a gel form called a depot. The depot is not always felt under the skin.
- Do not try to remove the depot.
- If you miss a dose of BRIXADI, see your healthcare provider to get your BRIXADI injection as soon as possible.

### What should I avoid while receiving BRIXADI?

- **Do not drive, operate heavy machinery or perform any other dangerous activities until you know how BRIXADI affects you.** BRIXADI can cause drowsiness and slow reaction times. BRIXADI can make you sleepy, dizzy, or lightheaded. This may happen more often in the first few days after your injection and when your dose is being changed.
- **You should not drink alcohol** or use prescription or over-the-counter medicines that contain alcohol during treatment with BRIXADI, because this can lead to loss of consciousness or even death.

### What are the possible side effects of BRIXADI?

#### BRIXADI can cause serious side effects, including:

- **Trouble breathing.** Taking BRIXADI with other opioid medicines, benzodiazepines, alcohol, or other central nervous system depressants can cause breathing problems that can lead to coma and death.
- **Sleepiness, dizziness, and problems with coordination.**
- **Physical dependence or abuse.**
- **Liver problems.** Call your healthcare provider right away if you notice any of these symptoms:
  - your skin or the white part of your eyes turns yellow (jaundice)
  - dark or “tea colored” urine
  - light colored stools (bowel movements)
  - loss of appetite
  - pain, aching, or tenderness on the right side of your stomach-area
  - nausea

Your healthcare provider should do tests to check your liver before and during treatment with BRIXADI.

- **Allergic reaction.** You may have a rash, hives, swelling of your face, wheezing, light-headedness when changing positions, feeling faint, or loss of consciousness. Call your healthcare provider or get emergency help right away.
- **Opioid withdrawal.** Call your healthcare provider right away if you get any of these symptoms:
  - shaking
  - sweating more than normal
  - feeling hot or cold more than normal
  - runny nose
  - watery eyes
  - goose bumps
  - diarrhea
  - vomiting
  - muscle aches

These symptoms may start weeks to months after your last dose of BRIXADI. Tell your healthcare provider if you develop any of these symptoms.

- **Decrease in blood pressure.** You may feel dizzy if you get up too fast from sitting or lying down.

The most common side effects of BRIXADI include:

- injection site pain
- headache
- constipation
- nausea
- injection site redness
- injection site itching
- trouble sleeping (insomnia)
- urinary tract infection

BRIXADI may affect fertility in males and females. Talk to your healthcare provider if this is a concern for you.

These are not all the of possible side effects of BRIXADI.

Call your doctor for medical advice about side effects. You may report side effects to FDA at 1-800-FDA-1088.

### General information about the safe and effective use of BRIXADI.

Medicines are sometimes prescribed for purposes other than those listed in a Medication Guide. You can ask your pharmacist or healthcare provider for information that is written for healthcare professionals.

### What are the ingredients in BRIXADI?

**Active ingredient:** buprenorphine

**Inactive ingredients:**

BRIXADI weekly: anhydrous ethanol and soybean phosphatidylcholine/glycerol dioleate.

BRIXADI monthly: N-methyl pyrrolidine and soybean phosphatidylcholine/glycerol dioleate.

**This label may not be the latest approved by FDA.  
For current labeling information, please visit <https://www.fda.gov/drugsatfda>**

Distributed by Braeburn, Inc., Plymouth Meeting, PA 19462, USA.  
© 2023 Braeburn, Inc. BRIXADI™ is a trademark of Braeburn Inc.  
Manufactured by: Pharmaceuticals International, Inc. (Pii), Cockeysville MD 21030  
For more information, go to [www.BRIXADI.com](http://www.BRIXADI.com) or call 1-833-274-9234

This Medication Guide has been approved by the U. S. Food and Drug Administration.

Issued:05/2023

## INSTRUCTIONS FOR USE BOOKLET

Weekly/Monthly  
**Brixadi**<sup>TM</sup>  
(buprenorphine) extended-release  
injection for subcutaneous use 



## WELCOME

This guide contains information on the appropriate use of BRIXADI™ (buprenorphine) extended-release injection for subcutaneous use, which is a single-dose, sterile pre-filled syringe for the treatment of moderate-to-severe opioid use disorder.

Prior to injecting BRIXADI, carefully read these instructions as well as the full Prescribing Information.

As a universal precaution, always wear gloves and inject BRIXADI under aseptic conditions.

## INDICATIONS AND USAGE

BRIXADI is indicated for the treatment of moderate to severe opioid use disorder in patients who have initiated treatment with a single dose of a transmucosal buprenorphine product or who are already being treated with buprenorphine.

BRIXADI should be used as part of a complete treatment plan that includes counseling and psychosocial support.

## DOSAGE FORMS AND STRENGTHS

FOR SUBCUTANEOUS INJECTION ONLY. DO NOT ADMINISTER BRIXADI INTRAVENOUSLY, INTRAMUSCULARLY, OR INTRADERMALLY.

- BRIXADI exists in two formulations.
- Doses of BRIXADI (weekly) cannot be combined to yield a monthly dose.
- Only healthcare providers should prepare and administer BRIXADI.
- Administer BRIXADI as a single injection. Do not divide.
- BRIXADI should be injected slowly, into the subcutaneous tissue of the buttock, thigh, abdomen, or upper arm.
  - In patients who are not currently receiving buprenorphine treatment, for BRIXADI (weekly), the upper arm site should only be used after steady state has been achieved (4 consecutive doses). Injection in the arm site was associated with approximately 10% lower plasma levels than other sites.
- Injection sites should be alternated/rotated between injections for BRIXADI (weekly).
- For all patients, the dose of BRIXADI must be individualized based on patient tolerability and/or efficacy.





## DOSAGE FORMS AND STRENGTHS (continued)

- BRIXADI (weekly) should be administered in 7-day intervals.
- BRIXADI (monthly) should be administered in 28-day intervals.
- For patients not currently receiving buprenorphine treatment, begin with a test dose of 4 mg transmucosal buprenorphine to establish that buprenorphine is tolerated without precipitated withdrawal, and then transition to BRIXADI (weekly). Initiating treatment with BRIXADI as the first buprenorphine product has not been studied. Initiating treatment with BRIXADI (monthly) in new entrants to treatment has not been studied.
- Patients who are currently being treated with other buprenorphine-containing products can start treatment with either BRIXADI (weekly) or BRIXADI (monthly).
- Administer each injection using only the syringe and safety needle included with the product. Caution: The BRIXADI needle cap is synthetically derived from natural rubber latex which may cause allergic reactions in latex-sensitive individuals.
- BRIXADI (weekly) is available in: 8 mg, 16 mg, 24 mg, and 32 mg.
- BRIXADI (monthly) is available in: 64 mg, 96 mg, and 128 mg.

To avoid missed doses, the weekly dose may be administered up to 2 days before or after the weekly time point, and the monthly dose may be administered up to 1 week before or after the monthly time point.

If a dose is missed, the next dose should be administered as soon as practically possible.

## INSTRUCTIONS FOR SAFETY SYRINGE USE

- Always use the injection technique described in the Instructions for Use.
- Do not use if the safety syringe is broken, or if the packaging is damaged.
- Do not uncap the safety syringe until you are ready to inject. Once it is uncapped, never try to recap the needle.
- Do not re-use the safety syringe.
- Examine the contents of the safety syringe carefully through the transparent housing. The liquid should be clear and yellowish to yellow in color. Inspect for cracks or breakage in the syringe or other parts. Do not use if the syringe is cracked or broken, or if the liquid is cloudy, discolored, or contains particles.



## CONTRAINDICATIONS

- BRIXADI is contraindicated in patients with hypersensitivity (e.g., anaphylactic shock) to buprenorphine, or any other ingredients in the solution for injection.

## ADDITIONAL IMPORTANT INFORMATION

- Store BRIXADI in its original packaging until ready for use.
- Check the expiration date on the BRIXADI label and its carton. If the medication has expired, do not use it.
- Injecting BRIXADI may cause skin reactions including redness, pain, or itching. Patients should be instructed to contact their healthcare provider if skin reactions occur.
- Do not inject BRIXADI where the skin is irritated, reddened, bruised, infected, or abnormal in any way.

## HOW SUPPLIED AND STORAGE

- BRIXADI is individually packaged. Each carton contains one safety syringe and one plunger. The parts of the syringe are outlined in **Figures 1, 2, and 3**.
- BRIXADI should be stored at room temperature at 20°C to 25°C (68°F to 77°F); with excursions permitted at 15°C to 30°C (59°F to 86°F) [see USP Controlled Room Temperature].
- BRIXADI is a Schedule III drug product. Handle with adequate security and accountability. After administration, syringes should be properly disposed per facility procedure for a Schedule III drug product, and per applicable federal, state, and local regulations.



## SAFETY SYRINGE PARTS

(see Figures 1, 2, 3 below)

Figure 1

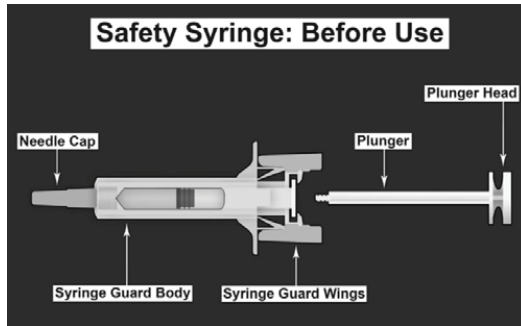

Figure 2

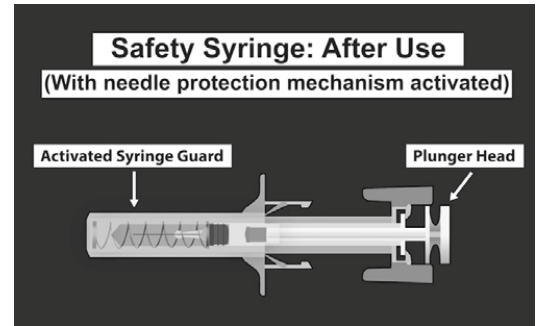
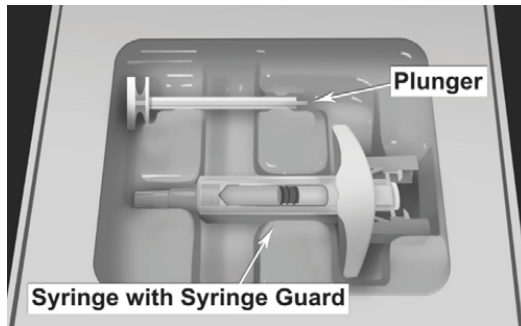

Figure 3



## MATERIALS NEEDED FOR INJECTION:

Illustrated in Figure 4.

- Alcohol wipe
- Cotton ball
- Sharps disposal container

Figure 4





## SELECTING AN INJECTION SITE

The areas for subcutaneous injection are highlighted in **Figure 5**. **BRIXADI should not be administered to the same site of injection for at least 8 weeks for BRIXADI (weekly). No injection site rotation is required for BRIXADI (monthly).**

**BRIXADI should be injected slowly into the subcutaneous tissue of the buttock, thigh, abdomen, or upper arm.**

**Figure 5**

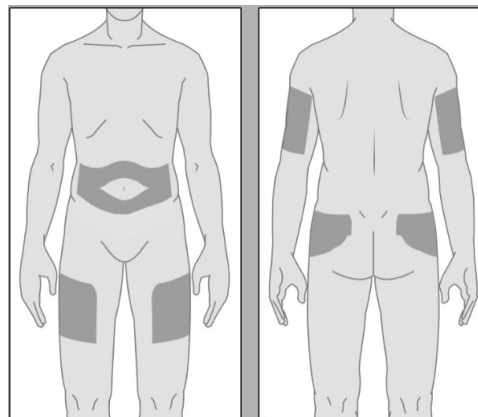

In patients who are not currently receiving buprenorphine treatment, for BRIXADI (weekly), the upper arm site should only be used after steady-state has been achieved (4 consecutive doses).

## PREPARE THE SAFETY SYRINGE

### Step 1:

Wash hands thoroughly with soap and water prior to handling the safety syringe.

### Step 2:

Remove the safety syringe components from the carton. Assemble the safety syringe. While holding the syringe guard body, insert the plunger into the body of the syringe and rotate clockwise until it is attached to the stopper inside the syringe as illustrated in **Figure 6**.

**Figure 6**

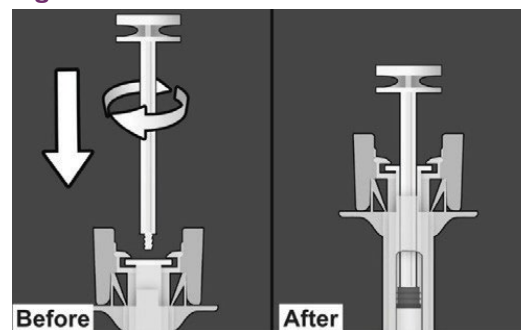



### Step 3:

Inspect the safety syringe closely:

Do not use the safety syringe after the expiration date shown on the carton or on the safety syringe label.

- The liquid should be clear and yellowish to yellow in color.
- A small air bubble may be visible.

Do not use the safety syringe if the liquid contains visible particles or is cloudy.

## PREPARATION OF SITE

### Step 4:

- Put on gloves.
- Clean the injection site with an alcohol wipe using a circular motion.

Do not touch the cleaned area again before injecting.

## ADMINISTERING INJECTION

### Step 5:

- Grasp the safety syringe by the syringe, as shown (see Figure 7).
- Carefully pull the needle cap straight off.
- Immediately dispose of the needle cap (Never try to recap the needle).

It is normal to see a small drop of liquid at the tip of the needle.

Figure 7





**Step 6:**

Pinch the skin at the injection site between your thumb and index finger as shown in **Figure 8**.

**Figure 8**

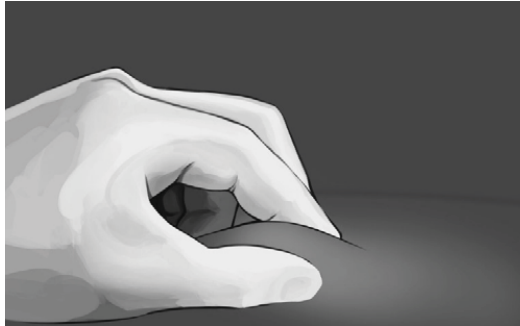

**Step 7:**

Hold the syringe, as shown, and insert the needle at an angle of approximately 90° (see **Figure 9**). The needle is designed to inject into the subcutaneous space. It is important to fully insert the needle.

**Figure 9**

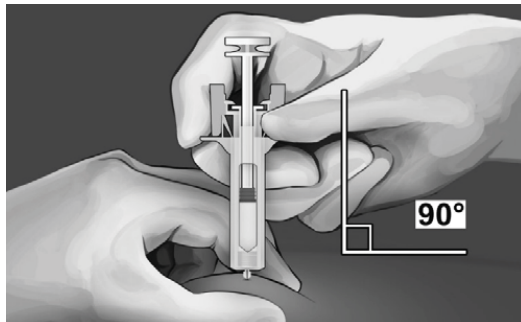



### Step 8:

- After the needle is completely inserted into the subcutaneous tissue, release the skin that you are grasping. Slowly press down the plunger head until it latches in the safety device 'wings' (**see Figure 10**). This will ensure that all of the medication has been injected.
- **Keep the plunger pressed fully down while you hold the safety syringe in place for an additional 2 seconds.**

Figure 10

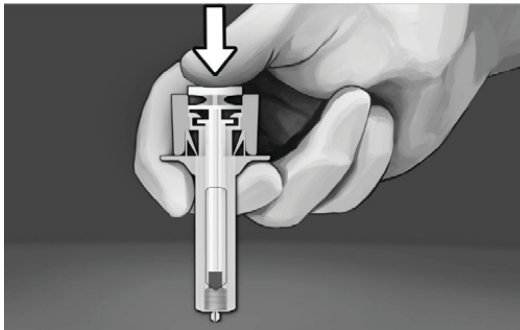

### Step 9:

- Gently pull the needle out of the skin.
- Keep the plunger fully depressed while you carefully lift the needle straight out from the injection site (**see Figure 11**).

Figure 11

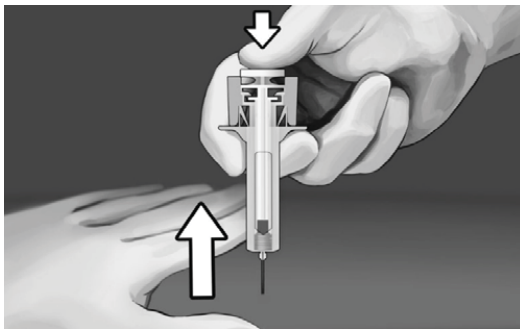



**Step 10:**

- As soon as you have completely removed the needle from the skin, slowly take your thumb off the plunger.
- Allow the syringe guard to automatically cover the exposed needle (see **Figure 12**).
- There may be a small amount of blood at the injection site. If needed, wipe with a cotton ball or gauze.

**Figure 12**

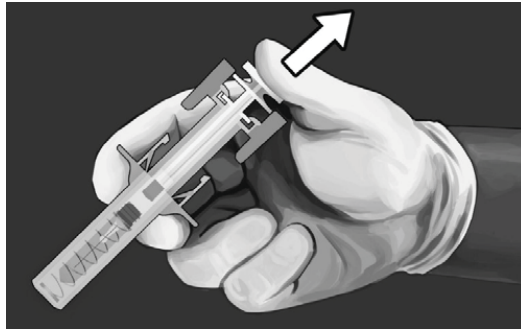

**DISPOSAL OF USED SAFETY SYRINGE**

**Step 11:**

Put the used safety syringe immediately into a sharps container (see **Figure 13**).

**Figure 13**







## POST INJECTION CARE

- Examine the injection site.
- If there is blood, press a cotton ball or gauze pad on the injection site.
- Do not rub the injection site.
- Apply an adhesive bandage if needed.
- Patient should be instructed to notify you immediately if excessive swelling, redness, heat, or drainage develops at the injection site.

FPO

121722



braeburn

05/23

Label may not be the latest approved version. For the latest approved version and additional information, please visit <https://www.fda.gov>

**Brixadi™** NDC 58284-208-01  
(buprenorphine) extended-release WEEKLY  
injection for subcutaneous use 

Caution: May Contain Natural Rubber Latex

**8 mg / 0.16 mL** **R<sub>x</sub> Only**

For Subcutaneous Use Only Braeburn Inc.  
BRLX-004-02  
MM/20



LOT AANNNN  
EXP MMMYYYY



120429

Reference ID: 5178299

Label may not be the latest approved by  
information, please visit <https://www>

**Brixadi™** NDC 58284-216-01  
(buprenorphine) extended-release WEEKLY  
injection for subcutaneous use 

Caution: May Contain Natural Rubber Latex

**16 mg / 0.32 mL** **R<sub>x</sub> Only**

For Subcutaneous Use Only Braeburn Inc.  
BRLX-605-02  
MM/20



LOT AANNNN  
EXP MMMYYYY



120431

Reference ID: 5178299

Label may not be the latest approved version. For the latest approved version and more information, please visit <https://www.fda.gov>

**Brixadi™** NDC 58284-224-01  
(buprenorphine) extended-release WEEKLY  
injection for subcutaneous use 

Caution: May Contain Natural Rubber Latex

**24 mg / 0.48 mL** **Rx Only**

For Subcutaneous Use Only Braeburn Inc.  
BRLX-006-02  
MM/20



LOT AANNNN  
EXP MMMYYYY

  
120433

Reference ID: 5178299

Label may not be the latest approved version. For the latest information, please visit <https://www.fda.gov>

**Brixadi™** NDC 58284-232-01  
(buprenorphine) extended-release WEEKLY  
injection for subcutaneous use 

Caution: May Contain Natural Rubber Latex

**32 mg / 0.64 mL** **R<sub>x</sub> Only**

For Subcutaneous Use Only Braeburn Inc.  
BRLX-607-02  
MM/20



LOT AANNNN  
EXP MMMYYYY

  
120435

Reference ID: 5178299

Label may not be the latest approved version. For the latest approved version and more information, please visit <https://www.fda.gov>

**Brixadi™** NDC 58284-264-01  
(buprenorphine) extended-release MONTHLY  
injection for subcutaneous use 

Caution: May Contain Natural Rubber Latex

**64 mg / 0.18 mL** **R<sub>x</sub> Only**

For Subcutaneous Use Only Braeburn Inc.  
BRLX-608-02  
MM/20



LOT AANNNN  
EXP MMMYYYY

  
121744

Reference ID: 5178299

Label may not be the latest approved version. For the latest approved version and more information, please visit <https://www.fda.gov>

**Brixadi™** NDC 58284-296-01  
(buprenorphine) extended-release MONTHLY  
injection for subcutaneous use 

Caution: May Contain Natural Rubber Latex

**96 mg / 0.27 mL** **R<sub>x</sub> Only**

For Subcutaneous Use Only Braeburn Inc.  
BRLX-609-02  
MM/20



LOT AANNNN  
EXP MMMYYYY



120439

Reference ID: 5178299



Label may not be the latest approved version. For the latest approved version and more information, please visit <https://www.fda.gov>

**Brixadi™** NDC 58284-228-01  
(buprenorphine) extended-release MONTHLY  
injection for subcutaneous use 

Caution: May Contain Natural Rubber Latex

**128 mg / 0.36 mL** **R<sub>x</sub> Only**

For Subcutaneous Use Only Braeburn Inc.  
BRIX-010-02  
MM/20



LOT AANNNN  
EXP MMMYYYY

  
120441

Reference ID: 5178299



**READ INSTRUCTIONS FOR USE  
PRIOR TO INJECTION.**

**INCLUDED:**

- One (1) sterile prefilled syringe with needle shield,  
8 mg (buprenorphine) per syringe
- One (1) plunger rod
- Prescribing Information
- Instructions for Use
- Medication Guide

**For Subcutaneous Use Only**



**READ INSTRUCTIONS FOR USE  
PRIOR TO INJECTION.**

**INCLUDED:**

- One (1) sterile prefilled syringe with needle shield,  
16 mg (buprenorphine) per syringe
- One (1) plunger rod
- Prescribing Information
- Instructions for Use
- Medication Guide

**For Subcutaneous Use Only**



**READ INSTRUCTIONS FOR USE  
PRIOR TO INJECTION.**

**INCLUDED:**

- One (1) sterile prefilled syringe with needle shield,  
24 mg (buprenorphine) per syringe
- One (1) plunger rod
- Prescribing Information
- Instructions for Use
- Medication Guide

**For Subcutaneous Use Only**





**READ INSTRUCTIONS FOR USE  
PRIOR TO INJECTION.**

**INCLUDED:**

- One (1) sterile prefilled syringe with needle shield,  
32 mg (buprenorphine) per syringe
- One (1) plunger rod
- Prescribing Information
- Instructions for Use
- Medication Guide

**For Subcutaneous Use Only**

**64 mg**  
0.18 mL  
of a 356 mg/mL solution  
per syringe (Monthly)

**Brixadi™**  
(buprenorphine) extended-release  
injection for subcutaneous use

**MONTHLY**

**SINGLE-DOSE PREFILLED SYRINGE KIT**

**64 mg MONTHLY**

**64 mg**  
0.18 mL  
of a 356 mg/mL solution  
per syringe (Monthly)

**Brixadi™**  
(buprenorphine) extended-release  
injection for subcutaneous use

**MONTHLY**

**SINGLE-DOSE PREFILLED SYRINGE KIT**

**64 mg MONTHLY**

**Do not use if the carton has been opened or damaged. Do not use if the liquid is cloudy. Please refer to package insert for complete product information. Inject BRIXADI™ no later than the date printed on the syringe label.**

**One (1) sterile prefilled syringe with needle shield, 64 mg (buprenorphine) per syringe**

**Inactive Ingredients:**  
Soybean Phosphatidylcholine, Glycerol Dioleate, N-methyl-2-pyrrolidone

**Caution: The Packaging of This Product Contains Natural Rubber Latex Which May Cause Allergic Reactions.**

**Rx ONLY**  
For questions, call 1-833-274-9234, or visit [www.BRIXADI.com](http://www.BRIXADI.com)

NDC 58284-264-01

3 58284 26401 5



**64 mg**  
0.18 mL  
of a 356 mg/mL solution  
per syringe (Monthly)

**Brixadi™**  
(buprenorphine) extended-release  
injection for subcutaneous use

**MONTHLY**

**SINGLE-DOSE PREFILLED SYRINGE KIT**

**64 mg MONTHLY**

**LOT 123456**  
**EXP MMDYYYY**  
**SN 12345678**



**VARIABLE DATA**

GTIN 00382842644015

**Brixadi™**  
(buprenorphine) extended-release  
injection for subcutaneous use

**MONTHLY**

**For Subcutaneous Use Only**

**64 mg**  
0.18 mL  
of a 356 mg/mL solution  
per syringe (Monthly)

**WARNING: SERIOUS HARM OR DEATH COULD RESULT IF INJECTED INTRAVENOUSLY.**

**SINGLE-DOSE PREFILLED SYRINGE KIT CONTENTS:**

- One (1) sterile prefilled syringe with needle shield, 64 mg (buprenorphine) per syringe
- One (1) plunger rod
- Prescribing Information
- Instructions for Use
- Medication Guide

**Attention: Dispense the enclosed Medication Guide to each patient.**

**Rx ONLY**  
Distributed by: Braeburn Inc., Plymouth Meeting, PA 19462  
Properly dispose of BRIXADI™ syringes per facility procedure for a Schedule III drug product, and per applicable federal, state, and local regulations. Once-monthly subcutaneous injection for treatment of opioid use disorder. For questions, call 1-833-274-9234.

BRIX-015-02 MM/20 120438

NDC 58284-264-01

**For Healthcare Provider Administration Only, Do Not Dispense to Patient.**

**READ INSTRUCTIONS FOR USE  
PRIOR TO INJECTION.**

**INCLUDED:**

- One (1) sterile prefilled syringe with needle shield,  
64 mg (buprenorphine) per syringe
- One (1) plunger rod
- Prescribing Information
- Instructions for Use
- Medication Guide

**For Subcutaneous Use Only**

**96 mg**  
0.27 mL  
of a 356 mg/mL solution  
per syringe (Monthly)

**Brixadi™**  
(buprenorphine) extended-release  
injection for subcutaneous use

**MONTHLY**

**SINGLE-DOSE PREFILLED SYRINGE KIT**

**96 mg**

**96 mg**  
0.27 mL  
of a 356 mg/mL solution  
per syringe (Monthly)

**Brixadi™**  
(buprenorphine) extended-release  
injection for subcutaneous use

**MONTHLY**

**SINGLE-DOSE PREFILLED SYRINGE KIT**

**96 mg**

**SINGLE-DOSE PREFILLED SYRINGE KIT**

**96 mg**  
0.27 mL  
of a 356 mg/mL solution  
per syringe (Monthly)

**Brixadi™**  
(buprenorphine) extended-release  
injection for subcutaneous use

**MONTHLY**

**SINGLE-DOSE PREFILLED SYRINGE KIT**

**96 mg**

**Do not use if the carton has been opened or damaged. Do not use if the liquid is cloudy. Please refer to package insert for complete product information. Inject BRIXADI™ no later than the date printed on the syringe label.**

**One (1) sterile prefilled syringe with needle shield, 96 mg (buprenorphine) per syringe**

**Inactive Ingredients:**  
Soybean Phosphatidylcholine, Glycerol Dioleate, N-methyl-2-pyrrolidone

**Caution: The Packaging of This Product Contains Natural Rubber Latex Which May Cause Allergic Reactions.**

**braeburn**

**Rx ONLY**  
For questions, call 1-833-274-9234, or visit [www.BRIXADI.com](http://www.BRIXADI.com)

**For Subcutaneous Use Only**  
For the Healthcare Provider: All healthcare providers who administer BRIXADI™ should review the Instructions for Use prior to administering BRIXADI™.  
Store BRIXADI™ at 20°C to 25°C (68°F to 77°F); with excursions permitted to 15°C to 30°C (59°F to 86°F) [see USP Controlled Room Temperature].

**NDC 58284-296-01**

3 58284 29601 6

6

**96 mg**  
0.27 mL  
of a 356 mg/mL solution  
per syringe (Monthly)

**Brixadi™**  
(buprenorphine) extended-release  
injection for subcutaneous use

**MONTHLY**

**SINGLE-DOSE PREFILLED SYRINGE KIT**

**96 mg**

**96 mg**  
0.27 mL  
of a 356 mg/mL solution  
per syringe (Monthly)

**Brixadi™**  
(buprenorphine) extended-release  
injection for subcutaneous use

**MONTHLY**

**SINGLE-DOSE PREFILLED SYRINGE KIT**

**96 mg**

**LOT 123456**  
**EXP MMDDYYYY**  
**SN 12345678**

**GTIN 00358284296016**

**VARIFIED DATA**

**Brixadi™**  
(buprenorphine) extended-release  
injection for subcutaneous use

**MONTHLY**

**For Subcutaneous Use Only**

**96 mg**  
0.27 mL  
of a 356 mg/mL solution  
per syringe (Monthly)

**WARNING: SERIOUS HARM OR DEATH COULD RESULT IF INJECTED INTRAVENOUSLY.**

**SINGLE-DOSE PREFILLED SYRINGE KIT CONTENTS:**

- One (1) sterile prefilled syringe with needle shield, 96 mg (buprenorphine) per syringe
- One (1) plunger rod
- Prescribing Information
- Instructions for Use
- Medication Guide

**Attention: Dispense the enclosed Medication Guide to each patient.**

**Rx ONLY**  
Distributed by: Braeburn Inc., Plymouth Meeting, PA 19462  
Properly dispose of BRIXADI™ syringes per facility procedure for a Schedule III drug product, and per applicable federal, state, and local regulations. Once-monthly subcutaneous injection for treatment of opioid use disorder. For questions, call 1-833-274-9234.

**For Healthcare Provider Administration Only, Do Not Dispense to Patient.**

BRIX-016-02 MM/20 120440  
NDC 58284-296-01

**READ INSTRUCTIONS FOR USE  
PRIOR TO INJECTION.**

**INCLUDED:**

- One (1) sterile prefilled syringe with needle shield, 96 mg (buprenorphine) per syringe
- One (1) plunger rod
- Prescribing Information
- Instructions for Use
- Medication Guide

**For Subcutaneous Use Only**



**READ INSTRUCTIONS FOR USE  
PRIOR TO INJECTION.**

**INCLUDED:**

- One (1) sterile prefilled syringe with needle shield,  
128 mg (buprenorphine) per syringe
- One (1) plunger rod
- Prescribing Information
- Instructions for Use
- Medication Guide

**For Subcutaneous Use Only**

# Risk Evaluation and Mitigation Strategy (REMS) Document

## BRIXADI (buprenorphine) extended-release REMS

### I. Administrative Information

Risk: Serious harm or death that could result from intravenous self-administration

Application Number: NDA 210136

Application Holder: Braeburn Inc.

Initial REMS Approval: 05/2023

### II. REMS Goal

The goal of the BRIXADI REMS is to mitigate the risk of serious harm or death that could result from intravenous self-administration by:

- Ensuring healthcare settings and pharmacies are certified and only dispense BRIXADI directly to a healthcare provider for administration by a healthcare provider.

### III. REMS Requirements

**Braeburn Inc. must ensure that healthcare settings, pharmacies, and wholesalers-distributors comply with the following requirements:**

---

#### 1. Healthcare settings and pharmacies that dispense BRIXADI must:

- 
- |                                 |  |
|---------------------------------|--|
| To become certified to dispense | <ol style="list-style-type: none"><li>1. Designate an authorized representative to carry out the certification process and oversee implementation and compliance with the REMS on behalf of the healthcare setting or pharmacy.</li><li>2. Have the authorized representative enroll in the REMS by completing the <a href="#">Healthcare Setting and Pharmacy Enrollment Form</a> and submitting it to the REMS.</li><li>3. Train all relevant staff involved in dispensing that the drug must be dispensed directly to a healthcare provider for administration by a healthcare provider, and the drug must not be dispensed to the patient.</li><li>4. Establish processes and procedures to verify BRIXADI is dispensed directly to a healthcare provider and the drug is not dispensed to the patient.</li><li>5. Establish processes and procedures to notify the healthcare provider not to dispense the drug directly to patients.</li></ol> |
| Before dispensing               | <ol style="list-style-type: none"><li>6. Verify that BRIXADI is dispensed directly to a healthcare provider and the drug is not dispensed to the patient.</li><li>7. Notify the healthcare provider not to dispense the drug directly to patients.</li></ol>   |
-



To maintain certification to dispense	8. Have a new authorized representative enroll in the REMS by completing and submitting the <a href="#">Healthcare Setting and Pharmacy Enrollment Form</a> , if the authorized representative changes.
At all times	9. Not distribute, transfer, loan or sell BRIXADI.  10. Maintain records of all processes and procedures including compliance with those processes and procedures.  11. Comply with audits by Braeburn Inc. or a third party acting on behalf of Braeburn Inc. to ensure that all processes and procedures are in place and are being followed.

**2. Wholesalers-Distributors that distribute BRIXADI must:**

To be able to distribute	1. Establish processes and procedures to ensure that the drug is distributed only to certified healthcare settings and pharmacies.  2. Train all relevant staff involved in distributing BRIXADI on the process and procedures to verify the healthcare settings and pharmacies are certified.
At all times	3. Distribute only to certified healthcare settings and pharmacies.  4. Maintain and submit records of all shipments of BRIXADI to Braeburn Inc.  5. Comply with audits carried out by Braeburn Inc. or a third party acting on behalf of Braeburn Inc. to ensure that all processes and procedures are in place and are being followed.

**To inform healthcare providers about the REMS and the risks and safe use of BRIXADI, Braeburn Inc. must disseminate REMS communication materials according to the table below:**

<b>Target Audience</b>	<b>Communication Materials &amp; Dissemination Plans</b>
All healthcare providers who prescribe buprenorphine for the treatment of opioid use disorder; all pharmacies authorized by DEA to handle schedule III controlled substances; all Opioid Treatment Programs certified under 42 CFR 8	REMS Letter: <a href="#">Healthcare Provider REMS Letter</a> with attachment: <a href="#">Fact Sheet: How to Obtain BRIXADI</a> . 1. Mail within 60 calendar days of the date of the approval of the REMS and again 6 months later, or 2. eMail within 60 calendar days of the date of the approval of the REMS and again 6 months later. 3. Make available via a link from the BRIXADI REMS Website. 4. Disseminate within 60 calendar days of the date of the approval of the REMS through professional societies and request the content be provided to their members. a. The professional societies are identified in Appendix A. 5. Disseminate at Professional Meetings where Braeburn Inc. has a presence for 1 year from the date of the approval of the REMS.
All new healthcare providers who prescribe buprenorphine	REMS Letter: <a href="#">Healthcare Provider REMS Letter</a> with attachment: <a href="#">Fact Sheet: How to Obtain BRIXADI</a>

<b>Target Audience</b>	<b>Communication Materials &amp; Dissemination Plans</b>
for the treatment of opioid use disorder since the last dissemination; all pharmacies authorized by DEA to handle schedule III controlled substances since the last dissemination; all Opioid Treatment Programs certified under 42 CFR 8 since the last dissemination	6. Mail annually from the date of the approval of the REMS, or 7. eMail annually from the date of the approval of the REMS.

---

**To support REMS operations, Braeburn Inc. must:**

1. Establish and maintain a REMS website, [www.BRIXADIREMS.com](http://www.BRIXADIREMS.com). The REMS website must include the capability to complete healthcare setting and pharmacy certification online, the option to print the Prescribing Information, Medication Guide, and REMS materials. All product websites for consumers and healthcare providers must include prominent REMS-specific links to the REMS website. The REMS website must not link back to the promotional product website.
2. Make the REMS website fully operational and all REMS materials available through website and call center by the date BRIXADI is first commercially distributed.
3. Establish and maintain a REMS call center for REMS participants at 1-866-492-9624.
4. Establish and maintain a validated, secure database of all REMS participants who are enrolled and/or certified in the BRIXADI REMS.
5. Ensure healthcare settings and pharmacies are able to enroll by fax, mail, email, and online.
6. Provide [Healthcare Provider REMS Letter, Fact Sheet: How to Obtain BRIXADI, Healthcare Setting and Pharmacy Enrollment Form](#) and the Prescribing Information to REMS participants who (1) attempt to dispense BRIXADI and are not yet certified or (2) inquire about how to become certified.
7. Notify healthcare settings and pharmacies, confirming certification, within 7 calendar days after they become certified in the REMS.
8. Provide wholesalers-distributors access to the database of certified healthcare settings and pharmacies.

**To ensure REMS participants' compliance with the REMS, Braeburn Inc. must:**

9. Verify annually that the authorized representative's name and contact information correspond to those of the current designated authorized representative for the certified healthcare setting or pharmacy. If different, the healthcare setting and pharmacy must be required to re-certify with a new authorized representative.
10. Maintain adequate records to demonstrate that REMS requirements have been met, including, but not limited to records of: BRIXADI distribution and dispensing; certification of pharmacies and healthcare settings; and audits of REMS participants.
11. Establish and maintain a plan for addressing non-compliance with REMS requirements.
12. Monitor healthcare settings, pharmacies, and wholesalers-distributors on an ongoing basis to ensure the requirements of the REMS are being met. Take corrective action if non-compliance is identified, including de-certification.

13. Audit a representative sample of healthcare settings no later than 90 calendar days after the healthcare setting is certified and receives its first shipment of BRIXADI, and audit a representative sample annually thereafter, to ensure that all REMS processes and procedures are in place, functioning, and support the REMS requirements.
14. Audit all pharmacies no later than 90 calendar days after the pharmacy is certified and receives its first shipment of BRIXADI, and audit a representative sample annually thereafter, to ensure that all REMS processes and procedures are in place, functioning, and support the REMS requirements.
15. Audit all wholesalers-distributors no later than 90 calendar days after they become authorized, and audit all wholesalers-distributors annually thereafter, to ensure that all REMS processes and procedures are in place, functioning, and support the REMS requirements.
16. Take reasonable steps to improve operations of and compliance with the requirements in the BRIXADI REMS based on monitoring and evaluation of the BRIXADI REMS.

## **IV. REMS Assessment Timetable**

Braeburn Inc. must submit REMS Assessments at 6 months, 12 months, and annually thereafter from the date of the initial approval of the REMS (05/23/2023). To facilitate inclusion of as much information as possible while allowing reasonable time to prepare the submission, the reporting interval covered by each assessment should conclude no earlier than 60 calendar days before the submission date for that assessment. Braeburn Inc. must submit each assessment so that it will be received by the FDA on or before the due date.

## **V. REMS Materials**

The following materials are part of the BRIXADI REMS and are appended:

### **Enrollment Forms:**

Healthcare Setting and Pharmacy:

1. [Healthcare Setting and Pharmacy Enrollment Form](#)

### **Communication Materials**

2. [Healthcare Provider REMS Letter](#)
3. [Fact Sheet: How to Obtain BRIXADI](#)

### **Other Materials**

4. [REMS Website](#)

## **VI. Statutory Elements**

This REMS is required under section 505-1 of the Federal Food, Drug, and Cosmetic Act (FD&C Act) (21 U.S.C. 355-1) and consists of the following elements:

1. Elements to Assure Safe Use (ETASU):
  - Pharmacies and health care settings that dispense BRIXADI are specially certified under 505-1(f)(3)(B)

**This label may not be the latest approved by FDA.  
For current labeling information, please visit <https://www.fda.gov/drugsatfda>**

2. Implementation System
3. Timetable for Submission of Assessments

**Appendix A: List of Professional Societies**

- AATOD – American Association of the Treatment of Opioid Dependence
- ASAM – American Society of Addiction Medicine
- AAAP - American Association of Addiction Psychiatry
- ABAM – American Board of Addiction Medicine
- FSMB – Federation of State Medical Boards
- ACEP – American College of Emergency Physicians
- NCPA – National Community of Pharmacists Association
- ASHP – American Society of Health-System Pharmacists
- AOAAM – American Osteopathic Academy of Addiction Medicine
- AANP – American Association of Nurse Practitioners
- AAPA – American Association of Physician Assistants
- Apha – American Pharmacists Association

# BRIXADI REMS



## HEALTHCARE SETTING AND PHARMACY ENROLLMENT FORM

BRIXADI is only available through the BRIXADI Risk Evaluation and Mitigation Strategy (REMS).

### Instructions

If a healthcare setting or a pharmacy intends to store a supply of and order BRIXADI directly from an authorized distributor, certification in the BRIXADI REMS is required. To become certified, healthcare settings and pharmacies must:

1. Designate an Authorized Representative who can ensure the Authorized Representative responsibilities listed in the "Authorized Representative Information and Responsibilities" section of the enrollment form are met and that each dispensing location meets the REMS requirements.
2. Agree to:
  - Train all relevant staff at each dispensing location involved in dispensing the drug directly to a healthcare provider, to ensure that the drug is not dispensed directly to a patient.
  - Establish process and procedures to verify that BRIXADI is dispensed directly to a healthcare provider.  
**Do not dispense BRIXADI directly to a patient.**
  - Establish process and procedures to notify the healthcare provider not to dispense BRIXADI directly to patients.
3. Complete and sign this ***BRIXADI REMS Healthcare Setting and Pharmacy Enrollment Form*** and submit it to the BRIXADI REMS.

Once certification of the healthcare setting/pharmacy is complete, a notification will be provided to the Authorized Representative.

Only one (1) form is needed per healthcare setting. A pharmacy is covered under their healthcare setting's enrollment in the BRIXADI REMS.

**Certification in the BRIXADI REMS is not required if a healthcare setting intends to only obtain BRIXADI for administration by a practitioner at a specific named patient's scheduled appointment from a REMS-certified pharmacy.**

The ***BRIXADI REMS Healthcare Setting and Pharmacy Enrollment Form*** contains two sections:

- "Authorized Representative Information and Responsibilities" section – page 2
- "Healthcare Setting and Pharmacy Information" section – page 3

For the initial enrollment, both sections noted above must be submitted. For **each** additional healthcare setting/ pharmacy where BRIXADI will be delivered, dispensed, and administered within your healthcare system for which the same Authorized Representative is responsible, the Authorized Representative will need to complete the "Healthcare Setting and Pharmacy Information" section on page 3.

If a designated Authorized Representative changes, the new Authorized Representative must complete and sign a new ***BRIXADI REMS Healthcare Setting and Pharmacy Enrollment Form***, including a "Healthcare Setting Information" section for each healthcare setting with which he/she is now affiliated.

To enroll, complete all required fields on the form and one "Healthcare Setting / Pharmacy Information" section for each dispensing site and submit via:

- **Online:** [www.BRIXADIREMS.com](http://www.BRIXADIREMS.com)
- **FAX:** 1-833-274-8597
- **Email:** [BRIXADIREMS@braeburnrx.com](mailto:BRIXADIREMS@braeburnrx.com)
- **Mail:** BRIXADI REMS Program, 6923 Lee Vista Blvd, Ste 300, Orlando, FL 32822

For questions regarding the BRIXADI REMS or how to enroll, visit [www.BRIXADIREMS.com](http://www.BRIXADIREMS.com) or contact the BRIXADI REMS at 1-866-492-9624.

BRIXADI REMS



## HEALTHCARE SETTING AND PHARMACY ENROLLMENT FORM (cont'd)

### Authorized Representative Information and Responsibilities

#### AUTHORIZED REPRESENTATIVE INFORMATION (\*REQUIRED FIELDS)

##### Role\*

- Nurse       Nurse Practitioner       Pharmacist       Physician       Physician Assistant  
 Practice Manager       Other: \_\_\_\_\_

##### Contact details\*

First name: \_\_\_\_\_ Last name: \_\_\_\_\_ Middle initial: \_\_\_\_\_  
Position/Title: \_\_\_\_\_  
Telephone number: \_\_\_\_\_ Alternate telephone number: \_\_\_\_\_ Office fax: \_\_\_\_\_  
Email: \_\_\_\_\_ Preferred method of communication:  Fax  Email  Phone

I am the Authorized Representative designated to carry out the certification process and oversee implementation and compliance with the REMS on behalf of my healthcare setting or pharmacy. By signing this form, I agree to:

- Certify in the BRIXADI REMS by completing the Healthcare Setting and Pharmacy Enrollment Form and submitting it to the REMS.
- Train all relevant staff involved in dispensing that the drug must be dispensed directly to a healthcare provider for administration by a healthcare provider, and that BRIXADI must not be dispensed directly to a patient.
- Establish processes and procedures to verify BRIXADI is dispensed directly to a healthcare provider, and BRIXADI is not dispensed to a patient.
- Establish processes and procedures to notify the healthcare provider not to dispense directly to patients. Notifications may be accomplished through a variety of mechanisms based on the healthcare setting. Phone calls, an auxiliary label printed automatically and affixed to the dispensed prescription, or reminders in the electronic medical record are potential mechanisms to communicate the alert.
- Not distribute, transfer, loan, or sell BRIXADI.
- Maintain records of all processes and procedures including compliance with those processes and procedures.
- Comply with audits by Braeburn or a third party acting on behalf of Braeburn to ensure that all processes and procedures are in place and being followed for the BRIXADI REMS.

By checking this box, you understand that your healthcare setting/pharmacy may be selected for audit within 90 days.

Healthcare Setting or Pharmacy Authorized Representative Signature\*: \_\_\_\_\_

Date\* (MM/DD/YYYY): \_\_\_ / \_\_\_ / \_\_\_

**By signing I acknowledge that I understand that there is a risk of serious harm or death that could result from intravenous self-administration of BRIXADI, and to not dispense BRIXADI directly to a patient. I understand that this enrollment applies to my healthcare setting(s) or pharmacy(ies) for which I am the designated Authorized Representative.**

# BRIXADI REMS



Weekly/Monthly  
**Brixadi**<sup>TM</sup>  
(buprenorphine) extended-release  
injection for subcutaneous use

## HEALTHCARE SETTING AND PHARMACY ENROLLMENT FORM (cont'd)

### Healthcare Setting and Pharmacy Information

Healthcare Setting/Pharmacy Name: \_\_\_\_\_

Street Address: \_\_\_\_\_ City: \_\_\_\_\_ State: \_\_\_\_\_ ZIP: \_\_\_\_\_

Facility Identifiers (provide at least 1) NPI: \_\_\_\_\_ NCPDP: \_\_\_\_\_ DEA: \_\_\_\_\_

Authorized Representative Name: \_\_\_\_\_

Primary Point of Contact IF NOT the Authorized Representative: \_\_\_\_\_

Point of Contact Name: \_\_\_\_\_

Street Address: \_\_\_\_\_ City: \_\_\_\_\_ State: \_\_\_\_\_ ZIP: \_\_\_\_\_

Telephone Number: \_\_\_\_\_ Alternate Telephone Number: \_\_\_\_\_ Office Fax: \_\_\_\_\_

Email: \_\_\_\_\_ Preferred Method of Communication:  Fax  Email  Phone

### Setting Type

**Pharmacy**

Specialty  Other: \_\_\_\_\_

**Healthcare Setting**

- Closed Healthcare System  Criminal Justice Facility  Criminal Justice Facility Pharmacy
- Department of Defense (DoD) Facility  Federally Qualified Health Center (FQHC)  FQHC Pharmacy
- Group Practice  Hospital  Hospital Pharmacy  Independent Practice  Institution
- Institution Pharmacy  Integrated Delivery Network (IDN)  IDN Pharmacy  Opioid Treatment Program (OTP)
- Outpatient Clinic  Veterans Administration (VA) Facility  VA Pharmacy
- Other: \_\_\_\_\_

I am the designated Authorized Representative for this healthcare setting or pharmacy.

Healthcare Setting or Pharmacy Authorized Representative Signature: \_\_\_\_\_

Date (MM/DD/YYYY): \_\_\_ / \_\_\_ / \_\_\_





BRIXADI (buprenorphine) extended-release injection for subcutaneous use CIII

**FDA-REQUIRED REMS SAFETY INFORMATION**

**WARNING: RISK OF SERIOUS HARM OR DEATH WITH INTRAVENOUS ADMINISTRATION; BRIXADI RISK EVALUATION AND MITIGATION STRATEGY**

- **Serious harm or death could result if administered intravenously. BRIXADI forms a liquid crystalline gel upon contact with body fluids and may cause occlusion, local tissue damage, and thrombo-embolic events, including life-threatening pulmonary emboli, if administered intravenously.**
- **Because of the risk of serious harm or death that could result from intravenous self-administration, BRIXADI is only available through a restricted program called the BRIXADI REMS. Healthcare settings and pharmacies that order and dispense BRIXADI must be certified in this program and comply with the REMS requirements.**

[Date]

Dear Healthcare Provider:

The purpose of this letter is to inform you about the **BRIXADI Risk Evaluation and Mitigation Strategy (REMS)**. The FDA determined that a **REMS** is necessary to ensure that the benefits of BRIXADI outweigh the **risk of serious harm or death that could result from intravenous self-administration of BRIXADI**.

Per the BRIXADI REMS, BRIXADI is only available through a restricted distribution program.

### **BRIXADI REMS Requirements:**

- Any pharmacy or healthcare setting (including a prescriber office) that intends to store a supply of and order BRIXADI directly from an authorized distributor **must be certified** in the BRIXADI REMS prior to purchasing / dispensing BRIXADI.

**NOTE:** Certification in the BRIXADI REMS is **not required** if a healthcare setting intends to only obtain BRIXADI from a REMS-certified pharmacy for administration by a practitioner at a **specific named patient's scheduled appointment**. The REMS-certified pharmacy will coordinate delivery to the administering practitioner with the patient's appointment.

- Healthcare providers are **not required** to certify in the REMS to prescribe BRIXADI.
- **BRIXADI must never be dispensed directly to a patient.**

The enclosed ***BRIXADI REMS Fact Sheet: How to Obtain BRIXADI***, provides information about **how your healthcare setting or pharmacy can obtain BRIXADI**.

Please visit [www.BRIXADIREMS.com](http://www.BRIXADIREMS.com) or contact the BRIXADI REMS at 1-866-492-9624 for BRIXADI REMS materials and for information about **how your healthcare setting or pharmacy can certify** in the BRIXADI REMS. For medical-related questions, call Braeburn's Information line 1-833-274-9234.

### **Indication**

BRIXADI is indicated for the treatment of moderate to severe opioid use disorder in patients who have initiated treatment with a single dose of a transmucosal buprenorphine product or who are already being treated with buprenorphine.

BRIXADI should be used as part of a complete treatment plan to include counseling and psychosocial support.

### **BRIXADI Storage**

Store BRIXADI at room temperature at 20°C to 25°C (68°F to 77°F); with excursions permitted at 15°C to 30°C (59°F to 86°F) [see USP Controlled Room Temperature]. BRIXADI is a Schedule III drug product. Handle with adequate security and accountability. After administration, syringes should be properly disposed, per facility procedure for a Schedule III drug product, and per applicable federal, state, and local regulations.

## Reporting Adverse Events

Healthcare providers are encouraged to report adverse events to the FDA. Healthcare providers should report all cases of intravenous administration and suspected adverse events associated with BRIXADI to the FDA at 1-800-FDA-1088 or online at [www.fda.gov/medwatch/report.htm](http://www.fda.gov/medwatch/report.htm) or to Braeburn at 1-833-274-9234 or send information to [drugsafety@braeburnrx.com](mailto:drugsafety@braeburnrx.com).

Sincerely,

<NAME>

<TITLE> Braeburn

Enclosed:

***BRIXADI REMS Fact Sheet: How to Obtain BRIXADI***



## BRIXADI™ REMS FACT SHEET

### How to Obtain BRIXADI

#### What is the BRIXADI REMS (Risk Evaluation and Mitigation Strategy)?

A REMS is a strategy to manage known or potential risks associated with a drug and is required by the Food and Drug Administration (FDA) to ensure that the benefits of the drug outweigh its risks. **BRIXADI is intended for subcutaneous injection only by a healthcare provider** and is only available through a restricted distribution program called the BRIXADI REMS. **BRIXADI must never be dispensed directly to the patient and must only be administered by a healthcare professional** in a healthcare setting. The goal of the REMS is to mitigate **the risk of serious harm or death that could result from intravenous self-administration.**

#### BRIXADI REMS Requirements

##### PRESCRIBER

1. Prescribers are **NOT required to be certified** in the BRIXADI REMS to prescribe BRIXADI.
2. Prescribers can obtain BRIXADI for a specific named patient's scheduled appointment by writing a prescription and sending it to a REMS-certified pharmacy. The REMS-certified pharmacy coordinates delivery to the prescriber or the practitioner administering BRIXADI with the patient's appointment date.
3. Prescribers that intend to keep a supply of BRIXADI in stock at their healthcare setting and obtain BRIXADI from a distributor, **must certify** their healthcare setting or practice in the BRIXADI REMS. See below.

##### HEALTHCARE SETTINGS/PHARMACIES

Any healthcare setting\* (including a prescriber office) or pharmacy that intends to keep a supply of BRIXADI in stock and order BRIXADI directly from an authorized distributor **must be certified** in the BRIXADI REMS prior to purchasing/dispensing BRIXADI.

\*Examples of healthcare settings include: group practice, independent practice, institution, Department of Defense (DoD) facility, outpatient clinic, hospital, Veterans Administration (VA) facility, opioid treatment program (OTP), closed healthcare system, and other healthcare settings.

#### How does a healthcare setting\* or pharmacy become certified?

##### To become certified in the BRIXADI REMS, healthcare settings and pharmacies must:

1. Designate an Authorized Representative that agrees to:
  - Train all relevant staff at each dispensing location involved in the dispensing of BRIXADI directly to a healthcare provider, to ensure that the drug is not dispensed directly to a patient.
  - Establish processes and procedures to verify that BRIXADI is dispensed directly to a healthcare provider. **BRIXADI must never be dispensed directly to a patient.**
  - Establish processes and procedures to notify the healthcare provider not to dispense BRIXADI directly to patients.
2. Complete the REMS enrollment process by filling out and signing the Healthcare Setting and Pharmacy Enrollment Form, which may be obtained at [www.BRIXADIREMS.com](http://www.BRIXADIREMS.com)

***BRIXADI must never be dispensed directly to a patient.***

**Does a prescriber that wants to have BRIXADI administered to a named patient at their scheduled appointment need to certify? How can healthcare providers obtain BRIXADI for their patients?**

Prescribers do not need to certify in the REMS. In advance of the patient's appointment, send a prescription for the named patient to a certified pharmacy. REMS-certified pharmacies can be found on the REMS website ([www.BRIXADIREMS.com](http://www.BRIXADIREMS.com)) or by calling 1-866-492-9624. The pharmacy will coordinate delivery with the patient's scheduled appointment and deliver to the prescriber or the administering practitioner designated by the prescriber.

**BRIXADI is never dispensed directly to the patient and must only be administered by a healthcare professional in a healthcare setting.**

**Does a prescriber that wants to keep a bulk supply of BRIXADI in stock at their office need to certify? How does a prescriber obtain BRIXADI?**

The prescriber's office/healthcare setting must certify in the REMS and obtain BRIXADI through an authorized distributor.

**How should BRIXADI be stored?**

Once BRIXADI is delivered for a named patient or is obtained for a healthcare setting's bulk supply:

- Store BRIXADI at room temperature at 20°C to 25°C (68°F to 77°F); with excursions permitted at 15°C to 30°C (59°F to 86°F) [see USP Controlled Room Temperature].
- BRIXADI is a Schedule III drug product. Handle with adequate security and accountability. After administration, syringes should be properly disposed per facility procedure for a Schedule III drug product and per applicable federal, state, and local regulations.

**Where can I find more information about the BRIXADI REMS?**

Visit [www.BRIXADIREMS.com](http://www.BRIXADIREMS.com) to access the following materials:

- **BRIXADI REMS Healthcare Setting and Pharmacy Enrollment Form**
- **BRIXADI REMS Dear Healthcare Provider Letter**
- **Prescribing Information**
- **Medication Guide**
- **REMS-Certified Pharmacy Locator**
- **List of Authorized Distributors**

Contact the BRIXADI REMS at 1-866-492-9624 for BRIXADI REMS materials and for additional information about the BRIXADI REMS.

Visit the REMS@FDA website at <https://www.accessdata.fda.gov/scripts/cder/remis/index.cfm>.

Call Braeburn's information line at 1-833-274-9234.

## Welcome to the BRIXADI REMS (Risk Evaluation and Mitigation Strategy)

### What is the BRIXADI REMS (Risk Evaluation and Mitigation Strategy)?

A REMS is a strategy to manage known or potential risks associated with a drug, and is required by the Food and Drug Administration (FDA) to ensure that the benefits of the drug outweigh its risks. **BRIXADI is intended for subcutaneous injection only by a healthcare provider** and is only available through a restricted distribution program called the BRIXADI REMS. BRIXADI must never be dispensed directly to the patient and must only be administered by a healthcare professional in a healthcare setting. The goal of the REMS is to mitigate the risk of serious harm or death that could result from intravenous self-administration.

### BRIXADI REMS Requirements

#### PRESCRIBERS

1. Prescribers are **NOT required to be certified** in the BRIXADI REMS to prescribe BRIXADI.
2. Prescribers can obtain BRIXADI for a specific named patient's scheduled appointment by writing a prescription and sending it to a REMS-certified pharmacy. The REMS-certified pharmacy coordinates delivery to the prescriber or the practitioner administering BRIXADI with the patient's appointment date.
3. Prescribers that intend to keep a supply of BRIXADI in stock at their healthcare setting and obtain BRIXADI from a distributor, **must certify** their healthcare setting or practice in the BRIXADI REMS. See below.

#### HEALTHCARE SETTINGS\*/PHARMACIES

Any healthcare setting\* (including a prescriber office) or pharmacy that intends to keep a supply of BRIXADI in stock and order BRIXADI directly from an authorized distributor **must be certified** in the BRIXADI REMS prior to purchasing/dispensing BRIXADI.

\* Examples of healthcare settings include: group practice, independent practice, institution, Department of Defense (DoD) facility, outpatient clinic, hospital, Veterans Administration (VA) facility, opioid treatment program (OTP), closed healthcare system, and other healthcare settings.

### How does a healthcare setting or pharmacy become certified in the BRIXADI REMS?

To become certified in the BRIXADI REMS, healthcare settings and pharmacies must:

#### 1. Designate an Authorized Representative that agrees to:

- Train all relevant staff at each dispensing location involved in the dispensing of BRIXADI directly to a healthcare provider, to ensure that the drug is not dispensed directly to a patient.
- Establish processes and procedures to verify that BRIXADI is dispensed directly to a healthcare provider. **BRIXADI must never be dispensed directly to a patient.**
- Establish processes and procedures to notify the healthcare provider not to dispense BRIXADI directly to patients.

#### 2. Complete the REMS enrollment process by filling out and signing the [Healthcare Setting and Pharmacy Enrollment Form](#)

### Does a prescriber that wants to have BRIXADI administered to a named patient at their scheduled appointment need to certify? How can healthcare providers obtain BRIXADI for their patients?

Prescribers do not need to certify in the REMS. In advance of the patient's appointment, send a prescription for the named patient to a certified pharmacy. REMS-certified pharmacies can be found [here](#) or by calling 1-866-492-9624. The pharmacy will coordinate delivery with the patient's scheduled appointment and deliver to the prescriber or the administering practitioner designated by the prescriber. **BRIXADI is never dispensed directly to the patient and must only be administered by a healthcare professional in a healthcare setting.**

### Does a prescriber that wants to keep a bulk supply of BRIXADI in stock at their office need to certify? How does a prescriber obtain BRIXADI?

The prescriber's office/healthcare setting must certify in the REMS and obtain BRIXADI through an authorized distributor.

### Resources for Healthcare Providers

- [BRIXADI REMS Healthcare Setting and Pharmacy Enrollment Form](#)
- [BRIXADI REMS Fact Sheet](#)
- [Dear Healthcare Provider Letter](#)

CERTIFICATION PORTAL

**BRIXADI must never be dispensed directly to a patient.**

### How should BRIXADI be stored?

Once BRIXADI is delivered for a named patient or is obtained for a healthcare setting's bulk supply:

- Store BRIXADI at room temperature at 20°C to 25°C (68°F to 77°F); with excursions permitted at 15°C to 30°C (59°F to 86°F) [see USP Controlled Room Temperature].
- BRIXADI is a Schedule III drug product. Handle with adequate security and accountability. After administration, syringes should be properly disposed per facility procedure for a Schedule III drug product and per applicable federal, state, and local regulations.

### Where can healthcare settings and pharmacies find more information about the BRIXADI REMS?

- Review the following materials:
  - [BRIXADI REMS Healthcare Setting and Pharmacy Enrollment Form](#)
  - [BRIXADI REMS Fact Sheet: How to Obtain BRIXADI](#)
  - [BRIXADI REMS Dear Healthcare Provider Letter](#)
  - [Prescribing Information](#)
  - [Medication Guide](#) (educational tool designed specifically for patients)
- Contact the BRIXADI REMS at 1-866-492-9624 for REMS materials and for additional information about the BRIXADI REMS.
- Visit the REMS@FDA website at: <https://www.accessdata.fda.gov/scripts/cder/remis/index.cfm>.
- Call Braeburn's Information line (1-833-274-9234).

Access the current list of certified pharmacies where BRIXADI can be obtained by calling the BRIXADI REMS at 1-866-492-9624.

### Indication

BRIXADI is indicated for the treatment of moderate to severe opioid use disorder in patients who have initiated treatment with a single dose of a transmucosal buprenorphine product or who are already being treated with buprenorphine.

BRIXADI should be used as part of a complete treatment plan that includes counseling and psychosocial support.

### Reporting Adverse Events

Healthcare providers are encouraged to report adverse events to the FDA. Healthcare providers should report all cases of intravenous administration and suspected adverse events associated with BRIXADI to the FDA at [1-800-FDA-1088](tel:1-800-FDA-1088) or online at [www.fda.gov/medwatch/report.htm](http://www.fda.gov/medwatch/report.htm) or to Braeburn at 1-833-274-9234 or send information to [drugsafety@braeburnrx.com](mailto:drugsafety@braeburnrx.com).

[Contact Us](#)

[Privacy Policy](#)

[Terms of Use](#)

[Medication Guide](#)

[Prescribing Information](#)

BRIXADI is a registered trademark of Braeburn, Inc.  
This site is intended for US residents only.  
2023 Braeburn, Inc. All rights reserved.



## Brixadi REMS Healthcare Setting and Pharmacy Enrollment Form

Right Click To Download PDF

Page 1 / 3 | Zoom 100%

**BRIXADI REMS**

**braeburn** **Brixadi**<sup>®</sup>  
(buprenorphine) extended-release  
injection for subcutaneous use ©

**HEALTHCARE SETTING AND PHARMACY ENROLLMENT FORM**

BRIXADI is only available through the BRIXADI Risk Evaluation and Mitigation Strategy (REMS).

**Instructions**

If a healthcare setting or a pharmacy intends to store a supply of and order BRIXADI directly from an authorized distributor, certification in the BRIXADI REMS is required. To become certified, healthcare settings and pharmacies must:

1. Designate an Authorized Representative who can ensure the Authorized Representative responsibilities listed in the "Authorized Representative Information and Responsibilities" section of the enrollment form are met and that each dispensing location meets the REMS requirements.
2. Agree to:
  - Train all relevant staff at each dispensing location involved in dispensing the drug directly to a healthcare provider, to ensure that the drug is not dispensed directly to a patient.
  - Establish process and procedures to verify that BRIXADI is dispensed directly to a healthcare provider.  
**Do not dispense BRIXADI directly to a patient.**
  - Establish process and procedures to notify the healthcare provider not to dispense BRIXADI directly to patients.
3. Complete and sign this **BRIXADI REMS Healthcare Setting and Pharmacy Enrollment Form** and submit it to the BRIXADI REMS.

Once certification of the healthcare setting/pharmacy is complete, a notification will be provided to the Authorized Representative.

Only one (1) form is needed per healthcare setting. A pharmacy is covered under their healthcare setting's enrollment in the BRIXADI REMS.

**Certification in the BRIXADI REMS is not required if a healthcare setting intends to only obtain BRIXADI for administration by a practitioner at a specific named patient's scheduled appointment from a REMS-certified pharmacy.**

The **BRIXADI REMS Healthcare Setting and Pharmacy Enrollment Form** contains two sections:

- "Authorized Representative Information and Responsibilities" section – page 2
- "Healthcare Setting and Pharmacy Information" section – page 3

For the initial enrollment, both sections noted above must be submitted. For **each** additional healthcare setting/pharmacy where BRIXADI will be delivered, dispensed, and administered within your healthcare system for which the same Authorized Representative is responsible, the Authorized Representative will need to complete the "Healthcare Setting and Pharmacy Information" section on page 3.

If a designated Authorized Representative changes, the new Authorized Representative must complete and sign a new **BRIXADI REMS Healthcare Setting and Pharmacy Enrollment Form**, including a "Healthcare Setting Information" section for each healthcare setting with which he/she is now affiliated.

To enroll, complete all required fields on the form and one "Healthcare Setting / Pharmacy Information" section for each dispensing site and submit via:

- **Online:** [www.BRIXADIREMS.com](http://www.BRIXADIREMS.com)
- **FAX:** 1-833-274-8597
- **Email:** [BRIXADIREMS@braeburnrx.com](mailto:BRIXADIREMS@braeburnrx.com)
- **Mail:** BRIXADI REMS Program, 6923 Lee Vista Blvd, Ste 300, Orlando, FL 32822

For questions regarding the BRIXADI REMS or how to enroll, visit [www.BRIXADIREMS.com](http://www.BRIXADIREMS.com) or contact the BRIXADI REMS at 1-866-492-9624.

1 of 3

Page 1 / 3 | Zoom 100%

Right Click To Download PDF

### Resources for Healthcare Providers

- [BRIXADI REMS Healthcare Setting and Pharmacy Enrollment Form](#)
- [BRIXADI REMS Fact Sheet](#)
- [Dear Healthcare Provider Letter](#)

CERTIFICATION PORTAL

**BRIXADI must never be dispensed directly to a patient.**

[Contact Us](#)

[Privacy Policy](#)

[Terms of Use](#)

[Medication Guide](#)

[Prescribing Information](#)

BRIXADI is a registered trademark of Braeburn, Inc.  
This site is intended for US residents only.  
2023 Braeburn, Inc. All rights reserved.

**braeburn**



## Brixadi REMS Fact Sheet

Right Click To Download PDF

Page 1 / 2 | Zoom 100%

**BRIXADI™ REMS FACT SHEET**  
How to Obtain BRIXADI

**What is the BRIXADI REMS (Risk Evaluation and Mitigation Strategy)?**

A REMS is a strategy to manage known or potential risks associated with a drug and is required by the Food and Drug Administration (FDA) to ensure that the benefits of the drug outweigh its risks. **BRIXADI is intended for subcutaneous injection only by a healthcare provider** and is only available through a restricted distribution program called the BRIXADI REMS. **BRIXADI must never be dispensed directly to the patient and must only be administered by a healthcare professional** in a healthcare setting. The goal of the REMS is to mitigate the risk of serious harm or death that could result from intravenous self-administration.

**BRIXADI REMS Requirements**

**PRESCRIBER**

1. Prescribers are **NOT required to be certified** in the BRIXADI REMS to prescribe BRIXADI.
2. Prescribers can obtain BRIXADI for a specific named patient's scheduled appointment by writing a prescription and sending it to a REMS-certified pharmacy. The REMS-certified pharmacy coordinates delivery to the prescriber or the practitioner administering BRIXADI with the patient's appointment date.
3. Prescribers that intend to keep a supply of BRIXADI in stock at their healthcare setting and obtain BRIXADI from a distributor, **must certify** their healthcare setting or practice in the BRIXADI REMS. See below.

**HEALTHCARE SETTINGS/PHARMACIES**

Any healthcare setting\* (including a prescriber office) or pharmacy that intends to keep a supply of BRIXADI in stock and order BRIXADI directly from an authorized distributor **must be certified** in the BRIXADI REMS prior to purchasing/dispensing BRIXADI.

**How does a healthcare setting\* or pharmacy become certified?**

**To become certified in the BRIXADI REMS, healthcare settings and pharmacies must:**

1. Designate an Authorized Representative that agrees to:
  - Train all relevant staff at each dispensing location involved in the dispensing of BRIXADI directly to a healthcare provider, to ensure that the drug is not dispensed directly to a patient.
  - Establish processes and procedures to verify that BRIXADI is dispensed directly to a healthcare provider. **BRIXADI must never be dispensed directly to a patient.**
  - Establish processes and procedures to notify the healthcare provider not to dispense BRIXADI directly to patients.
2. Complete the REMS enrollment process by filling out and signing the Healthcare Setting and Pharmacy Enrollment Form, which may be obtained at [www.BRIXADIREMS.com](http://www.BRIXADIREMS.com).

**BRIXADI must never be dispensed directly to a patient.**

\*Examples of healthcare settings include: group practice, independent practice, institution, Department of Defense (DoD) facility, outpatient clinic, hospital, Veterans Administration (VA) facility, opioid treatment program (OTP), closed healthcare system, and other healthcare settings.

Page 1 of 2

Page 1 / 2 | Zoom 100%

Right Click To Download PDF

### Resources for Healthcare Providers

- [BRIXADI REMS Healthcare Setting and Pharmacy Enrollment Form](#)
- [BRIXADI REMS Fact Sheet](#)
- [Dear Healthcare Provider Letter](#)

CERTIFICATION PORTAL

**BRIXADI must never be dispensed directly to a patient.**

## Dear Healthcare Provider Letter

Right Click To Download PDF

Page 1 / 3 Zoom 100%



BRIXADI (buprenorphine) extended-release injection for subcutaneous use CIII

**FDA-REQUIRED REMS SAFETY INFORMATION**

**WARNING: RISK OF SERIOUS HARM OR DEATH WITH INTRAVENOUS ADMINISTRATION; BRIXADI RISK EVALUATION AND MITIGATION STRATEGY**

- Serious harm or death could result if administered intravenously. BRIXADI forms a liquid crystalline gel upon contact with body fluids and may cause occlusion, local tissue damage, and thrombo-embolic events, including life-threatening pulmonary emboli, if administered intravenously.
- Because of the risk of serious harm or death that could result from intravenous self-administration, BRIXADI is only available through a restricted program called the BRIXADI REMS. Healthcare settings and pharmacies that order and dispense BRIXADI must be certified in this program and comply with the REMS requirements.

[Date]

Dear Healthcare Provider:

The purpose of this letter is to inform you about the **BRIXADI Risk Evaluation and Mitigation Strategy (REMS)**. The FDA determined that a REMS is necessary to ensure that the benefits of BRIXADI outweigh the **risk of serious harm or death that could result from intravenous self-administration of BRIXADI**.

Per the BRIXADI REMS, BRIXADI is only available through a restricted distribution program.

Page 1 of 3

Page 1 / 3 Zoom 100%

Right Click To Download PDF

### Resources for Healthcare Providers

- [BRIXADI REMS Healthcare Setting and Pharmacy Enrollment Form](#)
- [BRIXADI REMS Fact Sheet](#)
- [Dear Healthcare Provider Letter](#)

CERTIFICATION PORTAL

BRIXADI must never be dispensed directly to a patient.

[Contact Us](#)  
[Privacy Policy](#)  
[Terms of Use](#)  
[Medication Guide](#)  
[Prescribing Information](#)

BRIXADI is a registered trademark of Braeburn, Inc.  
This site is intended for US residents only.  
2023 Braeburn, Inc. All rights reserved.

 braeburn

## Privacy Policy

Right Click To Download PDF

Page 1 / 7 Zoom 100%

**Privacy Policy**

PLEASE READ THIS PRIVACY POLICY CAREFULLY BEFORE ACCESSING ANY PAGES IN THIS OR ANY OTHER BRAEBURN WEBSITE OR BEFORE ACCESSING, DOWNLOADING, VIEWING, OR USING, IN ANY MANNER, FROM YOUR SMART PHONE OR OTHER MOBILE DEVICE, ANY APPLICATION (OR "APP"), DISTRIBUTED, PRODUCED, DEVELOPED, MARKETED, OR MADE AVAILABLE BY BRAEBURN THROUGH ANY BRAEBURN WEBSITE (COLLECTIVELY, THE "SITE").

Braeburn Inc. (Braeburn) respects the privacy of visitors to our Site and those who wish to access specific content or services (referred to individually as "User" and collectively as "Users").

This Privacy Policy describes what information we may collect from you or on your behalf, how we use that information, and what we do to protect it. By using the Site you expressly consent to the collection, use, and disclosure of your personal information as described in this Privacy Policy.

This Privacy Policy is incorporated into and is subject to the Braeburn Terms of Use. Your use of the Site and any personal information you provide on the Site is subject to the Terms of this Privacy Policy and the Braeburn Terms of Use.

**THE INFORMATION BRAEBURN COLLECTS:**

**Personally Identifiable Information:** You may provide to Braeburn what is generally called "Personally Identifiable Information" (sometimes "PII") (such as your name, email address, postal mailing address, home/mobile telephone number, fax number, billing information, personally identifiable Health Information, and the names and email addresses of other

Page 1 / 7 Zoom 100%

Right Click To Download PDF

### Resources for Healthcare Providers

- [BRIXADI REMS Healthcare Setting and Pharmacy Enrollment Form](#)
- [BRIXADI REMS Fact Sheet](#)
- [Dear Healthcare Provider Letter](#)

CERTIFICATION PORTAL

**BRIXADI must never be dispensed directly to a patient.**

[Contact Us](#)  
[Privacy Policy](#)  
[Terms of Use](#)  
[Medication Guide](#)  
[Prescribing Information](#)

BRIXADI is a registered trademark of Braeburn, Inc.  
This site is intended for US residents only.  
2023 Braeburn, Inc. All rights reserved.

 braeburn



## BRIXADI REMS Online Enrollment Form

Please enter your information to receive an email notification from BRIXADI REMS with instructions to complete the BRIXADI REMS Healthcare Setting and Pharmacy Enrollment Form.

SUBMIT

[Contact Us](#)

[Privacy Policy](#)

[Terms of Use](#)

[Medication Guide](#)

[Prescribing Information](#)

BRIXADI is a registered trademark of Braeburn, Inc.  
This site is intended for US residents only.  
2023 Braeburn, Inc. All rights reserved.



Thank you for your submission. In moments you will be receiving an email notification from BRIXADI REMS with instructions to complete the BRIXADI REMS Healthcare Setting and Pharmacy Enrollment Form. If you do not receive this email, please call 1-866-492-9624.

#### Resources for Healthcare Providers

- [BRIXADI REMS Healthcare Setting and Pharmacy Enrollment Form](#)
- [BRIXADI REMS Fact Sheet](#)
- [Dear Healthcare Provider Letter](#)

CERTIFICATION PORTAL

BRIXADI must never be dispensed directly to a patient.

[Contact Us](#)  
[Privacy Policy](#)  
[Terms of Use](#)  
[Medication Guide](#)  
[Prescribing Information](#)

BRIXADI is a registered trademark of Braeburn, Inc.  
This site is intended for US residents only.  
2023 Braeburn, Inc. All rights reserved.

 braeburn



## Email Notification:



**Complete the requested form from Braeburn.**  
Braeburn has requested you to review and complete the  
BRIXADI REMS Healthcare Setting and Pharmacy  
Enrollment Form

[Get Started](#)

[Get started now](#)

Braeburn is using Dropbox Forms to give you the best mobile signing  
experience. [Try Dropbox Forms for free.](#)

---

 Warning: To prevent others from accessing your account, do not forward this  
email.

## Get Started Page:



---

### **BRIXADI REMS Healthcare Setting and Pharmacy Enrollment Form**

Click 'Get Started' below to begin.

---

**Authorized Representative Information and  
Responsibilities**

---

**Healthcare Setting and Pharmacy Information  
Form**

---

**Get started**

## Authorized Representative Flat Form Details:



Document 1 of 2

# Authorized Representative Information and Responsibilities

---

BRIXADI is only available through the BRIXADI Risk Evaluation and Mitigation Strategy (REMS).

If a healthcare setting or a pharmacy intends to store a supply of and order BRIXADI directly from an authorized distributor, certification in the BRIXADI REMS is required. To become certified, healthcare settings and pharmacies must:

1. Designate an Authorized Representative who can ensure the Authorized Representative responsibilities listed in the "Authorized Representative Information and Responsibilities" section of the enrollment form are met and that each dispensing location meets the REMS requirements.
2. Agree to:
  - Train all relevant staff at each dispensing location involved in dispensing the drug directly to a healthcare provider, to ensure that the drug is not dispensed directly to a patient.
  - Establish process and procedures to verify that BRIXADI is dispensed directly to a healthcare provider. **Do not dispense BRIXADI directly to a patient.**
  - Establish process and procedures to notify the healthcare provider not to dispense BRIXADI directly to patients.



3. Complete and sign this ***BRIXADI REMS Healthcare Setting and Pharmacy Enrollment Form*** and submit it to the BRIXADI REMS.

Once certification of the healthcare setting/pharmacy is complete, a notification will be provided to the Authorized Representative.

Only one (1) form is needed per healthcare setting. A pharmacy is covered under their healthcare setting's enrollment in the BRIXADI REMS.

***Certification in the BRIXADI REMS is not required if a healthcare setting intends to only obtain BRIXADI for administration by a practitioner at a specific named patient's scheduled appointment from a REMS-certified pharmacy.***

The ***BRIXADI REMS Healthcare Setting and Pharmacy Enrollment Form*** contains two sections:

- "Authorized Representative Information and Responsibilities" section
- "Healthcare Setting and Pharmacy Information" section

For the initial enrollment, both sections noted above must be submitted. For **each** additional healthcare setting/ pharmacy where BRIXADI will be delivered, dispensed, and administered within your healthcare system for which the same Authorized Representative is responsible, the Authorized Representative will need to complete the "Healthcare Setting and Pharmacy Information" section.

If a designated Authorized Representative changes, the new Authorized Representative must complete and sign a new ***BRIXADI REMS Healthcare Setting and Pharmacy Enrollment Form***, including a "Healthcare Setting Information" section for each healthcare setting with which he/she is now affiliated.

This is the online enrollment form. Please complete all required fields in the pages to follow.

For questions regarding the BRIXADI REMS or how to enroll, visit [www.BRIXADIREMS.com](http://www.BRIXADIREMS.com) or contact the BRIXADI REMS at 1-866-492-9624.

I acknowledge that I have read the instructions  
(uncheck to review again)

**Request Type \***

- New REMS Request  
 Update an Existing REMS

**Role \***

Select an item... 

**First Name \***



**Middle Initial**

**Last Name \***



**Position/Title \***



**Telephone Number \***

**Alternative Telephone Number**



**Office Fax Number**

**Email \***

**Preferred Method of Communication \***

I am the Authorized Representative designated to carry out the certification process and oversee implementation and compliance with the REMS on behalf of my healthcare setting or pharmacy. By signing this form, I agree to:

- Certify in the BRIXADI REMS by completing the Healthcare Setting and Pharmacy Enrollment Form and submitting it to the REMS.
- Train all relevant staff involved in dispensing that the drug must be dispensed directly to a healthcare provider for administration by a healthcare provider, and that BRIXADI must not be dispensed directly to a patient.
- Establish processes and procedures to verify BRIXADI is dispensed directly to a healthcare provider, and BRIXADI is not dispensed to a patient.
- Establish processes and procedures to notify the healthcare provider not to dispense directly to patients. Notifications may be accomplished through a variety of mechanisms based on the healthcare setting. Phone calls, an auxiliary label printed automatically and affixed to the dispensed prescription, or reminders in the electronic medical record are potential mechanisms to communicate the alert.
- Not to distribute, transfer, loan, or sell BRIXADI.
- Maintain records of all processes and procedures including compliance with those processes and procedures.

- Comply with audits by Braeburn or a third party acting on behalf of Braeburn to ensure that all processes and procedures are in place and being followed for the BRIXADI REMS.

**By signing I acknowledge that I understand that there is a risk of serious harm or death that could result from intravenous self-administration of BRIXADI, and to not dispense BRIXADI directly to a patient. I understand that this enrollment applies to my healthcare setting(s) or pharmacy(ies) for which I am the designated Authorized Representative.**

- \* By checking this box, you understand that your healthcare setting/pharmacy may be selected for audit within 90 days.



**Signature Date:** 03/21/2023

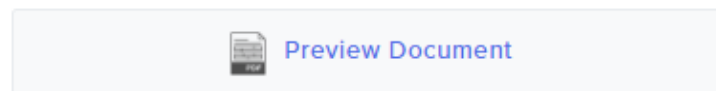

## Authorized Representative Dynamic Form Details:

Request Type Update:

**Request Type \***

New REMS Request

Update an Existing REMS

**Existing REMS ID to Replace \* ?**

Role Types:

**Role \***

Physician

Select an item...

Pharmacist

Physician Assistant

Practice Manager

Nurse

Nurse Practitioner

Physician

Other

Role Type "Other" Selection:

**Role \***

Other

**If Other, Please Specify: \***

**First Name \***

Preferred Communication Method Options:

**Preferred Method of Communication \***

Email	▼
Select an item...	
Telephone Number	
Alternate Phone Number	
Office Fax Number	
Email	

Program Requirements Agreement selection:

I am the Authorized Representative designated to carry out the certification process and oversee implementation and compliance with the REMS on behalf of my healthcare setting or pharmacy. By signing this form, I agree to:

- Certify in the BRIXADI REMS by completing the Healthcare Setting and Pharmacy Enrollment Form and submitting it to the REMS.
- Train all relevant staff involved in dispensing that the drug must be dispensed directly to a healthcare provider for administration by a healthcare provider, and that BRIXADI must not be dispensed directly to a patient.
- Establish processes and procedures to verify BRIXADI is dispensed directly to a healthcare provider, and BRIXADI is not dispensed to a patient.
- Establish processes and procedures to notify the healthcare provider not to dispense directly to patients. Notifications may be accomplished through a variety of mechanisms based on the healthcare setting. Phone calls, an auxiliary label printed automatically and affixed to the dispensed prescription, or reminders in the electronic medical record are potential mechanisms to communicate the alert.
- Not to distribute, transfer, loan, or sell BRIXADI.
- Maintain records of all processes and procedures including compliance with those processes and procedures.
- Comply with audits by Braeburn or a third party acting on behalf of Braeburn to ensure that all processes and procedures are in place and being followed for the BRIXADI REMS.

**By signing I acknowledge that I understand that there is a risk of serious harm or death that could result from intravenous self-administration of BRIXADI, and to not dispense BRIXADI directly to a patient. I understand that this enrollment applies to my healthcare setting(s) or pharmacy(ies) for which I am the designated Authorized Representative.**

\* By checking this box, you understand that your healthcare setting/pharmacy may be selected for audit within 90 days.

You must review the terms and conditions before you can submit the REMS request.

## Healthcare Setting Flat Form:



Document 2 of 2

# Healthcare Setting and Pharmacy Information Form

---

- I acknowledge that I have read the instructions  
(uncheck to review again)

### Request Type \*

- New REMS Request  
 Update an Existing REMS

Click the Authorized Representative signature box below to confirm the application of this signature to your submission.

X CLICK TO SIGN

---

This field has an error

- I have additional Healthcare Settings to submit for this Authorized Representative.



**Healthcare Setting Name \***

**Street Address \***

**City \***

**State \***

**Zipcode \***

**Facility Identifiers (Please Provide at least one of the following): \***

NPI

NCPDP

DEA

**Authorized Representative Name**

Jane G Smith

**Point of Contact Name**

**Street Address**

**City**

**State**

**Zipcode**

**Telephone Number**

**Alternative Telephone Number**

**Office Fax Number**

**Email**

**Preferred Method of Communication**

Select an item... 

**Setting Type: \***

\* I am the designated Authorized Representative for this healthcare setting or pharmacy.



**Signature Date:** 03/21/2023

I agree to be legally bound by the document, and agree to the Dropbox Sign [Terms](#) and [Privacy Policy](#). Click on "I agree" to sign this document.

 [Preview Document](#)

## Healthcare Setting Dynamic Form Details:

### Facility Identifiers

**Facility Identifiers (Please Provide at least one of the following): \***

NPI

1234567890

NPI is required

NCPDP

1234567

DEA

AB1234567

### Preferred Method of Communication

**Preferred Method of Communication**

Select an item... ▼

- Select an item...
- Telephone Number
- Alternate Phone Number
- Office Fax Number
- Email

Setting Type Pharmacy Selection:

**Setting Type: \***

**Type of Pharmacy \***

Select an item...  
Select an item...  
Specialty  
Other

Setting Type Pharmacy Other Selection and Field:

**Setting Type: \***

**Type of Pharmacy \***

Other

Retail Pharmacy Submissions are not allowed. Any reference to retail in the other field will cause the REMS request to be rejected.

**If Other, Please Specify: \***

Retail entries will be rejected

Setting Type Healthcare Setting Selected:

**Setting Type: \***

Pharmacy

Healthcare Setting

**Type of Healthcare Setting \***

Select an item... ▼

Select an item...

- Closed Healthcare System
- Criminal Justice Facility
- Criminal Justice Facility Pharmacy
- Department of Defense (DoD) Facility
- Federally Qualified Health Center (FQHC)
- FQHC Pharmacy
- Group Practice
- Hospital
- Hospital Pharmacy
- Independent Practice
- Institution
- Institution Pharmacy
- Integrated Delivery Network (IDN)
- IDN Pharmacy
- Opioid Treatment Program (OTP)
- Outpatient Clinic
- Veterans Administration (VA) Facility
- VA Pharmacy
- Other

Setting Type Healthcare Other Selection and Field:

**Setting Type: \***

Pharmacy

Healthcare Setting

**Type of Healthcare Setting \***

Other

**If Other, Please Specify: \***

## Preview Form:

BRIXADI REMS



Weekly/Monthly  
**Brixadi**  
(buprenorphine) extended-release  
injection for subcutaneous use ©

### HEALTHCARE SETTING AND PHARMACY ENROLLMENT FORM

BRIXADI is only available through the BRIXADI Risk Evaluation and Mitigation Strategy (REMS).

#### Instructions

If a healthcare setting or a pharmacy intends to store a supply of and order BRIXADI directly from an authorized distributor, certification in the BRIXADI REMS is required. To become certified, healthcare settings and pharmacies must:

1. Designate an Authorized Representative who can ensure the Authorized Representative responsibilities listed in the "Authorized Representative Information and Responsibilities" section of the enrollment form are met and that each dispensing location meets the REMS requirements.
2. Agree to:
  - Train all relevant staff at each dispensing location involved in dispensing the drug directly to a healthcare provider, to ensure that the drug is not dispensed directly to a patient.
  - Establish process and procedures to verify that BRIXADI is dispensed directly to a healthcare provider.  
**Do not dispense BRIXADI directly to a patient.**
  - Establish process and procedures to notify the healthcare provider not to dispense BRIXADI directly to patients.
3. Complete and sign this **BRIXADI REMS Healthcare Setting and Pharmacy Enrollment Form** and submit it to the BRIXADI REMS.

Once certification of the healthcare setting/pharmacy is complete, a notification will be provided to the Authorized Representative.

Only one (1) form is needed per healthcare setting. A pharmacy is covered under their healthcare setting's enrollment in the BRIXADI REMS.

**Certification in the BRIXADI REMS is not required if a healthcare setting intends to only obtain BRIXADI for administration by a practitioner at a specific named patient's scheduled appointment from a REMS-certified pharmacy.**

The **BRIXADI REMS Healthcare Setting and Pharmacy Enrollment Form** contains two sections:

- "Authorized Representative Information and Responsibilities" section – page 2
- "Healthcare Setting and Pharmacy Information" section – page 3

For the initial enrollment, both sections noted above must be submitted. For **each** additional healthcare setting/pharmacy where BRIXADI will be delivered, dispensed, and administered within your healthcare system for which the same Authorized Representative is responsible, the Authorized Representative will need to complete the "Healthcare Setting and Pharmacy Information" section on page 3.

If a designated Authorized Representative changes, the new Authorized Representative must complete and sign a new **BRIXADI REMS Healthcare Setting and Pharmacy Enrollment Form**, including a "Healthcare Setting Information" section for each healthcare setting with which he/she is now affiliated.

To enroll, complete all required fields on the form and one "Healthcare Setting / Pharmacy Information" section for each dispensing site and submit via:

- **Online:** [www.BRIXADIREMS.com](http://www.BRIXADIREMS.com)
- **FAX:** 1-833-274-8597
- **Email:** [BRIXADIREMS@braeburnrx.com](mailto:BRIXADIREMS@braeburnrx.com)
- **Mail:** BRIXADI REMS Program, 6923 Lee Vista Blvd, Ste 300, Orlando, FL 32822

For questions regarding the BRIXADI REMS or how to enroll, visit [www.BRIXADIREMS.com](http://www.BRIXADIREMS.com) or contact the BRIXADI REMS at 1-866-492-9624.



This is a test document for preview purposes. It is not legally binding.

BRIXADI REMS



Weekly/Monthly  
**Brixadi**  
(buprenorphine) extended-release  
injection for subcutaneous use ©

## HEALTHCARE SETTING AND PHARMACY ENROLLMENT FORM (cont'd)

### Authorized Representative Information and Responsibilities

#### AUTHORIZED REPRESENTATIVE INFORMATION (\*REQUIRED FIELDS)

##### Role\*

Nurse       Nurse Practitioner       Pharmacist       Physician       Physician Assistant  
 Practice Manager       Other: \_\_\_\_\_

##### Contact details\*

First name: Jane      Last name: Smith      Middle initial: G  
Position/Title: Physician  
Telephone number: 923-885-0931      Alternate telephone number: 923-885-9384      Office fax: 923-885-3728  
Email: jane.smith@testing.org      Preferred method of communication:  Fax     Email     Phone

I am the Authorized Representative designated to carry out the certification process and oversee implementation and compliance with the REMS on behalf of my healthcare setting or pharmacy. By signing this form, I agree to:

- Certify in the BRIXADI REMS by completing the Healthcare Setting and Pharmacy Enrollment Form and submitting it to the REMS.
- Train all relevant staff involved in dispensing that the drug must be dispensed directly to a healthcare provider for administration by a healthcare provider, and that BRIXADI must not be dispensed directly to a patient.
- Establish processes and procedures to verify BRIXADI is dispensed directly to a healthcare provider, and BRIXADI is not dispensed to a patient.
- Establish processes and procedures to notify the healthcare provider not to dispense directly to patients. Notifications may be accomplished through a variety of mechanisms based on the healthcare setting. Phone calls, an auxiliary label printed automatically and affixed to the dispensed prescription, or reminders in the electronic medical record are potential mechanisms to communicate the alert.
- Not distribute, transfer, loan, or sell BRIXADI.
- Maintain records of all processes and procedures including compliance with those processes and procedures.
- Comply with audits by Braeburn or a third party acting on behalf of Braeburn to ensure that all processes and procedures are in place and being followed for the BRIXADI REMS.

By checking this box, you understand that your healthcare setting/pharmacy may be selected for audit within 90 days.

Healthcare Setting or Pharmacy Authorized Representative Signature\*: Jane Smith

Date\* (MM/DD/YYYY): 03 /31 /2023

**By signing I acknowledge that I understand that there is a risk of serious harm or death that could result from intravenous self-administration of BRIXADI, and to not dispense BRIXADI directly to a patient. I understand that this enrollment applies to my healthcare setting(s) or pharmacy(ies) for which I am the designated Authorized Representative.**

This is a test document for preview purposes. It is not legally binding.

BRIXADI REMS



Weekly/Monthly  
**Brixadi**  
(buprenorphine) extended-release  
injection for subcutaneous use @

## HEALTHCARE SETTING AND PHARMACY ENROLLMENT FORM (cont'd)

### Healthcare Setting and Pharmacy Information

Healthcare Setting/Pharmacy Name: Generic Healthcare Setting  
Street Address: 111 Healthy Way City: Chicago State: Illinois ZIP: 91919  
Facility Identifiers (provide at least 1) NPI: \_\_\_\_\_ NCPDP: \_\_\_\_\_ DEA: DD1232343  
Authorized Representative Name: Jane G Smith  
Primary Point of Contact IF NOT the Authorized Representative: \_\_\_\_\_  
Point of Contact Name: John Smith  
Street Address: 123 Healthy Road City: Naperville State: Illinois ZIP: 91919  
Telephone Number: 234-123-2345 Alternate Telephone Number: 345-234-3454 Office Fax: 456-435-4567  
Email: john.smith@testing.org Preferred Method of Communication:  Fax  Email  Phone

### Setting Type

- Pharmacy**  
 Specialty  Other: \_\_\_\_\_
- Healthcare Setting**
- Closed Healthcare System  Criminal Justice Facility  Criminal Justice Facility Pharmacy  
 Department of Defense (DoD) Facility  Federally Qualified Health Center (FOHC)  FOHC Pharmacy  
 Group Practice  Hospital  Hospital Pharmacy  Independent Practice  Institution  
 Institution Pharmacy  Integrated Delivery Network (IDN)  IDN Pharmacy  Opioid Treatment Program (OTP)  
 Outpatient Clinic  Veterans Administration (VA) Facility  VA Pharmacy  
 Other: \_\_\_\_\_

I am the designated Authorized Representative for this healthcare setting or pharmacy.

Healthcare Setting or Pharmacy Authorized Representative Signature: Jane Smith

Date (MM/DD/YYYY): 03 /31 /2023

3 of 3

Close preview

## Submitter Notification Verbiage:

Update of REMS Notification:

Data pulled in from system or form data.

Subject:

"REMS ID XXXXXXXX has been updated"

Body:

"Healthcare Setting Doe Treatment Center is now re-enrolled in the BRIXADI REMS Program with the REMS ID XXXXXXXX. The Authorized Representative for XXXXXXXX is John Doe. [Click Here](#) to download or print your signed document.

For BRIXADI REMS Program questions 1-866-492-9624.

An additional site request has been sent to [john.doe@test.com](mailto:john.doe@test.com)"

New Enrollment Notification:

Subject:

"REMS ID XXXXXXXX has been completed"

Body:

"Healthcare Setting Doe Treatment Center is now enrolled in the BRIXADI REMS Program with the REMS ID XXXXXXXX. The Authorized Representative for XXXXXXXX is John Doe. [Click Here](#) to download or print your signed document.

For BRIXADI REMS Program questions please contact 1-866-492-9624.

An additional site request has been sent to [john.doe@test.com](mailto:john.doe@test.com)"

Duplicate Enrollment Notification:

Subject:

"REMS ID XXXXXXXX has been updated"

Body:

"An Existing REMS Enrollment with REMS ID XXXXXXXX was identified. Due to the BRIXADI REMS reconciliation process your form has been updated. The REMS ID YYYYYY is no longer valid. Please review the updated form XXXXXXXX.

-----  
**This is a representation of an electronic record that was signed electronically. Following this are manifestations of any and all electronic signatures for this electronic record.**  
-----

/s/  
-----

CELIA J WINCHELL  
05/23/2023 01:07:32 PM