

HIGHLIGHTS OF PRESCRIBING INFORMATION

These highlights do not include all the information needed to use COSENTYX safely and effectively. See full prescribing information for COSENTYX.

COSENTYX® (secukinumab) injection, for subcutaneous use
Initial U.S. Approval: 2015

RECENT MAJOR CHANGES

Dosage and Administration (2.2, 2.3, 2.4, 2.7, 2.8) 5/2023
Warnings and Precautions (5.5) 7/2023

INDICATIONS AND USAGE

COSENTYX is a human interleukin-17A antagonist indicated for the treatment of:

- moderate to severe plaque psoriasis in patients 6 years and older who are candidates for systemic therapy or phototherapy (1.1)
- active psoriatic arthritis (PsA) in patients 2 years of age and older (1.2)
- adults with active ankylosing spondylitis (AS) (1.3)
- adults with active non-radiographic axial spondyloarthritis (nr-axSpA) with objective signs of inflammation (1.4)
- active enthesitis-related arthritis (ERA) in patients 4 years of age and older (1.5)

DOSAGE AND ADMINISTRATION

- Prior to COSENTYX initiation, complete all age-appropriate vaccinations, evaluate patients for tuberculosis (TB) (2.1). See Full Prescribing Information for instructions on preparation and administration of COSENTYX. (2.7, 2.8, 2.9)
- **Plaque Psoriasis:**
 - *Adults* Recommended dosage is 300 mg by subcutaneous injection at Weeks 0, 1, 2, 3, and 4 followed by 300 mg every 4 weeks. For some patients, a dose of 150 mg may be acceptable. (2.2)
 - *Pediatric Patients 6 Years and Older* Recommended weight-based dosage is administered by subcutaneous injection at Weeks 0, 1, 2, 3, and 4 and every 4 weeks thereafter.
 - For patients < 50 kg (at the time of dosing), the dose is 75 mg.
 - For patients ≥ 50 kg (at the time of dosing), the dose is 150 mg. (2.2)
- **Psoriatic Arthritis:**

Adults: Recommended dosages are:

 - For PsA patients with coexistent moderate to severe plaque psoriasis, use the dosage and administration for plaque psoriasis. (2.2)
 - For other PsA patients, administer with or without a loading dosage.
 - With a loading dosage: 150 mg at Weeks 0, 1, 2, 3, and 4 and every 4 weeks thereafter
 - Without a loading dosage: 150 mg every 4 weeks
 - If a patient continues to have active PsA, consider a dosage of 300 mg every 4 weeks. (2.3)

Pediatric Patients 2 years and older Recommended weight-based dosage is administered by subcutaneous injection at Weeks 0, 1, 2, 3, and 4 and every 4 weeks thereafter.

 - For patients ≥ 15 kg and < 50 kg the dose is 75 mg.
 - For patients ≥ 50 kg the dose is 150 mg. (2.3)
- **Ankylosing Spondylitis:** Administer with or without a loading dosage. The recommended dosages are:
 - With a loading dosage: 150 mg at Weeks 0, 1, 2, 3, and 4 and every 4 weeks thereafter.

- Without a loading dosage: 150 mg every 4 weeks.
- If a patient continues to have active ankylosing spondylitis, consider a dosage of 300 mg every 4 weeks. (2.4)
- **Non-Radiographic Axial Spondyloarthritis:** Administer with or without a loading dosage. The recommended dosage is:
 - With a loading dosage: 150 mg at Weeks 0, 1, 2, 3, and 4 and every 4 weeks thereafter. (2.5)
 - Without a loading dosage: 150 mg every 4 weeks. (2.5)
- **Enthesitis-Related Arthritis:** Recommended weight-based dosage is administered by subcutaneous injection at Weeks 0, 1, 2, 3, and 4 and every 4 weeks thereafter.
 - For patients ≥ 15 kg and < 50 kg the dose is 75 mg.
 - For patients ≥ 50 kg the dose is 150 mg. (2.6)

DOSAGE FORMS AND STRENGTHS

- **Injection:** 300 mg/2 mL solution in a single-dose UnoReady® pen and in a single-dose prefilled syringe. (3)
- **Injection:** 150 mg/mL solution in a single-dose Sensoready® pen and in a single-dose prefilled syringe. (3)
- **Injection:** 75 mg/0.5 mL solution in a single-dose prefilled syringe (for pediatric patients). (3)

CONTRAINDICATIONS

Serious hypersensitivity to secukinumab or any excipients in COSENTYX. (4)

WARNINGS AND PRECAUTIONS

- **Infections:** Serious infections have occurred. Caution should be exercised when considering the use of COSENTYX in patients with a chronic infection or a history of recurrent infection. If a serious infection develops, discontinue COSENTYX until the infection resolves. (5.1)
- **Hypersensitivity Reactions:** If an anaphylactic reaction or other serious allergic reaction occurs, discontinue COSENTYX immediately and initiate appropriate therapy. (5.2)
- **Tuberculosis (TB):** Prior to initiating treatment with COSENTYX, evaluate for TB. (5.3)
- **Inflammatory Bowel Disease:** Cases of inflammatory bowel disease were observed in clinical trials. Caution should be exercised when prescribing COSENTYX to patients with inflammatory bowel disease. (5.4)
- **Eczematous Eruptions:** Cases of severe eczematous eruptions have occurred in patients receiving COSENTYX (5.5)
- **Immunizations:** Avoid use of live vaccines in patients treated with COSENTYX. (5.7)

ADVERSE REACTIONS

Most common adverse reactions (> 1%) are nasopharyngitis, diarrhea, and upper respiratory tract infection. (6.1)

To report SUSPECTED ADVERSE REACTIONS, contact Novartis Pharmaceuticals Corporation at 1-888-669-6682 or FDA at 1-800-FDA-1088 or www.fda.gov/medwatch.

See 17 for PATIENT COUNSELING INFORMATION and Medication Guide.

Revised: 7/2023

FULL PRESCRIBING INFORMATION: CONTENTS*

1 INDICATIONS AND USAGE

- 1.1 Plaque Psoriasis
- 1.2 Psoriatic Arthritis
- 1.3 Ankylosing Spondylitis
- 1.4 Non-Radiographic Axial Spondyloarthritis
- 1.5 Enthesitis-Related Arthritis

2 DOSAGE AND ADMINISTRATION

- 2.1 Testing and Procedures Prior to Treatment Initiation
- 2.2 Recommended Dosage Plaque Psoriasis
- 2.3 Recommended Dosage in Psoriatic Arthritis
- 2.4 Recommended Dosage in Ankylosing Spondylitis
- 2.5 Recommended Dosage in Non-Radiographic Axial Spondyloarthritis
- 2.6 Recommended Dosage in Enthesitis-Related Arthritis
- 2.7 Important Administration Instructions
- 2.8 Preparation for Use of COSENTYX 300 mg/2 mL UnoReady Pen, 150 mg/mL Sensoready Pen and Prefilled Syringes (300 mg/2 mL, 150 mg/mL, 75 mg/0.5 mL)

3 DOSAGE FORMS AND STRENGTHS

4 CONTRAINDICATIONS

5 WARNINGS AND PRECAUTIONS

- 5.1 Infections
- 5.2 Hypersensitivity Reactions
- 5.3 Pre-Treatment Evaluation for Tuberculosis
- 5.4 Inflammatory Bowel Disease
- 5.5 Eczematous Eruptions
- 5.6 Risk of Hypersensitivity in Latex-Sensitive Individuals
- 5.7 Immunizations

6 ADVERSE REACTIONS

- 6.1 Clinical Trials Experience
- 6.2 Immunogenicity

- 6.3 Postmarketing Experience

7 DRUG INTERACTIONS

8 USE IN SPECIFIC POPULATIONS

- 8.1 Pregnancy
- 8.2 Lactation
- 8.4 Pediatric Use
- 8.5 Geriatric Use

10 OVERDOSAGE

11 DESCRIPTION

12 CLINICAL PHARMACOLOGY

- 12.1 Mechanism of Action
- 12.2 Pharmacodynamics
- 12.3 Pharmacokinetics

13 NONCLINICAL TOXICOLOGY

- 13.1 Carcinogenesis, Mutagenesis, Impairment of Fertility

14 CLINICAL STUDIES

- 14.1 Adult Plaque Psoriasis
- 14.2 Pediatric Plaque Psoriasis
- 14.3 Adult Psoriatic Arthritis
- 14.4 Ankylosing Spondylitis
- 14.5 Non-Radiographic Axial Spondyloarthritis
- 14.6 Juvenile Psoriatic Arthritis and Enthesitis-Related Arthritis

16 HOW SUPPLIED/STORAGE AND HANDLING

- 16.1 How Supplied
- 16.2 Storage and Handling

17 PATIENT COUNSELING INFORMATION

*Sections or subsections omitted from the full prescribing information are not listed.

FULL PRESCRIBING INFORMATION

1 INDICATIONS AND USAGE

1.1 Plaque Psoriasis

COSENTYX[®] is indicated for the treatment of moderate to severe plaque psoriasis in patients 6 years and older who are candidates for systemic therapy or phototherapy.

1.2 Psoriatic Arthritis

COSENTYX is indicated for the treatment of active psoriatic arthritis (PsA) in patients 2 years of age and older.

1.3 Ankylosing Spondylitis

COSENTYX is indicated for the treatment of adult patients with active ankylosing spondylitis (AS).

1.4 Non-Radiographic Axial Spondyloarthritis

COSENTYX is indicated for the treatment of adult patients with active non-radiographic axial spondyloarthritis (nr-axSpA) with objective signs of inflammation.

1.5 Enthesitis-Related Arthritis

COSENTYX is indicated for the treatment of active enthesitis-related arthritis (ERA) in patients 4 years of age and older.

2 DOSAGE AND ADMINISTRATION

2.1 Testing and Procedures Prior to Treatment Initiation

Perform the following evaluations prior to COSENTYX initiation:

- Evaluate patients for tuberculosis (TB) infection. COSENTYX initiation is not recommended in patients with active TB infection. Initiate treatment of latent TB prior to initiation of COSENTYX [see *Warnings and Precautions (5.2)*].
- Complete all age-appropriate vaccinations as recommended by current immunization guidelines prior to initiating treatment with COSENTYX [see *Warnings and Precautions (5.6)*].

2.2 Recommended Dosage Plaque Psoriasis

Adults

The recommended dosage in adults with plaque psoriasis is 300 mg by subcutaneous injection at Weeks 0, 1, 2, 3, and 4 and every 4 weeks thereafter. Each 300 mg dosage is given as one subcutaneous injection of 300 mg or as two subcutaneous injections of 150 mg.

For some patients, a dosage of 150 mg by subcutaneous injection at Weeks 0, 1, 2, 3, and 4 and every 4 weeks thereafter may be acceptable.

Pediatric Patients 6 Years of Age and Older

The recommended weight-based dosage in pediatric patients 6 years of age and older with plaque psoriasis is administered by subcutaneous injection at Weeks 0, 1, 2, 3, and 4 and every 4 weeks thereafter.

- For patients < 50 kg (at the time of dosing), the recommended dose is 75 mg.
- For patients ≥ 50 kg (at the time of dosing), the recommended dose is 150 mg.

2.3 Recommended Dosage in Psoriatic Arthritis

Adults

For adult patients with PsA and with coexistent moderate to severe plaque psoriasis, use the dosage and administration recommendations in adults for plaque psoriasis [see *Dosage and Administration (2.2)*].

For other adult patients PsA, administer COSENTYX with or without a loading dosage by subcutaneous injection.

The recommended dosage:

- With a loading dosage is 150 mg at Weeks 0, 1, 2, 3, and 4 and every 4 weeks thereafter.
- Without a loading dosage is 150 mg every 4 weeks.

- If a patient continues to have active PsA, consider a dosage of 300 mg by subcutaneous injection every 4 weeks. Each 300 mg dosage is given as one subcutaneous injection of 300 mg or as two subcutaneous injections of 150 mg.

Pediatric Patients 2 Years of Age and Older

The recommended weight-based dosage in pediatric patients 2 years of age and older with PsA is administered by subcutaneous injection at Weeks 0, 1, 2, 3, and 4 and every 4 weeks thereafter.

- For patients ≥ 15 kg and < 50 kg, the recommended dose is 75 mg.
- For patients ≥ 50 kg, the recommended dose is 150 mg.

COSENTYX may be administered with or without methotrexate.

2.4 Recommended Dosage in Ankylosing Spondylitis

Administer COSENTYX with or without a loading dosage by subcutaneous injection in adult patients with active AS. The recommended dosage:

- With a loading dosage is 150 mg at Weeks 0, 1, 2, 3, and 4 and every 4 weeks thereafter.
- Without a loading dosage is 150 mg every 4 weeks.
- If a patient continues to have active AS, consider a dosage of 300 mg every 4 weeks by subcutaneous injection. Each 300 mg dosage is given as one subcutaneous injection of 300 mg or as two subcutaneous injections of 150 mg.

2.5 Recommended Dosage in Non-Radiographic Axial Spondyloarthritis

Administer COSENTYX with or without a loading dosage by subcutaneous injection in adult patients with active nr-axSpA. The recommended dosage:

- With a loading dosage is 150 mg at Weeks 0, 1, 2, 3, and 4 and every 4 weeks thereafter.
- Without a loading dosage is 150 mg every 4 weeks.

2.6 Recommended Dosage in Enthesitis-Related Arthritis

The recommended weight-based dosage in pediatric patients 4 years of age and older with ERA is administered by subcutaneous injection at Weeks 0, 1, 2, 3, and 4 and every 4 weeks thereafter.

- For patients ≥ 15 kg and < 50 kg, the recommended dose is 75 mg.
- For patients ≥ 50 kg, the recommended dose is 150 mg.

2.7 Important Administration Instructions

COSENTYX is intended for use under the guidance and supervision of a physician.

The COSENTYX “Instructions for Use” for each dosage form contains more detailed instructions on the preparation and administration of COSENTYX [see *Instructions for Use*].

UnoReady Pen/Sensoready Pen/Prefilled Syringes

Adult patients may self-administer COSENTYX or be injected by a caregiver after proper training in subcutaneous injection technique.

Pediatric patients should not self-administer COSENTYX. An adult caregiver should prepare and inject COSENTYX after proper training in subcutaneous injection technique.

Administration Instructions

Administer each injection at a different anatomic location (such as upper arms, thighs, or any quadrant of abdomen) than the previous injection, and not into areas where the skin is tender, bruised, erythematous, indurated, or affected by psoriasis. Administration of COSENTYX in the upper, outer arm may be performed by a caregiver or healthcare provider.

2.8 Preparation for Use of COSENTYX 300 mg/2 mL UnoReady Pen, 150 mg/mL Sensoready Pen and Prefilled Syringes (300 mg/2 mL, 150 mg/mL, 75 mg/0.5 mL)

Before injection, remove COSENTYX from the refrigerator and allow COSENTYX to reach room temperature (15 to 30 minutes for the Sensoready pen, the 150 mg/mL and 75 mg/0.5 mL prefilled syringes; 30 to 45 minutes for the UnoReady pen and the 300 mg/2 mL prefilled syringe) without removing the needle cap.

The removable cap of the COSENTYX 150 mg/mL Sensoready pen and the COSENTYX prefilled syringes (150 mg/mL, 75 mg/0.5 mL) contain natural rubber latex and should not be handled by latex-sensitive individuals [see *Warnings and Precautions (5.5)*].

Inspect COSENTYX visually for particulate matter and discoloration prior to administration. COSENTYX injection is a clear to slightly opalescent, colorless to slightly yellow solution. Do not use if the liquid contains visible particles, is discolored or cloudy. Discard any unused product.

3 DOSAGE FORMS AND STRENGTHS

- Injection: 300 mg/2 mL as a clear to opalescent, colorless to slightly yellowish solution in a single-dose UnoReady pen
- Injection: 300 mg/2 mL as a clear to opalescent, colorless to slightly yellowish solution in a single-dose prefilled syringe
- Injection: 150 mg/mL as a clear to opalescent, colorless to slightly yellowish solution in a single-dose Sensoready pen
- Injection: 150 mg/mL as a clear to opalescent, colorless to slightly yellowish solution in a single-dose prefilled syringe
- Injection: 75 mg/0.5 mL as a clear to opalescent, colorless to slightly yellowish solution in a single-dose prefilled syringe (for pediatric patients less than 50 kg)

4 CONTRAINDICATIONS

COSENTYX is contraindicated in patients with a previous serious hypersensitivity reaction to secukinumab or to any of the excipients in COSENTYX. Cases of anaphylaxis have been reported during treatment with COSENTYX [see *Warnings and Precautions (5.4)*].

5 WARNINGS AND PRECAUTIONS

5.1 Infections

COSENTYX may increase the risk of infections. In clinical trials, a higher rate of infections was observed in COSENTYX treated subjects compared to placebo-treated subjects. In placebo-controlled clinical trials in subjects with moderate to severe plaque psoriasis, higher rates of common infections, such as nasopharyngitis (11.4% versus 8.6%), upper respiratory tract infection (2.5% versus 0.7%) and mucocutaneous infections with candida (1.2% versus 0.3%) were observed with COSENTYX compared with placebo. A similar increase in risk of infection was seen in placebo-controlled trials in subjects with PsA, AS and nr-axSpA. The incidence of some types of infections appeared to be dose-dependent in clinical studies [see *Adverse Reactions (6.1)*]. In the postmarketing setting, serious and some fatal infections have been reported in patients receiving COSENTYX.

Exercise caution when considering the use of COSENTYX in patients with a chronic infection or a history of recurrent infection.

Instruct patients to seek medical advice if signs or symptoms suggestive of an infection occur. If a patient develops a serious infection, monitor the patient closely and discontinue COSENTYX until the infection resolves.

5.2 Hypersensitivity Reactions

Anaphylaxis and cases of urticaria occurred in COSENTYX treated subjects in clinical trials. If an anaphylactic or other serious allergic reaction occurs, administration of COSENTYX should be discontinued immediately and appropriate therapy initiated [see *Contraindications (4)*, *Adverse Reactions (6.1)*].

5.3 Pre-Treatment Evaluation for Tuberculosis

Evaluate patients for tuberculosis (TB) infection prior to initiating treatment with COSENTYX. Avoid administration of COSENTYX to patients with active TB infection. Initiate treatment of latent TB prior to administering COSENTYX.

Consider anti-TB therapy prior to initiation of COSENTYX in patients with a past history of latent or active TB in whom an adequate course of treatment cannot be confirmed. Monitor patients closely for signs and symptoms of active TB during and after treatment.

5.4 Inflammatory Bowel Disease

Caution should be used when prescribing COSENTYX to patients with inflammatory bowel disease. Exacerbations, in some cases serious, occurred in COSENTYX treated subjects during clinical trials in plaque psoriasis, PsA, AS and nr-axSpA. In addition, new onset inflammatory bowel disease cases occurred in clinical trials with COSENTYX. In an exploratory trial in 59 subjects with active Crohn's disease, there were trends toward greater disease activity and increased adverse events in the secukinumab group as compared to the placebo group. Patients who are treated with COSENTYX should be monitored for signs and symptoms of inflammatory bowel disease [see *Adverse Reactions (6.1)*].

5.5 Eczematous Eruptions

In postmarketing reports, cases of severe eczematous eruptions, including atopic dermatitis-like eruptions, dyshidrotic eczema, and erythroderma, were reported in patients receiving COSENTYX; some cases resulted in hospitalization. The onset of eczematous eruptions was variable, ranging from days to months after the first dose of COSENTYX.

Treatment may need to be discontinued to resolve the eczematous eruption. Some patients were successfully treated for eczematous eruptions while continuing COSENTYX.

5.6 Risk of Hypersensitivity in Latex-Sensitive Individuals

The removable caps of the COSENTYX 150 mg/mL Sensoready pen and the COSENTYX 1 mL and 0.5 mL prefilled syringes contain natural rubber latex, which may cause an allergic reaction in latex-sensitive individuals. The safe use of COSENTYX 150 mg/mL Sensoready pen or 1 mL and 0.5 mL prefilled syringes in latex-sensitive individuals has not been studied.

5.7 Immunizations

Prior to initiating therapy with COSENTYX, consider completion of all age-appropriate immunizations according to current immunization guidelines. COSENTYX may alter a patient's immune response to live vaccines. Avoid use of live vaccines in patients treated with COSENTYX [see *Clinical Pharmacology (12.2)*].

6 ADVERSE REACTIONS

The following adverse reactions are discussed in greater detail elsewhere in the labeling:

- Infections [see *Warnings and Precautions (5.1)*]
- Hypersensitivity Reactions [see *Warnings and Precautions (5.2)*]
- Inflammatory Bowel Disease [see *Warnings and Precautions (5.4)*]

6.1 Clinical Trials Experience

Because clinical trials are conducted under widely varying conditions, adverse reaction rates observed in the clinical trials of a drug cannot be directly compared to rates in the clinical trials of another drug and may not reflect the rates observed in practice.

Adult Plaque Psoriasis

A total of 3430 plaque psoriasis adult subjects were treated with COSENTYX in controlled and uncontrolled clinical trials. Of these, 1641 subjects were exposed for at least 1 year.

Four placebo-controlled Phase 3 trials in plaque psoriasis subjects were pooled to evaluate the safety of COSENTYX in comparison to placebo up to 12 weeks after treatment initiation, in Trials PsO1, PsO2, PsO3, and PsO4. In total, 2077 subjects were evaluated (691 to COSENTYX 300 mg group, 692 to COSENTYX 150 mg group, and 694 to placebo group). Subjects randomized to COSENTYX received 300 mg or 150 mg doses subcutaneously at Weeks 0, 1, 2, 3, and 4 followed by the same dose every 4 weeks [see *Clinical Studies (14)*].

Table 1 summarizes the adverse reactions that occurred at a rate of at least 1% and at a higher rate in the COSENTYX groups than the placebo group during the 12-week placebo-controlled period of the placebo-controlled trials.

Table 1: Adverse Reactions Reported by Greater Than 1% of Adult Subjects With Plaque Psoriasis Through Week 12 in Trials PsO1, PsO2, PsO3, and PsO4

Adverse reactions	COSENTYX		Placebo (N = 694) n (%)
	300 mg (N = 691) n (%)	150 mg (N = 692) n (%)	
Nasopharyngitis	79 (11.4)	85 (12.3)	60 (8.6)
Diarrhea	28 (4.1)	18 (2.6)	10 (1.4)
Upper respiratory tract infection	17 (2.5)	22 (3.2)	5 (0.7)
Rhinitis	10 (1.4)	10 (1.4)	5 (0.7)
Oral herpes	9 (1.3)	1 (0.1)	2 (0.3)
Pharyngitis	8 (1.2)	7 (1.0)	0 (0)
Urticaria	4 (0.6)	8 (1.2)	1 (0.1)
Rhinorrhea	8 (1.2)	2 (0.3)	1 (0.1)

Adverse reactions that occurred at rates less than 1% in the placebo-controlled period of Trials PsO1, PsO2, PsO3, and PsO4 through Week 12 included: sinusitis, tinea pedis, conjunctivitis, tonsillitis, oral candidiasis, impetigo, otitis media, otitis externa, inflammatory bowel disease, increased liver transaminases, and neutropenia.

Infections

In the placebo-controlled period of the clinical trials in plaque psoriasis (a total of 1382 subjects treated with COSENTYX and 694 subjects treated with placebo up to 12 weeks), infections were reported in 28.7% of subjects treated with COSENTYX compared with 18.9% of subjects treated with placebo. Serious infections occurred in 0.14% of subjects treated with COSENTYX and in 0.3% of subjects treated with placebo.

Over the entire treatment period (a total of 3430 plaque psoriasis subjects treated with COSENTYX for up to 52 weeks for the majority of subjects), infections were reported in 47.5% of subjects treated with COSENTYX (0.9 per patient-year of follow-up). Serious infections were reported in 1.2% of subjects treated with COSENTYX (0.015 per patient-year of follow-up).

Phase 3 data showed an increasing trend for some types of infection with increasing serum concentration of secukinumab. Candida infections, herpes viral infections, staphylococcal skin infections, and infections requiring treatment increased as serum concentration of secukinumab increased.

In the psoriasis open-label extension of Trials PsO1 and PsO2 (median follow-up of 3.9 years), representing 3582 subject-years of exposure, 74% of COSENTYX treated subjects reported infections (55 per 100 patient-years). Serious infections were reported in 4.5% of subjects (1.4 per 100 patient-years). Sepsis was reported in 5 subjects (0.2 per 100 patient-years).

Neutropenia was observed in controlled portion of clinical trials. Most cases of secukinumab-associated neutropenia were transient and reversible. No serious infections were associated with cases of neutropenia.

In the open-label extension of Trials PsO1 and PsO2, neutropenia ($ANC < 1 \times 10^9/L$) was reported in 1% of COSENTYX treated subjects (0.3 per 100 patient-years). Some cases of serious infections were associated with neutropenia; however, the causal relationship was not established.

Inflammatory Bowel Disease

Cases of inflammatory bowel disease, in some cases serious, were observed in clinical trials with COSENTYX. In the plaque psoriasis program, with 3430 subjects exposed to COSENTYX over the entire treatment period for up to 52 weeks (2725 patient-years), there were 3 cases (0.11 per 100 patient-years) of exacerbation of Crohn's disease, 2 cases (0.08 per 100 patient-years) of exacerbation of ulcerative colitis, and 2 cases (0.08 per 100 patient-years) of new onset ulcerative colitis. There were no cases in placebo subjects (N = 793; 176 patient-years) during the 12-week placebo-controlled period.

One case of exacerbation of Crohn's disease was reported in open-label portions of clinical trials in plaque psoriasis.

Hypersensitivity Reactions

Anaphylaxis and cases of urticaria occurred in COSENTYX treated subjects in clinical trials [see *Warnings and Precautions (5.2)*].

Pediatric Plaque Psoriasis

The safety of COSENTYX was assessed in two Phase 3 trials in pediatric subjects with plaque psoriasis.

The first was a randomized, double-blind, placebo and active-controlled, 236-week trial (Trial PsO6) that enrolled 162 pediatric subjects 6 years of age and older, with severe plaque psoriasis (defined by PASI score ≥ 20 , an IGA modified 2011 score of 4, and involving $\geq 10\%$ of the body surface area [BSA]) who were candidates for systemic therapy. The 162 subjects were randomized to receive placebo, a biologic active control, or COSENTYX. In the COSENTYX groups, subjects with body weight less than 25 kg received 75 mg, subjects with body weight 25 to less than 50 kg received either 75 mg or 150 mg (2 times the recommended dose), and subjects with body weight of at least 50 kg received either 150 mg or 300 mg (2 times the recommended dose).

The second trial was a randomized, open-label, 208-week trial (Trial PsO7; NCT03668613) of 84 subjects 6 years of age and older with moderate to severe plaque psoriasis (defined by a PASI score ≥ 12 , IGA mod 2011 score of ≥ 3 , and BSA involvement of $\geq 10\%$ at randomization) who were randomized into two COSENTYX arms [Arm 1: 75 mg for body weight (BW) < 50 kg or 150 mg for ≥ 50 kg; and Arm 2: 75 mg for BW < 25 kg, 150 mg for BW ≥ 25 kg and < 50 kg, or 300 mg for BW ≥ 50 kg].

The safety profile reported in these trials was consistent with the safety profile reported in adult plaque psoriasis trials.

Infections

One case of methicillin-resistant *Staphylococcus aureus* (MRSA) toxic shock syndrome (TSS) was reported in a COSENTYX treated subject during the placebo-controlled period.

In the pediatric safety pool, which includes all subjects who took at least one dose of COSENTYX during the treatment periods [198 subjects (287 patient years)], 22 (11%) subjects reported \geq Common Terminology Criteria for Adverse Events (CTCAE) Grade 2 neutropenia ($\geq 1,000$ to $< 1,500$ cells/mm³) with 57% of subjects followed for one year or more and 30% of subjects followed for two years or more. During the placebo-controlled period which included a total of 80 subjects treated with secukinumab and 41 subjects treated with placebo up to 12 weeks, \geq CTCAE Grade 2 neutropenia was reported in 3 (4%) of the subjects treated with secukinumab compared with no subjects treated with placebo. No serious infections were associated with cases of neutropenia.

Adult Psoriatic Arthritis

COSENTYX was studied in two placebo-controlled PsA trials with 1003 adult patients (703 patients on COSENTYX and 300 patients on placebo). Of the 703 patients who received COSENTYX, 299 patients received a subcutaneous loading dose of COSENTYX (PsA1) and 404 patients received an intravenous loading dose of secukinumab (PsA2) followed by COSENTYX administered by subcutaneous injection every four weeks. During the 16-week placebo-controlled period of the trials in patients with PsA, the overall proportion of patients with adverse events was similar in the secukinumab and placebo-treatment groups (59% and 58%, respectively). The adverse events that occurred at a proportion of at least 2% and at a higher proportion in the COSENTYX groups than the placebo groups during the 16-week placebo-controlled period were nasopharyngitis, upper respiratory tract infection, headache, nausea, and hypercholesterolemia. The safety profile observed in patients with PsA treated with COSENTYX is consistent with the safety profile in psoriasis.

Similar to the clinical trials in patients with psoriasis, there was an increased proportion of patients with infections in the COSENTYX groups (29%) compared to placebo group (26%).

There were cases of Crohn's disease and ulcerative colitis that include patients who experienced either exacerbations or the development of new disease. There were three cases of inflammatory bowel disease, of which two patients received secukinumab and one received placebo.

Adult Ankylosing Spondylitis

COSENTYX was studied in two placebo-controlled AS trials with 590 adult patients (394 patients on COSENTYX and 196 patients on placebo). Of the 394 patients who received COSENTYX, 145 patients received a subcutaneous load of COSENTYX (study AS1), and 249 received an intravenous loading dose of secukinumab (study AS2) followed by COSENTYX administered by subcutaneous injection every four weeks. During the 16-week placebo-controlled period of

the trials in patients with AS, the overall proportion of patients with adverse events was higher in the secukinumab groups than the placebo-treatment groups (66% and 59%, respectively). The adverse events that occurred at a proportion of at least 2% and at a higher proportion in the COSENTYX groups than the placebo groups during the 16-week placebo-controlled period were nasopharyngitis, nausea, and upper respiratory tract infection. The safety profile observed in patients with ankylosing spondylitis treated with COSENTYX is consistent with the safety profile in psoriasis. In a third controlled study of AS (study AS3), the safety profile of the 300 mg dose of COSENTYX was consistent with the safety profile of the 150 mg dose of COSENTYX.

Similar to clinical trials in patients with psoriasis, there was an increased proportion of patients with infections in the COSENTYX groups (31%) compared to the placebo group (18%).

In the original AS program, with 571 patients exposed to COSENTYX there were 8 cases of inflammatory bowel disease during the entire treatment period [5 Crohn's (0.7 per 100 patient-years) and 3 ulcerative colitis (0.4 per 100 patient-years)]. During the placebo-controlled 16-week period, there were 2 Crohn's disease exacerbations and 1 new onset ulcerative colitis case that was a serious adverse event in patients treated with COSENTYX compared to none of the patients treated with placebo. During the remainder of the study when all patients received COSENTYX, 1 patient developed Crohn's disease, 2 patients had Crohn's exacerbations, 1 patient developed ulcerative colitis, and 1 patient had an ulcerative colitis exacerbation.

Adult Non-Radiographic Axial Spondyloarthritis

COSENTYX was studied in one randomized, double-blind, placebo-controlled nr-axSpA trial with 555 adult patients (185 patients on with load COSENTYX, 184 patients on without load COSENTYX and 186 patients on placebo). The safety profile for patients with nr-axSpA treated with COSENTYX was overall similar to the safety profile seen in patients with AS and other previous experience with COSENTYX. Patients in nr-axSpA1 study who received the loading dosing regimen compared to those without the loading regimen, had higher incidence of infections and infestations (92 per 100 patient-years vs 72 per 100 patient-years), including nasopharyngitis, upper respiratory tract infection and urinary tract infection, and gastrointestinal disorders (27 per 100 patient-years vs 22 per 100 patient-years), including gastritis, lower abdominal pain, colitis, diarrhea, and hematochezia.

Juvenile Psoriatic Arthritis and Enthesitis-Related Arthritis

COSENTYX was studied in one double-blind, placebo-controlled, event-driven, randomized trial in 86 pediatric patients aged 2 to less than 18 years old with Juvenile Psoriatic Arthritis (JPsA) and ERA. The safety profile reported in this study was consistent with the safety profile of secukinumab.

6.2 Immunogenicity

As with all therapeutic proteins, there is the potential for immunogenicity. The immunogenicity of COSENTYX was evaluated using an electrochemiluminescence-based bridging immunoassay. Less than 1% of subjects treated with COSENTYX developed antibodies to secukinumab in up to 52 weeks of treatment. However, this assay has limitations in detecting anti-secukinumab antibodies in the presence of secukinumab; therefore, the incidence of antibody development might not have been reliably determined. Of the subjects who developed antidrug antibodies, approximately one-half had antibodies that were classified as neutralizing. Neutralizing antibodies were not associated with loss of efficacy.

The detection of antibody formation is highly dependent on the sensitivity and specificity of the assay. Additionally, the observed incidence of antibody (including neutralizing antibody) positivity in an assay may be influenced by several factors, including assay methodology, sample handling, timing of sample collection, concomitant medications, and underlying disease. For these reasons, comparison of incidence of antibodies to COSENTYX with the incidences of antibodies to other products may be misleading.

6.3 Postmarketing Experience

The following adverse reactions have been reported during postapproval use of COSENTYX. Because they are reported voluntarily from a population of uncertain size, it is not always possible to reliably estimate their frequency or establish a causal relationship to drug exposure.

Skin and Subcutaneous Tissue Disorders: Eczematous eruptions (atopic dermatitis-like eruptions, dyshidrotic eczema, and erythroderma) [*see Warnings and Precautions (5.5)*].

7 DRUG INTERACTIONS

CYP450 Substrates

The formation of CYP450 enzymes can be altered by increased levels of certain cytokines (e.g., IL-1, IL-6, IL-10, TNF α , IFN) during chronic inflammation.

Upon initiation or discontinuation of COSENTYX in patients who are receiving concomitant CYP450 substrates, particularly those with a narrow therapeutic index, consider monitoring for therapeutic effect or drug concentration and consider dosage adjustment of the CYP450 substrate as needed [*see Clinical Pharmacology (12.3)*].

8 USE IN SPECIFIC POPULATIONS

8.1 Pregnancy

Risk Summary

Limited available human data with COSENTYX use in pregnant women are insufficient to inform a drug-associated risk of adverse developmental outcomes. In an embryo-fetal development study, no adverse developmental effects were observed in infants born to pregnant monkeys after subcutaneous administration of secukinumab during organogenesis at doses up to 30 times the maximum recommended human dose (MRHD) (*see Data*).

The background risk of major birth defects and miscarriage for the indicated population is unknown; however, the background risk in the U.S. general population of major birth defects is 2% to 4% and of miscarriage is 15% to 20% of clinically recognized pregnancies.

Data

Animal Data

An embryo-fetal development study was performed in cynomolgus monkeys with secukinumab. No malformations or embryo-fetal toxicity were observed in fetuses from pregnant monkeys that were administered secukinumab weekly by the subcutaneous route during the period of organogenesis at doses up to 30 times the MRHD (on a mg/kg basis at a maternal dose of 150 mg/kg).

A pre- and post-natal development toxicity study was performed in mice with a murine analog of secukinumab. No treatment-related effects on functional, morphological, or immunological development were observed in fetuses from pregnant mice that were administered the murine analog of secukinumab on gestation days 6, 11, and 17 and on postpartum days 4, 10, and 16 at doses up to 150 mg/kg/dose.

8.2 Lactation

Risk Summary

It is not known whether secukinumab is excreted in human milk or absorbed systemically after ingestion. There are no data on the effects of COSENTYX on the breastfed child or the effects on milk production. The developmental and health benefits of breastfeeding should be considered along with the mother's clinical need for COSENTYX and any potential adverse effects on the breastfed child from COSENTYX or from the underlying maternal condition.

8.4 Pediatric Use

Pediatric Plaque Psoriasis

The safety and effectiveness of COSENTYX have been established in pediatric patients aged 6 years and older with moderate to severe plaque psoriasis [*see Adverse Reactions (6.1)* and *Clinical Studies (14.2)*]. Safety and effectiveness of COSENTYX in pediatric patients with plaque psoriasis below the age of 6 years have not been established.

Juvenile Psoriatic Arthritis and Enthesitis-Related Arthritis

The safety and effectiveness of COSENTYX have been established in pediatric patients weighing 15 kg or more with JPsA (2 years and older) and ERA (4 years and older) [*see Adverse Reactions (6.1)* and *Clinical Studies (14.6)*].

The safety and effectiveness of COSENTYX in pediatric patients with JPsA below the age of 2 years and with body weight less than 15 kg have not been established.

The safety and effectiveness of COSENTYX in pediatric patients with ERA below the age of 4 years and with body weight less than 15 kg have not been established.

8.5 Geriatric Use

Of the 3430 plaque psoriasis subjects exposed to COSENTYX in clinical trials, a total of 230 (7%) were 65 years or older, and 32 (1%) subjects were 75 years or older. Although no differences in safety or efficacy were observed between older and younger subjects, the number of subjects aged 65 years and older was not sufficient to determine whether they responded differently from younger subjects.

10 OVERDOSAGE

Doses up to 30 mg/kg intravenously have been administered in clinical trials without dose-limiting toxicity. In the event of overdosage, it is recommended that the patient be monitored for any signs or symptoms of adverse reactions and appropriate symptomatic treatment be instituted immediately.

11 DESCRIPTION

Secukinumab, a recombinant human monoclonal IgG1/ κ antibody, is an interleukin-17A antagonist. It is expressed in a recombinant Chinese Hamster Ovary (CHO) cell line. Secukinumab has a molecular mass of approximately 151 kDa; both heavy chains of secukinumab contain oligosaccharide chains.

COSENTYX Injection

COSENTYX injection is a sterile, preservative-free, clear to slightly opalescent, colorless to slightly yellow solution for subcutaneous use. COSENTYX is supplied in a single-dose 300 mg/2 mL UnoReady pen with a 27-gauge fixed ½-inch needle, a single-dose 150 mg/mL Sensoready pen with a 27-gauge fixed ½-inch needle, or a single-dose prefilled syringe (300 mg/2mL, 150 mg/mL, 75 mg/0.5 mL) with a 27-gauge fixed ½-inch needle. The removable cap of the COSENTYX 150 mg/mL Sensoready pen or 1 mL and 0.5 mL prefilled syringes contains natural rubber latex.

Each COSENTYX 300 mg/2 mL UnoReady pen or 300 mg/2 mL prefilled syringe contains 300 mg of secukinumab formulated in: L-histidine/histidine hydrochloride monohydrate (6.206 mg), L-methionine (1.492 mg), polysorbate 80 (0.4 mg), trehalose dihydrate (151.34 mg), and Sterile Water for Injection, USP, at pH of 5.8.

Each COSENTYX 150 mg/mL Sensoready pen or 150 mg/mL prefilled syringe contains 150 mg of secukinumab formulated in: L-histidine/histidine hydrochloride monohydrate (3.103 mg), L-methionine (0.746 mg), polysorbate 80 (0.2 mg), trehalose dihydrate (75.67 mg), and Sterile Water for Injection, USP, at pH of 5.8.

Each COSENTYX 75 mg/0.5 mL prefilled syringe contains 75 mg of secukinumab formulated in: L-histidine/histidine hydrochloride monohydrate (1.552 mg), L-methionine (0.373 mg), polysorbate 80 (0.1 mg), trehalose dihydrate (37.83 mg), and Sterile Water for Injection, USP, at pH of 5.8.

12 CLINICAL PHARMACOLOGY

12.1 Mechanism of Action

Secukinumab is a human IgG1 monoclonal antibody that selectively binds to the interleukin-17A (IL-17A) cytokine and inhibits its interaction with the IL-17 receptor. IL-17A is a naturally occurring cytokine that is involved in normal inflammatory and immune responses. Secukinumab inhibits the release of proinflammatory cytokines and chemokines.

12.2 Pharmacodynamics

Elevated levels of IL-17A are found in psoriatic plaques. Treatment with COSENTYX may reduce epidermal neutrophils and IL-17A levels in psoriatic plaques. Serum levels of total IL-17A (free and secukinumab-bound IL-17A) measured at Week 4 and Week 12 were increased following secukinumab treatment. These pharmacodynamic activities are based on small exploratory studies. The relationship between these pharmacodynamic activities and the mechanism(s) by which secukinumab exerts its clinical effects is unknown.

Increased numbers of IL-17A producing lymphocytes and innate immune cells and increased levels of IL-17A have been found in the blood of patients with PsA and AS. Increased numbers of IL-17A producing lymphocytes have also been found in patients with nr-axSpA.

Immune Response to Non-Live Vaccines During Treatment

Healthy individuals who received a single 150 mg dose of COSENTYX 2 weeks prior to vaccination with a non-U.S.-approved group C meningococcal polysaccharide conjugate vaccine and a non-U.S.-approved inactivated seasonal influenza vaccine had similar antibody responses compared to individuals who did not receive COSENTYX prior to

vaccination. The clinical effectiveness of meningococcal and influenza vaccines has not been assessed in patients undergoing treatment with COSENTYX [see *Warnings and Precautions (5.7)*].

12.3 Pharmacokinetics

The pharmacokinetic (PK) properties of secukinumab observed in PsA, AS and nr-axSpA patients were similar to the PK properties displayed in plaque psoriasis patients.

Absorption

Following a single subcutaneous dose of either 150 mg (one-half the recommended dose) or 300 mg (administered as two injections of 150 mg) in plaque psoriasis subjects, secukinumab reached peak mean (\pm SD) serum concentrations (C_{max}) of 13.7 ± 4.8 mcg/mL and 27.3 ± 9.5 mcg/mL, respectively, by approximately 6 days post dose.

Following multiple subcutaneous doses of secukinumab (administered as one or two injections of 150 mg), the mean (\pm SD) serum trough concentrations of secukinumab ranged from 22.8 ± 10.2 mcg/mL (150 mg) to 45.4 ± 21.2 mcg/mL (300 mg) at Week 12. At the 300 mg dose at Week 4 and Week 12, the mean trough concentrations resulted from the 150 mg/mL Sensoready pen were 23% to 26% higher than those from the prefilled syringe based on cross-study comparisons. Following multiple subcutaneous doses of 300 mg administered via the 300 mg/2 mL UnoReady pen, the mean serum trough concentrations of secukinumab were generally consistent with those in the previous Sensoready pen study used to deliver 300 mg.

Steady-state concentrations of secukinumab were achieved by Week 24 following the every 4-week dosing regimens. The mean (\pm SD) steady-state trough concentrations ranged from 16.7 ± 8.2 mcg/mL (150 mg) to 34.4 ± 16.6 mcg/mL (300 mg administered as two injections of 150 mg).

In healthy subjects and subjects with plaque psoriasis, secukinumab bioavailability ranged from 55% to 77% following subcutaneous dose of 150 mg (one-half the recommended dose) or 300 mg (administered as two injections of 150 mg).

Distribution

The mean volume of distribution during the terminal phase (V_z) following a single intravenous administration ranged from 7.10 to 8.60 L in plaque psoriasis subjects. Intravenous use is not recommended [see *Dosage and Administration (2)*].

Secukinumab concentrations in interstitial fluid in lesional and non-lesional skin of plaque psoriasis subjects ranged from 27% to 40% of those in serum at 1 and 2 weeks after a single subcutaneous dose of secukinumab 300 mg (administered as two injections of 150 mg).

Elimination

Metabolism

The metabolic pathway of secukinumab has not been characterized. As a human IgG1 κ monoclonal antibody secukinumab is expected to be degraded into small peptides and amino acids via catabolic pathways in the same manner as endogenous IgG.

Excretion

The mean systemic clearance (CL) ranged from 0.14 L/day to 0.22 L/day and the mean half-life ranged from 22 to 31 days in plaque psoriasis subjects following intravenous and subcutaneous administration across all psoriasis trials. Intravenous use is not recommended [see *Dosage and Administration (2)*].

Dose Linearity

Secukinumab exhibited dose-proportional pharmacokinetics in subjects with psoriasis over a dose range from 25 mg (approximately 0.083 times the recommended dose) to 300 mg following subcutaneous administrations.

Weight

Secukinumab clearance and volume of distribution increase as body weight increases.

Specific Populations

Patients with Hepatic or Renal Impairment

No formal trial of the effect of hepatic or renal impairment on the pharmacokinetics of secukinumab was conducted.

Geriatric Patients

Population pharmacokinetic analysis indicated that the clearance of secukinumab was not significantly influenced by age in adult subjects with plaque psoriasis, PsA and AS. Subjects who are 65 years or older had apparent clearance of secukinumab similar to subjects less than 65 years old.

Pediatric Patients

In a pool of the two pediatric trials, subjects with moderate to severe plaque psoriasis (6 years of age and older) were administered secukinumab at the recommended pediatric dosing regimen. At Week 24, secukinumab steady state mean \pm SD serum trough concentrations were 32.6 ± 10.8 mcg/mL (n = 8), 19.8 ± 6.96 mcg/mL (n = 24), and 27.3 ± 10.1 mcg/mL (n = 36), in subjects weighing less than 25 kg and receiving 75 mg of secukinumab, subjects weighing at least 25 and less than 50 kg and receiving 75 mg of secukinumab, and subjects weighing at least 50 kg and receiving 150 mg of secukinumab, respectively.

In a pediatric study, JPsA and ERA patients (2 to less than 18 years of age) were administered secukinumab at the recommended pediatric dosing regimen. At Week 24, patients weighing at least 15 kg and less than 50 kg, and patients weighing at least 50 kg had a mean \pm SD steady-state trough concentration of 25.2 ± 5.45 mcg/mL (n = 10) and 27.9 ± 9.57 mcg/mL (n = 19), respectively.

Drug Interactions

Cytochrome P450 Substrates

In adult subjects with plaque psoriasis, midazolam (CYP3A4 substrate) pharmacokinetics was similar when administered alone, or when administered following either a single or five weekly subcutaneous administrations of 300 mg secukinumab [see *Drug Interactions (7.3)*].

13 NONCLINICAL TOXICOLOGY

13.1 Carcinogenesis, Mutagenesis, Impairment of Fertility

Animal studies have not been conducted to evaluate the carcinogenic or mutagenic potential of COSENTYX. Some published literature suggests that IL-17A directly promotes cancer cell invasion in vitro, whereas other reports indicate IL-17A promotes T-cell mediated tumor rejection. Depletion of IL-17A with a neutralizing antibody inhibited tumor development in mice. The relevance of experimental findings in mouse models for malignancy risk in humans is unknown.

No effects on fertility were observed in male and female mice that were administered a murine analog of secukinumab at subcutaneous doses up to 150 mg/kg once weekly prior to and during the mating period.

14 CLINICAL STUDIES

14.1 Adult Plaque Psoriasis

Four multicenter, randomized, double-blind, placebo-controlled trials (Trials PsO1, PsO2, PsO3, and PsO4) enrolled 2403 subjects (691 randomized to COSENTYX 300 mg, 692 to COSENTYX 150 mg, 694 to placebo, and 323 to a biologic active control) 18 years of age and older with plaque psoriasis who had a minimum BSA involvement of 10%, and Psoriasis Area and Severity Index (PASI) score greater than or equal to 12, and who were candidates for phototherapy or systemic therapy. In these studies, each 300 mg dose was administered as two injections of 150 mg.

- Trial PsO1 (NCT01365455) enrolled 738 subjects (245 randomized to COSENTYX 300 mg, 245 to COSENTYX 150 mg, and 248 to placebo). Subjects received subcutaneous treatment at Weeks 0, 1, 2, 3, and 4 followed by dosing every 4 weeks. Subjects randomized to COSENTYX received 300 mg or 150 mg doses at Weeks 0, 1, 2, 3, and 4 followed by the same dose every 4 weeks. Subjects randomized to receive placebo that were non-responders at Week 12 were then crossed over to receive COSENTYX (either 300 mg or 150 mg) at Weeks 12, 13, 14, 15, and 16 followed by the same dose every 4 weeks. All subjects were followed for up to 52 weeks following first administration of study treatment.
- Trial PsO2 (NCT01358578) enrolled 1306 subjects (327 randomized to COSENTYX 300 mg, 327 to COSENTYX 150 mg, 326 to placebo, and 323 to a biologic active control). COSENTYX and placebo data are described. Subjects received subcutaneous treatment at Weeks 0, 1, 2, 3, and 4 followed by dosing every 4 weeks. Subjects randomized to COSENTYX received 300 mg or 150 mg doses at Weeks 0, 1, 2, 3, and 4 followed by the same dose every 4 weeks.

Subjects randomized to receive placebo that were non-responders at Week 12 then crossed over to receive COSENTYX (either 300 mg or 150 mg) at Weeks 12, 13, 14, 15, and 16 followed by the same dose every 4 weeks. All subjects were followed for up to 52 weeks following first administration of study treatment.

- Trial PsO3 (NCT01555125) enrolled 177 subjects (59 randomized to COSENTYX 300 mg, 59 to COSENTYX 150 mg, and 59 to placebo) and assessed safety, tolerability, and usability of COSENTYX self-administration via prefilled syringe for 12 weeks. Subjects received subcutaneous treatment at Weeks 0, 1, 2, 3, and 4, followed by the same dose every 4 weeks for up to 12 weeks total.
- Trial PsO4 (NCT01636687) enrolled 182 subjects (60 randomized to COSENTYX 300 mg, 61 to COSENTYX 150 mg, and 61 to placebo) and assessed safety, tolerability, and usability of COSENTYX self-administration via Sensoready pen for 12 weeks. Subjects received subcutaneous treatment at Weeks 0, 1, 2, 3, and 4, followed by the same dose every 4 weeks for up to 12 weeks total.

Endpoints

In all trials, the endpoints were the proportion of subjects who achieved a reduction in PASI score of at least 75% (PASI 75) from baseline to Week 12 and treatment success (clear or almost clear) on the Investigator’s Global Assessment modified 2011 (IGA). Other evaluated outcomes included the proportion of subjects who achieved a reduction in PASI score of at least 90% (PASI 90) from baseline at Week 12, maintenance of efficacy to Week 52, and improvements in itching, pain, and scaling at Week 12 based on the Psoriasis Symptom Diary[®].

The PASI is a composite score that takes into consideration both the percentage of BSA affected and the nature and severity of psoriatic changes within the affected regions (induration, erythema, and scaling). The IGA is a 5-category scale, including “0 = clear”, “1 = almost clear”, “2 = mild”, “3 = moderate” or “4 = severe” indicating the physician’s overall assessment of the psoriasis severity focusing on induration, erythema, and scaling. Treatment success of “clear” or “almost clear” consisted of no signs of psoriasis or normal to pink coloration of lesions, no thickening of the plaque, and none to minimal focal scaling.

Baseline Characteristics

Across all treatment groups, the baseline PASI score ranged from 11 to 72 with a median of 20 and the baseline IGA score ranged from “moderate” (62%) to “severe” (38%). Of the 2077 plaque psoriasis subjects who were included in the placebo-controlled trials, 79% were biologic-naïve (have never received a prior treatment with biologics) and 45% were non-biologic failures (failed to respond to a prior treatment with non-biologic therapies). Of the subjects who received a prior treatment with biologics, over one-third were biologic failures. Approximately 15% to 25% of trial subjects had a history of psoriatic arthritis.

Clinical Response

The results of Trials PsO1 and PsO2 are presented in Table 2.

Table 2: Clinical Outcomes at Week 12 in Adults With Plaque Psoriasis in Trials PsO1 and PsO2

	Trial PsO1			Trial PsO2		
	COSENTYX 300 mg (N = 245) n (%)	COSENTYX 150 mg (N = 245) n (%)	Placebo (N = 248) n (%)	COSENTYX 300 mg (N = 327) n (%)	COSENTYX 150 mg (N = 327) n (%)	Placebo (N = 326) n (%)
PASI 75 response	200 (82)	174 (71)	11 (4)	249 (76)	219 (67)	16 (5)
IGA of clear or almost clear	160 (65)	125 (51)	6 (2)	202 (62)	167 (51)	9 (3)

The results of Trials PsO3 and PsO4 are presented in Table 3.

Table 3: Clinical Outcomes at Week 12 in Adults With Plaque Psoriasis in Trials PsO3 and PsO4

	Trial PsO3			Trial PsO4		
	COSENTYX 300 mg (N = 59) n (%)	COSENTYX 150 mg (N = 59) n (%)	Placebo (N = 59) n (%)	COSENTYX 300 mg (N = 60) n (%)	COSENTYX 150 mg (N = 61) n (%)	Placebo (N = 61) n (%)
PASI 75 response	44 (75)	41 (69)	0 (0)	52 (87)	43 (70)	2 (3)
IGA of clear or almost clear	40 (68)	31 (53)	0 (0)	44 (73)	32 (52)	0 (0)

Examination of age, gender, and race subgroups did not identify differences in response to COSENTYX among these subgroups. Based on post-hoc subgroup analyses in subjects with moderate to severe psoriasis, subjects with lower body weight and lower disease severity may achieve an acceptable response with COSENTYX 150 mg.

PASI 90 response at Week 12 was achieved with COSENTYX 300 mg and 150 mg compared to placebo in 59% (145/245) and 39% (95/245) versus 1% (3/248) of subjects, respectively (Trial PsO1) and 54% (175/327) and 42% (137/327) versus 2% (5/326) of subjects, respectively (Trial PsO2). Similar results were seen in Trials PsO3 and PsO4.

With continued treatment over 52 weeks, subjects in Trial PsO1 who were PASI 75 responders at Week 12 maintained their responses in 81% (161/200) of the subjects treated with COSENTYX 300 mg and in 72% (126/174) of subjects treated with COSENTYX 150 mg. Trial PsO1 subjects who were clear or almost clear on the IGA at Week 12 also maintained their responses in 74% (119/160) of subjects treated with COSENTYX 300 mg and in 59% (74/125) of subjects treated with COSENTYX 150 mg. Similarly in Trial PsO2, PASI 75 responders maintained their responses in 84% (210/249) of subjects treated with COSENTYX 300 mg and in 82% (180/219) of subjects treated with COSENTYX 150 mg. Trial PsO2 subjects who were clear or almost clear on the IGA also maintained their responses in 80% (161/202) of subjects treated with COSENTYX 300 mg and in 68% (113/167) of subjects treated with COSENTYX 150 mg.

Among the subjects who chose to participate (39%) in assessments of patient reported outcomes, improvements in signs and symptoms related to itching, pain, and scaling, at Week 12 compared to placebo (Trials PsO1 and PsO2) were observed using the Psoriasis Symptom Diary[®].

Psoriasis Lesions of Scalp

A randomized, placebo-controlled trial (Trial PsO5; NCT02267135) enrolled 102 subjects with moderate to severe psoriasis lesions of scalp, defined as having a Psoriasis Scalp Severity Index (PSSI) score of greater than or equal to 12, an IGA scalp only score of 3 or greater, and at least 30% of the scalp affected. In this trial, 62% of subjects had at least 50% of scalp surface area affected. In this study, each 300 mg dose was administered as two injections of 150 mg. The proportions of subjects achieving an IGA scalp only score of 0 or 1 (clear or almost clear) were 56.9% and 5.9% for the COSENTYX 300 mg and the placebo groups, respectively.

300 mg/2 mL Pre-filled Syringe and 300 mg/2 mL UnoReady Pen

Two randomized, double-blind, placebo-controlled, 52-week trials (PsO6 and PsO7) enrolled 336 subjects at least 18 years of age with moderate to severe plaque psoriasis who are candidates for systemic therapy of phototherapy to evaluate the safety and efficacy of COSENTYX 300 mg administered with a single 300 mg/2 mL prefilled syringe (Trial PsO6, NCT02748863, 214 patients) or with a single 300 mg/2 mL UnoReady pen (Trial PsO7, NCT03589885, 122 patients) compared to two subcutaneous injections using a 150 mg/1 mL prefilled syringe. The co-primary endpoints for both trials were the proportion of subjects who achieved a PASI 75 response and IGA mod 2011 'clear' or 'almost clear' response with at least a two-grade reduction from baseline at Week 12.

Table 4: Clinical Outcomes at Week 12 in Adults With Plaque Psoriasis in Trials PsO6 and PsO7

	Trial PsO6			Trial PsO7		
	COSENTYX 300 mg		Placebo (N = 71) %	COSENTYX 300 mg		Placebo (N = 40) %
	2 mL PFS (N = 72) %	Two 1 mL PFS (N = 71) %		2 mL Pen (N = 41) %	Two 1 mL PFS (N = 41) %	
IGA of clear or almost clear	76	69	1	76	68	8
PASI 75 response	89	82	2	95	83	10
PASI 90 response	67	70	2	76	62	5

Missing data was imputed using multiple imputation. PFS=Prefilled syringe

14.2 Pediatric Plaque Psoriasis

A 52-week, multicenter randomized, double-blind, placebo and active-controlled trial (Trial PsO8; NCT02471144) enrolled 162 pediatric subjects 6 years of age and older, with severe plaque psoriasis (as defined by a PASI score ≥ 20 , an IGA modified 2011 score of 4, and involving $\geq 10\%$ of the BSA) who were candidates for systemic therapy.

Subjects were randomized to receive placebo, COSENTYX, or a biologic active control. In the COSENTYX groups, subjects with body weight less than 25 kg received 75 mg, subjects with body weight 25 to less than 50 kg received either 75 mg or 150 mg (2 times the recommended dose), and subjects with body weight at least 50 kg received either 150 mg or 300 mg (2 times the recommended dose). In this study, each 300 mg dose was administered as two injections of 150 mg. Subjects in the COSENTYX and placebo groups received subcutaneous treatment at Weeks 0, 1, 2, 3, and 4 followed by dosing every 4 weeks. At Week 12, subjects randomized to placebo who were non-responders were switched to COSENTYX (dose based on body weight) and received COSENTYX at Weeks 12, 13, 14, and 15, followed by the same dose every 4 weeks starting at Week 16.

Baseline Characteristics

Overall, 60% of the subjects were female, 83% were Caucasian, the median body weight was 50.6 kg, and the mean age was 13.5 years with 23% of the subjects less than 12 years. At baseline, the median PASI score was 26 (ranged from 17 to 60), and 99% of the subjects had an IGA modified 2011 score of 4 ('severe'). Approximately 43% of the subjects had prior exposure to phototherapy, 53% to conventional systemic therapy, 3% to biologics, and 9% had concomitant psoriatic arthritis.

Endpoints

The co-primary endpoints were the proportion of subjects who achieved a reduction in PASI score of at least 75% (PASI 75) from baseline to Week 12 and the proportion of subjects who achieved an IGA modified 2011 score of 'clear' or 'almost clear' (0 or 1) with at least a 2-point improvement from baseline to Week 12. The key secondary endpoint was the proportion of subjects who achieved a reduction in PASI score of at least 90% (PASI 90) from baseline to Week 12.

Clinical Response

Table 5 presents the efficacy results at Week 12 by baseline weight strata for the approved dose.

Table 5: Clinical Outcomes at Week 12 in Pediatric Subjects With Severe Plaque Psoriasis in Trial PsO8

	Body weight < 50 kg		Body weight \geq 50 kg		Total	
	COSENTYX 75 mg (N = 22) n (%)	Placebo (N = 20) n (%)	COSENTYX 150 mg (N = 21) n (%)	Placebo (N = 21) n (%)	COSENTYX ^a (N = 43) n (%)	Placebo (N = 41) n (%)
IGA of clear or almost clear	7 (32)	1 (5)	17 (81)	1 (5)	24 (56)	2 (5)
PASI 75 response	12 (55)	2 (10)	18 (86)	4 (19)	30 (70)	6 (15)
PASI 90 response	9 (41)	1 (5)	17 (81)	0 (0)	26 (60)	1 (2)

Non-responder imputation was used to handle missing values.
^aCOSENTYX treated subjects received 75 mg for subjects less than 50 kg and 150 mg for subjects at least 50 kg body weight.

14.3 Adult Psoriatic Arthritis

The safety and efficacy of COSENTYX were assessed in 1999 patients, in 3 randomized, double-blind, placebo-controlled studies (PsA1, PsA2 and PsA3) in adult patients, age 18 years and older with active psoriatic arthritis (greater than or equal to 3 swollen and greater than or equal to 3 tender joints) despite non-steroidal anti-inflammatory drug (NSAID), corticosteroid or disease modifying anti-rheumatic drug (DMARD) therapy. Patients in these studies had a diagnosis of PsA of at least 5 years across all studies. At baseline, over 61% and 42% of the patients had enthesitis and dactylitis, respectively. Overall, 31% of patients discontinued previous treatment with anti-TNF α agents due to either lack of efficacy or intolerance. In addition, approximately 53% of patients from both studies had concomitant methotrexate (MTX) use. Patients with different subtypes of PsA were enrolled, including polyarticular arthritis with no evidence of rheumatoid nodules (80%), asymmetric peripheral arthritis (63%), distal interphalangeal involvement (58%), spondylitis with peripheral arthritis (20%), and arthritis mutilans (7%).

PsA1 Study (NCT 01752634) evaluated 397 patients, who were treated with COSENTYX 75 mg, 150 mg or 300 mg (administered as two injections of 150 mg) subcutaneous treatment at Weeks 0, 1, 2, 3, and 4, followed by the same dose

every 4 weeks. Patients receiving placebo were re-randomized to receive COSENTYX (either 150 mg or 300 mg every 4 weeks) at Week 16 or Week 24 based on responder status. The primary endpoint was the percentage of patients achieving an ACR20 response at Week 24.

PsA2 Study (NCT 01392326) evaluated 606 patients, who were treated with secukinumab 10 mg/kg, intravenous treatment (or placebo) at Weeks 0, 2, and 4, followed by either 75 mg or 150 mg subcutaneous COSENTYX treatment (or placebo) every 4 weeks. Patients receiving placebo were re-randomized to receive COSENTYX (either 75 mg or 150 mg every 4 weeks) at Week 16 or Week 24 based on responder status.

PsA3 Study (NCT 02404350) evaluated 996 patients, who were treated with COSENTYX 150 mg or 300 mg (administered as two injections of 150 mg) subcutaneous treatment at Weeks 0, 1, 2, 3, and 4 followed by the same dose every 4 weeks, or once every 4 weeks of COSENTYX 150 mg. Patients treated with placebo received COSENTYX, either 150 mg or 300 mg, subcutaneous, per baseline randomization, at Week 16 or Week 24 based upon responder status. The primary endpoint was ACR20 response at Week 16 with the key secondary endpoint the change from baseline in modified Total Sharp Score (mTSS) at Week 24.

Clinical Response

In PsA1, patients treated with 150 mg or 300 mg COSENTYX demonstrated a greater clinical response, including ACR20, ACR50, and ACR70 compared to placebo at Week 24 (Table 6). Responses were similar in patients regardless of concomitant methotrexate treatment. Responses were seen regardless of prior anti-TNF α exposure.

In patients with coexistent plaque psoriasis receiving COSENTYX (n = 99), the skin lesions of psoriasis improved with treatment, relative to placebo, as measured by the Psoriasis Area Severity Index (PASI).

Table 6: Responses^a in PsA1 Study at Week 16 and Week 24

	COSENTYX 150 mg (N = 100)	COSENTYX 300 mg (N = 100)	Placebo (N = 98)	Difference from placebo (95% CI)	
				COSENTYX 150 mg	COSENTYX 300 mg
ACR20 response					
Week 16 (%)	60	57	18	42 (30, 54)	38 (26, 51)
Week 24 (%)	51	54	15	36 (24, 48)	39 (27, 51)
ACR50 response					
Week 16 (%)	37	35	6	31 (21, 42)	28 (18, 39)
Week 24 (%)	35	35	7	28 (18, 38)	28 (17, 38)
ACR70 response					
Week 16 (%)	17	15	2	15 (7, 23)	13 (5, 20)
Week 24 (%)	21	20	1	20 (12, 28)	19 (11, 27)

^aPatients who met escape criteria (less than 20% improvement in tender or swollen joint counts) at Week 16 were considered non-responders.

The percentage of patients achieving ACR20 response by visit is shown in Figure 1. Patients on placebo who received COSENTYX without a loading regimen achieved similar ACR20 responses over time (data not shown).

Figure 1: Percent of Patients Achieving ACR 20 Response^a in PsA1 Study Through Week 24

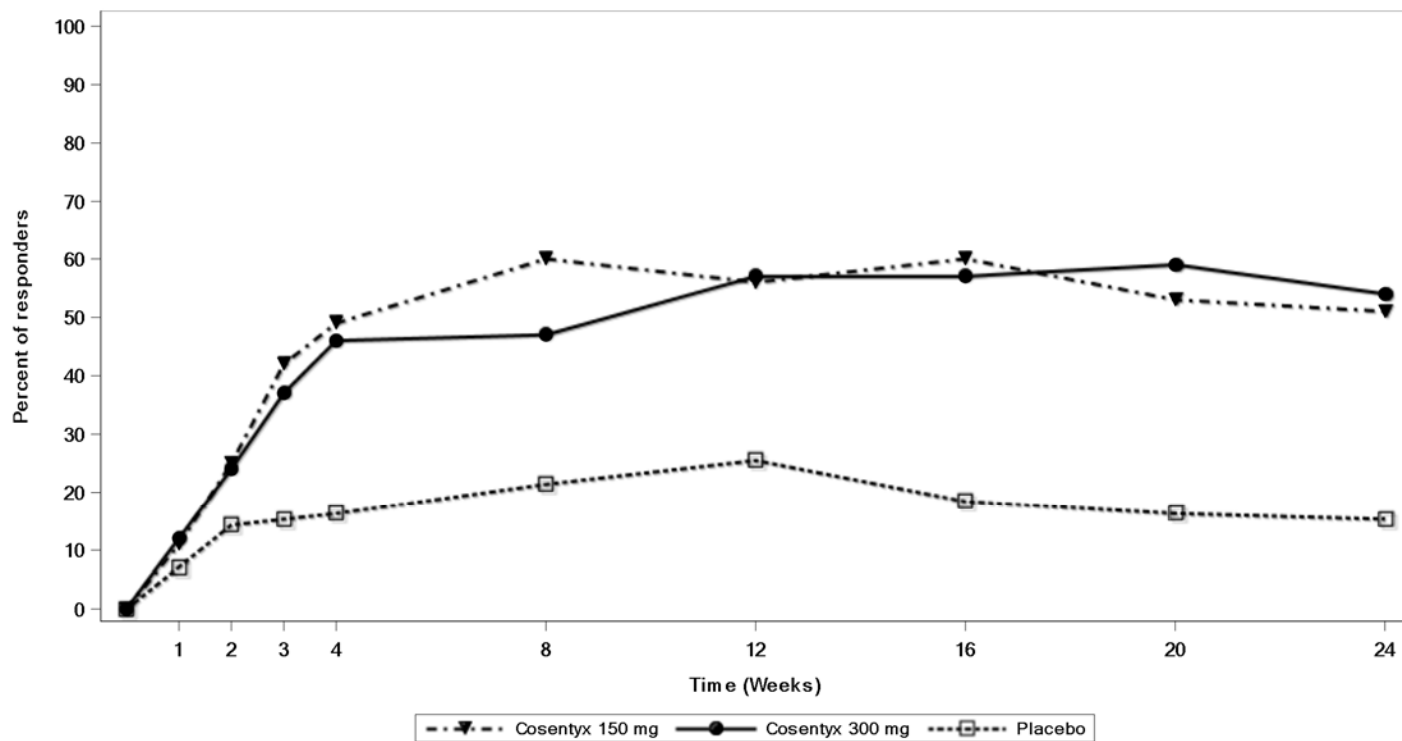

^aPatients who met escape criteria (less than 20% improvement in tender or swollen joint counts) at Week 16 were considered non-responders.

The improvements in the components of the ACR response criteria are shown in Table 7.

Table 7: Mean Change From Baseline in ACR Components at Week 16^a (PsA1 Study)

	COSENTYX 150 mg (N = 100)	COSENTYX 300 mg (N = 100)	Placebo (N = 98)
No. of swollen joints			
Baseline	12.0	11.2	12.1
Mean change at Week 16	-4.86	-5.83	-3.22
Number of tender joints			
Baseline	24.1	20.2	23.5
Mean change at Week 16	-10.70	-10.01	-1.77
Patient's assessment of pain			
Baseline	58.9	57.7	55.4
Mean change at Week 16	-22.91	-23.97	-7.98
Patient global assessment			
Baseline	62.0	60.7	57.6
Mean change at Week 16	-25.47	-25.40	-8.25
Physician global assessment			
Baseline	56.7	55.0	55.0
Mean change at Week 16	-29.24	-34.71	-14.95
Disability index (HAQ)			
Baseline	1.2200	1.2828	1.1684
Mean change at Week 16	-0.45	-0.55	-0.23
CRP (mg/L)			
Baseline	14.15	10.88	7.87
Mean change at Week 16 ^b	-8.41	-7.21	0.79

^aWeek 16 rather than Week 24 data are displayed to provide comparison between arms prior to placebo escape to COSENTYX.

^bMean change based upon observed data.

Improvements in enthesitis and dactylitis scores were observed in each COSENTYX group compared to placebo at Week 24.

Radiographic Response

In PsA3 Study, inhibition of progression of structural damage was assessed radiographically and expressed by the modified mTSS and its components, the Erosion Score (ES) and Joint Space Narrowing Score (JSN), at Week 24 compared to baseline. Radiographs of hands, wrists, and feet were obtained at baseline, Week 16 and/or Week 24 and scored independently by at least two readers who were blinded to treatment group and visit number. COSENTYX 150 mg without load, 150 mg with load and 300 mg with load treatment significantly inhibited progression of peripheral joint damage compared with placebo treatment as measured by change from baseline in mTSS at Week 24. The percentage of patients with no disease progression (defined as a change from baseline in mTSS of less than or equal to 0.0) from randomization to Week 24 was 75.7%, 70.9%, and 76.5% for COSENTYX 150 mg without load, 150 mg, 300 mg, respectively versus 68.2% for placebo.

Table 8: Rate of Change per 24 Weeks in Modified Total Sharp Score

Treatment	N	Rate of change per 24 weeks	Difference from placebo (95% CI)
COSENTYX 150 mg without load	210	-0.10	-0.61 (-0.95, -0.26)
COSENTYX 150 mg with load	213	0.14	-0.37 (-0.71, -0.03)
COSENTYX 300 mg with load	217	0.03	-0.48 (-0.82, -0.14)
Placebo	296	0.51	--

Results from a linear mixed effects model that excluded data after escape for placebo subjects who received escape therapy at Week 16. The model assumes approximately linear progression over time and estimates a difference in rates (slopes) of progression over 24 weeks to compare treatment arms.

Physical Function

Improvement in physical function as assessed by Health Assessment Questionnaire-Disability Index (HAQ-DI) demonstrated that the proportion of patients who achieved at least -0.3 improvement in HAQ-DI score from baseline was greater in the COSENTYX 150 mg and 300 mg groups compared to placebo at Weeks 16 and 24. At Week 16 in PsA1 study, estimated mean change from baseline was -0.23 in the placebo group compared with -0.45 in the COSENTYX 150 mg group and -0.55 in the COSENTYX 300 mg group.

14.4 Ankylosing Spondylitis

The safety and efficacy of COSENTYX were assessed in 816 patients in three randomized, double-blind, placebo-controlled studies (AS1, AS2, and AS3) in adult patients 18 years of age and older with active ankylosing spondylitis. Patients had active disease as defined by the Bath Ankylosing Spondylitis Disease Activity Index (BASDAI) greater or equal to 4 despite non-steroidal anti-inflammatory drug (NSAID), corticosteroid or disease modifying anti-rheumatic drug (DMARD) therapy. At baseline, approximately 13% and 25% used concomitant methotrexate or sulfasalazine, respectively. Overall, 29% of patients discontinued previous treatment with anti-TNF α agents due to either lack of efficacy or intolerance.

AS1 Study (NCT01649375) evaluated 219 patients, who were treated with COSENTYX 75 mg or 150 mg subcutaneous treatment at Weeks 0, 1, 2, 3, and 4, followed by the same dose every 4 weeks. At Week 16, patients receiving placebo were re-randomized to either COSENTYX 75 mg or 150 mg every 4 weeks. The primary endpoint was the percentage of patients achieving an ASAS20 response at Week 16.

AS2 Study (NCT01358175) evaluated 371 patients, who were treated with secukinumab 10 mg/kg intravenous treatment at Weeks 0, 2, and 4 (for both treatment arms) or placebo, followed by either 75 mg or 150 mg subcutaneous COSENTYX treatment every 4 weeks or placebo. Patients receiving placebo were re-randomized to receive COSENTYX (either 75 mg or 150 mg every 4 weeks) at Week 16 or Week 24 based on responder status.

AS3 Study (NCT02008916) evaluated 226 patients, who were treated with secukinumab 10 mg/kg intravenous treatment at Weeks 0, 2, and 4 (for both treatment arms) or placebo, followed by either 150 mg or 300 mg subcutaneous COSENTYX treatment every 4 weeks or placebo. Patients receiving placebo were re-randomized to receive COSENTYX (either 150 mg or 300 mg every 4 weeks) at Week 16. The primary endpoint was the percentage of patients achieving an

ASAS20 response at Week 16. Patients were blinded to the treatment regimen up to Week 52, and the study continued to Week 156. In this study, each 300 mg dose was administered as two injections of 150 mg.

Clinical Response

In AS1, patients treated with 150 mg COSENTYX demonstrated greater improvements in ASAS20 and ASAS40 responses compared to placebo at Week 16 (Table 9). Responses were similar in patients regardless of concomitant therapies.

Table 9: ASAS20 and ASAS40 Responses in All AS Patients at Week 16 in Study AS1

	COSENTYX 150 mg (n = 72)	Placebo (n = 74)	Difference from placebo (95% CI)
ASAS20 response, %	61	28	33 (18, 48)
ASAS40 response, %	36	11	25 (12, 38)

The improvements in the main components of the ASAS20 response criteria and other measures of disease activity are shown in Table 10.

Table 10: ASAS20 Components and Other Measures of Disease Activity at Week 16 (AS1 Study)

	COSENTYX 150 mg (N = 72)		Placebo (N = 74)	
	Baseline	Week 16 change from baseline	Baseline	Week 16 change from baseline
ASAS20 response criteria				
-Patient Global Assessment of Disease Activity (0-100 mm) ¹	67.5	-27.7	70.5	-12.9
-Total spinal pain (0-100 mm)	66.2	-28.5	69.2	-10.9
-BASFI (0-10) ²	6.2	-2.2	6.1	-0.7
-Inflammation (0-10) ³	6.5	-2.5	6.5	-0.8
BASDAI score⁴	6.6	-2.2	6.8	-0.9
BASMI⁵	3.6	-0.51	3.9	-0.22
hsCRP⁶ (mg/L) mean change at Week 16	27.0	-17.2	15.9	0.8

1. Percent of subjects with at least a 20%- and 10-unit improvement measured on a Visual Analog Scale (VAS) with 0 = none, 100 = severe.
2. Bath Ankylosing Spondylitis Functional Index.
3. Inflammation is the mean of two patient-reported stiffness self-assessments in BASDAI.
4. Bath Ankylosing Spondylitis Disease Activity Index.
5. Bath Ankylosing Spondylitis Metrology Index.
6. High sensitivity C-reactive protein / mean change based upon observed data.

The percentage of patients achieving ASAS20 responses by visit is shown in Figure 2. Patients on placebo who received COSENTYX without a loading regimen achieved similar ASAS20 responses over time (data not shown).

Figure 2: ASAS20 Responses in All AS1 Study Patients Over Time Up to Week 16

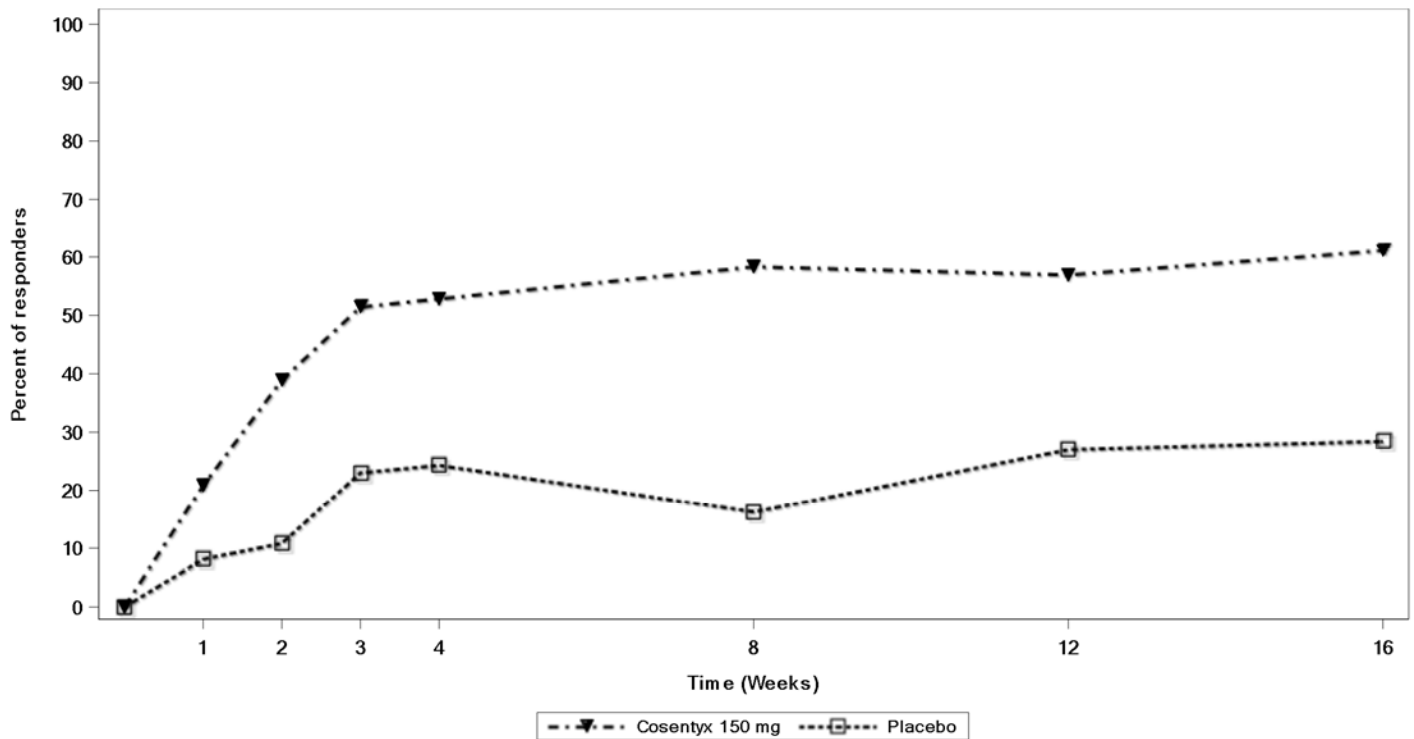

In AS3 Study, patients treated with COSENTYX (150 mg and 300 mg) demonstrated improved signs and symptoms, and had comparable efficacy responses, regardless of dose, that were superior to placebo at Week 16 for the primary and most secondary endpoints. At Week 16, the ASAS20 and ASAS40 responses were 58.1% and 40.5% for 150 mg and 60.5% and 42.1% for 300 mg, respectively. The percent of patients achieving ASAS20 responses by visit is shown in Figure 3.

Figure 3: ASAS20 Responses in All AS3 Study Patients Over Time Up to Week 16

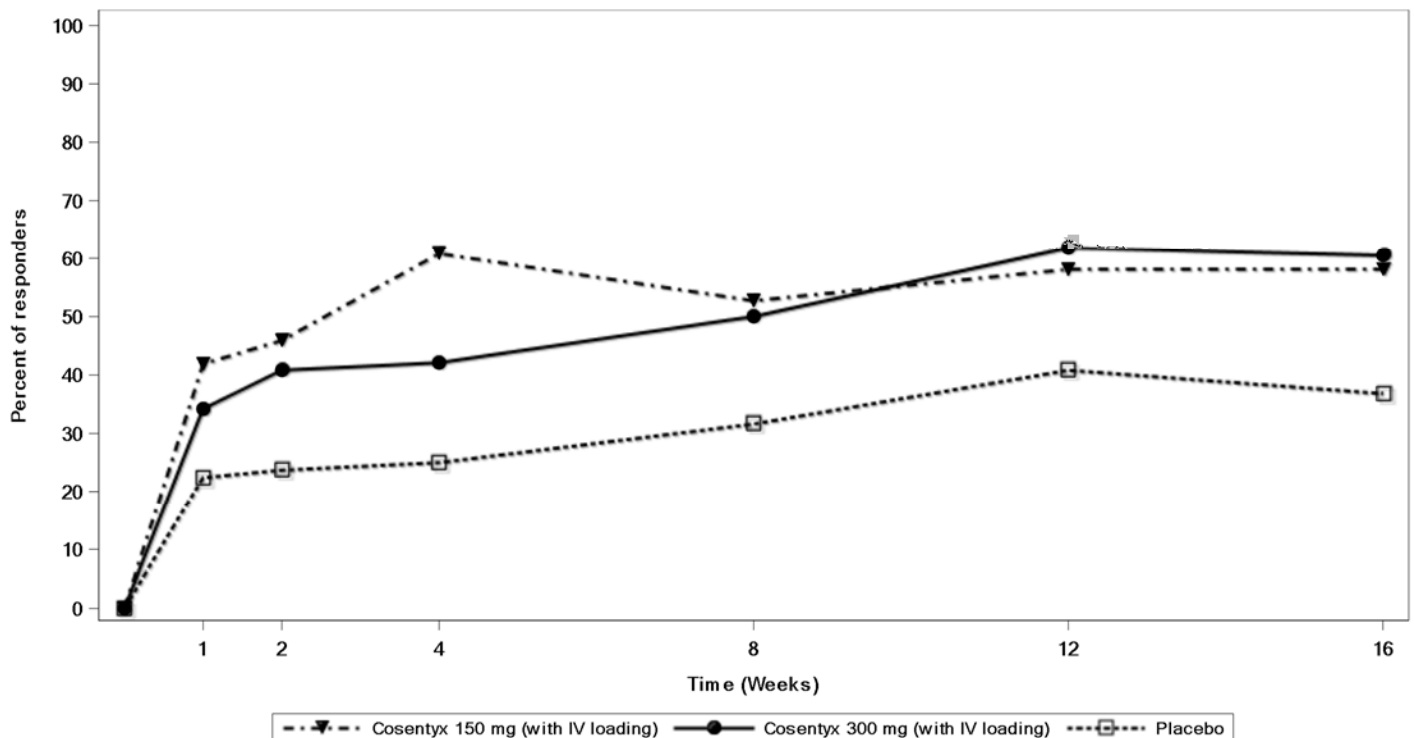

COSENTYX treated patients showed improvement compared to placebo-treated patients in health-related quality of life as assessed by ASQoL at Week 16.

14.5 Non-Radiographic Axial Spondyloarthritis

The safety and efficacy of COSENTYX were assessed in 555 patients in one randomized, double-blind, placebo-controlled Phase 3 study (nr-axSpA1, NCT02696031) in adult patients 18 years of age and older with active non-radiographic axial spondyloarthritis. Patients met ASAS criteria for axial spondyloarthritis and had active disease as defined by a BASDAI greater or equal to 4, a Visual Analogue Scale (VAS) for total back pain greater or equal to 40 (on a scale of 0-100 mm) despite NSAID therapy and no evidence of radiographic changes in the sacroiliac joints that would meet the modified New York criteria for AS. Patients also had to have objective signs of inflammation with a C-reactive protein (CRP) level above the upper limit of normal and/or evidence of sacroiliitis on Magnetic Resonance Imaging (MRI). Approximately 10% and 15% of patients used concomitant methotrexate or sulfasalazine, respectively. Overall, 10% of patients had received previous treatment with anti-TNF α agents and discontinued these due to either lack of efficacy or intolerance.

Patients were treated with COSENTYX 150 mg subcutaneous treatment with load (Weeks 0, 1, 2, 3, and 4) or without a load (Weeks 0 and 4) followed by the same dose every 4 weeks or placebo. In the double-blind period, patients (n = 555) received either placebo or COSENTYX for 52 weeks. Starting Week 16, dose adjustment or addition of concomitant NSAIDs and DMARDs was permitted. Starting at Week 20, patients were allowed to switch to open-label COSENTYX 150 mg monthly or other biologic at the discretion of the investigator and patient. The primary endpoint was at least 40% improvement in Assessment of Spondyloarthritis International Society (ASAS40) at Week 52.

Clinical Response

In nr-axSpA1 Study, treatment with COSENTYX 150 mg resulted in significant improvements in the measure of disease activity compared to placebo at Week 16 and Week 52 (Table 11).

Table 11: Clinical Response in nr-axSpA1 Study at Week 16 and Week 52

Number of subjects with ASAS40 response (%)	COSENTYX 150 mg without load (n = 184)	COSENTYX 150 mg with load (n = 185)	Placebo (n = 186)	Difference from placebo (95% CI)	
				COSENTYX 150 mg without load	COSENTYX 150 mg with load
Week 16	75 (41)	74 (40)	52 (28)	13 (3, 22)	12 (2, 22)
Week 52	70 (38)	62 (34)	36 (19)	19 (10, 28)	14 (5, 23)

Difference in proportions with 95% CI based on normal approximation.

The results of the main components of the ASAS40 response criteria are shown in Table 12.

Table 12: Main Components of the ASAS40 Response Criteria and Other Measures of Disease Activity in nr-axSpA Patients at Baseline and Week 16 in nr-axSpA1 Study

	COSENTYX 150 mg without load (N = 184)		COSENTYX 150 mg with load (N = 185)		Placebo (N = 186)	
	Baseline	Week 16 change from baseline	Baseline	Week 16 change from baseline	Baseline	Week 16 change from baseline
ASAS40 response criteria						
-Patient Global Assessment of Disease Activity (0-100 mm)	71.0	-26.2	72.6	-24.1	68.8	-13.8
-Total back pain (0-100 mm)	72.0	-25.5	73.3	-25.0	70.9	-15.6
-BASFI (0-10)	5.9	-1.6	6.2	-1.8	5.9	-1.0
-Inflammation (0-10)	6.8	-2.8	7.2	-2.8	6.6	-1.7
hsCRP (mg/L) mean change at Week 16	9.8	-4.7	13.4	-7.9	9.2	-2.4
BASDAI (0-10)						
-Spinal pain	6.9	-2.4	7.1	-2.4	6.8	-1.5
-Peripheral pain and swelling (0-10)	7.6	-3.0	7.8	-3.0	7.5	-2.0
	6.6	-2.4	6.3	-2.3	6.1	-1.6
BASMI	2.8	-0.3	2.9	-0.3	2.8	-0.1

The percentage of patients achieving an ASAS40 response by visit is shown in Figure 4.

Figure 4: ASAS40 Responses in nr-axSpA1 Study Over Time up to Week 16

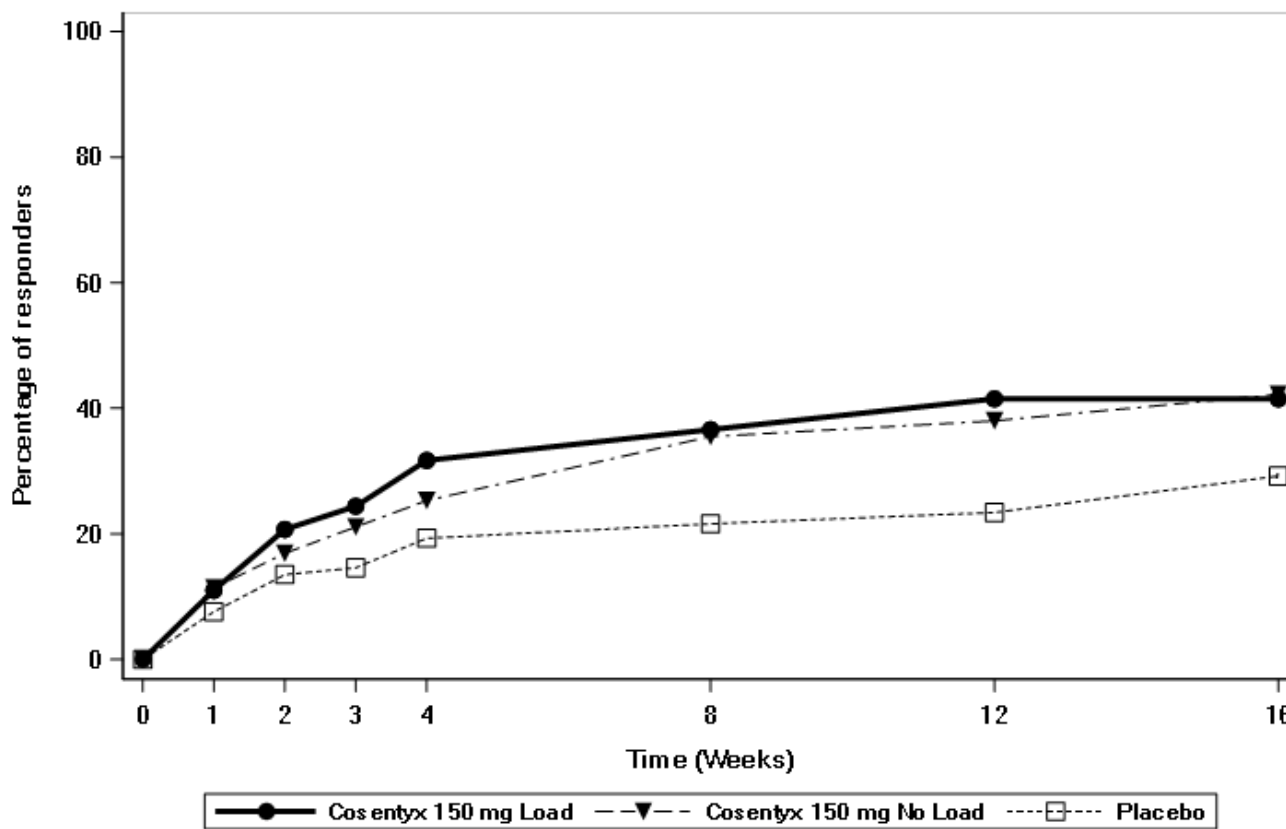

Health-Related Quality of Life

COSENTYX treated patients showed improvement in both load and without load arms compared to placebo-treated patients at Week 16 in health-related quality of life as measured by ASQoL (LS mean change: Week 16: -3.5 and -3.6 versus -1.8, respectively).

14.6 Juvenile Psoriatic Arthritis and Enthesitis-Related Arthritis

The efficacy and safety of secukinumab were assessed in 86 patients in a two-year, 3-part, double-blind, placebo-controlled, event-driven, randomized, Phase 3 study (NCT03031782) in patients 2 to less than 18 years of age with active ERA or JPsA as diagnosed based on a modified International League of Associations for Rheumatology (ILAR) Juvenile Idiopathic Arthritis (JIA) classification criteria. The study consisted of an open-label portion (Part 1) followed by randomized withdrawal (Part 2) followed by open-label treatment (Part 3). The JIA patient subtypes at study entry were: 60.5% ERA and 39.5% JPsA. In the study 67.6% of patients with JPsA, and 63.5% of patients with ERA, were treated concomitantly with methotrexate (MTX). Patients were given a dose of 75 mg if weighing less than 50 kg, or 150 mg if weighing at least 50 kg.

The primary endpoint was time to flare in Part 2. Disease flare was defined as at least 30% worsening in at least three of the six JIA ACR response criteria and at least 30% improvement in not more than one of the six JIA ACR response criteria and a minimum of two active joints.

In open-label Part 1, all patients received secukinumab until Week 12. Patients classified as responders (achieving JIA ACR30 response) at Week 12 entered into the Part 2 double-blind phase and were randomized 1:1 to continue treatment with secukinumab or begin treatment with placebo. Similar responses were seen in each JIA subtype (JPsA and ERA). The JIA ACR 30, 50, 70, and 90 responses for patients with JPsA and ERA at Week 12 are presented below in Table 13.

Table 13: JIA ACR 30, 50, 70, and 90 Responses at Week 12

Number of subjects with response (%)	JIA ACR 30	JIA ACR 50	JIA ACR 70	JIA ACR 90
JPsA (N = 34)	31 (91)	31 (91)	24 (71)	16 (47)
ERA (N = 52)	44 (85)	41 (79)	34 (65)	17 (33)

Juvenile Psoriatic Arthritis

During Part 2, a total of 11 JPAs patients in the placebo group experienced a flare event compared with 4 JPAs patients in the secukinumab group. The risk of flare was reduced by 85% for patients on secukinumab compared with patients on placebo (Hazard Ratio = 0.15, 95% CI: 0.04 to 0.56) (Figure 5).

Figure 5: Kaplan-Meier Estimates of the Time to Disease Flare in Part 2 for JPAs Patients

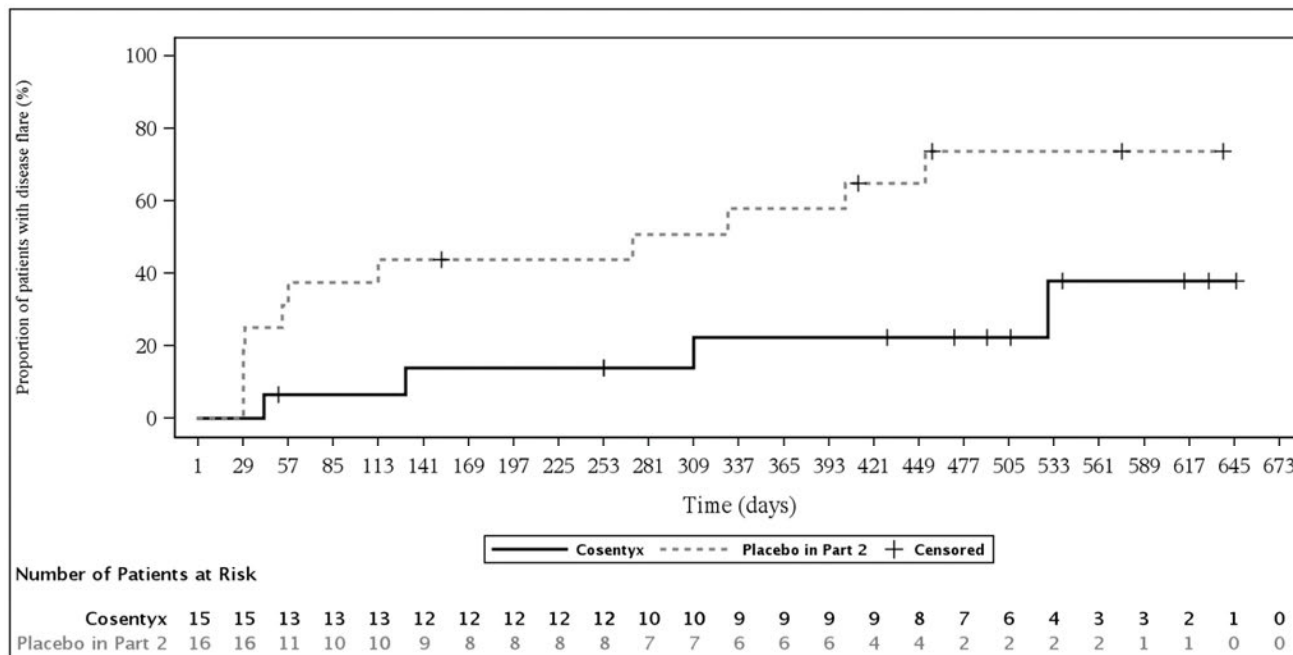

Enthesitis-Related Arthritis

During Part 2, a total of 10 ERA patients in the placebo group experienced a flare event compared with 6 ERA patients in the secukinumab group. The risk of flare was reduced by 53% for patients on secukinumab compared with patients on placebo (Hazard Ratio = 0.47, 95% CI: 0.17 to 1.32) (Figure 6). Supplementary analyses provided confirmatory evidence of the treatment effect in ERA.

Figure 6: Kaplan-Meier Estimates of the Time to Disease Flare in Part 2 for ERA Patients

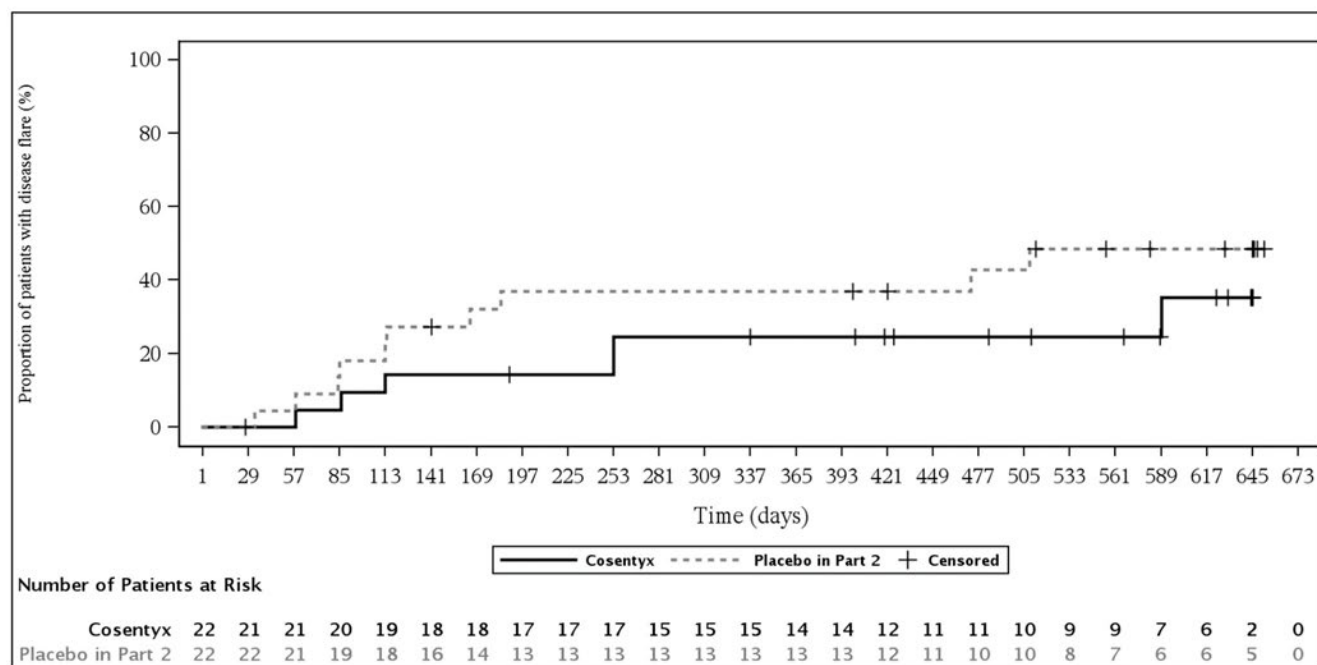

16 HOW SUPPLIED/STORAGE AND HANDLING

16.1 How Supplied

COSENTYX (secukinumab) injection is a clear to opalescent, colorless to slightly yellowish solution available as follows:

COSENTYX 300 mg/2 mL UnoReady pen:

- NDC 0078-1070-68: Carton of one 300 mg/2 mL (300 mg dose) single-dose UnoReady pen (injection)

COSENTYX 300 mg/2 mL (150 mg/mL) prefilled syringe:

- NDC 0078-1070-97: Carton of one 300 mg/2 mL (150 mg/mL) single-dose prefilled syringe (injection)

COSENTYX 150 mg/mL Sensoready pen:

- NDC 0078-0639-41: Carton of two 150 mg/mL (300 mg dose) single-dose Sensoready pens (injection)
- NDC 0078-0639-68: Carton of one 150 mg/mL single-dose Sensoready pen (injection)

COSENTYX 150 mg/mL prefilled syringe:

- NDC 0078-0639-98: Carton of two 150 mg/mL (300 mg dose) single-dose prefilled syringes (injection)
- NDC 0078-0639-97: Carton of one 150 mg/mL single-dose prefilled syringe (injection)

COSENTYX 75 mg/0.5 mL prefilled syringe (for pediatric patients less than 50 kg):

- NDC 0078-1056-97: Carton of one 75 mg/0.5 mL single-dose prefilled syringe (injection)

The removable cap of the COSENTYX 150 mg/mL Sensoready pen and prefilled syringe, and 75 mg/0.5 mL prefilled syringe contains natural rubber latex. Each 300 mg/2mL UnoReady pen, 150 mg/mL Sensoready pen and 300 mg/2mL, 150 mg/mL, and 75 mg/0.5 mL prefilled syringe is equipped with a needle safety guard.

16.2 Storage and Handling

Refrigerate COSENTYX at 2°C to 8°C (36°F to 46°F). Keep the product in the original carton to protect from light until the time of use. Do not freeze. To avoid foaming, do not shake. COSENTYX does not contain a preservative; discard any unused portion.

COSENTYX 150 mg/mL Sensoready Pens, and 150 mg/mL and 75 mg/0.5 mL Prefilled Syringes:

- May be stored for up to 4 days at room temperature not to exceed 30°C (86°F).
- Write the date COSENTYX is removed from and returned to the refrigerator in the space provided on the carton.

- Discard if stored outside of the refrigerator over 4 days.
- May be returned to the refrigerator only one time and must be stored at 2°C to 8°C (36°F to 46°F) until used or expired.

17 PATIENT COUNSELING INFORMATION

Advise the patient to read the FDA-approved patient labeling (Medication Guide and Instructions for Use).

Infections

Inform patients that COSENTYX may lower the ability of their immune system to fight infections. Instruct patients of the importance of communicating any history of infections to the doctor and contacting their doctor if they develop any symptoms of infection [*see Warnings and Precautions (5.1)*].

Hypersensitivity

Advise patients to seek immediate medical attention if they experience any symptoms of serious hypersensitivity reactions [*see Warnings and Precautions (5.2)*].

Eczematous Eruptions

Inform patients that skin reactions resembling eczema may occur with the use of COSENTYX. Instruct patients to seek medical advice if they develop signs or symptoms of eczema [*see Warnings and Precautions (5.5)*].

Risk of Hypersensitivity in Latex-Sensitive Individuals

Advise latex-sensitive patients that the removal caps of the COSENTYX 150 mg/mL Sensoready pen and the COSENTYX 1 mL and 0.5 mL prefilled syringes contain natural rubber latex, which may cause an allergic reaction in latex-sensitive individuals [*see Warnings and Precautions (5.6)*].

Immunization

Advise patients that vaccination with live vaccines is not recommended during COSENTYX treatment. Instruct patients to inform the healthcare practitioner that they are taking COSENTYX prior to a potential vaccination [*see Warnings and Precautions (5.7)*].

Instructions on Injection Technique

If a patient or caregiver is to administer COSENTYX using the UnoReady pen, Sensoready pen, or the prefilled syringe, instruct him/her in injection techniques and assess their ability to inject subcutaneously to ensure the proper administration of COSENTYX [*see Dosage and Administration (2.7, 2.8, 2.9), Medication Guide, and Instructions for Use*].

For pediatric patients, inform patients and caregivers that pediatric patients should not self-administer COSENTYX.

Instruct patients or caregivers in the technique of proper syringe and needle disposal and advise them not to reuse these items. Instruct patients to inject the full amount of COSENTYX according to the directions provided in the Medication Guide and Instructions for Use.

Storage

Instruct patients to store COSENTYX in a refrigerator at 2°C to 8°C (36°F to 46°F) and to discard expired or unused COSENTYX.

Inform patients that COSENTYX 150 mg/mL Sensoready pens, 150 mg/mL and 75 mg/0.5 mL prefilled syringes may be stored for up to 4 days at room temperature not to exceed 86°F (30°C). Instruct patients to discard if kept outside of the refrigerator over 4 days [*see How Supplied/Storage and Handling (16.2)*].

Manufactured by:

Manufactured by:

Novartis Pharmaceuticals Corporation
East Hanover, New Jersey 07936

US License Number 1244

© Novartis

MEDICATION GUIDE

COSENTYX® (koe-sen-tix)

(secukinumab)

injection, for subcutaneous use

What is the most important information I should know about COSENTYX?

COSENTYX is a medicine that affects your immune system. COSENTYX may increase your risk of having serious side effects such as:

Infections. COSENTYX may lower the ability of your immune system to fight infections and may increase your risk of infections. Some people have died from these infections.

- Your healthcare provider should check you for tuberculosis (TB) before starting treatment with COSENTYX.
- If your healthcare provider feels that you are at risk for TB, you may be treated with medicine for TB before you begin treatment with COSENTYX and during treatment with COSENTYX.
- Your healthcare provider should watch you closely for signs and symptoms of TB during treatment with COSENTYX. **Do not take COSENTYX if you have an active TB infection.**

Before starting COSENTYX, tell your healthcare provider if you:

- are being treated for an infection
- have an infection that does not go away or that keeps coming back
- have TB or have been in close contact with someone with TB
- think you have an infection or have symptoms of an infection such as:
 - fever, sweats, or chills
 - muscle aches
 - cough
 - shortness of breath
 - blood in your phlegm
 - weight loss
 - warm, red, or painful skin or sores on your body
 - diarrhea or stomach pain
 - burning when you urinate or urinate more often than normal

After starting COSENTYX, call your healthcare provider right away if you have any of the signs of infection listed above. Do not use COSENTYX if you have any signs of infection unless you are instructed to by your healthcare provider.

See “**What are the possible side effects of COSENTYX?**” for more information about side effects.

What is COSENTYX?

COSENTYX is a prescription medicine used to treat:

- people 6 years of age and older with moderate to severe plaque psoriasis (PsO) that involves large areas or many areas of the body, and who may benefit from taking injections or pills (systemic therapy) or phototherapy (treatment using ultraviolet or UV light alone or with systemic therapy)
- people 2 years of age and older with active psoriatic arthritis (PsA)
- adults with active ankylosing spondylitis (AS)
- adults with active non-radiographic axial spondyloarthritis (nr-axSpA) and objective signs of inflammation
- people 4 years of age and older with active enthesitis-related arthritis (ERA)

It is not known if COSENTYX is safe and effective in children:

- under 6 years of age with PsO
- under 2 years of age and weighing less than 33 pounds (15 kg) with active PsA
- under 4 years of age and weighing less than 33 pounds (15 kg) with active ERA

Do not use COSENTYX if you:

- have had a severe allergic reaction to secukinumab or any of the other ingredients in COSENTYX. See the end of this Medication Guide for a complete list of ingredients in COSENTYX.

Before using COSENTYX, tell your healthcare provider about all of your medical conditions, including if you:

- have any of the conditions or symptoms listed in the section “**What is the most important information I should know about COSENTYX?**”
- have inflammatory bowel disease (Crohn’s disease or ulcerative colitis).
- are allergic to latex. The needle cap on the COSENTYX Sensoready pen, and 150 mg/mL and 75 mg/0.5 mL prefilled syringes contains latex.
- have recently received or are scheduled to receive an immunization (vaccine). People who take COSENTYX **should not** receive live vaccines. Children should be brought up to date with all vaccines before starting COSENTYX.
- are pregnant or plan to become pregnant. It is not known if COSENTYX can harm your unborn baby. You and your healthcare provider should decide if you will use COSENTYX.
- are breastfeeding or plan to breastfeed. It is not known if COSENTYX passes into your breast milk.

Tell your healthcare provider about all the medicines you take, including prescription and over-the-counter medicines, vitamins, and herbal supplements.

Know the medicines you take. Keep a list of your medicines to show your healthcare provider and pharmacist when you get a new medicine.

How should I use COSENTYX?

Read the detailed “Instructions for Use” that comes with your COSENTYX for information on how to prepare and inject a dose of COSENTYX, and how to properly throw away (dispose of) used COSENTYX.

- Use COSENTYX exactly as prescribed by your healthcare provider.
- COSENTYX comes in a single-dose UnoReady pen, single-dose Sensoready pen, or single-dose prefilled syringes (300 mg/2 mL, 150 mg/mL, 75 mg/0.5 mL) that you or your caregiver may use at home to give injections.
- Your healthcare provider will decide which type of COSENTYX and which dose is right for you.
- If your healthcare provider decides that you or a caregiver may give your injections of COSENTYX at home, you should receive training on the right way to prepare and inject COSENTYX. Do not try to inject COSENTYX yourself, until you or your caregiver has been shown how to inject COSENTYX by your healthcare provider.
- Children should not inject themselves with COSENTYX. An adult caregiver should prepare and inject COSENTYX after receiving training on the right way to prepare and inject COSENTYX.
- **Do not handle the needle cap of the COSENTYX Sensoready pen, or the 75 mg/0.5 mL or 150 mg/mL prefilled syringes if you are sensitive to latex.**
- COSENTYX is given as an injection under your skin (subcutaneous injection), in your upper legs (thighs) or stomach-area (abdomen) by you or a caregiver. A caregiver or healthcare provider may also give you an injection of COSENTYX in your upper outer arm.
- **Do not** give an injection in an area of the skin that is tender, bruised, red or hard, or in an area of skin that is affected by psoriasis.
- Each injection should be given at a different site. **Do not** use the 2-inch area around your navel (belly button).
- If you inject more COSENTYX than prescribed, call your healthcare provider or go to the nearest emergency room right away.

What are the possible side effects of COSENTYX?

COSENTYX may cause serious side effects, including:

- See “**What is the most important information I should know about COSENTYX?**”
- **Inflammatory bowel disease.** New cases of inflammatory bowel disease or “flare-ups” can happen with COSENTYX and can sometimes be serious. If you have inflammatory bowel disease (ulcerative colitis or Crohn’s disease), tell your healthcare provider if you have worsening disease symptoms during treatment with COSENTYX or develop new symptoms of stomach pain or diarrhea.

- **Serious allergic reactions.** Get emergency medical help right away if you get any of the following symptoms of a serious allergic reaction:
 - feel faint
 - swelling of your face, eyelids, lips, mouth, tongue, or throat
 - trouble breathing or throat tightness
 - chest tightness
 - skin rash
 - hives (red, itchy bumps)

If you have a severe allergic reaction, do not give another injection of COSENTYX.

- **Severe skin reactions that look like eczema** can happen during treatment with COSENTYX from days to months after your first dose and can sometimes lead to hospitalization. Your healthcare provider may temporarily stop treatment with COSENTYX if you develop severe skin reactions. Tell your healthcare provider if you have any of the following signs or symptoms:
 - redness or rash
 - itching
 - small bumps or patches
 - your skin is dry or feels like leather
 - blisters on the hands or feet that ooze or become crusty
 - skin peeling

The most common side effects of COSENTYX include:

- cold symptoms
- diarrhea
- upper respiratory infections

These are not all of the possible side effects of COSENTYX.

Call your doctor for medical advice about side effects. You may report side effects to FDA at 1-800-FDA-1088.

How should I store COSENTYX?

- Store COSENTYX in a refrigerator, between 36°F to 46°F (2°C to 8°C).
- Keep COSENTYX in the original carton until ready for use to protect from light.
- **If you use COSENTYX Sensoready pen, or COSENTYX 75 mg/0.5 mL or 150 mg/mL prefilled syringe:**
 - It may be stored at room temperature, up to 86°F (30°C), for up to 4 days.
 - Write the date it was removed from and returned to the refrigerator in the space provided on the carton.
 - Throw it away if it has been stored outside of the refrigerator over 4 days.
 - It may be returned to the refrigerator **only 1 time** and must be stored between 36°F to 46°F (2°C to 8°C) until you use it or until it expires.
- Do not freeze COSENTYX.
- Do not shake COSENTYX.
- Throw away any expired or unused COSENTYX.

Keep COSENTYX and all medicines out of the reach of children.

General information about the safe and effective use of COSENTYX.

Medicines are sometimes prescribed for purposes other than those listed in a Medication Guide. Do not use COSENTYX for a condition for which it was not prescribed. Do not give COSENTYX to other people, even if they have the same symptoms that you have. It may harm them. You can ask your pharmacist or healthcare provider for information about COSENTYX that is written for health professionals.

What are the ingredients in COSENTYX?

Active ingredient: secukinumab.

Inactive ingredients:

L-histidine/histidine hydrochloride monohydrate, L-methionine, polysorbate 80, trehalose dihydrate, and sterile water for injection.

Manufactured by: Novartis Pharmaceuticals Corporation, East Hanover, New Jersey 07936, U.S. License Number 1244

For more information, call 1-888-669-6682 or go to www.COSENTYX.com

INSTRUCTIONS FOR USE

COSENTYX® [koe-sen-tix]

(secukinumab)

injection, for subcutaneous use

300 mg/2 mL single-dose prefilled syringe

Be sure that you read, understand, and follow this Instructions for Use before injecting COSENTYX. Your healthcare provider should show you how to prepare and inject COSENTYX properly using the prefilled syringe before you use it for the first time. Talk to your healthcare provider if you have any questions.

Important Information You Need to Know Before Injecting COSENTYX:

- **Do not use** the COSENTYX prefilled syringe if either the seal on the outside carton or the seal of the blister are broken. Keep the COSENTYX prefilled syringe in the sealed carton until you are ready to use it.
- **Do not use** the COSENTYX prefilled syringe if the syringe has been dropped onto a hard surface or dropped after removing the needle cap.
- **Do not shake** the COSENTYX prefilled syringe.
- The prefilled syringe has a needle guard that will be activated to cover the needle after the injection is finished. The needle guard will help to prevent needle stick injuries to anyone who handles the prefilled syringe.
- **Do not** remove the needle cap until just before you give the injection.
- Avoid touching the syringe guard wings before use. Touching them may cause the syringe guard to be activated too early.
- Throw away (dispose of) the used COSENTYX prefilled syringe right away after use. **Do not re-use the COSENTYX prefilled syringe.** See “How should I dispose of the used COSENTYX prefilled syringe?” at the end of this Instructions for Use.

How should I store COSENTYX?

- Store your carton of COSENTYX prefilled syringe in a refrigerator, between 36°F to 46°F (2°C to 8°C).
- Keep the COSENTYX prefilled syringe in the original carton until ready to use to protect from light.
- **Do not** freeze the COSENTYX prefilled syringe.
- Throw away (dispose of) any expired or unused COSENTYX prefilled syringes.

Keep COSENTYX and all medicines out of the reach of children.

COSENTYX prefilled syringe parts (see Figure A):

Figure A

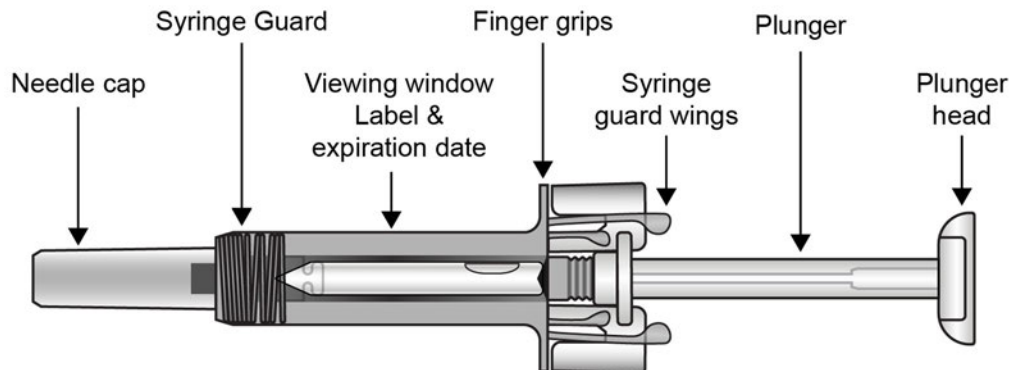

What you need for your injection:

Included in the carton:

A new COSENTYX prefilled syringe.

Each COSENTYX prefilled syringe contains **300 mg** of COSENTYX. Check to make sure that you have the correct medicine and dose.

Not included in the carton (**see Figure B**):

- 1 Alcohol wipe
- 1 Cotton ball or gauze
- Sharps disposal container

See “**How should I dispose of the used COSENTYX prefilled syringe?**” at the end of this Instructions for Use.

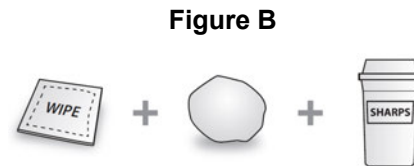

Prepare the COSENTYX 300 mg prefilled syringe

Step 1. Find a clean, well-lit, flat work surface.

Step 2. Take the carton containing the COSENTYX prefilled syringe out of the refrigerator and leave it **unopened** on your work surface for about 30 to 45 minutes so that it reaches room temperature.

Step 3. Wash your hands well with soap and water.

Step 4. Remove the COSENTYX prefilled syringe from the outer carton and take it out of the blister.

Step 5. Look through the viewing window on the COSENTYX prefilled syringe. The liquid inside should be clear. The color may be colorless to slightly yellow. You may see a small air bubble in the liquid. This is normal. **Do not use** the prefilled syringe if the liquid contains visible particles, or if the liquid is cloudy or discolored.

Step 6. Do not use the COSENTYX prefilled syringe if it is broken. Return the prefilled syringe and the package it came in to the pharmacy.

Step 7. Do not use the COSENTYX prefilled syringe if the expiration date has passed.

Choose and clean the injection site

- Areas of your body that you may use as injection sites include:
 - the front of your thighs (**see Figure C**)
 - the lower stomach-area (abdomen), but **not** the area 2 inches around your navel (belly button) (**see Figure C**)
 - the upper outer arms, if a caregiver or healthcare provider is giving you the injection (**see Figure D**)
- Choose a different site for each injection of COSENTYX.
- **Do not** inject into areas where the skin is tender, bruised, red, scaly, or hard, or in an area of skin that is affected by psoriasis. Avoid areas with scars or stretch marks.

Figure C

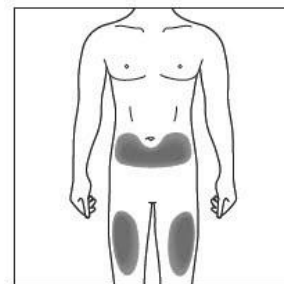
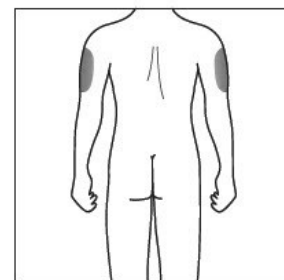

Figure D



Step 8. Using a circular motion, clean the injection site with the alcohol wipe. Leave it to dry before injecting. **Do not** touch the cleaned area again before injecting.

Giving the injection

Step 9. Carefully remove the needle cap from the COSENTYX prefilled syringe (see **Figure E**). Throw away the needle cap. You may see a drop of liquid at the end of the needle. This is normal.

Figure E

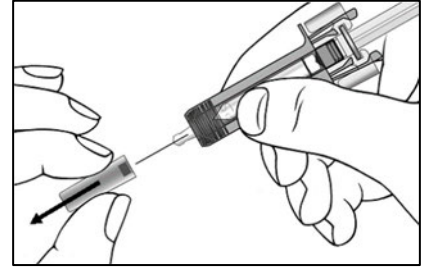

Step 10. With one hand gently pinch the skin at the injection site. With your other hand insert the needle into your skin at a 45-degree angle as shown (see **Figure F**). Push the needle all the way in to make sure that you inject your full dose.

Figure F

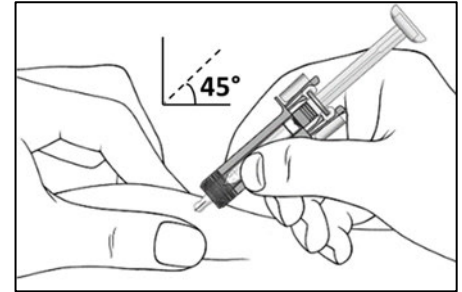

Step 11. Hold the COSENTYX prefilled syringe finger grips as shown (see **Figure G**). Slowly press down on the plunger as far as it will go, so that the plunger head is completely between the syringe guard wings. This will make sure that the syringe guard has been activated.

Figure G

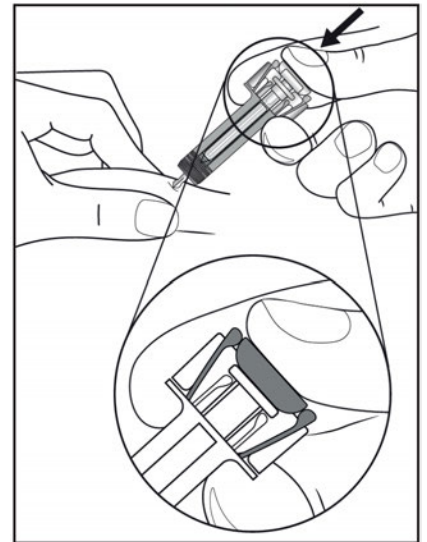

Step 12. Continue to press fully on the plunger for an additional 5 seconds. Hold the syringe in place for the full 5 seconds.

Figure H

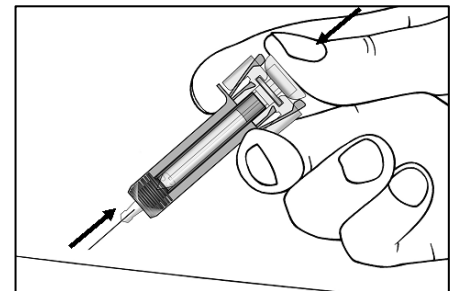

Step 13. Keep the plunger fully depressed while you carefully pull the needle straight out from the injection site (see **Figure H**).

Step 14. Slowly release the plunger and allow the syringe guard to automatically cover the exposed needle (see **Figure I**).

Step 15. There may be a small amount of blood at the injection site. You can press a cotton ball or gauze over the injection site and hold it for 10 seconds. **Do not** rub the injection site. You may cover the injection site with a small adhesive bandage, if needed.

Figure I

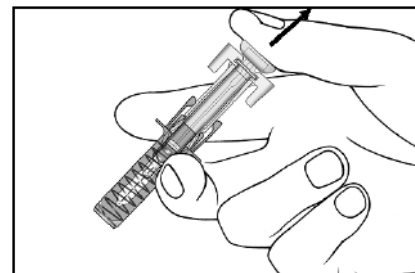

How should I dispose of the used COSENTYX prefilled syringe?

Step 16. Put your used prefilled syringe in an FDA-cleared sharps disposal container right away after use (see **Figure J**). **Do not throw away (dispose of)** the prefilled syringe in your household trash.

If you do not have an FDA-cleared sharps disposal container, you may use a household container that is:

- made of a heavy-duty plastic,
- can be closed with a tight-fitting, puncture-resistant lid, without sharps being able to come out,
- upright and stable during use,
- leak-resistant, and
- properly labeled to warn of hazardous waste inside the container.

Figure J

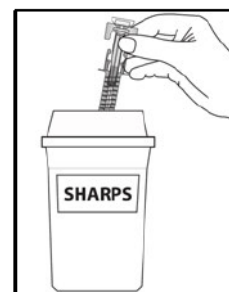

When your sharps disposal container is almost full, you will need to follow your community guidelines for the right way to dispose of your sharps disposal container. There may be state or local laws about how you should throw away used needles, syringes, and prefilled syringes. For more information about safe sharps disposal, and for specific information about sharps disposal in the state that you live in, go to the FDA's website at: <http://www.fda.gov/safesharpsdisposal>.

Manufactured by:
Novartis Pharmaceuticals Corporation
East Hanover, New Jersey 07936

US License Number 1244

© Novartis

This Instructions for Use has been approved by the U.S. Food and Drug Administration.

Revised: July 2023

INSTRUCTIONS FOR USE

COSENTYX® [koe-sen-tix]

(secukinumab)

injection, for subcutaneous use

150 mg/mL single-dose prefilled syringe

Be sure that you read, understand, and follow this Instructions for Use before injecting COSENTYX. Your healthcare provider should show you how to prepare and inject COSENTYX properly using the prefilled syringe before you use it for the first time. Children should not inject COSENTYX themselves using the prefilled syringe. An adult caregiver should prepare and inject COSENTYX after receiving proper training in subcutaneous injection technique. Talk to your healthcare provider if you have any questions.

Important Information You Need to Know Before Injecting COSENTYX:

- **Do not use** the COSENTYX prefilled syringe if either the seal on the outside carton or the seal of the blister are broken. Keep the COSENTYX prefilled syringe in the sealed carton until you are ready to use it.
- **Do not use** the COSENTYX prefilled syringe if the syringe has been dropped onto a hard surface or dropped after removing the needle cap.
- **Do not shake** the COSENTYX prefilled syringe.
- **The needle caps of the prefilled syringes contain latex. Do not handle the prefilled syringes if you are sensitive to latex.**
- The prefilled syringe has a needle guard that will be activated to cover the needle after the injection is finished. The needle guard will help to prevent needle stick injuries to anyone who handles the prefilled syringe.
- **Do not** remove the needle cap until just before you give the injection.
- Avoid touching the syringe guard wings before use. Touching them may cause the syringe guard to be activated too early.
- Throw away (dispose of) the used COSENTYX prefilled syringe right away after use. **Do not re-use the COSENTYX prefilled syringe.** See “**How should I dispose of used COSENTYX prefilled syringes?**” at the end of this Instructions for Use.

How should I store COSENTYX?

- Store your carton of COSENTYX prefilled syringes in a refrigerator, between 36°F to 46°F (2°C to 8°C).
- Keep the COSENTYX prefilled syringes in the original carton until ready to use to protect from light.
- The COSENTYX prefilled syringes may be stored at room temperature, up to 86°F (30°C), for up to 4 days.
- Write the date the COSENTYX prefilled syringes were removed from and returned to the refrigerator in the space provided on the carton.
- Throw away the COSENTYX prefilled syringe if it has been kept outside of the refrigerator over 4 days.
- COSENTYX prefilled syringe may be returned to the refrigerator **only 1 time** and must be stored between 36°F to 46°F (2°C to 8°C) until you use it or until it expires.
- **Do not** freeze the COSENTYX prefilled syringes.
- Throw away (dispose of) any expired or unused COSENTYX prefilled syringes.

Keep COSENTYX and all medicines out of the reach of children.

COSENTYX prefilled syringe parts (see Figure A):

Figure A

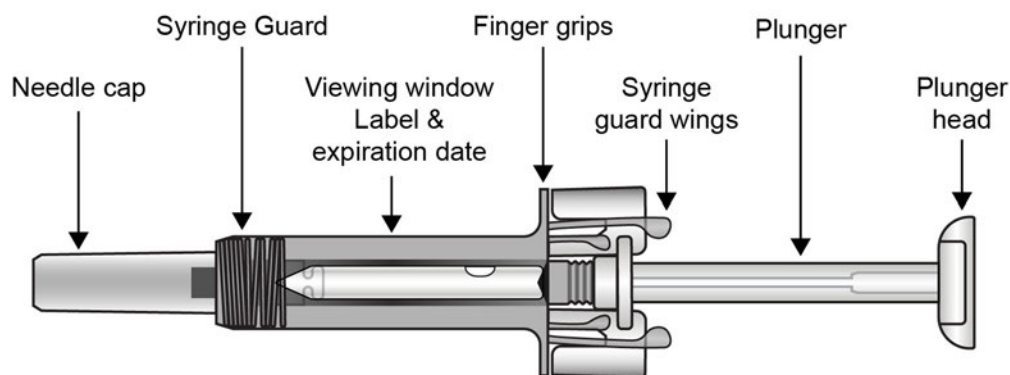

What you need for your injection:

Included in the carton:

A new COSENTYX prefilled syringe.

Each COSENTYX prefilled syringe contains **150 mg** of COSENTYX. Check to make sure that you have the correct medicine and dose.

- If your **prescribed dose** of COSENTYX is **150 mg**, you must give **1 injection**.
- If your **prescribed dose** of COSENTYX is **300 mg**, you must give **2 injections**.

Not included in the carton (**see Figure B**):

- 1 Alcohol wipe
- 1 Cotton ball or gauze
- Sharps disposal container

See “**How should I dispose of used COSENTYX prefilled syringes?**” at the end of this Instructions for Use.

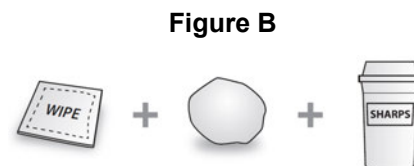

Prepare the COSENTYX 150 mg prefilled syringe

Step 1. Find a clean, well-lit, flat work surface.

Step 2. Take the carton containing the COSENTYX prefilled syringe out of the refrigerator and leave it **unopened** on your work surface for about 15 to 30 minutes so that it reaches room temperature.

Step 3. Wash your hands well with soap and water.

Step 4. Remove the COSENTYX prefilled syringe from the outer carton and take it out of the blister.

Step 5. Look through the viewing window on the COSENTYX prefilled syringe. The liquid inside should be clear. The color may be colorless to slightly yellow. You may see a small air bubble in the liquid. This is normal. **Do not use** the prefilled syringe if the liquid contains visible particles, or if the liquid is cloudy or discolored.

Step 6. **Do not use** the COSENTYX prefilled syringe if it is broken. Return the prefilled syringe and the package it came in to the pharmacy.

Step 7. **Do not use** the COSENTYX prefilled syringe if the expiration date has passed.

Choose and clean the injection site

- Areas of your body that you may use as injection sites include:
 - the front of your thighs (**see Figure C**)
 - the lower stomach-area (abdomen), but **not** the area 2 inches around your navel (belly button) (**see Figure C**)
 - the upper outer arms, if a caregiver or healthcare provider is giving you the injection (**see Figure D**)
- Choose a different site for each injection of COSENTYX.
- **Do not** inject into areas where the skin is tender, bruised, red, scaly, or hard, or in an area of skin that is affected by psoriasis. Avoid areas with scars or stretch marks.

Step 8. Using a circular motion, clean the injection site with the alcohol wipe. Leave it to dry before injecting. **Do not** touch the cleaned area again before injecting.

Figure C

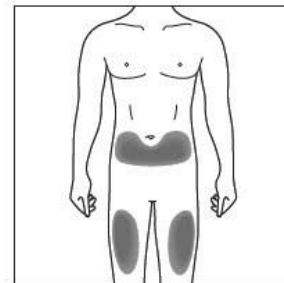
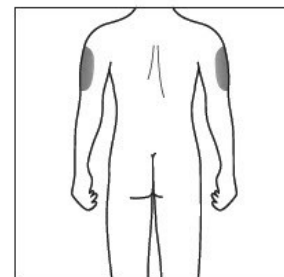

Figure D



Giving the injection

Step 9. Carefully remove the needle cap from the COSENTYX prefilled syringe (**see Figure E**). Throw away the needle cap. You may see a drop of liquid at the end of the needle. This is normal.

Figure E

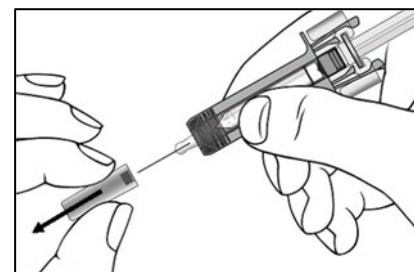

Step 10. With one hand gently pinch the skin at the injection site. With your other hand insert the needle into your skin at a 45-degree angle as shown (**see Figure F**). Push the needle all the way in to make sure that you inject your full dose.

Figure F

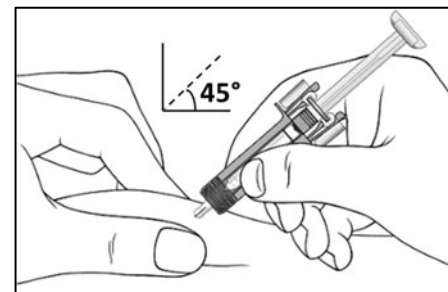

Step 11. Hold the COSENTYX prefilled syringe finger grips as shown (see **Figure G**). Slowly press down on the plunger as far as it will go, so that the plunger head is completely between the syringe guard wings. This will make sure that the syringe guard has been activated.

Step 12. Continue to press fully on the plunger for an additional 5 seconds. Hold the syringe in place for the full 5 seconds.

Figure G

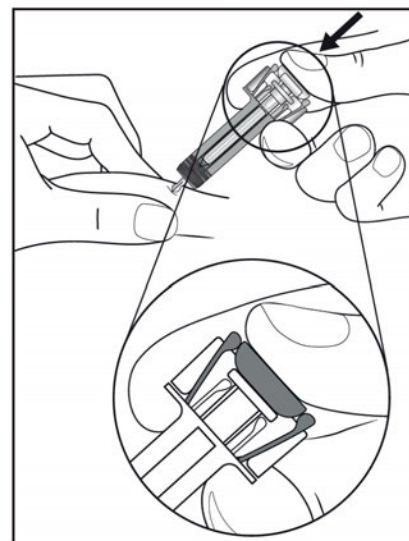

Step 13. Keep the plunger fully depressed while you carefully pull the needle straight out from the injection site (see **Figure H**).

Figure H

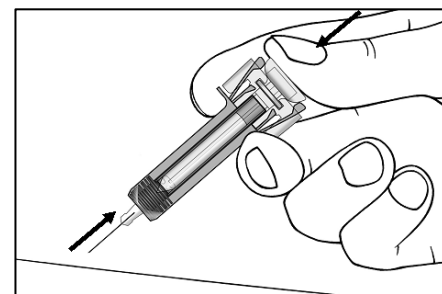

Step 14. Slowly release the plunger and allow the syringe guard to automatically cover the exposed needle (see **Figure I**).

Figure I

Step 15. There may be a small amount of blood at the injection site. You can press a cotton ball or gauze over the injection site and hold it for 10 seconds. **Do not** rub the injection site. You may cover the injection site with a small adhesive bandage, if needed.

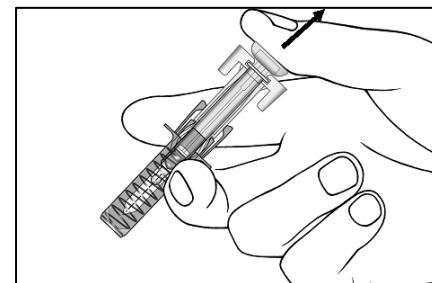

If your prescribed dose of COSENTYX is 300 mg, repeat Steps 4 through 15 with a new COSENTYX prefilled syringe.

How should I dispose of used COSENTYX prefilled syringes?

Step 16. Put your used prefilled syringes in an FDA-cleared sharps disposal container right away after use (see **Figure J**). **Do not throw away (dispose of)** the prefilled syringes in your household trash.

If you do not have an FDA-cleared sharps disposal container, you may use a household container that is:

- made of a heavy-duty plastic,
- can be closed with a tight-fitting, puncture-resistant lid, without sharps being able to come out,
- upright and stable during use,
- leak-resistant, and
- properly labeled to warn of hazardous waste inside the container.

Figure J

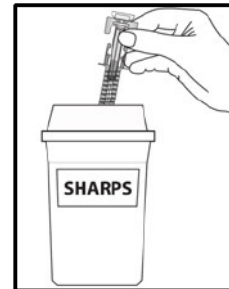

When your sharps disposal container is almost full, you will need to follow your community guidelines for the right way to dispose of your sharps disposal container. There may be state or local laws about how you should throw away used needles, syringes, and prefilled syringes. For more information about safe sharps disposal, and for specific information about sharps disposal in the state that you live in, go to the FDA's website at: <http://www.fda.gov/safesharpsdisposal>.

Manufactured by:
Novartis Pharmaceuticals Corporation
East Hanover, New Jersey 07936

US License Number 1244

© Novartis

This Instructions for Use has been approved by the U.S. Food and Drug Administration.

Revised: July 2023

INSTRUCTIONS FOR USE

COSENTYX® [koe-sen-tix]

(secukinumab)

injection, for subcutaneous use

75 mg/0.5 mL single-dose prefilled syringe

Be sure that you read, understand, and follow this Instructions for Use before injecting COSENTYX. Your healthcare provider should show you how to prepare and inject COSENTYX properly using the prefilled syringe before you use it for the first time. Children should not inject COSENTYX themselves using the prefilled syringe. An adult caregiver should prepare and inject COSENTYX after receiving proper training in subcutaneous injection technique. Talk to your healthcare provider if you have any questions.

Important Information You Need to Know Before Injecting COSENTYX:

- **Do not use** the COSENTYX prefilled syringe if either the seal on the outside carton or the seal of the blister are broken. Keep the COSENTYX prefilled syringe in the sealed carton until you are ready to use it.
- **Do not use** the COSENTYX prefilled syringe if the syringe has been dropped onto a hard surface or dropped after removing the needle cap.
- **Do not shake** the COSENTYX prefilled syringe.
- **The needle cap of the prefilled syringe contains latex. Do not handle the prefilled syringe if you are sensitive to latex.**
- The prefilled syringe has a needle guard that will be activated to cover the needle after the injection is finished. The needle guard will help to prevent needle stick injuries to anyone who handles the prefilled syringe.
- **Do not** remove the needle cap until just before you give the injection.
- Avoid touching the syringe guard wings before use. Touching them may cause the syringe guard to be activated too early.
- Throw away (dispose of) the used COSENTYX prefilled syringe right away after use. **Do not re-use the COSENTYX prefilled syringe.** See “How should I dispose of the used COSENTYX prefilled syringe?” at the end of this Instructions for Use.

How should I store COSENTYX?

- Store your carton of COSENTYX prefilled syringe in a refrigerator, between 36°F to 46°F (2°C to 8°C).
- Keep the COSENTYX prefilled syringe in the original carton until ready to use to protect from light.
- COSENTYX prefilled syringe may be stored at room temperature, up to 86°F (30°C), for up to 4 days.
- Write the date COSENTYX prefilled syringe was removed from and returned to the refrigerator in the space provided on the carton.
- Throw away COSENTYX prefilled syringe if it has been kept outside of the refrigerator over 4 days.
- COSENTYX prefilled syringe may be returned to the refrigerator only 1 time and must be stored between 36°F to 46°F (2°C to 8°C) until you use it or until it expires.
- Do not freeze the COSENTYX prefilled syringe.
- Throw away (dispose of) any expired or unused COSENTYX prefilled syringe.

Keep COSENTYX and all medicines out of the reach of children.

COSENTYX prefilled syringe parts (see Figure A):

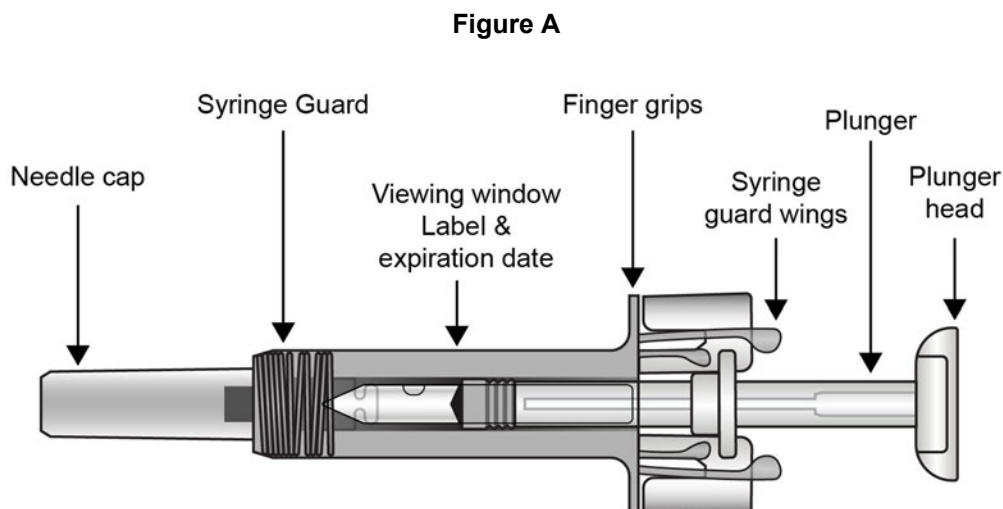

What you need for your injection:

Included in the carton:

A new COSENTYX prefilled syringe.

Each COSENTYX prefilled syringe contains **75 mg** of COSENTYX. Check to make sure that you have the correct medicine and dose.

Not included in the carton (**see Figure B**):

- 1 Alcohol wipe
- 1 Cotton ball or gauze
- Sharps disposal container

See “**How should I dispose of the used COSENTYX prefilled syringe?**” at the end of this Instructions for Use.

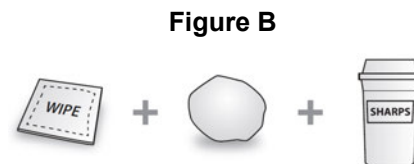

Prepare the COSENTYX 75 mg prefilled syringe

Step 1. Find a clean, well-lit, flat work surface.

Step 2. Take the carton containing the COSENTYX prefilled syringe out of the refrigerator and leave it **unopened** on your work surface for about 15 to 30 minutes so that it reaches room temperature.

Step 3. Wash your hands well with soap and water.

Step 4. Remove the COSENTYX prefilled syringe from the outer carton and take it out of the blister.

Step 5. Look through the viewing window on the COSENTYX prefilled syringe. The liquid inside should be clear. The color may be colorless to slightly yellow. You may see a small air bubble in the liquid. This is normal. **Do not use** the prefilled syringe if the liquid contains visible particles, or if the liquid is cloudy or discolored.

Step 6. Do not use the COSENTYX prefilled syringe if it is broken. Return the prefilled syringe and the package it came in to the pharmacy.

Step 7. Do not use the COSENTYX prefilled syringe if the expiration date has passed.

Choose and clean the injection site

- Areas of your body that you may use as injection sites include:
 - the front of your thighs (**see Figure C**)
 - the lower stomach-area (abdomen), but **not** the area 2 inches around your navel (belly button) (**see Figure C**)
 - the upper outer arms (**see Figure D**)
- Choose a different site for each injection of COSENTYX.
- **Do not** inject into areas where the skin is tender, bruised, red, scaly, or hard, or in an area of skin that is affected by psoriasis. Avoid areas with scars or stretch marks.

Step 8. Using a circular motion, clean the injection site with the alcohol wipe. Leave it to dry before injecting. **Do not** touch the cleaned area again before injecting.

Figure C

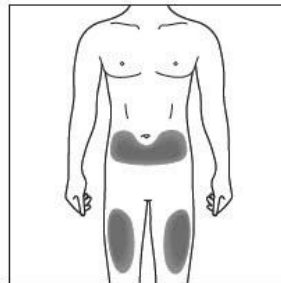
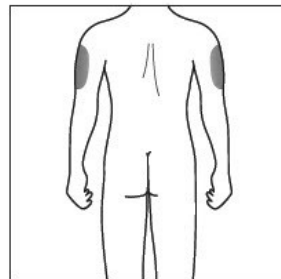

Figure D



Giving the injection

Step 9. Carefully remove the needle cap from the COSENTYX prefilled syringe (**see Figure E**). Throw away the needle cap. You may see a drop of liquid at the end of the needle. This is normal.

Figure E

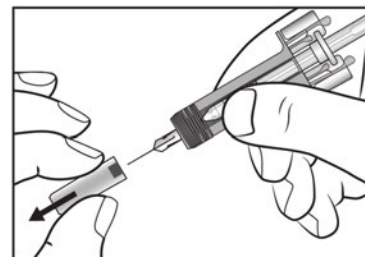

Step 10. With one hand gently pinch the skin at the injection site. With your other hand insert the needle into your skin at a 45-degree angle as shown (**see Figure F**). Push the needle all the way in to make sure that you inject your full dose.

Figure F

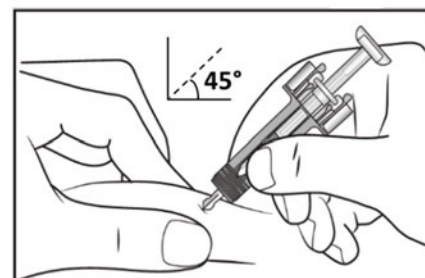

- Step 11.** Hold the COSENTYX prefilled syringe finger grips as shown (see **Figure G**). Slowly press down on the plunger as far as it will go, so that the plunger head is completely between the syringe guard wings. This will make sure that the syringe guard has been activated.
- Step 12.** Continue to press fully on the plunger for an additional 5 seconds. Hold the syringe in place for the full 5 seconds.

Figure G

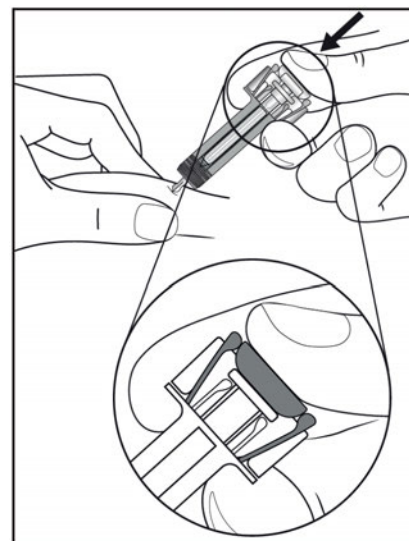

- Step 13.** Keep the plunger fully depressed while you carefully pull the needle straight out from the injection site (see **Figure H**).

Figure H

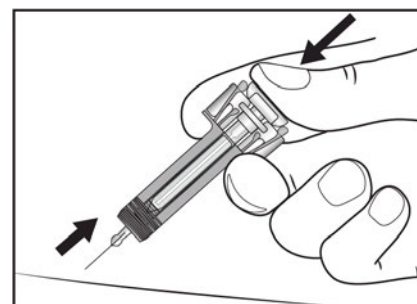

- Step 14.** Slowly release the plunger and allow the syringe guard to automatically cover the exposed needle (see **Figure I**).

Figure I

- Step 15.** There may be a small amount of blood at the injection site. You can press a cotton ball or gauze over the injection site and hold it for 10 seconds. **Do not** rub the injection site. You may cover the injection site with a small adhesive bandage, if needed.

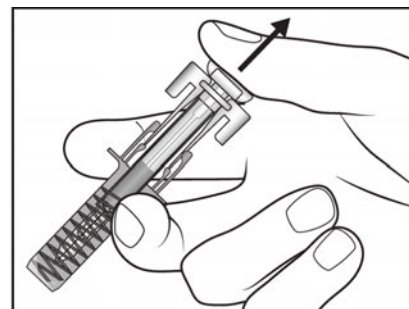

How should I dispose of the used COSENTYX prefilled syringe?

Step 16. Put your used prefilled syringe in an FDA-cleared sharps disposal container right away after use (see **Figure J**). **Do not throw away (dispose of)** the prefilled syringe in your household trash.

If you do not have an FDA-cleared sharps disposal container, you may use a household container that is:

- made of a heavy-duty plastic,
- can be closed with a tight-fitting, puncture-resistant lid, without sharps being able to come out,
- upright and stable during use,
- leak-resistant, and
- properly labeled to warn of hazardous waste inside the container.

Figure J

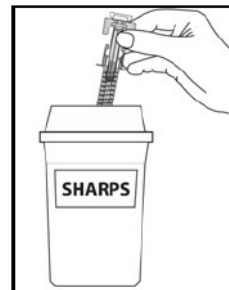

When your sharps disposal container is almost full, you will need to follow your community guidelines for the right way to dispose of your sharps disposal container. There may be state or local laws about how you should throw away used needles, syringes, and prefilled syringes. For more information about safe sharps disposal, and for specific information about sharps disposal in the state that you live in, go to the FDA's website at: <http://www.fda.gov/safesharpsdisposal>.

Manufactured by:
Novartis Pharmaceuticals Corporation
East Hanover, New Jersey 07936

US License Number 1244

© Novartis

This Instructions for Use has been approved by the U.S. Food and Drug Administration.

Revised: July 2023

INSTRUCTIONS FOR USE

COSENTYX® [koe-sen-tix]

(secukinumab)

injection, for subcutaneous use

300 mg/2 mL single-dose UnoReady® pen

Be sure that you read, understand, and follow this Instructions for Use before injecting COSENTYX. Your healthcare provider should show you how to prepare and properly inject with the COSENTYX UnoReady pen before you use it for the first time. Talk to your healthcare provider if you have any questions.

Cosentyx UnoReady pen parts

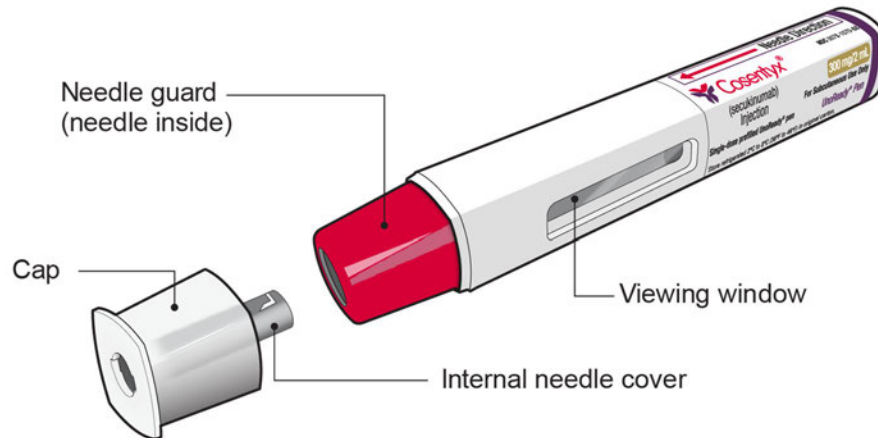

Figure A

The COSENTYX UnoReady pen is shown in **Figure A** with the cap removed.

Do not remove the cap until you are ready to inject.

Important information You Need to Know Before Injecting COSENTYX:

- **Do not** use the COSENTYX UnoReady pen if the seal on the outer carton is broken. Keep the COSENTYX UnoReady pen in the sealed outer carton until you are ready to use it.
- **Do not** shake the COSENTYX UnoReady pen.
- If you drop your COSENTYX UnoReady pen, **do not** use it if it looks damaged, or if you dropped it with the cap removed.
- The needle is covered by the needle guard and the needle will not be seen. **Do not** touch or push the needle guard because you could get a needle stick.
- Throw away (dispose of) the used COSENTYX UnoReady pen right away after use.
- **Do not** re-use the COSENTYX UnoReady pen. See “**Step 9. Disposing of the used COSENTYX UnoReady pen**” at the end of this Instructions for Use.

Storing the COSENTYX UnoReady pen

- Store your carton of COSENTYX UnoReady pen in a refrigerator between 36°F and 46°F (2°C and 8°C).
- Keep the COSENTYX UnoReady pen in the original carton until ready to use to protect from light.
- **Do not** freeze the COSENTYX UnoReady pen.
- Throw away (dispose of) any expired or unused COSENTYX UnoReady pen.

Keep the COSENTYX UnoReady pen and all medicines out of the reach of children.

What you need for your injection

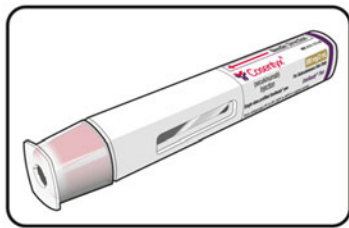

Figure B

Included in the carton (see Figure B)

- A new COSENTYX UnoReady pen
- Each** COSENTYX UnoReady pen contains **300 mg** of COSENTYX. Check to make sure that you have the correct medicine and dose.

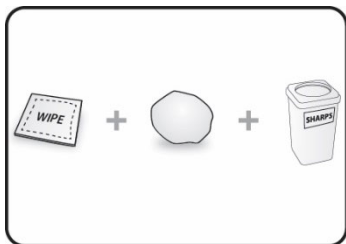

Figure C

Not included in the carton (see Figure C)

- 1 Alcohol wipe
- 1 Cotton ball or gauze
- Sharps disposal container. See “**Step 9. Disposing of the used COSENTYX UnoReady pen**” at the end of this Instructions for Use.

Prepare to inject

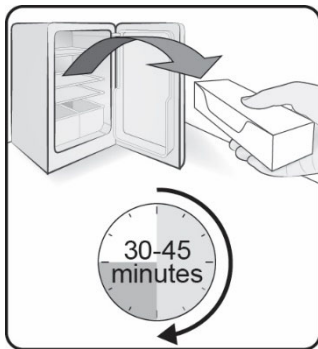

Figure D

Step 1. Bring to room temperature

Take the carton containing the COSENTYX UnoReady pen out of the refrigerator (see Figure D) and leave it **unopened for 30 to 45 minutes before injecting** to allow it to reach room temperature.

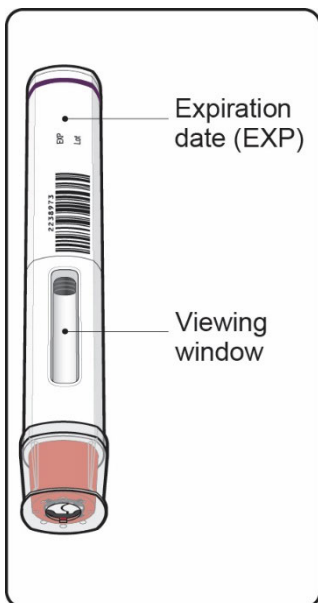

Figure E

Step 2. Important safety checks before you inject (see Figure E)

- Look at the expiration date (**EXP**) on your COSENTYX UnoReady pen. **Do not** use the COSENTYX UnoReady pen if the expiration date has passed.
- Look through the viewing window. The liquid should be clear. Its color may vary from colorless to slightly yellow.
- **Do not** use if the liquid contains visible particles, is cloudy or is discolored. You may see air bubbles, which is normal.

Contact your healthcare provider or pharmacist if the COSENTYX UnoReady pen fails any of these checks.

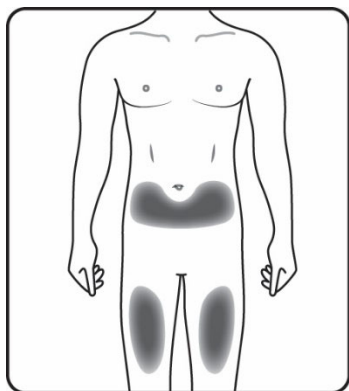

Figure F

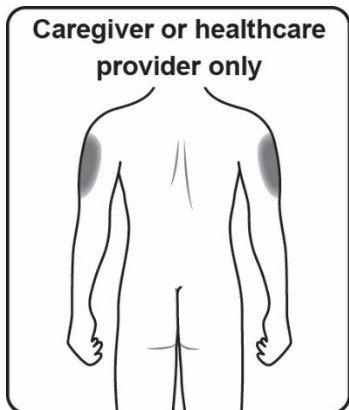

Figure G



Figure H

Step 3. Choose the injection site

- The recommended site is the front of the thighs. You may also use the lower abdomen, but **not** the area 2 inches around the navel (belly button) (see Figure F).
 - Choose a different site each time you give an injection.
 - **Do not** inject into areas where the skin is tender, bruised, red, scaly, or hard or in an area of skin that is affected by psoriasis. Avoid areas with scars or stretch marks.
-
- If a **caregiver** or **healthcare provider** is giving you your injection, they may also inject into your outer upper arm (see Figure G).

Step 4. Clean the injection site

- Wash your hands well with soap and water.
- Using a circular motion, clean the injection site with the alcohol wipe (see Figure H). Leave it to dry before injecting.
- **Do not** touch the cleaned area again before injecting.

Injecting with the COSENTYX UnoReady pen

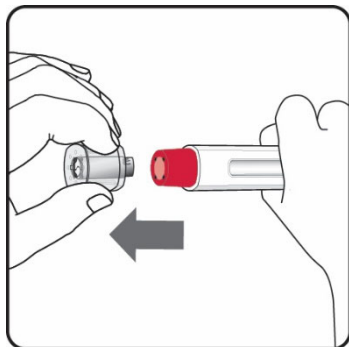

Figure I

Step 5. Remove the cap

- Only remove the cap when you are ready to use the COSENTYX UnoReady pen.
- **Pull** the cap straight off (see Figure I). **Do not** twist the cap.
- Throw away the cap. **Do not** try to re-attach the cap.
- Use the COSENTYX UnoReady pen within 5 minutes of removing the cap.

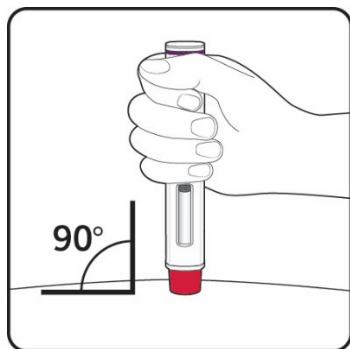

Figure J

Step 6. Position the COSENTYX UnoReady pen

Hold the COSENTYX UnoReady pen at 90 degrees against the cleaned injection site with the viewing window facing you (see Figure J).



Step 7. Injecting with the COSENTYX UnoReady pen as described below (see Figure K)

				<p>After the 2nd click, continue to hold down and slowly count to 5</p>		
<p>Start the injection</p> <ul style="list-style-type: none">Press and hold the COSENTYX UnoReady pen firmly against the skin to start the injection.The 1st click indicates the injection has started.Keep holding the COSENTYX UnoReady pen firmly against your skin after the 1st click.		<p>Monitor the injection</p> <ul style="list-style-type: none">The green indicator will move within the viewing window.The 2nd click indicates the injection is almost complete.Keep holding the COSENTYX UnoReady pen firmly against your skin after the 2nd click.		<ul style="list-style-type: none">Keep holding the COSENTYX UnoReady pen firmly against your skin and slowly count to 5.		<p>Complete the injection</p> <ul style="list-style-type: none">Check that the green indicator with a grey tip has stopped moving.The COSENTYX UnoReady pen can now be removed from your skin.

Figure K

After the injection

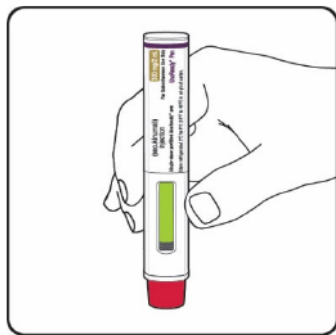

Figure L

Step 8. Check that the green indicator has filled the window (see Figure L)

- This means the medicine has been delivered. Contact your healthcare provider or pharmacist if the green indicator is not visible or does not fill the window.
- There may be a small amount of blood at the injection site. You can press a cotton ball or gauze over the injection site and hold it for a few seconds. **Do not** rub the injection site. You may cover the injection site with a small adhesive bandage, if needed.

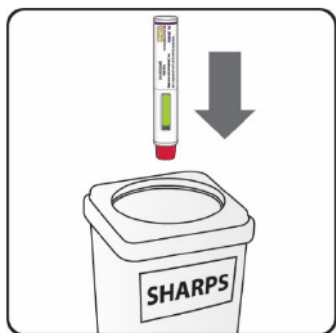

Figure M

Step 9. Disposing of the used COSENTYX UnoReady pen

- Put your used COSENTYX UnoReady pen in an FDA-cleared sharps disposal container right away after use (see Figure M). **Do not** throw away (dispose of) the COSENTYX UnoReady pen in your household trash. If you do not have an FDA-cleared sharps disposal container, you may use a household container that is:
 - made of a heavy-duty plastic,
 - can be closed with a tight-fitting, puncture-resistant lid, without sharps being able to come out,
 - upright and stable during use,
 - leak-resistant, and
 - properly labeled to warn of hazardous waste inside the container.
- When your sharps disposal container is almost full, you will need to follow your community guidelines for the right way to dispose of your sharps disposal container. There may be state or local laws about how you should throw away used needles, syringes, and COSENTYX UnoReady pens.

For more information about safe sharps disposal, and for specific information about sharps disposal in the state that you live in, go to the FDA's website at: <http://www.fda.gov/safesharpsdisposal>.

Manufactured by:
Novartis Pharmaceuticals Corporation
East Hanover, New Jersey 07936

US License Number 1244

© Novartis

This Instructions for Use has been approved by the U.S. Food and Drug Administration.

Revised: July 2023

INSTRUCTIONS FOR USE

COSENTYX® [koe-sen-tix]

(secukinumab)

injection, for subcutaneous use

150 mg/mL single-dose Sensoready® pen

Be sure that you read, understand, and follow this Instructions for Use before injecting COSENTYX. Your healthcare provider should show you how to prepare and inject COSENTYX properly using the Sensoready pen before you use it for the first time. Children should not inject COSENTYX themselves using the Sensoready pen. An adult caregiver should prepare and inject COSENTYX after receiving proper training in subcutaneous injection technique. Talk to your healthcare provider if you have any questions.

Important Information You Need to Know Before Injecting COSENTYX:

- **Do not use** the COSENTYX Sensoready pen if either the seal on the outer carton or the seal on the pen is broken. Keep the COSENTYX Sensoready pen in the sealed outer carton until you are ready to use it.
- **Do not shake** the COSENTYX Sensoready pen.
- The caps of the Sensoready pens contain latex. **Do not handle the Sensoready pens if you are sensitive to latex.**
- If you drop your COSENTYX Sensoready pen, **do not use** it if the Sensoready pen looks damaged, or if you dropped it with the cap removed.
- Throw away (dispose of) the used COSENTYX Sensoready pen right away after use. **Do not re-use the COSENTYX Sensoready pen.** See “**How should I dispose of used COSENTYX Sensoready pens?**” at the end of this Instructions for Use.

How should I store COSENTYX?

- Store your carton of COSENTYX Sensoready pens in a refrigerator, between 36°F to 46°F (2°C to 8°C).
- Keep the COSENTYX Sensoready pens in the original carton until ready to use to protect from light.
- The COSENTYX Sensoready pens may be stored at room temperature, up to 86°F (30°C), for up to 4 days.
- Write the date the COSENTYX Sensoready pens were removed from and returned to the refrigerator in the space provided on the carton.
- Throw away the COSENTYX Sensoready pen if it has been kept outside of the refrigerator over 4 days.
- COSENTYX Sensoready pen may be returned to the refrigerator **only 1 time** and must be stored between 36°F to 46°F (2°C to 8°C) until you use it or until it expires.
- **Do not freeze** the COSENTYX Sensoready pens.
- Throw away (dispose of) any expired or unused COSENTYX Sensoready pens.

Keep COSENTYX and all medicines out of the reach of children.

COSENTYX Sensoready pen parts (see Figure A):

Figure A

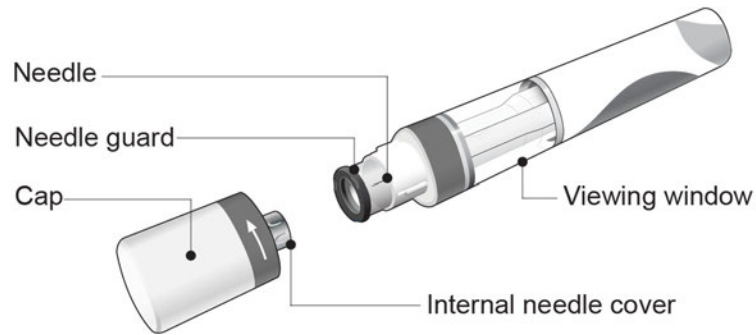

The COSENTYX Sensoready pen is shown above with the cap removed. **Do not** remove the cap until you are ready to inject.

What you need for your injection:

Included in the carton:

A new COSENTYX Sensoready pen (see Figure B).

Each COSENTYX Sensoready pen contains **150 mg** of COSENTYX. Check to make sure that you have the correct medicine and dose.

- If your **prescribed dose** of COSENTYX is **150 mg**, you must give **1 injection**.
- If your **prescribed dose** of COSENTYX is **300 mg**, you must give **2 injections**.

Not included in the carton (see Figure C):

- 1 Alcohol wipe
- 1 Cotton ball or gauze
- Sharps disposal container.

See “**How should I dispose of used COSENTYX Sensoready pens?**” at the end of this Instructions for Use.

Before your injection:

Take the carton containing the COSENTYX Sensoready pen out of the refrigerator and leave it **unopened for about 15 to 30 minutes before injecting** to allow it to reach room temperature.

Figure B

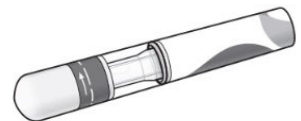

Figure C



Step 1. Important safety checks before you inject (see Figure D):

- Look through the viewing window. The liquid should be clear. Its color may vary from colorless to slightly yellow.

Do not use if the liquid contains visible particles, is cloudy or is discolored. You may see a small air bubble, which is normal.

- Look at the **expiration date (EXP)** on your Sensoready pen. **Do not use** your COSENTYX Sensoready pen if the expiration date has passed.

Contact your pharmacist if the COSENTYX Sensoready pen fails any of these checks.

Step 2. Choose the injection site:

- The recommended site is the front of the thighs. You may also use the lower abdomen, but **not** the area 2 inches around the navel (belly button) (see **Figure E**).
- Choose a different site each time you give an injection.
- **Do not** inject into areas where the skin is tender, bruised, red, scaly, or hard, or in an area of skin that is affected by psoriasis. Avoid areas with scars or stretch marks.
- If a **caregiver** or **healthcare provider** is giving you your injection, they may also inject into your outer upper arm (see **Figure F**).

Step 3. Cleaning the injection site:

- Wash your hands well with soap and water.
- Using a circular motion, clean the injection site with the alcohol wipe. Leave it to dry before injecting (see **Figure G**).
- **Do not** touch the cleaned area again before injecting.

Figure D

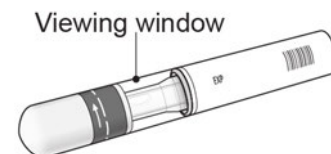

Figure E

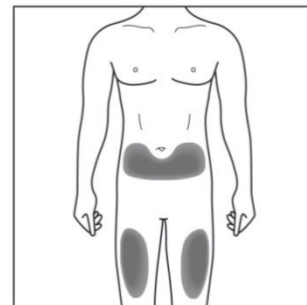

Figure F

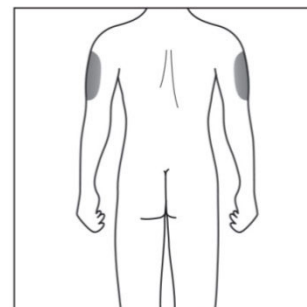
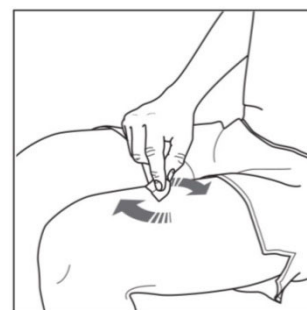

Figure G



Your injection:

Step 4. Removing the cap:

- Only remove the cap when you are ready to use the COSENTYX Sensoready pen.
- Twist off the cap in the direction of the arrow (see **Figure H**).
- Throw away the cap. **Do not try to re-attach the cap.**
- Use the COSENTYX Sensoready pen within 5 minutes of removing the cap.

Figure H

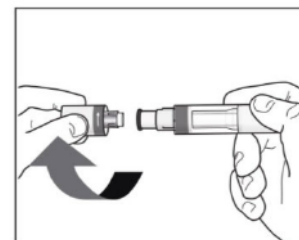

Step 5. Holding the COSENTYX Sensoready pen:

- Hold the COSENTYX Sensoready pen at 90 degrees to the cleaned injection site (see **Figure I**).

Figure I

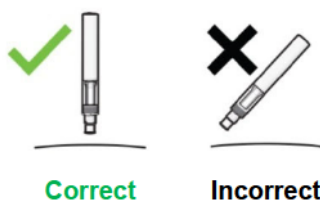
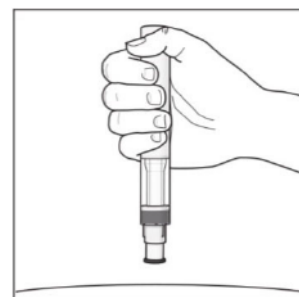

Important: During the injection you will hear 2 loud clicks:

- The 1st click indicates that **the injection has started**.
- Several seconds later a 2nd click will indicate that **the injection is almost finished**.

You must keep holding the COSENTYX Sensoready pen firmly against the skin until you see a **green indicator** fill the window and stop moving.

Step 6. Starting the injection:

- Press the COSENTYX Sensoready pen firmly against the skin to start the injection (see **Figure J**).
- The 1st click indicates the injection has started.
- **Keep holding** the COSENTYX Sensoready pen firmly against the skin.
- The **green indicator** shows the progress of the injection.

Figure J

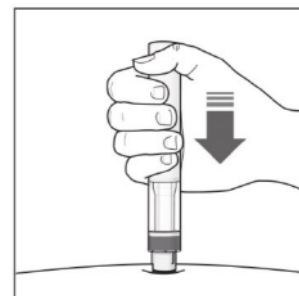

Step 7. Completing the injection:

- Listen for the 2nd click. This indicates the injection is **almost** complete.
- Check the **green indicator** fills the window and has stopped moving (see **Figure K**).
- The COSENTYX Sensoready pen can now be removed.

Figure K

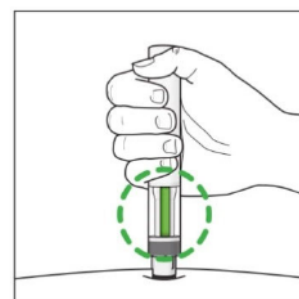

After the injection:

Step 8. Check the green indicator fills the window (see Figure L):

- This means the medicine has been delivered. Contact your healthcare provider if the green indicator is not visible.
- There may be a small amount of blood at the injection site. You can press a cotton ball or gauze over the injection site and hold it for 10 seconds. **Do not** rub the injection site. You may cover the injection site with a small adhesive bandage, if needed.

If your prescribed dose of COSENTYX is 300 mg, repeat Steps 1 through 8 with a new COSENTYX Sensoready pen.

How should I dispose of used COSENTYX Sensoready pens?

Step 9. Put your used Sensoready pen in an FDA-cleared sharps disposal container right away after use (see Figure M). **Do not throw away (dispose of)** the Sensoready pens in your household trash.

If you do not have an FDA-cleared sharps disposal container, you may use a household container that is:

- made of a heavy-duty plastic,
- can be closed with a tight-fitting, puncture-resistant lid, without sharps being able to come out,
- upright and stable during use,
- leak-resistant, and
- properly labeled to warn of hazardous waste inside the container.

When your sharps disposal container is almost full, you will need to follow your community guidelines for the right way to dispose of your sharps disposal container. There may be state or local laws about how you should throw away used needles, syringes, and Sensoready pens. For more information about safe sharps disposal, and for specific information about sharps disposal in the state that you live in, go to the FDA's website at: <http://www.fda.gov/safesharpsdisposal>.

Manufactured by:
Novartis Pharmaceuticals Corporation
East Hanover, New Jersey 07936

US License Number 1244

© Novartis

This Instructions for Use has been approved by the U.S. Food and Drug Administration.

Revised: July 2023

Figure L

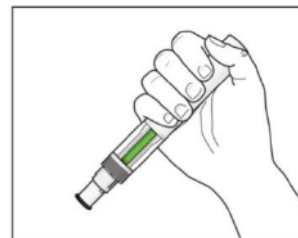
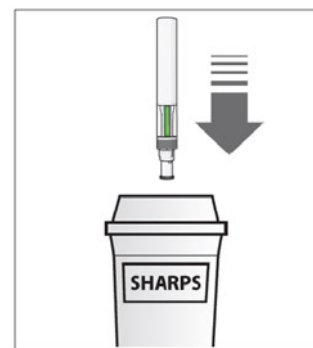

Figure M



This label may not be the latest approved by FDA.
For current labeling information, please visit <https://www.fda.gov/drugsatfda>



Cosentyx
(secukinumab)
Injection

Physician Sample – NOT FOR SALE

NDC 0078-1056-99

75 mg/0.5 mL

1 Single-dose Prefilled Syringe
For Subcutaneous Use Only

Caution: Contains Natural Rubber Latex Which May Cause Allergic Reaction.

Dosage: See Prescribing Information.

Store refrigerated 2°C to 8°C (36°F to 46°F) in original carton to protect from light. COSENTYX may be stored once for up to 4 consecutive days at room temperature not to exceed 30°C (86°F). Write the date COSENTYX was removed and returned to the refrigerator in the space provided on the carton. Discard COSENTYX if it has been stored outside of the refrigerator and not been used in over 4 days. If unused and not stored above 30°C (86°F), COSENTYX may be returned to the refrigerator only one time and must be stored at 2°C to 8°C (36°F to 46°F) until used or expired.

DO NOT FREEZE. Do not Shake.

Each single-dose prefilled syringe contains: 75 mg secukinumab, L-histidine/histidine HCl monohydrate (1.552 mg), L-methionine (0.373 mg), polysorbate 80 (0.1 mg), trehalose dihydrate (37.83 mg), and Water for Injection, USP.

Discard unused portion.

Sterile Solution - Contains No Preservative

Keep this and all drugs out of the reach of children.

Date removed from refrigerator:

___/___/___

Date returned to refrigerator:

___/___/___

Carton contains:

- 1 Single-dose Prefilled Syringe
- Prescribing Information
- Medication Guide
- Instructions for Use

For more information visit www.cosentyx.com or call 1-888-NOW-NOVA (1-888-669-6682)



Physician Sample – NOT FOR SALE



300054955

75 mg/0.5 mL

1 Single-dose Prefilled Syringe

300054955 US
55x33x152mm

EXP/LOT

Variable data printing

YYYY-MM
XXXXXXXX

Distributed by:
Novartis Pharmaceuticals Corporation
East Hanover, New Jersey 07936
Product of Austria
© Novartis

Manufactured by:
Novartis Pharmaceuticals Corporation
East Hanover, New Jersey 07936
US License No. 1244
at
Novartis Pharma Stein AG
Stein, Switzerland



Cosentyx
(secukinumab)
Injection

Physician Sample – NOT FOR SALE

NDC 0078-1056-99

Rx only

75 mg/0.5 mL

1 Single-dose Prefilled Syringe
For Subcutaneous Use Only

ATTENTION:
Dispense with enclosed Medication Guide.

Caution: Contains Natural Rubber Latex
Which May Cause Allergic Reaction.



NOVARTIS

This label may not be the latest approved by FDA.
For current labeling information, please visit <https://www.fda.gov/drugsatfda>

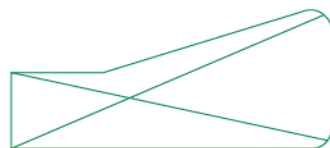
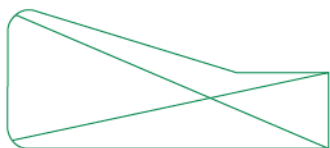

Cosentyx[®]
(secukinumab)
Injection

Physician Sample – NOT FOR SALE

NDC 0078-1056-99

75 mg/0.5 mL

1 Single-dose Prefilled Syringe
For Subcutaneous Use Only

Caution: Contains Natural Rubber Latex Which May Cause Allergic Reaction.

Dosage: See Prescribing Information.
Store refrigerated 2°C to 8°C (36°F to 46°F) in original carton to protect from light. COSENTYX may be stored once for up to 4 consecutive days at room temperature not to exceed 30°C (86°F). Write the date COSENTYX was removed and returned to the refrigerator in the space provided on the carton. Discard COSENTYX if it has been stored outside of the refrigerator and not been used in over 4 days. If unused and not stored above 30°C (86°F), COSENTYX may be returned to the refrigerator only one time and must be stored at 2°C to 8°C (36°F to 46°F) until used or expired.

DO NOT FREEZE. Do not Shake.

Each single-dose prefilled syringe contains: 75 mg secukinumab, L-histidine/histidine HCl monohydrate (1.552 mg), L-methionine (0.373 mg), polysorbate 80 (0.1 mg), trehalose dihydrate (37.83 mg), and Water for Injection, USP.

Discard unused portion.

Sterile Solution - Contains No Preservative
Keep this and all drugs out of the reach of children.

Date removed from refrigerator:

____/____/____
Date returned to refrigerator:
____/____/____

Carton contains:

- 1 Single-dose Prefilled Syringe
- Prescribing Information
- Medication Guide
- Instructions for Use

For more information visit www.cosentyx.com
or call 1-888-NOW-NOVA (1-888-669-6682)



(secukinumab)
Injection

Physician Sample – NOT FOR SALE

3 000549 61



1 Single-dose Prefilled Syringe

75 mg/0.5 mL

EXPLOT

Variable data printing

YYYY-MM
XXXXXXXX

Distributed by:
Novartis Pharmaceuticals Corporation
East Hanover, New Jersey 07936
Product of France
© Novartis

Manufactured by:
Novartis Pharmaceuticals Corporation
East Hanover, New Jersey 07936
US License No. 1244
at
Novartis Pharma Stein AG
Stein, Switzerland

300054961 US
58x38x155mm



Cosentyx[®]
(secukinumab)
Injection

Physician Sample – NOT FOR SALE

NDC 0078-1056-99

Rx only

75 mg/0.5 mL



1 Single-dose Prefilled Syringe
For Subcutaneous Use Only

ATTENTION:
Dispense with enclosed Medication Guide.

Caution: Contains Natural Rubber Latex
Which May Cause Allergic Reaction.



NOVARTIS

Cosentyx [®] (secukinumab) Injection	Caution: Contains Natural Rubber Latex Which May Cause Allergic Reaction. Dosage: See Prescribing Information. Sterile Solution - Contains No Preservative. Store refrigerated 2°C to 8°C (36°F to 46°F) in original carton to protect from light. COSENTYX may be stored once for up to 4 consecutive days at room temperature not to exceed	NDC 0078-1056-99 30°C (86°F), DO NOT FREEZE. Full Storage: Refer to prescribing information and carton. Each single-dose prefilled syringe contains: 75 mg secukinumab, L-histidine/histidine HCl monohydrate (1.552 mg), L-methionine (0.373 mg), polysorbate 80 (0.1 mg), trehalose dihydrate (37.83 mg), and Water for Injection, USP.	Rx only Physician Sample – NOT FOR SALE Keep this and all drugs out of the reach of children. Manufactured by: Novartis Pharmaceuticals Corporation East Hanover, New Jersey 07936 US License No. 1244 at Novartis Pharma Stein AG, Stein, Switzerland Distributed by: Novartis Pharmaceuticals Corporation East Hanover, New Jersey 07936 © Novartis	300054939 US   01110300781056997
75 mg/0.5 mL 1 Single-dose Prefilled Syringe For Subcutaneous Use Only				
EXP YYYY-MMM		Lot XXXXX		

This label may not be the latest approved by FDA.
For current labeling information, please visit <https://www.fda.gov/drugsatfda>

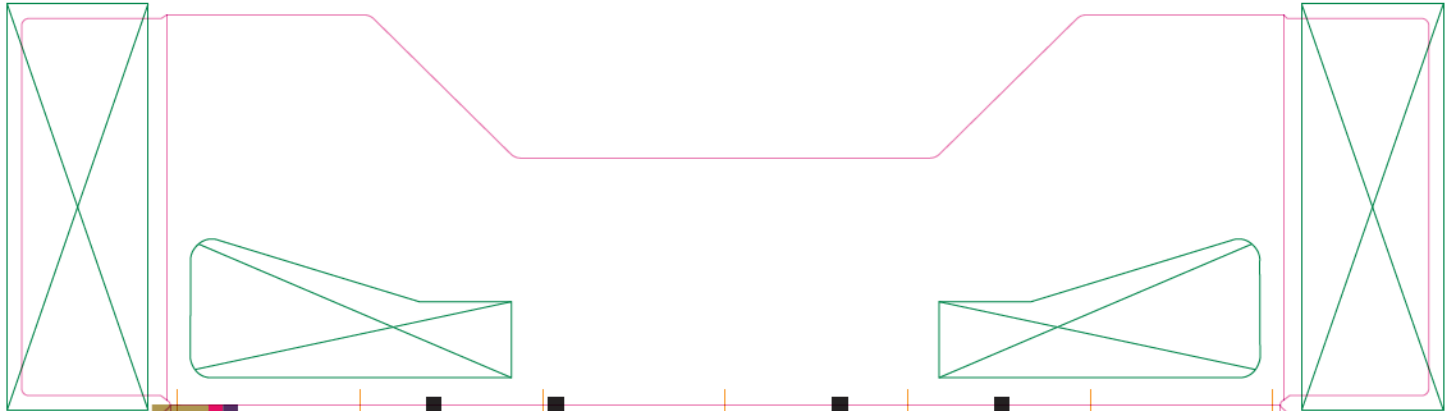

Cosentyx[®]
(secukinumab)
Injection

75 mg/0.5 mL

1 Single-dose Prefilled Syringe
For Subcutaneous Use Only

NDC 0078-1056-97

Caution: Contains Natural Rubber Latex Which May Cause Allergic Reaction.

Dosage: See Prescribing Information.
Store refrigerated 2°C to 8°C (36°F to 46°F) in original carton to protect from light. COSENTYX may be stored once for up to 4 consecutive days at room temperature not to exceed 30°C (86°F). Write the date COSENTYX was removed and returned to the refrigerator in the space provided on the carton. Discard COSENTYX if it has been stored outside of the refrigerator and not been used in over 4 days. If unused and not stored above 30°C (86°F), COSENTYX may be returned to the refrigerator only one time and must be stored at 2°C to 8°C (36°F to 46°F) until used or expired.

DO NOT FREEZE. Do not Shake.

Each single-dose prefilled syringe contains: 75 mg secukinumab, L-histidine/histidine HCl monohydrate (1.552 mg), L-methionine (0.373 mg), polysorbate 80 (0.1 mg), trehalose dihydrate (37.83 mg), and Water for Injection, USP.

Discard unused portion.

Sterile Solution - Contains No Preservative

Keep this and all drugs out of the reach of children.

Date removed from refrigerator:

___/___/___

Date returned to refrigerator:

___/___/___

Carton contains:

- 1 Single-dose Prefilled Syringe
- Prescribing Information
- Medication Guide
- Instructions for Use

For more information visit www.cosentyx.com
or call 1-888-NOW-NOVA (1-888-666-6682)



(secukinumab)
Injection

1 Single-dose Prefilled Syringe

75 mg/0.5 mL

300054960



ENTN: 00300781056976

EXPILOT



Distributed by:
Novartis Pharmaceuticals Corporation
East Hanover, New Jersey 07936
Product of Austria
© Novartis

Manufactured by:
Novartis Pharmaceuticals Corporation
East Hanover, New Jersey 07936
US License No. 1244
at
Novartis Pharma Stein AG
Stein, Switzerland

300054960 US
55x33x155mm



Cosentyx[®]
(secukinumab)
Injection

75 mg/0.5 mL

1 Single-dose Prefilled Syringe
For Subcutaneous Use Only

NDC 0078-1056-97
Rx only

ATTENTION:
Dispense with enclosed Medication Guide.

Caution: Contains Natural Rubber Latex
Which May Cause Allergic Reaction.



Serialization Variable data printing



YYYY-MMM
XXXXXXXXXX
SN NNNNNNNNNNNN

This label may not be the latest approved by FDA.
For current labeling information, please visit <https://www.fda.gov/drugsatfda>



Cosentyx[®]
(secukinumab)
Injection

75 mg/0.5 mL

1 Single-dose Prefilled Syringe
For Subcutaneous Use Only

NDC 0078-1056-97

Caution: Contains Natural Rubber Latex Which May Cause Allergic Reaction.

Dosage: See Prescribing Information.
Store refrigerated 2°C to 8°C (36°F to 46°F) in original carton to protect from light. COSENTYX may be stored once for up to 4 consecutive days at room temperature not to exceed 30°C (86°F). Write the date COSENTYX was removed and returned to the refrigerator in the space provided on the carton. Discard COSENTYX if it has been stored outside of the refrigerator and not been used in over 4 days. If unused and not stored above 30°C (86°F), COSENTYX may be returned to the refrigerator only one time and must be stored at 2°C to 8°C (36°F to 46°F) until used or expired.

DO NOT FREEZE. Do not Shake.

Each single-dose prefilled syringe contains: 75 mg secukinumab, L-histidine/histidine HCl monohydrate (1.552 mg), L-methionine (0.373 mg), polysorbate 80 (0.1 mg), trehalose dihydrate (37.83 mg), and Water for Injection, USP.

Discard unused portion.

Sterile Solution - Contains No Preservative

Keep this and all drugs out of the reach of children.

Date removed from refrigerator:

___/___/___

Date returned to refrigerator:

___/___/___

Carton contains:

- 1 Single-dose Prefilled Syringe
- Prescribing Information
- Medication Guide
- Instructions for Use

For more information visit www.cosentyx.com
or call 1-888-NOW-NOVA (1-888-669-6682)



1 Single-dose Prefilled Syringe

75 mg/0.5 mL

300054954



GTIN: 00300781056876

EXP/LOT



Distributed by:
Novartis Pharmaceuticals Corporation
East Hanover, New Jersey 07936
Product of France
© Novartis

Manufactured by:
Novartis Pharmaceuticals Corporation
East Hanover, New Jersey 07936
US License No. 1244
at
Novartis Pharma Stein AG
Stein, Switzerland

300054954 US
5x35x155mm

Serialization Variable data printing



YYYY-
XXXXXXXXXX
SN NNNNNNNNNNNN



Cosentyx[®]
(secukinumab)
Injection

75 mg/0.5 mL

1 Single-dose Prefilled Syringe
For Subcutaneous Use Only

NDC 0078-1056-97
Rx only

ATTENTION:
Dispense with enclosed Medication Guide.

Caution: Contains Natural Rubber Latex
Which May Cause Allergic Reaction.



NOVARTIS

Cosentyx [®] (secukinumab) Injection 75 mg/0.5 mL 1 Single-dose Prefilled Syringe For Subcutaneous Use Only	Caution: Contains Natural Rubber Latex Which May Cause Allergic Reaction. Dosage: See Prescribing Information. Sterile Solution - Contains No Preservative. Store refrigerated 2°C to 8°C (36°F to 46°F) in original carton to protect from light. COSENTYX may be stored once for up to 4 consecutive days at room temperature not to exceed	NDC 0078-1056-97 30°C (86°F). DO NOT FREEZE. Full Storage: Refer to prescribing information and carton. Each single-dose prefilled syringe contains: 75 mg secukinumab, L-histidine/histidine HCl monohydrate (1.552 mg), L-methionine (0.373 mg), polysorbate 80 (0.1 mg), trehalose dihydrate (37.83 mg), and Water for Injection, USP.	Rx only Keep this and all drugs out of the reach of children.	300054953 US Manufactured by: Novartis Pharmaceuticals Corporation East Hanover, New Jersey 07936 US License No. 1244 at Novartis Pharma Stein AG, Stein, Switzerland Distributed by: Novartis Pharmaceuticals Corporation East Hanover, New Jersey 07936 © Novartis
---	--	--	---	---



NOVARTIS

EXP YYYY-MMM Lot XXXXX

This label may not be the latest approved by FDA.
 For current labeling information, please visit <https://www.fda.gov/drugsatfda>

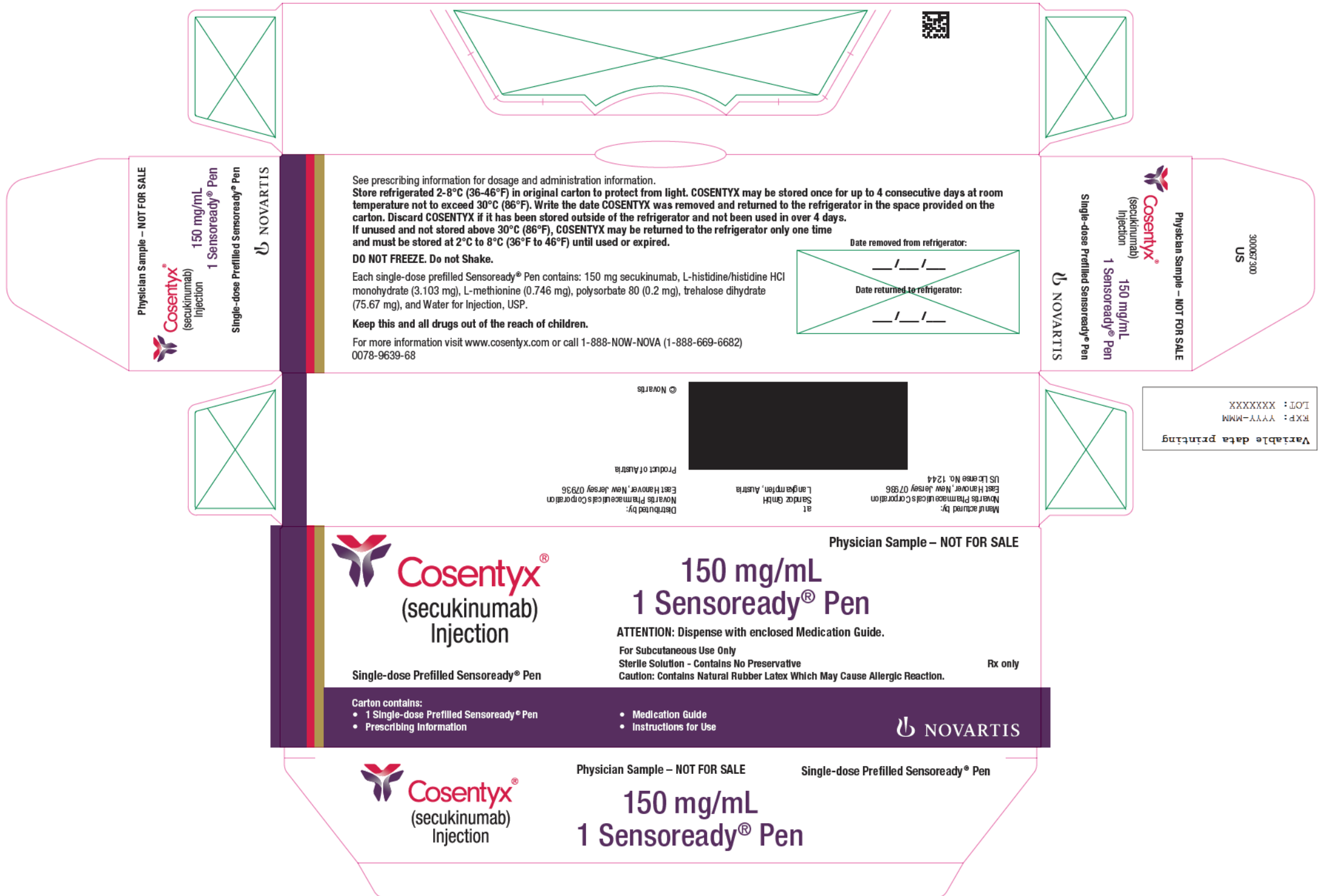

Physician Sample – NOT FOR SALE

Cosentyx[®]
 (secukinumab)
 Injection

150 mg/mL
 1 Sensoready[®] Pen

Single-dose Prefilled Sensoready[®] Pen

NOVARTIS

See prescribing information for dosage and administration information.
Store refrigerated 2-8°C (36-46°F) in original carton to protect from light. COSENTYX may be stored once for up to 4 consecutive days at room temperature not to exceed 30°C (86°F). Write the date COSENTYX was removed and returned to the refrigerator in the space provided on the carton. Discard COSENTYX if it has been stored outside of the refrigerator and not been used in over 4 days. If unused and not stored above 30°C (86°F), COSENTYX may be returned to the refrigerator only one time and must be stored at 2°C to 8°C (36°F to 46°F) until used or expired.

DO NOT FREEZE. Do not Shake.

Each single-dose prefilled Sensoready[®] Pen contains: 150 mg secukinumab, L-histidine/histidine HCl monohydrate (3.103 mg), L-methionine (0.746 mg), polysorbate 80 (0.2 mg), trehalose dihydrate (75.67 mg), and Water for Injection, USP.

Keep this and all drugs out of the reach of children.

For more information visit www.cosentyx.com or call 1-888-NOW-NOVA (1-888-669-6682) 0078-9639-68

Date removed from refrigerator:
 ___/___/___

Date returned to refrigerator:
 ___/___/___

300067300
 US

Physician Sample – NOT FOR SALE

Cosentyx[®]
 (secukinumab)
 Injection

150 mg/mL
 1 Sensoready[®] Pen

Single-dose Prefilled Sensoready[®] Pen

NOVARTIS

Variable data printing

RXP : YYYY-MM
 LOT : XXXXXXXX

Manufactured by:
 Novartis Pharmaceuticals Corporation
 East Hanover, New Jersey 07936
 US License No. 1244

at
 Sanofi GmbH
 Langkaufen, Austria

Distributed by:
 Novartis Pharmaceuticals Corporation
 East Hanover, New Jersey 07936
 Product of Austria

© Novartis

Physician Sample – NOT FOR SALE

Cosentyx[®]
 (secukinumab)
 Injection

150 mg/mL
 1 Sensoready[®] Pen

Single-dose Prefilled Sensoready[®] Pen

ATTENTION: Dispense with enclosed Medication Guide.
 For Subcutaneous Use Only
 Sterile Solution - Contains No Preservative
 Caution: Contains Natural Rubber Latex Which May Cause Allergic Reaction. Rx only

Carton contains:
 • 1 Single-dose Prefilled Sensoready[®] Pen
 • Prescribing Information

• Medication Guide
 • Instructions for Use

NOVARTIS

Physician Sample – NOT FOR SALE

Cosentyx[®]
 (secukinumab)
 Injection

150 mg/mL
 1 Sensoready[®] Pen

Single-dose Prefilled Sensoready[®] Pen

This label may not be the latest approved by FDA.
For current labeling information, please visit <https://www.fda.gov/drugsatfda>

To learn more about Cosentyx® Sensoready® Pen,
simply **Scan the QR** code with the camera app of your smartphone



This label may not be the latest approved by FDA.
For current labeling information, please visit <https://www.fda.gov/drugsatfda>



Physician Sample – NOT FOR SALE



Cosentyx[®]
(secukinumab)
Injection
150 mg/mL
1 Sensoready[®] Pen

Single-dose Prefilled Sensoready[®] Pen
NOVARTIS

See prescribing information for dosage and administration information.
Store refrigerated 2-8°C (36-46°F) in original carton to protect from light. COSENTYX may be stored once for up to 4 consecutive days at room temperature not to exceed 30°C (86°F). Write the date COSENTYX was removed and returned to the refrigerator in the space provided on the carton. Discard COSENTYX if it has been stored outside of the refrigerator and not been used in over 4 days. If unused and not stored above 30°C (86°F), COSENTYX may be returned to the refrigerator only one time and must be stored at 2°C to 8°C (36°F to 46°F) until used or expired.

DO NOT FREEZE. Do not Shake.

Each single-dose prefilled Sensoready[®] Pen contains: 150 mg secukinumab, L-histidine/histidine HCl monohydrate (3.103 mg), L-methionine (0.746 mg), polysorbate 80 (0.2 mg), trehalose dihydrate (75.67 mg), and Water for Injection, USP.

Keep this and all drugs out of the reach of children.

For more information visit www.cosentyx.com or call 1-888-NOW-NOVA (1-888-669-6682) 0078-9639-68

Date removed from refrigerator:

____/____/____

Date returned to refrigerator:

____/____/____

Physician Sample – NOT FOR SALE
Cosentyx[®]
(secukinumab)
Injection
150 mg/mL
1 Sensoready[®] Pen
Single-dose Prefilled Sensoready[®] Pen
NOVARTIS

300067301
US

Variable data printing
EXP: YYYY-MM
LOT: XXXXXXXX

Manufactured by:
Novartis Pharmaceuticals Corporation
East Hanover, New Jersey 07936
US License No. 1244
at
Sandoz GmbH
Langkampfen, Austria
Distributed by:
Novartis Pharmaceuticals Corporation
East Hanover, New Jersey 07936
Product of France
© Novartis



Cosentyx[®]
(secukinumab)
Injection

Single-dose Prefilled Sensoready[®] Pen

- Carton contains:
- 1 Single-dose Prefilled Sensoready[®] Pen
 - Prescribing Information

150 mg/mL
1 Sensoready[®] Pen

ATTENTION: Dispense with enclosed Medication Guide.

For Subcutaneous Use Only
Sterile Solution - Contains No Preservative

Caution: Contains Natural Rubber Latex Which May Cause Allergic Reaction.

Rx only

NOVARTIS



Cosentyx[®]
(secukinumab)
Injection

Physician Sample – NOT FOR SALE

150 mg/mL
1 Sensoready[®] Pen

Single-dose Prefilled Sensoready[®] Pen

This label may not be the latest approved by FDA.
For current labeling information, please visit <https://www.fda.gov/drugsatfda>

To learn more about Cosentyx[®] Sensoready[®] Pen,
simply **Scan the QR** code with the camera app of your smartphone



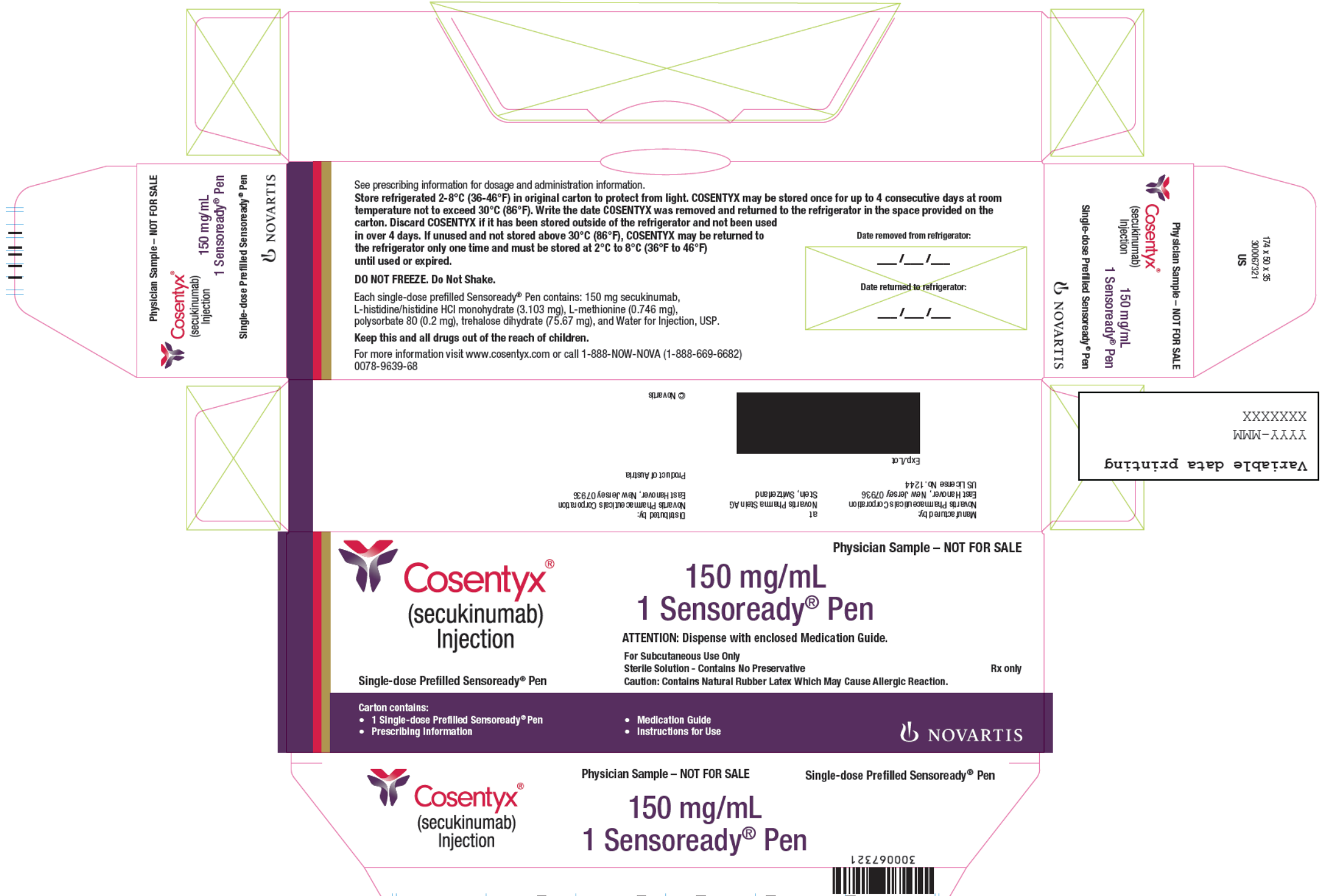

This label may not be the latest approved by FDA.
For current labeling information, please visit <https://www.fda.gov/drugsatfda>



To learn more about Cosentyx® Sensorady® Pen,
simply Scan the QR code with the camera app of your smartphone



This label may not be the latest approved by FDA.
For current labeling information, please visit <https://www.fda.gov/drugsatfda>



To learn more about Cosentyx® Sensorready® Pen,
simply Scan the QR code with the camera app of your smartphone





Physician Sample – NOT FOR SALE

150 mg/mL
2 Sensoready® Pens
(300 mg Dose)



Cosentyx[®]
(secukinumab)
Injection

Single-dose Prefilled
Sensoready® Pen

See prescribing information for dosage and administration information.

Store refrigerated 2-8°C (36-46°F) in original carton to protect from light. COSENTYX may be stored once for up to 4 consecutive days at room temperature not to exceed 30°C (86°F). Write the date COSENTYX was removed and returned to the refrigerator in the space provided on the carton. Discard COSENTYX if it has been stored outside of the refrigerator and not been used in over 4 days. If unused and not stored above 30°C (86°F), COSENTYX may be returned to the refrigerator only one time and must be stored at 2°C to 8°C (36°F to 46°F) until used or expired.

DO NOT FREEZE. Do not Shake.

Each single-dose prefilled Sensoready® Pen contains:
150 mg secukinumab, L-histidine/histidine HCl monohydrate (3.103 mg),
L-methionine (0.746 mg), polysorbate 80 (0.2 mg),
trehalose dihydrate (75.67 mg), and Water for Injection, USP.

Keep this and all drugs out of the reach of children.

For more information visit www.cosentyx.com or call 1-888-NOW-NOVA (1-888-669-6682)
0078-9639-41

Date removed from refrigerator:

— / — / —

Date returned to refrigerator:

— / — / —

Single-dose Prefilled
Sensoready® Pen

Cosentyx[®]
(secukinumab)
Injection

150 mg/mL
2 Sensoready® Pens
(300 mg Dose)



Physician Sample – NOT FOR SALE

300067302
US

Distributed by:
Novartis Pharmaceuticals Corporation
East Hanover, New Jersey 07936
Product of Austria
© Novartis

at
Sanofi GmbH
Langkampfen, Austria

Manufactured by:
Novartis Pharmaceuticals Corporation
East Hanover, New Jersey 07936
US License No. 1244

Variable data printing
EXP: YYYY-MM
LOT: XXXXXX

Physician Sample – NOT FOR SALE



Cosentyx[®]
(secukinumab)
Injection

Single-dose Prefilled Sensoready® Pen

For Subcutaneous Use Only
Sterile Solution - Contains No Preservative
Caution: Contains Natural Rubber Latex
Which May Cause Allergic Reaction.

ATTENTION: Dispense with enclosed Medication Guide.

Carton contains:

- 2 Single-dose Prefilled Sensoready® Pens
- Prescribing Information
- Medication Guide
- Instructions for Use



Rx only

Physician Sample – NOT FOR SALE

Cosentyx[®]
(secukinumab)
Injection

Single-dose Prefilled Sensoready® Pen

150 mg/mL
2 Sensoready® Pens
(300 mg Dose)

This label may not be the latest approved by FDA.
For current labeling information, please visit <https://www.fda.gov/drugsatfda>

Attention: Use both Sensoready® Pens for a 300 mg dose

To learn more about Cosentyx® Sensoready® Pen,
simply **Scan the QR** code with the camera app of your smartphone





Physician Sample – NOT FOR SALE

150 mg/mL
2 Sensoready® Pens
(300 mg Dose)



Cosentyx®
(secukinumab)
Injection

Single-dose Prefilled
Sensoready® Pen

See prescribing information for dosage and administration information.

Store refrigerated 2-8°C (36-46°F) in original carton to protect from light. COSENTYX may be stored once for up to 4 consecutive days at room temperature not to exceed 30°C (86°F). Write the date COSENTYX was removed and returned to the refrigerator in the space provided on the carton. Discard COSENTYX if it has been stored outside of the refrigerator and not been used in over 4 days. If unused and not stored above 30°C (86°F), COSENTYX may be returned to the refrigerator only one time and must be stored at 2°C to 8°C (36°F to 46°F) until used or expired.

DO NOT FREEZE. Do not Shake.

Each single-dose prefilled Sensoready® Pen contains:
150 mg secukinumab, L-histidine/histidine HCl monohydrate (3.103 mg),
L-methionine (0.746 mg), polysorbate 80 (0.2 mg),
trehalose dihydrate (75.67 mg), and Water for Injection, USP.

Keep this and all drugs out of the reach of children.

For more information visit www.cosentyx.com or call 1-888-NOW-NOVA (1-888-669-6682)
0078-9639-41

Date removed from refrigerator:

___/___/___

Date returned to refrigerator:

___/___/___

Single-dose Prefilled
Sensoready® Pen

Cosentyx®
(secukinumab)
Injection

150 mg/mL
2 Sensoready® Pens
(300 mg Dose)

NOVARTIS

Physician Sample – NOT FOR SALE

30067298
US

© Novartis

Distributed by:
Novartis Pharmaceuticals Corporation
East Hanover, New Jersey 07936
Product of France

at
Sandoz GmbH
Langkampfen, Austria

Manufactured by:
Novartis Pharmaceuticals Corporation
East Hanover, New Jersey 07936
US License No. 1244

Variable data printing
EXP: YYYY-MM
LOT: XXXXXXXX



Cosentyx®
(secukinumab)
Injection

Single-dose Prefilled Sensoready® Pen

For Subcutaneous Use Only
Sterile Solution - Contains No Preservative
Caution: Contains Natural Rubber Latex
Which May Cause Allergic Reaction.

ATTENTION: Dispense with enclosed Medication Guide.

Carton contains:

- 2 Single-dose Prefilled Sensoready® Pens
- Prescribing Information
- Medication Guide
- Instructions for Use

NOVARTIS

Physician Sample – NOT FOR SALE

Rx only



Cosentyx®
(secukinumab)
Injection

Single-dose Prefilled Sensoready® Pen

150 mg/mL
2 Sensoready® Pens
(300 mg Dose)

Physician Sample – NOT FOR SALE

This label may not be the latest approved by FDA.
For current labeling information, please visit <https://www.fda.gov/drugsatfda>

Attention: Use both Sensoready® Pens for a 300 mg dose

To learn more about Cosentyx® Sensoready® Pen,
simply **Scan the QR** code with the camera app of your smartphone



Physician Sample – NOT FOR SALE

150 mg/mL
2 Sensoready® Pens
(300 mg Dose)

Cosentyx®
(secukinumab)
Injection

Single-dose Prefilled
Sensoready® Pen

NOVARTIS

See prescribing information for dosage and administration information.

Store refrigerated 2-8°C (36-46°F) in original carton to protect from light. COSENTYX may be stored once for up to 4 consecutive days at room temperature not to exceed 30°C (86°F). Write the date COSENTYX was removed and returned to the refrigerator in the space provided on the carton. Discard COSENTYX if it has been stored outside of the refrigerator and not been used in over 4 days. If unused and not stored above 30°C (86°F), COSENTYX may be returned to the refrigerator only one time and must be stored at 2°C to 8°C (36°F to 46°F) until used or expired.

DO NOT FREEZE. Do Not Shake.

Each single-dose prefilled Sensoready® Pen contains:
150 mg secukinumab, L-histidine/histidine HCl monohydrate (3.103 mg),
L-methionine (0.746 mg), polysorbate 80 (0.2 mg),
trehalose dihydrate (75.67 mg), and Water for Injection, USP.

Keep this and all drugs out of the reach of children.

For more information visit www.cosentyx.com or call 1-888-NOW-NOVA (1-888-669-6682)
0078-9639-41

Single-dose Prefilled
Sensoready® Pen

Cosentyx®
(secukinumab)
Injection

150 mg/mL
2 Sensoready® Pens
(300 mg Dose)

NOVARTIS

Physician Sample – NOT FOR SALE

174 X 85 X 35
300067324
US

Date removed from refrigerator: _____/_____/_____
Date returned to refrigerator: _____/_____/_____

Physician Sample – NOT FOR SALE

150 mg/mL
2 Sensoready® Pens
(300 mg Dose)

Cosentyx®
(secukinumab)
Injection

Single-dose Prefilled
Sensoready® Pen

NOVARTIS

See prescribing information for dosage and administration information.

Store refrigerated 2-8°C (36-46°F) in original carton to protect from light. COSENTYX may be stored once for up to 4 consecutive days at room temperature not to exceed 30°C (86°F). Write the date COSENTYX was removed and returned to the refrigerator in the space provided on the carton. Discard COSENTYX if it has been stored outside of the refrigerator and not been used in over 4 days. If unused and not stored above 30°C (86°F), COSENTYX may be returned to the refrigerator only one time and must be stored at 2°C to 8°C (36°F to 46°F) until used or expired.

DO NOT FREEZE. Do Not Shake.

Each single-dose prefilled Sensoready® Pen contains:
150 mg secukinumab, L-histidine/histidine HCl monohydrate (3.103 mg),
L-methionine (0.746 mg), polysorbate 80 (0.2 mg),
trehalose dihydrate (75.67 mg), and Water for Injection, USP.

Keep this and all drugs out of the reach of children.

For more information visit www.cosentyx.com or call 1-888-NOW-NOVA (1-888-669-6682)
0078-9639-41

Single-dose Prefilled
Sensoready® Pen

Cosentyx®
(secukinumab)
Injection

150 mg/mL
2 Sensoready® Pens
(300 mg Dose)

NOVARTIS

Physician Sample – NOT FOR SALE

174 X 85 X 35
300067324
US

Date removed from refrigerator: _____/_____/_____
Date returned to refrigerator: _____/_____/_____

Physician Sample – NOT FOR SALE

150 mg/mL
2 Sensoready® Pens
(300 mg Dose)

Cosentyx®
(secukinumab)
Injection

Single-dose Prefilled Sensoready® Pen

For Subcutaneous Use Only
Sterile Solution - Contains No Preservative
Caution: Contains Natural Rubber Latex
Which May Cause Allergic Reaction.

ATTENTION: Dispense with enclosed Medication Guide.

Carton contains:

- 2 Single-dose Prefilled Sensoready® Pens
- Prescribing Information
- Medication Guide
- Instructions for Use

Cosentyx®
(secukinumab)
Injection

150 mg/mL
2 Sensoready® Pens
(300 mg Dose)

Rx only

NOVARTIS

Physician Sample – NOT FOR SALE

150 mg/mL
2 Sensoready® Pens
(300 mg Dose)

NOVARTIS

Physician Sample – NOT FOR SALE

174 X 85 X 35
300067324
US

Date removed from refrigerator: _____/_____/_____
Date returned to refrigerator: _____/_____/_____

Physician Sample – NOT FOR SALE

150 mg/mL
2 Sensoready® Pens
(300 mg Dose)

Cosentyx®
(secukinumab)
Injection

Single-dose Prefilled Sensoready® Pen

NOVARTIS

See prescribing information for dosage and administration information.

Store refrigerated 2-8°C (36-46°F) in original carton to protect from light. COSENTYX may be stored once for up to 4 consecutive days at room temperature not to exceed 30°C (86°F). Write the date COSENTYX was removed and returned to the refrigerator in the space provided on the carton. Discard COSENTYX if it has been stored outside of the refrigerator and not been used in over 4 days. If unused and not stored above 30°C (86°F), COSENTYX may be returned to the refrigerator only one time and must be stored at 2°C to 8°C (36°F to 46°F) until used or expired.

DO NOT FREEZE. Do Not Shake.

Each single-dose prefilled Sensoready® Pen contains:
150 mg secukinumab, L-histidine/histidine HCl monohydrate (3.103 mg),
L-methionine (0.746 mg), polysorbate 80 (0.2 mg),
trehalose dihydrate (75.67 mg), and Water for Injection, USP.

Keep this and all drugs out of the reach of children.

For more information visit www.cosentyx.com or call 1-888-NOW-NOVA (1-888-669-6682)
0078-9639-41

Single-dose Prefilled
Sensoready® Pen

Cosentyx®
(secukinumab)
Injection

150 mg/mL
2 Sensoready® Pens
(300 mg Dose)

NOVARTIS

Physician Sample – NOT FOR SALE

174 X 85 X 35
300067324
US

Date removed from refrigerator: _____/_____/_____
Date returned to refrigerator: _____/_____/_____

Variable data printing
XXXXXX
YYYY-MM

Manufactured by:
Novartis Pharmaceuticals Corporation
East Hanover, New Jersey 07936
US License No. 1244
at
Novartis Pharma Stein AG
Stein, Switzerland
Distributed by:
Novartis Pharmaceuticals Corporation
East Hanover, New Jersey 07936
Product of Austria
© Novartis
Exp./Lot



This label may not be the latest approved by FDA.
For current labeling information, please visit <https://www.fda.gov/drugsatfda>

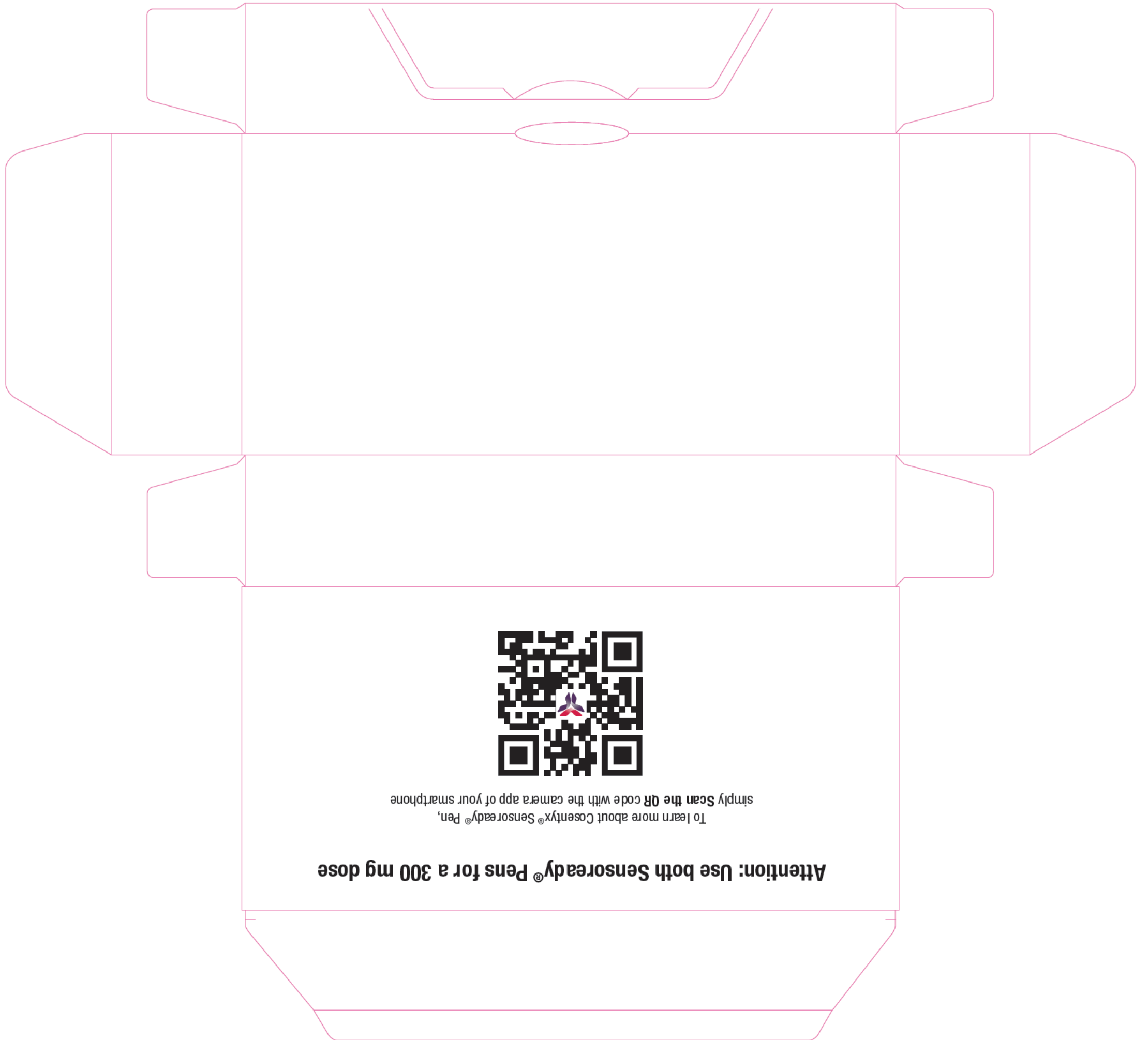

Attention: Use both Sensorready® Pens for a 300 mg dose

To learn more about Cosentyx® Sensorready® Pen,
simply Scan the QR code with the camera app of your smartphone



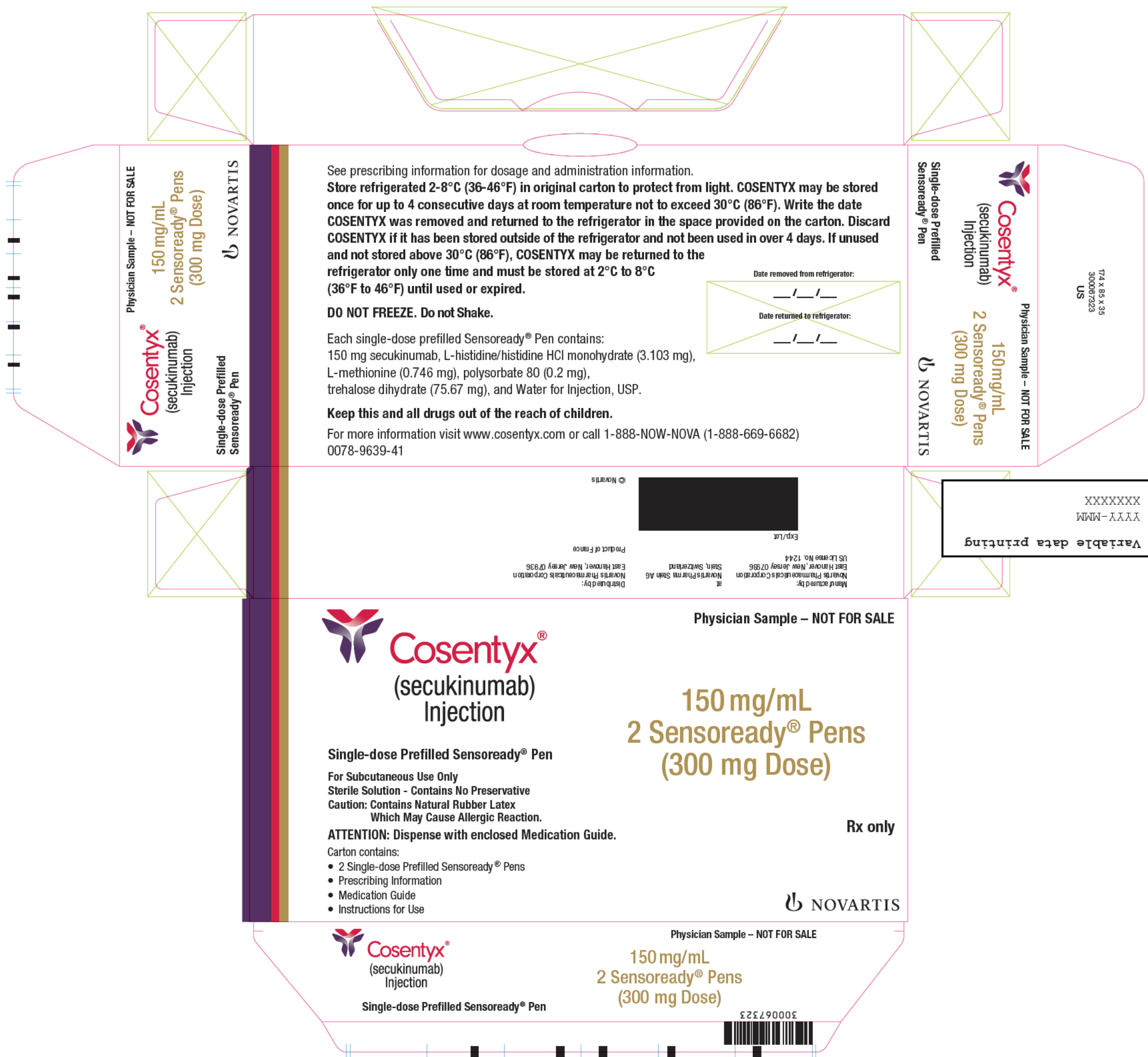

Physician Sample – NOT FOR SALE

150 mg/mL
2 Sensoready® Pens
(300 mg Dose)

NOVARTIS

Single-dose Prefilled
Sensoready® Pen

Cosentyx[®]
(secukinumab)
Injection

See prescribing information for dosage and administration information.
Store refrigerated 2-8°C (36-46°F) in original carton to protect from light. COSENTYX may be stored once for up to 4 consecutive days at room temperature not to exceed 30°C (86°F). Write the date COSENTYX was removed and returned to the refrigerator in the space provided on the carton. Discard COSENTYX if it has been stored outside of the refrigerator and not been used in over 4 days. If unused and not stored above 30°C (86°F), COSENTYX may be returned to the refrigerator only one time and must be stored at 2°C to 8°C (36°F to 46°F) until used or expired.

Date removed from refrigerator:
____/____/____

Date returned to refrigerator:
____/____/____

DO NOT FREEZE. Do not Shake.

Each single-dose prefilled Sensoready® Pen contains:
150 mg secukinumab, L-histidine/histidine HCl monohydrate (3.103 mg),
L-methionine (0.746 mg), polysorbate 80 (0.2 mg),
trehalose dihydrate (75.67 mg), and Water for Injection, USP.

Keep this and all drugs out of the reach of children.

For more information visit www.cosentyx.com or call 1-888-NOW-NOVA (1-888-669-6682)
0078-9639-41

Single-dose Prefilled
Sensoready® Pen

Cosentyx[®]
(secukinumab)
Injection

150 mg/mL
2 Sensoready® Pens
(300 mg Dose)

NOVARTIS

Physician Sample – NOT FOR SALE

174 x 85 x 35
300067323
US

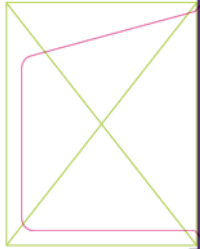

Manufactured by:
Novartis Pharmaceuticals Corporation
East Hanover, New Jersey 07936
US License No. 1244

at
Novartis Pharma Stein AG
Stein, Switzerland

Distributed by:
Novartis Pharmaceuticals Corporation
East Hanover, New Jersey 07936

Product of France

Exp./Lot

© Novartis

Variable data printing
XXXXXX
YY-YY-MM

Cosentyx[®]
(secukinumab)
Injection

Physician Sample – NOT FOR SALE

150 mg/mL
2 Sensoready® Pens
(300 mg Dose)

Single-dose Prefilled Sensoready® Pen

For Subcutaneous Use Only
Sterile Solution - Contains No Preservative
Caution: Contains Natural Rubber Latex
Which May Cause Allergic Reaction.

ATTENTION: Dispense with enclosed Medication Guide.

- Carton contains:
- 2 Single-dose Prefilled Sensoready® Pens
 - Prescribing Information
 - Medication Guide
 - Instructions for Use

Rx only

NOVARTIS

Cosentyx[®]
(secukinumab)
Injection

Physician Sample – NOT FOR SALE

150 mg/mL
2 Sensoready® Pens
(300 mg Dose)

Single-dose Prefilled Sensoready® Pen



This label may not be the latest approved by FDA.
For current labeling information, please visit <https://www.fda.gov/drugsatfda>



Attention: Use both Sensorready® Pens for a 300 mg dose

To learn more about Cosentyx® Sensorready® Pen,
simply **Scan the QR** code with the camera app of your smartphone



This label may not be the latest approved by FDA.
For current labeling information, please visit <https://www.fda.gov/drugsatfda>

NDC 0078-0639-68
Cosentyx[®]
(secukinumab)
Injection
150 mg/mL
1 Sensoready[®] Pen
Single-dose Prefilled Sensoready[®] Pen
NOVARTIS

See prescribing information for dosage and administration information.
Store refrigerated 2-8°C (36-46°F) in original carton to protect from light. COSENTYX may be stored once for up to 4 consecutive days at room temperature not to exceed 30°C (86°F). Write the date COSENTYX was removed and returned to the refrigerator in the space provided on the carton. Discard COSENTYX if it has been stored outside of the refrigerator and not been used in over 4 days.
If unused and not stored above 30°C (86°F), COSENTYX may be returned to the refrigerator only one time and must be stored at 2°C to 8°C (36°F to 46°F) until used or expired.
DO NOT FREEZE. Do not Shake.
Each single-dose prefilled Sensoready[®] Pen contains: 150 mg secukinumab, L-histidine/histidine HCl monohydrate (3.103 mg), L-methionine (0.746 mg), polysorbate 80 (0.2 mg), trehalose dihydrate (75.67 mg), and Water for Injection, USP.
Keep this and all drugs out of the reach of children.
For more information visit www.cosentyx.com or call 1-888-NOW-NOVA (1-888-669-6682)

Date removed from refrigerator: _____
Date returned to refrigerator: _____

Cosentyx[®]
(secukinumab)
Injection
150 mg/mL
1 Sensoready[®] Pen
Single-dose Prefilled Sensoready[®] Pen
NOVARTIS
NDC 0078-0639-68
300067310
US

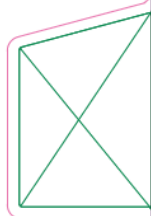

© Novartis
Product of Austria
East Hanover, New Jersey 07936
Novartis Pharmaceuticals Corporation
Distributed by:

at
Sandoz GmbH
Langkampfen, Austria
Manufactured by:
Novartis Pharmaceuticals Corporation
East Hanover, New Jersey 07936
US License No. 1244

Serialization Variable data printing
GTIN: XXXXXXXXXXXXXXXXXX
SN: XXXXXXXXXXXXXXXXXX
EXP: YY-YY-MM
LOT: XXXXXX

Cosentyx[®]
(secukinumab)
Injection

150 mg/mL
1 Sensoready[®] Pen

NDC 0078-0639-68

Single-dose Prefilled Sensoready[®] Pen

ATTENTION: Dispense with enclosed Medication Guide.
For Subcutaneous Use Only
Sterile Solution - Contains No Preservative
Caution: Contains Natural Rubber Latex Which May Cause Allergic Reaction. Rx only

- Carton contains:
- 1 Single-dose Prefilled Sensoready[®] Pen
 - Prescribing Information

- Medication Guide
- Instructions for Use

NOVARTIS

Cosentyx[®]
(secukinumab)
Injection

150 mg/mL
1 Sensoready[®] Pen

NDC 0078-0639-68

Single-dose Prefilled Sensoready[®] Pen

This label may not be the latest approved by FDA.
For current labeling information, please visit <https://www.fda.gov/drugsatfda>

To learn more about Cosentyx[®] Sensoready[®] Pen,
simply **Scan the QR** code with the camera app of your smartphone



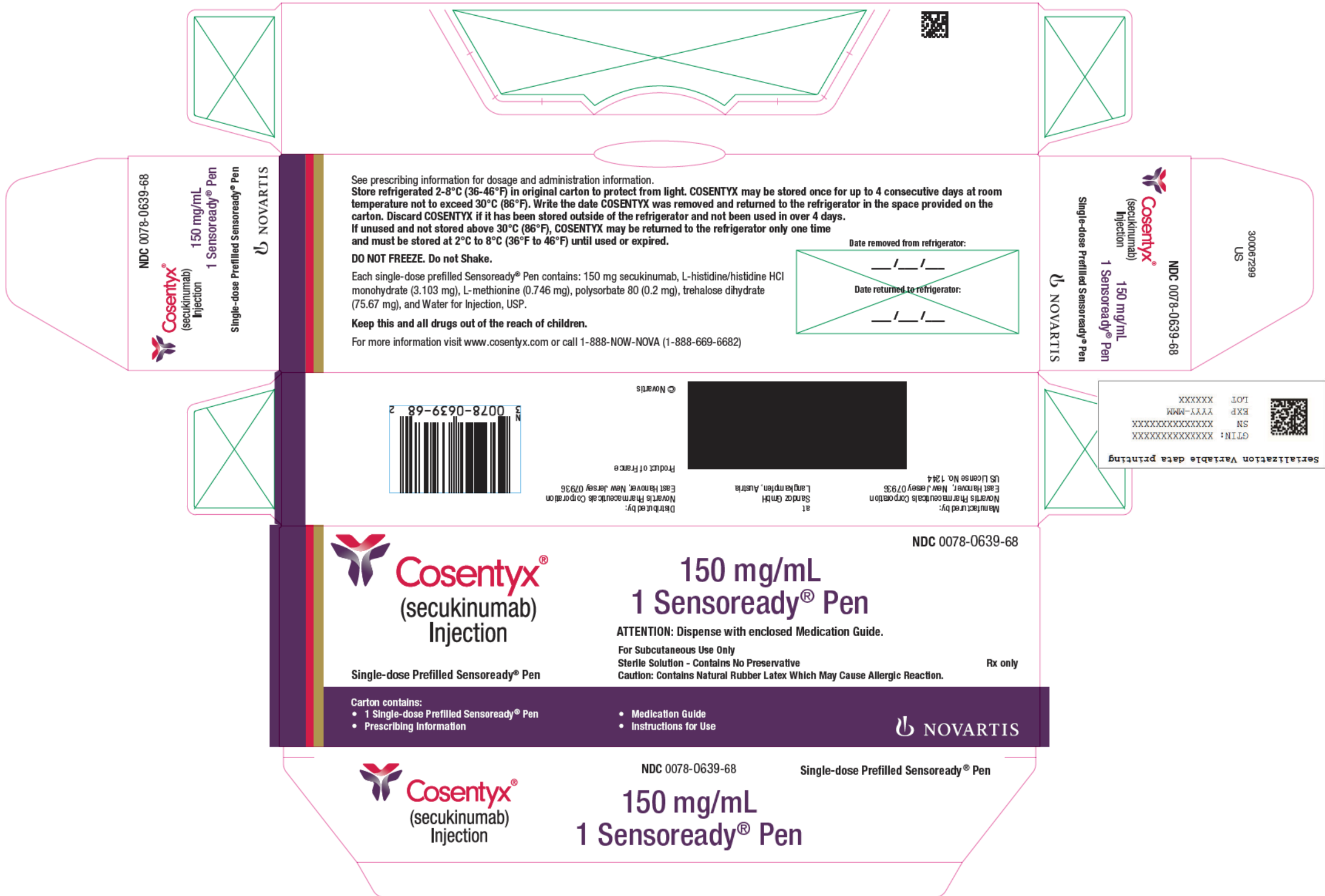

NDC 0078-0639-68
Cosentyx[®]
 (secukinumab)
 Injection
 150 mg/mL
 1 Sensoready[®] Pen
 NOVARTIS

See prescribing information for dosage and administration information.
Store refrigerated 2-8°C (36-46°F) in original carton to protect from light. COSENTYX may be stored once for up to 4 consecutive days at room temperature not to exceed 30°C (86°F). Write the date COSENTYX was removed and returned to the refrigerator in the space provided on the carton. Discard COSENTYX if it has been stored outside of the refrigerator and not been used in over 4 days. If unused and not stored above 30°C (86°F), COSENTYX may be returned to the refrigerator only one time and must be stored at 2°C to 8°C (36°F to 46°F) until used or expired.
DO NOT FREEZE. Do not Shake.
 Each single-dose prefilled Sensoready[®] Pen contains: 150 mg secukinumab, L-histidine/histidine HCl monohydrate (3.103 mg), L-methionine (0.746 mg), polysorbate 80 (0.2 mg), trehalose dihydrate (75.67 mg), and Water for Injection, USP.
Keep this and all drugs out of the reach of children.
 For more information visit www.cosentyx.com or call 1-888-NOW-NOVA (1-888-669-6682)

Date removed from refrigerator: / /

Date returned to refrigerator: / /

Cosentyx[®]
 (secukinumab)
 Injection
 150 mg/mL
 1 Sensoready[®] Pen
 NOVARTIS
 NDC 0078-0639-68
 30067299
 US

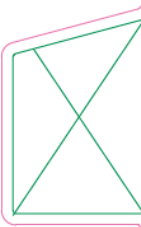

© Novartis
 Product of France
 Distributed by:
 Novartis Pharmaceuticals Corporation
 East Hanover, New Jersey 07936
 at
 Sandoz GmbH
 Langkaimpen, Austria



Manufactured by:
 Novartis Pharmaceuticals Corporation
 East Hanover, New Jersey 07936
 US License No. 1244

GTIN: XXXXXXXXXXXXXXXXXX
 SN: XXXXXXXXXXXXXXXXXX
 EXP: YY-YY-MM
 LOT: XXXXX
 Serialization Variable data printing

Cosentyx[®]
 (secukinumab)
 Injection

150 mg/mL
1 Sensoready[®] Pen

NDC 0078-0639-68

Single-dose Prefilled Sensoready[®] Pen

ATTENTION: Dispense with enclosed Medication Guide.
 For Subcutaneous Use Only
 Sterile Solution - Contains No Preservative
 Caution: Contains Natural Rubber Latex Which May Cause Allergic Reaction.

Rx only

- Carton contains:
- 1 Single-dose Prefilled Sensoready[®] Pen
 - Prescribing Information

- Medication Guide
- Instructions for Use



Cosentyx[®]
 (secukinumab)
 Injection

150 mg/mL
1 Sensoready[®] Pen

NDC 0078-0639-68

Single-dose Prefilled Sensoready[®] Pen

This label may not be the latest approved by FDA.
For current labeling information, please visit <https://www.fda.gov/drugsatfda>

To learn more about Cosentyx® Sensoready® Pen,
simply **Scan the QR** code with the camera app of your smartphone



This label may not be the latest approved by FDA.
For current labeling information, please visit <https://www.fda.gov/drugsatfda>

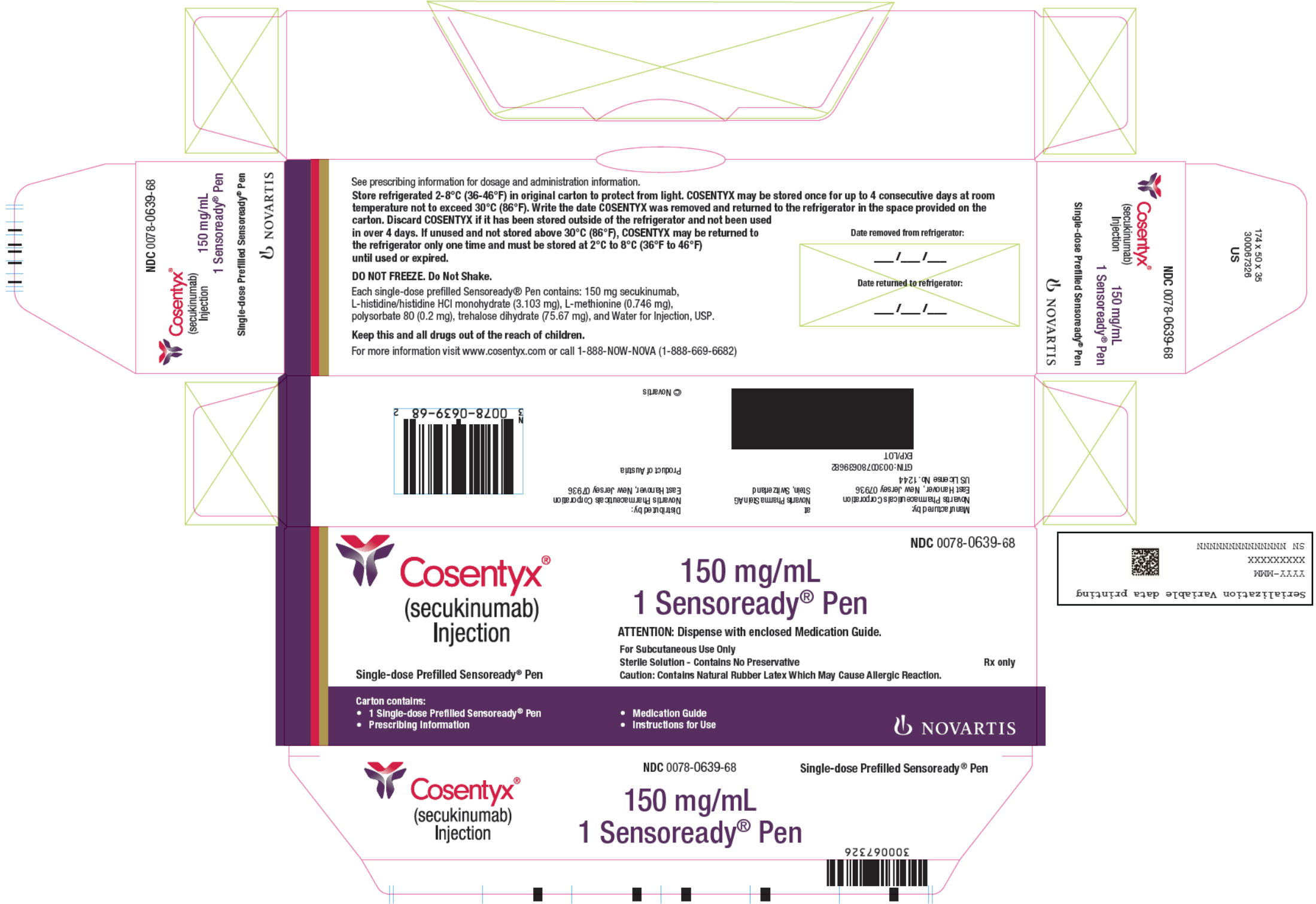

NDC 0078-0639-68
Cosentyx[®]
(secukinumab)
Injection
150 mg/mL
1 Sensoready[®] Pen
NOVARTIS

See prescribing information for dosage and administration information.
Store refrigerated 2-8°C (36-46°F) in original carton to protect from light. COSENTYX may be stored once for up to 4 consecutive days at room temperature not to exceed 30°C (86°F). Write the date COSENTYX was removed and returned to the refrigerator in the space provided on the carton. Discard COSENTYX if it has been stored outside of the refrigerator and not been used in over 4 days. If unused and not stored above 30°C (86°F), COSENTYX may be returned to the refrigerator only one time and must be stored at 2°C to 8°C (36°F to 46°F) until used or expired.
DO NOT FREEZE. Do Not Shake.
Each single-dose prefilled Sensoready[®] Pen contains: 150 mg secukinumab, L-histidine/histidine HCl monohydrate (3.103 mg), L-methionine (0.746 mg), polysorbate 80 (0.2 mg), trehalose dihydrate (75.67 mg), and Water for Injection, USP.
Keep this and all drugs out of the reach of children.
For more information visit www.cosentyx.com or call 1-888-NOW-NOVA (1-888-669-6682)

Date removed from refrigerator: _____
Date returned to refrigerator: _____

Cosentyx[®]
(secukinumab)
Injection
150 mg/mL
1 Sensoready[®] Pen
NOVARTIS
NDC 0078-0639-68

174 x 50 x 35
300067326
US



© Novartis
Product of Austria
East Hanover, New Jersey 07936
Novartis Pharmaceuticals Corporation
Distributed by:

Manufactured by:
Novartis Pharmaceuticals Corporation
East Hanover, New Jersey 07936
US License No. 1244
GTN: 00300780699682
EXP/LOT

Cosentyx[®]
(secukinumab)
Injection

150 mg/mL
1 Sensoready[®] Pen

NDC 0078-0639-68

ATTENTION: Dispense with enclosed Medication Guide.
For Subcutaneous Use Only
Sterile Solution - Contains No Preservative
Caution: Contains Natural Rubber Latex Which May Cause Allergic Reaction. **Rx only**

Carton contains:
• 1 Single-dose Prefilled Sensoready[®] Pen
• Prescribing Information

• Medication Guide
• Instructions for Use

NOVARTIS

Cosentyx[®]
(secukinumab)
Injection

150 mg/mL
1 Sensoready[®] Pen

NDC 0078-0639-68

Single-dose Prefilled Sensoready[®] Pen



XXXXXXXXXXXX
YYYY-MM
Serialization Variable data printing

This label may not be the latest approved by FDA.
For current labeling information, please visit <https://www.fda.gov/drugsatfda>



To learn more about Cosentyx® SensorReady® Pen,
simply Scan the QR code with the camera app of your smartphone



This label may not be the latest approved by FDA.
For current labeling information, please visit <https://www.fda.gov/drugsatfda>

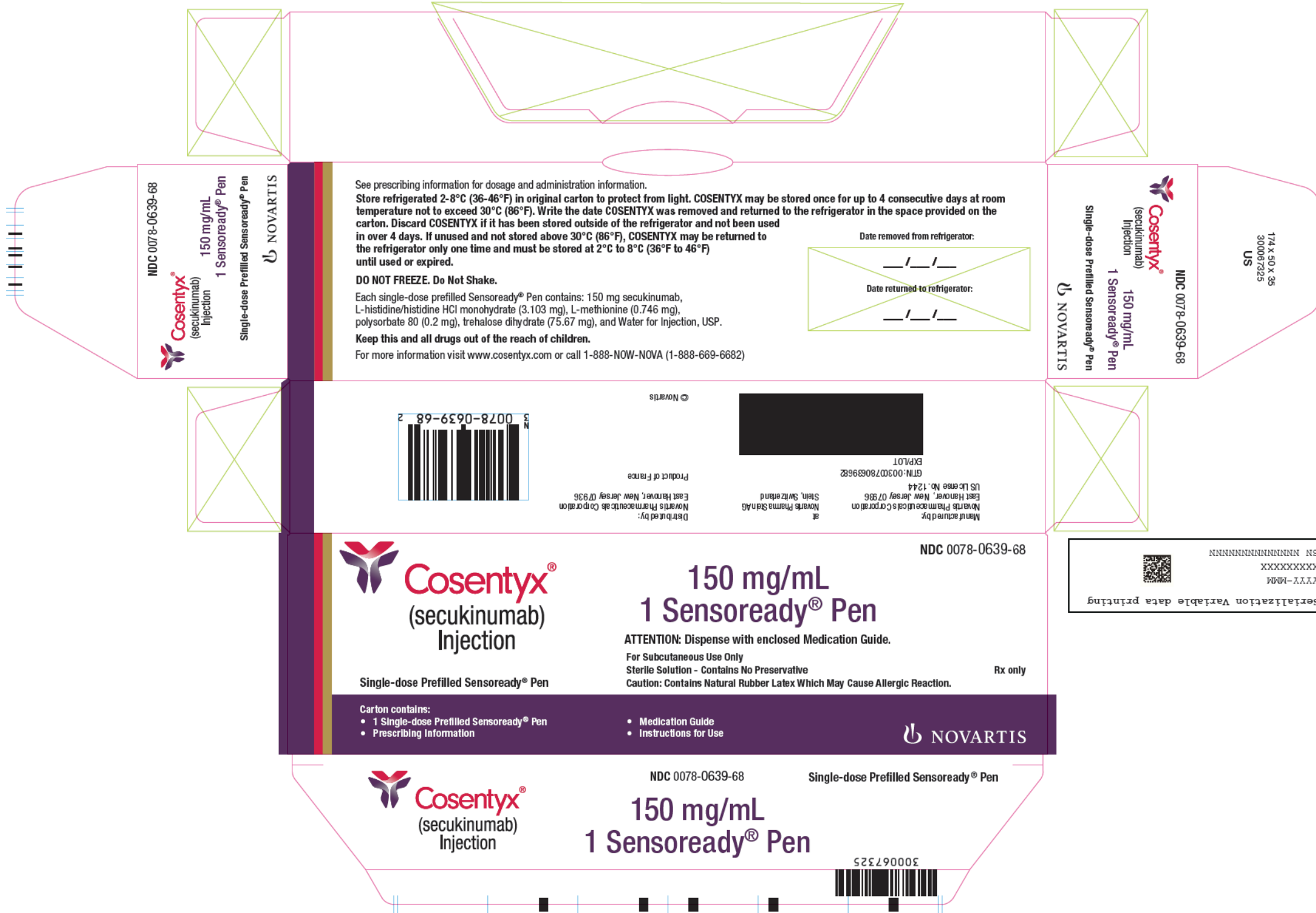

NDC 0078-0639-68
Cosentyx[®]
 (secukinumab)
 Injection
 150 mg/mL
 1 Sensoready[®] Pen
 Single-dose Prefilled Sensoready[®] Pen
 NOVARTIS

See prescribing information for dosage and administration information.
Store refrigerated 2-8°C (36-46°F) in original carton to protect from light. COSENTYX may be stored once for up to 4 consecutive days at room temperature not to exceed 30°C (86°F). Write the date COSENTYX was removed and returned to the refrigerator in the space provided on the carton. Discard COSENTYX if it has been stored outside of the refrigerator and not been used in over 4 days. If unused and not stored above 30°C (86°F), COSENTYX may be returned to the refrigerator only one time and must be stored at 2°C to 8°C (36°F to 46°F) until used or expired.
DO NOT FREEZE. Do Not Shake.
 Each single-dose prefilled Sensoready[®] Pen contains: 150 mg secukinumab, L-histidine/histidine HCl monohydrate (3.103 mg), L-methionine (0.746 mg), polysorbate 80 (0.2 mg), trehalose dihydrate (75.67 mg), and Water for Injection, USP.
Keep this and all drugs out of the reach of children.
 For more information visit www.cosentyx.com or call 1-888-NOW-NOVA (1-888-669-6682)

Date removed from refrigerator: ___/___/___
 Date returned to refrigerator: ___/___/___

Cosentyx[®]
 (secukinumab)
 Injection
 150 mg/mL
 1 Sensoready[®] Pen
 Single-dose Prefilled Sensoready[®] Pen
 NOVARTIS
 NDC 0078-0639-68

174 x 50 x 35
 300067325
 US

NDC 0078-0639-68



© Novartis
 Product of France
 Distributed by:
 Novartis Pharmaceuticals Corporation
 East Hanover, New Jersey 07936

Manufactured by:
 Novartis Pharmaceuticals Corporation
 East Hanover, New Jersey 07936
 at
 Novartis Pharma Stein AG
 Stein, Switzerland
 US License No. 1244
 GTN: 00300780689682
 EXPILOT

Cosentyx[®]
 (secukinumab)
 Injection

150 mg/mL
1 Sensoready[®] Pen

NDC 0078-0639-68

ATTENTION: Dispense with enclosed Medication Guide.
 For Subcutaneous Use Only
 Sterile Solution - Contains No Preservative
 Caution: Contains Natural Rubber Latex Which May Cause Allergic Reaction.
 Rx only

Carton contains:
 • 1 Single-dose Prefilled Sensoready[®] Pen
 • Prescribing Information

• Medication Guide
 • Instructions for Use

NOVARTIS

Cosentyx[®]
 (secukinumab)
 Injection

150 mg/mL
1 Sensoready[®] Pen

NDC 0078-0639-68

Single-dose Prefilled Sensoready[®] Pen



Serialization Variable data printing
 XXXX-YY-MM
 XXXXXXXXXXXXX
 NS NNNNNNNNNNNNN

This label may not be the latest approved by FDA.
For current labeling information, please visit <https://www.fda.gov/drugsatfda>

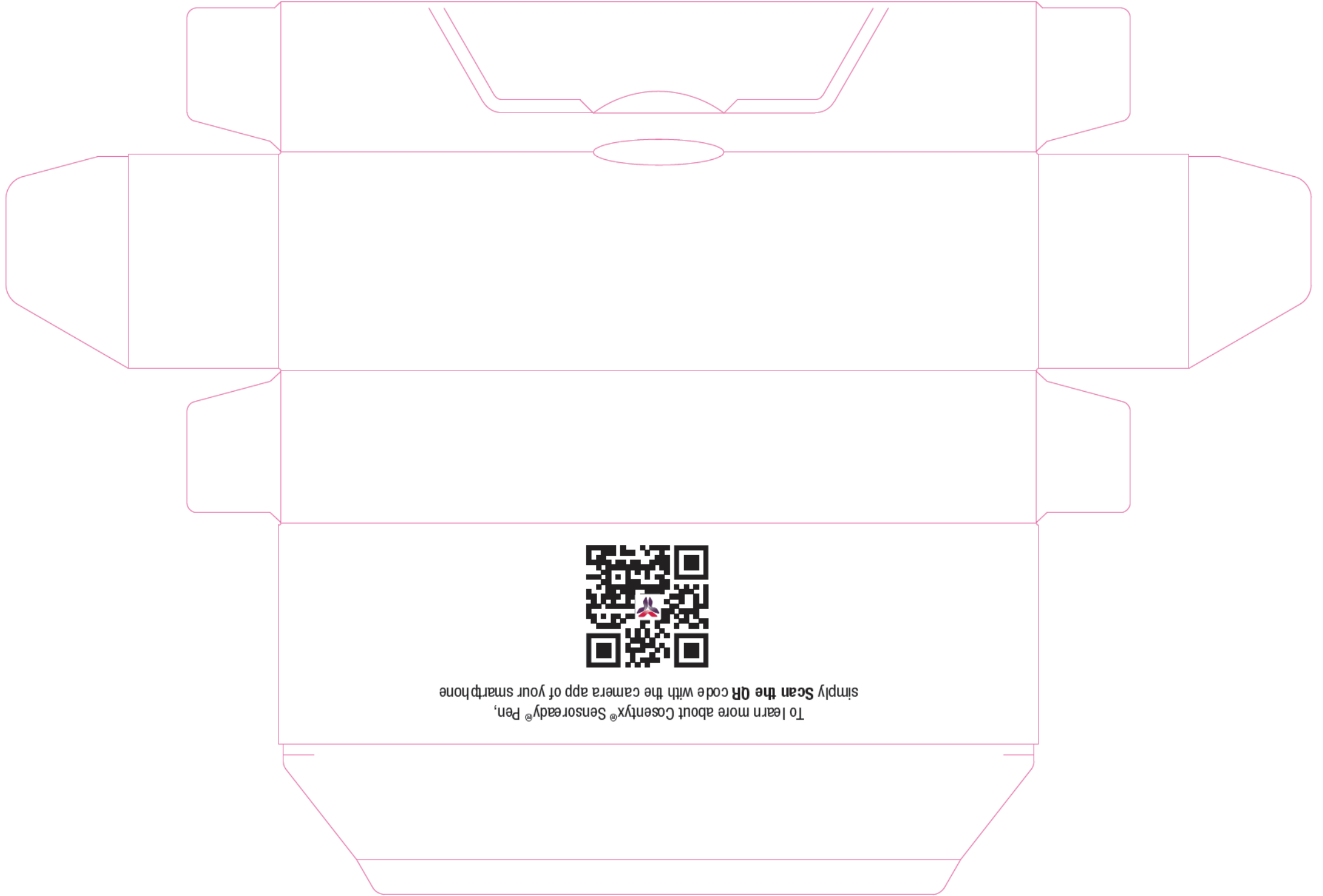

To learn more about Cosentyx® Sensorady® Pen,
simply Scan the QR code with the camera app of your smartphone



NDC 0078-0639-41

150 mg/mL
2 Sensoready® Pens
(300 mg Dose)

NOVARTIS

Cosentyx[®]
(secukinumab)
Injection

Single-dose Prefilled
Sensoready® Pen

See prescribing information for dosage and administration information.

Store refrigerated 2-8°C (36-46°F) in original carton to protect from light. COSENTYX may be stored once for up to 4 consecutive days at room temperature not to exceed 30°C (86°F). Write the date COSENTYX was removed and returned to the refrigerator in the space provided on the carton. Discard COSENTYX if it has been stored outside of the refrigerator and not been used in over 4 days. If unused and not stored above 30°C (86°F), COSENTYX may be returned to the refrigerator only one time and must be stored at 2°C to 8°C (36°F to 46°F) until used or expired.

DO NOT FREEZE. Do not Shake.

Each single-dose prefilled Sensoready® Pen contains:
150 mg secukinumab, L-histidine/histidine HCl monohydrate (3.103 mg),
L-methionine (0.746 mg), polysorbate 80 (0.2 mg),
trehalose dihydrate (75.67 mg), and Water for Injection, USP.

Keep this and all drugs out of the reach of children.

For more information visit www.cosentyx.com or call 1-888-NOW-NOVA (1-888-669-6682)

Date removed from refrigerator:

___/___/___

Date returned to refrigerator:

___/___/___

Single-dose Prefilled
Sensoready® Pen

Cosentyx[®]
(secukinumab)
Injection

150 mg/mL
2 Sensoready® Pens
(300 mg Dose)

NOVARTIS

NDC 0078-0639-41

300067303
US



Distributed by:
Novartis Pharmaceuticals Corporation
East Hanover, New Jersey 07936
Product of Austria

Manufactured by:
Novartis Pharmaceuticals Corporation
East Hanover, New Jersey 07936
US License No. 1244

at
Sandoz GmbH
Langkampfen, Austria

© Novartis

Cosentyx[®]
(secukinumab)
Injection

Single-dose Prefilled Sensoready® Pen

For Subcutaneous Use Only
Sterile Solution - Contains No Preservative
Caution: Contains Natural Rubber Latex
Which May Cause Allergic Reaction.

ATTENTION: Dispense with enclosed Medication Guide.

Carton contains:

- 2 Single-dose Prefilled Sensoready® Pens
- Prescribing Information
- Medication Guide
- Instructions for Use

NDC 0078-0639-41

CONTAINS TWO UNITS THAT
MAY NOT BE SOLD SEPARATELY

150 mg/mL
2 Sensoready® Pens
(300 mg Dose)

Rx only

NOVARTIS

NDC 0078-0639-41

Cosentyx[®]
(secukinumab)
Injection

Single-dose Prefilled Sensoready® Pen

150 mg/mL
2 Sensoready® Pens
(300 mg Dose)

Serialization Variable data printing
GTIN: XXXXXXXXXXXXXXXXXX
SN XXXXXXXXXXXXXXXXXX
EXP YYY-YY-MM
LOT XXXXXX



Attention: Use both Sensoready[®] Pens for a 300 mg dose

To learn more about Cosentyx[®] Sensoready[®] Pen,
simply **Scan the QR** code with the camera app of your smartphone



NDC 0078-0639-41

150 mg/mL
2 Sensoready® Pens
(300 mg Dose)

NOVARTIS

Cosentyx
(secukinumab)
Injection

Single-dose Prefilled
Sensoready® Pen

See prescribing information for dosage and administration information.

Store refrigerated 2-8°C (36-46°F) in original carton to protect from light. COSENTYX may be stored once for up to 4 consecutive days at room temperature not to exceed 30°C (86°F). Write the date COSENTYX was removed and returned to the refrigerator in the space provided on the carton. Discard COSENTYX if it has been stored outside of the refrigerator and not been used in over 4 days. If unused and not stored above 30°C (86°F), COSENTYX may be returned to the refrigerator only one time and must be stored at 2°C to 8°C (36°F to 46°F) until used or expired.

DO NOT FREEZE. Do not Shake.

Each single-dose prefilled Sensoready® Pen contains:
150 mg secukinumab, L-histidine/histidine HCl monohydrate (3.103 mg),
L-methionine (0.746 mg), polysorbate 80 (0.2 mg),
trehalose dihydrate (75.67 mg), and Water for Injection, USP.

Keep this and all drugs out of the reach of children.

For more information visit www.cosentyx.com or call 1-888-NOW-NOVA (1-888-669-6682)

Date removed from refrigerator:

___/___/___

Date returned to refrigerator:

___/___/___

Single-dose Prefilled
Sensoready® Pen

Cosentyx
(secukinumab)
Injection

150 mg/mL
2 Sensoready® Pens
(300 mg Dose)

NOVARTIS

300067311
US

NDC 0078-0639-41



Distributed by:
Novartis Pharmaceuticals Corporation
East Hanover, New Jersey 07935
Product of France

at
Sandoz GmbH
Langenlupfen, Austria

Manufactured by:
Novartis Pharmaceuticals Corporation
East Hanover, New Jersey 07935
US License No. 1244

© Novartis



Cosentyx
(secukinumab)
Injection

NDC 0078-0639-41

CONTAINS TWO UNITS THAT
MAY NOT BE SOLD SEPARATELY

150 mg/mL
2 Sensoready® Pens
(300 mg Dose)

Single-dose Prefilled Sensoready® Pen

For Subcutaneous Use Only
Sterile Solution - Contains No Preservative
Caution: Contains Natural Rubber Latex
Which May Cause Allergic Reaction.

ATTENTION: Dispense with enclosed Medication Guide.

Carton contains:

- 2 Single-dose Prefilled Sensoready® Pens
- Prescribing Information
- Medication Guide
- Instructions for Use

Rx only

NOVARTIS

NDC 0078-0639-41

Cosentyx
(secukinumab)
Injection

Single-dose Prefilled Sensoready® Pen

150 mg/mL
2 Sensoready® Pens
(300 mg Dose)

Serialization Variable data printing
GTIN: XXXXXXXXXXXXXXXXXXXX
SN: XXXXXXXXXXXXXXXXXXXX
EXP: YY-YY-MM
LOT: XXXXXX



This label may not be the latest approved by FDA.
For current labeling information, please visit <https://www.fda.gov/drugsatfda>

Attention: Use both Sensoready[®] Pens for a 300 mg dose

To learn more about Cosentyx[®] Sensoready[®] Pen,
simply **Scan the QR** code with the camera app of your smartphone



NDC 0078-0639-41

150 mg/mL
2 Sensoready® Pens
(300 mg Dose)



Cosentyx
(secukinumab)
Injection

Single-dose Prefilled
Sensoready® Pen

See prescribing information for dosage and administration information.
Store refrigerated 2-8°C (36-46°F) in original carton to protect from light. COSENTYX may be stored once for up to 4 consecutive days at room temperature not to exceed 30°C (86°F). Write the date COSENTYX was removed and returned to the refrigerator in the space provided on the carton. Discard COSENTYX if it has been stored outside of the refrigerator and not been used in over 4 days. If unused and not stored above 30°C (86°F), COSENTYX may be returned to the refrigerator only one time and must be stored at 2°C to 8°C (36°F to 46°F) until used or expired.

DO NOT FREEZE. Do Not Shake.

Each single-dose prefilled Sensoready® Pen contains:
150 mg secukinumab, L-histidine/histidine HCl monohydrate (3.103 mg),
L-methionine (0.746 mg), polysorbate 80 (0.2 mg),
trehalose dihydrate (75.67 mg), and Water for Injection, USP.

Keep this and all drugs out of the reach of children.

For more information visit www.cosentyx.com or call 1-888-NOW-NOVA (1-888-669-6682)

Date removed from refrigerator:

___/___/___

Date returned to refrigerator:

___/___/___

Single-dose Prefilled
Sensoready® Pen

Cosentyx
(secukinumab)
Injection

150 mg/mL
2 Sensoready® Pens
(300 mg Dose)



NDC 0078-0639-41

174 x 85 x 35
300067328
US



3 0078-0639-41 5

Manufactured by:
Novartis Pharmaceuticals Corporation
at
Novartis Pharma Stein AG
Stein, Switzerland
US License No. 1244
East Hanover, New Jersey 07936
G1NK 0380078D639415
EXP/LOT
© Novartis
Product of Austria



Cosentyx
(secukinumab)
Injection

Single-dose Prefilled Sensoready® Pen

For Subcutaneous Use Only
Sterile Solution - Contains No Preservative
Caution: Contains Natural Rubber Latex
Which May Cause Allergic Reaction.

ATTENTION: Dispense with enclosed Medication Guide.

Carton contains:

- 2 Single-dose Prefilled Sensoready® Pens
- Prescribing Information
- Medication Guide
- Instructions for Use

NDC 0078-0639-41

CONTAINS TWO UNITS THAT
MAY NOT BE SOLD SEPARATELY

150 mg/mL
2 Sensoready® Pens
(300 mg Dose)

Rx only



NDC 0078-0639-41

Cosentyx
(secukinumab)
Injection

Single-dose Prefilled Sensoready® Pen

150 mg/mL
2 Sensoready® Pens
(300 mg Dose)



300067328

XXXXXXXXXX
YYT-MMM
Serialization Variable data printing

This label may not be the latest approved by FDA.
For current labeling information, please visit <https://www.fda.gov/drugsatfda>



Attention: Use both Sensorready® Pens for a 300 mg dose

To learn more about Cosentyx® Sensorready® Pen,
simply Scan the QR code with the camera app of your smartphone



NDC 0078-0639-41

150 mg/mL
2 Sensoready® Pens
(300 mg Dose)

NOVARTIS

See prescribing information for dosage and administration information.

Store refrigerated 2-8°C (36-46°F) in original carton to protect from light. COSENTYX may be stored once for up to 4 consecutive days at room temperature not to exceed 30°C (86°F). Write the date COSENTYX was removed and returned to the refrigerator in the space provided on the carton. Discard COSENTYX if it has been stored outside of the refrigerator and not been used in over 4 days. If unused and not stored above 30°C (86°F), COSENTYX may be returned to the refrigerator only one time and must be stored at 2°C to 8°C (36°F to 46°F) until used or expired.

DO NOT FREEZE. Do Not Shake.

Each single-dose prefilled Sensoready® Pen contains:
 150 mg secukinumab, L-histidine/histidine HCl monohydrate (3.103 mg),
 L-methionine (0.746 mg), polysorbate 80 (0.2 mg),
 trehalose dihydrate (75.67 mg), and Water for Injection, USP.

Keep this and all drugs out of the reach of children.

For more information visit www.cosentyx.com or call 1-888-NOW-NOVA (1-888-669-6682)

Single-dose Prefilled
Sensoready® Pen

Cosentyx®
(secukinumab)
Injection

150 mg/mL
2 Sensoready® Pens
(300 mg Dose)

NOVARTIS

NDC 0078-0639-41

174 x 85 x 35
300067327
US

Date removed from refrigerator: _ / _ / _

Date returned to refrigerator: _ / _ / _

Single-dose Prefilled
Sensoready® Pen

Cosentyx®
(secukinumab)
Injection

NDC 0078-0639-41

See prescribing information for dosage and administration information.

Store refrigerated 2-8°C (36-46°F) in original carton to protect from light. COSENTYX may be stored once for up to 4 consecutive days at room temperature not to exceed 30°C (86°F). Write the date COSENTYX was removed and returned to the refrigerator in the space provided on the carton. Discard COSENTYX if it has been stored outside of the refrigerator and not been used in over 4 days. If unused and not stored above 30°C (86°F), COSENTYX may be returned to the refrigerator only one time and must be stored at 2°C to 8°C (36°F to 46°F) until used or expired.

DO NOT FREEZE. Do Not Shake.

Each single-dose prefilled Sensoready® Pen contains:
 150 mg secukinumab, L-histidine/histidine HCl monohydrate (3.103 mg),
 L-methionine (0.746 mg), polysorbate 80 (0.2 mg),
 trehalose dihydrate (75.67 mg), and Water for Injection, USP.

Keep this and all drugs out of the reach of children.

For more information visit www.cosentyx.com or call 1-888-NOW-NOVA (1-888-669-6682)

Single-dose Prefilled
Sensoready® Pen

Cosentyx®
(secukinumab)
Injection

150 mg/mL
2 Sensoready® Pens
(300 mg Dose)

NOVARTIS

NDC 0078-0639-41

Date removed from refrigerator: _ / _ / _

Date returned to refrigerator: _ / _ / _

Cosentyx®
(secukinumab)
Injection

Single-dose Prefilled Sensoready® Pen

For Subcutaneous Use Only
Sterile Solution - Contains No Preservative
Caution: Contains Natural Rubber Latex
Which May Cause Allergic Reaction.

ATTENTION: Dispense with enclosed Medication Guide.

Carton contains:

- 2 Single-dose Prefilled Sensoready® Pens
- Prescribing Information
- Medication Guide
- Instructions for Use

NDC 0078-0639-41

**CONTAINS TWO UNITS THAT
MAY NOT BE SOLD SEPARATELY**

150 mg/mL
2 Sensoready® Pens
(300 mg Dose)

Rx only

NOVARTIS

NDC 0078-0639-41

150 mg/mL
2 Sensoready® Pens
(300 mg Dose)

Single-dose Prefilled Sensoready® Pen

Manufactured by:
Novartis Pharmaceuticals Corporation
East Hanover, New Jersey 07936
US License No. 1244

at
Novartis Pharma Stein AG
Stein, Switzerland

Distributed by:
Novartis Pharmaceuticals Corporation
East Hanover, New Jersey 07936

Product of France

© Novartis

EXPLOT
G1IN 0030780639415

Date removed from refrigerator: _ / _ / _

Date returned to refrigerator: _ / _ / _

300067327



XXXXXXXXXXXXXXXXXXXX
NS
M04
XXXXXX
Serialization Variable data printing



This label may not be the latest approved by FDA.
For current labeling information, please visit <https://www.fda.gov/drugsatfda>



This label may not be the latest approved by FDA.
For current labeling information, please visit <https://www.fda.gov/drugsatfda>



300070517

NDC 0078-0639-97
150 mg/mL
1 Prefilled Syringe

Cosentyx
(secukinumab)
Injection

 **Cosentyx**[®]
(secukinumab)
Injection

NDC 0078-0639-97

150 mg/mL
1 Prefilled Syringe

ATTENTION: Dispense with enclosed Medication Guide.

For Subcutaneous Use Only

Sterile Solution - Contains No Preservative

Rx only

Caution: Contains Natural Rubber Latex Which May Cause Allergic Reaction.

Single-dose Prefilled Syringe

Carton contains:

- 1 Single-dose Prefilled Syringe
- Prescribing Information

- Medication Guide
- Instructions for Use

 **NOVARTIS**

GTIN: 0030078039972
EXP/LOT

Manufactured by:
Novartis Pharmaceuticals Corporation
East Hanover, New Jersey 07936
US License No. 1244
at
Novartis Pharma Stein AG
Stein, Switzerland

Distributed by:
Novartis Pharmaceuticals Corporation
East Hanover, New Jersey 07936

Product of Austria

© Novartis



N 3 0078-0639-97 2

See prescribing information for dosage and administration information.
Store refrigerated 2-8°C (36-46°F) in original carton to protect from light. COSENTYX may be stored once for up to 4 consecutive days at room temperature not to exceed 30°C (86°F). Write the date COSENTYX was removed and returned to the refrigerator in the space provided on the carton. Discard COSENTYX if it has been stored outside of the refrigerator and not been used in over 4 days. If unused and not stored above 30°C (86°F), COSENTYX may be returned to the refrigerator only one time and must be stored at 2°C to 8°C (36°F to 46°F) until used or expired.

DO NOT FREEZE. Do Not Shake.

Each single-dose prefilled syringe contains: 150 mg secukinumab, L-histidine/histidine HCl monohydrate (3.103 mg), L-methionine (0.746 mg), polysorbate 80 (0.2 mg), trehalose dihydrate (75.67 mg), and Water for Injection, USP.

Keep this and all drugs out of the reach of children.

For more information visit www.cosentyx.com or call 1-888-NOW-NOVA (1-888-669-6682)

Date removed from refrigerator:

__/__/__

Date returned to refrigerator:

__/__/__

Serialization Variable data printing



YYYY-MM
XXXXXXXXXX
SN NNNNNNNNNNNN

55x35x155mm
300070517
US

 **Cosentyx**[®]
(secukinumab)
Injection

NDC 0078-0639-97

150 mg/mL
1 Prefilled Syringe

ATTENTION: Dispense with enclosed Medication Guide.

For Subcutaneous Use Only

Rx only

Single-dose Prefilled Syringe

This label may not be the latest approved by FDA.
For current labeling information, please visit <https://www.fda.gov/drugsatfda>



300067332

NDC 0078-0639-97
150 mg/mL
1 Prefilled Syringe

Cosentyx
(secukinumab)
Injection



Cosentyx[®]
(secukinumab)
Injection

NDC 0078-0639-97

150 mg/mL
1 Prefilled Syringe

ATTENTION: Dispense with enclosed Medication Guide.

For Subcutaneous Use Only

Sterile Solution - Contains No Preservative

Rx only

Caution: Contains Natural Rubber Latex Which May Cause Allergic Reaction.

Single-dose Prefilled Syringe

Carton contains:

- 1 Single-dose Prefilled Syringe
- Prescribing Information

- Medication Guide
- Instructions for Use

NOVARTIS

GTIN: 0030078063972
EXPILOT

Manufactured by:
Novartis Pharmaceuticals Corporation
East Hanover, New Jersey 07936
US License No. 1244
at
Novartis Pharma Stein AG
Stein, Switzerland

Distributed by:
Novartis Pharmaceuticals Corporation
East Hanover, New Jersey 07936

Product of France

© Novartis



3 0078-0639-97 2

See prescribing information for dosage and administration information.

Store refrigerated 2-8°C (36-46°F) in original carton to protect from light. COSENTYX may be stored once for up to 4 consecutive days at room temperature not to exceed 30°C (86°F). Write the date COSENTYX was removed and returned to the refrigerator in the space provided on the carton. Discard COSENTYX if it has been stored outside of the refrigerator and not been used in over 4 days.

If unused and not stored above 30°C (86°F), COSENTYX may be returned to the refrigerator only one time and must be stored at 2°C to 8°C (36°F to 46°F) until used or expired.

DO NOT FREEZE. Do Not Shake.

Each single-dose prefilled syringe contains: 150 mg secukinumab, L-histidine/histidine HCl monohydrate (3.103 mg), L-methionine (0.746 mg), polysorbate 80 (0.2 mg), trehalose dihydrate (75.67 mg), and Water for Injection, USP.

Keep this and all drugs out of the reach of children.

For more information visit www.cosentyx.com or call 1-888-NOW-NOVA (1-888-669-6682)

Date removed from refrigerator:

___/___/___

Date returned to refrigerator:

___/___/___

Serialization Variable data printing



YYYY-MM
XXXXXXXXXX
SN NNNNNNNNNNN

55x35x145mm
300067332
US



Cosentyx[®]
(secukinumab)
Injection

Single-dose Prefilled Syringe

150 mg/mL
1 Prefilled Syringe

ATTENTION: Dispense with enclosed Medication Guide.

For Subcutaneous Use Only

Rx only

NDC 0078-0639-97

NDC 0078-0639-98
Single-dose Prefilled Syringe



150 mg/mL
2 Prefilled Syringes
(300 mg Dose)



 **Cosentyx[®]**
(secukinumab)
Injection

NDC 0078-0639-98

CONTAINS TWO UNITS THAT
MAY NOT BE SOLD SEPARATELY

150 mg/mL
2 Prefilled Syringes
(300 mg Dose)

Single-dose Prefilled Syringe

For Subcutaneous Use Only
Sterile Solution - Contains No Preservative
Caution: Contains Natural Rubber Latex
Which May Cause Allergic Reaction.

Rx only

ATTENTION: Dispense with enclosed Medication Guide.

Carton contains:

- 2 Single-dose Prefilled Syringes
- Prescribing Information
- Medication Guide
- Instructions for Use



GTIN: 00300780639988
EXP/LOT

Manufactured by:
Novartis Pharmaceuticals Corporation
East Hanover, New Jersey 07936
US License No. 1244
at
Novartis Pharma Stein AG
Stein, Switzerland

Distributed by:
Novartis Pharmaceuticals Corporation
East Hanover, New Jersey 07936

Product of Austria

© Novartis



See prescribing information for dosage and administration information.
Store refrigerated 2-8°C (36-46°F) in original carton to protect from light. COSENTYX may be stored once for up to 4 consecutive days at room temperature not to exceed 30°C (86°F). Write the date COSENTYX was removed from the refrigerator in the space provided on the carton. Discard COSENTYX if it has been stored outside of the refrigerator and not been used in over 4 days. If unused and not stored above 30°C (86°F), COSENTYX may be returned to the refrigerator only one time and must be stored at 2°C to 8°C (36°F to 46°F) until used or expired.

DO NOT FREEZE.

Do not Shake.

Each single-dose prefilled syringe contains:
150 mg secukinumab,
L-histidine/histidine HCl monohydrate (3.103 mg),
L-methionine (0.746 mg), polysorbate 80 (0.2 mg),
trehalose dihydrate (75.67 mg), and Water for Injection, USP.

Keep this and all drugs out of the reach of children.

For more information visit www.cosentyx.com or call 1-888-NOW-NOVA (1-888-669-6682)

Date removed from refrigerator:
____/____/____
Date returned to refrigerator:
____/____/____

Serialization Variable data printing



YYYY-MM
XXXXXXXXXX
SN NNNNNNNNNNN

93x35x155mm
300067334
US



150 mg/mL
2 Prefilled Syringes
(300 mg Dose)

NDC 0078-0639-98

Single-dose Prefilled Syringe

NDC 0078-0639-98
Single-dose Prefilled Syringe
150 mg/mL
2 Prefilled Syringes
(300 mg Dose)
300067341
Cosentyx[®]
(secukinumab)
Injection



Cosentyx[®] (secukinumab) Injection

NDC 0078-0639-98

CONTAINS TWO UNITS THAT
MAY NOT BE SOLD SEPARATELY

150 mg/mL
2 Prefilled Syringes
(300 mg Dose)

Single-dose Prefilled Syringe

For Subcutaneous Use Only
Sterile Solution - Contains No Preservative
Caution: Contains Natural Rubber Latex
Which May Cause Allergic Reaction.

Rx only

ATTENTION: Dispense with enclosed Medication Guide.

Carton contains:

- 2 Single-dose Prefilled Syringes
- Prescribing Information
- Medication Guide
- Instructions for Use



GTIN: 00300780639989
EXP/LOT

Manufactured by:
Novartis Pharmaceuticals Corporation
East Hanover, New Jersey 07936
US License No. 1244
at
Novartis Pharma Stein AG
Stein, Switzerland

Distributed by:
Novartis Pharmaceuticals Corporation
East Hanover, New Jersey 07936

Product of France

© Novartis



3 0078-0639-98 9

See prescribing information for dosage and administration information.

Store refrigerated 2-8°C (36-46°F) in original carton to protect from light. COSENTYX may be stored once for up to 4 consecutive days at room temperature not to exceed 30°C (86°F). Write the date COSENTYX was removed from the refrigerator in the space provided on the carton. Discard COSENTYX if it has been stored outside of the refrigerator and not been used in over 4 days. If unused and not stored above 30°C (86°F), COSENTYX may be returned to the refrigerator only one time and must be stored at 2°C to 8°C (36°F to 46°F) until used or expired.

DO NOT FREEZE.
Do not Shake.

Each single-dose prefilled syringe contains:
150 mg secukinumab,
L-histidine/histidine HCl monohydrate (3.103 mg),
L-methionine (0.746 mg), polysorbate 80 (0.2 mg),
trehalose dihydrate (75.67 mg), and Water for Injection, USP.

Keep this and all drugs out of the reach of children.

For more information visit www.cosentyx.com or call 1-888-NOW-NOVA (1-888-669-6682)

Date removed from refrigerator:
_ / _ / _

Date returned to refrigerator:
_ / _ / _

Serialization Variable data printing



YYYY-MM
XXXXXXXXXX
SN NNNNNNNNNNNN

89335x155 mm
300067341
SN
US



Cosentyx[®]
(secukinumab)
Injection

150 mg/mL
2 Prefilled Syringes
(300 mg Dose)

NDC 0078-0639-98

Single-dose Prefilled Syringe

This label may not be the latest approved by FDA.
For current labeling information, please visit <https://www.fda.gov/drugsatfda>

Cosentyx[®]
(secukinumab)
Injection
150 mg/mL
1 Prefilled Syringe

NDC 0078-0639-97
Single dose Prefilled Syringe
For Subcutaneous Use Only
Sterile Solution Contains No Preservative
Caution: Contains Natural Rubber Latex
Which May Cause Allergic Reaction.
Contains 1 Single dose Prefilled Syringe
Store refrigerated 2-8°C (36-46°F) in original
carton to protect from light. COSENTYX may be

stored once for up to 4 consecutive days at room
temperature not to exceed 30°C (86°F). DO NOT
FREEZE. Full Storage: Refer to prescribing
information and carton. Each single dose prefilled
syringe contains 150 mg secukinumab, L-histidine/
histidine HCl monohydrate (310.3 mg), L-methionine
(0.746 mg), polysorbate 80 (0.2 mg), trehalose
dihydrate (75.67 mg), and Water for Injection, USP.
Keep this and all drugs out of the reach of children.

Manufactured by
Novartis Pharmaceuticals Corporation
East Hanover, NJ 07936 US License No. 1244
at Novartis Pharma Stein AG, Stein, Switzerland
Distributed by Novartis Pharmaceuticals Corporation
East Hanover, New Jersey 07936

© Novartis 300067441 US



Rx only

 **NOVARTIS**



EXP YYYY-MMM

Lot XXXXX

This label may not be the latest approved by FDA.
For current labeling information, please visit <https://www.fda.gov/drugsatfda>

Cosentyx[®]
(secukinumab)
Injection

NDC 0078-0639-08
150 mg/mL
2 Prefilled Syringes
(300 mg Dose)

300067450 US



Attention: Use both syringes
for a 300 mg dose

Single-dose Prefilled Syringe Rx only



For Subcutaneous Use Only
Sterile Solution - Contains No Preservative
**Caution: Contains Natural Rubber Latex
Which May Cause Allergic Reaction.**
**CONTAINS TWO UNITS THAT MAY NOT BE
SOLD SEPARATELY**

Store refrigerated 2-8°C (36-46°F) in original
carton to protect from light. COSENTYX may
be stored once for up to 4 consecutive days at
room temperature not to exceed 30°C (86°F).
**DO NOT FREEZE. Full Storage: Refer to
prescribing information and carton.**

Each single-dose prefilled syringe contains:
150 mg secukinumab, L-histidine/histidine HCl
monohydrate (3.103 mg), L-methionine (0.746 mg),
polysorbate 80 (0.2 mg), trehalose dihydrate (75.67 mg),
and Water for Injection, USP.

300067450 US

Keep this and all drugs out of the reach of children.

300067450 US

© Novartis

Manufactured by: Novartis Pharmaceuticals Corporation, East Hanover, NJ 07936 US License No. 1244
at Novartis Pharma Stein AG, Stein, Switzerland

Distributed by: Novartis Pharmaceuticals Corporation, East Hanover, New Jersey 07936

NOVARTIS

EXP YYYY-MMM

Lot XXXXX

This is a representation of an electronic record that was signed electronically. Following this are manifestations of any and all electronic signatures for this electronic record.

/s/

TATIANA OUSSOVA
07/24/2023 12:07:57 PM