



US00D407405S

# United States Patent [19] Chiu

[11] Patent Number: **Des. 407,405**

[45] Date of Patent: **\*\*Mar. 30, 1999**

[54] **SPEAKER**  
[75] Inventor: **Cheng-Shun Chiu**, Pao-Chiao, Taiwan  
[73] Assignee: **Yeun Yah Industrial Co., Ltd.**,  
Taipei-Hsien, Taiwan  
[\*\*] Term: **14 Years**

D. 261,759 11/1981 Hata ..... D14/210  
D. 301,846 6/1989 Beyer ..... D14/195 X  
D. 324,864 3/1992 Hector ..... D14/210  
2,523,103 9/1950 Emde et al. .... D14/195 X

*Primary Examiner*—Philip S. Hyder  
*Assistant Examiner*—Nanda Bondade  
*Attorney, Agent, or Firm*—Skjerven Morrill MacPherson  
Franklin & Friel LLP; Thomas S. MacDonald

[21] Appl. No.: **86,653**  
[22] Filed: **Apr. 16, 1998**

## [57] CLAIM

The ornamental design for speaker, as shown and described.

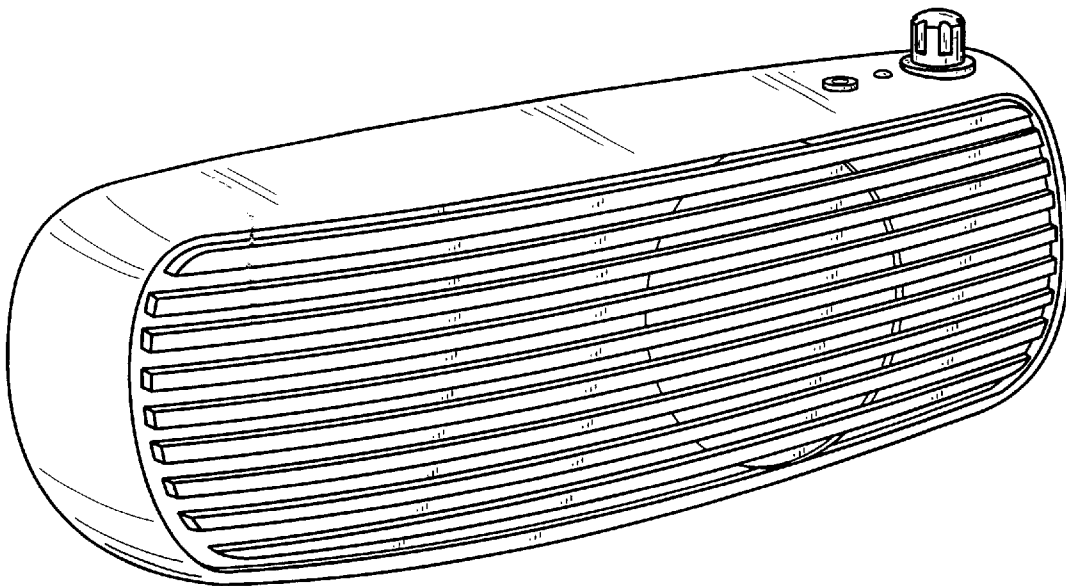
[51] **LOC (6) Cl.** ..... **14-01**  
[52] **U.S. Cl.** ..... **D14/214; D14/194; D14/197;**  
D14/219  
[58] **Field of Search** ..... D14/188, 194,  
D14/195, 196, 197, 204, 210-214, 219;  
181/144, 145, 148, 157, 198, 199; 381/24,  
88, 90, 153, 186, 203, 205

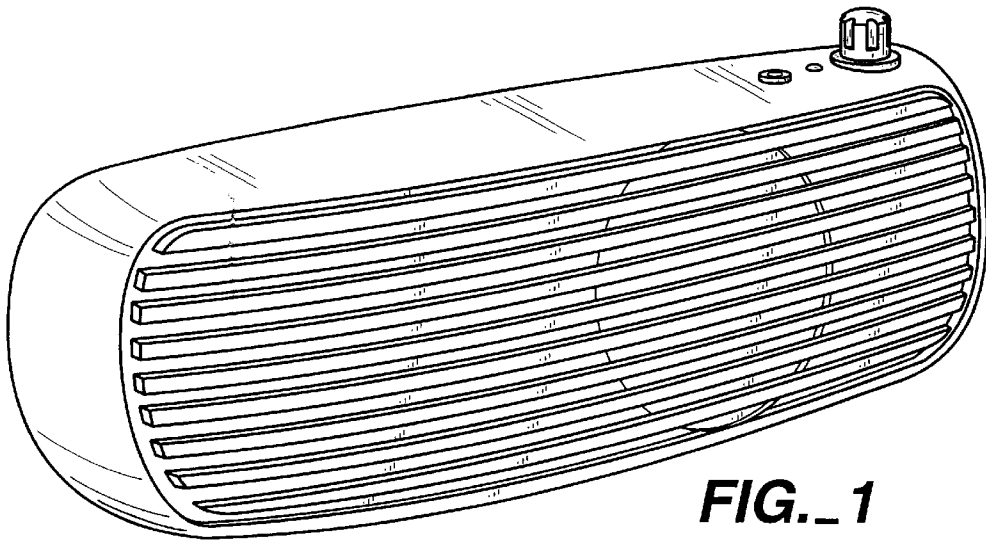
## DESCRIPTION

FIG. 1 is a perspective view of speaker showing my new design;  
FIG. 2 is a front elevational view thereof;  
FIG. 3 is a rear elevational view thereof;  
FIG. 4 is a left side elevational view thereof;  
FIG. 5 is a right side elevational view thereof;  
FIG. 6 is a top plan view thereof; and,  
FIG. 7 is a bottom plan view thereof.

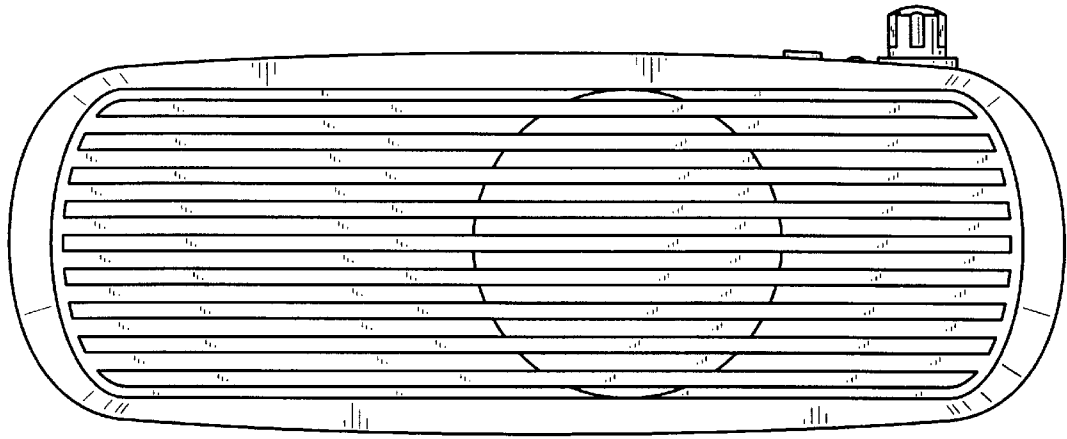
[56] **References Cited**  
U.S. PATENT DOCUMENTS  
D. 223,670 5/1972 Kloster ..... D14/214

**1 Claim, 2 Drawing Sheets**

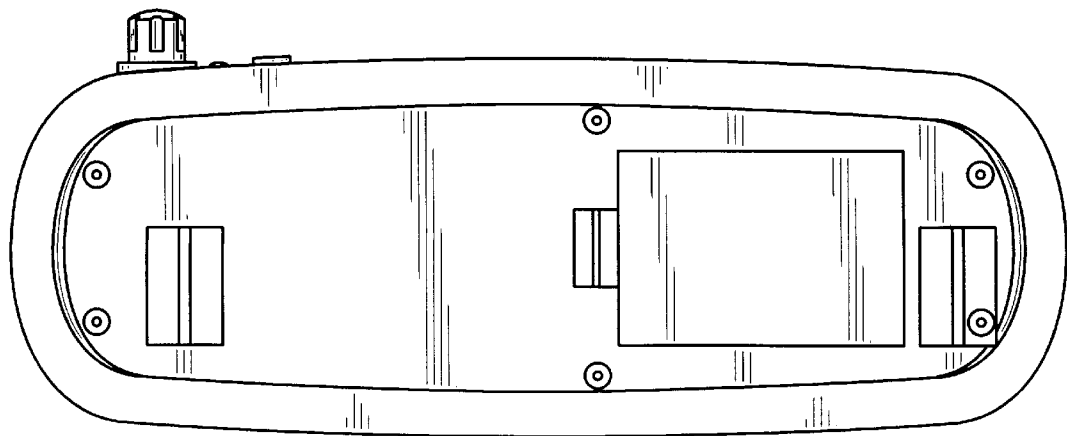




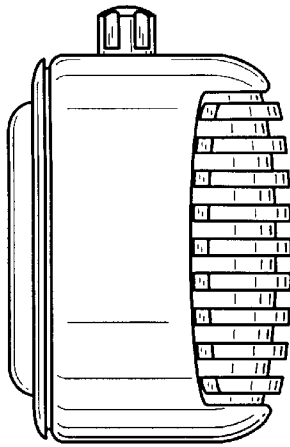
**FIG.\_1**



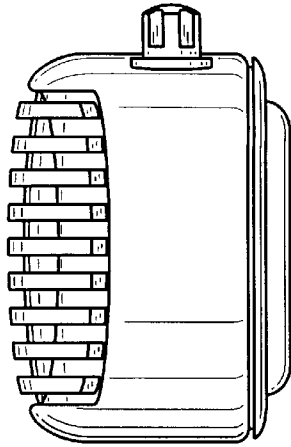
**FIG.\_2**



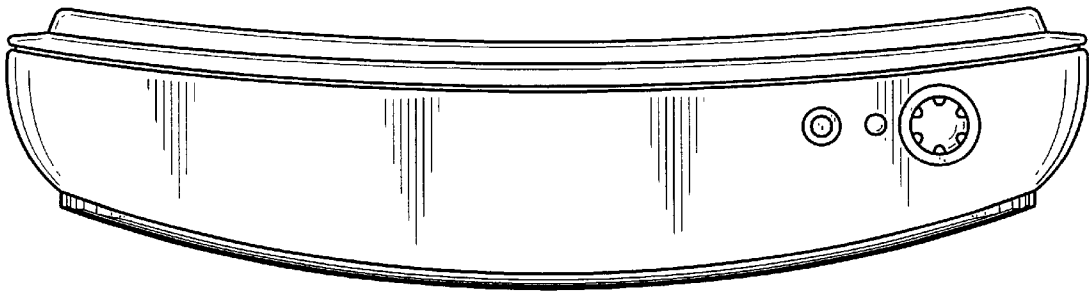
**FIG.\_3**



**FIG.\_4**



**FIG.\_5**



**FIG.\_6**



**FIG.\_7**