



(43) International Publication Date
8 October 2015 (08.10.2015)

- (51) International Patent Classification:
G06Q 10/10 (2012.01)
- (21) International Application Number:
PCT/US2015/022612
- (22) International Filing Date:
26 March 2015 (26.03.2015)
- (25) Filing Language: English
- (26) Publication Language: English
- (30) Priority Data:
61/973,139 31 March 2014 (31.03.2014) US
14/497,281 25 September 2014 (25.09.2014) US
- (71) Applicant: MICROSOFT TECHNOLOGY LICENSING, LLC [US/US]; One Microsoft Way, Redmond, WA 98052-6399 (US).
- (72) Inventors: MASTERSON, Joseph; c/o Microsoft Technology Licensing, LLC, LCA - International Patents (8/1172), One Microsoft Way, Redmond, WA 98052-6399 (US). DE SOUZA, Jeremy; c/o Microsoft Technology Licensing, LLC, LCA - International Patents (8/1172), One Microsoft Way, Redmond, WA 98052-6399 (US). MA, Jin; c/o Microsoft Technology Licensing, LLC, LCA - International Patents (8/1172), One Microsoft Way, Redmond, WA 98052-6399 (US). CATRINESCU, Elena; c/o Microsoft Technology Licensing, LLC, LCA - International Patents (8/1172), One Microsoft Way, Redmond, WA 98052-6399 (US). WADDOUPS, Nathan; c/o Microsoft Technology

Licensing, LLC, LCA - International Patents (8/1172), One Microsoft Way, Redmond, WA 98052-6399 (US). FERN, Kenneth; c/o Microsoft Technology Licensing, LLC, LCA - International Patents (8/1172), One Microsoft Way, Redmond, WA 98052-6399 (US). LIMONT, David, Paul; c/o Microsoft Technology Licensing, LLC, LCA - International Patents (8/1172), One Microsoft Way, Redmond, WA 98052-6399 (US). MEYERS, David, Lloyd, Jr.; c/o Microsoft Technology Licensing, LLC, LCA - International Patents (8/1172), One Microsoft Way, Redmond, WA 98052-6399 (US). PALMER, Michael, B.; c/o Microsoft Technology Licensing, LLC, LCA - International Patents (8/1172), One Microsoft Way, Redmond, WA 98052-6399 (US).

- (81) Designated States (unless otherwise indicated, for every kind of national protection available): AE, AG, AL, AM, AO, AT, AU, AZ, BA, BB, BG, BH, BN, BR, BW, BY, BZ, CA, CH, CL, CN, CO, CR, CU, CZ, DE, DK, DM, DO, DZ, EC, EE, EG, ES, FI, GB, GD, GE, GH, GM, GT, HN, HR, HU, ID, IL, IN, IR, IS, JP, KE, KG, KN, KP, KR, KZ, LA, LC, LK, LR, LS, LU, LY, MA, MD, ME, MG, MK, MN, MW, MX, MY, MZ, NA, NG, NI, NO, NZ, OM, PA, PE, PG, PH, PL, PT, QA, RO, RS, RU, RW, SA, SC, SD, SE, SG, SK, SL, SM, ST, SV, SY, TH, TJ, TM, TN, TR, TT, TZ, UA, UG, US, UZ, VC, VN, ZA, ZM, ZW.
- (84) Designated States (unless otherwise indicated, for every kind of regional protection available): ARIPO (BW, GH, GM, KE, LR, LS, MW, MZ, NA, RW, SD, SL, ST, SZ, TZ, UG, ZM, ZW), Eurasian (AM, AZ, BY, KG, KZ, RU,

[Continued on next page]

(54) Title: GENERATING CONTENT ITEMS OUT OF AN ELECTRONIC COMMUNICATION WORKFLOW

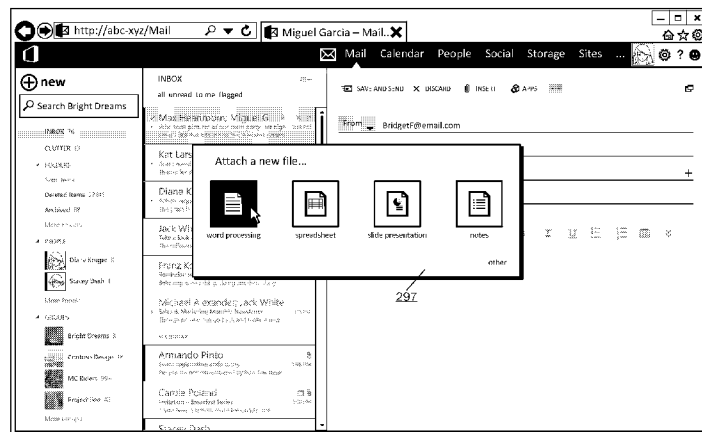

FIG. 2L

(57) Abstract: Inline document collaboration workflows are provided. When a user receives an electronic communication that includes an attached content item, the receiving user may select the attached content item and cause the attached content item to be displayed in an immersive view in proximity to an electronic communication pane in which an electronic communication may be conducted about any topic including the content item that is displayed in proximity to the electronic communication pane. During editing of a content item, an electronic communication may be generated from a user interface in which the content item is being generated, or alternatively a new content item may be generated out of an electronic communications user interface.

WO 2015/153250 A1

TJ, TM), European (AL, AT, BE, BG, CH, CY, CZ, DE, DK, EE, ES, FI, FR, GB, GR, HR, HU, IE, IS, IT, LT, LU, LV, MC, MK, MT, NL, NO, PL, PT, RO, RS, SE, SI, SK, SM, TR), OAPI (BF, BJ, CF, CG, CI, CM, GA, GN, GQ, GW, KM, ML, MR, NE, SN, TD, TG).

— *as to the applicant's entitlement to claim the priority of the earlier application (Rule 4.17(iii))*

Published:

— *with international search report (Art. 21(3))*

Declarations under Rule 4.17:

— *as to applicant's entitlement to apply for and be granted a patent (Rule 4.17(ii))*

GENERATING CONTENT ITEMS OUT OF AN ELECTRONIC COMMUNICATION WORKFLOW

BACKGROUND

5 [0001] Computer and computer software users have become accustomed to generating, editing, receiving and sending many types of content items, for example, documents of different types, photographs, images, electronic mail items, calendaring items, notes items, and the like. In a typical electronic mail setting, a user often attaches a document or other content item (hereafter referred to as “attachment” or “content item”) to an electronic mail
10 item he/she then sends to a receiving user for review or editing. The receiving user then typically downloads the received attachment to her local computing device or to an enterprise (local or remote) storage depository, for example, a company or school file server or a remote server at which the receiving user has a storage location or at a collaborative file storage location at which the sending user and the receiving user store
15 content items for receiving and editing as part of a collaborative work group of any of a number of types.

[0002] That is, many user tasks involve using both content items of various types and electronic communications (e.g., electronic mail) together in a general workflow that involves sending and receiving electronic communications and reviewing various content
20 items. Current software solutions treat electronic communications and content items as two separate entities. Users must do a lot of manual work such as opening received attached content items, editing and saving attached content items, re-attaching edited content items to a subsequent electronic communication, and then sending the communication along with the edited and attached content item to a desired one or more
25 recipients. There is a need for methods and systems for allowing relevant content items to be paired with relevant communications (electronic mail or other types of communications) so that a user may reduce the time-consuming and inefficient process of receiving, storing, editing, storing, retrieving, attaching, and disposing of content items in association with an electronic communications system. It is with respect to these and
30 other considerations that the present invention has been made.

SUMMARY

[0003] This summary is provided to introduce a selection of concepts in a simplified form that are further described below in the detailed description. This summary is not

intended to identify key features or essential features of the claimed subject matter, nor is it intended as an aid in determining the scope of the claimed subject matter.

[0004] Embodiments of the present invention solve the above and other problems by providing inline document collaboration workflows. According to embodiments, when a user receives an electronic communication that includes an attached content item, the receiving user may select the attached content item and cause the attached content item to be displayed in an immersive view in proximity to an electronic communication pane in which an electronic communication may be conducted about any topic including the content item that is displayed in proximity to the electronic communication pane.

Electronic communications may be conducted without edits to the selected and displayed content item. Alternatively, if the user desires to edit the selected and displayed content item, the user may enter an editing mode wherein functionality associated with a document type of the selected and displayed document may be displayed in the immersive view pane where the selected and displayed document is displayed. Using the provided functionality, the user may edit the displayed document, and according to one embodiment, upon editing the desired document, an instance of the edited document may be automatically saved for subsequent communication. According to one embodiment, upon initiating an editing function with respect to a selected and displayed content item, an electronic communication may be automatically generated in the electronic communication pane for attaching a copy of or pointer to the edited content item and for providing a communication to one or more recipients.

[0005] According to one embodiment, a “hide” function may be enabled for hiding temporarily or until subsequently “unhidden” the electronic communication thread to allow a greater display surface space for the selected and viewed or edited content item.

In addition, a user may initiate and conduct an electronic communication about a content item by initiating the electronic communication from a client application associated with the content item.

[0006] According to another embodiment, a new content item may be generated out of an electronic communications user interface. For example, if a user is utilizing an electronic mail client application and an associated user interface, an insert function may be provided for allowing the user to insert a new content item of various types into the electronic communications user interface. If the user selects to enter a file of a given file type, an instance of a user interface for the selected document type that includes functionality of the associated application, for example, word processing functionality,

may be displayed in the immersive view pane of the electronic communication user interface for allowing the user to create a content item of the desired document type.

[0007] The details of one or more embodiments are set forth in the accompanying drawings and description below. Other features and advantages will be apparent from a reading of the following detailed description and a review of the associated drawings. It is to be understood that the following detailed description is explanatory only and is not restrictive of the invention as claimed.

DESCRIPTION OF THE DRAWINGS

[0008] FIGURE 1 is simplified block diagram illustrating a system for electronic communication-based storage and use of documents and other content items to support multiple workflows.

[0009] FIGURE 2A illustrates a computer-generated user interface of an electronic mail application with which embodiments the present invention practiced.

[0010] FIGURE 2B illustrates a computer-generated user interface of an electronic mail application with an immersive view pane in which a received content item may be displayed for viewing.

[0011] FIGURE 2C illustrates a computer-generated user interface of an electronic mail application with an immersive view pane in which a received content item may be displayed for viewing.

[0012] FIGURE 2D illustrates a computer-generated user interface of an electronic mail application with an immersive view pane in which a received content item may be displayed for viewing.

[0013] FIGURE 2E illustrates a computer-generated user interface of an electronic mail application with an immersive view pane and showing a launching of a software application associated with a received content item.

[0014] FIGURE 2F illustrates a computer-generated user interface of an electronic mail application with an immersive view pane and showing a display of software application functionality for allowing editing of a received content item.

[0015] FIGURE 2G illustrates a computer-generated user interface of an electronic mail application and showing attachment of an edited content item for disposition according to embodiments of the present invention.

[0016] FIGURE 2H illustrates a computer-generated user interface showing a “hide email” function.

[0017] FIGURE 2I illustrates a computer-generated software application user interface from which an electronic communication may be launched in association with a content item.

5 [0018] FIGURE 2J illustrates a computer-generated electronic mail user interface with which a content item may be sent to one or more desired recipients.

[0019] FIGURE 2K illustrates a computer-generated electronic communication user interface in which a content item may be created.

[0020] FIGURE 2L illustrates a computer-generated electronic communication user interface in which a content item may be created.

10 [0021] FIGURE 2M illustrates a computer-generated electronic communication user interface in which a content item may be created.

[0022] FIGURE 3 is a flowchart illustrating a method for inline document collaboration through various workflows.

15 [0023] FIGURE 4 is a block diagram illustrating example physical components of a computing device with which embodiments of the invention may be practiced.

[0024] FIGURES 5A and 5B are simplified block diagrams of a mobile computing device with which embodiments of the present invention may be practiced.

[0025] FIGURE 6 is a simplified block diagram of a distributed computing system in which embodiments of the present invention may be practiced.

20 **DETAILED DESCRIPTION**

[0026] The following detailed description refers to the accompanying drawings.

Wherever possible, the same reference numbers are used in the drawings and the following description to refer to the same or similar elements. While embodiments of the invention may be described, modifications, adaptations, and other implementations are possible. For example, substitutions, additions, or modifications may be made to the elements illustrated in the drawings, and the methods described herein may be modified by substituting, reordering, or adding stages to the disclosed methods. Accordingly, the following detailed description does not limit the invention, but instead, the proper scope of the invention is defined by the appended claims.

30 [0027] As briefly described above, embodiments of the present invention are directed to providing inline document collaboration workflows. According to embodiments, when a user receives an electronic communication such as electronic mail, text message, instant message, chat message, or the like, where the electronic communication includes an attached content item, for example, a document, dataset, image, and the like, the receiving

user may select the attached content item and cause the attached content item to be displayed in an immersive view in a user interface in a side-by-side or top/bottom orientation relative to an electronic communication pane in which an electronic communication may be conducted about any topic including the content item that is displayed in proximity to the electronic communication pane.

[0028] Electronic communications may be conducted without edits to the selected and displayed content item. Alternatively, if the user desires to edit the selected and displayed content item, the user may enter an editing mode wherein functionality associated with a document type of the selected and displayed document (for example, a word processing functionality, a spreadsheet functionality, slide presentation functionality, notes taking functionality, and the like) may be displayed in the immersive view pane where the selected and displayed document is displayed. Using the provided functionality, the user may edit the displayed document, and according to one embodiment, upon editing the desired document, an instance of the edited document may be automatically saved with the electronic communication message at an electronic communication server, or alternatively, the changes made to the edited document may be pushed to a corresponding instance of the document stored at another storage location.

[0029] Upon initiating an editing function with respect to a selected and displayed content item, an electronic communication may be automatically generated in the electronic communication pane for attaching a copy of or pointer to the edited content item and for providing a communication to one or more recipients to which the edited content item will be sent. Upon sending the automatically-generated communication and the attached edited content item, an electronic communication conversation may be displayed in the electronic communication pane showing a conversation thread associated with the edited content item.

[0030] According to one embodiment, a “hide” function may be enabled for hiding temporarily or until subsequently “unhidden” the electronic communication thread to allow a greater display surface space for the selected and viewed or edited content item.

[0031] A user may initiate and conduct an electronic communication about a content item by initiating the electronic communication from a client application associated with the content item. For example, if a user is currently editing a spreadsheet document in a user interface provided by a spreadsheet application, electronic communication functionality may be provided in the client application user interface, for example, “reply with changes” or “send document to recipients”, or the like may be provided in the user

interface of the client application. Thus, for example, if a user is editing an example spreadsheet document, the user may select a communications functionality, for example, “reply with changes” functionality, and an instance of electronic communications user interface, for example, an electronic mail user interface, may be provided in proximity to
5 the being-edited document or overlaying the being-edited document, and an electronic communication may be automatically generated in the electronic communication user interface for sending the being-edited document to a desired recipient. According to this embodiment, an attachment of the being-edited document may be automatically placed into the automatically-generated electronic communication, so that a recipient of the
10 communication may select the attachment for view and/or editing the being-edited document.

[0032] A new content item may be generated out of an electronic communications user interface. For example, if a user is utilizing an electronic mail client application and an associated user interface, an insert function may be provided for allowing the user to insert
15 a new content item of various types into the electronic communications user interface. If the user selects to enter a file of a given file type, for example, a word processing document, a spreadsheet document, a slide presentation document, a notes taking application document, or the like, an instance of a user interface for the selected document type that includes functionality of the associated application, for example, word processing
20 functionality, may be displayed in the immersive view pane of the electronic communication user interface for allowing the user to create a content item of the desired document type. When the user completes creation of the content item of the desired document type, the newly created document may be stored with an electronic communication at a corresponding electronic communication server, or the document may
25 be saved to a different storage location, as desired.

[0033] Upon entering edit mode for the document being created, an electronic communication, for example, an electronic mail, may be automatically generated in a corresponding electronic communication pane, and an attachment may be placed in the automatically-generated electronic communication for sending the being-created content
30 item to a desired recipient. According to this embodiment, upon selection of a save and send function, the newly created document may be both saved to a desired location, and the electronic communication may be sent to a desired recipient along with an attachment of the newly created content item or along with a pointer to a storage location of the newly

created content item to allow a recipient of the electronic communication to access the newly created content item.

[0034] FIGURE 1 is simplified block diagram illustrating a system 100 for electronic communication-based storage and use of documents and other content items to support multiple workflows. As illustrated in FIGURE 1, a variety of users 102a, 102b, 102c, 102n are illustrated in association with respective client devices 104a, 104b, 104c, 104n. The users and the associated client devices are illustrative of one or more users who may generate, edit, receive, send, or otherwise interact with content items of various types as described herein. The client devices 104a-104n are illustrative of a variety of computing devices, for example, desktop computing devices, laptop computing devices, tablet computing devices, handheld computing devices (mobile phones), and the like. Each of the example computing devices may be interacted with according to a variety of input means, for example, keyboard input, mouse input, electronic pen and ink input, touch input, gesture input, voice input, eye tracking input, and the like. At each of the client devices 104a-104n, a variety of software applications may be provided for allowing the one or more users to interact with a variety of content items. For example, software applications such as electronic mail applications, word processing applications, slide presentation applications, spreadsheet applications, notes taking applications, desktop publishing applications, calendaring applications, image processing and editing applications, and the like may be operated at the client devices by the one or more users 102a-102n. The network 120 is illustrative of an enterprise-based network, for example, an intranet, or a distributed computing network, for example, the Intranet, over which the various users may communicate with each other and with other computing systems, as described herein.

[0035] The mailbox server 108 is illustrative of an electronic communication system that may be located local to one of the various users, or that may be located remotely from the various users for allowing electronic mail and other electronic communications between the various users. An example of a server 108 may be an EXCHANGE server from Microsoft Corporation. The electronic communication item 110 (e.g., email item) is illustrative of an electronic communication that may be communicated between one or more users for passing text-based communications, and a variety of attached files, for example, audio files, text files, image files, data files, and the like. The temporary copy of a document 106 is illustrative of a temporary storage of an edited attached content item that is edited in association with an electronic communication item and that is temporarily

stored with an electronic communication at the electronic mail server 108 for disposition according to embodiments of the present invention. The collaboration server 112 is illustrative of a local or remote storage repository at which one or more content items may be stored. For example, the collaboration server 112 may be a shared resources server
5 located at an enterprise accessible by the various users, or may be remotely located from the various users at which the various users may store and collaborate on various documents. An example of such a collaboration server 112 may include a SHAREPOINT server or ONEDRIVE server from Microsoft Corporation.

[0036] According to embodiments, when an attached content item is received and edited
10 by a given user, a temporary copy 106 of the edited content item is stored with the received electronic communication item 110 at the electronic communication server 108. The content item is only stored at the collaboration server 112 if a given user desires to store the received content item apart from the electronic communication server 108 as described with respect to embodiments illustrated and described herein.

[0037] Figure 2A illustrates a computer-generated user interface of an electronic
15 communication application with which embodiments the present invention practiced. An example electronic communication application suitable for embodiments described herein includes OUTLOOK from Microsoft Corporation. As illustrated in Figure 2A, a user interface 200 for an example electronic mail application with which a user may send and
20 receive a variety of electronic messages, and with which a user may send and receive content item attachments according to embodiments of the present invention is illustrated. An electronic mail folder pane 210 is illustrated on the left side of the user interface 200 in which a variety of folders, contact items, group items, calendar items, and the like, may be provided to allow a user to select various folders, contacts, or other items associated with
25 her electronic communication application functionality. An electronic communication items folder 205 is illustrated in which a variety of electronic communication items received by the receiving user are displayed that may be selectively reviewed and responded to according to the functionality of the associated electronic communication application. For example, the pane 205 may include an inbox for listing all received
30 electronic mail items, a sent box for listing sent electronic mail items and/or the contents of a given folder of electronic communication items.

[0038] On the right side of the example user interface 200 is displayed an electronic communication viewing pane in which a given electronic communication message or electronic communication conversation thread of items may be displayed for allowing a

user to read or otherwise interact with a given electronic communication message, for example, replying to the message, forwarding the message, and the like. That is, upon selection of a given communication item (e.g., an electronic mail item) listed in an inbox displayed in the pane 205, the selected item may be opened in the pane 215 to allow the user to read or respond to the communication item. If the selected communication item contains a thread of multiple communication items comprising a communication conversation, then the entire thread of items may be displayed in the pane 215 to allow the user to navigate through the various items in the thread.

[0039] As illustrated in Figure 2A, an example electronic mail message 235 has been received by the receiving user and has been opened in the electronic communications pane or canvas 215. The received electronic mail message includes three example attachments 220, 225, 230. As should be appreciated, the attachments 220, 225, 230 are illustrative of any attached content item, for example, a word processing document, a spreadsheet document, a slide presentation document, a notes document, an image file, a photograph, and the like, that may be received by the receiving user from a sending user.

[0040] If a user selects one of the attached content items 220, 225, 230, the selected content item may be displayed in an immersive view pane 237 for allowing a user to view and/or edit the selected content item. As illustrated in Figure 2A, an example user selects the example word processing document attachment icon 220 for viewing and interacting with the selected document 220, as described herein.

[0041] Referring now to Figure 2B, in response to the receiving user's selection of the attachment item 220, as illustrated in Figure 2A, the associated document 240 is automatically displayed in an immersive view pane 237 for allowing the user to review and interact with the associated document 240. As illustrated in Figure 2B, the immersive view pane is positioned on the left side of the user interface 200, and the electronic mail view pane 215 remains displayed on the right side of the user interface 200. As should be appreciated, the respective viewing panes may be displayed in other orientations, for example in a right/left orientation where the immersive view pane is displayed on the right side of the user interface and the electronic mail pane is displayed on the left, a top/bottom orientation where the immersive view pane is displayed on the top of the interface 200 and the electronic communication pane is displayed on the bottom of the interface 200, or a bottom/top orientation where the immersive view pane is displayed on the bottom of the interface 200 and the electronic communication view pane is displayed on a top of the interface 200. Alternatively, if the computing device in use by the receiving user is a

small form device, such as a tablet computing device or mobile phone, and display space is insufficient for displaying both the immersive view pane and the electronic communication view pane, then the immersive view pane 237 may be displayed over the entire display surface of the computing device, and a functionality button or control may be provided for selectively returning the electronic communication view pane to display, as desired. Alternatively, a truncated display of the electronic communication view pane may be provided and the remaining display space may be used for the immersive view pane.

[0042] Referring still to Figure 2B, according to one embodiment, a user of the electronic communication user interface 200 may begin an electronic communication in the electronic communication pane 215 without editing the content item 240 selected and displayed in the immersive view pane 237. That is, by selecting one or more communication functions, for example, the reply function 246, a reply to all function, a forward function, and the like, the user may conduct an electronic communication with a variety of users inside the electronic communication pane 215 without affecting a display of the content item 240 displayed in the immersive view pane 237.

[0043] Referring to Figure 2C, after selection of an electronic mail conversation function, for example, the reply function 246, a new electronic communication is illustrated as being generated in the electronic communication pane 215 for allowing the user to enter an electronic communication. As should be appreciated, if desired, the user generating the electronic communication 235 may attach the content item 240 to the communication 235 for sending the communication and the attached content item to one or more other recipients, or the user may simply wish to reply back to the sending user that originally sent the communication having the attached content item 240. In such a case, each user at two different locations may select and display the attached content item 240 in their respective immersive view panes, while simultaneously conducting an electronic communication in the electronic communication pane 215 about any topic, including the content item 240 that is displayed in the immersive view panes of each of their respective electronic communication user interfaces 200.

[0044] Referring now to Figure 2D, an edit/copy function 245 is provided for allowing a user to selectively edit the document 240 displayed in the immersive view pane 237. That is, as will be described below, selection of the edit/copy function 245 may cause a provision of functionality associated with the document 240 to allow the user to edit the document 240 in association with the provided functionality. As should be appreciated,

the edit/copy function 245 is illustrative of one of a variety of functions that may be provided in the immersive view pane for allowing a user to operate on the document displayed in the immersive view pane. For example, other functions that may be provided may include a send function for allowing the user to send the document 240 to another user, a save function for allowing a user to save the document to a storage location such as the collaboration server 112, described above, and the like.

[0045] Referring to FIGURE 2E, according to embodiments of the present invention, if a user selects the edit/copy function 245, an application associated with the content item type for the content item displayed in the immersive view pane may be launched in the immersive view pane. In Figure 2E, a word processing web-based application 250 is launched in response to a selection of an edit/copy function for the document displayed in the immersive view pane, as illustrated in Figure 2C. That is, if the document 240 is a word processing application, then selection of an edit function associated with the document 240 may cause the launching and retrieval of word processing functionality for allowing a user to edit the document in association with application functionality with which the document was created. For example, if the document 240 is a spreadsheet document, then selection of an edit function 245 may cause the launching of spreadsheet application functionality in the immersive view pane. Likewise, if the document 240 is a slide presentation, then selection of an edit function 245 may cause the launching and provision of slide presentation application functionality in the immersive view pane for use with the document displayed in the immersive view pane. As illustrated in Figure 2E, a web-based application 250 is launched in response to the selection of an edit/copy function 245, but as appreciated, a local or remote word processing application may similarly be launched for providing functionality in association with the document 245.

[0046] Referring now to Figure 2F, in response to a selection of an edit/copy function 245, as illustrated in Figures 2D, and in response to a launching of an associated example word processing application, as illustrated in Figure 2E, a variety of word processing functionalities 255 may be provided in the immersive view pane for allowing the receiving user to edit the document 240. As should be appreciated, an instance of a word processing application may be launched and displayed in the immersive view pane, or selected functionalities, for example, formatting functionalities may be provided in the immersive view pane for allowing a user to operate certain word processing functions on the document 240. Likewise, if the document 240 is a spreadsheet document, then an instance

of a spreadsheet application may be launched in the immersive view pane, or certain functionalities of a spreadsheet application may be provided in the immersive view pane.

[0047] Referring still to Figure 2F, according to one embodiment, when the receiving user selects the document 240 for editing, a draft communication 217, for example, a draft reply electronic mail item may be automatically generated and displayed in the electronic communication view pane to allow the user to communicate the edited document or other content item when the user completes the editing process. Referring to the draft communication 217, according to one embodiment, an automatic reply message to the original sender of the electronic mail message that attached the document 240 that is being edited by the receiving user may be generated so that upon completion of edits to the document 240, the editing user may select a save and send function 260 for automatically attaching the edited version of the document or content item 240 to the draft communication 217 for sending the communication to the original sending user. Thus, a communication from the sending user to the receiving user is enabled where the receiving user opens an attachment 221 received from the sending user, edits the attachment and automatically sends the edited version of the attachment back to the original sending user without the need for saving the attachment to a hard drive or other storage repository at which edits are made and saved followed by a retrieval and re-attachment of the edited content item to a communication for transmitting to the original sending user.

[0048] As described above with reference to Figure 1, when the user begins the editing process for an attached content item, as illustrated in Figure 2D, a temporary copy of the content item being edited is saved along with the received electronic communication item 110 at the electronic communication server 108. According to one embodiment, the edited attachment is renamed to provide information to an individual recipient of the edited document and to distinguish the edited document from a previous version of the edited document. For example, a document with a file name of "Document A" may be renamed to include a name or other identification for the editing user and a new name of "Document A.editing user" may be applied to the edited version of the attached content item, and the renamed and edited version of the content item may be stored as a temporary copy of the document 106 at the electronic communication server 108, as illustrated in Figure 1. Thus, the edited version of the content item is not stored at a separate local or remote storage area, such as the collaboration server 112 from which the edited version of the content item must be retrieved for eventual communication to another user.

[0049] Referring still to Figures 1 through 2F, sending of an edited version of an attached content item back to the original sending user is illustrated and described. According to embodiments, other functionality of the electronic communication application may be utilized for disposing of an edited version of the received attached content item. For example, instead of using a save/send function 260, as illustrated in 5 Figure 2D, another function such as “send as meeting request” may be provided which, when selected, causes an automatic generation of a meeting request and an automatic attachment of the edited content item to the meeting request. Likewise, another function, such as, “add to notes” may be provided, which when selected, causes an automatic 10 presentation of a notes user interface component in the electronic communication view pane and automatically attaches an edited version of the attached content item to an electronic notes document. Another function, such as, “add to calendar entry” may be provided, which when selected, causes an automatic opening of a calendar function and an automatic attachment of the edited version of the content item to a calendar item in an 15 associated electronic calendaring application. As should be appreciated, any number of functions may be provided similar to the save and send function 260 which when selected may cause the provision of a user interface component in the electronic communication view pane for automatically attaching the edited version of the attached content item to another content item associated with a selected functionality.

[0050] Referring now to Figure 2G, after the automatically-generated electronic communication is sent to the one or more desired recipients, the sending user may utilize the electronic communication user interface 200 for any electronic communication functionality, for example, electronic mail, text messaging, instant messaging, and the like. According to one embodiment, the sending user may review an electronic communication 20 25 conversation or thread 275 in the electronic communication pane 215 concerning the recently-sent electronic communication 217 showing the attachment 221 with which the user attached an edited version of the content item 240, and showing a subsequent conversation item 218 received back from the recipient of the user’s electronic communication containing yet another version of the content item 240 illustrated as 30 attachment 222, and showing an additional attachment 225 that the sending user wishes to have the recipient review. Thus, an electronic conversation about a given topic including edits to the content item 240 may be conducted between various users.

[0051] As illustrated and described above with references to Figures 2A through 2G, a content item may be launched from an attachment received in an electronic

communication, and launched content item may be displayed in an immersive view pane to allow a user to view the displayed content item and his/her electronic communications simultaneously. Referring now to Figure 2H, according to an embodiment, a “hide email” function 285 is illustrated which when selected may cause the electronic communications pane 215 to be temporarily hidden from view so that the immersive view pane 237 may be expanded to consume all available display space to allow the user a larger view of the selected content item 240. As should be appreciated, a similar function, for example, a “unhide email” function may be provided after hiding the electronic communications pane for allowing a user to selectively return the electronic communications pane back into view. Similarly, a function may be provided for allowing the user to selectively hide the immersive view pane for allowing a display of other electronic communications panes 210 and 205, as illustrated with reference to Figure 2A. Similarly, a “unhide” function may be provided for un-hiding the immersive view pane and for bringing the immersive view pane back into display along side the electronic communications pane, as illustrated and described herein.

[0052] FIGURE 2I illustrates a computer-generated software application user interface 200 from which an electronic communication may be launched in association with a content item. As illustrated and described above, a content item, for example, a document, may be launched by selecting an attachment associated with the content item from an electronic communication item which causes a display of the selected item in an immersive view pane. According to another embodiment, an electronic communication functionality and interface may be launched from a content item that is being provided by associated software application functionality. As illustrated in Figure 2I, a user interface 290 is illustrated as a spreadsheet functionality user interface that may be provided by a spreadsheet application for allowing a user to enter and manipulate various data items. According to this embodiment, one or more electronic communications functionalities 292 may be provided in the user interface of a given software application for initiating an electronic communication out of the user interface in association with a document or other content item being generated via the associated user interface. For example, as illustrated in Figure 2I, a “reply with changes” functionality 292 is provided in the example spreadsheet application user interface 290 for automatically initiating an electronic communication for communicating with one or more users about any topic, but likely for communicating with other users about the document contained in the user interface from which the communication is initiated.

[0053] As should be appreciated, the illustration of the spreadsheet application user interface and associated data is for purposes of example only. That is, electronic communication functionality may be enabled in accordance with the functionality of any software application, for example, a word processing application, a slide presentation application, a notes taking application, a database application, and the like. In addition, the “reply with changes” function 292 is for purposes of example, and is not limiting of other electronic communications functionalities, for example, “forwarding”, “sending”, “send as an attachment”, “forward as an attachment”, and the like. That is, any electronic communication functionality available to an associated electronic communications application, for example, an electronic mail application, may be provided as a selectable functionality in a given software application user interface.

[0054] Referring to Figure 2J, in response to a user selection of the electronic communications function 292 an instance of an associated electronic communications user interface may be automatically launched and provided, as illustrated in Figure 2J. As illustrated in Figure 2J, in response to selection of the electronic communication functionality 292 illustrated in Figure 2I, not only is an instance of the electronic mail user interface launched, but an electronic mail item may be automatically generated, and the document being edited in the example spreadsheet may be automatically attached to the electronic mail item as attachment 225, such that when a user selects a function 293 for disposition of the communication (e.g., sending, forwarding, replying, replying to all, etc.), then the communication may be sent to a desired user along with an attachment of the edited document or along with a pointer to a location of the stored edited document.

[0055] As should be appreciated, while the spreadsheet user interface illustrated in Figure 2I and the electronic mail user interface illustrated in Figure 2J are illustrated as displayed apart from other displayed content, the example spreadsheet user interface may be displayed in an immersive view pane, as described above, and the launched electronic communications interface may be displayed in an electronic communications pane, as described above, so that the being-edited document and the launched electronic communications interface are displayed in a side-by-side or top/bottom orientation. Thus, according to this embodiment, a user may launch an electronic communications session out of a document generation/editing session for communicating a given content item to one or more other users.

[0056] Referring now to Figure 2K, according to another embodiment, in addition to displaying and enabling editing of a content item that is attached to an electronic

communication, as described above, according to another embodiment, a new content item may be generated out of an electronic communication user interface. As illustrated in Figure 2K, the electronic mail user interface 200 with its folder pane 210 and electronic mail listing pane 205 and electronic communications pane 215 is illustrated. In addition, 5 an insert function 295 is illustrated for allowing a user to selectively insert objects of various types into an electronic mail item for sending the electronic mail item along with the inserted object to one or more recipients. According to an embodiment, in addition to inserting a given object, for example, an attachment, a photograph, a content item, a document, a data object, and the like, a new file function 296 may be enabled which when 10 selected may allow for the creation of a new content item 294 within the electronic communication user interface 200 that subsequently may be saved and passed to one or more other users via an electronic communication.

[0057] Referring now to Figure 2L, in response to selecting the “new file” function 296, as illustrated in Figure 2K, a user interface object 297 may be presented for allowing the 15 user to select a file type associated with the new content item the user desires to create. For example, the user may be allowed to select from a word processing file, a spreadsheet file, a slide presentation file, a notes taking file, a desktop publishing file, a database file, and the like. That is, as should be appreciated, any file type that may be called upon by the electronic communications application for functionality may be used for allowing the 20 user to create a content item of that type.

[0058] Referring now to Figure 2M, in response to selecting the example word processing file type, an instance of a word processing application user interface may be provided in the immersive view pane of the electronic communications user interface 200 for allowing a user to create a document of that type in the immersive view pane. That is, 25 functionality of the selected word processing file type is provided in the immersive view pane and a blank drafting surface 298 is provided for allowing the user to enter content as illustrated in Figure 2M. According to one embodiment, after the user completes entry of the content, the user may save the generated content to a storage location of the user’s choice, or the user may select a “save and send” function 299 for automatically saving the 30 newly-entered content item to an electronic communication item, for example, an electronic mail item to allow the newly-generated content item to be transmitted with the communication item to a desired recipient. For example, as illustrated and described above with reference to Figure 1, the newly-generated content item may be automatically

stored with an electronic mail item 216 at an electronic mail box 108 for subsequent transmission with the electronic mail item 216.

[0059] When generation of the new content item is initiated, the electronic mail item 216 may be automatically generated to allow a user to send the newly-generated content item to a desired recipient upon completion of the content item. According to this
5 embodiment, the automatically-generated electronic mail item 216 may be displayed in the electronic communication pane 215, and attachment 216A may be associated with the electronic mail item 216. Upon selection of the “save and send” function 299, the generated document 298A may be automatically stored with the electronic mail item 216
10 at the electronic mail box 108, and the attachment 216A may be updated to point to the storage location of the stored document 298A such that a subsequent recipient of the electronic mail item 216 may select the attachment for opening, viewing and editing, if desired the newly-generated document 298A.

[0060] Having described the system architecture, various user interface components and
15 various aspects and embodiments of the present invention with respect to FIGURES 1 through 2M, FIGURE 3 is a flowchart illustrating a method for inline document collaboration through various workflows. The routine 300 begins as operation 305 and then proceeds to operation 310 where a user receives an electronic communication with an attached content item. For example, the user may receive an electronic mail, instant
20 message, text message, chat message, or the like, having an attached content item. At operation 315, user may view the attached content item in an immersive view to allow the user to view the attached content item and his/her electronic communications pane showing various electronic communication items simultaneously. At operation 320, the user may conduct an electronic communications conversation apart from the display of the selected content item, as illustrated and described above with reference to Figure 2C.
25

[0061] At operation 325, if the user desires to edit the attached and displayed content item, the user may enter an edit mode wherein functionality associated with the content item will be provided. In response to entering the edit mode, an electronic communication may be automatically generated for allowing the user to subsequently send an edited
30 version of the content item to one or more desired recipients. At operation 330, in response to selection of a function for saving edits to the content item and for sending the edited content item to one or more desired recipients, the edited content item may be stored with the electronic mail item in an electronic mail server 108, or the edited content

item may be automatically stored in a separate storage location, for example, the collaboration server 112.

[0062] At operation 335, when the electronic communication is sent to the desired recipients, the edited content item may be attached to the communication if it is been saved with the email, or a pointer to the saved content item may be attached to the communication to point the recipient of the communication to a storage location for the edited content item. At operation 340, after the automatically-generated communication is sent, the user's electronic communications user interface 200 may return back to a starting configuration, and the user may view a communication conversation including a communication associated with the sent edited content item. At operation 340, hiding an electronic communication may be enabled, if desired.

[0063] At operation 345, if a user desires to generate an electronic communication out of a user interface associated with the generation of a given content item, the user may select an electronic communications function from a user interface provided by the associated software application, for example, a word processing application user interface, a spreadsheet application user interface, a slide presentation application user interface, and the like, and at operation 350, a "save and send" function may be utilized for saving edits to an associated content item and for sending a generated and/or edit content item to one or more desired recipients, as illustrated and described above with reference to Figures 2I and 2J.

[0064] At operation 355, if a user utilizing his/her electronic communications application and user interface 200 desires to create a new content item, the user may select to insert a new content item within an electronic communication, as illustrated above with reference to Figure 2K. At operation 360, an appropriate file type may be selected, and an instance of an associated software application user interface, for example, a word processing application user interface, may be provided in the immersive view pane for allowing the user to generate a new content item of the desired file type.

[0065] At operation 365, the content item of the selected file type may be generated. The generated content item may be saved a desired storage location, or if desired, the user may utilize a "save and send" function for saving the generated document with an automatically-generated electronic communication item and for sending the electronic communication item to a desired recipient by attaching the newly-generated content item to the automatically-generated electronic communication item. The routine ends at operation 395.

[0066] While the invention has been described in the general context of program modules that execute in conjunction with an application program that runs on an operating system on a computer, those skilled in the art will recognize that the invention may also be implemented in combination with other program modules. Generally, program modules
5 include routines, programs, components, data structures, and other types of structures that perform particular tasks or implement particular abstract data types.

[0067] The embodiments and functionalities described herein may operate via a multitude of computing systems including, without limitation, desktop computer systems, wired and wireless computing systems, mobile computing systems (e.g., mobile
10 telephones, netbooks, tablet or slate type computers, notebook computers, and laptop computers), hand-held devices, multiprocessor systems, microprocessor-based or programmable consumer electronics, minicomputers, and mainframe computers.

[0068] In addition, the embodiments and functionalities described herein may operate over distributed systems (e.g., cloud-based computing systems), where application
15 functionality, memory, data storage and retrieval and various processing functions may be operated remotely from each other over a distributed computing network, such as the Internet or an intranet. User interfaces and information of various types may be displayed via on-board computing device displays or via remote display units associated with one or more computing devices. For example user interfaces and information of various types
20 may be displayed and interacted with on a wall surface onto which user interfaces and information of various types are projected. Interaction with the multitude of computing systems with which embodiments of the invention may be practiced include, keystroke entry, touch screen entry, voice or other audio entry, gesture entry where an associated computing device is equipped with detection (e.g., camera) functionality for capturing and
25 interpreting user gestures for controlling the functionality of the computing device, and the like.

[0069] FIGURES 4-6 and the associated descriptions provide a discussion of a variety of operating environments in which embodiments of the invention may be practiced. However, the devices and systems illustrated and discussed with respect to FIGURES 4-6
30 are for purposes of example and illustration and are not limiting of a vast number of computing device configurations that may be utilized for practicing embodiments of the invention, described herein.

[0070] FIGURE 4 is a block diagram illustrating physical components (i.e., hardware) of a computing device 400 with which embodiments of the invention may be practiced.

The computing device components described below may be suitable for the client device 104A-N described above. In a basic configuration, the computing device 400 may include at least one processing unit 402 and a system memory 404. Depending on the configuration and type of computing device, the system memory 404 may comprise, but is not limited to, volatile storage (e.g., random access memory), non-volatile storage (e.g., read-only memory), flash memory, or any combination of such memories. The system memory 404 may include an operating system 405 and one or more program modules 406 suitable for running software applications 450. The operating system 405, for example, may be suitable for controlling the operation of the computing device 400. Furthermore, 5
10
15
20
25
embodiments of the invention may be practiced in conjunction with a graphics library, other operating systems, or any other application program and is not limited to any particular application or system. This basic configuration is illustrated in FIGURE 4 by those components within a dashed line 408. The computing device 400 may have additional features or functionality. For example, the computing device 400 may also include additional data storage devices (removable and/or non-removable) such as, for example, magnetic disks, optical disks, or tape. Such additional storage is illustrated in FIGURE 4 by a removable storage device 409 and a non-removable storage device 410.

[0071] As stated above, a number of program modules and data files may be stored in the system memory 404. While executing on the processing unit 402, the program modules 406 may perform processes including, but not limited to, one or more of the stages of the method 300 illustrated in FIGURE 3. Other program modules that may be used in accordance with embodiments of the present invention and may include applications such as electronic mail and contacts applications, word processing applications, spreadsheet applications, database applications, slide presentation applications, drawing or computer-aided application programs, etc.

[0072] Furthermore, embodiments of the invention may be practiced in an electrical circuit comprising discrete electronic elements, packaged or integrated electronic chips containing logic gates, a circuit utilizing a microprocessor, or on a single chip containing electronic elements or microprocessors. For example, embodiments of the invention may be practiced via a system-on-a-chip (SOC) where each or many of the components 30
illustrated in FIGURE 4 may be integrated onto a single integrated circuit. Such an SOC device may include one or more processing units, graphics units, communications units, system virtualization units and various application functionality all of which are integrated (or “burned”) onto the chip substrate as a single integrated circuit. When operating via an

SOC, the functionality, described herein, with respect to providing an activity stream across multiple workloads may be operated via application-specific logic integrated with other components of the computing device 400 on the single integrated circuit (chip).

Embodiments of the invention may also be practiced using other technologies capable of performing logical operations such as, for example, AND, OR, and NOT, including but not limited to mechanical, optical, fluidic, and quantum technologies. In addition, 5
embodiments of the invention may be practiced within a general purpose computer or in any other circuits or systems.

[0073] The computing device 400 may also have one or more input device(s) 412 such as a keyboard, a mouse, a pen, a sound input device, a touch input device, etc. The output 10
device(s) 414 such as a display, speakers, a printer, etc. may also be included. The aforementioned devices are examples and others may be used. The computing device 400 may include one or more communication connections 416 allowing communications with other computing devices 418. Examples of suitable communication connections 416
15 include, but are not limited to, RF transmitter, receiver, and/or transceiver circuitry; universal serial bus (USB), parallel, and/or serial ports.

[0074] The term computer readable media as used herein may include computer storage media. Computer storage media may include volatile and nonvolatile, removable and non-removable media implemented in any method or technology for storage of information, 20
such as computer readable instructions, data structures, or program modules. The system memory 404, the removable storage device 409, and the non-removable storage device 410 are all computer storage media examples (i.e., memory storage.) Computer storage media may include RAM, ROM, electrically erasable read-only memory (EEPROM), flash memory or other memory technology, CD-ROM, digital versatile disks (DVD) or
25 other optical storage, magnetic cassettes, magnetic tape, magnetic disk storage or other magnetic storage devices, or any other article of manufacture which can be used to store information and which can be accessed by the computing device 400. Any such computer storage media may be part of the computing device 400. Computer storage media does not include a carrier wave or other propagated or modulated data signal.

[0075] Communication media may be embodied by computer readable instructions, data 30
structures, program modules, or other data in a modulated data signal, such as a carrier wave or other transport mechanism, and includes any information delivery media. The term “modulated data signal” may describe a signal that has one or more characteristics set or changed in such a manner as to encode information in the signal. By way of example,

and not limitation, communication media may include wired media such as a wired network or direct-wired connection, and wireless media such as acoustic, radio frequency (RF), infrared, and other wireless media.

[0076] FIGURES 5A and 5B illustrate a mobile computing device 500, for example, a mobile telephone, a smart phone, a tablet personal computer, a laptop computer, and the like, with which embodiments of the invention may be practiced. With reference to FIGURE 5A, one embodiment of a mobile computing device 500 for implementing the embodiments is illustrated. In a basic configuration, the mobile computing device 500 is a handheld computer having both input elements and output elements. The mobile computing device 500 typically includes a display 505 and one or more input buttons 510 that allow the user to enter information into the mobile computing device 500. The display 505 of the mobile computing device 500 may also function as an input device (e.g., a touch screen display). If included, an optional side input element 515 allows further user input. The side input element 515 may be a rotary switch, a button, or any other type of manual input element. In alternative embodiments, mobile computing device 500 may incorporate more or less input elements. For example, the display 505 may not be a touch screen in some embodiments. In yet another alternative embodiment, the mobile computing device 500 is a portable phone system, such as a cellular phone. The mobile computing device 500 may also include an optional keypad 535. Optional keypad 535 may be a physical keypad or a “soft” keypad generated on the touch screen display. In various embodiments, the output elements include the display 505 for showing a graphical user interface (GUI), a visual indicator 520 (e.g., a light emitting diode), and/or an audio transducer 525 (e.g., a speaker). In some embodiments, the mobile computing device 500 incorporates a vibration transducer for providing the user with tactile feedback. In yet another embodiment, the mobile computing device 500 incorporates input and/or output ports, such as an audio input (e.g., a microphone jack), an audio output (e.g., a headphone jack), and a video output (e.g., a HDMI port) for sending signals to or receiving signals from an external device.

[0077] FIGURE 5B is a block diagram illustrating the architecture of one embodiment of a mobile computing device. That is, the mobile computing device 500 can incorporate a system (i.e., an architecture) 502 to implement some embodiments. In one embodiment, the system 502 is implemented as a “smart phone” capable of running one or more applications (e.g., browser, e-mail, calendaring, contact managers, messaging clients, games, and media clients/players). In some embodiments, the system 502 is integrated as a

computing device, such as an integrated personal digital assistant (PDA) and wireless phone.

[0078] One or more application programs 550 may be loaded into the memory 562 and run on or in association with the operating system 564. Examples of the application
5 programs include phone dialer programs, electronic communication applications, personal information management (PIM) programs, word processing programs, spreadsheet programs, Internet browser programs, messaging programs, and so forth. The system 502 also includes a non-volatile storage area 568 within the memory 562. The non-volatile storage area 568 may be used to store persistent information that should not be lost if the
10 system 502 is powered down. The application programs 550 may use and store information in the non-volatile storage area 568, such as e-mail or other messages used by an e-mail application, and the like. A synchronization application (not shown) also resides on the system 502 and is programmed to interact with a corresponding synchronization application resident on a host computer to keep the information stored in the non-volatile
15 storage area 568 synchronized with corresponding information stored at the host computer. As should be appreciated, other applications may be loaded into the memory 562 and run on the mobile computing device 500.

[0079] The system 502 has a power supply 570, which may be implemented as one or more batteries. The power supply 570 might further include an external power source,
20 such as an AC adapter or a powered docking cradle that supplements or recharges the batteries.

[0080] The system 502 may also include a radio 572 that performs the function of transmitting and receiving radio frequency communications. The radio 572 facilitates wireless connectivity between the system 502 and the “outside world,” via a
25 communications carrier or service provider. Transmissions to and from the radio 572 are conducted under control of the operating system 564. In other words, communications received by the radio 572 may be disseminated to the application programs 550 via the operating system 564, and vice versa.

[0081] The visual indicator 520 may be used to provide visual notifications and/or an
30 audio interface 574 may be used for producing audible notifications via the audio transducer 525. In the illustrated embodiment, the visual indicator 520 is a light emitting diode (LED) and the audio transducer 525 is a speaker. These devices may be directly coupled to the power supply 570 so that when activated, they remain on for a duration dictated by the notification mechanism even though the processor 560 and other

components might shut down for conserving battery power. The LED may be programmed to remain on indefinitely until the user takes action to indicate the powered-on status of the device. The audio interface 574 is used to provide audible signals to and receive audible signals from the user. For example, in addition to being coupled to the audio transducer
5 525, the audio interface 574 may also be coupled to a microphone to receive audible input, such as to facilitate a telephone conversation. In accordance with embodiments of the present invention, the microphone may also serve as an audio sensor to facilitate control of notifications, as will be described below. The system 502 may further include a video
10 interface 576 that enables an operation of an on-board camera 530 to record still images, video stream, and the like.

[0082] A mobile computing device 500 implementing the system 502 may have additional features or functionality. For example, the mobile computing device 500 may also include additional data storage devices (removable and/or non-removable) such as, magnetic disks, optical disks, or tape. Such additional storage is illustrated in FIGURE 5B
15 by the non-volatile storage area 568.

[0083] Data/information generated or captured by the mobile computing device 500 and stored via the system 502 may be stored locally on the mobile computing device 500, as described above, or the data may be stored on any number of storage media that may be accessed by the device via the radio 572 or via a wired connection between the mobile
20 computing device 500 and a separate computing device associated with the mobile computing device 500, for example, a server computer in a distributed computing network, such as the Internet. As should be appreciated such data/information may be accessed via the mobile computing device 500 via the radio 572 or via a distributed computing network. Similarly, such data/information may be readily transferred between computing
25 devices for storage and use according to well-known data/information transfer and storage means, including electronic mail and collaborative data/information sharing systems.

[0084] FIGURE 6 illustrates one embodiment of the architecture of a system for providing the functionality described herein across components of a distributed computing environment. Content developed, interacted with, or edited in association with the
30 applications described above may be stored in different communication channels or other storage types. For example, various documents may be stored using a directory service 622, a web portal 624, a mailbox service 626, an instant messaging store 628, or a social networking site 630. The application 620 (e.g., an electronic communication application) may use any of these types of systems or the like for providing the functionalities

described herein across multiple workloads, as described herein. A server 615, 108 may provide the functionality to clients 605A-C and 104A-N. As one example, the server 615, 108 may be a web server providing the application functionality described herein over the web. The server 615, 108 may provide the application functionality over the web to
5 clients 605A-C and 104A-N through a network 120, 610. By way of example, a client computing device 104A-N may be implemented and embodied in a personal computer 605A, a tablet computing device 605B and/or a mobile computing device 605C (e.g., a smart phone), or other computing device. Any of these embodiments of the client computing device may obtain content from the store 616.

10 **[0085]** Embodiments of the present invention, for example, are described above with reference to block diagrams and/or operational illustrations of methods, systems, and computer program products according to embodiments of the invention. The functions/acts noted in the blocks may occur out of the order as shown in any flowchart. For example, two blocks shown in succession may in fact be executed substantially concurrently or the
15 blocks may sometimes be executed in the reverse order, depending upon the functionality/acts involved.

[0086] The description and illustration of one or more embodiments provided in this application are not intended to limit or restrict the scope of the invention as claimed in any way. The embodiments, examples, and details provided in this application are considered
20 sufficient to convey possession and enable others to make and use the best mode of claimed invention. The claimed invention should not be construed as being limited to any embodiment, example, or detail provided in this application. Regardless of whether shown and described in combination or separately, the various features (both structural and methodological) are intended to be selectively included or omitted to produce an
25 embodiment with a particular set of features. Having been provided with the description and illustration of the present application, one skilled in the art may envision variations, modifications, and alternate embodiments falling within the spirit of the broader aspects of the general inventive concept embodied in this application that do not depart from the broader scope of the claimed invention.

CLAIMS

1. A computing device for generating a content item out of an electronic communication workflow, comprising:

a processing unit; and

a computer-readable medium containing computer executable instructions, which when executed by the processing unit, cause the computing device to:

provide a computer-generated electronic communications user interface including a communications pane for receiving and generating electronic communications;

receive an electronic communication including an content item;

receive a selection to open the content item;

display the content item in an immersive view pane in proximity to the electronic communication pane;

receive an indication to edit the displayed content item;

in response to receiving an indication to edit the displayed content item, display an editing mode wherein functionality associated with a document type of the displayed content item is displayed in the immersive view pane;

receive one or more edits to the displayed content item;

upon receiving one or more edits to the displayed content item, automatically store the displayed content item;

generate an electronic communication, in the electronic communication pane, to convey the content item to one or more recipients.

2. The computing device of claim 1, wherein generating the electronic communication, in the electronic communication pane, to convey the content item to the one or more recipients further comprises attaching the content item to the electronic communication.

3. The computing device of claim 2, wherein attaching the content item to the electronic communication includes inserting an attachment icon into the electronic communication that points to the stored content item, such that selection of the attachment icon causes a retrieval of the stored content item.

4. The computing device of claim 1, wherein automatically storing the displayed content item includes storing the content item at a remote storage location from which the content item may be retrieved for attaching to the electronic communication or from which the content item may be retrieved by a recipient of the electronic communication.

5. The computing device of claim 1, wherein automatically storing the displayed content item includes storing the content item at a remote storage location from which the content item may be retrieved for attaching to the electronic communication or from which the content item may be retrieved by a recipient of the electronic communication.

6. The computing device of claim 4, wherein storing the content item at a remote storage location includes storing the content item at a collaboration server from which the content item may be accessed by one or more members of a collaborative workgroup.

7. The computing device of claim 1, wherein displaying an editing mode wherein functionality associated with a document type of the displayed content item is displayed in the immersive view pane includes launching an instance of an application user interface in the immersive view pane for providing the one or more application functionality controls.

8. A method of generating a content item out of an electronic communication workflow, comprising:

- providing a computer-generated electronic communications user interface including a communications pane for receiving and generating electronic communications;

- receiving an electronic communication including an content item;

- displaying the content item in an immersive view pane in proximity to the electronic communication pane;

- in response to receiving an indication to edit the displayed content item, displaying an editing mode wherein functionality associated with a document type of the displayed content item is displayed in the immersive view pane;

- receiving one or more edits to the displayed content item;

upon receiving one or more edits to the displayed content item, automatically storing the displayed content item;

generating an electronic communication, in the electronic communication pane, to convey the content item to one or more recipients.

9. The method of claim 8, wherein generating the electronic communication, in the electronic communication pane, to convey the content item to the one or more recipients further comprises attaching the content item to the electronic communication.

10. The method of claim 9, wherein attaching the content item to the electronic communication includes inserting an attachment icon into the electronic communication that points to the stored content item, such that selection of the attachment icon causes a retrieval of the stored content item.

11. The method of claim 8, wherein automatically storing the displayed content item includes storing the content item at a remote storage location from which the content item may be retrieved for attaching to the electronic communication or from which the content item may be retrieved by a recipient of the electronic communication.

12. The method of claim 8, wherein automatically storing the displayed content item includes storing the content item at a remote storage location from which the content item may be retrieved for attaching to the electronic communication or from which the content item may be retrieved by a recipient of the electronic communication.

13. The method of claim 12, wherein storing the content item at a remote storage location includes storing the content item at a collaboration server from which the content item may be accessed by one or more members of a collaborative workgroup.

14. The method of claim 8, wherein displaying an editing mode wherein functionality associated with a document type of the displayed content item is displayed in the immersive view pane includes launching an instance of an application user interface in the immersive view pane for providing the one or more application functionality controls.

15. A computer-readable medium containing computer executable instructions, which when executed by a computer perform a method of generating a content item out of an electronic communication workflow, comprising:

providing a computer-generated electronic communications user interface including a communications pane for receiving and generating electronic communications;

receiving an electronic communication including an content item;

receiving a selection to open the content item;

displaying the content item in an immersive view pane in proximity to the electronic communication pane;

receiving an indication to edit the displayed content item;

in response to receiving an indication to edit the displayed content item, displaying an editing mode wherein functionality associated with a document type of the displayed content item is displayed in the immersive view pane;

receiving one or more edits to the displayed content item;

upon receiving one or more edits to the displayed content item, automatically storing the displayed content item; and

generating an electronic communication, in the electronic communication pane, to convey the content item to one or more recipients.

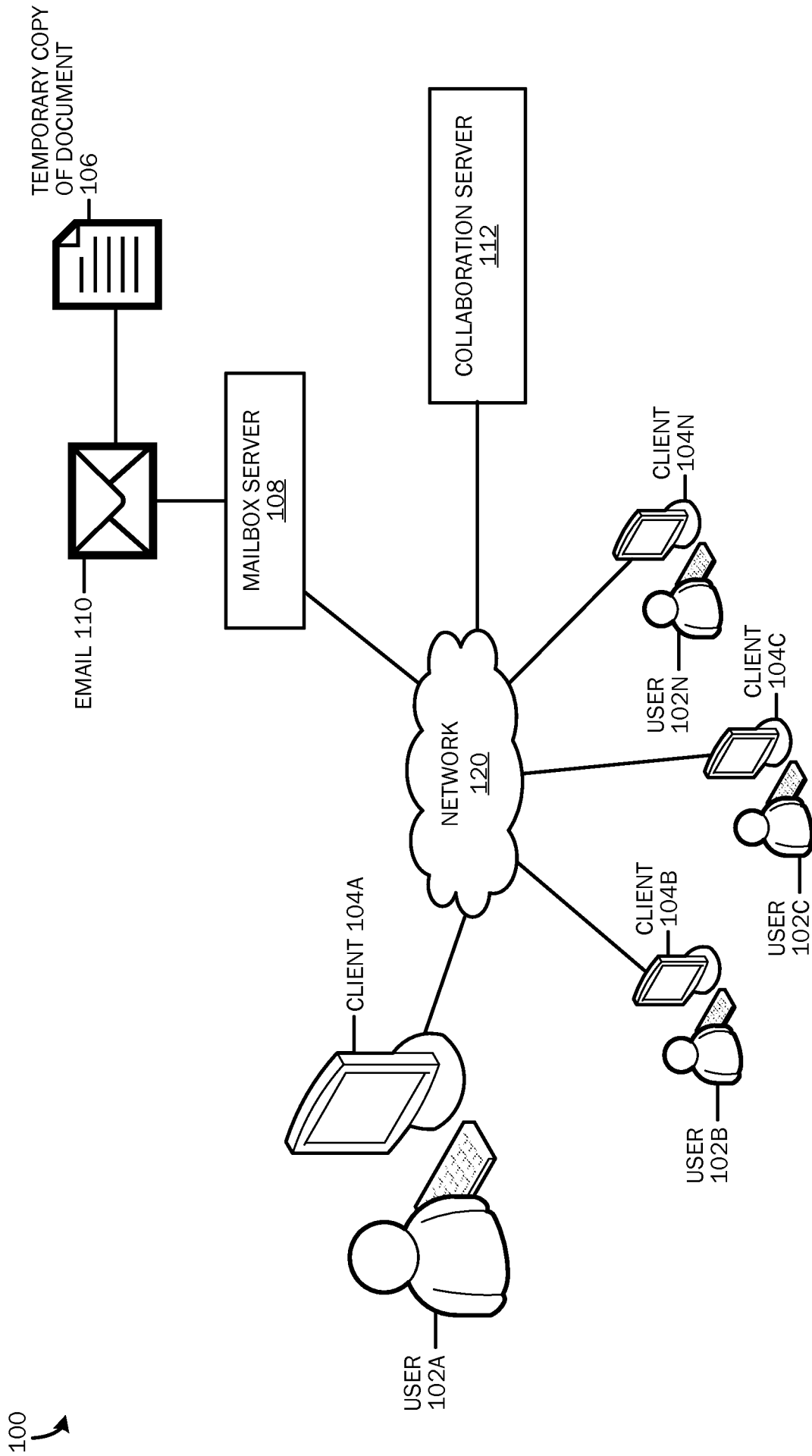

FIG. 1

200

The screenshot displays an email client interface with the following components:

- Top Bar:** Includes navigation icons (back, forward, search, etc.), a search bar containing "http://abc-xyz/Mail", and a profile header for "Miguel Garcia - Mail..".
- Navigation Menu:** A horizontal bar with icons for Mail, Calendar, People, Social, Storage, and Sites.
- Inbox (205):** A list of email items with subjects like "Max Headroom; Miguel G", "Kat Larsson; Max Headroom", "Diane Kruger; Stacey Dash", "Jack White", "Franz Kofi", "Michael Alexander; Jack White", "Armando Pinto", and "Carole Polard".
- Search Bar (210):** A search field with the text "Search Bright Dreams".
- Review Deck (215):** A detailed view of an email from Miguel Garcia, dated Tue 10/8/2023 11:04 AM. The email content includes:
 - To: Maria Love;
 - Subject: "All about dogs" (with a paw print icon).
 - Body text: "Hey Armando, I made a few updates to the deck I added the numbers from the latest data we got in yesterday. Also, I think we should include this picture (attached) what do you think?"
 - Attachments: "Mariana Logo" (with a portrait icon).
- Annotations:**
 - Number 200 points to the top navigation area.
 - Number 210 points to the search bar.
 - Number 215 points to the email review deck.
 - Number 220 points to the email subject line.
 - Number 225 points to the email body text.
 - Number 230 points to the paw print icon.
 - Number 235 points to the "Mariana Logo" attachment.

FIG. 2A

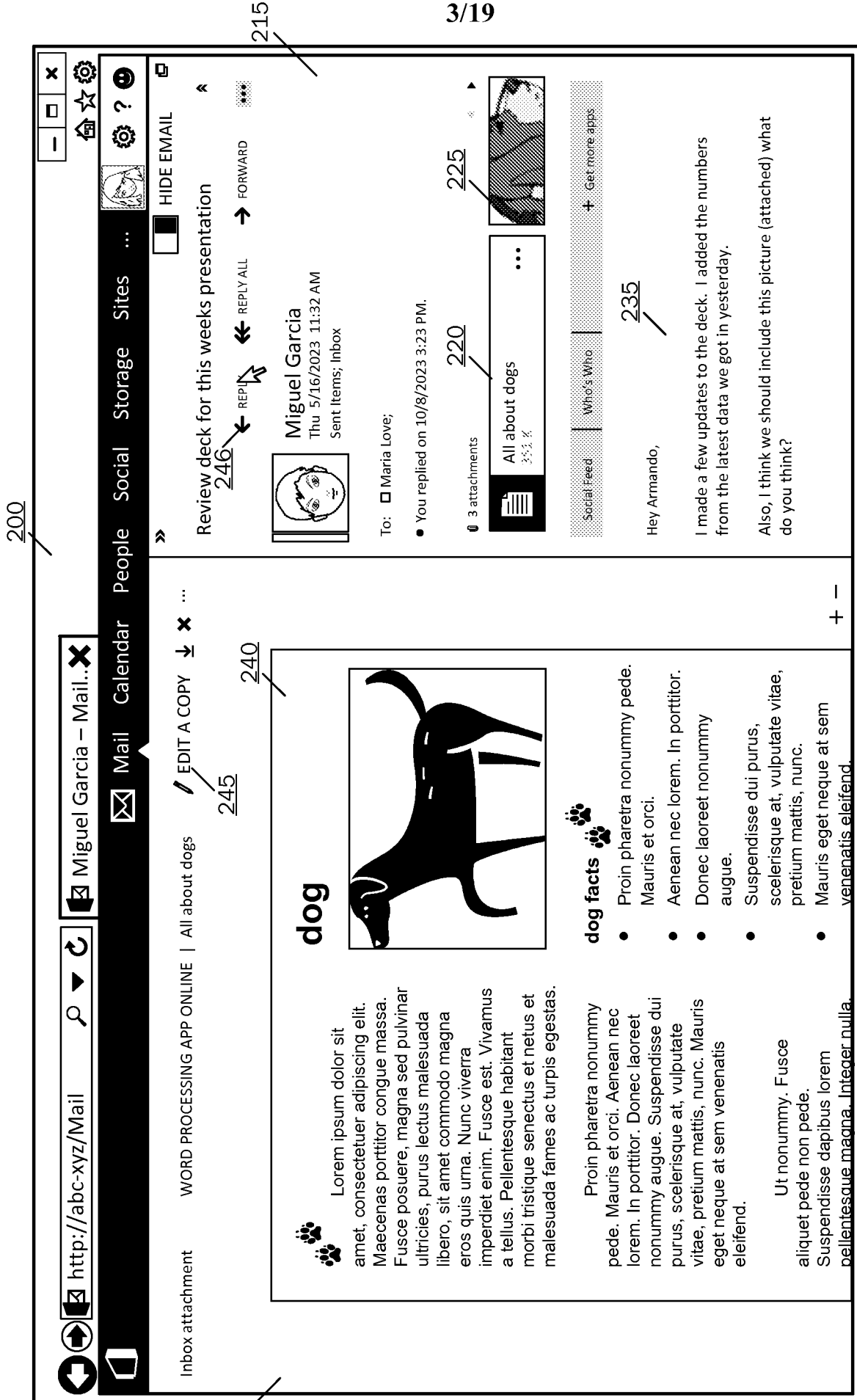

FIG. 2B

200

4/19

Miguel Garcia - Mail..

Inbox attachment

WORD PROCESSING APP ONLINE
| All about dogs
EDIT A COPY

240

Mail

Calendar

People

Social

Storage

Sites

SAVE AND SEND

DISCARD

INSERT

APPS

To: Maria Love;

Cc:

Subject: RE: Review deck for this weeks presentation

Calibri

12

235

From: Maria Love

Sent: Thursday, May 16, 2023 11:32 AM

To: Miguel Garcia; Armando Smith

Subject: RE: Review deck for this weeks presentation

Hey, Armando,

I made a few updates to the deck. I added the numbers from the latest data we got in yesterday.

Also, I think we should include this picture (attached) what do you think?

Maria

215

FIG. 2C

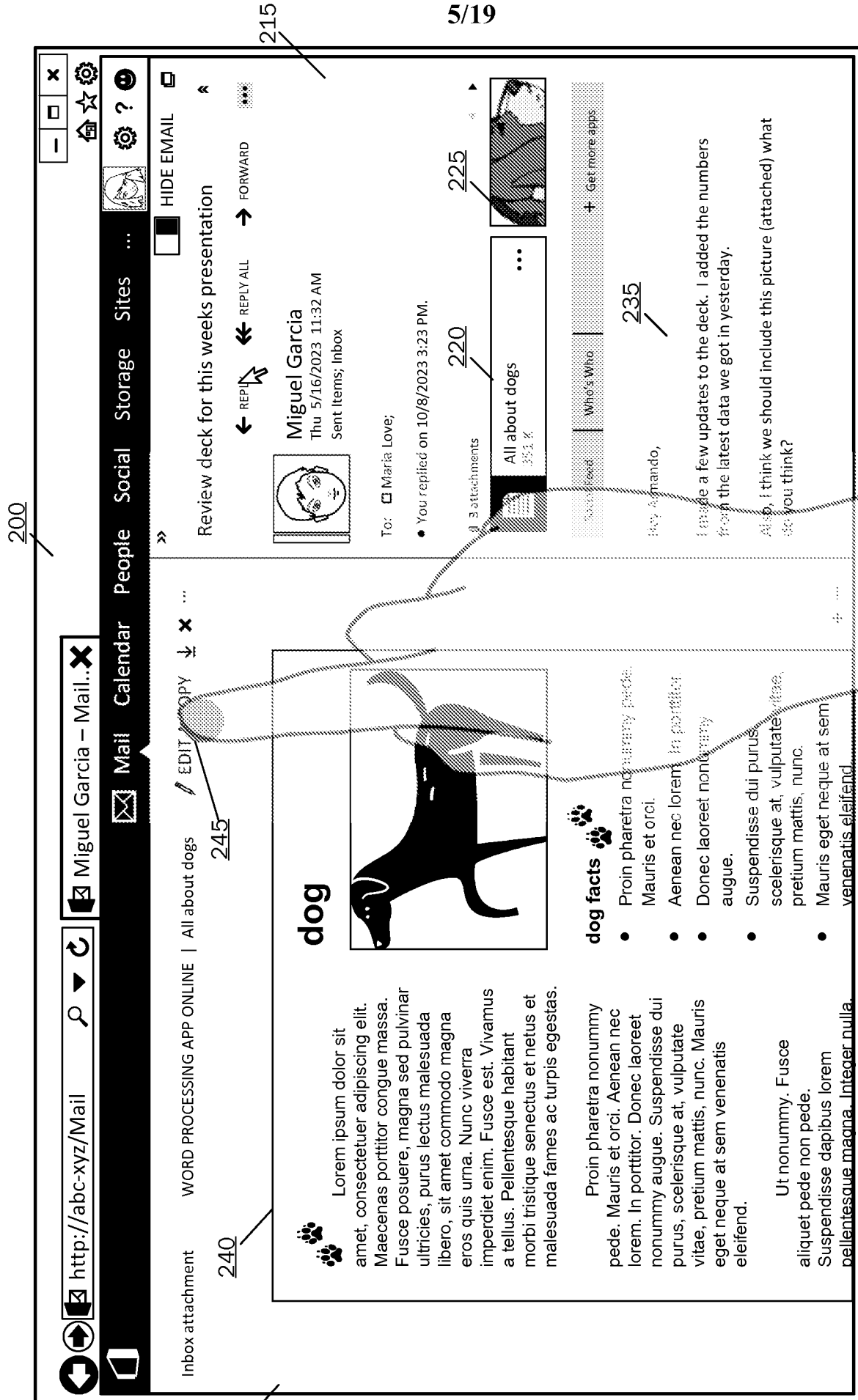

5/19

FIG. 2D

200

215

245

240

237

220

225

235

dog



Lorem ipsum dolor sit amet, consectetur adipiscing elit. Maecenas porttitor congue massa. Fusce posuere, magna sed pulvinar ultricies, purus lectus malesuada libero, sit amet commodo magna eros quis urna. Nunc viverra imperdiet enim. Fusce est. Vivamus a tellus. Pellentesque habitant morbi tristique senectus et netus et malesuada fames ac turpis egestas.

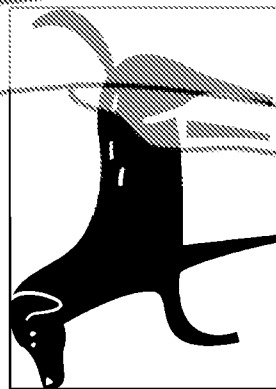

dog facts

- Proin pharetra nonummy pede. Mauris et orci.
- Aenean nec lorem. In porttitor purus, scelerisque at, vulputate vitae, pretium mattis, nunc. Mauris eget neque at sem venenatis eleifend.
- Ut nonummy. Fusce aliquet pede non pede.
- Suspendisse dapibus lorem pellentesque magna. Integer nulla. venenatis eleifend.

Who's Who

By Armando,

I made a few updates to the deck. I added the numbers from the latest data we got in yesterday.

Also, I think we should include this picture (attached) what do you think?



All about dogs
35.1 K

Review deck for this weeks presentation

← REPLY ← REPLY ALL → FORWARD

☑ HIDE EMAIL

Miguel Garcia
Thu 5/16/2023 11:32 AM
Sent Items; Inbox

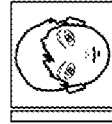

To: ☑ Maria Love;

- You replied on 10/8/2023 3:23 PM.

3 attachments

+ Get more apps

Miguel Garcia - Mail..

http://abc-xyz/Mail

WORD PROCESSING APP ONLINE | All about dogs

Inbox attachment

Navigation icons: Home, Settings, Help, Search, Mail, Calendar, People, Social, Storage, Sites

200

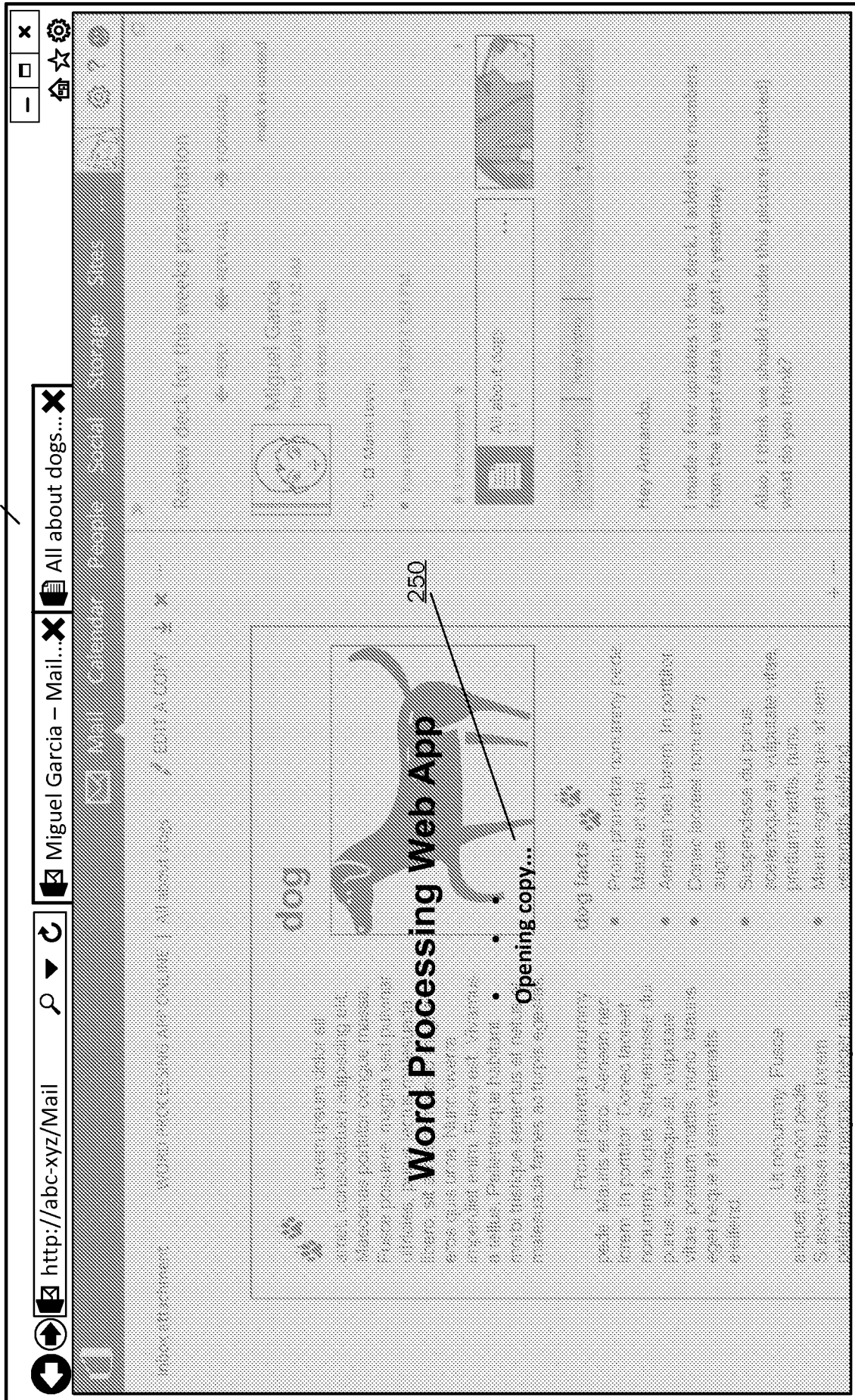

250

FIG. 2E

200

The screenshot displays a web browser window with the address bar showing 'http://abc-xyz/Mail'. The browser tabs include 'Miguel Garcia - Mail...' and 'All about dogs...'. The main content area shows a word processing application interface with a menu bar (FILE, HOME, INSERT, PAGE LAYOUT, FORMULAS) and a ribbon with options like 'Paste', 'Clipboard', 'Font', and 'Alignment'. The document content includes a heading 'dog', a paragraph of Lorem Ipsum text, a list of 'dog facts', and a detailed email view on the right side. The email view shows a subject line 'RE: Review deck for this weeks presentation', a recipient 'Maria Love', and a body of text including 'I made a few updates to the deck. I added the numbers from the latest data we got in yesterday.' and 'Also, I think we should include this picture (attached) what do you think?'. A signature 'Maria' is visible at the bottom of the email. Various callout numbers (200, 217, 221, 240, 255) are placed around the interface elements.

FIG. 2F

200

The screenshot displays an email client interface with the following components:

- Navigation Bar (200):** Includes a search bar with the URL "http://abc-xyz/Mail", a "new" button, and a "Search Bright Dreams" search bar.
- Left Panel:** Shows a "new" button, a search bar, and a list of folders including "INBOX 75", "CLUSTER 13", "FOLDERS", "Sent Items", "Deleted Items 2741", "Archived 88", "Move folders", "PEOPLE", "GROUPS", and "Bright Dreams 3".
- INBOX List:** A list of email items with subjects like "Max Headroom: Miguel G", "Kat Larson: Max Headroom", "Diane Kruger, Stacey Dash", "Jack White", "Franz Kohl", "Michael Alexander: Jack White", "Aymardo Pinho", and "Carole Poland".
- Conversation Item 217:**
 - Sender:** Miguel Garcia (Tue 10/8/2023 11:04 AM, Sent Items; Inbox)
 - To:** Maria Love
 - Content:** "You replied on 1/10/2024 9:11 AM." and "1 attachment: All about dogs.docx" with a URL.
 - Actions:** REPLY, REPLY ALL, FORWARD, mark as unread.
- Conversation Item 218:**
 - Sender:** Maria Love (Thu 5/16/2023 11:32 AM, Sent Items; Inbox)
 - Content:** "I've made some changes. Let me know what you think!" and "2 attachments: All about dogs.docx" and "Dog statistics.xlsx" with URLs.
 - Actions:** REPLY, REPLY ALL, FORWARD, mark as unread.
- Header:** "Review deck for this weeks presentation" and "8/19".
- Footer:** "Hi, Miguel, I've made good progress on our deck for this week. Could you look it over and send me back a..."

FIG. 2G

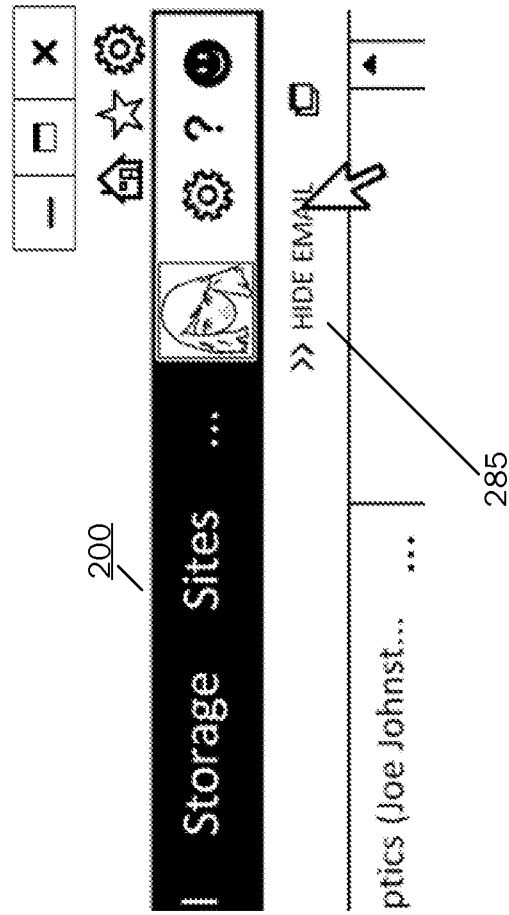

FIG. 2H

290

200

292

← BACK

Spreadsheet Application Online

HOME INSERT PAGE LAYOUT FORMULAS VIEW

Clipboard Paste

Font

Calibri (Body) 11

B I U

Alignment

Tables

Callouts

Formulas

Data

Insert/Delete

← SHOW EMAIL

http://abc-xyz/Mail

Bridget Fox ~ Mail...

Mail Calendar People Social Storage Sites

	A	B	C	E	F
1	BREEDS	AVG SIZE	AVG LIFE SPAN	INTELLIGENCE	
2	Poodle				
3	Laborador Ret				
4	German Sheph				
5	Beagle				
6	Bulldog				
7					
8					
9					
10					
11					

2018-2019 2020-2021 DOGS Future Projections

FIG. 2I

200

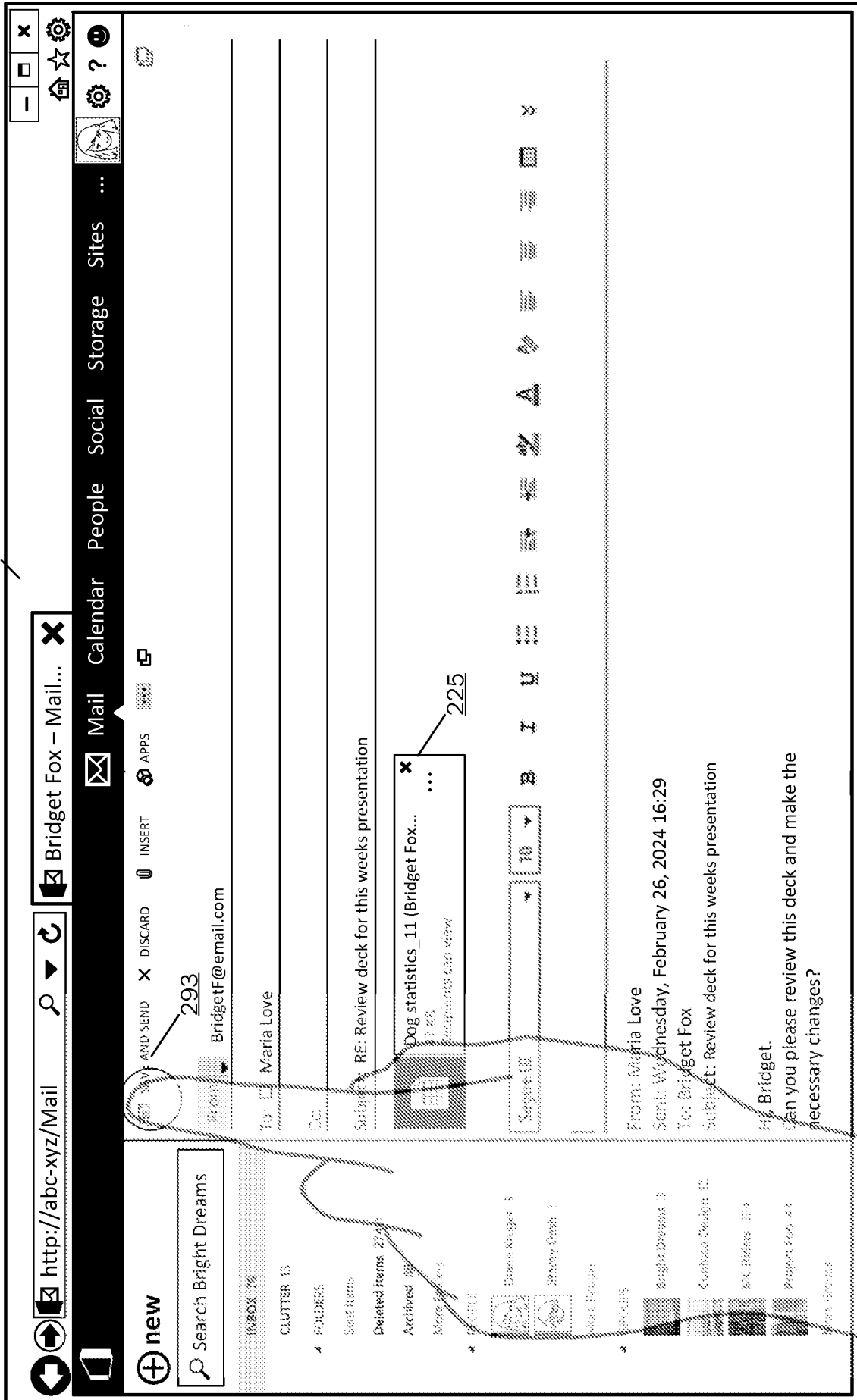
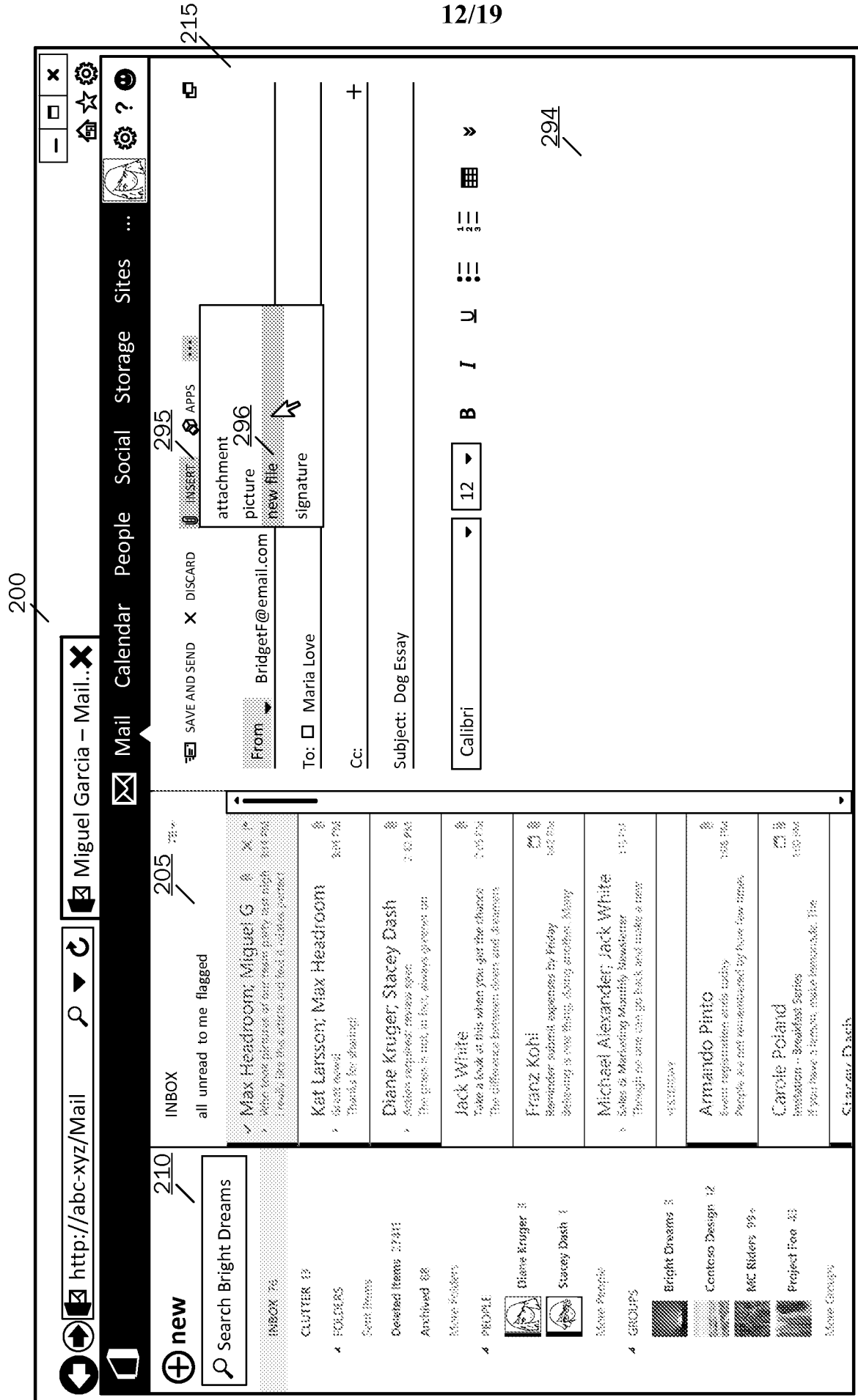

FIG. 2J



12/19

FIG. 2K

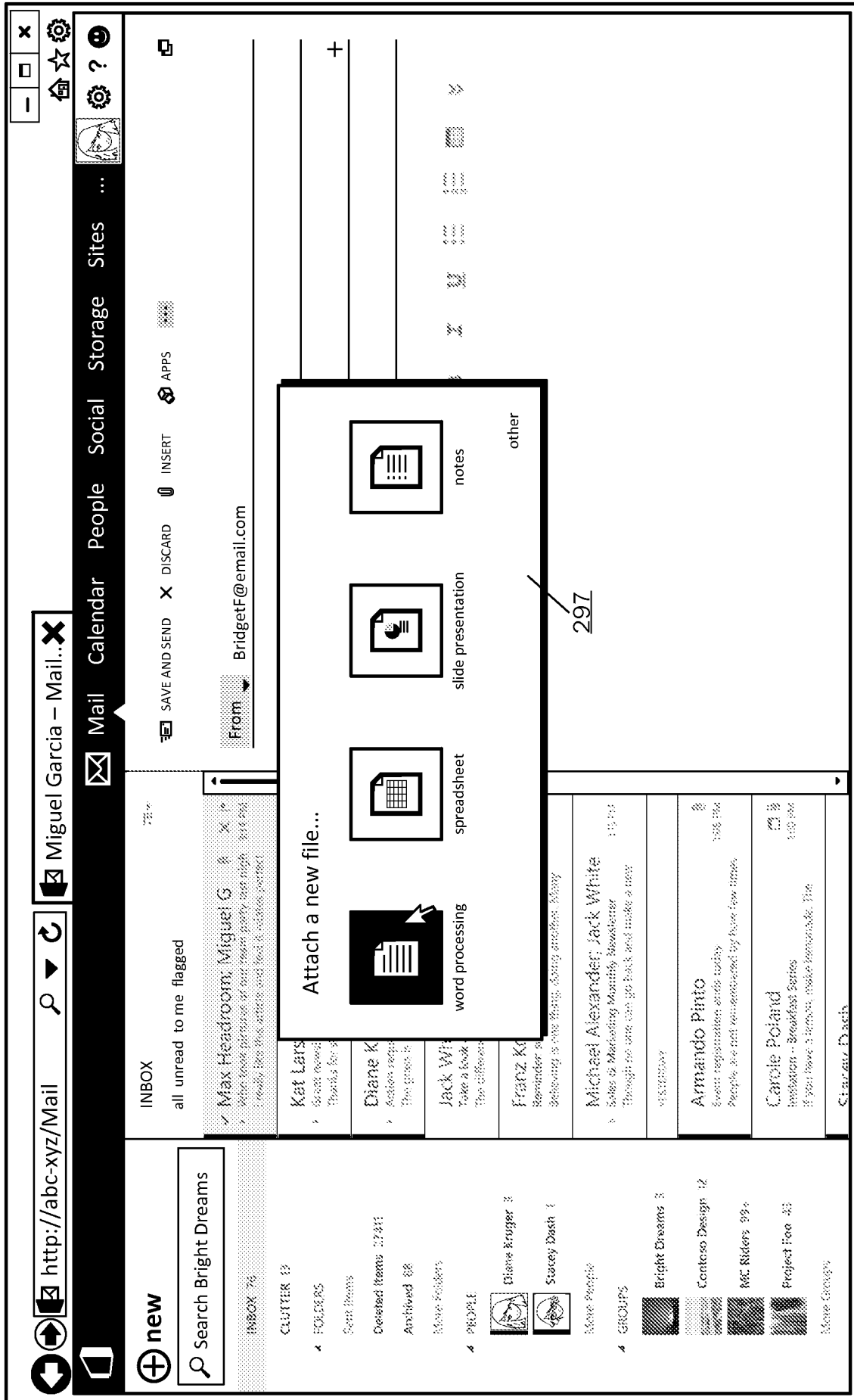

FIG. 2L

200

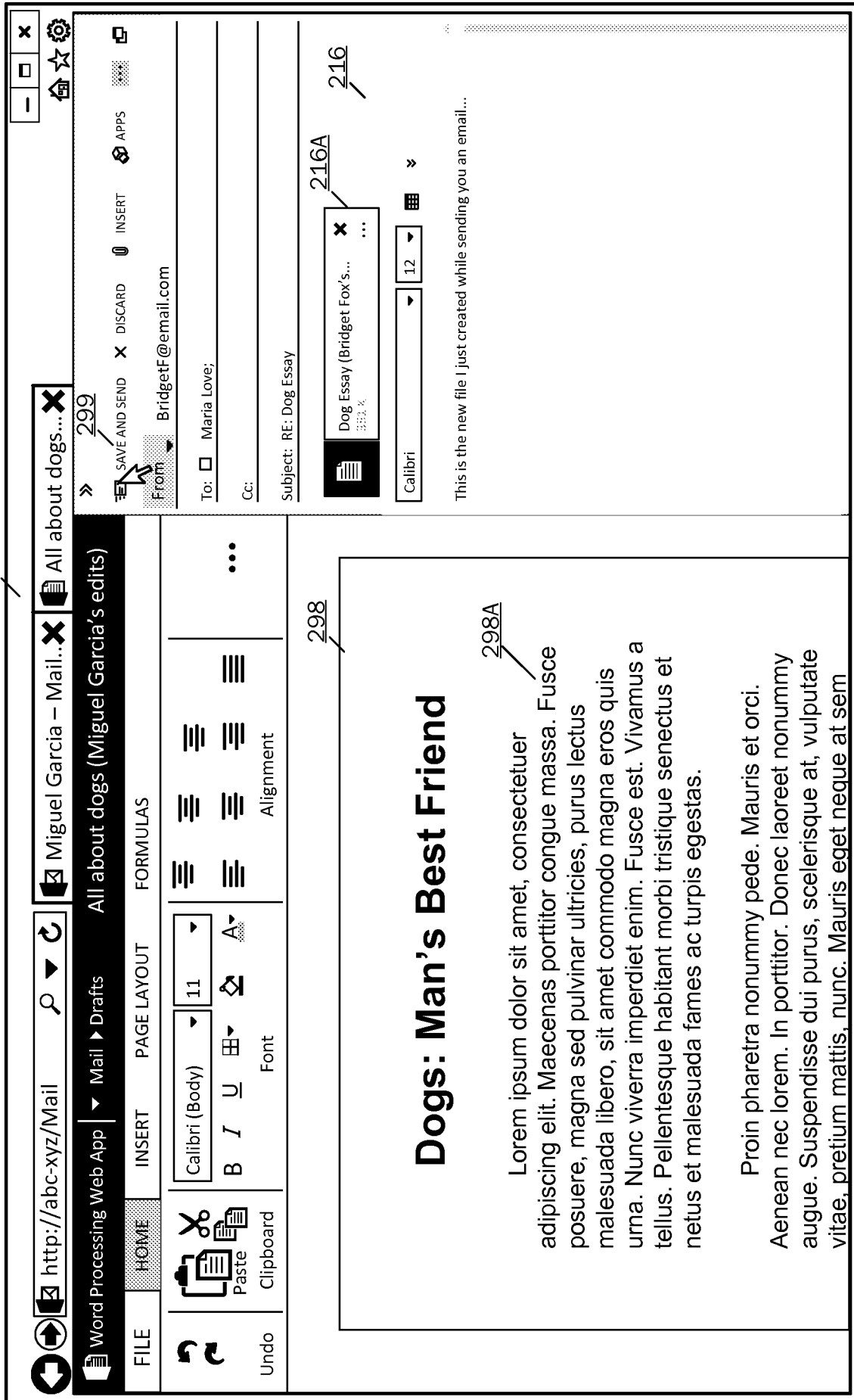

FIG. 2M

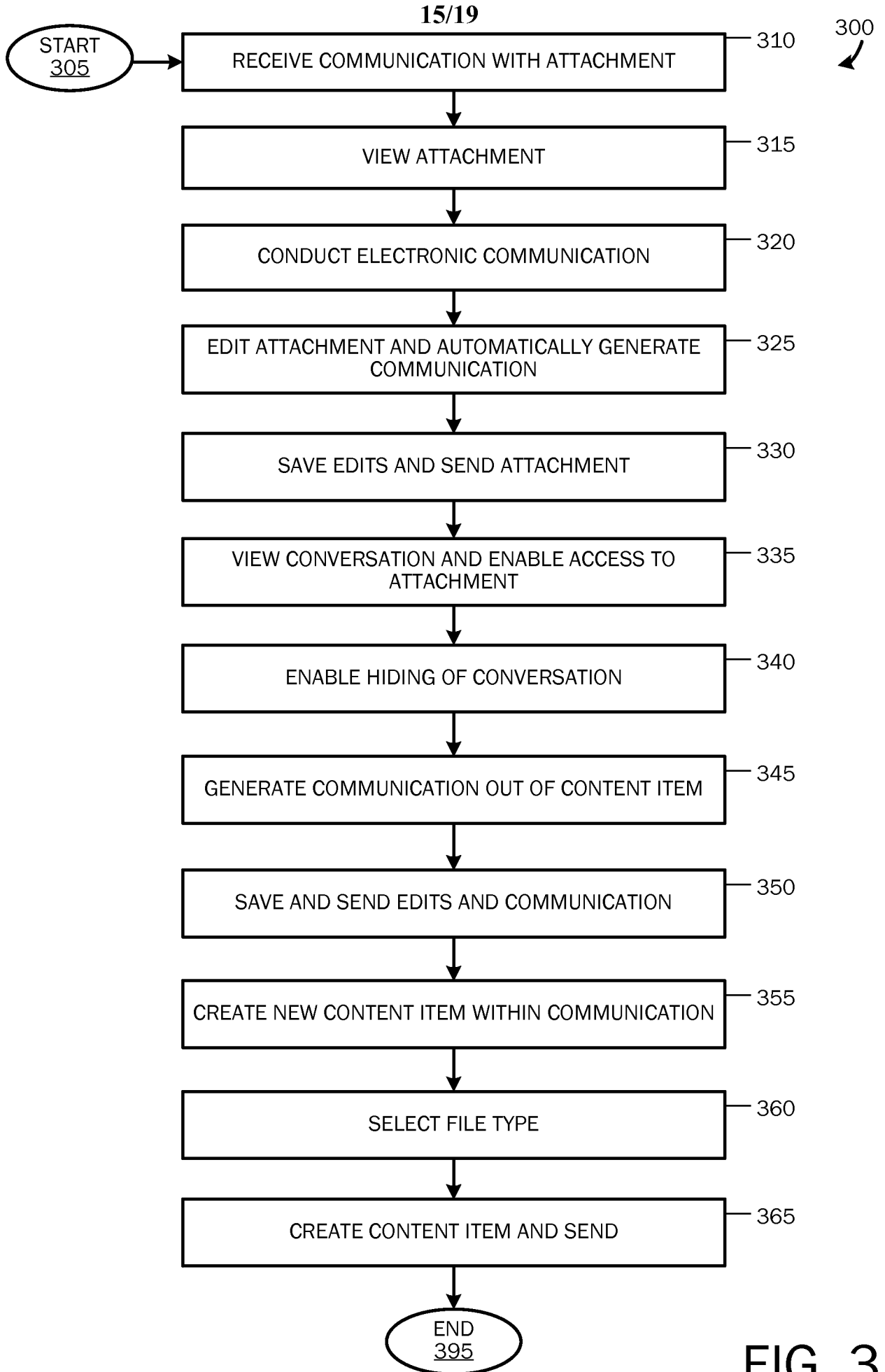

FIG. 3

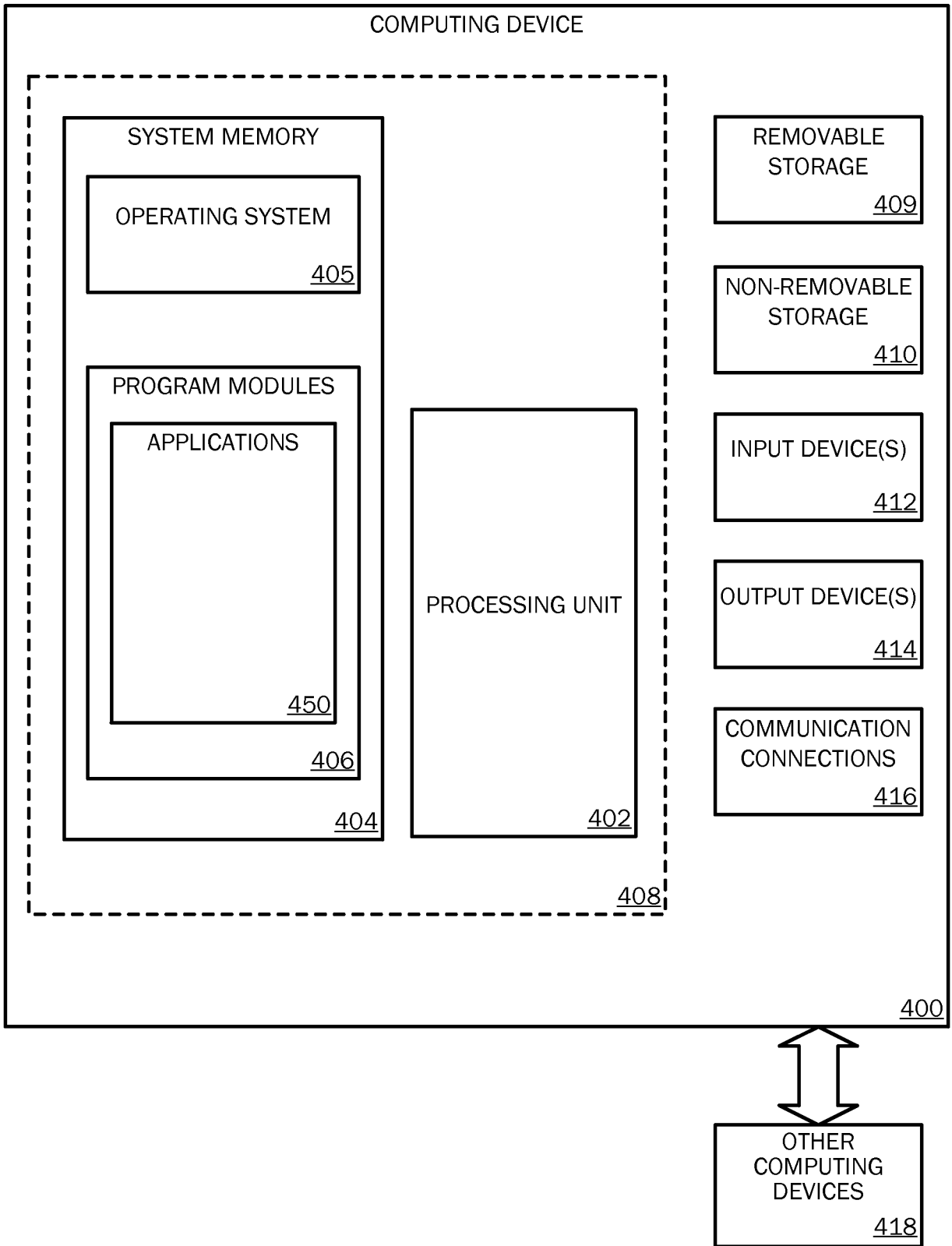
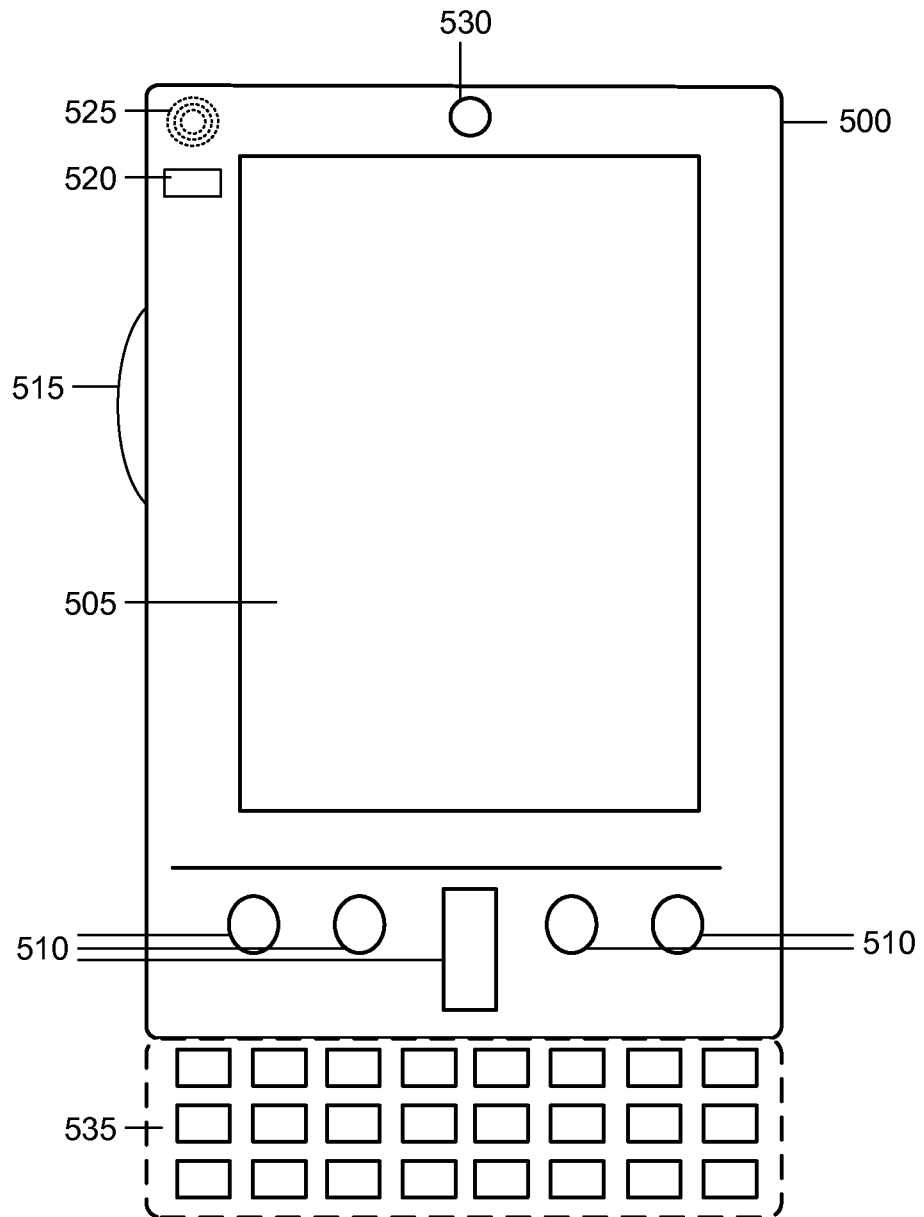

FIG. 4



MOBILE COMPUTING DEVICE

FIG. 5A

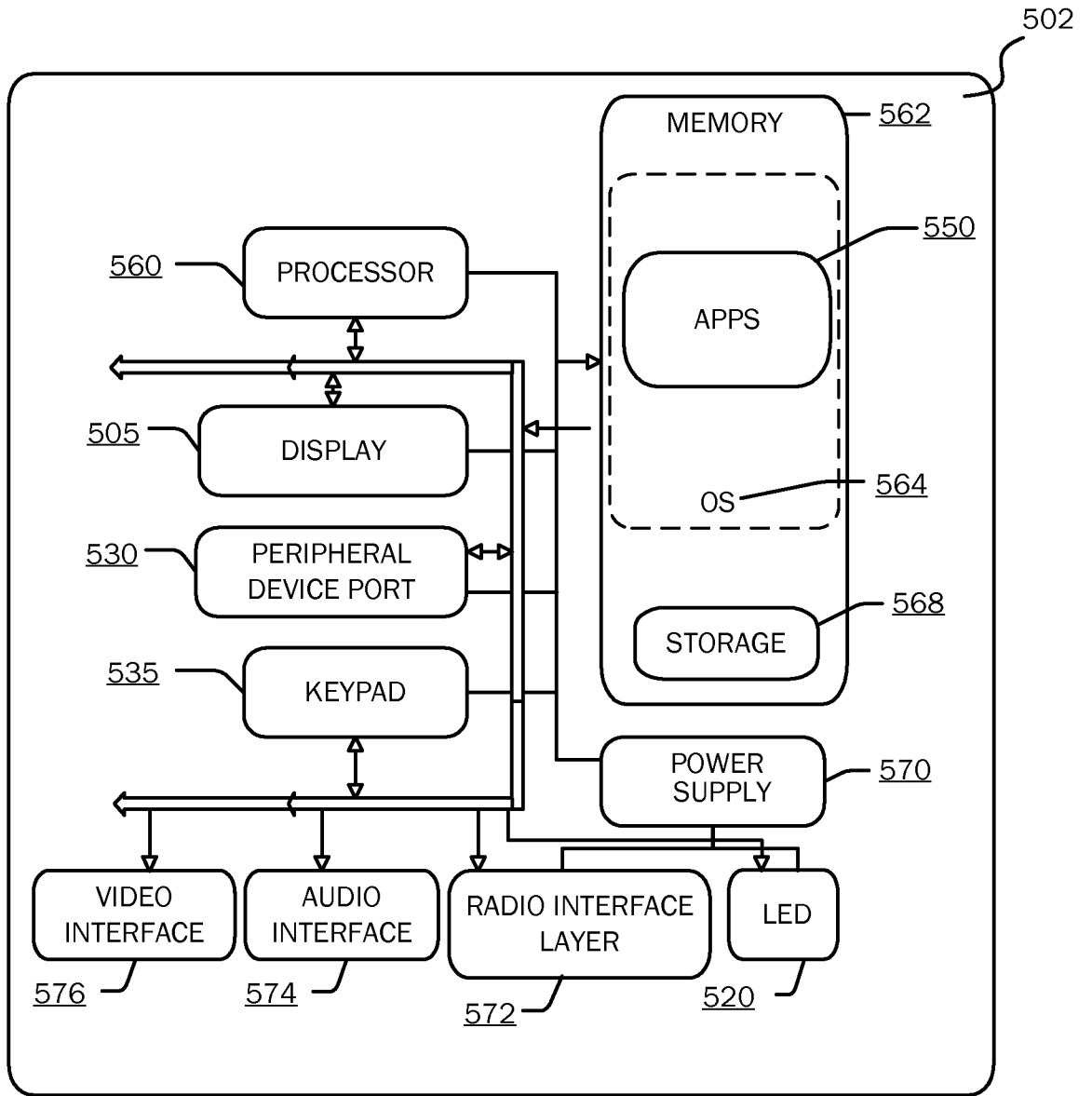

FIG. 5B

19/19

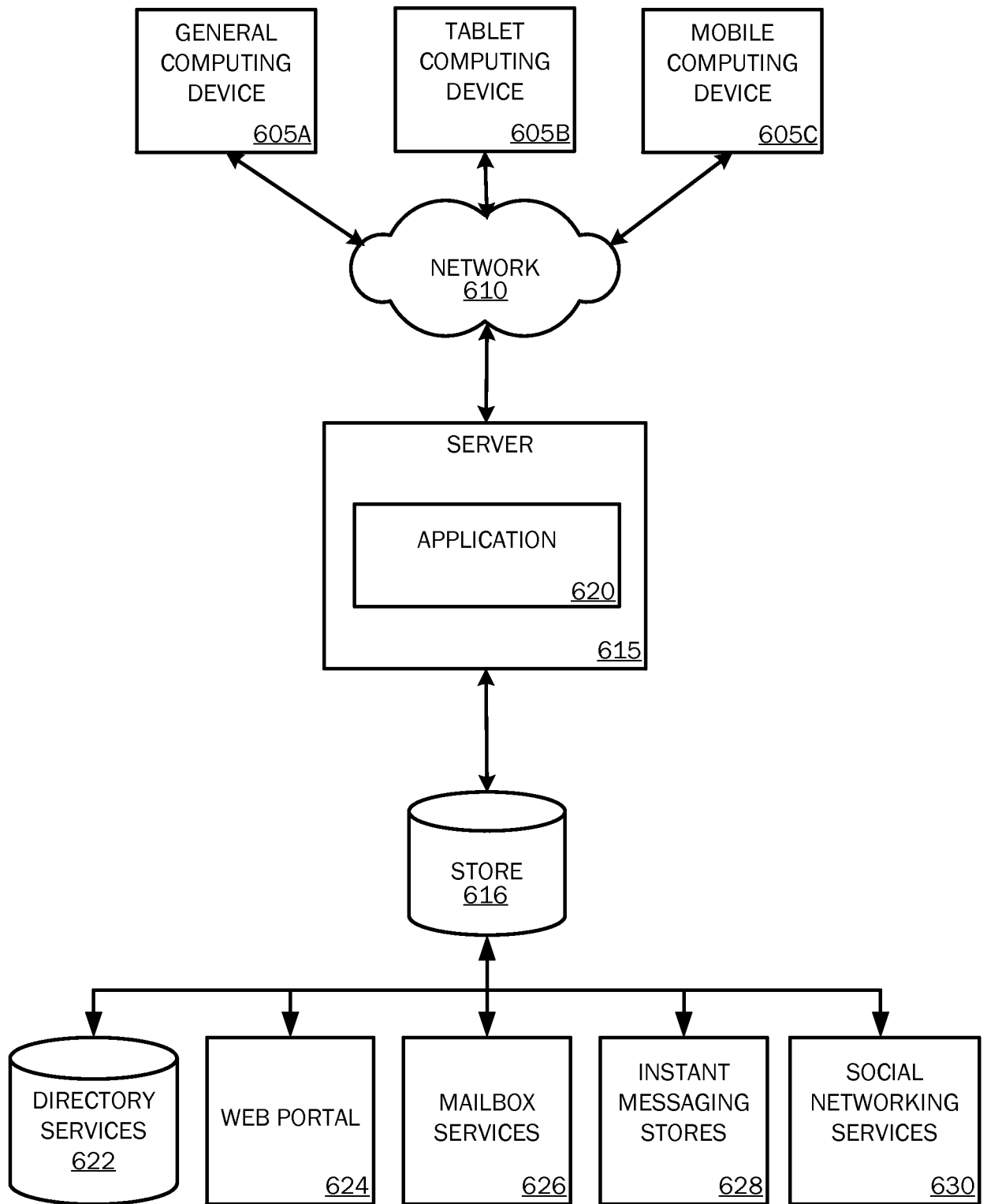

FIG. 6

INTERNATIONAL SEARCH REPORT

International application No
PCT/US2015/022612

A. CLASSIFICATION OF SUBJECT MATTER
INV. G06Q10/10
ADD.
According to International Patent Classification (IPC) or to both national classification and IPC

B. FIELDS SEARCHED
Minimum documentation searched (classification system followed by classification symbols)
G06Q
Documentation searched other than minimum documentation to the extent that such documents are included in the fields searched

Electronic data base consulted during the international search (name of data base and, where practicable, search terms used)
EPO-Internal, WPI Data

C. DOCUMENTS CONSIDERED TO BE RELEVANT

Category*	Citation of document, with indication, where appropriate, of the relevant passages	Relevant to claim No.
X	US 2011/276897 A1 (CREVIER DANIEL W [US] ET AL) 10 November 2011 (2011-11-10) paragraphs [0004], [0006], [0013] - [0014], [0016] - [0020], [0022], [0024] - [0025], [0027] - [0032] paragraphs [0033] - [0035], [0039] - [0040], [0042] - [0043], [0045] - [0047] claim 1 figures 1,2	1-15
X	US 2006/075046 A1 (YOZELL-EPSTEIN REBEKAH [US] ET AL) 6 April 2006 (2006-04-06) paragraphs [0019] - [0029], [0033] - [0038], [0042] - [0048] figure 2A	1-15
	----- -/--	

Further documents are listed in the continuation of Box C.

See patent family annex.

* Special categories of cited documents :

"A" document defining the general state of the art which is not considered to be of particular relevance

"E" earlier application or patent but published on or after the international filing date

"L" document which may throw doubts on priority claim(s) or which is cited to establish the publication date of another citation or other special reason (as specified)

"O" document referring to an oral disclosure, use, exhibition or other means

"P" document published prior to the international filing date but later than the priority date claimed

"T" later document published after the international filing date or priority date and not in conflict with the application but cited to understand the principle or theory underlying the invention

"X" document of particular relevance; the claimed invention cannot be considered novel or cannot be considered to involve an inventive step when the document is taken alone

"Y" document of particular relevance; the claimed invention cannot be considered to involve an inventive step when the document is combined with one or more other such documents, such combination being obvious to a person skilled in the art

"&" document member of the same patent family

Date of the actual completion of the international search 16 June 2015	Date of mailing of the international search report 29/06/2015
---	--

Name and mailing address of the ISA/ European Patent Office, P.B. 5818 Patentlaan 2 NL - 2280 HV Rijswijk Tel. (+31-70) 340-2040, Fax: (+31-70) 340-3016	Authorized officer Thareau-Berthet, N
--	--

INTERNATIONAL SEARCH REPORT

International application No
PCT/US2015/022612

C(Continuation). DOCUMENTS CONSIDERED TO BE RELEVANT		
Category*	Citation of document, with indication, where appropriate, of the relevant passages	Relevant to claim No.
X	US 2004/267871 A1 (PRATLEY CHRISTOPHER [US] ET AL) 30 December 2004 (2004-12-30) paragraphs [0007] - [0012], [0044] - [0045], [0048] - [0049], [0072] - [0075] figure 4 -----	1-15
X	US 2013/117376 A1 (FILMAN SARAH M [US] ET AL) 9 May 2013 (2013-05-09) paragraphs [0006] - [0008], [0020] - [0028], [0041] - [0044] figure 3 -----	1-15
X	US 8 108 464 B1 (ROCHELLE JONATHAN [US] ET AL) 31 January 2012 (2012-01-31) column 1, lines 27-63 column 2, lines 30-37 column 3, line 13 - column 5, line 53 column 6, line 21 - column 9, line 52 figures 2,4,9C -----	1-15

INTERNATIONAL SEARCH REPORT

Information on patent family members

International application No PCT/US2015/022612

Patent document cited in search report	Publication date	Patent family member(s)	Publication date	
US 2011276897	A1	10-11-2011	CN 102859513 A	02-01-2013
			EP 2567325 A2	13-03-2013
			US 2011276897 A1	10-11-2011
			WO 2011139802 A2	10-11-2011

US 2006075046	A1	06-04-2006	AU 2005203710 A1	13-04-2006
			BR PI0503556 A	10-07-2007
			CA 2517402 A1	30-03-2006
			EP 1643426 A2	05-04-2006
			JP 2006107490 A	20-04-2006
			JP 2012155755 A	16-08-2012
			KR 20060050409 A	19-05-2006
			MX PA05009272 A	18-04-2006
			US 2006075046 A1	06-04-2006
			US 2010095224 A1	15-04-2010

US 2004267871	A1	30-12-2004	AT 475150 T	15-08-2010
			CN 1577279 A	09-02-2005
			EP 1492041 A1	29-12-2004
			JP 4721663 B2	13-07-2011
			JP 2005018791 A	20-01-2005
			KR 20050002576 A	07-01-2005
			US 2004267871 A1	30-12-2004
			US 2010005398 A1	07-01-2010

US 2013117376	A1	09-05-2013	CN 103907110 A	02-07-2014
			EP 2776946 A1	17-09-2014
			JP 2014532950 A	08-12-2014
			KR 20140092831 A	24-07-2014
			US 2013117376 A1	09-05-2013
			WO 2013070684 A1	16-05-2013

US 8108464	B1	31-01-2012	US 8108464 B1	31-01-2012
			US 8291019 B1	16-10-2012
			US 8560613 B1	15-10-2013
			US 8990310 B1	24-03-2015
