



US00D842101S

(12) **United States Design Patent** (10) **Patent No.:** **US D842,101 S**  
**Breen et al.** (45) **Date of Patent:** **\*\* Mar. 5, 2019**

(54) **PACKAGE** 4,113,100 A \* 9/1978 Soja ..... B65D 5/5445  
229/112  
(71) Applicant: **Kimberly-Clark Worldwide, Inc.,** 4,252,236 A 2/1981 Roccaforte  
Neenah, WI (US) 4,778,057 A 10/1988 Allen et al.  
4,793,487 A 12/1988 Bentsen et al.  
4,883,675 A 11/1989 Wernz  
(72) Inventors: **Kathleen M. Breen**, Neenah, WI (US);  
**Shawn Michael Janes**, Neenah, WI  
(US); **Kindra K. Bolsinger**, Cincinnati,  
OH (US) (Continued)  
(73) Assignee: **Kimberly-Clark Worldwide, Inc.,**  
Neenah, WI (US)  
(\*\*) Term: **15 Years**  
(21) Appl. No.: **29/634,822**  
(22) Filed: **Jan. 25, 2018**

FOREIGN PATENT DOCUMENTS  
WO WO 2006/061839 A2 6/2006  
WO WO 2007/070998 A2 6/2007  
OTHER PUBLICATIONS  
Co-pending U.S. Appl. No. 29/634,821, filed Jan. 25, 2018, by  
Breen et al. for "Package."  
(Continued)

**Related U.S. Application Data**  
(62) Division of application No. 29/589,146, filed on Dec.  
28, 2016, now Pat. No. Des. 811,876.  
(51) **LOC (11) Cl.** ..... **09-03**  
(52) **U.S. Cl.**  
USPC ..... **D9/434**; D9/432  
(58) **Field of Classification Search**  
USPC ..... D9/414-423, 430-432, 433, 434, 456,  
D9/457, 711, 713, 721-722  
CPC ... B65D 5/00; B65D 5/02; B65D 5/18; B65D  
5/20  
See application file for complete search history.

*Primary Examiner* — Vy N Koenig  
(74) *Attorney, Agent, or Firm* — Kimberly-Clark  
Worldwide, Inc.

(56) **References Cited**  
U.S. PATENT DOCUMENTS  
2,967,610 A 1/1961 Ebert et al.  
3,090,483 A 5/1963 Altree et al.  
3,158,312 A 11/1964 Daniel  
3,215,332 A 11/1965 Bess  
3,860,304 A 1/1975 Bolton  
3,884,348 A \* 5/1975 Ross ..... B65D 5/48016  
206/746

(57) **CLAIM**  
The ornamental design for a package, as shown and  
described.

**DESCRIPTION**  
FIG. 1 is a perspective view of a package showing our new  
design;  
FIG. 2 is a front view of the package of FIG. 1;  
FIG. 3 is a back view of the package of FIG. 1;  
FIG. 4 is a first side view of the package of FIG. 1;  
FIG. 5 is a second side view of the package of FIG. 1;  
FIG. 6 is a top view of the package of FIG. 1; and,  
FIG. 7 is a bottom view of the package of FIG. 1.  
In the drawings, the evenly spaced broken lines represent  
environmental structure and form no part of the claimed  
design; the dash-dot-dot-dash broken lines represent bound-  
aries of the claimed design and form no part of the claimed  
design.

**1 Claim, 5 Drawing Sheets**

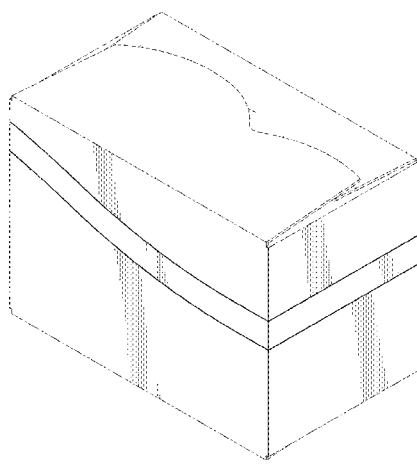

(56)

References Cited

U.S. PATENT DOCUMENTS

4,905,837 A \* 3/1990 Schuster ..... B65D 5/5475  
 229/120.011  
 4,964,526 A 10/1990 Stephens  
 5,318,223 A 6/1994 Gale  
 5,361,905 A 11/1994 McQueeney et al.  
 5,533,667 A 7/1996 Gale  
 6,799,695 B1 10/2004 Borrero  
 D567,080 S 4/2008 Bone et al.  
 7,373,765 B2 5/2008 Welchel et al.  
 7,377,384 B2 5/2008 Mitten et al.  
 D586,210 S 2/2009 Noschang et al.  
 D600,548 S 9/2009 Seol et al.  
 D603,700 S 11/2009 Paredes et al.  
 D614,025 S 4/2010 Paredes et al.  
 7,913,845 B2 3/2011 Velazquez et al.  
 7,958,994 B2 6/2011 Weinmann  
 D655,156 S 3/2012 Schrimpf et al.  
 D669,793 S \* 10/2012 Hynes ..... D9/434  
 D672,646 S 12/2012 Vanden Boom et al.  
 D677,580 S \* 3/2013 Powers ..... D9/434  
 D680,428 S 4/2013 Vanden Boom et al.  
 D685,262 S 7/2013 Hunter  
 D692,311 S 10/2013 Wilcoxon et al.  
 D693,681 S 11/2013 Allen et al.  
 D701,118 S 3/2014 Klopp et al.  
 D705,056 S 5/2014 Gagliardo et al.  
 D706,629 S 6/2014 Bartels et al.

D711,737 S 8/2014 Hara et al.  
 D712,736 S \* 9/2014 Hara ..... D9/432  
 D715,142 S 10/2014 Allen et al.  
 D732,952 S 6/2015 Ghini et al.  
 D752,439 S \* 3/2016 Abel ..... D9/499  
 D774,400 S \* 12/2016 Miyazaki ..... D9/434  
 D775,964 S \* 1/2017 Mochizuki ..... D9/432  
 D778,167 S \* 2/2017 Mochizuki ..... D9/432  
 D785,452 S 5/2017 Lee et al.  
 D800,573 S \* 10/2017 Mochizuki ..... D9/624  
 D811,876 S \* 3/2018 Breen ..... D9/432  
 D812,466 S \* 3/2018 Janes ..... D9/432  
 2003/0130632 A1 7/2003 Costea et al.  
 2008/0190791 A1 8/2008 Ghini et al.  
 2009/0108010 A1 4/2009 Ludden-Biegel  
 2011/0095021 A1 4/2011 Clough

OTHER PUBLICATIONS

Co-pending U.S. Appl. No. 29/634,823, filed Jan. 25, 2018, by Breen et al. for "Package."  
 Co-pending U.S. Appl. No. 29/634,826, filed Jan. 25, 2018, by Janes et al. for "Package."  
 Co-pending U.S. Appl. No. 29/634,831, filed Jan. 25, 2018, by Janes et al. for "Package."  
 Co-pending U.S. Appl. No. 29/634,838, filed Jan. 25, 2018, by Janes et al. for "Package."

\* cited by examiner

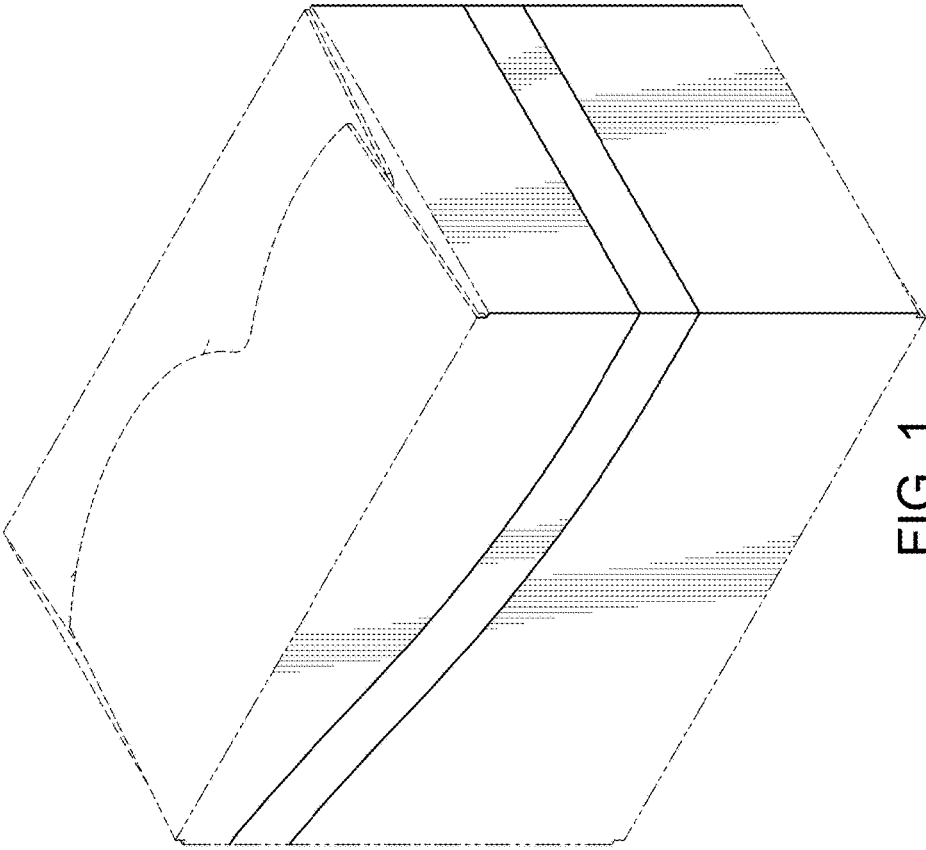

FIG. 1

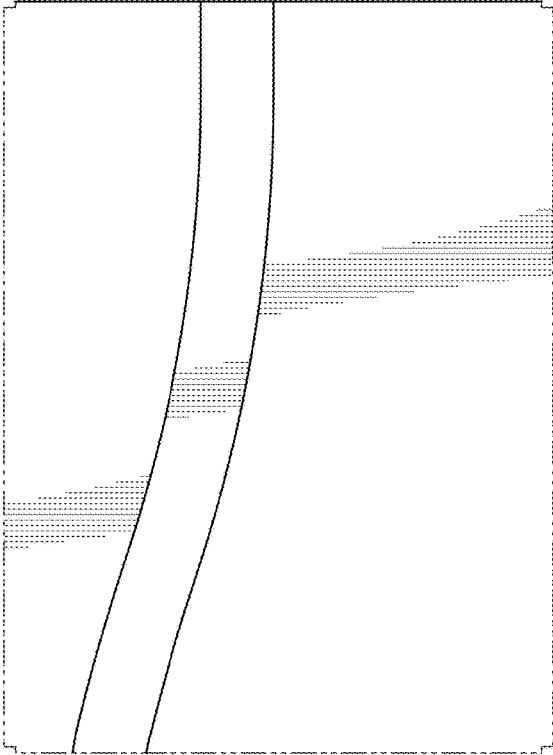

FIG. 2

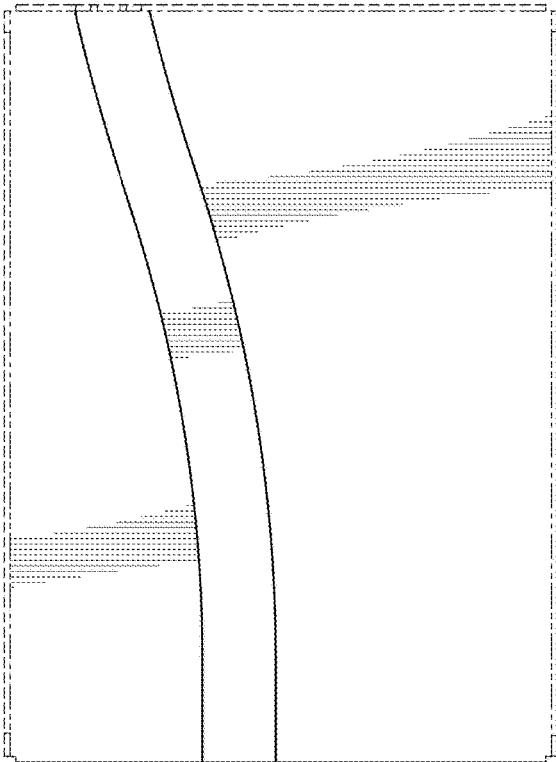

FIG. 3

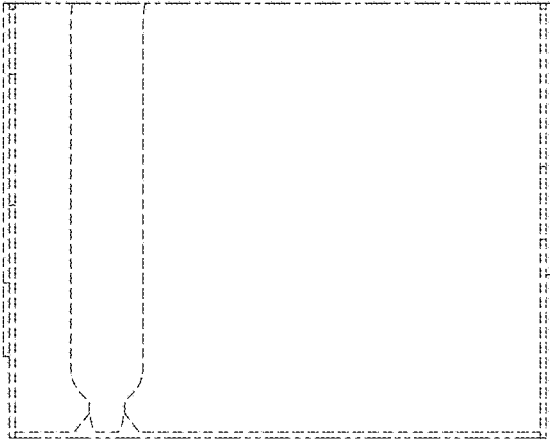

FIG. 5

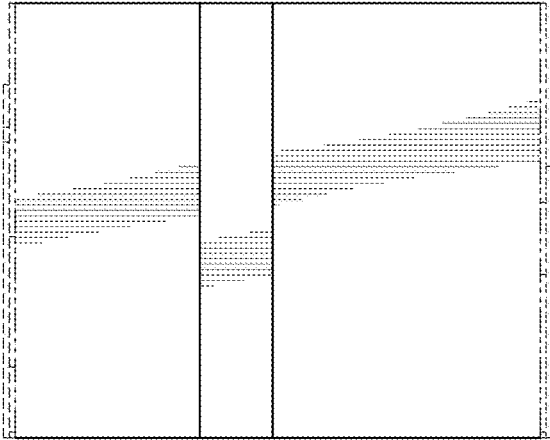

FIG. 4

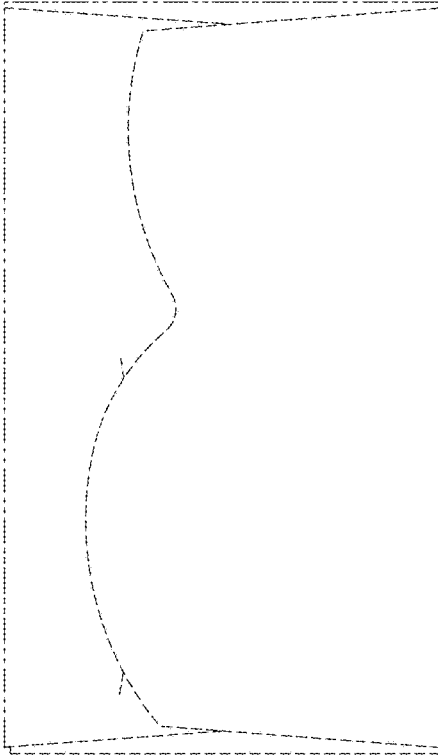

FIG. 6



FIG. 7