

United States Patent [19]

Bee et al.

[11] Des. 266,561

[45] ** Oct. 19, 1982

[54] TELEPHONE HANDSET

[75] Inventors: **James W. M. Bee**, Palo Alto, Calif.;
Peter D. H. Trussler, Ottawa,
Canada

[73] Assignee: **Northern Telecom Limited**, Montreal,
Canada

[**] Term: **14 Years**

[21] Appl. No.: **90,001**

[22] Filed: **Oct. 31, 1979**

[30] **Foreign Application Priority Data**

Oct. 4, 1979 [CA] Canada 04-10-79-1

[51] Int. Cl. **D14-03**

[52] U.S. Cl. **D14/63; D14/64**

[58] Field of Search **D14/53, 63, 64;**
179/100 D, 100 R, 156, 146, 178, 179

[56]

References Cited

U.S. PATENT DOCUMENTS

D. 210,668	4/1968	Janda	D14/63
D. 229,837	1/1974	Genaro et al.	D14/63
D. 245,602	8/1977	Genaro et al.	D14/63
D. 256,465	8/1980	Tyler	D14/63
D. 256,583	8/1980	Marshall	D14/64 X
3,558,831	8/1980	Prescott	179/100 R

Primary Examiner—Bernard Ansher

Attorney, Agent, or Firm—John E. Mowle

[57]

CLAIM

The ornamental design for a telephone handset, substantially as shown.

DESCRIPTION

FIG. 1 is a top perspective view of the telephone handset, showing my new design;
FIG. 2 is a top view thereof;
FIG. 3 is a view of one side that is also a mirror image of the other side;
FIG. 4 is a bottom plan view thereof;
FIG. 5 is a view of one end; and
FIG. 6 is a view of the other end thereof.

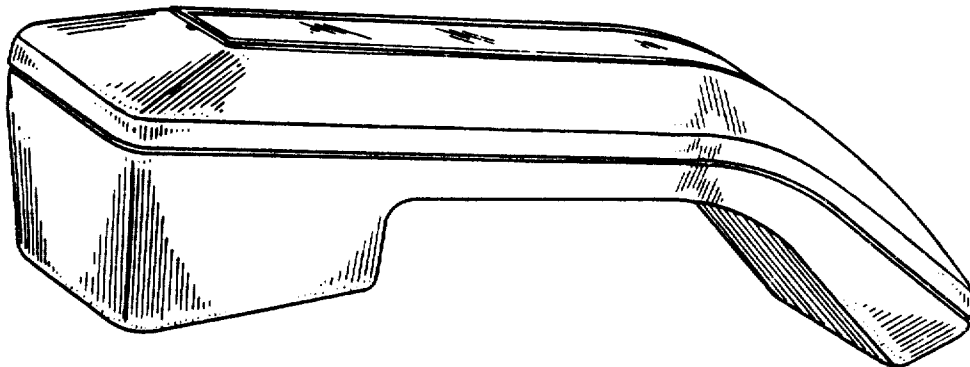

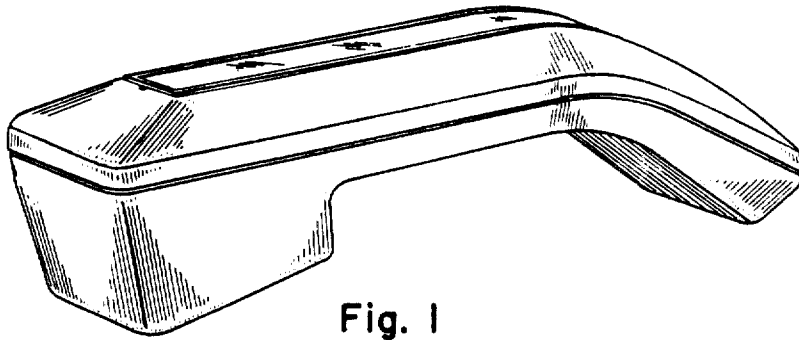

Fig. 1

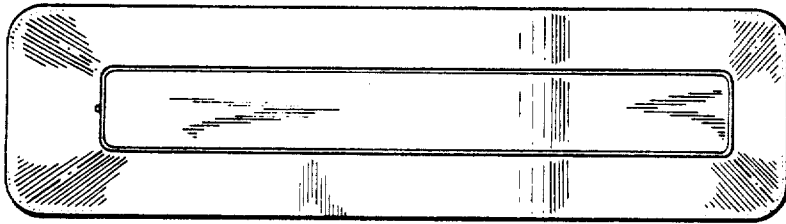

Fig. 2

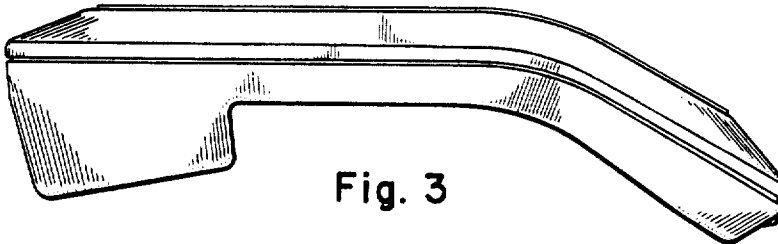

Fig. 3

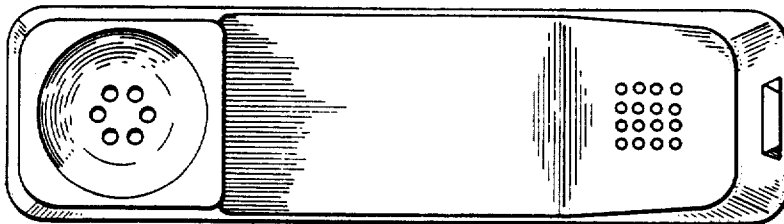

Fig. 4

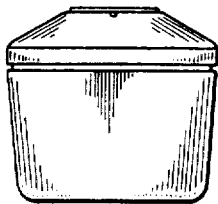

Fig. 5

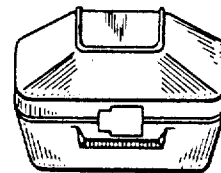

Fig. 6