



US00D656116S

(12) **United States Design Patent**
Kim et al.

(10) **Patent No.:** **US D656,116 S**

(45) **Date of Patent:** **** Mar. 20, 2012**

(54) **TELEVISION RECEIVER**

(75) Inventors: **Ji-Gwang Kim**, Seoul (KR); **Jun-Ho Yang**, Kyunggi-do (KR)

(73) Assignee: **Samsung Electronics Co., Ltd.**, Suwon, Kyunggi-Do (KR)

(**) Term: **14 Years**

(21) Appl. No.: **29/373,614**

(22) Filed: **May 3, 2011**

(30) **Foreign Application Priority Data**

Jan. 21, 2011 (KR) 30-2011-0002687

(51) **LOC (9) Cl.** **14-03**

(52) **U.S. Cl.** **D14/126**

(58) **Field of Classification Search** D14/125-134, D14/239, 371, 136, 374-377, 440, 450, 448, D14/336, 342; 312/7.2; 348/836, 838, 180, 348/184, 325, 739; 341/12; 248/917-924, 248/465; 345/104, 133, 156, 168, 87, 173; 720/605, 669, 600, 655; 369/99, 197; D21/329, D21/515, 577, 622, 333, 433, 448, 452, 450, D21/331; D6/477, 479, 300; 273/148 B; 446/484, 175, 356; D10/15, 26

See application file for complete search history.

(56) **References Cited**

U.S. PATENT DOCUMENTS

D494,941 S	8/2004	Kim
D499,386 S	12/2004	Yang
D512,424 S	12/2005	Kim
D521,511 S	5/2006	Kim et al.
D521,996 S	5/2006	Kim et al.
D521,997 S	5/2006	Park et al.
D522,509 S	6/2006	Park et al.
D524,313 S	7/2006	Boo et al.
D527,003 S	8/2006	Kim et al.
D528,115 S	9/2006	Yoon
D528,116 S	9/2006	Won et al.
D529,910 S	10/2006	Ota

D532,764 S	11/2006	Kim et al.
D533,848 S	12/2006	Lee et al.
D534,510 S	1/2007	Kang et al.
D534,883 S	1/2007	Kang et al.
D535,267 S	1/2007	Kang et al.
D536,677 S	2/2007	Kim et al.
D537,079 S	2/2007	Park
D539,242 S	3/2007	Lee et al.
D539,281 S	3/2007	Kim et al.
D539,767 S	4/2007	Kang et al.
D540,277 S	4/2007	Kim et al.
D541,236 S	4/2007	Kim et al.
D541,763 S	5/2007	Kim
D542,746 S	5/2007	Kim
D542,747 S	5/2007	Kim et al.
D542,748 S	5/2007	Kim et al.
D542,749 S	5/2007	Kim et al.
D543,163 S	5/2007	Yang et al.
D543,164 S	5/2007	Yang et al.

(Continued)

OTHER PUBLICATIONS

U.S. Appl. No. 29/308,894, Applicant: Eui-Seok Kim, et al., filed Jul. 14, 2008 entitled LCD Monitor.

(Continued)

Primary Examiner — Raphael Barkai
(74) *Attorney, Agent, or Firm* — Flynn, Thiel, Boutell & Tanis, P.C.

(57) **CLAIM**

The ornamental design for a television receiver, as shown and described.

DESCRIPTION

FIG. 1 is a top front perspective view of a television receiver showing our new design;
FIG. 2 is a front elevational view thereof;
FIG. 3 is a rear elevational view thereof;
FIG. 4 is a left side elevational view thereof;
FIG. 5 is a right side elevational view thereof;
FIG. 6 is a top plan view thereof; and,
FIG. 7 is a bottom plan view thereof.

1 Claim, 4 Drawing Sheets

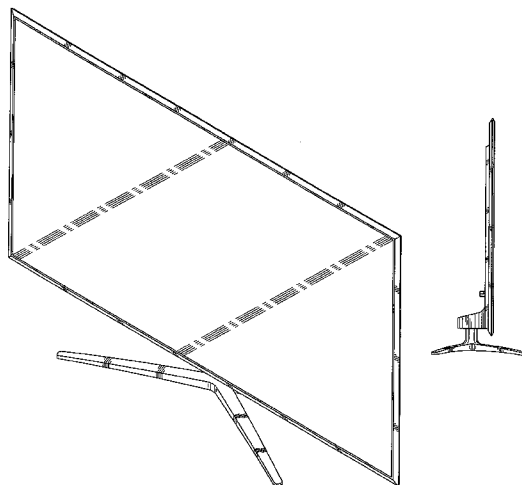

U.S. PATENT DOCUMENTS

D544,849 S 6/2007 Yang et al.
 D545,312 S 6/2007 Kim
 D545,313 S 6/2007 Kim
 D545,314 S 6/2007 Kim
 D545,315 S 6/2007 Kim
 D545,316 S 6/2007 Kim
 D545,776 S 7/2007 Kwon
 D545,820 S 7/2007 Won et al.
 D546,331 S 7/2007 Kim
 D547,276 S 7/2007 Yang et al.
 D547,313 S 7/2007 Kim
 D548,205 S 8/2007 Kim et al.
 D548,206 S 8/2007 Han
 D548,708 S 8/2007 Park et al.
 D551,186 S 9/2007 Yang et al.
 D551,194 S 9/2007 Kim et al.
 D551,636 S 9/2007 Kang et al.
 D553,108 S 10/2007 Won et al.
 D554,601 S 11/2007 Won et al.
 D556,159 S 11/2007 Park et al.
 D556,160 S 11/2007 Lee et al.
 D556,709 S 12/2007 Kim et al.
 D556,755 S 12/2007 Lee et al.
 D556,756 S 12/2007 Kataoka et al.
 D556,757 S 12/2007 Kim et al.
 D558,201 S 12/2007 Park et al.
 D558,696 S 1/2008 Park et al.
 D561,130 S 2/2008 Won et al.
 D561,134 S 2/2008 Kim et al.
 D561,135 S 2/2008 Won et al.
 D561,136 S 2/2008 Won et al.
 D564,472 S 3/2008 Won et al.
 D565,521 S 4/2008 Yang et al.
 D567,198 S 4/2008 Yang et al.
 D567,199 S 4/2008 Kim et al.
 D569,818 S 5/2008 Kim et al.
 D570,841 S 6/2008 Kim et al.
 D572,680 S 7/2008 Lee et al.
 D572,682 S 7/2008 Won et al.
 D573,118 S 7/2008 Yang et al.
 D573,559 S 7/2008 Kim et al.
 D575,247 S 8/2008 Lee
 D576,622 S 9/2008 Park
 D579,889 S 11/2008 Noh
 D582,365 S 12/2008 Yang et al.
 D582,366 S 12/2008 Yang et al.
 D582,867 S 12/2008 Song et al.
 D584,258 S 1/2009 Yang et al.
 D584,309 S 1/2009 Kim et al.
 D584,310 S 1/2009 Kim et al.
 D584,729 S 1/2009 Kim et al.
 D586,811 S 2/2009 Kim et al.
 D587,712 S 3/2009 Park et al.
 D592,621 S 5/2009 Han et al.
 D593,974 S 6/2009 Yang et al.
 D596,596 S * 7/2009 Honda D14/126
 D597,041 S 7/2009 Cho et al.
 D597,977 S 8/2009 Won et al.
 D597,978 S 8/2009 Won et al.
 D601,104 S 9/2009 Kim
 D603,816 S 11/2009 Kim et al.
 D603,817 S 11/2009 Kim et al.
 D605,148 S 12/2009 Boo et al.
 D605,149 S 12/2009 Kim et al.
 D605,150 S 12/2009 Kim
 D607,426 S 1/2010 Yang
 D608,311 S 1/2010 Lee et al.
 D608,314 S 1/2010 Boo et al.
 D609,658 S 2/2010 Kim et al.
 D610,143 S 2/2010 Park et al.
 D614,596 S 4/2010 Won et al.
 D615,509 S 5/2010 Song et al.

D615,510 S 5/2010 Won et al.
 D615,511 S 5/2010 Shin et al.
 D615,938 S 5/2010 Song et al.
 D616,842 S 6/2010 Kim
 D616,884 S 6/2010 Kim et al.
 D618,640 S * 6/2010 Won et al. D14/126
 D619,979 S 7/2010 Lee et al.
 D620,461 S 7/2010 Han et al.
 D620,901 S 8/2010 Won et al.
 D620,902 S 8/2010 Kim et al.
 D620,903 S 8/2010 Song et al.
 D622,235 S 8/2010 Lee et al.
 D623,620 S * 9/2010 Kim et al. D14/126
 D624,035 S 9/2010 Lee et al.
 D624,036 S 9/2010 Lee et al.
 D624,512 S * 9/2010 Kim et al. D14/126
 D625,278 S 10/2010 Kim et al.
 D626,101 S 10/2010 Kim et al.
 D630,209 S 1/2011 Lee et al.
 D631,023 S * 1/2011 Kim et al. D14/126
 D632,291 S 2/2011 Park
 D634,323 S 3/2011 Park et al.
 D634,324 S 3/2011 Park et al.
 D634,722 S 3/2011 Kim et al.
 D634,745 S 3/2011 Park et al.
 D635,569 S 4/2011 Park
 D635,943 S * 4/2011 Kim et al. D14/126
 D635,975 S 4/2011 Seo et al.
 D635,976 S 4/2011 Lee et al.
 D637,567 S 5/2011 Kim et al.
 D639,759 S 6/2011 Shin et al.
 D642,147 S * 7/2011 Won et al. D14/126
 D643,002 S * 8/2011 Choi et al. D14/126
 D648,294 S * 11/2011 Kim et al. D14/126

OTHER PUBLICATIONS

U.S. Appl. No. 29/372,111, Applicant: Jae-Seung Song, et al., filed Oct. 15, 2010 entitled LED Monitor with TV Receiver.
 U.S. Appl. No. 29/373,058, Applicant: Jung-Hyun Lee, et al., filed Feb. 23, 2011 entitled LED Television Receiver.
 U.S. Appl. No. 29/373,050, Applicant: Jung-Hyun Lee, et al., filed Feb. 23, 2011 entitled LED Television Receiver.
 U.S. Appl. No. 29/373,051, Applicant: Kyu-Mi Han, et al., filed Feb. 23, 2011 entitled LED Television Receiver.
 U.S. Appl. No. 29/373,292, Applicant: Min-Hyoung Boo et al., filed Mar. 25, 2011 entitled Television Receiver.
 U.S. Appl. No. 29/343,461, Applicant: Sung-Jin Ann, et al., filed Apr. 12, 2011 entitled Television Receiver.
 U.S. Appl. No. 29/373,607, Applicant: Gyoo-Sang Choi, et al., filed May 3, 2011 entitled Television Receiver.
 U.S. Appl. No. 29/373,608, Applicant: Kimg-Hyun Lee, et al., filed May 3, 2011 entitled Television Receiver.
 U.S. Appl. No. 29/373,609, Applicant: Jin-Su Park, et al., filed May 3, 2011 entitled Television Receiver.
 U.S. Appl. No. 29/373,610, Applicant: Ok-Keun Lee, et al., filed May 3, 2011 entitled Television Receiver.
 U.S. Appl. No. 29/373,611, Applicant: Sung-Jin Ann, et al., filed May 3, 2011 entitled Television Receiver.
 U.S. Appl. No. 29/373,612, Applicant: Kyu-Mi Han, et al., filed May 3, 2011 entitled Television Receiver.
 U.S. Appl. No. 29/373,613, Applicant: Ji-Gwang Kim, et al., filed May 3, 2011 entitled Television Receiver.
 U.S. Appl. No. 29/373,615, Applicant: Ok-Keun Lee, et al., filed May 3, 2011 entitled Television Receiver.
 U.S. Appl. No. 29/373,616, Applicant: Bong-Kun Shin, et al., filed May 3, 2011 entitled Television Receiver.
 U.S. Appl. No. 29/373,618, Applicant: Ji-Gwang Kim, et al., filed May 3, 2011 entitled Television Receiver.

* cited by examiner

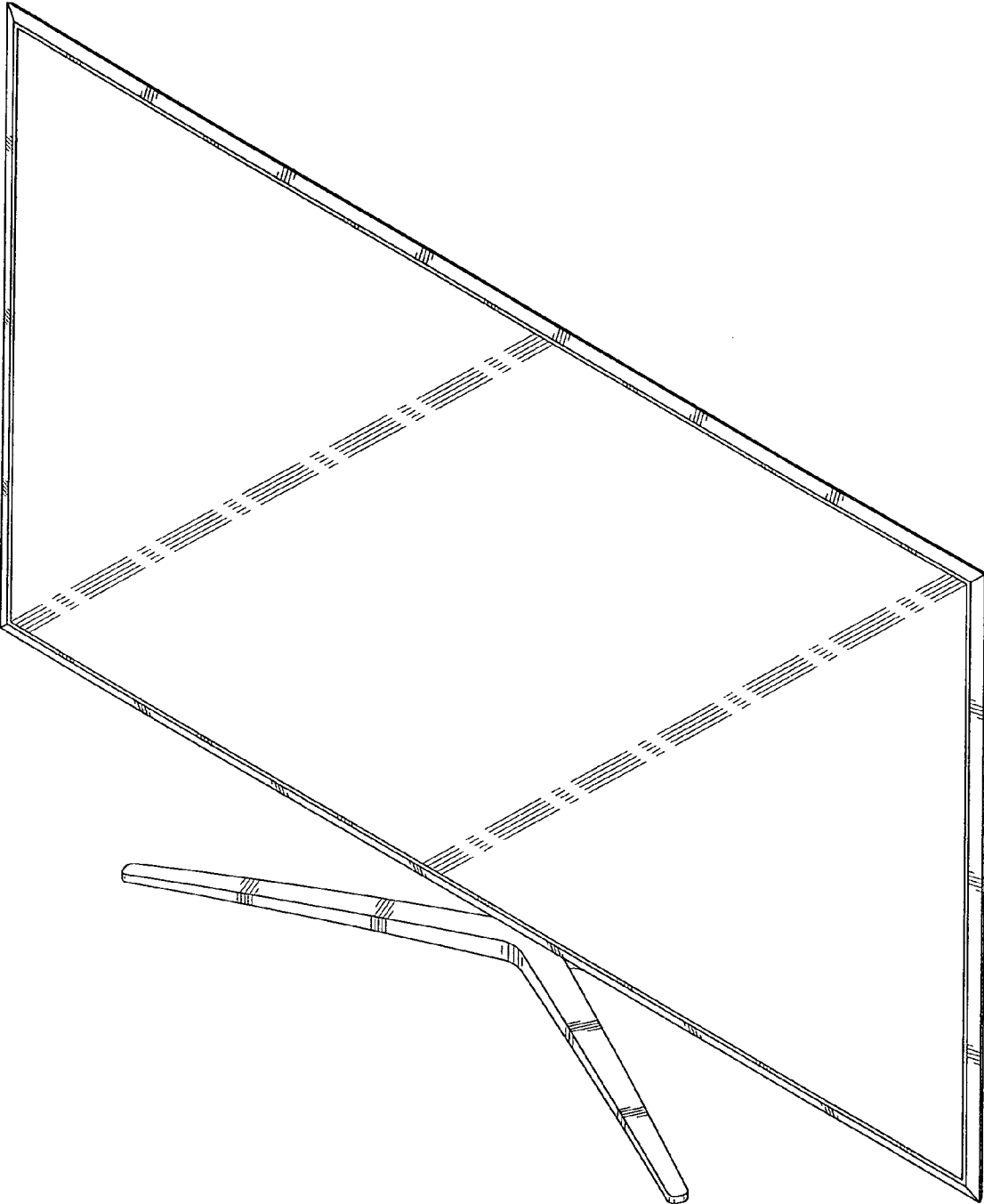

FIG.1

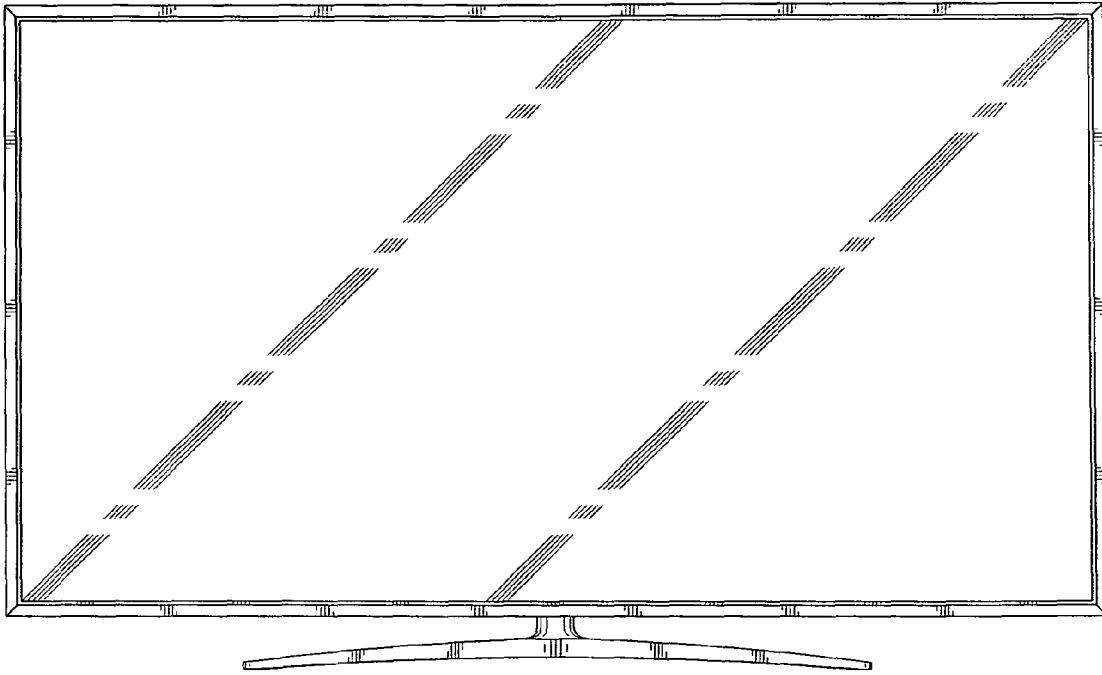

FIG. 2

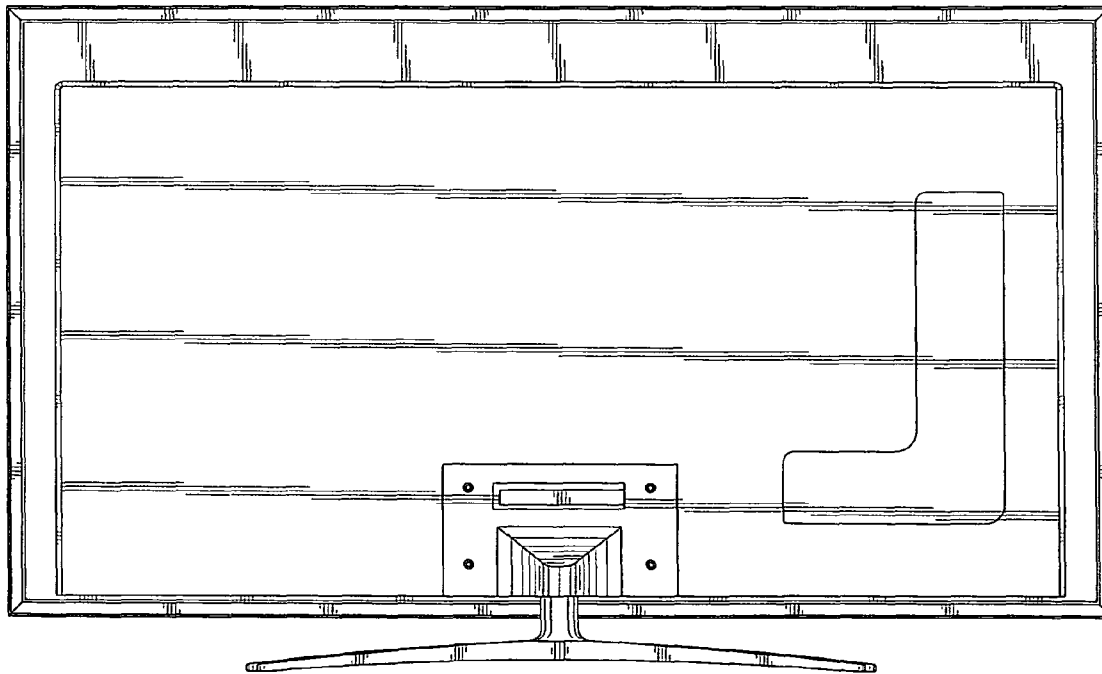

FIG. 3

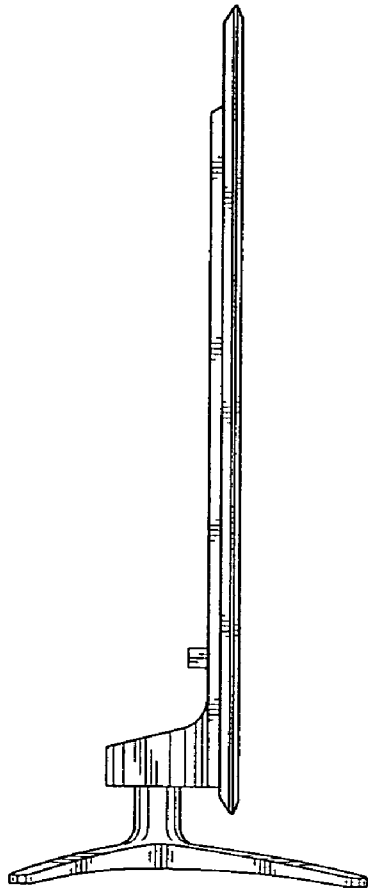

FIG. 4

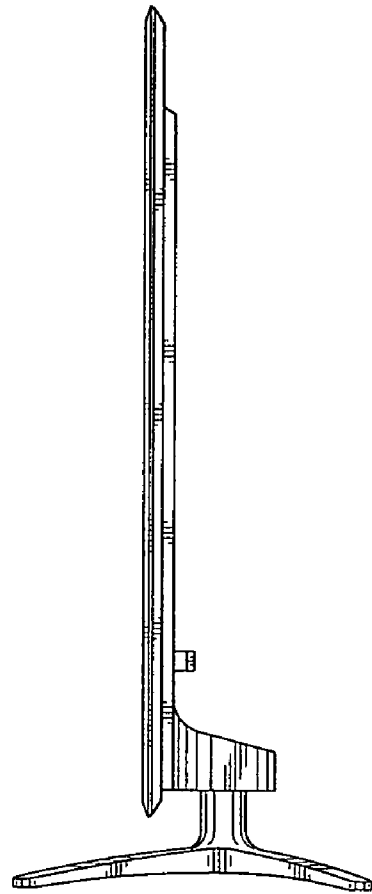

FIG. 5

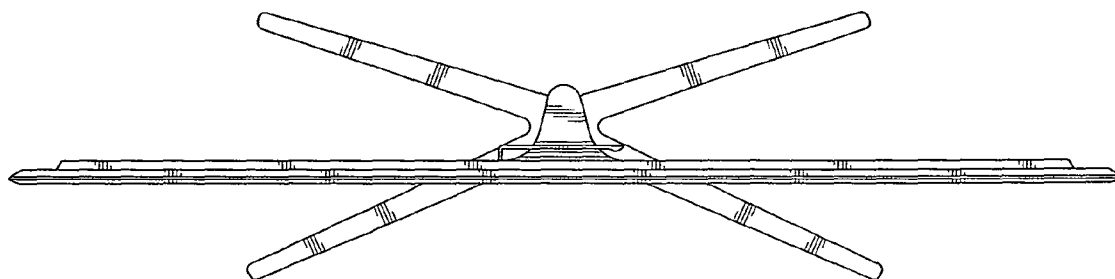

FIG. 6

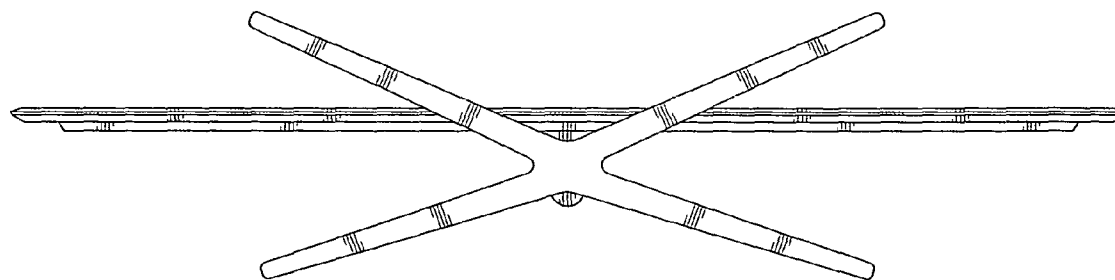

FIG. 7