



US00D666556S

(12) **United States Design Patent**
Byrne

(10) **Patent No.:** **US D666,556 S**

(45) **Date of Patent:** **** Sep. 4, 2012**

(54) **POWER AND DATA CENTER**

(76) Inventor: **Norman R. Byrne, Ada, MI (US)**

(**) Term: **14 Years**

(21) Appl. No.: **29/407,333**

(22) Filed: **Nov. 28, 2011**

Related U.S. Application Data

(63) Continuation-in-part of application No. 29/343,190, filed on Sep. 9, 2009, now Pat. No. Des. 649,514.

(51) **LOC (9) Cl.** **13-03**

(52) **U.S. Cl.** **D13/139.4**

(58) **Field of Classification Search** D13/139.1, D13/139.2, 139.3, 139.4, 139.5, 139.6, 139.7, D13/139.8, 138.1, 138.2, 123, 133, 137.1, D13/137.2, 184, 137.3, 137.4, 124, 160, 162, D13/164, 178, 154, 156, 107, 110, 145, 177; D14/433, 256; D8/350, 353; 174/53, 55, 174/56, 59, 66, 494, 153 G, 152 G, 154, 167, 174/168, 650, 656; 439/101, 105, 43, 53, 439/374, 894, 46, 55, 63, 92, 93, 95, 102, 439/106, 107, 108, 135, 149, 222, 266, 285, 439/291, 300, 344, 373, 535, 620.21, 638, 439/660, 907, 650, 651, 652, 653, 654; 361/42
See application file for complete search history.

(56) **References Cited**

U.S. PATENT DOCUMENTS

D353,363	S	12/1994	Toby	
5,575,668	A *	11/1996	Timmerman	439/131
D392,254	S	3/1998	Gevaert	
D407,374	S *	3/1999	Byrne	D13/139.4
5,980,279	A *	11/1999	Muller	439/142
D420,327	S *	2/2000	Byrne	D13/139.4
6,028,267	A	2/2000	Byrne	
D437,827	S *	2/2001	Gershfeld	D13/139.4
6,290,518	B1	9/2001	Byrne	
D455,123	S	4/2002	Gershfeld	
D455,716	S	4/2002	Gershfeld	

D457,137	S	5/2002	Gershfeld	
D472,213	S	3/2003	Byrne	
6,923,663	B2	8/2005	Oddsden	
7,045,706	B1	5/2006	Lincoln	
D526,961	S *	8/2006	Kissinger et al.	D13/139.4
D535,257	S	1/2007	Byrne	
D556,139	S	11/2007	Gershfeld	
D597,960	S *	8/2009	Dinh et al.	D13/152
7,736,178	B2 *	6/2010	Byrne	439/574
D622,219	S *	8/2010	Byrne	D13/147
D626,070	S *	10/2010	Byrne	D13/139.4
D639,244	S *	6/2011	Byrne	D13/139.4
7,989,738	B2 *	8/2011	Byrne	219/452.11
D649,514	S *	11/2011	Byrne	D13/139.4
2004/0147147	A1	7/2004	Griepentrog	
2004/0238197	A1	12/2004	Gates, II	

* cited by examiner

Primary Examiner — Angela J Lee

(74) *Attorney, Agent, or Firm* — Varnum, Riddering, Schmidt & Howlett LLP

(57) **CLAIM**

I claim, the ornamental power and data center, as shown and described.

DESCRIPTION

FIG. 1 is a rearview of my power and data center in accordance with my invention;
FIG. 2 is a top plan view thereof;
FIG. 3 is a left-side elevation view thereof;
FIG. 4 is a front elevation view thereof;
FIG. 5 is a right-side view thereof;
FIG. 6 is an underside view thereof;
FIG. 7 is a perspective view thereof, showing my power and data center in open configuration; and,
FIG. 8 is a further perspective view thereof, showing my power and data center in a closed configuration.
The broken lines shown in the drawings represent portions of the power and data center that form no part of the claimed design.

1 Claim, 2 Drawing Sheets

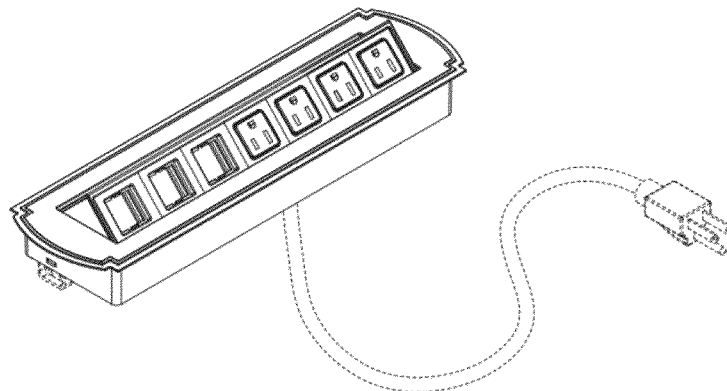

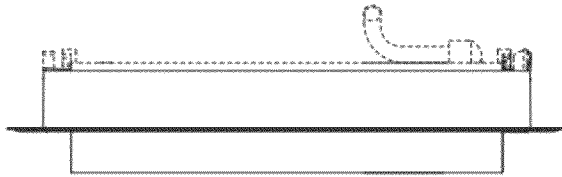

Fig. 1

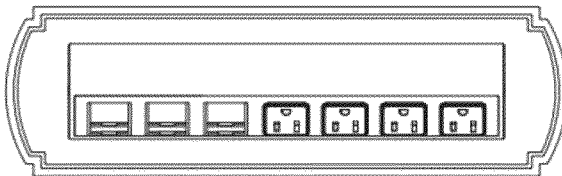

Fig. 2

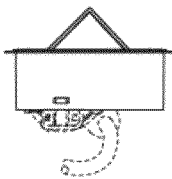

Fig. 3

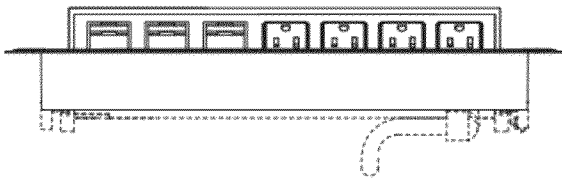

Fig. 4

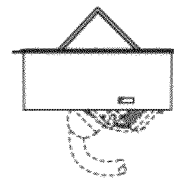

Fig. 5

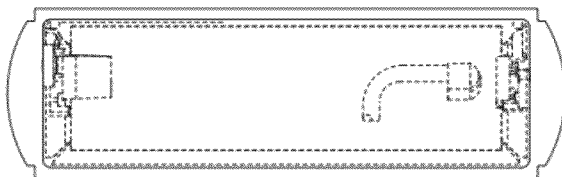

Fig. 6

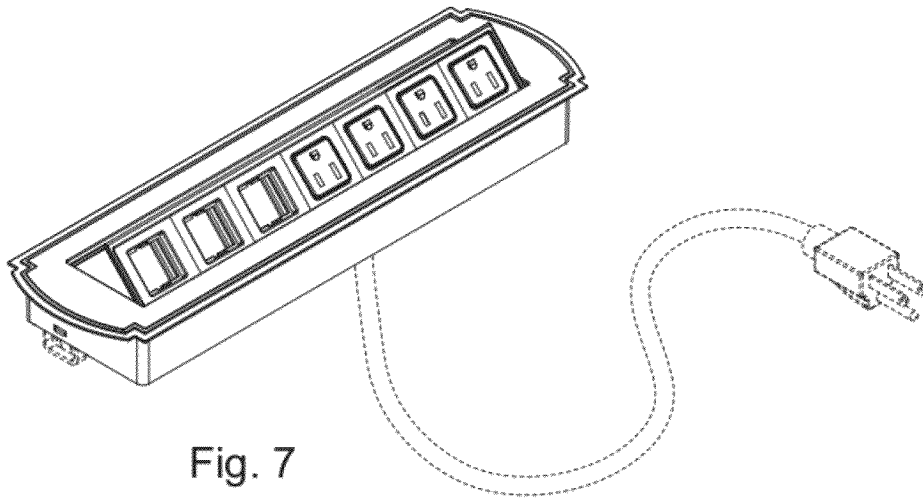

Fig. 7

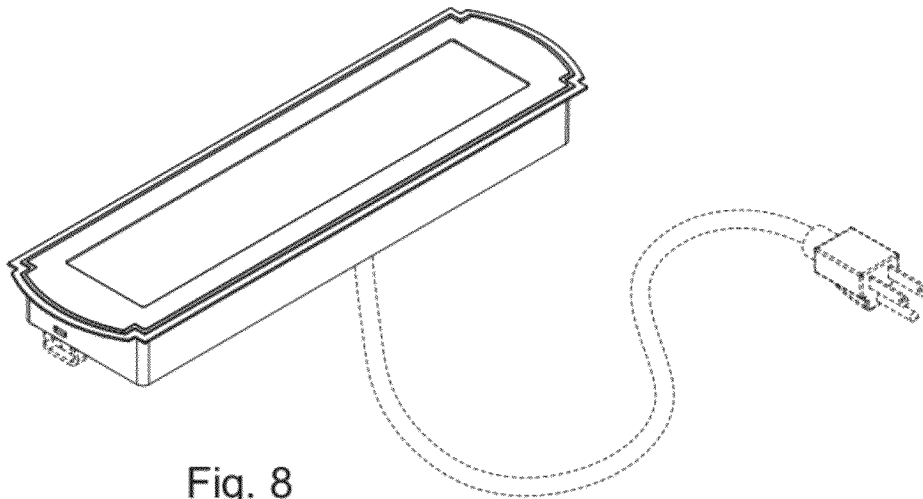

Fig. 8