



US00D910120S

(12) **United States Design Patent** (10) **Patent No.:** **US D910,120 S**  
**DeMarco et al.** (45) **Date of Patent:** **\*\* \*Feb. 9, 2021**

(54) **GAMING MACHINE**

(56) **References Cited**

(71) Applicant: **ARISTOCRAT TECHNOLOGIES AUSTRALIA PTY LIMITED**, North Ryde (AU)

U.S. PATENT DOCUMENTS

(72) Inventors: **Dominic J. DeMarco**, Round Rock, TX (US); **Bruce Edward Urban**, Las Vegas, NV (US); **James Franklin Stair**, Las Vegas, NV (US); **Ariel David Turgel**, San Francisco, CA (US); **Daniel Harden**, Palo Alto, CA (US); **Alexander Abele**, Aalen (DE)

D415,124	S	*	10/1999	Rooyakkers	.....	D14/306
D428,864	S	*	8/2000	Rooyakkers	.....	D14/306
D464,377	S		10/2002	Wurz		
D479,243	S		9/2003	Ohashi		
D508,719	S	*	8/2005	de Haas	.....	D21/325
D513,044	S	*	12/2005	Morrison	.....	D21/370
6,997,810	B2		2/2006	Cole		
D531,677	S		11/2006	Mallory		
D546,893	S	*	7/2007	Yamashita	.....	D21/325
D560,724	S		1/2008	Johnson		
D560,725	S		1/2008	Johnson		
D562,338	S		2/2008	Keohane		
D572,314	S		7/2008	Vallejo		
D579,456	S		10/2008	Chen		
D587,319	S		2/2009	Moises Deiab		
D599,858	S		9/2009	Lesley		
D599,859	S		9/2009	Lesley		
D604,773	S	*	11/2009	De Viveiros Ortiz	.....	D21/325
D612,432	S	*	3/2010	De Viveiros Ortiz	.....	D21/325
D613,802	S		4/2010	Meyers		
D619,177	S	*	7/2010	Lee	.....	D21/325
D622,781	S		8/2010	Lesley		
D626,182	S		10/2010	Cole		
D628,208	S		11/2010	Potemski		
D646,337	S		10/2011	Kelly		
D652,454	S		1/2012	Yepez		
D666,625	S		9/2012	Gilmore		
D668,261	S		10/2012	Arnold		
D673,620	S		1/2013	Johnson		
D673,621	S		1/2013	Johnson		
D677,736	S		3/2013	Dorn		
D678,956	S		3/2013	Lesley		
D679,722	S		4/2013	Ray		
D685,033	S		6/2013	Wudtke		
D689,899	S		9/2013	Lee		
D691,665	S		10/2013	Chudek		
D693,841	S		11/2013	Velasco		
D695,733	S	*	12/2013	Damhuis	.....	D14/307
D697,558	S		1/2014	Myers		
D704,273	S		5/2014	Chudek		
D706,741	S		6/2014	Myers		
D707,646	S		6/2014	Kim		
D713,841	S		9/2014	Lim		
8,832,598	B2		9/2014	Hirata		
D719,616	S		12/2014	Inoue		
D723,626	S		3/2015	Vasquez		
D727,431	S		4/2015	Themann		
D728,585	S		5/2015	Lee		
D730,993	S		6/2015	Castro		

(73) Assignee: **Aristocrat Technologies Australia Pty Ltd.**, North Ryde (AU)

(\* ) Notice: This patent is subject to a terminal disclaimer.

(\*\*) Term: **15 Years**

(21) Appl. No.: **29/684,942**

(22) Filed: **Mar. 25, 2019**

(51) **LOC (13) Cl.** ..... **21-03**

(52) **U.S. Cl.**  
USPC ..... **D21/369**

(58) **Field of Classification Search**  
USPC ..... D21/369, 370, 371, 385, 329, 325, 394;  
D14/307, 172, 129, 325, 401, 371, 126,  
D14/439, 432, 450, 128, 375, 248, 374,  
D14/341, 138 G, 127; 463/28, 13, 11,  
463/16, 20, 25, 31, 46, 23, 30, 17, 36, 29,  
463/42, 34, 32, 35, 19, 21, 22; 273/292,  
273/203, 138.2, 143 R, 142 R, 138.1;  
D19/60; D16/226; D8/335, 331, 334;  
D26/141; D7/641  
CPC ..... G07F 17/32; G07F 17/34; G07F 17/3211;  
G07F 17/3244; G07F 17/3267  
See application file for complete search history.

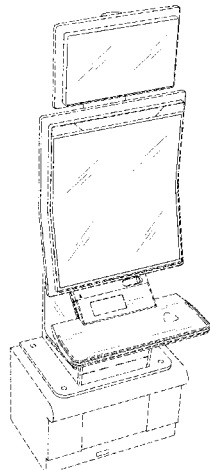

US D910,120 S

D732,520 S 6/2015 Themann  
D734,733 S 7/2015 Park  
D736,171 S 8/2015 Lee  
D740,887 S 10/2015 Randazzo  
D740,888 S 10/2015 Depalma  
D742,974 S 11/2015 Lesley  
D749,342 S 2/2016 Escandon  
D759,096 S 6/2016 Seo  
D760,275 S 6/2016 Zhang  
D765,136 S 8/2016 Lee  
RE46,169 E 10/2016 Kelly  
D772,240 S 11/2016 Edstrom  
D772,273 S 11/2016 Spector  
D773,512 S 12/2016 Miura  
D780,852 S \* 3/2017 Sharp ..... D21/329  
D785,664 S 5/2017 Yao  
D790,563 S 6/2017 Lam  
9,679,435 B2 \* 6/2017 Schrementi ..... G07F 17/3213  
9,704,337 B2 7/2017 Riggs  
D794,661 S 8/2017 Nishizawa  
D794,664 S 8/2017 Okabe  
D801,435 S \* 10/2017 Themann ..... D21/369  
D803,323 S \* 11/2017 Bussey ..... D21/369  
D803,324 S 11/2017 Bussey  
D809,068 S \* 1/2018 Ballman ..... D21/369  
D809,069 S \* 1/2018 Ballman ..... D21/369  
D812,146 S 3/2018 Castro  
D812,147 S 3/2018 Castro  
D812,148 S 3/2018 Castro  
D812,149 S 3/2018 Castro  
D814,455 S 4/2018 Kwon  
D816,079 S 4/2018 Yamazaki  
D818,048 S 5/2018 Calhoun  
D819,747 S 6/2018 Castro  
D820,915 S 6/2018 Lee  
D826,338 S 8/2018 Bussey  
D832,356 S 10/2018 Castro  
D833,534 S \* 11/2018 Lee ..... D21/369  
D834,652 S 11/2018 Lee  
10,127,761 B2 11/2018 Woels  
10,181,236 B2 1/2019 Goldstein  
D843,458 S 3/2019 Castro  
D843,467 S 3/2019 Johnson  
D843,468 S 3/2019 Johnson  
D843,473 S 3/2019 Zedell, Jr.  
D843,474 S 3/2019 Lesley  
D843,475 S 3/2019 Lesley  
D843,476 S 3/2019 Lesley  
D843,477 S 3/2019 Lesley  
D843,478 S 3/2019 Lesley  
D843,479 S 3/2019 Castro  
D843,480 S 3/2019 Castro  
D843,482 S 3/2019 Holland  
D844,062 S 3/2019 Lesley  
D846,650 S 4/2019 Stair  
D847,905 S 5/2019 Lewis  
D849,149 S 5/2019 Bussey  
D849,150 S 5/2019 Gallagher  
D850,536 S 6/2019 Stair  
D850,537 S 6/2019 Urban  
D854,621 S 7/2019 Calhoun  
D858,641 S 9/2019 Legras  
D858,642 S 9/2019 Legras  
D859,347 S 9/2019 Kwon  
D862,602 S 10/2019 Kariya  
D865,066 S \* 10/2019 Ortiz De Viveiros ..... D21/369  
D865,873 S \* 11/2019 Lewis ..... D21/369  
D866,666 S 11/2019 Ditton  
D866,667 S 11/2019 Stair  
D866,668 S 11/2019 Ditton  
D868,165 S \* 11/2019 Ortiz De Viveiros ..... D21/369  
D870,818 S \* 12/2019 Curbbun ..... D21/369  
D870,820 S 12/2019 Urban  
D871,506 S 12/2019 Castro  
D871,507 S 12/2019 Urban  
D872,190 S \* 1/2020 Zedell, Jr. .... D21/369  
D875,091 S 2/2020 Kwon  
10,580,252 B2 3/2020 Whelan  
D880,605 S 4/2020 Bussey

D880,606 S 4/2020 Glenn, II  
D880,608 S 4/2020 Glenn, II  
D880,610 S 4/2020 Glenn, II  
D880,611 S 4/2020 Glenn, II  
D880,612 S 4/2020 Bernard  
D880,613 S 4/2020 Bernard  
D880,614 S 4/2020 Bernard  
D880,615 S 4/2020 Bernard  
D881,284 S 4/2020 Glenn  
D881,285 S 4/2020 Glenn  
D882,697 S 4/2020 Lesley  
2013/0084948 A1 4/2013 Watkins  
2014/0335934 A1 11/2014 Meyer  
2015/0018070 A1 1/2015 Meyer  
2015/0036073 A1 2/2015 Im  
2016/0093143 A1 3/2016 Lamb  
2016/0195938 A1 7/2016 Kim  
2017/0039802 A1 2/2017 Prabhu  
2017/0046906 A1 2/2017 Hilbert  
2017/0092052 A1 3/2017 McKay  
2017/0301177 A1 10/2017 Pawloski  
2018/0075689 A1 3/2018 Castro  
2018/0078847 A1 3/2018 Sorreta  
2018/0078854 A1 3/2018 Achmueller  
2018/0082523 A1 3/2018 Palermo  
2019/0012874 A1 1/2019 Goldstein  
2019/0046872 A1 2/2019 Glenn, II  
2019/0096161 A1 3/2019 Barbour  
2019/0096170 A1 \* 3/2019 Lewis ..... G07F 17/3216  
2019/0096173 A1 \* 3/2019 Brandau ..... G07F 17/3216  
2019/0102971 A1 \* 4/2019 Schoonmaker ..... F16M 11/06  
2019/0102974 A1 4/2019 Bussey  
2019/0102984 A1 4/2019 Gallagher  
2019/0287337 A1 \* 9/2019 Shiraishi ..... G07F 17/34  
2020/0111291 A1 \* 4/2020 Pariseau ..... G07F 17/34  
2020/0111295 A1 \* 4/2020 Glenn ..... A63F 9/24  
2020/0111296 A1 \* 4/2020 Miura ..... G07F 17/34  
2020/0111297 A1 4/2020 Kazama  
2020/0111328 A1 \* 4/2020 Bland ..... G07F 17/3213

OTHER PUBLICATIONS

Office Action dated Jun. 1, 2020 for U.S. Appl. No. 29/684,808 (pp. 1-9).  
Office Action dated Jun. 1, 2020 for U.S. Appl. No. 29/684,812 (pp. 1-9).  
Office Action dated Jun. 1, 2020 for U.S. Appl. No. 29/684,832 (pp. 1-9).  
Office Action dated Jun. 1, 2020 for U.S. Appl. No. 29/684,836 (pp. 1-9).  
Office Action dated Jun. 1, 2020 for U.S. Appl. No. 29/684,844 (pp. 1-9).  
Office Action dated Jun. 1, 2020 for U.S. Appl. No. 29/684,849 (pp. 1-9).  
Office Action dated Jun. 5, 2020 for U.S. Appl. No. 29/684,847 (pp. 1-9).  
Office Action dated Jun. 12, 2020 for U.S. Appl. No. 29/684,810 (pp. 1-10).  
Office Action dated Jun. 12, 2020 for U.S. Appl. No. 29/684,814 (pp. 1-10).  
Office Action dated Jun. 12, 2020 for U.S. Appl. No. 29/684,817 (pp. 1-11).  
Office Action dated Jun. 12, 2020 for U.S. Appl. No. 29/684,838 (pp. 1-11).  
Office Action dated Jun. 12, 2020 for U.S. Appl. No. 29/684,842 (pp. 1-11).  
Office Action dated Jun. 12, 2020 for U.S. Appl. No. 29/684,883 (pp. 1-8).  
Office Action dated Jun. 12, 2020 for U.S. Appl. No. 29/684,890 (pp. 1-9).  
Office Action dated Jun. 12, 2020 for U.S. Appl. No. 29/684,891 (pp. 1-9).  
Office Action dated Jun. 12, 2020 for U.S. Appl. No. 29/684,894 (pp. 1-10).

Office Action dated Jun. 12, 2020 for U.S. Appl. No. 29/684,899 (pp. 1-9).  
Office Action dated Jun. 12, 2020 for U.S. Appl. No. 29/684,915 (pp. 1-10).  
Office Action dated Jun. 12, 2020 for U.S. Appl. No. 29/684,922 (pp. 1-10).  
Office Action dated Jun. 12, 2020 for U.S. Appl. No. 29/684,925 (pp. 1-10).  
Office Action dated Jun. 12, 2020 for U.S. Appl. No. 29/684,929 (pp. 1-10).  
Office Action dated Jun. 12, 2020 for U.S. Appl. No. 29/684,934 (pp. 1-10).  
Office Action dated Jun. 12, 2020 for U.S. Appl. No. 29/684,936 (pp. 1-10).  
Office Action dated Jun. 12, 2020 for U.S. Appl. No. 29/684,941 (pp. 1-12).  
Office Action dated Jul. 10, 2020 for U.S. Appl. No. 29/684,900 (pp. 1-10).  
Office Action dated Jul. 10, 2020 for U.S. Appl. No. 29/684,938 (pp. 1-13).  
Notice of Allowance dated Aug. 5, 2020 for U.S. Appl. No. 29/678,496 (pp. 1-7).  
Office Action dated Jun. 1, 2020 for U.S. Appl. No. 29/684,806 (pp. 1-9).  
Office Action dated Jun. 1, 2020 for U.S. Appl. No. 29/684,807 (pp. 1-8).  
Office Action dated Jun. 1, 2020 for U.S. Appl. No. 29/684,809 (pp. 1-7).  
Office Action dated Jun. 1, 2020 for U.S. Appl. No. 29/684,811 (pp. 1-7).  
Office Action dated Jun. 12, 2020 for U.S. Appl. No. 29/684,912 (pp. 1-10).  
Corrected Notice of Allowability dated Aug. 17, 2020 for U.S. Appl. No. 29/678,496 (pp. 1-4).

\* cited by examiner

*Primary Examiner* — Ryan Harvey  
(74) *Attorney, Agent, or Firm* — Armstrong Teasdale LLP  
(57)

**CLAIM**

We claim the ornamental design for a gaming machine, as shown and described.

**DESCRIPTION**

FIG. 1 is a front perspective view of a gaming machine showing our new design;

FIG. 2 is a front view of the gaming machine shown in FIG. 1;  
FIG. 3 is a back view of the gaming machine shown in FIG. 1;  
FIG. 4 is a right side view of the gaming machine shown in FIG. 1;  
FIG. 5 is a left side view of the gaming machine shown in FIG. 1;  
FIG. 6 is a top view of the gaming machine shown in FIG. 1;  
FIG. 7 is a bottom view of the gaming machine shown in FIG. 1;  
FIG. 8 is a front perspective view of a gaming machine showing an alternative embodiment of our new design;  
FIG. 9 is a front view of the gaming machine shown in FIG. 8;  
FIG. 10 is a front perspective view of a gaming machine showing a further embodiment of our new design;  
FIG. 11 is a front view of the gaming machine shown in FIG. 10;  
FIG. 12 is a back view of the gaming machine shown in FIG. 10;  
FIG. 13 is a right side view of the gaming machine shown in FIG. 10;  
FIG. 14 is a left side view of the gaming machine shown in FIG. 10;  
FIG. 15 is a top view of the gaming machine shown in FIG. 10;  
FIG. 16 is a bottom view of the gaming machine shown in FIG. 10;  
FIG. 17 is a front perspective view of a gaming machine showing another alternative embodiment of our new design; and,  
FIG. 18 is a front view of the gaming machine shown in FIG. 17.  
The broken line showing of portions of the gaming machine depicts environment and forms no part of the claimed design.

**1 Claim, 18 Drawing Sheets**

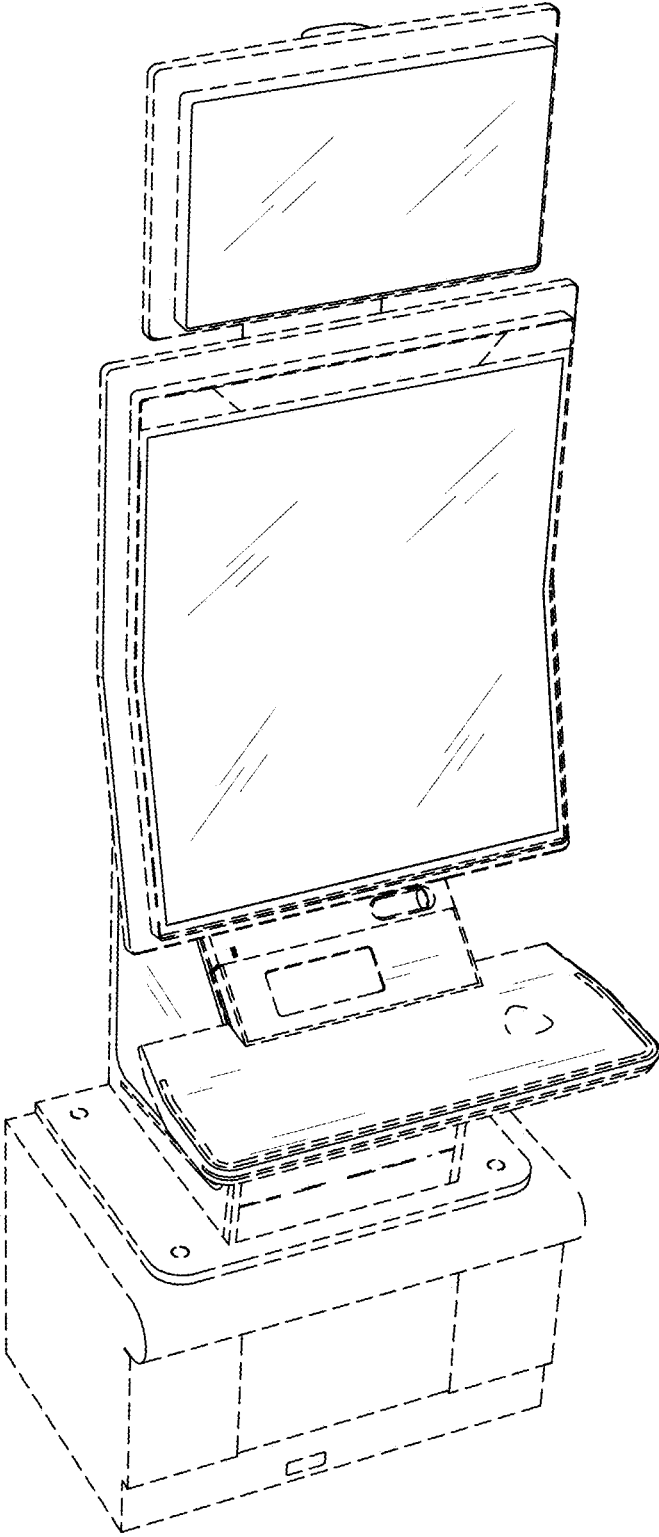

FIG. 1

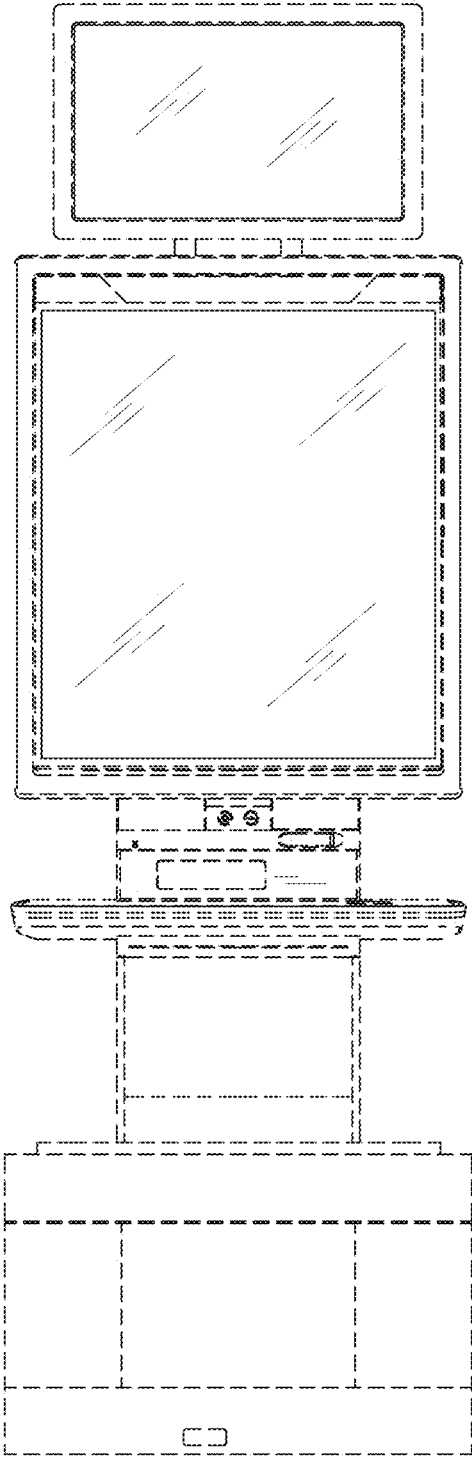

FIG. 2

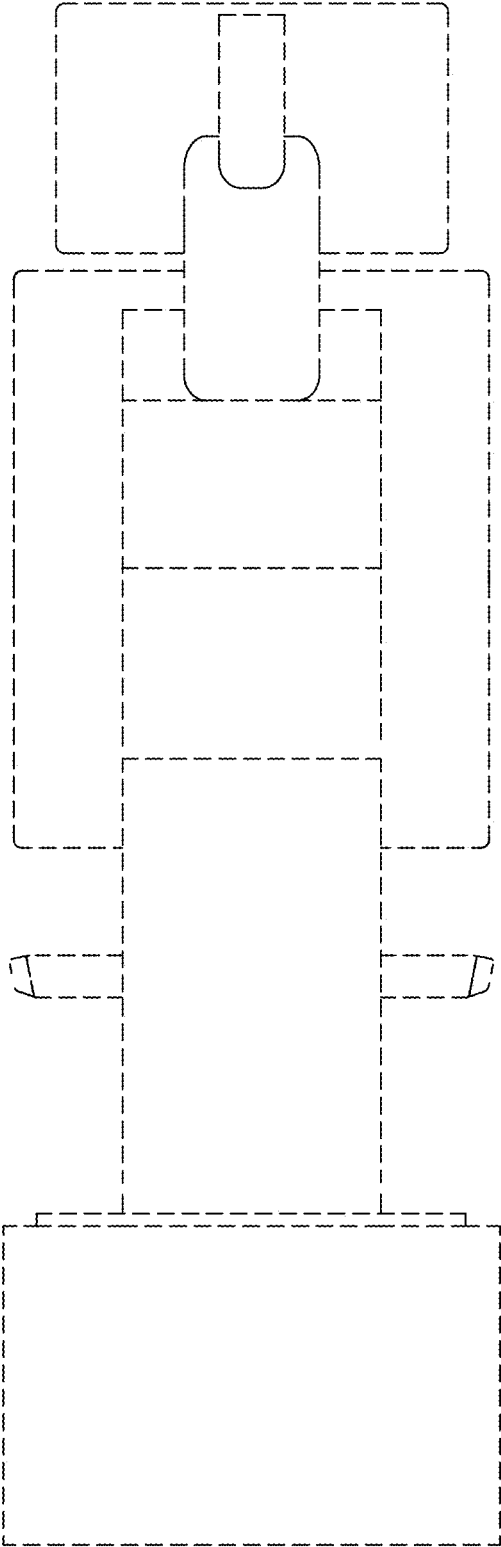

FIG. 3

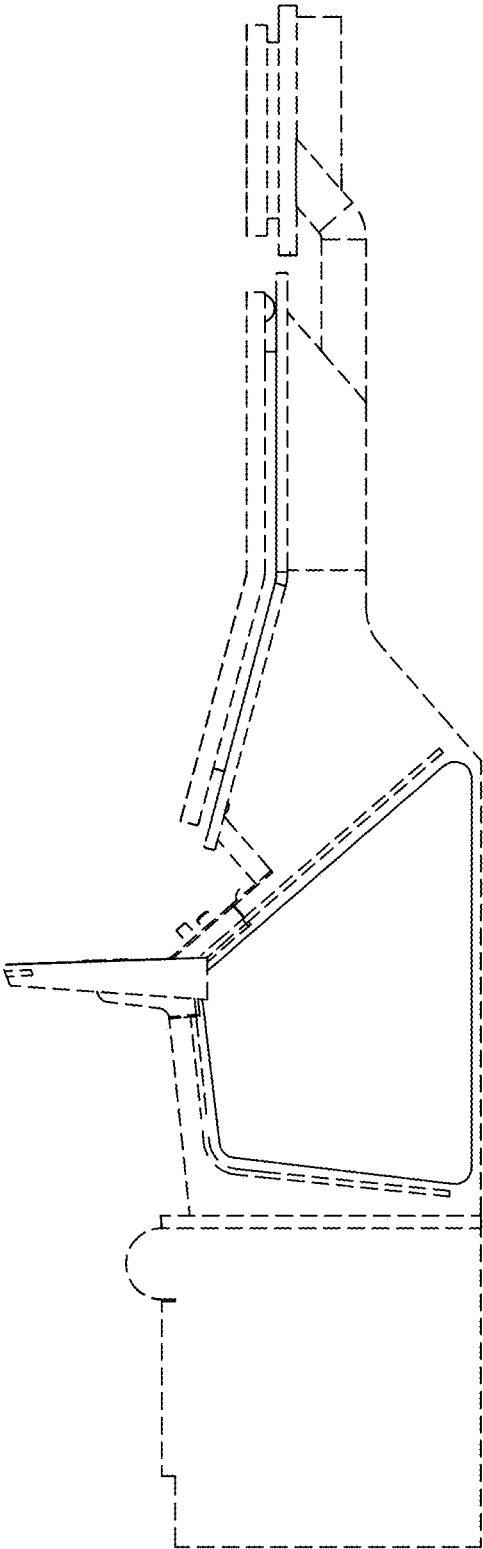

FIG. 4

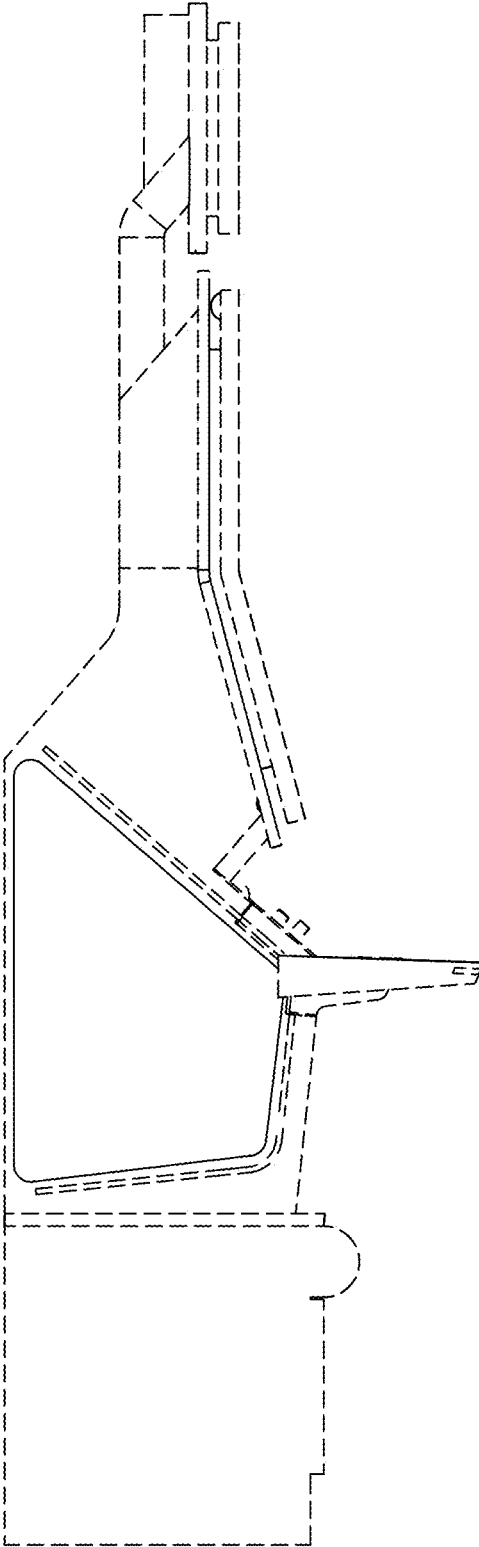

FIG. 5



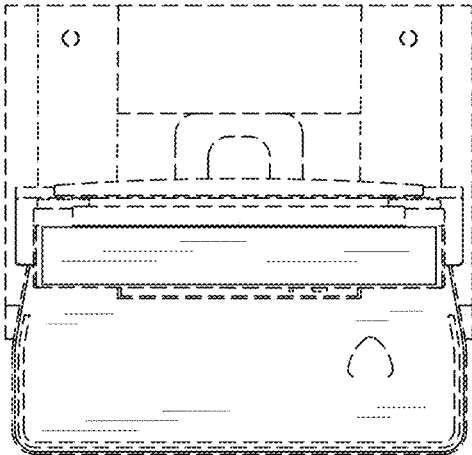

FIG. 6

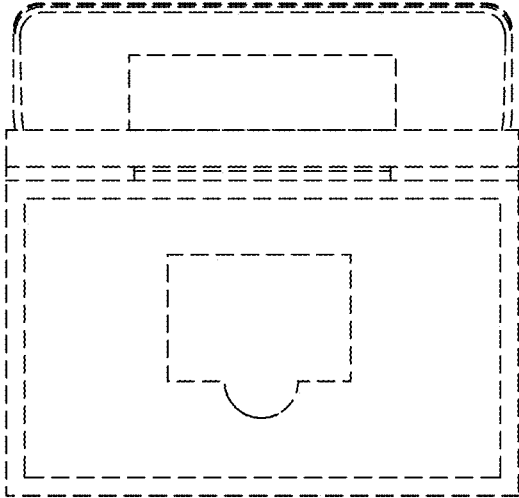

FIG. 7

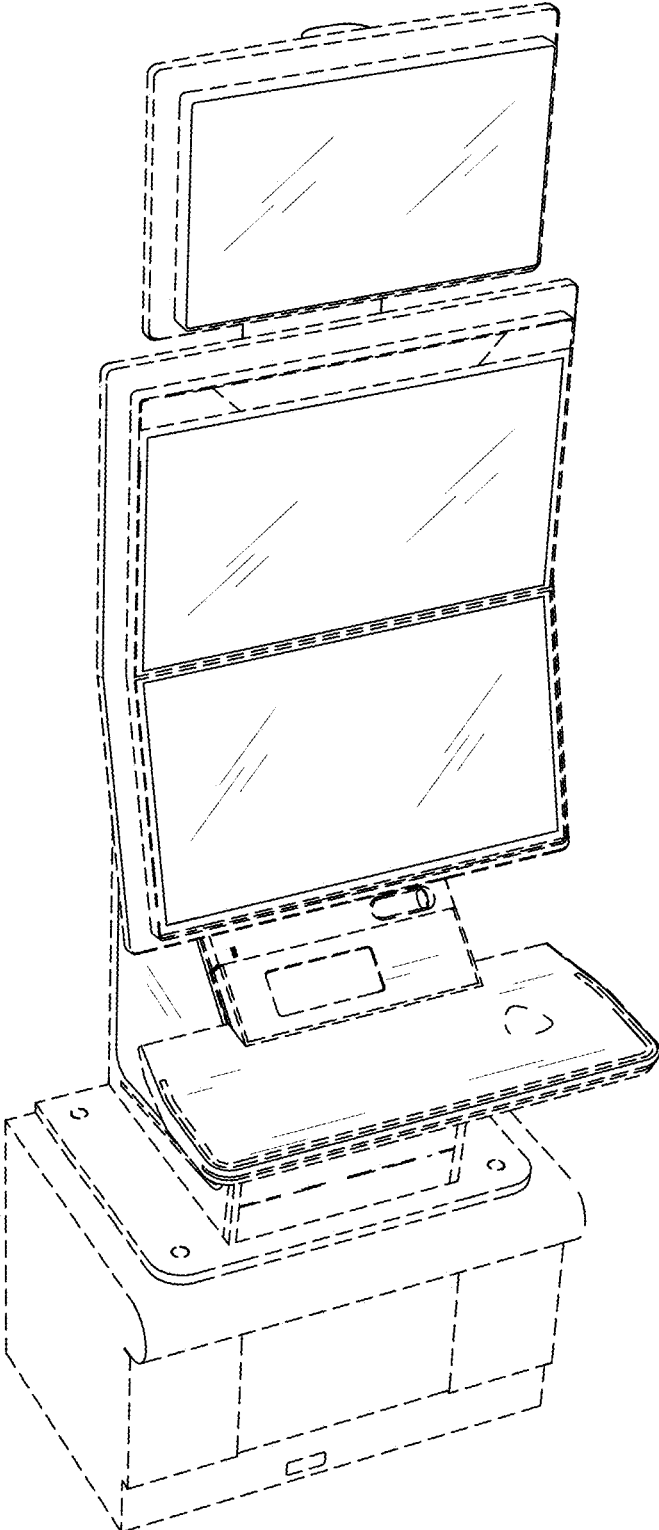

FIG. 8

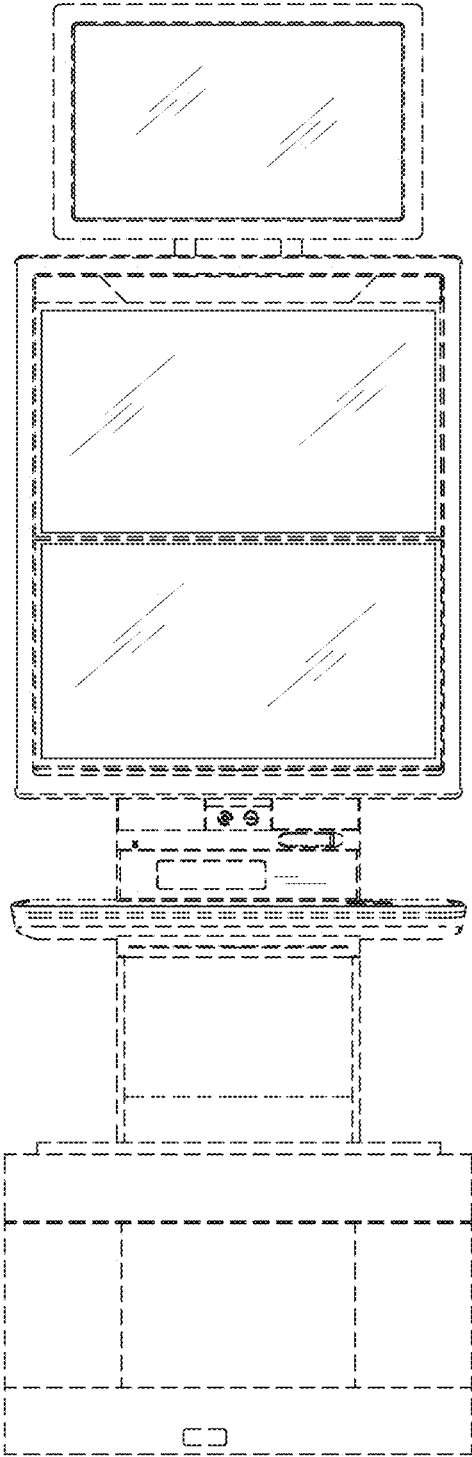

FIG. 9

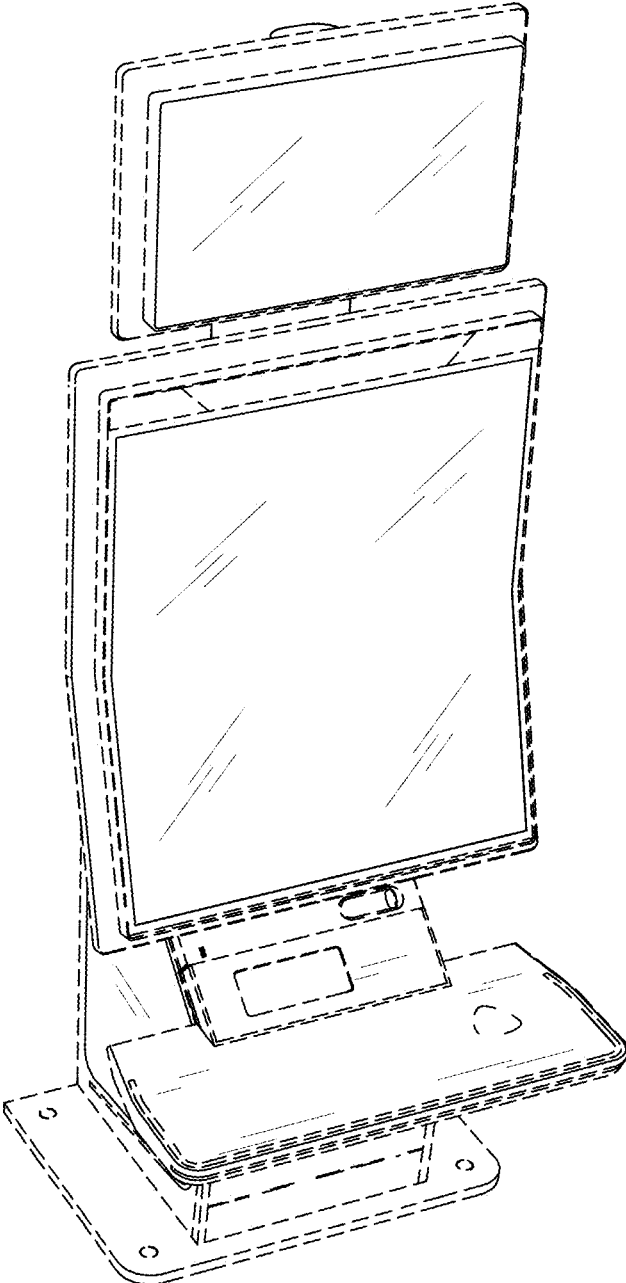

FIG. 10

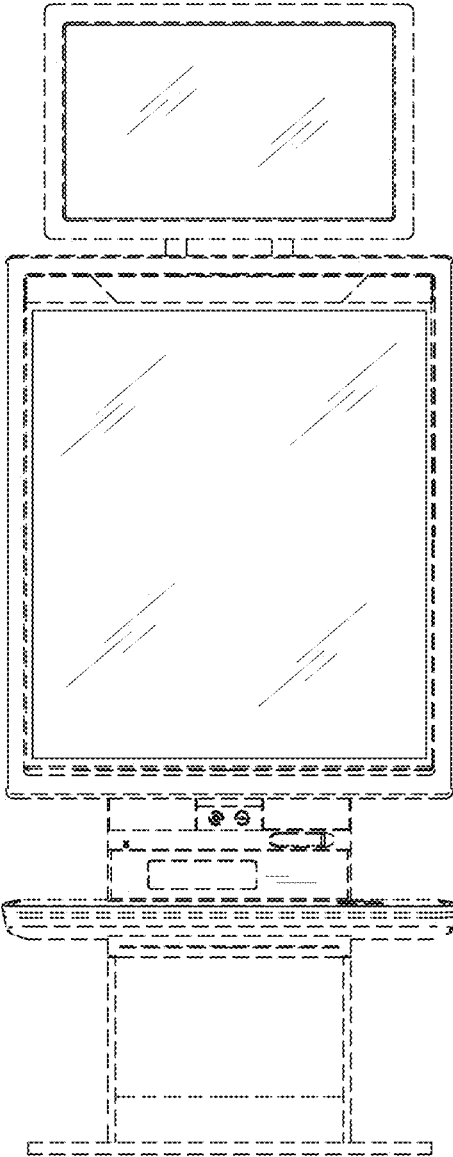

FIG. 11

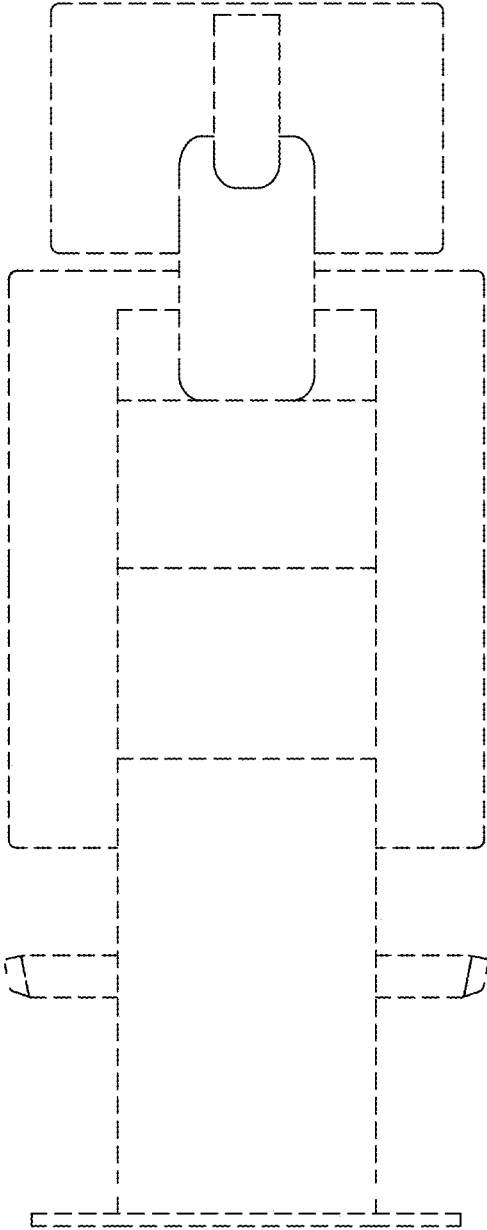

FIG. 12

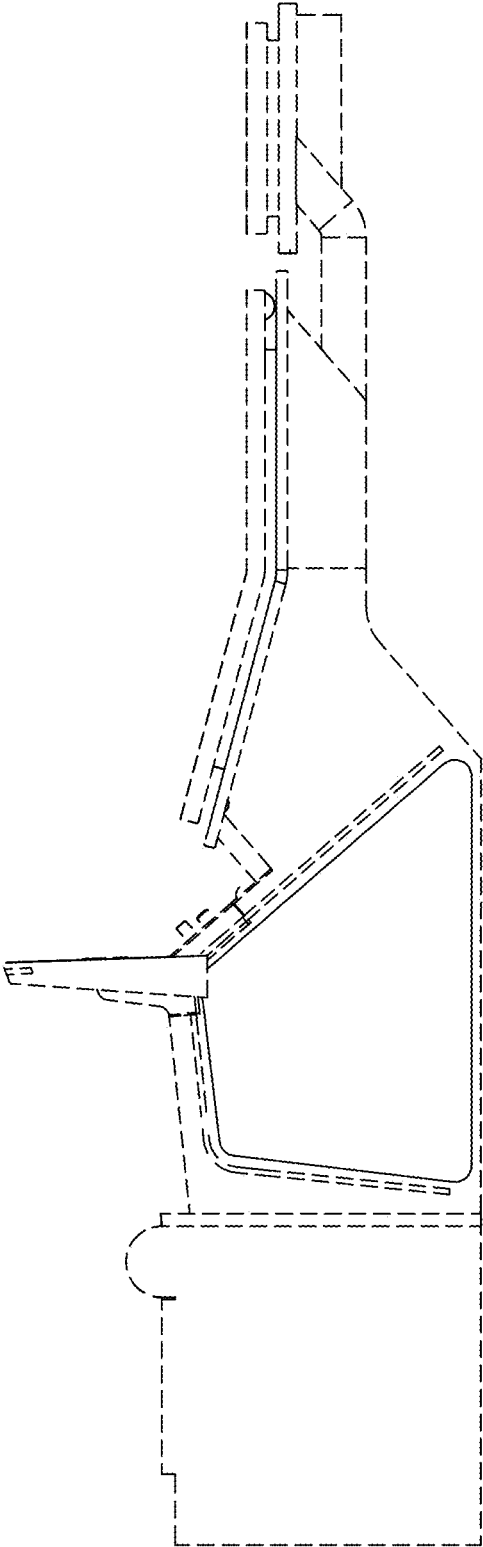

FIG. 13



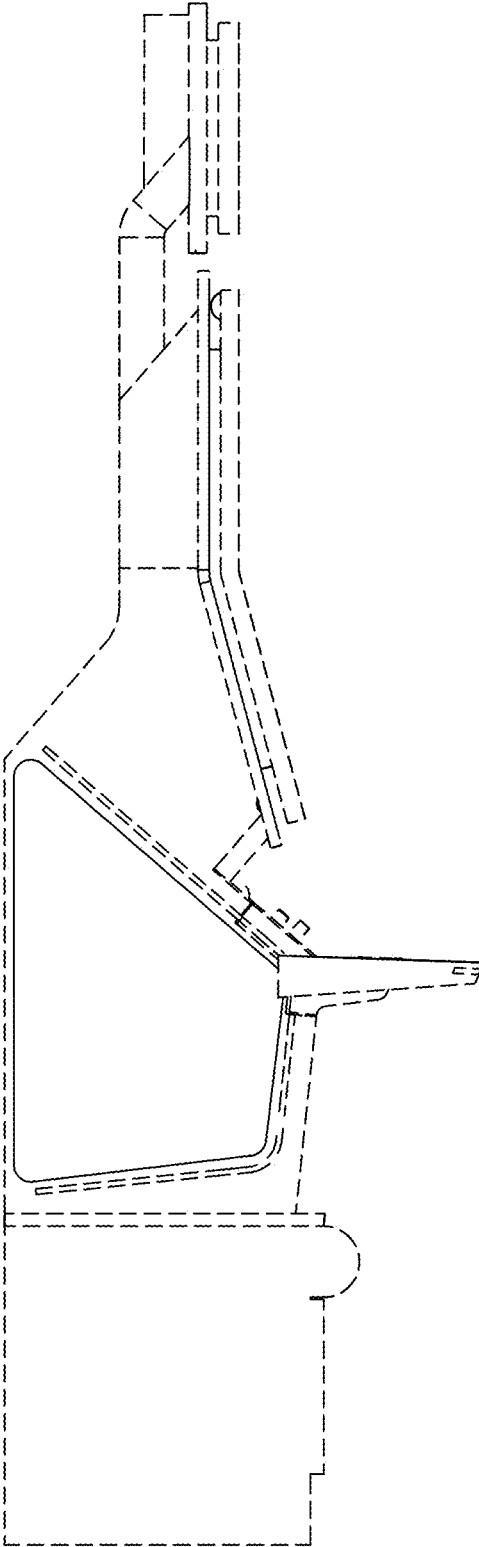

FIG. 14

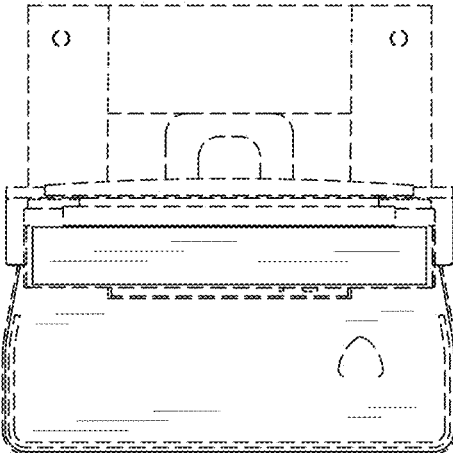

FIG. 15

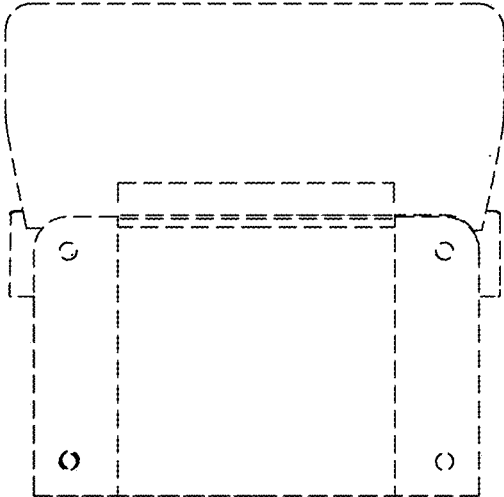

FIG. 16

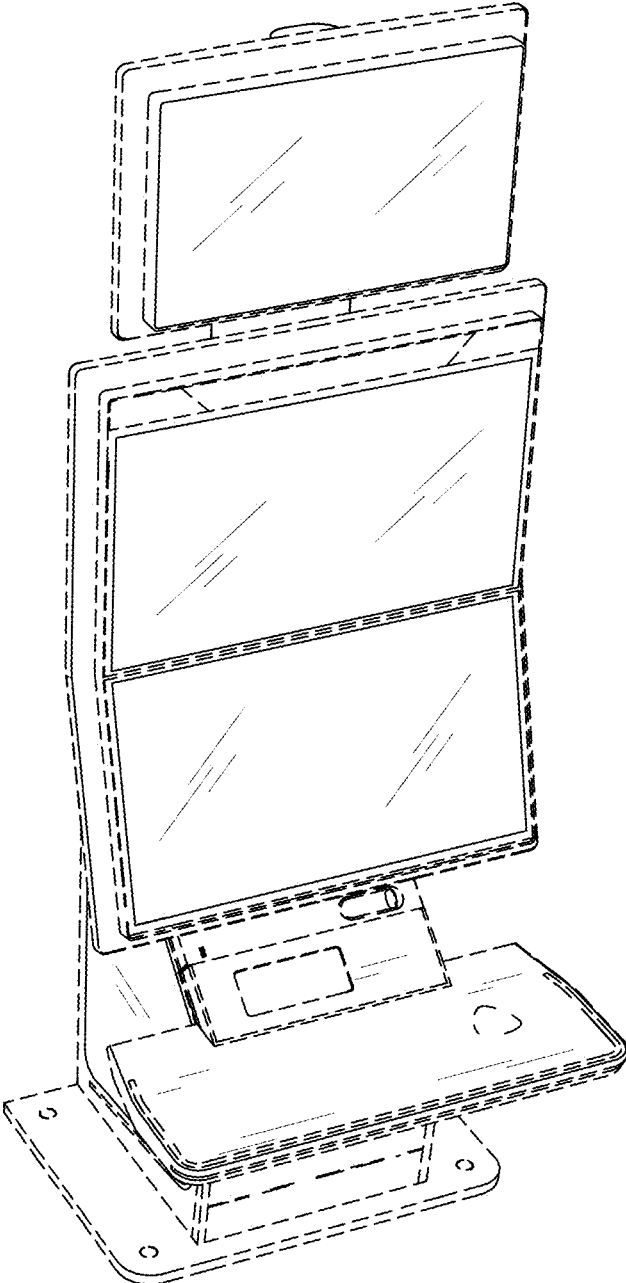

FIG. 17

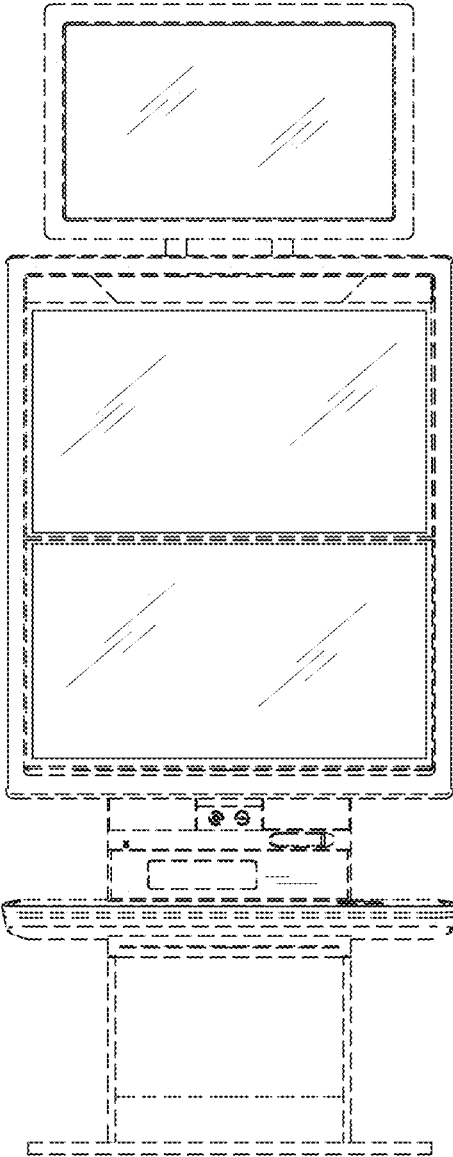

FIG. 18