



US00D392254S

United States Patent [19] Gevaert

[11] Patent Number: **Des. 392,254**
[45] Date of Patent: ****Mar. 17, 1998**

[54] **POWER/DATA MODULE**
[75] Inventor: **Steven C. Gevaert, Green Bay, Wis.**
[73] Assignee: **Krueger International, Inc., Green Bay, Wis.**
[**] Term: **14 Years**

5,342,993 8/1994 Siems .
5,351,173 9/1994 Byrne .
5,575,668 11/1996 Timmerman 439/131

FOREIGN PATENT DOCUMENTS

0410588 1/1991 European Pat. Off. .
0648001 4/1995 European Pat. Off. .

Primary Examiner—Kay H. Chin
Assistant Examiner—Lavone D. Tabor
Attorney, Agent, or Firm—Andrus, Scales, Starke & Sawall

[21] Appl. No.: **55,601**
[22] Filed: **Jun. 7, 1996**

[51] **LOC (6) Cl.** **13-03**
[52] **U.S. Cl.** **D13/143**
[58] **Field of Search** D13/133, 137,
D13/139, 143, 146, 156; 174/48, 53, 66,
67; 220/3.2, 4.02, 241; 439/131, 135, 535

[57] CLAIM

The ornamental design for a power/data module, as shown and described.

DESCRIPTION

FIG. 1 is an isometric view of a power/data module incorporating my new design;
FIG. 2 is a top plan view thereof;
FIG. 3 is a side elevation view thereof;
FIG. 4 is an end elevation view thereof;
FIG. 5 is a rear elevation view thereof;
FIG. 6 is an isometric view thereof similar to FIG. 1, showing the power/data module in an open position;
FIG. 7 is a top plan view of the module in its open position of FIG. 6;
FIG. 8 is a front elevation view of the module in its open position;
FIG. 9 is a rear elevation view of the module in its open position; and
FIG. 10 is a side elevation view of the module in its open position.
The broken lines showing a flat surface in FIGS. 1, 3-6 and 10 and the outer walls of the module in FIGS. 1, 3, 4, and 6-10 and the plug sockets in FIG. 6, are for illustrative purposes only and form no part of the claimed design.

1 Claim, 3 Drawing Sheets

[56] References Cited

U.S. PATENT DOCUMENTS

D. 353,363 12/1994 Toby D13/143
3,131,512 5/1964 MacLeod, Jr. .
3,433,886 3/1969 Myers .
3,646,244 2/1972 Cole .
3,794,956 2/1974 Dubreuil .
3,972,579 8/1976 Kohaut .
4,296,981 10/1981 Hildebrandt et al. .
4,372,629 2/1983 Propst et al. .
4,511,198 4/1985 Mitchell et al. .
4,551,577 11/1985 Byrne .
4,747,788 5/1988 Byrne .
4,792,881 12/1988 Wilson et al. .
4,984,982 1/1991 Brownlie et al. .
5,023,396 6/1991 Bartee et al. .
5,103,741 4/1992 Grund et al. .
5,122,069 6/1992 Brownlie et al. .
5,230,552 7/1993 Schipper et al. .
5,231,562 7/1993 Pierce et al. .
5,299,943 4/1994 Shieh .
5,318,259 6/1994 Fussler .
5,318,453 6/1994 Hwang .

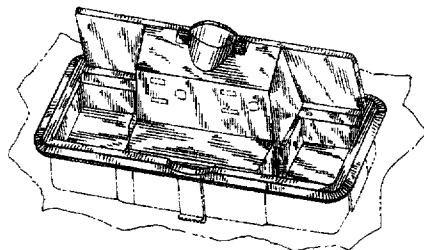
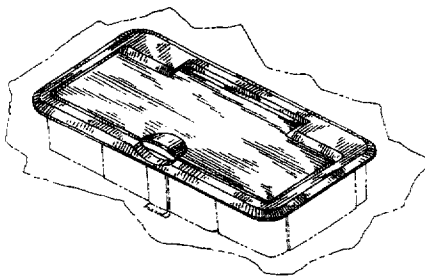

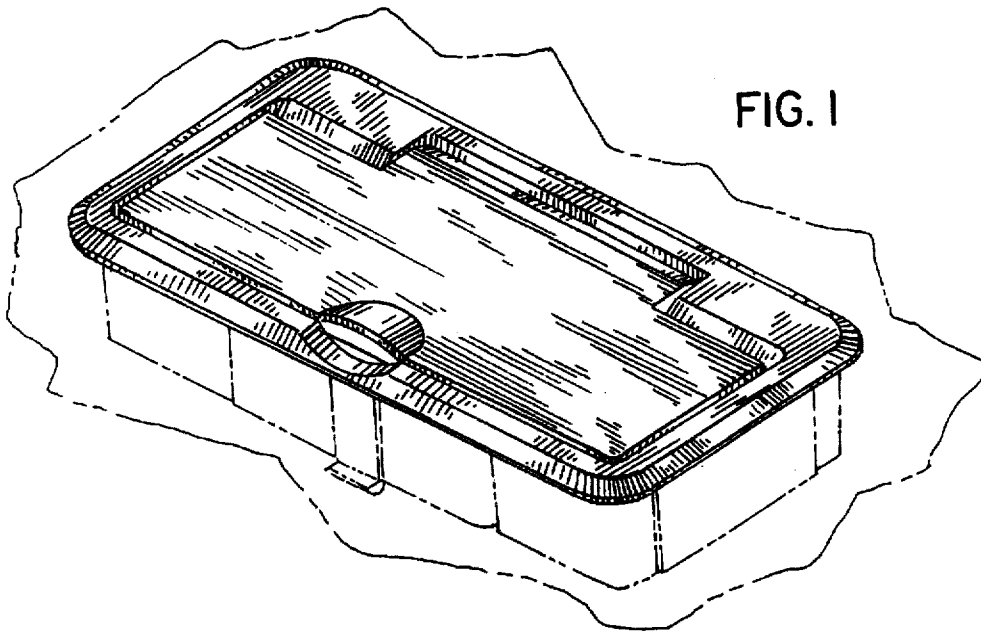

FIG. 1

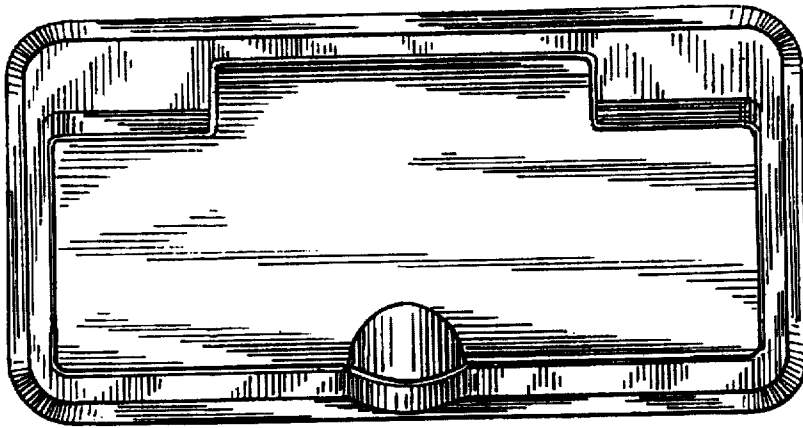

FIG. 2

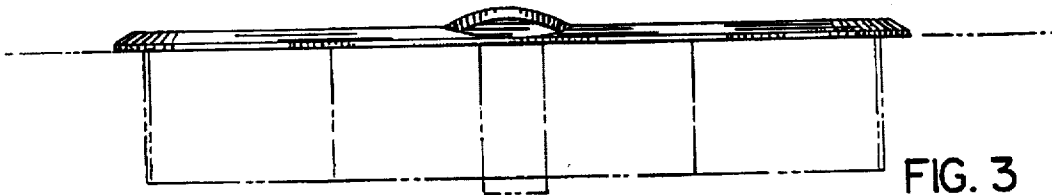

FIG. 3

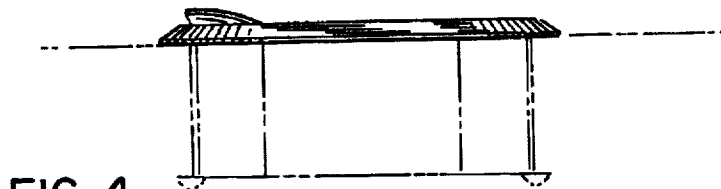

FIG. 4



FIG. 5

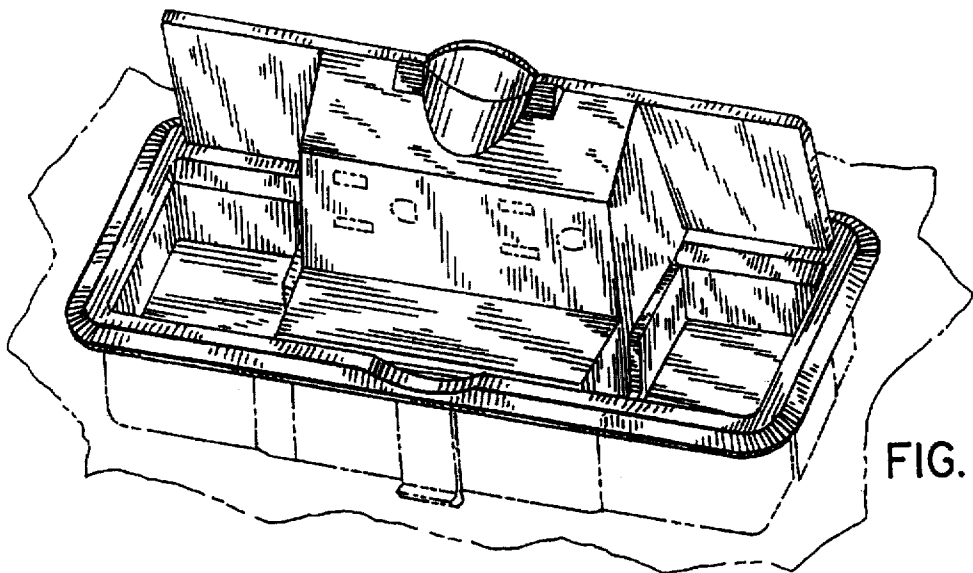

FIG. 6

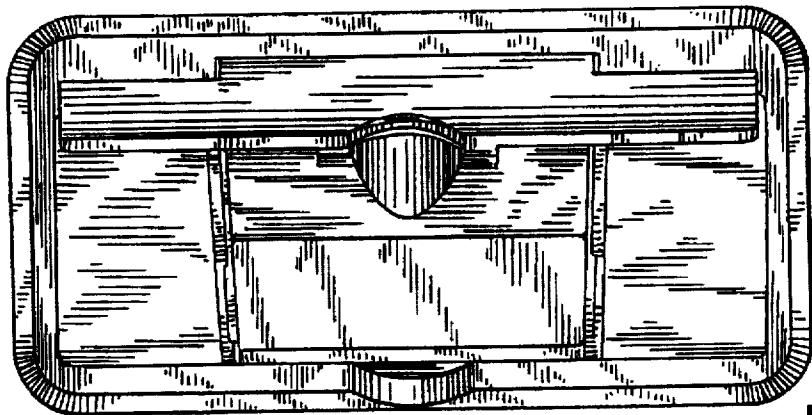

FIG. 7

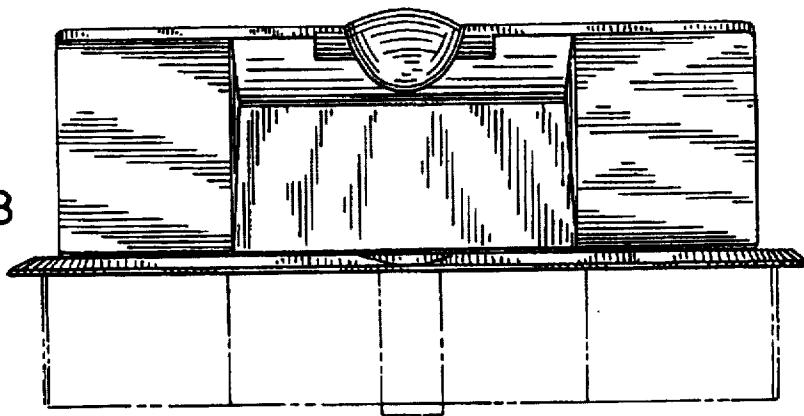

FIG. 8

