



US0D1027747S

(12) **United States Design Patent**
Seo et al.

(10) **Patent No.:** **US D1,027,747 S**
(45) **Date of Patent:** **** May 21, 2024**

(54) **FRONT BUMPER LOWER COVER FOR AN AUTOMOBILE**

(71) Applicants: **Hyundai Motor Company**, Seoul (KR); **Kia Corporation**, Seoul (KR)

(72) Inventors: **Jun Seok Seo**, Seongnam-si (KR); **Duck Hyun Hwang**, Hanam-si (KR)

(73) Assignees: **Hyundai Motor Company**, Seoul (KR); **Kia Corporation**, Seoul (KR)

(**) Term: **15 Years**

(21) Appl. No.: **35/516,614**

(22) Filed: **Sep. 14, 2022**

(80) **Hague Agreement Data**

Int. Filing Date: **Sep. 14, 2022**
Int. Reg. No.: **DM/223544**
Int. Reg. Date: **Sep. 14, 2022**
Int. Reg. Pub. Date: **Mar. 17, 2023**

(30) **Foreign Application Priority Data**

Apr. 15, 2022 (KR) 30-2022-0014830

(51) **LOC (14) Cl.** **12-16**

(52) **U.S. Cl.**
USPC **D12/169**

(58) **Field of Classification Search**
USPC D12/86, 90, 91, 92, 163, 164, 169, 171, D12/196, 216
CPC B60R 19/02; B60R 19/18; B60R 19/24; B60R 19/56; B60R 2019/007; B62D 25/0845
See application file for complete search history.

(56) **References Cited**

U.S. PATENT DOCUMENTS

7,192,068 B1 * 3/2007 Kim B60R 19/18 293/133
D735,096 S * 7/2015 Nissl D12/169

D855,510 S * 8/2019 Nissl D12/169
D877,001 S * 3/2020 Izard D12/169
D877,002 S * 3/2020 Izard D12/169
D890,650 S * 7/2020 Kang D12/169
D890,653 S * 7/2020 Sarreméjean D12/169
D893,368 S * 8/2020 Oh D12/169
D908,556 S * 1/2021 Gilbert D12/169
D910,505 S * 2/2021 Wheel D12/169
D910,506 S * 2/2021 Wheel D12/169
D958,025 S * 7/2022 Nakagawa D12/169

(Continued)

OTHER PUBLICATIONS

“Hyundai. 2024 Palisade.” Hyundai Motors., Sep. 20, 2023 [online], [retrieved on Jan. 11, 2024]. Retrieved from the Internet <URL: <https://secure.viewer.zmags.com/publication/cdb09bf8#/cdb09bf8/1>>.*

(Continued)

Primary Examiner — Darlington Ly
(74) *Attorney, Agent, or Firm* — Fox Rothschild LLP

(57) **CLAIM**

The ornamental design for a front bumper lower cover for an automobile, as shown and described.

DESCRIPTION

1. Front bumper lower cover for an automobile
1.1 is a front and left side perspective view of a front bumper lower cover for an automobile embodying our new design;
1.2 is a front elevation view thereof;
1.3 is a rear elevation view thereof;
1.4 is a right side elevation view thereof;
1.5 is a left side view thereof;
1.6 is a top plan view thereof;
1.7 is a bottom plan view thereof;
1.8 is a bottom, front, and left side perspective view thereof; and
1.9 is a top, rear, and left side perspective view thereof.

1 Claim, 9 Drawing Sheets

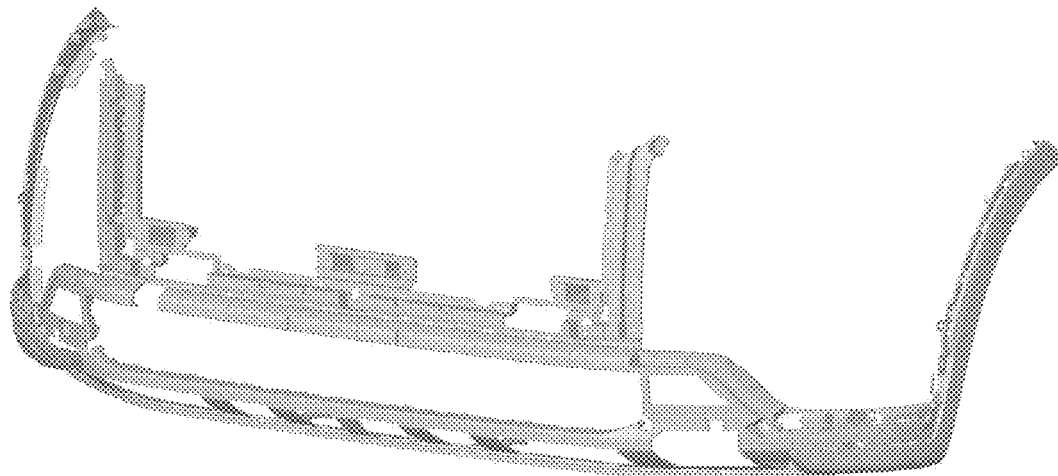

(56)

References Cited

U.S. PATENT DOCUMENTS

D983,708 S * 4/2023 Honda D12/169
 D1,005,905 S * 11/2023 Huang D12/169
 D1,007,383 S * 12/2023 Mochizuki D12/169
 D1,008,119 S * 12/2023 Thogersen D12/169
 2006/0249961 A1 * 11/2006 Flotzinger B60R 19/04
 293/115
 2008/0079271 A1 * 4/2008 Maruko B60R 19/52
 293/102
 2008/0093868 A1 * 4/2008 Steller B60R 19/18
 293/142
 2009/0243340 A1 * 10/2009 Goldsberry B60R 19/50
 296/191

OTHER PUBLICATIONS

“Hyundai. 2023 Palisade.” Hyundai Motors., Oct. 13, 2022 [online], [retrieved on Jan. 11, 2024]. Retrieved from the Internet <URL:

<https://secure.viewer.zmags.com/publication/9db1be6e#9db1be6e/1>>.*

“Hyundai. 2022 Palisade.” Hyundai Motors., Jun. 17, 2021 [online], [retrieved on Jan. 11, 2024]. Retrieved from the Internet <URL: <https://secure.viewer.zmags.com/publication/47a3ea68#47a3ea68/1>>.*

“Bumper & Components—Front for 2021 Hyundai Palisade.” Hyundai OEM Parts Online., 2021 [online], [retrieved on Jan. 11, 2024]. Retrieved from the Internet <URL: <https://hyundai.oempartsonline.com/v-2021-hyundai-palisade--calligraphy--3-81-v6-gas/body--bumper-and-components-front>>.*

“Hyundai Palisade Front Bumper Lower Cover . . .” Painted Auto Body Parts., Feb. 19, 2021 [online], [retrieved on Jan. 11, 2024]. Retrieved from the Internet <URL: <https://paintedautobodyparts.com/hyundai-palisade-front-bumper-lower-cover-txt-black-w-sensor-se-sel-capoem-86550s8010-2020-2022-pl-hy1015115c.html>>.*

* cited by examiner

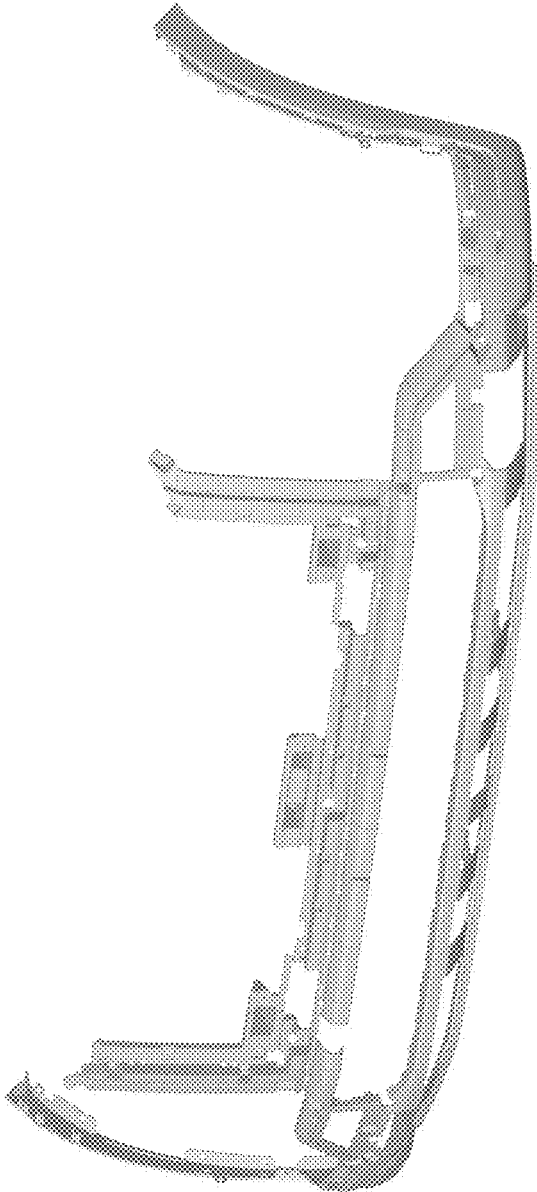

1.1

1.2

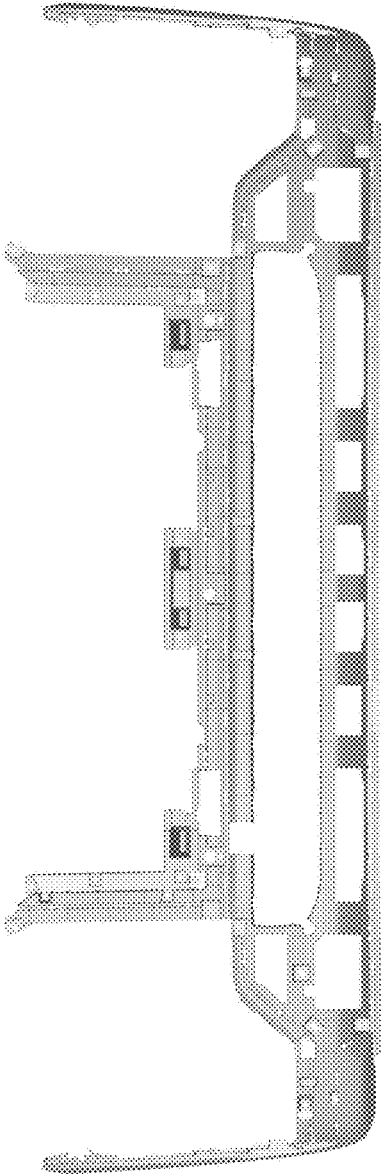

1.3

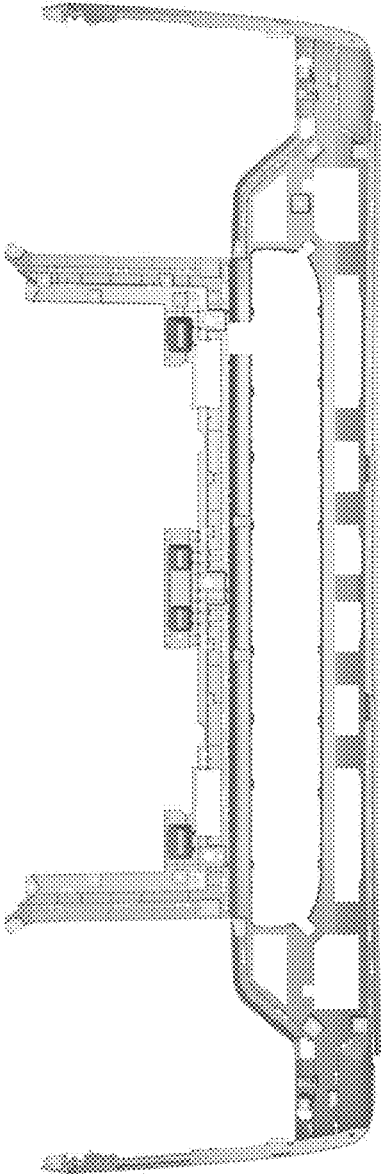

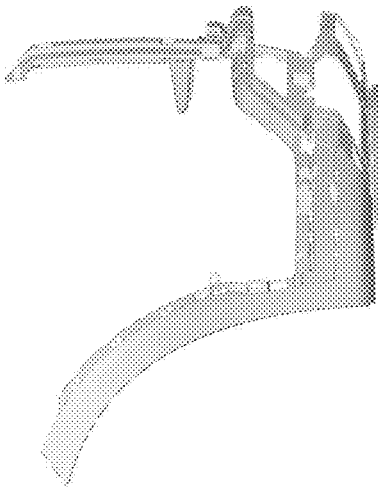

1.4

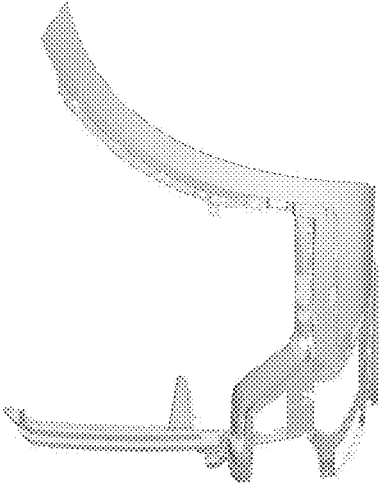

1.5

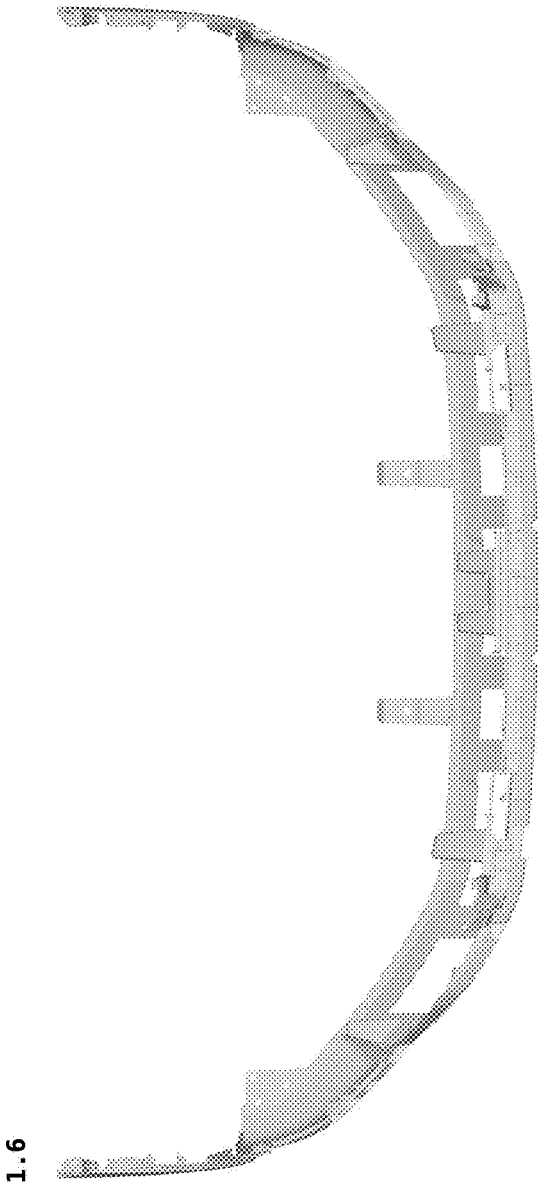

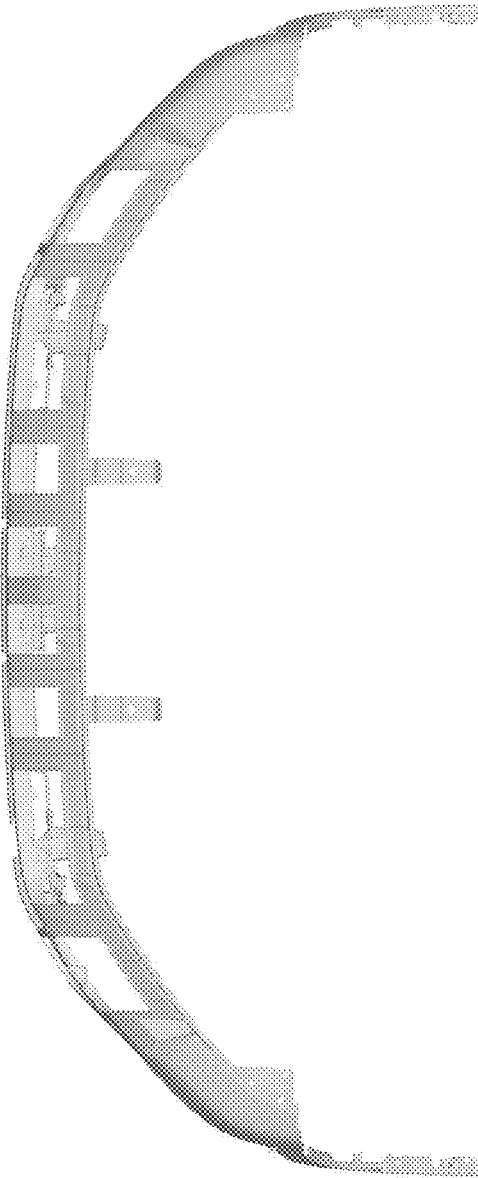

1.7

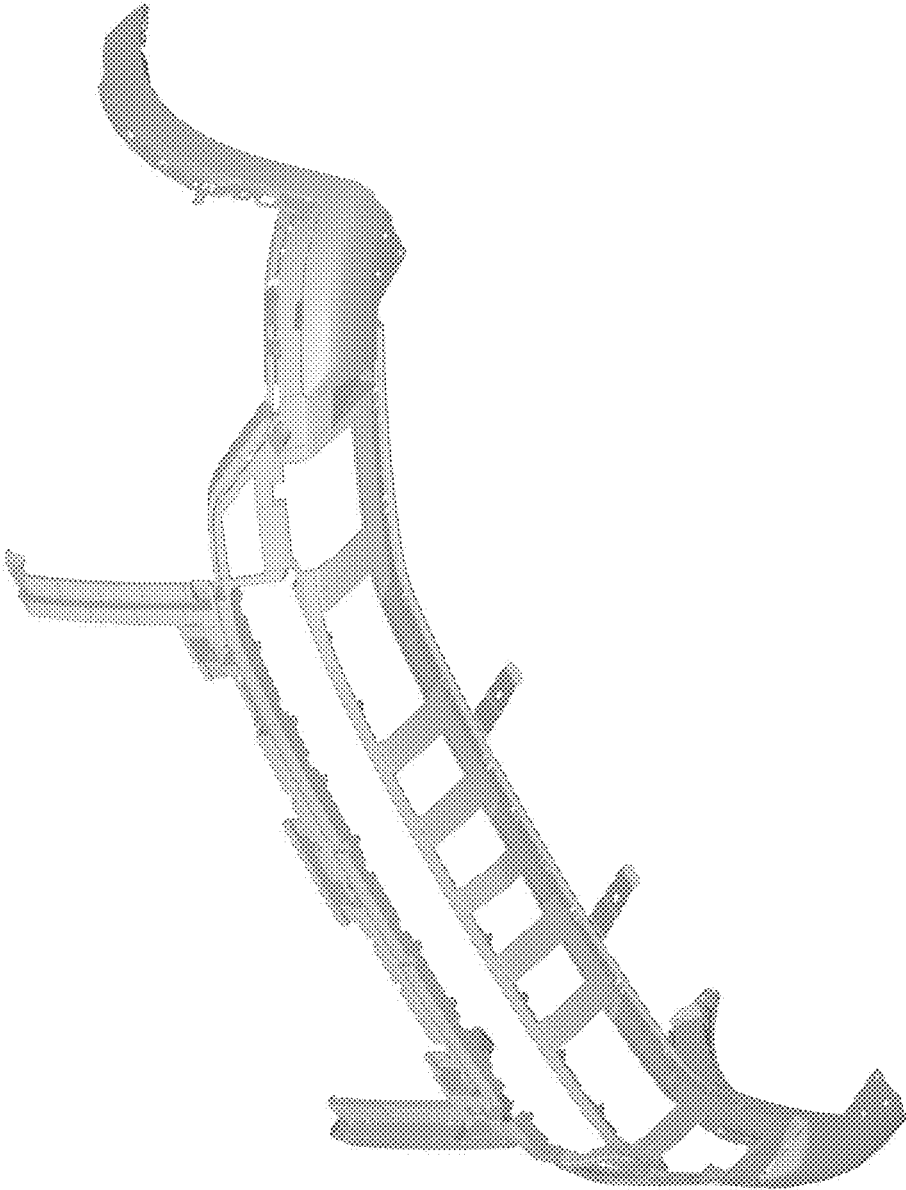

1.8

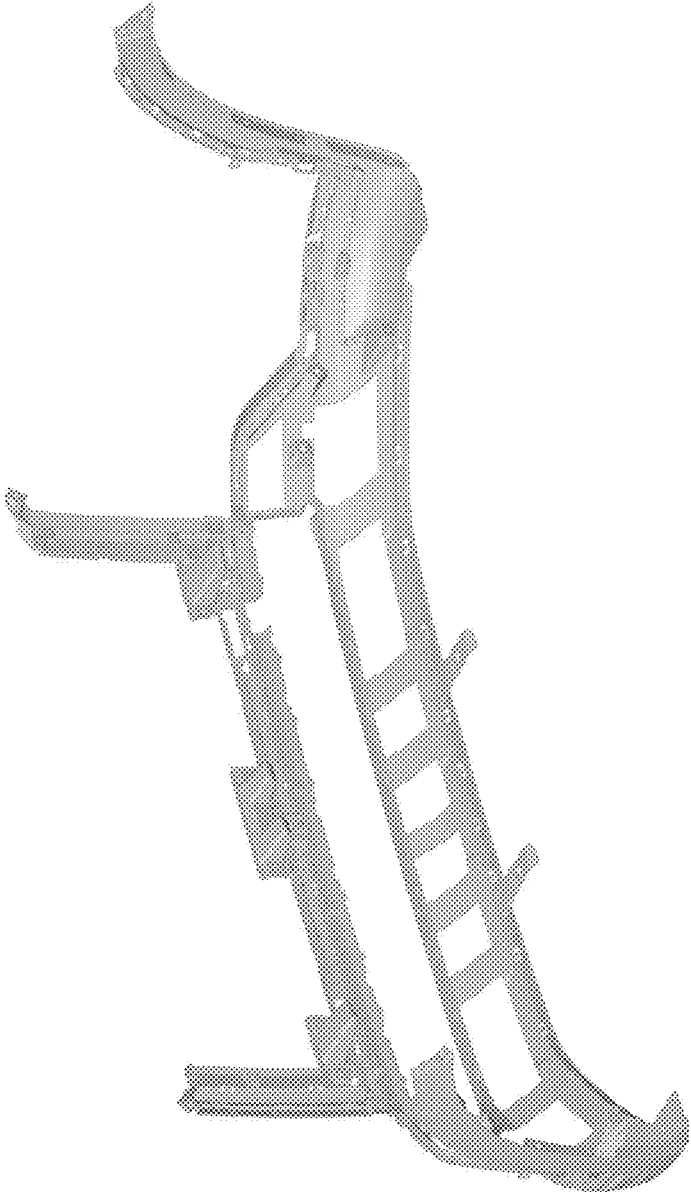

1.9