



US00D869201S

(12) **United States Design Patent**
Davis et al.

(10) **Patent No.:** **US D869,201 S**
(45) **Date of Patent:** **** Dec. 10, 2019**

(54) **CONSOLE**

D66,028 S 11/1924 Lyons et al.
D66,889 S 3/1925 Schleicher
D68,065 S 8/1925 Schleicher

(Continued)

(71) Applicant: **WALKER EDISON FURNITURE COMPANY LLC**, Salt Lake City, UT (US)

FOREIGN PATENT DOCUMENTS

(72) Inventors: **Matthew Davis**, Murray, UT (US);
Brad Bonham, Draper, UT (US);
Richard Packer, Kaysville, UT (US)

GB 1162368 8/1969

OTHER PUBLICATIONS

(73) Assignee: **Walker Edison Furniture Company LLC**, Salt Lake City, UT (US)

U.S. Appl. No. 29/611,962, filed Jul. 27, 2017, Davis.
(Continued)

(**) Term: **15 Years**

Primary Examiner — R. Johnson

(21) Appl. No.: **29/656,486**

(74) *Attorney, Agent, or Firm* — Workman Nydegger

(22) Filed: **Jul. 12, 2018**

(57) **CLAIM**

(51) **LOC (12) Cl.** **06-04**

The ornamental design for a console, as shown and described.

(52) **U.S. Cl.**

DESCRIPTION

USPC **D6/669**

(58) **Field of Classification Search**

USPC D6/512, 553, 559, 657, 659, 660, 661,
D6/662, 663, 667, 669, 671, 671.1, 672,
D6/673, 675, 682, 682.3, 683.1, 694
CPC A47B 46/00; A47B 47/00; A47B 47/02;
A47B 47/021; A47B 47/022; A47B
47/04; A47B 55/00; A47B 67/00; A47B
67/02; A47B 67/04; A47B 83/04; A47B
7/00; A47B 81/00; A47B 81/007; A47B
81/02; A47F 3/00; A47F 3/005

See application file for complete search history.

FIG. 1 is a front perspective view of a console, showing the first embodiment of our new design;
FIG. 2 is a front elevation view thereof;
FIG. 3 is a back elevation view thereof;
FIG. 4 is a top plan view thereof;
FIG. 5 is a bottom plan view thereof;
FIG. 6 is a right elevation view thereof;
FIG. 7 is a left elevation view thereof;
FIG. 8 is a front perspective view of a console, showing the second embodiment of our new design;
FIG. 9 is a front elevation view thereof;
FIG. 10 is a back elevation view thereof;
FIG. 11 is a top plan view thereof;
FIG. 12 is a bottom plan view thereof;
FIG. 13 is a right elevation view thereof; and,
FIG. 14 is a left elevation view thereof.

The broken lines in the drawings are for the purpose of illustrating portions of the article that form no part of the claimed design.

(56) **References Cited**

U.S. PATENT DOCUMENTS

245,925 A 8/1881 Kinsley
309,799 A 12/1884 Poulson
D47,600 S 7/1915 Koch
D61,344 S 8/1922 Mayer
1,475,088 A 11/1923 Specht et al.
D64,390 S 4/1924 Arons
D64,922 S 6/1924 Naill

1 Claim, 8 Drawing Sheets

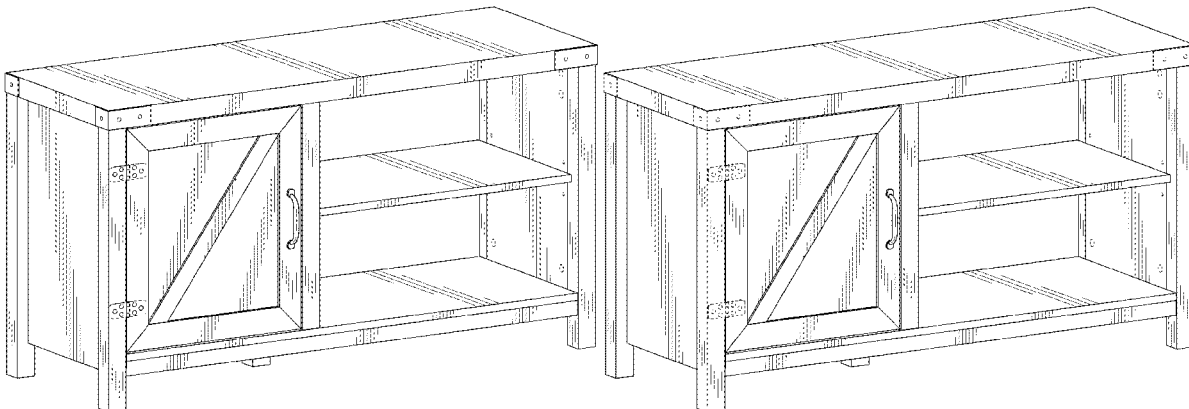

(56)

References Cited

U.S. PATENT DOCUMENTS

D68,659	S	11/1925	Smith	D428,609	S	7/2000	Williams
D78,127	S	3/1929	Schleicher	D430,431	S	9/2000	Walter
2,207,307	A	7/1940	Teller	D448,203	S	9/2001	Jeup
D166,077	S	3/1952	Haas	D452,624	S	1/2002	de Blois
2,696,419	A	12/1954	Wallance	D454,264	S	3/2002	Patik
D175,869	S	10/1955	Trout	D455,916	S	4/2002	Fluhrer
2,743,720	A	5/1956	Dollinger	6,393,207	B1	5/2002	Martin
D182,836	S	5/1958	Lubberts	D466,333	S	12/2002	Hwang
2,850,346	A	* 9/1958	Holderle	6,515,262	B1	2/2003	Li
			A47F 3/005	D477,160	S	7/2003	Grosfillex
			312/140.4	D478,432	S	8/2003	Juneau
D186,115	S	9/1959	Church	D479,925	S	9/2003	Hsieh
D188,196	S	6/1960	Lubberts	D485,709	S	1/2004	de Blois
D188,197	S	6/1960	Swarts	D492,989	S	7/2004	Beck
3,039,621	A	6/1962	Pilcher	D495,898	S	9/2004	Walker
D193,516	S	* 9/1962	Deaton	6,789,859	B1	9/2004	Ho
D196,451	S	10/1963	McMullen	D499,274	S	12/2004	Juneau
3,217,671	A	11/1965	Walsh	D499,281	S	12/2004	Yamaguchi
3,272,582	A	9/1966	Mack	D499,583	S	12/2004	Anderson
3,354,878	A	11/1967	Balls	D507,428	S	* 7/2005	Weatherly
RE27,186	E	10/1971	Ferdinand	D510,211	S	10/2005	Welborn, Jr.
RE27,200	E	10/1971	Ferdinand et al.	D519,203	S	4/2006	Haas
3,762,789	A	10/1973	Robertson	D522,771	S	6/2006	Berry
3,766,863	A	10/1973	Swick	D528,327	S	9/2006	O'Reilly
D233,294	S	10/1974	Goulder	D534,379	S	1/2007	Juneau
D236,676	S	9/1975	Urti	D534,998	S	1/2007	Charnick
D238,277	S	12/1975	Parker	D536,770	S	2/2007	Mayer
D239,352	S	3/1976	Petrick	D538,406	S	* 3/2007	Mayer
D248,429	S	9/1978	Robinson	D539,057	S	3/2007	Senda
D249,429	S	9/1978	Robinson	D543,057	S	5/2007	Grady
D249,860	S	10/1978	Ungaro	D543,728	S	6/2007	Becker
4,182,244	A	1/1980	Hutchins	D548,488	S	8/2007	Weatherly
D262,847	S	2/1982	Keller	D548,490	S	8/2007	Becker
D269,754	S	7/1983	Kates	D549,991	S	9/2007	Stravitz
D270,858	S	10/1983	McInnes	D554,393	S	11/2007	Yalif
D281,901	S	12/1985	Demrick	D555,397	S	11/2007	Yalif
D283,343	S	4/1986	Haythornthwaite	D559,583	S	1/2008	Zambelli
D303,596	S	9/1989	Goetz	D559,584	S	1/2008	Zambelli
D304,982	S	12/1989	Bush	D560,077	S	1/2008	Zambelli
D305,930	S	2/1990	MacAleese	D560,396	S	1/2008	Weatherly
D319,230	S	8/1991	Sugiyama	D560,930	S	2/2008	Woodward
5,036,778	A	8/1991	Briosi	D561,317	S	2/2008	Ou
D319,743	S	9/1991	Grey	D562,597	S	2/2008	Weatherly
D327,735	S	7/1992	Smith	D564,789	S	3/2008	deCarolis
D328,341	S	7/1992	Chiu	D567,346	S	4/2008	Lin
D329,693	S	9/1992	Mills	D587,483	S	3/2009	Zambelli
D336,184	S	6/1993	Borgen	D587,484	S	3/2009	Domack
D347,754	S	6/1994	Mehlin	D587,497	S	3/2009	Zambelli
D348,576	S	7/1994	Narramore	D588,831	S	3/2009	Mohundro
D348,726	S	7/1994	Wilson	D589,280	S	3/2009	Zambelli
D353,960	S	1/1995	Barfield	D591,533	S	5/2009	Karsson
5,409,122	A	4/1995	Lazarus	7,530,538	B2	5/2009	Whalen
5,452,812	A	9/1995	Niequist	D593,776	S	6/2009	Sexton
D363,841	S	11/1995	Nourse	D594,248	S	6/2009	Zambelli
D364,055	S	11/1995	Pakla	D604,546	S	11/2009	Alman
D364,064	S	11/1995	Lorenz	D605,874	S	12/2009	Zambelli
5,463,966	A	11/1995	Nilsson	D611,727	S	3/2010	Vail
D365,472	S	12/1995	Rehnberg	D614,888	S	5/2010	Sexton
D366,110	S	1/1996	Darr	D618,015	S	6/2010	Sexton
D367,383	S	2/1996	Hatrick-Smith	D620,278	S	7/2010	Zambelli
D373,693	S	9/1996	Elhage	D622,834	S	8/2010	Jiang
5,628,256	A	5/1997	Lazarus	D623,442	S	9/2010	Zambelli
D385,431	S	10/1997	Lee	D623,876	S	9/2010	Zambelli
5,695,081	A	12/1997	Alkalay	D623,877	S	9/2010	Zambelli
D389,343	S	1/1998	Van Der Merwe	D625,123	S	9/2010	Zambelli
D390,936	S	2/1998	French	D630,453	S	1/2011	Rafieha
5,752,500	A	5/1998	Jamieson	D632,902	S	2/2011	Rafieha
5,782,231	A	7/1998	Wade	D638,922	S	5/2011	Zhou
5,833,084	A	11/1998	Chang	7,934,494	B1	5/2011	Schneider
D403,529	S	1/1999	De Blaay	D640,072	S	6/2011	Sexton
D407,577	S	4/1999	Dorst	D641,861	S	7/2011	Okamoto
D408,174	S	4/1999	Aspenwall	D644,853	S	9/2011	Becker
D420,114	S	2/2000	Johnson	D653,051	S	1/2012	Lin
D423,810	S	5/2000	Dorst	D653,739	S	2/2012	Gibbs
D425,330	S	5/2000	O'Hare	D654,289	S	2/2012	Zambelli
6,074,029	A	6/2000	Snoke	D654,995	S	2/2012	Asofsky
				D654,996	S	2/2012	Asofsky
				D655,946	S	3/2012	Sexton
				D658,750	S	5/2012	Nemes

(56)

References Cited

U.S. PATENT DOCUMENTS

D663,137 S	7/2012	Andersen	D834,354 S	11/2018	Davis	
D663,138 S	7/2012	Andersen	D834,355 S	11/2018	Davis	
D665,897 S	8/2012	Martin	D835,437 S	12/2018	Stukenberg	
D666,281 S	8/2012	Nemes	D835,925 S	12/2018	Denby	
D667,654 S	9/2012	Lenney	D838,523 S	1/2019	Yamamoto	
D668,475 S	10/2012	Zambelli	D843,756 S	3/2019	Johnson	
D669,704 S	10/2012	Zambelli	D845,041 S *	4/2019	Davis	D6/675
D669,706 S	10/2012	Zambelli	D845,679 S	4/2019	Li	
D669,707 S	10/2012	Zambelli	D845,683 S	4/2019	Pedersen	
D674,891 S	1/2013	Huang	D848,766 S	5/2019	Chen	
D675,716 S	2/2013	Schwartz	D848,768 S	5/2019	Johnson	
D687,250 S	8/2013	Weatherly	D848,770 S	5/2019	Davis	
D694,873 S	12/2013	Nemes	D849,457 S	5/2019	Kundig	
D696,758 S	12/2013	Ernst	D850,815 S	6/2019	Nicoll	
8,607,776 B2	12/2013	Jansson	D858,148 S	9/2019	Crutcher	
8,813,656 B1	8/2014	Hazzard	2004/0079714 A1	4/2004	Andrew	
D716,288 S	10/2014	O'Heron	2004/0222721 A1	11/2004	Kelley	
D717,081 S	11/2014	Dworman	2004/0237853 A1	12/2004	Sholz	
D717,569 S	11/2014	Davis	2005/0000241 A1	1/2005	Kucera	
D718,957 S	12/2014	Heiser	2005/0103734 A1	5/2005	Saltzberg	
D719,384 S	12/2014	Sowers	2007/0062983 A1	3/2007	Barnett	
D720,563 S	1/2015	Burden	2007/0236111 A1	10/2007	Gray	
D723,148 S	2/2015	Lawrence	2008/0181587 A1	7/2008	Patil	
D723,843 S	3/2015	Lai	2008/0203042 A1	8/2008	Felsenthal	
9,004,060 B2	4/2015	Benedetti	2008/0216817 A1	9/2008	Yungbluth	
D731,823 S	6/2015	Kelinske	2009/0025414 A1	1/2009	Koga	
D736,012 S	8/2015	Davis	2009/0151375 A1	6/2009	Tarr	
D737,418 S	8/2015	Hrydovyy	2009/0170421 A1	7/2009	Adrian	
D738,477 S	9/2015	Nemes	2009/0220221 A1	9/2009	Zhou	
D738,647 S	9/2015	Muller	2010/0307179 A1	12/2010	Fava	
D741,630 S	10/2015	Meissner	2011/0000477 A1	1/2011	Kwon	
D742,142 S	11/2015	Everson	2011/0017691 A1	1/2011	Wu	
D742,662 S	11/2015	Muller	2011/0079688 A1	4/2011	Grove	
D743,192 S	11/2015	Davis	2011/0080261 A1	4/2011	Asofsky	
D746,614 S	1/2016	Sheppard	2011/0120166 A1	5/2011	Nadel	
D747,123 S	1/2016	Zambelli	2011/0220090 A1	9/2011	Atemboski	
D747,788 S	1/2016	Baker	2014/0116418 A1	5/2014	Thomas	
D747,900 S	1/2016	Sheppard	2014/0252939 A1	9/2014	Tunzi	
9,228,742 B2	1/2016	Akiyama	2014/0265754 A1	9/2014	Patterson	
D748,768 S	2/2016	Stanton	2014/0265807 A1	9/2014	Kendall	
D752,905 S	4/2016	Healy	2014/0318529 A1	10/2014	Nielsen	
D753,930 S	4/2016	Vengadakrishnan	2015/0182021 A1	7/2015	Chang	
D757,350 S	5/2016	Levy	2015/0323190 A1	11/2015	Stein	
D758,766 S	6/2016	Kirar	2016/0018112 A1	1/2016	Phillips	
D759,997 S	6/2016	Ruiz	2016/0100698 A1	4/2016	Clark	
D767,752 S	9/2016	Davis	2016/0209102 A1	7/2016	Vulava	
D767,753 S	9/2016	Edmund	2016/0223213 A1	8/2016	Grohova	
D768,413 S	10/2016	Huang	2016/0256032 A1	9/2016	Bhajak	
D773,862 S	12/2016	Davis	2017/0211814 A1	7/2017	Bourne	
D775,866 S	1/2017	Ben Avi	2018/0064246 A1	3/2018	Kassanoff	
D777,479 S	1/2017	Anderson				
D778,641 S	2/2017	Anderson				
D778,646 S	2/2017	Davis				
D783,324 S	4/2017	Akana				
D791,302 S	7/2017	Davis				
D791,522 S	7/2017	Rodd				
D792,132 S	7/2017	Peota				
D793,776 S	8/2017	Davis				
D798,640 S	10/2017	Anderson				
D807,671 S	1/2018	Caillouet				
D808,203 S	1/2018	Davis				
D808,688 S	1/2018	Everson				
D808,690 S	1/2018	Hsu				
D812,938 S	3/2018	Moore				
D814,410 S	4/2018	Emslie				
D817,037 S	5/2018	Davis				
D817,038 S	5/2018	Davis				
D817,040 S	5/2018	Davis				
D817,666 S	5/2018	Davis				
D817,667 S	5/2018	Davis				
D821,038 S	6/2018	Rathman				
D824,703 S	8/2018	Yamamoto				
D825,233 S	8/2018	Yamamoto				
D825,959 S	8/2018	Rockwell				
D833,782 S	11/2018	Amacher				

OTHER PUBLICATIONS

U.S. Appl. No. 29/611,963, filed Jul. 27, 2017, Davis.
 U.S. Appl. No. 29/634,946, filed Jan. 25, 2018, Davis.
 U.S. Appl. No. 29/634,903, filed Jan. 25, 2018, Davis.
 U.S. Appl. No. 29/654,941, filed Jun. 28, 2018, Davis.
 U.S. Appl. No. 29/654,935, filed Jun. 28, 2018, Davis.
 U.S. Appl. No. 29/654,950, filed Jun. 28, 2018, Davis.
 U.S. Appl. No. 29/656,499, filed Jul. 12, 2018, Davis.
 U.S. Appl. No. 29/656,479, filed Jul. 12, 2018, Davis.
 U.S. Appl. No. 29/656,485, filed Jul. 12, 2018, Davis.
 U.S. Appl. No. 29/656,497, filed Jul. 12, 2018, Davis.
 Electric fireplace, image post date May 26, 2014, site visited Aug. 8, 2016, (online), <<https://www.tineye.com/search/3c3d0c0fb7030b3079ebefa0774a5b4e94120332/?pluginver>>.
 Media Console with Electric Fireplace, image post date Dec. 6, 2015, site visited Aug. 8, 2016, (online), <<http://www.overstock.com/Home-Garden/Media-Console-with-Electric-Fireplace-in-Barnwood/10309735/product.html?recset=05953330-aaa1-4640-a796-f225c2f8176d&refccid=MRISGGB2MZGZXYKK4EFV125H6Q&recalg=809,828,512&recidx=1#reviews>>.
 Tv Stand With Fireplace, image post date Sep. 12, 2015, site visited Aug. 8, 2016, (online), <<https://www.tineye.com/search/77be8934bf07249cbb245c8ea0f719199437b185/>>.

(56) **References Cited**

OTHER PUBLICATIONS

Walker Edison TV Stand with Fireplace Insert, image post date Jul. 31, 2015, site visited Aug. 8, 2016, (online), <<https://www.amazon.com/Walker-Edison-Fireplace-Insert-Espresso/dp/B0OPNONTAK>.

Manchester Fireplace TV Console, image post date Dec. 17, 2015, site visited Aug. 8, 2016, (online), <<http://www.walmart.com/ip/Manchester-Media-Fireplace-Stand-for-TVs-up-to-70/46360223>.

Monet Fireplace; Canadian Tire Company website: <http://www.canadiantire.ca/en/pdp/monet-fireplace-0643572p.html>; retrieved on Dec. 21, 2016.

TV and Media Consoles, image post date Sep. 21, 2013, site visited Oct. 26, 2016, (online), <<http://web.archive.org/web/20130921074219/http://www.electrificfireplacesdirect.com/Gallery/tv-and-media-consoles.html>>.

"Kendall Electric Media Fireplace—Espresso" Dec. 24, 2012, amazon.com, site visited Mar. 6, 2018 <http://www.amazon.com/Kendall-Electric-Media-Fireplace-Espresso/dp/B009LIT6XQ/ref=cm_cr_ar_p_d_product_top?ie=UTF8>(Year: 2012).

"Whalen Media Fireplace Console for TVs up to 70" Gray" Nov. 24, 2015, walmart.com, site visited Mar. 6, 2018 <<https://www.walmart.com/ip/Whalen-Media-Fireplace-Console-for-TVs-up-to-70-Gray/54189794>> (Year: 2015).

"Boston Loft Furnishings . . ." Nov. 7, 2016, themine.com, site visited Mar. 2, 2018 <https://www.themine.com/tv-stands/boston-loft-furnishings-reamrock-infrared-electric-fireplace-media-stand-with-convertible-corner_g2733659.html> (Year: 2016).

"Ameriwood Home Everett 70-inch . . ." Dec. 6, 2016, overstock.com, site visited Mar. 2, 2018 <<http://www.overstock.com/Home-Garden/Ameriwood-Home-Everett-70-inch-Sonoma-Oak-TV-Stand-with-Glass-Doors/12710691/product.html>> (Year: 2016).

Metal Coffee Table; <https://www.overstock.com/Home-Garden/42-Metal-Coffee-Table-42-x-24-x-18h/15951452/product.html> Retrieved on Nov. 13, 2018.

Modern Two-Tone Writing Desk; <https://www.overstock.com/Home-Garden/44-Modern-Two-Tone-Writing-Desk/19684325/product.html> Retrieved on Nov. 13, 2018.

U.S. Appl. No. 29/654,936, filed Jun. 19, 2019, Notice of Allowance.

U.S. Appl. No. 29/656,479, filed Jun. 27, 2019, Notice of Allowance.

U.S. Appl. No. 29/654,930, filed Jun. 28, 2018, Davis.

U.S. Appl. No. 29/654,936, filed Jun. 28, 2018, Davis.

U.S. Appl. No. 29/654,952, filed Jun. 28, 2018, Davis.

U.S. Appl. No. 29/656,492, filed Jul. 12, 2018, Davis.

U.S. Appl. No. 29/656,489, filed Jul. 12, 2018, Davis.

U.S. Appl. No. 29/634,889, filed Jan. 25, 2018, Davis.

U.S. Appl. No. 29/677,722, filed Jan. 23, 2019, Davis.

U.S. Appl. No. 29/677,723, filed Jan. 23, 2019, Davis.

U.S. Appl. No. 29/677,724, filed Jan. 23, 2019, Davis.

U.S. Appl. No. 29/677,738, filed Jan. 23, 2019, Davis.

U.S. Appl. No. 29/677,755, filed Jan. 23, 2019, Davis.

U.S. Appl. No. 29/677,761, filed Jan. 23, 2019, Davis.

Czapla TV Stand for TVs up to 65"; <https://www.allmodern.com/furniture/pdp/mercury-row-czapla-tv-stand-for-tvs-up-to-65-a000303456.html> ; Retrieved on May 7, 2019.

Nelson Media Cabinet; <https://www.franceandson.com/collections/storage-shelving-media-cabinets/products/nelson-media-cabinet36051> ; Retrieved on May 7, 2019.

Hal TV Stand for TVs up to 60"; <https://www.allmodern.com/furniture/pdp/hal-tv-stand-for-tvs-up-to-60-a000176456.html> ; Retrieved on May 7, 2019.

Wigington TV Stand for TVs up to 60"; <https://www.allmodern.com/furniture/pdp/wigington-tv-stand-for-tvs-up-to-60-golv3670.html?piid> ; Retrieved on May 7, 2019.

Cliffmay Slat Media Stand Light Oak Brown—Project 62; https://www.target.com/p/cliffmay-slat-media-stand-light-oak-brown-project-62-153/-/A-53517373?ref=tgt_adv_XS000000&AFID=google_pla_df&fndsrc=tgtao&CPNG=PLA_Furniture%2BShopping_Priority%2BBrands&adgroup=SC_Project+62&Lid=700000001170770pgs

&network=g&device=c&location=9029756&gclid=aw.ds&ds_rl=1246978&ds_rl=1247068&ds_rl=1246978&ref=tgt_adv_XS000000&AFID=google_pla_df&CPNG=PLA_Furniture+Shopping_Priority+Brands&adgroup=SC_Project%2062&Lid=700000001170770pgs&network=g&device=c&location=9029756&gclid=EAIAIqobChMI7Nb9wo-H3wIVByIpCh1fSg4IEAQYBSABEGKyPD_BwE&gclid=aw.ds ; Retrieved on May 7, 2019.

Audrey Woven Media Console 65"; <https://www.zinhome.com/audrey-woven-media-console-65/> ; Retrieved on May 14, 2019.

Demilune Mesh Door Industrial Sideboard; https://belleescape.com/demilune-mesh-wire-door-industrial-chic-sideboard.html?_SID=U ; Retrieved on May 14, 2019.

Tuk Cabinet; <https://blackroosterdecor.com/collections/storage/products/tuk-cabinet> ; Retrieved on May 14, 2019.

Rustic Style 31 Inches Metal TV Stand With Wire Mesh Doors Cabinet, Black; <https://casagear.com/products/rustic-style-31-inches-metal-tv-stand-with-wire-mesh-doors-cabinet-black>; May 14, 2019.

Geo-Marquetry Buffet; https://www.anthropologie.com/shop/geo-marquetry-buffet?adpos=1o27&adtype=pla&cm_mmc=Google-_-US%20-%20Shopping%20-%20Furniture-_-Organizing%20and%20Storage-_-42699934&color=&countryCode=US &creative=191389729567&device=c&gclid=

EAIAIqobChMivITGgYOH3wIVEdNkCh3t8wRPEAkYgYABEGJG_PD_BwE&inventoryCountry=US&matchtype=&mrkgadid=3202938336&mrkg1=694&network=g&product_id=42699934&quantity=1&size=ALL&type=Standard&utm_campaign=US%20-%20Shopping%20-%20Furniture&utm_content=42699934&utm_medium=paid_search&utm_source=Google&utm_term=Organizing%20and%20Storage; Retrieved on May 14, 2019.

Suspend II Media Console; <https://www.cb2.com/suspend-ii-media-console/s23915>; Retrieved on May 14, 2019.

Hooker Furniture Melange Mirrored Angle Console; https://www.furniturecrate.com/hooker-melange-mirrored-angle-console.html?gdftrk=gdfv21650_a_7c92_a_7c8357_a_7c654170&gclid=CjwKEAiA05unBRCymrGilanF9SwSjACqDFRm1WwgePUsp65sXRC14RkJfScYn--yCjNuB-GTt3W-FxoCQL7w_wcB; Retrieved on May 14, 2019.

FurnitureMaxx Besteen Contemporary Wood Dark Gray Dining Room Server; https://www.amazon.com/dp/B07GVS1VK2/ref=cm_sw_r_pi_dp_U_x_evuOBbFM3298G; Retrieved on May 14, 2019.

Jaydyn Media TV Stand/Credenza; https://www.macys.com/shop/product/jaydyn-media-tv-stand-credenza?ID=2883210&CategoryID=35319#fn=FURNITURE_CATEGORY=Buffet%20&%20Sideboards&SIZE=&sp=3&spc=131&ruleId=129%7CBOOST%20ATTRIBUTE%7CBOOST%20SAVED%20SET&searchPass=matchNone&slotId=2; Retrieved on May 14, 2019.

Sideboard; <https://www.allmodern.com/furniture/pdp/sideboard-set11710.html>; Retrieved on May 14, 2019.

Belham Living Trenton Industrial End Table; https://www.hayneedle.com/product/belham-living-trenton-industrial-end-table-new.cfm?source=pla&kwid=OccasionalTables%20iprefer&tid=REDU113-1&adtype=pla&kw=&gclid=EAIAIqobChMIvOu-6veI3wVB8ZkCh0ZdAfEakYAyABEGLyMfD_BwE; Retrieved on May 15, 2019.

Belham Living Hampton Chair Side Table—Black; <https://www.hayneedle.com/product/belham-living-hampton-chair-side-table-black.cfm>; Retrieved on May 15, 2019.

International Concepts Hampton End Table; https://www.hayneedle.com/product/internationalconcepts-hampton-end-table.cfm?source=pla&kwid=OccasionalTables%20level05&tid=WW1545-1&adtype=pla&kw=&gclid=EAIAIqobChMIpsnoq_m3wIVGNVCh348gtDEAKYIiABEGLP7fD_BwE; Retrieved on May 15, 2019.

Hampton Weathered Taupe Gray Coffee Table; https://www.homedepot.com/p/International-Concepts-Hampton-Weathered-Taupe-Gray-Coffee-Table-OT09-70C/302946359?MERCH=REC_-PIPHorizontal2_nr_-204737265_-302946359_-N; Retrieved on May 15, 2019.

Convenience Concepts Oxford Rectangle Coffee Table; <https://www.hayneedle.com/product/convenience-concepts-oxford-rectangle-coffee-table.cfm?source=pla&kwid=OccasionalTables%20newsus>

(56)

References Cited

OTHER PUBLICATIONS

&tid=CONV338-5&adtype=pla&kw=&gclid=EAlaIQobChMhuzv9_mI3wIVWx-tBh1rUAItEAKYHyABEgJ2hPD_B wE; Retrieved on May 15, 2019.

Belham Living Jamestown Rustic Coffee Table with Unique Driftwood Finish; <https://www.hayneedle.com/product/jamestown-rustic-coffee-table.cfm>; Retrieved on May 15, 2019.

Restriction Requirement for U.S. Appl. No. 29/654,950 dated Sep. 25, 2019.

Office Action for U.S. Appl. No. 29/656,489 dated Sep. 25, 2019.

Office Action for U.S. Appl. No. 29/656,497 dated Sep. 25, 2019.

Office Action for U.S. Appl. No. 29/656,499, dated Sep. 26, 2019.

Notice of Allowance for U.S. Appl. No. 29/656,485 dated Oct. 2, 2019.

* cited by examiner

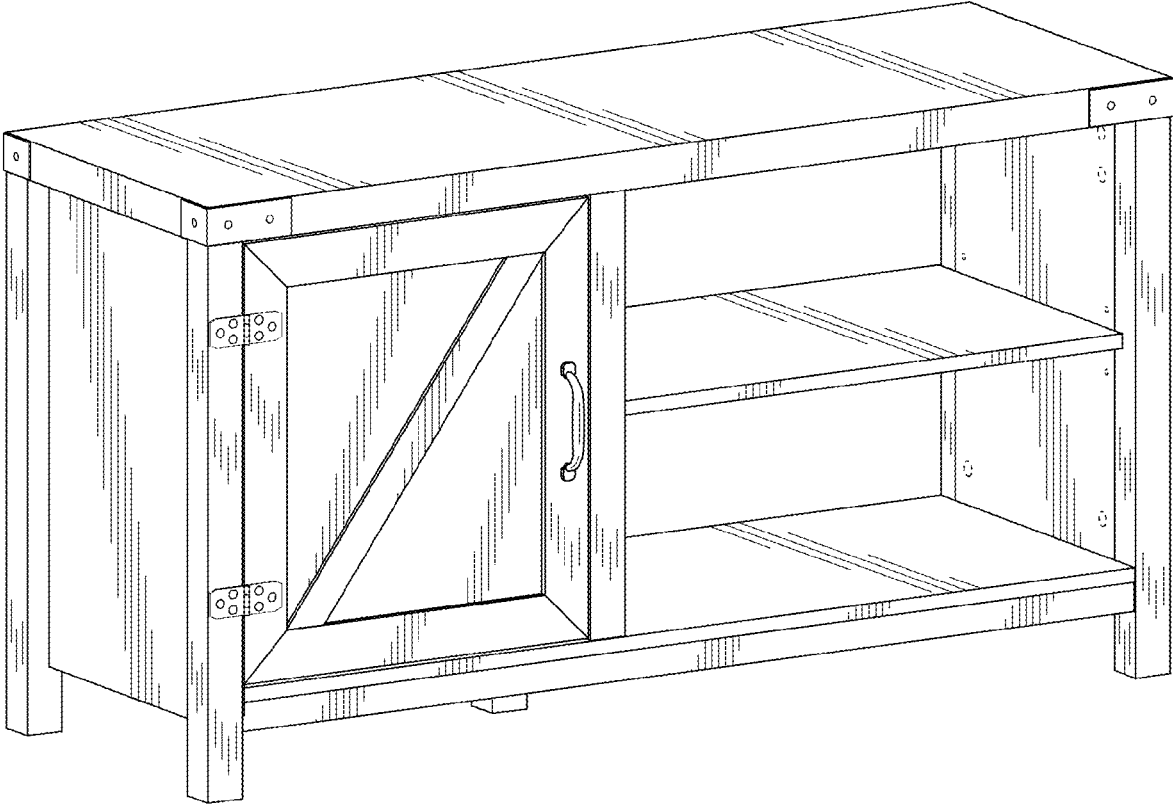

FIG. 1

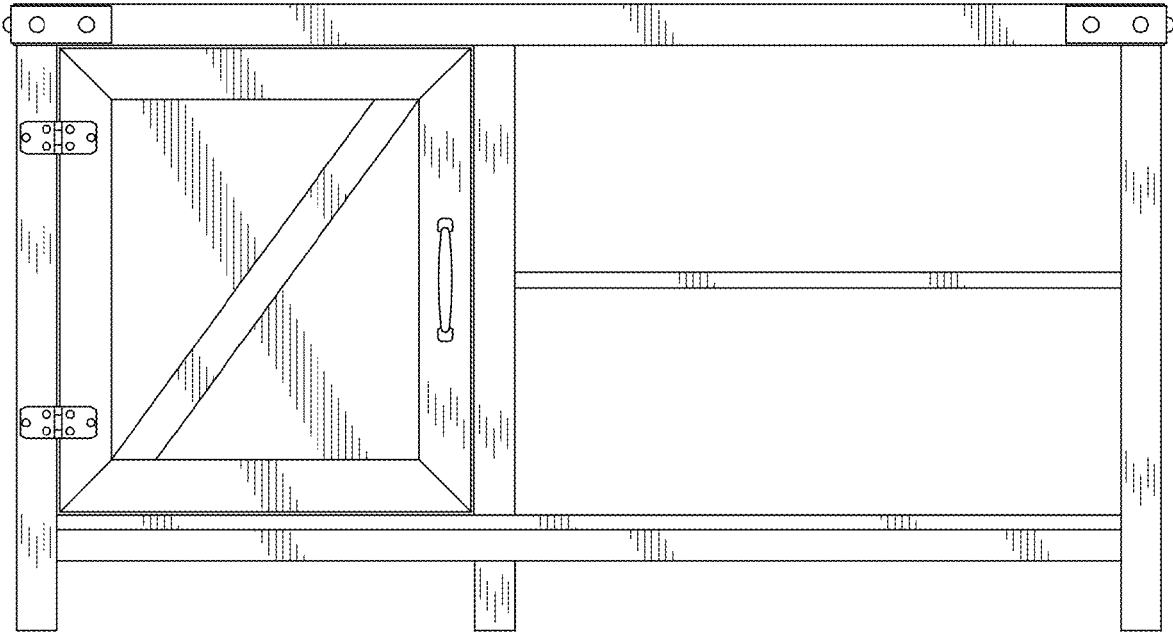

FIG. 2

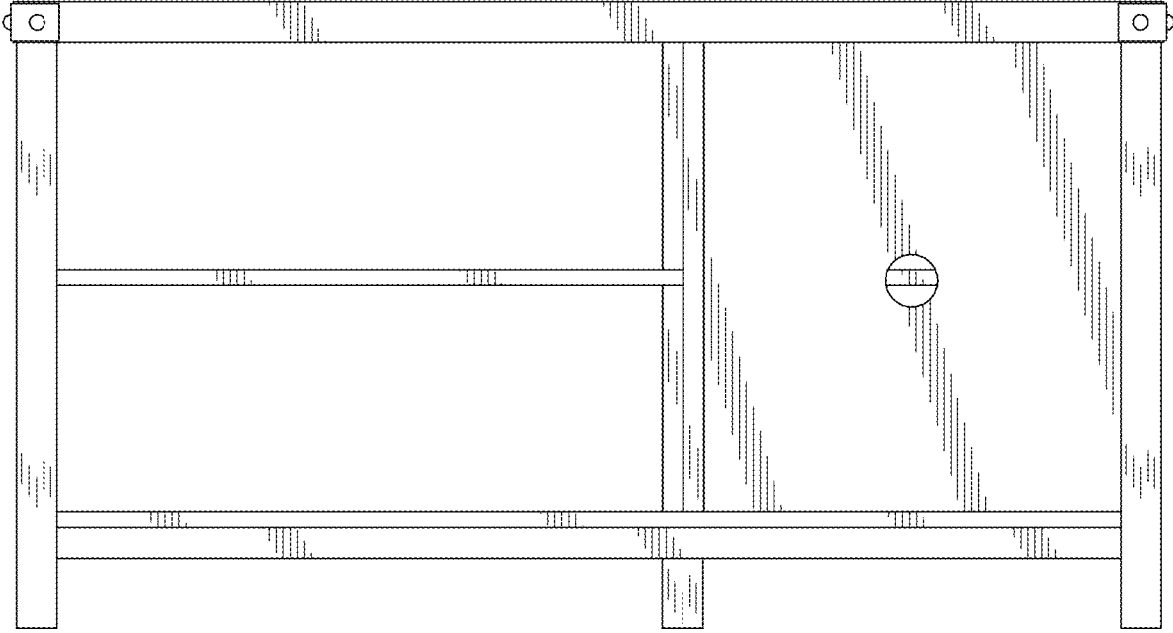

FIG. 3

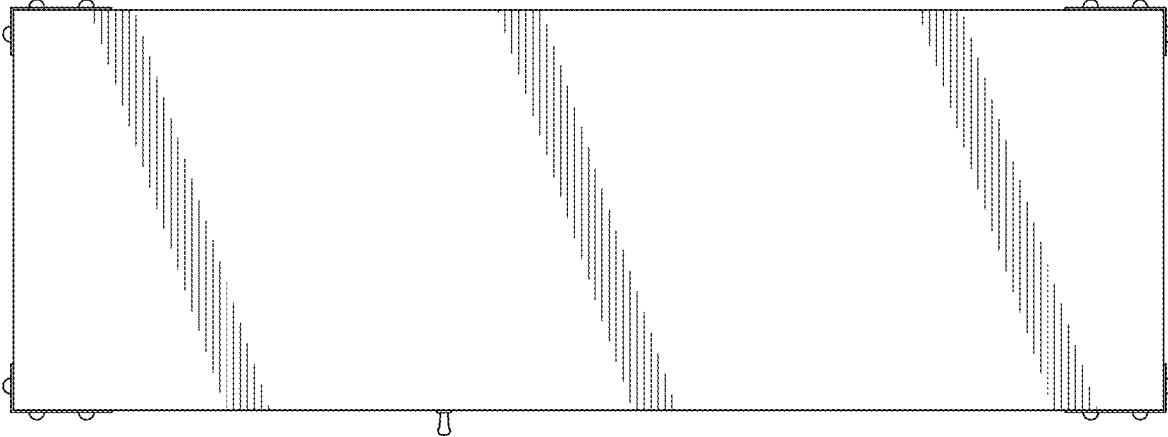

FIG. 4

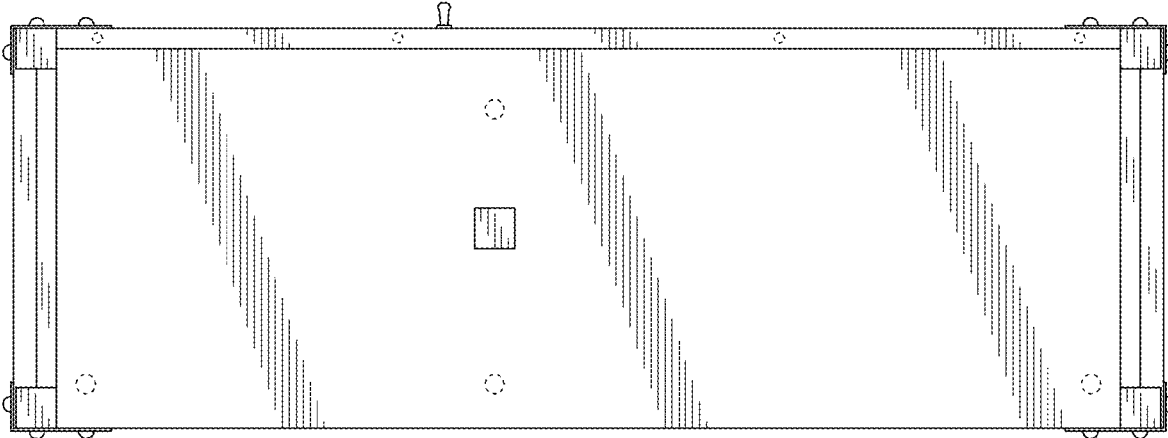

FIG. 5

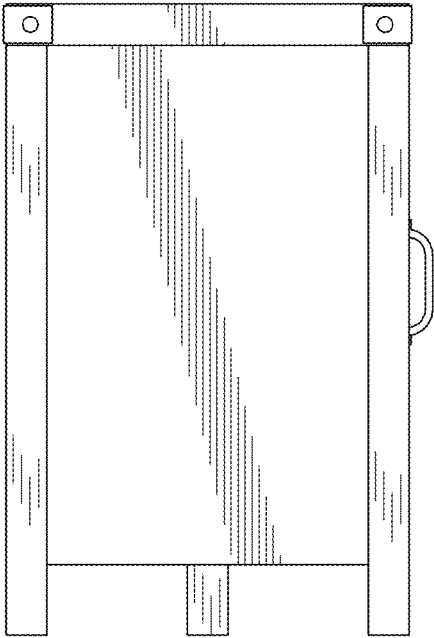

FIG. 6

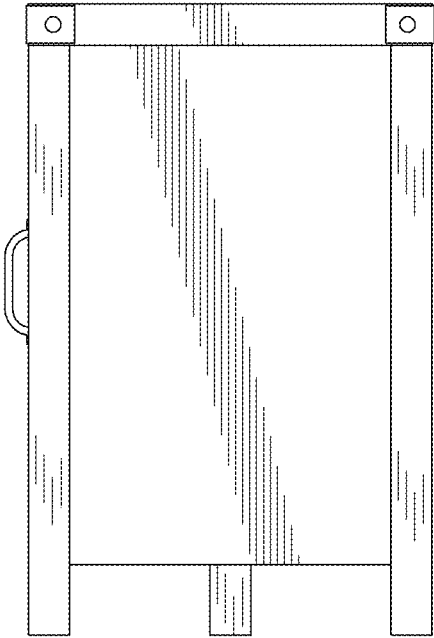

FIG. 7

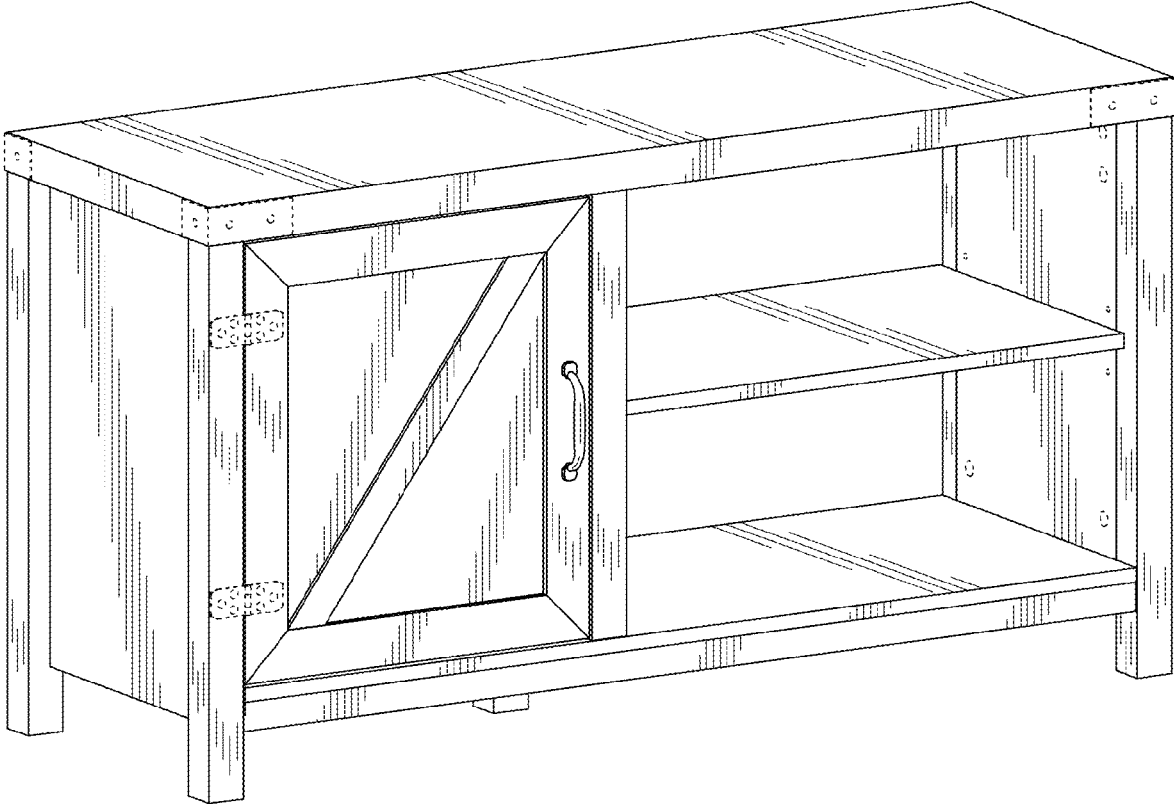

FIG. 8

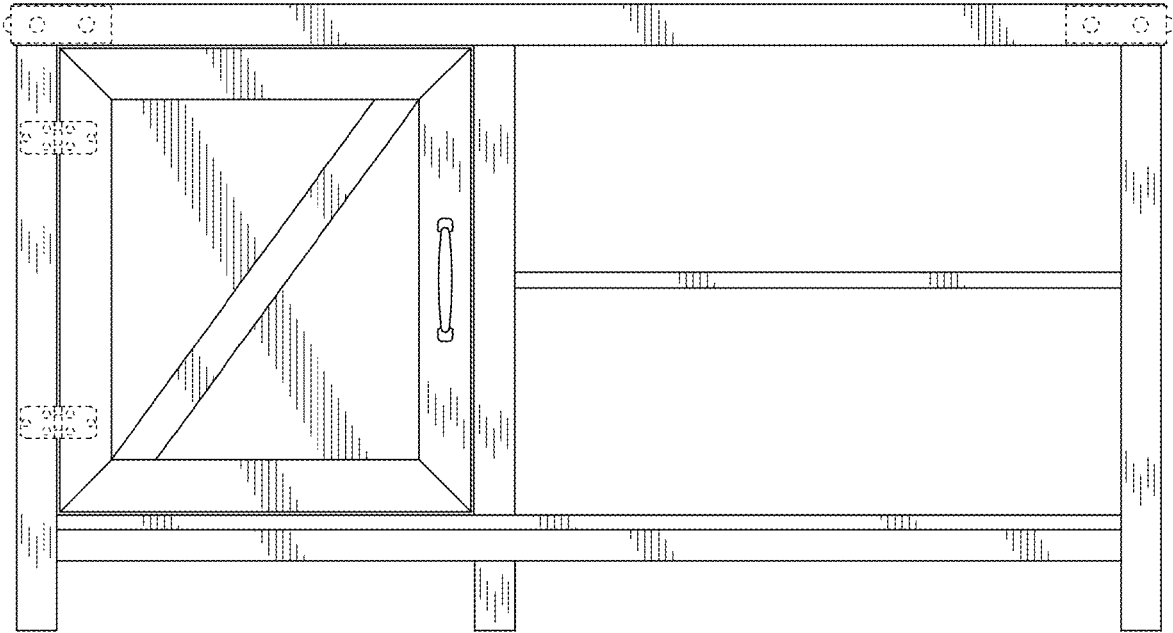

FIG. 9

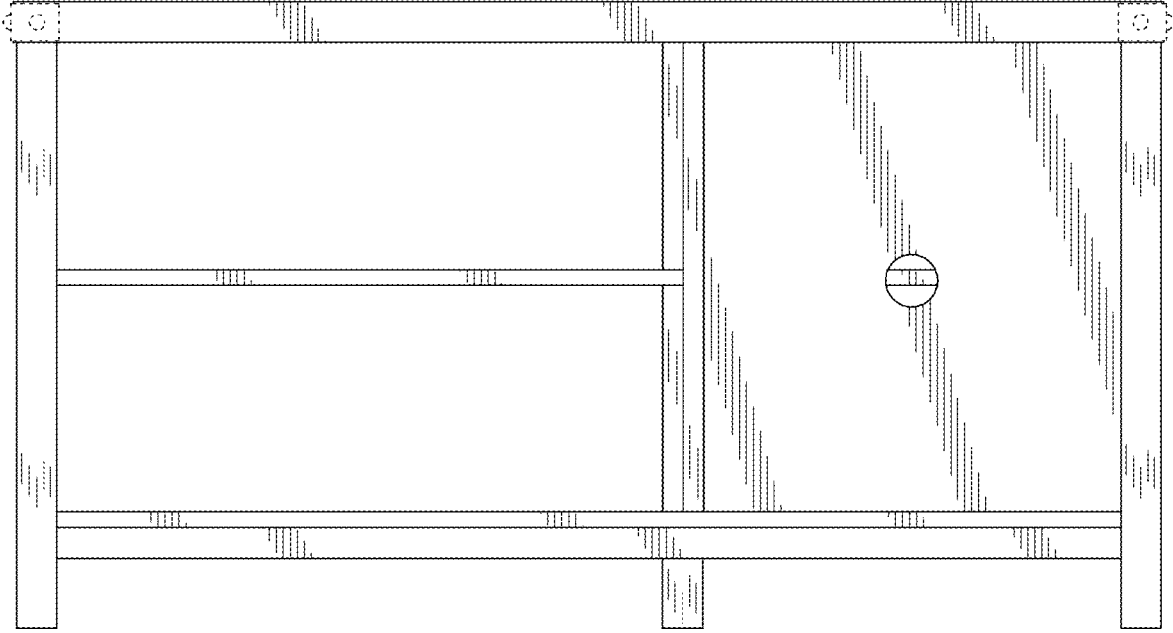

FIG. 10

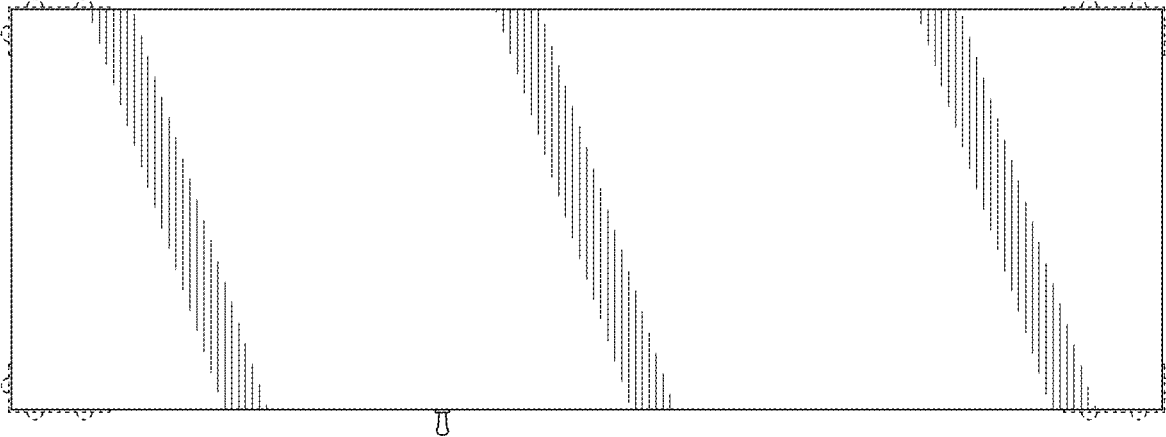

FIG. 11

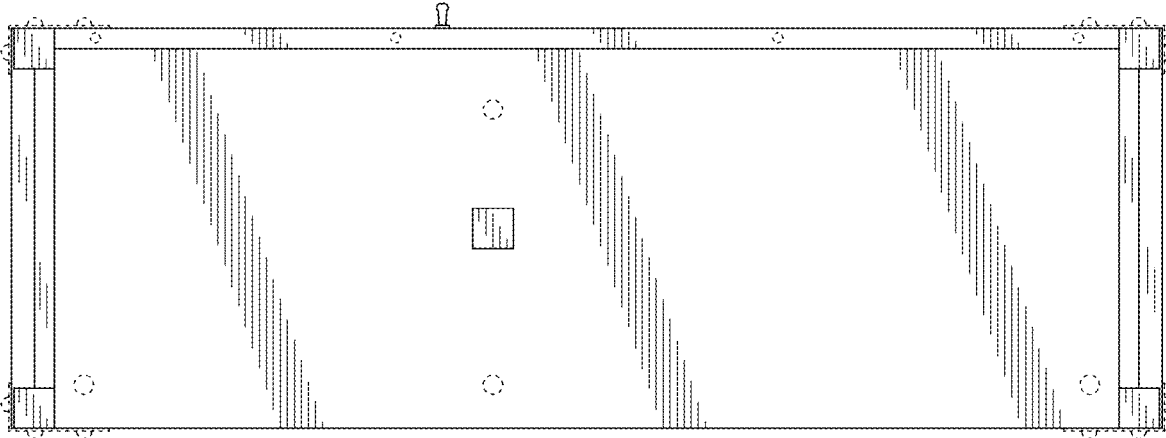

FIG. 12

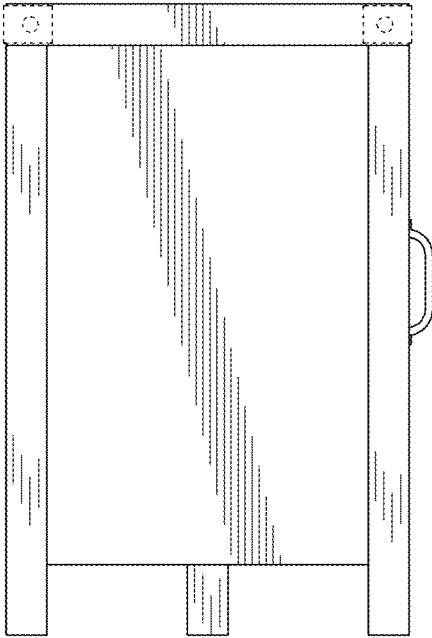

FIG. 13

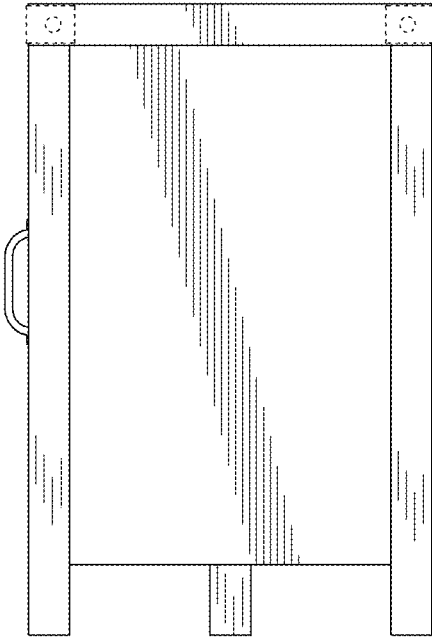

FIG. 14