



US00D409789S

United States Patent [19]
Crosby

[11] **Patent Number: Des. 409,789**

[45] **Date of Patent: ** May 11, 1999**

[54] **CEILING LAMP**

[75] Inventor: **Doyle Crosby**, Richmond, Calif.

[73] Assignee: **Boyd Lighting Company**, San Francisco, Calif.

[**] Term: **14 Years**

[21] Appl. No.: **29/086,185**

[22] Filed: **Apr. 9, 1998**

[51] **LOC (6) Cl.** **26-05**

[52] **U.S. Cl.** **D26/88; D26/85**

[58] **Field of Search** **D26/72, 80, 81,**
D26/82, 83, 84, 85, 86, 88, 89, 90; 362/147,
404-408

[56] **References Cited**

PUBLICATIONS

Ampinco Electric Fixture Parts catalog, p. 49, holder # 12793, Nov. 1927.

Arcraft Horizon lighting catalog, p. 90, wall lamp #AC6536, 1992.

Beardsley Chandelier Mfg. Co. lighting catalog, p. 9, ceiling lamp # S9-39, 1929.

Progress lighting catalog, p. 35, ceiling lamp # P 3408, 1962.

Thomas Lighting catalog, p. 80, ceiling lamp # M-1563, 1979.

Primary Examiner—Susan J. Lucas

Attorney, Agent, or Firm—Jack Lo

[57] **CLAIM**

The ornamental design for a ceiling lamp, as shown and described.

DESCRIPTION

FIG. 1 is a bottom perspective view of a ceiling lamp showing a first embodiment of my new design.

FIG. 2 is a front view thereof; the rear, left, and right side views are identical thereto.

FIG. 3 is a bottom view thereof; the top view is not a part of the claimed design.

FIG. 4 is a bottom perspective view of a second embodiment.

FIG. 5 is a front view thereof; the rear, left, and right side views are identical thereto.

FIG. 6 is a bottom view thereof; the top view is not a part of the claimed design.

FIG. 7 is a bottom perspective view of a third embodiment.

FIG. 8 is a front view thereof; the rear, left, and right side views are identical thereto.

FIG. 9 is a bottom view thereof; the top view is not a part of the claimed design.

FIG. 10 is a bottom perspective view of a fourth embodiment.

FIG. 11 is a front view thereof; the rear, left, and right side views are identical thereto; and,

FIG. 12 is a bottom view thereof; the top view is not a part of the claimed design.

1 Claim, 10 Drawing Sheets

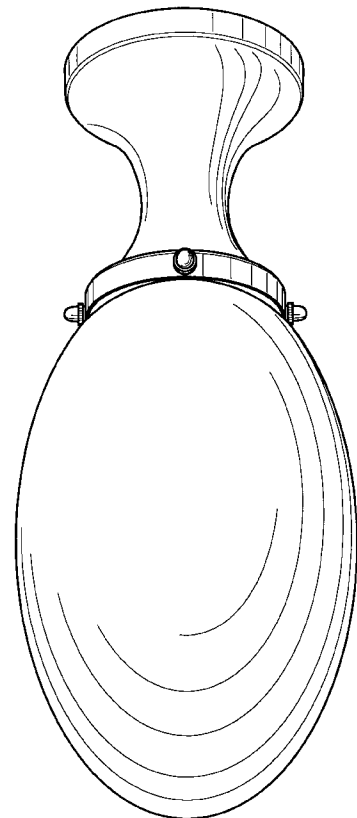
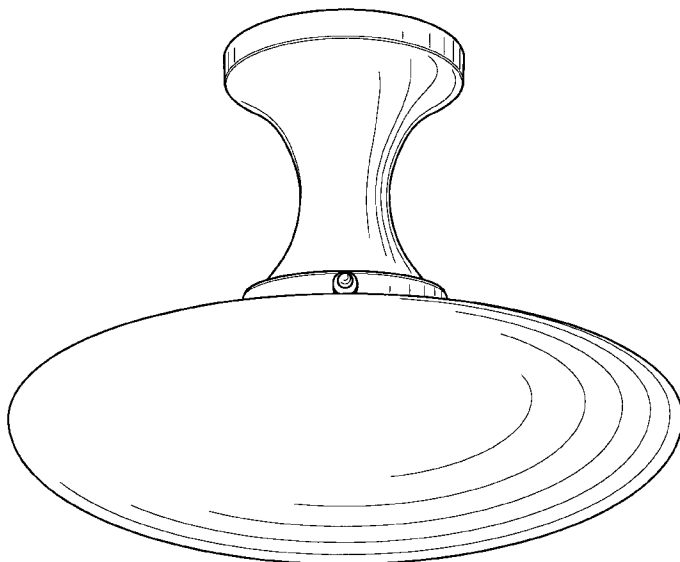

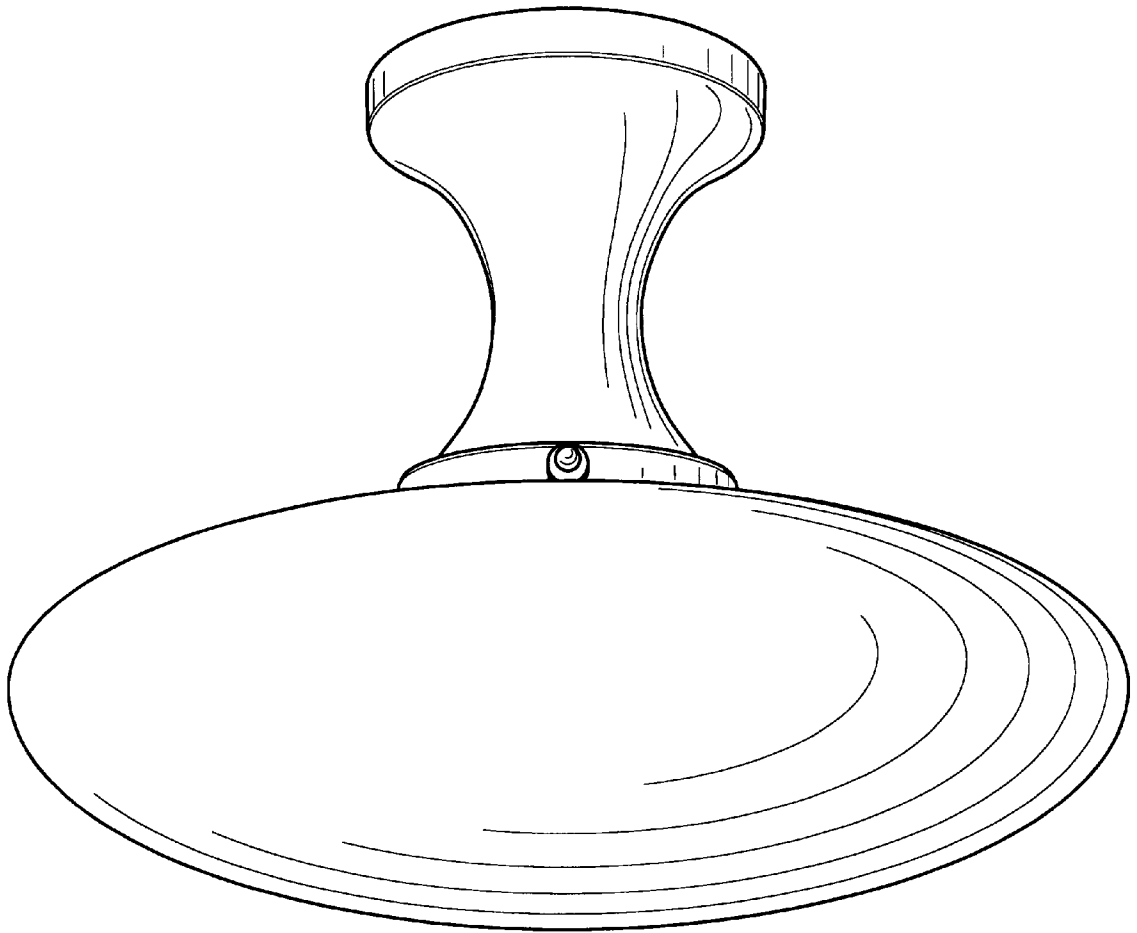

Fig. 1

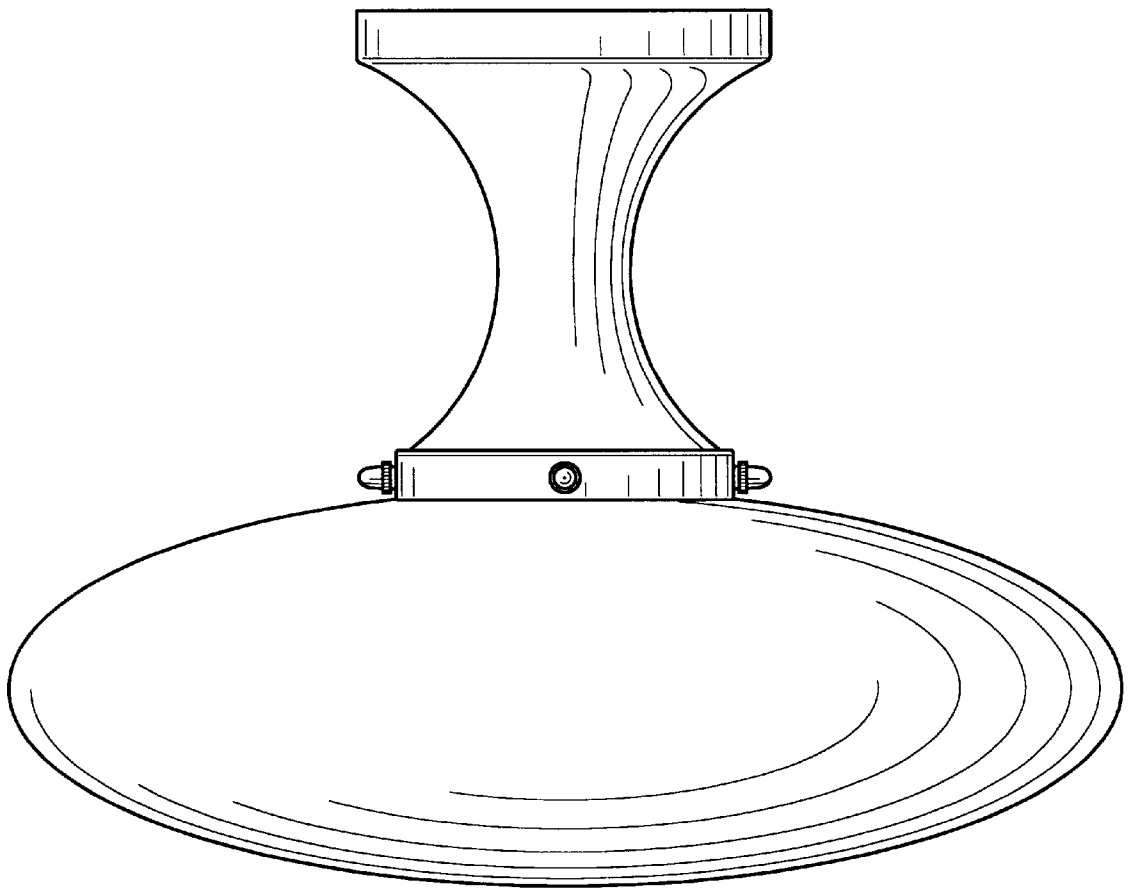

Fig. 2

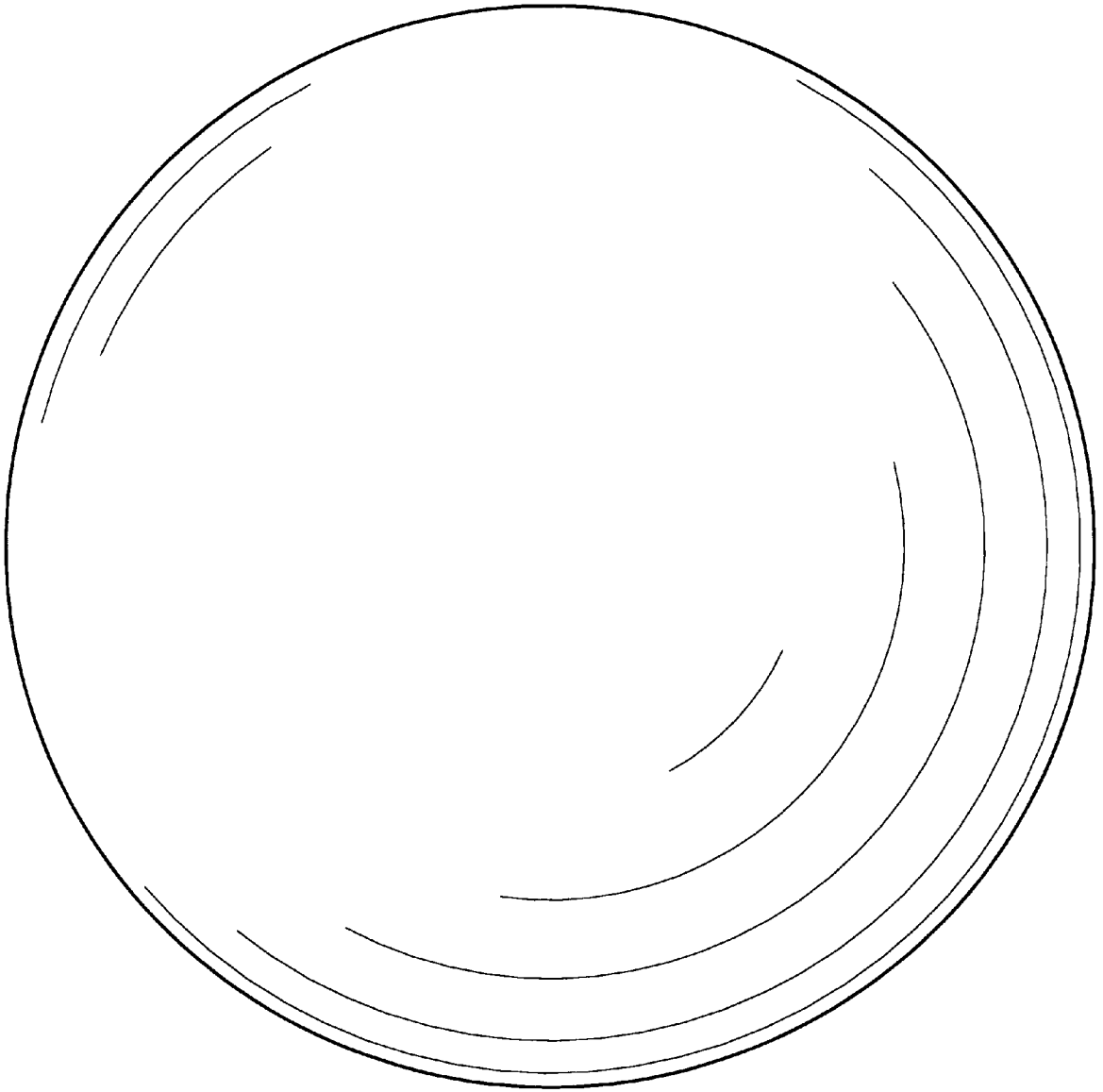

Fig. 3

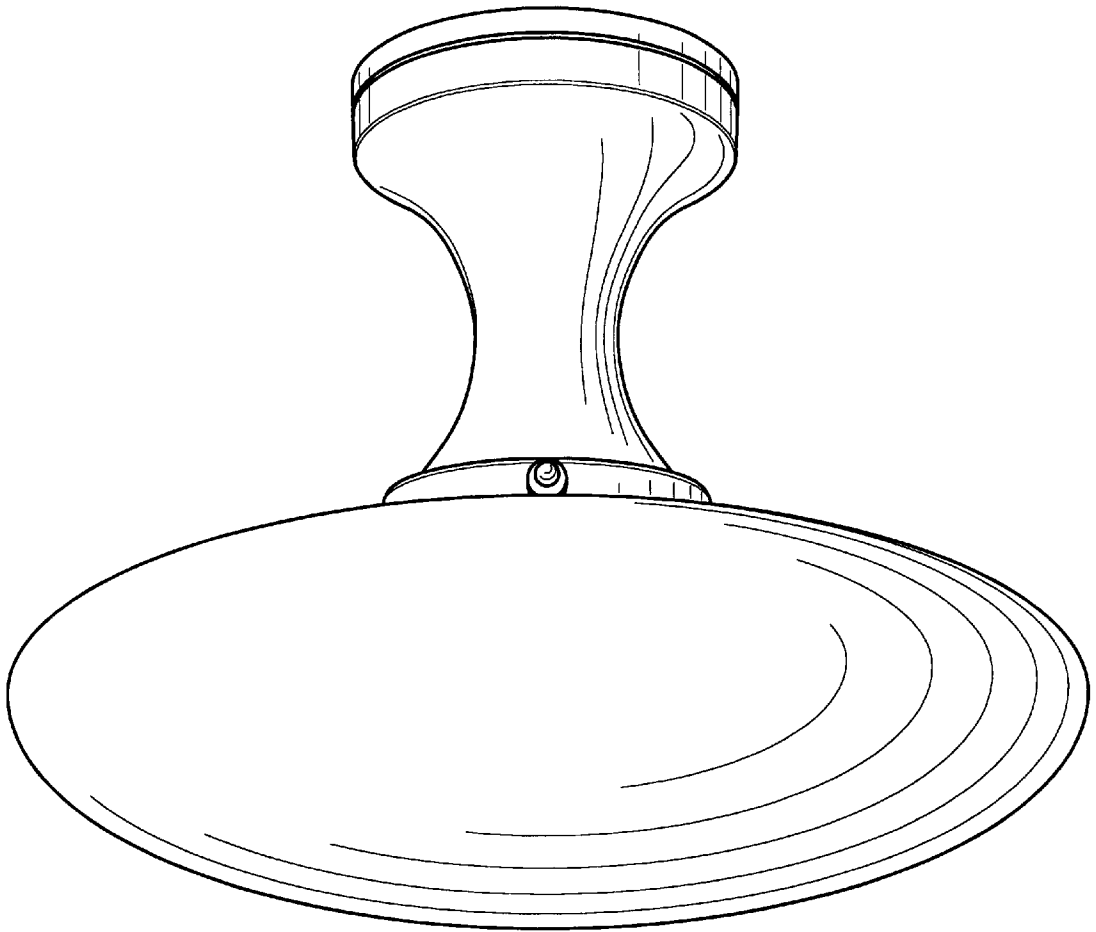

Fig. 4

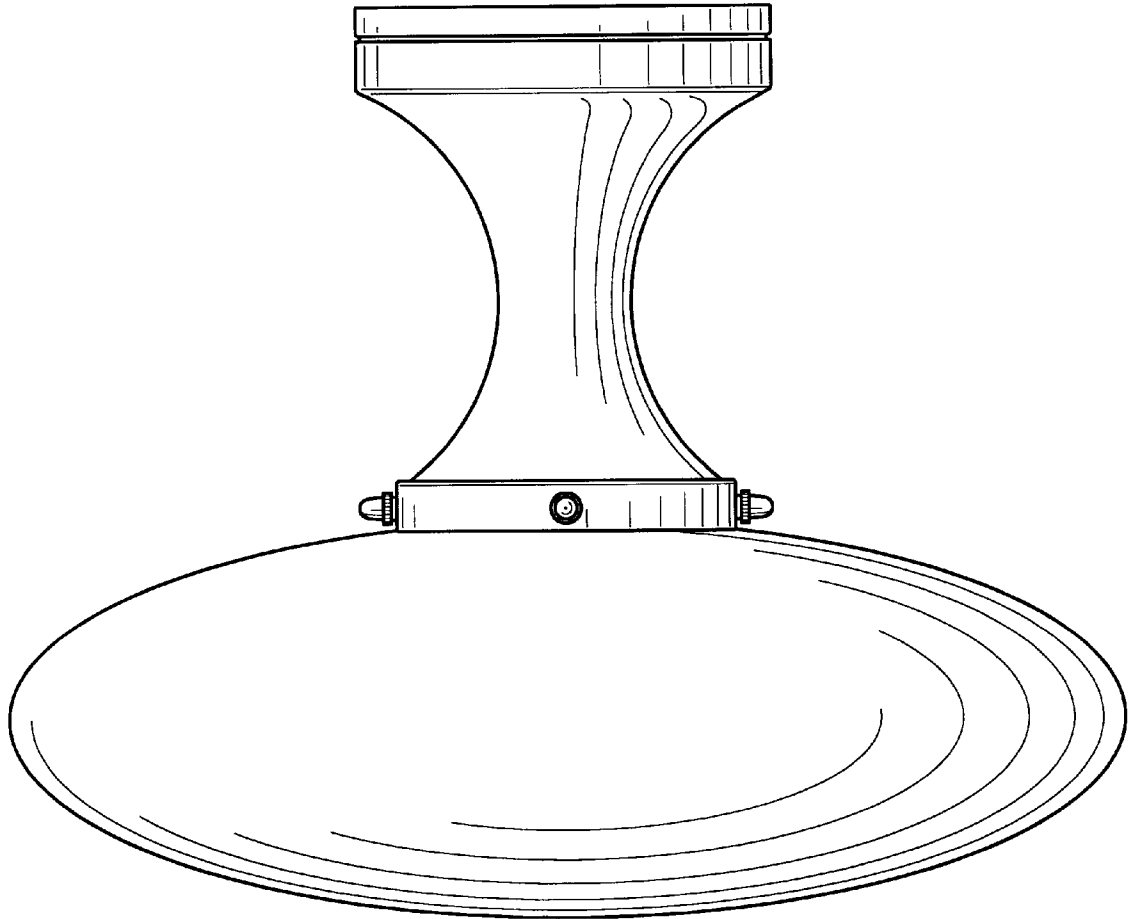

Fig. 5

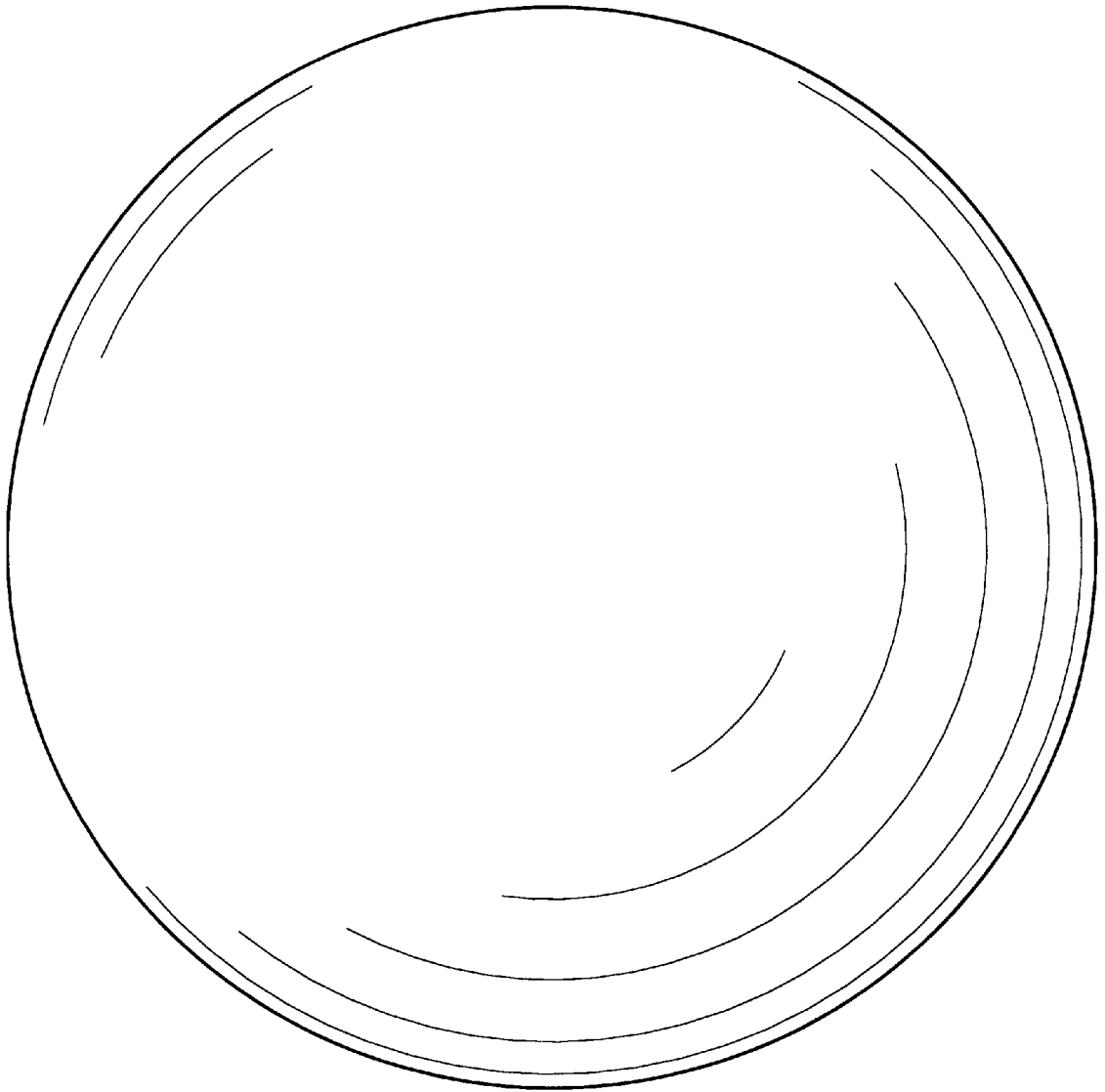

Fig. 6

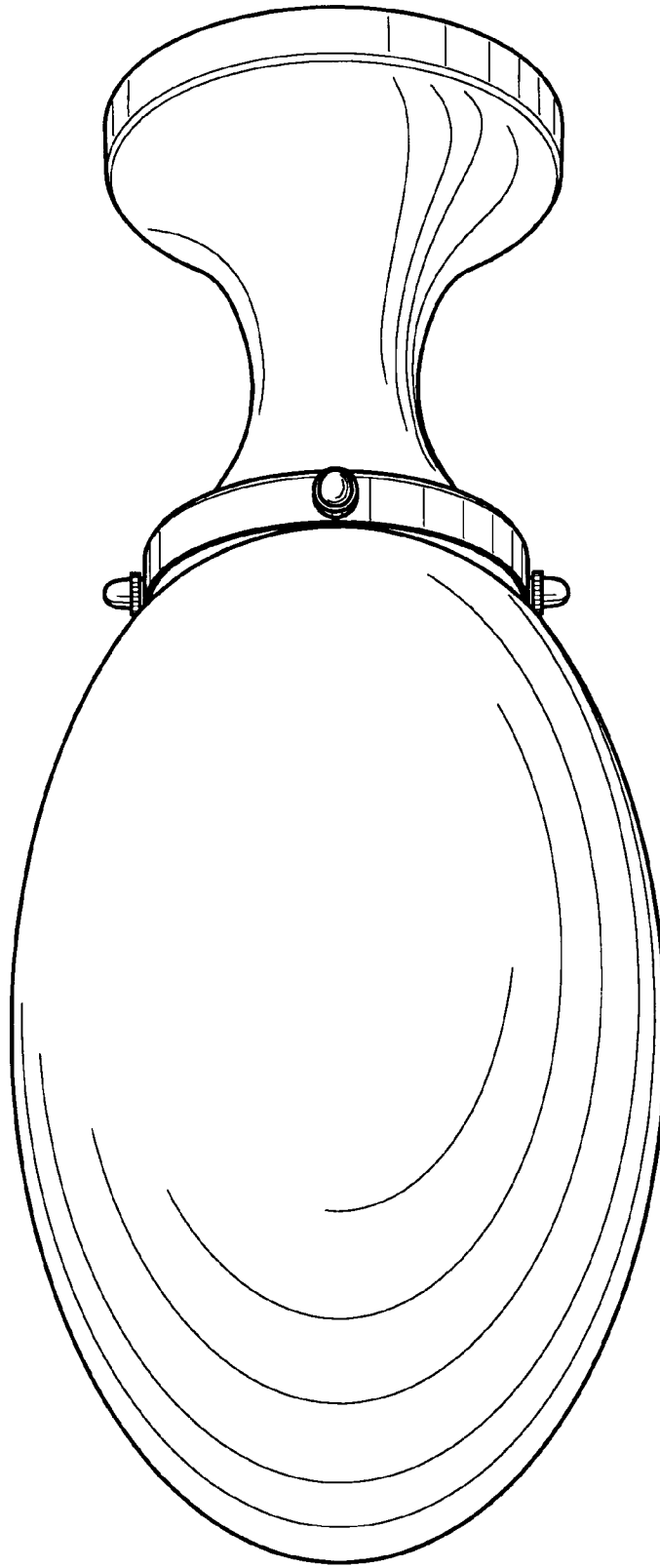

Fig. 7

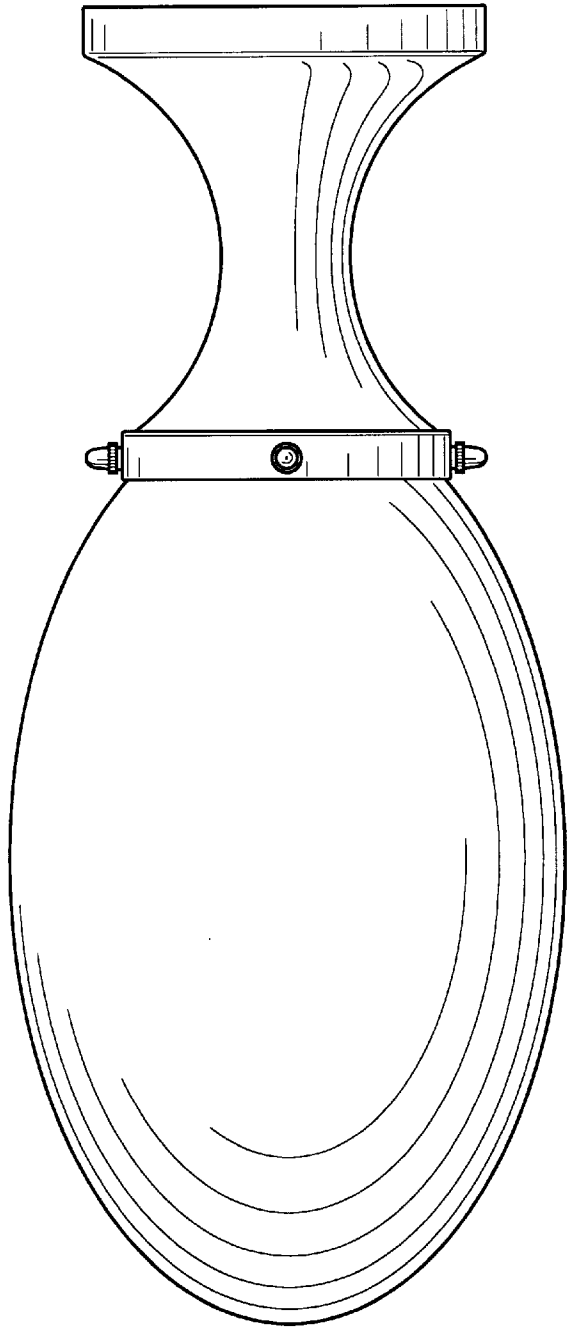

Fig. 8

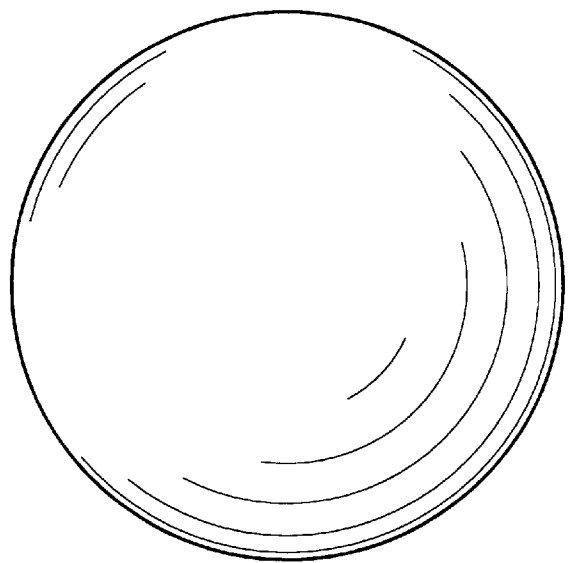

Fig. 9

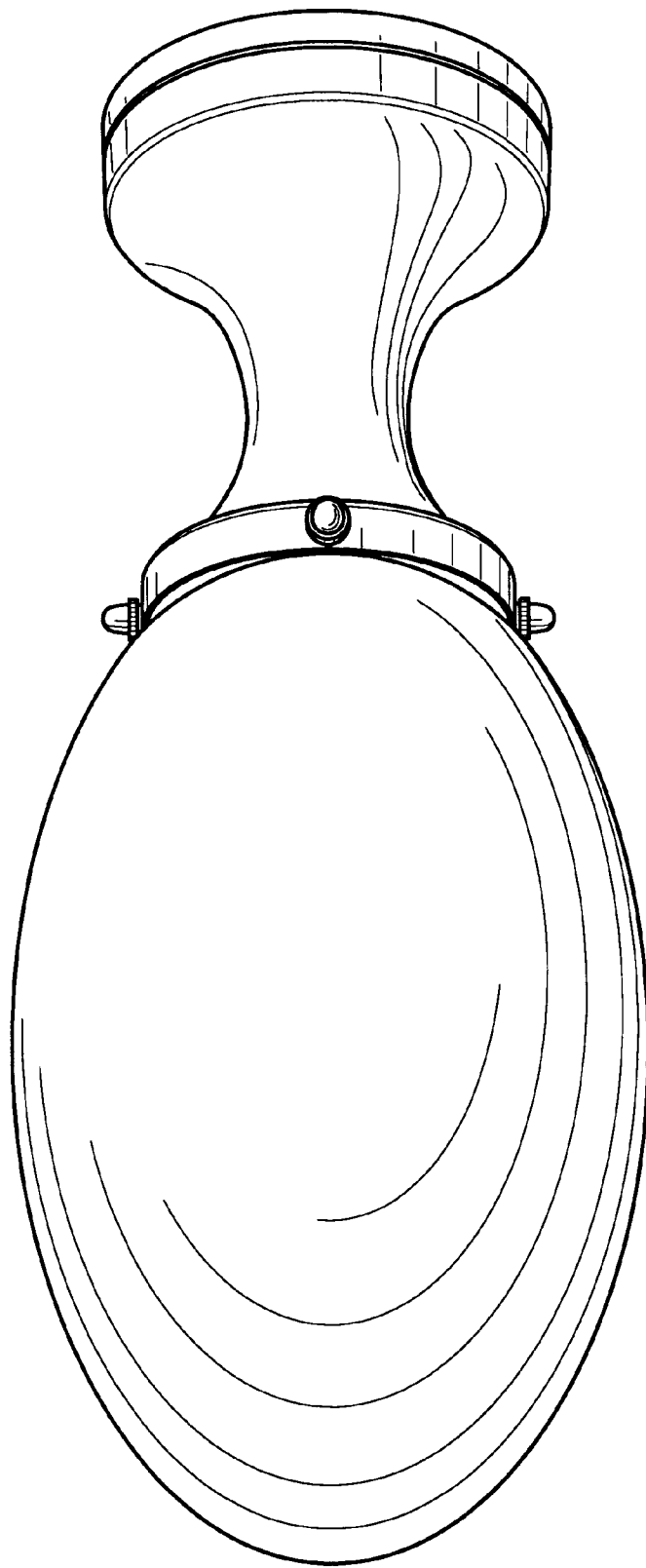

Fig. 10

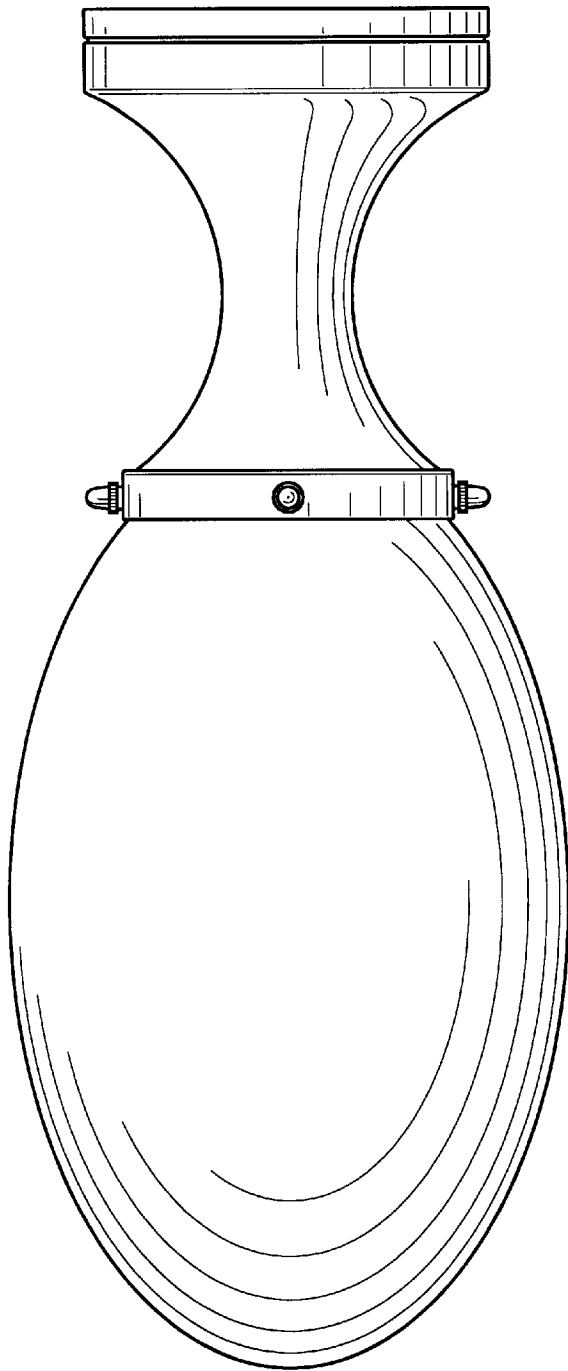

Fig. 11

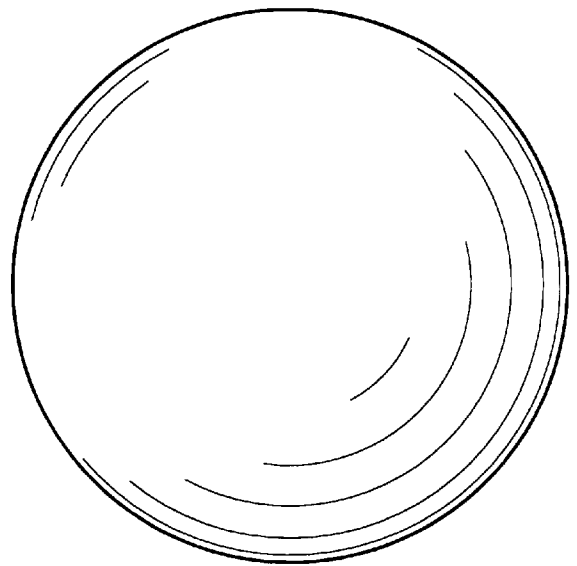

Fig. 12