



US00D793870S

(12) **United States Design Patent** (10) **Patent No.:** **US D793,870 S**
Abdourahim (45) **Date of Patent:** **** Aug. 8, 2017**

(54) **WATCHCASE**
(71) Applicant: **HARRY WINSTON SA,**
Plan-les-Ouates (CH)
(72) Inventor: **Delphine Abdourahim,** New York, NY
(US)
(73) Assignee: **HARRY WINSTON SA,**
Plan-les-Ouates (CH)

D398,860 S * 9/1998 Paredes D10/30
D464,272 S * 10/2002 Man D10/30
D504,332 S * 4/2005 Chodat D10/39
D545,695 S * 7/2007 Laucella D10/31
D594,350 S * 6/2009 Arpa D10/32
D608,665 S * 1/2010 Perrenoud D10/38
D615,882 S * 5/2010 Laucella D10/39
D629,324 S * 12/2010 Lattmann D10/125
D632,591 S * 2/2011 Thevenaz D10/31

(Continued)

(**) Term: **15 Years**
(21) Appl. No.: **29/538,539**
(22) Filed: **Sep. 4, 2015**

(30) **Foreign Application Priority Data**

Mar. 4, 2015 (WO) DM/085 761

(51) **LOC (10) Cl.** **10-02**

(52) **U.S. Cl.**
USPC **D10/30**

(58) **Field of Classification Search**
USPC D10/1, 17, 22, 30-39, 122-132; D11/3,
D11/16, 44
CPC G04B 45/0069; G04B 45/0076; G04B
47/04; G04B 47/042; G04B 37/0008;
G04B 19/06; G04F 7/08

See application file for complete search history.

(56) **References Cited**

U.S. PATENT DOCUMENTS

3,583,151 A * 6/1971 Tissot G04B 37/0008
368/295
D323,784 S * 2/1992 Gueit D10/32
D339,532 S * 9/1993 Frappe D10/126
D339,534 S * 9/1993 Frappe D10/125
D339,752 S * 9/1993 Frappe D10/125
D358,776 S * 5/1995 Pandel D10/30
D390,148 S * 2/1998 Brzezinski D10/30
D396,654 S * 8/1998 Pitteloud D10/30
D397,945 S * 9/1998 Gruosi D10/30

OTHER PUBLICATIONS

Harry Winston Premier Baguette-cut diamonds | posted at
Watchonista.com 2012 © Watchonista The Watches Network, 2017
[online][site visited May 10, 2017]. Available from Internet: <http://
www.watchonista.com/harry-winston/watches/premier-ladies-ba-
guette-cut-diamonds>.*

(Continued)

Primary Examiner — Sandra Snapp

Assistant Examiner — Katherine Glennon

(74) *Attorney, Agent, or Firm* — Donald J. Ranft; Collen
IP

(57) **CLAIM**

The ornamental design for a watchcase, as shown and
described.

DESCRIPTION

FIG. 1 is a front right perspective view of a watchcase
showing my new design;

FIG. 2 is a rear left perspective view thereof;

FIG. 3 is a front view thereof;

FIG. 4 is a rear view thereof;

FIG. 5 is a right side view thereof;

FIG. 6 is a left side view thereof;

FIG. 7 is a bottom view thereof; and,

FIG. 8 is a top view thereof.

The portions of the watchcase shown in broken lines form no
part of the claimed design.

1 Claim, 6 Drawing Sheets

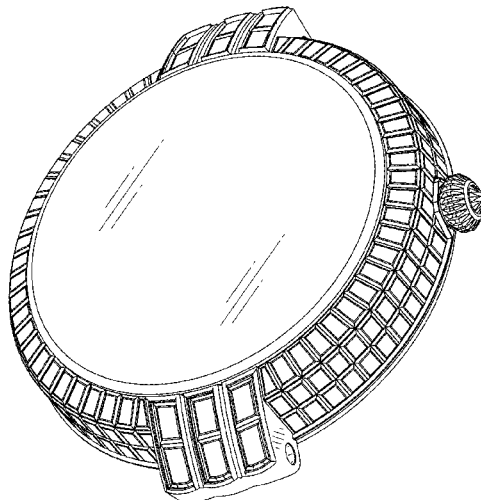

(56)

References Cited

U.S. PATENT DOCUMENTS

D646,183 S * 10/2011 De Witt D10/38
D647,808 S * 11/2011 Giroud D10/38
D705,675 S * 5/2014 Abdourahim D10/39
D708,073 S * 7/2014 Parmigiani D10/38
D708,966 S * 7/2014 Lasserre D10/39
D781,721 S * 3/2017 Abdourahim D10/38

OTHER PUBLICATIONS

Harry Winston Tourbillon | posted at hautetime.com May 28, 2013
© 2017 Haute Time [online][site visited May 10, 2017]. Available
from Internet: <<http://www.hautetime.com/rock-stars-haute-time-s-five-best-diamond-tourbillons/24566/>> p. 6.*

Jaeger-LeCoultre watch baguette gems | posted at watchesbysjx.
com 2014 (Jul. 16, 2014) SJX © 2011-2017 [online][site visited
May 10, 2017]. Available from Internet: <<http://watchesbysjx.com/2014/07/pre-ww-2014-introducing-the-jaeger-lecoultre-master-grande-tradition-grande-complication-high-jewellery-with-specs-price.html>>.*

Harry Winston Premier Ladies Baguette-cut Diamond watch |
posted at watchallure.com Nov. 18, 2012 Copyright © 2017—
WatchAllure® [online][site visited May 13, 2017]. Available from
Internet: <<https://www.watchallure.com/harry-winston%E2%80%99s-dazzling-premier-ladies-collection/>> p. 2.*

* cited by examiner

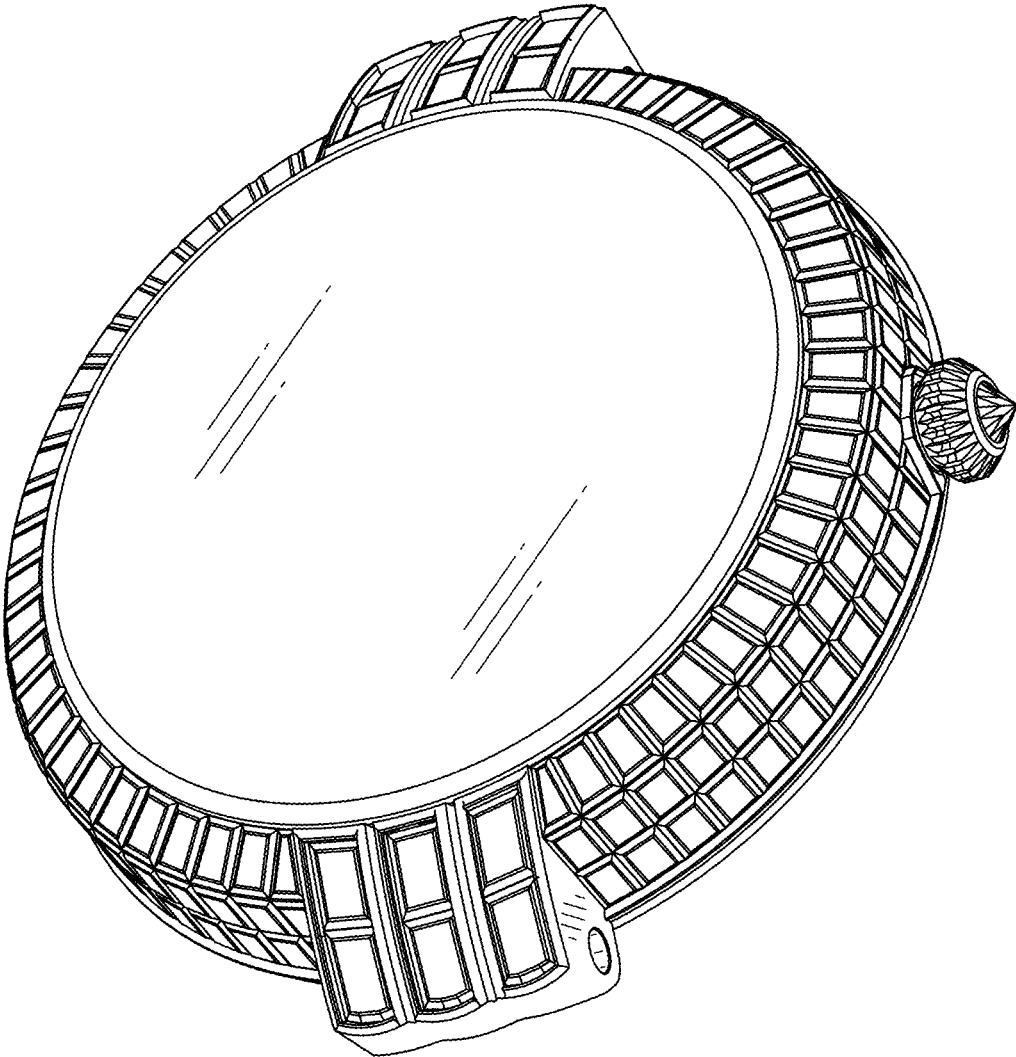

FIG. 1

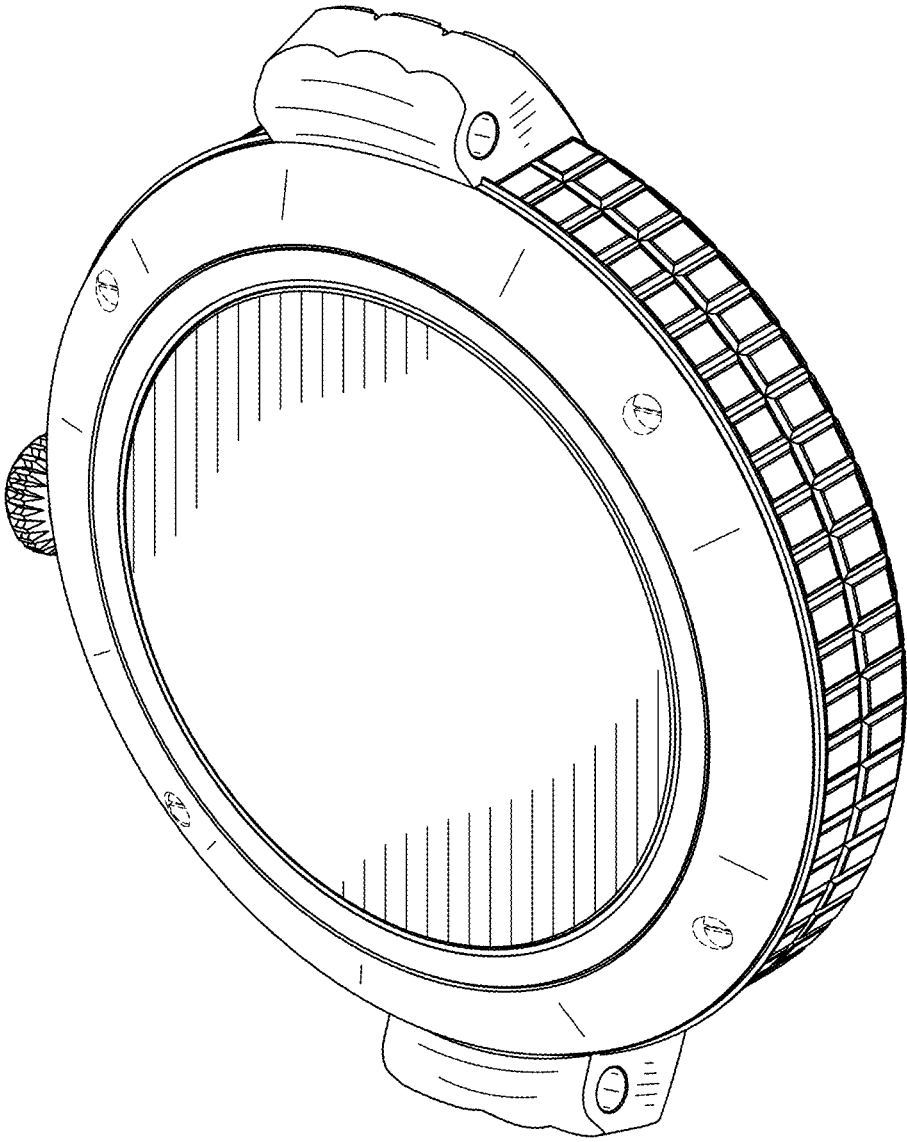

FIG. 2

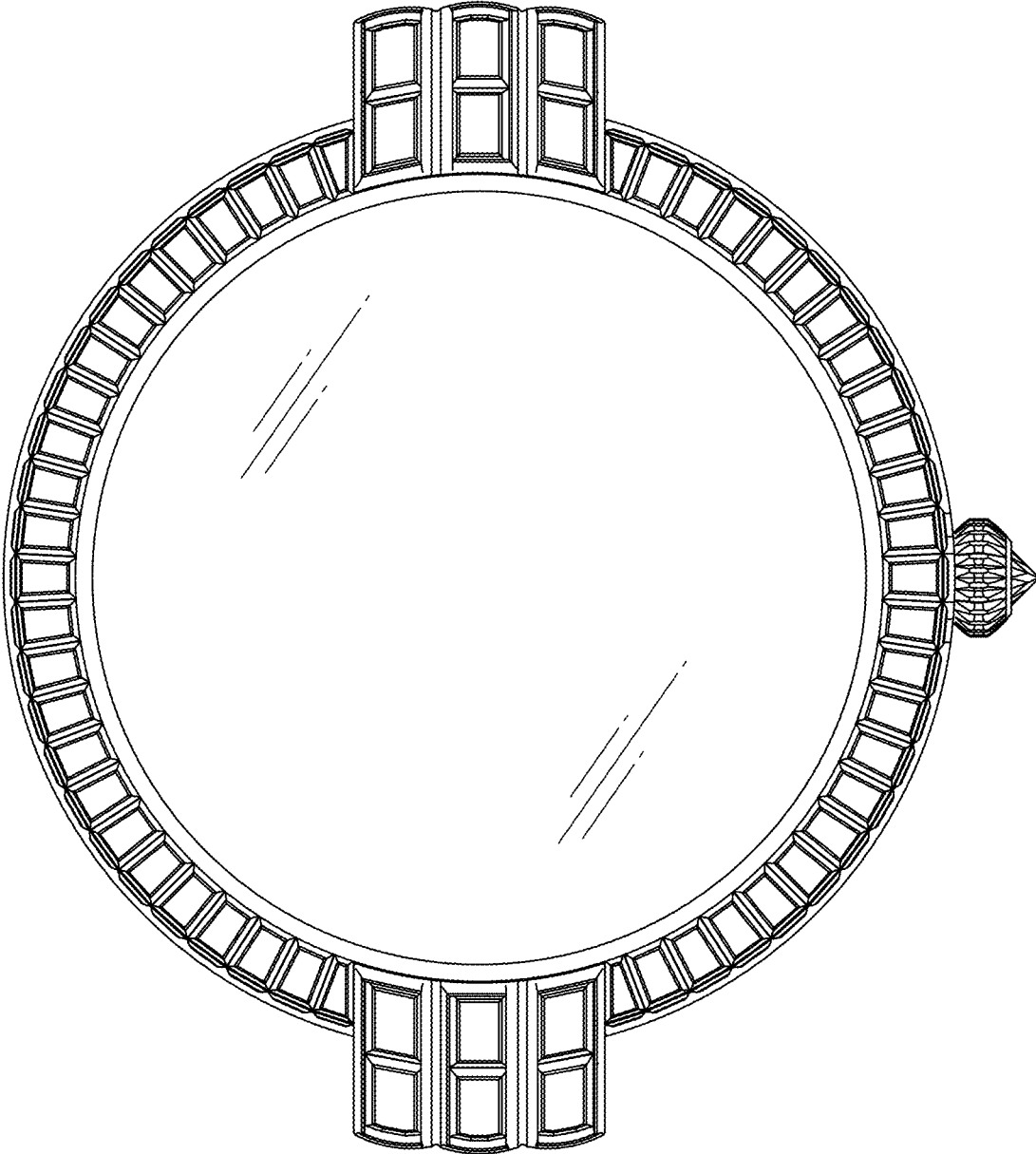

FIG. 3

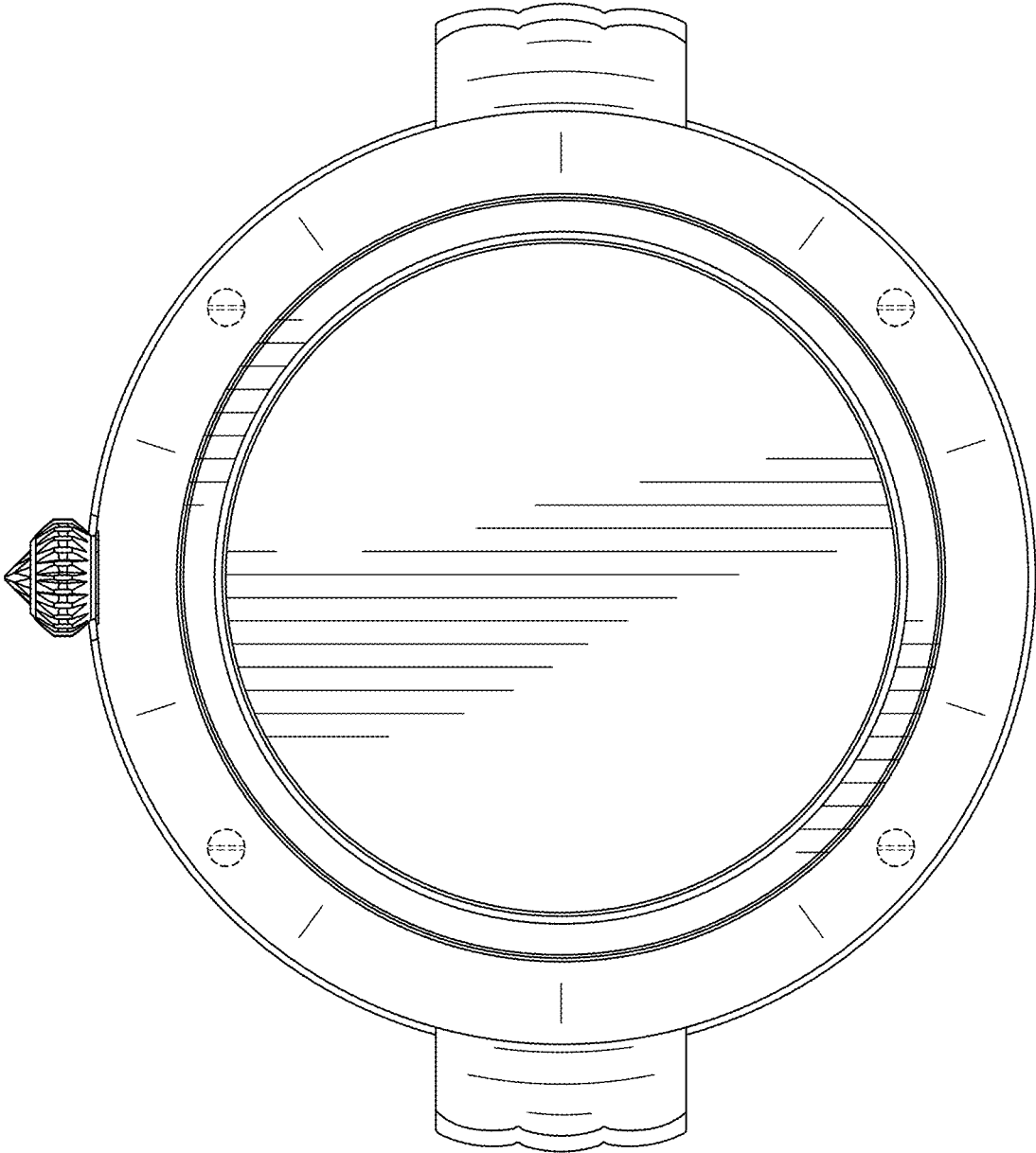

FIG. 4

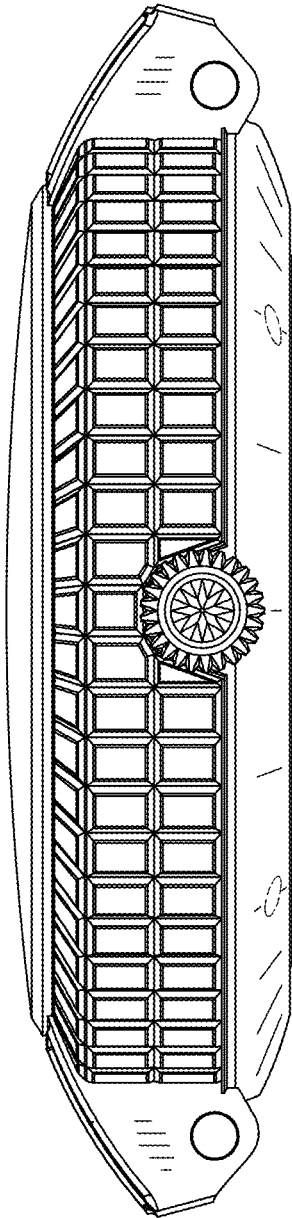

FIG. 5

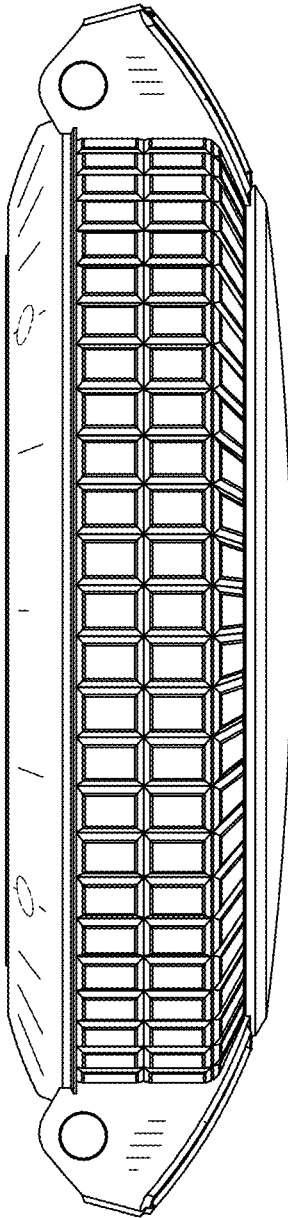

FIG. 6

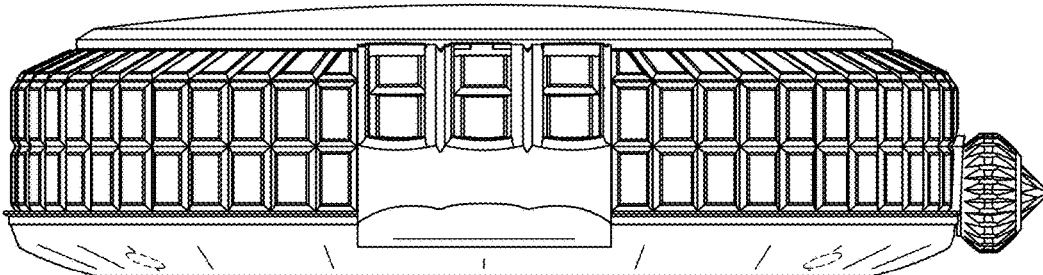

FIG. 7

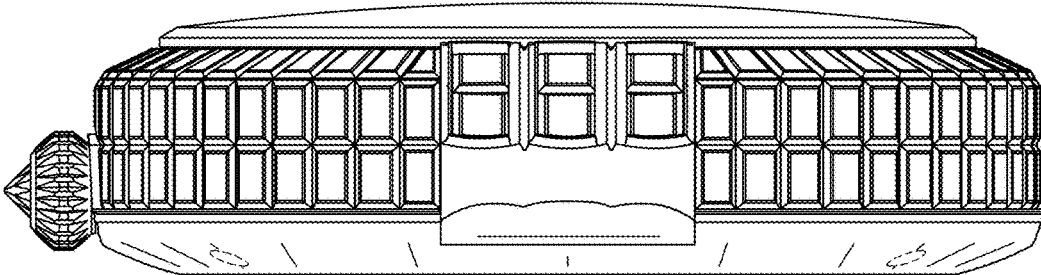

FIG. 8