



US00D367962S

United States Patent [19]
Leslie

[11] **Patent Number:** **Des. 367,962**

[45] **Date of Patent:** ****Mar. 19, 1996**

[54] **HANDLE FOR A ROUND BRUSH**
[75] Inventor: **Stuart M. Leslie**, Brooklyn, N.Y.
[73] Assignee: **Goody Products, Inc.**, Kearny, N.J.
[**] Term: **14 Years**

Assistant Examiner—Lavone D. Tabor
Attorney, Agent, or Firm—Foley & Lardner

[57] **CLAIM**

The ornamental design for a handle for a round brush, as shown and described.

DESCRIPTION

[21] Appl. No.: **34,023**
[22] Filed: **Jan. 25, 1995**
[52] **U.S. Cl.** **D4/138**
[58] **Field of Search** D4/128, 130-136,
D4/138; D28/25, 29, 35; 15/143.1, 159.1,
160, 186, 187; 132/120, 212, 313, 121

FIG. 1 is a top perspective view of a handle for a round brush showing my new design;

FIG. 2 is a front elevational view thereof, the rear elevational view being a mirror image of the front view shown;

FIG. 3 is a top plan view thereof;

FIG. 4 is a bottom plan view thereof;

FIG. 5 is a left end elevational view thereof; and,

FIG. 6 is a right end elevational view thereof.

The broken line showing of bristles in FIG. 2 is for illustrative purposes only and forms no part of the claimed design.

[56] **References Cited**

U.S. PATENT DOCUMENTS

D. 270,381	8/1983	Muller et al.	D4/128
D. 306,097	2/1990	Gingras	D4/138
D. 310,754	9/1990	Gingras	D4/138
D. 337,437	7/1993	Lunderman	D4/138

OTHER PUBLICATIONS

Goody Products, Inc. 1994 Product Catalog—pp. 33, 34, 37 and 38; Hairbrushes.

Primary Examiner—A. Hugo Word

1 Claim, 2 Drawing Sheets

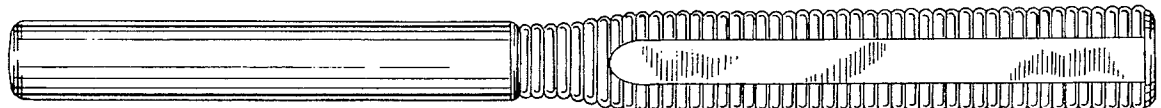
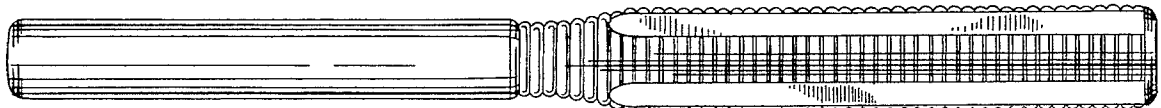

FIG. 5

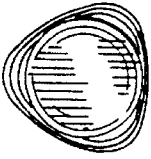

FIG. 6

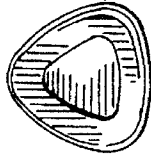
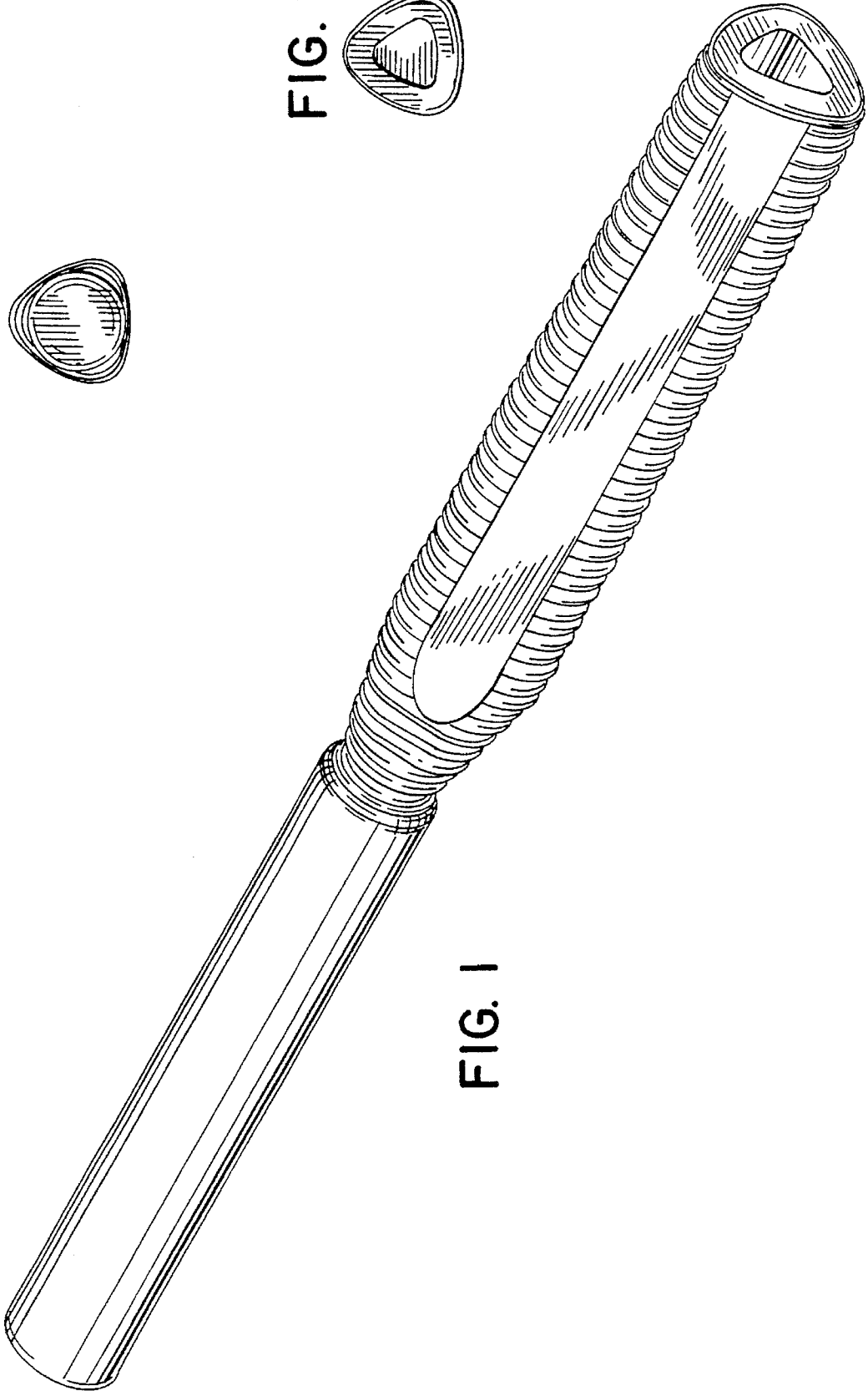

FIG. 1



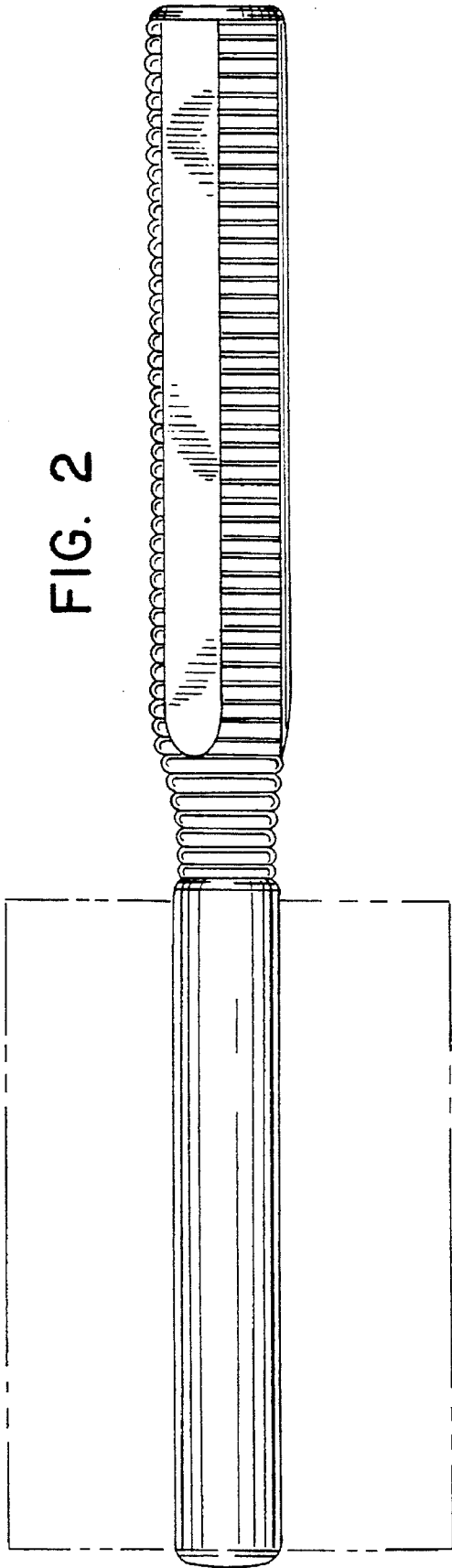

FIG. 2

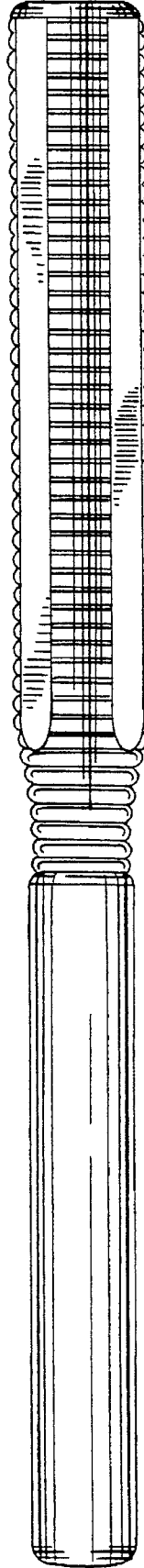

FIG. 3

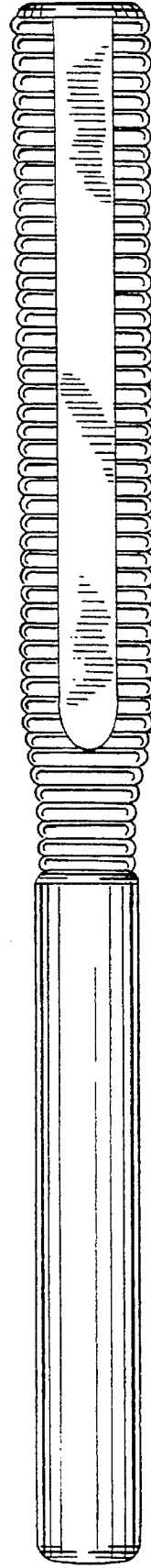

FIG. 4