



(12) **United States Design Patent**
Xu

(10) **Patent No.:** **US D1,013,887 S**
(45) **Date of Patent:** **** Feb. 6, 2024**

(54) **MESSAGE APPARATUS**
(71) Applicant: **Dongguan Farka Silicone Products Co., Ltd., Dongguan (CN)**
(72) Inventor: **Shengyi Xu, Yongzhou (CN)**
(73) Assignee: **Dongguan Farka Silicone Products Co., Ltd., Dongguan (CN)**
(**) Term: **15 Years**

D879,988 S * 3/2020 Zhou D24/215
D880,713 S * 4/2020 Sedic D24/215
D882,815 S * 4/2020 Dumler D24/215
D888,980 S * 6/2020 Tsuyama D24/215
D890,947 S * 7/2020 Takahori D24/215
D893,040 S * 8/2020 Qiu D24/215
D898,215 S * 10/2020 Endo D24/215
D902,427 S * 11/2020 Okamura D24/215
D918,409 S * 5/2021 Sedic D24/215
D930,847 S * 9/2021 Endo D24/215
D958,391 S * 7/2022 Sedic D24/215

(Continued)

(21) Appl. No.: **29/835,843**

(22) Filed: **Apr. 21, 2022**

(30) **Foreign Application Priority Data**

Mar. 14, 2022 (CN) 202230129876.1

(51) **LOC (14) Cl.** **24-01**
(52) **U.S. Cl.**

USPC **D24/215**

(58) **Field of Classification Search**

USPC D24/133, 141, 188, 189, 190, 200, 211,
D24/212, 213, 214, 215; D7/612;
D9/428

CPC A61H 7/007; A61H 15/0078; A61H 23/02;
A61H 39/04; A61H 7/003; A61H 7/005;
A61H 15/008

See application file for complete search history.

(56) **References Cited**

U.S. PATENT DOCUMENTS

D560,813 S * 1/2008 Matsuura D24/216
D674,909 S * 1/2013 Matsuura D24/215
D695,414 S * 12/2013 Matsuura D24/215
D736,400 S * 8/2015 Matsuura D24/215
D736,401 S * 8/2015 Matsuura D24/215
D837,996 S * 1/2019 Sugimoto A61B 10/0058
D24/215
D843,592 S * 3/2019 Tsuyama D24/215
D868,989 S * 12/2019 Marshall D24/215

OTHER PUBLICATIONS

Amazon, "Male Masturbators Egg", Date First Available: May 10, 2023. https://www.amazon.com/Masturbators-Portable-Textured-Double-Sided-Masturbation/dp/B0C4T43DGY/ref=cm_cr_ar_p_d_product_top?ie=UTF8 (Year: 2023).*

Primary Examiner — Michael A Maharajh

(74) *Attorney, Agent, or Firm* — Georgi Korobanov

(57) **CLAIM**

The ornamental design for a massage apparatus, as shown and described.

DESCRIPTION

FIG. 1 is a perspective view of a massage apparatus, showing my new design;
FIG. 2 is a perspective view of an open state thereof;
FIG. 3 is another perspective view thereof;
FIG. 4 is a front view thereof;
FIG. 5 is a rear view thereof;
FIG. 6 is a left side view thereof;
FIG. 7 is a right side view thereof;
FIG. 8 is a top plan view thereof; and,
FIG. 9 is a bottom plan view thereof.

The broken lines shown in the drawings are for the purpose of illustrating portions of the massage apparatus which form no part of the claimed design.

1 Claim, 9 Drawing Sheets

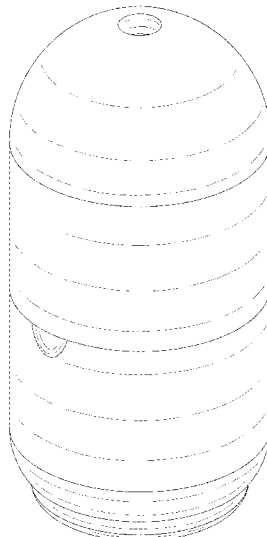

(56)

References Cited

U.S. PATENT DOCUMENTS

D959,010	S	*	7/2022	Li	D24/215
D965,166	S	*	9/2022	Cai	D24/215
D965,881	S	*	10/2022	Zhou	D24/209

* cited by examiner

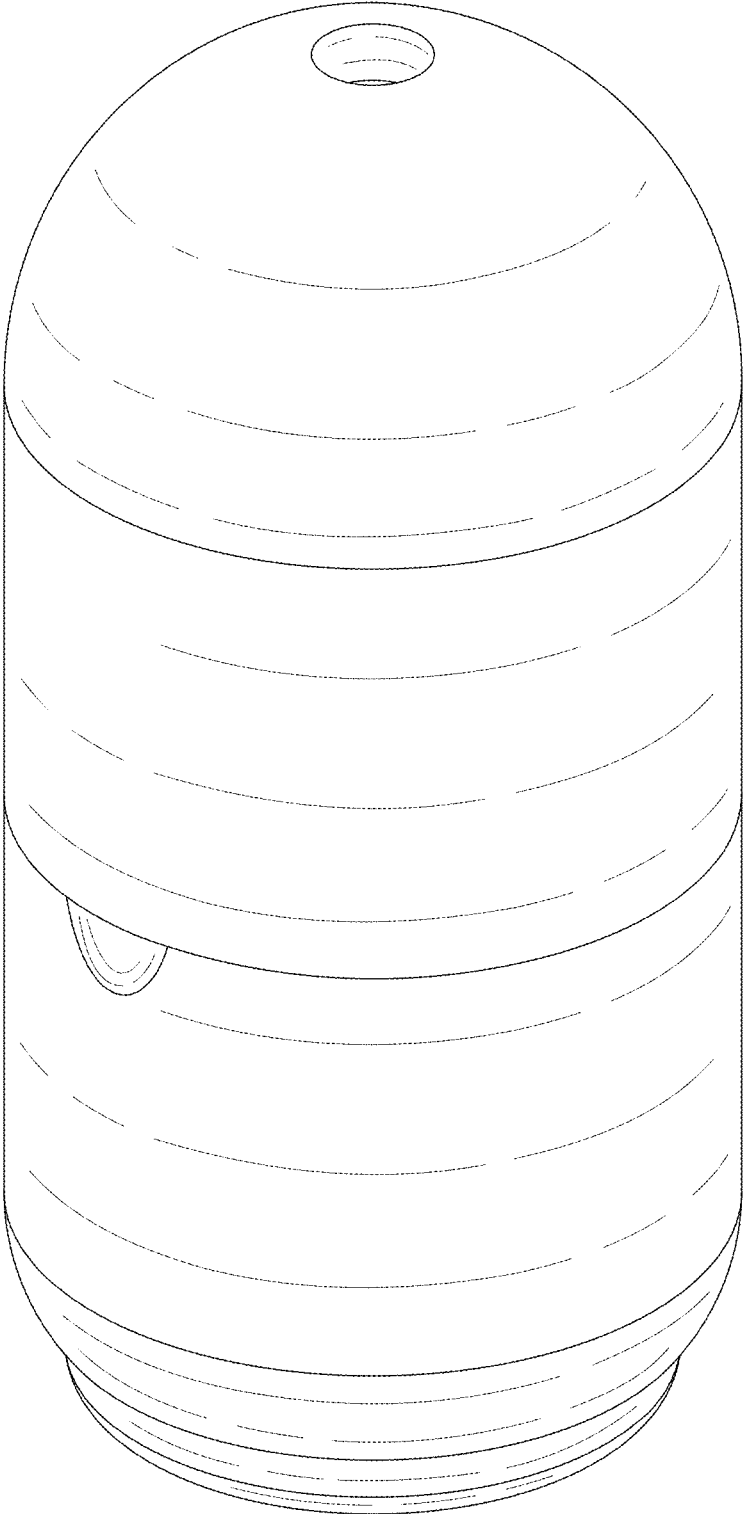

FIG. 1

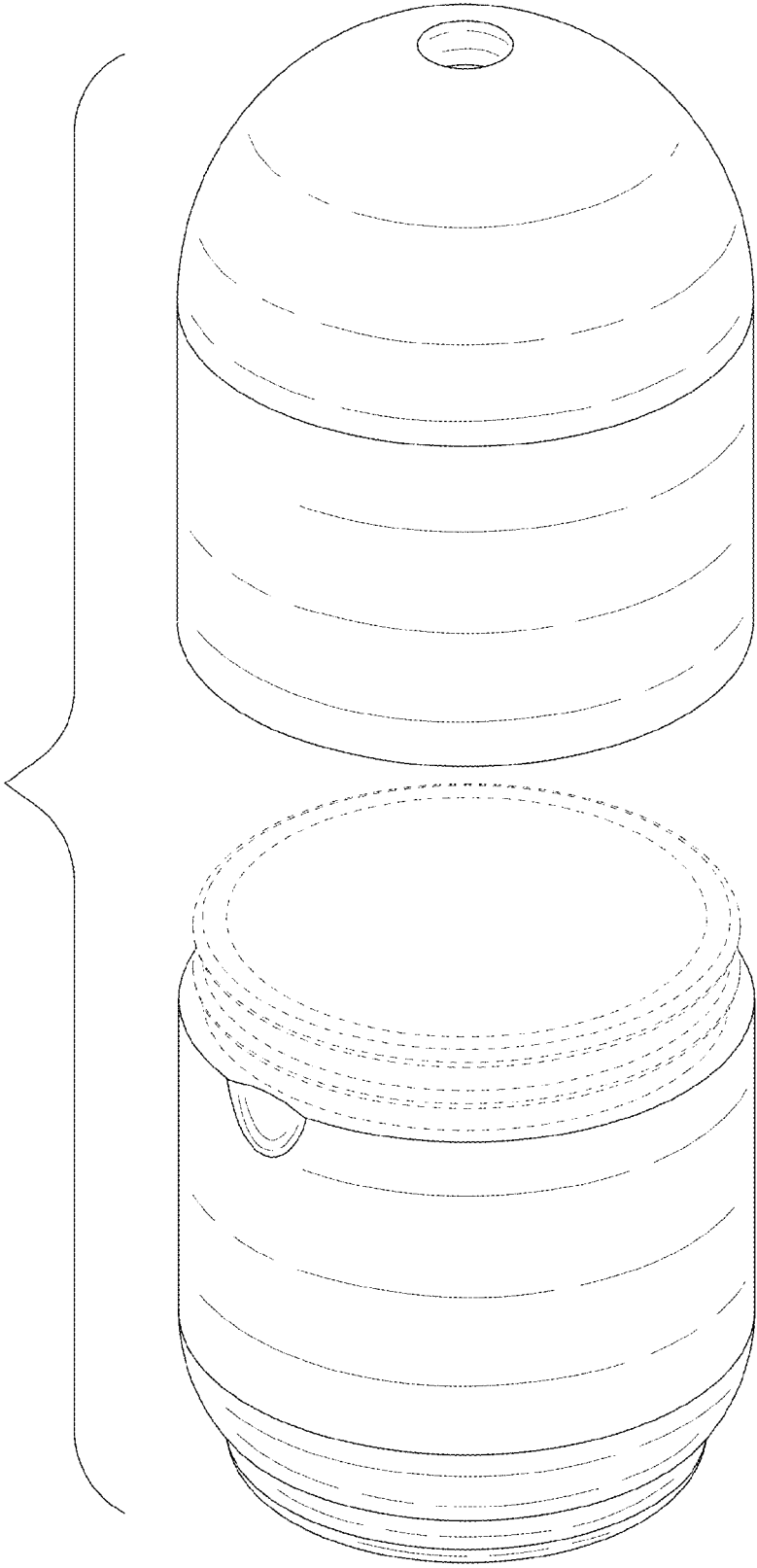

FIG. 2

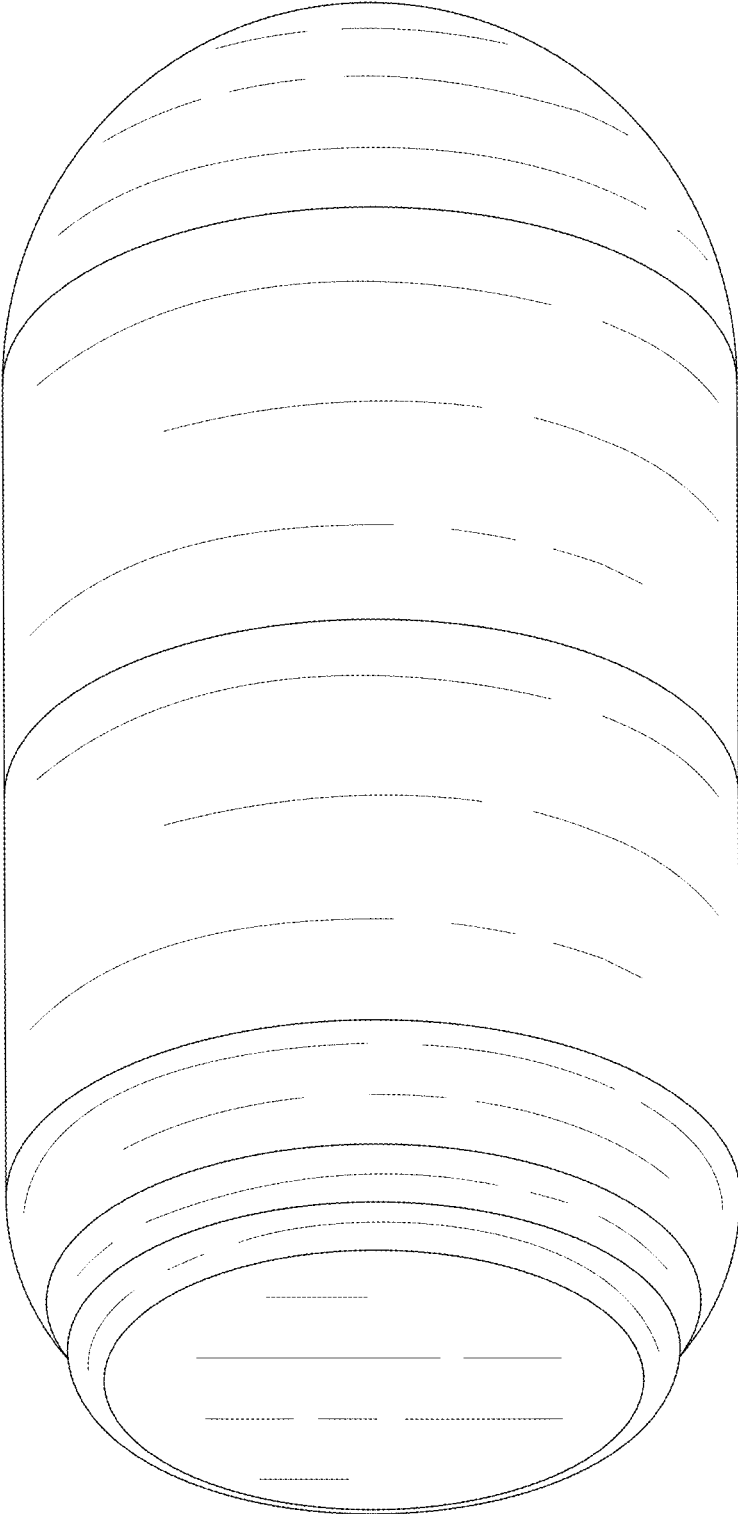

FIG. 3

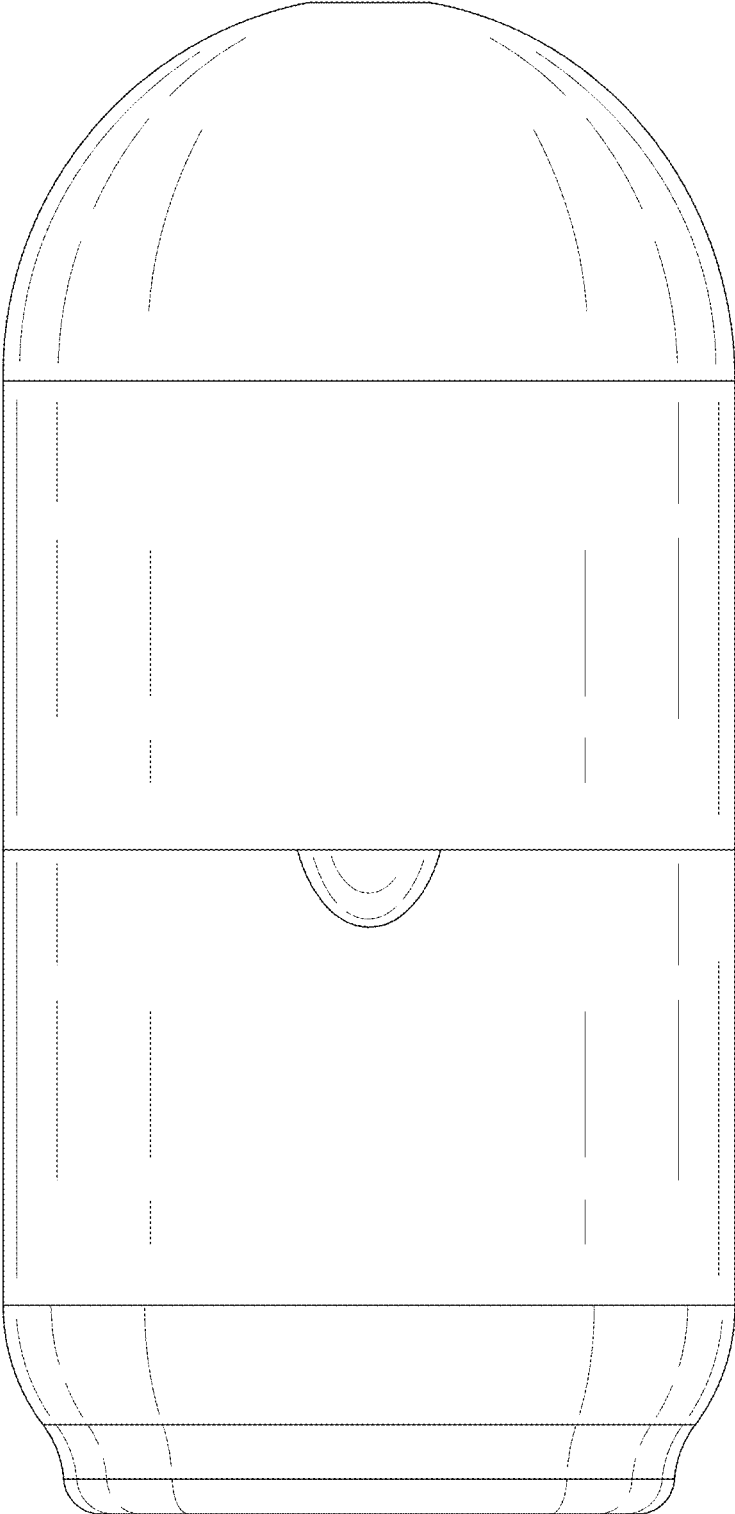

FIG. 4

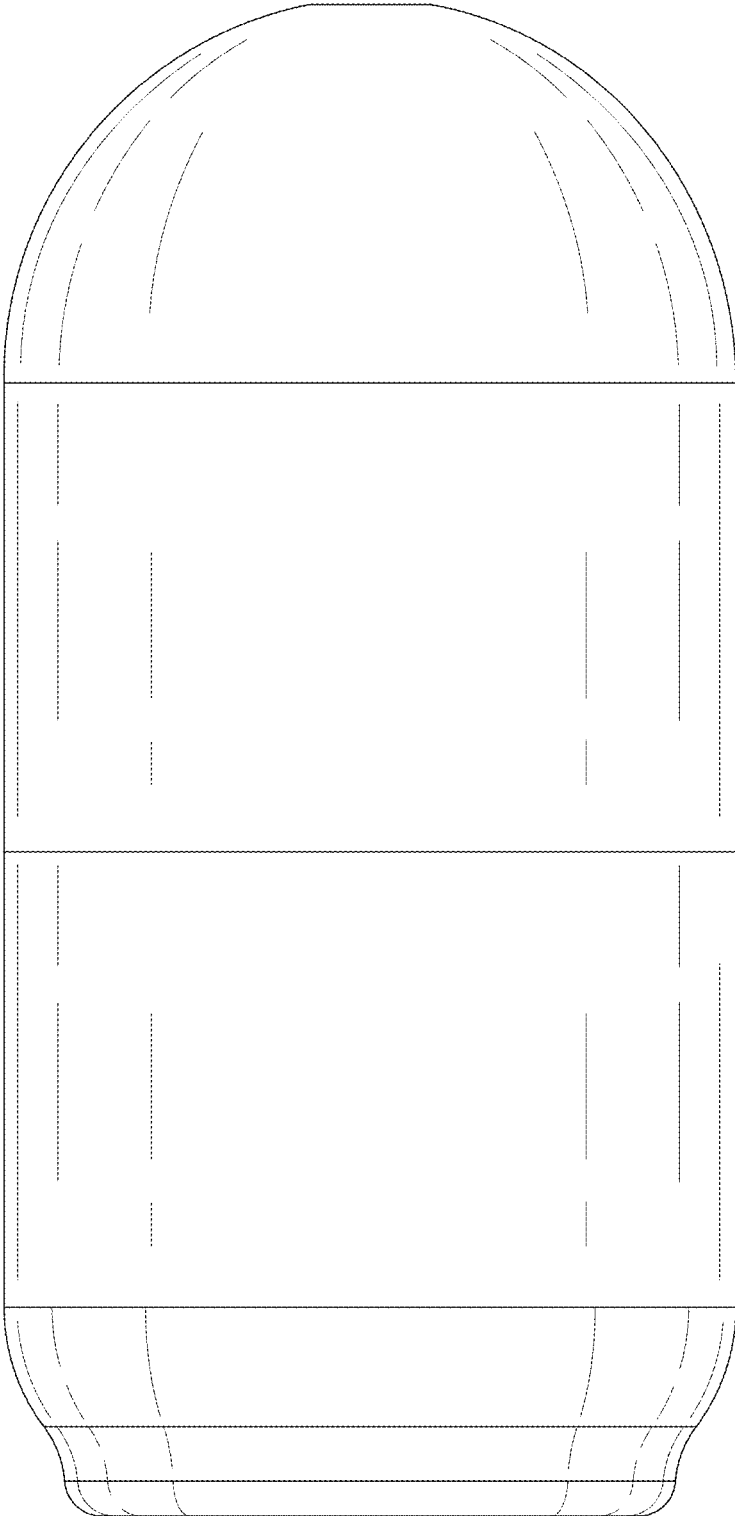

FIG. 5

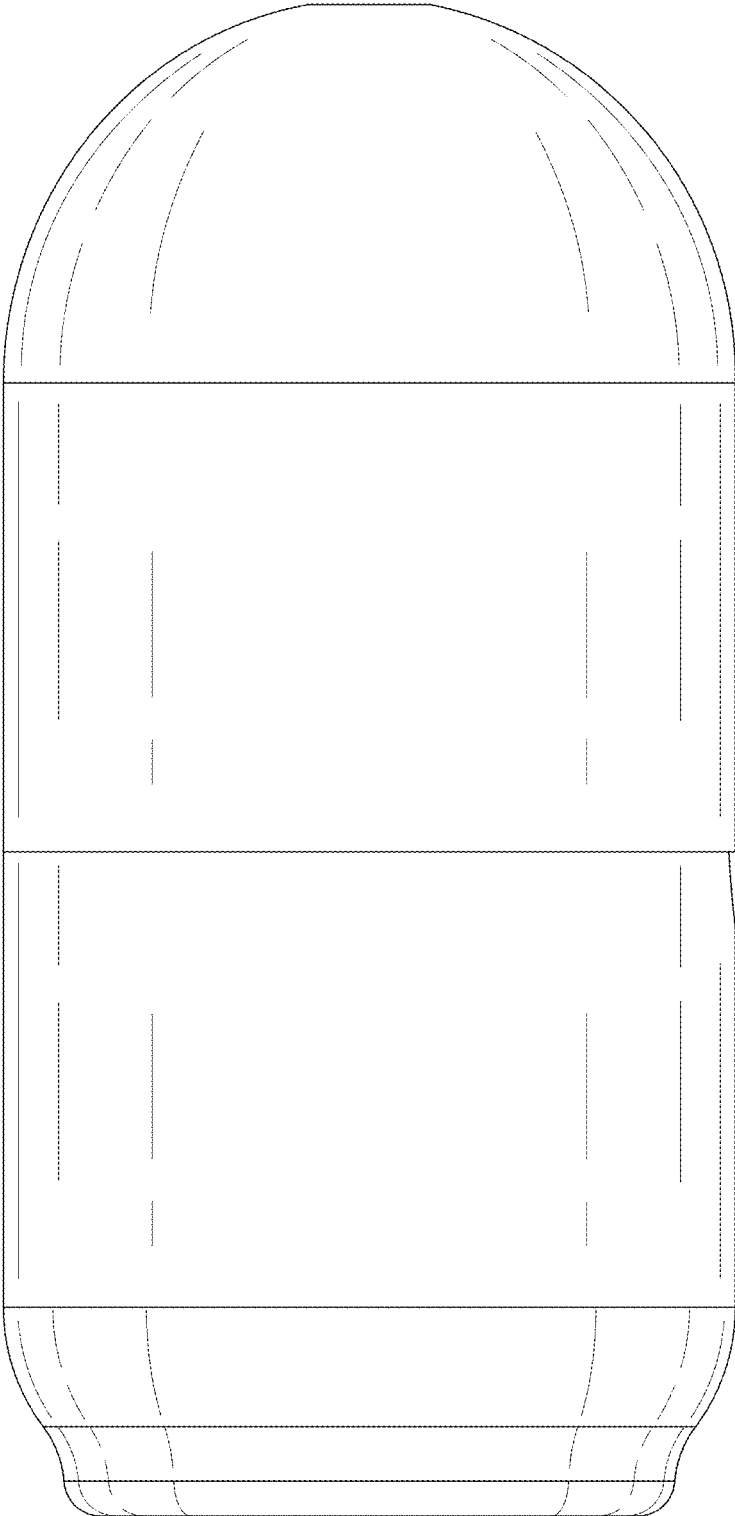

FIG. 6

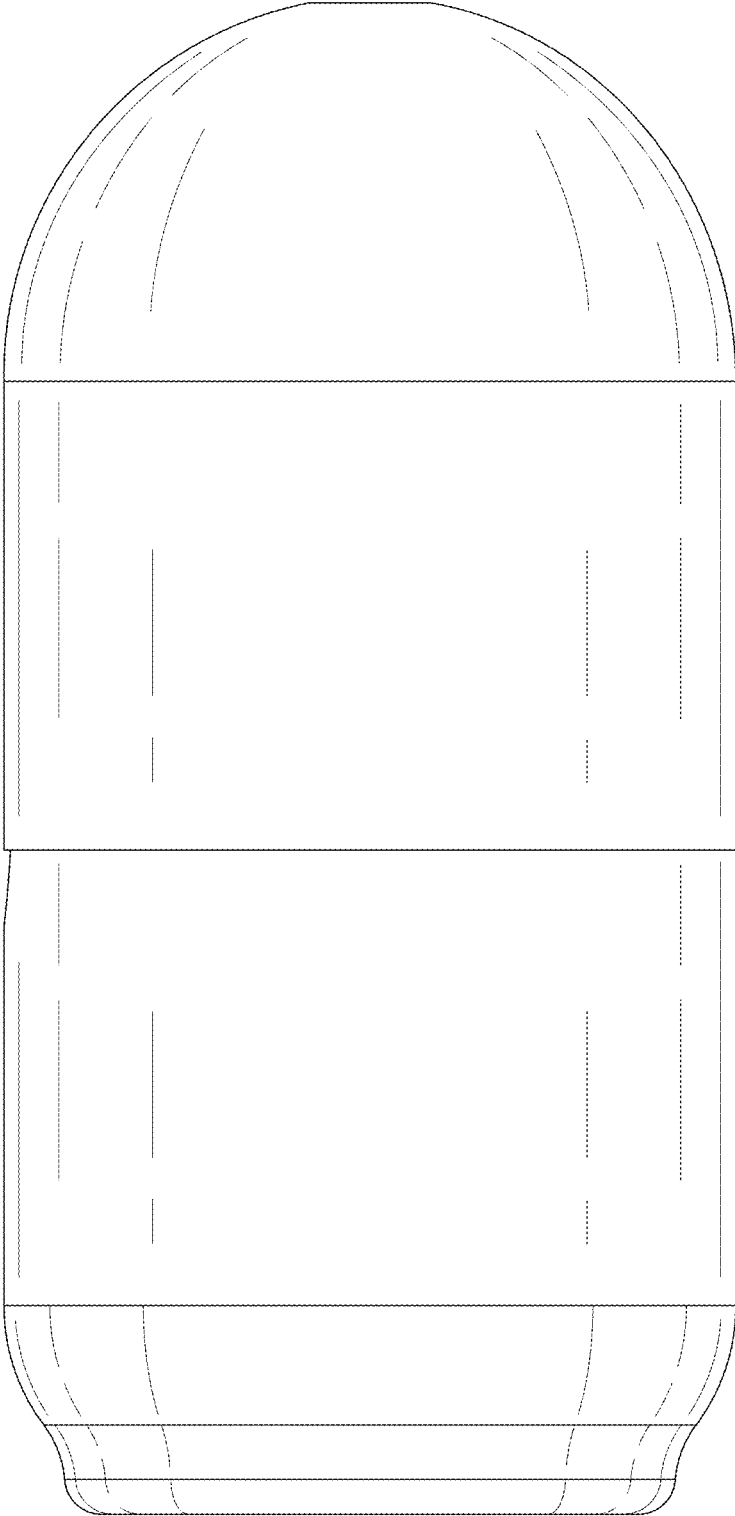

FIG. 7

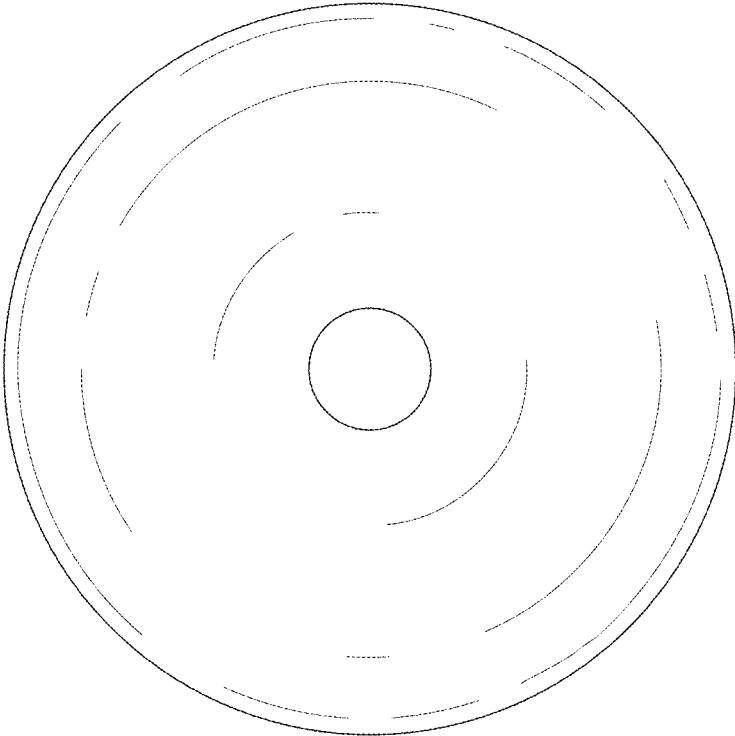

FIG. 8

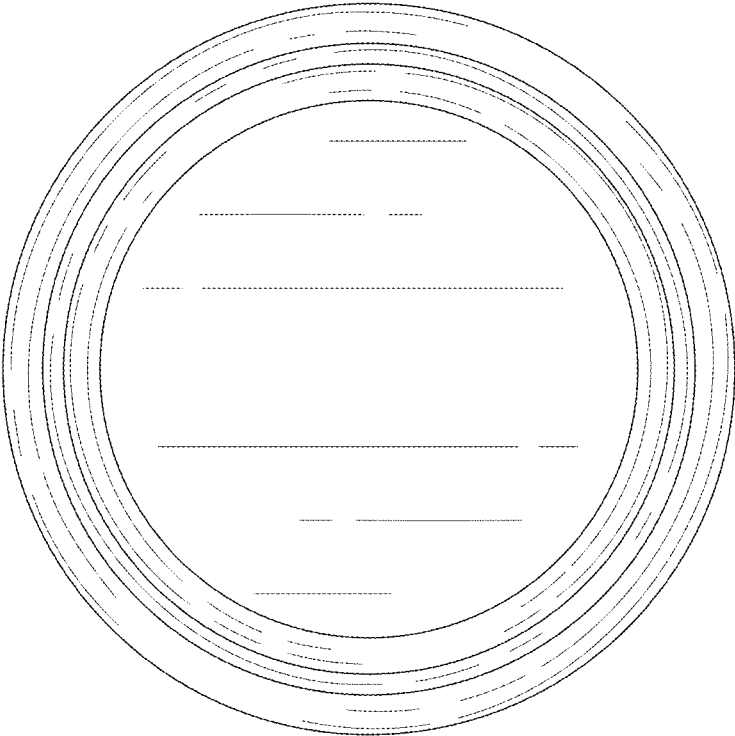

FIG. 9