



US00D850441S

(12) **United States Design Patent**  
**Lee et al.**

(10) **Patent No.:** **US D850,441 S**  
(45) **Date of Patent:** **\*\* Jun. 4, 2019**

(54) **MONITOR FOR DATA PROCESSING DEVICE**

(71) Applicant: **LG ELECTRONICS INC.**, Seoul (KR)  
(72) Inventors: **Taejin Lee**, Seoul (KR); **Yeonjin Kim**, Seoul (KR); **Gangho Woo**, Seoul (KR)  
(73) Assignee: **LG ELECTRONICS INC.**, Seoul (KR)

D627,351 S \* 11/2010 Wang ..... D14/375  
D635,975 S \* 4/2011 Seo ..... D14/374  
D704,709 S \* 5/2014 Bussoli ..... D14/128  
D745,511 S \* 12/2015 Lee ..... F16M 11/105  
D14/336  
D790,541 S \* 6/2017 Jung ..... D14/374  
D790,542 S \* 6/2017 Jung ..... D14/374  
D812,610 S \* 3/2018 Varghese ..... D14/371  
D816,629 S \* 5/2018 Won ..... D14/126  
D816,671 S \* 5/2018 Jung ..... D14/374

(Continued)

(\*\*) Term: **15 Years**

(21) Appl. No.: **35/504,960**

(22) Filed: **Nov. 17, 2017**

(80) **Hague Agreement Data**

Int. Filing Date: **Nov. 17, 2017**  
Int. Reg. No.: **DM/099428**  
Int. Reg. Date: **Nov. 17, 2017**  
Int. Reg. Pub. Date: **May 18, 2018**

(30) **Foreign Application Priority Data**

May 19, 2017 (KR) ..... 30-2017-0022675

(51) **LOC (11) Cl.** ..... **14-02**

(52) **U.S. Cl.**  
USPC ..... **D14/336**

(58) **Field of Classification Search**

USPC ..... D14/126, 239, 335, 336, 340, 374, 375, D14/451, 452; D21/515  
CPC ..... G06F 1/1626; H04N 5/64; H04N 5/645; H05K 5/00; H05K 5/0204  
See application file for complete search history.

(56) **References Cited**

**U.S. PATENT DOCUMENTS**

6,651,943 B2 \* 11/2003 Cho ..... F16M 11/105  
248/122.1  
D624,893 S \* 10/2010 Kasuga ..... D14/126

**OTHER PUBLICATIONS**

www.theverge.com: Liao, Shannon: LG's new ultrawide gaming monitors have up to 144Hz refresh rates. Dated Aug. 29, 2018; 2 pages. Found online Feb. 25, 2019 at <https://www.theverge.com/circuitbreaker/2018/8/29/17797568/lg-curved-gaming-monitor-new-specs-ifa-2018>.\*

(Continued)

*Primary Examiner* — Robert M. Spear  
(74) *Attorney, Agent, or Firm* — Birch, Stewart, Kolasch & Birch, LLP

(57) **CLAIM**

The ornamental design for a monitor for data processing device, as shown and described.

**DESCRIPTION**

- 1. Monitor for data processing device
- 1.1 : Perspective
- 1.2 : Rear perspective
- 1.3 : Front
- 1.4 : Back
- 1.5 : Left
- 1.6 : Right
- 1.7 : Top
- 1.8 : Bottom

(Continued)

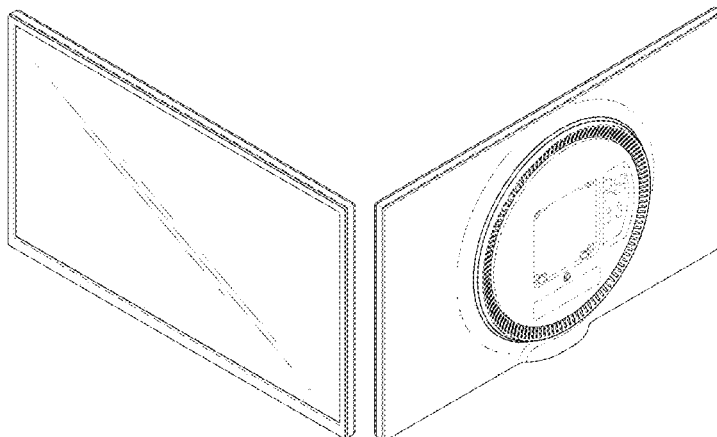

The parallel fine lines and curves shown in all the drawings indicate the relief of surface of the product; the broken lines indicate unclaimed portions of the article that form no part of the claimed design.

**1 Claim, 8 Drawing Sheets**

(56)

**References Cited**

U.S. PATENT DOCUMENTS

D819,585 S *	6/2018	Kang .....	D14/126
D826,887 S *	8/2018	Kymm .....	D14/126
D829,185 S *	9/2018	Song .....	D14/126
D837,876 S *	1/2019	Lyons .....	D18/4.5

OTHER PUBLICATIONS

Screenshot of LG 27GL850G-B 17" Gaming Monitor. No date.  
Found online Feb. 25, 2019 at <https://www.lg.com/us/monitors/lg-27GL850G-B-gaming-monitor>.\*

\* cited by examiner

1.1

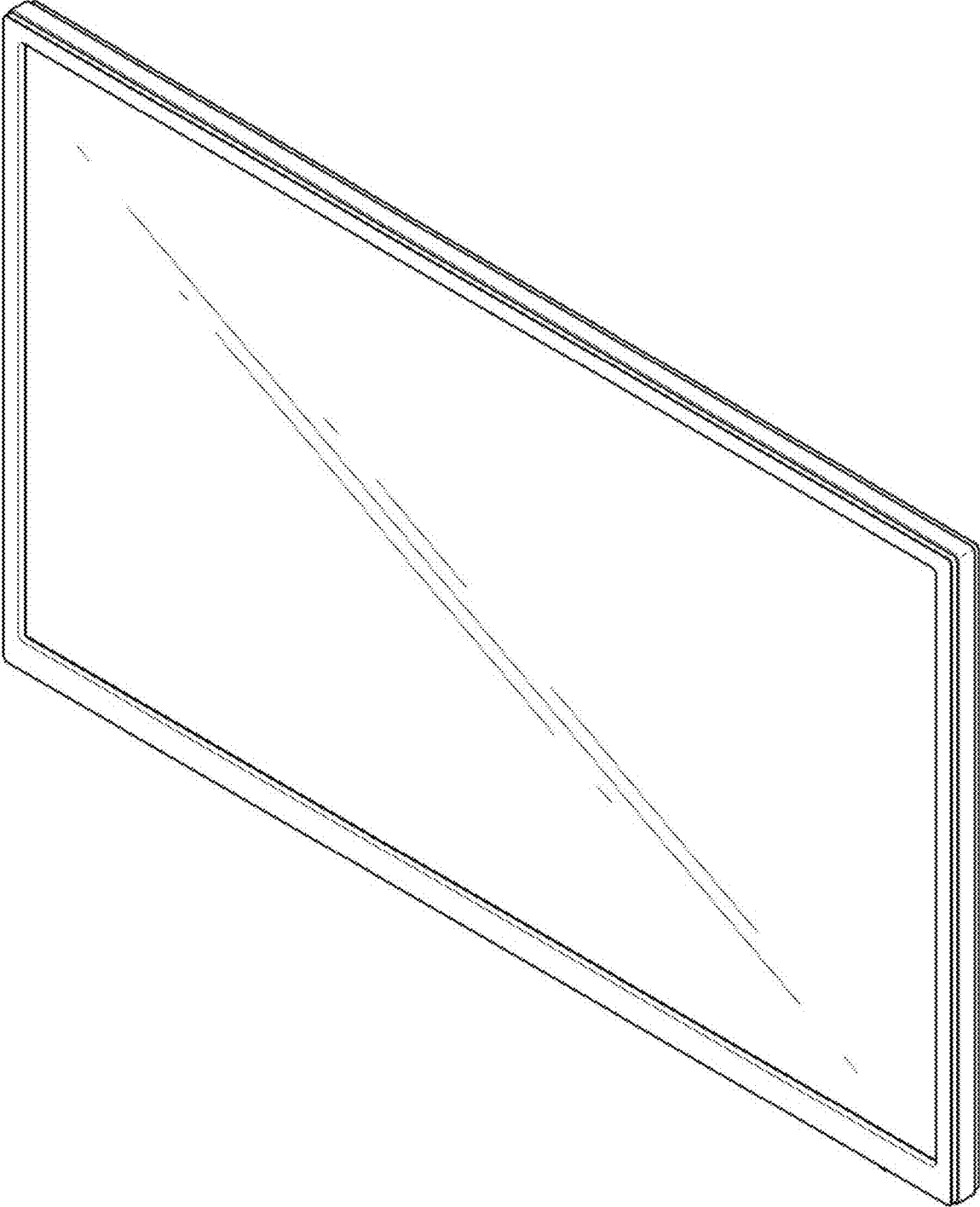

1.2

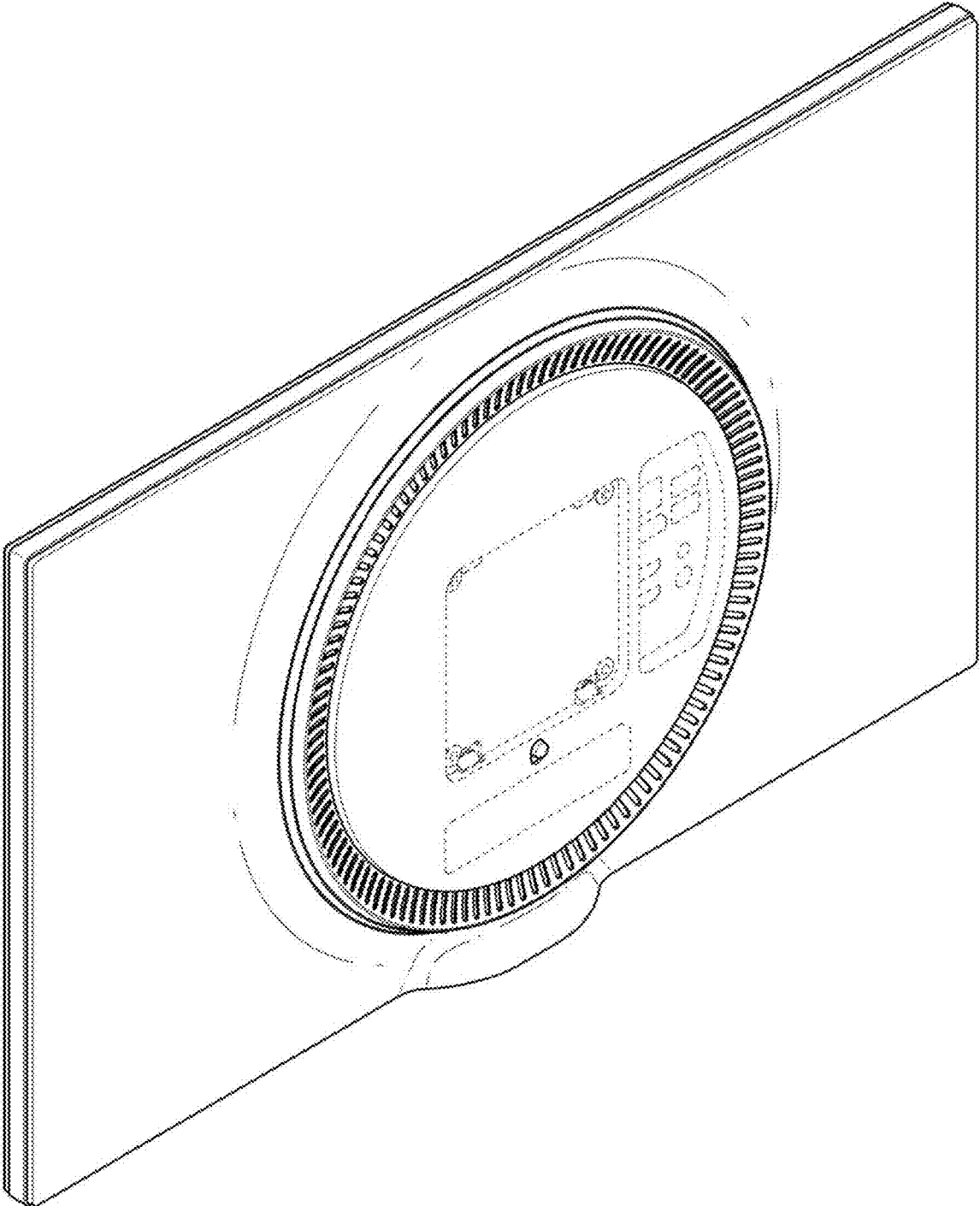

1.3

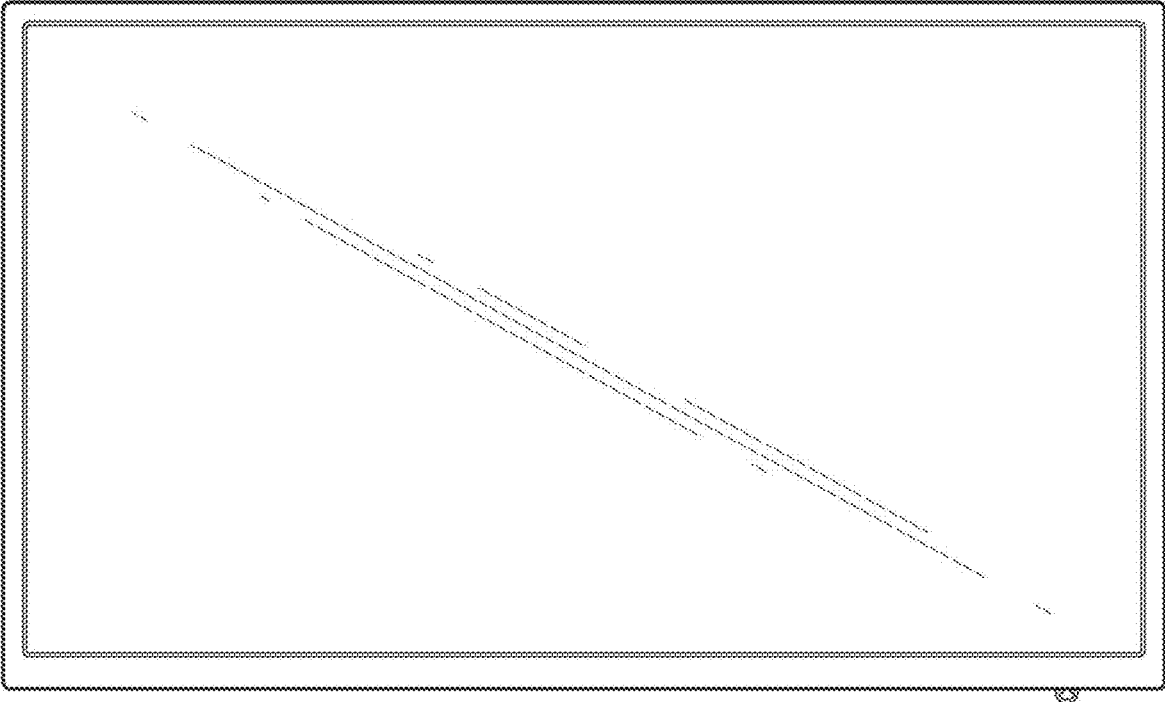

1.4

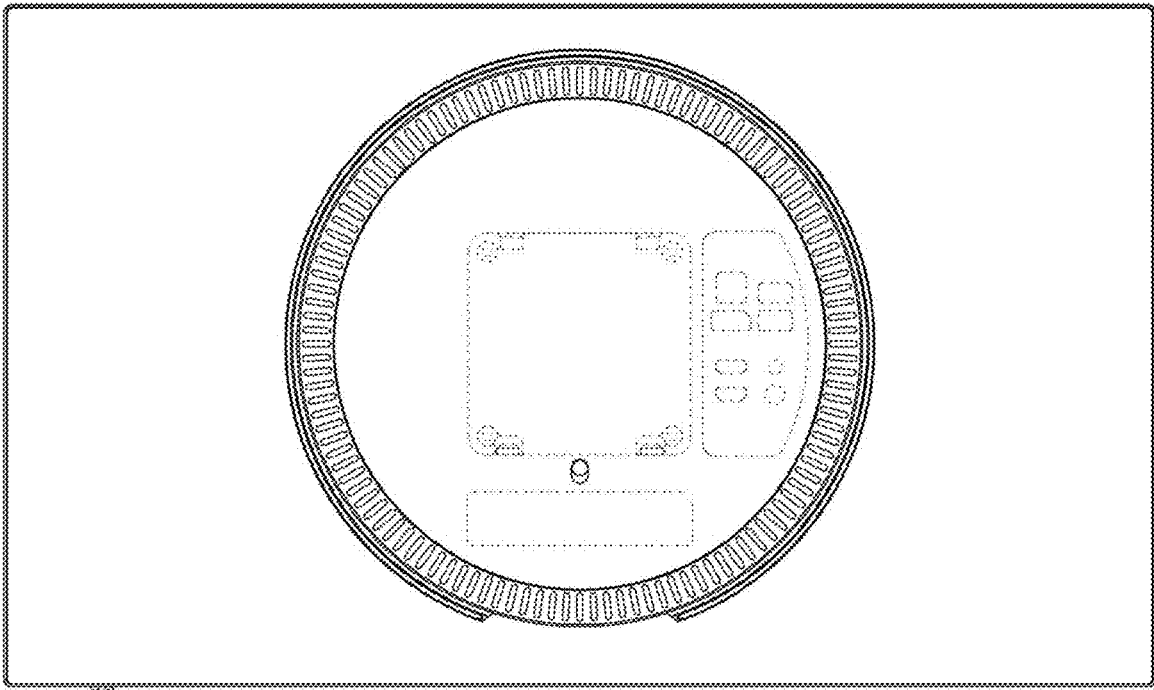

1.5

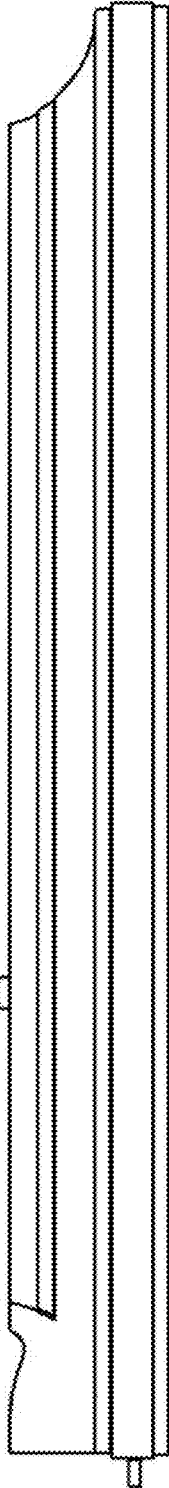

1.6

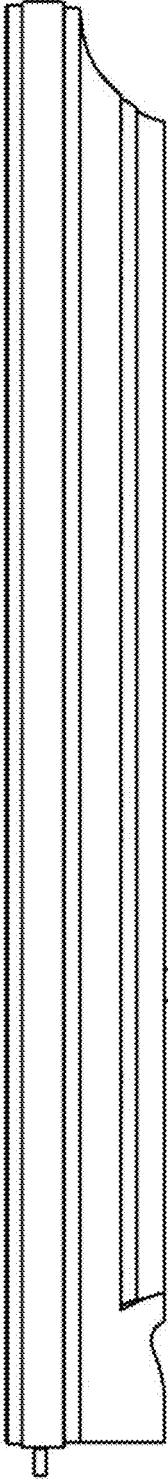



1.7



1.8

