



US00D723030S

(12) **United States Design Patent**
Park

(10) **Patent No.:** **US D723,030 S**

(45) **Date of Patent:** **** Feb. 24, 2015**

(54) **PORTABLE ELECTRONIC DEVICE**

(75) Inventor: **Daeyoeb Park, Kimpo-si (KR)**

(73) Assignee: **Samsung Electronics Co., Ltd., Gyeonggi-do (KR)**

(**) Term: **14 Years**

(21) Appl. No.: **29/430,409**

(22) Filed: **Aug. 24, 2012**

(30) **Foreign Application Priority Data**

Feb. 24, 2012 (KR) 30-2012-0008911

(51) **LOC (10) Cl.** **14-02**

(52) **U.S. Cl.**

USPC **D14/341**

(58) **Field of Classification Search**

CPC ... H04M 1/00; H04M 11/066; H04M 1/2478;
H04M 1/72519; H04M 2201/38; H04M
2250/22

USPC D14/341-347, 137, 138 R, 138 AA,
D14/138 C, 138 G, 496, 203.1, 203.3, 203.4,
D14/203.7, 129, 130, 147, 218, 248, 389,
D14/388, 426, 420; D10/65, 104.1;
D18/6-7; D21/324, 329, 330;
455/556.1, 556.2, 566, 575.1, 90.3;
379/433.04, 433.01, 433.06, 916;
345/173, 901, 905; 361/679.26, 679.3,
361/679.55, 679.56

See application file for complete search history.

(56) **References Cited**

U.S. PATENT DOCUMENTS

D593,087 S * 5/2009 Andre et al. D14/341
D601,538 S * 10/2009 Hong D14/138 G
D601,539 S * 10/2009 Hong D14/138 G
D602,014 S * 10/2009 Andre et al. D14/341
D602,486 S * 10/2009 Andre et al. D14/341
D604,297 S * 11/2009 Andre et al. D14/341

D613,735 S * 4/2010 Andre et al. D14/341
D615,083 S * 5/2010 Andre et al. D14/341
D615,088 S * 5/2010 Matsuoka D14/439
D622,270 S * 8/2010 Andre et al. D14/341
D626,937 S * 11/2010 Yeo et al. D14/203.7
D627,777 S * 11/2010 Akana et al. D14/341
D634,319 S * 3/2011 Andre et al. D14/341
D639,805 S * 6/2011 Song et al. D14/341
D640,663 S * 6/2011 Arnholt et al. D14/138 G
D641,018 S * 7/2011 Lee et al. D14/341
D643,827 S * 8/2011 Lee et al. D14/138 G
D644,196 S * 8/2011 Lee et al. D14/138 AD
D644,197 S * 8/2011 Lee et al. D14/138 G
D645,010 S * 9/2011 Lee et al. D14/138 G
D646,248 S * 10/2011 Lee D14/138 G
D650,352 S * 12/2011 Cho D14/138 G
D654,047 S * 2/2012 Kim et al. D14/138 G
D654,048 S * 2/2012 Ichinose et al. D14/138 G
D657,764 S * 4/2012 Hong D14/138 G

(Continued)

Primary Examiner — Barbara Fox

(74) *Attorney, Agent, or Firm* — Harness, Dickey & Pierce, P.L.C.

(57) **CLAIM**

I claim the ornamental design for a portable electronic device, as shown and described.

DESCRIPTION

FIG. 1 is a front/right-side/top perspective view of a portable electronic device showing my new design;
FIG. 2 is a front-side elevational view thereof;
FIG. 3 is a rear-side elevational view thereof;
FIG. 4 is a left-side elevational view thereof;
FIG. 5 is a right-side elevational view thereof;
FIG. 6 is a top-side elevational view thereof;
FIG. 7 is a bottom-side elevational view thereof; and,
FIG. 8 is an enlarged view of the circled portion shown in FIG. 7.

The broken lines shown in the drawings represent portions of the portable electronic device that form no part of the claimed design.

1 Claim, 7 Drawing Sheets

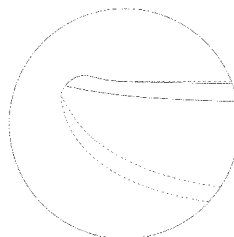
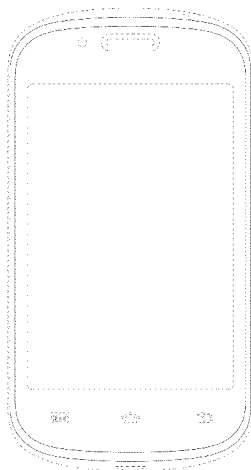

(56)

References Cited

U.S. PATENT DOCUMENTS

D662,484 S *	6/2012	Sunderland	D14/138 R	D687,823 S *	8/2013	Ryu et al.	D14/341
D662,489 S *	6/2012	Yeo	D14/203.7	D687,824 S *	8/2013	Chun et al.	D14/341
D663,298 S *	7/2012	Song et al.	D14/341	D687,825 S *	8/2013	Lee et al.	D14/341
D667,396 S *	9/2012	Koh	D14/341	D689,481 S *	9/2013	Song et al.	D14/341
D668,650 S *	10/2012	Han	D14/341	D691,133 S *	10/2013	Akana et al.	D14/341
D669,448 S *	10/2012	Hong	D14/138 G	D691,980 S *	10/2013	Park	D14/138 G
D670,259 S *	11/2012	Gioscia et al.	D14/138 AD	D692,423 S *	10/2013	Kim et al.	D14/341
D671,086 S *	11/2012	Yu et al.	D14/138 G	D692,880 S *	11/2013	Song et al.	D14/341
D671,514 S *	11/2012	Kim et al.	D14/138 G	D692,881 S *	11/2013	Akana et al.	D14/341
D672,345 S *	12/2012	Li	D14/341	D693,341 S *	11/2013	Akana et al.	D14/341
D672,739 S *	12/2012	Sin	D14/138 G	D696,247 S *	12/2013	Kim	D14/341
D674,369 S *	1/2013	JaeWoong	D14/138 G	D696,662 S *	12/2013	Song et al.	D14/341
D675,203 S *	1/2013	Yang	D14/341	D696,664 S *	12/2013	Iida et al.	D14/342
D676,819 S *	2/2013	Choi	D14/138 G	D698,356 S *	1/2014	Park	D14/345
D676,824 S *	2/2013	Lee	D14/138 G	D698,782 S *	2/2014	Hong	D14/341
D677,644 S *	3/2013	Park	D14/138 G	D698,783 S *	2/2014	Hong	D14/341
D677,660 S *	3/2013	Groene et al.	D14/341	D698,785 S *	2/2014	Canizares et al.	D14/341
D678,271 S *	3/2013	Chiu	D14/341	D698,786 S *	2/2014	Jondrow et al.	D14/341
D681,584 S *	5/2013	Sung	D14/138 G	D700,179 S *	2/2014	Hong	D14/341
D686,177 S *	7/2013	Lee	D14/138 G	D700,180 S *	2/2014	Hong	D14/341
D687,002 S *	7/2013	Song et al.	D14/138 G	D700,605 S *	3/2014	Hong	D14/341
					D701,191 S *	3/2014	Suk	D14/138 G
					D701,202 S *	3/2014	Choi	D14/341
					2010/0333043 A1 *	12/2010	Faris et al.	715/863

* cited by examiner

FIG. 1

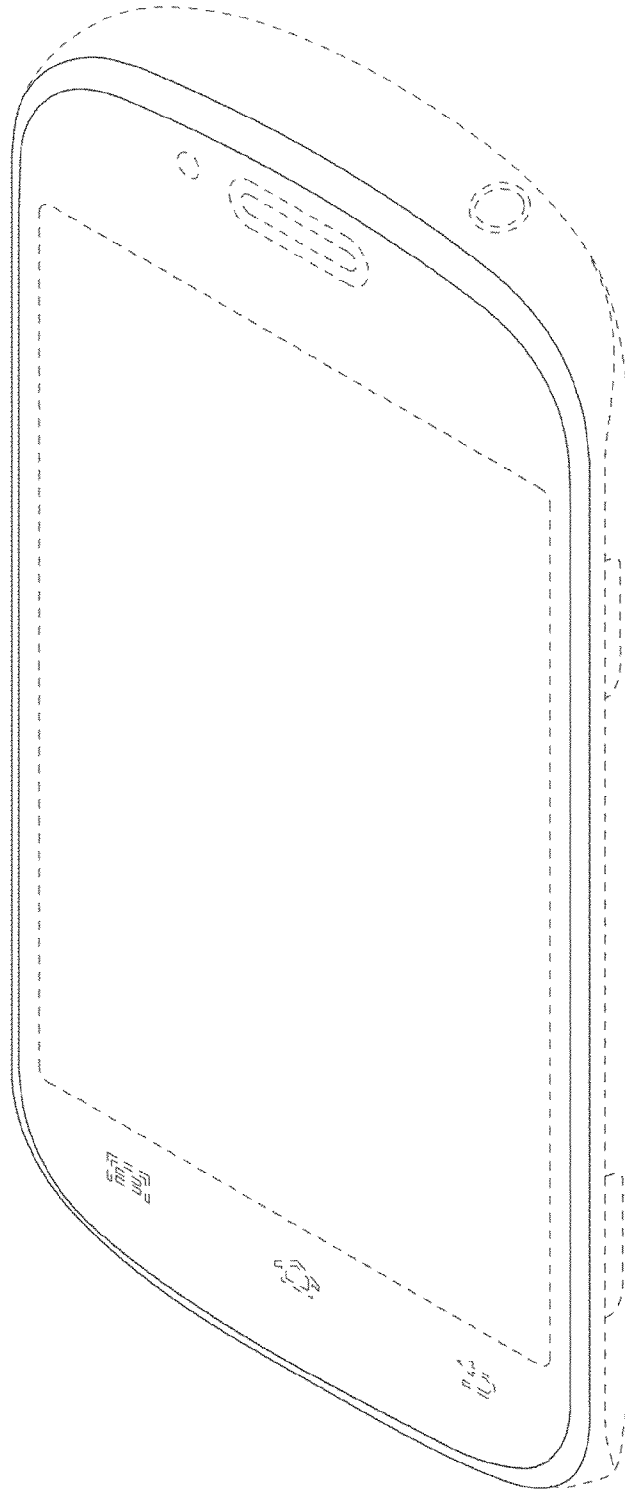

FIG.2

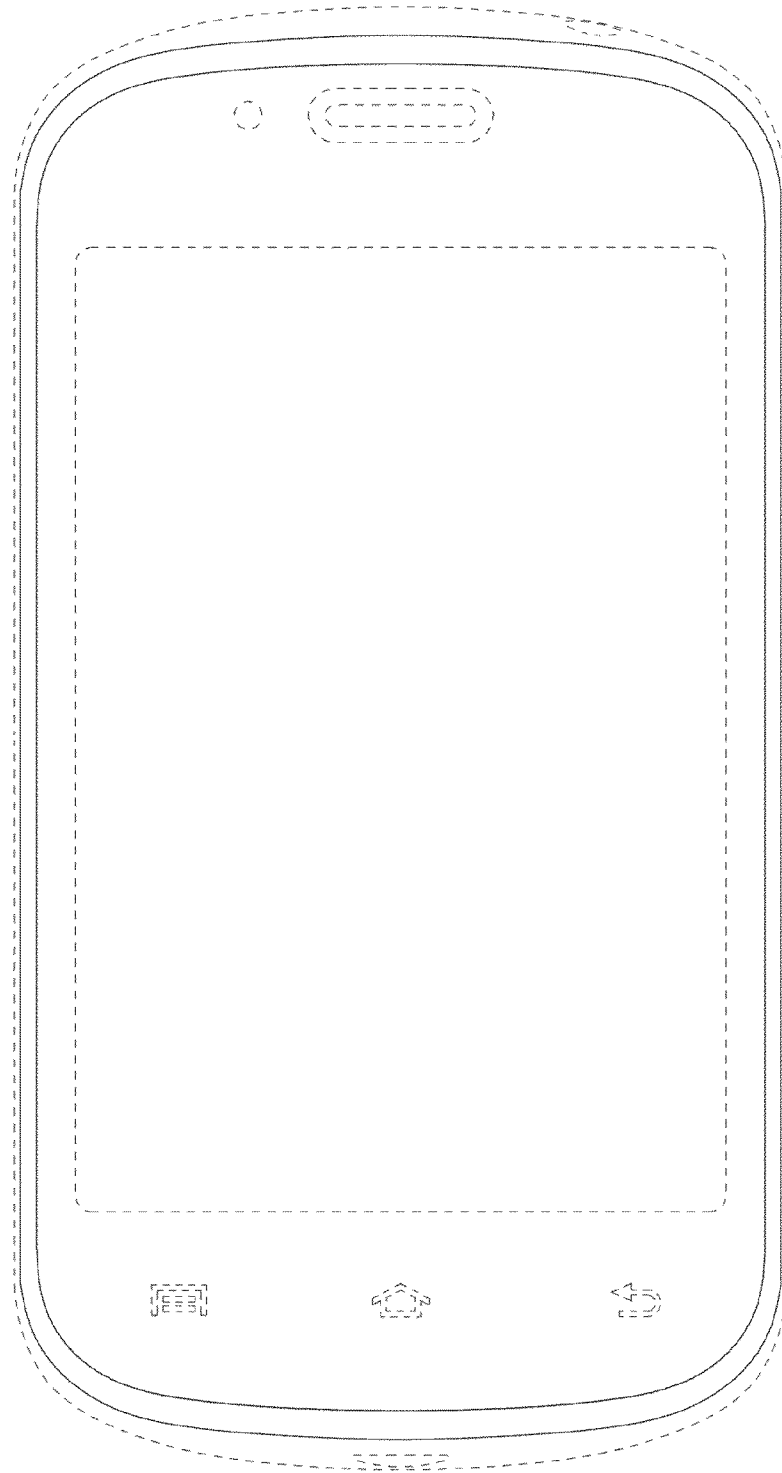

FIG.3

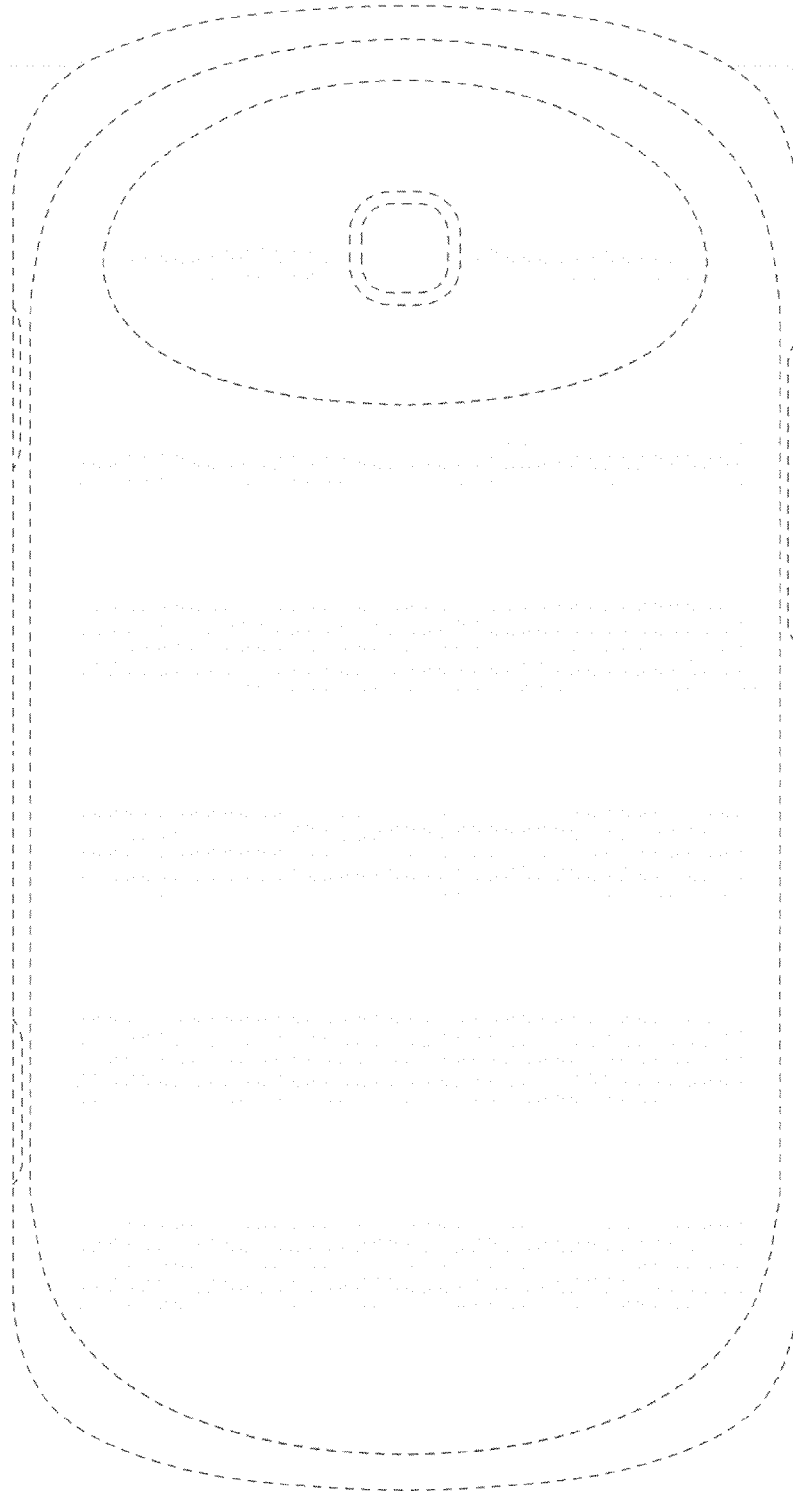

FIG.4



FIG.5

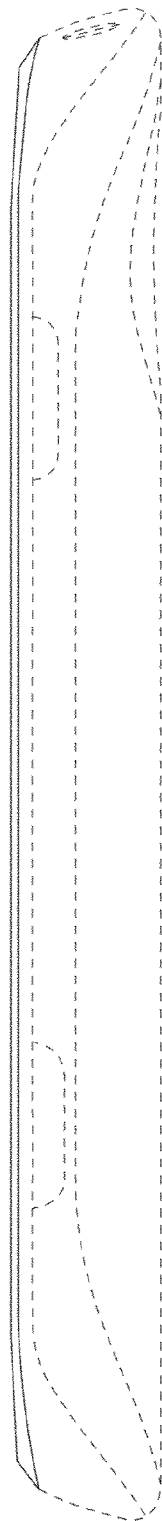

FIG.6

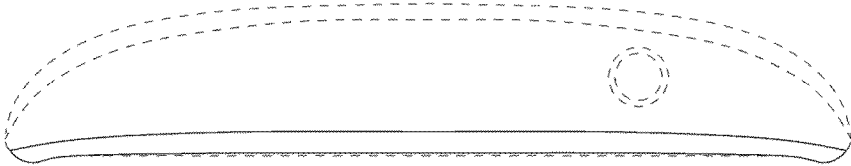

FIG.7

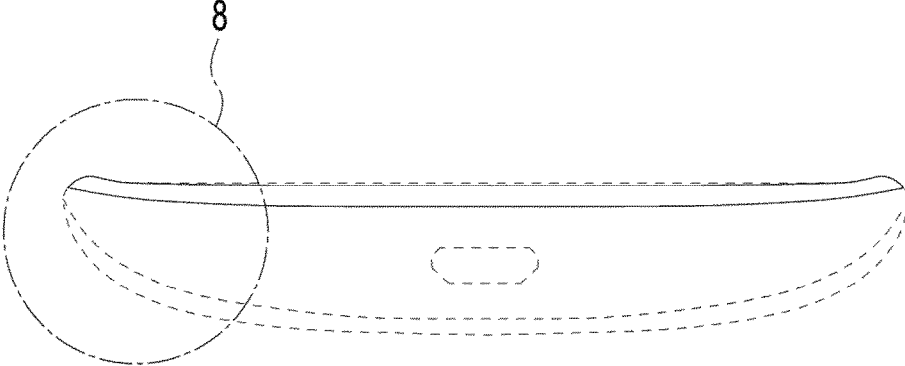

FIG.8

