



US00D740816S

(12) **United States Design Patent**
Bosveld et al.

(10) **Patent No.:** **US D740,816 S**

(45) **Date of Patent:** **** Oct. 13, 2015**

(54) **HEADSET WITH VISOR**
(71) Applicant: **Microsoft Corporation**, Redmond, WA (US)
(72) Inventors: **Paul Bosveld**, Seattle, WA (US); **Nicolas Denhez**, Seattle, WA (US); **YeongKyu Yoo**, Bellevue, WA (US); **Phil Frank**, Portland, OR (US); **Young Duk Song**, Kirkland, WA (US); **Henric Jentz**, Seattle, WA (US); **Aditha Adams**, Seattle, WA (US); **Travis Hosler**, Seattle, WA (US); **Andrew Hodge**, Palo Alto, CA (US)

(73) Assignee: **Microsoft Corporation**, Redmond, WA (US)

(**) Term: **14 Years**

(21) Appl. No.: **29/515,201**

(22) Filed: **Jan. 20, 2015**

(51) **LOC (10) Cl.** **14-02**

(52) **U.S. Cl.**
USPC **D14/372**

(58) **Field of Classification Search**
USPC D14/372, 496, 432, 371, 125, 126, 129, D14/299; D16/300-342; 351/158, 153, 144; 345/7-9, 905; 455/344; 348/115, 53, 348/121, 739
CPC G02B 27/017; G02B 27/0158; G02B 27/0161; G02B 27/0181; G02B 27/0185; G02B 27/0189

See application file for complete search history.

(56) **References Cited**

U.S. PATENT DOCUMENTS

D601,641 S * 10/2009 Yeung D21/483
D687,434 S * 8/2013 Serota D14/372
D701,206 S * 3/2014 Luckey et al. D14/372
D704,706 S * 5/2014 Serota D14/372
D709,880 S * 7/2014 Kim et al. D14/372

D714,786 S * 10/2014 Pombo et al. D14/372
D719,953 S * 12/2014 Nokuo et al. D14/372
D722,054 S * 2/2015 Serota D14/372
D724,559 S * 3/2015 Reaux D14/205
D727,318 S * 4/2015 Garcia Marin et al. D14/372
D727,896 S * 4/2015 Lалуque D14/372
2013/0237146 A1* 9/2013 Serota 455/12.1
2013/0285886 A1* 10/2013 Pombo et al. 345/8

* cited by examiner

Primary Examiner — Austin Murphy

(74) *Attorney, Agent, or Firm* — Banner & Witcoff, Ltd.

(57) **CLAIM**

The ornamental design for a headset with visor, as shown and described.

DESCRIPTION

FIG. 1 is a front perspective view of a headset with visor showing our new design;
FIG. 2 is a rear perspective view thereof;
FIG. 3 is a front view thereof;
FIG. 4 is a rear view thereof;
FIG. 5 is a left side view thereof;
FIG. 6 is a right side view thereof;
FIG. 7 is a top view thereof;
FIG. 8 is a bottom view thereof;
FIG. 9 is a front perspective view of the headset with visor of FIGS. 1-8 shown with selected disclaimed features removed for clarity;
FIG. 10 is a rear perspective view thereof;
FIG. 11 is a front view thereof;
FIG. 12 is a rear view thereof;
FIG. 13 is a left side view thereof;
FIG. 14 is a right side view thereof;
FIG. 15 is a top view thereof; and
FIG. 16 is a bottom view thereof.

The broken line showing of the remainder of the headset with visor is for environmental purposes only and forms no part of the claimed design. FIGS. 9-16 show the headset with visor of FIGS. 1-8 with selected disclaimed features removed for clarity.

1 Claim, 16 Drawing Sheets

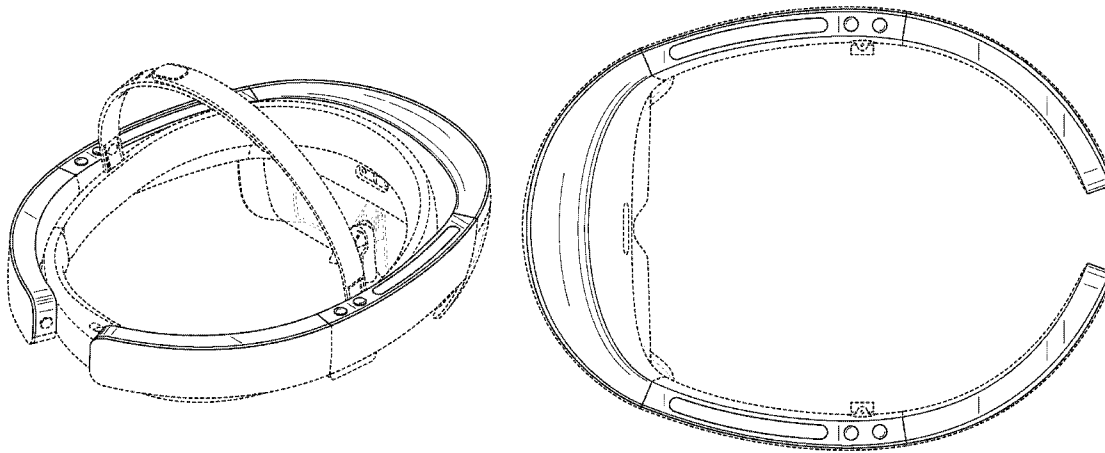

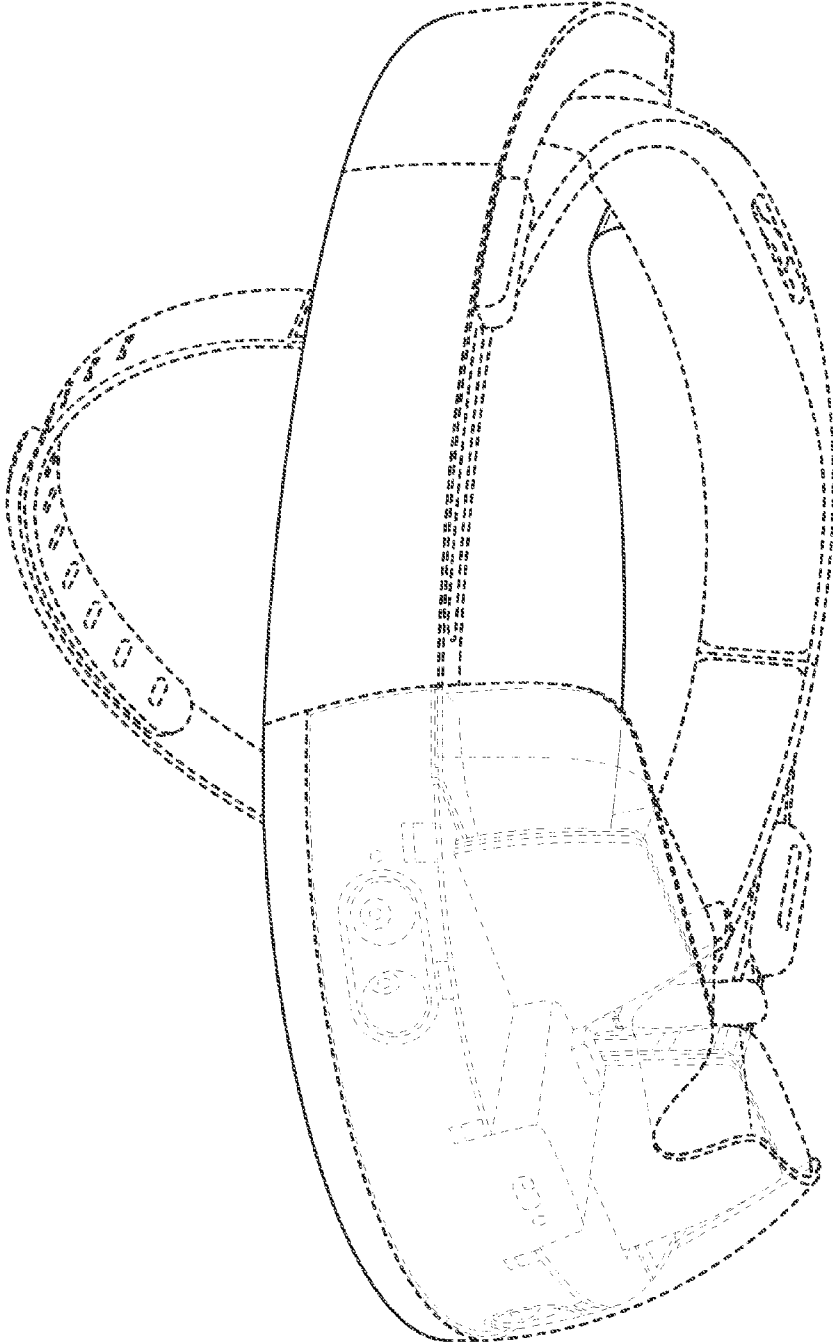

FIG. 1

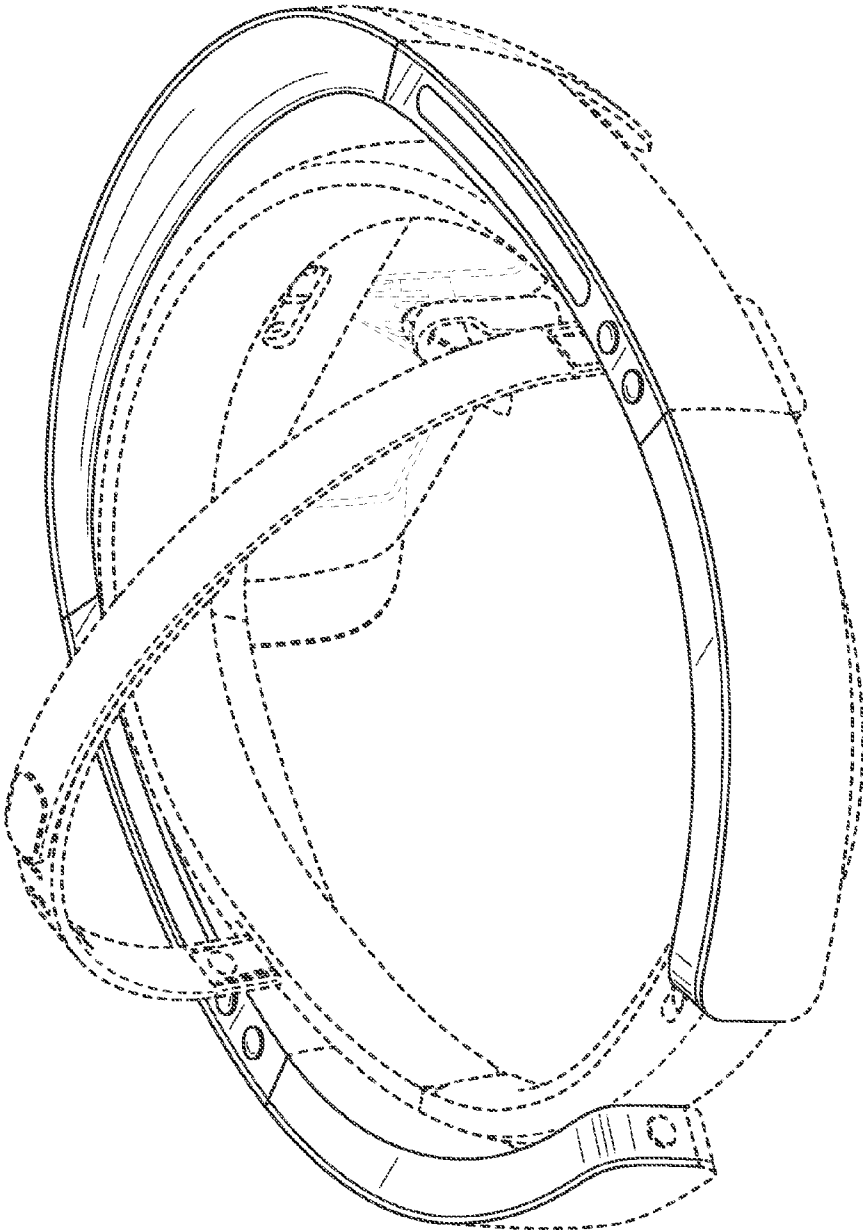

FIG. 2

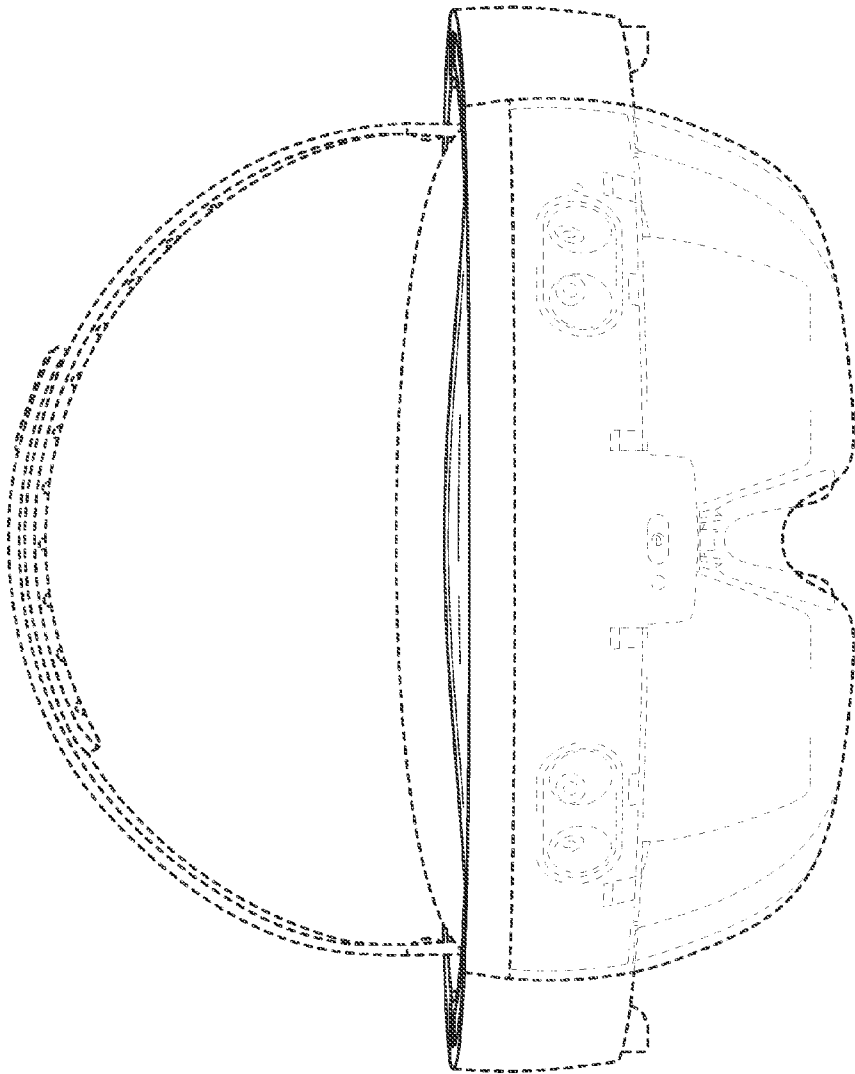

FIG. 3

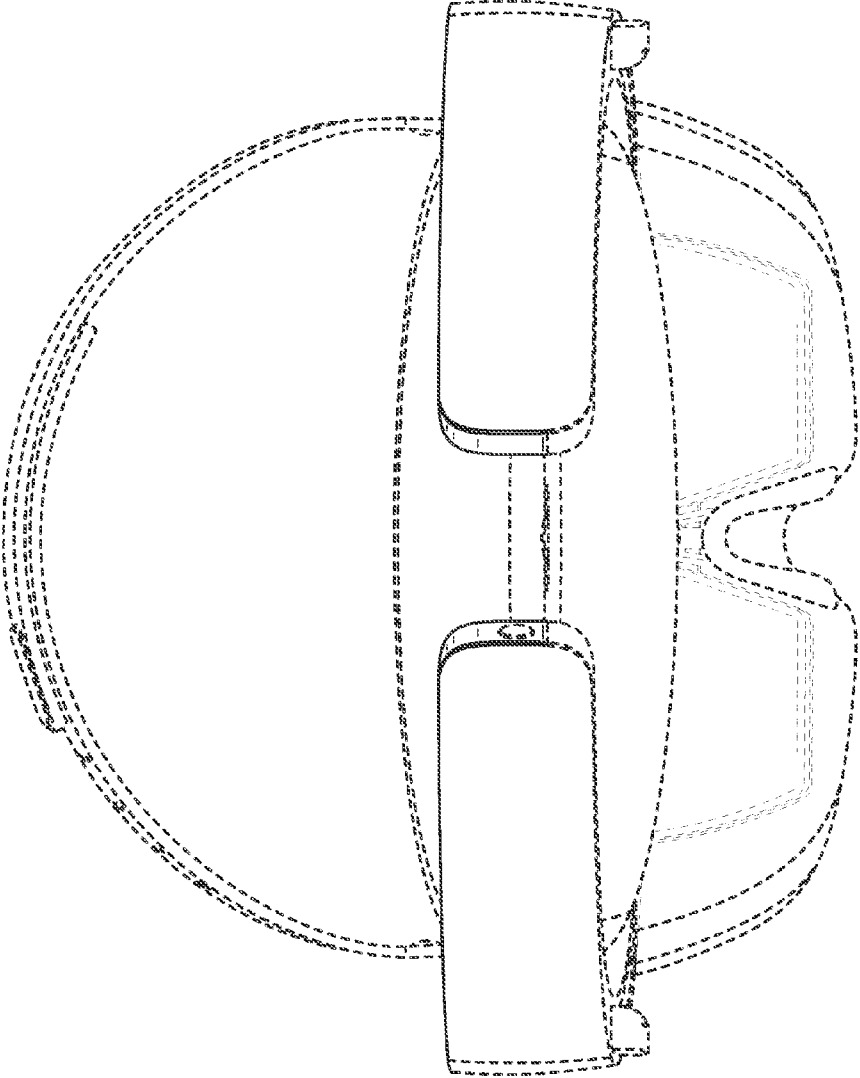

FIG. 4

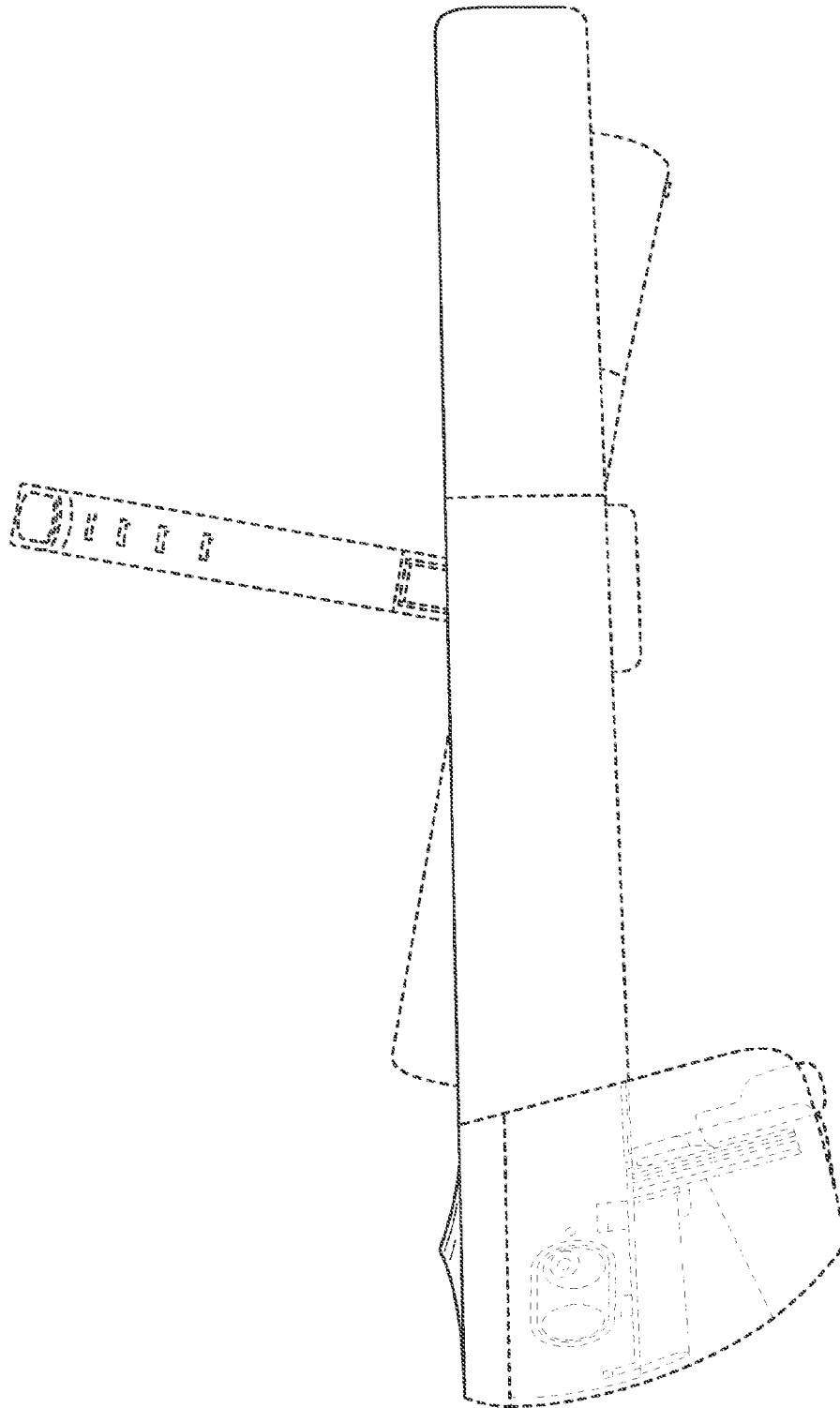

FIG. 5

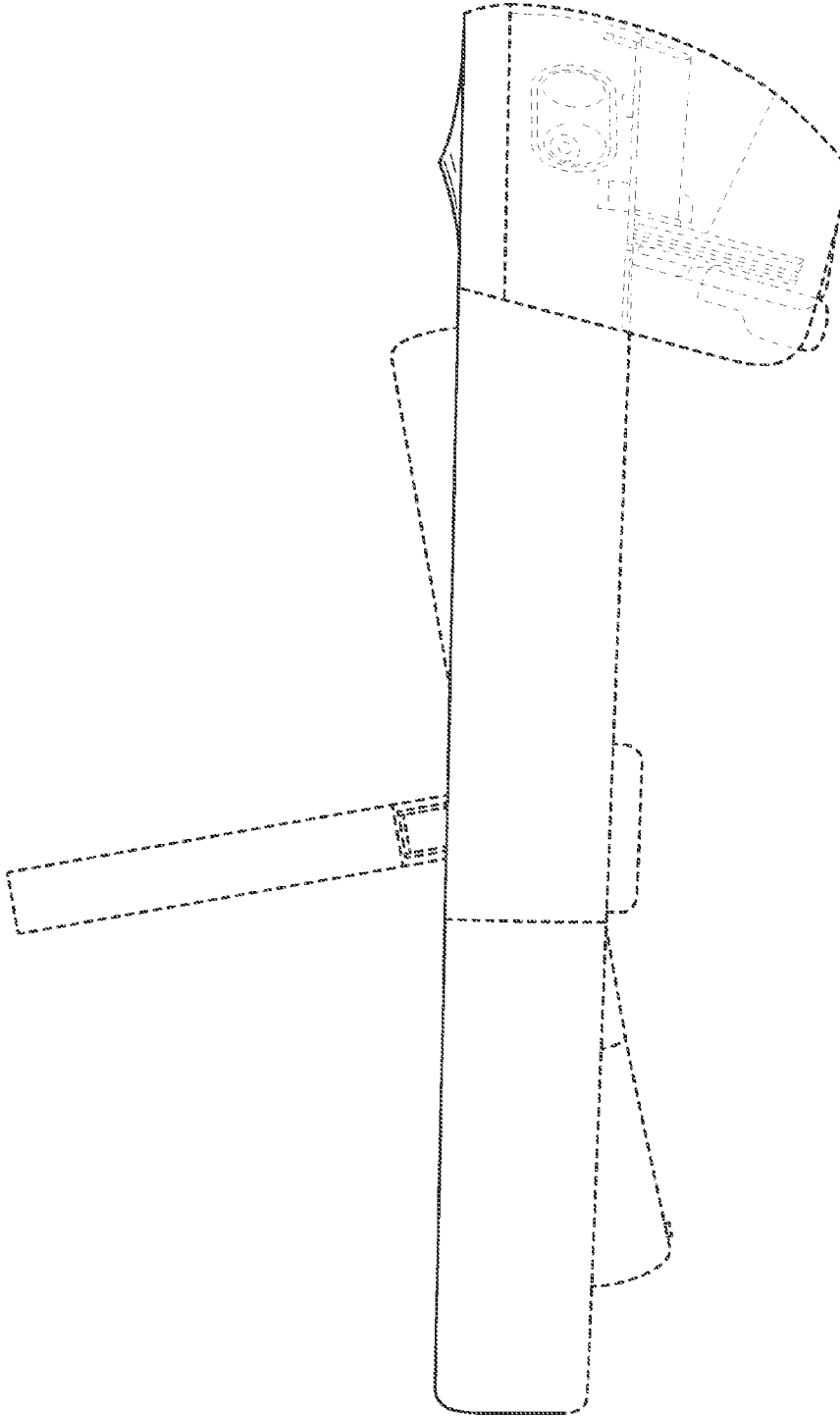

FIG. 6

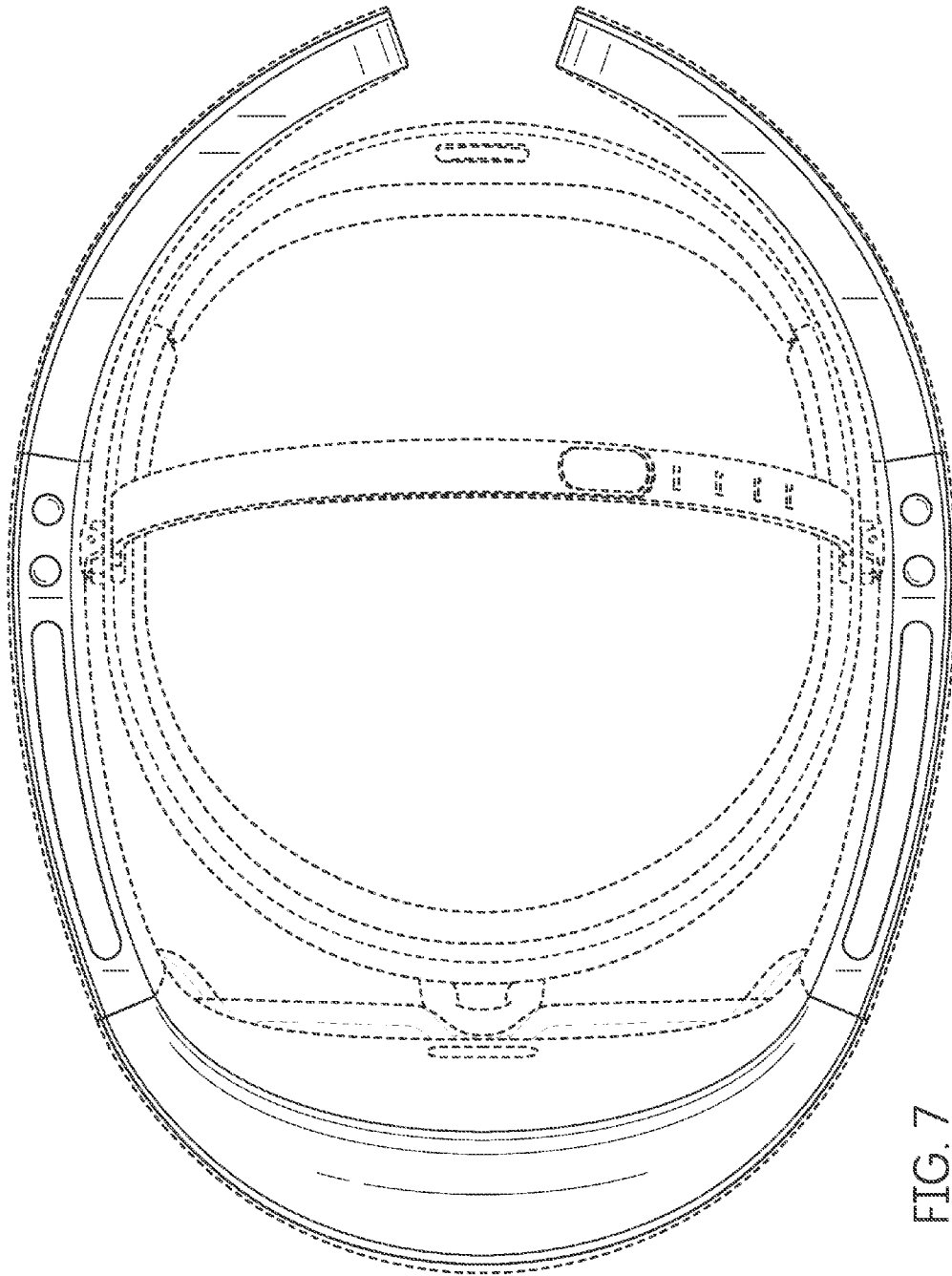

FIG. 7

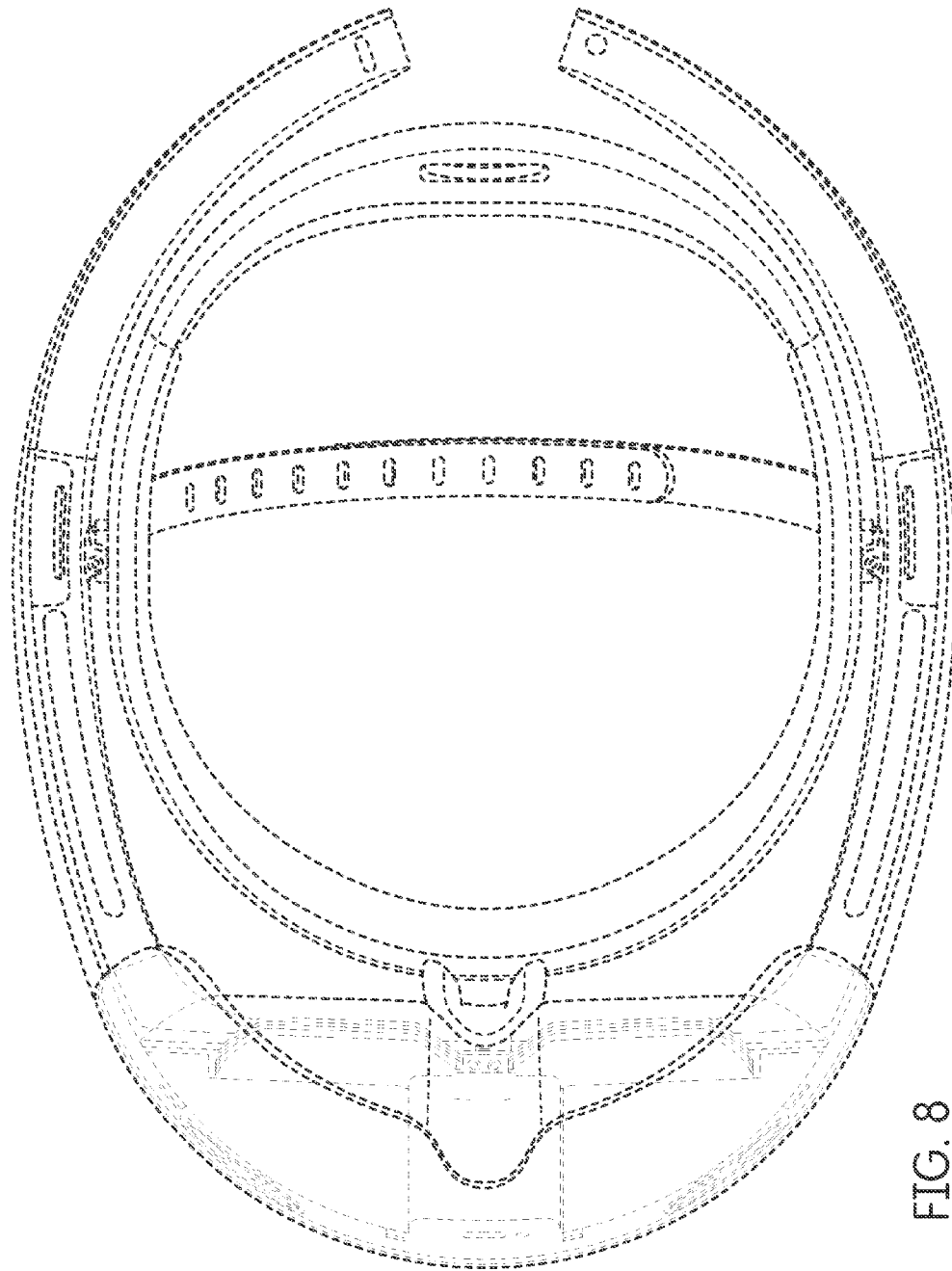

FIG. 8

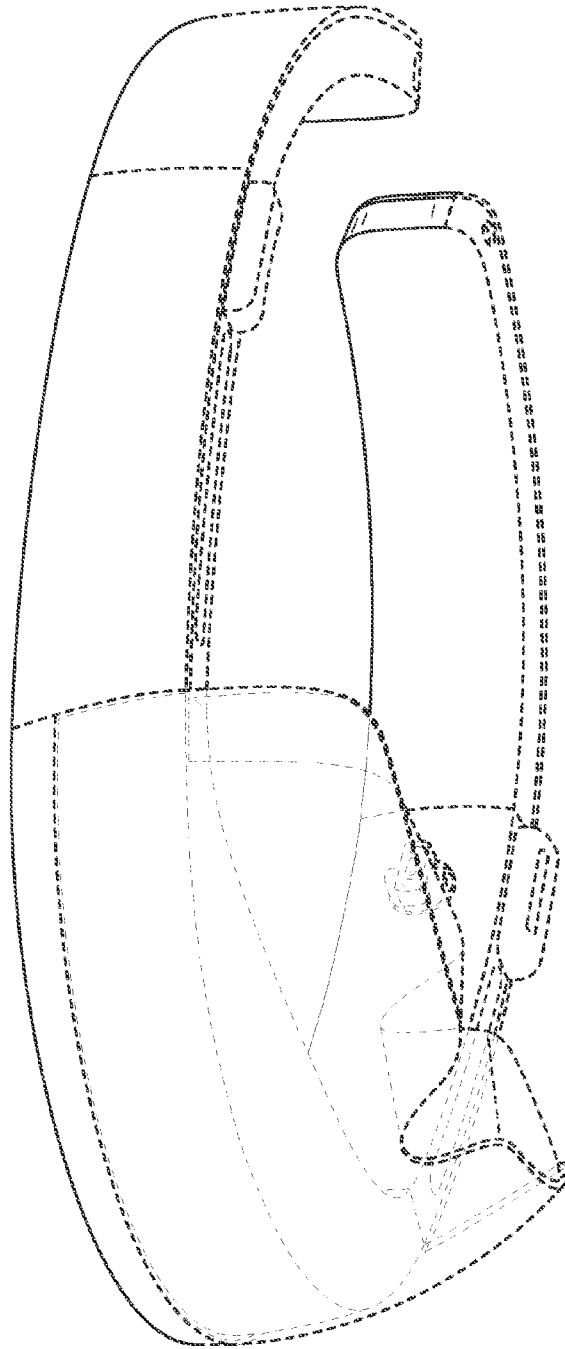

FIG. 9

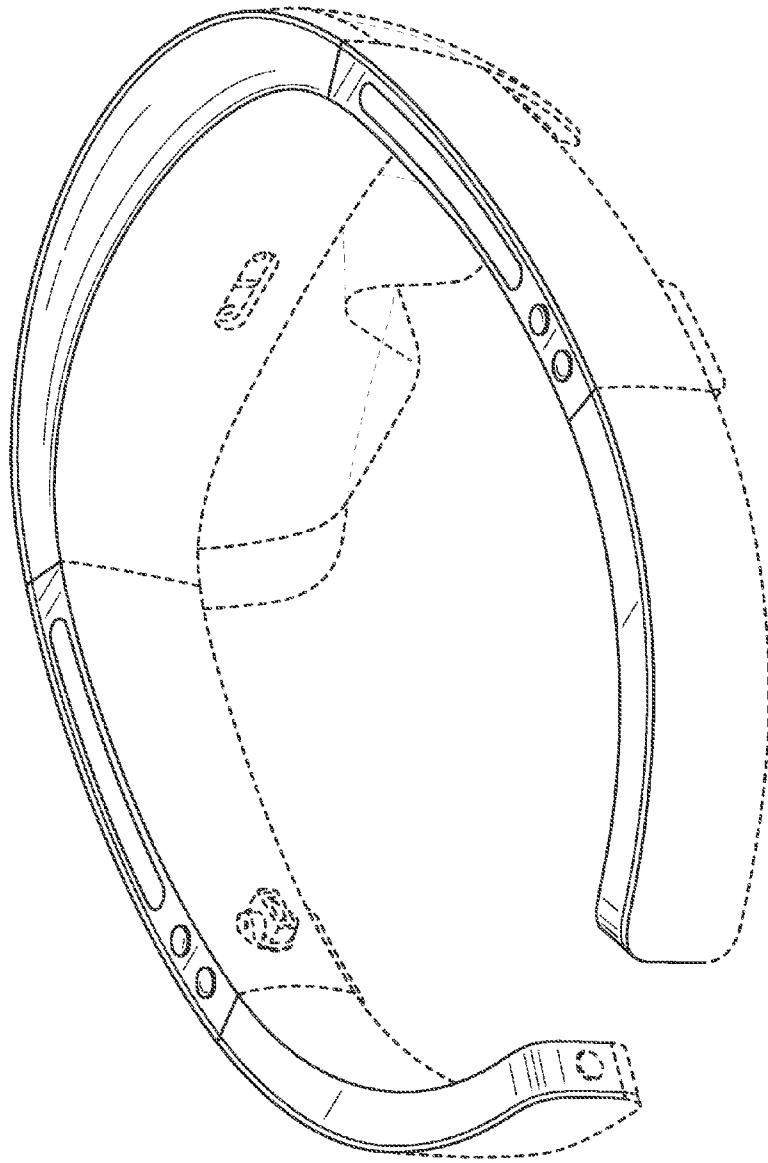

FIG. 10

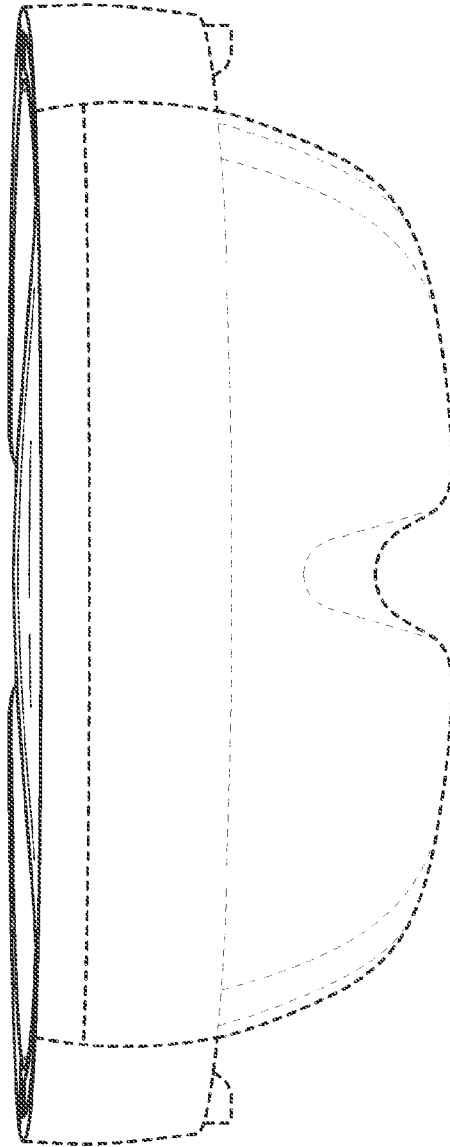

FIG. 11

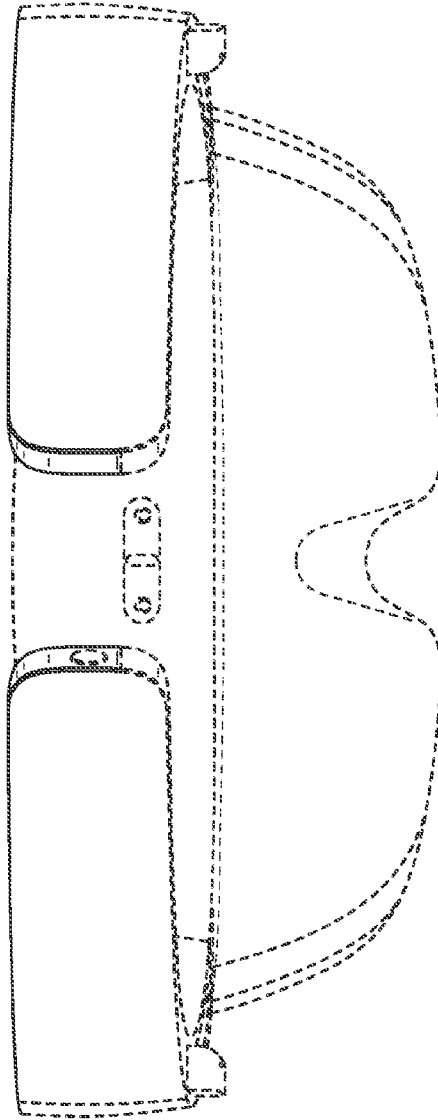

FIG. 12

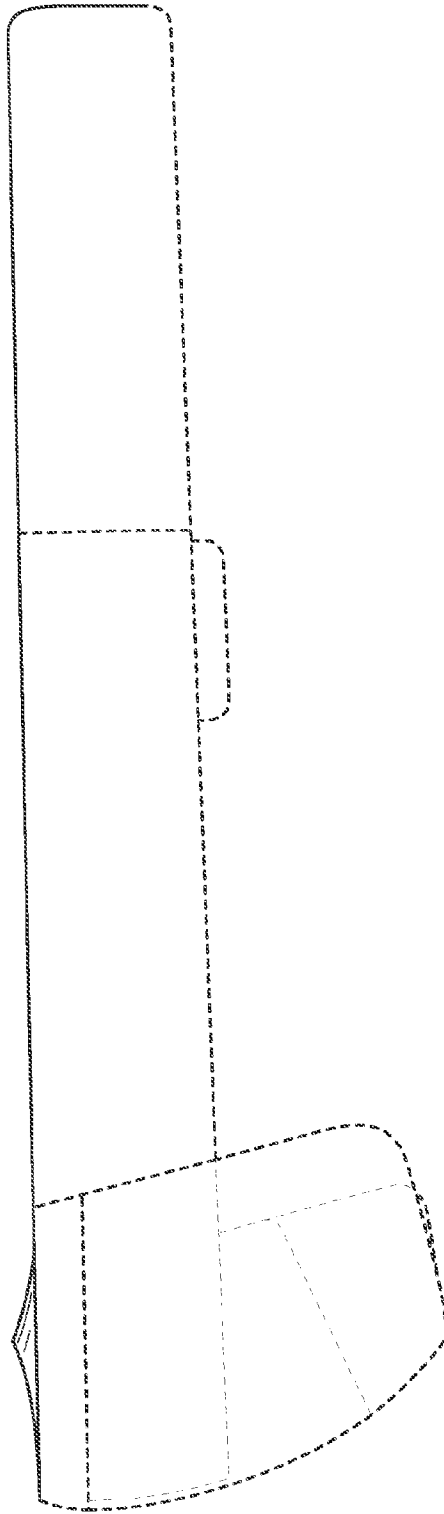

FIG. 13

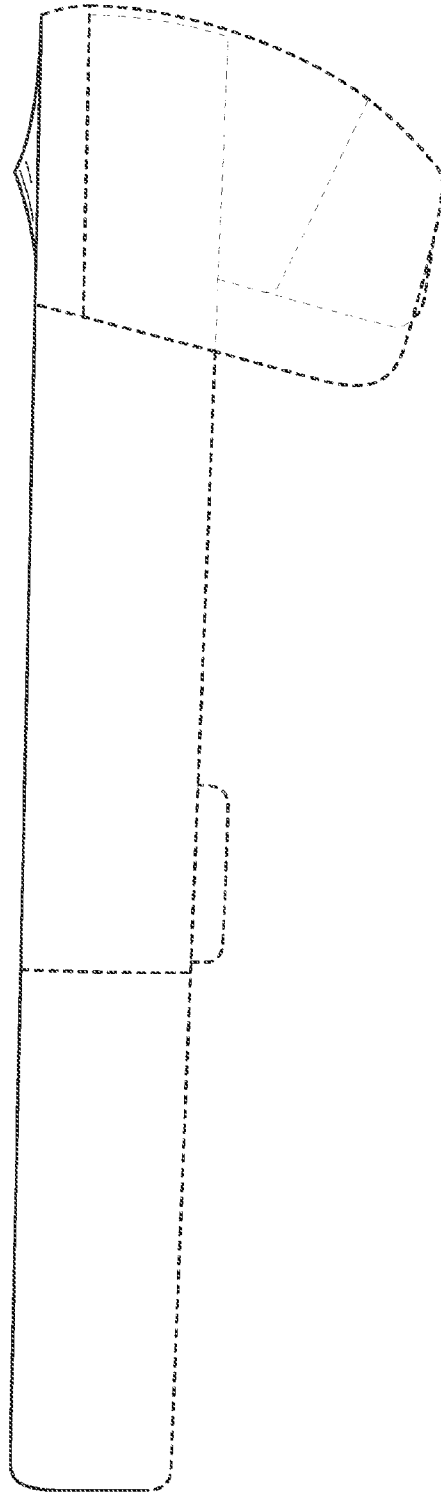

FIG. 14

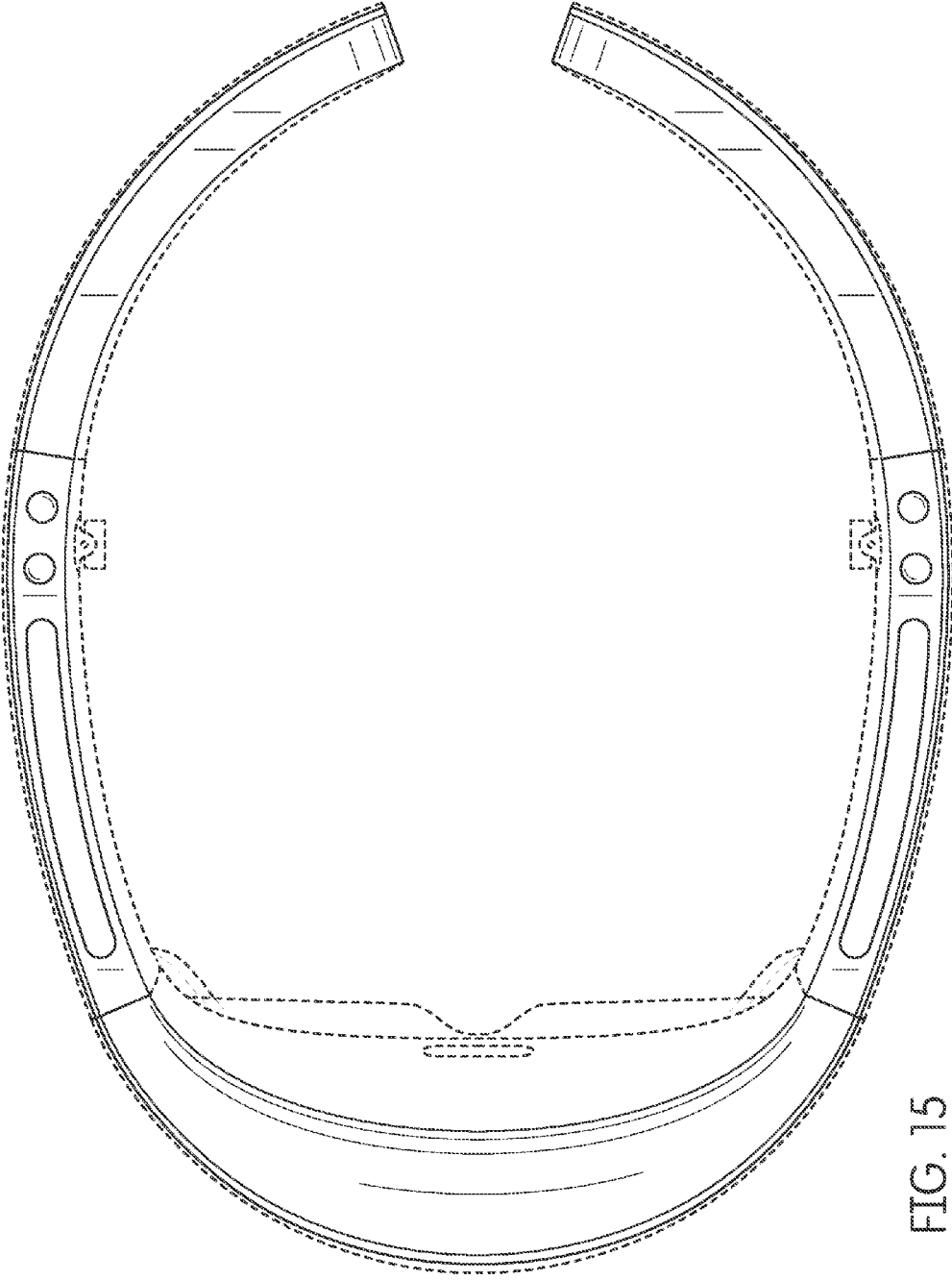

FIG. 15

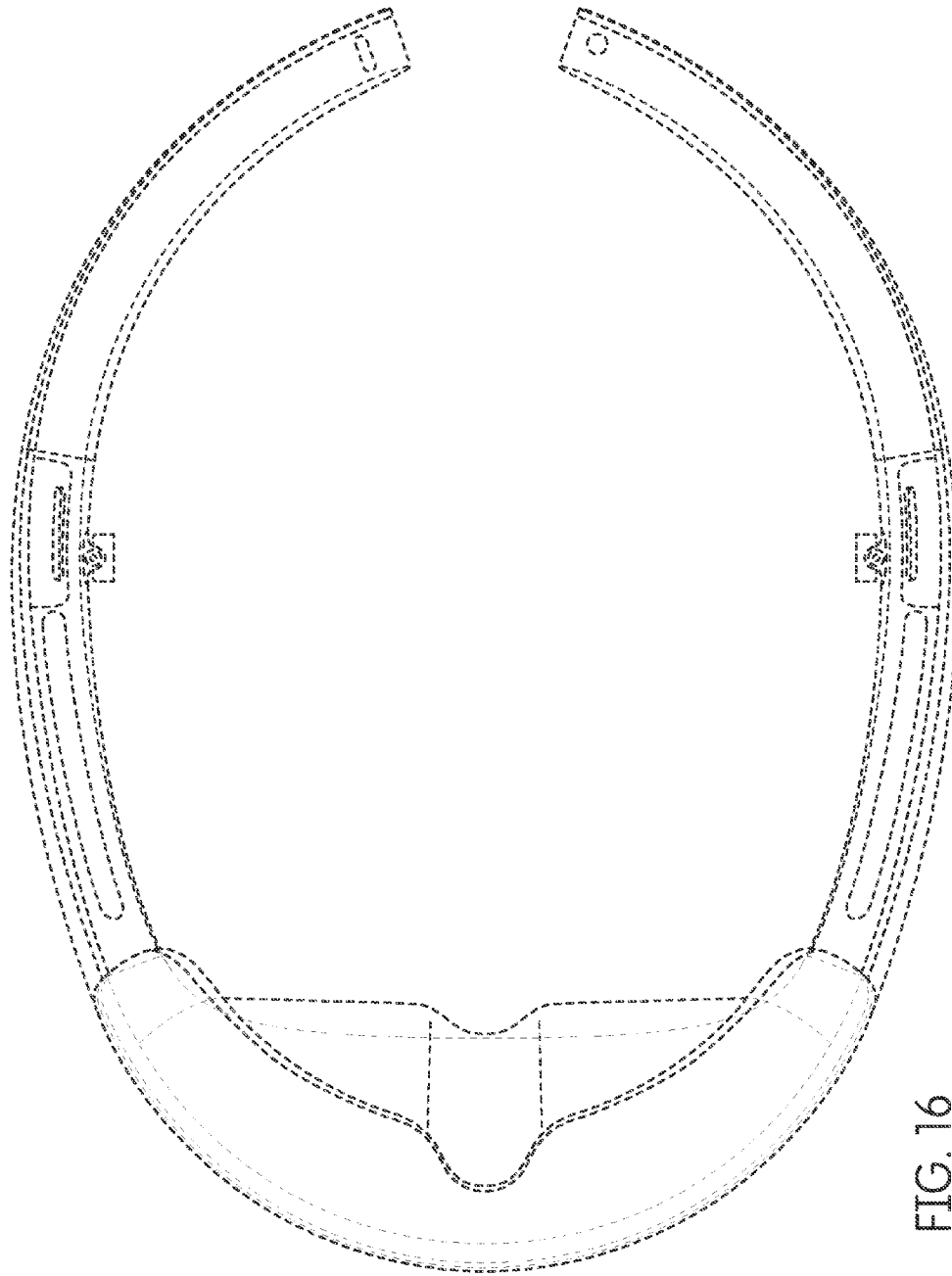

FIG. 16