



(86) Date de dépôt PCT/PCT Filing Date: 2004/01/26
 (87) Date publication PCT/PCT Publication Date: 2004/08/12
 (85) Entrée phase nationale/National Entry: 2005/07/22
 (86) N° demande PCT/PCT Application No.: US 2004/002028
 (87) N° publication PCT/PCT Publication No.: 2004/066931
 (30) Priorités/Priorities: 2003/01/24 (60/442,171) US;
 2003/09/05 (60/500,316) US

(51) Cl.Int.⁷/Int.Cl.⁷ A61K 31/496, A61K 31/56, A61K 31/541,
 A61K 31/54, A61K 31/5375, A61K 31/198, A61P 29/00,
 A61K 31/506, A61K 31/505, A61K 31/495, A61K 31/472,
 A61K 31/47, ...

(71) Demandeur/Applicant:
 ELAN PHARMACEUTICALS, INC., US

(72) Inventeurs/Inventors:
 KARLIK, STEVE J., CA;
 PLEISS, MICHAEL A., US;
 KONRADI, ANDREI W., US;
 GRANT, FRANCINE S., US;
 SEMKO, CHRISTOPHER M., US;
 ...

(74) Agent: BARRIGAR INTELLECTUAL PROPERTY LAW

(54) Titre : COMPOSITION ET METHODE DESTINEES A TRAITER LES MALADIES DE DEMYELINISATION ET LA
 PARALYSIE PAR ADMINISTRATION D'AGENTS DE REMYELINISATION
 (54) Title: COMPOSITION FOR AND TREATMENT OF DEMYELINATING DISEASES AND PARALYSIS BY
 ADMINISTRATION OF REMYELINATING AGENTS

(57) **Abrégé/Abstract:**

The application provides for methods and compositions for inhibiting demyelination, promoting remyelination and/or treating paralysis in a subject in need thereof. Preferably, such compositions include immunoglobulins (e.g., antibodies, antibody fragments, and recombinantly produced antibodies or fragments), polypeptides (e.g., soluble forms of the ligand proteins for integrins) and small molecules, which when administered in an effective amount inhibits demyelination and/or promotes remyelination in a patient. The compositions and methods described herein can also utilize other anti-inflammatory agents used to palliate conditions and diseases associated with demyelination.

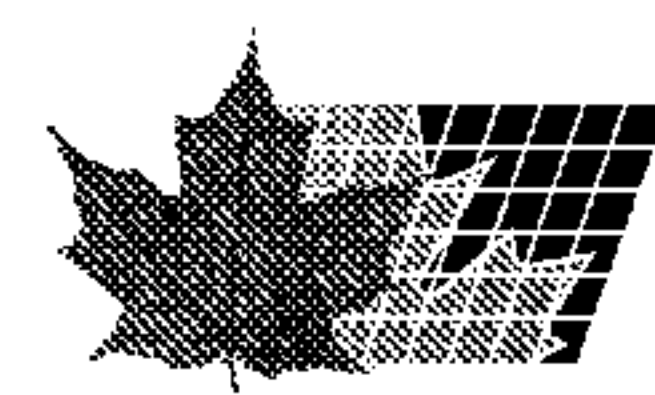

(51) Cl.Int.⁷/Int.Cl.⁷ (suite/continued) A61K 31/445, A61K 31/44, A61K 31/427, A61K 31/4164, A61K 31/415, A61K 31/40, A61K 31/397, A61K 31/395, A61K 31/381, A61K 31/216, A61K 38/21

(72) Inventeurs(suite)/Inventors(continued): DRESSEN, DAREN, US; MESSERSMITH, ELIZABETH, US; FREEDMAN, STEPHEN, US; YEDNOCK, TED, US

(12) INTERNATIONAL APPLICATION PUBLISHED UNDER THE PATENT COOPERATION TREATY (PCT)

(19) World Intellectual Property
Organization
International Bureau



(43) International Publication Date
12 August 2004 (12.08.2004)

PCT

(10) International Publication Number
WO 2004/066931 A2

- (51) International Patent Classification⁷: **A61K** GB, GD, GE, GH, GM, HR, HU, ID, IL, IN, IS, JP, KE, KG, KP, KR, KZ, LC, LK, LR, LS, LT, LU, LV, MA, MD, MG, MK, MN, MW, MX, MZ, NA, NI, NO, NZ, OM, PG, PH, PL, PT, RO, RU, SC, SD, SE, SG, SK, SL, SY, TJ, TM, TN, TR, TT, TZ, UA, UG, US, UZ, VC, VN, YU, ZA, ZM, ZW.
- (21) International Application Number: PCT/US2004/002028
- (22) International Filing Date: 26 January 2004 (26.01.2004)
- (25) Filing Language: English
- (26) Publication Language: English
- (30) Priority Data:
60/442,171 24 January 2003 (24.01.2003) US
60/500,316 5 September 2003 (05.09.2003) US
- (71) Applicant (for all designated States except US): **ELAN PHARMACEUTICALS INC.** [US/US]; 800 Gateway Boulevard, South San Francisco, CA 94080 (US).
- (72) Inventors; and
- (75) Inventors/Applicants (for US only): **KARLIK, Steve, J.** [CA/CA]; 55 St. John Street, South, St. Mary's, Ontario N4X 1A3 (CA). **PLEISS, Michael, A.** [US/US]; 848 Stella Court, Sunnyvale, CA 94087-1355 (US). **KONRADI, Andrei, W.** [US/US]; 30 Victoria Road, Burlingame, CA 94010 (US). **GRANT, Francine, S.** [FR/US]; 3860 80th Avenue, Mercer Island, WA 98040 (US). **SEMKO, Christopher, M.** [CA/US]; 4993 Norris Road, Fremont, CA 94536 (US). **DRESSEN, Daren** [US/US]; 3110 Casa De Campo #2, San Mateo, CA 94403 (US). **MESSERSMITH, Elizabeth** [US/US]; 950 Sea View Drive, El Cerrito, CA 94530 (US). **FREEDMAN, Stephen** [GB/US]; 2189 Ridgpoint Court, Walnut Creek, CA 94596 (US). **YEDNOCK, Ted** [US/US]; 184 Arroyo Road, Forest Knolls, CA 94933 (US).
- (74) Agents: **REA, Teresa, Stanek et al.**; Burns, Doane, Swecker & Mathis, L.L.P., P.O. Box 1404, Alexandria, VA 22313-1404 (US).
- (81) Designated States (unless otherwise indicated, for every kind of national protection available): AE, AG, AL, AM, AT, AU, AZ, BA, BB, BG, BR, BW, BY, BZ, CA, CH, CN, CO, CR, CU, CZ, DE, DK, DM, DZ, EC, EE, EG, ES, FI, GB, GD, GE, GH, GM, HR, HU, ID, IL, IN, IS, JP, KE, KG, KP, KR, KZ, LC, LK, LR, LS, LT, LU, LV, MA, MD, MG, MK, MN, MW, MX, MZ, NA, NI, NO, NZ, OM, PG, PH, PL, PT, RO, RU, SC, SD, SE, SG, SK, SL, SY, TJ, TM, TN, TR, TT, TZ, UA, UG, UZ, VC, VN, YU, ZA, ZM, ZW, ARIPO patent (BW, GH, GM, KE, LS, MW, MZ, SD, SL, SZ, TZ, UG, ZM, ZW), Eurasian patent (AM, AZ, BY, KG, KZ, MD, RU, TJ, TM), European patent (AT, BE, BG, CH, CY, CZ, DE, DK, EE, ES, FI, FR, GB, GR, HU, IE, IT, LU, MC, NL, PT, RO, SE, SI, SK, TR), OAPI patent (BF, BJ, CF, CG, CI, CM, GA, GN, GQ, GW, ML, MR, NE, SN, TD, TG).
- Declarations under Rule 4.17:**
- as to applicant's entitlement to apply for and be granted a patent (Rule 4.17(ii)) for the following designations AE, AG, AL, AM, AT, AU, AZ, BA, BB, BG, BR, BW, BY, BZ, CA, CH, CN, CO, CR, CU, CZ, DE, DK, DM, DZ, EC, EE, EG, ES, FI, GB, GD, GE, GH, GM, HR, HU, ID, IL, IN, IS, JP, KE, KG, KP, KR, KZ, LC, LK, LR, LS, LT, LU, LV, MA, MD, MG, MK, MN, MW, MX, MZ, NA, NI, NO, NZ, OM, PG, PH, PL, PT, RO, RU, SC, SD, SE, SG, SK, SL, SY, TJ, TM, TN, TR, TT, TZ, UA, UG, UZ, VC, VN, YU, ZA, ZM, ZW, ARIPO patent (BW, GH, GM, KE, LS, MW, MZ, SD, SL, SZ, TZ, UG, ZM, ZW), Eurasian patent (AM, AZ, BY, KG, KZ, MD, RU, TJ, TM), European patent (AT, BE, BG, CH, CY, CZ, DE, DK, EE, ES, FI, FR, GB, GR, HU, IE, IT, LU, MC, NL, PT, RO, SE, SI, SK, TR), OAPI patent (BF, BJ, CF, CG, CI, CM, GA, GN, GQ, GW, ML, MR, NE, SN, TD, TG)
 - as to the applicant's entitlement to claim the priority of the earlier application (Rule 4.17(iii)) for all designations
 - as to the applicant's entitlement to claim the priority of the earlier application (Rule 4.17(iii)) for all designations
- Published:**
- without international search report and to be republished upon receipt of that report
- For two-letter codes and other abbreviations, refer to the "Guidance Notes on Codes and Abbreviations" appearing at the beginning of each regular issue of the PCT Gazette.

(54) Title: COMPOSITION FOR AND TREATMENT OF DEMYELINATING DISEASES AND PARALYSIS BY ADMINISTRATION OF REMYELINATING AGENTS

(57) Abstract: The application provides for methods and compositions for inhibiting demyelination, promoting remyelination and/or treating paralysis in a subject in need thereof. Preferably, such compositions include immunoglobulins (e.g., antibodies, antibody fragments, and recombinantly produced antibodies or fragments), polypeptides (e.g., soluble forms of the ligand proteins for integrins) and small molecules, which when administered in an effective amount inhibits demyelination and/or promotes remyelination in a patient. The compositions and methods described herein can also utilize other anti-inflammatory agents used to palliate conditions and diseases associated with demyelination.

WO 2004/066931 A2

DEMANDE OU BREVET VOLUMINEUX

LA PRÉSENTE PARTIE DE CETTE DEMANDE OU CE BREVET COMPREND PLUS D'UN TOME.

CECI EST LE TOME 1 DE 2
CONTENANT LES PAGES 1 À 330

NOTE : Pour les tomes additionels, veuillez contacter le Bureau canadien des brevets

JUMBO APPLICATIONS/PATENTS

THIS SECTION OF THE APPLICATION/PATENT CONTAINS MORE THAN ONE VOLUME

THIS IS VOLUME 1 OF 2
CONTAINING PAGES 1 TO 330

NOTE: For additional volumes, please contact the Canadian Patent Office

NOM DU FICHER / FILE NAME :

NOTE POUR LE TOME / VOLUME NOTE:

**COMPOSITION FOR AND TREATMENT OF DEMYELINATING DISEASES AND
PARALYSIS BY ADMINISTRATION OF REMYELINATING AGENTS**

FIELD OF THE INVENTION

5 This invention relates generally to compositions, compounds that can be used to treat demyelinating diseases and conditions and/or reduce paralysis in a patient.

BACKGROUND OF THE INVENTION

10 Inflammation is a response of vascularized tissues to infection or injury and is affected by adhesion of leukocytes to the endothelial cells of blood vessels and their infiltration into the surrounding tissues. In normal inflammation, the infiltrating leukocytes release toxic mediators to kill invading organisms, phagocytize debris and dead cells, and play a role in tissue repair and the immune response. However, in pathologic inflammation, infiltrating leukocytes are over-
15 responsive and can cause serious or fatal damage. *See, e.g., Hickey, Psychoneuroimmunology II* (Academic Press 1990).

 The integrins are a family of cell-surface glycoproteins involved in cell-adhesion, immune cell migration and activation. Alpha-4 integrin is expressed by all circulating leukocytes except neutrophils, and forms heterodimeric receptors in
20 conjunction with either the beta-1 (β_1) or beta-7 (β_7) integrin subunits; both alpha-4 beta-1 ($\alpha_4\beta_1$) and alpha-4 beta-7 ($\alpha_4\beta_7$) play a role in migration of leukocytes across the vascular endothelium (Springer *et al.*, *Cell* 1994, 76: 301-14; Butcher *et al.*, *Science* 1996, 272: 60-6) and contribute to cell activation and survival within the
25 parenchyma (Damle *et al.*, *J. Immunol.* 1993; 151: 2368-79; Koopman *et al.*, *J. Immunol.* 1994, 152: 3760-7; Leussink *et al.*, *Acta Neuropathol.* 2002, 103: 131-136). $\alpha_4\beta_1$ is constitutively expressed on lymphocytes, monocytes, macrophages, mast cells, basophils and eosinophils.

 Alpha-4 beta-1 (also known as very late antigen-4, VLA-4), binds to vascular cell adhesion molecule-1 (Lobb *et al.*, *J. Clin. Invest.* 1994, 94: 1722-8), which is
30 expressed by the vascular endothelium at many sites of chronic inflammation (Bevilacqua *et al.*, 1993 *Annu. Rev. Immunol.* 11: 767-804; Postigo *et al.*, 1993 *Res.*

Immunol. 144: 723-35). $\alpha_4\beta_1$ has other ligands, including fibronectin and other extracellular matrix (ECM) components.

The alpha-4 beta-7 dimer interacts with mucosal addressin cell adhesion molecule (MAdCAM-1), and mediates homing of lymphocytes to the gut (Farstad *et al.*, 1997 *Am. J. Pathol.* 150: 187-99; Issekutz, 1991 *J. Immunol.* 147: 4178-84).
5 Expression of MAdCAM-1 on the vascular endothelium is also increased at sites of inflammation in the intestinal tract of patients with inflammatory bowel disease (IBD) (Briskin *et al.*, 1997 *Am. J. Pathol.* 151: 97-110).

Adhesion molecules such as alpha-4 integrins are potential targets for
10 therapeutic agents. For instance, the VLA-4 receptor of which alpha-4 integrin is a subunit is an important target because of its interaction with a ligand residing on brain endothelial cells. Diseases and conditions resulting from brain inflammation have particularly severe consequences. In another example, the alpha-4 beta-7
15 integrin dimer is an important target due to its involvement in lymphocyte homing and pathological inflammation in the gastrointestinal tract.

Alpha-4 beta-1 integrin is expressed on the extracellular surface of activated lymphocytes and monocytes, which have been implicated in the pathogenesis of acute inflammatory brain lesions and blood brain barrier (BBB) breakdown associated with multiple sclerosis (MS) (Coles *et al.*, 1999 *Ann. Neurol.* 46(3): 296-
20 304). Agents against alpha-4 integrin have been tested for their anti-inflammatory potential both *in vitro* and *in vivo*. See Yednock *et al.*, *Nature* 1992, 356: 63-66; U.S. Patent No. 5,840,299 to Bendig *et al.*, issued November 24, 1998, and U.S. Patent No. 6,001,809 to Thorsett *et al.*, issued December 14, 1999. The *in vitro* experiments demonstrate that alpha-4 integrin antibodies block attachment of
25 lymphocytes to brain endothelial cells. Experiments testing the effect of alpha-4 integrin antibodies on animals having the artificially induced condition simulating multiple sclerosis, experimental autoimmune encephalomyelitis (EAE), have demonstrated that administration of anti-alpha-4 integrin antibodies prevents inflammation of the brain and subsequent paralysis in the animals. Collectively,
30 these experiments identify anti-alpha-4 integrin antibodies as potentially useful

therapeutic agents for treating multiple sclerosis and other inflammatory diseases and disorders.

To date, no therapies have been discovered which inhibit or prevent demyelination let alone agents that promote remyelination. For example, multiple sclerosis impacts human health and costs for maintaining health more than any other demyelinating disease. No effective treatment exists for MS. It is a disease that afflicts primarily young adults (*i.e.*, mean age of 30) with an incidence of 1 case per 1,000 individuals. Experimental autoimmune encephalomyelitis is the major animal model used for studying MS. However, unlike with EAE, MS is an autoimmune disease with an unknown cause. Disease progression is characterized by an influx of immune cells into the central nerve system that eventually results in edema, demyelination, axonal damage and loss.

New compounds, compositions and methods for using these compounds and compositions to inhibit demyelination, to promote remyelination and/or treat paralysis associated with demyelination are needed and continue to be sought out for the treatment of diseases such as MS, as well as other demyelinating diseases linked with inflammation.

SUMMARY OF THE INVENTION

Based on the above, new compositions and methods of treating these diseases are needed which will effectively treat or inhibit these diseases such that patients can achieve long life spans and better quality of life.

The invention relates to methods of promoting remyelination of nerve cells in a mammal comprising administering to the mammal a remyelination agent in a remyelinating effective amount. Preferably, the mammal in the methods of the present invention is a human, and the human suffers from a condition that demyelinate cells.

Conditions which demyelinate cells according to the invention include multiple sclerosis, congenital metabolic disorder, a neuropathy with abnormal myelination, drug induced demyelination, radiation induced demyelination, a hereditary demyelinating condition, a prion induced demyelinating condition,

encephalitis induced demyelination, or a spinal cord injury. Preferably the condition is multiple sclerosis.

The invention further relates to a composition comprising a therapeutically effective amount of a remyelinating agent, which prevents demyelination and/or promotes remyelination when administered to a subject in need thereof.

In the methods and compositions of the invention, the remyelinating agent may be an antibody, an immunologically active fragment of an antibody, a compound, or combinations thereof. The antibody or immunologically active fragment thereof is preferably natalizumab (Antegren[®]) or an immunologically active fragment thereof.

In the methods and compositions of the invention, the remyelinating agent may be a small compound of formula I, IA, IB, IC, II, IIA, or IIB. The compounds are preferably compounds of the following formula IB

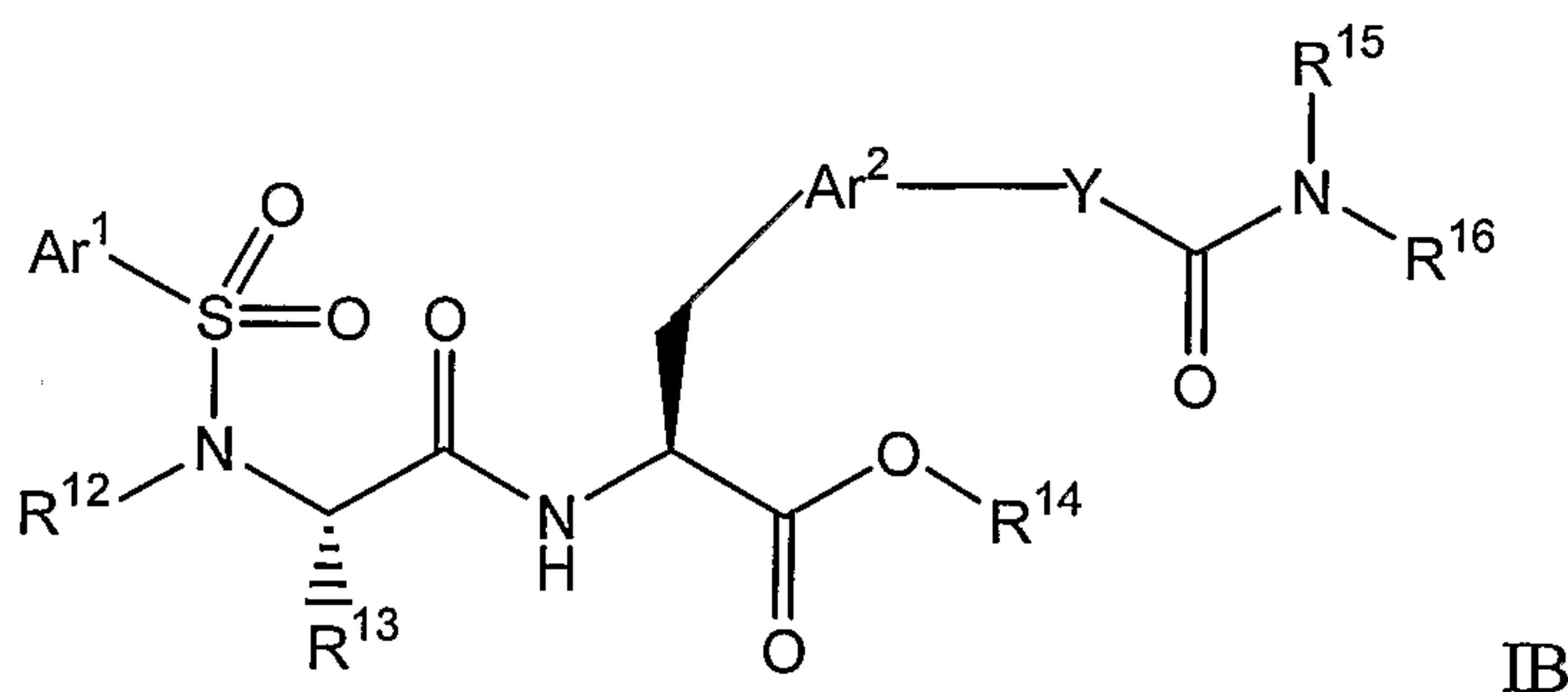

wherein:

Ar¹ is selected from the group consisting of aryl, substituted aryl, heteroaryl, and substituted heteroaryl;

Ar² is selected from the group consisting of aryl, substituted aryl, heteroaryl and substituted heteroaryl;

R¹² is selected from the group consisting of alkyl, substituted alkyl, cycloalkyl, and substituted cycloalkyl or R¹² and R¹³ together with the nitrogen atom bound to R¹² and the carbon atom bound to R¹³ form a heterocyclic or substituted heterocyclic group;

R^{13} is selected from the group consisting of hydrogen, alkyl, and substituted alkyl, or R^{12} and R^{13} together with the nitrogen atom bound to R^{12} and the carbon atom bound to R^{13} form a heterocyclic or substituted heterocyclic group;

R^{14} is selected from the group consisting of hydrogen, alkyl, substituted alkyl, cycloalkyl, substituted cycloalkyl, aryl, and substituted aryl;

R^{15} is selected from the group consisting of alkyl, and substituted alkyl, or R^{15} and R^{16} together with the nitrogen atom to which they are bound form a heterocyclic or substituted heterocyclic group;

R^{16} is selected from the group consisting of alkyl and substituted alkyl or R^{15} and R^{16} together with the nitrogen atom to which they are bound form a heterocyclic or substituted heterocyclic group; and

Y is selected from the group consisting of -O-, -NR¹⁰⁰-, and -CH₂- wherein R^{100} is hydrogen or alkyl;

and pharmaceutically acceptable salts thereof.

In a further embodiment, the compounds are preferably compounds of the following formula IC

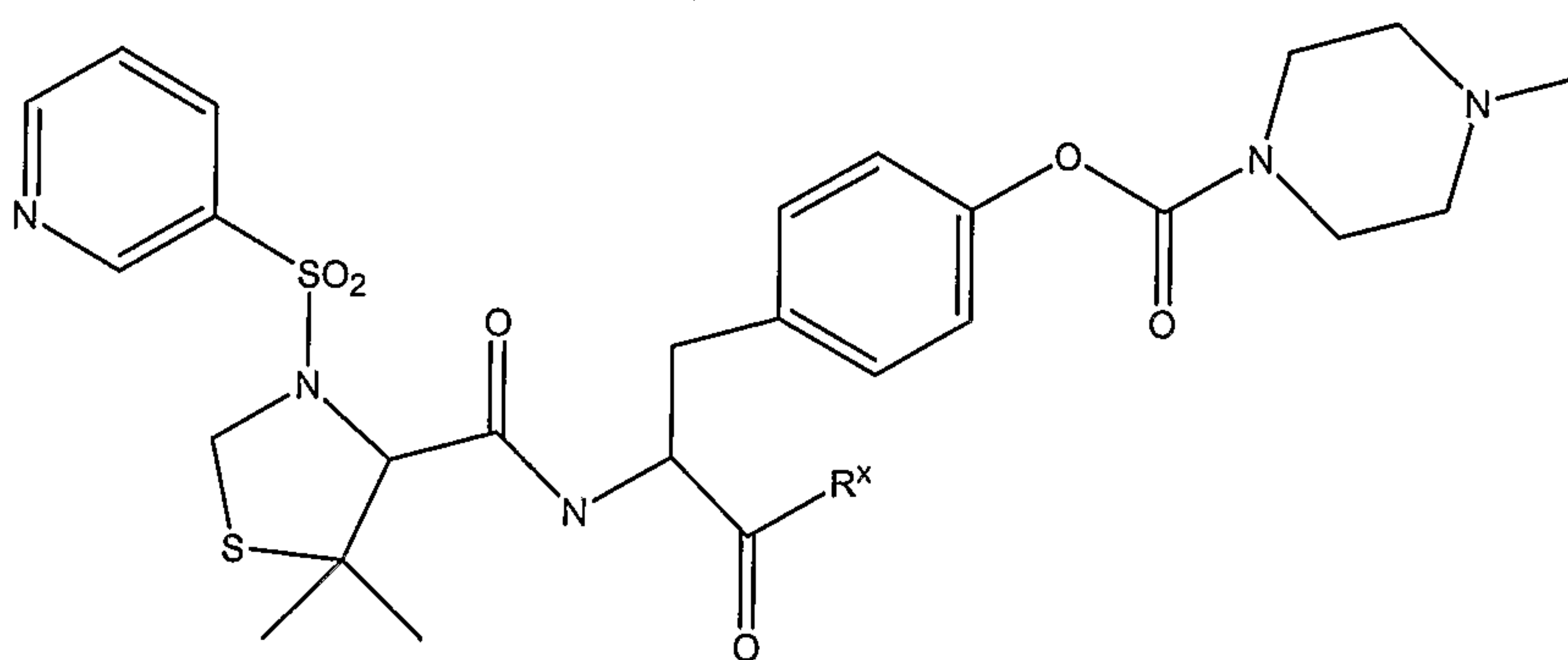

IC

20

wherein R^x is hydroxy or C₁₋₅ alkoxy and pharmaceutically acceptable salts thereof. Preferably, the compound is *N*-[*N*-(3-pyridinesulfonyl)-*L*-3,3-dimethyl-4-thiaprolyl]-*O*-[1-methylpiperazin-4-ylcarbonyl]-*L*-tyrosine isopropyl ester.

In another embodiment, the compounds are preferably compounds of the following formula IIB

25

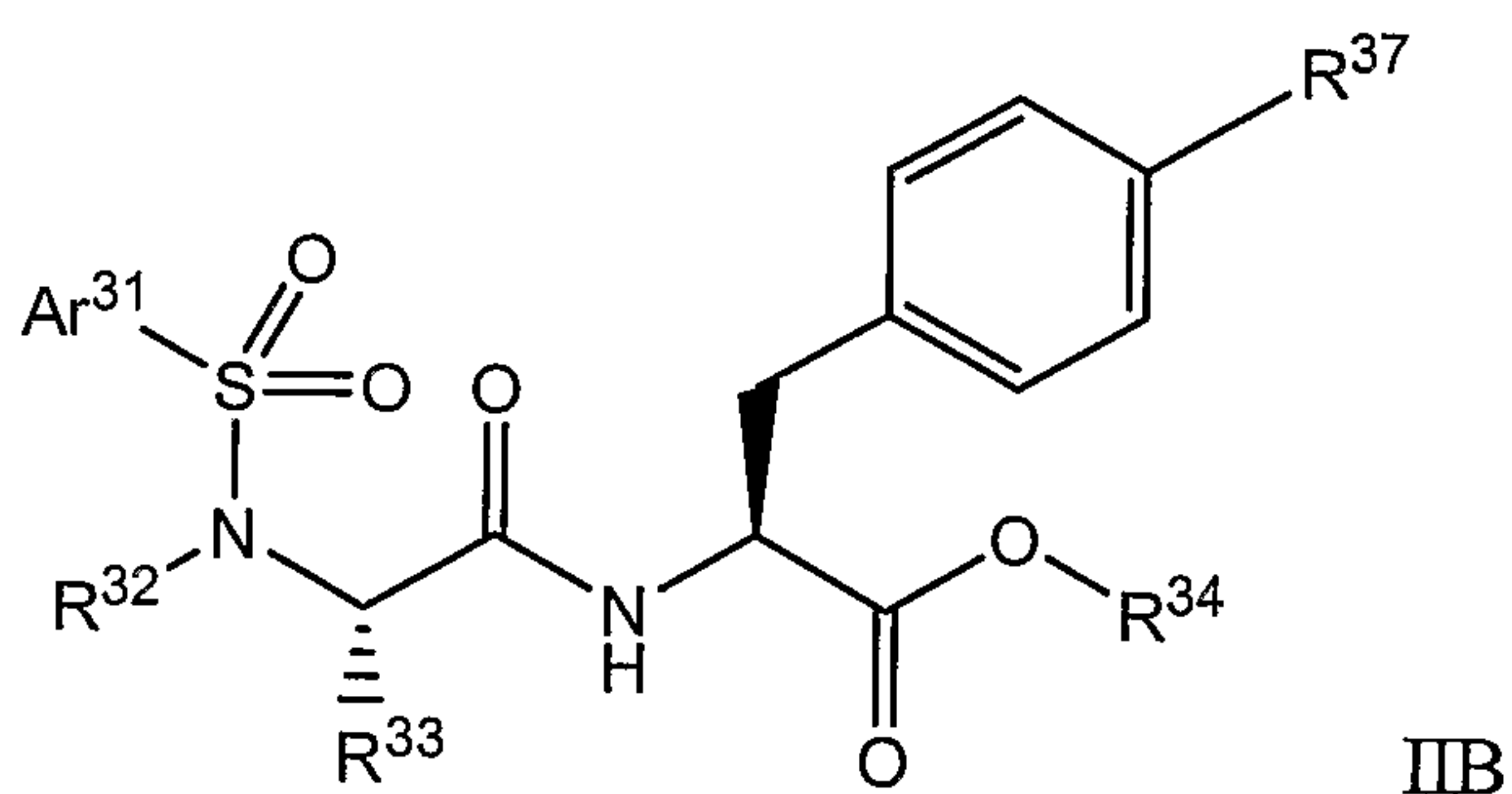

wherein:

5 Ar^{31} is selected from the group consisting of aryl, substituted aryl, heteroaryl, and substituted heteroaryl;

R^{32} is selected from the group consisting of alkyl, substituted alkyl, cycloalkyl, and substituted cycloalkyl or R^{32} and R^{33} together with the nitrogen atom bound to R^{32} and the carbon atom bound to R^{33} form a heterocyclic or substituted heterocyclic group;

10

R^{33} is selected from the group consisting of hydrogen, alkyl, and substituted alkyl, or R^{32} and R^{33} together with the nitrogen atom bound to R^{32} and the carbon atom bound to R^{33} form a heterocyclic or substituted heterocyclic group;

R^{34} is selected from the group consisting of hydrogen, alkyl, substituted alkyl, cycloalkyl, substituted cycloalkyl, aryl, and substituted aryl; and

15

R^{37} is aryl, heteroaryl, substituted aryl, substituted heteroaryl, heterocyclic, substituted heterocyclic, aryloxy, substituted aryloxy, aralkoxy, substituted aralkoxy, heteroaryloxy, substituted heteroaryloxy;

and pharmaceutically acceptable salts thereof.

20 In yet another embodiment, the compound is *N*-[*N*-(3-pyridinesulfonyl)-*L*-3,3-dimethyl-4-thiaprolyl]-*O*-[1-methylpiperazin-4-ylcarbonyl]-*L*-tyrosine isopropyl ester.

The invention also relates to a pharmaceutical composition comprising a therapeutically effective amount of a compound of formula I, IA, IB, IC, II, IIA, or IIB and pharmaceutically acceptable salts thereof. Preferably, the compound is a compound of the formula IB, IC, or IIB. In a preferred embodiment, the compound

25

is *N*-[*N*-(3-pyridinesulfonyl)-*L*-3,3-dimethyl-4-thiaprolyl]-*O*-[1-methylpiperazin-4-ylcarbonyl]-*L*-tyrosine isopropyl ester.

The remyelinating agent of the invention can be administered alone or in combination with other remyelinating agents, anti-alpha-4-agents, or anti-inflammatory agents. The invention further relates to pharmaceutical compositions comprising a pharmaceutically acceptable carrier and a therapeutically effective amount of a remyelinating agent as disclosed herein. The pharmaceutical compositions of the present invention may further comprise one or more additional agents, including other remyelinating agents, anti-alpha-4-agents, or anti-inflammatory agents.

The compositions of the invention may be administered by a variety of modes of administration including oral, parenteral (*e.g.*, subcutaneous, subdural, intravenous, intramuscular, intrathecal, intraperitoneal, intracerebral, intraarterial, or intralesional routes of administration), topical, localized (*e.g.*, surgical application or surgical suppository), rectal, and pulmonary (*e.g.*, aerosols, inhalation, or powder).

Another aspect of the invention provides for a combination therapy comprising a therapeutically effective amount of a remyelinating agent and a therapeutically effective amount of an anti-inflammatory agent. Anti-inflammatory agents include but are not limited to an adrenocorticotrophic hormone (ACTH), a corticosteroid (*e.g.*, prednisone, methylprednisolone, dexamethasone, cortisol, cortisone, fludrocortisone, prednisolone, 6 α -methylprednisolone, triamcinolone, and betamethasone), an interferon (*e.g.*, interferon beta-1b and interferon beta-1a), Copaxone[®], or a nonsteroidal anti-inflammatory drug (*e.g.*, aspirin, a sodium salicylate, choline magnesium trisalicylate, salsalate, diflunisal, sulfasalazine, olsalazine, a para-aminophenol derivatives, an indole, an indene acetic acid, a heteroaryl acetic acid, an anthranilic acid, an enolic acid, an alkanones, a diaryl-substituted furanone, a diaryl-substituted pyrazoles, an indole acetic acids, and a sulfonanilide). The remyelinating agent can be selected from any of the compounds of formula I, IA, IB, IC, II, IIA, or IIB. Alternatively, the remyelinating agent can be an antibody against VLA-4 or an immunologically active fragment thereof or a

polypeptide which binds to VLA-4 thereby preventing it from binding to a cognate ligand.

The combination therapy can be used to treat a subject who suffers from multiple sclerosis, a congenital metabolic disorder, a neuropathy with abnormal myelination, drug induced demyelination, radiation induced demyelination, a hereditary demyelinating condition, a prion induced demyelinating condition, encephalitis induced demyelination, or a spinal cord injury.

Yet another aspect of the invention provides for a use of a compound of formula I, IA, IB, IC, II, IIA, or IIB for the preparation of a medicament for the treatment of a demyelinating disease in a subject in need thereof. Preferably, the compound is a compound of the formula IB, IC, or IIB. In a preferred embodiment, the compound is *N*-[*N*-(3-pyridinesulfonyl)-*L*-3,3-dimethyl-4-thiaprolyl]-*O*-[1-methylpiperazin-4-ylcarbonyl]-*L*-tyrosine isopropyl ester.

In another aspect of the invention, a method is provided for reversing paralysis in a subject with a demyelinating disease comprising administering to the subject a remyelinating agent in an amount sufficient to inhibit lymphocyte infiltration of immune cells in the spinal cord to promote remyelination of nerve cells in the spinal cord and thereby treating paralysis in said subject in need thereof. Another aspect of the invention provides for a use of a remyelinating agent for the preparation of a medicament for the treatment of a demyelinating disease in a subject in need thereof or for the treatment of paralysis in a subject with a demyelinating disease.

These and other objects, advantages, and features of the invention will become apparent to those persons skilled in the art upon reading the details of the methods and formulations as more fully described below.

BRIEF DESCRIPTIONS OF THE DRAWINGS

FIG. 1A. Prolonged reversal of chronic experimental autoimmune encephalomyelitis during *N*-[*N*-(3-pyridinesulfonyl)-*L*-3,3-dimethyl-4-thiaprolyl]-*O*-[1-methylpiperzain-4-ylcarbonyl]-*L*-tyrosine isopropyl ester treatment. EAE was induced in female Hartley guinea pigs via nuchal intradermal injection of 0.6 mL of

a 1:1 mixture of homogenized isologous CNS tissue and complete Freund's adjuvant (CFA), with 10 mg/mL of inactivated *M. tuberculosis*. Beginning on day 40 post immunization, animals received either saline (n=20, 0.5 mL/day) or *N*-[*N*-(3-pyridinesulfonyl)-L-3,3-dimethyl-4-thiaprolyl]-*O*-[1-methylpiperzain-4-ylcarbonyl]-L-tyrosine isopropyl ester (n=25, 30 mg/kg, 2x/day) for 10, 20, 30 or 40 days. Over the course of the treatment period, the mean clinical score of animals treated with *N*-[*N*-(3-pyridinesulfonyl)-L-3,3-dimethyl-4-thiaprolyl]-*O*-[1-methylpiperzain-4-ylcarbonyl]-L-tyrosine isopropyl ester was significantly lower than that of the saline control group ($p < 0.001$, Mann Whitney rank sum test). Furthermore, there were no adverse side effects observed during prolonged *N*-[*N*-(3-pyridinesulfonyl)-L-3,3-dimethyl-4-thiaprolyl]-*O*-[1-methylpiperzain-4-ylcarbonyl]-L-tyrosine isopropyl ester administration, and no escape from treatment as has been previously observed with antibodies.

FIG. 1B. Return to clinically active disease following removal of *N*-[*N*-(3-pyridinesulfonyl)-L-3,3-dimethyl-4-thiaprolyl]-*O*-[1-methylpiperzain-4-ylcarbonyl]-L-tyrosine isopropyl ester. After 30 days of treatment with *N*-[*N*-(3-pyridinesulfonyl)-L-3,3-dimethyl-4-thiaprolyl]-*O*-[1-methylpiperzain-4-ylcarbonyl]-L-tyrosine isopropyl ester, five animals were maintained for an additional 10 days without-small molecule administration. Once *N*-[*N*-(3-pyridinesulfonyl)-L-3,3-dimethyl-4-thiaprolyl]-*O*-[1-methylpiperzain-4-ylcarbonyl]-L-tyrosine isopropyl ester was withdrawn, animals returned to clinical progression of disease. Between day 70 and day 80, the mean clinical score of post-*N*-[*N*-(3-pyridinesulfonyl)-L-3,3-dimethyl-4-thiaprolyl]-*O*-[1-methylpiperzain-4-ylcarbonyl]-L-tyrosine isopropyl ester animals was significantly higher than that of animals receiving *N*-[*N*-(3-pyridinesulfonyl)-L-3,3-dimethyl-4-thiaprolyl]-*O*-[1-methylpiperzain-4-ylcarbonyl]-L-tyrosine isopropyl ester throughout the treatment period ($p < 0.05$, Mann Whitney rank sum test).

FIG. 2. Pathological recovery during prolonged *N*-[*N*-(3-pyridinesulfonyl)-L-3,3-dimethyl-4-thiaprolyl]-*O*-[1-methylpiperzain-4-ylcarbonyl]-L-tyrosine isopropyl ester treatment. Panels A, C, E, G, I and K were solochrome-R-cyanin (SCR) stained spinal cord sections (magnification 40X). Panels B, D, F, H, J and L

show high magnification (250X) of hematoxylin-eosin (H-E) stained sections taken from the dorsal medial region of the corresponding SCR-stained photo. This section (2A) taken from a normal guinea pig shows neither inflammation nor demyelination, as does panel (2B), the corresponding H-E section. By day 40 post-immunization, an animal that had received no treatment showed extensive meningeal inflammation and a large dorso-medial plaque of demyelination (2C). The density of infiltrating cells in this area (2D) was much higher than in FIG 2. Even later in disease, at day 60 post-immunization, a saline-treated animal showed a large subpial area of demyelination (2E), with a very high density of cellular infiltrates (2F). In contrast, an animal that received 20 days of *N*-[*N*-(3-pyridinesulfonyl)-L-3,3-dimethyl-4-thiaprolyl]-*O*-[1-methylpiperzain-4-ylcarbonyl]-L-tyrosine isopropyl ester treatment had a much smaller area of demyelination (2G), and a much lower density of cellular infiltration within the lesion area (2H). The animal represented in 2I received 40 days of saline treatment. Virtually the entire section was infiltrated and demyelinated, including invasion of some areas of gray matter. While the cellular infiltration in 2J was reduced from day 60 post-immunization (see 2F), it was still much higher than normal levels seen in 2B. After 40 days of *N*-[*N*-(3-pyridinesulfonyl)-L-3,3-dimethyl-4-thiaprolyl]-*O*-[1-methylpiperzain-4-ylcarbonyl]-L-tyrosine isopropyl ester treatment, however, there was almost no meningeal and perivascular inflammation, and the myelin was apparently intact (2K). The cellular infiltration (2L) was practically the same as in a normal animal (2B).

FIG. 3. Reduced pathological abnormality in chronic EAE during *N*-[*N*-(3-pyridinesulfonyl)-L-3,3-dimethyl-4-thiaprolyl]-*O*-[1-methylpiperzain-4-ylcarbonyl]-L-tyrosine isopropyl ester treatment. Animals received either saline (n=20) or *N*-[*N*-(3-pyridinesulfonyl)-L-3,3-dimethyl-4-thiaprolyl]-*O*-[1-methylpiperzain-4-ylcarbonyl]-L-tyrosine isopropyl ester (n=25) for 10, 20, 30 or 40 days. Additionally, a subgroup of animals received *N*-[*N*-(3-pyridinesulfonyl)-L-3,3-dimethyl-4-thiaprolyl]-*O*-[1-methylpiperzain-4-ylcarbonyl]-L-tyrosine isopropyl ester for 30 days, and then treatment was withdrawn for the remaining 10 days of the experiment (Post-*N*-[*N*-(3-pyridinesulfonyl)-L-3,3-dimethyl-4-thiaprolyl]-*O*-[1-methylpiperzain-4-ylcarbonyl]-L-tyrosine isopropyl ester group). Following

sacrifice, the brain and spinal cord were fixed in formalin and embedded in paraffin. Five μm sections were stained with hematoxylin-eosin (H-E) or solochrome-R-cyanin, and blindly assigned a 4-digit pathological score based on evaluation in each of four categories: (3A) meningeal inflammation, (3B) perivascular infiltration, (3C) encephalitis, and (3D) demyelination. Note that non-EAE animals would have a score of zero in all categories. Over the course of the treatment period, animals that received *N*-[*N*-(3-pyridinesulfonyl)-L-3,3-dimethyl-4-thiaprolyl]-*O*-[1-methylpiperzain-4-ylcarbonyl]-L-tyrosine isopropyl ester showed a significant decrease in the mean pathological score in each of the four categories with respect to saline-treated animals ($p < 0.001$, 2-way ANOVA). When *N*-[*N*-(3-pyridinesulfonyl)-L-3,3-dimethyl-4-thiaprolyl]-*O*-[1-methylpiperzain-4-ylcarbonyl]-L-tyrosine isopropyl ester was removed and animals were maintained for an additional 10 days without treatment, the mean combined pathological score in all four categories returned to significantly higher than animals that continued to receive the small molecule ($p < 0.05$, Kruskal Wallis ANOVA on ranks with SNK test).

FIG. 4. Reduced spinal cord infiltration with *N*-[*N*-(3-pyridinesulfonyl)-L-3,3-dimethyl-4-thiaprolyl]-*O*-[1-methylpiperzain-4-ylcarbonyl]-L-tyrosine isopropyl ester treatment. The mean number of infiltrating cells was counted in representative areas from twelve pie-shaped areas covering the whole spinal cord (see methods). A significant increase in cellular infiltration occurred with the induction of EAE compared to non-EAE animals (δ , $p < 0.05$; Kruskal Wallis ANOVA on ranks with SNK test). *N*-[*N*-(3-pyridinesulfonyl)-L-3,3-dimethyl-4-thiaprolyl]-*O*-[1-methylpiperzain-4-ylcarbonyl]-L-tyrosine isopropyl ester-treated animals had fewer cells in the spinal cord than saline-treated animals following 10, 20, 30 or 40 days of therapy ($*$, $p < 0.001$, two-way ANOVA). Furthermore, animals treated for 20, 30 or 40 days with *N*-[*N*-(3-pyridinesulfonyl)-L-3,3-dimethyl-4-thiaprolyl]-*O*-[1-methylpiperzain-4-ylcarbonyl]-L-tyrosine isopropyl ester had significantly lower cell counts than control (d40) EAE animals ($\#$, $p < 0.05$, Kruskal Wallis ANOVA, on ranks with SNK test). After removal of *N*-[*N*-(3-pyridinesulfonyl)-L-3,3-dimethyl-4-thiaprolyl]-*O*-[1-methylpiperzain-4-ylcarbonyl]-L-tyrosine isopropyl ester, the mean cell count in animals maintained for an additional 10 days without the small

molecule was significantly increased compared to animals that received continuous *N*-[*N*-(3-pyridinesulfonyl)-*L*-3,3-dimethyl-4-thiaprolyl]-*O*-[1-methylpiperzain-4-ylcarbonyl]-*L*-tyrosine isopropyl ester treatment ($p < 0.05$, Kruskal Wallis ANOVA on ranks with SNK test).

5 **FIG. 5.** Reduced expression of inflammatory cytokines with *N*-[*N*-(3-pyridinesulfonyl)-*L*-3,3-dimethyl-4-thiaprolyl]-*O*-[1-methylpiperzain-4-ylcarbonyl]-*L*-tyrosine isopropyl ester treatment. A piece of lumbar spinal cord was snap frozen in liquid nitrogen and routinely processed to extract RNA for quantitative PCR analysis. While negligible cytokine RNA levels were detected in non-EAE animals, expression of IL-2(B), IL-10(C) and MCP-1(A) were elevated in d40 control animals with CNS inflammation. While saline-treated animals had increased inflammatory cytokine levels throughout the duration of the experiment, animals receiving *N*-[*N*-(3-pyridinesulfonyl)-*L*-3,3-dimethyl-4-thiaprolyl]-*O*-[1-methylpiperzain-4-ylcarbonyl]-*L*-tyrosine isopropyl ester showed a marked decrease in their expression, coincident with clinical and pathological recovery. Upon removal of *N*-[*N*-(3-pyridinesulfonyl)-*L*-3,3-dimethyl-4-thiaprolyl]-*O*-[1-methylpiperzain-4-ylcarbonyl]-*L*-tyrosine isopropyl ester and reinfiltration of the CNS, expression of IL-2, IL-10 and MCP-1 again rose to levels comparable to those in saline-treated animals.

15 **FIG. 6.** Expression of α_4 integrin on lymphocytes. On day 80 post immunization, heparinized blood samples were collected from non-EAE animals, saline-treated animals, *N*-[*N*-(3-pyridinesulfonyl)-*L*-3,3-dimethyl-4-thiaprolyl]-*O*-[1-methylpiperzain-4-ylcarbonyl]-*L*-tyrosine isopropyl ester-treated animals and animals 10 days following withdrawal of *N*-[*N*-(3-pyridinesulfonyl)-*L*-3,3-dimethyl-4-thiaprolyl]-*O*-[1-methylpiperzain-4-ylcarbonyl]-*L*-tyrosine isopropyl ester. Samples were exposed to antibody against α_4 integrin, then examined on a flow cytometer, gating on different cell populations by light scatter. Treatment of animals with *N*-[*N*-(3-pyridinesulfonyl)-*L*-3,3-dimethyl-4-thiaprolyl]-*O*-[1-methylpiperzain-4-ylcarbonyl]-*L*-tyrosine isopropyl ester caused a large increase in β_4 integrin bright lymphocytes in the circulation compared to saline-treated animals. These results indicate the number of alpha-4 expressing cells. There are more alpha-4 expressing cells when the compound is present than in the saline-control treated animals. The

x-axis represents alpha-4 expression; the y-axis represents cell number assessed by FACS.

FIG. 7. Expression of α_4 integrin on lymphocytes and monocytes in the circulation at day 80 post-immunization. Heparinized blood samples were collected from all groups of animals on day 80 post-immunization, exposed to antibody against α_4 integrin, and sorted by flow cytometry. Panel A shows that Treatment with *N*-[*N*-(3-pyridinesulfonyl)-L-3,3-dimethyl-4-thiaprolyl]-*O*-[1-methylpiperzain-4-ylcarbonyl]-L-tyrosine isopropyl ester caused a large increase in the percentage of α_4 integrin bright lymphocytes in the circulation compared to non-EAE and saline-treated animals, suggesting that activated peripheral lymphocytes were unable to enter the CNS in the presence of the inhibitor. Consistent with this idea, the percentage of these cells in the circulation returned to saline-treated levels when *N*-[*N*-(3-pyridinesulfonyl)-L-3,3-dimethyl-4-thiaprolyl]-*O*-[1-methylpiperzain-4-ylcarbonyl]-L-tyrosine isopropyl ester was removed and CNS inflammation returned as shown in Panel B. The general expression of β_4 integrin on circulating monocytes was increased in all EAE animals, although there were no discernable subpopulations. This monocytic increase in α_4 integrin expression was not affected by *N*-[*N*-(3-pyridinesulfonyl)-L-3,3-dimethyl-4-thiaprolyl]-*O*-[1-methylpiperzain-4-ylcarbonyl]-L-tyrosine isopropyl ester, suggesting that the inhibitor did not affect the peripheral immune reaction.

FIG 8. Shadow plaques are observed in *N*-[*N*-(3-pyridinesulfonyl)-L-3,3-dimethyl-4-thiaprolyl]-*O*-[1-methylpiperzain-4-ylcarbonyl]-L-tyrosine isopropyl ester treated animals. Images 8A-F are representative solochrome-R-cyanin stained spinal cord sections from separate animals within the treatment groups. (8A) A low power image (40x) shows the extent of demyelination in the spinal cord. (8B) A high power image (100x) of a demyelinated lesion in a "day 0" (day 0 is at least measured 40 days post disease induction wherein the animal achieves a clinical score of 2 or greater) control animal shows dense cellular infiltration and foamy macrophages containing phagocytosed myelin debris (arrows). (8C) A lesion from an animal that received 20 days of saline treatment remains completely devoid of myelin (250x). (8D) In contrast, animals that received 20 days of *N*-[*N*-(3-

pyridinesulfonyl)-L-3,3-dimethyl-4-thiaprolyl]-O-[1-methylpiperzain-4-ylcarbonyl]-L-tyrosine isopropyl ester treatment presented lesions with a diffuse blue stain covering the plaque (250x). (8E) Severe demyelination was evident in the spinal cord after 40 days of vehicle treatment (100x). (8F) After 40 days of *N*-[*N*-(3-pyridinesulfonyl)-L-3,3-dimethyl-4-thiaprolyl]-O-[1-methylpiperzain-4-ylcarbonyl]-L-tyrosine isopropyl ester therapy, however, the majority of lesions showed clear myelin pallor (100x).

FIG. 9. Semithin and EM sections confirm remyelination with *N*-[*N*-(3-pyridinesulfonyl)-L-3,3-dimethyl-4-thiaprolyl]-O-[1-methylpiperzain-4-ylcarbonyl]-L-tyrosine isopropyl ester treatments. Toluidine blue semi-thin sections are shown in panels 9A, 9B, and 9C (all 400x). Representative EM sections from the same animals are shown in panels 9D, 9E and 9F (9D and 9E, 1100x; 9F, 1300x). (FIG. 9A and 9D) Normal myelin. (9B and 9E) Day 30 of saline treatment. Some small caliber axons showed thinly myelinated sheaths (*t*), juxtaposed between complete demyelination (*d*) and normal myelin (*n*). Some axons are undergoing Wallerian degeneration (arrows). In this case, degenerating axons were observed within the normal appearing myelin (arrows, 9B). Electron microscopy confirmed with absence of myelin wrapping around large caliber axons (9E). (9C and 9F) Day 30 *N*-[*N*-(3-pyridinesulfonyl)-L-3,3-dimethyl-4-thiaprolyl]-O-[1-methylpiperzain-4-ylcarbonyl]-L-tyrosine isopropyl ester treatment. In animals that received *N*-[*N*-(3-pyridinesulfonyl)-L-3,3-dimethyl-4-thiaprolyl]-O-[1-methylpiperzain-4-ylcarbonyl]-L-tyrosine isopropyl ester, an area of normal appearing myelin at the left of the image (*n*) sits adjacent to a large area of thinly myelinated axons of similar caliber (*t*). The area of thinly myelinated axons was more extensive and consisted of large caliber axons (9C). EM confirms multiple layers of thin myelin wrappings around large diameter axons indicative of remyelination (9F).

FIG. 10. *N*-[*N*-(3-pyridinesulfonyl)-L-3,3-dimethyl-4-thiaprolyl]-O-[1-methylpiperzain-4-ylcarbonyl]-L-tyrosine isopropyl ester increased both the incidence and area of remyelination within the spinal cord. (10A) The number of lesions showing myelin pallor was expressed as a percent of the total number of lesions within a mean of twelve spinal cord cross sections for each animal. *N*-[*N*-(3-

pyridinesulfonyl)-L-3,3-dimethyl-4-thiaprolyl]-O-[1-methylpiperzain-4-ylcarbonyl]-L-tyrosine isopropyl ester (black bars) increased the incidence of remyelination with respect to saline-treated animals (white bars), and there was a time-dependent increase in the frequency of shadow plaques with *N*-[*N*-(3-pyridinesulfonyl)-L-3,3-dimethyl-4-thiaprolyl]-O-[1-methylpiperzain-4-ylcarbonyl]-L-tyrosine isopropyl ester treatment. (10B) Representation of methodology for determining the degree of remyelination. The shapes of all lesions within a spinal cord section were traced, and the area within the outline was calculated. Lesions showing myelin pallor were also traced to yield the total area of remyelination for each animal, and the degree of remyelination was expressed as a percent of the total lesion area. (10C-F) Each scatter plot shows the total lesion area along the x-axis, and the percentage of that lesion showing myelin pallor along the y-axis. Lesions in saline treated animals (white symbols) show little remyelination. In contrast, after 20, 30 or 40 days of *N*-[*N*-(3-pyridinesulfonyl)-L-3,3-dimethyl-4-thiaprolyl]-O-[1-methylpiperzain-4-ylcarbonyl]-L-tyrosine isopropyl ester treatment, most lesions in *N*-[*N*-(3-pyridinesulfonyl)-L-3,3-dimethyl-4-thiaprolyl]-O-[1-methylpiperzain-4-ylcarbonyl]-L-tyrosine isopropyl ester-treated animals (black symbols) showed variability in the degree of remyelination (0-100%). The mean percent areas are shown in the bar graphs at the right of each scatter plot (saline, white bar; *N*-[*N*-(3-pyridinesulfonyl)-L-3,3-dimethyl-4-thiaprolyl]-O-[1-methylpiperzain-4-ylcarbonyl]-L-tyrosine isopropyl ester, black bar). After 20, 30 or 40 days of therapy, *N*-[*N*-(3-pyridinesulfonyl)-L-3,3-dimethyl-4-thiaprolyl]-O-[1-methylpiperzain-4-ylcarbonyl]-L-tyrosine isopropyl ester-treated animals had significantly higher percentages of remyelination (50%) than after 10 days of treatment or all saline controls (<10%).

FIGS. 11A and 11B. DNA and amino acid sequences of the mouse 21.6 light chain variable region respectively.

FIGS. 12A and 12B. DNA and amino acid sequences of the mouse 21.6 heavy chain variable region, respectively.

FIG. 13. Comparisons of the amino acid sequences of mouse and reshaped human 21.6 light chain variable regions. The amino acid residues that are part of the Chothia canonical sequences for the CDR loop structures are marked with an

asterisk. RE1 shows the FRs and CDRs from the V_L region of human RE1 light chain. La and Lb are the two versions of reshaped human 21.6 V_L region. The residues in the FRs of La that differ from those in the RE1 sequence are underlined. In Lb, only the residues in the framework regions that differ from those of RE1 are shown.

FIG. 14. Comparisons of the amino acid sequences of the mouse and reshaped human 21.6 heavy chain variable regions. The amino acid residues that are part of the canonical sequences for the Chothia CDR loop structures are marked with an asterisk. 2*CL shows the FRs and CDRs from the V_H region of human 21/28'CL antibody. Ha, Hb, and Hc are the three versions of reshaped human 21.6 V_H region. The residues in the FRs of Ha that differ from those in the 21/28'CL sequence are underlined. In Hb and Hc, only the residues in the framework regions that differ from those of 21/28'CL are shown.

FIGS. 15A and 15B. cDNA and amino acid sequences of the first version ("a") of reshaped human 21.6 light chain variable region.

FIGS. 16A and 16B. DNA and amino acid sequences of the first version ("a") of reshaped human 21.6 heavy chain variable region.

FIGS. 17A and 17B. FIG. 17A is the 109 amino acid long sequence of mouse kappa V_L regions from subgroup 5 used to design the reshaped human 21.6 light chain variable regions. FIG. 17B is the 114 amino acid long sequence of human V_L regions from subgroup 1 used to design the reshaped human 21.6 light chain variable regions. The sequences are further described in Table 10 *infra*.

FIGS. 18A and 18B. FIG. 18A is the 125 amino acid long consensus sequence of mouse V_H regions from subgroup 2c used to design the reshaped human 21.6 heavy chain variable regions. FIG. 18B is the 129 amino acid long consensus sequence of human V_H regions from subgroup 1 used to design the reshaped human 21.6 heavy chain variable regions. The sequences are further described in Table 11 *infra*.

DETAILED DESCRIPTION OF THE INVENTION

Before the present methods and therapeutic agents are described, it is to be understood that this invention is not limited to particular methods and therapeutic agents described, as such may, of course, vary. It is also to be understood that the terminology used herein is for the purpose of describing particular embodiments only, and is not intended to be limiting, since the scope of the present invention will be limited only by the appended claims.

Where a range of values is provided, it is understood that each intervening value, to the tenth of the unit of the lower limit unless the context clearly dictates otherwise, between the upper and lower limit of that range and any other stated or intervening value in that stated range is encompassed within the invention. The upper and lower limits of these smaller ranges may independently be included in the smaller, subject to any specifically excluded limit in the stated range. Where the stated range includes one or both of the limits, ranges excluding either both of those included limits are also included in the invention. Also contemplated are any values that fall within the cited ranges.

Unless defined otherwise, all technical and scientific terms used herein have the same meaning as commonly understood by one of ordinary skill in the art to which this invention belongs. Although any methods and materials similar or equivalent to those described herein can also be used in the practice or testing of the present invention, the preferred methods and materials are now described. All publications mentioned herein are incorporated herein by reference to disclose and describe the methods and/or materials in connection with which the publications are cited.

25

1. Abbreviations and Definitions

In accordance with this detailed description, the following abbreviations and definitions apply. It must be noted that as used herein, the singular forms "a", "and", and "the" include plural referents unless the context clearly dictates otherwise. Thus, for example, reference to "an antibody" includes a plurality of such antibodies and

30

reference to "the dosage" includes reference to one or more dosages and equivalents thereof known to those skilled in the art, and so forth.

The publications discussed herein are provided solely for their disclosure prior to the filing date of the present application. Nothing herein is to be construed
 5 as an admission that the present invention is not entitled to antedate such publication by virtue of prior invention. Further, the dates of publication provided may be different from the actual publication dates, which may need to be independently confirmed.

10 1.1. Abbreviations

The following abbreviations have been used herein.

	AC	acid ceramidase
	AcOH	acetic acid
	ACTH	adrenocorticotropic hormone
15	ADEM	acute disseminated encephalomyelitis
	ALD	adrenoleukodystrophy
	AMN	adrenomyeloneuropathy
	aq or aq.	aqueous
	BBB	blood brain barrier
20	bd	broad doublet
	bm	broad multiplet
	Bn	benzyl
	Boc	<i>tert</i> -butoxycarbonyl
	Boc ₂ O	di- <i>tert</i> -butyl dicarbonate
25	BOP	benzotriazol-1-yloxy- tris(dimethylamino)phosphonium hexafluorophosphate
	bs	broad singlet
	C	constant region of an immunoglobulin
30	CACH	childhood ataxia with central nervous system hypomyelination

	CADASIL	cerebral autosomal dominant arteriopathy with subcortical infarcts and leukoencephalopathy
	Cbz	carbobenzyloxy
	cDNA	complementary deoxyribnucleic acid
5	CDR	complementarity determining region
	CDR1	complementarity determining region 1
	CDR2	complementarity determining region 2
	CDR3	complementarity determining region 3
	CFA	complete Freund's adjuvant
10	CHCl ₃	chloroform
	CH ₂ Cl ₂	dichloromethane
	CIDP	chronic immune demyelinating polyneuropathy
	CJD	Creutzfeld-Jakob disease
	CNS	central nervous system
15	(COCl) ₂	oxalyl chloride
	COX-2	cyclooxygenase-2
	CS	Cockayne's syndrome
	CSF	colony stimulating factor
	CTX	Cerebrotendinous xanthomatosis
20	d	doublet
	DBU	1,8-diazabicyclo[5.4.0]undec-7-ene
	DCC	1,3-dicyclohexylcarbodiimide
	dd	doublet of doublets
	DMAP	4- <i>N,N</i> -dimethylaminopyridine
25	DME	ethylene glycol dimethyl ether
	DMF	<i>N,N</i> -dimethylformamide
	DMSO	dimethylsulfoxide
	DNA	deoxyribonucleic acid
	dt	doublet of triplets
30	EAE	experimental autoimmune encephalomyelitis
	EBNA2	Epstein-Barr virus nuclear antigen 2

	ECM	extracellular matrix
	EDC hydrochloride	1-(3-dimethylaminopropyl)-3-ethylcarbodiimide
	EDTA	ethylenediaminetetraacetate
5	ELAMS	endothelial adhesion molecules
	EM	electron microscopy
	Et ₃ N	triethylamine
	Et ₂ O	diethyl ether
	EtOAc	ethyl acetate
10	EtOH	ethanol
	eq or eq.	equivalent
	FACS	fluorescence activated cell sorter
	Fmoc	<i>N</i> -(9-fluorenylmethoxycarbonyl)
	FmocONSu	<i>N</i> -(9-fluorenylmethoxycarbonyl)-Succinimide
15	FR	framework region
	FR1	framework region 1
	FR2	framework region 2
	FR3	framework region 3
	g	grams
20	GA	glatiramer acetate
	GALOP polyneuropathy	gait disorder, autoantibody, late-age, onset,
	GM-CSF	granulocyte monocyte colony stimulating factor
	GSD	Gerstmann-Straussler disease
25	h or hr	hour
	H	heavy chain of an immunoglobulin
	HAMA	human anti-mouse antibody
	HBr	hydrobromic acid
	HCl	hydrochloric acid
30	H-E	hematoxylin-eosin
	hex A	hexoaminidase A

	HIC	Hydrophobic interaction chromatography
	HIG	human immunoglobulin
	HMSN IV	hereditary motor and sensory neuropathy IV (also known as hereditary ataxia polyneuritis)
5	H ₂ O	water
	HOBT	1-hydroxybenzotriazole hydrate
	HUVEC	human umbilical vascular endothelial cells
	ICAM-1	intercellular adhesion molecule 1
	Ig	immunoglobulin
10	IgG	immunoglobulin G
	IgM	immunoglobulin M
	IL	interleukin
	IL-1	interleukin-1
	IL-2	interleukin-2
15	IL-8	interleukin-8
	K ₂ CO ₃	potassium carbonate
	L	light chain of an immunoglobulin
	LFA-1	lymphocyte function-related antigen 1- (also known as β_2 integrin, CD11a/CD18 and $\alpha_L\beta_2$)
20	m	multiplet
	MAbs	monoclonal antibodies
	Mac-1	$\alpha_M\beta_2$ integrin (also known as CD11b/CD18)
	MAdCAM-1	mucosal addressin cell adhesion molecule
25	MALDI/TOF MS	matrix-assisted laser desorption ionization/time-of-flight mass spectrometry
	MBP	myelin basic protein
	MCP-1	monocyte chemotactic protein 1
	MeOH	methanol
	MES	2-(<i>N</i> -morpholino)ethanesulfonic acid
30	mg	milligram
	MgSO ₄	magnesium sulfate

	min.	minute
	MIP-1 α	macrophage inflammatory protein 1 alpha
	MIP-1 β	macrophage inflammatory protein 1 beta
	mL	milliliter
5	MLD	metachromatic leukodystrophy
	mm	millimeter
	mM	millimolar
	mmol	millimol
	MOG	myelin-oligodendrocyte glycoprotein
10	mp	melting point
	MS	multiple sclerosis
	N	normal
	NaCl	sodium chloride
	Na ₂ CO ₃	sodium carbonate
15	NaHCO ₃	sodium bicarbonate
	NaOEt	sodium ethoxide
	NaOH	sodium hydroxide
	NH ₄ Cl	ammonium chloride
	NMM	<i>N</i> -methylmorpholine
20	NSAID	nonsteroidal anti-inflammatory
	PCR	polymerase chain reaction
	PEG	polyethylene glycol
	Phe	L-phenylalanine
	PKU	phenylketonuria
25	PLP	proteolipid protein
	PMSF	phenylmethylsulfonylfluoride
	POEMS	polyneuropathy organomegaly endocrinopathy, M-protein and skin changes
	Pro	L-proline
30	PRP	prion related protein
	psi	pounds per square inch

	PtO ₂	platinum oxide
	q	quartet
	quint.	quintet
5	RANTES	regulated upon activation, normal T-cell expressed and secreted chemokine (also known as small inducible cytokine A5)
	RNA	ribonucleic acid
	rt	room temperature
	RT-PCR	reverse transcription polymerase chain reaction
10	s	singlet
	SAMIs	selective adhesion molecule inhibitors
	sat or sat.	saturated
	scFv	single chain Fv fragment
	SCR	solochrome-R-cyanlin
15	SDS	sodium dodecyl sulfate
	SDS-PAGE	sodium dodecyl sulfate polyacrylamide gel electrophoresis
	SP-MS	secondary progressive multiple sclerosis
	t	triplet
20	t-BuOH	<i>tert</i> -butanol
	TFA	trifluoroacetic acid
	TGF-β	tumor growth factor beta
	THF	tetrahydrofuran
	TLC or tlc	thin layer chromatography
25	TNF	tumor necrosis factor
	TNF-α	tumor necrosis factor alpha
	TNF-β	tumor necrosis factor beta
	Ts	tosyl
	TsCl	tosyl chloride
30	TsOH	tosylate
	UV	ultraviolet

	VCAM-1	vascular cell adhesion molecule 1
	V _H	heavy chain of the variable domain
	V _L	light chain of the variable domain
	VLA-4	very late antigen 4 (also known as alpha-4 beta-1,
5	$\alpha_4\beta_1$)	
	μ L	microliter
	ϕ	phenyl

1.2. Definitions

10 Abbreviations for the twenty naturally occurring amino acids follow conventional usage (IMMUNOLOGY-A SYNTHESIS (2nd ed., E. S. Golub & D. R. Gren, eds., Sinauer Associates, Sunderland, Mass., 1991)). Stereoisomers (*e.g.*, D-amino acids) of the twenty conventional amino acids, unnatural amino acids such as α,α -disubstituted amino acids, N-alkyl amino acids, lactic acid, and other
15 unconventional amino acids may also be suitable components for polypeptides of the present invention. Examples of unconventional amino acids include: 4-hydroxyproline, γ -carboxyglutamate, ϵ -N,N,N-trimethyllysine, ϵ -N-acetyllysine, O-phosphoserine, N-acetylserine, N-formylmethionine, 3-methylhistidine, 5-hydroxylysine, ω -N-methylarginine, and other similar amino acids and imino acids
20 (*e.g.*, 4-hydroxyproline). Moreover, amino acids may be modified by glycosylation, phosphorylation and the like.

In the polypeptide notation used herein, the left-hand direction is the amino terminal direction and the right-hand direction is the carboxy-terminal direction, in accordance with standard usage and convention. Similarly, unless specified
25 otherwise, the left-hand end of single-stranded polynucleotide sequences is the 5' end; the left-hand direction of double-stranded polynucleotide sequences is referred to as the 5' direction. The direction of 5' to 3' addition of nascent RNA transcripts is referred to as the transcription direction; sequence regions on the DNA strand having the same sequence as the RNA and which are 5' to the 5' end of the RNA transcript
30 are referred to as "upstream sequences"; sequence regions on the DNA strand having

the same sequence as the RNA and which are 3' to the 3' end of the RNA transcript are referred to as "downstream sequences."

The phrase "polynucleotide sequence" refers to a single or double-stranded polymer of deoxyribonucleotide or ribonucleotide bases read from the 5' to the 3' end. It includes self-replicating plasmids, infectious polymers of DNA or RNA and non-functional DNA or RNA.

The following terms are used to describe the sequence relationships between two or more polynucleotides: "reference sequence", "comparison window", "sequence identity", "percentage of sequence identity", and "substantial identity". A "reference sequence" is a defined sequence used as a basis for a sequence comparison; a reference sequence may be a subset of a larger sequence, for example, as a segment of a full-length cDNA or gene sequence given in a sequence listing, such as a polynucleotide sequence of FIGS. 11 or 12, or may comprise a complete DNA or gene sequence. Generally, a reference sequence is at least 20 nucleotides in length, frequently at least 25 nucleotides in length, and often at least 50 nucleotides in length. Since two polynucleotides may each (1) comprise a sequence (*i.e.*, a portion of the complete polynucleotide sequence) that is similar between the two polynucleotides, and (2) may further comprise a sequence that is divergent between the two polynucleotides, sequence comparisons between two (or more) polynucleotides are typically performed by comparing sequences of the two polynucleotides over a "comparison window" to identify and compare local regions of sequence similarity. A "comparison window", as used herein, refers to a conceptual segment of at least 20 contiguous nucleotide positions wherein a polynucleotide sequence may be compared to a reference sequence of at least 20 contiguous nucleotides and wherein the portion of the polynucleotide sequence in the comparison window may comprise additions or deletions (*i.e.*, gaps) of 20 percent or less as compared to the reference sequence (which does not comprise additions or deletions) for optimal alignment of the two sequences. Optimal alignment of sequences for aligning a comparison window may be conducted by the local homology algorithm of Smith & Waterman, *Adv. Appl. Math.* 2: 482 (1981), by the homology alignment algorithm of Needleman & Wunsch, *J. Mol. Biol.* 48: 443

(1970), by the search for similarity method of Pearson & Lipman, *Proc. Natl. Acad. Sci. (USA)* 85: 2444 (1988) (each of which is incorporated by reference in its entirety), by computerized implementations of these algorithms (GAP, BESTFIT, FASTA, and TFASTA in the Wisconsin Genetics Software Package Release 7.0, Genetics Computer Group, 575 Science Dr., Madison, Wis.), or by inspection, and the best alignment (*i.e.*, resulting in the highest percentage of sequence similarity over the comparison window) generated by the various methods is selected. The term "sequence identity" means that two polynucleotide sequences are identical (*i.e.*, on a nucleotide-by-nucleotide basis) over the window of comparison. The term "percentage of sequence identity" is calculated by comparing two optimally aligned sequences over the window of comparison, determining the number of positions at which the identical nucleic acid base (*e.g.*, A, T, C, G, U, or I) occurs in both sequences to yield the number of matched positions, dividing the number of matched positions by the total number of positions in the window of comparison (*i.e.*, the window size), and multiplying the result by 100 to yield the percentage of sequence identity. The terms "substantial identity" as used herein denotes a characteristic of a polynucleotide sequence, wherein the polynucleotide comprises a sequence that has at least 85 percent sequence identity, preferably at least 90 to 95 percent sequence identity, more usually at least 99 percent sequence identity as compared to a reference sequence over a comparison window of at least 20 nucleotide positions, frequently over a window of at least 25-50 nucleotides, wherein the percentage of sequence identity is calculated by comparing the reference sequence to the polynucleotide sequence which may include deletions or additions which total 20 percent or less of the reference sequence over the window of comparison. The reference sequence may be a subset of a larger sequence.

As applied to polypeptides, the term "sequence identity" means peptides share identical amino acids at corresponding positions. The term "sequence similarity" means peptides have identical or similar amino acids (*i.e.*, conservative substitutions) at corresponding positions. The term "substantial identity" means that two peptide sequences, when optimally aligned, such as by the programs GAP or BESTFIT using default gap weights, share at least 80 percent sequence identity,

preferably at least 90 percent sequence identity, more preferably at least 95 percent sequence identity or more (*e.g.*, 99 percent sequence identity). Preferably, residue positions that are not identical differ by conservative amino acid substitutions. The term "substantial similarity" means that two peptide sequences share corresponding percentages of sequence similarity.

The term "substantially similar" as used herein is intended to mean any polypeptide that has an alteration in the sequence such that a functionally equivalent amino acid is substituted for one or more amino acids in the polypeptide, thus producing a change that has no or relatively little effect on the binding properties of the polypeptide. For example, one or more amino acid residues within the sequence can be substituted by another amino acid of a similar polarity or similar size.

The term "substantially pure" means an object species is the predominant species present (*i.e.*, on a molar basis it is more abundant than any other individual species in the composition), and preferably a substantially purified fraction is a composition wherein the object species comprises at least about 50 percent (on a molar basis) of all macromolecular species present. Generally, a substantially pure composition will comprise more than about 80 to 90 percent of all macromolecular species present in the composition. Most preferably, the object species is purified to essential homogeneity (contaminant species cannot be detected in the composition by conventional detection methods) wherein the composition consists essentially of a single macromolecular species.

For purposes of classifying amino acids substitutions as conservative or non-conservative, amino acids are grouped as follows: Group I (hydrophobic sidechains): norleucine, met, ala, val, leu, ile; Group II (neutral hydrophilic side chains): cys, ser, thr; Group III (acidic side chains): asp, glu; Group IV (basic side chains): asn, gln, his, lys, arg; Group V (residues influencing chain orientation): gly, pro; and Group VI (aromatic side chains): trp, tyr, phe. Conservative substitutions involve substitutions between amino acids in the same class. Non-conservative substitutions constitute exchanging a member of one of these classes for another.

Amino acids from the variable regions of the mature heavy and light chains of immunoglobulins are designated H_x and L_x respectively, where "x" is a number

designating the position of an amino acids according to the scheme of Kabat *et al.*, SEQUENCES OF PROTEINS OF IMMUNOLOGICAL INTEREST (National Institutes of Health, Bethesda, Md. (1987) and (1991)) (hereinafter collectively referred to as "Kabat" incorporated by reference in their entirety). Kabat lists many amino acid sequences for antibodies for each subclass, and list the most commonly occurring amino acid for each residue position in that subclass. Kabat uses a method for assigning a residue number to each amino acid in a listed sequence, and this method for assigning residue numbers has become standard in the field. Kabat's scheme is extendible to other antibodies not included in the compendium by aligning the antibody in question with one of the consensus sequences in Kabat. The use of the Kabat numbering system readily identifies amino acids at equivalent positions in different antibodies. For example, an amino acid at the L50 position of a human antibody occupies the equivalence position to an amino acid position L50 of a mouse antibody.

The term "reagent" or "agent" is used to denote a biologically active molecule that binds to a ligand receptor. For example, antibodies or fragments thereof which immunoreact with the VLA-4 receptor or VCAM-1 can be useful to promote remyelination and/or reduces paralysis in a subject in a statistically significant amount. Peptides, or peptidomimetics or related compounds, which can act to bind the cell surface receptor, are also contemplated, and can be made synthetically by methods known in the art. Other reagents that react with a VLA-4 receptor as discussed herein or as apparent to those skilled in the art are also contemplated.

A "remyelinating agent" as used herein refers to any agent that promotes remyelination and/or reduces paralysis in a subject in a statistically significant amount. Preferably, such agents include immunoglobulins (*e.g.*, antibodies, antibody fragments, and recombinantly produced antibodies or fragments), polypeptides (*e.g.*, soluble forms of the ligand proteins for integrins) and small molecules, which when administered in an effective amount inhibits demyelination and/or promotes remyelination in a patient. Such may also result in the reduction of paralysis when administered in an effective amount to the patient. These agents can

be selected from anti-alpha4 integrin agents (preferably anti-alpha4 beta1 antagonists) and anti-VCAM-1 agents. However, with reference to the present invention, such anti-alpha4 integrin and anti-VCAM-1 agents only include those which when administered in an effective amount inhibits demyelination and/or promotes remyelination and/or reduces paralysis.

The term "anti-alpha-4 integrin agent" as used herein refers to any agent that binds specifically to an integrin comprising an alpha-4 subunit and inhibits activity of the integrin. The term "integrin antagonist" includes any agent that inhibits alpha-4 subunit-containing integrins from binding with an integrin ligand and/or receptor. Preferably, the integrin antagonist inhibits the alpha-4 beta-1 dimer from binding to its cognate ligand(s). Such antagonists can include anti-integrin antibodies or antibody homolog-containing proteins, as well as other molecules such as soluble forms of the ligand proteins for integrins. Soluble forms of the ligand proteins for alpha-4 subunit-containing integrins include soluble VCAM-1, VCAM-1 fusion proteins, or bifunctional VCAM-1/Ig fusion proteins. For example, a soluble form of an integrin ligand or a fragment thereof may be administered to bind to integrin, and preferably compete for an integrin binding site on cells, thereby leading to effects similar to the administration of antagonists such as anti-integrin (e.g., VLA-4) antibodies. In particular, soluble integrin mutants that bind ligand but do not elicit integrin-dependent signaling are included within the scope of the invention.

By "natalizumab" or "Antegren[®]" is meant a humanized antibody against VLA-4 as described in commonly owned U.S. Patent Nos. 5,840,299 and 6,033,665, which are herein incorporated by reference in their entirety. Also contemplated herein are other VLA-4 specific antibodies. Such remyelinating antibodies and immunoglobulins include but are not limited to those immunoglobulins described in U.S. Patent Nos. 6,602,503 and 6,551,593, published U.S. Application No. 20020197233 (Relton *et al.*), and as further discussed herein.

The term "efficacy" as used herein in the context of a chronic dosage regime refers to the effectiveness of a particular treatment regime. Efficacy can be measured based on change the course of the disease in response to an agent of the

present invention. For example, in the treatment of MS, efficacy can be measured by the frequency of relapses in relapsing-remitting MS, and by the presence or absence of new lesions in the central nervous system as detected using methods such as MRI.

5 The term "success" as used herein in the context of a chronic treatment regime refers to the effectiveness of a particular treatment regime. This includes a balance of efficacy, toxicity (*e.g.*, side effects and patient tolerance of a formulation or dosage unit), patient compliance, and the like. For a chronic administration regime to be considered "successful" it must balance different aspects of patient care and efficacy to produce the most favorable patient outcome.

10 The terms "specifically binds" or "binds specifically" as used herein refer to the situation in which one member of a specific binding pair will not show any significant binding to molecules other than its specific binding partner (*e.g.*, an affinity of about 1000x or more for its binding partner). In the present invention, the small compounds, such as *N*-[*N*-(3-pyridinesulfonyl)-*L*-3,3-dimethyl-4-thiapropyl]-
15 *O*-[1-methylpiperzain-4-ylcarbonyl]-*L*-tyrosine isopropyl ester, will not show significant binding to any polypeptide other than an alpha-4 integrin or a receptor comprising an alpha-4 integrin. For example, the small compounds used in the methods of the invention that bind to an alpha-4 integrin with a binding affinity of greater than 0.3 nM are said to bind specifically to an alpha-4 integrin.

20 The terms "elicits an immune response" and "elicits a host immune response" as used herein refer to the production of an immune response to a receptor comprising an alpha-4 integrin in a subject upon introduction of an agent of the invention to the subject. An immune response in the subject can be characterized by a serum reactivity with an alpha-4 integrin receptor that is at least twice that of an
25 untreated subject, more preferably three times the reactivity of an untreated subject, and even more preferably at least four times the reactivity of an untreated subject, with serum immunoreactivity measured using a serum dilution of approximately 1:100.

30 The term "pharmaceutically acceptable carrier or excipient" is intended to mean any compound used in forming a part of the formulation that is intended to act merely as a carrier, *i.e.*, not intended to have biological activity itself. The

pharmaceutically acceptable carrier or excipient is generally safe, non-toxic and neither biologically nor otherwise undesirable. A pharmaceutically acceptable carrier or excipient as used in the specification and claims includes both one and more than one such carrier.

5 The terms "treating", and "treatment" and the like are used herein to generally mean obtaining a desired pharmacological and physiological effect. More specifically, the reagents described herein which are used to treat a subject with a demyelinating disease or condition to do one or more of the following: (1) prevent demyelination; (2) inhibit demyelination; (3) promote remyelination; (4) slow or halt
10 paralysis; and (5) reduce/reverse paralysis. Thus, the effect may be prophylactic in terms of preventing or partially preventing a disease, symptom or condition thereof and/or may be therapeutic in terms of a partial or complete cure of a disease, condition, symptom or adverse effect attributed to the disease depending on the condition or disease being treated. The term "treatment", as used herein, covers any
15 treatment of a disease in a mammal, particularly a human, and includes: (a) preventing the disease from occurring in a subject which may be predisposed to the disease but has not yet been diagnosed as having it; (b) inhibiting the disease, *i.e.*, arresting its development; or (c) relieving the disease, *i.e.*, causing regression of the disease and/or its symptoms or conditions. The invention is directed towards
20 treating a patient's suffering from disease related to pathological inflammation. The present invention is involved in preventing, inhibiting, or relieving adverse effects attributed to pathological inflammation and demyelination over long periods of time and/or are such caused by the physiological responses to inappropriate inflammation present in a biological system over long periods of time.

25 By "therapeutically effective amount" is meant an amount of agent, reagent, or combination of reagents disclosed herein that when administered to a mammal is sufficient to promote remyelination of mammalian cells and/or reduce paralysis in an animal in a statistically significant amount.

30 By the term "remyelinating effective amount" is meant an amount of an agent, reagent, or composition effective to inhibit demyelination and/or promote remyelination in a subject and/or reduce paralysis. The "remyelinating effective

amount" will vary depending on the compound or composition, the specific disease to be treated and its severity, and the age, weight, etc., of the mammal to be treated.

By "chronic administration" is meant administration of an agent, reagent, or combination therapy of the invention in an amount and periodicity to result in one or more of the following: (1) reduce paralysis in a subject with a demyelinating disease or condition, (2) halt progression of paralysis in a subject with a demyelinating disease or condition; (3) promote remyelination in a subject with a demyelinating disease or condition; and (4) prevent demyelination in a subject with a demyelinating disease or condition. Administration is preferably biweekly, weekly, monthly, or every other month, but can be daily. More preferably the treatment is weekly or monthly and is administered for 6 months to several years or the remainder of the patient's life depending on the disease or condition being treated.

Additional definitions relevant to the compounds of Formulae I, IA, IB, IC, II, IIA, and IIB are as defined therein.

2. General Aspects of the Invention

The present invention is based on the surprising result that chronic administration of an emerging class of new compounds known as selective adhesion molecule inhibitors (SAMIs) provides appropriate control of the inflammatory response in such a manner as to promote remyelination. Existing inhibitors have not provided such control over the inflammatory response, and disease continues to progress. What the inventors have shown herein is that a class of small compounds, preferably exemplified by the compounds of formula I and II, preferably formula IB, IC, and IIB, is useful in treating such pathological inflammation. These small compounds can be administered using a chronic dosage regime or a short-term dosage regime. However, the chronic dosage regime is preferred to maintain the suppression of the pathological inflammation. Thus, in order to realize some of the more important advantages of the invention, the levels of remyelinating agents agent need to be maintained over a number of months or even years.

In a general sense, the method of the invention does not involve any particular mode of administration, since the mode of administration is dependent

upon the form of the active agent and the formulation developed to administer the active agent. Modes of administration include oral, parenteral (*e.g.*, subcutaneous, subdural, intravenous, intramuscular, intrathecal, intraperitoneal, intracerebral, intraarterial, or intralesional routes of administration), topical, localized (*e.g.*,
5 surgical application or surgical suppository), rectal, and pulmonary (*e.g.*, aerosols, inhalation, or powder). Preferably, the route of administration is parenteral. The route of administration is based on the composition being administered (*e.g.*, immunoglobulin being administered intravenously versus small compound being administered orally), tissue targeting (*e.g.*, intrathecal administration to target the site
10 of a spinal cord injury), and the like, as would be known to the artisan of ordinary skill.

Additionally, the remyelinating agents can be combined with other compounds or compositions used to treat, ameliorate or palliate symptoms associated with demyelination conditions or diseases. Furthermore, the compounds
15 disclosed herein can be administered alone or in combination with other agents, such as other remyelinating agents, including antibodies and immunologically active fragments thereof (*e.g.*, natalizumab). When administered in combination, the small compounds may be administered in the same formulation as these other compounds or compositions, or in a separate formulation. When administered in combination,
20 the remyelinating agent antibodies are generally administered in a separate formulation than the small compound remyelinating agents, other compounds, and compositions. When administered in combinations, the remyelinating agents may be administered prior to, following, or concurrently with the other compounds and compositions used to treat, ameliorate, or palliate symptoms. The general concept of
25 the invention relates to introducing relatively constant amounts of an active agent to a patient's circulatory system over a period of months or years. This chronic administration of a remyelinating agent is one that provides appropriate control over pathological inflammation being maintained at a constant level over a period of time. By maintaining therapeutic levels of an active agent for a period of time,
30 pathological inflammation can be chronically suppressed in the patient.

In a very specific sense, the invention involves obtaining and maintaining a receptor saturation level in a human patient of a dimer comprising alpha-4 integrin in a range of from about 65% to 100%, more preferably between 75% and 100%, and even more preferably between 80-100%. These receptor saturation levels are
5 maintained at these levels chronically (*e.g.*, over a period of 6 months or so) to allow for continued suppression of pathological inflammation.

In general, the remyelinating agents may be selected from agents that specifically bind to an alpha-4-integrin or binds specifically an alpha-4-integrin. For example, the small compounds used in the methods of the invention may be selected
10 from compounds that have a binding affinity for alpha-4-integrin of 0.3 to 3 nM. Also, antibodies such as natalizumab, which have a binding affinity for alpha-4-integrin of about 0.2 to about 0.4 nM, may also selected.

In another aspect of the invention, the compounds and compositions described herein can be used to inhibit immune cell migration from the bloodstream
15 to the central nervous system in the instance of, for example, multiple sclerosis, or to areas which result in inflammatory-induced destruction of the myelin. Preferably, these agents or reagents inhibit immune cell migration in a manner that inhibits demyelination and that further may promote remyelination. The agents or reagents may also prevent demyelination and promote remyelination of the central nervous
20 system for congenital metabolic disorders in which infiltrating immune cells affect the development myelin sheath, mainly in the CNS. The reagents preferably also reduce paralysis when administered to a subject with paralysis induced by a demyelinating disease or condition.

25 **3. Indications for Treatment**

Inflammatory diseases that are included for treatment by the compositions, compounds and methods disclosed herein include generally conditions relating to demyelination. Histologically, myelin abnormalities are either demyelinating or dysmyelinating. Demyelination implies the destruction of myelin. Dysmyelination
30 refers to defective formation or maintenance of myelin resulting from dysfunction of the oligodendrocytes. Preferably, the compositions and methods disclosed herein are

contemplated to treat diseases and conditions relating to demyelination and aid with remyelination. Additional diseases or conditions contemplated for treatment include meningitis, encephalitis, and spinal cord injuries and conditions generally which induce demyelination as a result of an inflammatory response. The compounds, compositions and methods disclosed herein are not directed towards diseases and conditions wherein there is, for example, a genetic defect leading to improper myelin formation, *e.g.*, dysmyelination.

The compositions, compounds and cocktails disclosed herein are contemplated for use in treating conditions and diseases associated with demyelination. Diseases and conditions involving demyelination include, but are not limited to, multiple sclerosis, congenital metabolic disorders (*e.g.*, phenylketonuria, Tay-Sachs disease, Niemann-Pick disease, Gaucher's disease, Hurler's syndrome, Krabbe's disease and other leukodystrophies), neuropathies with abnormal myelination (*e.g.*, Guillain Barré, chronic immune demyelinating polyneuropathy (CIDP), multifocal CIDP, anti-MAG syndrome, GALOP syndrome, anti-sulfatide antibody syndrome, anti-GM2 antibody syndrome, POEMS syndrome, perineuritis, IgM anti-GD1b antibody syndrome), drug related demyelination (*e.g.*, caused by the administration of chloroquine, FK506, perhexiline, procainamide, and zimeldine), other hereditary demyelinating conditions (*e.g.*, carbohydrate-deficient glycoprotein, Cockayne's syndrome, congenital hypomyelinating, congenital muscular dystrophy, Farber's disease, Marinesco-Sjögren syndrome, metachromatic leukodystrophy, Pelizaeus-Merzbacher disease, Refsum disease, prion related conditions, and Salla disease) and other demyelinating conditions (*e.g.*, meningitis, encephalitis or spinal cord injury) or diseases.

There are various disease models that can be used to study these diseases *in vivo*. For example, animal models include but are not limited to:

Table 1

Disease Model	Species
EAE	Mouse, rat, guinea pig
Myelin-oligodendrocyte glycoprotein (MOG) induced EAE	Rat
TNF- α transgenic model of demyelination	Mouse

3.1. Multiple Sclerosis

The most common demyelinating disease is multiple sclerosis, but many other metabolic and inflammatory disorders result in deficient or abnormal myelination. MS is a chronic neurologic disease, which appears in early adulthood and progresses to a significant disability in most cases. There are approximately 350,000 cases of MS in the United States alone. Outside of trauma, MS is the most frequent cause of neurologic disability in early to middle adulthood.

The cause of MS is yet to be determined. MS is characterized by chronic inflammation, demyelination and gliosis (scarring). Demyelination may result in either negative or positive effects on axonal conduction. Positive conduction abnormalities include slowed axonal conduction, variable conduction block that occurs in the presence of high-but not low-frequency trains of impulses or complete conduction block. Positive conduction abnormalities include ectopic impulse generation, spontaneously or following mechanical stress and abnormal "cross-talk" between demyelinated axons.

T cells reactive against myelin proteins, either myelin basic protein (MBP) or myelin proteolipid protein (PLP) have been observed to mediate CNS inflammation in experimental allergic encephalomyelitis. Patients have also been observed as having elevated levels of CNS immunoglobulin (Ig). It is further possible that some of the tissue damage observed in MS is mediated by cytokine products of activated T cells, macrophages or astrocytes.

Today, 80% patients diagnosed with MS live 20 years after onset of illness. Therapies for managing MS include (1) treatment aimed at modification of the disease course, including treatment of acute exacerbation and directed to long-term suppression of the disease; (2) treatment of the symptoms of MS; (3) prevention and treatment of medical complications, and (4) management of secondary personal and social problems.

The onset of MS may be dramatic or so mild as to not cause a patient to seek medical attention. The most common symptoms include weakness in one or more limbs, visual blurring due to optic neuritis, sensory disturbances, diplopia and ataxia.

The course of disease may be stratified into three general categories: (1) relapsing MS, (2) chronic progressive MS, and (3) inactive MS. Relapsing MS is characterized by recurrent attacks of neurologic dysfunction. MS attacks generally evolve over days to weeks and may be followed by complete, partial or no recovery. Recovery from attacks generally occurs within weeks to several months from the peak of symptoms, although rarely some recovery may continue for 2 or more years.

Chronic progressive MS results in gradually progressive worsening without periods of stabilization or remission. This form develops in patients with a prior history of relapsing MS, although in 20% of patients, no relapses can be recalled. Acute relapses also may occur during the progressive course.

A third form is inactive MS. Inactive MS is characterized by fixed neurologic deficits of variable magnitude. Most patients with inactive MS have an earlier history of relapsing MS.

Disease course is also dependent on the age of the patient. For example, favourable prognostic factors include early onset (excluding childhood), a relapsing course and little residual disability 5 years after onset. By contrast, poor prognosis is associated with a late age of onset (*i.e.*, age 40 or older) and a progressive course. These variables are interdependent, since chronic progressive MS tends to begin at a later age than relapsing MS. Disability from chronic progressive MS is usually due to progressive paraplegia or quadriplegia (paralysis) in patients. In one aspect of the invention, patients will preferably be treated when the patient is in remission rather than in a relapsing stage of the disease.

Short-term use of either adrenocorticotrophic hormone or oral corticosteroids (*e.g.*, oral prednisone or intravenous methylprednisolone) is the only specific therapeutic measure for treating patients with acute exacerbation of MS.

Newer therapies for MS include treating the patient with interferon beta-1b, interferon beta-1a, and Copaxone[®] (formerly known as copolymer 1). These three drugs have been shown to significantly reduce the relapse rate of the disease. These drugs are self-administered intramuscularly or subcutaneously.

However, none of the current treatment modalities inhibit demyelination, let alone promote or allow spontaneous remyelination or reduce paralysis. One

aspect of the invention contemplates treating MS with agents disclosed herein either alone or in combination with other standard treatment modalities.

3.2. Congenital Metabolic Disorders

5 Congenital metabolic disorders include phenylketonuria (PKU) and other aminoacidurias, Tay-Sachs disease, Niemann-Pick disease, Gaucher's disease, Hurler's syndrome, Krabbe's disease and other leukodystrophies that impact the developing sheath as described more fully below.

10 PKU is an inherited error of metabolism caused by a deficiency in the enzyme phenylalanine hydroxylase. Loss of this enzyme results in mental retardation, organ damage, unusual posture and can, in cases of maternal PKU, severely compromise pregnancy. A model for studying PKU has been discovered in mice. Preferably infants identified with PKU are sustained on a phenylalanine free or lowered diet. An aspect of the invention would be to combine such diets with the
15 compounds and compositions disclosed herein to prevent demyelination and remyelinate cells damaged due to PKU.

Classical Tay-Sachs disease appears in the subject at about age 6 months and will eventually result in the death of the subject by age 5 years. The disease is due to the lack of the enzyme, hexoaminidase A (hex A), which is necessary for degrading
20 certain fatty substances in the brain and nerve cells. The substances in the absence of the enzyme accumulate and lead to the destruction of nerve cells. Another form of hex A enzyme deficiency occurs later in life and is referred to as juvenile, chronic and adult onset forms of hex A deficiency. Symptoms are similar to those that characterize classical Tay-Sachs disease. There is also an adult onset form of the
25 enzyme deficiency. Currently there is no cure or treatment for the disease/deficiency, only the preventative measure of *in utero* testing of the fetus for the disease. Thus, the compounds and compositions disclosed herein may be useful in ameliorating or preventing the destruction of the cells.

30 Niemann-Pick disease falls into three categories: the acute infantile form, Type B is a less common, chronic, non-neurological form, and Type C is a biochemically and genetically distinct form of the disease. In a normal individual,

cellular cholesterol is imported into lysosomes for processing, after which it is released. Cells taken from subjects with Niemann-Pick have been shown to be defective in releasing cholesterol from lysosomes. This leads to an excessive build-up of cholesterol inside lysosomes, causing processing errors. NPC1 was found to have known sterol-sensing regions similar to those in other proteins, which suggests it plays a role in regulating cholesterol traffic. No successful therapies have been identified for Types A and C forms of Neumann-Pick. For Type C, patients are recommended to follow a low-cholesterol diet. Thus, the compounds and compositions disclosed herein may be useful in ameliorating or preventing the destruction of the cells.

Gaucher's disease is an inherited illness caused by a gene mutation. Normally, this gene is responsible for an enzyme called glucocerebrosidase that the body needs to break down the fat, glucocerebroside. In patients with Gaucher's disease, the body is not able to properly produce this enzyme and the fat cannot be broken down. Like Tay-Sachs disease, Gaucher's disease is considerably more common in the descendants of Jewish people from Eastern Europe (Ashkenazi), although individuals from any ethnic group may be affected. Among the Ashkenazi Jewish population, Gaucher's disease is the most common genetic disorder, with an incidence of approximately 1 in 450 persons. In the general public, Gaucher's disease affects approximately 1 in 100,000 persons.

In 1991, enzyme replacement therapy became available as the first effective treatment for Gaucher's disease. The treatment consists of a modified form of the glucocerebrosidase enzyme given intravenously. It is contemplated that the compositions and compounds disclosed herein can be used alone or more preferably in combination with glycocerebrosidase administration to treat the disease in an afflicted subject.

Hurler's syndrome, also known as mucopolysaccharidosis type I, is a class of overlapping diseases. These genetic diseases share in common the cellular accumulation of mucopolysaccharides in fibroblasts. The diseases are genetically distinguishable. Fibroblast and bone marrow transplantation does not seem to be helpful, thus compounds and compositions useful in ameliorating disease severity

and progression are needed. The compounds and compositions disclosed herein may be administered to a subject to ameliorate disease progression and/or severity.

Krabbe's disease (also known as Globoid cell leukodystrophy) is an autosomal recessive condition resulting from galactosylceramidase (or galactocerebrosidase) deficiency, a lysosomal enzyme that catabolises a major lipid component of myelin. Incidence in France is an estimated 1:150,000 births. The disease leads to demyelination of the central and peripheral nervous system. Onset generally occurs during the first year of life and the condition is rapidly progressive, but juvenile, adolescent or adult onset forms have also been reported, with a more variable rate of progression. Diagnosis is established from enzyme assay (galactosylceramidase deficiency). There are several natural animal models (mouse, dog, monkey). Krabbe's disease, like all leukodystrophies, has no known cures or effective treatments. One embodiment of the instant invention is to use the compositions and compounds disclosed herein to treat or ameliorate Krabbe's disease and other leukodystrophies.

Leukodystrophies are a group of genetically determined progressive disorders that affect the brain, spinal cord and peripheral nerves. They include adrenoleukodystrophy (ALD), adrenomyeloneuropathy (AMN), Aicardi-Goutiers syndrome, Alexander's disease, CACH (*i.e.*, childhood ataxia with central nervous system hypomyelination or vanishing white matter disease), CADASIL (*i.e.*, cerebral autosomal dominant arteriopathy with subcortical infarcts and leukoencephalopathy), Canavan disease (spongy degeneration), Cerebrotendinous Xanthomatosis (CTX), Krabbe's disease (discussed above), metachromatic leukodystrophy (MLD), neonatal adrenoleukodystrophy, ovarioleukodystrophy syndrome, Pelizaeus-Merzbacher disease (X-linked spastic paraplegia), Refsum disease, van der Knaap syndrome (vacuulating leukodystrophy with subcortical cysts) and Zellweger syndrome. None of the diseases have effective treatments let alone cures. Consequently, means of treating or ameliorating the symptoms of the disease, such as by using the compositions and compounds disclosed herein, is needed.

30

3.3. Neuropathies with Abnormal Myelination

A variety of chronic immune polyneuropathies exist which result in demyelination in the patient. The age of onset for the conditions varies by condition. Standard treatments for these diseases exist and could be combined with the compositions and compounds disclosed herein. Alternatively, the compositions and compounds disclosed can be used alone. Existing standard therapies include the following:

Table 2

Neuropathy	Clinical Features	Treatment
Chronic Immune Demyelinating Polyneuropathy (CIDP)	Onset between 1-80 years. Characterized by weakness, sensory loss, and nerve hypertrophy.	T-cell immunosuppression with prednisone, cyclosporine A or methotrexate, HIG, plasma exchange
Multifocal CIDP	Onset between 28 to 58 years and characterized by asymmetric weakness, sensory loss with a course that is slowly progressive or relapsing-remitting.	T cell immunosuppression with prednisone Human immunoglobulin (HIG)
Multifocal Motor Neuropathy (MMN)	Onset ranges from 25 to 70 years, with twice as many men as women. Features include weakness, muscle atrophy, fasciculations, and cramps which are progressive over 1-30 years.	HIG B cell immunosuppression with plasma exchange cyclophosphamide, Rituxan
Neuropathy with IgM binding to Myelin-Associated Glycoprotein (MAG)	Onset is usually over age 50 and is characterized by sensory loss (100%), weakness, gait disorder, tremor which is all slowly progressive.	B-cell immunosuppression plasma exchange cyclophosphamide Rituxan α -interferon cladribine or fludarabine prednisone
GALOP Syndrome (G ait disorder, A utoantibody, L ate-age, O nset, P olyneuropathy)	A gait disorder with polyneuropathy	HIG Plasma exchange cyclophosphamide
POEMS Syndrome (P olyneuropathy, O rganomegaly, E ndocrinopathy, M -Protein and S kin changes) also known as Crow-Fukase Syndrome and Takatsuki disease	Onset occurs between 27 and 80 years with weakness, sensory loss, reduced or absent tendon reflexes, skin disorders and other features.	Osteosclerotic lesions are treated with irradiation. Widespread lesions with chemotherapy (Melphalan and prednisone).

10

3.4. Drug and Radiation Induced Demyelination

Certain drugs and radiation can induce demyelination in subjects. Drugs that are responsible for demyelination include but are not limited to chloroquine, FK506, perhexiline, procainamide, and zimeldine.

Radiation also can induce demyelination. Central nervous system (CNS) toxicity due to radiation is believed to be caused by (1) damage to vessel structures, (2) deletion of oligodendrocyte-2 astrocyte progenitors and mature oligodendrocytes, (3) deletion of neural stem cell populations in the hippocampus, cerebellum and cortex, and generalized alterations of cytokine expression. Most radiation damage results from radiotherapies administered during the treatment of certain cancers. See for review Belka *et al.*, 2001 *Br. J. Cancer* 85: 1233-9. However, radiation exposure may also be an issue for astronauts (Hopewell, 1994 *Adv. Space Res.* 14: 433-42) as well as in the event of exposure to radioactive substances.

Patients who have received drugs or been exposed accidentally or intentionally to radiation may experience a benefit by administered one of the compounds or compositions disclosed herein to prevent demyelination or to promote remyelination.

3.5. Hereditary Conditions Involving Demyelination

Additional inherited syndromes/diseases that result in demyelination include Cockayne's syndrome, congenital hypomyelinating, Farber's disease, metachromatic leukodystrophy, Peliszaeus-Merzbacher disease, Refsum, prion related conditions and Salla disease.

Cockayne's syndrome (CS) is a rare inherited disorder in which people are sensitive to sunlight, have short stature and have the appearance of premature aging. In the classical form of Cockayne's syndrome (Type I), the symptoms are progressive and typically become apparent after the age of one year. An early onset or congenital form of Cockayne's syndrome (Type II) is apparent at birth. Interestingly, unlike other DNA repair diseases, Cockayne's syndrome is not linked to cancer. CS is a multi-system disorder that causes both profound growth failure of the soma and brain and progressive cachexia, retinal, cochlear, and neurologic degeneration, with a leukodystrophy and demyelinating neuropathy without an increase in cancer. After exposure to UV (*e.g.*, sunlight), subjects with Cockayne's syndrome can no longer perform transcription-coupled repair. Two genes defective in Cockayne's syndrome, CSA and CSB, have been identified so far. The CSA gene is found on chromosome

5. Both genes code for proteins that interacts with components of the transcriptional machinery and with DNA repair proteins.

To date, no cures or effective treatments for patients with this disease have been identified. Thus, one aspect of the invention is treatment of this disease with the compounds and compositions disclosed herein.

Congenital hypomyelination has several names including congenital dysmyelinating neuropathy, congenital hypomyelinating polyneuropathy, congenital hypomyelination (Onion Bulb) polyneuropathy, congenital hypomyelination neuropathy, congenital neuropathy caused by hypomyelination, hypomyelination neuropathy and CHN. Hereditary peripheral neuropathies, among the most common genetic disorders in humans, are a complex, clinically and genetically heterogeneous group of disorders that produce progressive deterioration of the peripheral nerves. Congenital hypomyelination is one of a group of disorders. This group includes hereditary neuropathy with liability to pressure palsies, Charcot-Marie-Tooth disease, Dejerine-Sottas syndrome, and congenital hypomyelinating neuropathy. There are no known cures or effective treatments for any of these disorders.

Farber's disease has several names include: Farber lipogranulomatosis, ceramidase deficiency, acid ceramidase deficiency, AC deficiency, N-laurylsphingosine deacylase deficiency, and N-acylsphingosine amidohydrolase. As certain names reveal, the disease occurs due to a deficiency of acid ceramidase (also known as N-acylsphingosine amidohydrolase, ASAH). The lack of the enzyme results in an accumulation of non-sulfonated acid mucopolysaccharide in the neurons and glial cells. Patients with the disease usually die before the age of 2 years.

Metachromatic leukodystrophy (MLD) is a genetic disorder caused by a deficiency of the enzyme arylsulfatase A. It is one of a group of genetic disorders called the leukodystrophies that affect growth of the myelin sheath. There are three forms of MLD: late infantile, juvenile, and adult. In the late infantile form, which is the most common, onset of symptoms begins between ages 6 months and 2 years. The infant is usually normal at birth, but eventually loses previously gained abilities. Symptoms include hypotonia (low muscle tone), speech abnormalities, loss of

mental abilities, blindness, rigidity (*i.e.*, uncontrolled muscle tightness), convulsions, impaired swallowing, paralysis, and dementia. Symptoms of the juvenile form begin between ages 4 and 14, and include impaired school performance, mental deterioration, ataxia, seizures, and dementia. In the adult form, symptoms, which
5 begin after age 16, may include impaired concentration, depression, psychiatric disturbances, ataxia, tremor, and dementia. Seizures may occur in the adult form, but are less common than in the other forms. In all three forms mental deterioration is usually the first sign.

Peliszaeus-Merzbacher disease (also known as perinatal sudanophilic
10 leukodystrophy) is an X-linked genetic disorder that causes an abnormality of a proteolipid protein. The abnormality results in an infant's death typically before the age of one year. There are no known treatments or cures for the disease.

Refsum disease (also referred to as phytanic acid oxidase deficiency, hereditary ataxia polyneuritis or hereditary motor and sensory neuropathy
15 IV, HMSN IV) is caused by mutations in the gene, which encodes phytanoyl-CoA hydroxylase (PAHX or PHYH). The major clinical features are retinitis pigmentosa, chronic polyneuropathy and cerebellar signs. Phytanic acid, an unusual branched chain fatty acid (3,7,11,15-tetramethyl-hexadecanoic acid) accumulates in the tissues and body fluids of patients with the disease and is unable to be metabolised due to
20 the lack of PAHX. Plasmapheresis performed once or twice monthly effectively removes the acid from the body and permits liberalization of dietary restrictions limiting phytanic acid intake.

Prion related conditions include Gerstmann-Straussler disease (GSD), Creutzfeldt-Jakob disease (CJD), familial fatal insomnia and aberrant isoforms of
25 the prion protein can act as infectious agents in these disorders as well as in kuru and scrapie (a disease found in sheep). The term prion derives from "protein infectious agent" (Prusiner, *Science* 216: 136-44, 1982). There is a proteolytic cleavage of the prion related protein (PRP) which results in an amyloidogenic peptide that polymerises into insoluble fibrils

30 Salla disease and other types of sialurias are diseases involving problems with sialic acid storage. They are autosomal recessive neurodegenerative disorders

that may present as a severe infantile form (*i.e.*, ISSD) or as a slowly progressive adult form that is prevalent in Finland (*i.e.*, Salla disease). The main symptoms are hypotonia, cerebellar ataxia and mental retardation. These conditions and diseases are also contemplated for palliative or ameliorating treatments.

5

3.6. Other Demyelinating Conditions

Other conditions that result in demyelination include post-infectious encephalitis (also known as acute disseminated encephalomyelitis, ADEM), meningitis and injuries to the spinal cord. The compositions and compounds disclosed herein are also contemplated for use in treating these other demyelinating conditions.

10

4. Remyelinating Agents

According to the present invention, the remyelinating agents can be selected from agents that specifically bind to alpha-4-integrins. Various types of agents with the ability to bind to and inhibit alpha-4 integrin may be remyelinating agents and thus may be used in the practice of the invention. Many such alpha-4-integrin antagonists have been identified and characterized, and specific agents are described below. These alpha-4-integrin antagonists may be screened for remyelination activity. Specifically, these agents may include both small compounds and polypeptides (*e.g.*, immunoglobulins). Given the teachings disclosed herein, one skilled in the art will be able to identify other agents that will be able to inhibit the alpha-4-comprising integrin dimers in a manner that biologically mimics or is similar to the specifically described agents to inhibit demyelination and/or promote remyelination and/or reduce paralysis. The present invention is intended to include the chronic administration of such agents. As it is also contemplated to include combinations of agents, discussion of agents other than small compounds is also provided.

15

20

25

4.1. Compounds

30

Various compounds have been identified as agents, which interfere with VLA-4 and VCAM-1 binding. Certain of these compounds, when administered to a patient in an effective amount inhibit demyelination and/or promote remyelination and/or reduce paralysis. Compounds according to the present invention include
 5 compounds within formulae I, IA, IB, IC, II, IIA, and IIB described in section 4.1.1. below.

4.1.1. Compounds of Formula I and Formula II

In one aspect, the compounds that can be utilized as remyleinating agents are
 10 compounds defined by formula I below. These compounds have a binding affinity to VLA-4 as expressed by an IC₅₀ of about 15 μM or less (measured as described in Example A below) and act as remyleinating agents:

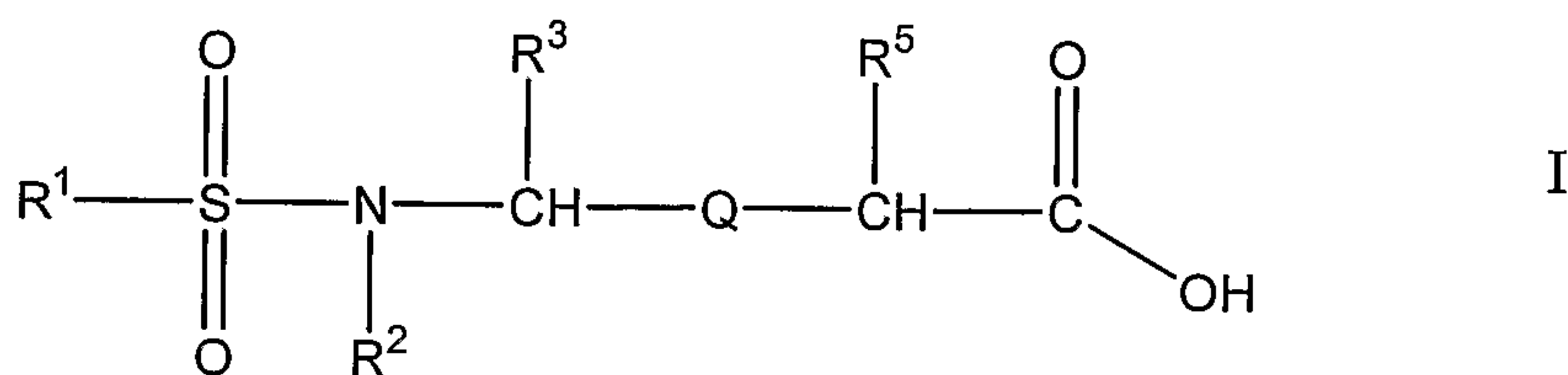

15

wherein

R¹ is selected from the group consisting of alkyl, substituted alkyl, aryl, substituted aryl, cycloalkyl, substituted cycloalkyl, heterocyclic, substituted heterocyclic, heteroaryl and substituted heteroaryl;

20 R² is selected from the group consisting of hydrogen, alkyl, cycloalkyl, substituted cycloalkyl, cycloalkenyl, substituted cycloalkenyl, heterocyclic, substituted heterocyclic, substituted alkyl, aryl, substituted aryl, heteroaryl, substituted heteroaryl, and R¹ and R² together with the nitrogen atom bound to R² and the SO₂ group bound to R¹ can form a heterocyclic or a substituted heterocyclic
 25 group;

R³ is selected from the group consisting of hydrogen, alkyl, substituted alkyl, cycloalkyl, substituted cycloalkyl, aryl, substituted aryl, heteroaryl, substituted heteroaryl, heterocyclic, substituted heterocyclic and, when R² does not form a

heterocyclic group with R^1 , R^2 and R^3 together with the nitrogen atom bound to R^2 and the carbon atom bound to R^3 can form a heterocyclic or a substituted heterocyclic group;

R^5 is $-(CH_2)_x-Ar-R^{5'}$ where $R^{5'}$ is selected from the group consisting of $-O-Z-NR^8R^{8'}$ and $-O-Z-R^{8''}$ wherein R^8 and $R^{8'}$ are independently selected from the group consisting of hydrogen, alkyl, substituted alkyl, cycloalkyl, substituted cycloalkyl, heterocyclic, substituted heterocyclic, and where R^8 and $R^{8'}$ are joined to form a heterocycle or a substituted heterocycle, $R^{8''}$ is selected from the group consisting of heterocycle and substituted heterocycle, and Z is selected from the group consisting of $-C(O)-$ and $-SO_2-$;

Ar is aryl, heteroaryl, substituted aryl or substituted heteroaryl;

x is an integer of from 1 to 4;

Q is $-C(X)NR^7-$ wherein R^7 is selected from the group consisting of hydrogen and alkyl; and X is selected from the group consisting of oxygen and sulfur;

and pharmaceutically acceptable salts thereof.

In another embodiment, the compounds can be provided as prodrugs which convert (*e.g.*, hydrolyze, metabolize, etc.) *in vivo* to a compound of formula I above. In a preferred example of such an embodiment, the carboxylic acid group of the compound of formula I is modified into a group which, *in vivo*, will convert to a carboxylic acid group (including salts thereof). In a particularly preferred embodiment, such prodrugs are represented by compounds of formula IA:

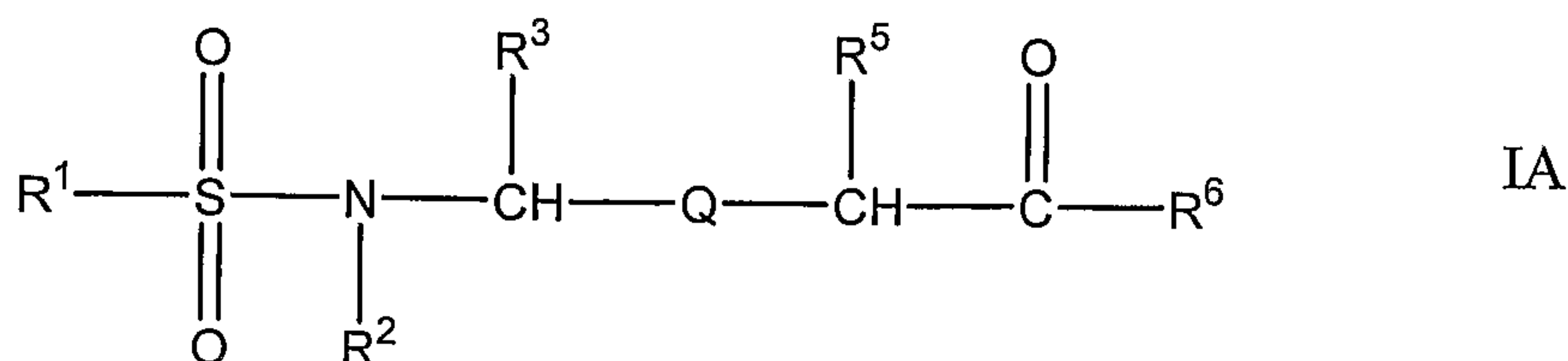

wherein:

R^1 is selected from the group consisting of alkyl, substituted alkyl, aryl, substituted aryl, cycloalkyl, substituted cycloalkyl, heterocyclic, substituted heterocyclic, heteroaryl and substituted heteroaryl;

R^2 is selected from the group consisting of hydrogen, alkyl, cycloalkyl, substituted cycloalkyl, cycloalkenyl, substituted cycloalkenyl, heterocyclic, substituted heterocyclic, substituted alkyl, aryl, substituted aryl, heteroaryl, substituted heteroaryl, and R^1 and R^2 together with the nitrogen atom bound to R^2 and the SO_2 group bound to R^1 can form a heterocyclic or a substituted heterocyclic group;

R^3 is selected from the group consisting of hydrogen, alkyl, substituted alkyl, cycloalkyl, substituted cycloalkyl, aryl, substituted aryl, heteroaryl, substituted heteroaryl, heterocyclic, substituted heterocyclic and, when R^2 does not form a heterocyclic group with R^1 , R^2 and R^3 together with the nitrogen atom bound to R^2 and the carbon atom bound to R^3 can form a heterocyclic or a substituted heterocyclic group;

R^5 is $-(CH_2)_x-Ar-R^{5'}$ where $R^{5'}$ is selected from the group consisting of $-O-Z-NR^8R^{8'}$ and $-O-Z-R^{8''}$ wherein R^8 and $R^{8'}$ are independently selected from the group consisting of hydrogen, alkyl, substituted alkyl, cycloalkyl, substituted cycloalkyl, heterocyclic, substituted heterocyclic, and where R^8 and $R^{8'}$ are joined to form a heterocycle or a substituted heterocycle, $R^{8''}$ is selected from the group consisting of heterocycle and substituted heterocycle, and Z is selected from the group consisting of $-C(O)-$ and $-SO_2-$;

Ar is aryl, heteroaryl, substituted aryl or substituted heteroaryl;

x is an integer of from 1 to 4;

R^6 is selected from the group consisting of 2,4-dioxo-tetrahydrofuran-3-yl (3,4-enol), amino, alkoxy, substituted alkoxy, cycloalkoxy, substituted cycloalkoxy, $-O-(N-succinimidyl)$, $-NH-adamantyl$, $-O-cholest-5-en-3-\beta-yl$, $-NHOY$ where Y is hydrogen, alkyl, substituted alkyl, aryl, and substituted aryl, $-NH(CH_2)_pCOOY$ where p is an integer of from 1 to 8 and Y is as defined above, $-OCH_2NR^9R^{10}$ where R^9 is selected from the group consisting of $-C(O)-aryl$ and $-C(O)-substituted\ aryl$ and R^{10} is selected from the group consisting of hydrogen and $-CH_2COOR^{11}$ where R^{11} is

alkyl, and -NHSO₂Z' where Z' is alkyl, substituted alkyl, cycloalkyl, substituted cycloalkyl, aryl, substituted aryl, heteroaryl, substituted heteroaryl, heterocyclic and substituted heterocyclic;

Q is -C(X)NR⁷- wherein R⁷ is selected from the group consisting of hydrogen and alkyl; and X is selected from the group consisting of oxygen and sulfur;

and pharmaceutically acceptable salts thereof

with the following provisos

(A) when R¹ and R² together with the SO₂ group pendent to R¹ and the nitrogen pendent to R² form a saccharin-2-yl group, R³ is -CH₃, R⁵ is *p*-[(CH₃)₂NC(O)O-]benzyl and Q is -C(O)NH- then R⁶ is not -OC(CH₃)₃;

(B) when R¹ is *p*-methylphenyl, R² and R³ together with the nitrogen atom pendent to R² and the carbon atom pendent to R³ form a pyrrodinyl ring derived from D-proline; R⁵ is *p*-[(4-methylpiperazin-1-yl)NC(O)O-]benzyl derived from D-phenylalanine and Q is -C(O)NH- then R⁶ is not -OC(CH₃)₃;

(C) when R¹ is pyrimidin-2-yl, R² and R³ together with the nitrogen atom bound to R² and the carbon atom bound to R³ form a pyrrolidinyl ring, R⁵ is *p*-[(CH₃)₂NC(O)O-]benzyl and Q is -C(O)NH- then R⁶ is not -OC(CH₃)₃; and

(D) when R¹ is *p*-methylphenyl, R² and R³ together with the nitrogen atom pendent to R² and the carbon atom pendent to R³ form a (2S)-piperazin-2-carbonyl ring; R⁵ is *p*-[(CH₃)₂NC(O)O-]benzyl and Q is -C(O)NH- then R⁶ is not -OC(CH₃)₃.

Further description of the compounds of the above formulae I and IA and procedures and reaction conditions for preparing these compounds are described in U.S.S.N.s 09/126,958 (filed July 31, 1998 and issued as U.S. Patent No. 6,489,300), herein incorporated by reference in their entirety.

Preferably, in the compounds of formula I and IA above, R¹ is selected from the group consisting of alkyl, substituted alkyl, aryl, substituted aryl, heterocyclic,

substituted heterocyclic, heteroaryl and substituted heteroaryl. More preferably R¹ is selected from the group consisting of aryl, substituted aryl, heteroaryl and substituted heteroaryl.

5 Preferably R¹, in the compounds of formula I and IA above is selected from the group consisting of phenyl, 4-methylphenyl, 4-*t*-butylphenyl, 2,4,6-trimethylphenyl, 2-fluorophenyl, 3-fluorophenyl, 4-fluorophenyl, 2,4-difluorophenyl, 3,4-difluorophenyl, 3,5-difluorophenyl, 2-chlorophenyl, 3-chlorophenyl, 4-chlorophenyl, 3,4-dichlorophenyl, 3,5-dichlorophenyl, 3-chloro-4-fluorophenyl, 4-bromophenyl, 2-methoxyphenyl, 3-methoxyphenyl, 4-methoxyphenyl, 3,4-dimethoxyphenyl, 4-*t*-butoxyphenyl, 4-(3'-dimethylamino-*n*-propoxy)-phenyl, 2-carboxyphenyl, 2-(methoxycarbonyl)phenyl, 4-(H₂NC(O)-)phenyl, 4-(H₂NC(S)-)phenyl, 4-cyanophenyl, 4-trifluoromethylphenyl, 4-trifluoromethoxyphenyl, 3,5-di-(trifluoromethyl)phenyl, 4-nitrophenyl, 4-aminophenyl, 4-(CH₃C(O)NH-) phenyl, 4-(PhNHC(O)NH-)phenyl, 4-amidinophenyl, 4-methylamidinophenyl, 4-(CH₃SC(=NH)-)phenyl, 4-chloro-3-(H₂NS(O)₂-)phenyl, 1-naphthyl, 2-naphthyl, pyridin-2-yl, pyridin-3-yl, pyrimidin-2-yl, quinolin-8-yl, 2-(trifluoroacetyl)-1,2,3,4-tetrahydroisoquinolin-7-yl, morpholin-4-yl, 2-thienyl, 5-chloro-2-thienyl, 2,5-dichloro-4-thienyl, 1-N-methylimidazol-4-yl, 1-N-methylpyrazol-3-yl, 1-N-methylpyrazol-4-yl, 1-N-butylpyrazol-4-yl, 1-N-methyl-3-methyl-5-chloropyrazol-4-yl, 1-N-methyl-5-methyl-3-chloropyrazol-4-yl, 2-thiazolyl and 5-methyl-1,3,4-thiadiazol-2-yl.

25 Preferably, R², in the compounds of formula I and IA above is selected from the group consisting of methyl, benzyl, -(CH₂)₂-2-thienyl, and -(CH₂)₂-φ.

30 In one preferred embodiment, R² and R³, in the compounds of formula I and IA above together with the nitrogen atom bound to the R² substituent and the carbon bound to the R³ substituent form a heterocyclic group or a substituted heterocyclic group of 4 to 6 ring atoms having 1 to 2 heteroatoms in the ring selected from the group consisting of nitrogen, oxygen and sulfur which ring is optionally substituted

with 1 to 2 substituents selected from the group consisting of fluoro, methyl, hydroxy, oxo (=O), amino, phenyl, thiophenyl, thiobenzyl, (thiomorpholin-4-yl)C(O)O-, CH₃S(O)₂- and CH₃S(O)₂O-, or can be fused to another ring such as a phenyl or cycloalkyl ring to provide for a fused ring heterocycle of from 10 to 14 ring atoms having 1 to 2 heteroatoms in the ring selected from the group consisting of nitrogen, oxygen and sulfur. Such heterocyclic rings include azetidiny (e.g., L-azetidiny), thiazolidiny (e.g., L-thiazolidiny), piperidiny (e.g., L-piperidiny), piperaziny (e.g., L-piperaziny), dihydroindolyl (e.g., L-2,3-dihydroindol-2-yl), tetrahydroquinoliny (e.g., L-1,2,3,4-tetrahydroquinolin-2-yl), thiomorpholiny (e.g., L-thiomorpholin-3-yl), pyrrolidiny (e.g., L-pyrrolidiny), substituted pyrrolidiny such as 4-hydroxypyrrolidiny (e.g., 4- α -(or β -)hydroxy-L-pyrrolidiny), 4-oxopyrrolidiny (e.g., 4-oxo-L-pyrrolidiny), 4-fluoropyrrolidiny (e.g., 4- α -(or β -)fluoro-L-pyrrolidiny), 4,4-difluoropyrrolidiny (e.g., 4,4-difluoro-L-pyrrolidiny), 4-(thiomorpholin-4-ylC(O)O-)pyrrolidiny (e.g., 4- α -(or β -)(thiomorpholin-4-ylC(O)O-)-L-pyrrolidiny, 4-(CH₃S(O)₂O-)pyrrolidiny (e.g., 4- α -(or β -)(CH₃S(O)₂O-)-L-pyrrolidiny, 3-phenylpyrrolidiny (e.g., 3- α -(or β -)phenyl-L-pyrrolidiny), 3-thiophenylpyrrolidiny (e.g., 3- α -(or β -)thiophenyl-L-pyrrolidiny), 4-aminopyrrolidiny (e.g., 4- α -(or β -)amino-L-pyrrolidiny), 3-methoxypyrrolidiny (e.g., 3- α -(or β -)methoxy-L-pyrrolidiny), 4,4-dimethylpyrrolidiny, substituted piperaziny such as 4-N-Cbz-piperaziny and 4-(CH₃S(O)₂-)piperaziny, substituted thiazolidiny such as 5,5-dimethylthiazolidin-4-yl, 1,1-dioxo-thiazolidiny (e.g., L-1,1-dioxo-thiazolidin-2-yl), substituted 1,1-dioxo-thiazolidiny such as L-1,1-dioxo-5,5-dimethylthiazolidin-2-yl, 1,1-dioxothiomorpholiny (e.g., L-1,1-dioxo-thiomorpholin-3-yl) and the like.

25

Q, in the compounds of formula I and IA above, is preferably -C(O)NH- or -C(S)NH-.

In the compounds of formula I and IA above, Ar is preferably aryl or substituted aryl and, even more preferably, is phenyl or substituted phenyl. Preferably, x is 1.

30

In the compounds of formula I and IA above, R⁵ is preferably selected from all possible isomers arising by substitution with the following groups:

- 3-[(CH₃)₂NC(O)O-]benzyl,
 5 4-[(CH₃)₂NC(O)O-]benzyl,
 4-[(piperidin-1'-yl)C(O)O-]benzyl,
 4-[(piperidin-4'-yl)C(O)O-]benzyl,
 4-[(1'-methylpiperidin-4'-yl)C(O)O-]benzyl,
 4-[(4'-hydroxypiperidin-1'-yl)C(O)O-]benzyl,
 10 4-[(4'-formyloxypiperidin-1'-yl)C(O)O-]benzyl,
 4-[(4'-ethoxycarbonylpiperidin-1'-yl)C(O)O-]benzyl,
 4-[(4'-carboxypiperidin-1'-yl)C(O)O-]benzyl,
 4-[(3'-hydroxymethylpiperidin-1'-yl)C(O)O-]benzyl,
 4-[(4'-hydroxymethylpiperidin-1'-yl)C(O)O-]benzyl,
 15 4-[(4'-phenyl-1'-Boc-piperidin-4'-yl)-C(O)O-]benzyl,
 4-[(4'-piperidon-1'-yl ethylene ketal)C(O)O-]benzyl,
 4-[(piperazin-4'-yl)-C(O)O-]benzyl,
 4-[(1'-Boc-piperazin-4'-yl)-C(O)O-]benzyl,
 4-[(4'-methylpiperazin-1'-yl)C(O)O-]benzyl,
 20 4-[(4'-methylhomopiperazin-1'-yl)C(O)O-]benzyl,
 4-[(4'-(2-hydroxyethyl)piperazin-1'-yl)C(O)O-]benzyl,
 4-[(4'-phenylpiperazin-1'-yl)C(O)O-]benzyl,
 4-[(4'-(pyridin-2-yl)piperazin-1'-yl)C(O)O-]benzyl,
 4-[(4'-(4-trifluoromethylpyridin-2-yl)piperazin-1'-yl)C(O)O-]benzyl,
 25 4-[(4'-(pyrimidin-2-yl)piperazin-1'-yl)C(O)O-]benzyl,
 4-[(4'-acetylpiperazin-1'-yl)C(O)O-]benzyl,
 4-[(4'-(phenylC(O)-)piperazin-1'-yl)C(O)O-]benzyl,
 4-[(4'-(pyridin-4-ylC(O)-)piperazin-1'-yl)C(O)O-]benzyl,
 4-[(4'-(phenylNHC(O)-)piperazin-1'-yl)C(O)O-]benzyl,
 30 4-[(4'-(phenylNHC(S)-)piperazin-1'-yl)C(O)O-]benzyl,
 4-[(4'-methanesulfonylpiperazin-1'-yl-C(O)O-]benzyl,

- 4-[(4'-trifluoromethanesulfonylpiperazin-1'-yl)-C(O)O-]benzyl,
 4-[(morpholin-4'-yl)C(O)O-]benzyl,
 3-nitro-4-[(morpholin-4'-yl)-C(O)O-]benzyl,
 4-[(thiomorpholin-4'-yl)C(O)O-]benzyl,
 5 4-[(thiomorpholin-4'-yl sulfone)-C(O)O-]benzyl
 (alternative nomenclature 4-[(1,1-dioxothiomorpholin-4-yl)-
 C(O)O-]benzyl),
 4-[(pyrrolidin-1'-yl)C(O)O-]benzyl,
 4-[(2'-methylpyrrolidin-1'-yl)C(O)O-]benzyl,
 10 4-[(2'-(methoxycarbonyl)pyrrolidin-1'-yl)C(O)O-]benzyl,
 4-[(2'-(hydroxymethyl)pyrrolidin-1'-yl)C(O)O-]benzyl,
 4-[(2'-(N,N-dimethylamino)ethyl)(CH₃)NC(O)O-]benzyl,
 4-[(2'-(N-methyl-N-toluene-4-sulfonylamino)ethyl)(CH₃)N-
 C(O)O-]benzyl,
 15 4-[(2'-(morpholin-4'-yl)ethyl)(CH₃)NC(O)O-]benzyl,
 4-[(2'-(hydroxy)ethyl)(CH₃)NC(O)O-]benzyl,
 4-[bis(2'-(hydroxy)ethyl)NC(O)O-]benzyl,
 4-[(2'-(formyloxy)ethyl)(CH₃)NC(O)O-]benzyl,
 4-[(CH₃OC(O)CH₂)HNC(O)O-]benzyl,
 20 4-[2'-(phenylNHC(O)O-)ethyl-]HNC(O)O-]benzyl,
 3-chloro-4-[(CH₃)₂NC(O)O-]benzyl,
 3-chloro-4-[(4'-methylpiperazin-1'-yl)C(O)O-]benzyl,
 3-chloro-4-[(4'-(pyridin-2-yl)piperazin-1'-yl)C(O)O-]benzyl,
 3-chloro-4-[(thiomorpholin-4'-yl)C(O)O-]benzyl, and
 25 3-fluoro-4-[(CH₃)₂NC(O)O-]benzyl.

In the compounds of formula IA, R⁶ is preferably 2,4-dioxo-tetrahydrofuran-3-yl (3,4-enol), methoxy, ethoxy, *n*-propoxy, isopropoxy, *n*-butoxy, *t*-butoxy, cyclopentoxy, cyclopropylmethoxy, neopentoxy, 2- α -isopropyl-4- β -methylcyclohexoxy, 2- β -isopropyl-4- β -methylcyclohexoxy, 2-methoxyphenoxy, 2-(morpholin-4-yl)ethoxy, -O(CH₂CH₂O)₂CH₃, 2-(phenoxy)ethoxy, -

OCH₂C(CH₃)₂NHBoc, -NH₂, benzyloxy, -NHCH₂COOH, -NHCH₂CH₂COOH, -NH-adamantyl, -NHSO₂-*p*-CH₃-φ, -NHCH₂CH₂COOCH₂CH₃, -NHOY' where Y' is hydrogen, methyl, *iso*-propyl or benzyl, O-(N-succinimidyl), -O-cholest-5-en-3-β-yl, -OCH₂-OC(O)C(CH₃)₃, -O(CH₂)_zNHC(O)W where z is 1 or 2 and W is selected
 5 from the group consisting of pyrid-3-yl, N-methylpyridyl, and N-methyl-1,4-dihydro-pyrid-3-yl, -NR''C(O)-R' where R' is aryl, heteroaryl or heterocyclic and R'' is hydrogen or -CH₂C(O)OCH₂CH₃.

Even more preferably, R⁶ in the compounds of formula IA is selected from
 10 the group consisting of methoxy, ethoxy, *n*-propoxy, isopropoxy, *n*-butoxy, *t*-butoxy, cyclopentoxy, cyclopropylmethoxy, neopentoxy, 2-α-isopropyl-4-β-methylcyclohexoxy, 2-β-isopropyl-4-β-methylcyclohexoxy, 2-methoxyphenoxy, 2-(morpholin-4-yl)ethoxy, -O(CH₂CH₂O)₂CH₃, 2-(phenoxy)ethoxy, -OCH₂C(CH₃)₂NHBoc, and benzyloxy.

15

Preferred compounds within the scope of formula I and IA above include by way of example:

20 *N*-(toluene-4-sulfonyl)-L-prolyl-L-4-(4-methylpiperazin-1-ylcarbonyloxy)phenylalanine ethyl ester

N-(toluene-4-sulfonyl)-L-prolyl-L-4-(*N,N*-dimethylcarbamyloxy)phenylalanine ethyl ester

25 *N*-(toluene-4-sulfonyl)-L-prolyl-L-4-(4-methylpiperazin-1-ylcarbonyloxy)phenylalanine isopropyl ester

30 *N*-(toluene-4-sulfonyl)-L-prolyl-L-4-(4-methylpiperazin-1-ylcarbonyloxy)phenylalanine *n*-butyl ester

N-(toluene-4-sulfonyl)-L-prolyl-L-4-(4-methylpiperazin-1-ylcarbonyloxy)phenylalanine cyclopentyl ester

35 *N*-(toluene-4-sulfonyl)-L-prolyl-L-4-(4-methylpiperazin-1-ylcarbonyloxy)phenylalanine *tert*-butyl ester

- N*-(toluene-4-sulfonyl)-L-prolyl-L-4-(4-methylpiperazin-1-ylcarbonyloxy)phenylalanine
- 5 *N*-(toluene-4-sulfonyl)-L-prolyl-L-4-(*N,N*-dimethylcarbamyloxy)phenylalanine isopropyl ester
- N*-(toluene-4-sulfonyl)-L-prolyl-L-4-(*N,N*-dimethylcarbamyloxy)phenylalanine *n*-butyl ester
- 10 *N*-(toluene-4-sulfonyl)-L-prolyl-L-4-(*N,N*-dimethylcarbamyloxy)phenylalanine cyclopentyl ester
- N*-(toluene-4-sulfonyl)-L-prolyl-L-4-(*N,N*-dimethylcarbamyloxy)phenylalanine *tert*-butyl ester
- 15 *N*-(toluene-4-sulfonyl)-L-prolyl-L-4-(*N,N*-dimethylcarbamyloxy)phenylalanine
- N*-(toluene-4-sulfonyl)-L-prolyl-L-4-(isonipecotoxyloxy)phenylalanine ethyl ester
- 20 *N*-(α -toluenesulfonyl)-L-prolyl-L-4-(*N*-methylisonipecotoxyloxy)phenylalanine ethyl ester
- 25 *N*-(α -toluenesulfonyl)-L-prolyl-L-4-(4-methylpiperazin-1-ylcarbonyloxy)phenylalanine
- N*-(toluene-4-sulfonyl)-L-prolyl-L-3-(*N,N*-dimethylcarbamyloxy)phenylalanine ethyl ester
- 30 *N*-(toluene-4-sulfonyl)-L-prolyl-L-4-(1-*tert*-butylcarbonyloxy-4-phenylpiperidin-4-ylcarbonyloxy)phenylalanine ethyl ester
- N*-(toluene-4-sulfonyl)-L-(5,5-dimethyl)thiaprolyl-L-4-(*N,N*-dimethylcarbamyloxy)phenylalanine isopropyl ester
- 35 *N*-(toluene-4-sulfonyl)-L-(5,5-dimethyl)thiaprolyl-L-4-(*N,N*-dimethylcarbamyloxy)phenylalanine *tert*-butyl ester
- 40 *N*-(toluene-4-sulfonyl)-L-(5,5-dimethyl)thiaprolyl-L-4-(*N,N*-dimethylcarbamyloxy)phenylalanine
- N*-(toluene-4-sulfonyl)-L-[(1,1-dioxo)thiamorpholin-3-carbonyl]-L-4-(*N,N*-dimethylcarbamyloxy)phenylalanine *tert*-butyl ester
- 45

- N*-(toluene-4-sulfonyl)-L-[(1,1-dioxo)thiamorpholin-3-carbonyl]-L-4-(*N,N*-dimethylcarbamyloxy)phenylalanine
- 5 *N*-(toluene-4-sulfonyl)-L-(5,5-dimethyl)thiaprolyl-L-4-(4-methylpiperazin-1-ylcarbonyloxy)phenylalanine *tert*-butyl ester
- N*-(toluene-4-sulfonyl)-L-(5,5-dimethyl)thiaprolyl-L-4-(4-methylpiperazin-1-ylcarbonyloxy)phenylalanine
- 10 *N*-(toluene-4-sulfonyl)sarcosyl-L-4-(*N,N*-dimethylcarbamyloxy)phenylalanine isopropyl ester
- N*-(toluene-4-sulfonyl)sarcosyl-L-4-(*N,N*-dimethylcarbamyloxy)phenylalanine *tert*-butyl ester
- 15 *N*-(toluene-4-sulfonyl)sarcosyl-L-4-(*N,N*-dimethylcarbamyloxy)phenylalanine
- N*-(toluene-4-sulfonyl)-L-prolyl-L-4-(*N,N*-dimethylaminosulfonyloxy)phenylalanine *tert*-butyl ester
- 20 *N*-(toluene-4-sulfonyl)-L-prolyl-L-4-(*N,N*-dimethylaminosulfonyloxy)phenylalanine
- N*-(1-methylimidazole-4-sulfonyl)-L-prolyl-L-4-(*N,N*-dimethylcarbamyloxy)phenylalanine *tert*-butyl ester
- 25 *N*-(4-aminobenzenesulfonyl)-L-prolyl-L-4-(*N,N*-dimethylcarbamyloxy)phenylalanine *tert*-butyl ester
- 30 *N*-(toluene-4-sulfonyl)sarcosyl-L-4-(morpholin-4-ylcarbonyloxy)phenylalanine *tert*-butyl ester
- N*-(toluene-4-sulfonyl)-L-prolyl-L-4-(morpholin-4-ylcarbonyloxy)phenylalanine *tert*-butyl ester
- 35 *N*-(α -toluenesulfonyl)-L-(5,5-dimethyl)thiaprolyl-L-4-(*N,N*-dimethylcarbamyloxy)phenylalanine
- N*-(toluene-4-sulfonyl)-L-(piperazin-2-carbonyl)-L-4-(*N,N*-dimethylcarbamyloxy)phenylalanine
- 40 *N*-(α -toluenesulfonyl)-L-(5,5-dimethyl)thiaprolyl-L-4-(*N,N*-dimethylcarbamyloxy)phenylalanine *tert*-butyl ester
- 45

- N*-(toluene-4-sulfonyl)-L-prolyl-L-4-(*N,N*-dimethylcarbamyloxy)phenylalanine *N*-adamantyl amide
- 5 *N*-(toluene-4-sulfonyl)-L-prolyl-L-4-(*N,N*-dimethylcarbamyloxy)phenylalanyl-glycine
- N*-(toluene-4-sulfonyl)-L-prolyl-L-4-(*N,N*-dimethylaminosulfonyloxy)phenylalanine methyl ester
- 10 *N*-(toluene-4-sulfonyl)-L-(piperazin-2-carbonyl)-L-4-(*N,N*-dimethylcarbamyloxy)phenylalanine *tert*-butyl ester
- N*-(toluene-4-sulfonyl)-L-(4-benzyloxycarbonylpiperazin-2-carbonyl)-L-4-(*N,N*-dimethylcarbamyloxy)phenylalanine *tert*-butyl ester
- 15 *N*-(toluene-4-sulfonyl)sarcosyl-L-4-(isonipecotoxyloxy)phenylalanine
- N*-(toluene-4-sulfonyl)-L-[(1,1-dioxo)thiamorpholin-3-carbonyl]-L-4-(morpholin-4-ylcarbonyloxy)phenylalanine *tert*-butyl ester
- 20 *N*-(toluene-4-sulfonyl)-L-[(1,1-dioxo)thiamorpholin-3-carbonyl]-L-4-(morpholin-4-ylcarbonyloxy)phenylalanine
- N*-(1-methylpyrazole-4-sulfonyl)-L-prolyl-L-4-(*N,N*-dimethylcarbamyloxy)phenylalanine *tert*-butyl ester
- 25 *N*-(4-fluorobenzenesulfonyl)-L-prolyl-L-4-(*N,N*-dimethylcarbamyloxy)phenylalanine *tert*-butyl ester
- 30 *N*-(toluene-4-sulfonyl)sarcosyl-L-4-(4-methylpiperazin-1-ylcarbonyloxy)phenylalanine *tert*-butyl ester
- N*-(toluene-4-sulfonyl)-L-(1,1-dioxo-5,5-dimethyl)thiaprolyl-L-4-(*N,N*-dimethylcarbamyloxy)phenylalanine *tert*-butyl ester
- 35 *N*-(1-methylimidazole-4-sulfonyl)-L-prolyl-L-4-(*N,N*-dimethylcarbamyloxy)phenylalanine
- 2-(saccharin-2-yl)propionoyl-L-4-(*N,N*-dimethylcarbamyloxy)phenylalanine *tert*-butyl ester
- 40 *N*-(toluene-4-sulfonyl)-L-(1,1-dioxo-5,5-dimethyl)thiaprolyl-L-4-(*N,N*-dimethylcarbamyloxy)phenylalanine
- 45 *N*-(4-fluorobenzenesulfonyl)-L-prolyl-L-4-(*N,N*-dimethylcarbamyloxy)phenylalanine

- N*-(pyridine-3-sulfonyl)-*L*-prolyl-*L*-4-(*N,N*-dimethylcarbamyloxy)phenylalanine
- 5 *N*-(toluene-4-sulfonyl)-*D*-prolyl-*L*-4-(4-methylpiperazin-1-ylcarbonyloxy)phenylalanine *tert*-butyl ester
- N*-(toluene-4-sulfonyl)-*L-N*-methylalanyl-*L*-4-(4-methylpiperazin-1-ylcarbonyloxy)phenylalanine *tert*-butyl ester
- 10 *N*-(4-nitrobenzenesulfonyl)-*L*-prolyl-*L*-4-(*N,N*-dimethylcarbamyloxy)phenylalanine *tert*-butyl ester
- N*-(toluene-4-sulfonyl)-*L*-[(1,1-dioxo)thiomorpholin-3-carbonyl]-*L*-4-(*N,N*-dimethylaminosulfonyloxy)phenylalanine *tert*-butyl ester
- 15 *N*-(toluene-4-sulfonyl)sarcosyl-*L*-4-(thiomorpholin-4-ylcarbonyloxy)phenylalanine *tert*-butyl ester
- 20 *N*-(toluene-4-sulfonyl)-*L-N*-methylalanyl-*L*-4-(4-methylpiperazin-1-ylcarbonyloxy)phenylalanine
- N*-(toluene-4-sulfonyl)-*L*-prolyl-*L*-4-(1,1-dioxothiomorpholin-4-ylcarbonyloxy)phenylalanine
- 25 *N*-(toluene-4-sulfonyl)-*L*-prolyl-*L*-4-(thiomorpholin-4-ylcarbonyloxy)phenylalanine
- N*-(toluene-4-sulfonyl)-*L*-prolyl-*L*-4-(isonipecotoyloxy)phenylalanine
- 30 *N*-(toluene-4-sulfonyl)-*L*-prolyl-*L*-4-(pyrrolidin-1-ylcarbonyloxy)phenylalanine
- N*-(toluene-4-sulfonyl)-*L*-prolyl-*L*-4-(morpholin-4-ylcarbonyloxy)phenylalanine
- 35 *N*-(toluene-4-sulfonyl)-*L*-prolyl-*L*-4-(4-methylpiperazin-1-ylcarbonyloxy)phenylalanine neopentyl ester
- 40 *N*-(toluene-4-sulfonyl)-*L*-prolyl-*L*-4-(*N,N*-dimethylcarbamyloxy)phenylalanine neopentyl ester
- N*-(toluene-4-sulfonyl)-*L*-prolyl-*L*-4-(4-*tert*-butyloxycarbonylpiperazin-1-ylcarbonyloxy)phenylalanine ethyl ester
- 45

- N*-(toluene-4-sulfonyl)-*L*-prolyl-*L*-4-(morpholin-4-ylcarbonyloxy)phenylalanine ethyl ester
- 5 2-(saccharin-2-yl)propionoyl-*L*-4-(4-methylpiperazin-1-ylcarbonyloxy)phenylalanine *tert*-butyl ester
- 2-(saccharin-2-yl)propionoyl-*L*-4-(*N,N*-dimethylcarbamyloxy)phenylalanine
- 10 *N*-(toluene-4-sulfonyl)sarcosyl-*L*-4-(1,1-dioxothiomorpholin-4-ylcarbonyloxy)phenylalanine *tert*-butyl ester
- N*-(toluene-4-sulfonyl)sarcosyl-*L*-4-(thiomorpholin-4-ylcarbonyloxy)phenylalanine
- 15 *N*-(toluene-4-sulfonyl)-*L-N*-methylalanyl-*L*-4-(*N,N*-dimethylcarbamyloxy)phenylalanine *tert*-butyl ester
- N*-(toluene-4-sulfonyl)-*L*-(thiamorpholin-3-carbonyl)-*L*-4-(*N,N*-dimethylcarbamyloxy)phenylalanine *tert*-butyl ester
- 20 *N*-(toluene-4-sulfonyl)sarcosyl-*L*-4-(1,1-dioxothiomorpholin-4-ylcarbonyloxy)phenylalanine
- N*-(toluene-4-sulfonyl)-*L*-(1,1-dioxothiamorpholin-3-carbonyl)-*L*-4-(*N,N*-dimethylcarbamyloxy)phenylalanine *tert*-butyl ester
- 25 *N*-(toluene-4-sulfonyl)-*L*-(1,1-dioxothiamorpholin-3-carbonyl)-*L*-4-(morpholin-4-ylcarbonyloxy)phenylalanine *tert*-butyl ester
- 30 *N*-(toluene-4-sulfonyl)-*L-N*-methylalanyl-*L*-4-(*N,N*-dimethylcarbamyloxy)phenylalanine
- N*-(4-fluorobenzenesulfonyl)-*L*-(thiamorpholin-3-carbonyl)-*L*-4-(*N,N*-dimethylcarbamyloxy)phenylalanine *tert*-butyl ester
- 35 *N*-(4-fluorobenzenesulfonyl)-*L*-(1,1-dioxothiamorpholin-3-carbonyl)-*L*-4-(*N,N*-dimethylcarbamyloxy)phenylalanine *tert*-butyl ester
- 40 *N*-(pyridine-3-sulfonyl)-*L*-prolyl-*L*-4-(*N,N*-dimethylcarbamyloxy)phenylalanine *tert*-butyl ester
- N*-(pyrimidine-2-sulfonyl)-*L*-prolyl-*L*-4-(*N,N*-dimethylcarbamyloxy)phenylalanine *tert*-butyl ester
- 45 *N*-(4-nitrobenzenesulfonyl)-*L*-prolyl-*L*-4-(*N,N*-dimethylcarbamyloxy)phenylalanine

- N*-(4-cyanobenzenesulfonyl)-L-prolyl-L-4-(*N,N*-dimethylcarbamyloxy)phenylalanine *tert*-butyl ester
- 5 *N*-(toluene-4-sulfonyl)-L-(1,1-dioxothiamorpholin-3-carbonyl)-L-4-(*N,N*-dimethylaminosulfonyloxy)phenylalanine
- N*-(toluene-4-sulfonyl)-L-(1,1-dioxothiamorpholin-3-carbonyl)-L-4-(*N,N*-dimethylcarbamyloxy)phenylalanine
- 10 *N*-(toluene-4-sulfonyl)-L-(1,1-dioxo)thiaprolyl-L-4-(*N,N*-dimethylcarbamyloxy)phenylalanine *tert*-butyl ester
- N*-(4-fluorobenzenesulfonyl)-L-prolyl-L-4-(*N,N*-dimethylcarbamyloxy)phenylalanine *tert*-butyl ester
- 15 *N*-(1-methylpyrazole-4-sulfonyl)-L-prolyl-L-4-(*N,N*-dimethylcarbamyloxy)phenylalanine
- N*-(toluene-4-sulfonyl)-L-(1,1-dioxo)thiaprolyl-L-4-(*N,N*-dimethylcarbamyloxy)phenylalanine
- 20 *N*-(4-fluorobenzenesulfonyl)-L-thiaprolyl-L-4-(*N,N*-dimethylcarbamyloxy)phenylalanine
- N*-(toluene-4-sulfonyl)-L-prolyl-L-4-(piperazin-1-ylcarbonyloxy)phenylalanine
- 25 *N*-(toluene-4-sulfonyl)-L-prolyl-L-4-(1-*tert*-butyloxycarbonylpiperazin-1-ylcarbonyloxy)phenylalanine *tert*-butyl ester
- 30 *N*-(toluene-4-sulfonyl)-L-prolyl-L-4-(piperazin-1-ylcarbonyloxy)phenylalanine ethyl ester
- 35 *N*-(toluene-4-sulfonyl)-L-prolyl-L-4-(4-acetylpiperazin-1-ylcarbonyloxy)phenylalanine ethyl ester
- N*-(toluene-4-sulfonyl)-L-prolyl-L-4-(4-methanesulfonylpiperazin-1-ylcarbonyloxy)phenylalanine ethyl ester
- 40 *N*-(toluene-4-sulfonyl)-L-prolyl-L-4-(morpholin-4-ylcarbonyloxy)-3-nitrophenylalanine
- N*-(toluene-4-sulfonyl)-L-prolyl-L-4-(1-*tert*-butyloxycarbonylpiperazin-1-ylcarbonyloxy)phenylalanine
- 45

- N*-(toluene-4-sulfonyl)-*L*-*N*-methyl-2-(*tert*-butyl)glycinyll-*L*-4-(4-methylpiperazin-1-ylcarbonyloxy)phenylalanine *tert*-butyl ester
- 5 *N*-(4-fluorobenzenesulfonyl)-*L*-(5,5-dimethyl)thiaprolyl-*L*-4-(*N,N*-dimethylcarbamyloxy)phenylalanine *tert*-butyl ester
- N*-(4-fluorobenzenesulfonyl)-*L*-(1,1-dioxothiamorpholin-3-carbonyl)-*L*-4-(1,1-dioxothiomorpholin-4-ylcarbonyloxy)phenylalanine *tert*-butyl ester
- 10 *N*-(toluene-4-sulfonyl)-*L*-(1,1-dioxothiamorpholin-3-carbonyl)-*L*-4-(1,1-dioxothiomorpholin-4-ylcarbonyloxy)phenylalanine *tert*-butyl ester
- N*-(4-fluorobenzenesulfonyl)-*L*-prolyl-*L*-4-(1,1-dioxothiomorpholin-4-ylcarbonyloxy)phenylalanine *tert*-butyl ester
- 15 *N*-(4-fluorobenzenesulfonyl)-*L*-prolyl-*L*-4-(thiomorpholin-4-ylcarbonyloxy)phenylalanine *tert*-butyl ester
- N*-(4-fluorobenzenesulfonyl)-*L*-prolyl-*L*-4-(morpholin-4-ylcarbonyloxy)phenylalanine *tert*-butyl ester
- 20 *N*-(4-fluorobenzenesulfonyl)-*L*-(5,5-dimethyl)thiaprolyl-*L*-4-(*N,N*-dimethylcarbamyloxy)phenylalanine
- N*-(4-fluorobenzenesulfonyl)-*L*-(1,1-dioxothiamorpholin-3-carbonyl)-*L*-4-(morpholin-4-ylcarbonyloxy)phenylalanine *tert*-butyl ester
- 25 *N*-(4-trifluoromethoxybenzenesulfonyl)-*L*-prolyl-*L*-4-(*N,N*-dimethylcarbamyloxy)phenylalanine *tert*-butyl ester
- 30 *N*-(toluene-4-sulfonyl)-*L*-(1,1-dioxothiamorpholin-3-carbonyl)-*L*-4-(*N,N*-dimethylcarbamyloxy)phenylalanine isopropyl ester
- 35 3-[*N*-(toluene-4-sulfonyl)-*N*-methylamino]-1-[1-*tert*-butyloxycarbonyl-2-(*N,N*-dimethylcarbamyloxy)phenylethyl]azetidin-2-one
- N*-(4-fluorobenzenesulfonyl)-*L*-(1,1-dioxo-5,5-dimethyl)thiaprolyl-*L*-4-(*N,N*-dimethylcarbamyloxy)phenylalanine *tert*-butyl ester
- 40 *N*-(toluene-4-sulfonyl)-*L*-(1,1-dioxo-5,5-dimethyl)thiaprolyl-*L*-4-(*N,N*-dimethylcarbamyloxy)phenylalanine isopropyl ester
- N*-(toluene-4-sulfonyl)-*L*-(1,1-dioxothiamorpholin-3-carbonyl)-*L*-4-(morpholin-4-ylcarbonyloxy)phenylalanine
- 45

- N*-(4-fluorobenzenesulfonyl)-L-(5,5-dimethyl)thiaprolyl-L-4-(*N,N*-dimethylcarbamyloxy)phenylalanine
- 5 *N*-(pyrimidine-2-sulfonyl)-L-prolyl-L-4-(*N,N*-dimethylcarbamyloxy)phenylalanine
- N*-(toluene-4-sulfonyl)-L-(1,1-dioxothiomorpholin-3-carbonyl)-L-4-(4-methylpiperazin-1-ylcarbonyloxy)phenylalanine *tert*-butyl ester
- 10 3-[*N*-(toluene-4-sulfonyl)-*N*-methylamino]-1-[1-carboxy-2-(*N,N*-dimethylcarbamyloxy)phenylethyl]azetid-2-one
- N*-(1-methylpyrazole-4-sulfonyl)-L-prolyl-L-4-(4-methylpiperazin-1-ylcarbonyloxy)phenylalanine *tert*-butyl ester
- 15 *N*-(4-fluorobenzenesulfonyl)-L-(1,1-dioxo)thiaprolyl-L-4-(*N,N*-dimethylcarbamyloxy)phenylalanine
- N*-(toluene-4-sulfonyl)-L-prolyl-L-4-(isonipecotoxyloxy)phenylalanine *tert*-butyl ester
- 20 *N*-(toluene-4-sulfonyl)-L-prolyl-L-4-(1,1-dioxothiomorpholin-4-ylcarbonyloxy)phenylalanine *tert*-butyl ester
- N*-(toluene-4-sulfonyl)-L-prolyl-L-4-(thiomorpholin-4-ylcarbonyloxy)phenylalanine *tert*-butyl ester
- 25 *N*-(toluene-4-sulfonyl)-L-prolyl-L-4-(pyrrolidin-1-ylcarbonyloxy)phenylalanine *tert*-butyl ester
- 30 *N*-(4-fluorobenzenesulfonyl)-L-thiaprolyl-L-4-(*N,N*-dimethylcarbamyloxy)phenylalanine *tert*-butyl ester
- N*-(4-fluorobenzenesulfonyl)-L-(1,1-dioxo)thiaprolyl-L-4-(*N,N*-dimethylcarbamyloxy)phenylalanine *tert*-butyl ester
- 35 *N*-(2,5-dichlorothiophene-3-sulfonyl)-L-prolyl-L-4-(*N,N*-dimethylcarbamyloxy)phenylalanine *tert*-butyl ester
- N*-(4-acetamidobenzenesulfonyl)-L-prolyl-L-4-(*N,N*-dimethylcarbamyloxy)phenylalanine *tert*-butyl ester
- 40 *N*-(4-*tert*-butylbenzenesulfonyl)-L-(1,1-dioxothiomorpholin-3-carbonyl)-L-4-(*N,N*-dimethylcarbamyloxy)phenylalanine *tert*-butyl ester
- 45

- N*-(pyridine-2-sulfonyl)-*L*-prolyl-*L*-4-(*N,N*-dimethylcarbamyloxy)phenylalanine
- 5 *N*-(2-fluorobenzenesulfonyl)-*L*-(1,1-dioxothiomorpholin-3-carbonyl)-*L*-4-(*N,N*-dimethylcarbamyloxy)phenylalanine *tert*-butyl ester
- N*-(3-fluorobenzenesulfonyl)-*L*-(1,1-dioxothiomorpholin-3-carbonyl)-*L*-4-(*N,N*-dimethylcarbamyloxy)phenylalanine *tert*-butyl ester
- 10 *N*-(2,4-difluorobenzenesulfonyl)-*L*-(1,1-dioxothiomorpholin-3-carbonyl)-*L*-4-(*N,N*-dimethylcarbamyloxy)phenylalanine *tert*-butyl ester
- N*-(4-acetamidobenzenesulfonyl)-*L*-prolyl-*L*-4-(*N,N*-dimethylcarbamyloxy)phenylalanine
- 15 *N*-(4-trifluoromethoxybenzenesulfonyl)-*L*-prolyl-*L*-4-(*N,N*-dimethylcarbamyloxy)phenylalanine
- N*-(4-fluorobenzenesulfonyl)-*L*-(5,5-dimethyl)thiaprolyl-*L*-4-(*N,N*-dimethylcarbamyloxy)phenylalanine *tert*-butyl ester
- 20 *N*-(4-cyanobenzenesulfonyl)-*L*-prolyl-*L*-4-(*N,N*-dimethylcarbamyloxy)phenylalanine
- N*-(toluene-4-sulfonyl)-*L*-(3,3-dimethyl)prolyl-*L*-4-(*N,N*-dimethylcarbamyloxy)phenylalanine *tert*-butyl ester
- 25 *N*-(toluene-4-sulfonyl)-*L*-(3,3-dimethyl)prolyl-*L*-4-(*N,N*-dimethylcarbamyloxy)phenylalanine isopropyl ester
- 30 *N*-(1-methylpyrazole-4-sulfonyl)-*L*-prolyl-*L*-4-(*N,N*-dimethylcarbamyloxy)phenylalanine *iso*-propyl ester
- N*-(1-methylpyrazole-4-sulfonyl)-*L*-(5,5-dimethyl)thiaprolyl-*L*-4-(*N,N*-dimethylcarbamyloxy)phenylalanine *tert*-butyl ester
- 35 *N*-(1-methylpyrazole-4-sulfonyl)-*L*-(5,5-dimethyl)thiaprolyl-*L*-4-(*N,N*-dimethylcarbamyloxy)phenylalanine
- N*-(toluene-4-sulfonyl)-*L*-prolyl-*L*-4-(*N*-(1,4-dioxo-8-aza-spiro[4.5]decan-8-yl)carbonyloxy)phenylalanine ethyl ester
- 40 *N*-(toluene-4-sulfonyl)-*L*-prolyl-*L*-4-(*N*-(1,4-dioxo-8-aza-spiro[4.5]decan-8-yl)carbonyloxy)phenylalanine
- 45

- N-(toluene-4-sulfonyl)-L-prolyl-L-4-(4'-acetylpiperazin-1-ylcarbonyloxy)phenylalanine
- 5 N-(toluene-4-sulfonyl)-L-prolyl-L-4-(4'-methanesulfonylpiperazin-1-ylcarbonyloxy)phenylalanine
- N-(toluene-4-sulfonyl)-L-prolyl-L-4-(4'-phenylpiperazin-1-ylcarbonyloxy)phenylalanine
- 10 N-(toluene-4-sulfonyl)-L-prolyl-L-4-(piperazin-1-ylcarbonyloxy)phenylalanine *tert*-butyl ester
- 2-(saccharin-2-yl)propionyl-L-4-(4'-methylpiperazin-1-ylcarbonyloxy)phenylalanine
- 15 N-(toluene-4-sulfonyl)-L-prolyl-L-4-(4'-methanesulfonylpiperazin-1-ylcarbonyloxy)phenylalanine *tert*-butyl ester
- 20 N-(toluene-4-sulfonyl)-L-prolyl-L-4-(N,N-dimethylcarbamyloxy)phenylalanine (N'-*tert*-butoxycarbonyl-2-amino-2-methylpropyl) ester
- N-(toluene-4-sulfonyl)-L-prolyl-L-4-(4'-acetylpiperazin-1-ylcarbonyloxy)phenylalanine *tert*-butyl ester
- 25 N-(toluene-4-sulfonyl)-L-prolyl-L-4-(4'-hydroxypiperidin-1-ylcarbonyloxy)phenylalanine *tert*-butyl ester
- 30 N-(toluene-4-sulfonyl)-L-prolyl-L-4-(N-(2'-(morpholin-4'-yl)ethyl)carbamyloxy)phenylalanine *tert*-butyl ester
- N-(toluene-4-sulfonyl)-L-prolyl-L-4-(N-(1,4-dioxa-8-aza-spiro[4.5]decan-8-yl)carbonyloxy)phenylalanine *tert*-butyl ester
- 35 N-(toluene-4-sulfonyl)-L-prolyl-L-4-(N-(2'-hydroxyethyl)-N-methylcarbamyloxy)phenylalanine *tert*-butyl ester
- 40 N-(toluene-4-sulfonyl)-L-prolyl-L-4-(4'-(2-hydroxyethyl)piperazin-1-ylcarbonyloxy)-L-phenylalanine *tert*-butyl ester
- N-(toluene-4-sulfonyl)-L-prolyl-L-4-(N-(2'-formyloxyethyl)-N-methylcarbamyloxy)phenylalanine
- 45 N-(toluene-4-sulfonyl)-L-prolyl-L-4-(N-(2'-hydroxyethyl)-N-methylcarbamyloxy)phenylalanine isopropyl ester

- N-(toluene-4-sulfonyl)-L-prolyl-L-4-(N-(methoxycarbonylmethyl)carbamyloxy)phenylalanine *tert*-butyl ester
- 5 N-(1-methylpyrazole-4-sulfonyl)-L-(5,5-dimethyl)thiaprolyl-L-(4-N,N-dimethylcarbamyloxy)phenylalanine isopropyl ester
- N-(toluene-4-sulfonyl)-L-prolyl-L-4-(4'-methoxypiperidin-1-ylcarbonyloxy)phenylalanine isopropyl ester
- 10 N-(toluene-4-sulfonyl)-L-prolyl-L-4-(4'-methoxypiperidin-1-ylcarbonyloxy)phenylalanine
- N-(toluene-4-sulfonyl)-L-4-oxoprolyl-L-4-(N,N-dimethylcarbamyloxy)phenylalanine *tert*-butyl ester
- 15 N-(toluene-4-sulfonyl)-L-*trans*-4-hydroxyprolyl-L-4-(N,N-dimethylcarbamyloxy)phenylalanine *tert*-butyl ester
- N-(3-fluorobenzenesulfonyl)-L-prolyl-L-4-(N,N-dimethylcarbamyloxy)phenylalanine *tert*-butyl ester
- 20 N-(morpholino-sulfonyl)-L-prolyl-L-(4-N,N-dimethylcarbamyloxy)phenylalanine *tert*-butyl ester
- N-(morpholino-sulfonyl)-L-prolyl-L-(4-N,N-dimethylcarbamyloxy)phenylalanine
- 25 N-(1-methylpyrazole-4-sulfonyl)-L-(1,1-dioxothiamorpholin-3-carbonyl)-L-4-(N,N-dimethylcarbamyloxy)phenylalanine *tert*-butyl ester
- 30 N-(2-fluorobenzenesulfonyl)-L-(1,1-dioxothiamorpholin-3-carbonyl)-L-4-(N,N-dimethylcarbamyloxy)phenylalanine
- N-(2,4-difluorobenzenesulfonyl)-L-(1,1-dioxothiamorpholin-3-carbonyl)-L-4-(N,N-dimethylcarbamyloxy)phenylalanine
- 35 N-(toluene-4-sulfonyl)-L-(thiamorpholin-3-carbonyl)-L-4-(N,N-dimethylcarbamyloxy)phenylalanine
- N-(pyridine-3-sulfonyl)-L-(5,5-dimethyl-thiaprolyl-L-4-(N,N-dimethylcarbamyloxy)phenylalanine isopropyl ester
- 40 N-(3-fluorobenzenesulfonyl)-L-(1,1-dioxothiamorpholin-3-carbonyl)-L-4-(N,N-dimethylcarbamyloxy)phenylalanine
- 45

- N*-(1-methylpyrazole-4-sulfonyl)-*L*-(1,1-dioxothiomorpholin-3-carbonyl)-*L*-4-(*N,N*-dimethylcarbamyloxy)phenylalanine
- 5 *N*-(4-*tert*-butylbenzenesulfonyl)-*L*-(1,1-dioxothiomorpholin-3-carbonyl)-*L*-4-(*N,N*-dimethylcarbamyloxy)phenylalanine
- N*-(toluene-4-sulfonyl)-(3,3-dimethyl)prolyl-*L*-4-(*N,N*-dimethylcarbamyloxy)phenylalanine
- 10 *N*-(2,5-dichlorothiophene-3-sulfonyl)-*L*-prolyl-*L*-4-(*N,N*-dimethylcarbamyloxy)phenylalanine
- N*-(4-methoxybenzenesulfonyl)-*L*-prolyl-*L*-4-(*N,N*-dimethylcarbamyloxy)phenylalanine
- 15 *N*-(4-methoxybenzenesulfonyl)-*L*-prolyl-*L*-4-(*N,N*-dimethylcarbamyloxy)phenylalanine isopropyl ester
- N*-(toluene-4-sulfonyl)-*L*-(1-oxo-thiomorpholin-3-carbonyl)-*L*-4-(*N,N*-dimethylcarbamyloxy)phenylalanine
- 20 *N*-(toluene-4-sulfonyl)-*L*-(1-oxo-thiomorpholin-3-carbonyl)-*L*-4-(*N,N*-dimethylcarbamyloxy)phenylalanine *tert*-butyl ester
- N*-(3,4-difluorobenzenesulfonyl)-*L*-prolyl-4-(*N,N*-dimethylcarbamyloxy)phenylalanine isopropyl ester
- 25 *N*-(3,4-difluorobenzenesulfonyl)-*L*-prolyl-4-(*N,N*-dimethylcarbamyloxy)phenylalanine
- 30 *N*-(3,4-difluorobenzenesulfonyl)-*L*-(1,1-dioxothiomorpholin-3-carbonyl)-*L*-4-(*N,N*-dimethylcarbamyloxy)phenylalanine *tert*-butyl ester
- N*-(3,4-difluorobenzenesulfonyl)-*L*-(1,1-dioxothiomorpholin-3-carbonyl)-*L*-4-(*N,N*-dimethylcarbamyloxy)phenylalanine
- 35 *N*-(toluene-4-sulfonyl)-*L*-(5,5-dimethyl)thiaprolyl-*L*-(thiomorpholin-4-ylcarbonyloxy)phenylalanine *tert*-butyl ester
- N*-(toluene-4-sulfonyl)-*L*-(5,5-dimethyl)thiaprolyl-*L*-(thiomorpholin-4-ylcarbonyloxy)phenylalanine
- 40 *N*-(1-methylpyrazole-4-sulfonyl)-*L*-(5,5-dimethyl)thiaprolyl-*L*-4-(*N,N*-dimethylcarbamyloxy)phenylalanine ethyl ester
- 45

- N*-(pyridine-3-sulfonyl)-L-(5,5-dimethyl)thiaprolyl-L-4-(*N,N*-dimethylcarbamyloxy)phenylalanine
- 5 *N*-(pyridine-2-sulfonyl)-L-prolyl-L-4-(*N,N*-dimethylcarbamyloxy)phenylalanine isopropyl ester
- N*-(pyridine-2-sulfonyl)-L-prolyl-L-4-(*N,N*-dimethylcarbamyloxy)phenylalanine
- 10 *N*-(pyridine-2-sulfonyl)-L-(5,5-dimethyl)thiaprolyl-L-4-(*N,N*-dimethylcarbamyloxy)phenylalanine isopropyl ester
- N*-(pyridine-2-sulfonyl)-L-(5,5-dimethyl)thiaprolyl-L-4-(*N,N*-dimethylcarbamyloxy)phenylalanine
- 15 *N*-(toluene-4-sulfonyl)-L-(thiamorpholin-3-carbonyl)-L-4-(*N,N*-dimethylcarbamyloxy)phenylalanine isopropyl ester
- N*-(3-fluorobenzenesulfonyl)-L-(5,5-dimethyl)thiaprolyl-L-4-(*N,N*-dimethylcarbamyloxy)phenylalanine isopropyl ester
- 20 *N*-(2-fluorobenzenesulfonyl)-L-(5,5-dimethyl)thiaprolyl-L-4-(*N,N*-dimethylcarbamyloxy)phenylalanine isopropyl ester
- N*-(3,4-difluorobenzenesulfonyl)-L-(5,5-dimethyl)thiaprolyl-L-4-(*N,N*-dimethylcarbamyloxy)phenylalanine isopropyl ester
- 25 *N*-(3,5-difluorobenzenesulfonyl)-L-(5,5-dimethyl)thiaprolyl-L-4-(*N,N*-dimethylcarbamyloxy)phenylalanine isopropyl ester
- 30 *N*-(2,4-difluorobenzenesulfonyl)-L-(5,5-dimethyl)thiaprolyl-L-4-(*N,N*-dimethylcarbamyloxy)phenylalanine isopropyl ester
- N*-(4-chlorobenzenesulfonyl)-L-(5,5-dimethyl)thiaprolyl-L-4-(*N,N*-dimethylcarbamyloxy)phenylalanine isopropyl ester
- 35 *N*-(3-chlorobenzenesulfonyl)-L-(5,5-dimethyl)thiaprolyl-L-4-(*N,N*-dimethylcarbamyloxy)phenylalanine isopropyl ester
- N*-(2-chlorobenzenesulfonyl)-L-(5,5-dimethyl)thiaprolyl-L-4-(*N,N*-dimethylcarbamyloxy)phenylalanine isopropyl ester
- 40 *N*-(3,4-dichlorobenzenesulfonyl)-L-(5,5-dimethyl)thiaprolyl-L-4-(*N,N*-dimethylcarbamyloxy)phenylalanine isopropyl ester
- 45

- N*-(3,5-dichlorobenzenesulfonyl)-L-(5,5-dimethyl)thiaprolyl-L-4-(*N,N*-dimethylcarbamyloxy)phenylalanine isopropyl ester
- 5 *N*-(3-chlorobenzenesulfonyl)-L-(1,1-dioxothiamorpholin-3-carbonyl)-L-4-(*N,N*-dimethylcarbamyloxy)phenylalanine *tert*-butyl ester
- N*-(3,4-dichlorobenzenesulfonyl)-L-(1,1-dioxothiamorpholin-3-carbonyl)-L-4-(*N,N*-dimethylcarbamyloxy)phenylalanine *tert*-butyl ester
- 10 *N*-(4-methoxybenzenesulfonyl)-L-(5,5-dimethyl)thiaprolyl-L-4-(*N,N*-dimethylcarbamyloxy)phenylalanine isopropyl ester
- N*-(3-methoxybenzenesulfonyl)-L-(5,5-dimethyl)thiaprolyl-L-4-(*N,N*-dimethylcarbamyloxy)phenylalanine isopropyl ester
- 15 *N*-(2-methoxybenzenesulfonyl)-L-(5,5-dimethyl)thiaprolyl-L-4-(*N,N*-dimethylcarbamyloxy)phenylalanine isopropyl ester
- N*-(3,4-dimethoxybenzenesulfonyl)-L-(5,5-dimethyl)thiaprolyl-L-4-(*N,N*-dimethylcarbamyloxy)phenylalanine isopropyl ester
- 20 *N*-(2,4-difluorobenzenesulfonyl)-L-(thiamorpholin-3-carbonyl)-L-4-(*N,N*-dimethylcarbamyloxy)phenylalanine isopropyl ester
- N*-(3,4-dichlorobenzenesulfonyl)-L-(1,1-dioxothiamorpholin-3-carbonyl)-L-4-(*N,N*-dimethylcarbamyloxy)phenylalanine
- 25 *N*-(3-chlorobenzenesulfonyl)-L-(1,1-dioxothiamorpholin-3-carbonyl)-L-4-(*N,N*-dimethylcarbamyloxy)phenylalanine
- 30 *N*-(3-chloro-4-fluorobenzenesulfonyl)-L-(1,1-dioxothiamorpholin-3-carbonyl)-L-4-(*N,N*-dimethylcarbamyloxy)phenylalanine *tert*-butyl ester
- N*-(1-methylpyrazole-4-sulfonyl)-L-(thiamorpholin-3-carbonyl)-L-4-(*N,N*-dimethylcarbamyloxy)phenylalanine *tert*-butyl ester
- 35 *N*-(3,4-difluorobenzenesulfonyl)-L-(thiamorpholin-3-carbonyl)-L-4-(*N,N*-dimethylcarbamyloxy)phenylalanine *tert*-butyl ester
- N*-(toluene-4-sulfonyl)-L-(5,5-dimethyl)thioprolyl-L-(thiomorpholin-4-ylcarbonyloxy)phenylalanine isopropyl ester
- 40 *N*-(3,4-difluorobenzenesulfonyl)-L-(thiamorpholin-3-carbonyl)-L-4-(*N,N*-dimethylcarbamyloxy)phenylalanine
- 45

- N*-(2,5-dichlorothiophene-3-sulfonyl)-*L*-(5,5-dimethyl)thiaprolyl-*L*-4-(*N,N*-dimethylcarbamyloxy)phenylalanine isopropyl ester
- 5 *N*-(1-methylpyrazole-4-sulfonyl)-*L*-(5,5-dimethyl)thiaprolyl-*L*-4-(thiomorpholin-4-ylcarbonyloxy)phenylalanine isopropyl ester
- N*-(8-quinolinesulfonyl)-*L*-prolyl-*L*-4-(*N,N*-dimethylcarbamyloxy)phenylalanine isopropyl ester
- 10 *N*-(8-quinolinesulfonyl)-*L*-prolyl-*L*-4-(*N,N*-dimethylcarbamyloxy)phenylalanine
- N*-(8-quinolinesulfonyl)-*L*-(5,5-dimethyl)thiaprolyl-*L*-4-(*N,N*-dimethylcarbamyloxy)phenylalanine isopropyl ester
- 15 *N*-(8-quinolinesulfonyl)-*L*-(5,5-dimethyl)thiaprolyl-*L*-4-(*N,N*-dimethylcarbamyloxy)phenylalanine
- N*-(toluene-4-sulfonyl)-*L*-prolyl-*L*-4-(4-phenylpiperazin-1-ylcarbonyloxy)phenylalanine *tert*-butyl ester
- 20 *N*-(toluene-4-sulfonyl)-*L*-prolyl-*L*-4-(4'-(ethoxycarbonyl)piperidin-1-ylcarbonyloxy)phenylalanine *tert*-butyl ester
- N*-(pyridine-3-sulfonyl)-*L*-(5,5-dimethyl)thiaprolyl-*L*-4-(*N,N*-dimethylcarbamyloxy)phenylalanine *tert*-butyl ester
- 25 *N*-(3-sulfonamido-4-chloro-benzenesulfonyl)-*L*-prolyl-*L*-4-(*N,N*-dimethylcarbamyloxy)phenylalanine isopropyl ester
- 30 *N*-(toluene-4-sulfonyl)-*L*-(1-oxothiomorpholin-3-carbonyl)-*L*-4-(*N,N*-dimethylcarbamyloxy)phenylalanine isopropyl ester
- N*-(2,4-difluorobenzenesulfonyl)-*L*-(1-oxothiomorpholin-3-carbonyl)-*L*-4-(*N,N*-dimethylcarbamyloxy)phenylalanine *tert*-butyl ester
- 35 *N*-(1-methylpyrazole-4-sulfonyl)-*L*-(5,5-dimethyl)thiaprolyl-*L*-4-(*N,N*-dimethylcarbamyloxy)phenylalanine 2,2-dimethylpropyl ester
- N*-(pyridine-3-sulfonyl)-*L*-(5,5-dimethyl)thiaprolyl-*L*-4-(*N,N*-dimethylcarbamyloxy)phenylalanine 2,2-dimethylpropyl ester
- 40 *N*-(1-methylpyrazole-4-sulfonyl)-*L*-(5,5-dimethyl)thiaprolyl-*L*-4-(*N,N*-dimethylcarbamyloxy)phenylalanine cyclopropylmethyl ester
- 45

- N*-(1-methylpyrazole-4-sulfonyl)-*L*-(5,5-dimethyl)thiaprolyl-*L*-4-(*N,N*-dimethylcarbamyloxy)phenylalanine methyl ester
- 5 *N*-(pyridine-3-sulfonyl)-*L*-(5,5-dimethyl)thiaprolyl-*L*-4-(*N,N*-dimethylcarbamyloxy)phenylalanine ethyl ester
- N*-(pyridine-3-sulfonyl)-*L*-(5,5-dimethyl)thiaprolyl-*L*-4-(*N,N*-dimethylcarbamyloxy)phenylalanine cyclopropylmethyl ester
- 10 *N*-(1-methylpyrazole-4-sulfonyl)-*L*-(5,5-dimethyl)thiaprolyl-*L*-4-(*N,N*-dimethylcarbamyloxy)phenylalanine 2-methoxyphenyl ester
- N*-(1-methylpyrazole-4-sulfonyl)-*L*-(5,5-dimethyl)thiaprolyl-*L*-4-(*N,N*-dimethylcarbamyloxy)phenylalanine *n*-butyl ester
- 15 *N*-(1-methylpyrazole-4-sulfonyl)-*L*-(5,5-dimethyl)thiaprolyl-*L*-4-(*N,N*-dimethylcarbamyloxy)phenylalanine *n*-propyl ester
- N*-(1-methylpyrazole-4-sulfonyl)-*L*-(5,5-dimethyl)thiaprolyl-*L*-4-(*N,N*-dimethylcarbamyloxy)phenylalanine 2,2-dimethylpropionyloxymethyl ester
- 20 *N*-(toluene-4-sulfonyl)-*L*-prolyl-*L*-4-(*N*-(4'-(2'-aminoethyl)morpholino)carbamyloxy)phenylalanine
- 25 *N*-(toluene-4-sulfonyl)-*L*-prolyl-*L*-4-[4-(carboxy)piperidin-1-ylcarbonyloxy]phenylalanine
- N*-(toluene-4-sulfonyl)-*L*-prolyl-*L*-4-(*N,N*-bis-(2-hydroxyethyl)carbamyloxy)phenylalanine isopropyl ester
- 30 *N*-(toluene-4-sulfonyl)-*L*-prolyl-*L*-4-[3-(hydroxymethyl)piperidin-1-ylcarbonyloxy]phenylalanine isopropyl ester
- N*-(toluene-4-sulfonyl)-*L*-prolyl-*L*-4-(4-trifluoromethanesulfonylpiperazin-1-ylcarbonyloxy)phenylalanine *tert*-butyl ester
- 35 *N*-(4-(*N*-phenylurea)benzenesulfonyl)-*L*-prolyl-*L*-4-(*N,N*-dimethylcarbamyloxy)phenylalanine *tert*-butyl ester
- 40 *N*-(2-trifluoroacetyl-1,2,3,4-tetrahydroisoquinolin-7-sulfonyl)-*L*-prolyl-*L*-4-(*N,N*-dimethylcarbamyloxy)phenylalanine isopropyl ester
- N*-(1-methylpyrazole-3-sulfonyl)-*L*-(5,5-dimethyl)thiaprolyl-*L*-4-(*N,N*-dimethylcarbamyloxy)phenylalanine isopropyl ester
- 45

- N*-(1-methylpyrazole-3-sulfonyl)-L-(5,5-dimethyl)thiaprolyl-L-4-(*N,N*-dimethylcarbamyloxy)phenylalanine
- 5 *N*-(pyridine-4-sulfonyl)-L-(5,5-dimethyl)thiaprolyl-L-4-(*N,N*-dimethylcarbamyloxy)phenylalanine isopropyl ester
- N*-(pyridine-4-sulfonyl)-L-(5,5-dimethyl)thiaprolyl-L-4-(*N,N*-dimethylcarbamyloxy)phenylalanine
- 10 *N*-(toluene-4-sulfonyl)-L-(5,5-dimethyl)thiaprolyl-L-4-(*N*-methyl-*N*-(2-dimethylaminoethyl)carbamyloxy)phenylalanine *tert*-butyl ester
- N*-(toluene-4-sulfonyl)-L-prolyl-L-4-(*N*-methyl-*N*-(2-dimethylaminoethyl)carbamyloxy)phenylalanine *tert*-butyl ester
- 15 *N*-(toluene-4-sulfonyl)-L-(5,5-dimethyl)thiaprolyl-L-4-(*N*-methyl-*N*-(2-dimethylaminoethyl)carbamyloxy)phenylalanine
- N*-(toluene-4-sulfonyl)-L-prolyl-L-4-(*N*-methyl-*N*-(2-dimethylaminoethyl)carbamyloxy)phenylalanine
- 20 *N*-(4-fluorobenzenesulfonyl)-L-(5,5-dimethyl)thiaprolyl-L-3-chloro-4-(4-methylpiperazin-1-ylcarbonyloxy)phenylalanine *tert*-butyl ester
- 25 *N*-(4-fluorobenzenesulfonyl)-L-(5,5-dimethyl)thiaprolyl-L-3-chloro-4-(*N,N*-dimethylcarbamyloxy)phenylalanine
- N*-(4-fluorobenzenesulfonyl)-L-(5,5-dimethyl)thiaprolyl-L-3-chloro-4-(thiomorpholin-4-ylcarbonyloxy)phenylalanine *tert*-butyl ester
- 30 *N*-(4-fluorobenzenesulfonyl)-L-(5,5-dimethyl)thiaprolyl-L-3-chloro-4-(thiomorpholin-4-ylcarbonyloxy)phenylalanine isopropyl ester
- N*-(4-fluorobenzenesulfonyl)-L-(5,5-dimethyl)thiaprolyl-L-3-chloro-4-(*N,N*-dimethylcarbamyloxy)]phenylalanine isopropyl ester
- 35 *N*-(toluene-4-sulfonyl)-L-(5,5-dimethyl)thiaprolyl-L-3-chloro-4-(*N,N*-dimethylcarbamyloxy)phenylalanine isopropyl ester
- 40 *N*-(4-fluorobenzenesulfonyl)-L-(5,5-dimethyl)thiaprolyl-L-3-chloro-4-(4-methylpiperazin-1-ylcarbonyloxy)]phenylalanine isopropyl ester
- N*-(toluene-4-sulfonyl)-L-prolyl-L-3-chloro-4-(*N,N*-dimethylcarbamyloxy)]phenylalanine isopropyl ester
- 45

- N*-(4-fluorobenzenesulfonyl)-L-(5,5-dimethyl)thiaprolyl-L-3-chloro-4-(4-(2'-pyridyl)-piperazin-1-ylcarbonyloxy)]phenylalanine isopropyl ester
- 5 *N*-(4-fluorobenzenesulfonyl)-L-(5,5-dimethyl)thiaprolyl-L-3-chloro-4-(4-(2'-pyridyl)-piperazin-1-ylcarbonyloxy)]phenylalanine *tert*-butyl ester
- N*-(4-nitrobenzenesulfonyl)-L-prolyl-L-4-(*N,N*-dimethylcarbamyloxy)phenylalanine isopropyl ester
- 10 *N*-(4-aminobenzenesulfonyl)-L-prolyl-L-4-(*N,N*-dimethylcarbamyloxy)phenylalanine isopropyl ester
- N*-(toluene-4-sulfonyl)-L-prolyl-L-4-(thiomorpholin-4-ylcarbonyloxy)phenylalanine isopropyl ester
- 15 *N*-(toluene-4-sulfonyl)-L-prolyl-L-4-(4-phenylcarbamyloxy)piperazin-1-ylcarbonyloxy)phenylalanine isopropyl ester
- N*-(toluene-4-sulfonyl)-L-prolyl-L-4-(4-phenylcarbamyloxy)piperazin-1-ylcarbonyloxy)phenylalanine
- 20 *N*-(1-*n*-butylpyrazole-4-sulfonyl)-L-(5,5-dimethyl)thiaprolyl-L-4-(*N,N*-dimethylcarbamyloxy)phenylalanine isopropyl ester
- 25 *N*-(toluene-4-sulfonyl)-L-prolyl-L-4-(pyridin-4-ylcarbonyl)piperazin-1-ylcarbonyloxy)phenylalanine isopropyl ester
- N*-(toluene-4-sulfonyl)-L-4-oxoprolyl-L-4-(*N,N*-dimethylcarbamyloxy)phenylalanine
- 30 *N*-(toluene-4-sulfonyl)-L-*trans*-4-hydroxyprolyl-L-4-(*N,N*-dimethylcarbamyloxy)phenylalanine
- N*-(4-cyanobenzenesulfonyl)-L-prolyl-L-4-(*N,N*-dimethylcarbamyloxy)phenylalanine isopropyl ester
- 35 *N*-(4-aminobenzenesulfonyl)-L-prolyl-L-4-(*N,N*-dimethylcarbamyloxy)phenylalanine
- N*-(toluene-4-sulfonyl)-L-4-oxoprolyl-L-4-(4-methylpiperazin-1-ylcarbonyloxy)phenylalanine *tert*-butyl ester
- 40 *N*-(toluene-4-sulfonyl)-L-prolyl-L-4-[3-(hydroxymethyl)piperidin-1-ylcarbonyloxy]phenylalanine
- 45

- N*-(toluene-4-sulfonyl)-*L*-(4,4-difluoro)prolyl-*L*-4-(*N,N*-dimethylcarbamyloxy)phenylalanine isopropyl ester
- 5 *N*-(toluene-4-sulfonyl)-*L*-(4,4-difluoro)prolyl-*L*-4-(*N,N*-dimethylcarbamyloxy)phenylalanine
- N*-(toluene-4-sulfonyl)-*L*-prolyl-*L*-(4-benzoylpiperazin-1-ylcarbonyloxy)phenylalanine isopropyl ester
- 10 *N*-(1-methyl-1*H*-imidazole-4-sulfonyl)-*L*-prolyl-*L*-4-(*N,N*-dimethylcarbamyloxy)phenylalanine isopropyl ester
- N*-(toluene-4-sulfonyl)-*L*-4-(thiomorpholin-4-ylcarbonyloxy)prolyl-*L*-4-(thiomorpholin-4-ylcarbonyloxy)phenylalanine
- 15 *N*-(4-cyanobenzenesulfonyl)-*L*-prolyl-*L*-4-(thiomorpholin-4-ylcarbonyloxy)phenylalanine isopropyl ester
- N*-(4-amidinobenzenesulfonyl)-*L*-prolyl-*L*-4-(*N,N*-dimethylcarbamyloxy)phenylalanine methyl ester
- 20 *N*-(toluene-4-sulfonyl)-*L*-4-oxoprolyl-*L*-4-(thiomorpholin-4-ylcarbonyloxy)phenylalanine *tert*-butyl ester
- 25 *N*-(toluene-4-sulfonyl)-*L*-4-hydroxyprolyl-*L*-4-(thiomorpholin-4-ylcarbonyloxy)phenylalanine
- N*-(toluene-4-sulfonyl)-*L*-prolyl-*L*-(4-benzoylpiperazin-1-ylcarbonyloxy)phenylalanine
- 30 *N*-(4-amidinobenzenesulfonyl)-*L*-prolyl-*L*-4-(thiomorpholin-4-ylcarbonyloxy)phenylalanine methyl ester
- N*-(3-fluorobenzenesulfonyl)-*L*-prolyl-*L*-4-(*N,N*-dimethylcarbonyloxy)phenylalanine
- 35 *N*-(toluene-4-sulfonyl)-*L*-prolyl-*L*-4-[*N*-methyl-*N*-(2-(*N'*-methyl-*N'*-toluenesulfonyl-amino)ethyl)carbamyloxy]phenylalanine isopropyl ester
- 40 *N*-(toluene-4-sulfonyl)-*L*-prolyl-*L*-4-[*N*-(2-(*N'*-phenylaminocarbonyloxy)ethyl)carbamyloxy]phenylalanine isopropyl ester
- N*-(4-fluorobenzenesulfonyl)-*L*-4-(*trans*-hydroxy)prolyl-*L*-4-(*N,N*-dimethylcarbamyloxy)phenylalanine isopropyl ester
- 45

- N*-(4-fluorobenzenesulfonyl)-L-4-(*trans*-hydroxy)prolyl-L-4-(*N,N*-dimethylcarbamyloxy)phenylalanine *tert*-butyl ester
- 5 *N*-(4-amidinobenzenesulfonyl)-L-prolyl-L-4-(*N,N*-dimethylcarbamyloxy)phenylalanine
- 10 piperazine-1,4-dicarboxylic acid bis-{4-[(2*S*)-2-*tert*-butoxycarbonyl-2-((4*R*)-5,5-dimethyl-3-(toluene-4-sulfonyl)thiazolidine-4-carboxamido)ethyl]phenyl} ester
- 15 piperazine-1,4-dicarboxylic acid bis-{4-[(2*S*)-2-carboxy-2-((4*R*)-5,5-dimethyl-3-(toluene-4-sulfonyl)thiazolidine-4-carboxamido)ethyl]phenyl} ester
- N*-(toluene-4-sulfonyl)-L-(pyrazin-3-carbonyl)-L-4-(*N,N*-dimethylcarbamyloxy)phenylalanine *tert*-butyl ester
- 20 *N*-(4-fluorobenzenesulfonyl)-L-(5,5-dimethyl)thiaprolyl-L-4-(2-hydroxymethylpyrrolidin-1-ylcarbonyloxy)phenylalanine *tert*-butyl ester
- N*-(4-fluorobenzenesulfonyl)-L-(5,5-dimethyl)thiaprolyl-L-4-(2-hydroxymethylpyrrolidin-1-ylcarbonyloxy)phenylalanine
- 25 *N*-(toluene-4-sulfonyl)-L-prolyl-L-4-(2-methoxycarbonylpyrrolidin-1-ylcarbonyloxy)phenylalanine *tert*-butyl ester
- N*-(4-fluorobenzenesulfonyl)-L-(5,5-dimethyl)thiaprolyl-L-3-chloro-4-(thiomorpholin-4-ylcarbonyloxy)phenylalanine
- 30 *N*-(4-fluorobenzenesulfonyl)-L-(5,5-dimethyl)thiaprolyl-L-4-(4-(2-pyridyl)piperazin-1-ylcarbonyloxy)]phenylalanine
- N*-(4-fluorobenzenesulfonyl)-L-(5,5-dimethyl)thiaprolyl-L-4-(4-(2-pyridyl)piperazin-1-ylcarbonyloxy)]phenylalanine *tert*-butyl ester
- 35 piperazine-1,4-dicarboxylic acid bis-{4-[(2*S*)-2-isopropoxycarbonyl-2-((2*R*)-1-(toluene-4-sulfonyl)pyrrolidine-2-carboxamido)ethyl]phenyl} ester
- 40 *N*-(toluene-4-sulfonyl)-L-(4-hydroxy)prolyl-L-4-(thiomorpholin-4-ylcarbonyloxy)phenylalanine *tert*-butyl ester
- N*-(toluene-4-sulfonyl)-L-prolyl-L-4-(*N,N*-dimethylcarbamyloxy)phenylalanine 2-(2-methoxyethoxy)ethyl ester
- 45 *N*-(4-fluorobenzenesulfonyl)-L-(5,5-dimethyl)thiaprolyl-L-4-(4-(2-pyrimidyl)piperazin-1-ylcarbonyloxy)]phenylalanine *tert*-butyl ester

- N*-(4-fluorobenzenesulfonyl)-L-(5,5-dimethyl)thiaprolyl-L-3-fluoro-4-(*N,N*-dimethylcarbamyloxy)phenylalanine isopropyl ester
- 5 *N*-(toluene-4-sulfonyl)-L-(1-methanesulfonylpyrazin-3-carbonyl)-L-4-(*N,N*-dimethylcarbamyloxy)phenylalanine *tert*-butyl ester
- 10 *N*-[2-(1,1-dioxo-2,3-dihydro-3,3-dimethyl-1,2-benzisothiazol-2-yl)acetyl]-L-4-(*N,N*-dimethylcarbamyloxy)phenylalanine
- N*-[2-(*N*-2,10-camphorsultamyl)acetyl]-L-4-(*N,N*-dimethylcarbamyloxy)phenylalanine *tert*-butyl ester
- 15 *N*-[2-(*N*-2,10-camphorsultamyl)acetyl]-L-4-(*N,N*-dimethylcarbamyloxy)phenylalanine
- N*-[2-(*N*-2,10-camphorsultamyl)acetyl]-L-3-chloro-4-(*N,N*-dimethylcarbamyloxy)phenylalanine isopropyl ester
- 20 *N*-(4-bromobenzenesulfonyl)-L-(5,5-dimethyl)thiaprolyl-L-4-(*N,N*-dimethylcarbamyloxy)phenylalanine *tert*-butyl ester
- N*-(4-bromobenzenesulfonyl)-L-(5,5-dimethyl)thiaprolyl-L-4-(*N,N*-dimethylcarbamyloxy)phenylalanine
- 25 *N*-(toluene-4-sulfonyl)-L-(4-hydroxy)prolyl-L-4-(4-methylpiperazin-1-ylcarbonyloxy)phenylalanine
- N*-(4-fluorobenzenesulfonyl)-L-(5,5-dimethyl)thiaprolyl-L-4-(4-(2-pyrimidyl)piperazin-1-ylcarbonyloxy)]phenylalanine
- 30 piperazine-1,4-dicarboxylic acid bis-{4-[(2*S*)-2-*tert*-butoxycarbonyl-2-((2*R*)-1-(toluene-4-sulfonyl)pyrrolidine-2-carboxamido)ethyl]phenyl} ester
- 35 *N*-(4-fluorobenzenesulfonyl)-L-(5,5-dimethyl)thiaprolyl-L-4-(4-(2-pyridyl)piperazin-1-ylcarbonyloxy)]phenylalanine isopropyl ester
- N*-(4-fluorobenzenesulfonyl)thiazolidinyl-2-carbonyl-L-4-(*N,N*-dimethylcarbamyloxy)phenylalanine
- 40 *N*-(4-fluorobenzenesulfonyl)thiazolidinyl-2-carbonyl-L-4-(*N,N*-dimethylcarbamyloxy)phenylalanine *tert*-butyl ester
- N*-(toluene-4-sulfonyl)-L-(4-oxo)prolyl-L-4-(thiomorpholin-4-ylcarbonyloxy)phenylalanine
- 45

- N*-(toluene-4-sulfonyl)-L-(4-oxo)prolyl-L-4-(4-methylpiperazin-1-ylcarbonyloxy)phenylalanine
- 5 *N*-(4-fluorobenzenesulfonyl)thiazolidinyl-2-carbonyl-L-4-(4-(2-pyridyl)piperazin-1-ylcarbonyloxy)]phenylalanine
- N*-(4-nitrobenzenesulfonyl)-L-prolyl-L-4-(4-(2-pyridyl)piperazin-1-ylcarbonyloxy)]phenylalanine *tert*-butyl ester
- 10 *N*-(4-fluorobenzenesulfonyl)thiazolidinyl-2-carbonyl-L-4-(4-(2-pyridyl)piperazin-1-ylcarbonyloxy)]phenylalanine *tert*-butyl ester
- N*-(4-bromobenzenesulfonyl)-L-(5,5-dimethyl)thiaprolyl-L-4-(4-(2-pyridyl)piperazin-1-ylcarbonyloxy)]phenylalanine
- 15 *N*-(toluene-4-sulfonyl)-L-prolyl-L-4-(4-(*N*-phenylthiocarbonyl)piperazin-1-ylcarbonyloxy)]phenylalanine isopropyl ester
- N*-(4-fluorobenzenesulfonyl)thiazolidinyl-2-carbonyl-L-4-(4-methylhomopiperazin-1-ylcarbonyloxy)phenylalanine *tert*-butyl ester
- 20 piperazine-1,4-dicarboxylic acid bis-{4-[(2*S*)-2-carboxyl-2-((2*R*)-1-(toluene-4-sulfonyl)pyrrolidine-2-carboxamido)ethyl]phenyl} ester
- 25 *N*-(toluene-4-sulfonyl)-L-4-(methanesulfonyloxy)prolyl-L-4-(*N,N*-dimethylcarbamyloxy)phenylalanine *tert*-butyl ester
- N*-(4-aminocarbonylbenzenesulfonyl)-L-prolyl-L-4-(*N,N*-dimethylcarbamyloxy)phenylalanine
- 30 *N*-(4-aminocarbonylbenzenesulfonyl)-L-prolyl-L-4-(thiomorpholin-4-ylcarbonyloxy)phenylalanine
- N*-(4-amidinobenzenesulfonyl)-L-prolyl-L-4-(thiomorpholin-4-ylcarbonyloxy)phenylalanine
- 35 *N*-(4-nitrobenzenesulfonyl)-L-prolyl-L-4-(4-(2-pyridyl)piperazin-1-ylcarbonyloxy)]phenylalanine
- N*-(4-fluorobenzenesulfonyl)-L-(5,5-dimethyl)thiaprolyl-L-3-chloro-4-(4-(2-pyridyl)piperazin-1-ylcarbonyloxy)]phenylalanine ethyl ester
- 40 *N*-(4-fluorobenzenesulfonyl)-L-(5,5-dimethyl)thiaprolyl-L-3-chloro-4-(4-(2-pyridyl)piperazin-1-ylcarbonyloxy)phenylalanine
- 45

- N*-(4-fluorobenzenesulfonyl)thiazolidinyl-2-carbonyl-L-4-(4-methylhomopiperazin-1-ylcarbonyloxy)phenylalanine
- 5 *N*-(1-methylpyrazole-3-sulfonyl)-L-(5,5-dimethyl)thiaprolyl-L-3-chloro-4-(*N,N*-dimethylcarbamyloxy)phenylalanine isopropyl ester
- N*-(1-methylimidazole-4-sulfonyl)-L-prolyl-L-4-(4-(2-pyridyl)piperazin-1-ylcarbonyloxy)phenylalanine isopropyl ester
- 10 *N*-(1-methylimidazole-4-sulfonyl)-L-prolyl-L-4-(4-(2-pyridyl)piperazin-1-ylcarbonyloxy)phenylalanine *tert*-butyl ester
- N*-(toluene-4-sulfonyl)-L-prolyl-L-4-(4-(2-pyridyl)piperazin-1-ylcarbonyloxy)phenylalanine
- 15 *N*-(toluene-4-sulfonyl)-L-prolyl-L-4-(4-(2-pyridyl)piperazin-1-ylcarbonyloxy)phenylalanine *tert*-butyl ester
- N*-(toluene-4-sulfonyl)-L-prolyl-L-4-(4-(2-pyridyl)piperazin-1-ylcarbonyloxy)phenylalanine isopropyl ester
- 20 *N*-(4-fluorobenzenesulfonyl)-L-prolyl-L-4-(4-(2-pyridyl)piperazin-1-ylcarbonyloxy)phenylalanine isopropyl ester
- N*-(4-fluorobenzenesulfonyl)-L-prolyl-L-4-(4-(2-pyridyl)piperazin-1-ylcarbonyloxy)phenylalanine *tert*-butyl ester
- 25 *N*-(4-fluorobenzenesulfonyl)-L-prolyl-L-4-(4-(2-pyridyl)piperazin-1-ylcarbonyloxy)phenylalanine *tert*-butyl ester
- N*-(toluene-4-sulfonyl)-L-(1-methanesulfonylpyrazin-3-carbonyl)-L-4-(*N,N*-dimethylcarbamyloxy)phenylalanine
- 30 *N*-(toluene-4-sulfonyl)-L-4-(methanesulfonyloxy)prolyl-L-4-(*N,N*-dimethylcarbamyloxy)phenylalanine
- N*-(methanesulfonyl)-*N*-benzylglycinyll-L-4-(*N,N*-dimethylcarbamyloxy)phenylalanine *tert*-butyl ester
- 35 *N*-(4-bromobenzenesulfonyl)-L-(5,5-dimethyl)thiaprolyl-L-4-(4-(2-pyridyl)piperazin-1-ylcarbonyloxy)phenylalanine *tert*-butyl ester
- N*-(4-trifluoromethoxybenzenesulfonyl)-L-(5,5-dimethyl)thiaprolyl-L-4-(*N,N*-dimethylcarbamyloxy)phenylalanine
- 40 *N*-(4-trifluoromethoxybenzenesulfonyl)-L-(5,5-dimethyl)thiaprolyl-L-4-(*N,N*-dimethylcarbamyloxy)phenylalanine *tert*-butyl ester
- 45

- N*-(4-trifluoromethoxybenzenesulfonyl)-*L*-(5,5-dimethyl)thiaprolyl-*L*-4-(4-(2-pyridyl)piperazin-1-ylcarbonyloxy)phenylalanine *tert*-butyl ester
- 5 *N*-(4-fluorobenzenesulfonyl)-*L*-prolyl-*L*-4-(4-(2-pyridyl)piperazin-1-ylcarbonyloxy)phenylalanine
- N*-(4-fluorobenzenesulfonyl)-*L*-(4-hydroxy)prolyl-*L*-4-(4-(2-pyridyl)piperazin-1-ylcarbonyloxy)phenylalanine
- 10 *N*-(4-trifluoromethoxybenzenesulfonyl)-*L*-(5,5-dimethyl)thiaprolyl-*L*-4-(4-(2-pyridyl)piperazin-1-ylcarbonyloxy)phenylalanine
- N*-(1-methylimidazole-4-sulfonyl)-*L*-prolyl-*L*-3-chloro-4-(*N,N*-dimethylcarbamyloxy)phenylalanine
- 15 *N*-(1-methylimidazole-4-sulfonyl)-*L*-prolyl-*L*-3-chloro-4-(*N,N*-dimethylcarbamyloxy)phenylalanine isopropyl ester
- N*-(1-methylimidazole-4-sulfonyl)-*L*-prolyl-*L*-4-(4-(2-pyridyl)piperazin-1-ylcarbonyloxy)phenylalanine
- 20 *N*-(1-methylimidazole-4-sulfonyl)-*L*-(5,5-dimethyl)thiaprolyl-*L*-4-(4-(2-pyridyl)piperazin-1-ylcarbonyloxy)phenylalanine
- N*-(1-methylpyrazole-3-sulfonyl)-*L*-prolyl-*L*-4-(4-(2-pyridyl)piperazin-1-ylcarbonyloxy)phenylalanine
- 25 *N*-(1-methylpyrazole-3-sulfonyl)-*L*-prolyl-*L*-4-(4-(2-pyridyl)piperazin-1-ylcarbonyloxy)phenylalanine isopropyl ester
- 30 *N*-(1-methylpyrazole-3-sulfonyl)-*L*-prolyl-*L*-4-(4-(2-pyridyl)piperazin-1-ylcarbonyloxy)phenylalanine *tert*-butyl ester
- N*-(1-methylpyrazole-3-sulfonyl)-*L*-(5,5-dimethyl)thiaprolyl-*L*-4-(4-(2-pyridyl)piperazin-1-ylcarbonyloxy)phenylalanine *tert*-butyl ester
- 35 *N*-(1-methylimidazole-4-sulfonyl)-*L*-prolyl-*L*-3-chloro-4-(4-(2-pyridyl)piperazin-1-ylcarbonyloxy)phenylalanine isopropyl ester
- N*-(1-methylpyrazole-3-sulfonyl)-*L*-(5,5-dimethyl)thiaprolyl-*L*-4-(*N,N*-dimethylcarbamyloxy)phenylalanine 2-phenoxyethyl ester
- 40 *N*-(1-methylpyrazole-3-sulfonyl)-*L*-(5,5-dimethyl)thiaprolyl-*L*-3-chloro-4-(4-(2-pyridyl)piperazin-1-ylcarbonyloxy)phenylalanine
- 45

N-(1-methylpyrazole-3-sulfonyl)-*L*-(5,5-dimethyl)thiaprolyl-*L*-3-chloro-4-(4-(2-pyridyl)piperazin-1-ylcarbonyloxy)phenylalanine ethyl ester

5 *N*-(3-chloro-1,5-dimethylpyrazole-3-sulfonyl)-*L*-(5,5-dimethyl)thiaprolyl-*L*-3-chloro-4-(4-(5-trifluoromethyl-2-pyridyl)piperazin-1-ylcarbonyloxy)phenylalanine

and pharmaceutically acceptable salts thereof as well as any of the ester compounds recited above wherein one ester is replaced with another ester selected from the group consisting of methyl ester, ethyl ester, *n*-propyl ester, isopropyl ester, *n*-butyl ester, isobutyl ester, *sec*-butyl ester, *tert*-butyl ester and neopentyl ester.

More preferred compounds within the scope of formula I, IA, and IB include by way of example:

15

N-(toluene-4-sulfonyl)-*L*-prolyl-*L*-4-(4-methylpiperazin-1-ylcarbonyloxy)phenylalanine ethyl ester

20

N-(toluene-4-sulfonyl)-*L*-prolyl-*L*-4-(*N,N*-dimethylcarbamyloxy)phenylalanine ethyl ester

N-(toluene-4-sulfonyl)-*L*-prolyl-*L*-4-(4-methylpiperazin-1-ylcarbonyloxy)phenylalanine isopropyl ester

25

N-(toluene-4-sulfonyl)-*L*-prolyl-*L*-4-(4-methylpiperazin-1-ylcarbonyloxy)phenylalanine *n*-butyl ester

N-(toluene-4-sulfonyl)-*L*-prolyl-*L*-4-(4-methylpiperazin-1-ylcarbonyloxy)phenylalanine cyclopentyl ester

30

N-(toluene-4-sulfonyl)-*L*-prolyl-*L*-4-(4-methylpiperazin-1-ylcarbonyloxy)phenylalanine *tert*-butyl ester

35

N-(toluene-4-sulfonyl)-*L*-prolyl-*L*-4-(4-methylpiperazin-1-ylcarbonyloxy)phenylalanine

N-(toluene-4-sulfonyl)-*L*-prolyl-*L*-4-(*N,N*-dimethylcarbamyloxy)phenylalanine isopropyl ester

40

N-(toluene-4-sulfonyl)-*L*-prolyl-*L*-4-(*N,N*-dimethylcarbamyloxy)phenylalanine *n*-butyl ester

- N*-(toluene-4-sulfonyl)-*L*-prolyl-*L*-4-(*N,N*-dimethylcarbamyloxy)phenylalanine cyclopentyl ester
- 5 *N*-(toluene-4-sulfonyl)-*L*-prolyl-*L*-4-(*N,N*-dimethylcarbamyloxy)phenylalanine *tert*-butyl ester
- N*-(toluene-4-sulfonyl)-*L*-prolyl-*L*-4-(*N,N*-dimethylcarbamyloxy)phenylalanine
- 10 *N*-(toluene-4-sulfonyl)-*L*-prolyl-*L*-4-(isonipecotoxy)phenylalanine ethyl ester
- N*-(α -toluenesulfonyl)-*L*-prolyl-*L*-4-(*N*-methylisonipecotoxy)phenylalanine ethyl ester
- 15 *N*-(α -toluenesulfonyl)-*L*-prolyl-*L*-4-(4-methylpiperazin-1-ylcarbonyloxy)phenylalanine
- N*-(toluene-4-sulfonyl)-*L*-prolyl-*L*-3-(*N,N*-dimethylcarbamyloxy)phenylalanine ethyl ester
- 20 *N*-(toluene-4-sulfonyl)-*L*-prolyl-*L*-4-(1-*tert*-butylcarbonyloxy-4-phenylpiperidin-4-ylcarbonyloxy)phenylalanine ethyl ester
- 25 *N*-(toluene-4-sulfonyl)-*L*-(5,5-dimethyl)thiaprolyl-*L*-4-(*N,N*-dimethylcarbamyloxy)phenylalanine isopropyl ester
- N*-(toluene-4-sulfonyl)-*L*-(5,5-dimethyl)thiaprolyl-*L*-4-(*N,N*-dimethylcarbamyloxy)phenylalanine *tert*-butyl ester
- 30 *N*-(toluene-4-sulfonyl)-*L*-(5,5-dimethyl)thiaprolyl-*L*-4-(*N,N*-dimethylcarbamyloxy)phenylalanine
- N*-(toluene-4-sulfonyl)-*L*-[(1,1-dioxo)thiamorpholin-3-carbonyl]-*L*-4-(*N,N*-dimethylcarbamyloxy)phenylalanine *tert*-butyl ester
- 35 *N*-(toluene-4-sulfonyl)-*L*-[(1,1-dioxo)thiamorpholin-3-carbonyl]-*L*-4-(*N,N*-dimethylcarbamyloxy)phenylalanine
- 40 *N*-(toluene-4-sulfonyl)-*L*-(5,5-dimethyl)thiaprolyl-*L*-4-(4-methylpiperazin-1-ylcarbonyloxy)phenylalanine *tert*-butyl ester
- N*-(toluene-4-sulfonyl)-*L*-(5,5-dimethyl)thiaprolyl-*L*-4-(4-methylpiperazin-1-ylcarbonyloxy)phenylalanine
- 45

- N*-(toluene-4-sulfonyl)sarcosyl-L-4-(*N,N*-dimethylcarbamyloxy)phenylalanine isopropyl ester
- 5 *N*-(toluene-4-sulfonyl)sarcosyl-L-4-(*N,N*-dimethylcarbamyloxy)phenylalanine *tert*-butyl ester
- N*-(toluene-4-sulfonyl)sarcosyl-L-4-(*N,N*-dimethylcarbamyloxy)phenylalanine
- 10 *N*-(1-methylimidazole-4-sulfonyl)-L-prolyl-L-4-(*N,N*-dimethylcarbamyloxy)phenylalanine *tert*-butyl ester
- N*-(4-aminobenzenesulfonyl)-L-prolyl-L-4-(*N,N*-dimethylcarbamyloxy)phenylalanine *tert*-butyl ester
- 15 *N*-(toluene-4-sulfonyl)sarcosyl-L-4-(morpholin-4-ylcarbonyloxy)phenylalanine *tert*-butyl ester
- N*-(toluene-4-sulfonyl)-L-prolyl-L-4-(morpholin-4-ylcarbonyloxy)phenylalanine *tert*-butyl ester
- 20 *N*-(α -toluenesulfonyl)-L-(5,5-dimethyl)thiaprolyl-L-4-(*N,N*-dimethylcarbamyloxy)phenylalanine
- N*-(toluene-4-sulfonyl)-L-(piperazin-2-carbonyl)-L-4-(*N,N*-dimethylcarbamyloxy)phenylalanine
- 25 *N*-(α -toluenesulfonyl)-L-(5,5-dimethyl)thiaprolyl-L-4-(*N,N*-dimethylcarbamyloxy)phenylalanine *tert*-butyl ester
- 30 *N*-(toluene-4-sulfonyl)-L-(piperazin-2-carbonyl)-L-4-(*N,N*-dimethylcarbamyloxy)phenylalanine *tert*-butyl ester
- N*-(toluene-4-sulfonyl)-L-(4-benzyloxycarbonylpiperazin-2-carbonyl)-L-4-(*N,N*-dimethylcarbamyloxy)phenylalanine *tert*-butyl ester
- 35 *N*-(toluene-4-sulfonyl)sarcosyl-L-4-(isonipecotoyloxy)phenylalanine
- N*-(toluene-4-sulfonyl)-L-[(1,1-dioxo)thiamorpholin-3-carbonyl]-L-4-(morpholin-4-ylcarbonyloxy)phenylalanine *tert*-butyl ester
- 40 *N*-(toluene-4-sulfonyl)-L-[(1,1-dioxo)thiamorpholin-3-carbonyl]-L-4-(morpholin-4-ylcarbonyloxy)phenylalanine
- N*-(1-methylpyrazole-4-sulfonyl)-L-prolyl-L-4-(*N,N*-dimethylcarbamyloxy)phenylalanine *tert*-butyl ester
- 45

- N*-(4-fluorobenzenesulfonyl)-L-prolyl-L-4-(*N,N*-dimethylcarbamyloxy)phenylalanine *tert*-butyl ester
- 5 *N*-(toluene-4-sulfonyl)sarcosyl-L-4-(4-methylpiperazin-1-ylcarbonyloxy)phenylalanine *tert*-butyl ester
- N*-(toluene-4-sulfonyl)-L-(1,1-dioxo-5,5-dimethyl)thiaprolyl-L-4-(*N,N*-dimethylcarbamyloxy)phenylalanine *tert*-butyl ester
- 10 *N*-(1-methylimidazole-4-sulfonyl)-L-prolyl-L-4-(*N,N*-dimethylcarbamyloxy)phenylalanine
- N*-(toluene-4-sulfonyl)-L-(1,1-dioxo-5,5-dimethyl)thiaprolyl-L-4-(*N,N*-dimethylcarbamyloxy)phenylalanine
- 15 *N*-(4-fluorobenzenesulfonyl)-L-prolyl-L-4-(*N,N*-dimethylcarbamyloxy)phenylalanine
- N*-(pyridine-3-sulfonyl)-L-prolyl-L-4-(*N,N*-dimethylcarbamyloxy)phenylalanine
- 20 *N*-(toluene-4-sulfonyl)-D-prolyl-L-4-(4-methylpiperazin-1-ylcarbonyloxy)phenylalanine *tert*-butyl ester
- 25 *N*-(toluene-4-sulfonyl)-L-*N*-methylalanyl-L-4-(4-methylpiperazin-1-ylcarbonyloxy)phenylalanine *tert*-butyl ester
- N*-(4-nitrobenzenesulfonyl)-L-prolyl-L-4-(*N,N*-dimethylcarbamyloxy)phenylalanine *tert*-butyl ester
- 30 *N*-(toluene-4-sulfonyl)sarcosyl-L-4-(thiomorpholin-4-ylcarbonyloxy)phenylalanine *tert*-butyl ester
- N*-(toluene-4-sulfonyl)-L-*N*-methylalanyl-L-4-(4-methylpiperazin-1-ylcarbonyloxy)phenylalanine
- 35 *N*-(toluene-4-sulfonyl)-L-prolyl-L-4-(1,1-dioxothiomorpholin-4-ylcarbonyloxy)phenylalanine
- 40 *N*-(toluene-4-sulfonyl)-L-prolyl-L-4-(thiomorpholin-4-ylcarbonyloxy)phenylalanine
- N*-(toluene-4-sulfonyl)-L-prolyl-L-4-(isonipecotoyloxy)phenylalanine
- 45

- N*-(toluene-4-sulfonyl)-*L*-prolyl-*L*-4-(pyrrolidin-1-ylcarbonyloxy)phenylalanine
- 5 *N*-(toluene-4-sulfonyl)-*L*-prolyl-*L*-4-(morpholin-4-ylcarbonyloxy)phenylalanine
- N*-(toluene-4-sulfonyl)-*L*-prolyl-*L*-4-(4-methylpiperazin-1-ylcarbonyloxy)phenylalanine neopentyl ester
- 10 *N*-(toluene-4-sulfonyl)-*L*-prolyl-*L*-4-(*N,N*-dimethylcarbamyloxy)phenylalanine neopentyl ester
- N*-(toluene-4-sulfonyl)-*L*-prolyl-*L*-4-(4-*tert*-butyloxycarbonylpiperazin-1-ylcarbonyloxy)phenylalanine ethyl ester
- 15 *N*-(toluene-4-sulfonyl)-*L*-prolyl-*L*-4-(morpholin-4-ylcarbonyloxy)phenylalanine ethyl ester
- N*-(toluene-4-sulfonyl)sarcosyl-*L*-4-(1,1-dioxothiomorpholin-4-ylcarbonyloxy)phenylalanine *tert*-butyl ester
- 20 *N*-(toluene-4-sulfonyl)sarcosyl-*L*-4-(thiomorpholin-4-ylcarbonyloxy)phenylalanine
- N*-(toluene-4-sulfonyl)-*L-N*-methylalanyl-*L*-4-(*N,N*-dimethylcarbamyloxy)phenylalanine *tert*-butyl ester
- 25 *N*-(toluene-4-sulfonyl)-*L*-(thiamorpholin-3-carbonyl)-*L*-4-(*N,N*-dimethylcarbamyloxy)phenylalanine *tert*-butyl ester
- 30 *N*-(toluene-4-sulfonyl)sarcosyl-*L*-4-(1,1-dioxothiomorpholin-4-ylcarbonyloxy)phenylalanine
- N*-(toluene-4-sulfonyl)-*L*-(1,1-dioxothiamorpholin-3-carbonyl)-*L*-4-(*N,N*-dimethylcarbamyloxy)phenylalanine *tert*-butyl ester
- 35 *N*-(toluene-4-sulfonyl)-*L*-(1,1-dioxothiamorpholin-3-carbonyl)-*L*-4-(morpholin-4-ylcarbonyloxy)phenylalanine *tert*-butyl ester
- N*-(toluene-4-sulfonyl)-*L-N*-methylalanyl-*L*-4-(*N,N*-dimethylcarbamyloxy)phenylalanine
- 40 *N*-(4-fluorobenzenesulfonyl)-*L*-(thiamorpholin-3-carbonyl)-*L*-4-(*N,N*-dimethylcarbamyloxy)phenylalanine *tert*-butyl ester
- 45

- N*-(4-fluorobenzenesulfonyl)-*L*-(1,1-dioxothiomorpholin-3-carbonyl)-*L*-4-(*N,N*-dimethylcarbamyloxy)phenylalanine *tert*-butyl ester
- 5 *N*-(pyridine-3-sulfonyl)-*L*-prolyl-*L*-4-(*N,N*-dimethylcarbamyloxy)phenylalanine *tert*-butyl ester
- N*-(pyrimidine-2-sulfonyl)-*L*-prolyl-*L*-4-(*N,N*-dimethylcarbamyloxy)phenylalanine *tert*-butyl ester
- 10 *N*-(4-nitrobenzenesulfonyl)-*L*-prolyl-*L*-4-(*N,N*-dimethylcarbamyloxy)phenylalanine
- N*-(4-cyanobenzenesulfonyl)-*L*-prolyl-*L*-4-(*N,N*-dimethylcarbamyloxy)phenylalanine *tert*-butyl ester
- 15 *N*-(toluene-4-sulfonyl)-*L*-(1,1-dioxothiomorpholin-3-carbonyl)-*L*-4-(*N,N*-dimethylcarbamyloxy)phenylalanine
- N*-(toluene-4-sulfonyl)-*L*-(1,1-dioxo)thiaprolyl-*L*-4-(*N,N*-dimethylcarbamyloxy)phenylalanine *tert*-butyl ester
- 20 *N*-(toluene-4-sulfonyl)-*L*-(1,1-dioxo)thiaprolyl-*L*-4-(*N,N*-dimethylcarbamyloxy)phenylalanine *tert*-butyl ester
- N*-(4-fluorobenzenesulfonyl)-*L*-prolyl-*L*-4-(*N,N*-dimethylcarbamyloxy)phenylalanine *tert*-butyl ester
- 25 *N*-(1-methylpyrazole-4-sulfonyl)-*L*-prolyl-*L*-4-(*N,N*-dimethylcarbamyloxy)phenylalanine
- N*-(toluene-4-sulfonyl)-*L*-(1,1-dioxo)thiaprolyl-*L*-4-(*N,N*-dimethylcarbamyloxy)phenylalanine
- 30 *N*-(4-fluorobenzenesulfonyl)-*L*-thiaprolyl-*L*-4-(*N,N*-dimethylcarbamyloxy)phenylalanine
- N*-(toluene-4-sulfonyl)-*L*-prolyl-*L*-4-(piperazin-1-ylcarbonyloxy)phenylalanine
- 35 *N*-(toluene-4-sulfonyl)-*L*-prolyl-*L*-4-(1-*tert*-butyloxycarbonylpiperazin-1-ylcarbonyloxy)phenylalanine *tert*-butyl ester
- N*-(toluene-4-sulfonyl)-*L*-prolyl-*L*-4-(piperazin-1-ylcarbonyloxy)phenylalanine ethyl ester
- 40 *N*-(toluene-4-sulfonyl)-*L*-prolyl-*L*-4-(4-acetylpiperazin-1-ylcarbonyloxy)phenylalanine ethyl ester
- 45

- N*-(toluene-4-sulfonyl)-*L*-prolyl-*L*-4-(4-methanesulfonylpiperazin-1-ylcarbonyloxy)phenylalanine ethyl ester
- 5 *N*-(toluene-4-sulfonyl)-*L*-prolyl-*L*-4-(morpholin-4-ylcarbonyloxy)-3-nitrophenylalanine
- N*-(toluene-4-sulfonyl)-*L*-prolyl-*L*-4-(1-*tert*-butyloxycarbonylpiperazin-1-ylcarbonyloxy)phenylalanine
- 10 *N*-(toluene-4-sulfonyl)-*L*-*N*-methyl-2-(*tert*-butyl)glycinyll-*L*-4-(4-methylpiperazin-1-ylcarbonyloxy)phenylalanine *tert*-butyl ester
- N*-(4-fluorobenzenesulfonyl)-*L*-(5,5-dimethyl)thiaprolyl-*L*-4-(*N,N*-dimethylcarbamyloxy)phenylalanine *tert*-butyl ester
- 15 *N*-(4-fluorobenzenesulfonyl)-*L*-(1,1-dioxothiamorpholin-3-carbonyl)-*L*-4-(1,1-dioxothiomorpholin-4-ylcarbonyloxy)phenylalanine *tert*-butyl ester
- N*-(toluene-4-sulfonyl)-*L*-(1,1-dioxothiamorpholin-3-carbonyl)-*L*-4-(1,1-dioxothiomorpholin-4-ylcarbonyloxy)phenylalanine *tert*-butyl ester
- 20 *N*-(4-fluorobenzenesulfonyl)-*L*-prolyl-*L*-4-(1,1-dioxothiomorpholin-4-ylcarbonyloxy)phenylalanine *tert*-butyl ester
- N*-(4-fluorobenzenesulfonyl)-*L*-prolyl-*L*-4-(thiomorpholin-4-ylcarbonyloxy)phenylalanine *tert*-butyl ester
- 25 *N*-(4-fluorobenzenesulfonyl)-*L*-prolyl-*L*-4-(morpholin-4-ylcarbonyloxy)phenylalanine *tert*-butyl ester
- 30 *N*-(4-fluorobenzenesulfonyl)-*L*-(5,5-dimethyl)thiaprolyl-*L*-4-(*N,N*-dimethylcarbamyloxy)phenylalanine
- N*-(4-fluorobenzenesulfonyl)-*L*-(1,1-dioxothiamorpholin-3-carbonyl)-*L*-4-(morpholin-4-ylcarbonyloxy)phenylalanine *tert*-butyl ester
- 35 *N*-(4-trifluoromethoxybenzenesulfonyl)-*L*-prolyl-*L*-4-(*N,N*-dimethylcarbamyloxy)phenylalanine *tert*-butyl ester
- N*-(toluene-4-sulfonyl)-*L*-(1,1-dioxothiamorpholin-3-carbonyl)-*L*-4-(*N,N*-dimethylcarbamyloxy)phenylalanine isopropyl ester
- 40 3-[*N*-(toluene-4-sulfonyl)-*N*-methylamino]-1-[1-*tert*-butyloxycarbonyl-2-(*N,N*-dimethylcarbamyloxy)phenylethyl]azetid-2-one
- 45

- 5 *N*-(4-fluorobenzenesulfonyl)-L-(1,1-dioxo-5,5-dimethyl)thiaprolyl-L-4-(*N,N*-dimethylcarbamyloxy)phenylalanine *tert*-butyl ester
N-(toluene-4-sulfonyl)-L-(1,1-dioxo-5,5-dimethyl)thiaprolyl-L-4-(*N,N*-dimethylcarbamyloxy)phenylalanine isopropyl ester
N-(toluene-4-sulfonyl)-L-(1,1-dioxothiomorpholin-3-carbonyl)-L-4-(morpholin-4-ylcarbonyloxy)phenylalanine
 10 *N*-(4-fluorobenzenesulfonyl)-L-(5,5-dimethyl)thiaprolyl-L-4-(*N,N*-dimethylcarbamyloxy)phenylalanine
N-(pyrimidine-2-sulfonyl)-L-prolyl-L-4-(*N,N*-dimethylcarbamyloxy)phenylalanine
 15 *N*-(toluene-4-sulfonyl)-L-(1,1-dioxothiomorpholin-3-carbonyl)-L-4-(4-methylpiperazin-1-ylcarbonyloxy)phenylalanine *tert*-butyl ester
 20 3-[*N*-(toluene-4-sulfonyl)-*N*-methylamino]-1-[1-carboxy-2-(*N,N*-dimethylcarbamyloxy)phenylethyl]azetidin-2-one
N-(1-methylpyrazole-4-sulfonyl)-L-prolyl-L-4-(4-methylpiperazin-1-ylcarbonyloxy)phenylalanine *tert*-butyl ester
 25 *N*-(4-fluorobenzenesulfonyl)-L-(1,1-dioxo)thiaprolyl-L-4-(*N,N*-dimethylcarbamyloxy)phenylalanine
N-(toluene-4-sulfonyl)-L-prolyl-L-4-(isonipecotoxyloxy)phenylalanine *tert*-butyl ester
 30 *N*-(toluene-4-sulfonyl)-L-prolyl-L-4-(1,1-dioxothiomorpholin-4-ylcarbonyloxy)phenylalanine *tert*-butyl ester
N-(toluene-4-sulfonyl)-L-prolyl-L-4-(thiomorpholin-4-ylcarbonyloxy)phenylalanine *tert*-butyl ester
 35 *N*-(toluene-4-sulfonyl)-L-prolyl-L-4-(pyrrolidin-1-ylcarbonyloxy)phenylalanine *tert*-butyl ester
 40 *N*-(4-fluorobenzenesulfonyl)-L-thiaprolyl-L-4-(*N,N*-dimethylcarbamyloxy)phenylalanine *tert*-butyl ester
N-(4-fluorobenzenesulfonyl)-L-(1,1-dioxo)thiaprolyl-L-4-(*N,N*-dimethylcarbamyloxy)phenylalanine *tert*-butyl ester
 45

- N*-(2,5-dichlorothiophene-3-sulfonyl)-L-prolyl-L-4-(*N,N*-dimethylcarbamoyloxy)phenylalanine *tert*-butyl ester
- 5 *N*-(4-acetamidobenzenesulfonyl)-L-prolyl-L-4-(*N,N*-dimethylcarbamoyloxy)phenylalanine *tert*-butyl ester
- N*-(4-*tert*-butylbenzenesulfonyl)-L-(1,1-dioxothiamorpholin-3-carbonyl)-L-4-(*N,N*-dimethylcarbamoyloxy)phenylalanine *tert*-butyl ester
- 10 *N*-(pyridine-2-sulfonyl)-L-prolyl-L-4-(*N,N*-dimethylcarbamoyloxy)phenylalanine
- N*-(2-fluorobenzenesulfonyl)-L-(1,1-dioxothiamorpholin-3-carbonyl)-L-4-(*N,N*-dimethylcarbamoyloxy)phenylalanine *tert*-butyl ester
- 15 *N*-(3-fluorobenzenesulfonyl)-L-(1,1-dioxothiamorpholin-3-carbonyl)-L-4-(*N,N*-dimethylcarbamoyloxy)phenylalanine *tert*-butyl ester
- N*-(2,4-difluorobenzenesulfonyl)-L-(1,1-dioxothiamorpholin-3-carbonyl)-L-4-(*N,N*-dimethylcarbamoyloxy)phenylalanine *tert*-butyl ester
- 20 *N*-(4-acetamidobenzenesulfonyl)-L-prolyl-L-4-(*N,N*-dimethylcarbamoyloxy)phenylalanine
- N*-(4-trifluoromethoxybenzenesulfonyl)-L-prolyl-L-4-(*N,N*-dimethylcarbamoyloxy)phenylalanine
- 25 *N*-(4-fluorobenzenesulfonyl)-L-(5,5-dimethyl)thiaprolyl-L-4-(*N,N*-dimethylcarbamoyloxy)phenylalanine *tert*-butyl ester
- 30 *N*-(4-cyanobenzenesulfonyl)-L-prolyl-L-4-(*N,N*-dimethylcarbamoyloxy)phenylalanine
- N*-(toluene-4-sulfonyl)-L-(3,3-dimethyl)prolyl-L-4-(*N,N*-dimethylcarbamoyloxy)phenylalanine *tert*-butyl ester
- 35 *N*-(toluene-4-sulfonyl)-L-(3,3-dimethyl)prolyl-L-4-(*N,N*-dimethylcarbamoyloxy)phenylalanine isopropyl ester
- N*-(1-methylpyrazole-4-sulfonyl)-L-prolyl-L-4-(*N,N*-dimethylcarbamoyloxy)phenylalanine *iso*-propyl ester
- 40 *N*-(1-methylpyrazole-4-sulfonyl)-L-(5,5-dimethyl)thiaprolyl-L-4-(*N,N*-dimethylcarbamoyloxy)phenylalanine *tert*-butyl ester
- 45

- N-(1-methylpyrazole-4-sulfonyl)-L-(5,5-dimethyl)thiaprolyl-L-4-(N,N-dimethylcarbamyloxy)phenylalanine
- 5 N-(toluene-4-sulfonyl)-L-prolyl-L-4-(N-(1,4-dioxo-8-aza-spiro[4.5]decan-8-yl)carbonyloxy)phenylalanine ethyl ester
- N-(toluene-4-sulfonyl)-L-prolyl-L-4-(N-(1,4-dioxo-8-aza-spiro[4.5]decan-8-yl)carbonyloxy)phenylalanine
- 10 N-(toluene-4-sulfonyl)-L-prolyl-L-4-(4'-acetylpiperazin-1-ylcarbonyloxy)phenylalanine
- N-(toluene-4-sulfonyl)-L-prolyl-L-4-(4'-methanesulfonylpiperazin-1-ylcarbonyloxy)phenylalanine
- 15 N-(toluene-4-sulfonyl)-L-prolyl-L-4-(4'-phenylpiperazin-1-ylcarbonyloxy)phenylalanine
- N-(toluene-4-sulfonyl)-L-prolyl-L-4-(piperazin-1-ylcarbonyloxy)phenylalanine *tert*-butyl ester
- 20 N-(toluene-4-sulfonyl)-L-prolyl-L-4-(4'-methanesulfonylpiperazin-1-ylcarbonyloxy)phenylalanine *tert*-butyl ester
- 25 N-(toluene-4-sulfonyl)-L-prolyl-L-4-(N,N-dimethylcarbamyloxy)phenylalanine (N'-*tert*-butoxycarbonyl-2-amino-2-methylpropyl) ester
- 30 N-(toluene-4-sulfonyl)-L-prolyl-L-4-(4'-acetylpiperazin-1-ylcarbonyloxy)phenylalanine *tert*-butyl ester
- N-(toluene-4-sulfonyl)-L-prolyl-L-4-(4'-hydroxypiperidin-1-ylcarbonyloxy)phenylalanine *tert*-butyl ester
- 35 N-(toluene-4-sulfonyl)-L-prolyl-L-4-(N-(2'-(morpholin-4'-yl)ethyl)carbamyloxy)phenylalanine *tert*-butyl ester
- N-(toluene-4-sulfonyl)-L-prolyl-L-4-(N-(1,4-dioxo-8-aza-spiro[4.5]decan-8-yl)carbonyloxy)phenylalanine *tert*-butyl ester
- 40 N-(toluene-4-sulfonyl)-L-prolyl-L-4-(N-(2'-hydroxyethyl)-N-methylcarbamyloxy)phenylalanine *tert*-butyl ester
- 45 N-(toluene-4-sulfonyl)-L-prolyl-L-4-(4'-(2-hydroxyethyl)piperazin-1-ylcarbonyloxy)-L-phenylalanine *tert*-butyl ester

- N-(toluene-4-sulfonyl)-L-prolyl-L-4-(N-(2'-formyloxyethyl)-N-methylcarbamyloxy)phenylalanine
- 5 N-(toluene-4-sulfonyl)-L-prolyl-L-4-(N-(2'-hydroxyethyl)-N-methylcarbamyloxy)phenylalanine isopropyl ester
- N-(toluene-4-sulfonyl)-L-prolyl-L-4-(N-(methoxycarbonylmethyl)carbamyloxy)phenylalanine *tert*-butyl ester
- 10 N-(1-methylpyrazole-4-sulfonyl)-L-(5,5-dimethyl)thiaprolyl-L-(4-N,N-dimethylcarbamyloxy)phenylalanine isopropyl ester
- N-(toluene-4-sulfonyl)-L-prolyl-L-4-(4'-methoxypiperidin-1-ylcarbonyloxy)phenylalanine isopropyl ester
- 15 N-(toluene-4-sulfonyl)-L-prolyl-L-4-(4'-methoxypiperidin-1-ylcarbonyloxy)phenylalanine
- N-(toluene-4-sulfonyl)-L-4-oxoprolyl-L-4-(N,N-dimethylcarbamyloxy)phenylalanine *tert*-butyl ester
- 20 N-(toluene-4-sulfonyl)-L-*trans*-4-hydroxyprolyl-L-4-(N,N-dimethylcarbamyloxy)phenylalanine *tert*-butyl ester
- 25 N-(3-fluorobenzenesulfonyl)-L-prolyl-L-4-(N,N-dimethylcarbamyloxy)phenylalanine *tert*-butyl ester
- N-(morpholino-sulfonyl)-L-prolyl-L-(4-N,N-dimethylcarbamyloxy)phenylalanine *tert*-butyl ester
- 30 N-(morpholino-sulfonyl)-L-prolyl-L-(4-N,N-dimethylcarbamyloxy)phenylalanine
- N-(1-methylpyrazole-4-sulfonyl)-L-(1,1-dioxothiamorpholin-3-carbonyl)-L-4-(N,N-dimethylcarbamyloxy)phenylalanine *tert*-butyl ester
- 35 N-(2-fluorobenzenesulfonyl)-L-(1,1-dioxothiamorpholin-3-carbonyl)-L-4-(N,N-dimethylcarbamyloxy)phenylalanine
- 40 N-(2,4-difluorobenzenesulfonyl)-L-(1,1-dioxothiamorpholin-3-carbonyl)-L-4-(N,N-dimethylcarbamyloxy)phenylalanine
- N-(toluene-4-sulfonyl)-L-(thiamorpholin-3-carbonyl)-L-4-(N,N-dimethylcarbamyloxy)phenylalanine
- 45

- N*-(pyridine-3-sulfonyl)-L-(5,5-dimethyl-thiaprolyl-L-4-(*N,N*-dimethylcarbamyloxy)phenylalanine isopropyl ester
- 5 *N*-(3-fluorobenzenesulfonyl)-L-(1,1-dioxothiamorpholin-3-carbonyl)-L-4-(*N,N*-dimethylcarbamyloxy)phenylalanine
- N*-(1-methylpyrazole-4-sulfonyl)-L-(1,1-dioxothiamorpholin-3-carbonyl)-L-4-(*N,N*-dimethylcarbamyloxy)phenylalanine
- 10 *N*-(4-*tert*-butylbenzenesulfonyl)-L-(1,1-dioxothiamorpholin-3-carbonyl)-L-4-(*N,N*-dimethylcarbamyloxy)phenylalanine
- N*-(toluene-4-sulfonyl)-(3,3-dimethyl)prolyl-L-4-(*N,N*-dimethylcarbamyloxy)phenylalanine
- 15 *N*-(2,5-dichlorothiophene-3-sulfonyl)-L-prolyl-L-4-(*N,N*-dimethylcarbamyloxy)phenylalanine
- N*-(4-methoxybenzenesulfonyl)-L-prolyl-L-4-(*N,N*-dimethylcarbamyloxy)phenylalanine
- 20 *N*-(4-methoxybenzenesulfonyl)-L-prolyl-L-4-(*N,N*-dimethylcarbamyloxy)phenylalanine isopropyl ester
- N*-(toluene-4-sulfonyl)-L-(1-oxo-thiomorpholin-3-carbonyl)-L-4-(*N,N*-dimethylcarbamyloxy)phenylalanine
- 25 *N*-(toluene-4-sulfonyl)-L-(1-oxo-thiomorpholin-3-carbonyl)-L-4-(*N,N*-dimethylcarbamyloxy)phenylalanine *tert*-butyl ester
- 30 *N*-(3,4-difluorobenzenesulfonyl)-L-prolyl-4-(*N,N*-dimethylcarbamyloxy)phenylalanine isopropyl ester
- N*-(3,4-difluorobenzenesulfonyl)-L-prolyl-4-(*N,N*-dimethylcarbamyloxy)phenylalanine
- 35 *N*-(3,4-difluorobenzenesulfonyl)-L-(1,1-dioxothiamorpholin-3-carbonyl)-L-4-(*N,N*-dimethylcarbamyloxy)phenylalanine *tert*-butyl ester
- 40 *N*-(3,4-difluorobenzenesulfonyl)-L-(1,1-dioxothiamorpholin-3-carbonyl)-L-4-(*N,N*-dimethylcarbamyloxy)phenylalanine
- N*-(toluene-4-sulfonyl)-L-(5,5-dimethyl)thiaprolyl-L-(thiomorpholin-4-ylcarbonyloxy)phenylalanine *tert*-butyl ester
- 45

- N*-(toluene-4-sulfonyl)-L-(5,5-dimethyl)thiaprolyl-L-(thiomorpholin-4-ylcarbonyloxy)phenylalanine
- 5 *N*-(1-methylpyrazole-4-sulfonyl)-L-(5,5-dimethyl)thiaprolyl-L-4-(*N,N*-dimethylcarbamyloxy)phenylalanine ethyl ester
- N*-(pyridine-3-sulfonyl)-L-(5,5-dimethyl)thiaprolyl-L-4-(*N,N*-dimethylcarbamyloxy)phenylalanine
- 10 *N*-(pyridine-2-sulfonyl)-L-prolyl-L-4-(*N,N*-dimethylcarbamyloxy)phenylalanine isopropyl ester
- N*-(pyridine-2-sulfonyl)-L-prolyl-L-4-(*N,N*-dimethylcarbamyloxy)phenylalanine
- 15 *N*-(pyridine-2-sulfonyl)-L-(5,5-dimethyl)thiaprolyl-L-4-(*N,N*-dimethylcarbamyloxy)phenylalanine isopropyl ester
- N*-(pyridine-2-sulfonyl)-L-(5,5-dimethyl)thiaprolyl-L-4-(*N,N*-dimethylcarbamyloxy)phenylalanine
- 20 *N*-(toluene-4-sulfonyl)-L-(thiomorpholin-3-carbonyl)-L-4-(*N,N*-dimethylcarbamyloxy)phenylalanine isopropyl ester
- N*-(3-fluorobenzenesulfonyl)-L-(5,5-dimethyl)thiaprolyl-L-4-(*N,N*-dimethylcarbamyloxy)phenylalanine isopropyl ester
- 25 *N*-(2-fluorobenzenesulfonyl)-L-(5,5-dimethyl)thiaprolyl-L-4-(*N,N*-dimethylcarbamyloxy)phenylalanine isopropyl ester
- 30 *N*-(3,4-difluorobenzenesulfonyl)-L-(5,5-dimethyl)thiaprolyl-L-4-(*N,N*-dimethylcarbamyloxy)phenylalanine isopropyl ester
- N*-(3,5-difluorobenzenesulfonyl)-L-(5,5-dimethyl)thiaprolyl-L-4-(*N,N*-dimethylcarbamyloxy)phenylalanine isopropyl ester
- 35 *N*-(2,4-difluorobenzenesulfonyl)-L-(5,5-dimethyl)thiaprolyl-L-4-(*N,N*-dimethylcarbamyloxy)phenylalanine isopropyl ester
- N*-(4-chlorobenzenesulfonyl)-L-(5,5-dimethyl)thiaprolyl-L-4-(*N,N*-dimethylcarbamyloxy)phenylalanine isopropyl ester
- 40 *N*-(3-chlorobenzenesulfonyl)-L-(5,5-dimethyl)thiaprolyl-L-4-(*N,N*-dimethylcarbamyloxy)phenylalanine isopropyl ester
- 45

- N*-(2-chlorobenzenesulfonyl)-L-(5,5-dimethyl)thiaprolyl-L-4-(*N,N*-dimethylcarbamyloxy)phenylalanine isopropyl ester
- 5 *N*-(3,4-dichlorobenzenesulfonyl)-L-(5,5-dimethyl)thiaprolyl-L-4-(*N,N*-dimethylcarbamyloxy)phenylalanine isopropyl ester
- N*-(3,5-dichlorobenzenesulfonyl)-L-(5,5-dimethyl)thiaprolyl-L-4-(*N,N*-dimethylcarbamyloxy)phenylalanine isopropyl ester
- 10 *N*-(3-chlorobenzenesulfonyl)-L-(1,1-dioxothiamorpholin-3-carbonyl)-L-4-(*N,N*-dimethylcarbamyloxy)phenylalanine *tert*-butyl ester
- N*-(3,4-dichlorobenzenesulfonyl)-L-(1,1-dioxothiamorpholin-3-carbonyl)-L-4-(*N,N*-dimethylcarbamyloxy)phenylalanine *tert*-butyl ester
- 15 *N*-(4-methoxybenzenesulfonyl)-L-(5,5-dimethyl)thiaprolyl-L-4-(*N,N*-dimethylcarbamyloxy)phenylalanine isopropyl ester
- N*-(3-methoxybenzenesulfonyl)-L-(5,5-dimethyl)thiaprolyl-L-4-(*N,N*-dimethylcarbamyloxy)phenylalanine isopropyl ester
- 20 *N*-(2-methoxybenzenesulfonyl)-L-(5,5-dimethyl)thiaprolyl-L-4-(*N,N*-dimethylcarbamyloxy)phenylalanine isopropyl ester
- N*-(3,4-dimethoxybenzenesulfonyl)-L-(5,5-dimethyl)thiaprolyl-L-4-(*N,N*-dimethylcarbamyloxy)phenylalanine isopropyl ester
- 25 *N*-(2,4-difluorobenzenesulfonyl)-L-(thiamorpholin-3-carbonyl)-L-4-(*N,N*-dimethylcarbamyloxy)phenylalanine isopropyl ester
- 30 *N*-(3,4-dichlorobenzenesulfonyl)-L-(1,1-dioxothiamorpholin-3-carbonyl)-L-4-(*N,N*-dimethylcarbamyloxy)phenylalanine
- N*-(3-chlorobenzenesulfonyl)-L-(1,1-dioxothiamorpholin-3-carbonyl)-L-4-(*N,N*-dimethylcarbamyloxy)phenylalanine
- 35 *N*-(3-chloro-4-fluorobenzenesulfonyl)-L-(1,1-dioxothiamorpholin-3-carbonyl)-L-4-(*N,N*-dimethylcarbamyloxy)phenylalanine *tert*-butyl ester
- N*-(1-methylpyrazole-4-sulfonyl)-L-(thiamorpholin-3-carbonyl)-L-4-(*N,N*-dimethylcarbamyloxy)phenylalanine *tert*-butyl ester
- 40 *N*-(3,4-difluorobenzenesulfonyl)-L-(thiamorpholin-3-carbonyl)-L-4-(*N,N*-dimethylcarbamyloxy)phenylalanine *tert*-butyl ester
- 45

- N*-(toluene-4-sulfonyl)-*L*-(5,5-dimethyl)thiopropyl-*L*-(thiomorpholin-4-ylcarbonyloxy)phenylalanine isopropyl ester
- 5 *N*-(3,4-difluorobenzenesulfonyl)-*L*-(thiomorpholin-3-carbonyl)-*L*-4-(*N,N*-dimethylcarbamyloxy)phenylalanine
- N*-(2,5-dichlorothiophene-3-sulfonyl)-*L*-(5,5-dimethyl)thiopropyl-*L*-4-(*N,N*-dimethylcarbamyloxy)phenylalanine isopropyl ester
- 10 *N*-(1-methylpyrazole-4-sulfonyl)-*L*-(5,5-dimethyl)thiopropyl-*L*-4-(thiomorpholin-4-ylcarbonyloxy)phenylalanine isopropyl ester
- N*-(8-quinolinesulfonyl)-*L*-propyl-*L*-4-(*N,N*-dimethylcarbamyloxy)phenylalanine isopropyl ester
- 15 *N*-(8-quinolinesulfonyl)-*L*-propyl-*L*-4-(*N,N*-dimethylcarbamyloxy)phenylalanine
- N*-(8-quinolinesulfonyl)-*L*-(5,5-dimethyl)thiopropyl-*L*-4-(*N,N*-dimethylcarbamyloxy)phenylalanine isopropyl ester
- 20 *N*-(8-quinolinesulfonyl)-*L*-(5,5-dimethyl)thiopropyl-*L*-4-(*N,N*-dimethylcarbamyloxy)phenylalanine
- N*-(toluene-4-sulfonyl)-*L*-propyl-*L*-4-(4-phenylpiperazin-1-ylcarbonyloxy)phenylalanine *tert*-butyl ester
- 25 *N*-(toluene-4-sulfonyl)-*L*-propyl-*L*-4-(4'-(ethoxycarbonyl)piperidin-1-ylcarbonyloxy)phenylalanine *tert*-butyl ester
- 30 *N*-(pyridine-3-sulfonyl)-*L*-(5,5-dimethyl)thiopropyl-*L*-4-(*N,N*-dimethylcarbamyloxy)phenylalanine *tert*-butyl ester
- N*-(3-sulfonamido-4-chloro-benzenesulfonyl)-*L*-propyl-*L*-4-(*N,N*-dimethylcarbamyloxy)phenylalanine isopropyl ester
- 35 *N*-(toluene-4-sulfonyl)-*L*-(1-oxothiomorpholin-3-carbonyl)-*L*-4-(*N,N*-dimethylcarbamyloxy)phenylalanine isopropyl ester
- N*-(2,4-difluorobenzenesulfonyl)-*L*-(1-oxothiomorpholin-3-carbonyl)-*L*-4-(*N,N*-dimethylcarbamyloxy)phenylalanine *tert*-butyl ester
- 40 *N*-(1-methylpyrazole-4-sulfonyl)-*L*-(5,5-dimethyl)thiopropyl-*L*-4-(*N,N*-dimethylcarbamyloxy)phenylalanine 2,2-dimethylpropyl ester
- 45

- N*-(pyridine-3-sulfonyl)-L-(5,5-dimethyl)thiaprolyl-L-4-(*N,N*-dimethylcarbamyloxy)phenylalanine 2,2-dimethylpropyl ester
- 5 *N*-(1-methylpyrazole-4-sulfonyl)-L-(5,5-dimethyl)thiaprolyl-L-4-(*N,N*-dimethylcarbamyloxy)phenylalanine cyclopropylmethyl ester
- N*-(1-methylpyrazole-4-sulfonyl)-L-(5,5-dimethyl)thiaprolyl-L-4-(*N,N*-dimethylcarbamyloxy)phenylalanine methyl ester
- 10 *N*-(pyridine-3-sulfonyl)-L-(5,5-dimethyl)thiaprolyl-L-4-(*N,N*-dimethylcarbamyloxy)phenylalanine ethyl ester
- N*-(pyridine-3-sulfonyl)-L-(5,5-dimethyl)thiaprolyl-L-4-(*N,N*-dimethylcarbamyloxy)phenylalanine cyclopropylmethyl ester
- 15 *N*-(1-methylpyrazole-4-sulfonyl)-L-(5,5-dimethyl)thiaprolyl-L-4-(*N,N*-dimethylcarbamyloxy)phenylalanine 2-methoxyphenyl ester
- N*-(1-methylpyrazole-4-sulfonyl)-L-(5,5-dimethyl)thiaprolyl-L-4-(*N,N*-dimethylcarbamyloxy)phenylalanine *n*-butyl ester
- 20 *N*-(1-methylpyrazole-4-sulfonyl)-L-(5,5-dimethyl)thiaprolyl-L-4-(*N,N*-dimethylcarbamyloxy)phenylalanine *n*-propyl ester
- N*-(1-methylpyrazole-4-sulfonyl)-L-(5,5-dimethyl)thiaprolyl-L-4-(*N,N*-dimethylcarbamyloxy)phenylalanine 2,2-dimethylpropionyloxymethyl ester
- 25 *N*-(toluene-4-sulfonyl)-L-prolyl-L-4-(*N*-(4'-(2'-aminoethyl)morpholino)carbamyloxy)phenylalanine
- 30 *N*-(toluene-4-sulfonyl)-L-prolyl-L-4-[4-(carboxy)piperidin-1-ylcarbonyloxy]phenylalanine
- N*-(toluene-4-sulfonyl)-L-prolyl-L-4-(*N,N*-bis-(2-hydroxyethyl)carbamyloxy)phenylalanine isopropyl ester
- 35 *N*-(toluene-4-sulfonyl)-L-prolyl-L-4-[3-(hydroxymethyl)piperidin-1-ylcarbonyloxy]phenylalanine isopropyl ester
- N*-(toluene-4-sulfonyl)-L-prolyl-L-4-(4-trifluoromethanesulfonylpiperazin-1-ylcarbonyloxy)phenylalanine *tert*-butyl ester
- 40 *N*-(4-(*N*-phenylurea)benzenesulfonyl)-L-prolyl-L-4-(*N,N*-dimethylcarbamyloxy)phenylalanine *tert*-butyl ester
- 45

- N*-(2-trifluoroacetyl-1,2,3,4-tetrahydroisoquinolin-7-sulfonyl)-*L*-prolyl-*L*-4-(*N,N*-dimethylcarbamyloxy)phenylalanine isopropyl ester
- 5 *N*-(1-methylpyrazole-3-sulfonyl)-*L*-(5,5-dimethyl)thiaprolyl-*L*-4-(*N,N*-dimethylcarbamyloxy)phenylalanine isopropyl ester
- N*-(1-methylpyrazole-3-sulfonyl)-*L*-(5,5-dimethyl)thiaprolyl-*L*-4-(*N,N*-dimethylcarbamyloxy)phenylalanine
- 10 *N*-(pyridine-4-sulfonyl)-*L*-(5,5-dimethyl)thiaprolyl-*L*-4-(*N,N*-dimethylcarbamyloxy)phenylalanine isopropyl ester
- N*-(pyridine-4-sulfonyl)-*L*-(5,5-dimethyl)thiaprolyl-*L*-4-(*N,N*-dimethylcarbamyloxy)phenylalanine
- 15 *N*-(toluene-4-sulfonyl)-*L*-(5,5-dimethyl)thiaprolyl-*L*-4-(*N*-methyl-*N*-(2-dimethylaminoethyl)carbamyloxy)phenylalanine *tert*-butyl ester
- N*-(toluene-4-sulfonyl)-*L*-prolyl-*L*-4-(*N*-methyl-*N*-(2-dimethylaminoethyl)carbamyloxy)phenylalanine *tert*-butyl ester
- 20 *N*-(toluene-4-sulfonyl)-*L*-(5,5-dimethyl)thiaprolyl-*L*-4-(*N*-methyl-*N*-(2-dimethylaminoethyl)carbamyloxy)phenylalanine
- N*-(toluene-4-sulfonyl)-*L*-prolyl-*L*-4-(*N*-methyl-*N*-(2-dimethylaminoethyl)carbamyloxy)phenylalanine
- 25 *N*-(4-fluorobenzenesulfonyl)-*L*-(5,5-dimethyl)thiaprolyl-*L*-3-chloro-4-(4-methylpiperazin-1-ylcarbonyloxy)phenylalanine *tert*-butyl ester
- 30 *N*-(4-fluorobenzenesulfonyl)-*L*-(5,5-dimethyl)thiaprolyl-*L*-3-chloro-4-(*N,N*-dimethylcarbamyloxy)phenylalanine
- N*-(4-fluorobenzenesulfonyl)-*L*-(5,5-dimethyl)thiaprolyl-*L*-3-chloro-4-(thiomorpholin-4-ylcarbonyloxy)phenylalanine *tert*-butyl ester
- 35 *N*-(4-fluorobenzenesulfonyl)-*L*-(5,5-dimethyl)thiaprolyl-*L*-3-chloro-4-(thiomorpholin-4-ylcarbonyloxy)phenylalanine isopropyl ester
- 40 *N*-(4-fluorobenzenesulfonyl)-*L*-(5,5-dimethyl)thiaprolyl-*L*-3-chloro-4-(*N,N*-dimethylcarbamyloxy)]phenylalanine isopropyl ester
- N*-(toluene-4-sulfonyl)-*L*-(5,5-dimethyl)thiaprolyl-*L*-3-chloro-4-(*N,N*-dimethylcarbamyloxy)phenylalanine isopropyl ester
- 45

- N*-(4-fluorobenzenesulfonyl)-*L*-(5,5-dimethyl)thiaprolyl-*L*-3-chloro-4-(4-methylpiperazin-1-ylcarbonyloxy)]phenylalanine isopropyl ester
- 5 *N*-(toluene-4-sulfonyl)-*L*-prolyl-*L*-3-chloro-4-(*N,N*-dimethylcarbamyloxy)]phenylalanine isopropyl ester
- N*-(4-fluorobenzenesulfonyl)-*L*-(5,5-dimethyl)thiaprolyl-*L*-3-chloro-4-(4-(2'-pyridyl)-piperazin-1-ylcarbonyloxy)]phenylalanine isopropyl ester
- 10 *N*-(4-fluorobenzenesulfonyl)-*L*-(5,5-dimethyl)thiaprolyl-*L*-3-chloro-4-(4-(2'-pyridyl)-piperazin-1-ylcarbonyloxy)]phenylalanine *tert*-butyl ester
- N*-(4-nitrobenzenesulfonyl)-*L*-prolyl-*L*-4-(*N,N*-dimethylcarbamyloxy)phenylalanine isopropyl ester
- 15 *N*-(4-aminobenzenesulfonyl)-*L*-prolyl-*L*-4-(*N,N*-dimethylcarbamyloxy)phenylalanine isopropyl ester
- N*-(toluene-4-sulfonyl)-*L*-prolyl-*L*-4-(thiomorpholin-4-ylcarbonyloxy)phenylalanine isopropyl ester
- 20 *N*-(toluene-4-sulfonyl)-*L*-prolyl-*L*-4-(4-phenylcarbamyloxy)piperazin-1-ylcarbonyloxy)phenylalanine isopropyl ester
- N*-(toluene-4-sulfonyl)-*L*-prolyl-*L*-4-(4-phenylcarbamyloxy)piperazin-1-ylcarbonyloxy)phenylalanine
- 25 *N*-(1-*n*-butylpyrazole-4-sulfonyl)-*L*-(5,5-dimethyl)thiaprolyl-*L*-4-(*N,N*-dimethylcarbamyloxy)phenylalanine isopropyl ester
- 30 *N*-(toluene-4-sulfonyl)-*L*-prolyl-*L*-4-(pyridin-4-ylcarbonyl)piperazin-1-ylcarbonyloxy)phenylalanine isopropyl ester
- N*-(toluene-4-sulfonyl)-*L*-4-oxoprolyl-*L*-4-(*N,N*-dimethylcarbamyloxy)phenylalanine
- 35 *N*-(toluene-4-sulfonyl)-*L-trans*-4-hydroxyprolyl-*L*-4-(*N,N*-dimethylcarbamyloxy)phenylalanine
- N*-(4-cyanobenzenesulfonyl)-*L*-prolyl-*L*-4-(*N,N*-dimethylcarbamyloxy)phenylalanine isopropyl ester
- 40 *N*-(4-aminobenzenesulfonyl)-*L*-prolyl-*L*-4-(*N,N*-dimethylcarbamyloxy)phenylalanine
- 45

- N*-(toluene-4-sulfonyl)-L-4-oxopropyl-L-4-(4-methylpiperazin-1-ylcarbonyloxy)phenylalanine *tert*-butyl ester
- 5 *N*-(toluene-4-sulfonyl)-L-propyl-L-4-[3-(hydroxymethyl)piperidin-1-ylcarbonyloxy]phenylalanine
- N*-(toluene-4-sulfonyl)-L-(4,4-difluoro)propyl-L-4-(*N,N*-dimethylcarbamyloxy)phenylalanine isopropyl ester
- 10 *N*-(toluene-4-sulfonyl)-L-(4,4-difluoro)propyl-L-4-(*N,N*-dimethylcarbamyloxy)phenylalanine
- N*-(toluene-4-sulfonyl)-L-propyl-L-(4-benzoylpiperazin-1-ylcarbonyloxy)phenylalanine isopropyl ester
- 15 *N*-(1-methyl-1H-imidazole-4-sulfonyl)-L-propyl-L-4-(*N,N*-dimethylcarbamyloxy)phenylalanine isopropyl ester
- N*-(toluene-4-sulfonyl)-L-4-(thiomorpholin-4-ylcarbonyloxy)propyl-L-4-(thiomorpholin-4-ylcarbonyloxy)phenylalanine
- 20 *N*-(4-cyanobenzenesulfonyl)-L-propyl-L-4-(thiomorpholin-4-ylcarbonyloxy)phenylalanine isopropyl ester
- N*-(4-amidinobenzenesulfonyl)-L-propyl-L-4-(*N,N*-dimethylcarbamyloxy)phenylalanine methyl ester
- 25 *N*-(toluene-4-sulfonyl)-L-4-oxopropyl-L-4-(thiomorpholin-4-ylcarbonyloxy)phenylalanine *tert*-butyl ester
- 30 *N*-(toluene-4-sulfonyl)-L-4-hydroxypropyl-L-4-(thiomorpholin-4-ylcarbonyloxy)phenylalanine
- N*-(toluene-4-sulfonyl)-L-propyl-L-(4-benzoylpiperazin-1-ylcarbonyloxy)phenylalanine
- 35 *N*-(4-amidinobenzenesulfonyl)-L-propyl-L-4-(thiomorpholin-4-ylcarbonyloxy)phenylalanine methyl ester
- N*-(3-fluorobenzenesulfonyl)-L-propyl-L-4-(*N,N*-dimethylcarbonyloxy)phenylalanine
- 40 *N*-(toluene-4-sulfonyl)-L-propyl-L-4-[*N*-methyl-*N*-(2-(*N'*-methyl-*N'*-toluenesulfonyl-amino)ethyl)carbamyloxy]phenylalanine isopropyl ester
- 45

- N*-(toluene-4-sulfonyl)-L-prolyl-L-4-[*N*-(2-(*N'*-phenylaminocarbonyloxy)ethyl)carbamyloxy)]phenylalanine isopropyl ester
- 5 *N*-(4-fluorobenzenesulfonyl)-L-4-(*trans*-hydroxy)prolyl-L-4-(*N,N*-dimethylcarbamyloxy)phenylalanine isopropyl ester
- N*-(4-fluorobenzenesulfonyl)-L-4-(*trans*-hydroxy)prolyl-L-4-(*N,N*-dimethylcarbamyloxy)phenylalanine *tert*-butyl ester
- 10 *N*-(4-amidinobenzenesulfonyl)-L-prolyl-L-4-(*N,N*-dimethylcarbamyloxy)phenylalanine
- N*-(toluene-4-sulfonyl)-L-(pyrazin-3-carbonyl)-L-4-(*N,N*-dimethylcarbamyloxy)phenylalanine *tert*-butyl ester
- 15 *N*-(4-fluorobenzenesulfonyl)-L-(5,5-dimethyl)thiaprolyl-L-4-(2-hydroxymethylpyrrolidin-1-ylcarbonyloxy)phenylalanine *tert*-butyl ester
- N*-(4-fluorobenzenesulfonyl)-L-(5,5-dimethyl)thiaprolyl-L-4-(2-hydroxymethylpyrrolidin-1-ylcarbonyloxy)phenylalanine
- 20 *N*-(toluene-4-sulfonyl)-L-prolyl-L-4-(2-methoxycarbonylpyrrolidin-1-ylcarbonyloxy)phenylalanine *tert*-butyl ester
- N*-(4-fluorobenzenesulfonyl)-L-(5,5-dimethyl)thiaprolyl-L-3-chloro-4-(thiomorpholin-4-ylcarbonyloxy)phenylalanine
- N*-(4-fluorobenzenesulfonyl)-L-(5,5-dimethyl)thiaprolyl-L-4-(4-(2-pyridyl)piperazin-1-ylcarbonyloxy)]phenylalanine
- 30 *N*-(4-fluorobenzenesulfonyl)-L-(5,5-dimethyl)thiaprolyl-L-4-(4-(2-pyridyl)piperazin-1-ylcarbonyloxy)]phenylalanine *tert*-butyl ester
- N*-(toluene-4-sulfonyl)-L-(4-hydroxy)prolyl-L-4-(thiomorpholin-4-ylcarbonyloxy)phenylalanine *tert*-butyl ester
- 35 *N*-(toluene-4-sulfonyl)-L-prolyl-L-4-(*N,N*-dimethylcarbamyloxy)phenylalanine 2-(2-methoxyethoxy)ethyl ester
- N*-(4-fluorobenzenesulfonyl)-L-(5,5-dimethyl)thiaprolyl-L-4-(4-(2-pyrimidyl)piperazin-1-ylcarbonyloxy)]phenylalanine *tert*-butyl ester
- 40 *N*-(4-fluorobenzenesulfonyl)-L-(5,5-dimethyl)thiaprolyl-L-3-fluoro-4-(*N,N*-dimethylcarbamyloxy)phenylalanine isopropyl ester
- 45

- N*-(toluene-4-sulfonyl)-L-(1-methanesulfonylpyrazin-3-carbonyl)-L-4-(*N,N*-dimethylcarbamyloxy)phenylalanine *tert*-butyl ester
- 5 *N*-(4-bromobenzenesulfonyl)-L-(5,5-dimethyl)thiaprolyl-L-4-(*N,N*-dimethylcarbamyloxy)phenylalanine *tert*-butyl ester
- N*-(4-bromobenzenesulfonyl)-L-(5,5-dimethyl)thiaprolyl-L-4-(*N,N*-dimethylcarbamyloxy)phenylalanine
- 10 *N*-(toluene-4-sulfonyl)-L-(4-hydroxy)prolyl-L-4-(4-methylpiperazin-1-ylcarbonyloxy)phenylalanine
- N*-(4-fluorobenzenesulfonyl)-L-(5,5-dimethyl)thiaprolyl-L-4-(4-(2-pyrimidyl)piperazin-1-ylcarbonyloxy)]phenylalanine
- 15 *N*-(4-fluorobenzenesulfonyl)-L-(5,5-dimethyl)thiaprolyl-L-4-(4-(2-pyridyl)piperazin-1-ylcarbonyloxy)]phenylalanine isopropyl ester
- N*-(4-fluorobenzenesulfonyl)thiazolidinyl-2-carbonyl-L-4-(*N,N*-dimethylcarbamyloxy)phenylalanine
- 20 *N*-(4-fluorobenzenesulfonyl)thiazolidinyl-2-carbonyl-L-4-(*N,N*-dimethylcarbamyloxy)phenylalanine *tert*-butyl ester
- N*-(toluene-4-sulfonyl)-L-(4-oxo)prolyl-L-4-(thiomorpholin-4-ylcarbonyloxy)phenylalanine
- 25 *N*-(toluene-4-sulfonyl)-L-(4-oxo)prolyl-L-4-(4-methylpiperazin-1-ylcarbonyloxy)phenylalanine
- 30 *N*-(4-fluorobenzenesulfonyl)thiazolidinyl-2-carbonyl-L-4-(4-(2-pyridyl)piperazin-1-ylcarbonyloxy)]phenylalanine
- N*-(4-nitrobenzenesulfonyl)-L-prolyl-L-4-(4-(2-pyridyl)piperazin-1-ylcarbonyloxy)]phenylalanine *tert*-butyl ester
- 35 *N*-(4-fluorobenzenesulfonyl)thiazolidinyl-2-carbonyl-L-4-(4-(2-pyridyl)piperazin-1-ylcarbonyloxy)]phenylalanine *tert*-butyl ester
- 40 *N*-(4-bromobenzenesulfonyl)-L-(5,5-dimethyl)thiaprolyl-L-4-(4-(2-pyridyl)piperazin-1-ylcarbonyloxy)]phenylalanine
- N*-(toluene-4-sulfonyl)-L-prolyl-L-4-(4-(*N*-phenylthiocarbonyl)piperazin-1-ylcarbonyloxy)]phenylalanine isopropyl ester
- 45

- 5 *N*-(4-fluorobenzenesulfonyl)thiazolidinyl-2-carbonyl-L-4-(4-methylhomopiperazin-1-ylcarbonyloxy)phenylalanine *tert*-butyl ester

 5 *N*-(toluene-4-sulfonyl)-L-4-(methanesulfonyloxy)prolyl-L-4-(*N,N*-dimethylcarbamyloxy)phenylalanine *tert*-butyl ester

 10 *N*-(4-aminocarbonylbenzenesulfonyl)-L-prolyl-L-4-(*N,N*-dimethylcarbamyloxy)phenylalanine

 10 *N*-(4-aminocarbonylbenzenesulfonyl)-L-prolyl-L-4-(thiomorpholin-4-ylcarbonyloxy)phenylalanine

 15 *N*-(4-amidinobenzenesulfonyl)-L-prolyl-L-4-(thiomorpholin-4-ylcarbonyloxy)phenylalanine

 15 *N*-(4-nitrobenzenesulfonyl)-L-prolyl-L-4-(4-(2-pyridyl)piperazin-1-ylcarbonyloxy)]phenylalanine

 20 *N*-(4-fluorobenzenesulfonyl)-L-(5,5-dimethyl)thiaprolyl-L-3-chloro-4-(4-(2-pyridyl)piperazin-1-ylcarbonyloxy)]phenylalanine ethyl ester

 20 *N*-(4-fluorobenzenesulfonyl)-L-(5,5-dimethyl)thiaprolyl-L-3-chloro-4-(4-(2-pyridyl)piperazin-1-ylcarbonyloxy)phenylalanine

 25 *N*-(4-fluorobenzenesulfonyl)thiazolidinyl-2-carbonyl-L-4-(4-methylhomopiperazin-1-ylcarbonyloxy)phenylalanine

 30 *N*-(1-methylpyrazole-3-sulfonyl)-L-(5,5-dimethyl)thiaprolyl-L-3-chloro-4-(*N,N*-dimethylcarbamyloxy)phenylalanine isopropyl ester

 30 *N*-(1-methylimidazole-4-sulfonyl)-L-prolyl-L-4-(4-(2-pyridyl)piperazin-1-ylcarbonyloxy)phenylalanine isopropyl ester

 35 *N*-(1-methylimidazole-4-sulfonyl)-L-prolyl-L-4-(4-(2-pyridyl)piperazin-1-ylcarbonyloxy)phenylalanine *tert*-butyl ester

 40 *N*-(toluene-4-sulfonyl)-L-prolyl-L-4-(4-(2-pyridyl)piperazin-1-ylcarbonyloxy)phenylalanine

 40 *N*-(toluene-4-sulfonyl)-L-prolyl-L-4-(4-(2-pyridyl)piperazin-1-ylcarbonyloxy)phenylalanine *tert*-butyl ester

 45 *N*-(toluene-4-sulfonyl)-L-prolyl-L-4-(4-(2-pyridyl)piperazin-1-ylcarbonyloxy)phenylalanine isopropyl ester

- N*-(4-fluorobenzenesulfonyl)-L-prolyl-L-4-(4-(2-pyridyl)piperazin-1-ylcarbonyloxy)phenylalanine isopropyl ester
- 5 *N*-(4-fluorobenzenesulfonyl)-L-prolyl-L-4-(4-(2-pyridyl)piperazin-1-ylcarbonyloxy)phenylalanine *tert*-butyl ester
- N*-(toluene-4-sulfonyl)-L-(1-methanesulfonylpyrazin-3-carbonyl)-L-4-(*N,N*-dimethylcarbamyloxy)phenylalanine
- 10 *N*-(toluene-4-sulfonyl)-L-4-(methanesulfonyloxy)prolyl-L-4-(*N,N*-dimethylcarbamyloxy)phenylalanine
- N*-(4-bromobenzenesulfonyl)-L-(5,5-dimethyl)thiaprolyl-L-4-(4-(2-pyridyl)piperazin-1-ylcarbonyloxy)phenylalanine *tert*-butyl ester
- 15 *N*-(4-trifluoromethoxybenzenesulfonyl)-L-(5,5-dimethyl)thiaprolyl-L-4-(*N,N*-dimethylcarbamyloxy)phenylalanine
- N*-(4-trifluoromethoxybenzenesulfonyl)-L-(5,5-dimethyl)thiaprolyl-L-4-(*N,N*-dimethylcarbamyloxy)phenylalanine *tert*-butyl ester
- 20 *N*-(4-trifluoromethoxybenzenesulfonyl)-L-(5,5-dimethyl)thiaprolyl-L-4-(4-(2-pyridyl)piperazin-1-ylcarbonyloxy)phenylalanine *tert*-butyl ester
- N*-(4-fluorobenzenesulfonyl)-L-prolyl-L-4-(4-(2-pyridyl)piperazin-1-ylcarbonyloxy)phenylalanine
- 25 *N*-(4-fluorobenzenesulfonyl)-L-(4-hydroxy)prolyl-L-4-(4-(2-pyridyl)piperazin-1-ylcarbonyloxy)phenylalanine
- 30 *N*-(4-trifluoromethoxybenzenesulfonyl)-L-(5,5-dimethyl)thiaprolyl-L-4-(4-(2-pyridyl)piperazin-1-ylcarbonyloxy)phenylalanine
- N*-(1-methylimidazole-4-sulfonyl)-L-prolyl-L-3-chloro-4-(*N,N*-dimethylcarbamyloxy)phenylalanine
- 35 *N*-(1-methylimidazole-4-sulfonyl)-L-prolyl-L-3-chloro-4-(*N,N*-dimethylcarbamyloxy)phenylalanine isopropyl ester
- N*-(1-methylimidazole-4-sulfonyl)-L-prolyl-L-4-(4-(2-pyridyl)piperazin-1-ylcarbonyloxy)phenylalanine
- 40 *N*-(1-methylimidazole-4-sulfonyl)-L-(5,5-dimethyl)thiaprolyl-L-4-(4-(2-pyridyl)piperazin-1-ylcarbonyloxy)phenylalanine
- 45

N-(1-methylpyrazole-3-sulfonyl)-L-prolyl-L-4-(4-(2-pyridyl)piperazin-1-ylcarbonyloxy)phenylalanine

5 *N*-(1-methylpyrazole-3-sulfonyl)-L-prolyl-L-4-(4-(2-pyridyl)piperazin-1-ylcarbonyloxy)phenylalanine isopropyl ester

N-(1-methylpyrazole-3-sulfonyl)-L-prolyl-L-4-(4-(2-pyridyl)piperazin-1-ylcarbonyloxy)phenylalanine *tert*-butyl ester

10 *N*-(1-methylpyrazole-3-sulfonyl)-L-(5,5-dimethyl)thiaprolyl-L-4-(4-(2-pyridyl)piperazin-1-ylcarbonyloxy)phenylalanine *tert*-butyl ester

15 *N*-(1-methylimidazole-4-sulfonyl)-L-prolyl-L-3-chloro-4-(4-(2-pyridyl)piperazin-1-ylcarbonyloxy)phenylalanine isopropyl ester

N-(1-methylpyrazole-3-sulfonyl)-L-(5,5-dimethyl)thiaprolyl-L-4-(*N,N*-dimethylcarbamyloxy)phenylalanine 2-phenoxyethyl ester

20 *N*-(1-methylpyrazole-3-sulfonyl)-L-(5,5-dimethyl)thiaprolyl-L-3-chloro-4-(4-(2-pyridyl)piperazin-1-ylcarbonyloxy)phenylalanine

N-(1-methylpyrazole-3-sulfonyl)-L-(5,5-dimethyl)thiaprolyl-L-3-chloro-4-(4-(2-pyridyl)piperazin-1-ylcarbonyloxy)phenylalanine ethyl ester

25 *N*-(3-chloro-1,5-dimethylpyrazole-3-sulfonyl)-L-(5,5-dimethyl)thiaprolyl-L-3-chloro-4-(4-(5-trifluoromethyl-2-pyridyl)piperazin-1-ylcarbonyloxy)phenylalanine

and pharmaceutically acceptable salts thereof.

30

Preferred compounds of formula I and IA above include those set forth in Table 3 below:

Table 3

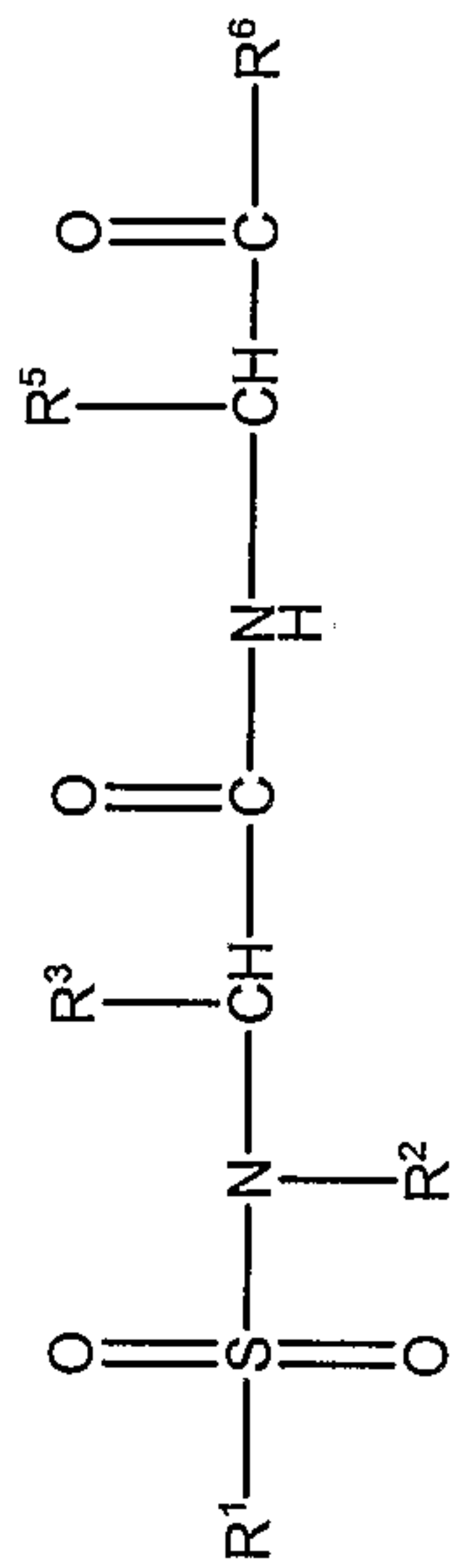

R ¹	R ²	R ³	R ⁵	R ⁶
<i>p</i> -CH ₃ -φ-	R ² /R ³ = cyclic 3 carbon atoms (L-pyrrolidinyl)		<i>p</i> -[(4-methylpiperazin-1-yl)C(O)O-]benzyl-	-OCH ₂ CH ₃
<i>p</i> -CH ₃ -φ-	R ² /R ³ = cyclic 3 carbon atoms (L-pyrrolidinyl)		<i>p</i> -[(CH ₃) ₂ NC(O)O-]benzyl-	-OCH ₂ CH ₃
<i>p</i> -CH ₃ -φ-	R ² /R ³ = cyclic 3 carbon atoms (L-pyrrolidinyl)		<i>p</i> -[(4-methylpiperazin-1-yl)C(O)O-]benzyl-	-OCH(CH ₃) ₂
<i>p</i> -CH ₃ -φ-	R ² /R ³ = cyclic 3 carbon atoms (L-pyrrolidinyl)		<i>p</i> -[(4-methylpiperazin-1-yl)C(O)O-]benzyl-	-O- <i>n</i> -butyl
<i>p</i> -CH ₃ -φ-	R ² /R ³ = cyclic 3 carbon atoms (L-pyrrolidinyl)		<i>p</i> -[(4-methylpiperazin-1-yl)C(O)O-]benzyl-	-O-cyclopentyl
<i>p</i> -CH ₃ -φ-	R ² /R ³ = cyclic 3 carbon atoms (L-pyrrolidinyl)		<i>p</i> -[(4-methylpiperazin-1-yl)C(O)O-]benzyl-	-OC(CH ₃) ₃
<i>p</i> -CH ₃ -φ-	R ² /R ³ = cyclic 3 carbon atoms (L-pyrrolidinyl)		<i>p</i> -[(4-methylpiperazin-1-yl)C(O)O-]benzyl-	-OH
<i>p</i> -CH ₃ -φ-	R ² /R ³ = cyclic 3 carbon atoms (L-pyrrolidinyl)		<i>p</i> -[(CH ₃) ₂ NC(O)O-]benzyl-	-OCH(CH ₃) ₂

R ¹	R ²	R ³	R ⁵	R ⁶
<i>p</i> -CH ₃ -φ-	R ² /R ³ = cyclic 3 carbon atoms (L-pyrrolidinyl)		<i>p</i> -[(CH ₃) ₂ NC(O)O-]benzyl-	-O- <i>n</i> -butyl
<i>p</i> -CH ₃ -φ-	R ² /R ³ = cyclic 3 carbon atoms (L-pyrrolidinyl)		<i>p</i> -[(CH ₃) ₂ NC(O)O-]benzyl-	-O-cyclopentyl
<i>p</i> -CH ₃ -φ-	R ² /R ³ = cyclic 3 carbon atoms (L-pyrrolidinyl)		<i>p</i> -[(CH ₃) ₂ NC(O)O-]benzyl-	-OC(CH ₃) ₃
<i>p</i> -CH ₃ -φ-	R ² /R ³ = cyclic 3 carbon atoms (L-pyrrolidinyl)		<i>p</i> -[(CH ₃) ₂ NC(O)O-]benzyl-	-OH
<i>p</i> -CH ₃ -φ-	R ² /R ³ = cyclic 3 carbon atoms (L-pyrrolidinyl)		<i>p</i> -[(piperidin-4-yl)C(O)O-]benzyl-	-OCH ₂ CH ₃
φ-CH ₂ -	R ² /R ³ = cyclic 3 carbon atoms (L-pyrrolidinyl)		<i>p</i> -[(1-methylpiperidin-4-yl)C(O)O-]benzyl-	-OCH ₂ CH ₃
φ-CH ₂ -	R ² /R ³ = cyclic 3 carbon atoms (L-pyrrolidinyl)		<i>p</i> -[(4-methylpiperazin-1-yl)C(O)O-]benzyl-	-OH
<i>p</i> -CH ₃ -φ-	R ² /R ³ = cyclic 3 carbon atoms (L-pyrrolidinyl)		<i>m</i> -[(CH ₃) ₂ NC(O)O-]benzyl-	-OCH ₂ CH ₃
<i>p</i> -CH ₃ -φ-	R ² /R ³ = cyclic 3 carbon atoms (L-pyrrolidinyl)		<i>p</i> -[(1-Boc-4-phenylpiperidin-4-yl)-C(O)O-]benzyl-	-OCH ₂ CH ₃
<i>p</i> -CH ₃ -φ-	R ² /R ³ = cyclic -CH ₂ -S-C(CH ₃) ₂ - (L-5,5-dimethylthiazolidin-4-yl)		<i>p</i> -[(CH ₃) ₂ NC(O)O-]benzyl-	-OCH(CH ₃) ₂

R ¹	R ²	R ³	R ⁵	R ⁶
<i>p</i> -CH ₃ -φ-	R ² /R ³ = cyclic -CH ₂ -S-C(CH ₃) ₂ - (L-5,5-dimethylthiazolidin-4-yl)		<i>p</i> -[(CH ₃) ₂ NC(O)O-]benzyl-	-OC(CH ₃) ₃
<i>p</i> -CH ₃ -φ-	R ² /R ³ = cyclic -CH ₂ -S-C(CH ₃) ₂ - (L-5,5-dimethylthiazolidin-4-yl)		<i>p</i> -[(CH ₃) ₂ NC(O)O-]benzyl-	-OH
<i>p</i> -CH ₃ -φ-	R ² /R ³ = cyclic -CH ₂ CH ₂ -SO ₂ -CH ₂ - (L-1,1-dioxothiomorpholin-3-yl)		<i>p</i> -[(CH ₃) ₂ NC(O)O-]benzyl-	-OC(CH ₃) ₃
<i>p</i> -CH ₃ -φ-	R ² /R ³ = cyclic -CH ₂ CH ₂ -SO ₂ -CH ₂ - (L-1,1-dioxothiomorpholin-3-yl)		<i>p</i> -[(CH ₃) ₂ NC(O)O-]benzyl-	-OH
<i>p</i> -CH ₃ -φ-	R ² /R ³ = cyclic -CH ₂ -S-C(CH ₃) ₂ - (L-5,5-dimethylthiazolidin-4-yl)		<i>p</i> -[(4-methylpiperazin-1-yl)C(O)O-]benzyl-	-OC(CH ₃) ₃
<i>p</i> -CH ₃ -φ-	R ² /R ³ = cyclic -CH ₂ -S-C(CH ₃) ₂ - (L-5,5-dimethylthiazolidin-4-yl)		<i>p</i> -[(4-methylpiperazin-1-yl)C(O)O-]benzyl-	-OH
<i>p</i> -CH ₃ -φ-	CH ₃ -	H	<i>p</i> -[(CH ₃) ₂ NC(O)O-]benzyl-	-OCH(CH ₃) ₂
<i>p</i> -CH ₃ -φ-	CH ₃ -	H	<i>p</i> -[(CH ₃) ₂ NC(O)O-]benzyl-	-OC(CH ₃) ₃
<i>p</i> -CH ₃ -φ-	CH ₃ -	H	<i>p</i> -[(CH ₃) ₂ NC(O)O-]benzyl-	-OH
1-methylimidazol-4-yl	R ² /R ³ = cyclic 3 carbon atoms (L-pyrrolidinyl)		<i>p</i> -[(CH ₃) ₂ NC(O)O-]benzyl-	-OC(CH ₃) ₃
<i>p</i> -NH ₂ -φ-	R ² /R ³ = cyclic 3 carbon atoms (L-pyrrolidinyl)		<i>p</i> -[(CH ₃) ₂ NC(O)O-]benzyl-	-OC(CH ₃) ₃
<i>p</i> -CH ₃ -φ-	CH ₃ -	H	<i>p</i> -[(morpholin-4-yl)C(O)O-]benzyl-	-OC(CH ₃) ₃
<i>p</i> -CH ₃ -φ-	R ² /R ³ = cyclic 3 carbon atoms (L-pyrrolidinyl)		<i>p</i> -[(morpholin-4-yl)C(O)O-]benzyl-	-OC(CH ₃) ₃

R ¹	R ²	R ³	R ⁵	R ⁶
ϕ -CH ₂ -	R ² /R ³ = cyclic -CH ₂ -S-C(CH ₃) ₂ - (L-5,5-dimethylthiazolidin-4-yl)		<i>p</i> -[(CH ₃) ₂ NC(O)O-]benzyl-	-OH
<i>p</i> -CH ₃ - ϕ -	R ² /R ³ = cyclic -CH ₂ CH ₂ -NH-CH ₂ - (L-piperazinyl)		<i>p</i> -[(CH ₃) ₂ NC(O)O-]benzyl-	-OH
ϕ -CH ₂ -	R ² /R ³ = cyclic -CH ₂ -S-C(CH ₃) ₂ - (L-5,5-dimethylthiazolidin-4-yl)		<i>p</i> -[(CH ₃) ₂ NC(O)O-]benzyl-	-OC(CH ₃) ₃
<i>p</i> -CH ₃ - ϕ -	R ² /R ³ = cyclic -CH ₂ CH ₂ -NH-CH ₂ - (L-piperazinyl)		<i>p</i> -[(CH ₃) ₂ NC(O)O-]benzyl-	-OC(CH ₃) ₃
<i>p</i> -CH ₃ - ϕ -	R ² /R ³ = cyclic -CH ₂ CH ₂ -(Cbz)NHCH ₂ - [L-4-N-(Cbz)-piperazinyl]		<i>p</i> -[(CH ₃) ₂ NC(O)O-]benzyl-	-OC(CH ₃) ₃
<i>p</i> -CH ₃ - ϕ -	CH ₃ -	H	<i>p</i> -[(piperidin-1-yl)C(O)O-]benzyl-	-OH
<i>p</i> -CH ₃ - ϕ -	R ² /R ³ = cyclic -CH ₂ CH ₂ -SO ₂ -CH ₂ - (L-1,1-dioxothiomorpholin-3-yl)		<i>p</i> -[(morpholin-4-yl)C(O)O-]benzyl-	-OC(CH ₃) ₃
<i>p</i> -CH ₃ - ϕ -	R ² /R ³ = cyclic -CH ₂ CH ₂ -SO ₂ -CH ₂ - (L-1,1-dioxothiomorpholin-3-yl)		<i>p</i> -[(morpholin-4-yl)C(O)O-]benzyl-	-OH
1-methylpyrazol-4-yl	R ² /R ³ = cyclic 3 carbon atoms (L-pyrrolidinyl)		<i>p</i> -[(CH ₃) ₂ NC(O)O-]benzyl-	-OC(CH ₃) ₃
<i>p</i> -F- ϕ	R ² /R ³ = cyclic 3 carbon atoms (L-pyrrolidinyl)		<i>p</i> -[(CH ₃) ₂ NC(O)O-]benzyl-	-OC(CH ₃) ₃
<i>p</i> -CH ₃ - ϕ	-CH ₃	H	<i>p</i> -[(4-methylpiperazin-1-yl)C(O)O-]benzyl-	-OC(CH ₃) ₃

R ¹	R ²	R ³	R ⁵	R ⁶
<i>p</i> -CH ₃ -φ	R ² /R ³ = cyclic -CH ₂ -SO ₂ -C(CH ₃) ₂ - (L-1,1-dioxo-5,5- dimethylthiazolidin-4-yl)		<i>p</i> -[(CH ₃) ₂ NC(O)O-]benzyl-	-OC(CH ₃) ₃
1-methylpyrazol-4-yl	R ² /R ³ = cyclic 3 carbon atoms (L-pyrrolidinyl)		<i>p</i> -[(CH ₃) ₂ NC(O)O-]benzyl-	-OH
<i>p</i> -CH ₃ -φ	R ² /R ³ = cyclic -CH ₂ -SO ₂ -C(CH ₃) ₂ - (L-1,1-dioxo-5,5- dimethylthiazolidin-4-yl)		<i>p</i> -[(CH ₃) ₂ NC(O)O-]benzyl-	-OH
<i>p</i> -F-φ	R ² /R ³ = cyclic 3 carbon atoms (L-pyrrolidinyl)		<i>p</i> -[(CH ₃) ₂ NC(O)O-]benzyl-	-OH
3-pyridyl	R ² /R ³ = cyclic 3 carbon atoms (L-pyrrolidinyl)		<i>p</i> -[(CH ₃) ₂ NC(O)O-]benzyl-	-OH
<i>p</i> -CH ₃ -φ	R ² /R ³ = cyclic 3 carbon atoms (D-pyrrolidinyl)		<i>p</i> -[(4-methylpiperazin-1-yl)C(O)O-]benzyl-	-OC(CH ₃) ₃
<i>p</i> -CH ₃ -φ	-CH ₃	-CH ₃	<i>p</i> -[(4-methylpiperazin-1-yl)C(O)O-]benzyl-	-OC(CH ₃) ₃
<i>p</i> -nitro-φ	R ² /R ³ = cyclic 3 carbon atoms (L-pyrrolidinyl)		<i>p</i> -[(CH ₃) ₂ NC(O)O-]benzyl-	-OC(CH ₃) ₃
<i>p</i> -CH ₃ -φ	-CH ₃	H	<i>p</i> -[(thiomorpholin-4-yl)C(O)O-]benzyl-	-OC(CH ₃) ₃
<i>p</i> -CH ₃ -φ	-CH ₃	-CH ₃	<i>p</i> -[(4-methylpiperazin-1-yl)C(O)O-]benzyl-	-OH
<i>p</i> -CH ₃ -φ	R ² /R ³ = cyclic 3 carbon atoms (L-pyrrolidinyl)		<i>p</i> -[(thiomorpholin-4-yl sulfone)-C(O)O-]benzyl-	-OH
<i>p</i> -CH ₃ -φ	R ² /R ³ = cyclic 3 carbon atoms (L-pyrrolidinyl)		<i>p</i> -[(thiomorpholin-4-yl)C(O)O-]benzyl-	-OH

R ¹	R ²	R ³	R ⁵	R ⁶
<i>p</i> -CH ₃ -φ	R ² /R ³ = cyclic 3 carbon atoms (L-pyrrolidiny)		<i>p</i> -[(piperidin-1-yl)C(O)O-]benzyl-	-OH
<i>p</i> -CH ₃ -φ	R ² /R ³ = cyclic 3 carbon atoms (L-pyrrolidiny)		<i>p</i> -[(pyrrolidin-1-yl)C(O)O-]benzyl-	-OH
<i>p</i> -CH ₃ -φ	R ² /R ³ = cyclic 3 carbon atoms (L-pyrrolidiny)		<i>p</i> -[(morpholin-4-yl)C(O)O-]benzyl-	-OH
<i>p</i> -CH ₃ -φ	R ² /R ³ = cyclic 3 carbon atoms (L-pyrrolidiny)		<i>p</i> -[(4-methylpiperazin-1-yl)C(O)O-]benzyl-	-OCH ₂ C(CH ₃) ₃
<i>p</i> -CH ₃ -φ	R ² /R ³ = cyclic 3 carbon atoms (L-pyrrolidiny)		<i>p</i> -[(CH ₃) ₂ NC(O)O-]benzyl-	-OCH ₂ C(CH ₃) ₃
<i>p</i> -CH ₃ -φ	R ² /R ³ = cyclic 3 carbon atoms (L-pyrrolidiny)		<i>p</i> -[(1-Boc-piperazin-4-yl)C(O)O-]benzyl-	-OCH ₂ CH ₃
<i>p</i> -CH ₃ -φ	R ² /R ³ = cyclic 3 carbon atoms (L-pyrrolidiny)		<i>p</i> -[(morpholin-4-yl)C(O)O-]benzyl-	-OCH ₂ CH ₃
<i>p</i> -CH ₃ -φ	-CH ₃	H	<i>p</i> -[(thiomorpholin-4-yl sulfone)-C(O)O-]benzyl-	-OC(CH ₃) ₃
<i>p</i> -CH ₃ -φ	-CH ₃	H	<i>p</i> -[(thiomorpholin-4-yl)C(O)O-]benzyl-	-OH
<i>p</i> -CH ₃ -φ	-CH ₃	-CH ₃	<i>p</i> -[(CH ₃) ₂ NC(O)O-]benzyl-	-OC(CH ₃) ₃
<i>p</i> -CH ₃ -φ	R ² /R ³ = cyclic -CH ₂ -CH ₂ -S-CH ₂ - (L-thiomorpholin-3-yl)		<i>p</i> -[(CH ₃) ₂ NC(O)O-]benzyl-	-OC(CH ₃) ₃
<i>p</i> -CH ₃ -φ	-CH ₃	H	<i>p</i> -[(thiomorpholin-4-yl sulfone)-C(O)O-]benzyl-	-OH
<i>p</i> -CH ₃ -φ	R ² /R ³ = cyclic -CH ₂ -CH ₂ -SO ₂ -CH ₂ - (L-1,1-dioxothiomorpholin-3-yl)		<i>p</i> -[(CH ₃) ₂ NC(O)O-]benzyl-	-OC(CH ₃) ₃

R ¹	R ²	R ³	R ⁵	R ⁶
<i>p</i> -CH ₃ -φ	R ² /R ³ = cyclic -CH ₂ -CH ₂ -SO ₂ -CH ₂ - (L-1,1-dioxothiomorpholin-3-yl)		<i>p</i> -[(morpholin-4-yl)C(O)O-]benzyl-	-OC(CH ₃) ₃
<i>p</i> -CH ₃ -φ	-CH ₃	-CH ₃	<i>p</i> -[(CH ₃) ₂ NC(O)O-]benzyl-	-OH
<i>p</i> -F-φ	R ² /R ³ = cyclic -CH ₂ -CH ₂ -S-CH ₂ - (L-thiomorpholin-3-yl)		<i>p</i> -[(CH ₃) ₂ NC(O)O-]benzyl-	-OC(CH ₃) ₃
<i>p</i> -F-φ	R ² /R ³ = cyclic -CH ₂ -CH ₂ -SO ₂ -CH ₂ - (L-1,1-dioxothiomorpholin-3-yl)		<i>p</i> -[(CH ₃) ₂ NC(O)O-]benzyl-	-OC(CH ₃) ₃
pyridin-3-yl	R ² /R ³ = cyclic 3 carbon atoms (L-pyrrolidiny)		<i>p</i> -[(CH ₃) ₂ NC(O)O-]benzyl-	-OC(CH ₃) ₃
<i>p</i> -nitro-φ	R ² /R ³ = cyclic 3 carbon atoms (L-pyrrolidiny)		<i>p</i> -[(CH ₃) ₂ NC(O)O-]benzyl-	-OH
<i>p</i> -N≡C-φ	R ² /R ³ = cyclic 3 carbon atoms (L-pyrrolidiny)		<i>p</i> -[(CH ₃) ₂ NC(O)O-]benzyl-	-OC(CH ₃) ₃
<i>p</i> -CH ₃ -φ	R ² /R ³ = cyclic -CH ₂ -CH ₂ -SO ₂ -CH ₂ - (L-1,1-dioxothiomorpholin-3-yl)		<i>p</i> -[(CH ₃) ₂ NC(O)O-]benzyl-	-OH
<i>p</i> -CH ₃ -φ	R ² /R ³ = cyclic -CH ₂ -SO ₂ -CH ₂ - (L-1,1-dioxothiazolidin-4-yl)		<i>p</i> -[(CH ₃) ₂ NC(O)O-]benzyl-	-OC(CH ₃) ₃
<i>p</i> -F ₃ C-φ	R ² /R ³ = cyclic 3 carbon atoms (L-pyrrolidiny)		<i>p</i> -[(CH ₃) ₂ NC(O)O-]benzyl-	-OC(CH ₃) ₃
1-methylpyrazol-4-yl	R ² /R ³ = cyclic 3 carbon atoms (L-pyrrolidiny)		<i>p</i> -[(CH ₃) ₂ NC(O)O-]benzyl-	-OH

R ¹	R ²	R ³	R ⁵	R ⁶
<i>p</i> -CH ₃ -φ	R ² /R ³ = cyclic -CH ₂ -SO ₂ -CH ₂ - (L-1,1-dioxothiazolidin-4-yl)		<i>p</i> -[(CH ₃) ₂ NC(O)O-]benzyl-	-OH
<i>p</i> -F-φ	R ² /R ³ = cyclic -CH ₂ -S-CH ₂ - (L-thiazolidin-4-yl)		<i>p</i> -[(CH ₃) ₂ NC(O)O-]benzyl-	-OH
<i>p</i> -CH ₃ -φ	R ² /R ³ = cyclic 3 carbon atoms (L-pyrrolidiny)		<i>p</i> -[(CH ₃) ₂ NC(O)O-]benzyl-	2,4-dioxo- tetrahydrofuran-3-yl (3,4-enol)
<i>p</i> -CH ₃ -φ	R ² /R ³ = cyclic 3 carbon atoms (L-pyrrolidiny)		<i>p</i> -[(piperazin-4-yl)C(O)O-]benzyl-	-OH
<i>p</i> -CH ₃ -φ	R ² /R ³ = cyclic 3 carbon atoms (L-pyrrolidiny)		<i>p</i> -[(1-Boc-piperazin-4-yl)C(O)O-]benzyl-	-OC(CH ₃) ₃
<i>p</i> -CH ₃ -φ	R ² /R ³ = cyclic 3 carbon atoms (L-pyrrolidiny)		<i>p</i> -[(piperazin-4-yl)C(O)O-]benzyl-	-OCH ₂ CH ₃
<i>p</i> -CH ₃ -φ	R ² /R ³ = cyclic 3 carbon atoms (L-pyrrolidiny)		<i>p</i> -[(4-acetyl)piperazin-1-yl)C(O)O-]benzyl-	-OCH ₂ CH ₃
<i>p</i> -CH ₃ -φ	R ² /R ³ = cyclic 3 carbon atoms (L-pyrrolidiny)		<i>p</i> -[(4-methanesulfonylpiperazin-1-yl)-C(O)O-]benzyl-	-OCH ₂ CH ₃
<i>p</i> -CH ₃ -φ	R ² /R ³ = cyclic 3 carbon atoms (L-pyrrolidiny)		3-nitro-4-[(morpholin-4-yl)-C(O)O-]benzyl-	-OH
<i>p</i> -CH ₃ -φ	R ² /R ³ = cyclic 3 carbon atoms (L-pyrrolidiny)		<i>p</i> -[(1-Boc-piperazin-4-yl)C(O)O-]benzyl-	-OH
<i>p</i> -CH ₃ -φ	-CH ₃	-C(CH ₃) ₃	<i>p</i> -[(4-methylpiperazin-1-yl)C(O)O-]benzyl-	-OC(CH ₃) ₃

R ¹	R ²	R ³	R ⁵	R ⁶
<i>p</i> -F-φ	R ² /R ³ = cyclic -CH ₂ -S-C(CH ₃) ₂ - (L-5,5-dimethylthiazolidin-4-yl)		<i>p</i> -[(CH ₃) ₂ NC(O)O-]benzyl-	-OC(CH ₃) ₃
<i>p</i> -F-φ	R ² /R ³ = cyclic -CH ₂ -CH ₂ -SO ₂ -CH ₂ - (L-1,1-dioxothiomorpholin-3-yl)		<i>p</i> -[(1,1-dioxothiomorpholin-4-yl)-C(O)O-]benzyl-	-OC(CH ₃) ₃
<i>p</i> -CH ₃ -φ	R ² /R ³ = cyclic -CH ₂ -CH ₂ -SO ₂ -CH ₂ - (L-1,1-dioxothiomorpholin-3-yl)		<i>p</i> -[(1,1-dioxothiomorpholin-4-yl)-C(O)O-]benzyl-	-OC(CH ₃) ₃
<i>p</i> -F-φ	R ² /R ³ = cyclic 3 carbon atoms (L-pyrrolidinyl)		<i>p</i> -[(1,1-dioxothiomorpholin-4-yl)-C(O)O-]benzyl-	-OC(CH ₃) ₃
<i>p</i> -F-φ	R ² /R ³ = cyclic 3 carbon atoms (L-pyrrolidinyl)		<i>p</i> -[(thiomorpholin-4-yl)C(O)O-]benzyl-	-OC(CH ₃) ₃
<i>p</i> -F-φ	R ² /R ³ = cyclic 3 carbon atoms (L-pyrrolidinyl)		<i>p</i> -[(morpholin-4-yl)C(O)O-]benzyl-	-OC(CH ₃) ₃
<i>p</i> -F-φ	R ² /R ³ = cyclic -CH ₂ -S-C(CH ₃) ₂ - (L-5,5-dimethylthiazolidin-4-yl)		<i>p</i> -[(CH ₃) ₂ NC(O)O-]benzyl-	-OH
<i>p</i> -F-φ	R ² /R ³ = cyclic -CH ₂ -CH ₂ -SO ₂ -CH ₂ - (L-1,1-dioxothiomorpholin-3-yl)		<i>p</i> -[(morpholin-4-yl)C(O)O-]benzyl-	-OC(CH ₃) ₃
<i>p</i> -F ₃ CO-φ	R ² /R ³ = cyclic 3 carbon atoms (L-pyrrolidinyl)		<i>p</i> -[(CH ₃) ₂ NC(O)O-]benzyl-	-OC(CH ₃) ₃
<i>p</i> -CH ₃ -φ	R ² /R ³ = cyclic -CH ₂ -CH ₂ -SO ₂ -CH ₂ - (L-1,1-dioxothiomorpholin-3-yl)		<i>p</i> -[(CH ₃) ₂ NC(O)O-]benzyl-	-OCH(CH ₃) ₂

R ¹	R ²	R ³	R ⁵	R ⁶
<i>p</i> -F-φ	R ² /R ³ = cyclic -CH ₂ -SO ₂ -C(CH ₃) ₂ - (L-1,1-dioxo-5,5- dimethylthiazolidin-4-yl)		<i>p</i> -[(CH ₃) ₂ NC(O)O-]benzyl-	-OC(CH ₃) ₃
<i>p</i> -CH ₃ -φ	R ² /R ³ = cyclic -CH ₂ -SO ₂ -C(CH ₃) ₂ - (L-1,1-dioxo-5,5- dimethylthiazolidin-4-yl)		<i>p</i> -[(CH ₃) ₂ NC(O)O-]benzyl-	-OCH(CH ₃) ₂
<i>p</i> -CH ₃ -φ	R ² /R ³ = cyclic -CH ₂ -CH ₂ -SO ₂ -CH ₂ - (L-1,1-dioxothiomorpholin-3-yl)		<i>p</i> -[(morpholin-4-yl)C(O)O-]benzyl-	-OH
<i>p</i> -F-φ	R ² /R ³ = cyclic -CH ₂ -SO ₂ -C(CH ₃) ₂ - (L-1,1-dioxo-5,5- dimethylthiazolidin-4-yl)		<i>p</i> -[(CH ₃) ₂ NC(O)O-]benzyl-	-OH
pyrimidin-2-yl	R ² /R ³ = cyclic 3 carbon atoms (L-pyrrolidiny)		<i>p</i> -[(CH ₃) ₂ NC(O)O-]benzyl-	-OH
<i>p</i> -CH ₃ -φ	R ² /R ³ = cyclic -CH ₂ -CH ₂ -SO ₂ -CH ₂ - (L-1,1-dioxothiomorpholin-3-yl)		<i>p</i> -[(4-methylpiperazin-1-yl)C(O)O-]benzyl-	-OC(CH ₃) ₃
<i>p</i> -F-φ	R ² /R ³ = cyclic -CH ₂ -SO ₂ -CH ₂ - (L-1,1-dioxothiazolidin-4-yl)		<i>p</i> -[(CH ₃) ₂ NC(O)O-]benzyl-	-OC(CH ₃) ₃
2,5-dichlorothien-3-yl	R ² /R ³ = cyclic 3 carbon atoms (L-pyrrolidiny)		<i>p</i> -[(CH ₃) ₂ NC(O)O-]benzyl-	-OC(CH ₃) ₃
<i>p</i> -CH ₃ C(O)NH-φ	R ² /R ³ = cyclic 3 carbon atoms (L-pyrrolidiny)		<i>p</i> -[(CH ₃) ₂ NC(O)O-]benzyl-	-OC(CH ₃) ₃

R ¹	R ²	R ³	R ⁵	R ⁶
<i>p</i> -C(CH ₃) ₃ -φ	R ² /R ³ = cyclic -CH ₂ -CH ₂ -SO ₂ -CH ₂ - (L-1,1-dioxothiomorpholin-3-yl)		<i>p</i> -[(CH ₃) ₂ NC(O)O-]benzyl-	-OC(CH ₃) ₃
pyridin-2-yl	R ² /R ³ = cyclic 3 carbon atoms (L-pyrrolidiny)		<i>p</i> -[(CH ₃) ₂ NC(O)O-]benzyl-	-OH
<i>o</i> -F-φ	R ² /R ³ = cyclic -CH ₂ -CH ₂ -SO ₂ -CH ₂ - (L-1,1-dioxothiomorpholin-3-yl)		<i>p</i> -[(CH ₃) ₂ NC(O)O-]benzyl-	-OC(CH ₃) ₃
<i>m</i> -F-φ	R ² /R ³ = cyclic -CH ₂ -CH ₂ -SO ₂ -CH ₂ - (L-1,1-dioxothiomorpholin-3-yl)		<i>p</i> -[(CH ₃) ₂ NC(O)O-]benzyl-	-OC(CH ₃) ₃
2,4-difluoro-φ	R ² /R ³ = cyclic -CH ₂ -CH ₂ -SO ₂ -CH ₂ - (L-1,1-dioxothiomorpholin-3-yl)		<i>p</i> -[(CH ₃) ₂ NC(O)O-]benzyl-	-OC(CH ₃) ₃
<i>p</i> -CH ₃ C(O)NH-φ	R ² /R ³ = cyclic 3 carbon atoms (L-pyrrolidiny)		<i>p</i> -[(CH ₃) ₂ NC(O)O-]benzyl-	-OH
<i>p</i> -C(F) ₃ O-φ	R ² /R ³ = cyclic 3 carbon atoms (L-pyrrolidiny)		<i>p</i> -[(CH ₃) ₂ NC(O)O-]benzyl-	-OH
<i>p</i> -F-φ	R ² /R ³ = cyclic -CH ₂ -S-C(CH ₃) ₂ - (L-5,5-dimethylthiazolidin-4-yl)		<i>p</i> -[(CH ₃) ₂ NC(O)O-]benzyl-	-OCH(CH ₃) ₂
<i>p</i> -N≡C-φ	R ² /R ³ = cyclic 3 carbon atoms (L-pyrrolidiny)		<i>p</i> -[(CH ₃) ₂ NC(O)O-]benzyl-	-OH
morpholin-4-yl	R ² /R ³ = cyclic 3 carbon atoms (L-pyrrolidiny)		<i>p</i> -[(CH ₃) ₂ NC(O)O-]benzyl-	-OC(CH ₃) ₃

R ¹	R ²	R ³	R ⁵	R ⁶
<i>p</i> -CH ₃ -φ	R ² /R ³ = cyclic -CH ₂ -CH ₂ -C(CH ₃) ₂ - (L-4,4-dimethyl pyrrolidinyI)		<i>p</i> -[(CH ₃) ₂ NC(O)O-]benzyl-	-OC(CH ₃) ₃
<i>p</i> -CH ₃ -φ	R ² /R ³ = cyclic -CH ₂ -CH ₂ -C(CH ₃) ₂ - (L-4,4-dimethyl pyrrolidinyI)		<i>p</i> -[(CH ₃) ₂ NC(O)O-]benzyl-	-OCH(CH ₃) ₂
1-methylpyrazol-4-yl	R ² /R ³ = cyclic 3 carbon atoms (L-pyrrolidinyI)		<i>p</i> -[(CH ₃) ₂ NC(O)O-]benzyl-	-OCH(CH ₃) ₂
<i>p</i> -CH ₃ -φ	R ² /R ³ = cyclic -CH ₂ -S-C(CH ₃) ₂ - (L-5,5-dimethylthiazolidin-4-yl)		<i>p</i> -[(CH ₃) ₂ NC(O)O-]benzyl-	-OCH(CH ₃) ₂
<i>p</i> -CH ₃ -φ	R ² /R ³ = cyclic 3 carbon atoms (L-pyrrolidinyI)		<i>p</i> -[(thiomorpholin-4-yl)C(O)O-]benzyl-	-OC(CH ₃) ₃
1-methylimidazol-4-yl	R ² /R ³ = cyclic 3 carbon atoms (L-pyrrolidinyI)		<i>p</i> -[(CH ₃) ₂ NC(O)O-]benzyl-	-OH
<i>p</i> -CH ₃ -φ	R ² /R ³ = cyclic -CH ₂ -CH ₂ -SO ₂ -CH ₂ - (L-1,1-dioxothiomorpholin-3-yl)		<i>p</i> -[(CH ₃) ₂ NC(O)O-]benzyl-	-OC(CH ₃) ₃
1-methylpyrazol-4-yl	R ² /R ³ = cyclic -CH ₂ -S-C(CH ₃) ₂ - (L-5,5-dimethylthiazolidin-4-yl)		<i>p</i> -[(CH ₃) ₂ NC(O)O-]benzyl-	-OC(CH ₃) ₃
<i>p</i> -CH ₃ C(O)NH-φ	R ² /R ³ = cyclic 3 carbon atoms (L-pyrrolidinyI)		<i>p</i> -[(CH ₃) ₂ NC(O)O-]benzyl-	-OC(CH ₃) ₃
<i>p</i> -(CH ₃) ₃ C-φ	R ² /R ³ = cyclic -CH ₂ -CH ₂ -SO ₂ -CH ₂ - (L-1,1-dioxothiomorpholin-3-yl)		<i>p</i> -[(CH ₃) ₂ NC(O)O-]benzyl-	-OC(CH ₃) ₃

R ¹	R ²	R ³	R ⁵	R ⁶
1-methylpyrazol-4-yl	R ² /R ³ = cyclic -CH ₂ -S-C(CH ₃) ₂ - (L-5,5-dimethylthiazolidin-4-yl)		<i>p</i> -[(CH ₃) ₂ NC(O)O-]benzyl-	-OH
pyridin-3-yl-	R ² /R ³ = cyclic 3 carbon atoms (L-pyrrolidiny)		<i>p</i> -[(CH ₃) ₂ NC(O)O-]benzyl-	-OH
<i>p</i> -N=C-φ-	R ² /R ³ = cyclic 3 carbon atoms (L-pyrrolidiny)		<i>p</i> -[(CH ₃) ₂ NC(O)O-]benzyl-	-OH
<i>p</i> -F-φ-	R ² /R ³ = cyclic -CH ₂ -S-C(CH ₃) ₂ - (L-5,5-dimethylthiazolidin-4-yl)		<i>p</i> -[(CH ₃) ₂ NC(O)O-]benzyl-	-OCH(CH ₃) ₂
<i>p</i> -CH ₃ -φ-	R ² /R ³ = cyclic 3 carbon atoms (L-pyrrolidiny)		<i>p</i> -[(1,4-dioxa-8-azaspiro[4.5]decan-8-yl)-C(O)O-]benzyl-	-OCH ₂ CH ₃
<i>p</i> -CH ₃ -φ-	R ² /R ³ = cyclic 3 carbon atoms (L-pyrrolidiny)		<i>p</i> -[(1,4-dioxa-8-azaspiro[4.5]decan-8-yl)-C(O)O-]benzyl-	-OH
<i>p</i> -CH ₃ -φ-	R ² /R ³ = cyclic 3 carbon atoms (L-pyrrolidiny)		<i>p</i> -[(4-acetyl)piperazin-1-yl]C(O)O-]benzyl-	-OH
<i>p</i> -CH ₃ -φ-	R ² /R ³ = cyclic 3 carbon atoms (L-pyrrolidiny)		<i>p</i> -[(4-methanesulfonyl)piperazin-1-yl]-C(O)O-]benzyl-	-OH
<i>p</i> -CH ₃ -φ-	R ² /R ³ = cyclic 3 carbon atoms (L-pyrrolidiny)		<i>p</i> -[(4-φ-piperazin-1-yl)C(O)(O)-]benzyl-	-OH
<i>p</i> -CH ₃ -φ-	R ² /R ³ = cyclic 3 carbon atoms (L-pyrrolidiny)		<i>p</i> -[(piperazin-1-yl)C(O)O-]benzyl-	-OC(CH ₃) ₃

R ¹	R ²	R ³	R ⁵	R ⁶
<i>p</i> -CH ₃ -φ-	R ² /R ³ = cyclic -CH ₂ CH ₂ -NH-CH ₂ - (L-piperaziny)		<i>p</i> -[(CH ₃) ₂ NC(O)O-]benzyl-	-OC(CH ₃) ₃
<i>p</i> -F ₃ CO-φ-	R ² /R ³ = cyclic 3 carbon atoms (L-pyrrolidiny)		<i>p</i> -[(CH ₃) ₂ NC(O)O-]benzyl-	-OH
<i>p</i> -CH ₃ -φ-	R ² /R ³ = cyclic -CH ₂ -CH ₂ -C(CH ₃) ₂ - (4,4-dimethyl pyrrolidiny)		<i>p</i> -[(CH ₃) ₂ NC(O)O-]benzyl-	-OC(CH ₃) ₃
<i>p</i> -CH ₃ -φ-	R ² /R ³ = cyclic -CH ₂ -CH ₂ -C(CH ₃) ₂ - (4,4-dimethyl pyrrolidiny)		<i>p</i> -[(CH ₃) ₂ NC(O)O-]benzyl-	-OCH(CH ₃) ₂
<i>p</i> -CH ₃ C(O)NH-φ-	R ² /R ³ = cyclic 3 carbon atoms (L-pyrrolidiny)		<i>p</i> -[(CH ₃) ₂ NC(O)O-]benzyl-	-OH
<i>o</i> -F-φ-	R ² /R ³ = cyclic -CH ₂ -CH ₂ -SO ₂ -CH ₂ - (L-1,1-dioxothiomorpholin-3-yl)		<i>p</i> -[(CH ₃) ₂ NC(O)O-]benzyl-	-OC(CH ₃) ₃
morpholin-4-yl-	R ² /R ³ = cyclic 3 carbon atoms (L-pyrrolidiny)		<i>p</i> -[(CH ₃) ₂ NC(O)O-]benzyl-	-OC(CH ₃) ₃
<i>m</i> -F-φ-	R ² /R ³ = cyclic -CH ₂ -CH ₂ -SO ₂ -CH ₂ - (L-1,1-dioxothiomorpholin-3-yl)		<i>p</i> -[(CH ₃) ₂ NC(O)O-]benzyl-	-OC(CH ₃) ₃
2,4-difluoro-φ-	R ² /R ³ = cyclic -CH ₂ -CH ₂ -SO ₂ -CH ₂ - (L-1,1-dioxothiomorpholin-3-yl)		<i>p</i> -[(CH ₃) ₂ NC(O)O-]benzyl-	-OC(CH ₃) ₃
morpholin-4-yl-	R ² /R ³ = cyclic 3 carbon atoms (L-pyrrolidiny)		<i>p</i> -[(CH ₃) ₂ NC(O)O-]benzyl-	-OH

R ¹	R ²	R ³	R ⁵	R ⁶
1-methylpyrazol-4-yl-	R ² /R ³ = cyclic -CH ₂ -CH ₂ -SO ₂ -CH ₂ - (L-1,1-dioxothiomorpholin-3-yl)		<i>p</i> -[(CH ₃) ₂ NC(O)O-]benzyl-	-OC(CH ₃) ₃
<i>o</i> -F-φ-	R ² /R ³ = cyclic -CH ₂ -CH ₂ -SO ₂ -CH ₂ - (L-1,1-dioxothiomorpholin-3-yl)		<i>p</i> -[(CH ₃) ₂ NC(O)O-]benzyl-	-OH
2,4-difluoro-φ-	R ² /R ³ = cyclic -CH ₂ -CH ₂ -SO ₂ -CH ₂ - (L-1,1-dioxothiomorpholin-3-yl)		<i>p</i> -[(CH ₃) ₂ NC(O)O-]benzyl-	-OH
<i>p</i> -CH ₃ -φ-	R ² /R ³ = cyclic -CH ₂ -CH ₂ -S-CH ₂ - (L-thiomorpholin-3-yl)		<i>p</i> -[(CH ₃) ₂ NC(O)O-]benzyl-	-OH
pyridin-3-yl-	R ² /R ³ = cyclic -CH ₂ -S-C(CH ₃) ₂ - (L-5,5-dimethylthiazolidin-4-yl)		<i>p</i> -[(CH ₃) ₂ NC(O)O-]benzyl-	-OCH(CH ₃) ₂
<i>m</i> -F-φ-	R ² /R ³ = cyclic -CH ₂ -CH ₂ -SO ₂ -CH ₂ - (L-1,1-dioxothiomorpholin-3-yl)		<i>p</i> -[(CH ₃) ₂ NC(O)O-]benzyl-	-OH
pyridin-2-yl-	R ² /R ³ = cyclic 3 carbon atoms (L-pyrrolidinyl)		<i>p</i> -[(CH ₃) ₂ NC(O)O-]benzyl-	-OCH(CH ₃) ₂
1-methylpyrazol-4-yl	R ² /R ³ = cyclic -CH ₂ -CH ₂ -SO ₂ -CH ₂ - (L-1,1-dioxothiomorpholin-3-yl)		<i>p</i> -[(CH ₃) ₂ NC(O)O-]benzyl-	-OH
<i>p</i> -CH ₃ -φ-	R ² /R ³ = cyclic 3 carbon atoms (L-pyrrolidinyl)		<i>p</i> -[(4-methanesulfonylpiperazin-1-yl)-C(O)O-]benzyl-	-OC(CH ₃) ₃
<i>p</i> -CH ₃ -φ-	R ² /R ³ = cyclic 3 carbon atoms (L-pyrrolidinyl)		<i>p</i> -[(4-φ-piperazin-1-yl)C(O)(O)-]benzyl-	-OC(CH ₃) ₃

R ¹	R ²	R ³	R ⁵	R ⁶
<i>p</i> -CH ₃ -φ-	R ² /R ³ = cyclic 3 carbon atoms (L-pyrrolidinyl)		<i>p</i> -[(CH ₃) ₂ NC(O)O-]benzyl-	-O-CH ₂ C(CH ₃) ₂ - NHC(O)OC(CH ₃) ₃
<i>p</i> -CH ₃ -φ-	R ² /R ³ = cyclic 3 carbon atoms (L-pyrrolidinyl)		<i>p</i> -[(CH ₃) ₂ NC(O)O-]benzyl-	-O-CH ₂ CH ₂ - (morpholin-4-yl)
<i>p</i> -CH ₃ -φ-	R ² /R ³ = cyclic 3 carbon atoms (L-pyrrolidinyl)		<i>p</i> -[(4-acetylpiperazin-1-yl)C(O)O-]benzyl-	-OC(CH ₃) ₃
<i>p</i> -CH ₃ -φ-	R ² /R ³ = cyclic 3 carbon atoms (L-pyrrolidinyl)		<i>p</i> -[(CH ₃) ₂ NCH ₂ CH ₂ N(CH ₃)C(O)O-]benzyl-	-OC(CH ₃) ₃
<i>p</i> -CH ₃ -φ-	R ² /R ³ = cyclic -CH ₂ -S-C(CH ₃) ₂ - (L-5,5-dimethylthiazolidin-4-yl)		<i>p</i> -[(CH ₃) ₂ NCH ₂ CH ₂ N(CH ₃)C(O)O-]benzyl-	-OC(CH ₃) ₃
<i>p</i> -CH ₃ -φ-	R ² /R ³ = cyclic -CH ₂ -S-C(CH ₃) ₂ - (L-5,5-dimethylthiazolidin-4-yl)		<i>p</i> -[(CH ₃) ₂ NCH ₂ CH ₂ N(CH ₃)C(O)O-]benzyl-	-OH
<i>p</i> -CH ₃ -φ-	R ² /R ³ = cyclic 3 carbon atoms (L-pyrrolidinyl)		<i>p</i> -[(CH ₃) ₂ NCH ₂ CH ₂ N(CH ₃)C(O)O-]benzyl-	-OH
<i>p</i> -CH ₃ -φ-	R ² /R ³ = cyclic 3 carbon atoms (L-pyrrolidinyl)		<i>p</i> -[(4-hydroxypiperidin-1-yl)C(O)O-]benzyl-	-OC(CH ₃) ₃
<i>p</i> -(CH ₃) ₃ C-φ-	R ² /R ³ = cyclic -CH ₂ -CH ₂ -SO ₂ -CH ₂ - (L-1,1-dioxothiomorpholin-3-yl)		<i>p</i> -[(CH ₃) ₂ NC(O)O-]benzyl-	-OH
<i>p</i> -CH ₃ -φ-	R ² /R ³ = cyclic -CH ₂ -S-C(CH ₃) ₂ - (L-5,5-dimethylthiazolidin-4-yl)		<i>p</i> -[(thiomorpholin-4-yl)C(O)O-]benzyl-	-OC(CH ₃) ₃

R ¹	R ²	R ³	R ⁵	R ⁶
2,5-dichlorothien-3-yl-	R ² /R ³ = cyclic 3 carbon atoms (L-pyrrolidiny)		<i>p</i> -[(CH ₃) ₂ NC(O)O-]benzyl-	-OH
<i>p</i> -CH ₃ O-φ-	R ² /R ³ = cyclic 3 carbon atoms (L-pyrrolidiny)		<i>p</i> -[(CH ₃) ₂ NC(O)O-]benzyl-	-OCH(CH ₃) ₂
<i>p</i> -CH ₃ -φ-	R ² /R ³ = cyclic -CH ₂ -CH ₂ -C(CH ₃) ₂ - (4,4-dimethyl pyrrolidiny)		<i>p</i> -[(CH ₃) ₂ NC(O)O-]benzyl-	-OH
<i>p</i> -F-φ-	R ² /R ³ = cyclic -CH ₂ -S-C(CH ₃) ₂ - (L-5,5-dimethylthiazolidin-4-yl)		3-chloro-4-[(4-methylpiperazin-1-yl)C(O)O-]-benzyl-	-OC(CH ₃) ₃
<i>p</i> -F-φ-	R ² /R ³ = cyclic -CH ₂ -S-C(CH ₃) ₂ - (L-5,5-dimethylthiazolidin-4-yl)		3-chloro-4-[(CH ₃) ₂ NC(O)O-]-benzyl-	-OH
<i>p</i> -F-φ-	R ² /R ³ = cyclic -CH ₂ -S-C(CH ₃) ₂ - (L-5,5-dimethylthiazolidin-4-yl)		3-chloro-4-[(thiomorpholin-4-yl)C(O)O-]-benzyl-	-OC(CH ₃) ₃
<i>p</i> -CH ₃ -φ-	R ² /R ³ = cyclic 3 carbon atoms (L-pyrrolidiny)		<i>p</i> -[(morpholin-4-yl)-CH ₂ CH ₂ NHC(O)O-]benzyl-	-OC(CH ₃) ₃
<i>p</i> -CH ₃ -φ-	R ² /R ³ = cyclic 3 carbon atoms (L-pyrrolidiny)		<i>p</i> -[(1,4-dioxo-8-azaspiro[4.5]decan-8-yl)-C(O)O-]benzyl-	-OC(CH ₃) ₃
<i>p</i> -F-φ-	R ² /R ³ = cyclic -CH ₂ -S-C(CH ₃) ₂ - (L-5,5-dimethylthiazolidin-4-yl)		3-chloro-4-[(CH ₃) ₂ NC(O)O-]-benzyl-	-OC(CH ₃) ₃
<i>p</i> -CH ₃ -φ-	R ² /R ³ = cyclic -CH ₂ -S-C(CH ₃) ₂ - (L-5,5-dimethylthiazolidin-4-yl)		<i>p</i> -[(thiomorpholin-4-yl)C(O)O-]benzyl-	-OH

R ¹	R ²	R ³	R ⁵	R ⁶
pyridin-2-yl-	R ² /R ³ = cyclic 3 carbon atoms (L-pyrrolidiny)		<i>p</i> -[(CH ₃) ₂ NC(O)O-]benzyl-	-OH
<i>p</i> -CH ₃ -φ-	R ² /R ³ = cyclic -CH ₂ -CH ₂ -(O)-CH ₂ - (L-1-oxothiomorpholin-4-yl)		<i>p</i> -[(CH ₃) ₂ NC(O)O-]benzyl-	-OCH(CH ₃) ₂
4-Cl-3-(NH ₂ -SO ₂ -)-φ-	R ² /R ³ = cyclic 3 carbon atoms (L-pyrrolidiny)		<i>p</i> -[(CH ₃) ₂ NC(O)O-]benzyl-	-OCH(CH ₃) ₂
<i>p</i> -F-φ-	R ² /R ³ = cyclic -CH ₂ -S-C(CH ₃) ₂ - (L-5,5-dimethylthiazolidin-4-yl)		3-chloro-4-[(thiomorpholin-4-yl)C(O)O-]-benzyl-	-OCH(CH ₃) ₂
<i>p</i> -F-φ-	R ² /R ³ = cyclic -CH ₂ -S-C(CH ₃) ₂ - (L-5,5-dimethylthiazolidin-4-yl)		3-chloro-4-[(CH ₃) ₂ NC(O)O-]-benzyl-	-OCH(CH ₃) ₂
<i>p</i> -CH ₃ -φ-	R ² /R ³ = cyclic 3 carbon atoms (L-pyrrolidiny)		<i>p</i> -[HOCH ₂ CH ₂ N(CH ₃)C(O)O-]benzyl-	-OC(CH ₃) ₃
<i>p</i> -F-φ-	R ² /R ³ = cyclic -CH ₂ -S-C(CH ₃) ₂ - (L-5,5-dimethylthiazolidin-4-yl)		<i>p</i> -[(2-(hydroxymethyl)pyrrolidin-1-yl)-C(O)O-]-benzyl-	-OC(CH ₃) ₃
<i>p</i> -F-φ-	R ² /R ³ = cyclic -CH ₂ -S-C(CH ₃) ₂ - (L-5,5-dimethylthiazolidin-4-yl)		<i>p</i> -[(2-(hydroxymethyl)pyrrolidin-1-yl)-C(O)O-]-benzyl-	-OH
<i>p</i> -CH ₃ -φ-	R ² /R ³ = cyclic 3 carbon atoms (L-pyrrolidiny)		<i>p</i> -[(2-(CH ₃ OC(O)-)pyrrolidin-1-yl)-C(O)O-]-benzyl-	-OC(CH ₃) ₃
<i>p</i> -CH ₃ -φ-	R ² /R ³ = cyclic 3 carbon atoms (L-pyrrolidiny)		<i>p</i> -[(4-(HC(O)O-)piperidin-1-yl)-C(O)O-]-benzyl-	-OH

R ¹	R ²	R ³	R ⁵	R ⁶
<i>p</i> -CH ₃ -φ-	R ² /R ³ = cyclic 3 carbon atoms (L-pyrrolidinyl)		<i>p</i> -[(4-(hydroxypiperidin-1-yl)-C(O)O)-]benzyl-	-OCH(CH ₃) ₂
<i>p</i> -F-φ-	R ² /R ³ = cyclic -CH ₂ -S-C(CH ₃) ₂ - (L-5,5-dimethylthiazolidin-4-yl)		3-chloro-4-[(thiomorpholin-4-yl)C(O)O]-]benzyl-	-OH
<i>p</i> -CH ₃ -φ-	R ² /R ³ = cyclic 3 carbon atoms (L-pyrrolidinyl)		<i>p</i> -[(4-(CH ₃ CH ₂ OC(O)-)piperidin-1-yl)C(O)O]-]benzyl-	-OC(CH ₃) ₃
<i>p</i> -CH ₃ -φ-	R ² /R ³ = cyclic 3 carbon atoms (L-pyrrolidinyl)		<i>p</i> -[(4-(HOCH ₂ CH ₂)piperazin-1-yl)-C(O)O]-]benzyl-	-OC(CH ₃) ₃
<i>p</i> -F-φ-	R ² /R ³ = cyclic -CH ₂ -S-C(CH ₃) ₂ - (L-5,5-dimethylthiazolidin-4-yl)		<i>p</i> -[(4-(pyridin-2-yl)piperazin-1-yl)-C(O)O]-]benzyl-	-OH
<i>p</i> -F-φ-	R ² /R ³ = cyclic -CH ₂ -S-C(CH ₃) ₂ - (L-5,5-dimethylthiazolidin-4-yl)		<i>p</i> -[(4-(pyridin-2-yl)piperazin-1-yl)-C(O)O]-]benzyl-	-OC(CH ₃) ₃
<i>p</i> -CH ₃ -φ-	R ² /R ³ = cyclic 3 carbon atoms (L-pyrrolidinyl)		<i>p</i> -[HC(O)OCH ₂ CH ₂ N(CH ₃)C(O)O]-]benzyl-	-OH
<i>p</i> -CH ₃ -φ-	R ² /R ³ = cyclic 3 carbon atoms (L-pyrrolidinyl)		<i>p</i> -[HOCH ₂ CH ₂ N(CH ₃)C(O)O]-]benzyl-	-OCH(CH ₃) ₂
<i>p</i> -CH ₃ -φ-	R ² /R ³ = cyclic 3 carbon atoms (L-pyrrolidinyl)		<i>p</i> -[CH ₃ OC(O)CH ₂ NHC(O)O]-]benzyl-	-OC(CH ₃) ₃
quinolin-8-yl-	R ² /R ³ = cyclic 3 carbon atoms (L-pyrrolidinyl)		<i>p</i> -[(CH ₃) ₂ NC(O)O]-]benzyl-	-OCH(CH ₃) ₂

R ¹	R ²	R ³	R ⁵	R ⁶
3,4-difluoro-φ-	R ² /R ³ = cyclic 3 carbon atoms (L-pyrrolidiny)		<i>p</i> -[(CH ₃) ₂ NC(O)O-]benzyl-	-OCH(CH ₃) ₂
<i>p</i> -CH ₃ -φ-	R ² /R ³ = cyclic 3 carbon atoms (L-pyrrolidiny)		<i>p</i> -[(thiomorpholin-4-yl)-C(O)O-]benzyl-	-OCH(CH ₃) ₂
<i>p</i> -CH ₃ O-φ-	R ² /R ³ = cyclic 3 carbon atoms (L-pyrrolidiny)		<i>p</i> -[(CH ₃) ₂ NC(O)O-]benzyl-	-OH
<i>p</i> -CH ₃ -φ-	R ² /R ³ = cyclic -CH ₂ -CH ₂ -(O)-CH ₂ - (L-1-oxothiomorpholin-4-yl)		<i>p</i> -[(CH ₃) ₂ NC(O)O-]benzyl-	-OH
3,4-difluoro-φ-	R ² /R ³ = cyclic -CH ₂ CH ₂ -SO ₂ -CH ₂ - (L-1,1-dioxothiomorpholin-3-yl)		<i>p</i> -[(CH ₃) ₂ NC(O)O-]benzyl-	-OC(CH ₃) ₃
<i>p</i> -H ₂ N-φ-	R ² /R ³ = cyclic 3 carbon atoms (L-pyrrolidiny)		<i>p</i> -[(CH ₃) ₂ NC(O)O-]benzyl-	-OCH(CH ₃) ₂
3,4-difluoro-φ-	R ² /R ³ = cyclic -CH ₂ CH ₂ -SO ₂ -CH ₂ - (L-1,1-dioxothiomorpholin-3-yl)		<i>p</i> -[(CH ₃) ₂ NC(O)O-]benzyl-	-OH
3,4-difluoro-φ-	R ² /R ³ = cyclic 3 carbon atoms (L-pyrrolidiny)		<i>p</i> -[(CH ₃) ₂ NC(O)O-]benzyl-	-OH
quinolin-8-yl-	R ² /R ³ = cyclic 3 carbon atoms (L-pyrrolidiny)		<i>p</i> -[(CH ₃) ₂ NC(O)O-]benzyl-	-OH
1-methylpyrazol-4-yl-	R ² /R ³ = cyclic -CH ₂ -S-C(CH ₃) ₂ - (L-5,5-dimethylthiazolidin-4-yl)		<i>p</i> -[(CH ₃) ₂ NC(O)O-]benzyl-	-OCH(CH ₃) ₂

R ¹	R ²	R ³	R ⁵	R ⁶
<i>p</i> -CH ₃ -φ-	R ² /R ³ = cyclic -CH ₂ -CH ₂ -(O)-CH ₂ - (L-1-oxothiophorolin-4-yl)		<i>p</i> -[(CH ₃) ₂ NC(O)O-]benzyl-	-OC(CH ₃) ₃
1- <i>n</i> -butylpyrazol-4-yl-	R ² /R ³ = cyclic -CH ₂ -S-C(CH ₃) ₂ - (L-5,5-dimethylthiazolidin-4-yl)		<i>p</i> -[(CH ₃) ₂ NC(O)O-]benzyl-	-OCH(CH ₃) ₂
1-methylpyrazol-3-yl	R ² /R ³ = cyclic -CH ₂ -S-C(CH ₃) ₂ - (L-5,5-dimethylthiazolidin-4-yl)		<i>p</i> -[(CH ₃) ₂ NC(O)O-]benzyl-	-OCH(CH ₃) ₂
2-(CF ₃ C(O)-)-1,2,3,4-tetrahydro-isoquinolin-7-yl	R ² /R ³ = cyclic 3 carbon atoms (L-pyrrolidiny)		<i>p</i> -[(CH ₃) ₂ NC(O)O-]benzyl-	-OCH(CH ₃) ₂
<i>p</i> -CH ₃ -φ-	R ² /R ³ = cyclic 3 carbon atoms (L-pyrrolidiny)		<i>p</i> -[(4-(φNHC(O)-)-piperazin-1-yl)-C(O)O-]benzyl-	-OH
<i>p</i> -CH ₃ -φ-	R ² /R ³ = cyclic 3 carbon atoms (L-pyrrolidiny)		<i>p</i> -[(4-methoxypiperidin-1-yl)C(O)O-]benzyl-	-OH
<i>p</i> -CH ₃ -φ-	R ² /R ³ = cyclic 3 carbon atoms (L-pyrrolidiny)		<i>p</i> -[(4-(pyridin-4-ylC(O))piperazin-1-yl)-C(O)O-]benzyl-	-OCH(CH ₃) ₂
<i>p</i> -CH ₃ -φ-	R ² /R ³ = cyclic -CH ₂ -C(O)-CH ₂ - (L-4-oxopyrrolidiny)		<i>p</i> -[(CH ₃) ₂ NC(O)O-]benzyl-	-OC(CH ₃) ₃
<i>p</i> -CH ₃ -φ-	R ² /R ³ = cyclic -CH ₂ -CH(OH)CH ₂ - (L-4-hydroxypyrrolidiny)		<i>p</i> -[(CH ₃) ₂ NC(O)O-]benzyl-	-OC(CH ₃) ₃
<i>m</i> -F-φ-	R ² /R ³ = cyclic 3 carbon atoms (L-pyrrolidiny)		<i>p</i> -[(CH ₃) ₂ NC(O)O-]benzyl-	-OC(CH ₃) ₃

R ¹	R ²	R ³	R ⁵	R ⁶
<i>p</i> -CH ₃ -φ-	R ² /R ³ = cyclic 3 carbon atoms (L-pyrrolidiny)		<i>p</i> -[(4-methoxypiperidin-1-yl)C(O)O-]benzyl-	-OCH(CH ₃) ₂
<i>p</i> -CH ₃ -φ-	R ² /R ³ = cyclic 3 carbon atoms (L-pyrrolidiny)		<i>p</i> -[(4-(φNHC(O)-)piperazin-1-yl)-C(O)O-]benzyl-	-OCH(CH ₃) ₂
<i>p</i> -(φNHC(O)NH)φ-	R ² /R ³ = cyclic 3 carbon atoms (L-pyrrolidiny)		<i>p</i> -[(CH ₃) ₂ NC(O)O-]benzyl-	-OC(CH ₃) ₃
<i>p</i> -F-φ-	R ² /R ³ = cyclic -CH ₂ -S-C(CH ₃) ₂ - (L-5,5-dimethylthiazolidin-4-yl)		3-chloro-4-[(4-methylpiperidin-1-yl)-C(O)O-]benzyl-	-OCH(CH ₃) ₂
<i>p</i> -CH ₃ -φ-	R ² /R ³ = cyclic -CH ₂ -S-C(CH ₃) ₂ - (L-5,5-dimethylthiazolidin-4-yl)		3-chloro-4-[(CH ₃) ₂ NC(O)O-]benzyl-	-OCH(CH ₃) ₂
<i>p</i> -CH ₃ -φ-	R ² /R ³ = cyclic 3 carbon atoms (L-pyrrolidiny)		<i>p</i> -[(4-(CH ₃ SO ₂ -)piperazin-1-yl)-C(O)O]benzyl-	-OC(CH ₃) ₃
<i>p</i> -CH ₃ -φ-	R ² /R ³ = cyclic 3 carbon atoms (L-pyrrolidiny)		<i>p</i> -[(morpholin-4-yl)CH ₂ CH ₂ NHC(O)O-]benzyl-	-OH
<i>p</i> -CH ₃ -φ-	R ² /R ³ = cyclic 3 carbon atoms (L-pyrrolidiny)		<i>p</i> -[(4-(HO(O)-)piperidin-1-yl)C(O)O-]benzyl-	-OH
<i>p</i> -CH ₃ -φ-	R ² /R ³ = cyclic 3 carbon atoms (L-pyrrolidiny)		<i>p</i> -[(HOCH ₂ CH ₂) ₂ NC(O)O-]benzyl-	-OCH(CH ₃) ₂
<i>p</i> -O ₂ N-φ-	R ² /R ³ = cyclic 3 carbon atoms (L-pyrrolidiny)		<i>p</i> -[(CH ₃) ₂ NC(O)O-]benzyl-	-OCH(CH ₃) ₂

R ¹	R ²	R ³	R ⁵	R ⁶
<i>p</i> -CH ₃ -φ-	R ² /R ³ = cyclic 3 carbon atoms (L-pyrrolidinyl)		<i>p</i> -[(4-(HOCH ₂ -)piperidin-1-yl)-C(O)O-]benzyl-	-OCH(CH ₃) ₂
<i>p</i> -CH ₃ -φ-	R ² /R ³ = cyclic 3 carbon atoms (L-pyrrolidinyl)		3-chloro-4-[(CH ₃) ₂ NC(O)O-]benzyl-	-OCH(CH ₃) ₂
<i>p</i> -CH ₃ -φ-	R ² /R ³ = cyclic -CH ₂ -CH ₂ -S-CH ₂ - (L-thiomorpholin-3-yl)		<i>p</i> -[(CH ₃) ₂ NC(O)O-]benzyl-	-OCH(CH ₃) ₂
1-methylpyrazol-3-yl-	R ² /R ³ = cyclic -CH ₂ -S-C(CH ₃) ₂ - (L-5,5-dimethylthiazolidin-4-yl)		<i>p</i> -[(CH ₃) ₂ NC(O)O-]benzyl-	-OH
<i>m</i> -F-φ-	R ² /R ³ = cyclic -CH ₂ -S-C(CH ₃) ₂ - (L-5,5-dimethylthiazolidin-4-yl)		<i>p</i> -[(CH ₃) ₂ NC(O)O-]benzyl-	-OCH(CH ₃) ₂
<i>o</i> -F-φ-	R ² /R ³ = cyclic -CH ₂ -S-C(CH ₃) ₂ - (L-5,5-dimethylthiazolidin-4-yl)		<i>p</i> -[(CH ₃) ₂ NC(O)O-]benzyl-	-OCH(CH ₃) ₂
3,4-difluoro-φ-	R ² /R ³ = cyclic -CH ₂ -S-C(CH ₃) ₂ - (L-5,5-dimethylthiazolidin-4-yl)		<i>p</i> -[(CH ₃) ₂ NC(O)O-]benzyl-	-OCH(CH ₃) ₂
3,5-difluoro-φ-	R ² /R ³ = cyclic -CH ₂ -S-C(CH ₃) ₂ - (L-5,5-dimethylthiazolidin-4-yl)		<i>p</i> -[(CH ₃) ₂ NC(O)O-]benzyl-	-OCH(CH ₃) ₂
2,4-difluoro-φ-	R ² /R ³ = cyclic -CH ₂ -S-C(CH ₃) ₂ - (L-5,5-dimethylthiazolidin-4-yl)		<i>p</i> -[(CH ₃) ₂ NC(O)O-]benzyl-	-OCH(CH ₃) ₂
<i>p</i> -NH ₂ -φ-	R ² /R ³ = cyclic 3 carbon atoms (L-pyrrolidinyl)		<i>p</i> -[(CH ₃) ₂ NC(O)O-]benzyl-	-OH

R ¹	R ²	R ³	R ⁵	R ⁶
<i>p</i> -N≡C-φ-	R ² /R ³ = cyclic 3 carbon atoms (L-pyrrolidiny)		<i>p</i> -[(CH ₃) ₂ NC(O)O-]benzyl-	-OCH(CH ₃) ₂
<i>p</i> -CH ₃ -φ-	R ² /R ³ = cyclic -CH ₂ CH(OH)CH ₂ - (L-4-hydroxypyrrolidiny)		<i>p</i> -[(CH ₃) ₂ NC(O)O-]benzyl-	-OH
<i>p</i> -CH ₃ -φ-	R ² /R ³ = cyclic -CH ₂ C(O)CH ₂ - (L-4-oxypyrrolidiny)		<i>p</i> -[(CH ₃) ₂ NC(O)O-]benzyl-	-OH
pyridin-2-yl-	R ² /R ³ = cyclic -CH ₂ -S-C(CH ₃) ₂ - (L-5,5-dimethylthiazolidin-4-yl)		<i>p</i> -[(CH ₃) ₂ NC(O)O-]benzyl-	-OCH(CH ₃) ₂
<i>p</i> -Cl-φ-	R ² /R ³ = cyclic -CH ₂ -S-C(CH ₃) ₂ - (L-5,5-dimethylthiazolidin-4-yl)		<i>p</i> -[(CH ₃) ₂ NC(O)O-]benzyl-	-OCH(CH ₃) ₂
<i>m</i> -Cl-φ-	R ² /R ³ = cyclic -CH ₂ -S-C(CH ₃) ₂ - (L-5,5-dimethylthiazolidin-4-yl)		<i>p</i> -[(CH ₃) ₂ NC(O)O-]benzyl-	-OCH(CH ₃) ₂
<i>o</i> -Cl-φ-	R ² /R ³ = cyclic -CH ₂ -S-C(CH ₃) ₂ - (L-5,5-dimethylthiazolidin-4-yl)		<i>p</i> -[(CH ₃) ₂ NC(O)O-]benzyl-	-OCH(CH ₃) ₂
3,4-dichloro-φ-	R ² /R ³ = cyclic -CH ₂ -S-C(CH ₃) ₂ - (L-5,5-dimethylthiazolidin-4-yl)		<i>p</i> -[(CH ₃) ₂ NC(O)O-]benzyl-	-OCH(CH ₃) ₂
3,5-dichloro-φ-	R ² /R ³ = cyclic -CH ₂ -S-C(CH ₃) ₂ - (L-5,5-dimethylthiazolidin-4-yl)		<i>p</i> -[(CH ₃) ₂ NC(O)O-]benzyl-	-OCH(CH ₃) ₂
1-methylpyrazol-4-yl-	R ² /R ³ = cyclic -CH ₂ -S-C(CH ₃) ₂ - (L-5,5-dimethylthiazolidin-4-yl)		<i>p</i> -[(CH ₃) ₂ NC(O)O-]benzyl-	-OCH ₂ CH ₃

R ¹	R ²	R ³	R ⁵	R ⁶
pyridin-3-yl-	R ² /R ³ = cyclic -CH ₂ -S-C(CH ₃) ₂ - (L-5,5-dimethylthiazolidin-4-yl)		<i>p</i> -[(CH ₃) ₂ NC(O)O-]benzyl-	-OH
1-methylpyrazol-4-yl-	R ² /R ³ = cyclic -CH ₂ -S-C(CH ₃) ₂ - (L-5,5-dimethylthiazolidin-4-yl)		<i>p</i> -[(thiomorpholin-4-yl)-C(O)O-]benzyl-	-OCH(CH ₃) ₂
quinolin-8-yl	R ² /R ³ = cyclic -CH ₂ -S-C(CH ₃) ₂ - (L-5,5-dimethylthiazolidin-4-yl)		<i>p</i> -[(CH ₃) ₂ NC(O)O-]benzyl-	-OCH(CH ₃) ₂
<i>m</i> -Cl-φ-	R ² /R ³ = cyclic -CH ₂ CH ₂ -SO ₂ -CH ₂ - (L-1,1-dioxothiomorpholin-3-yl)		<i>p</i> -[(CH ₃) ₂ NC(O)O-]benzyl-	-OC(CH ₃) ₃
pyridin-2-yl	R ² /R ³ = cyclic -CH ₂ -S-C(CH ₃) ₂ - (L-5,5-dimethylthiazolidin-4-yl)		<i>p</i> -[(CH ₃) ₂ NC(O)O-]benzyl-	-OH
3,4-dichloro-φ-	R ² /R ³ = cyclic -CH ₂ CH ₂ -SO ₂ -CH ₂ - (L-1,1-dioxothiomorpholin-3-yl)		<i>p</i> -[(CH ₃) ₂ NC(O)O-]benzyl-	-OC(CH ₃) ₃
2,5-dichlorothiien-3-yl-	R ² /R ³ = cyclic -CH ₂ -S-C(CH ₃) ₂ - (L-5,5-dimethylthiazolidin-4-yl)		<i>p</i> -[(CH ₃) ₂ NC(O)O-]benzyl-	-OCH(CH ₃) ₂
<i>p</i> -CH ₃ O-φ-	R ² /R ³ = cyclic -CH ₂ -S-C(CH ₃) ₂ - (L-5,5-dimethylthiazolidin-4-yl)		<i>p</i> -[(CH ₃) ₂ NC(O)O-]benzyl-	-OCH(CH ₃) ₂
<i>m</i> -CH ₃ O-φ-	R ² /R ³ = cyclic -CH ₂ -S-C(CH ₃) ₂ - (L-5,5-dimethylthiazolidin-4-yl)		<i>p</i> -[(CH ₃) ₂ NC(O)O-]benzyl-	-OCH(CH ₃) ₂
<i>o</i> -CH ₃ O-φ-	R ² /R ³ = cyclic -CH ₂ -S-C(CH ₃) ₂ - (L-5,5-dimethylthiazolidin-4-yl)		<i>p</i> -[(CH ₃) ₂ NC(O)O-]benzyl-	-OCH(CH ₃) ₂

R ¹	R ²	R ³	R ⁵	R ⁶
3,4-dimethoxy-φ-	R ² /R ³ = cyclic -CH ₂ -S-C(CH ₃) ₂ - (L-5,5-dimethylthiazolidin-4-yl)		<i>p</i> -[(CH ₃) ₂ NC(O)O-]benzyl-	-OCH(CH ₃) ₂
2,4-difluoro-φ-	R ² /R ³ = cyclic -CH ₂ -CH ₂ -S-CH ₂ - (L-thiomorpholin-3-yl)		<i>p</i> -[(CH ₃) ₂ NC(O)O-]benzyl-	-OC(CH ₃) ₃
3,4-dichloro-φ-	R ² /R ³ = cyclic -CH ₂ CH ₂ -SO ₂ -CH ₂ - (L-1,1-dioxothiomorpholin-3-yl)		<i>p</i> -[(CH ₃) ₂ NC(O)O-]benzyl-	-OH
<i>m</i> -Cl-φ-	R ² /R ³ = cyclic -CH ₂ CH ₂ -SO ₂ -CH ₂ - (L-1,1-dioxothiomorpholin-3-yl)		<i>p</i> -[(CH ₃) ₂ NC(O)O-]benzyl-	-OH
2,4-difluoro-φ-	R ² /R ³ = cyclic -CH ₂ -CH ₂ -S(O)-CH ₂ - (L-1-oxothiomorpholin-4-yl)		<i>p</i> -[(CH ₃) ₂ NC(O)O-]benzyl-	-OC(CH ₃) ₃
<i>p</i> -CH ₃ -φ-	R ² /R ³ = cyclic -CH ₂ -C(O)-CH ₂ - (L-4-oxopyrrolidinyl)		<i>p</i> -[(4-methylpiperizin-1-yl)C(O)O-]benzyl-	-OCH(CH ₃) ₂
<i>p</i> -CH ₃ -φ-	R ² /R ³ = cyclic -CH ₂ CH(OH)CH ₂ - (L-4-hydroxypyrrolidinyl)		<i>p</i> -[(thiomorpholin-4-yl)-C(O)O-]benzyl-	-OC(CH ₃) ₃
<i>p</i> -CH ₃ -φ-	R ² /R ³ = cyclic 3 carbon atoms (L-pyrrolidinyl)		<i>p</i> -[(3-(HOCH ₂)-piperidin-1-yl)-C(O)O-]benzyl-	-OH
<i>p</i> -CH ₃ -φ-	R ² /R ³ = cyclic -CH ₂ -CF ₂ -CH ₂ - (L-4,4-difluoro-pyrrolidinyl)		<i>p</i> -[(CH ₃) ₂ NC(O)O-]benzyl-	-OCH(CH ₃) ₂
<i>p</i> -CH ₃ -φ-	R ² /R ³ = cyclic 3 carbon atoms (L-pyrrolidinyl)		<i>p</i> -[(CH ₃) ₂ NC(O)O-]benzyl-	-O(CH ₂ CH ₂ O) ₂ CH ₃

R ¹	R ²	R ³	R ⁵	R ⁶
<i>p</i> -CH ₃ -φ-	R ² /R ³ = cyclic -CH ₂ CH(-O-C(O)thiomorpholin-4-yl)-CH ₂ - (L-4-(thiomorpholin-4-yl)C(O)O-pyrrolidiny]		<i>p</i> -[(thiomorpholin-4-yl)-C(O)O-]benzyl-	-OC(CH ₃) ₃
<i>p</i> -CH ₃ -φ-	R ² /R ³ = cyclic -CH ₂ -CF ₂ -CH ₂ - (L-4,4-difluoro-pyrrolidiny]		<i>p</i> -[(CH ₃) ₂ NC(O)O-]benzyl-	-OH
<i>p</i> -F-φ-	R ² /R ³ = cyclic -CH ₂ -S-C(CH ₃) ₂ - (L-5,5-dimethylthiazolidin-4-yl]		<i>p</i> -[(4-(pyrimidin-2-yl)piperazin-1-yl)-C(O)O-]benzyl-	-OC(CH ₃) ₃
<i>p</i> -CH ₃ -φ-	R ² /R ³ = cyclic 3 carbon atoms (L-pyrrolidiny]		<i>p</i> -[(4-(φC(O)-)piperazin-1-yl)-C(O)O-]benzyl-	-OCH(CH ₃) ₂
<i>p</i> -F-φ-	R ² /R ³ = cyclic -CH ₂ -S-C(CH ₃) ₂ - (L-5,5-dimethylthiazolidin-4-yl]		3-fluoro-4-[(CH ₃) ₂ NC(O)O-]benzyl-	-OCH(CH ₃) ₂
<i>p</i> -F-φ-	R ² /R ³ = cyclic -CH ₂ -S-C(CH ₃) ₂ - (L-5,5-dimethylthiazolidin-4-yl]		3-chloro-4-[(4-(pyridin-2-yl)piperazin-1-yl)C(O)O-]benzyl-	-OCH(CH ₃) ₂
<i>p</i> -F-φ-	R ² /R ³ = cyclic -CH ₂ -S-C(CH ₃) ₂ - (L-5,5-dimethylthiazolidin-4-yl]		3-chloro-4-[(4-(pyridin-2-yl)piperazin-1-yl)C(O)O-]benzyl-	-OC(CH ₃) ₃
<i>p</i> -CH ₃ -φ-	R ² /R ³ = cyclic -CH ₂ CH ₂ N(-SO ₂ CH ₃)-CH ₂ - (L-4-methanesulfonyl-piperazinyl]		<i>p</i> -[(CH ₃) ₂ NC(O)O-]benzyl-	-OC(CH ₃) ₃
1-methylimidazol-4-yl-	R ² /R ³ = cyclic 3 carbon atoms (L-pyrrolidiny]		<i>p</i> -[(CH ₃) ₂ NC(O)O-]benzyl-	-OCH(CH ₃) ₂
<i>p</i> -Br-φ-	R ² /R ³ = cyclic -CH ₂ -S-C(CH ₃) ₂ - (L-5,5-dimethylthiazolidin-4-yl]		<i>p</i> -[(CH ₃) ₂ NC(O)O-]benzyl-	-OC(CH ₃) ₃

R ¹	R ²	R ³	R ⁵	R ⁶
<i>p</i> -Br-φ-	R ² /R ³ = cyclic -CH ₂ -S-C(CH ₃) ₂ - (L-5,5-dimethylthiazolidin-4-yl)		<i>p</i> -[(CH ₃) ₂ NC(O)O-]benzyl-	-OH
<i>p</i> -NH ₂ C(=N)-φ-	R ² /R ³ = cyclic 3 carbon atoms (L-pyrrolidiny)		<i>p</i> -[(CH ₃) ₂ NC(O)O-]benzyl-	-OCH ₃
<i>p</i> -N≡C-φ-	R ² /R ³ = cyclic 3 carbon atoms (L-pyrrolidiny)		<i>p</i> -[(thiomorpholin-4-yl)-C(O)O-]benzyl-	-OCH(CH ₃) ₂
<i>p</i> -CH ₃ -φ-	R ² /R ³ = cyclic -CH ₂ CH(O-C(O)thiomorpholin-4-yl)-CH ₂ - (L-4-(thiomorpholin-4-yl)C(O)O-pyrrolidiny)		<i>p</i> -[(thiomorpholin-4-yl)-C(O)O-]benzyl-	-OH
<i>p</i> -CH ₃ -φ-	R ² /R ³ = cyclic -CH ₂ -C(O)-CH ₂ - (L-4-oxopyrrolidiny)		<i>p</i> -[(thiomorpholin-4-yl)-C(O)O-]benzyl-	-OC(CH ₃) ₃
<i>p</i> -CH ₃ -φ-	R ² /R ³ = cyclic -CH ₂ -C(O)-CH ₂ - (L-4-oxopyrrolidiny)		<i>p</i> -[(thiomorpholin-4-yl)-C(O)O-]benzyl-	-OH
<i>p</i> -CH ₃ -φ-	R ² /R ³ = cyclic -CH ₂ -C(O)-CH ₂ - (L-4-oxopyrrolidiny)		<i>p</i> -[(4-methylpiperazin-1-yl)-C(O)O-]benzyl-	-OH
<i>p</i> -F-φ-	R ² /R ³ = cyclic -CH ₂ -S-C(CH ₃) ₂ - (L-5,5-dimethylthiazolidin-4-yl)		<i>p</i> -[(4-(pyrimidin-2-yl)piperazin-1-yl)-C(O)O-]benzyl-	-OH
quinolin-8-yl-	R ² /R ³ = cyclic -CH ₂ -S-C(CH ₃) ₂ - (L-5,5-dimethylthiazolidin-4-yl)		<i>p</i> -[(CH ₃) ₂ NC(O)O-]benzyl-	-OH
pyridin-4-yl-	R ² /R ³ = cyclic -CH ₂ -S-C(CH ₃) ₂ - (L-5,5-dimethylthiazolidin-4-yl)		<i>p</i> -[(CH ₃) ₂ NC(O)O-]benzyl-	-OCH(CH ₃) ₂

R ¹	R ²	R ³	R ⁵	R ⁶
<i>p</i> -F-φ-	R ² /R ³ = cyclic -CH ₂ -S-C(CH ₃) ₂ - (L-5,5-dimethylthiazolidin-4-yl)		<i>p</i> -[(4-(pyridin-2-yl)piperazin-1-yl)C(O)O-]benzyl-	-OCH(CH ₃) ₂
<i>m</i> -F-φ-	R ² /R ³ = cyclic 3 carbon atoms (L-pyrrolidiny)		<i>p</i> -[(CH ₃) ₂ NC(O)O-]benzyl-	-OH
<i>p</i> -F-φ-	R ² /R ³ = cyclic -CH ₂ -CH ₂ -S- (thiazolidin-2-yl)		<i>p</i> -[(CH ₃) ₂ NC(O)O-]benzyl-	-OH
<i>p</i> -F-φ-	R ² /R ³ = cyclic -CH ₂ -CH ₂ -S- (thiazolidin-2-yl)		<i>p</i> -[(CH ₃) ₂ NC(O)O-]benzyl-	-OC(CH ₃) ₃
<i>p</i> -CH ₃ -φ-	R ² /R ³ = cyclic -CH ₂ -C(O)-CH ₂ - (L-4-oxopyrrolidiny)		<i>p</i> -[(thiomorpholin-4-yl)C(O)O-]benzyl-	-OH
<i>p</i> -NH ₂ -C(=N)-φ-	R ² /R ³ = cyclic 3 carbon atoms (L-pyrrolidiny)		<i>p</i> -[(thiomorpholin-4-yl)C(O)O-]benzyl-	-OCH ₃
<i>p</i> -CH ₃ -φ-	R ² /R ³ = cyclic -CH ₂ -C(O)-CH ₂ - (L-4-oxopyrrolidiny)		<i>p</i> -[(4-methylpiperazin-1-yl)-C(O)O-]benzyl-	-OH
<i>p</i> -F-φ-	R ² /R ³ = cyclic -CH ₂ -CH ₂ -S- (thiazolidin-2-yl)		<i>p</i> -[(4-pyridin-2-yl)piperazin-1-yl)-C(O)O-]benzyl-	-OH
<i>p</i> -NO ₂ -φ-	R ² /R ³ = cyclic 3 carbon atoms (L-pyrrolidiny)		<i>p</i> -[(4-pyridin-2-yl)piperazin-1-yl)-C(O)O-]benzyl-	-OC(CH ₃) ₃
<i>p</i> -F-φ-	R ² /R ³ = cyclic -CH ₂ -CH ₂ -S- (thiazolidin-2-yl)		<i>p</i> -[(4-pyridin-2-yl)piperazin-1-yl)-C(O)O-]benzyl-	-OC(CH ₃) ₃

R ¹	R ²	R ³	R ⁵	R ⁶
<i>p</i> -Br-φ-	R ² /R ³ = cyclic -CH ₂ -S-C(CH ₃) ₂ - (L-5,5-dimethylthiazolidin-4-yl)		<i>p</i> -[(4-pyridin-2-yl)piperazin-1-yl]-C(O)O-]benzyl-	-OH
<i>p</i> -CH ₃ -φ-	R ² /R ³ = cyclic 3 carbon atoms (L-pyrrolidiny]		<i>p</i> -[(4-(φC(O)-)piperazin-1-yl)C(O)O-]benzyl-	-OH
<i>p</i> -CH ₃ -φ-	R ² /R ³ = cyclic 3 carbon atoms (L-pyrrolidiny]		<i>p</i> -[(4-(φNHC(S)-)piperazin-1-yl)C(O)O-]benzyl-	-OCH(CH ₃) ₂
<i>p</i> -F-φ-	R ² /R ³ = cyclic -CH ₂ -CH ₂ -S- (thiazolidin-2-yl)		<i>p</i> -[(4-CH ₃ -homopiperazin-1-yl)C(O)O-]benzyl-	-OC(CH ₃) ₃
<i>p</i> -CH ₃ -φ-	R ² /R ³ = cyclic 3 carbon atoms (L-pyrrolidiny]		<i>p</i> -[<i>p</i> -CH ₃ -φ-SO ₂ N(CH ₃)CH ₂ CH ₂ N(CH ₃)-C(O)O-]benzyl-	-OCH(CH ₃) ₂
<i>p</i> -CH ₃ -φ-	R ² /R ³ = cyclic 3 carbon atoms (L-pyrrolidiny]		<i>p</i> -[φNHC(O)O-CH ₂ CH ₂ NHC(O)O-]benzyl-	-OCH(CH ₃) ₂
3-Cl-4-F-φ-	R ² /R ³ = cyclic -CH ₂ CH ₂ -SO ₂ -CH ₂ - (L-1,1-dioxothiomorpholin-3-yl)		<i>p</i> -[(CH ₃) ₂ NC(O)O-]benzyl-	-OC(CH ₃) ₃
1-methylpyrazol-4-yl-	R ² /R ³ = cyclic -CH ₂ CH ₂ -S-CH ₂ - (L-thiomorpholin-3-yl)		<i>p</i> -[(CH ₃) ₂ NC(O)O-]benzyl-	-OC(CH ₃) ₃
<i>p</i> -CH ₃ -φ-	R ² /R ³ = cyclic -CH ₂ CH(-OSO ₂ CH ₃)-CH ₂ - (L-4-methanesulfoxy-pyrrolidiny]		<i>p</i> -[(CH ₃) ₂ NC(O)O-]benzyl-	-OC(CH ₃) ₃
<i>p</i> -H ₂ NC(O)-φ-	R ² /R ³ = cyclic 3 carbon atoms (L-pyrrolidiny]		<i>p</i> -[(CH ₃) ₂ NC(O)O-]benzyl-	-OH

R ¹	R ²	R ³	R ⁵	R ⁶
<i>p</i> -H ₂ N-C(=N)-φ	R ² /R ³ = cyclic 3 carbon atoms (L-pyrrolidiny)		<i>p</i> -[(CH ₃) ₂ NC(O)O-]benzyl-	-OH
<i>p</i> -H ₂ NC(O)-φ	R ² /R ³ = cyclic 3 carbon atoms (L-pyrrolidiny)		<i>p</i> -[(thiomorpholin-4-yl)C(O)O-]benzyl-	-OH
<i>p</i> -H ₂ N-C(=N)-φ	R ² /R ³ = cyclic 3 carbon atoms (L-pyrrolidiny)		<i>p</i> -[(thiomorpholin-4-yl)C(O)O-]benzyl-	-OH
<i>p</i> -NO ₂ -φ	R ² /R ³ = cyclic 3 carbon atoms (L-pyrrolidiny)		<i>p</i> -[(4-(pyridin-2-yl)piperazin-1-yl)-C(O)O-]benzyl-	-OH
<i>p</i> -F-φ	R ² /R ³ = cyclic -CH ₂ -S-C(CH ₃) ₂ - (L-5,5-dimethylthiazolidin-4-yl)		3-chloro-4-[(4-(pyridin-2-yl)piperazin-1-yl)C(O)O-]benzyl-	-OCH ₂ CH ₃
<i>p</i> -F-φ	R ² /R ³ = cyclic -CH ₂ -S-C(CH ₃) ₂ - (L-5,5-dimethylthiazolidin-4-yl)		3-chloro-4-[(4-(pyridin-2-yl)piperazin-1-yl)C(O)O-]benzyl-	-OH
<i>p</i> -F-φ	R ² /R ³ = cyclic -CH ₂ -CH ₂ -S- (thiazolidin-2-yl)		<i>p</i> -[(4-CH ₃ -homopiperazin-1-yl)C(O)O-]benzyl-	-OH
1-methylpyrazol-4-yl-	R ² /R ³ = cyclic -CH ₂ -S-C(CH ₃) ₂ - (L-5,5-dimethylthiazolidin-4-yl)		3-chloro-4-[(CH ₃) ₂ NC(O)O-]benzyl-	-OCH(CH ₃) ₂
1-methylimidazol-4-yl-	R ² /R ³ = cyclic 3 carbon atoms (L-pyrrolidiny)		<i>p</i> -[(4-(pyridin-2-yl)piperazin-1-yl)C(O)O-]benzyl-	-OCH(CH ₃) ₂
1-methylimidazol-4-yl-	R ² /R ³ = cyclic 3 carbon atoms (L-pyrrolidiny)		<i>p</i> -[(4-(pyridin-2-yl)piperazin-1-yl)C(O)O-]benzyl-	-OC(CH ₃) ₃

R ¹	R ²	R ³	R ⁵	R ⁶
<i>p</i> -CH ₃ -φ-	R ² /R ³ = cyclic 3 carbon atoms (L-pyrrolidiny)		<i>p</i> -[(4-(pyridin-2-yl)piperazin-1-yl)C(O)O-]benzyl-	-OH
<i>p</i> -CH ₃ -φ-	R ² /R ³ = cyclic 3 carbon atoms (L-pyrrolidiny)		<i>p</i> -[(4-(pyridin-2-yl)piperazin-1-yl)C(O)O-]benzyl-	-OC(CH ₃) ₃
<i>p</i> -CH ₃ -φ-	R ² /R ³ = cyclic 3 carbon atoms (L-pyrrolidiny)		<i>p</i> -[(4-(pyridin-2-yl)piperazin-1-yl)C(O)O-]benzyl-	-OCH(CH ₃) ₂
<i>p</i> -F-φ-	R ² /R ³ = cyclic 3 carbon atoms (L-pyrrolidiny)		<i>p</i> -[(4-(pyridin-2-yl)piperazin-1-yl)C(O)O-]benzyl-	-OCH(CH ₃) ₂
<i>p</i> -F-φ-	R ² /R ³ = cyclic 3 carbon atoms (L-pyrrolidiny)		<i>p</i> -[(4-(pyridin-2-yl)piperazin-1-yl)C(O)O-]benzyl-	-OCH(CH ₃) ₂
<i>p</i> -CH ₃ -φ-	R ² /R ³ = cyclic -CH ₂ CH ₂ N(-SO ₂ -CH ₃)CH ₂ - (4-methanesulfonyl-piperazin-2-yl)		<i>p</i> -[(CH ₃) ₂ NC(O)O-]benzyl-	-OH
<i>p</i> -CH ₃ -φ-	R ² /R ³ = cyclic -CH ₂ CH(-OSO ₂ -CH ₃)CH ₂ - (L-4-methanesulfoxy-pyrrolidiny)		<i>p</i> -[(CH ₃) ₂ NC(O)O-]benzyl-	-OH
3,4-difluoro-φ-	R ² /R ³ = cyclic -CH ₂ -CH ₂ -S-CH ₂ - (L-thiomorpholin-3-yl)		<i>p</i> -[(CH ₃) ₂ NC(O)O-]benzyl-	-OC(CH ₃) ₃
pyridin-3-yl	R ² /R ³ = cyclic -CH ₂ -S-C(CH ₃) ₂ - (L-5,5-dimethylthiazolidin-4-yl)		<i>p</i> -[(thiomorpholin-4-yl)C(O)O-]benzyl-	-OCH(CH ₃) ₂
3,4-difluoro-φ-	R ² /R ³ = cyclic -CH ₂ -CH ₂ -S-CH ₂ - (L-thiomorpholin-3-yl)		<i>p</i> -[(CH ₃) ₂ NC(O)O-]benzyl-	-OH

R ¹	R ²	R ³	R ⁵	R ⁶
<i>p</i> -F-φ-	R ² /R ³ = cyclic -CH ₂ CH(OH)CH ₂ - (L-4-hydroxypyrrolidiny)		<i>p</i> -[(CH ₃) ₂ NC(O)O-]benzyl-	-OCH(CH ₃) ₂
<i>p</i> -Br-φ-	R ² /R ³ = cyclic -CH ₂ -S-C(CH ₃) ₂ - (L-5,5-dimethylthiazolidin-4-yl)		<i>p</i> -[(4-(pyridin-2-yl)piperazin-1-yl)C(O)O-]benzyl-	-OC(CH ₃) ₃
<i>p</i> -CF ₃ O-φ-	R ² /R ³ = cyclic -CH ₂ -S-C(CH ₃) ₂ - (L-5,5-dimethylthiazolidin-4-yl)		<i>p</i> -[(CH ₃) ₂ NC(O)O-]benzyl-	-OH
<i>p</i> -CF ₃ O-φ-	R ² /R ³ = cyclic -CH ₂ -S-C(CH ₃) ₂ - (L-5,5-dimethylthiazolidin-4-yl)		<i>p</i> -[(CH ₃) ₂ NC(O)O-]benzyl-	-OC(CH ₃) ₃
<i>p</i> -CF ₃ O-φ-	R ² /R ³ = cyclic -CH ₂ -S-C(CH ₃) ₂ - (L-5,5-dimethylthiazolidin-4-yl)		<i>p</i> -[(4-(pyridin-2-yl)piperazin-1-yl)C(O)O-]benzyl-	-OC(CH ₃) ₃
<i>p</i> -F-φ-	R ² /R ³ = cyclic 3 carbon atoms (L-pyrrolidiny)		<i>p</i> -[(4-(pyridin-2-yl)piperazin-1-yl)C(O)O-]benzyl-	-OH
<i>p</i> -F-φ-	R ² /R ³ = cyclic -CH ₂ CH(OH)CH ₂ - (L-4-hydroxypyrrolidiny)		<i>p</i> -[(4-(pyridin-2-yl)piperazin-1-yl)C(O)O-]benzyl-	-OH
<i>p</i> -CF ₃ O-φ-	R ² /R ³ = cyclic -CH ₂ -S-C(CH ₃) ₂ - (L-5,5-dimethylthiazolidin-4-yl)		<i>p</i> -[(4-(pyridin-2-yl)piperazin-1-yl)C(O)O-]benzyl-	-OH
1-methylimidazol-4-yl-	R ² /R ³ = cyclic 3 carbon atoms (L-pyrrolidiny)		3-chloro-4-[(CH ₃) ₂ NC(O)O-]benzyl-	-OH
1-methylimidazol-4-yl-	R ² /R ³ = cyclic 3 carbon atoms (L-pyrrolidiny)		3-chloro-4-[(CH ₃) ₂ NC(O)O-]benzyl-	-OCH(CH ₃) ₂

R ¹	R ²	R ³	R ⁵	R ⁶
1-methylimidazol-4-yl-	R ² /R ³ = cyclic 3 carbon atoms (L-pyrrolidiny)		<i>p</i> -[(4-(pyridin-2-yl)piperazin-1-yl)C(O)O-]benzyl-	-OH
1-methylimidazol-4-yl-	R ² /R ³ = cyclic -CH ₂ -S-C(CH ₃) ₂ - (L-5,5-dimethylthiazolidin-4-yl)		<i>p</i> -[(4-(pyridin-2-yl)piperazin-1-yl)C(O)O-]benzyl-	-OH
1-methylpyrazol-4-yl-	R ² /R ³ = cyclic 3 carbon atoms (L-pyrrolidiny)		<i>p</i> -[(4-(pyridin-2-yl)piperazin-1-yl)C(O)O-]benzyl-	-OH
1-methylpyrazol-4-yl-	R ² /R ³ = cyclic 3 carbon atoms (L-pyrrolidiny)		<i>p</i> -[(4-(pyridin-2-yl)piperazin-1-yl)C(O)O-]benzyl-	-OCH(CH ₃) ₂
1-methylpyrazol-4-yl-	R ² /R ³ = cyclic 3 carbon atoms (L-pyrrolidiny)		<i>p</i> -[(4-(pyridin-2-yl)piperazin-1-yl)C(O)O-]benzyl-	-OC(CH ₃) ₃
1-methylpyrazol-4-yl-	R ² /R ³ = cyclic -CH ₂ -S-C(CH ₃) ₂ - (L-5,5-dimethylthiazolidin-4-yl)		<i>p</i> -[(4-(pyridin-2-yl)piperazin-1-yl)C(O)O-]benzyl-	-OC(CH ₃) ₃
1-methylimidazol-4-yl-	R ² /R ³ = cyclic 3 carbon atoms (L-pyrrolidiny)		3-chloro-4-[(4-(pyridin-2-yl)piperazin-1-yl)C(O)O]benzyl-	-OCH(CH ₃) ₂
1-methylpyrazol-4-yl-	R ² /R ³ = cyclic -CH ₂ -S-C(CH ₃) ₂ - (L-5,5-dimethylthiazolidin-4-yl)		<i>p</i> -[(CH ₃) ₂ NC(O)O-]benzyl-	-OCH ₂ CH ₂ Oφ
1-methylpyrazol-4-yl-	R ² /R ³ = cyclic -CH ₂ -S-C(CH ₃) ₂ - (L-5,5-dimethylthiazolidin-4-yl)		3-chloro-4-[(4-(pyridin-2-yl)piperazin-1-yl)C(O)O-]benzyl-	-OH
1-methylpyrazol-4-yl-	R ² /R ³ = cyclic -CH ₂ -S-C(CH ₃) ₂ - (L-5,5-dimethylthiazolidin-4-yl)		3-chloro-4-[(4-(pyridin-2-yl)piperazin-1-yl)C(O)O-]benzyl-	-OCH ₂ CH ₃

R ¹	R ²	R ³	R ⁵	R ⁶
1,5-dimethyl-3-chloropyrazol-4-yl-	R ² /R ³ = cyclic -CH ₂ -S-C(CH ₃) ₂ - (L-5,5-dimethylthiazolidin-4-yl)	-	<i>p</i> -[4-[5-CF ₃ -pyridin-2-yl]piperazin-1-yl)-C(O)O-]benzyl-	-OH
<i>p</i> -F- ϕ - pyridin-4-yl-	R ² /R ³ = cyclic -CH ₂ CH(OH)CH ₂ - (L-4-hydroxypyrrolidinyl)		<i>p</i> -[(CH ₃) ₂ NC(O)O-]benzyl-	-OC(CH ₃) ₃
pyridin-4-yl-	R ² /R ³ = cyclic -CH ₂ -S-C(CH ₃) ₂ - (L-5,5-dimethylthiazolidin-4-yl)		<i>p</i> -[(CH ₃) ₂ NC(O)O-]benzyl-	-OH
1-methylpyrazol-4-yl-	R ² /R ³ = cyclic -CH ₂ -S-C(CH ₃) ₂ - (L-5,5-dimethylthiazolidin-4-yl)		<i>p</i> -[(CH ₃) ₂ NC(O)O-]benzyl-	-OCH ₂ C(CH ₃) ₃
1-methylpyrazol-4-yl-	R ² /R ³ = cyclic -CH ₂ -S-C(CH ₃) ₂ - (L-5,5-dimethylthiazolidin-4-yl)		<i>p</i> -[(CH ₃) ₂ NC(O)O-]benzyl-	-OCH ₂ O- C(O)C(CH ₃) ₃
pyridin-3-yl-	R ² /R ³ = cyclic -CH ₂ -S-C(CH ₃) ₂ - (L-5,5-dimethylthiazolidin-4-yl)		<i>p</i> -[(CH ₃) ₂ NC(O)O-]benzyl-	-OCH ₂ C(CH ₃) ₃
1-methylpyrazol-4-yl-	R ² /R ³ = cyclic -CH ₂ -S-C(CH ₃) ₂ - (L-5,5-dimethylthiazolidin-4-yl)		<i>p</i> -[(CH ₃) ₂ NC(O)O-]benzyl-	2-CH ₃ O- ϕ -O-
1-methylpyrazol-4-yl-	R ² /R ³ = cyclic -CH ₂ -S-C(CH ₃) ₂ - (L-5,5-dimethylthiazolidin-4-yl)		<i>p</i> -[(CH ₃) ₂ NC(O)O-]benzyl-	-OCH ₂ cyclopropyl
1-methylpyrazol-4-yl-	R ² /R ³ = cyclic -CH ₂ -S-C(CH ₃) ₂ - (L-5,5-dimethylthiazolidin-4-yl)		<i>p</i> -[(CH ₃) ₂ NC(O)O-]benzyl-	-OCH ₂ CH ₂ CH ₃
1-methylpyrazol-4-yl-	R ² /R ³ = cyclic -CH ₂ -S-C(CH ₃) ₂ - (L-5,5-dimethylthiazolidin-4-yl)		<i>p</i> -[(CH ₃) ₂ NC(O)O-]benzyl-	-OCH ₂ CH ₂ CH ₂ CH ₃

R ¹	R ²	R ³	R ⁵	R ⁶
1-methylpyrazol-4-yl-	R ² /R ³ = cyclic -CH ₂ -S-C(CH ₃) ₂ - (L-5,5-dimethylthiazolidin-4-yl)		<i>p</i> -[(CH ₃) ₂ NC(O)O-]benzyl-	-O-CH ₃
pyridin-3-yl-	R ² /R ³ = cyclic -CH ₂ -S-C(CH ₃) ₂ - (L-5,5-dimethylthiazolidin-4-yl)		<i>p</i> -[(CH ₃) ₂ NC(O)O-]benzyl-	-OC(CH ₃) ₃
pyridin-3-yl-	R ² /R ³ = cyclic -CH ₂ -S-C(CH ₃) ₂ - (L-5,5-dimethylthiazolidin-4-yl)		<i>p</i> -[(CH ₃) ₂ NC(O)O-]benzyl-	-OCH ₂ CH ₃
pyridin-3-yl-	R ² /R ³ = cyclic -CH ₂ -S-C(CH ₃) ₂ - (L-5,5-dimethylthiazolidin-4-yl)		<i>p</i> -[(CH ₃) ₂ NC(O)O-]benzyl-	-OCH ₂ cyclopropyl

In a preferred embodiment of the compounds of formula I and IA, the compounds are defined by formula IB below:

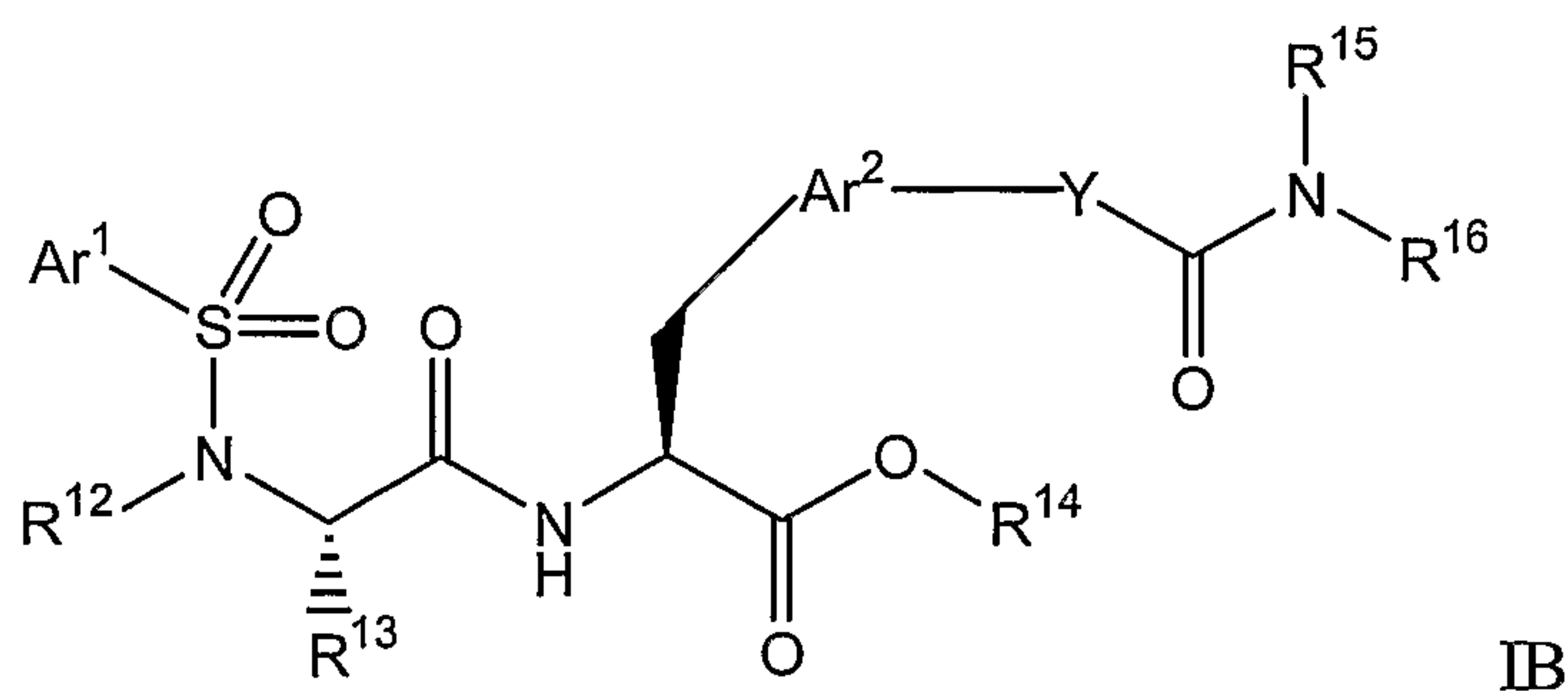

5

wherein:

Ar¹ is selected from the group consisting of aryl, substituted aryl, heteroaryl, and substituted heteroaryl;

10 Ar² is selected from the group consisting of aryl, substituted aryl, heteroaryl and substituted heteroaryl;

R¹² is selected from the group consisting of alkyl, substituted alkyl, cycloalkyl, and substituted cycloalkyl or R¹² and R¹³ together with the nitrogen atom bound to R¹² and the carbon atom bound to R¹³ form a heterocyclic or substituted heterocyclic group;

15 R¹³ is selected from the group consisting of hydrogen, alkyl, and substituted alkyl, or R¹² and R¹³ together with the nitrogen atom bound to R¹² and the carbon atom bound to R¹³ form a heterocyclic or substituted heterocyclic group;

R¹⁴ is selected from the group consisting of hydrogen, alkyl, substituted alkyl, cycloalkyl, substituted cycloalkyl, aryl, and substituted aryl;

20 R¹⁵ is selected from the group consisting of alkyl, and substituted alkyl, or R¹⁵ and R¹⁶ together with the nitrogen atom to which they are bound form a heterocyclic or substituted heterocyclic group;

25 R¹⁶ is selected from the group consisting of alkyl and substituted alkyl or R¹⁵ and R¹⁶ together with the nitrogen atom to which they are bound form a heterocyclic or substituted heterocyclic group; and

Y is selected from the group consisting of -O-, -NR¹⁰⁰-, and -CH₂- wherein R¹⁰⁰ is hydrogen or alkyl;

and pharmaceutically acceptable salts thereof.

5 Preferably, in the compounds of formula IB above, R¹² is alkyl, substituted alkyl, or R¹² and R¹³ together with the nitrogen atom bound to R¹² and the carbon atom bound to R¹³ form a heterocyclic or substituted heterocyclic group. Preferably, in the compounds of formula IB above, R¹⁴ is hydrogen or alkyl.

10 Preferably, in the compounds of formula IB above, Ar¹ is selected from the group consisting of phenyl, 4-methylphenyl, 4-*t*-butylphenyl, 2,4,6-trimethylphenyl, 2-fluorophenyl, 3-fluorophenyl, 4-fluorophenyl, 2,4-difluorophenyl, 3,4-difluorophenyl, 3,5-difluorophenyl, 2-chlorophenyl, 3-chlorophenyl, 4-chlorophenyl, 3,4-dichlorophenyl, 3,5-dichlorophenyl, 3-chloro-4-fluorophenyl, 4-bromophenyl, 2-
15 methoxyphenyl, 3-methoxyphenyl, 4-methoxyphenyl, 3,4-dimethoxyphenyl, 4-*t*-butoxyphenyl, 4-(3'-dimethylamino-*n*-propoxy)-phenyl, 2-carboxyphenyl, 2-(methoxycarbonyl)phenyl, 4-(H₂NC(O)-)phenyl, 4-(H₂NC(S)-)phenyl, 4-cyanophenyl, 4-trifluoromethylphenyl, 4-trifluoromethoxyphenyl, 3,5-di-(trifluoromethyl)phenyl, 4-nitrophenyl, 4-aminophenyl, 4-(CH₃C(O)NH-)phenyl, 4-
20 (PhNHC(O)NH-)phenyl, 4-amidinophenyl, 4-methylamidinophenyl, 4-[CH₃SC(=NH)-]phenyl, 4-chloro-3-[H₂NS(O)₂-]phenyl, 1-naphthyl, 2-naphthyl, pyridin-2-yl, pyridin-3-yl, pyridine-4-yl, pyrimidin-2-yl, quinolin-8-yl, 2-(trifluoroacetyl)-1,2,3,4-tetrahydroisoquinolin-7-yl, 2-thienyl, 5-chloro-2-thienyl, 2,5-dichloro-4-thienyl, 1-*N*-methylimidazol-4-yl, 1-*N*-methylpyrazol-3-yl, 1-*N*-
25 methylpyrazol-4-yl, 1-*N*-butylpyrazol-4-yl, 1-*N*-methyl-3-methyl-5-chloropyrazol-4-yl, 1-*N*-methyl-5-methyl-3-chloropyrazol-4-yl, 2-thiazolyl and 5-methyl-1,3,4-thiadiazol-2-yl.

30 Preferably, in the compounds of formula IB above, R¹² and R¹³ together with the nitrogen atom bound to R¹² and the carbon atom bound to R¹³ form a heterocyclic or substituted heterocyclic of the formula:

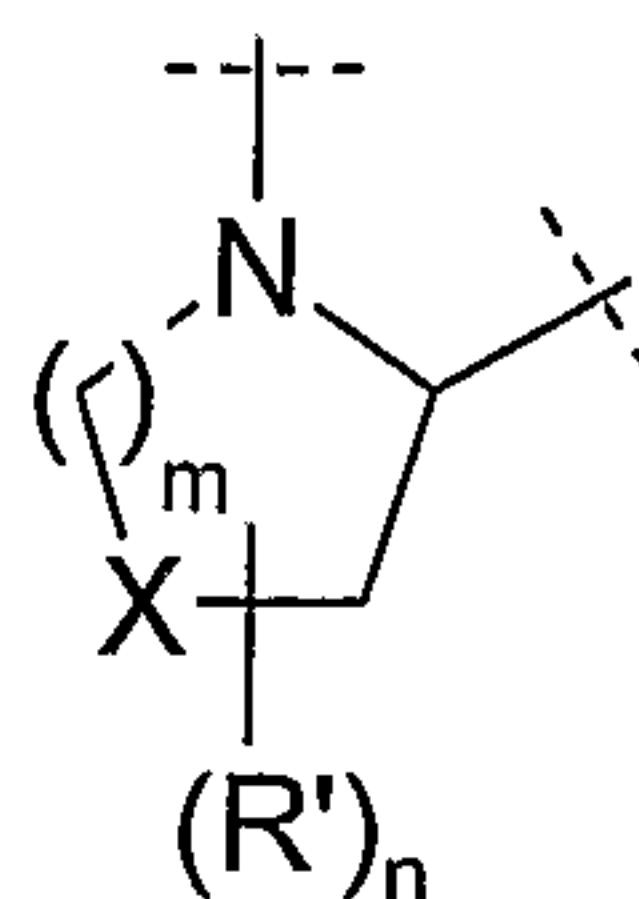

wherein

X is selected from the group consisting of -S-, -SO-, -SO₂, and optionally substituted -CH₂-;

m is an integer of 0 to 12;

n is an integer of 0 to 2; and

R' is selected from the group consisting of alkyl, substituted alkyl, and amino.

10

Preferably, *m* is 1, X is -S- or -CH₂-, R' is alkyl or substituted alkyl.

Even more preferably, R¹² and R¹³ together with the nitrogen atom bound to R¹² and the carbon atom bound to R¹³ form a heterocyclic or substituted heterocyclic selected from the group consisting of azetidiny, thiazolidiny, piperidiny, piperaziny, thiomorpholinyl, pyrrolidiny, 4-hydroxypyrrolidiny, 4-oxopyrrolidiny, 4-fluoropyrrolidiny, 4,4-difluoropyrrolidiny, 4-(thiomorpholin-4-ylC(O)O-)pyrrolidiny, 4-[CH₃S(O)₂O-]pyrrolidiny, 3-phenylpyrrolidiny, 3-thiophenylpyrrolidiny, 4-aminopyrrolidiny, 3-methoxypyrrolidiny, 4,4-dimethylpyrrolidiny, 4-*N*-Cbz-piperaziny, 4-[CH₃S(O)₂-]piperaziny, thiazolidin-3-yl, 5,5-dimethyl-thiazolidin-3-yl, 5,5-dimethylthiazolidin-4-yl, 1,1-dioxo-thiazolidiny, 1,1-dioxo-5,5-dimethylthiazolidin-2-yl and 1,1-dioxothiomorpholinyl.

20

Preferably, in the compounds of formula IB, Ar² is selected from the group consisting of phenyl, 2-pyridyl, 3-pyridyl, 4-pyridyl, and 4-pyrid-2-onyl.

25

Preferably, in formula IB, Y is -O-, and when Y is -O-, the moiety -OC(O)NR¹⁵R¹⁶ is preferably selected from the group consisting of (CH₃)₂NC(O)O-, (piperidin-1-yl)C(O)O-, (4-hydroxypiperidin-1-yl)C(O)O-, (4-formyloxypiperidin-1-yl)C(O)O-, (4-ethoxycarbonylpiperidin-1-yl)C(O)O-, (4-carboxypiperidin-1-yl)C(O)O-, (3-hydroxymethylpiperidin-1-yl)C(O)O-, (4-hydroxymethylpiperidin-1-yl)C(O)O-, (4-piperidon-1-yl ethylene ketal)C(O)O-, (piperazin-1-yl)-C(O)O-, (1-Boc-piperazin-4-yl)-C(O)O-, (4-methylpiperazin-1-yl)C(O)O-, (4-methylhomopiperazin-1-yl)C(O)O-, (4-(2-hydroxyethyl)piperazin-1-yl)C(O)O-, (4-phenylpiperazin-1-yl)C(O)O-, (4-(pyridin-2-yl)piperazin-1-yl)C(O)O-, (4-(4-trifluoromethylpyridin-2-yl)piperazin-1-yl)C(O)O-, (4-(pyrimidin-2-yl)piperazin-1-yl)C(O)O-, (4-acetylpiperazin-1-yl)C(O)O-, (4-(phenylC(O)-)piperazin-1-yl)C(O)O-, (4-(pyridin-4'-ylC(O)-)piperazin-1-yl)C(O)O-, (4-(phenylNHC(O)-)piperazin-1-yl)C(O)O-, (4-(phenylNHC(S)-)piperazin-1-yl)C(O)O-, (4-methanesulfonylpiperazin-1-yl)-C(O)O-, (4-trifluoromethanesulfonylpiperazin-1-yl)-C(O)O-, (morpholin-4-yl)C(O)O-, (thiomorpholin-4-yl)C(O)O-, (thiomorpholin-4'-yl sulfone)-C(O)O-, (pyrrolidin-1-yl)C(O)O-, (2-methylpyrrolidin-1-yl)C(O)O-, (2-(methoxycarbonyl)pyrrolidin-1-yl)C(O)O-, (2-(hydroxymethyl)pyrrolidin-1-yl)C(O)O-, (2-(N,N-dimethylamino)ethyl)(CH₃)NC(O)O-, (2-(N-methyl-N-toluene-4-sulfonylamino)ethyl)(CH₃)N-C(O)O-, (2-(morpholin-4-yl)ethyl)(CH₃)NC(O)O-, (2-(hydroxy)ethyl)(CH₃)NC(O)O-, bis(2-(hydroxy)ethyl)NC(O)O-, (2-(formyloxy)ethyl)(CH₃)NC(O)O-, (CH₃OC(O)CH₂)HNC(O)O-, and 2-[(phenylNHC(O)-)ethyl-]HNC(O)O-.

In a preferred embodiment, the compounds are defined by formula IC below

25

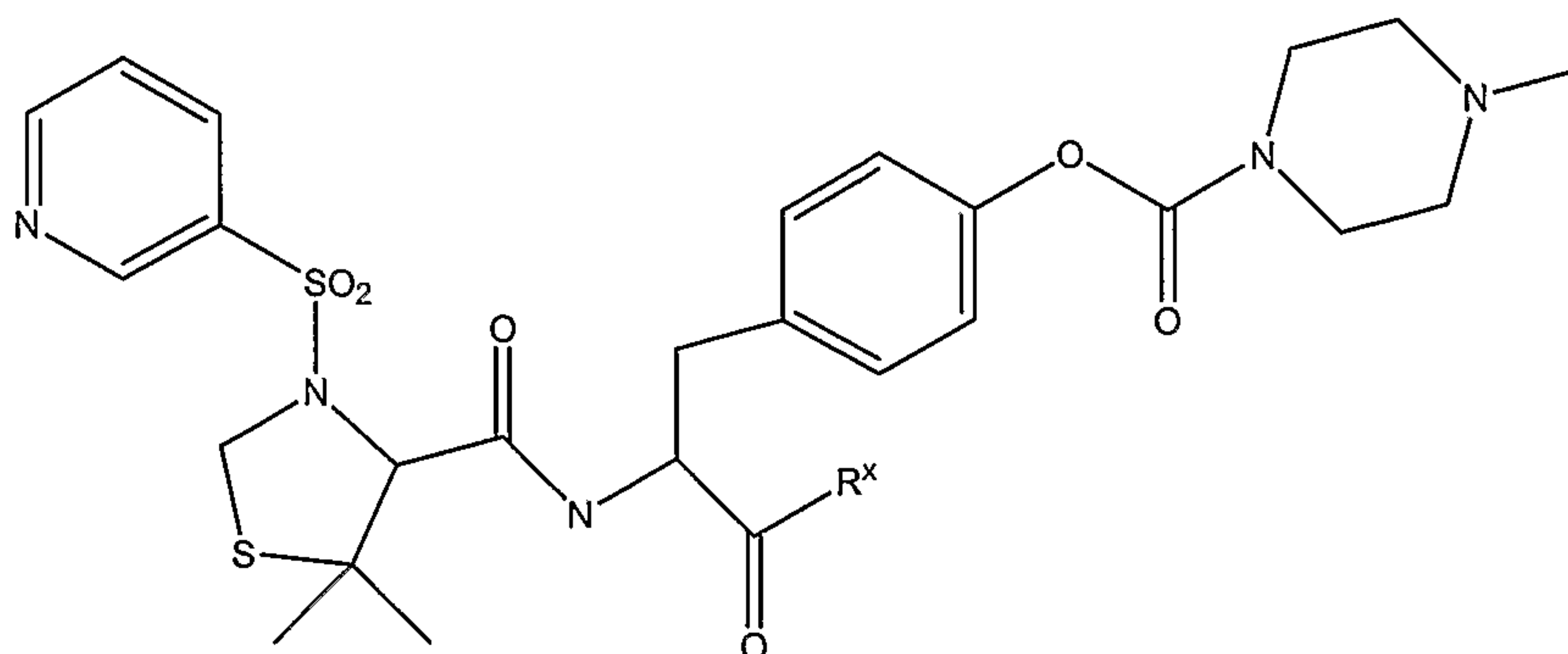

IC

wherein R^x is hydroxy or C₁₋₅ alkoxy and pharmaceutically acceptable salts thereof.

5 Preferably, the compound is *N*-[*N*-(3-pyridinesulfonyl)-*L*-3,3-dimethyl-4-thiaprolyl]-*O*-[1-methylpiperazin-4-ylcarbonyl]-*L*-tyrosine isopropyl ester.

In another aspect, the compounds that can be utilized as remyleinating agents are compounds defined by formula II below. These compounds have a binding
10 affinity to VLA-4 as expressed by an IC₅₀ of about 15 μM or less (measured as described in Example A below) and act as remyleinating agents:

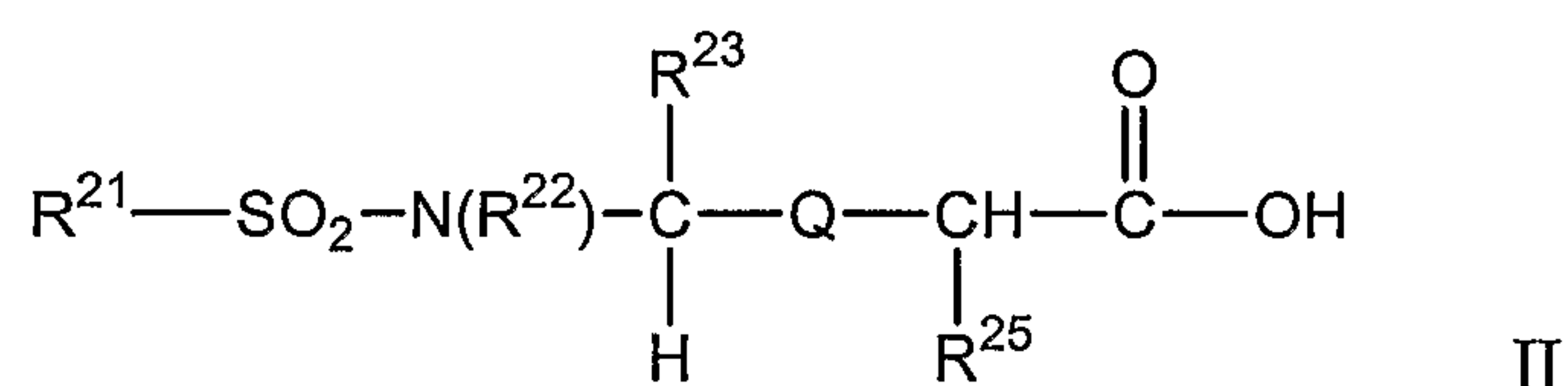

15 wherein:

R²¹ is selected from the group consisting of alkyl, substituted alkyl, aryl, substituted aryl, cycloalkyl, substituted cycloalkyl, heterocyclic, substituted heterocyclic, heteroaryl and substituted heteroaryl;

R²² is selected from the group consisting of hydrogen, alkyl, substituted alkyl, cycloalkyl, substituted cycloalkyl, cycloalkenyl, substituted cycloalkenyl, heterocyclic, substituted heterocyclic, aryl, substituted aryl, heteroaryl, substituted heteroaryl, and R²¹ and R²² together with the nitrogen atom bound to R²² and the SO₂ group bound to R²¹ can form a heterocyclic or a substituted heterocyclic group;

20

R²³ is selected from the group consisting of hydrogen, alkyl, substituted alkyl, cycloalkyl, substituted cycloalkyl, aryl, substituted aryl, heteroaryl, substituted heteroaryl, heterocyclic, substituted heterocyclic and where R²² and R²³ together with the nitrogen atom bound to R²² and the carbon atom bound to R²³ can form a saturated heterocyclic group or a saturated substituted heterocyclic group with the proviso that when monosubstituted, the substituent on said saturated substituted heterocyclic group is not carboxyl;

Q is -C(X)NR⁷- wherein R⁷ is selected from the group consisting of hydrogen and alkyl;

X is selected from the group consisting of oxygen and sulfur; and

R²⁵ is -CH₂Ar²²-R^{25'} where Ar²² is aryl or heteroaryl and R^{25'} is selected from the group consisting of aryl, heteroaryl, substituted aryl, substituted heteroaryl, heterocyclic, substituted heterocyclic, aryloxy, substituted aryloxy, aralkoxy, substituted aralkoxy, heteroaryloxy, substituted heteroaryloxy, heterocyclic-O-, substituted heterocyclic-O-, heteroaralkoxy, and substituted heteroaralkoxy ; and pharmaceutically acceptable salts thereof.

In another embodiment, the compounds of this invention can also be provided as prodrugs which convert (*e.g.*, hydrolyze, metabolize, etc.) *in vivo* to a compound of formula II above. In a preferred example of such an embodiment, the carboxylic acid in the compound of formula II is modified into a group which, *in vivo*, will convert to the carboxylic acid (including salts thereof). In a particularly preferred embodiment, such prodrugs are represented by compounds of formula IIA:

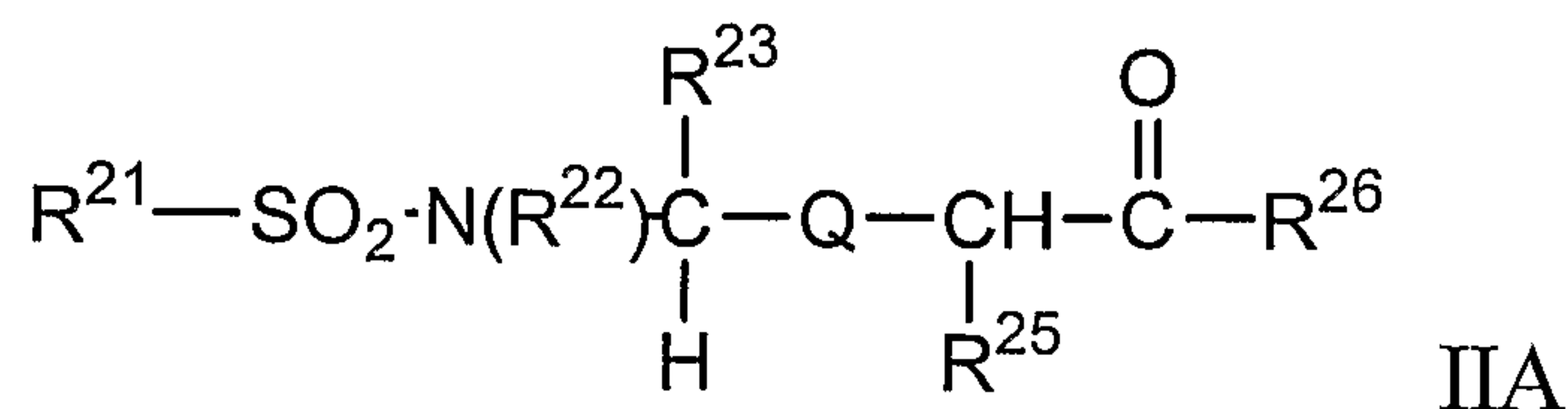

where

R^{21} is selected from the group consisting of alkyl, substituted alkyl, aryl, substituted aryl, cycloalkyl, substituted cycloalkyl, heterocyclic, substituted heterocyclic, heteroaryl and substituted heteroaryl;

R^{22} is selected from the group consisting of hydrogen, alkyl, substituted alkyl, cycloalkyl, substituted cycloalkyl, cycloalkenyl, substituted cycloalkenyl, heterocyclic, substituted heterocyclic, aryl, substituted aryl, heteroaryl, and substituted heteroaryl, and R^{21} and R^{22} together with the nitrogen atom bound to R^{22} and the SO_2 group bound to R^{21} can form a heterocyclic or a substituted heterocyclic group;

R^{23} is selected from the group consisting of hydrogen, alkyl, substituted alkyl, cycloalkyl, substituted cycloalkyl, aryl, substituted aryl, heteroaryl, substituted heteroaryl, heterocyclic, and substituted heterocyclic, and R^{22} and R^{23} together with the nitrogen atom bound to R^{22} and the carbon atom bound to R^{23} can form a saturated heterocyclic group or a saturated substituted heterocyclic group with the proviso that when monosubstituted, the substituent on said saturated substituted heterocyclic group is not carboxyl;

R^{25} is $-CH_2Ar^{22}-R^{25'}$ where Ar^{22} is aryl or heteroaryl and $R^{25'}$ is selected from the group consisting of aryl, heteroaryl, substituted aryl, substituted heteroaryl, heterocyclic, substituted heterocyclic, aryloxy, substituted aryloxy, aralkoxy, substituted aralkoxy, heteroaryloxy, substituted heteroaryloxy, heterocyclic-O-, substituted heterocyclic-O-, heteroaralkoxy, and substituted heteroaralkoxy ;

R^{26} is selected from the group consisting of 2,4-dioxo-tetrahydrofuran-3-yl (3,4-enol), amino, alkoxy, substituted alkoxy, cycloalkoxy, substituted cycloalkoxy, -O-(N-succinimidyl), -NH-adamantyl, -O-cholest-5-en-3- β -yl, -NHOY where Y is hydrogen, alkyl, substituted alkyl, aryl, and substituted aryl, $-NH(CH_2)_pCOOY$ where p is an integer of from 1 to 8 and Y is as defined above, $-OCH_2NR^{29}R^{30}$ where R^{29} is selected from the group consisting of -C(O)-aryl and -C(O)-substituted aryl and R^{30} is selected from the group consisting of hydrogen and $-CH_2COOR^{31}$ where R^{31} is alkyl, and $-NHSO_2Z'$ where Z' is alkyl, substituted alkyl, cycloalkyl, substituted cycloalkyl, aryl, substituted aryl, heteroaryl, substituted heteroaryl, heterocyclic or substituted heterocyclic;

Q is $-C(X)NR^7$ - wherein R^7 is selected from the group consisting of hydrogen and alkyl; and

X is selected from the group consisting of oxygen and sulfur;
and pharmaceutically acceptable salts thereof.

5

Further description of the compounds of the above formulae II and IIA and procedures and reaction conditions for preparing these compounds are described in U.S.S.N.s 09/127,346 (filed July 31, 1998), 09/688,820 (Continuation, filed October 17, 2000 and issued as U.S. Patent No. 6,583,139) and 10/382,988 (Continuation, filed March 7, 2003), all of which are herein incorporated by reference in their entirety.

10

Preferably, in the compounds of formula II and IIA above, R^{21} is selected from the group consisting of alkyl, substituted alkyl, aryl, substituted aryl, heterocyclic, substituted heterocyclic, heteroaryl and substituted heteroaryl. More preferably R^{21} is selected from the group consisting of aryl, substituted aryl, heteroaryl and substituted heteroaryl.

15

Even more preferably, in the compounds of formula II and IIA above, R^{21} is selected from the group consisting of 4-methylphenyl, 4-chlorophenyl, 1-naphthyl, 2-naphthyl, 4-methoxyphenyl, phenyl, 2,4,6-trimethylphenyl, 2-(methoxycarbonyl)phenyl, 2-carboxyphenyl, 3,5-dichlorophenyl, 4-trifluoromethylphenyl, 3,4-dichlorophenyl, 3,4-dimethoxyphenyl, 4-($CH_3C(O)NH$ -)phenyl, 4-trifluoromethoxyphenyl, 4-cyanophenyl, 3,5-di-(trifluoromethyl)phenyl, 4-*t*-butylphenyl, 4-*t*-butoxyphenyl, 4-nitrophenyl, 2-thienyl, 1-N-methyl-3-methyl-5-chloropyrazol-4-yl, 1-N-methylimidazol-4-yl, 4-bromophenyl, 4-amidinophenyl, 4-methylamidinophenyl, 4-[$CH_3SC(=NH)$]phenyl, 5-chloro-2-thienyl, 2,5-dichloro-4-thienyl, 1-N-methyl-4-pyrazolyl, 2-thiazolyl, 5-methyl-1,3,4-thiadiazol-2-yl, 4-[$H_2NC(S)$]phenyl, 4-aminophenyl, 4-fluorophenyl, 2-fluorophenyl, 3-fluorophenyl, 3,5-difluorophenyl, pyridin-3-yl, pyrimidin-2-yl, 4-(3'-dimethylamino-*n*-propoxy)-phenyl, and 1-methylpyrazol-4-yl.

25

30

Preferably, R^{22} , in the compounds of formula II and IIA above, is hydrogen, methyl, phenyl, benzyl, $-(CH_2)_2$ -2-thienyl, and $-(CH_2)_2$ - ϕ .

5 In another preferred embodiment, R^{22} and R^{23} , in the compounds of formula II and IIA above, and R^{32} and R^{33} , in the compounds of formula IIB, together with the nitrogen atom bound to R^{22} or R^{32} and the carbon atom bound to R^{23} or R^{33} form a saturated heterocyclic group or a saturated substituted heterocyclic group with the proviso that when monosubstituted, the substituent on said saturated substituted
10 heterocyclic group is not carboxyl.

Q, in the compounds of formula II and IIA above, is preferably $-C(O)NH-$ or $-C(S)NH-$.

15 In the compounds of formula II and IIA, R^{25} is preferably selected from the group consisting of all possible isomers arising by substitution with the following groups: 4-(2-carboxyphenoxy)benzyl, 4-(benzyloxy)benzyl, 4-[(1-methylpiperidin-4-yl)-O-]benzyl, 4-(imidazolid-2-one-1-yl)benzyl, and 4-(3-formylimidazolid-2-one-1-yl)benzyl.

20 In the compounds of formula IIA, R^{26} is preferably 2,4-dioxo-tetrahydrofuran-3-yl (3,4-enol), methoxy, ethoxy, *iso*-propoxy, *n*-butoxy, *t*-butoxy, cyclopentoxy, *neo*-pentoxy, 2- α -*iso*-propyl-4- β -methylcyclohexoxy, 2- β -isopropyl-4- β -methylcyclohexoxy, $-NH_2$, benzyloxy, $-NHCH_2COOH$, $-NHCH_2CH_2COOH$, $-NH$ -adamantyl, $-NHCH_2CH_2COOCH_2CH_3$, $-NHSO_2$ -*p*- CH_3 - ϕ , $-NHOR^8$ where R^8 is hydrogen, methyl, *iso*-propyl or benzyl, O-(N-succinimidyl), $-O$ -cholest-5-en-3- β -yl, $-OCH_2-OC(O)C(CH_3)_3$, $-O(CH_2)_zNHC(O)W$ where z is 1 or 2 and W is selected from the group consisting of pyrid-3-yl, N-methylpyridyl, and N-methyl-1,4-dihydro-pyrid-3-yl, $-NR''C(O)-R'$ where R' is aryl, heteroaryl or heterocyclic and R''
25 is hydrogen or $-CH_2C(O)OCH_2CH_3$.
30

Preferred compounds within the scope of formulae II and IIA above include by way of example the following:

5 *N*-(Toluene-4-sulfonyl)-L-prolyl-4-(α -methylbenzyloxy)-
L-phenylalanine

N-(Toluene-4-sulfonyl)-L-prolyl-4-(2-carboxyphenoxy)-
L-phenylalanine

10 *N*-(Toluene-4-sulfonyl)-L-prolyl-O-(benzyl)-L-tyrosine

and pharmaceutically acceptable salts thereof.

15 Preferred compounds of formula II and IIA above include those set forth in
Table 4 below.

Table 4

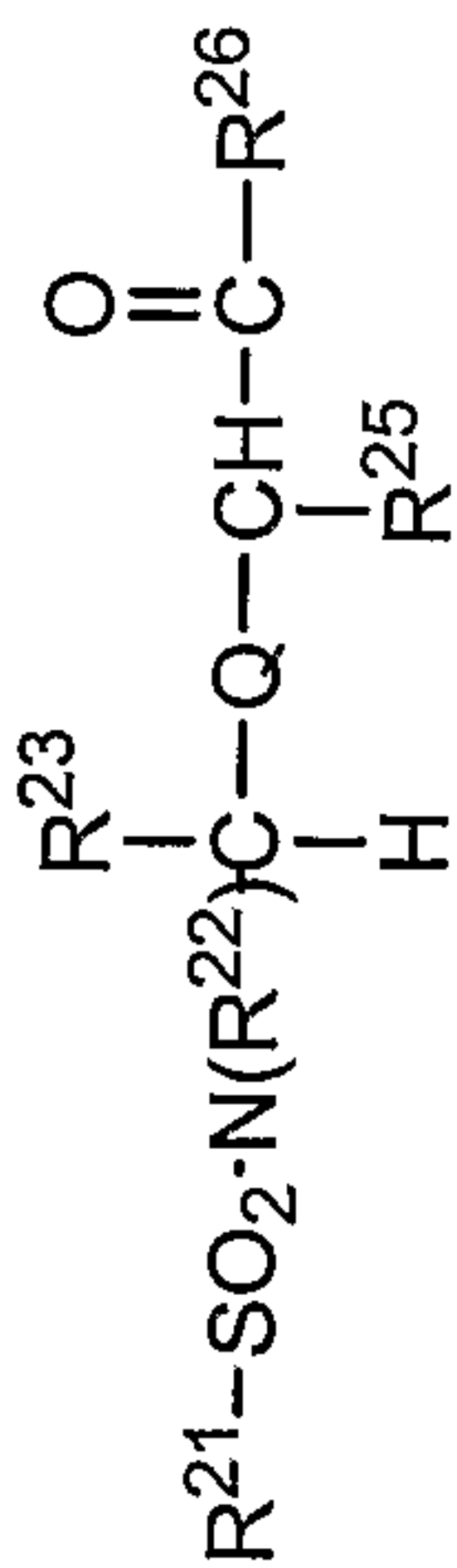

R ²¹	R ²²	R ²³	R ²⁵	R ²⁶	Q = -C(O)NR ⁷ - wherein R ⁷ is:
p-CH ₃ -φ-	R ²² /R ²³ = cyclic 3 carbon atoms (L-pyrrolidinyl)		<i>p</i> -[O-(<i>o</i> -carboxyphenyl)]-benzyl-	-OH	H
p-CH ₃ -φ-	R ²² /R ²³ = cyclic 3 carbon atoms (L-pyrrolidinyl)		<i>p</i> -benzyloxybenzyl-	-OH	H
p-CH ₃ -φ-	R ²² /R ²³ = cyclic 3 carbon atoms (L-pyrrolidinyl)		<i>p</i> -[(1-methylpiperidin-4-yl)-O-]benzyl-	-OCH ₂ CH ₃	H
p-CH ₃ -φ-	R ²² /R ²³ = cyclic 3 carbon atoms (L-pyrrolidinyl)		<i>p</i> -[(imidazolid-2-one-1-yl)benzyl]-	-OC(CH ₃) ₃	H
p-CH ₃ -φ-	R ²² /R ²³ = cyclic 3 carbon atoms (L-pyrrolidinyl)		<i>p</i> -[3-formylimidazolid-2-one-1-yl)benzyl]-	-OH	H
p-CH ₃ -φ-	R ²² /R ²³ = cyclic 3 carbon atoms (L-pyrrolidinyl)		<i>p</i> -[(imidazolid-2-one-1-yl)benzyl]-	-OH	H
p-CH ₃ -φ-	R ²² /R ²³ = cyclic 3 carbon atoms (L-pyrrolidinyl)		<i>p</i> -[1-H-2-oxo-3-methyl tetrahydro pyrimidin-1-yl]benzyl-	-Ot-Bu	H
p-CH ₃ -φ-	R ²² /R ²³ = cyclic 3 carbon atoms (L-pyrrolidinyl)		<i>p</i> -[1-H-2-oxo-3-methyl tetrahydro pyrimidin-1-yl]benzyl-	-OH	H

R ²¹	R ²² R ²² /R ²³ = cyclic 3 carbon atoms (L-pyrrolidinyl)	R ²³	R ²⁵	R ²⁶	Q = -C(O)NR ⁷ - wherein R ⁷ is:
p-CH ₃ -φ-	R ²² /R ²³ = cyclic 3 carbon atoms (L-pyrrolidinyl)		4-[2-methoxy phenyl]-benzyl-	-Ot-Bu	H
p-CH ₃ -φ-	R ²² /R ²³ = cyclic 3 carbon atoms (L-pyrrolidinyl)		4-[2-methoxy phenyl]-benzyl-	-OH	H
p-CH ₃ -φ-	R ²² /R ²³ = cyclic 3 carbon atoms (L-pyrrolidinyl)		<i>p</i> -[2,4,5-trioxo-3-(3-chlorophenyl)- tetrahydroimidazol-1-yl]-benzyl-	-OBz	H

In a preferred embodiment of the compounds of formula II and IIA, the compounds are defined by formula IIB below:

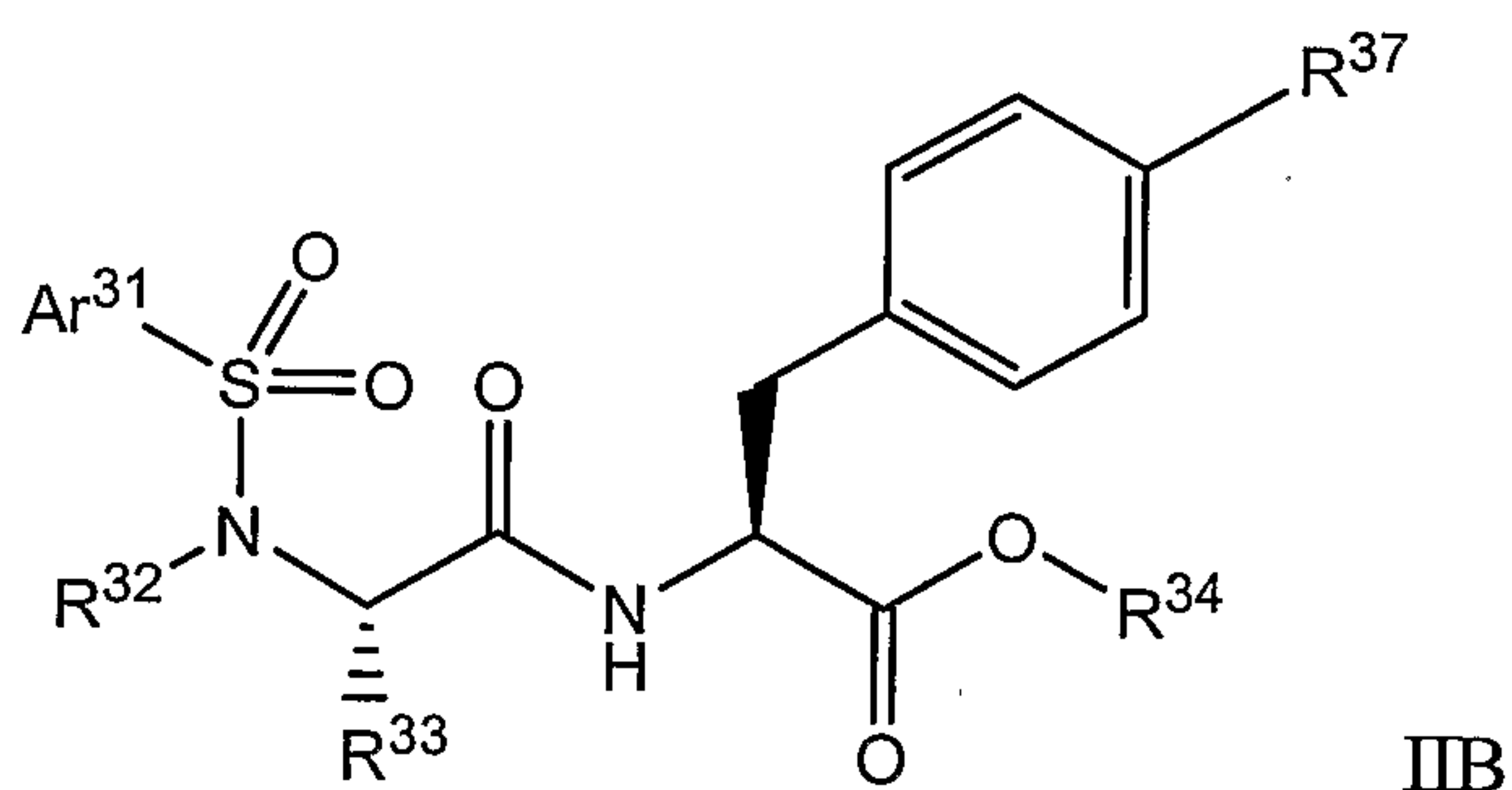

5

wherein:

Ar^{31} is selected from the group consisting of aryl, substituted aryl, heteroaryl, and substituted heteroaryl;

10 R^{32} is selected from the group consisting of alkyl, substituted alkyl, cycloalkyl, and substituted cycloalkyl or R^{32} and R^{33} together with the nitrogen atom bound to R^{32} and the carbon atom bound to R^{33} form a heterocyclic or substituted heterocyclic group;

15 R^{33} is selected from the group consisting of hydrogen, alkyl, and substituted alkyl, or R^{32} and R^{33} together with the nitrogen atom bound to R^{32} and the carbon atom bound to R^{33} form a heterocyclic or substituted heterocyclic group;

R^{34} is selected from the group consisting of hydrogen, alkyl, substituted alkyl, cycloalkyl, substituted cycloalkyl, aryl, and substituted aryl; and

20 R^{37} is aryl, heteroaryl, substituted aryl, substituted heteroaryl, heterocyclic, substituted heterocyclic, aryloxy, substituted aryloxy, aralkoxy, substituted aralkoxy, heteroaryloxy, substituted heteroaryloxy;

and pharmaceutically acceptable salts thereof.

25 Preferably, in the compounds of formula IIB above, R^{32} is alkyl, substituted alkyl, or R^{32} and R^{33} together with the nitrogen atom bound to R^{32} and the carbon atom bound to R^{33} form a heterocyclic or substituted heterocyclic group and R^{34} is hydrogen or alkyl.

Preferably, in the compounds of formula IIB above, R³⁷ is aryl, substituted aryl, heteroaryl, substituted heteroaryl, heterocyclic, or substituted heterocyclic. In a preferred embodiment, R³⁷ is substituted aryl wherein the aryl is substituted with one to three substituents independently selected from the group consisting alkyl and alkoxy. In a preferred embodiment, R³⁷ is substituted heteroaryl wherein the heteroaryl is substituted with one to three substituents independently selected from the group consisting alkyl, alkoxy, and oxo. In another preferred embodiment R³⁷ is substituted aryl or heteroaryl wherein aryl or heteroaryl is 2,6-di-substituted. In yet another preferred embodiment R³⁷ is 2,6-di-substituted aryl wherein the substituents are independently selected from the group consisting of alkyl and alkoxy. In yet another preferred embodiment R³⁷ is 2,6-di-substituted heteroaryl wherein the substituents are independently selected from the group consisting of alkyl, oxo, and alkoxy. In another preferred embodiment, R³⁷ is selected from the group consisting of 2,6-dialkoxyaryl, 2,6-dialkoxyheteroaryl, 2-alkyl-6-alkoxyaryl, 2-alkyl-6-alkoxyheteroaryl, 2-oxo-6-alkoxyheteroaryl, 2-oxo-6-alkylheteroaryl, and optionally substituted imidazolidin-2,4-dion-3-yl.

Preferably in the compounds of formula IIB above, Ar³¹ is selected from the group consisting of 4-methylphenyl, 4-chlorophenyl, 1-naphthyl, 2-naphthyl, 4-methoxyphenyl, phenyl, 2,4,6-trimethylphenyl, 2-(methoxycarbonyl)phenyl, 2-carboxyphenyl, 3,5-dichlorophenyl, 4-trifluoromethylphenyl, 3,4-dichlorophenyl, 3,4-dimethoxyphenyl, 4-(CH₃C(O)NH-)phenyl, 4-trifluoromethoxyphenyl, 4-cyanophenyl, 3,5-di-(trifluoromethyl)phenyl, 4-*t*-butylphenyl, 4-*t*-butoxyphenyl, 4-nitrophenyl, 2-thienyl, 1-N-methyl-3-methyl-5-chloropyrazol-4-yl, 1-N-methylimidazol-4-yl, 4-bromophenyl, 4-amidinophenyl, 4-methylamidinophenyl, 4-[CH₃SC(=NH)]phenyl, 5-chloro-2-thienyl, 2,5-dichloro-4-thienyl, 1-N-methyl-4-pyrazolyl, 2-thiazolyl, 5-methyl-1,3,4-thiadiazol-2-yl, 4-[H₂NC(S)]phenyl, 4-aminophenyl, 4-fluorophenyl, 2-fluorophenyl, 3-fluorophenyl, 3,5-difluorophenyl, pyridin-3-yl, pyrimidin-2-yl, 4-(3'-dimethylamino-*n*-propoxy)-phenyl, and 1-methylpyrazol-4-yl.

When describing the compounds, compositions and methods of this invention, the following terms have the following meanings, unless otherwise indicated.

5

Definitions

As used herein, "acyl" refers to the groups H-C(O)-, alkyl-C(O)-, substituted alkyl-C(O)-, alkenyl-C(O)-, substituted alkenyl-C(O)-, alkynyl-C(O)-, substituted alkynyl-C(O)-, cycloalkyl-C(O)-, substituted cycloalkyl-C(O)-, aryl-C(O)-, substituted aryl-C(O)-, heteroaryl-C(O)-, substituted heteroaryl-C(O), heterocyclic-C(O)-, and substituted heterocyclic-C(O)- wherein alkyl, substituted alkyl, alkenyl, substituted alkenyl, alkynyl, substituted alkynyl, cycloalkyl, substituted cycloalkyl, aryl, substituted aryl, heteroaryl, substituted heteroaryl, heterocyclic and substituted heterocyclic are as defined herein.

15

"Acylamino" refers to the group -C(O)NRR where each R is independently selected from the group consisting of hydrogen, alkyl, substituted alkyl, alkenyl, substituted alkenyl, alkynyl, substituted alkynyl, aryl, substituted aryl, cycloalkyl, substituted cycloalkyl, heteroaryl, substituted heteroaryl, heterocyclic, substituted heterocyclic and where each R is joined to form together with the nitrogen atom a heterocyclic or substituted heterocyclic ring wherein alkyl, substituted alkyl, alkenyl, substituted alkenyl, alkynyl, substituted alkynyl, cycloalkyl, substituted cycloalkyl, aryl, substituted aryl, heteroaryl, substituted heteroaryl, heterocyclic and substituted heterocyclic are as defined herein.

25

"Acyloxy" refers to the groups alkyl-C(O)O-, substituted alkyl-C(O)O-, alkenyl-C(O)O-, substituted alkenyl-C(O)O-, alkynyl-C(O)O-, substituted alkynyl-C(O)O-, aryl-C(O)O-, substituted aryl-C(O)O-, cycloalkyl-C(O)O-, substituted cycloalkyl-C(O)O-, heteroaryl-C(O)O-, substituted heteroaryl-C(O)O-, heterocyclic-C(O)O-, and substituted heterocyclic-C(O)O- wherein alkyl, substituted alkyl, alkenyl, substituted alkenyl, alkynyl, substituted alkynyl, cycloalkyl, substituted

30

cycloalkyl, aryl, substituted aryl, heteroaryl, substituted heteroaryl, heterocyclic and substituted heterocyclic are as defined herein.

"Alkenoxy" refers to the group "alkenyl-O-".

5

"Substituted alkenoxy" refers to the group "substituted alkenyl-O-".

"Alkenyl" refers to alkenyl group preferably having from 2 to 10 carbon atoms and more preferably 2 to 6 carbon atoms and having at least 1 and preferably from 1-2 sites of alkenyl unsaturation.

10

"Substituted alkenyl" refers to alkenyl groups having from 1 to 5 substituents independently selected from the group consisting of alkoxy, substituted alkoxy, acyl, acylamino, thiocarbonylamino, acyloxy, amino, amidino, alkylamidino, thioamidino, aminoacyl, aminocarbonylamino, aminothiocarbonylamino, aminocarbonyloxy, aryl, substituted aryl, aryloxy, substituted aryloxy, aryloxyaryl, substituted aryloxyaryl, halogen, hydroxyl, cyano, nitro, carboxyl, carboxylalkyl, carboxyl-substituted alkyl, carboxyl-cycloalkyl, carboxyl-substituted cycloalkyl, carboxylaryl, carboxyl-substituted aryl, carboxylheteroaryl, carboxyl-substituted heteroaryl, carboxylheterocyclic, carboxyl-substituted heterocyclic, cycloalkyl, substituted cycloalkyl, guanidino, guanidinosulfone, thiol, thioalkyl, substituted thioalkyl, thioaryl, substituted thioaryl, thiocycloalkyl, substituted thiocycloalkyl, thioheteroaryl, substituted thioheteroaryl, thioheterocyclic, substituted thioheterocyclic, heteroaryl, substituted heteroaryl, heterocyclic, substituted heterocyclic, cycloalkoxy, substituted cycloalkoxy, heteroaryloxy, substituted heteroaryloxy, heterocyclyloxy, substituted heterocyclyloxy, oxycarbonylamino, oxythiocarbonylamino, cycloalkyloxy, substituted cycloalkyloxy, heteroaryloxy, substituted heteroaryloxy, -OS(O)₂-alkyl, -OS(O)₂-substituted alkyl, -OS(O)₂-aryl, -OS(O)₂-substituted aryl, -OS(O)₂-heteroaryl, -OS(O)₂-substituted heteroaryl, -OS(O)₂-heterocyclic, -OS(O)₂-substituted heterocyclic, -OSO₂-NRR where R is hydrogen or alkyl, -NRS(O)₂-alkyl, -NRS(O)₂-substituted alkyl, -NRS(O)₂-aryl, -

15

20

25

30

NRS(O)₂-substituted aryl, -NRS(O)₂-heteroaryl, -NRS(O)₂-substituted heteroaryl, -
 NRS(O)₂-heterocyclic, -NRS(O)₂-substituted heterocyclic, -NRS(O)₂-NR-alkyl, -
 NRS(O)₂-NR-substituted alkyl, -NRS(O)₂-NR-aryl, -NRS(O)₂-NR-substituted aryl, -
 NRS(O)₂-NR-heteroaryl, -NRS(O)₂-NR-substituted heteroaryl, -NRS(O)₂-NR-
 5 heterocyclic, -NRS(O)₂-NR-substituted heterocyclic where R is hydrogen or alkyl,
 mono- and di-alkylamino, mono- and di-(substituted alkyl)amino, mono- and di-
 arylamino, mono- and di-substituted arylamino, mono- and di-heteroarylamino,
 mono- and di-substituted heteroarylamino, mono- and di-heterocyclic amino, mono-
 and di-substituted heterocyclic amino, unsymmetric di-substituted amines having
 10 different substituents independently selected from the group consisting of alkyl,
 substituted alkyl, aryl, substituted aryl, heteroaryl, substituted heteroaryl,
 heterocyclic, substituted heterocyclic and substituted alkenyl groups having amino
 groups blocked by conventional blocking groups such as Boc, Cbz, formyl, and the
 like or alkenyl/substituted alkenyl groups substituted with -SO₂-alkyl, -SO₂-
 15 substituted alkyl, -SO₂-alkenyl, -SO₂-substituted alkenyl, -SO₂-cycloalkyl, -SO₂-
 substituted cycloalkyl, -SO₂-aryl, -SO₂-substituted aryl, -SO₂-heteroaryl, -SO₂-
 substituted heteroaryl, -SO₂-heterocyclic, -SO₂-substituted heterocyclic and -
 SO₂NRR where R is hydrogen or alkyl.

Preferably, the substituents are independently selected from the group
 20 consisting of alkoxy, substituted alkoxy, acyl, acylamino, acyloxy, amino,
 substituted amino, aminoacyl, aminocarbonylamino, aminocarbonyloxy, aryl,
 substituted aryl, aryloxy, substituted aryloxy, carboxyl, carboxyl esters, cyano,
 cycloalkyl, substituted cycloalkyl, cycloalkyloxy, substituted cycloalkyloxy, halogen,
 heteroaryl, substituted heteroaryl, heteroaryloxy, substituted heteroaryloxy,
 25 heterocyclic, substituted heterocyclic, hydroxyl, nitro, and oxycarbonylamino.

"Alkoxy" refers to the group "alkyl-O-" which includes, by way of example,
 methoxy, ethoxy, *n*-propoxy, *iso*-propoxy, *n*-butoxy, *tert*-butoxy, *sec*-butoxy, *n*-
 pentoxy, *n*-hexoxy, 1,2-dimethylbutoxy, and the like.

30

"Substituted alkoxy" refers to the group "substituted alkyl-O-".

"Alkyl" refers to alkyl groups preferably having from 1 to 10 carbon atoms and more preferably 1 to 6 carbon atoms. This term is exemplified by groups such as methyl, t-butyl, n-heptyl, octyl and the like.

5

"Substituted alkyl" refers to an alkyl group, of from 1 to 10 carbon atoms, having from 1 to 5 substituents independently selected from the group consisting of alkoxy, substituted alkoxy, acyl, acylamino, thiocarbonylamino, acyloxy, amino, amidino, alkyl amidino, thioamidino, aminoacyl, aminocarbonylamino, aminothiocarbonylamino, aminocarbonyloxy, aryl, substituted aryl, aryloxy, substituted aryloxy, aryloxylaryl, substituted aryloxyaryl, cyano, halogen, hydroxyl, nitro, carboxyl, carboxylalkyl, carboxyl-substituted alkyl, carboxyl-cycloalkyl, carboxyl-substituted cycloalkyl, carboxylaryl, carboxyl-substituted aryl, carboxylheteroaryl, carboxyl-substituted heteroaryl, carboxylheterocyclic, carboxyl-substituted heterocyclic, cycloalkyl, substituted cycloalkyl, guanidino, guanidinosulfone, thiol, thioalkyl, substituted thioalkyl, thioaryl, substituted thioaryl, thiocycloalkyl, substituted thiocycloalkyl, thioheteroaryl, substituted thioheteroaryl, thioheterocyclic, substituted thioheterocyclic, heteroaryl, substituted aryl, substituted heteroaryl, heterocyclic, substituted heterocyclic, cycloalkoxy, substituted cycloalkoxy, heteroaryloxy, substituted heteroaryloxy, heterocyclyloxy, substituted heterocyclyloxy, oxycarbonylamino, oxythiocarbonylamino, cycloalkyloxy, substituted cycloalkyloxy, heteroaryloxy, substituted heteroaryloxy, -OS(O)₂-alkyl, -OS(O)₂-substituted alkyl, -OS(O)₂-aryl, -OS(O)₂-substituted aryl, -OS(O)₂-heteroaryl, -OS(O)₂-substituted heteroaryl, -OS(O)₂-heterocyclic, -OS(O)₂-substituted heterocyclic, -OSO₂-NRR where R is hydrogen or alkyl, -NRS(O)₂-alkyl, -NRS(O)₂-substituted alkyl, -NRS(O)₂-aryl, -NRS(O)₂-substituted aryl, -NRS(O)₂-heteroaryl, -NRS(O)₂-substituted heteroaryl, -NRS(O)₂-heterocyclic, -NRS(O)₂-substituted heterocyclic, -NRS(O)₂-NR-alkyl, -NRS(O)₂-NR-substituted alkyl, -NRS(O)₂-NR-aryl, -NRS(O)₂-NR-substituted aryl, -NRS(O)₂-NR-heteroaryl, -NRS(O)₂-NR-substituted heteroaryl, -NRS(O)₂-NR-heterocyclic, -NRS(O)₂-NR-substituted heterocyclic where R is hydrogen or alkyl, mono- and di-alkylamino,

30

mono- and di-(substituted alkyl)amino, mono- and di-arylamino, mono- and di-substituted arylamino, mono- and di-heteroarylamino, mono- and di-substituted heteroarylamino, mono- and di-heterocyclic amino, mono- and di-substituted heterocyclic amino, unsymmetric di-substituted amines having different substituents independently selected from the group consisting of alkyl, substituted alkyl, aryl, substituted aryl, heteroaryl, substituted heteroaryl, heterocyclic and substituted heterocyclic and substituted alkyl groups having amino groups blocked by conventional blocking groups such as Boc, Cbz, formyl, and the like or alkyl/substituted alkyl groups substituted with -SO₂-alkyl, -SO₂-substituted alkyl, -SO₂-alkenyl, -SO₂-substituted alkenyl, -SO₂-cycloalkyl, -SO₂-substituted cycloalkyl, -SO₂-aryl, -SO₂-substituted aryl, -SO₂-heteroaryl, -SO₂-substituted heteroaryl, -SO₂-heterocyclic, -SO₂-substituted heterocyclic and -SO₂NRR where R is hydrogen or alkyl.

Preferably, the substituents are independently selected from the group consisting of alkoxy, substituted alkoxy, acyl, acylamino, acyloxy, amino, substituted amino, aminoacyl, aminocarbonylamino, aminocarbonyloxy, aryl, substituted aryl, aryloxy, substituted aryloxy, carboxyl, carboxyl esters, cyano, cycloalkyl, substituted cycloalkyl, cycloalkyloxy, substituted cycloalkyloxy, halogen, heteroaryl, substituted heteroaryl, heteroaryloxy, substituted heteroaryloxy, heterocyclic, substituted heterocyclic, hydroxyl, nitro, and oxycarbonylamino.

"Alkylene" refers to linear and branched divalent alkyl groups having from 1 to 10 carbon atoms and more preferably 1 to 6 carbon atoms. This term is exemplified by groups such as methylene (-CH₂-), 1,6-heptylene, 1,8-octylene, ethylene (-CH₂CH₂-), the propylene isomers (*e.g.*, -CH₂CH₂CH₂- and -CH(CH₃)CH₂-) and the like.

"Substituted alkylene" refers to alkylene groups having from 1 to 5 substituents independently selected from the group consisting of alkoxy, substituted alkoxy, acyl, acylamino, thiocarbonylamino, acyloxy, amino, amidino, alkylamidino, thioamidino, aminoacyl, aminocarbonylamino, aminothiocarbonylamino,

aminocarbonyloxy, aryl, substituted aryl, aryloxy, substituted aryloxy, aryloxyaryl,
 substituted aryloxyaryl, halogen, hydroxyl, cyano, nitro, carboxyl, carboxylalkyl,
 carboxyl-substituted alkyl, carboxyl-cycloalkyl, carboxyl-substituted cycloalkyl,
 carboxylaryl, carboxyl-substituted aryl, carboxylheteroaryl, carboxyl-substituted
 5 heteroaryl, carboxylheterocyclic, carboxyl-substituted heterocyclic, cycloalkyl,
 substituted cycloalkyl, guanidino, guanidinosulfone, thiol, thioalkyl, substituted
 thioalkyl, thioaryl, substituted thioaryl, thiocycloalkyl, substituted thiocycloalkyl,
 thioheteroaryl, substituted thioheteroaryl, thioheterocyclic, substituted
 thioheterocyclic, heteroaryl, substituted heteroaryl, heterocyclic, substituted
 10 heterocyclic, cycloalkoxy, substituted cycloalkoxy, heteroaryloxy, substituted
 heteroaryloxy, heterocyclyloxy, substituted heterocyclyloxy, oxycarbonylamino,
 oxythiocarbonylamino, -OS(O)₂-alkyl, -OS(O)₂-substituted alkyl, -OS(O)₂-aryl, -
 OS(O)₂-substituted aryl, -OS(O)₂-heteroaryl, -OS(O)₂-substituted heteroaryl, -
 OS(O)₂-heterocyclic, -OS(O)₂-substituted heterocyclic, -OSO₂-NRR where R is
 15 hydrogen or alkyl, -NRS(O)₂-alkyl, -NRS(O)₂-substituted alkyl, -NRS(O)₂-aryl, -
 NRS(O)₂-substituted aryl, -NRS(O)₂-heteroaryl, -NRS(O)₂-substituted heteroaryl, -
 NRS(O)₂-heterocyclic, -NRS(O)₂-substituted heterocyclic, -NRS(O)₂-NR-alkyl, -
 NRS(O)₂-NR-substituted alkyl, -NRS(O)₂-NR-aryl, -NRS(O)₂-NR-substituted aryl, -
 NRS(O)₂-NR-heteroaryl, -NRS(O)₂-NR-substituted heteroaryl, -NRS(O)₂-NR-
 20 heterocyclic, -NRS(O)₂-NR-substituted heterocyclic where R is hydrogen or alkyl,
 mono- and di-alkylamino, mono- and di-(substituted alkyl)amino, mono- and di-
 arylamino, mono- and di-substituted arylamino, mono- and di-heteroarylamino,
 mono- and di-substituted heteroarylamino, mono- and di-heterocyclic amino, mono-
 and di-substituted heterocyclic amino, unsymmetric di-substituted amines having
 25 different substituents independently selected from the group consisting of alkyl,
 substituted alkyl, aryl, substituted aryl, heteroaryl, substituted heteroaryl,
 heterocyclic, substituted heterocyclic and substituted alkenyl groups having amino
 groups blocked by conventional blocking groups such as Boc, Cbz, formyl, and the
 like or alkenyl/substituted alkenyl groups substituted with -SO₂-alkyl, -SO₂-
 30 substituted alkyl, -SO₂-alkenyl, -SO₂-substituted alkenyl, -SO₂-cycloalkyl, -SO₂-
 substituted cycloalkyl, -SO₂-aryl, -SO₂-substituted aryl, -SO₂-heteroaryl, -SO₂-

substituted heteroaryl, -SO₂-heterocyclic, -SO₂-substituted heterocyclic and -SO₂NRR where R is hydrogen or alkyl.

"Alkynyl" refers to alkynyl group preferably having from 2 to 10 carbon atoms and more preferably 3 to 6 carbon atoms and having at least 1 and preferably from 1-2 sites of alkynyl unsaturation.

"Substituted alkynyl" refers to alkynyl groups having from 1 to 5 substituents independently selected from the group consisting of alkoxy, substituted alkoxy, acyl, acylamino, thiocarbonylamino, acyloxy, amino, amidino, alkylamidino, thioamidino, aminoacyl, aminocarbonylamino, aminothiocarbonylamino, aminocarbonyloxy, aryl, substituted aryl, aryloxy, substituted aryloxy, aryloxyaryl, substituted aryloxyaryl, halogen, hydroxyl, cyano, nitro, carboxyl, carboxylalkyl, carboxyl-substituted alkyl, carboxyl-cycloalkyl, carboxyl-substituted cycloalkyl, carboxylaryl, carboxyl-substituted aryl, carboxylheteroaryl, carboxyl-substituted heteroaryl, carboxylheterocyclic, carboxyl-substituted heterocyclic, cycloalkyl, substituted cycloalkyl, guanidino, guanidinosulfone, thiol, thioalkyl, substituted thioalkyl, thioaryl, substituted thioaryl, thiocycloalkyl, substituted thiocycloalkyl, thioheteroaryl, substituted thioheteroaryl, thioheterocyclic, substituted thioheterocyclic, heteroaryl, substituted heteroaryl, heterocyclic, substituted heterocyclic, cycloalkoxy, substituted cycloalkoxy, heteroaryloxy, substituted heteroaryloxy, heterocyclyloxy, substituted heterocyclyloxy, oxycarbonylamino, oxythiocarbonylamino, -OS(O)₂-alkyl, -OS(O)₂-substituted alkyl, -OS(O)₂-aryl, -OS(O)₂-substituted aryl, -OS(O)₂-heteroaryl, -OS(O)₂-substituted heteroaryl, -OS(O)₂-heterocyclic, -OS(O)₂-substituted heterocyclic, -OSO₂-NRR where R is hydrogen or alkyl, -NRS(O)₂-alkyl, -NRS(O)₂-substituted alkyl, -NRS(O)₂-aryl, -NRS(O)₂-substituted aryl, -NRS(O)₂-heteroaryl, -NRS(O)₂-substituted heteroaryl, -NRS(O)₂-heterocyclic, -NRS(O)₂-substituted heterocyclic, -NRS(O)₂-NR-alkyl, -NRS(O)₂-NR-substituted alkyl, -NRS(O)₂-NR-aryl, -NRS(O)₂-NR-substituted aryl, -NRS(O)₂-NR-heteroaryl, -NRS(O)₂-NR-substituted heteroaryl, -NRS(O)₂-NR-heterocyclic, -NRS(O)₂-NR-substituted heterocyclic where R is hydrogen or alkyl,

mono- and di-alkylamino, mono- and di-(substituted alkyl)amino, mono- and di-arylamino, mono- and di-substituted arylamino, mono- and di-heteroarylamino, mono- and di-substituted heteroarylamino, mono- and di-heterocyclic amino, mono- and di-substituted heterocyclic amino, unsymmetric di-substituted amines having
5 different substituents independently selected from the group consisting of alkyl, substituted alkyl, aryl, substituted aryl, heteroaryl, substituted heteroaryl, heterocyclic, substituted heterocyclic and substituted alkynyl groups having amino groups blocked by conventional blocking groups such as Boc, Cbz, formyl, and the like or alkynyl/substituted alkynyl groups substituted with -SO₂-alkyl, -SO₂-
10 substituted alkyl, -SO₂-alkenyl, -SO₂-substituted alkenyl, -SO₂-cycloalkyl, -SO₂-substituted cycloalkyl, -SO₂-aryl, -SO₂-substituted aryl, -SO₂-heteroaryl, -SO₂-substituted heteroaryl, -SO₂-heterocyclic, -SO₂-substituted heterocyclic and -SO₂NRR where R is hydrogen or alkyl.

15 "Amidino" refers to the group H₂NC(=NH)- and the term "alkylamidino" refers to compounds having 1 to 3 alkyl groups (*e.g.*, alkylHNC(=NH)-).

"Amino" refers to the group -NH₂.

20 "Substituted amino" refers to the group -NRR, where each R group is independently selected from the group consisting of hydrogen, alkyl, substituted alkyl, alkenyl, substituted alkenyl, cycloalkyl, substituted cycloalkyl, aryl, substituted aryl, heteroaryl, substituted heteroaryl, heterocyclic, and substituted heterocyclic, provided that both R groups are not hydrogen; or where the R groups
25 can be joined together with the nitrogen atom to form a heterocyclic or substituted heterocyclic ring.

"Aminoacyl" refers to the groups -NRC(O)alkyl, -NRC(O)substituted alkyl, -NRC(O)cycloalkyl, -NRC(O)substituted cycloalkyl, -NRC(O)alkenyl, -
30 NRC(O)substituted alkenyl, -NRC(O)alkynyl, -NRC(O)substituted alkynyl, -NRC(O)aryl, -NRC(O)substituted aryl, -NRC(O)heteroaryl, -NRC(O)substituted

heteroaryl, -NRC(O)heterocyclic, and -NRC(O)substituted heterocyclic where R is hydrogen or alkyl and wherein alkyl, substituted alkyl, alkenyl, substituted alkenyl, alkynyl, substituted alkynyl, cycloalkyl, substituted cycloalkyl, aryl, substituted aryl, heteroaryl, substituted heteroaryl, heterocyclic and substituted heterocyclic are as
5 defined herein.

"Aminocarbonylamino" refers to the groups -NRC(O)NRR, -NRC(O)NR-alkyl, -NRC(O)NR-substituted alkyl, -NRC(O)NR-alkenyl, -NRC(O)NR-substituted alkenyl, -NRC(O)NR-alkynyl, -NRC(O)NR-substituted alkynyl, -NRC(O)NR-aryl, -
10 NRC(O)NR-substituted aryl, -NRC(O)NR-cycloalkyl, -NRC(O)NR-substituted cycloalkyl, -NRC(O)NR-heteroaryl, and -NRC(O)NR-substituted heteroaryl, -NRC(O)NR-heterocyclic, and -NRC(O)NR-substituted heterocyclic where each R is independently hydrogen, alkyl or where each R is joined to form together with the nitrogen atom a heterocyclic or substituted heterocyclic ring as well as where one of
15 the amino groups is blocked by conventional blocking groups such as Boc, Cbz, formyl, and the like and wherein alkyl, substituted alkyl, alkenyl, substituted alkenyl, alkynyl, substituted alkynyl, cycloalkyl, substituted cycloalkyl, aryl, substituted aryl, heteroaryl, substituted heteroaryl, heterocyclic and substituted heterocyclic are as defined herein.

"Aminocarbonyloxy" refers to the groups -NRC(O)O-alkyl, -NRC(O)O-substituted alkyl, -NRC(O)O-alkenyl, -NRC(O)O-substituted alkenyl, -NRC(O)O-alkynyl, -NRC(O)O-substituted alkynyl, -NRC(O)O-cycloalkyl, -NRC(O)O-substituted cycloalkyl, -NRC(O)O-aryl, -NRC(O)O-substituted aryl, -NRC(O)O-
25 heteroaryl, -NRC(O)O-substituted heteroaryl, -NRC(O)O-heterocyclic, and -NRC(O)O-substituted heterocyclic where R is hydrogen or alkyl and wherein alkyl, substituted alkyl, alkenyl, substituted alkenyl, alkynyl, substituted alkynyl, cycloalkyl, substituted cycloalkyl, aryl, substituted aryl, heteroaryl, substituted heteroaryl, heterocyclic and substituted heterocyclic are as defined herein.

30

"Aminothiocabonylamino" refers to the groups -NRC(S)NRR, -NRC(S)NR-alkyl, -NRC(S)NR-substituted alkyl, -NRC(S)NR-alkenyl, -NRC(S)NR-substituted alkenyl, -NRC(S)NR-alkynyl, -NRC(S)NR-substituted alkynyl, -NRC(S)NR-aryl, -NRC(S)NR-substituted aryl, -NRC(S)NR-cycloalkyl, -NRC(S)NR-substituted cycloalkyl, -NRC(S)NR-heteroaryl, and -NRC(S)NR-substituted heteroaryl, -NRC(S)NR-heterocyclic, and -NRC(S)NR-substituted heterocyclic where each R is independently hydrogen, alkyl or where each R is joined to form together with the nitrogen atom a heterocyclic or substituted heterocyclic ring as well as where one of the amino groups is blocked by conventional blocking groups such as Boc, Cbz, formyl, and the like and wherein alkyl, substituted alkyl, alkenyl, substituted alkenyl, alkynyl, substituted alkynyl, cycloalkyl, substituted cycloalkyl, aryl, substituted aryl, heteroaryl, substituted heteroaryl, heterocyclic and substituted heterocyclic are as defined herein.

"Aryl" refers to an unsaturated aromatic carbocyclic group of from 6 to 14 carbon atoms having a single ring (*e.g.*, phenyl) or multiple condensed rings (*e.g.*, naphthyl or anthryl) which condensed rings may or may not be aromatic (*e.g.*, 2-benzoxazolinone, 2H-1,4-benzoxazin-3(4H)-one-7yl, and the like) provided that the point of attachment is through an aromatic ring atom. Preferred aryls include phenyl, naphthyl and 5,6,7,8-tetrahydronaphth-2-yl.

"Substituted aryl" refers to aryl groups which are substituted with from 1 to 3 substituents selected from the group consisting of hydroxy, acyl, acylamino, thiocabonylamino, acyloxy, alkyl, substituted alkyl, alkoxy, substituted alkoxy, alkenyl, substituted alkenyl, alkynyl, substituted alkynyl, amidino, alkylamidino, thioamidino, amino, aminoacyl, aminocabonyloxy, aminocabonylamino, aminothiocabonylamino, aryl, substituted aryl, aryloxy, substituted aryloxy, cycloalkoxy, substituted cycloalkoxy, heteroaryloxy, substituted heteroaryloxy, heterocyclyloxy, substituted heterocyclyloxy, carboxyl, carboxylalkyl, carboxyl-substituted alkyl, carboxyl-cycloalkyl, carboxyl-substituted cycloalkyl, carboxylaryl, carboxyl-substituted aryl, carboxylheteroaryl, carboxyl-substituted heteroaryl,

5 carboxylheterocyclic, carboxyl-substituted heterocyclic, carboxylamido, cyano, thiol, thioalkyl, substituted thioalkyl, thioaryl, substituted thioaryl, thioheteroaryl, substituted thioheteroaryl, thiocycloalkyl, substituted thiocycloalkyl, thioheterocyclic, substituted thioheterocyclic, cycloalkyl, substituted cycloalkyl,

10 guanidino, guanidinosulfone, halo, nitro, heteroaryl, substituted heteroaryl, heterocyclic, substituted heterocyclic, cycloalkoxy, substituted cycloalkoxy, heteroaryloxy, substituted heteroaryloxy, heterocyclyloxy, substituted heterocyclyloxy, oxycarbonylamino, oxythiocarbonylamino, -S(O)₂-alkyl, -S(O)₂-substituted alkyl, -S(O)₂-cycloalkyl, -S(O)₂-substituted cycloalkyl, -S(O)₂-alkenyl, -S(O)₂-substituted alkenyl, -S(O)₂-aryl, -S(O)₂-substituted aryl, -S(O)₂-heteroaryl, -S(O)₂-substituted heteroaryl, -S(O)₂-heterocyclic, -S(O)₂-substituted heterocyclic, -OS(O)₂-alkyl, -OS(O)₂-substituted alkyl, -OS(O)₂-aryl, -OS(O)₂-substituted aryl, -OS(O)₂-heteroaryl, -OS(O)₂-substituted heteroaryl, -OS(O)₂-heterocyclic, -OS(O)₂-substituted heterocyclic, -OSO₂-NRR where R is hydrogen or alkyl, -NRS(O)₂-alkyl, -NRS(O)₂-substituted alkyl, -NRS(O)₂-aryl, -NRS(O)₂-substituted aryl, -NRS(O)₂-heteroaryl, -NRS(O)₂-substituted heteroaryl, -NRS(O)₂-heterocyclic, -NRS(O)₂-substituted heterocyclic, -NRS(O)₂-NR-alkyl, -NRS(O)₂-NR-substituted alkyl, -NRS(O)₂-NR-aryl, -NRS(O)₂-NR-substituted aryl, -NRS(O)₂-NR-heteroaryl, -NRS(O)₂-NR-substituted heteroaryl, -NRS(O)₂-NR-heterocyclic, -NRS(O)₂-NR-substituted heterocyclic where R is hydrogen or alkyl, mono- and di-alkylamino, mono- and di-(substituted alkyl)amino, mono- and di-arylamino, mono- and di-substituted arylamino, mono- and di-heteroarylamino, mono- and di-substituted heteroarylamino, mono- and di-heterocyclic amino, mono- and di-substituted heterocyclic amino, unsymmetric di-substituted amines having different substituents

25 independently selected from the group consisting of alkyl, substituted alkyl, aryl, substituted aryl, heteroaryl, substituted heteroaryl, heterocyclic and substituted heterocyclic and amino groups on the substituted aryl blocked by conventional blocking groups such as Boc, Cbz, formyl, and the like or substituted with -SO₂NRR where R is hydrogen or alkyl.

30 Preferred substituents are selected from the group consisting of hydroxy, acyl, acylamino, acyloxy, alkyl, substituted alkyl, alkoxy, substituted alkoxy,

alkenyl, substituted alkenyl, amino, substituted amino, aminoacyl,
aminocarbonyloxy, aminocarbonylamino, aryl, substituted aryl, aryloxy, substituted
aryloxy, cycloalkoxy, substituted cycloalkoxy, heteroaryloxy, substituted
heteroaryloxy, heterocyclyloxy, substituted heterocyclyloxy, carboxyl, carboxyl
5 esters, cyano, cycloalkyl, substituted cycloalkyl, halo, nitro, heteroaryl, substituted
heteroaryl, heterocyclic, substituted heterocyclic, and oxycarbonylamino.

"Aryloxy" refers to the group aryl-O- which includes, by way of example,
phenoxy, naphthoxy, and the like.

10

"Substituted aryloxy" refers to substituted aryl-O- groups.

"Aryloxyaryl" refers to the group -aryl-O-aryl.

15

"Substituted aryloxyaryl" refers to aryloxyaryl groups substituted with from 1
to 3 substituents on either or both aryl rings selected from the group consisting of
hydroxy, acyl, acylamino, thiocarbonylamino, acyloxy, alkyl, substituted alkyl,
alkoxy, substituted alkoxy, alkenyl, substituted alkenyl, alkynyl, substituted alkynyl,
amidino, alkylamidino, thioamidino, amino, aminoacyl, aminocarbonyloxy,
aminocarbonylamino, aminothiocarbonylamino, aryl, substituted aryl, aryloxy,
20 substituted aryloxy, cycloalkoxy, substituted cycloalkoxy, heteroaryloxy, substituted
heteroaryloxy, heterocyclyloxy, substituted heterocyclyloxy, carboxyl, carboxylalkyl,
carboxyl-substituted alkyl, carboxyl-cycloalkyl, carboxyl-substituted cycloalkyl,
carboxylaryl, carboxyl-substituted aryl, carboxylheteroaryl, carboxyl-substituted
25 heteroaryl, carboxylheterocyclic, carboxyl-substituted heterocyclic, carboxylamido,
cyano, thiol, thioalkyl, substituted thioalkyl, thioaryl, substituted thioaryl,
thioheteroaryl, substituted thioheteroaryl, thiocycloalkyl, substituted thiocycloalkyl,
thioheterocyclic, substituted thioheterocyclic, cycloalkyl, substituted cycloalkyl,
guanidino, guanidinosulfone, halo, nitro, heteroaryl, substituted heteroaryl,
30 heterocyclic, substituted heterocyclic, cycloalkoxy, substituted cycloalkoxy,
heteroaryloxy, substituted heteroaryloxy, heterocyclyloxy, substituted

heterocycloxy, oxycarbonylamino, oxythiocarbonylamino, -S(O)₂-alkyl, -S(O)₂-
 substituted alkyl, -S(O)₂-cycloalkyl, -S(O)₂-substituted cycloalkyl, -S(O)₂-alkenyl, -
 S(O)₂-substituted alkenyl, -S(O)₂-aryl, -S(O)₂-substituted aryl, -S(O)₂-heteroaryl, -
 S(O)₂-substituted heteroaryl, -S(O)₂-heterocyclic, -S(O)₂-substituted heterocyclic, -
 5 OS(O)₂-alkyl, -OS(O)₂-substituted alkyl, -OS(O)₂-aryl, -OS(O)₂-substituted aryl, -
 OS(O)₂-heteroaryl, -OS(O)₂-substituted heteroaryl, -OS(O)₂-heterocyclic, -OS(O)₂-
 substituted heterocyclic, -OSO₂-NRR where R is hydrogen or alkyl, -NRS(O)₂-alkyl,
 -NRS(O)₂-substituted alkyl, -NRS(O)₂-aryl, -NRS(O)₂-substituted aryl, -NRS(O)₂-
 heteroaryl, -NRS(O)₂-substituted heteroaryl, -NRS(O)₂-heterocyclic, -NRS(O)₂-
 10 substituted heterocyclic, -NRS(O)₂-NR-alkyl, -NRS(O)₂-NR-substituted alkyl, -
 NRS(O)₂-NR-aryl, -NRS(O)₂-NR-substituted aryl, -NRS(O)₂-NR-heteroaryl, -
 NRS(O)₂-NR-substituted heteroaryl, -NRS(O)₂-NR-heterocyclic, -NRS(O)₂-NR-
 substituted heterocyclic where R is hydrogen or alkyl, mono- and di-alkylamino,
 mono- and di-(substituted alkyl)amino, mono- and di-arylamino, mono- and di-
 15 substituted arylamino, mono- and di-heteroarylamino, mono- and di-substituted
 heteroarylamino, mono- and di-heterocyclic amino, mono- and di-substituted
 heterocyclic amino, unsymmetric di-substituted amines having different substituents
 independently selected from the group consisting of alkyl, substituted alkyl, aryl,
 substituted aryl, heteroaryl, substituted heteroaryl, heterocyclic and substituted
 20 heterocyclic and amino groups on the substituted aryl blocked by conventional
 blocking groups such as Boc, Cbz, formyl, and the like or substituted with -SO₂NRR
 where R is hydrogen or alkyl.

"Aralkoxy" refers to aryl-alkylene-O- groups.

25

"Substituted aralkoxy" refers to substituted aryl-alkylene-O- groups.

"Carboxyl" refers to the group -COOH and pharmaceutically acceptable salts thereof.

30

"Carboxyl esters" refers -C(O)O-alkyl, -C(O)O-substituted alkyl, -C(O)O-alkenyl, -C(O)O-substituted alkenyl, -C(O)O-aryl, -C(O)O-substituted aryl, -C(O)O-cycloalkyl, -C(O)O-substituted cycloalkyl, -C(O)O-heteroaryl, -C(O)O-substituted heteroaryl, -C(O)O-heterocyclic, and -C(O)O-substituted heterocyclic.

5

"Cycloalkenyl" refers to cyclic alkenyl groups of from 3 to 8 carbon atoms having a single cyclic ring.

"Cycloalkoxy" refers to -O-cycloalkyl groups.

10

"Substituted cycloalkoxy" refers to -O-substituted cycloalkyl groups.

"Cycloalkyl" refers to cyclic alkyl groups of from 3 to 12 carbon atoms having a single or multiple condensed rings including, by way of example, adamantyl, cyclopropyl, cyclobutyl, cyclopentyl, cyclohexyl, cyclooctyl and the like. Preferably "cycloalkyl" refers to cyclic alkyl groups of from 3 to 8 carbon atoms having a single cyclic ring.

15

"Substituted cycloalkyl" and "substituted cycloalkenyl" refers to an cycloalkyl or cycloalkenyl group, preferably of from 3 to 8 carbon atoms, having from 1 to 5 substituents independently selected from the group consisting of oxo (=O), thioxo (=S), alkoxy, substituted alkoxy, acyl, acylamino, thiocarbonylamino, acyloxy, amino, amidino, alkylamidino, thioamidino, aminoacyl, aminocarbonylamino, aminothiocarbonylamino, aminocarbonyloxy, aryl, substituted aryl, aryloxy, substituted aryloxy, aryloxyaryl, substituted aryloxyaryl, halogen, hydroxyl, cyano, nitro, carboxyl, carboxylalkyl, carboxyl-substituted alkyl, carboxyl-cycloalkyl, carboxyl-substituted cycloalkyl, carboxylaryl, carboxyl-substituted aryl, carboxylheteroaryl, carboxyl-substituted heteroaryl, carboxylheterocyclic, carboxyl-substituted heterocyclic, cycloalkyl, substituted cycloalkyl, guanidino, guanidinosulfone, thiol, thioalkyl, substituted thioalkyl, thioaryl, substituted thioaryl, thiocycloalkyl, substituted thiocycloalkyl, thioheteroaryl, substituted thioheteroaryl,

20
25
30

thioheterocyclic, substituted thioheterocyclic, heteroaryl, substituted heteroaryl,
 heterocyclic, substituted heterocyclic, cycloalkoxy, substituted cycloalkoxy,
 heteroaryloxy, substituted heteroaryloxy, heterocyclyloxy, substituted
 heterocyclyloxy, oxycarbonylamino, oxythiocarbonylamino, -OS(O)₂-alkyl, -
 5 OS(O)₂-substituted alkyl, -OS(O)₂-aryl, -OS(O)₂-substituted aryl, -OS(O)₂-
 heteroaryl, -OS(O)₂-substituted heteroaryl, -OS(O)₂-heterocyclic, -OS(O)₂-
 substituted heterocyclic, -OSO₂-NRR where R is hydrogen or alkyl, -NRS(O)₂-alkyl,
 -NRS(O)₂-substituted alkyl, -NRS(O)₂-aryl, -NRS(O)₂-substituted aryl, -NRS(O)₂-
 heteroaryl, -NRS(O)₂-substituted heteroaryl, -NRS(O)₂-heterocyclic, -NRS(O)₂-
 10 substituted heterocyclic, -NRS(O)₂-NR-alkyl, -NRS(O)₂-NR-substituted alkyl, -
 NRS(O)₂-NR-aryl, -NRS(O)₂-NR-substituted aryl, -NRS(O)₂-NR-heteroaryl, -
 NRS(O)₂-NR-substituted heteroaryl, -NRS(O)₂-NR-heterocyclic, -NRS(O)₂-NR-
 substituted heterocyclic where R is hydrogen or alkyl, mono- and di-alkylamino,
 mono- and di-(substituted alkyl)amino, mono- and di-arylamino, mono- and di-
 15 substituted arylamino, mono- and di-heteroarylamino, mono- and di-substituted
 heteroarylamino, mono- and di-heterocyclic amino, mono- and di-substituted
 heterocyclic amino, unsymmetric di-substituted amines having different substituents
 independently selected from the group consisting of alkyl, substituted alkyl, aryl,
 substituted aryl, heteroaryl, substituted heteroaryl, heterocyclic and substituted
 20 heterocyclic and substituted alkynyl groups having amino groups blocked by
 conventional blocking groups such as Boc, Cbz, formyl, and the like or
 alkynyl/substituted alkynyl groups substituted with -SO₂-alkyl, -SO₂-substituted
 alkyl, -SO₂-alkenyl, -SO₂-substituted alkenyl, -SO₂-cycloalkyl, -SO₂-substituted
 cycloalkyl, -SO₂-aryl, -SO₂-substituted aryl, -SO₂-heteroaryl, -SO₂-substituted
 25 heteroaryl, -SO₂-heterocyclic, -SO₂-substituted heterocyclic and -SO₂NRR where R
 is hydrogen or alkyl.

Preferred substituents are selected from the group consisting of oxo (=O),
 thioxo (=S), alkoxy, substituted alkoxy, acyl, acylamino, acyloxy, amino, substituted
 amino, aminoacyl, aminocarbonylamino, aminocarbonyloxy, aryl, substituted aryl,
 30 aryloxy, substituted aryloxy, carboxyl, carboxyl esters, cyano, cycloalkyl, substituted
 cycloalkyl, cycloalkyloxy, substituted cycloalkyloxy, halogen, heteroaryl, substituted

heteroaryl, heteroaryloxy, substituted heteroaryloxy, heterocyclic, substituted heterocyclic, hydroxyl, nitro, and oxycarbonylamino.

"Guanidino" refers to the groups -NRC(=NR)NRR, -NRC(=NR)NR-alkyl, -
5 NRC(=NR)NR-substituted alkyl, -NRC(=NR)NR-alkenyl, -NRC(=NR)NR-
substituted alkenyl, -NRC(=NR)NR-alkynyl, -NRC(=NR)NR-substituted alkynyl, -
NRC(=NR)NR-aryl, -NRC(=NR)NR-substituted aryl, -NRC(=NR)NR-cycloalkyl, -
NRC(=NR)NR-heteroaryl, -NRC(=NR)NR-substituted heteroaryl, -NRC(=NR)NR-
heterocyclic, and -NRC(=NR)NR-substituted heterocyclic where each R is
10 independently hydrogen and alkyl as well as where one of the amino groups is
blocked by conventional blocking groups such as Boc, Cbz, formyl, and the like and
wherein alkyl, substituted alkyl, alkenyl, substituted alkenyl, alkynyl, substituted
alkynyl, cycloalkyl, substituted cycloalkyl, aryl, substituted aryl, heteroaryl,
substituted heteroaryl, heterocyclic and substituted heterocyclic are as defined
15 herein.

"Guanidinosulfone" refers to the groups -NRC(=NR)NRSO₂-alkyl, -
NRC(=NR)NRSO₂-substituted alkyl, -NRC(=NR)NRSO₂-alkenyl, -
NRC(=NR)NRSO₂-substituted alkenyl, -NRC(=NR)NRSO₂-alkynyl, -
20 NRC(=NR)NRSO₂-substituted alkynyl, -NRC(=NR)NRSO₂-aryl, -
NRC(=NR)NRSO₂-substituted aryl, -NRC(=NR)NRSO₂-cycloalkyl, -
NRC(=NR)NRSO₂-substituted cycloalkyl, -NRC(=NR)NRSO₂-heteroaryl, and -
NRC(=NR)NRSO₂-substituted heteroaryl, -NRC(=NR)NRSO₂-heterocyclic, and -
NRC(=NR)NRSO₂-substituted heterocyclic where each R is independently hydrogen
25 and alkyl and wherein alkyl, substituted alkyl, alkenyl, substituted alkenyl, alkynyl,
substituted alkynyl, cycloalkyl, substituted cycloalkyl, aryl, substituted aryl,
heteroaryl, substituted heteroaryl, heterocyclic and substituted heterocyclic are as
defined herein.

30 "Halo" or "halogen" refers to fluoro, chloro, bromo and iodo and preferably
is fluoro, chloro or bromo.

"Heteroaryl" refers to an aromatic carbocyclic group of from 2 to 10 carbon atoms and 1 to 4 heteroatoms selected from the group consisting of oxygen, nitrogen and sulfur within the ring or oxides thereof. Such heteroaryl groups can have a single ring (*e.g.*, pyridyl or furyl) or multiple condensed rings (*e.g.*, indoliziny1 or benzothienyl) wherein one or more of the condensed rings may or may not be aromatic provided that the point of attachment is through an aromatic ring atom. Additionally, the heteroatoms of the heteroaryl group may be oxidized, *i.e.*, to form pyridine N-oxides or 1,1-dioxo-1,2,5-thiadiazoles and the like. Additionally, the carbon atoms of the ring may be substituted with an oxo (=O). Preferred heteroaryls include pyridyl, pyrrolyl, indolyl, furyl, pyridazinyl, pyrimidinyl, pyrazinyl, 1-oxo-1,2,5-thiadiazolyl and 1,1-dioxo-1,2,5-thiadiazolyl.

"Substituted heteroaryl" refers to heteroaryl groups which are substituted with from 1 to 3 substituents selected from the group consisting of hydroxy, acyl, acylamino, thiocarbonylamino, acyloxy, alkyl, substituted alkyl, alkoxy, substituted alkoxy, alkenyl, substituted alkenyl, alkynyl, substituted alkynyl, amidino, alkylamidino, thioamidino, amino, aminoacyl, aminocarbonyloxy, aminocarbonylamino, aminothiocarbonylamino, aryl, substituted aryl, aryloxy, substituted aryloxy, cycloalkoxy, substituted cycloalkoxy, heteroaryloxy, substituted heteroaryloxy, heterocyclyloxy, substituted heterocyclyloxy, carboxyl, carboxylalkyl, carboxyl-substituted alkyl, carboxyl-cycloalkyl, carboxyl-substituted cycloalkyl, carboxylaryl, carboxyl-substituted aryl, carboxylheteroaryl, carboxyl-substituted heteroaryl, carboxylheterocyclic, carboxyl-substituted heterocyclic, carboxylamido, cyano, thiol, thioalkyl, substituted thioalkyl, thioaryl, substituted thioaryl, thioheteroaryl, substituted thioheteroaryl, thiocycloalkyl, substituted thiocycloalkyl, thioheterocyclic, substituted thioheterocyclic, cycloalkyl, substituted cycloalkyl, guanidino, guanidinosulfone, halo, nitro, heteroaryl, substituted heteroaryl, heterocyclic, substituted heterocyclic, cycloalkoxy, substituted cycloalkoxy, heteroaryloxy, substituted heteroaryloxy, heterocyclyloxy, substituted heterocyclyloxy, oxycarbonylamino, oxythiocarbonylamino, -S(O)₂-alkyl, -S(O)₂-

substituted alkyl, -S(O)₂-cycloalkyl, -S(O)₂-substituted cycloalkyl, -S(O)₂-alkenyl, -
 S(O)₂-substituted alkenyl, -S(O)₂-aryl, -S(O)₂-substituted aryl, -S(O)₂-heteroaryl, -
 S(O)₂-substituted heteroaryl, -S(O)₂-heterocyclic, -S(O)₂-substituted heterocyclic, -
 OS(O)₂-alkyl, -OS(O)₂-substituted alkyl, -OS(O)₂-aryl, -OS(O)₂-substituted aryl, -
 5 OS(O)₂-heteroaryl, -OS(O)₂-substituted heteroaryl, -OS(O)₂-heterocyclic, -OS(O)₂-
 substituted heterocyclic, -OSO₂-NRR where R is hydrogen or alkyl, -NRS(O)₂-alkyl,
 -NRS(O)₂-substituted alkyl, -NRS(O)₂-aryl, -NRS(O)₂-substituted aryl, -NRS(O)₂-
 heteroaryl, -NRS(O)₂-substituted heteroaryl, -NRS(O)₂-heterocyclic, -NRS(O)₂-
 substituted heterocyclic, -NRS(O)₂-NR-alkyl, -NRS(O)₂-NR-substituted alkyl, -
 10 NRS(O)₂-NR-aryl, -NRS(O)₂-NR-substituted aryl, -NRS(O)₂-NR-heteroaryl, -
 NRS(O)₂-NR-substituted heteroaryl, -NRS(O)₂-NR-heterocyclic, -NRS(O)₂-NR-
 substituted heterocyclic where R is hydrogen or alkyl, mono- and di-alkylamino,
 mono- and di-(substituted alkyl)amino, mono- and di-arylamino, mono- and di-
 substituted arylamino, mono- and di-heteroarylamino, mono- and di-substituted
 15 heteroarylamino, mono- and di-heterocyclic amino, mono- and di-substituted
 heterocyclic amino, unsymmetric di-substituted amines having different substituents
 independently selected from the group consisting of alkyl, substituted alkyl, aryl,
 substituted aryl, heteroaryl, substituted heteroaryl, heterocyclic and substituted
 heterocyclic and amino groups on the substituted aryl blocked by conventional
 20 blocking groups such as Boc, Cbz, formyl, and the like or substituted with -SO₂NRR
 where R is hydrogen or alkyl.

Preferably the substituents are selected from the group consisting of those
 defined above as preferred for substituted aryl.

25 "Heteroaryloxy" refers to the group -O-heteroaryl and "substituted
 heteroaryloxy" refers to the group -O-substituted heteroaryl.

"Heteroaralkoxy" refers to the group heteroaryl-alkylene-O-.

30 "Substituted heteroaralkoxy" refers to the group substituted heteroaryl-
 alkylene-O-.

"Heterocycle" or "heterocyclic" refers to a saturated or unsaturated group having a single ring or multiple condensed rings, from 1 to 10 carbon atoms and from 1 to 4 hetero atoms selected from the group consisting of nitrogen, sulfur or oxygen within the ring wherein, in fused ring systems, one or more the rings can be aryl or heteroaryl.

"Substituted heterocyclic" refers to heterocycle groups which are substituted with from 1 to 3 substituents selected from the group consisting of oxo (=O), thioxo (=S), alkoxy, substituted alkoxy, acyl, acylamino, thiocarbonylamino, acyloxy, amino, amidino, alkylamidino, thioamidino, aminoacyl, aminocarbonylamino, aminothiocarbonylamino, aminocarbonyloxy, aryl, substituted aryl, aryloxy, substituted aryloxy, aryloxyaryl, substituted aryloxyaryl, halogen, hydroxyl, cyano, nitro, carboxyl, carboxylalkyl, carboxyl-substituted alkyl, carboxyl-cycloalkyl, carboxyl-substituted cycloalkyl, carboxylaryl, carboxyl-substituted aryl, carboxylheteroaryl, carboxyl-substituted heteroaryl, carboxylheterocyclic, carboxyl-substituted heterocyclic, cycloalkyl, substituted cycloalkyl, guanidino, guanidinosulfone, thiol, thioalkyl, substituted thioalkyl, thioaryl, substituted thioaryl, thiocycloalkyl, substituted thiocycloalkyl, thioheteroaryl, substituted thioheteroaryl, thioheterocyclic, substituted thioheterocyclic, heteroaryl, substituted heteroaryl, heterocyclic, substituted heterocyclic, cycloalkoxy, substituted cycloalkoxy, heteroaryloxy, substituted heteroaryloxy, -C(O)O-aryl, -C(O)O-substituted aryl, heterocyclyloxy, substituted heterocyclyloxy, oxycarbonylamino, oxythiocarbonylamino, -OS(O)₂-alkyl, -OS(O)₂-substituted alkyl, -OS(O)₂-aryl, -OS(O)₂-substituted aryl, -OS(O)₂-heteroaryl, -OS(O)₂-substituted heteroaryl, -OS(O)₂-heterocyclic, -OS(O)₂-substituted heterocyclic, -OSO₂-NRR where R is hydrogen or alkyl, -NRS(O)₂-alkyl, -NRS(O)₂-substituted alkyl, -NRS(O)₂-aryl, -NRS(O)₂-substituted aryl, -NRS(O)₂-heteroaryl, -NRS(O)₂-substituted heteroaryl, -NRS(O)₂-heterocyclic, -NRS(O)₂-substituted heterocyclic, -NRS(O)₂-NR-alkyl, -NRS(O)₂-NR-substituted alkyl, -NRS(O)₂-NR-aryl, -NRS(O)₂-NR-substituted aryl, -NRS(O)₂-NR-heteroaryl, -NRS(O)₂-NR-substituted heteroaryl, -NRS(O)₂-NR-

heterocyclic, -NRS(O)₂-NR-substituted heterocyclic where R is hydrogen or alkyl, mono- and di-alkylamino, mono- and di-(substituted alkyl)amino, mono- and di-arylamino, mono- and di-substituted arylamino, mono- and di-heteroarylamino, mono- and di-substituted heteroarylamino, mono- and di-heterocyclic amino, mono- and di-substituted heterocyclic amino, unsymmetric di-substituted amines having different substituents independently selected from the group consisting of alkyl, substituted alkyl, aryl, substituted aryl, heteroaryl, substituted heteroaryl, heterocyclic and substituted heterocyclic and substituted alkynyl groups having amino groups blocked by conventional blocking groups such as Boc, Cbz, formyl, and the like or alkynyl/substituted alkynyl groups substituted with -SO₂-alkyl, -SO₂-substituted alkyl, -SO₂-alkenyl, -SO₂-substituted alkenyl, -SO₂-cycloalkyl, -SO₂-substituted cycloalkyl, -SO₂-aryl, -SO₂-substituted aryl, -SO₂-heteroaryl, -SO₂-substituted heteroaryl, -SO₂-heterocyclic, -SO₂-substituted heterocyclic and -SO₂NRR where R is hydrogen or alkyl.

Preferably, the substituents are selected from the group consisting of the preferred substituents defined for substituted cycloalkyl.

Examples of heterocycles and heteroaryls include, but are not limited to, azetidine, pyrrole, imidazole, pyrazole, pyridine, pyrazine, pyrimidine, pyridazine, indolizine, isoindole, indole, dihydroindole, indazole, purine, quinolizine, isoquinoline, quinoline, phthalazine, naphthylpyridine, quinoxaline, quinazoline, cinnoline, pteridine, carbazole, carboline, phenanthridine, acridine, phenanthroline, isothiazole, phenazine, isoxazole, phenoxazine, phenothiazine, imidazolidine, imidazoline, piperidine, piperazine, indoline, phthalimide, 1,2,3,4-tetrahydroisoquinoline, 4,5,6,7-tetrahydrobenzo[b]thiophene, thiazole, thiazolidine, thiophene, benzo[b]thiophene, morpholino, morpholinyl, thiomorpholino, thiomorpholinyl (also referred to as thiamorpholinyl), piperidinyl, pyrrolidine, tetrahydrofuranyl, and the like.

"Heterocycloxy" refers to the group -O-heterocyclic and "substituted heterocycloxy" refers to the group -O-substituted heterocyclic.

"*N,N*-Dimethylcarbamoyloxy" refers to the group $-\text{OC}(\text{O})\text{N}(\text{CH}_3)_2$.

"Oxo" refers to $(=\text{O})$.

5

"Oxyalkylene" refers to $-\text{OCH}_2\text{CHR}^d$ - where R^d is alkyl.

"Oxycarbonylamino" refers to the groups $-\text{OC}(\text{O})\text{NH}_2$, $-\text{OC}(\text{O})\text{NRR}$, $-\text{OC}(\text{O})\text{NR-alkyl}$, $-\text{OC}(\text{O})\text{NR-substituted alkyl}$, $-\text{OC}(\text{O})\text{NR-alkenyl}$, $-\text{OC}(\text{O})\text{NR-substituted alkenyl}$, $-\text{OC}(\text{O})\text{NR-alkynyl}$, $-\text{OC}(\text{O})\text{NR-substituted alkynyl}$, $-\text{OC}(\text{O})\text{NR-cycloalkyl}$, $-\text{OC}(\text{O})\text{NR-substituted cycloalkyl}$, $-\text{OC}(\text{O})\text{NR-aryl}$, $-\text{OC}(\text{O})\text{NR-substituted aryl}$, $-\text{OC}(\text{O})\text{NR-heteroaryl}$, $-\text{OC}(\text{O})\text{NR-substituted heteroaryl}$, $-\text{OC}(\text{O})\text{NR-heterocyclic}$, and $-\text{OC}(\text{O})\text{NR-substituted heterocyclic}$ where R is hydrogen, alkyl or where each R is joined to form, together with the nitrogen atom a heterocyclic or substituted heterocyclic ring and wherein alkyl, substituted alkyl, alkenyl, substituted alkenyl, alkynyl, substituted alkynyl, cycloalkyl, substituted cycloalkyl, aryl, substituted aryl, heteroaryl, substituted heteroaryl, heterocyclic and substituted heterocyclic are as defined herein.

"Oxythiocarbonylamino" refers to the groups $-\text{OC}(\text{S})\text{NH}_2$, $-\text{OC}(\text{S})\text{NRR}$, $-\text{OC}(\text{S})\text{NR-alkyl}$, $-\text{OC}(\text{S})\text{NR-substituted alkyl}$, $-\text{OC}(\text{S})\text{NR-alkenyl}$, $-\text{OC}(\text{S})\text{NR-substituted alkenyl}$, $-\text{OC}(\text{S})\text{NR-alkynyl}$, $-\text{OC}(\text{S})\text{NR-substituted alkynyl}$, $-\text{OC}(\text{S})\text{NR-cycloalkyl}$, $-\text{OC}(\text{S})\text{NR-substituted cycloalkyl}$, $-\text{OC}(\text{S})\text{NR-aryl}$, $-\text{OC}(\text{S})\text{NR-substituted aryl}$, $-\text{OC}(\text{S})\text{NR-heteroaryl}$, $-\text{OC}(\text{S})\text{NR-substituted heteroaryl}$, $-\text{OC}(\text{S})\text{NR-heterocyclic}$, and $-\text{OC}(\text{S})\text{NR-substituted heterocyclic}$ where R is hydrogen, alkyl or where each R is joined to form together with the nitrogen atom a heterocyclic or substituted heterocyclic ring and wherein alkyl, substituted alkyl, alkenyl, substituted alkenyl, alkynyl, substituted alkynyl, cycloalkyl, substituted cycloalkyl, aryl, substituted aryl, heteroaryl, substituted heteroaryl, heterocyclic and substituted heterocyclic are as defined herein.

30

"Thioalkyl" refers to the groups $-\text{S-alkyl}$.

"Substituted thioalkyl" refers to the group -S-substituted alkyl.

"Thioamidino" refers to the group $RSC(=NH)-$ where R is hydrogen or alkyl.

5

"Thioaryl" refers to the group -S-aryl and "substituted thioaryl" refers to the group -S-substituted aryl.

"Thiocarbonylamino" refers to the group -C(S)NRR where each R is selected from the group consisting of hydrogen, alkyl, substituted alkyl, alkenyl, substituted alkenyl, alkynyl, substituted alkynyl, aryl, substituted aryl, cycloalkyl, substituted cycloalkyl, heteroaryl, substituted heteroaryl, heterocyclic, substituted heterocyclic and where each R is joined to form, together with the nitrogen atom a heterocyclic or substituted heterocyclic ring wherein alkyl, substituted alkyl, alkenyl, substituted alkenyl, alkynyl, substituted alkynyl, cycloalkyl, substituted cycloalkyl, aryl, substituted aryl, heteroaryl, substituted heteroaryl, heterocyclic and substituted heterocyclic are as defined herein.

10
15

"Thiocycloalkyl" refers to the groups -S-cycloalkyl.

20

"Substituted thiocycloalkyl" refers to the group -S-substituted cycloalkyl.

"Thioheteroaryl" refers to the group -S-heteroaryl and "substituted thioheteroaryl" refers to the group -S-substituted heteroaryl.

25

"Thioheterocyclic" refers to the group -S-heterocyclic and "substituted thioheterocyclic" refers to the group -S-substituted heterocyclic.

"Thiol" refers to the group -SH.

30

"Optionally substituted" means that the recited group may be unsubstituted or the recited group may be substituted.

"Pharmaceutically acceptable salt" refers to salts which retain the biological effectiveness and properties of the compounds of this invention and which are not biologically or otherwise undesirable. In many cases, the compounds of this invention are capable of forming acid and/or base salts by virtue of the presence of amino and/or carboxyl groups or groups similar thereto.

Pharmaceutically-acceptable base addition salts can be prepared from inorganic and organic bases. Salts derived from inorganic bases, include by way of example only, sodium, potassium, lithium, ammonium, calcium and magnesium salts. Salts derived from organic bases include, but are not limited to, salts of primary, secondary and tertiary amines, such as alkyl amines, dialkyl amines, trialkyl amines, substituted alkyl amines, di(substituted alkyl) amines, tri(substituted alkyl) amines, alkenyl amines, dialkenyl amines, trialkenyl amines, substituted alkenyl amines, di(substituted alkenyl) amines, tri(substituted alkenyl) amines, cycloalkyl amines, di(cycloalkyl) amines, tri(cycloalkyl) amines, substituted cycloalkyl amines, disubstituted cycloalkyl amine, trisubstituted cycloalkyl amines, cycloalkenyl amines, di(cycloalkenyl) amines, tri(cycloalkenyl) amines, substituted cycloalkenyl amines, disubstituted cycloalkenyl amine, trisubstituted cycloalkenyl amines, aryl amines, diaryl amines, triaryl amines, heteroaryl amines, diheteroaryl amines, triheteroaryl amines, heterocyclic amines, diheterocyclic amines, triheterocyclic amines, mixed di- and tri-amines where at least two of the substituents on the amine are different and are selected from the group consisting of alkyl, substituted alkyl, alkenyl, substituted alkenyl, cycloalkyl, substituted cycloalkyl, cycloalkenyl, substituted cycloalkenyl, aryl, heteroaryl, heterocyclic, and the like. Also included are amines where the two or three substituents, together with the amino nitrogen, form a heterocyclic or heteroaryl group.

Examples of suitable amines include, by way of example only,

isopropylamine, trimethyl amine, diethyl amine, tri(iso-propyl) amine, tri(n-propyl) amine, ethanolamine, 2-dimethylaminoethanol, tromethamine, lysine, arginine, histidine, caffeine, procaine, hydrabamine, choline, betaine, ethylenediamine, glucosamine, N-alkylglucamines, theobromine, purines, piperazine, piperidine, morpholine, N-ethylpiperidine, and the like. It should also be understood that other carboxylic acid derivatives would be useful in the practice of this invention, for example, carboxylic acid amides, including carboxamides, lower alkyl carboxamides, dialkyl carboxamides, and the like.

Pharmaceutically acceptable acid addition salts may be prepared from inorganic and organic acids. Salts derived from inorganic acids include hydrochloric acid, hydrobromic acid, sulfuric acid, nitric acid, phosphoric acid, and the like. Salts derived from organic acids include acetic acid, propionic acid, glycolic acid, pyruvic acid, oxalic acid, malic acid, malonic acid, succinic acid, maleic acid, fumaric acid, tartaric acid, citric acid, benzoic acid, cinnamic acid, mandelic acid, methanesulfonic acid, ethanesulfonic acid, p-toluene-sulfonic acid, salicylic acid, and the like.

The term "pharmaceutically-acceptable cation" refers to the cation of a pharmaceutically-acceptable salt.

Compound Preparation

The compounds of this invention can be prepared from readily available starting materials using the following general methods and procedures. It will be appreciated that where typical or preferred process conditions (*i.e.*, reaction temperatures, times, mole ratios of reactants, solvents, pressures, etc.) are given, other process conditions can also be used unless otherwise stated. Optimum reaction conditions may vary with the particular reactants or solvent used, but such conditions can be determined by one skilled in the art by routine optimization procedures.

Additionally, as will be apparent to those skilled in the art, conventional protecting groups may be necessary to prevent certain functional groups from undergoing undesired reactions. Suitable protecting groups for various functional groups as well as suitable conditions for protecting and deprotecting particular functional groups are well known in the art. For example, numerous protecting groups are described in T. W. Greene and G. M. Wuts, *Protecting Groups in Organic Synthesis*, Second Edition, Wiley, New York, 1991, and references cited therein.

Furthermore, the compounds of this invention will typically contain one or more chiral centers. Accordingly, if desired, such compounds can be prepared or isolated as pure stereoisomers, *i.e.*, as individual enantiomers or diastereomers, or as stereoisomer-enriched mixtures. All such stereoisomers (and enriched mixtures) are included within the scope of this invention, unless otherwise indicated. Pure stereoisomers (or enriched mixtures) may be prepared using, for example, optically active starting materials or stereoselective reagents well-known in the art. Alternatively, racemic mixtures of such compounds can be separated using, for example, chiral column chromatography, chiral resolving agents and the like.

According to the following compound preparation, R^1 , R^2 , R^3 , R^5 , R^6 , and R^7 are as defined herein for formulae I, IA, II, and IIA. In addition, according to the following compound preparation, R^1 is equivalent to:

Ar^1 as herein defined for formula IB,

R^{21} as herein defined for formulae II and IIA, and

Ar^{21} as herein defined for formula IIB;

R^2 is equivalent to:

R^{12} as herein defined for formula IB,

R^{22} as herein defined for formulae II and IIA, and

R^{32} as herein defined for formula IIB;

R^3 is equivalent to:

R^{13} as herein defined for formula IB,

R^{23} as herein defined for formulae II and IIA, and

R^{33} as herein defined for formula IIB;

R^5 is equivalent to:

R^{25} as herein defined for formulae II and IIA; and

5 R^6 is equivalent to:

OH for formulae I and II,

OR^{14} as herein defined for formula IB,

R^{26} as herein defined for formula IIA, and

OR^{34} as herein defined for formula IIB.

10

In a preferred method of synthesis, the compounds of formulae I, IA, II, and IIA, wherein Q is $-C(O)NR^7-$, and compounds of formulae IB, IC, and IIB are prepared by first coupling an amino acid of formula III:

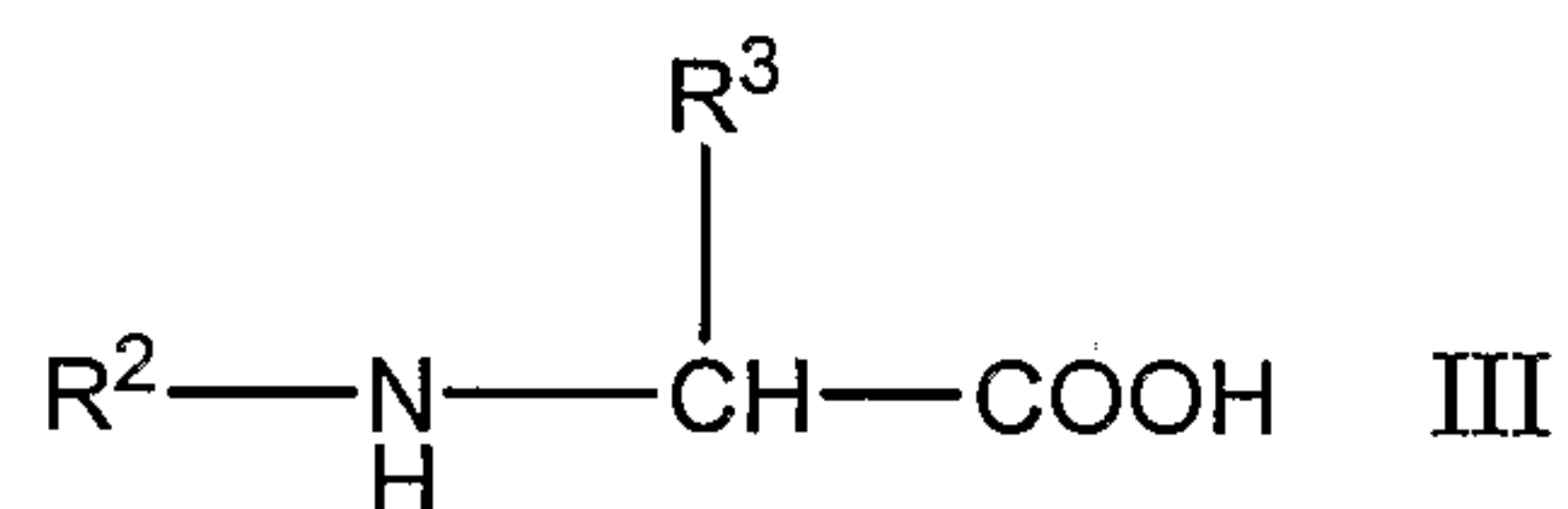

15

with a sulfonyl chloride of formula IV:

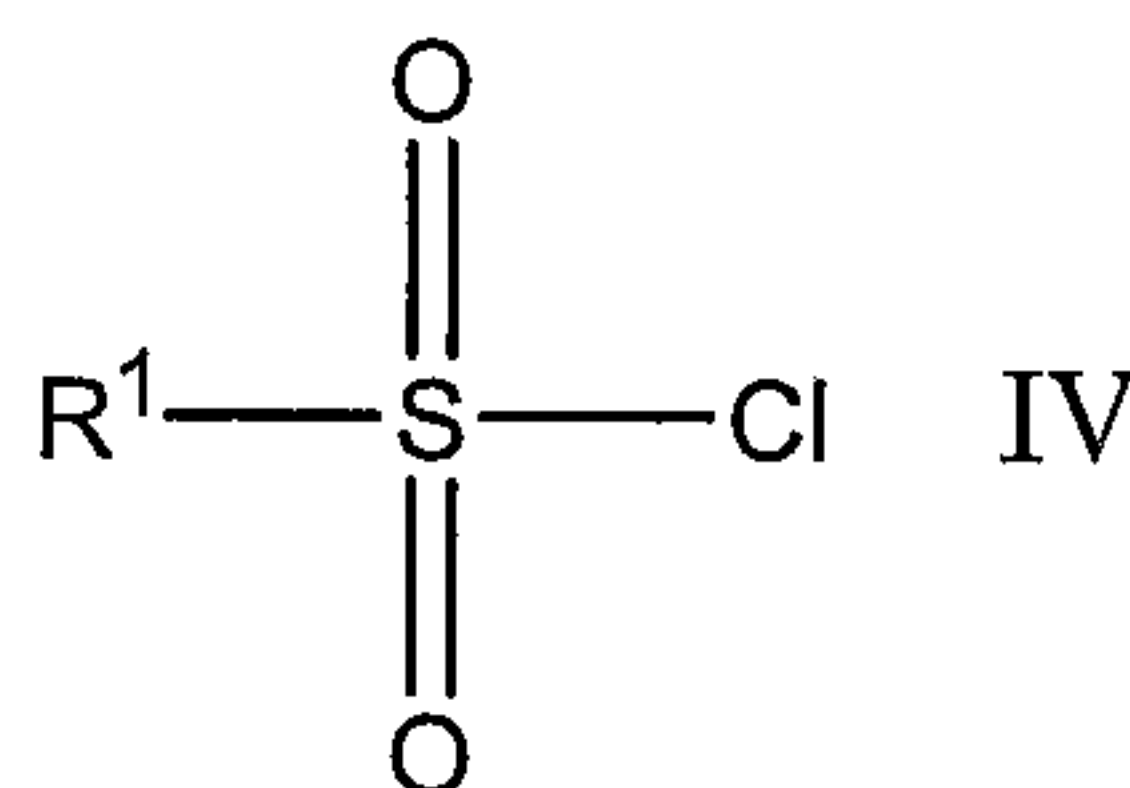

20

to provide an *N*-sulfonyl amino acid of formula V:

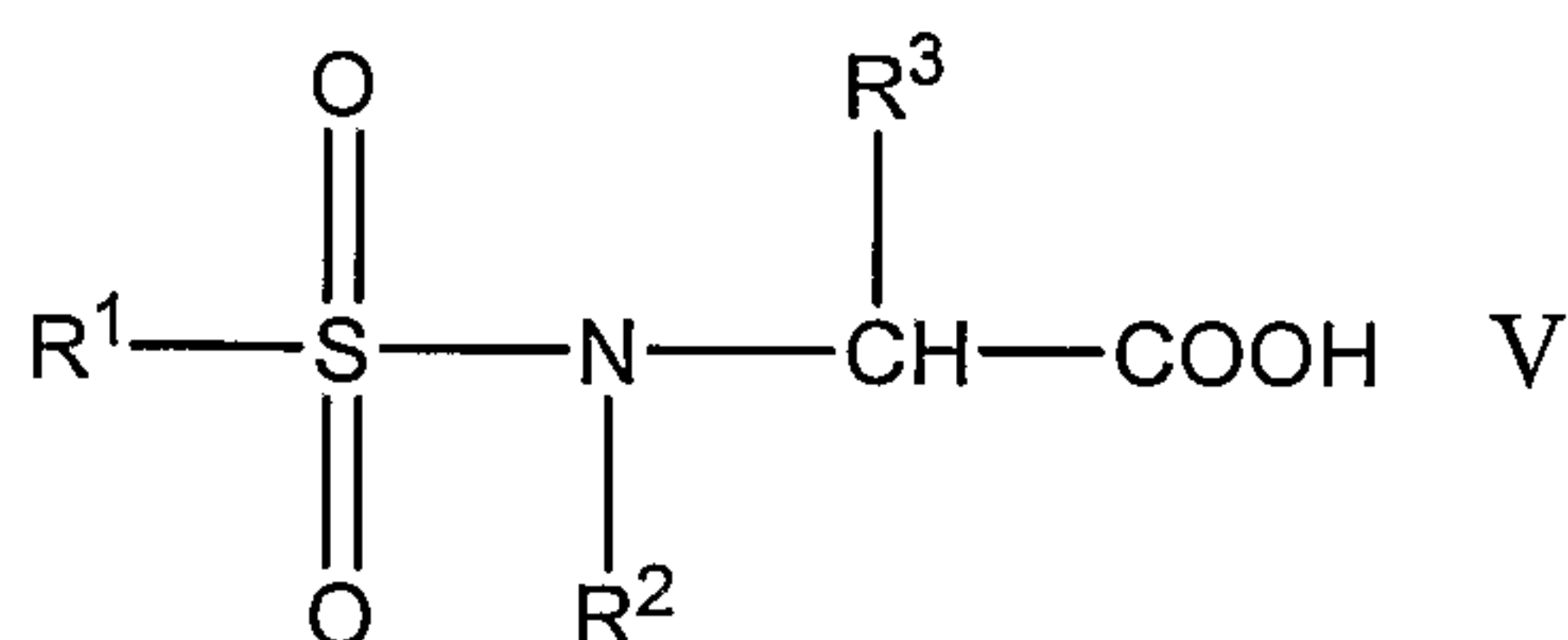

This reaction is typically conducted by reacting the amino acid of formula III with at least one equivalent, preferably about 1.1 to about 2 equivalents, of sulfonyl chloride IV in an inert diluent such as dichloromethane and the like. Generally, the reaction is conducted at a temperature ranging from about -70°C to about 40°C for about 1 to about 24 hours. Preferably, this reaction is conducted in the presence of a suitable base to scavenge the acid generated during the reaction. Suitable bases include, by way of example, tertiary amines, such as triethylamine, diisopropylethylamine, *N*-methylnorpholine and the like. Alternatively, the reaction can be conducted under Schotten-Baumann-type conditions using aqueous alkali, such as sodium hydroxide and the like, as the base. Upon completion of the reaction, the resulting *N*-sulfonyl amino acid V is recovered by conventional methods including neutralization, extraction, precipitation, chromatography, filtration, and the like.

The amino acids of formula III employed in the above reaction are either known compounds or compounds that can be prepared from known compounds by conventional synthetic procedures. Examples of suitable amino acids for use in this reaction include, but are not limited to, L-proline, *trans*-4-hydroxyl-L-proline, *cis*-4-hydroxyl-L-proline, *trans*-3-phenyl-L-proline, *cis*-3-phenyl-L-proline, L-(2-methyl)proline, L-pipecolinic acid, L-azetidine-2-carboxylic acid, L-indoline-2-carboxylic acid, L-1,2,3,4-tetrahydroisoquinoline-3-carboxylic acid, L-thiazolidine-4-carboxylic acid, L-(5,5-dimethyl)thiazolidine-4-carboxylic acid, L-thiamorpholine-3-carboxylic acid, glycine, 2-*tert*-butylglycine, D,L-phenylglycine, L-alanine, α -methylalanine, *N*-methyl-L-phenylalanine, L-diphenylalanine, sarcosine, D,L-phenylsarcosine, L-aspartic acid β -*tert*-butyl ester, L-glutamic acid γ -*tert*-butyl ester, L-(*O*-benzyl)serine, 1-aminocyclopropanecarboxylic acid, 1-aminocyclobutanecarboxylic acid, 1-aminocyclopentanecarboxylic acid (cycloleucine) 1-aminocyclohexanecarboxylic acid, L-serine and the like. If desired, the corresponding carboxylic acid esters of the amino acids of formula III, such as the methyl esters, ethyl esters and the like, can be employed in the above reaction with the sulfonyl chloride IV. Subsequent hydrolysis of the ester group to the carboxylic acid using conventional reagents and conditions, *i.e.*, treatment with an

alkali metal hydroxide in an inert diluent such as methanol/water, then provides the *N*-sulfonyl amino acid V.

Similarly, the sulfonyl chlorides of formula IV employed in the above reaction are either known compounds or compounds that can be prepared from known compounds by conventional synthetic procedures. Such compounds are typically prepared from the corresponding sulfonic acid, *i.e.*, from compounds of the formula R^1-SO_3H , using phosphorous trichloride and phosphorous pentachloride. This reaction is generally conducted by contacting the sulfonic acid with about 2 to 5 molar equivalents of phosphorous trichloride and phosphorous pentachloride, either neat or in an inert solvent, such as dichloromethane, at temperature in the range of about 0°C to about 80°C for about 1 to about 48 hours to afford the sulfonyl chloride. Alternatively, the sulfonyl chlorides of formula IV can be prepared from the corresponding thiol compound, *i.e.*, from compounds of the formula R^1-SH , by treating the thiol with chlorine (Cl_2) and water under conventional reaction conditions.

Examples of sulfonyl chlorides suitable for use in this invention include, but are not limited to, methanesulfonyl chloride, 2-propanesulfonyl chloride, 1-butanesulfonyl chloride, benzenesulfonyl chloride, 1-naphthalenesulfonyl chloride, 2-naphthalenesulfonyl chloride, *p*-toluenesulfonyl chloride, α -toluenesulfonyl chloride, 4-acetamidobenzenesulfonyl chloride, 4-amidinobenzenesulfonyl chloride, 4-*tert*-butylbenzenesulfonyl chloride, 4-bromobenzenesulfonyl chloride, 2-carboxybenzenesulfonyl chloride, 4-cyanobenzenesulfonyl chloride, 3,4-dichlorobenzenesulfonyl chloride, 3,5-dichlorobenzenesulfonyl chloride, 3,4-dimethoxybenzenesulfonyl chloride, 3,5-ditrifluoromethylbenzenesulfonyl chloride, 4-fluorobenzenesulfonyl chloride, 4-methoxybenzenesulfonyl chloride, 2-methoxycarbonylbenzenesulfonyl chloride, 4-methylamidobenzenesulfonyl chloride, 4-nitrobenzenesulfonyl chloride, 4-thioamidobenzenesulfonyl chloride, 4-trifluoromethylbenzenesulfonyl chloride, 4-trifluoromethoxybenzenesulfonyl chloride, 2,4,6-trimethylbenzenesulfonyl chloride, 2-phenylethanesulfonyl chloride, 2-thiophenesulfonyl chloride, 5-chloro-2-thiophenesulfonyl chloride, 2,5-dichloro-4-thiophenesulfonyl chloride, 2-thiazolesulfonyl chloride, 2-methyl-4-thiazolesulfonyl

chloride, 1-methyl-4-imidazolesulfonyl chloride, 1-methyl-4-pyrazolesulfonyl chloride, 5-chloro-1,3-dimethyl-4-pyrazolesulfonyl chloride, 3-pyridinesulfonyl chloride, 2-pyrimidinesulfonyl chloride and the like. If desired, a sulfonyl fluoride, sulfonyl bromide or sulfonic acid anhydride may be used in place of the sulfonyl chloride in the above reaction to form the *N*-sulfonyl amino acids of formula V.

The intermediate *N*-sulfonyl amino acids of formula V can also be prepared by reacting a sulfonamide of formula VI:

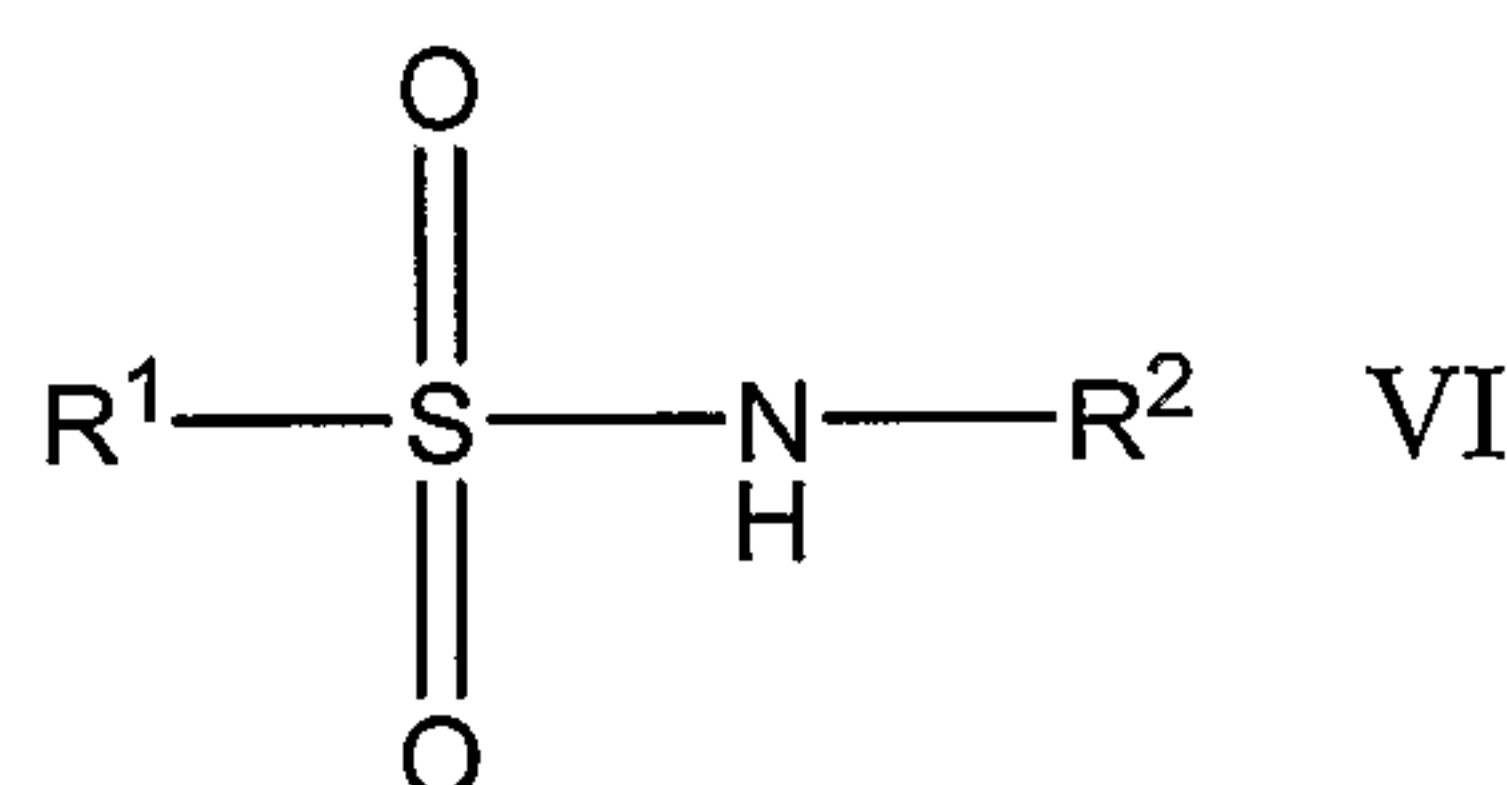

10

with a carboxylic acid derivative of the formula $\text{L}(\text{R}^3)\text{CHCOOR}^y$ where L is a leaving group, such as chloro, bromo, iodo, mesylate, tosylate and the like, and R^y is hydrogen or an alkyl group. This reaction is typically conducted by contacting the sulfonamide VI with at least one equivalent, preferably 1.1 to 2 equivalents, of the carboxylic acid derivative in the presence of a suitable base, such as triethylamine, in an inert diluent, such as DMF, at a temperature ranging from about 24°C to about 37°C for about 0.5 to about 4 hours. This reaction is further described in Zuckermann *et al.*, *J. Am. Chem. Soc.*, **1992**, *114*, 10646-10647. Preferred carboxylic acid derivatives for use in this reaction are α -chloro and α -bromocarboxylic acid esters such as *tert*-butyl bromoacetate and the like. When a carboxylic acid ester is employed in this reaction, the ester group is subsequently hydrolyzed using conventional procedures to afford an *N*-sulfonyl amino acid of formula V.

25

The compounds of the present invention are then prepared by coupling the intermediate *N*-sulfonyl amino acid of formula V with an amino acid derivative of formula VII:

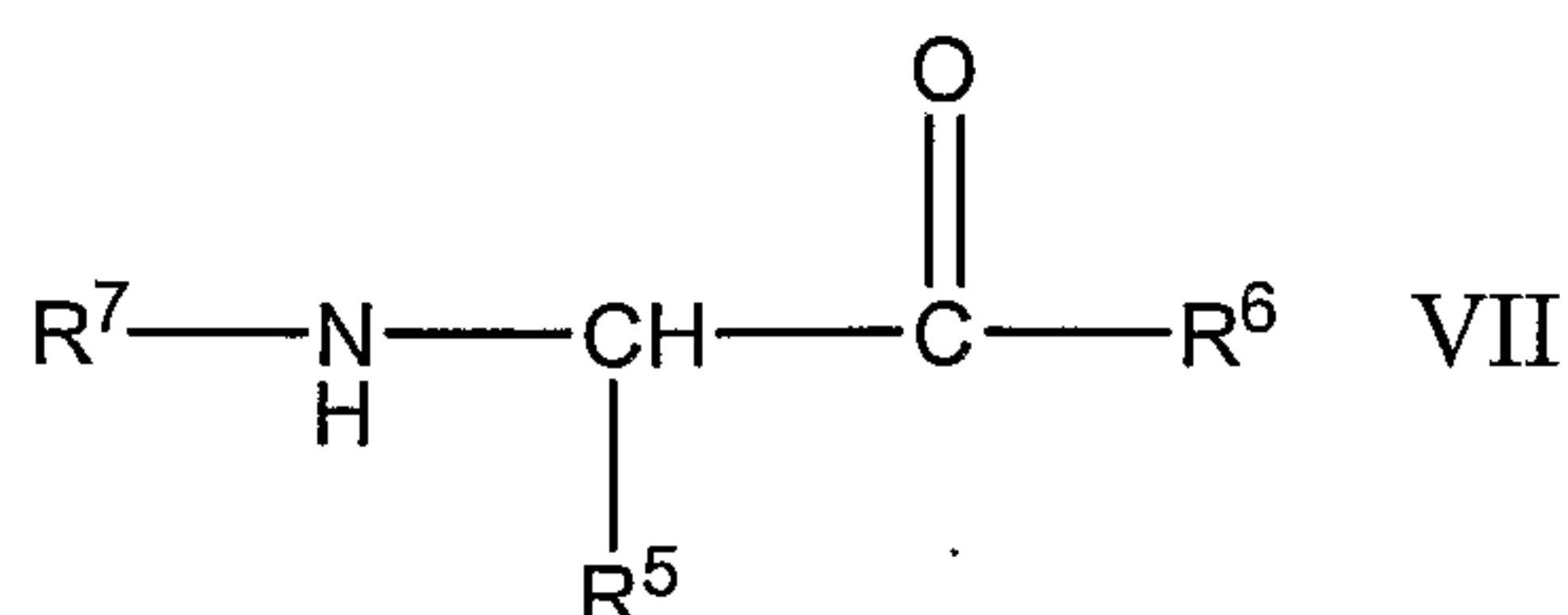

This coupling reaction is typically conducted using well-known coupling
 5 reagents such as carbodiimides, BOP reagent (benzotriazol-1-yloxy-
 tris(dimethylamino)phosphonium hexafluorophosphate) and the like. Suitable
 carbodiimides include, by way of example, dicyclohexylcarbodiimide (DCC), 1-(3-
 dimethylamino-propyl)-3-ethylcarbodiimide (EDC) and the like. If desired, polymer
 supported forms of carbodiimide coupling reagents may also be used including, for
 10 example, those described in *Tetrahedron Letters*, **34**(48), 7685 (1993). Additionally,
 well-known coupling promoters, such as N-hydroxysuccinimide, 1-
 hydroxybenzotriazole and the like, may be used to facilitate the coupling reaction.

This coupling reaction is typically conducted by contacting the *N*-
 sulfonylamino acid V with about 1 to about 2 equivalents of the coupling reagent
 15 and at least one equivalent, preferably about 1 to about 1.2 equivalents, of amino
 acid derivative VII in an inert diluent, such as dichloromethane, chloroform,
 acetonitrile, tetrahydrofuran, *N,N*-dimethylformamide and the like. Generally, this
 reaction is conducted at a temperature ranging from about 0°C to about 37°C for
 about 12 to about 24 hours. Upon completion of the reaction, the compound of the
 20 present invention is recovered by conventional methods including neutralization,
 extraction, precipitation, chromatography, filtration, and the like.

Alternatively, the *N*-sulfonyl amino acid V can be converted into an acid
 halide and the acid halide coupled with amino acid derivative VII to provide
 compounds of the present invention. The acid halide of V can be prepared by
 25 contacting V with an inorganic acid halide, such as thionyl chloride, phosphorous
 trichloride, phosphorous tribromide or phosphorous penta-chloride, or preferably,
 with oxalyl chloride under conventional conditions. Generally, this reaction is
 conducted using about 1 to 5 molar equivalents of the inorganic acid halide or oxalyl

chloride, either neat or in an inert solvent, such as dichloromethane or carbon tetrachloride, at temperature in the range of about 0°C to about 80°C for about 1 to about 48 hours. A catalyst, such as DMF, may also be used in this reaction.

The acid halide of *N*-sulfonyl amino acid V is then contacted with at least one equivalent, preferably about 1.1 to about 1.5 equivalents, of amino acid derivative VII in an inert diluent, such as dichloromethane, at a temperature ranging from about -70°C to about 40°C for about 1 to about 24 hours. Preferably, this reaction is conducted in the presence of a suitable base to scavenge the acid generated during the reaction. Suitable bases include, by way of example, tertiary amines, such as triethylamine, diisopropylethylamine, *N*-methyilmorpholine and the like. Alternatively, the reaction can be conducted under Schotten-Baumann-type conditions using aqueous alkali, such as sodium hydroxide and the like. Upon completion of the reaction, the compound of the present invention is recovered by conventional methods including neutralization, extraction, precipitation, chromatography, filtration, and the like.

Alternatively, the compounds of the present invention can be prepared by first forming a diamino acid derivative of formula VIII:

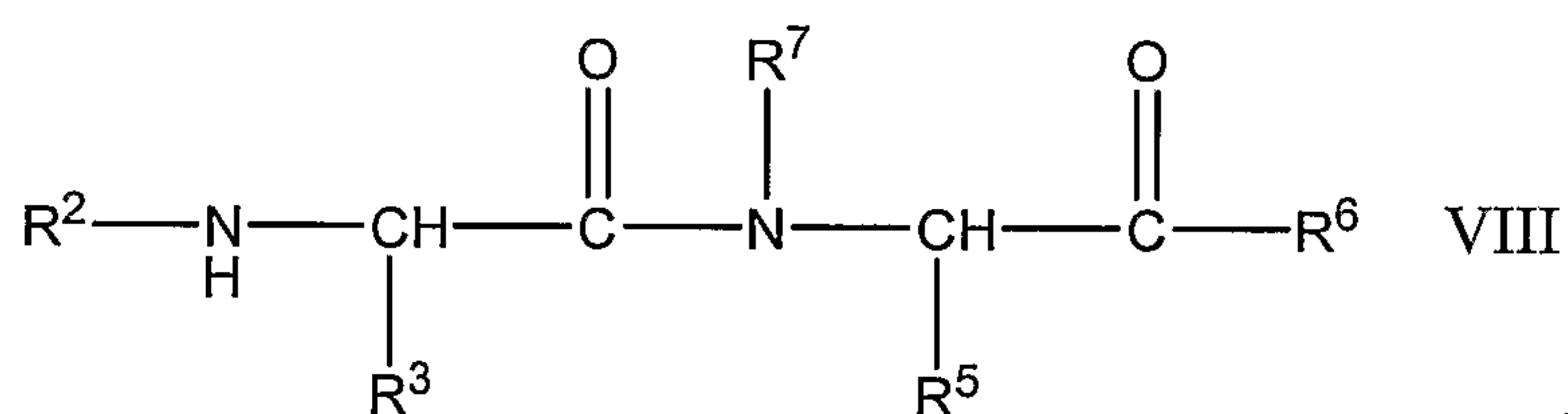

20

25

The diamino acid derivatives of formula VIII can be readily prepared by coupling an amino acid of formula III with an amino acid derivative of formula VII using conventional amino acid coupling techniques and reagents, such as carbodiimides, BOP reagent and the like, as described above. Diamino acid VIII can then be sulfonated using a sulfonyl chloride of formula IV and using the synthetic procedures described above to provide a compound of the present invention.

The amino acid derivatives of formula VII employed in the above reactions are either known compounds or compounds that can be prepared from known compounds by conventional synthetic procedures. For example, amino acid derivatives of formula VII can be prepared by C-alkylating commercially available diethyl 2-acetamidomalonate (Aldrich, Milwaukee, Wisconsin, USA) with an alkyl or substituted alkyl halide. This reaction is typically conducted by treating the diethyl 2-acetamidomalonate with at least one equivalent of sodium ethoxide and at least one equivalent of an alkyl or substituted alkyl halide in refluxing ethanol for about 6 to about 12 hours. The resulting C-alkylated malonate is then deacetylated, hydrolyzed and decarboxylated by heating in aqueous hydrochloric acid at reflux for about 6 to about 12 hours to provide the amino acid, typically as the hydrochloride salt.

Examples of amino acid derivatives of formula VII suitable for use in the above reactions include, but are not limited to, L-tyrosine methyl ester, L-3,5-diiodotyrosine methyl ester, L-3-iodotyrosine methyl ester, β -(4-hydroxy-naphth-1-yl)-L-alanine methyl ester, β -(6-hydroxy-naphth-2-yl)-L-alanine methyl ester, and the like. If desired, of course, other esters or amides of the above-described compounds may also be employed.

For ease of synthesis, the compounds of the present invention are typically prepared as an ester, *i.e.*, where R⁶ is an alkoxy or substituted alkoxy group and the like. If desired, the ester group can be hydrolysed using conventional conditions and reagents to provide the corresponding carboxylic acid. Typically, this reaction is conducted by treating the ester with at least one equivalent of an alkali metal hydroxide, such as lithium, sodium or potassium hydroxide, in an inert diluent, such as methanol or mixtures of methanol and water, at a temperature ranging about 0°C to about 24°C for about 1 to about 10 hours. Alternatively, benzyl esters may be removed by hydrogenolysis using a palladium catalyst, such as palladium on carbon. The resulting carboxylic acids may be coupled, if desired, to amines such as β -alanine ethyl ester, hydroxyamines such as hydroxylamine and *N*-hydroxysuccinimide, alkoxyamines and substituted alkoxyamines such as *O*-

methylhydroxylamine and *O*-benzylhydroxylamine, and the like, using conventional coupling reagents and conditions as described above.

As will be apparent to those skilled in the art, other functional groups present on any of the substituents of the compounds of the present invention can be readily modified or derivatized either before or after the above-described coupling reactions using well-known synthetic procedures. For example, a nitro group present on a substituent of a compound of the present invention or an intermediate thereof may be readily reduced by hydrogenation in the presence of a palladium catalyst, such as palladium on carbon, to provide the corresponding amino group. This reaction is typically conducted at a temperature of from about 20°C to about 50°C for about 6 to about 24 hours in an inert diluent, such as methanol. Compounds having a nitro group on, *e.g.*, the R³ substituent, can be prepared, for example, by using a 4-nitrophenylalanine derivative and the like in the above-described coupling reactions.

Similarly, a pyridyl group can be hydrogenated in the presence of a platinum catalyst, such as platinum oxide, in an acidic diluent to provide the corresponding piperidinyll analogue. Generally, this reaction is conducted by treating the pyridine compound with hydrogen at a pressure ranging from about 20 psi to about 60 psi, preferably about 40 psi, in the presence of the catalyst at a temperature of about 20°C to about 50°C for about 2 to about 24 hours in an acidic diluent, such as a mixture of methanol and aqueous hydrochloric acid. Compounds having a pyridyl group can be readily prepared by using, for example, β-(2-pyridyl)-, β-(3-pyridyl)- or β-(4-pyridyl)-L-alanine derivatives in the above-described coupling reactions.

Additionally, when a substituent of a compound of the present invention or an intermediate thereof contains a primary or secondary amino group, such amino groups can be further derivatized either before or after the above coupling reactions to provide, by way of example, amides, sulfonamides, ureas, thioureas, carbamates, secondary or tertiary amines and the like. Compounds having a primary amino group on such a substituent may be prepared, for example, by reduction of the corresponding nitro compound as described above. Alternatively, such compounds can be prepared by using an amino acid derivative of formula VII derived from lysine, 4-aminophenylalanine and the like in the above-described coupling reactions.

By way of illustration, a compound of the present invention or an intermediate thereof having a substituent containing a primary or secondary amino group can be readily *N*-acylated using conventional acylating reagents and conditions to provide the corresponding amide. This acylation reaction is typically conducted by treating the amino compound with at least one equivalent, preferably about 1.1 to about 1.2 equivalents, of a carboxylic acid in the presence of a coupling reagent such as a carbodiimide, BOP reagent (benzotriazol-1-yloxy-tris(dimethylamino)-phosphonium hexafluorophosphate) and the like, in an inert diluent, such as dichloromethane, chloroform, acetonitrile, tetrahydrofuran, *N,N*-dimethylformamide and the like, at a temperature ranging from about 0°C to about 37°C for about 4 to about 24 hours. Preferably, a promoter, such as *N*-hydroxysuccinimide, 1-hydroxybenzotriazole and the like, is used to facilitate the acylation reaction. Examples of carboxylic acids suitable for use in this reaction include, but are not limited to, *N*-*tert*-butyloxycarbonylglycine, *N*-*tert*-butyloxycarbonyl-L-phenylalanine, *N*-*tert*-butyloxycarbonyl-L-aspartic acid benzyl ester, benzoic acid, *N*-*tert*-butyloxycarbonylisonipecotic acid, *N*-methylisonipecotic acid, *N*-*tert*-butyloxycarbonylnipecotic acid, *N*-*tert*-butyloxycarbonyl-L-tetrahydroisoquinoline-3-carboxylic acid, *N*-(toluene-4-sulfonyl)-L-proline and the like.

Alternatively, a compound of the present invention or an intermediate thereof containing a primary or secondary amino group can be *N*-acylated using an acyl halide or a carboxylic acid anhydride to form the corresponding amide. This reaction is typically conducted by contacting the amino compound with at least one equivalent, preferably about 1.1 to about 1.2 equivalents, of the acyl halide or carboxylic acid anhydride in an inert diluent, such as dichloromethane, at a temperature ranging from about of about -70°C to about 40°C for about 1 to about 24 hours. If desired, an acylation catalyst such as 4-(*N,N*-dimethylamino)pyridine may be used to promote the acylation reaction. The acylation reaction is preferably conducted in the presence of a suitable base to scavenge the acid generated during the reaction. Suitable bases include, by way of example, tertiary amines, such as triethylamine, diisopropylethylamine, *N*-methylmorpholine and the like.

Alternatively, the reaction can be conducted under Schotten-Baumann-type conditions using aqueous alkali, such as sodium hydroxide and the like.

Examples of acyl halides and carboxylic acid anhydrides suitable for use in this reaction include, but are not limited to, 2-methylpropionyl chloride, trimethylacetyl chloride, phenylacetyl chloride, benzoyl chloride, 2-bromobenzoyl chloride, 2-methylbenzoyl chloride, 2-trifluoromethylbenzoyl chloride, isonicotinoyl chloride, nicotinoyl chloride, picolinoyl chloride, acetic anhydride, succinic anhydride and the like. Carbamyl chlorides, such as *N,N*-dimethylcarbamyl chloride, *N,N*-diethylcarbamyl chloride and the like, can also be used in this reaction to provide ureas. Similarly, dicarbonates, such as di-*tert*-butyl dicarbonate, may be employed to provide carbamates.

In a similar manner, a compound of the present invention or an intermediate thereof containing a primary or secondary amino group may be *N*-sulfonated to form a sulfonamide using a sulfonyl halide or a sulfonic acid anhydride. Sulfonyl halides and sulfonic acid anhydrides suitable for use in this reaction include, but are not limited to, methanesulfonyl chloride, chloromethanesulfonyl chloride, *p*-toluenesulfonyl chloride, trifluoromethanesulfonic anhydride and the like. Similarly, sulfamoyl chlorides, such as dimethylsulfamoyl chloride, can be used to provide sulfamides (*e.g.*, >N-SO₂-N<).

Additionally, a primary and secondary amino group present on a substituent of a compound of the present invention or an intermediate thereof can be reacted with an isocyanate or a thioisocyanate to give a urea or thiourea, respectively. This reaction is typically conducted by contacting the amino compound with at least one equivalent, preferably about 1.1 to about 1.2 equivalents, of the isocyanate or thioisocyanate in an inert diluent, such as toluene and the like, at a temperature ranging from about 24°C to about 37°C for about 12 to about 24 hours. The isocyanates and thioisocyanates used in this reaction are commercially available or can be prepared from commercially available compounds using well-known synthetic procedures. For example, isocyanates and thioisocyanates are readily prepared by reacting the appropriate amine with phosgene or thiophosgene. Examples of isocyanates and thioisocyanates suitable for use in this reaction include,

but are not limited to, ethyl isocyanate, *n*-propyl isocyanate, 4-cyanophenyl isocyanate, 3-methoxyphenyl isocyanate, 2-phenylethyl isocyanate, methyl thioisocyanate, ethyl thioisocyanate, 2-phenylethyl thioisocyanate, 3-phenylpropyl thioisocyanate, 3-(*N,N*-diethylamino)propyl thioisocyanate, phenyl thioisocyanate, 5 benzyl thioisocyanate, 3-pyridyl thioisocyanate, fluorescein isothiocyanate (isomer L), and the like.

Furthermore, when a compound of the present invention or an intermediate thereof contains a primary or secondary amino group, the amino group can be reductively alkylated using aldehydes or ketones to form a secondary or tertiary 10 amino group. This reaction is typically conducted by contacting the amino compound with at least one equivalent, preferably about 1.1 to about 1.5 equivalents, of an aldehyde or ketone and at least one equivalent based on the amino compound of a metal hydride reducing agent, such as sodium cyanoborohydride, in an inert diluent, such as methanol, tetrahydrofuran, mixtures thereof and the like, at a 15 temperature ranging from about 0°C to about 50°C for about 1 to about 72 hours. Aldehydes and ketones suitable for use in this reaction include, by way of example, benzaldehyde, 4-chlorobenzaldehyde, valeraldehyde and the like.

In a similar manner, when a compound of the present invention or an intermediate thereof has a substituent containing a hydroxyl group, the hydroxyl 20 group can be further modified or derivatized either before or after the above coupling reactions to provide, by way of example, ethers, carbamates and the like. Compounds of formulae I and II having a hydroxyl group on the R⁵ substituent, for example, can be prepared using an amino acid derivative of formula VII derived from tyrosine and the like in the above-described reactions.

25 By way of example, a compound of the present invention or an intermediate thereof having a substituent containing a hydroxyl group can be readily *O*-alkylated to form ethers. This *O*-alkylation reaction is typically conducted by contacting the hydroxy compound with a suitable alkali or alkaline earth metal base, such as potassium carbonate, in an inert diluent, such as acetone, 2-butanone and the like, to 30 form the alkali or alkaline earth metal salt of the hydroxyl group. This salt is generally not isolated, but is reacted *in situ* with at least one equivalent of an alkyl or

substituted alkyl halide or sulfonate, such as an alkyl chloride, bromide, iodide, mesylate or tosylate, to afford the ether. Generally, this reaction is conducted at a temperature ranging from about 60°C to about 150°C for about 24 to about 72 hours. Preferably, a catalytic amount of sodium or potassium iodide is added to the reaction mixture when an alkyl chloride or bromide is employed in the reaction.

Examples of alkyl or substituted alkyl halides and sulfonates suitable for use in this reaction include, but are not limited to, *tert*-butyl bromoacetate, *N-tert*-butyl chloroacetamide, 1-bromoethylbenzene, ethyl α -bromophenylacetate, 2-(*N*-ethyl-*N*-phenylamino)ethyl chloride, 2-(*N,N*-ethylamino)ethyl chloride, 2-(*N,N*-diisopropylamino)ethyl chloride, 2-(*N,N*-dibenzylamino)ethyl chloride, 3-(*N,N*-ethylamino)propyl chloride, 3-(*N*-benzyl-*N*-methylamino)propyl chloride, *N*-(2-chloroethyl)morpholine, 2-(hexamethyleneimino)ethyl chloride, 3-(*N*-methylpiperazine)propyl chloride, 1-(3-chlorophenyl)-4-(3-chloropropyl)piperazine, 2-(4-hydroxy-4-phenylpiperidine)ethyl chloride, *N-tert*-butyloxycarbonyl-3-piperidinemethyl tosylate and the like.

Alternatively, a hydroxyl group present on a substituent of a compound of the present invention or an intermediate thereof can be *O*-alkylating using the Mitsunobu reaction. In this reaction, an alcohol, such as 3-(*N,N*-dimethylamino)-1-propanol and the like, is reacted with about 1.0 to about 1.3 equivalents of triphenylphosphine and about 1.0 to about 1.3 equivalents of diethyl azodicarboxylate in an inert diluent, such as tetrahydrofuran, at a temperature ranging from about -10°C to about 5°C for about 0.25 to about 1 hour. About 1.0 to about 1.3 equivalents of a hydroxy compound, such as *N-tert*-butyltyrosine methyl ester, is then added and the reaction mixture is stirred at a temperature of about 0°C to about 30°C for about 2 to about 48 hours to provide the *O*-alkylated product.

In a similar manner, a compound of the present invention or an intermediate thereof containing a aryl hydroxy group can be reacted with an aryl iodide to provide a diaryl ether. Generally, this reaction is conducted by forming the alkali metal salt of the hydroxyl group using a suitable base, such as sodium hydride, in an inert diluent such as xylenes at a temperature of about -25°C to about 10°C. The salt is then treated with about 1.1 to about 1.5 equivalents of cuprous bromide dimethyl

sulfide complex at a temperature ranging from about 10°C to about 30°C for about 0.5 to about 2.0 hours, followed by about 1.1 to about 1.5 equivalents of an aryl iodide, such as sodium 2-iodobenzoate and the like. The reaction is then heated to about 70°C to about 150°C for about 2 to about 24 hours to provide the diaryl ether.

5 Additionally, a hydroxy-containing compound can also be readily derivatized to form a carbamate. In one method for preparing such carbamates, a hydroxy compound of the present invention or an intermediate thereof is contacted with about 1.0 to about 1.2 equivalents of 4-nitrophenyl chloroformate in an inert diluent, such as dichloromethane, at a temperature ranging from about -25°C to about 0°C for
10 about 0.5 to about 2.0 hours. Treatment of the resulting carbonate with an excess, preferably about 2 to about 5 equivalents, of a trialkylamine, such as triethylamine, for about 0.5 to 2 hours, followed by about 1.0 to about 1.5 equivalents of a primary or secondary amine provides the carbamate. Examples of amines suitable for using in this reaction include, but are not limited to, piperazine, 1-methylpiperazine, 1-
15 acetylpiperazine, morpholine, thiomorpholine, pyrrolidine, piperidine and the like.

 Alternatively, in another method for preparing carbamates, a hydroxy-containing compound is contacted with about 1.0 to about 1.5 equivalents of a carbamyl chloride in an inert diluent, such as dichloromethane, at a temperature ranging from about 25°C to about 70°C for about 2 to about 72 hours. Typically,
20 this reaction is conducted in the presence of a suitable base to scavenge the acid generated during the reaction. Suitable bases include, by way of example, tertiary amines, such as triethylamine, diisopropylethylamine, *N*-methyldmorpholine and the like. Additionally, at least one equivalent (based on the hydroxy compound) of 4-
(*N,N*-dimethylamino)pyridine is preferably added to the reaction mixture to facilitate
25 the reaction. Examples of carbamyl chlorides suitable for use in this reaction include, by way of example, dimethylcarbamyl chloride, diethylcarbamyl chloride and the like.

 Likewise, when a compound of the present invention or an intermediate thereof contains a primary or secondary hydroxyl group, such hydroxyl groups can
30 be readily converted into a leaving group and displaced to form, for example, amines, sulfides and fluorides. For example, derivatives of 4-hydroxy-L-proline can

be converted into the corresponding 4-amino, 4-thio or 4-fluoro-L-proline derivatives via nucleophilic displacement of the derivatized hydroxyl group. Generally, when a chiral compound is employed in these reactions, the stereochemistry at the carbon atom attached to the derivatized hydroxyl group is typically inverted.

These reactions are typically conducted by first converting the hydroxyl group into a leaving group, such as a tosylate, by treatment of the hydroxy compound with at least one equivalent of a sulfonyl halide, such as *p*-toluenesulfonyl chloride and the like, in pyridine. This reaction is generally conducted at a temperature of from about 0°C to about 70°C for about 1 to about 48 hours. The resulting tosylate can then be readily displaced with sodium azide, for example, by contacting the tosylate with at least one equivalent of sodium azide in an inert diluent, such as a mixture of *N,N*-dimethylformamide and water, at a temperature ranging from about 0°C to about 37°C for about 1 to about 12 hours to provide the corresponding azido compound. The azido group can then be reduced by, for example, hydrogenation using a palladium on carbon catalyst to provide the amino (-NH₂) compound.

Similarly, a tosylate group can be readily displaced by a thiol to form a sulfide. This reaction is typically conducted by contacting the tosylate with at least one equivalent of a thiol, such as thiophenol, in the presence of a suitable base, such as 1,8-diazabicyclo[5.4.0]undec-7-ene (DBU), in an inert diluent, such as *N,N*-dimethylformamide, at a temperature of from about 0°C to about 37°C for about 1 to about 12 hours to provide the sulfide. Additionally, treatment of a tosylate with morpholinosulfur trifluoride in an inert diluent, such as dichloromethane, at a temperature ranging from about 0°C to about 37°C for about 12 to about 24 hours affords the corresponding fluoro compound.

Furthermore, a compound of the present invention or an intermediate thereof having a substituent containing an iodoaryl group, for example, when R⁵, of formula I or II, is a (4-iodophenyl)methyl group, can be readily converted either before or after the above coupling reactions into a biaryl compound. Typically, this reaction is conducted by treating the iodoaryl compound with about 1.1 to about 2 equivalents

of an arylzinc iodide, such as 2-(methoxycarbonyl)phenylzinc iodide, in the presence of a palladium catalyst, such as palladium tetra(triphenylphosphine), in an inert diluent, such as tetrahydrofuran, at a temperature ranging from about 24°C to about 30°C until the reaction is complete. This reaction is further described, for example, in Rieke, *J. Org. Chem.* 1991, 56, 1445.

In some cases, the compounds of the present invention or intermediates thereof may contain substituents having one or more sulfur atoms. Such sulfur atoms will be present, for example, when the amino acid of formula III employed in the above reactions is derived from L-thiazolidine-4-carboxylic acid, L-(5,5-dimethyl)thiazolidine-4-carboxylic acid, L-thiamorpholine-3-carboxylic acid and the like. When present, such sulfur atoms can be oxidized either before or after the above coupling reactions to provide a sulfoxide or sulfone compound using conventional reagents and reaction conditions. Suitable reagents for oxidizing a sulfide compound to a sulfoxide include, by way of example, hydrogen peroxide, 3-chloroperoxybenzoic acid (MCPBA), sodium periodate and the like. The oxidation reaction is typically conducted by contacting the sulfide compound with about 0.95 to about 1.1 equivalents of the oxidizing reagent in an inert diluent, such as dichloromethane, at a temperature ranging from about -50°C to about 75°C for about 1 to about 24 hours. The resulting sulfoxide can then be further oxidized to the corresponding sulfone by contacting the sulfoxide with at least one additional equivalent of an oxidizing reagent, such as hydrogen peroxide, MCPBA, potassium permanganate and the like. Alternatively, the sulfone can be prepared directly by contacting the sulfide with at least two equivalents, and preferably an excess, of the oxidizing reagent. Such reactions are described further in March, "*Advanced Organic Chemistry*", 4th Ed., pp. 1202-1202, Wiley Publishers, (1992).

As described above, the compounds of the present invention having an R² substituent other than hydrogen can be prepared using an *N*-substituted amino acid of formula III, such as sarcosine, *N*-methyl-L-phenylalanine and the like, in the above-described coupling reactions. Alternatively, such compounds can be prepared by *N*-alkylation of a sulfonamide of formula I or V (where R² is hydrogen) using conventional synthetic procedures. Typically, this *N*-alkylation reaction is

conducted by contacting the sulfonamide with at least one equivalent, preferably 1.1 to 2 equivalents, of an alkyl or substituted alkyl halide in the presence of a suitable base, such as potassium carbonate, in an inert diluent, such as acetone, 2-butanone and the like, at a temperature ranging from about 25°C to about 70°C for about 2 to about 48 hours. Examples of alkyl or substituted alkyl halides suitable for use in this reaction include, but are not limited to, methyl iodide, and the like.

Additionally, the sulfonamides of formula I or V wherein R² is hydrogen and R¹ is a 2-alkoxycarbonylaryl group can be intramolecularly cyclized to form 1,2-benzisothiazol-3-one derivatives or analogues thereof. This reaction is typically conducted by treating a sulfonamide, such as *N*-(2-methoxycarbonylphenylsulfonyl)glycine-*L*-phenylalanine benzyl ester, with about 1.0 to 1.5 equivalents of a suitable base, such as an alkali metal hydride, in an inert diluent, such as tetrahydrofuran, at a temperature ranging from about 0°C to about 30°C for about 2 to about 48 hours to afford the cyclized 1,2-benzisothiazol-3-one derivative.

Lastly, the compounds of formula I or II where Q is -C(S)NR⁷- are prepared by using an amino thionoacid derivative in place of amino acid III in the above described synthetic procedures. Such amino thionoacid derivatives can be prepared by the procedures described in Shalaky *et al.*, *J. Org. Chem.*, 61:9045-9048 (1996) and Brain *et al.*, *J. Org. Chem.*, 62:3808-3809 (1997) and references cited therein.

4.1.2. Pharmaceutical Formulations of the Compounds

In general, the compounds of the subject invention will be administered in a therapeutically effective amount by any of the accepted modes of administration for these compounds. The compounds can be administered by a variety of routes, including, but not limited to, oral, parenteral (*e.g.*, subcutaneous, subdural, intravenous, intramuscular, intrathecal, intraperitoneal, intracerebral, intraarterial, or intralesional routes of administration), topical, intranasal, localized (*e.g.*, surgical application or surgical suppository), rectal, and pulmonary (*e.g.*, aerosols, inhalation, or powder). Accordingly, these compounds are effective as both injectable and oral compositions. The compounds can be administered continuously by infusion or by

bolus injection. Preferably, the compounds are administered by parenteral routes. More preferably, the compounds are administered by intravenous routes. Such compositions are prepared in a manner well known in the pharmaceutical art.

5 The actual amount of the compound of the subject invention, *i.e.*, the active ingredient, will depend on a number of factors, such as the severity of the disease, *i.e.*, the condition or disease associated with demyelination or the paralysis associated with demyelination to be treated, the age and relative health of the subject, the potency of the compound used, the route and form of administration, and other factors.

10 Toxicity and therapeutic efficacy of such compounds can be determined by standard pharmaceutical procedures in cell cultures or experimental animals, *e.g.*, for determining the LD₅₀ (the dose lethal to 50% of the population) and the ED₅₀ (the dose therapeutically effective in 50% of the population). The dose ratio between toxic and therapeutic effects is the therapeutic index and it can be expressed as the
15 ratio LD₅₀/ED₅₀. Compounds that exhibit large therapeutic indices are preferred.

The data obtained from the cell culture assays and animal studies can be used in formulating a range of dosage for use in humans. The dosage of such compounds lies preferably within a range of circulating concentrations that include the ED₅₀ with little or no toxicity. The dosage may vary within this range depending upon the
20 dosage form employed and the route of administration utilized. For any compound used in the method of the invention, the therapeutically effective dose can be estimated initially from cell culture assays. A dose may be formulated in animal models to achieve a circulating plasma concentration range which includes the IC₅₀ (*i.e.*, the concentration of the test compound which achieves a half-maximal
25 inhibition of symptoms) as determined in cell culture. Such information can be used to more accurately determine useful doses in humans. Levels in plasma may be measured, for example, by high performance liquid chromatography. The effective blood level of the compounds of the subject invention is preferably greater than or equal to 10 ng/ml.

30 The amount of the pharmaceutical composition administered to the patient will vary depending upon what is being administered, the purpose of the administration,

such as prophylaxis or therapy, the state of the patient, the manner of administration, and the like. In therapeutic applications, compositions are administered to a patient already suffering from a disease in an amount sufficient to cure or at least partially arrest the symptoms of the disease and its complications. An amount adequate to
5 accomplish this is defined as "therapeutically effective dose." Amounts effective for this use will depend on the disease condition being treated as well as by the judgment of the attending clinician depending upon factors such as the severity of the inflammation, the age, weight and general condition of the patient, and the like.

The compositions administered to a patient are in the form of pharmaceutical
10 compositions described *supra*. These compositions may be sterilized by conventional sterilization techniques, or may be sterile filtered. The resulting aqueous solutions may be packaged for use as is, or lyophilized, the lyophilized preparation being combined with a sterile aqueous carrier prior to administration. The pH of the compound preparations typically will be between 3 and 11, more
15 preferably from 5 to 9 and most preferably from 7 to 8. It will be understood that use of certain of the foregoing excipients, carriers, or stabilizers will result in the formation of pharmaceutical salts.

The active compound is effective over a wide dosage range and is generally administered in a pharmaceutically or therapeutically effective amount. The
20 therapeutic dosage of the compounds of the present invention will vary according to, for example, the particular use for which the treatment is made, the manner of administration of the compound, the health and condition of the patient, and the judgment of the prescribing physician. For example, for intravenous administration, the dose will typically be in the range of about 20 μg to about 500 μg per kilogram
25 body weight, preferably about 100 μg to about 300 μg per kilogram body weight. Suitable dosage ranges for intranasal administration are generally about 0.1 μg to 1 mg per kilogram body weight. Effective doses can be extrapolated from dose-response curves derived from *in vitro* or animal model test systems. Typically, the clinician will administer the compound until a dosage is reached that achieves
30 the desired effect.

When employed as pharmaceuticals, the compounds of the subject invention are usually administered in the form of pharmaceutical compositions. This invention also includes pharmaceutical compositions, which contain as the active ingredient, one or more of the compounds of the subject invention above, associated with one or more pharmaceutically acceptable carriers or excipients. The excipient employed is typically one suitable for administration to human subjects or other mammals. In making the compositions of this invention, the active ingredient is usually mixed with an excipient, diluted by an excipient or enclosed within a carrier which can be in the form of a capsule, sachet, paper or other container. When the excipient serves as a diluent, it can be a solid, semi-solid, or liquid material, which acts as a vehicle, carrier or medium for the active ingredient. Thus, the compositions can be in the form of tablets, pills, powders, lozenges, sachets, cachets, elixirs, suspensions, emulsions, solutions, syrups, aerosols (as a solid or in a liquid medium), ointments containing, for example, up to 10% by weight of the active compound, soft and hard gelatin capsules, suppositories, sterile injectable solutions, and sterile packaged powders.

In preparing a formulation, it may be necessary to mill the active compound to provide the appropriate particle size prior to combining with the other ingredients. If the active compound is substantially insoluble, it ordinarily is milled to a particle size of less than 200 mesh. If the active compound is substantially water soluble, the particle size is normally adjusted by milling to provide a substantially uniform distribution in the formulation, *e.g.* about 40 mesh.

Some examples of suitable excipients include lactose, dextrose, sucrose, sorbitol, mannitol, starches, gum acacia, calcium phosphate, alginates, tragacanth, gelatin, calcium silicate, microcrystalline cellulose, polyvinylpyrrolidone, cellulose, sterile water, syrup, and methyl cellulose. The formulations can additionally include: lubricating agents such as talc, magnesium stearate, and mineral oil; wetting agents; emulsifying and suspending agents; preserving agents such as methyl- and propylhydroxy-benzoates; sweetening agents; and flavoring agents. The compositions of the invention can be formulated so as to provide quick, sustained or

delayed release of the active ingredient after administration to the patient by employing procedures known in the art.

The quantity of active compound in the pharmaceutical composition and unit dosage form thereof may be varied or adjusted widely depending upon the particular application, the manner or introduction, the potency of the particular compound, and the desired concentration. The term "unit dosage forms" refers to physically discrete units suitable as unitary dosages for human subjects and other mammals, each unit containing a predetermined quantity of active material calculated to produce the desired therapeutic effect, in association with a suitable pharmaceutical excipient. The concentration of therapeutically active compound may vary from about 1 mg/ml to 1 g/ml.

Preferably, the compound can be formulated for parenteral administration in a suitable inert carrier, such as a sterile physiological saline solution. For example, the concentration of compound in the carrier solution is typically between about 1-100 mg/ml. The dose administered will be determined by route of administration. Preferred routes of administration include parenteral or intravenous administration. A therapeutically effective dose is a dose effective to produce a significant decrease in demyelination and a notable increase in remyelination. Preferably, the amount is sufficient to produce a statistically significant amount of remyelination in a subject.

By way of example, for preparing solid compositions such as tablets, the principal active ingredient is mixed with a pharmaceutical excipient to form a solid preformulation composition containing a homogeneous mixture of a compound of the present invention. When referring to these preformulation compositions as homogeneous, it is meant that the active ingredient is dispersed evenly throughout the composition so that the composition may be readily subdivided into equally effective unit dosage forms such as tablets, pills and capsules. This solid preformulation is then subdivided into unit dosage forms of the type described above containing from, for example, 0.1 to about 500 mg of the active ingredient of the present invention.

The tablets or pills of the present invention may be coated or otherwise compounded to provide a dosage form affording the advantage of prolonged action.

For example, the tablet or pill can comprise an inner dosage and an outer dosage component, the latter being in the form of an envelope over the former. The two components can be separated by an enteric layer, which serves to resist disintegration in the stomach and permit the inner component to pass intact into the duodenum or to be delayed in release. A variety of materials can be used for such enteric layers or coatings, such materials including a number of polymeric acids and mixtures of polymeric acids with such materials as shellac, cetyl alcohol, and cellulose acetate.

The liquid forms in which the novel compositions of the present invention may be incorporated for administration orally or by injection include aqueous solutions, suitably flavored syrups, aqueous or oil suspensions, and flavored emulsions with edible oils such as corn oil, cottonseed oil, sesame oil, coconut oil, or peanut oil, as well as elixirs and similar pharmaceutical vehicles.

Compositions for inhalation or insufflation include solutions and suspensions in pharmaceutically acceptable, aqueous or organic solvents, or mixtures thereof, and powders. The liquid or solid compositions may contain suitable pharmaceutically acceptable excipients as described *supra*. The compositions may be administered by the oral or nasal respiratory route for local or systemic effect. Compositions in preferably pharmaceutically acceptable solvents may be nebulized by use of inert gases. Nebulized solutions may be inhaled directly from the nebulizing device or the nebulizing device may be attached to a face mask tent, or intermittent positive pressure breathing machine. Solution, suspension, or powder compositions may be administered, preferably orally or nasally, from devices which deliver the formulation in an appropriate manner.

The compounds of this invention can be administered in a sustained release form. Suitable examples of sustained-release preparations include semipermeable matrices of solid hydrophobic polymers containing the protein, which matrices are in the form of shaped articles, *e.g.*, films, or microcapsules. Examples of sustained-release matrices include polyesters, hydrogels (*e.g.*, poly(2-hydroxyethyl-methacrylate) as described by Langer *et al.*, *J. Biomed. Mater. Res.* 15: 167-277 (1981) and Langer, *Chem. Tech.* 12: 98-105 (1982) or poly(vinyl alcohol)),

polylactides (U.S. Patent No. 3,773,919), copolymers of L-glutamic acid and gamma ethyl-L-glutamate (Sidman *et al.*, *Biopolymers* 22: 547-556, 1983), non-degradable ethylene-vinyl acetate (Langer *et al.*, *supra*), degradable lactic acid-glycolic acid copolymers such as the LUPRON DEPOT™ (*i.e.* injectable microspheres composed
 5 of lactic acid-glycolic acid copolymer and leuprolide acetate), and poly-D-(-)-3-hydroxybutyric acid (EP 133,988).

The compounds of this invention can be administered in a sustained release form, for example a depot injection, implant preparation, or osmotic pump, which can be formulated in such a manner as to permit a sustained release of the active
 10 ingredient. Implants for sustained release formulations are well-known in the art. Implants may be formulated as, including but not limited to, microspheres, slabs, with biodegradable or non-biodegradable polymers. For example, polymers of lactic acid and/or glycolic acid form an erodible polymer that is well-tolerated by the host. The implant is placed in proximity to the site of protein deposits (*e.g.*, the site of
 15 formation of amyloid deposits associated with neurodegenerative disorders), so that the local concentration of active agent is increased at that site relative to the rest of the body.

The following formulation examples illustrate pharmaceutical compositions of the present invention.

20 Formulation Example 1

Hard gelatin capsules containing the following ingredients are prepared:

<u>Ingredient</u>	<u>Quantity</u> <u>(mg/capsule)</u>
Active Ingredient	30.0
Starch	305.0
Magnesium stearate	5.0

The above ingredients are mixed and filled into hard gelatin capsules
 25 in 340 mg quantities.

Formulation Example 2

A tablet formula is prepared using the ingredients below:

<u>Ingredient</u>	<u>Quantity</u> <u>(mg/capsule)</u>
Active Ingredient	25.0
Cellulose, microcrystalline	200.0
Colloidal silicon dioxide	10.0
Stearic acid	5.0

5 The components are blended and compressed to form tablets, each weighing
240 mg.

Formulation Example 3

10 A dry powder inhaler formulation is prepared containing the following
components:

<u>Ingredient</u>	<u>Weight %</u>
Active Ingredient	5
Lactose	95

The active mixture is mixed with the lactose and the mixture is added to a
dry powder inhaling appliance.

15

Formulation Example 4

Tablets, each containing 30 mg of active ingredient, are prepared as follows:

<u>Ingredient</u>	<u>Quantity</u> <u>(mg/capsule)</u>
Active Ingredient	30.0 mg
Starch	45.0 mg
Microcrystalline cellulose	35.0 mg
Polyvinylpyrrolidone (as 10% solution in water)	4.0 mg
Sodium carboxymethyl starch	4.5 mg
Magnesium stearate	0.5 mg
Talc	<u>1.0 mg</u>
Total	120 mg

The active ingredient, starch and cellulose are passed through a No. 20 mesh U.S. sieve and mixed thoroughly. The solution of polyvinyl-pyrrolidone is mixed with the resultant powders, which are then passed through a 16 mesh U.S. sieve. The granules so produced are dried at 50° to 60°C and passed through a 16 mesh U.S. sieve. The sodium carboxymethyl starch, magnesium stearate, and talc, previously passed through a No. 30 mesh U.S. sieve, are then added to the granules, which after mixing, are compressed on a tablet machine to yield tablets each weighing 150 mg.

10 Formulation Example 5

Capsules, each containing 40 mg of medicament are made as follows:

<u>Ingredient</u>	<u>Quantity (mg/capsule)</u>
Active Ingredient	40.0 mg
Starch	109.0 mg
Magnesium stearate	1.0 mg
Total	150.0 mg

15 The active ingredient, cellulose, starch, an magnesium stearate are blended, passed through a No. 20 mesh U.S. sieve, and filled into hard gelatin capsules in 150 mg quantities.

Formulation Example 6

20 Suppositories, each containing 25 mg of active ingredient are made as follows:

<u>Ingredient</u>	<u>Amount</u>
Active Ingredient	25 mg
Saturated fatty acid glycerides	to 2,000 mg

25 The active ingredient is passed through a No. 60 mesh U.S. sieve and suspended in the saturated fatty acid glycerides previously melted using the minimum heat necessary. The mixture is then poured into a suppository mold of nominal 2.0 g capacity and allowed to cool.

Formulation Example 7

Suspensions, each containing 50 mg of medicament per 5.0 ml dose are made as follows:

5

<u>Ingredient</u>	<u>Amount</u>
Active Ingredient	50.0 mg
Xanthan gum	4.0 mg
Sodium carboxymethyl cellulose (11%)	
Microcrystalline cellulose (89%)	50.0 mg
Sucrose	1.75 g
Sodium benzoate	10.0 mg
Flavor and Color	q.v.
Purified water	to 5.0 ml

The medicament, sucrose and xanthan gum are blended, passed through a No. 10 mesh U.S. sieve, and then mixed with a previously made solution of the microcrystalline cellulose and sodium carboxymethyl cellulose in water. The sodium benzoate, flavor, and color are diluted with some of the water and added with stirring. Sufficient water is then added to produce the required volume.

10

Formulation Example 8

Hard gelatin tablets, each containing 15 mg of active ingredient are made as follows:

15

<u>Ingredient</u>	<u>Quantity (mg/capsule)</u>
Active Ingredient	15.0 mg
Starch	407.0 mg
Magnesium stearate	3.0 mg
Total	425.0 mg

The active ingredient, cellulose, starch, and magnesium stearate are blended, passed through a No. 20 mesh U.S. sieve, and filled into hard gelatin capsules in 560 mg quantities.

20

Formulation Example 9

An intravenous formulation may be prepared as follows:

<u>Ingredient</u>	<u>Quantity</u>
Active Ingredient	250.0 mg
Isotonic saline	1000 ml

5 Therapeutic compound compositions generally are placed into a container having a sterile access port, for example, an intravenous solution bag or vial having a stopper pierceable by a hypodermic injection needle or similar sharp instrument.

Formulation Example 10

10 A topical formulation may be prepared as follows:

<u>Ingredient</u>	<u>Quantity</u>
Active Ingredient	1-10 g
Emulsifying Wax	30 g
Liquid Paraffin	20 g
White Soft Paraffin	to 100 g

15 The white soft paraffin is heated until molten. The liquid paraffin and emulsifying wax are incorporated and stirred until dissolved. The active ingredient is added and stirring is continued until dispersed. The mixture is then cooled until solid.

20 Another preferred formulation employed in the methods of the present invention employs transdermal delivery devices ("patches"). Such transdermal patches may be used to provide continuous or discontinuous infusion of the compounds of the present invention in controlled amounts. The construction and use of transdermal patches for the delivery of pharmaceutical agents is well known in the art. *See, e.g.*, U.S. Patent No. 5,023,252, issued June 11, 1991, herein incorporated by reference. Such patches may be constructed for continuous, pulsatile, or on demand delivery of pharmaceutical agents.

25 Direct or indirect placement techniques may be used when it is desirable or necessary to introduce the pharmaceutical composition to the brain. Direct

techniques usually involve placement of a drug delivery catheter into the host's ventricular system to bypass the blood-brain barrier. One such implantable delivery system used for the transport of biological factors to specific anatomical regions of the body is described in U.S. Patent No. 5,011,472, which is herein incorporated by
5 reference.

Indirect techniques, which are generally preferred, usually involve formulating the compositions to provide for drug latentiation by the conversion of hydrophilic drugs into lipid-soluble drugs. Latentiation is generally achieved through blocking of the hydroxy, carbonyl, sulfate, and primary amine groups
10 present on the drug to render the drug more lipid soluble and amenable to transportation across the blood-brain barrier. Alternatively, the delivery of hydrophilic drugs may be enhanced by intra-arterial infusion of hypertonic solutions which can transiently open the blood-brain barrier.

According to one aspect of the invention, the compound may be administered
15 alone, as a combination of compounds, in combination with remyelinating and/or anti-alpha-4-antibodies, or in combination with an anti-inflammatory agent, which is typically used to treat conditions and diseases associated with demyelination. When administered in combination, the small compounds may be administered in the same formulation as these other compounds or compositions, or in a separate formulation.
20 When administered in combinations, the remyelinating agents may be administered prior to, following, or concurrently with the other compounds and compositions.

Pharmaceutical compositions of the invention are suitable for use in a variety of drug delivery systems. Suitable formulations for use in the present invention are found in *Remington's Pharmaceutical Sciences*, Mace Publishing Company,
25 Philadelphia, PA, 17th ed. (1985).

In order to enhance serum half-life, the compounds may be encapsulated, introduced into the lumen of liposomes, prepared as a colloid, or other conventional techniques may be employed which provide an extended serum half-life of the compounds. A variety of methods are available for preparing liposomes, as
30 described in, *e.g.*, Szoka *et al.*, U.S. Patent Nos. 4,235,871, 4,501,728 and 4,837,028 each of which is incorporated herein by reference.

Polymer conjugates

Compounds of the present invention may be formulated and administered as polymer conjugates. Polymer conjugates may exhibit benefits over non-conjugated polymers, such as improved solubility and stability.

As such, single polymer molecules may be employed for conjugation with the compounds of the present invention, although it is also contemplated that more than one polymer molecule can be attached as well. The conjugated compounds of the present invention may find utility in both *in vivo* as well as non-*in vivo* applications. Additionally, it will be recognized that the conjugating polymer may utilize any other groups, moieties, or other conjugated species, as appropriate to the end use application. By way of example, it may be useful in some applications to covalently bond to the polymer a functional moiety imparting UV-degradation resistance, or antioxidation, or other properties or characteristics to the polymer. As a further example, it may be advantageous in some applications to functionalize the polymer to render it reactive and enable it to cross-link to a drug molecule and to enhance various properties or characteristics of the overall conjugated material. Accordingly, the polymer may contain any functionality, repeating groups, linkages, or other constituent structures which do not preclude the efficacy of the conjugated the compounds of the present invention composition for its intended purpose.

Illustrative polymers that may usefully be employed to achieve these desirable characteristics are described *supra*, as well as in PCT WO 01/54690 (to Zheng *et al.*) incorporated by reference herein in its entirety. The polymer may be coupled to the compounds of the present invention (preferably via a linker moiety) to form stable bonds that are not significantly cleavable by human enzymes. Generally, for a bond to be not "significantly" cleavable requires that no more than about 20% of the bonds connecting the polymer and the compounds of the present invention to which the polymer is linked, are cleaved within a 24 hour period, as measured by standard techniques in the art including, but not limited to, high pressure liquid chromatography (HPLC).

The compounds of the present inventions are conjugated most preferably via a terminal reactive group on the polymer although conjugations can also be branched from non-terminal reactive groups. The polymer with the reactive group(s) is designated herein as "activated polymer". The reactive group selectively reacts with reactive groups on the compounds of the present invention. The activated polymer(s) is reacted so that attachment may occur at any available functional group on compounds of the present invention. Amino, carbon, free carboxylic groups, suitably activated carbonyl groups, hydroxyl, guanidyl, oxidized carbohydrate moieties, amino, carbon and mercapto groups of the compounds of the present invention (if available) can be used as attachment sites.

Generally, about 1.0 to about 10 moles of activated polymer per mole of the compounds of the present invention, depending on concentration, is employed. The final amount is a balance between maximizing the extent of the reaction while minimizing non-specific modifications of the product and, at the same time, defining chemistries that will maintain optimum activity, while at the same time optimizing the half-life of the compounds of the present invention. Preferably, at least about 50% of the biological activity of the compounds of the present invention is retained, and most preferably 100% is retained.

The reactions may take place by any suitable art-recognized method used for reacting biologically active materials with inert polymers. Generally, the process involves preparing an activated polymer and thereafter reacting the compounds of the present invention with the activated polymer to produce a soluble compound suitable for formulation. This modification reaction can be performed by several methods, which may involve one or more steps. The polymeric substances included herein are preferably water-soluble at room temperature. A non-limiting list of such polymers includes polyalkylene oxide homopolymers such as polyethylene glycol (PEG) or polypropylene glycols, polyoxyethylenated polyols, copolymers thereof and block copolymers thereof, provided that the water solubility of the block copolymers is maintained.

In the preferred practice of the present invention, polyalkylene glycol residues of C₁-C₄ alkyl polyalkylene glycols, preferably polyethylene glycol (PEG), or

poly(oxy)alkylene glycol residues of such glycols are advantageously incorporated in the polymer systems of interest. Thus, the polymer to which the compounds of the present invention are attached may be a homopolymer of polyethylene glycol (PEG) or is a polyoxyethylated polyol, provided in all cases that the polymer is soluble in water at room temperature. Non-limiting examples of such polymers include polyalkylene oxide homopolymers such as PEG or polypropylene glycols, polyoxyethylenated glycols, copolymers thereof and block copolymers thereof, provided that the water solubility of the block copolymer is maintained.

Examples of polyoxyethylated polyols include, but are not limited to, polyoxyethylated glycerol, polyoxyethylated sorbitol, polyoxyethylated glucose, or the like. The glycerol backbone of polyoxyethylated glycerol is the same backbone occurring naturally in, for example, animals and humans in mono-, di-, and triglycerides. Therefore, this branching would not necessarily be seen as a foreign agent in the body.

Those of ordinary skill in the art will recognize that the foregoing list is merely illustrative and that all polymer materials having the qualities described herein are contemplated. The polymer need not have any particular molecular weight, but it is preferred that the molecular weight be between about 300 and 100,000, more preferably between 10,000 and 40,000. In particular, sizes of 20,000 or more are most effective at preventing loss of the product due to filtration in the kidneys.

Polyethylene glycol (PEG) and related polyalkylene oxides (PAO's) are known in the art as being useful adjuncts for the preparation of drugs. See for example, PCT WO 93/24476. PEG has also been conjugated to proteins, peptides and enzymes to increase aqueous solubility and circulating life *in vivo* as well as reduce antigenicity. See, for example, U.S. Patent Nos. 5,298,643 and 5,321,095, both to Greenwald *et al.* PCT WO 93/24476 discloses using an ester linkage to covalently bind an organic molecule to water-soluble polyethylene glycols. Thus, the compounds of the invention are preferably administered as polyethylene glycol (PEG) derivatives.

As such, the compounds or conjugates of this invention may contain one or more polyethylene glycol (PEG) substituents covalently attached thereto. Such conjugates demonstrate improved serum half-life, as compared to compounds lacking polyethylene glycol substituents. Without being limited to any theory, the improved serum half-life is believed to be associated with the covalent conjugation of at least one polyethylene glycol entity onto the structure of the compound.

The term "PEG" refers to polymers comprising multiple oxyalkylene units. Such polymers are optionally mono-capped with a substituent preferably selected from alkyl, aryl, substituted alkyl, and substituted aryl. Inclusive of such polymers are those diamino capped polyoxyalkylene polymers which are known in the art as Jeffamines[®]. Still further, such polymers can optionally contain one or more non-oxyalkylene units such as the commercially available poly[di(ethylene glycol)adipates, poly[di(ethylene glycol)phthalate diols, and the like.

By PEG derivative is meant a polyethylene glycol polymer in which one or both of the terminal hydroxyl groups found in polyethylene glycol itself has been modified. Examples of suitable modifications include replacing one or both hydroxyl group(s) with alternative functional groups, which may be protected or unprotected, with low molecular weight ligands, or with another macromolecule or polymer. Modification of the terminal hydroxyl groups in the polyethylene glycol may be achieved by reacting the polyethylene glycol with compounds comprising complementary reactive functional groups, including functional groups which are able to undergo a reaction with the hydroxyl groups in polyethylene glycol. The PEG derivatives of the compounds of this invention may contain one or more polyethylene glycol (PEG) substituents covalently attached thereto by a linking group.

"Linking group" or "linker" refers to a group or groups that covalently links a non-PEG substituted compound of the present invention with one or more PEG groups. Each linker may be chiral or achiral, linear, branched or cyclic and may be homogenous or heterogeneous in its atom content (*e.g.*, linkers containing only carbon atoms or linkers containing carbon atoms as well as one or more heteroatoms present on the linker.

The PEG group or groups are covalently attached to the linker using conventional chemical techniques providing for covalent linkage of the PEG group to the linker. The linker, in turn, may be covalently attached to the otherwise, non-PEG substituted compounds of the present invention. Reaction chemistries resulting in such linkages are well known in the art. Such reaction chemistries involve the use of complementary functional groups on the linker, the non-PEG substituted compound of the present invention and the PEG groups. Preferably, the complementary functional groups on the linker are selected relative to the functional groups available on the PEG group for bonding or which can be introduced onto the PEG group for bonding. Again, such complementary functional groups are well known in the art.

Such polymers have a number average molecular weight of from about 100 to 100,000; preferably from about 1,000 to 50,000; more preferably from about 10,000 to about 40,000.

15

5. Immunoglobulins

In one specific embodiment, the agents of the invention are immunoglobulins the when administered to a patient inhibit demyelination and/or promote remyelination and/or reduce paralysis. These immunoglobulins may be selected from immunoglobulins that selectively bind to an alpha-4 integrin or a dimer comprising alpha-4 integrin, such as alpha-4 beta-1, or bind VCAM-1. Preferably, the immunoglobulins bind alpha-4 beta-1 and inhibits alpha-4 beta-1 activity. The immunoglobulins are preferably antibodies or fragments thereof.

By "antibodies" is meant to include complete immunoglobulins such as IgG1 (or any IgG subclass) or IgM, or inhibitors derived from antibodies, such as natalizumab (Antegren[®]).

By "antibody homolog" is meant to include intact antibodies consisting of immunoglobulin light and heavy chains linked via disulfide bonds. The term "antibody homolog" is also intended to encompass a protein comprising one or more polypeptides selected from immunoglobulin light chains, immunoglobulin heavy chains and antigen-binding fragments thereof which are capable of binding to one or

30

more antigens (*i.e.*, integrin or integrin ligand). The component polypeptides of an antibody homolog composed of more than one polypeptide may optionally be disulfide-bound or otherwise covalently crosslinked. Accordingly, therefore, "antibody homologs" include intact immunoglobulins of types IgA, IgG, IgE, IgD, IgM (as well as subtypes thereof, *e.g.*, IgG1), wherein the light chains of the immunoglobulin may be of types kappa or lambda. "Antibody homologs" also includes portions of intact antibodies that retain antigen-binding specificity, for example Fab fragments, Fab' fragments, F(ab')₂ fragments, Fv fragments, scFv fragments, heavy and light chain monomers or dimers or mixtures thereof.

When the agent of the invention is an antibody, a monoclonal antibody is the preferred antibody. In contrast to polyclonal antibody preparations, which typically include different antibodies directed against different epitopes, each monoclonal antibody is directed against a single epitope on the antigen. A second advantage of monoclonal antibodies is that they are synthesized by means that are uncontaminated by other immunoglobulins, *e.g.*, by phage display or isolation from a hybridoma. Although the present invention intends to encompass both polyclonal and monoclonal antibodies as agents of the invention, monoclonal antibodies are preferred as they are highly specific, and the invention is thus discussed primarily in terms of monoclonal antibodies.

"Native antibodies and immunoglobulins" are usually heterotetrameric glycoproteins of about 150,000 Daltons, composed of two identical light (L) chains and two identical heavy (H) chains. Each light chain is linked to a heavy chain by one covalent disulfide bond, while the number of disulfide linkages varies between the heavy chains of different immunoglobulin isotypes. Each heavy and light chain also has regularly spaced intrachain disulfide bridges. Each heavy chain has at one end a variable domain (V_H) followed by a number of constant domains. Each light chain has a variable domain at one end (V_L) and a constant domain at its other end; the constant domain of the light chain is aligned with the first constant domain of the heavy chain, and the light chain variable domain is aligned with the variable domain of the heavy chain. Particular amino acid residues are believed to form an interface

between the light and heavy chain variable domains (Clothia *et al.*, 1985, *J. Mol. Biol.*, 186: 651-63; Novotny *et al.*, 1985, *Proc. Natl. Acad. Sci. USA*, 82: 4592-6).

In addition, other antibodies can be identified using techniques available in the art. For example, monoclonal antibodies of the present invention can be produced using phage display technology. Antibody fragments, which selectively bind to an alpha-4 integrin or a dimer comprising an alpha-4 integrin, are then isolated. Exemplary preferred methods for producing such antibodies via phage display are disclosed in U.S. Patent Nos. 6,225,447; 6,180,336; 6,172,197; 6,140,471; 5,969,108; 5,885,793; 5,872,215; 5,871,907; 5,858,657; 5,837,242; 5,733,743 and 5,565,332.

A "variant" antibody refers herein to an immunoglobulin molecule that differs in amino acid sequence from a "parent" antibody amino acid sequence by virtue of addition, deletion and/or substitution of one or more amino acid residue(s) in the parent antibody sequence. The parent antibody or immunoglobulin can be a polyclonal antibody, monoclonal antibody, humanized antibody, primatized[®] antibody or any antibody fragment. In the preferred embodiment, the variant comprises one or more amino acid substitution(s) in one or more hypervariable region(s) of the parent antibody. For example, the variant may comprise at least one, *e.g.*, from about one to about ten, and preferably from about two to about five, substitutions in one or more hypervariable regions of the parent antibody. Ordinarily, the variant will have an amino acid sequence having at least 75% amino acid sequence identity with the parent antibody heavy or light chain variable domain sequences, more preferably at least 80%, more preferably at least 85%, more preferably at least 90%, and most preferably at least 95%. Identity or homology with respect to this sequence is defined herein as the percentage of amino acid residues in the candidate sequence that are identical with the parent antibody residues, after aligning the sequences and introducing gaps, if necessary, to achieve the maximum percent sequence identity. No N-terminal, C-terminal, or internal extensions, deletions, or insertions into the antibody sequence shall be construed as affecting sequence identity or homology. The variant retains the ability to bind the receptor and preferably has properties that are superior to those of the parent antibody. For

example, the variant may have a stronger binding affinity, enhanced ability to activate the receptor, *etc.* To analyze such properties, one should compare a Fab form of the variant to a Fab form of the parent antibody or a full-length form of the variant to a full-length form of the parent antibody. The variant antibody of particular interest herein is one which displays at least about 10 fold, preferably at least about 20 fold, and most preferably at least about 50 fold, enhancement in biological activity when compared to the parent antibody. The "parent" antibody herein is one that is encoded by an amino acid sequence used for the preparation of the variant. Preferably, the parent antibody has a human framework region and has human antibody constant region(s). For example, the parent antibody may be a humanized or human antibody. An "isolated" antibody is one that has been identified and separated and/or recovered from a component of its natural environment. Contaminant components of its natural environment are materials that would interfere with diagnostic or therapeutic uses for the antibody, and may include enzymes, hormones, and other proteinaceous or non-proteinaceous solutes. In preferred embodiments, the antibody will be purified (1) to greater than 95% by weight of antibody as determined by the Lowry method, and most preferably more than 99% by weight, (2) to a degree sufficient to obtain at least 15 residues of N-terminal or internal amino acid sequence by use of a spinning cup sequenator, or (3) to homogeneity by SDS-PAGE under reducing or non-reducing conditions using Coomassie blue or, preferably, silver stain. Isolated antibody includes the antibody *in situ* within recombinant cells since at least one component of the antibody's natural environment will not be present. Ordinarily, however, isolated antibodies will be prepared by at least one purification step.

25

5.1. Monoclonal Antibodies

Monoclonal antibodies can also be produced using the conventional hybridoma methods or genetically engineered. These methods have been widely applied to produce hybrid cell lines that secrete high levels of monoclonal antibodies against many specific antigens, and can also be used to produce monoclonal antibodies of the present invention. For example, mice (*e.g.*, Balb/c mice) can be

30

immunized with an antigenic alpha-4 epitope by intraperitoneal injection. After sufficient time has passed to allow for an immune response, the mice are sacrificed and the spleen cells obtained and fused with myeloma cells, using techniques well known in the art. The resulting fused cells, hybridomas, are then grown in a selective medium, and the surviving cells grown in such medium using limiting dilution conditions. After cloning and recloning, hybridomas can be isolated that secrete antibodies (for example, of the IgG or IgM class or IgG1 subclass) that selectively bind to the target, alpha-4 or a dimer comprising an alpha-4 integrin. To produce agents specific for human use, the isolated monoclonal can then be used to produce chimeric and humanized antibodies. Antibodies can also be prepared that are anti-peptide antibodies. Such anti-peptide antibodies would be prepared against peptides of alpha-4 integrin.

The term "chimeric", when referring to an agent of the invention, means that the agent is comprised of a linkage (chemical cross-linkage or covalent or other type) of two or more proteins having disparate structures and/or having disparate sources of origin. Thus, a chimeric alpha-4 integrin antagonist may include one moiety that is an alpha-4 integrin antagonist or fragment and another moiety that is not an alpha-4 integrin antagonist.

A species of "chimeric" protein is a "fusion" or "fusion protein" refers to a co-linear, covalent linkage of two or more proteins or fragments thereof via their individual peptide backbones, most preferably through genetic expression of a polynucleotide molecule encoding those proteins. Thus, preferred fusion proteins are chimeric proteins that include a remyelinating antibody or fragment thereof covalently linked to a second moiety that is not original to the remyelinating antibody (*i.e.*, which derives from another immunoglobulin or polypeptide). Preferred fusion proteins of the invention may include portions of intact antibodies that retain antigen-binding specificity, for example, Fab fragments, Fab' fragments, F(ab')₂ fragments, Fv fragments, scFv fragments, heavy chain monomers or dimers, light chain monomers or dimers, dimers consisting of one heavy and one light chain, and the like.

The most preferred fusion proteins are chimeric and comprise a remyelinating moiety fused or otherwise linked to all or part of the hinge and constant regions of an immunoglobulin light chain, heavy chain, or both. Thus, this invention features a molecule which includes: (1) remyelinating moiety, (2) a second peptide, *e.g.*, one which increases solubility or *in vivo* life time of the remyelinating moiety, *e.g.*, a member of the immunoglobulin super family or fragment or portion thereof, *e.g.*, a portion or a fragment of IgG, *e.g.*, the human IgG1 heavy chain constant region, *e.g.*, CH2, CH3, and hinge regions. Specifically, a "remyelinating moiety/Ig fusion" is a protein comprising a biologically active remyelinating moiety of the invention. A species of remyelinating agents is an "integrin /Fc fusion" which is a protein comprising an remyelinating immunoglobulin of the invention linked to at least a part of the constant domain of an immunoglobulin. A preferred Fc fusion comprises an remyelinating immunoglobulin of the invention linked to a fragment of an antibody containing the C terminal domain of the heavy immunoglobulin chains.

The term "fusion protein" also means a remyelinating moiety that is chemically linked via a mono- or hetero-functional molecule to a second moiety that is not a remyelinating moiety (resulting in a "chimeric" molecule) and is made *de novo* from purified protein as described below. Thus, one example of a chemically linked, as opposed to recombinantly linked, chimeric molecule that is a fusion protein may comprise: (1) an alpha-4 integrin subunit targeting moiety, *e.g.*, a VCAM-1 moiety capable of binding to VLA-4) on the surface of VLA-4 bearing cells; (2) a second molecule which increases solubility or *in vivo* life time of the targeting moiety, *e.g.*, a polyalkylene glycol polymer such as polyethylene glycol (PEG). The alpha-4 targeting moiety can be any naturally occurring alpha-4 ligand or fragment thereof, *e.g.*, a VCAM-1 peptide or a similar conservatively substituted amino acid sequence.

Chimeric, primatized® and humanized antibodies can be produced from non-human antibodies, and can have the same or similar binding affinity as the antibody from which they are produced. Techniques developed for the production of chimeric antibodies (Morrison *et al.*, 1984 *Proc. Natl. Acad. Sci.* 81: 6851; Neuberger *et al.*, 1984 *Nature* 312: 604; Takeda *et al.*, 1985 *Nature* 314: 452) by

splicing the genes from a mouse antibody molecule of appropriate antigen specificity together with genes from, for example, a human antibody molecule of appropriate biological activity can be used; such antibodies are within the scope of this invention. For example, a nucleic acid encoding a variable (V) region of a mouse monoclonal antibody can be joined to a nucleic acid encoding a human constant (C) region, *e.g.*, IgG1 or IgG4. The resulting antibody is thus a species hybrid, generally with the antigen binding domain from the non-human antibody and the C or effector domain from a human antibody.

Humanized antibodies are antibodies with variable regions that are primarily from a human antibody (the acceptor antibody), but which have complementarity determining regions substantially from a non-human antibody (the donor antibody). *See, e.g.*, Queen *et al.*, 1989 *Proc. Natl Acad. Sci. USA* 86: 10029-33; WO 90/07861; and U.S. Patent Nos. 6,054,297; 5,693,761; 5,585,089; 5,530,101 and 5,224,539. The constant region or regions of these antibodies are generally also from a human antibody. The human variable domains are typically chosen from human antibodies having sequences displaying a high homology with the desired non-human variable region binding domains. The heavy and light chain variable residues can be derived from the same antibody, or a different human antibody. In addition, the sequences can be chosen as a consensus of several human antibodies, such as described in WO 92/22653.

Specific amino acids within the human variable region are selected for substitution based on the predicted conformation and antigen binding properties. This can be determined using techniques such as computer modeling, prediction of the behavior and binding properties of amino acids at certain locations within the variable region, and observation of effects of substitution. For example, when an amino acid differs between a non-human variable region and a human variable region, the human variable region can be altered to reflect the amino acid composition of the non-human variable region. Several examples of humanizing anti- α -4 antibodies are described herein.

By "humanized antibody homolog" is meant an antibody homolog, produced by recombinant DNA technology, in which some or all of the amino acids of a

human immunoglobulin light or heavy chain that are not required for antigen binding have been substituted for the corresponding amino acids from a nonhuman mammalian immunoglobulin light or heavy chain. A "human antibody homolog" is an antibody homolog in which all the amino acids of an immunoglobulin light or heavy chain (regardless of whether or not they are required for antigen binding) are derived from a human source.

In a specific embodiment, the antibodies used in the chronic dosage regime of the present invention are humanized antibodies as disclosed in U.S. Patent No. 5,840,299, which is incorporated herein by reference.

In another embodiment, transgenic mice containing human antibody genes can be immunized with an antigenic alpha-4 structure and hybridoma technology can be used to generate human antibodies that selectively bind to alpha-4.

Chimeric, human and/or humanized antibodies can be produced by recombinant expression, *e.g.*, expression in human hybridomas (Cole *et al.*, *Monoclonal Antibodies and Cancer Therapy*, Alan R. Liss, p. 77 (1985)), in myeloma cells or in Chinese Hamster Ovary (CHO) cells. Alternatively, antibody-coding sequences can be incorporated into vectors suitable for introducing into the genome of animal thereby producing a transgenic animal. One example would be to produce such antibodies in the milk of a transgenic animal such as a bovine. *See e.g.*, U.S. Patent Nos. 5,849,992 and 5,304,489. Suitable transgenes include transgenes having a promoter and/or enhancer from a mammary gland specific gene, for example casein or β -lactoglobulin.

5.1.1. Humanized and Primatized[®] Antibodies

In one embodiment of the invention, humanized (and primatized[®]) immunoglobulins (or antibodies) specific for the alpha-4 subunit of VLA-4 are provided, which when administered in an effective amount inhibit demyelination and/or promote remyelination and/or reduce paralysis. Humanized and primatized[®] antibodies are antibodies of animal (typically mammalian) origin that have been modified using genetic engineering techniques. The techniques are used to replace constant region and/or variable region framework sequences with human sequences,

while retaining the original antigen specificity of the antibody. Humanized and primatized® antibodies are commonly derived from rodent (*e.g.*, mouse and hamster) antibodies with specificity for human antigens (*e.g.*, human VCAM-1 or human VLA-4). By reshaping the donor antibody (the antibody from the animal to which the antigen was administered) to have sequences from the animal to which the antibody will be administered for therapeutic purposes, there will be a reduced host response in the animal upon administration of the antibody. Only the Fc regions or all but the complementarity determining regions (CDRs) can be replaced with acceptor domains, wherein the acceptor is the animal to whom the reshaped antibody is to be administered (*e.g.*, mammals such as humans, domesticated animals, agricultural animals and the like).

Antibodies that bind to the alpha-4 subunit of VLA-4 which when administered to a patient in an effective amount inhibit demyelination are preferred. More preferred are those antibodies which when administered in an effective amount induce remyelination and/or reduce paralysis in a subject wherein the subject is suffering from a demyelinating disease or condition.

Typically, CDRs of a murine antibody are transplanted onto the corresponding regions in a human antibody, since it is the CDRs (*i.e.*, three in antibody heavy chains, three in light chains) that are the regions of the mouse antibody (or any other animal antibody), which bind to a specific antigen. Transplantation of CDRs is achieved by genetic engineering, whereby CDR DNA sequences are determined by cloning of murine heavy and light chain variable (V) region gene segments, and are then transferred to corresponding human V regions by site directed mutagenesis. In the final stage of the process, human constant region gene segments of the desired isotype (usually gamma I for CH and kappa for CL) are added and the humanized heavy and light chain genes are co-expressed in mammalian cells to produce soluble humanized antibody.

The transfer of these CDRs to a human antibody confers on this antibody the antigen binding properties of the original murine antibody. The six CDRs in the murine antibody are mounted structurally on a V region "framework" region. The reason that CDR-grafting is successful is that framework regions between mouse and

human antibodies may have very similar 3-D structures with similar points of attachment for CDRs, such that CDRs can be interchanged. Such humanized antibody homologs may be prepared, as exemplified in, *e.g.*, Jones *et al.*, 1986, *Nature* 321: 522-5; Riechmann *et al.*, 1988, *Nature* 332: 323-7; Queen *et al.*, 1989, *Proc. Nat. Acad. Sci. USA* 86: 10029; and Orlandi *et al.*, 1989, *Proc. Nat. Acad. Sci. USA* 86: 3833.

Nonetheless, certain amino acids within framework regions are thought to interact with CDRs and to influence overall antigen binding affinity. The direct transfer of CDRs from a murine antibody to produce a recombinant humanized antibody without any modifications of the human V region frameworks often results in a partial or complete loss of binding affinity. In several cases, it appears to be critical to alter residues in the framework regions of the acceptor antibody (*e.g.*, human antibody) in order to obtain binding activity.

Queen *et al.*, 1989 (*supra*) and WO 90/07861 (Protein Design Labs) have described the preparation of a humanized antibody that contains modified residues in the framework regions of the acceptor antibody by combining the CDRs of a murine MAb (anti-Tac) with human immunoglobulin framework and constant regions. One solution to solve the problem of the loss of binding affinity without any modifications of the human V region framework residues involves two key steps. First, the human V framework regions are chosen by computer analysts for optimal protein sequence homology to the V region framework of the original murine antibody. In the second step, the tertiary structure of the murine V region is modeled by computer in order to visualize framework amino acid residues that are likely to interact with the murine CDRs. These murine amino acid residues are then superimposed on the homologous human framework. For additional detail, see U.S. Patent Nos. 5,693,762; 5,693,761; 5,585,089; and 5,530,101 (Protein Design Labs).

Certain alpha-4 subunit-containing integrin antagonists useful in the present invention include chimeric and humanized recombinant antibody homologs (*i.e.*, intact immunoglobulins and portions thereof) with B epitope specificity that have been prepared and are described in U.S. Patent No. 5,932,214 (MAb HP1/2). The starting material for the preparation of chimeric (mouse Variable-human Constant)

and humanized anti-integrin antibody homologs may be a murine monoclonal anti-integrin antibody as previously described, a monoclonal anti-integrin antibody commercially available (*e.g.*, HP2/1, Amac International, Inc., Westbrook, Me). Other preferred humanized anti-VLA-4 antibody homologs are described by Athena
5 Neurosciences, Inc. in PCT/US95/01219 (Jul. 27, 1995), U.S. Patent Nos. 5,840,299 and 6,033,665. The content of the 5,932,214, 5,840,299 and 6,033,665 patents are incorporated by reference in their entirety herein.

These humanized anti-VLA-4 antibodies comprise a humanized light chain and a humanized heavy chain. The humanized light chain comprises three
10 complementarity determining regions (CDR1, CDR2 and CDR3) having amino acid sequences from the corresponding complementarity determining regions of a mouse 21.6 immunoglobulin light chain, and a variable region framework from a human kappa light chain variable region framework sequence except in at least position the amino acid position is occupied by the same amino acid present in the equivalent
15 position of the mouse 21.6 immunoglobulin light chain variable region framework. The humanized heavy chain comprises three complementarity determining regions (CDR1, CDR2 and CDR3) having amino acid sequences from the corresponding complementarity determining regions of a mouse 21.6 immunoglobulin heavy chain, and a variable region framework from a human heavy chain variable region
20 framework sequence except in at least one position the amino acid position is occupied by the same amino acid present in the equivalent position of the mouse 21.6 immunoglobulin heavy chain variable region framework. *See*, U.S. Patent Nos. 5,840,299 and 6,033,665

Fragments of an isolated alpha-4 integrin antagonist (*e.g.*, fragments of
25 antibody homologs described herein) can also be produced efficiently by recombinant methods, by proteolytic digestion, or by chemical synthesis using methods known to those of skill in the art. In recombinant methods, internal or terminal fragments of a polypeptide can be generated by removing one or more nucleotides from one end (for a terminal fragment) or both ends (for an internal
30 fragment) of a DNA sequence which encodes for the isolated hedgehog polypeptide. Expression of the mutagenized DNA produces polypeptide fragments. Digestion

with certain endonucleases can also generate DNAs, which encode an array of fragments. DNAs that encode fragments of a protein can also be generated by random shearing, restriction digestion, or a combination thereof. Protein fragments can be generated directly from intact proteins. Peptides can be cleaved specifically
5 by proteolytic enzymes, including, but not limited to plasmin, thrombin, trypsin, chymotrypsin, or pepsin. Each of these enzymes is specific for the type of peptide bond it attacks. Trypsin catalyzes the hydrolysis of peptide bonds in which the carbonyl group is from a basic amino acid, usually arginine or lysine. Pepsin and chymotrypsin catalyze the hydrolysis of peptide bonds from aromatic amino acids,
10 such as tryptophan, tyrosine, and phenylalanine. Alternative sets of cleaved protein fragments are generated by preventing cleavage at a site which is susceptible to a proteolytic enzyme. For instance, reaction of the ϵ -amino acid group of lysine with ethyltrifluorothioacetate in mildly basic solution yields blocked amino acid residues whose adjacent peptide bond is no longer susceptible to hydrolysis by trypsin.
15 Proteins can be modified to create peptide linkages that are susceptible to proteolytic enzymes. For instance, alkylation of cysteine residues with β -haloethylamines yields peptide linkages that are hydrolyzed by trypsin (Lindley, 1956, *Nature* 178: 647). In addition, chemical reagents that cleave peptide chains at specific residues can be used. For example, cyanogen bromide cleaves peptides at methionine residues
20 (Gross *et al.*, 1961, *J. Am. Chem. Soc.* 83: 1510). Thus, by treating proteins with various combinations of modifiers, proteolytic enzymes and/or chemical reagents, the proteins may be divided into fragments of a desired length with no overlap of the fragments, or divided into overlapping fragments of a desired length.

25 5.1.1.1. Natalizumab And Related Humanized Antibodies

The invention provides for a method of using humanized immunoglobulins that specifically bind to a VLA-4 ligand either alone or in combination to promote remyelination. One preferred antibody for use in such methods of treatment and in medicaments includes that described in U.S. Patent No. 5,840,299 assigned to Elan
30 Pharmaceuticals, which is herein incorporated in its entirety. Another aspect

contemplates the use of fragments of these antibodies with remyelinating activity as assessed *in vivo*.

The humanized antibodies comprise a humanized light chain and a humanized heavy chain. In one aspect, the humanized light chain can comprise three complementarity determining regions (*i.e.*, CDR1, CDR2 and CDR3) having amino acid sequences from the corresponding complementarity determining regions of a mouse 21-6 immunoglobulin light chain, and a variable region framework from a human kappa light chain variable region framework sequence except in at least one position selected from a first group consisting of positions L45, L49, L58 and L69, wherein the amino acid position is occupied by the same amino acid present in the equivalent position of the mouse 21.6 immunoglobulin light chain variable region framework.

The humanized heavy chain comprises three complementarity determining regions (*i.e.*, CDR1, CDR2 and CDR3) having amino acid sequences from the corresponding complementarity determining regions of a mouse 21-6 immunoglobulin heavy chain, and a variable region framework from a human heavy chain variable region framework sequence except in at least one position selected from a group consisting of H27, H28, H29, H30, H44, H71, wherein the amino acid position is occupied by the same amino acid present in the equivalent position of the mouse 21-6 immunoglobulin heavy chain variable region framework. The immunoglobulins specifically bind to VLA-4 with an affinity having a lower limit of about 10^7 M^{-1} and an upper limit of about five times the affinity of the mouse 21-6 immunoglobulin.

Usually, the humanized light and heavy chain variable region frameworks are from RE1 and 21/28'CL variable region framework sequences respectively. When the humanized light chain variable region framework is from RE1, at least two framework amino acids are replaced. One amino acid is from the first group of positions described *supra*. The other amino acids are from a third group consisting of positions L104, L105 and L107. This position is occupied by the same amino acid present in the equivalent position of a kappa light chain from a human immunoglobulin other than RE1.

Some humanized immunoglobulins have a mature light chain variable region sequence designated La or Lb, or a mature heavy chain variable region sequence designated Ha, Hb or Hc (FIG. 13). Preferred humanized immunoglobulins include those having a La light chain and an Ha, Hb or Hc heavy chain (FIG. 14).

5 The humanized immunoglobulins have variable framework regions substantially from a human immunoglobulin (termed an acceptor immunoglobulin) and complementarity determining regions substantially from a mouse immunoglobulin termed mu MAb 21.6 (referred to as the donor immunoglobulin). The constant region(s), if present, are also substantially from a human
10 immunoglobulin. The humanized antibodies exhibit a specific binding affinity for VLA-4 of at least 10^7 , 10^8 , 10^9 , or 10^{10} M^{-1} . Usually the upper limit of binding affinity of the humanized antibodies for VLA-4 is within a factor of three or five of that of mu MAb 21.6 (about 10^9 M^{-1}). Often the lower limit of binding affinity is also within a factor of three or five of that of mu MAb 21.6.

15 Humanized antibodies can be produced as exemplified, for example, with the mouse MAb 21.6 monoclonal antibody. The starting material for production of humanized antibodies is mu MAb 21.6. The isolation and properties of this antibody are described in U.S. Patent No. 6,033,655 (assigned to Elan Pharmaceuticals, Inc.), which is herein incorporated by reference in its entirety. Briefly, mu MAb 21.6 is
20 specific for the alpha-4 subunit of VLA-4 and has been shown to inhibit human lymphocyte binding to tissue cultures of rat brain cells stimulated with tumor necrosis factor. From N-terminal to C-terminal, both light and heavy chains comprise the domains FR1, CDR1, FR2, CDR2, FR3, CDR3 and FR4. The assignment of amino acids to each domain is in accordance with the numbering
25 convention of Kabat.

The next step involved selecting human antibodies to supply framework residues. The substitution of mouse CDRs into a human variable domain framework is most likely to result in retention of their correct spatial orientation if the human variable domain framework adopts the same or similar conformation to the mouse
30 variable framework from which the CDRs originated. This is achieved by obtaining the human variable domains from human antibodies whose framework sequences

exhibit a high degree of sequence identity with the murine variable framework domains from which the CDRs were derived. The heavy and light chain variable framework regions can be derived from the same or different human antibody sequences. The human antibody sequences can be the sequences of naturally occurring human antibodies or can be consensus sequences of several human antibodies. See Kettleborough *et al.*, *Protein Engineering* 4: 773 (1991); Kolbinger *et al.*, *Protein Engineering* 6: 971 (1993).

Suitable human antibody sequences are identified by computer comparisons of the amino acid sequences of the mouse variable regions with the sequences of known human antibodies. The comparison is performed separately for heavy and light chains but the principles are similar for each. This comparison reveals that the mu 21.6 light chain shows greatest sequence identity to human light chains of subtype kappa 1; the mu 21.6 heavy chain shows greatest sequence identity to human heavy chains of subtype one, as defined by Kabat, *supra*. Thus, light and heavy human framework regions are usually derived from human antibodies of these subtypes, or from consensus sequences of such subtypes. The preferred light and heavy chain human variable regions showing greatest sequence identity to the corresponding regions from mu MAb 21.6 are from antibodies RE1 and 21/28'CL respectively.

Computer modeling can then be used to further enhance the humanized antibody's ability to bind to its cognate antigen. The unnatural juxtaposition of murine CDR regions with human variable framework region can result in unnatural conformational restraints, which, unless corrected by substitution of certain amino acid residues, lead to loss of binding affinity. The selection of amino acid residues for substitution is determined, in part, by computer modeling. Computer hardware and software for producing three-dimensional images of immunoglobulin molecules are widely available. In general, molecular models are produced starting from solved structures for immunoglobulin chains or domains thereof. The chains to be modeled are compared for amino acid sequence similarity with chains or domains of solved three dimensional structures, and the chains or domains showing the greatest sequence similarity is/are selected as starting points for construction of the molecular

model. For example, for the light chain of mu MAb 21.6, the starting point for modeling the framework regions, CDR1 and CDR2 regions, was the human light chain RE1. For the CDR3 region, the starting point was the CDR3 region from the light chain of a different human antibody HyHEL-5. The solved starting structures are modified to allow for differences between the actual amino acids in the immunoglobulin chains or domains being modeled, and those in the starting structure. The modified structures are then assembled into a composite immunoglobulin. Finally, the model is refined by energy minimization and by verifying that all atoms are within appropriate distances from one another and that bond lengths and angles are within chemically acceptable limits.

As noted *supra*, the humanized antibodies of the invention comprise variable framework regions substantially from a human immunoglobulin and complementarity determining regions substantially from a mouse immunoglobulin termed mu MAb 21.6. Having identified the complementarity determining regions (CDRs) of mu MAb 21.6 and appropriate human acceptor immunoglobulins, the next step is to determine which, if any, residues from these components should be substituted to optimize the properties of the resulting humanized antibody. In general, substitution of human amino acid residues with murine should be minimized, because introduction of murine residues increases the risk of the antibody eliciting a HAMA response in humans. Amino acids are selected for substitution based on their possible influence on CDR conformation and/or binding to antigen. Investigation of such possible influences is by modeling, examination of the characteristics of the amino acids at particular locations, or empirical observation of the effects of substitution or mutagenesis of particular amino acids.

When an amino acid differs between a mu MAb 21.6 variable framework region and an equivalent human variable framework region, the human framework amino acid should usually be substituted by the equivalent mouse amino acid if it is reasonably expected that the amino acid:

(1) non-covalently binds antigen directly (*e.g.*, amino acids at positions L49, L69 of mu MAb 21.6),

(2) is adjacent to a CDR region, is part of a CDR region under the alternative definition proposed by Chothia *et al.*, *supra*, or otherwise interacts with a CDR region (*e.g.*, is within about 3 Å of a CDR region) (*e.g.*, amino acids at positions L45, L58, H27, H28, H29, H30 and H71 of mu MAb 21.6), or

(3) participates in the V_L - V_H interface (*e.g.*, amino acids at position H44 of mu MAb 21.6).

Other candidates for substitution are acceptor human framework amino acids that are unusual for a human immunoglobulin at that position (*e.g.*, amino acids at positions L104, L105 and L107 of mu MAb 21.6). These amino acids can be substituted with amino acids from the equivalent position of more typical human immunoglobulins. Alternatively, amino acids from equivalent positions in the mouse MAb 21.6 can be introduced into the human framework regions when such amino acids are typical of human immunoglobulin at the equivalent positions.

In general, substitution of all or most of the amino acids fulfilling the above criteria is desirable. Occasionally, however, there is some ambiguity about whether a particular amino acid meets the above criteria, and alternative variant immunoglobulins are produced, one of which has that particular substitution, the other of which does not. The humanized antibodies will usually contain a substitution of a human light chain framework residue with a corresponding mu MAb 21.6 residue in at least 1, 2 or 3, and more usually 4, of the following positions: L45, L49, L58 and L69. The humanized antibodies also usually contain a substitution of a human heavy chain framework residue in at least 1, 2, 3, 4, or 5, and sometimes 6, of the following positions: H27, H28, H29, H30, H44 and H71. Optionally, H36 may also be substituted. In preferred embodiments when the human light chain acceptor immunoglobulin is RE1, the light chain also contains substitutions in at least 1 or 2, and more usually 3, of the following positions: L104, L105 and L107. These positions are substituted with the amino acid from the equivalent position of a human immunoglobulin having a more typical amino acid residues. Appropriate amino acids to substitute are shown in FIGS. 13 and 14.

Usually the CDR regions in humanized antibodies are substantially identical, and more usually, identical to the corresponding CDR regions in the mu MAb 21.6 antibody. Occasionally, however, it is desirable to change one of the residues in a CDR region. For example, Example 4 identifies an amino acid similarity between the mu MAb 21.6 CDR3 and the VCAM-1 ligand. This observation suggests that the binding affinity of humanized antibodies might be improved by redesigning the heavy chain CDR3 region to resemble VCAM-1 even more closely. Accordingly, one or more amino acids from the CDR3 domain can be substituted with amino acids from the VCAM-1 binding domain. Although not usually desirable, it is sometimes possible to make one or more conservative amino acid substitutions of CDR residues without appreciably affecting the binding affinity of the resulting humanized immunoglobulin.

Other than for the specific amino acid substitutions discussed above, the framework regions of humanized immunoglobulins are usually substantially identical, and more usually, identical to the framework regions of the human antibodies from which they were derived. Of course, many of the amino acids in the framework region make little or no direct contribution to the specificity or affinity of an antibody. Thus, many individual conservative substitutions of framework residues can be tolerated without appreciable change of the specificity or affinity of the resulting humanized immunoglobulin. However, in general, such substitutions are undesirable.

Production of Variable Regions. Having conceptually selected the CDR and framework components of humanized immunoglobulins, a variety of methods are available for producing such immunoglobulins. Because of the degeneracy of the code, a variety of nucleic acid sequences will encode each immunoglobulin amino acid sequence. The desired nucleic acid sequences can be produced by *de novo* solid-phase DNA synthesis or by PCR mutagenesis of an earlier prepared variant of the desired polynucleotide. Oligonucleotide-mediated mutagenesis is a preferred method for preparing substitution, deletion and insertion variants of target polypeptide DNA. See Adelman *et al.*, *DNA* 2: 183 (1983). Briefly, the target polypeptide DNA is altered by hybridizing an oligonucleotide encoding the desired

mutation to a single-stranded DNA template. After hybridization, a DNA polymerase is used to synthesize an entire second complementary strand of the template that incorporates the oligonucleotide primer, and encodes the selected alteration in the target polypeptide DNA.

5 Selection of Constant Region. The variable segments of humanized antibodies produced as described *supra* are typically linked to at least a portion of an immunoglobulin constant region (Fc), typically that of a human immunoglobulin. Human constant region DNA sequences can be isolated in accordance with well-known procedures from a variety of human cells, but preferably immortalized B-
10 cells (*see Kabat et al., supra, and WO 87/02671*) (each of which is incorporated by reference in its entirety). Ordinarily, the antibody will contain both light chain and heavy chain constant regions. The heavy chain constant region usually includes CH1, hinge, CH2, CH3, and CH4 regions.

 The humanized antibodies include antibodies having all types of constant
15 regions, including IgM, IgG, IgD, IgA and IgE, and any isotype, including IgG1, IgG2, IgG3 and IgG4. When it is desired that the humanized antibody exhibit cytotoxic activity, the constant domain is usually a complement-fixing constant domain and the class is typically IgG₁. When such cytotoxic activity is not desirable, the constant domain may be of the IgG₂ class. The humanized antibody may
20 comprise sequences from more than one class or isotype.

5.1.1.2. Other Anti-VLA-4 Antibodies

 Other anti-VLA-4 antibodies include but are not limited to HP1/2, HP-2/1, HP2/4, L25, and P4C2. These antibodies may also be administered in an effective
25 amount to inhibit demyelination and/or promote remyelination and/or reduce paralysis in a patient as one skilled in the art as discussed herein and as generally known in the art would readily appreciate.

 Frequently, monoclonal antibodies created in mice are later humanized to avoid the human anti-mouse antibody (HAMA) immune response in a human
30 subject injected with a mouse antibody. This occurs by CDR grafting or reshaping. Thus, typically the antibodies are first mouse monoclonal antibodies that through

CDR grafting or reshaping become humanized, as discussed above for the 21.6 antibody.

Specifically, the humanized antibodies have specificity for VLA-4 and have the ability to promote remyelination, prevent demyelination and/or reduce paralysis. These antibodies are derived from sources (*e.g.*, mouse typically) that at least one or more of the complementarity determining regions (CDRs) of the variable domains are derived from a donor non-human anti-VLA-4 antibody, and in which there may or may not have been minimal alteration of the acceptor antibody heavy and/or light variable framework region in order to retain donor antibody binding specificity. Preferably, the antigen binding regions of the CDR-grafted heavy chain variable domain comprise the CDRs corresponding to positions 31-35 (CDR1), 50-65 (CDR2) and 95-102 (CDR3). In a preferred embodiment, the heavy chain further includes non-human residues at framework positions 27-30 (Kabat numbering). The heavy chain can further include non-human residues at framework position 75 (Kabat numbering). The heavy chain can further include non-human residues at framework position(s) 77-79 or 66-67 and 69-71 or 84-85 or 38 and 40 or 24 (Kabat numbering). Preferably, the antigen binding regions of the CDR-grafted light chain variable domain comprise CDRs corresponding to positions 24-34 (CDR1), 50-56 (CDR2) and 89-97 (CDR3). In a preferred embodiment, the light chain further includes non-human residues at framework positions 60 and 67 (Kabat numbering). These residue designations are numbered according to the Kabat numbering (Kabat *et al.*, 5th ed. 4 vol. SEQUENCES OF PROTEINS OF IMMUNOLOGICAL INTEREST, U.S. Department of Health Human Services, NIH, USA (1991)).

Synthesis and Humanization of Mouse Antibody HP1/2. HP1/2 is another antibody that is directed against VLA-4. The method of preparing a humanized version of this antibody for use in human subjects is described herein and is further described in U.S. Patent No. 6,602,503 assigned to Biogen, Inc., and hereby incorporated by reference in its entirety. The sequences of the humanized antibodies are provided as follows. The HP1/2 V_H DNA sequence and its translated amino acid sequence are:

```

5'-gtc aaa ctg cag cag tct ggg gca gag ctt gtg aag cca ggg gcc tca
48
N-Val Lys Leu Gln Gln Ser Gly Ala Glu Leu Val Lys Pro Gly Ala Ser
1 5 10 15
5
gtc aag ttg ttc tgc aca gct tct ggc ttc aac att aaa gac acc tat
96
Val Lys Leu Phe Cys Thr Ala Ser Gly Phe Asn Ile Lys Asp Thr Tyr
20 25 30
10
atg cac tgg gtg aag cag agg cct caa cag ggc ctg gag tgg att gga
144
Met His Trp Val Lys Gln Arg Pro Gln Gln Gly Leu Glu Trp Ile Gly
35 40 45
15
agg att gat cct gcg agt ggc gat act aaa tat gac ccg aag ttc cag
192
Arg Ile Asp Pro Ala Ser Gly Asp Thr Lys Tyr Asp Pro Lys Phe Gln
50 55 60
20
gtc aag gcc act att aca gcg gac acg tcc tcc aac aca gcc tgg ctg
240
Val Lys Ala Thr Ile Thr Ala Asp Thr Ser Ser Asn Thr Ala Trp Leu
65 70 75 80
25
cag ctc agc agc ctg aca tct gag gac act gcc gtc tac tac tgt gca
288
Gln Leu Ser Ser Leu Thr Ser Glu Asp Thr Ala Val Tyr Tyr Cys Ala
85 90 95
30
gac gga atg tgg gta tca acg gga tat gct ctg gac ttc tgg ggc caa
336
Asp Gly Met Trp Val Ser Thr Gly Tyr Ala Leu Asp Phe Trp Gly Gln
100 105 110
35
ggg acc acg gtc acc gtc tcc tca-3'
360
Gly Thr Thr Val Thr Val Ser Ser-C
115 120
40

```

A comparison between HP1/2 V_H the two sequences and a consensus sequence of family IIC revealed that the only unusual residues are at amino acid positions 80, 98 and 121 (*i.e.*, 79, 94 and 121 in Kabat numbering). Although Tyr-80 is invariant in subgroup IIC other sequenced murine V_H regions have other aromatic amino acids at this position, although none have Trp. The majority of human and murine V_H s have an arginine residue at Kabat position 94. The presence of Asp-94 in HP1/2 V_H is extremely rare; there is only one reported example of a negatively charged residue at this position. Proline at Kabat position 113 is also unusual but is unlikely to be important in the conformation of the CDRs because of its distance from them. The amino acids making up CDR1 have been found in three

other sequenced murine V_H regions. However, CDR2 and CDR3 are unique to HP1/2 and are not found in any other reported murine V_H .

The HP1/2 V_K DNA sequence and its translated amino acid sequence are as follows:

```

5      5' -agt att gtg atg acc cag act ccc aaa ttc ctg ctt gtt tca gca gga
48      N-Ser Ile Val Met Thr Gln Thr Pro Lys Phe Leu Leu Val Ser Ala Gly
10      1          5          10          15
      gac agg gtt acc ata acc tgc aag gcc agt cag agt gtg act aat gat
96      Asp Arg Val Thr Ile Thr Cys Lys Ala Ser Gln Ser Val Thr Asn Asp
15      20          25          30
      gta gct tgg tac caa cag aag cca ggg cag tct cct aaa ctg ctg ata
144     Val Ala Trp Tyr Gln Gln Lys Pro Gly Gln Ser Pro Lys Leu Leu Ile
20      35          40          45
      tat tat gca tcc aat cgc tac act gga gtc cct gat cgc ttc act ggc
192     Tyr Tyr Ala Ser Asn Arg Tyr Thr Gly Val Pro Asp Arg Phe Thr Gly
25      50          55          60
      agt gga tat ggg acg gat ttc act ttc acc atc agc act gtg cag gct
240     Ser Gly Tyr Gly Thr Asp Phe Thr Phe Thr Ile Ser Thr Val Gln Ala
30      65          70          75          80
      gaa gac ctg gca gtt tat ttc tgt cag cag gat tat agc tct ccg tac
288     Glu Asp Leu Ala Val Tyr Phe Cys Gln Gln Asp Tyr Ser Ser Pro Tyr
35      85          90          95
      acg ttc gga ggg ggg acc aag ctg gag atc-3'
318     Thr Phe Gly Gly Gly Thr Lys Leu Glu Ile-C
40      100         105

```

HP1/2 V_K is a member of Kabat family V (Kabat *et al.*, 5th ed., 4 vol., SEQUENCES OF PROTEINS OF IMMUNOLOGICAL INTEREST, U.S. Department of Health Human Services (1991)) and has no unusual residues. The amino acids of CDR1 and CDR3 are unique. The amino acids making up CDR2 have been reported in one other murine V_K .

Design of a CDR-grafted Anti-VLA-4 Antibody. To design a CDR-grafted anti-VLA-4 antibody, it was necessary to determine which residues of murine HP1/2 comprise the CDRs of the light and heavy chains. Three regions of hypervariability

amid the less variable framework sequences are found on both light and heavy chains (Wu and Kabat, *J. Exp. Med.* 132: 211-250 (1970); Kabat *et al.*, (1991)). In most cases these hypervariable regions correspond to, but may extend beyond, the CDR. CDRs of murine HP1/2 were elucidated in accordance with Kabat *et al.*,
 5 (1991) by alignment with other V_H and V_K sequences. The CDRs of murine HP1/2 V_H were identified and correspond to the residues identified in the humanized V_H sequences as follows:

10	CDR1	AA ₃₁ -AA ₃₅
	CDR2	AA ₅₀ -AA ₆₆
	CDR3	AA ₉₉ -AA ₁₁₀

These correspond to AA₃₁-AA₃₅, AA₅₀-AA₆₅, and AA₉₅-AA₁₀₂, respectively, in Kabat numbering. The CDRs of murine HP1/2 V_K were identified and correspond to
 15 the residues identified in the humanized V_K sequences as follows:

20	CDR1	AA ₂₄ -AA ₃₄
	CDR2	AA ₅₀ -AA ₅₆
	CDR3	AA ₈₉ -AA ₉₇

These correspond to the same numbered amino acids in Kabat numbering. Thus, only the boundaries of the V_K , but not V_H , CDRs corresponded to the Kabat CDR residues. The human frameworks chosen to accept the HP1/2 (donor) CDRs were NEWM and RE1 for the heavy and light chains, respectively. The NEWM and the
 25 RE1 sequences have been published in Kabat *et al.*, (1991).

The DNA and corresponding amino acid sequence of the humanized heavy chain variable region of the humanized HP1/2 antibody is:

30	5'-atg gac tgg acc tgg agg gtc ttc tgc ttg ctg gct gta gca cca ggt
48	N-Met Asp Trp Thr Trp Arg Val Phe Cys Leu Leu Ala Val Ala Pro Gly
	1 5 10 15
35	gcc cac tcc cag gtc caa ctg cag gag tcc ggt gct gaa gtt gtt aaa
96	Ala His Ser Gln Val Gln Leu Gln Glu Ser Gly Ala Glu Val Val Lys
	20 25 30
40	ccg ggt tcc tcc gtt aaa ctg tcc tgc aaa gct tcc ggt ttc aac atc
144	Pro Gly Ser Ser Val Lys Leu Ser Cys Lys Ala Ser Gly Phe Asn Ile
	35 40 45

192 aaa gac acc tac atg cac tgg gtt aaa cag cgt ccg ggt cag ggt ctg
 Lys Asp Thr Tyr Met His Trp Val Lys Gln Arg Pro Gly Gln Gly Leu
 50 55 60
 5
 240 gaa tgg atc ggt cgt atc gac ccg gct tcc ggt gac acc aaa tac gac
 Glu Trp Ile Gly Arg Ile Asp Pro Ala Ser Gly Asp Thr Lys Tyr Asp
 65 70 75 80
 10
 288 ccg aaa ttc cag gtt aaa gct acc atc acc gct gac gaa tcc acc tcc
 Pro Lys Phe Gln Val Lys Ala Thr Ile Thr Ala Asp Glu Ser Thr Ser
 85 90 95
 15
 336 acc gct tac ctg gaa ctg tcc tcc ctg cgt tcc gaa gac acc gct gtt
 Thr Ala Tyr Leu Glu Leu Ser Ser Leu Arg Ser Glu Asp Thr Ala Val
 100 105 110
 20
 384 tac tac tgc gct gac ggt atg tgg gtt tcc acc ggt tac gct ctg gac
 Tyr Tyr Cys Ala Asp Gly Met Trp Val Ser Thr Gly Tyr Ala Leu Asp
 115 120 125
 25
 ttc tgg ggt cag ggt acc acg gtc acc gtc tcc tca ggt gag tcc-3'
 Phe Trp Gly Gln Gly Thr Thr Val Thr Val Ser Ser Gly Glu Ser-C
 130 135 140 429

30 The DNA and corresponding amino acid sequence of the humanized light chain variable region of the humanized HP1/2 antibody

5'-atg ggt tgg tcc tgc atc atc ctg ttc ctg gtt gct acc gct acc ggt
 48
 35 N-Met Gly Trp Ser Cys Ile Ile Leu Phe Leu Val Ala Thr Ala Thr Gly
 1 5 10 15
 96 gtt cac tcc atc gtt atg acc cag tcc ccg gac tcc ctg gct gtt tcc
 Val His Ser Ile Val Met Thr Gln Ser Pro Asp Ser Leu Ala Val Ser
 20 25 30
 144 ctg ggt gaa cgt gtt acc atc aac tgc aaa gct tcc cag tcc gtt acc
 Leu Gly Glu Arg Val Thr Ile Asn Cys Lys Ala Ser Gln Ser Val Thr
 35 40 45
 192 aac gac gtt gct tgg tac cag cag aaa ccg ggt cag tcc ccg aaa ctg
 Asn Asp Val Ala Trp Tyr Gln Gln Lys Pro Gly Gln Ser Pro Lys Leu
 50 55 60
 240 ctg atc tac tac gct tcc aac cgt tac acc ggt gtt ccg gac cgt ttc
 Leu Ile Tyr Tyr Ala Ser Asn Arg Tyr Thr Gly Val Pro Asp Arg Phe
 55 65 70 75 80
 288 tcc ggt tcc ggt tac ggt acc gac ttc acc ttc acc atc tcc tcc gtt

```

      Ser Gly Ser Gly Tyr Gly Thr Asp Phe Thr Phe Thr Ile Ser Ser Val
                        85                                90                                95
5   336   cag gct gaa gac gtt gct gtt tac tac tgc cag cag gac tac tcc tcc
      Gln Ala Glu Asp Val Ala Val Tyr Tyr Cys Gln Gln Asp Tyr Ser Ser
                        100                                105                                110
      ccg tac acc ttc ggt ggt ggt acc aaa ctg gag atc taa ggatcctc-3'
10  383   Pro Tyr Thr Phe Gly Gly Gly Thr Lys Leu Glu Ile-C
                        115                                120

```

In addition to the above humanized HP1/2 antibody light and heavy chains, other acceptor heavy and light chains regions can also be utilized for insertion of the donor HP1/2 regions. All the following constructs contain Ser-75 (Kabat numbering). The STAW construct further contains Gln to Thr at position 77, Phe to Ala at position 78, and Ser to Trp at position 79 (Kabat numbering). The V_H DNA sequence and its translated amino acid sequence are set forth below:

```

20   5'-atg gac tgg acc tgg agg gtc ttc tgc ttg ctg gct gta gca cca ggt
48   N-Met Asp Trp Thr Trp Arg Val Phe Cys Leu Leu Ala Val Ala Pro Gly
      1          5          10          15
25   gcc cac tcc cag gtc caa ctg cag gag agc ggt cca ggt ctt gtg aga
96   Ala His Ser Gln Val Gln Leu Gln Glu Ser Gly Pro Gly Leu Val Arg
      20          25          30
30   cct agc cag acc ctg agc ctg acc tgc acc gtg tct ggc ttc aac att
144   Pro Ser Gln Thr Leu Ser Leu Thr Cys Thr Val Ser Gly Phe Asn Ile
      35          40          45
35   aaa gac acc tat atg cac tgg gtg aga cag cca cct gga cga ggt ctt
192   Lys Asp Thr Tyr Met His Trp Val Arg Gln Pro Pro Gly Arg Gly Leu
      50          55          60
40   gag tgg att gga agg att gat cct gcg agt ggc gat act aaa tat gac
240   Glu Trp Ile Gly Arg Ile Asp Pro Ala Ser Gly Asp Thr Lys Tyr Asp
      65          70          75          80
45   ccg aag ttc cag gtc aga gtg aca atg ctg gta gac acc agc agc aac
288   Pro Lys Phe Gln Val Arg Val Thr Met Leu Val Asp Thr Ser Ser Asn
      85          90          95
50   aca gcc tgg ctg aga ctc agc agc gtg aca gcc gcc gac acc gcg gtc
336   Thr Ala Trp Leu Arg Leu Ser Ser Val Thr Ala Ala Asp Thr Ala Val
      100          105          110

```

```

384   tat tat tgt gca gac gga atg tgg gta tca acg gga tat gct ctg gac
      Tyr Tyr Cys Ala Asp Gly Met Trp Val Ser Thr Gly Tyr Ala Leu Asp
          115                    120                    125
5
429   ttc tgg ggc caa ggg acc acg gtc acc gtc tcc tca ggt gag tcc-3'
      Phe Trp Gly Gln Gly Thr Thr Val Thr Val Ser Ser Gly Glu Ser-C
          130                    135                    140
10

```

The KAITAS construct contains the additional changes of Arg to Lys (position 66), Val to Ala (position 67), Met to Ile (position 69), Leu to Thr (position 70) and Val to Ala (position 71) (Kabat numbering). The KAITAS V_H DNA sequence and its translated amino acid sequence are set forth below:

```

15   5'-atg gac tgg acc tgg agg gtc ttc tgc ttg ctg gct gta gca cca ggt
48   N-Met Asp Trp Thr Trp Arg Val Phe Cys Leu Leu Ala Val Ala Pro Gly
      1          5          10          15
20   gcc cac tcc cag gtc caa ctg cag gag agc ggt cca ggt ctt gtg aga
96   Ala His Ser Gln Val Gln Leu Gln Glu Ser Gly Pro Gly Leu Val Arg
      20          25          30
25   cct agc cag acc ctg agc ctg acc tgc acc gtg tct ggc ttc aac att
144  Pro Ser Gln Thr Leu Ser Leu Thr Cys Thr Val Ser Gly Phe Asn Ile
      35          40          45
30   aaa gac acc tat atg cac tgg gtg aga cag cca cct gga cga ggt ctt
192  Lys Asp Thr Tyr Met His Trp Val Arg Gln Pro Pro Gly Arg Gly Leu
      50          55          60
35   gag tgg att gga agg att gat cct gcg agt ggc gat act aaa tat gac
240  Glu Trp Ile Gly Arg Ile Asp Pro Ala Ser Gly Asp Thr Lys Tyr Asp
      65          70          75          80
40   ccg aag ttc cag gtc aaa gcg aca att acg gca gac acc agc agc aac
288  Pro Lys Phe Gln Val Lys Ala Thr Ile Thr Ala Asp Thr Ser Ser Asn
      85          90          95
45   cag ttc agc ctg aga ctc agc agc gtg aca gcc gcc gac acc gcg gtc
336  Gln Phe Ser Leu Arg Leu Ser Ser Val Thr Ala Ala Asp Thr Ala Val
      100         105         110
50   tat tat tgt gca gac gga atg tgg gta tca acg gga tat gct ctg gac
384  Tyr Tyr Cys Ala Asp Gly Met Trp Val Ser Thr Gly Tyr Ala Leu Asp
      115                    120                    125
55   ttc tgg ggc caa ggg acc acg gtc acc gtc tcc tca ggt gag tcc-3'
429

```

Phe Trp Gly Gln Gly Thr Thr Val Thr Val Ser Ser Gly Glu Ser-C
 130 135 140

The SSE construct comprises the additional changes of Ala to Ser (position
 5 84) and Ala to Glu (position 85) (Kabat numbering). The SSE V_H DNA sequence
 and its translated amino acid sequence are set forth below:

5'-cag gtc caa ctg cag gag agc ggt cca ggt ctt gtg aga cct agc cag
 48
 10 N-Gln Val Gln Leu Gln Glu Ser Gly Pro Gly Leu Val Arg Pro Ser Gln
 1 5 10 15
 acc ctg agc ctg acc tgc acc gtg tct ggc ttc aac att aaa gac acc
 96
 15 Thr Leu Ser Leu Thr Cys Thr Val Ser Gly Phe Asn Ile Lys Asp Thr
 20 20 25 30
 tat atg cac tgg gtg aga cag cca cct gga cga ggt ctt gag tgg att
 144
 20 Tyr Met His Trp Val Arg Gln Pro Pro Gly Arg Gly Leu Glu Trp Ile
 35 40 45
 gga agg att gat cct gcg agt ggc gat act aaa tat gac ccg aag ttc
 192
 25 Gly Arg Ile Asp Pro Ala Ser Gly Asp Thr Lys Tyr Asp Pro Lys Phe
 50 55 60
 cag gtc aga gtg aca atg ctg gta gac acc agc agc aac cag ttc agc
 240
 30 Gln Val Arg Val Thr Met Leu Val Asp Thr Ser Ser Asn Gln Phe Ser
 65 70 75 80
 ctg aga ctc agc agc gtg aca tct gag gac acc gcg gtc tat tat tgt
 288
 35 Leu Arg Leu Ser Ser Val Thr **Ser Glu** Asp Thr Ala Val Tyr Tyr Cys
 85 90 95
 gca gac gga atg tgg gta tca acg gga tat gct ctg gac ttc tgg ggc
 336
 40 Ala Asp Gly Met Trp Val Ser Thr Gly Tyr Ala Leu Asp Phe Trp Gly
 100 105 110
 caa ggg acc acg gtc acc gtc tcc tca ggt gag tcc-3'
 372
 45 Gln Gly Thr Thr Val Thr Val Ser Ser Gly Glu Ser-C
 115 120

The KRS construct comprises the additional changes of Arg to Lys (position
 38) and Pro to Arg (position 40) (Kabat numbering). The KRS V_H DNA sequence
 50 and its translated amino acid sequence are set forth below:

5'-atg gac tgg acc tgg agg gtc ttc tgc ttg ctg gct gta gca cca ggt
 48
 55 N-Met Asp Trp Thr Trp Arg Val Phe Cys Leu Leu Ala Val Ala Pro Gly
 1 5 10 15

96 gcc cac tcc cag gtc caa ctg cag gag agc ggt cca ggt ctt gtg aga
 5 96 Ala His Ser Gln Val Gln Leu Gln Glu Ser Gly Pro Gly Leu Val Arg
 20 25 30
 144 cct agc cag acc ctg agc ctg acc tgc acc gtg tct ggc ttc aac att
 10 144 Pro Ser Gln Thr Leu Ser Leu Thr Cys Thr Val Ser Gly Phe Asn Ile
 35 40 45
 192 aaa gac acc tat atg cac tgg gtg aaa cag cga cct gga cga ggt ctt
 15 192 Lys Asp Thr Tyr Met His Trp Val Lys Gln Arg Pro Gly Arg Gly Leu
 50 55 60
 240 gag tgg att gga agg att gat cct gcg agt ggc gat act aaa tat gac
 20 240 Glu Trp Ile Gly Arg Ile Asp Pro Ala Ser Gly Asp Thr Lys Tyr Asp
 65 70 75 80
 288 ccg aag ttc cag gtc aga gtg aca atg ctg gta gac acc agc agc aac
 25 288 Pro Lys Phe Gln Val Arg Val Thr Met Leu Val Asp Thr Ser Ser Asn
 85 90 95
 336 cag ttc agc ctg aga ctc agc agc gtg aca gcc gcc gac acc gcg gtc
 30 336 Gln Phe Ser Leu Arg Leu Ser Ser Val Thr Ala Ala Asp Thr Ala Val
 100 105 110
 384 tat tat tgt gca gac gga atg tgg gta tca acg gga tat gct ctg gac
 35 384 Tyr Tyr Cys Ala Asp Gly Met Trp Val Ser Thr Gly Tyr Ala Leu Asp
 115 120 125
 429 ttc tgg ggc caa ggg acc acg gtc acc gtc tcc tca ggt gag tcc-3'
 40 429 Phe Trp Gly Gln Gly Thr Thr Val Thr Val Ser Ser Gly Glu Ser-C
 130 135 140

The AS construct comprises the change Val to Ala at position 24 (Kabat numbering). The AS V_H DNA sequence and its translated amino acid sequence are:

45 5'-atg gac tgg acc tgg agg gtc ttc tgc ttg ctg gct gta gca cca ggt
 48 N-Met Asp Trp Thr Trp Arg Val Phe Cys Leu Leu Ala Val Ala Pro Gly
 1 5 10 15
 50 gcc cac tcc cag gtc caa ctg cag gag agc ggt cca ggt ctt gtg aga
 96 Ala His Ser Gln Val Gln Leu Gln Glu Ser Gly Pro Gly Leu Val Arg
 20 25 30
 55 cct agc cag acc ctg agc ctg acc tgc acc gcg tct ggc ttc aac att
 144 Pro Ser Gln Thr Leu Ser Leu Thr Cys Thr Ala Ser Gly Phe Asn Ile
 35 40 45

```

192   aaa gac acc tat atg cac tgg gtg aga cag cca cct gga cga ggt ctt
5     Lys Asp Thr Tyr Met His Trp Val Arg Gln Pro Pro Gly Arg Gly Leu
      50                    55                    60
240   gag tgg att gga agg att gat cct gcg agt ggc gat act aaa tat gac
10    Glu Trp Ile Gly Arg Ile Asp Pro Ala Ser Gly Asp Thr Lys Tyr Asp
      65                    70                    75                    80
288   ccg aag ttc cag gtc aga gtg aca atg ctg gta gac acc agc agc aac
15    Pro Lys Phe Gln Val Arg Val Thr Met Leu Val Asp Thr Ser Ser Asn
      85                    90                    95
336   cag ttc agc ctg aga ctc agc agc gtg aca gcc gcc gac acc gcg gtc
20    Gln Phe Ser Leu Arg Leu Ser Ser Val Thr Ala Ala Asp Thr Ala Val
      100                   105                   110
384   tat tat tgt gca gac gga atg tgg gta tca acg gga tat gct ctg gac
25    Tyr Tyr Cys Ala Asp Gly Met Trp Val Ser Thr Gly Tyr Ala Leu Asp
      115                   120                   125
429   ttc tgg ggc caa ggg acc acg gtc acc gtc tcc tca ggt gag tcc-3'
30    Phe Trp Gly Gln Gly Thr Thr Val Thr Val Ser Ser Gly Glu Ser-C
      130                   135                   140

```

The humanized light chain generally requires few, if any, modifications.

However, in the preparation of humanized anti-VLA-4 antibodies, several empirical changes did improve the immunological activity of the antibody towards its ligand. For example, the humanized heavy chain with the Ser mutation with the murine light chain was about 2.5 fold lower potency than murine HP1/2. The same humanized heavy chain with a humanized light chain was about 4-fold lower potency.

A humanized V_K construct (VK1) comprises a Ser to Asp substitution at position 60, and a Ser for a Tyr at position 67. The DNA sequence and its translated amino acid sequence are set forth below:

```

40   5'-atg ggt tgg tcc tgc atc atc ctg ttc ctg gtt gct acc gct acc ggt
48   N-Met Gly Trp Ser Cys Ile Ile Leu Phe Leu Val Ala Thr Ala Thr Gly
      1                    5                    10                    15
45   gtt cac tcc gac atc cag ctg acc cag agc cca agc agc ctg agc gcc
96   Val His Ser Asp Ile Gln Leu Thr Gln Ser Pro Ser Ser Leu Ser Ala
      20                    25                    30
50   agc gtg ggt gac aga gtg acc atc acc tgt aag gcc agt cag agt gtg
144

```

```

Ser Val Gly Asp Arg Val Thr Ile Thr Cys Lys Ala Ser Gln Ser Val
      35          40          45
5  192 act aat gat gta gct tgg tac cag cag aag cca ggt aag gct cca aag
Thr Asn Asp Val Ala Trp Tyr Gln Gln Lys Pro Gly Lys Ala Pro Lys
      50          55          60
10 240 ctg ctg atc tac tat gca tcc aat cgc tac act ggt gtg cca agc aga
Leu Leu Ile Tyr Tyr Ala Ser Asn Arg Tyr Thr Gly Val Pro Ser Arg
      65          70          75
15 288 ttc agc ggt agc ggt agc ggt acc gac ttc acc ttc acc atc agc agc
Phe Ser Gly Ser Gly Ser Gly Thr Asp Phe Thr Phe Thr Ile Ser Ser
      85          90          95
20 336 ctc cag cca gag gac atc gcc acc tac tac tgc cag cag gat tat agc
Leu Gln Pro Glu Asp Ile Ala Thr Tyr Tyr Cys Gln Gln Asp Tyr Ser
      100          105          110
25 tg-3' 386 tct ccg tac acg ttc ggc caa ggg acc aag gtg gaa atc aaa cgt aag
C Ser Pro Tyr Thr Phe Gly Gln Gly Thr Lys Val Glu Ile Lys Arg Lys-
      115          120          125

```

30 Another V_K construct (*i.e.*, VK2) has the DQMDY sequences of the original RE1 framework restored. The DNA and corresponding amino acid sequence are provided below:

```

5'-atg ggt tgg tcc tgc atc atc ctg ttc ctg gtt gct acc gct acc ggt
35 48 N-Met Gly Trp Ser Cys Ile Ile Leu Phe Leu Val Ala Thr Ala Thr Gly
      1          5          10          15
40 96 gtc cac tcc agc atc gtg atg acc cag agc cca agc agc ctg agc gcc
Val His Ser Ser Ile Val Met Thr Gln Ser Pro Ser Ser Leu Ser Ala
      20          25          30
45 144 agc gtg ggt gac aga gtg acc atc acc tgt aag gcc agt cag agt gtg
Ser Val Gly Asp Arg Val Thr Ile Thr Cys Lys Ala Ser Gln Ser Val
      35          40          45
50 192 act aat gat gta gct tgg tac cag cag aag cca ggt aag gct cca aag
Thr Asn Asp Val Ala Trp Tyr Gln Gln Lys Pro Gly Lys Ala Pro Lys
      50          55          60
55 240 ctg ctg atc tac tat gca tcc aat cgc tac act ggt gtg cca gat aga
Leu Leu Ile Tyr Tyr Ala Ser Asn Arg Tyr Thr Gly Val Pro Asp Arg
      65          70          75          80

```

288 ttc agc ggt agc ggt tat ggt acc gac ttc acc ttc acc atc agc agc
 Phe Ser Gly Ser Gly Tyr Gly Thr Asp Phe Thr Phe Thr Ile Ser Ser
 85 90 95
 5
 336 ctc cag cca gag gac atc gcc acc tac tac tgc cag cag gat tat agc
 Leu Gln Pro Glu Asp Ile Ala Thr Tyr Tyr Cys Gln Gln Asp Tyr Ser
 100 105 110
 10
 tg-3' 386 tct ccg tac acg ttc ggc caa ggg acc aag gtg gaa atc aaa cgt aag
 Ser Pro Tyr Thr Phe Gly Gln Gly Thr Lys Val Glu Ile Lys Arg Lys-
 C
 15 115 120 125

A third V_K construct is VK3 has SVM versus DQM in the amino terminus and two other residue changes. The DNA and corresponding amino acid sequence are:

20 5' -atg ggt tgg tcc tgc atc atc ctg ttc ctg gtt gct acc gct acc ggt
 48 N-Met Gly Trp Ser Cys Ile Ile Leu Phe Leu Val Ala Thr Ala Thr Gly
 1 5 10 15
 25 gtc cac tcc gac atc cag atg acc cag agc cca agc agc ctg agc gcc
 96 Val His Ser Asp Ile Gln Met Thr Gln Ser Pro Ser Ser Leu Ser Ala
 20 25 30
 30 agc gtg ggt gac aga gtg acc atc acc tgt aag gcc agt cag agt gtg
 144 Ser Val Gly Asp Arg Val Thr Ile Thr Cys Lys Ala Ser Gln Ser Val
 35 35 40 45
 35 act aat gat gta gct tgg tac cag cag aag cca ggt aag gct cca aag
 192 Thr Asn Asp Val Ala Trp Tyr Gln Gln Lys Pro Gly Lys Ala Pro Lys
 50 55 60
 40 ctg ctg atc tac tat gca tcc aat cgc tac act ggt gtg cca gat aga
 240 Leu Leu Ile Tyr Tyr Ala Ser Asn Arg Tyr Thr Gly Val Pro Asp Arg
 65 70 75 80
 45 ttc agc ggt agc ggt tat ggt acc gac ttc acc ttc acc atc agc agc
 288 Phe Ser Gly Ser Gly Tyr Gly Thr Asp Phe Thr Phe Thr Ile Ser Ser
 85 90 95
 50 ctc cag cca gag gac atc gcc acc tac tac tgc cag cag gat tat agc
 336 Leu Gln Pro Glu Asp Ile Ala Thr Tyr Tyr Cys Gln Gln Asp Tyr Ser
 100 105 110
 55 tct ccg tac acg ttc ggc caa ggg acc aag gtg gaa atc aaa cgt aag
 tg-3' 386 Ser Pro Tyr Thr Phe Gly Gln Gly Thr Lys Val Glu Ile Lys Arg Lys-
 C

115

120

125

5 Details regarding how each of these light and heavy chain sequences were prepared are provided in U.S. Patent No. 6,602,503, which is hereby incorporated by reference in its entirety for all purposes. Various combinations of the above light and heavy chains can be prepared based on computer modeling as known in the art.

10 Additional antibodies that recognize and bind to alpha-4 integrin are known in the art. These include but are not limited to GG5/3 (Keszthelyi *et al.*, *Neurology* 47(4): 1053-1059 (1996)), FW3-218-1 (ATCC No.: HB-261; an IgG2b antibody against sheep alpha 4 integrin), and R1-2 (ATCC No.: HB-227; IgG2b antibody developed in *Rattus norvegicus*). Whether the antibodies are developed in mouse or other animals, each of the sequences can be genetically engineered such that they are humanized based on what is known in the art and with the aid of computer modeling. The anti-alpha-4 integrin humanized antibodies can then be assessed for their ability to promote remyelination and/or inhibit demyelination and/or reduce paralysis based on the *in vitro* and *in vivo* assays disclosed herein.

5.2. Antibody Fragments

20 Also contemplated for use in treating disorders and conditions involving demyelination are antibody fragments of antibodies that bind to anti-alpha-4 or VCAM-1 such that they inhibit VLA-4 and VCAM-1 interaction. Antibody fragments include Fab, F(ab')₂, scFv and Fv fragments which can be used in the compositions disclosed herein.

25 The term "Fab fragment" as used herein refers to a partial antibody molecule containing a single antigen-binding region, which consists of a portion of both the heavy and light chains of the molecule.

The term "F(ab')₂ fragment" as used herein refers to a partial antibody molecule containing both antigen binding regions, and which consists of the light chains and a portion of the heavy chains of the molecule.

30 The term "Fv fragment" as used herein refers to the portion of the antibody molecule involved in antigen recognition and binding.

The term "scFv" as used herein refers to single chain Fv (scFv) fragments. These scFv fragments are recombinant antibody derivatives that consist only of the variable domains of antibody heavy and light chains connected by a flexible linker. scFv antibody fragments comprise the V_H and V_L domains of antibody, wherein these domains are present in a single polypeptide chain. Generally, the Fv polypeptide further comprises a polypeptide linker between the V_H and V_L domains which enables the scFv to form the desired structure for antigen binding. For a review of scFv see Pluckthun in *The Pharmacology of Monoclonal Antibodies*, vol. 113, 269-315 (Rosenburg and Moore eds., Springer-Verlag, New York 1994).

Also included in antibody fragments are diabodies. The term "diabodies" refers to small antibody fragments with two antigen-binding sites, which fragments comprise a heavy chain variable domain (V_H) connected to a light chain variable domain (V_L) in the same polypeptide chain (V_H - V_L). By using a linker that is too short to allow pairing between the two domains on the same chain, the domains are forced to pair with the complementary domains of another chain and create two antigen-binding sites. Diabodies are described more fully in, for example, EP 404,097; WO 93/11161; and Hollinger *et al.*, 1993 *Proc. Natl. Acad. Sci. USA* 90: 6444-8.

Antibody fragments also include linear antibodies. The expression "linear antibodies" when used throughout this application refers to the antibodies described in, *e.g.*, Zapata *et al.*, 1995 *Protein Eng.* 8(10): 1057-62. Briefly, these antibodies comprise a pair of tandem Fd segments (V_H - C_{H1} - V_H - C_{H1}), which form a pair of antigen binding regions. Linear antibodies can be bispecific or monospecific.

Papain digestion of antibodies produces two identical antigen binding fragments, called "Fab" fragments, each with a single antigen binding site, and a residual "Fc" fragment, whose name reflects its ability to crystallize readily. Pepsin treatment yields an $F(ab')_2$ fragment that has two antigen combining sites and is still capable of cross-linking antigen.

Several mouse anti-VLA-4 monoclonal antibodies have been previously described. *See, e.g.*, U.S. Patent Nos. 6,602,503, 6,033,665, and 5,840,299, as further discussed herein and which are herein incorporated by reference in their entirety;

Sanchez-Madrid *et al.*, 1986, *Eur. J. Immunol.* 16: 1343-9; Hemler *et al.*, 1987, *J. Biol. Chem.* 262: 11478-85; Pulido *et al.*, 1991, *J. Biol. Chem.*, 266: 10241-45; Issekutz *et al.*, 1991, *J. Immunol.*, 147: 109 (TA-2 MAb)). These anti-VLA-4 monoclonal antibodies and other anti-VLA-4 antibodies (*e.g.*, U.S. Patent No. 5,888,507- Biogen, Inc. and references cited therein) capable of recognizing the alpha and/or beta chain of VLA-4 will be useful in the methods of treatment according to the present invention. AntiVLA-4 antibodies that will recognize the VLA-4 alpha-4 chain epitopes involved in binding to VCAM-1 and fibronectin ligands (*i.e.*, antibodies which can bind to VLA-4 at a site involved in ligand recognition and block VCAM-1 and fibronectin binding) are preferred. Such antibodies have been defined as B epitope-specific antibodies (B1 or B2) (Pulido *et al.*, 1991, *supra*) and are also anti-VLA-4 antibodies according to the present invention.

Fully human monoclonal antibody homologs against VLA-4 are another preferred binding agent that may block or coat VLA-4 ligands in the method of the invention. In their intact form these may be prepared using *in vitro*-primed human splenocytes, as described by Boerner *et al.*, 1991, *J. Immunol.*, 147: 86-95. Alternatively, they may be prepared by repertoire cloning as described by Persson *et al.*, 1991, *Proc. Nat. Acad. Sci. USA*, 88: 2432-36 or by Huang *et al.*, 1991, *J. Immunol. Meth.*, 141: 227-236. U.S. Patent No. 5,798,230 (Aug. 25, 1998, "Process for the preparation of human monoclonal antibodies and their use") describes preparation of human monoclonal antibodies from human B cells. According to this process, human antibody-producing B cells are immortalized by infection with an Epstein-Barr virus, or a derivative thereof, that expresses Epstein-Barr virus nuclear antigen 2 (EBNA2). EBNA2 function, which is required for immortalization, is subsequently shut off, which results in an increase in antibody production. Additional methods are known in the art.

For yet another method for producing fully human antibodies, *see, e.g.*, U.S. Patent No. 5,789,650, which describes transgenic non-human animals capable of producing heterologous antibodies and transgenic non-human animals having inactivated endogenous immunoglobulin genes. Endogenous immunoglobulin genes

are suppressed by antisense polynucleotides and/or by antiserum directed against endogenous immunoglobulins. Heterologous antibodies are encoded by immunoglobulin genes not normally found in the genome of that species of non-human animal. One or more transgenes containing sequences of unrearranged heterologous human immunoglobulin heavy chains are introduced into a non-human animal thereby forming a transgenic animal capable of functionally rearranging transgenic immunoglobulin sequences and producing a repertoire of antibodies of various isotypes encoded by human immunoglobulin genes. Such heterologous human antibodies are produced in B-cells, which are thereafter immortalized, *e.g.*, by fusing with an immortalizing cell line such as a myeloma or by manipulating such B-cells by other techniques to perpetuate a cell line capable of producing a monoclonal, heterologous, fully human antibody homolog. Large non-immunized human phage display libraries may also be used to isolate high affinity antibodies that can be developed as human therapeutics using standard phage technology.

Following the early methods for the preparation of true "chimeric antibodies" (*i.e.*, where the entire constant and entire variable regions are derived from different sources), a new approach was described in EP 0239400 (Winter *et al.*) whereby antibodies are altered by substitution (within a given variable region) of their complementarity determining regions (CDRs) for one species with those from another. This process may be used, for example, to substitute the CDRs from human heavy and light chain Ig variable region domains with alternative CDRs from murine variable region domains. These altered Ig variable regions may subsequently be combined with human Ig constant regions to create antibodies, which are totally human in composition except for the substituted murine CDRs. Such CDR-substituted antibodies would be predicted to be less likely to elicit an immune response in humans compared to true chimeric antibodies, because the CDR-substituted antibodies contain considerably less non-human components. The process for humanizing monoclonal antibodies via CDR "grafting" has been termed "reshaping" (Riechmann *et al.*, 1988, *Nature* 332: 323-7; and Verhoeyen *et al.*, 1988, *Science* 239: 1534-6).

5.3. Antibody Purification

When using recombinant techniques, the antibody can be produced intracellularly, in the periplasmic space, or directly secreted into the medium. If the antibody is produced intracellularly, as a first step, the particulate debris, either host cells or lysed fragments, is removed, for example, by centrifugation or ultrafiltration. Carter *et al.*, *Bio/Technology* 10: 163-7 (1992) describe a procedure for isolating antibodies, which are secreted to the periplasmic space of *E. coli*. Briefly, cell paste is thawed in the presence of sodium acetate (pH 3.5), EDTA, and phenylmethylsulfonylfluoride (PMSF) over about 30 min. Cell debris can be removed by centrifugation. In instances when the antibody is secreted into the medium, supernatants from such expression systems are generally first concentrated using a commercially available protein concentration filter, for example, an Amicon or Millipore Pellicon ultrafiltration unit. A protease inhibitor such as PMSF may be included in any of the foregoing steps to inhibit proteolysis and antibiotics may be included to prevent the growth of adventitious contaminants.

The antibody composition prepared from the cells is preferably subjected to at least one purification step prior to LPHIC. Examples of suitable purification steps include hydroxylapatite chromatography, gel electrophoresis, dialysis, and affinity chromatography, with affinity chromatography being the preferred purification technique. The suitability of protein A as an affinity ligand depends on the species and isotype of any immunoglobulin Fc domain that is present in the antibody. Protein A can be used to purify antibodies that are based on human $\gamma 1$, $\gamma 2$, or $\gamma 4$ heavy chains (Lindmark *et al.*, 1983 *J. Immunol. Meth.* 62: 1-13). Protein G is recommended for all mouse isotypes and for human $\gamma 3$ (Guss *et al.*, 1986 *EMBO J.* 5: 1567-75). The matrix to which the affinity ligand is attached is most often agarose, but other matrices are available. Mechanically stable matrices such as controlled pore glass or poly(styrenedivinyl)benzene allow for faster flow rates and shorter processing times than can be achieved with agarose. Where the antibody comprises a C_H3 domain, the Bakerbond ABX™ resin (J. T. Baker, Phillipsburg, N.J.) is useful for purification. Other techniques for protein purification such as fractionation on an ion-exchange column, ethanol precipitation, Reverse Phase

HPLC, chromatography on silica, chromatography on heparin SEPHAROSE™, chromatography on an anion or cation exchange resin (such as a polyaspartic acid column), chromatofocusing, SDS-PAGE, and ammonium sulfate precipitation are also available depending on the antibody to be recovered.

5 Following any preliminary purification step(s), the mixture comprising the antibody of interest and contaminant(s) is subjected to LPHIC. Often, the antibody composition to be purified will be present in a buffer from the previous purification step. However, it may be necessary to add a buffer to the antibody composition prior to the LPHIC step. Many buffers are available and can be selected by routine
10 experimentation. The pH of the mixture comprising the antibody to be purified and at least one contaminant in a loading buffer is adjusted to a pH of about 2.5-4.5 using either an acid or base, depending on the starting pH. Preferably, the loading buffer has a low salt concentration (*i.e.*, less than about 0.25 M salt).

 The mixture is loaded on the HIC column. HIC columns normally comprise
15 a base matrix (*e.g.*, cross-linked agarose or synthetic copolymer material) to which hydrophobic ligands (*e.g.*, alkyl or aryl groups) are coupled. A preferred HIC column comprises an agarose resin substituted with phenyl groups (*e.g.*, a Phenyl SEPHAROSE™ column). Many HIC columns are available commercially. Examples include, but are not limited to, Phenyl SEPHAROSE 6 FAST FLOW™
20 column with low or high substitution (Pharmacia LKB Biotechnology, AB, Sweden); Phenyl SEPHAROSE™ High Performance column (Pharmacia LKB Biotechnology, AB, Sweden); Octyl SEPHAROSE™ High Performance column (Pharmacia LKB Biotechnology, AB, Sweden); FRACTOGEL™ EMD Propyl or FRACTOGEL™ EMD Phenyl columns (E. Merck, Germany); MACRO-PREP™
25 Methyl or MACRO-PREP™ t-Butyl Supports (Bio-Rad, California); WP HI-Propyl (C₃)™ column (J. T. Baker, New Jersey); and TOYOPEARL™ ether, phenyl or butyl columns (TosoHaas, PA).

 The antibody is eluted from the column using an elution buffer, which is normally the same as the loading buffer. The elution buffer can be selected using
30 routine experimentation. The pH of the elution buffer is between about 2.5-4.5 and has a low salt concentration (*i.e.*, less than about 0.25 M salt). It has been

discovered that it is not necessary to use a salt gradient to elute the antibody of interest; the desired product is recovered in the flow through fraction, which does not bind significantly to the column.

The LPHIC step provides a way to remove a correctly folded and disulfide bonded antibody from unwanted contaminants (*e.g.*, incorrectly associated light and heavy fragments). In particular, the method provides a means to substantially remove an impurity characterized herein as a correctly folded antibody fragment whose light and heavy chains fail to associate through disulfide bonding.

Diagnostic or therapeutic formulations of the purified protein can be made by providing the antibody composition in the form of a physiologically acceptable carrier, examples of which are provided below.

To remove contaminants (*e.g.*, unfolded antibody and incorrectly associated light and heavy fragments) from the HIC column so that it can be re-used, a composition including urea (*e.g.*, 6.0 M urea, 1% MES buffer pH 6.0, 4 mM ammonium sulfate) can be flowed through the column. Other methods are known in the art.

5.4. Immunoglobulin Formulations

Antibodies and immunoglobulins having the desired therapeutic effect may be administered in a physiologically acceptable carrier to a subject. The antibodies may be administered in a variety of ways including but not limited to parenteral administration, including subcutaneous, subdural, intravenous, intramuscular, intrathecal, intraperitoneal, intracerebral, intraarterial, or intralesional routes of administration, localized (*e.g.*, surgical application or surgical suppository), and pulmonary (*e.g.*, aerosols, inhalation, or powder) and as described further below.

Depending upon the manner of introduction, the immunoglobulins may be formulated in a variety of ways. The concentration of therapeutically active immunoglobulin in the formulation (*i.e.*, a formulation sufficient to inhibit demyelination and/or promote remyelination) may vary from about 1 mg/ml to 1 g/ml. Preferably, the immunoglobulin composition, when administered to a subject

in need thereof, reaches a blood level of immunoglobulin in the subject of about 10 ng/ml or more.

Preferably, the immunoglobulin is formulated for parenteral administration in a suitable inert carrier, such as a sterile physiological saline solution. For example, the concentration of immunoglobulin in the carrier solution is typically between about 1-100 mg/ml. The dose administered will be determined by route of administration. Preferred routes of administration include parenteral or intravenous administration.

For parenteral administration, the antibodies of the invention can be administered as injectionable dosages of a solution or suspension of the substance in a physiologically acceptable diluent with a pharmaceutical carrier which can be a sterile liquid such as water and oils with or without the addition of a surfactant and other pharmaceutically preparations are those of petroleum, animal, vegetable, or synthetic origin, for example, peanut oil, soybean oil, and mineral oil. In general, glycols such as propylene glycol or polyethylene glycol are preferred liquid carriers, particularly for injectable solutions. The antibodies of this invention can be administered in the form of a depot injection or implant preparation, which can be formulated in such a manner as to permit a sustained release of the active ingredient. A preferred composition comprises monoclonal antibody at 5 mg/mL, formulated in aqueous buffer consisting of 50 mM L-histidine, 150 mM NaCl, adjusted to pH 6.0 with HCl.

A therapeutically effective dose is a dose effective to produce a significant decrease in demyelination and a notable increase in remyelination. Preferably, the amount is sufficient to produce a statistically significant amount of remyelination in a subject.

According to an important feature of the invention, an immunoglobulin that recognizes and binds to VLA-4 may be administered alone, or in combination with an anti-inflammatory agent, which is typically used to treat conditions and diseases associated with demyelination. Administration of anti-inflammatory agents can occur prior to, concurrent with or after administration with the immunoglobulin.

A therapeutically effective amount of a remyelinating antibody or immunoglobulin, *e.g.*, natalizumab, can be estimated by comparison with established effective doses for known antibodies, taken together with data obtained for natalizumab in both *in vivo* and *in vitro* models. Preferably the data is from inhibition of demyelination studies. As is known in the art, adjustments in the dose may be necessary due to immunoglobulin degeneration or metabolism, systemic versus localized delivery, as well as the age, body weight, general health, sex, diet, time of administration, drug interactions and the severity of the condition of the subject to whom the immunoglobulin is administered. Such adjustments may be made and appropriate doses determined by one of skill in the art through routine experimentation.

Therapeutic formulations of the immunoglobulin are prepared for storage by mixing the immunoglobulin having the desired degree of purity with optional physiologically acceptable carriers, excipients, or stabilizers (*Remington's Pharmaceutical Sciences*, 16th ed., A. Osol, Ed., 1980 and more recent editions), in the form of lyophilized cake or aqueous solutions. Acceptable immunoglobulin carriers, excipients or stabilizers are nontoxic, nontherapeutic and/or non-immunogenic to recipients at the dosages and concentrations employed, and include buffers such as phosphate, citrate, and other organic acids; antioxidants including ascorbic acid; low molecular weight (less than about 10 residues) polypeptides; proteins, such as serum albumin, gelatin, or immunoglobulins; hydrophilic polymers such as polyvinylpyrrolidone; amino acids such as glycine, glutamine, asparagine, arginine or lysine; monosaccharides, disaccharides, and other carbohydrates including glucose, mannose, or dextrans; chelating agents such as EDTA; sugar alcohols such as mannitol or sorbitol; salt-forming counterions such as sodium; and/or nonionic surfactants such as Tween, Pluronic or polyethylene glycol (PEG). Specific examples of carrier molecules include but are not limited to glycosaminoglycans (*e.g.*, heparin sulfate), hyaluronic acid, keratan-sulfate, chondroitin 4-sulfate, chondroitin 6-sulfate, heparan sulfate and dermatin sulfate, perlecan and pentopolysulfate.

Pharmaceutical compositions comprising immunoglobulins can also include if desired, pharmaceutically acceptable, non-toxic carriers or diluents, which are vehicles commonly used to formulated pharmaceutical compositions for animal or human administration. The diluent is selected so as not to affect the biological activity of the combination. Examples include but are not limited to distilled water, physiological phosphate-buffered saline, Ringer's solutions, dextrose solution, and Hank's solution.

The agents of the invention can be formulated into preparations for injections by dissolving, suspending or emulsifying them in an aqueous or nonaqueous solvent, such as vegetable or other similar oils, synthetic aliphatic acid glycerides, esters of higher aliphatic acids or propylene glycol. The formulations may also contain conventional additives, such as solubilizers, isotonic agents, suspending agents, emulsifying agents, stabilizers and preservatives.

The immunoglobulins may also be utilized in aerosol formulation to be administered via inhalation or pulmonary delivery. The agents of the present invention can be formulated into pressurized acceptable propellants such as dichlorodifluoromethane, propane, nitrogen and the like.

The immunoglobulin also may be entrapped in microcapsules prepared, for example, by coacervation techniques or by interfacial polymerization (*e.g.*, hydroxymethylcellulose or gelatin-microcapsules and poly-methylmethacrylate microcapsules), in colloidal drug delivery systems (*e.g.*, liposomes, albumin microspheres, microemulsions, nano-particles and nanocapsules), or in macroemulsions. Such techniques are disclosed in *Remington's Pharmaceutical Sciences, supra*.

The immunoglobulin to be used for *in vivo* administration must be sterile. This is readily accomplished by filtration through sterile filtration membranes, prior to or following lyophilization and reconstitution. The immunoglobulin ordinarily will be stored in lyophilized form or in solution.

Therapeutic immunoglobulin compositions generally are placed into a container having a sterile access port, for example, an intravenous solution bag or

vial having a stopper pierceable by a hypodermic injection needle or similar sharp instrument.

Suitable examples of sustained-release preparations include semipermeable matrices of solid hydrophobic polymers containing the protein, which matrices are in the form of shaped articles, *e.g.*, films, or microcapsules. Examples of sustained-release matrices include polyesters, hydrogels (*e.g.*, poly(2-hydroxyethyl-methacrylate) as described by Langer *et al.*, *J. Biomed. Mater. Res.* 15: 167-277 (1981) and Langer, *Chem. Tech.* 12: 98-105 (1982) or poly(vinylalcohol)), polylactides (U.S. Patent No. 3,773,919), copolymers of L-glutamic acid and gamma ethyl-L-glutamate (Sidman *et al.*, *Biopolymers* 22: 547-556, 1983), non-degradable ethylene-vinyl acetate (Langer *et al.*, *supra*), degradable lactic acid-glycolic acid copolymers such as the LUPRON DEPOT™ (*i.e.*, injectable microspheres composed of lactic acid-glycolic acid copolymer and leuprolide acetate), and poly-D-(-)-3-hydroxybutyric acid (EP 133,988).

While polymers such as ethylene-vinyl acetate and lactic acid-glycolic acid enable release of molecules for over 100 days, certain hydrogels release proteins for shorter time periods. When encapsulated antibodies remain in the body for a long time, they may denature or aggregate as a result of exposure to moisture at 37°C., resulting in a loss of biological activity and possible changes in immunogenicity. Rational strategies can be devised for immunoglobulin stabilization depending on the mechanism involved. For example, if the aggregation mechanism is discovered to be intermolecular S-S bond formation through thio-disulfide interchange, stabilization may be achieved by modifying sulfhydryl residues, lyophilizing from acidic solutions, controlling moisture content, using appropriate additives, developing specific polymer matrix compositions, and the like.

Sustained-release immunoglobulin compositions also include liposomally entrapped immunoglobulin. Liposomes containing the immunoglobulin are prepared by methods known *per se*. See, *e.g.*, Epstein *et al.*, *Proc. Natl. Acad. Sci. USA* 82: 3688-92 (1985); Hwang *et al.*, *Proc. Natl. Acad. Sci. USA* 77: 4030-4 (1980); U.S. Patent Nos. 4,485,045; 4,544,545; 6,139,869; and 6,027,726. Ordinarily, the liposomes are of the small (about 200 to about 800 Angstroms), unilamellar type in

which the lipid content is greater than about 30 mole percent (mol. %) cholesterol; the selected proportion being adjusted for the optimal immunoglobulin therapy.

The immunoglobulins of this invention can be administered in a sustained release form, for example a depot injection, implant preparation, or osmotic pump, which can be formulated in such a manner as to permit a sustained release of the active ingredient. Implants for sustained release formulations are well-known in the art. Implants are formulated as microspheres, slabs, etc. with biodegradable or non-biodegradable polymers. For example, polymers of lactic acid and/or glycolic acid form an erodible polymer that is well-tolerated by the host. The implant is placed in proximity to the site of protein deposits (*e.g.*, the site of formation of amyloid deposits associated with neurodegenerative disorders), so that the local concentration of active agent is increased at that site relative to the rest of the body.

In addition, immunoglobulins which prevent demyelination and/or induce remyelination may be provided by administering a polynucleotide encoding a whole or partial antibody (*e.g.*, a single chain Fv) to a subject. The polynucleotide is administered to a subject in an appropriate vehicle to allow the expression of the immunoglobulin in the subject in a therapeutically effective amount.

A typical daily dosage might range for immunoglobulins ranges from about 1 $\mu\text{g}/\text{kg}$ to up to about 10 mg/kg or more, depending on the factors mentioned herein. Typically, the clinician will administer immunoglobulin until a dosage is reached that achieves the desired effect. The progress of this therapy is easily monitored by conventional assays.

A "stable" antibody or antibody fragment formulation is one in which the protein therein essentially retains its physical stability and/or chemical stability and/or biological activity upon storage. Various analytical techniques for measuring protein stability are available in the art and are reviewed in *Peptide and Protein Drug Delivery*, 247-301, (Vincent Lee Ed., Marcel Dekker, Inc., New York, N.Y., Pubs. 1991) and A. Jones, *Adv. Drug Delivery Rev.* 10: 29-90 (1993), for example. Stability can be measured at a selected temperature for a selected time period. Preferably, the formulation is stable at room temperature (about 30°C) or at 40°C for at least 1 month and/or stable at about 2-8°C for at least 1 year for at least about 2

years. Furthermore, the formulation is preferably stable following freezing (to, *e.g.*, -70°C) and thawing of the formulation.

A protein "retains its physical stability" in a pharmaceutical formulation if it shows no signs of aggregation, precipitation and/or denaturation upon visual examination of color and/or clarity, or as measured by UV light scattering or by size exclusion chromatography.

A protein "retains its chemical stability" in a pharmaceutical formulation, if the chemical stability at a given time is such that the protein is considered to still retain its biological activity as defined below. Chemical stability can be assessed by detecting and quantifying chemically altered forms of the protein. Chemical alteration may involve size modification (*e.g.*, clipping) that can be evaluated using size exclusion chromatography, SDS-PAGE and/or matrix-assisted laser desorption ionization/time-of-flight mass spectrometry (MALDI/TOF MS), for example. Other types of chemical alteration include charge alteration (*e.g.*, occurring as a result of deamidation) that can be evaluated by, *e.g.*, ion-exchange chromatography.

An immunoglobulin "retains its biological activity" in a pharmaceutical formulation, if the biological activity of the immunoglobulin at a given time is within about 10% (within the errors of the assay) of the biological activity exhibited at the time the pharmaceutical formulation was prepared as determined in an antigen-binding assay, for example.

5.5. Routes of Administration of Immunoglobulin Compositions

As discussed briefly above, the pharmaceutical compositions discussed *supra* can be administered for prophylactic and/or therapeutic treatments of multiple sclerosis or other demyelination related disorders. In therapeutic applications, compositions are administered to a patient suspected of, or already suffering from a disease such as multiple sclerosis, in an amount sufficient to promote remyelination. An amount adequate to accomplish this is defined as a therapeutically- or pharmaceutically-effective dose.

The pharmaceutical compositions will be administered by parenteral, topical, intravenous, oral, or subcutaneous, intramuscular local administration, such as by

aerosol or transdermally, for prophylactic and/or therapeutic treatment. Although the proteinaceous substances of this invention may survive passage through the gut following oral administration (p.o.), subcutaneous (s.c.), intravenous (i.v.), intramuscular (i.m.), intraperitoneal administration by depot injection; or by implant preparation are preferred.

The pharmaceutical compositions can be administered in a variety of unit dosage forms depending upon the method of administration. For example, unit dosage forms suitable for oral administration include powder, tablets, pills, capsules, and lozenges.

Effective doses of the compositions of the present invention, for the treatment of the above described conditions will vary depending upon many different factors, including means of administration, target site, physiological state of the patient, and other medicaments administered. Thus, treatment dosages will need to be titrated to optimize safety and efficacy. These compositions may be administered to mammals for veterinary use and for clinical use in humans in a manner similar to other therapeutic agents, *i.e.*, in a physiologically acceptable carrier. In general, the administration dosage will range from about 0.0001 to 100 mg/kg, and more usually 0.01 to 0.5 mg/kg of the host body weight.

In a preferred treatment regime, the antibody is administered by intravenous infusion or subcutaneous injection at a dose from 1 to 5 mg antibody per kilo of patient bodyweight. The dose is repeated at interval from 2 to 8 weeks. Within this range, the preferred treatment regimen is 3 mg antibody per kilo of bodyweight repeated at a 4-week interval.

6. Drug Combinations

As stated previously, no previously described drug or drug combination was identified as stopping the progressive loss of neurologic function for demyelinating diseases. Some drugs existed which suppressed immune-mediated inflammation and can also decrease the relapse rate of multiple sclerosis. These and other drugs used to treat symptoms associated with multiple sclerosis and demyelination-associated conditions and diseases are also contemplated for use in combination with

the compounds and compositions disclosed herein. Selection of one or more agent to be utilized in a cocktail and/or combination with the compounds and compositions disclosed herein will be dependent on the management of the disease. For example, in MS, disease management can be categorized into two groups: (1) treatment designed to arrest the disease process, and (2) symptomatic management. Various combinations of drugs can be used in category (D). For example, the compounds and compositions disclosed herein can be administered with immunosuppressant agents to further inhibit the influx of immune cells and thereby demyelinating activity. For example, immunosuppressants such as corticosteroids may be used.

The remyelinating agents (*e.g.*, anti- α -4 integrin antibodies, small compound α -4 integrin antagonists and the like) can be combined with other compounds or compositions used to treat, ameliorate or palliate symptoms associated with demyelinating conditions or diseases.

Other agents utilized to treat, ameliorate or palliate symptoms associated with demyelination conditions or diseases, including multiple sclerosis, include but are not limited to: muscle relaxants (*e.g.*, diazepam, cyclobenzaprine, clonazepam, clonidine, primidone, and the like), anticholinergics (*e.g.*, propantheline, dicyclomine, and the like), central nervous system stimulants (*e.g.*, pemoline), non-steroidal anti-inflammatory agents (NSAIDs such as ibuprofen, naproxen and ketoprofen), interferons, immune globulin, glatiramer (Copaxone[®]), mitoxantrone (Novantrone[®]), misoprostol, tumor necrosis factor- α inhibitors (*e.g.*, pirfenidone, infliximab and the like) and corticosteroids (*e.g.*, glucocorticoids and mineralocorticoids).

Common agents for treating multiple sclerosis include interferon beta-1b (Betaseron[®]), interferon beta-1a (Avonex[®]), high-dose interferon beta-1a (Rebif[®]), glatiramer (Copaxone[®]), immune globulin, mitoxantrone (Novantrone[®]), corticosteroids (*e.g.*, prednisone, methylprednisolone, dexamethasone and the like). Other corticosteroids may also be used and include but are not limited to cortisol, cortisone, fludrocortisone, prednisolone, 6 α -methylprednisolone, triamcinolone, and betamethasone.

Dosage forms of the agents to be used in combination with the compounds and compositions disclosed herein would vary depending on the subject and drug combination being utilized. For example, interferons are typically administered as follows: Interferon beta-1a (Avonex[®]) is administered 30 µg once a week; interferon beta-1a is administered at about 22 µg or 44 µg three times a week; and interferon beta-1b (Betaseron[®]) is administered at 250 µg on alternate days (Durelli *et al.*, *Lancet* 359: 1453-60, 2002). Typically the interferons are administered for relapsing or remitting multiple sclerosis. Thus, in combination with the remyelinating agents disclosed herein, preferred ranges of interferons may include about 0.1 µg to about 250 µg and more preferably about 0.5 µg to about 50 µg, depending on the manner in which the agent is administered in conjunction with the other remyelinating compounds and compositions disclosed herein.

Non-steroidal anti-inflammatories (NSAIDs) contemplated for use with this invention include but are not limited to non-selective COX inhibitors and selective COX-2 inhibitors. Non-selective COX inhibitors include but are not limited to salicylic acid derivatives (*e.g.*, aspirin, sodium salicylates, choline magnesium trisalicylate, salsalate, diflunisal, sulfasalazine, and olsalazine), para-aminophenol derivatives (*e.g.*, acetaminophen), indole and indene acetic acids (*e.g.*, tolmetin, diclofenac, and ketorolac), heteroaryl acetic acids (*e.g.*, abuprofen, naproxen, flurbiprofen, ketoprofen, fenoprofen, and oxaprozin), anthranilic acids or fenamates (*e.g.*, mefenamic acid and meclofenamic acid), enolic acids (*e.g.*, oxicams such as piroxicam and meloxicam), and alkanones (*e.g.*, nabumetone). Selective COX-2 inhibitors include diaryl-substituted furanones (*e.g.*, rofecoxib), diaryl-substituted pyrazoles (*e.g.*, celecoxib), indole acetic acids (*e.g.*, etodolac), and sulfonanilides (*e.g.*, nimesulide). NS are oftentimes administered in combination with interferon to lessen the flu-like symptoms experienced by patients receiving, for example, Avonex[®]. Common NS include naproxen, ibuprofen and ketoprofen. Paracetamol is also frequently administered to patients. *See*, Reess *et al.*, 2002 *Mult. Scler.* 8: 15-8.

Glatiramer acetate (GA, Copaxone[®]) is a synthetic molecule that inhibits activation of myelin basic protein-reactive T cells and induces a T-cell repertoire

characterized by anti-inflammatory effects. Moreover, glatiramer can access the central nervous system (CNS), whereas interferon-beta cannot (Dhib-Jalbut, 2002 *Neurology* 58: S3-9; Weinstock-Guttman *et al.*, 2000 *Drugs* 59: 401-10).

5 Mitoxantrone is an anthracenedione synthetic agent, which has been shown to be effective for treating secondary progressive multiple sclerosis (SP-MS). However, use of this drug is again limited by its cumulative cardiotoxicity (Weinstock-Guttman *et al.*, 2000).

10 Tumor necrosis factor-alpha (TNF- α) may be a key cytokine in demyelination (Walker *et al.*, 2001 *Mult. Scler.* 7: 305-12). Thus use of agents that antagonize TNF- α function or inhibit its synthesis may be useful in combination with the agents and compounds disclosed herein. This can include anti-TNF- α antibodies (*e.g.*, infliximab) as well as agents such as pirfenidone. Pirfenidone is a non-peptide drug, which has been shown to decrease synthesis of TNF- α and to block receptors for TNF- α . *Id.*

15 The long mainstay in most demyelinating conditions and diseases has been the use of ACTH, glucocorticoids and corticoid steroids. These agents are used for their anti-edema and anti-inflammatory effects. ACTH is commonly administered to a subject at 80 U given intravenously in 500 mL of 5% dextrose and water over 6-8 hours for 3 days. It may also be administered at 40 U/ml intramuscularly at a dose of
20 40 U every 12 hours for 7 days, with the dose then reduced every 3 days. *See*, S. Hauser, "Multiple sclerosis and other demyelinating diseases," in *Harrison's Principles of Internal Medicine* 2287-95 (13th ed., Isselbacher *et al.*, ed. 1994). Methylprednisolone is typically administered slowly in 500 ml D5W over 6 hours, preferably in the morning. Common dosages include 1000 mg daily for 3 days, 500
25 mg daily for 3 days and 250 mg daily for 3 days. *Id.* A methylprednisolone-prednisone combination is also commonly administered. Typically 1000 mg of intravenous methylprednisolone is administered over three days followed by oral prednisone at 1 mg/kg per day for 14 days. Thus, for use in combination with the compounds and compositions disclosed herein, the steroids may be administered in
30 amounts ranging from about 1 to about 1000 mg/kg over about 1 to 14 days, as needed.

A side effect in demyelinating conditions such as MS, is fatigue and decreased cognitive function. Agents such as amantadine hydrochloride and pemoline have been frequently used to treat fatigue associated with MS (Geisler *et al.*, 1996 *Arch. Neurol.* 53: 185-8).

5 The benefit of such combination therapies is that it may lessen the class-specific and agent-specific side effects currently encountered with some of the drugs. Class-specific side effects of interferon-beta include fever, chills, myalgias, arthralgias and other flu-like symptoms beginning 2-6 hours after injection and typically resolving 24 hours post injection. Occasionally interferon-beta also
10 induces transient worsening of preexisting MS symptoms. Agent specific side effects include injection-site reactions with interferon beta-1b. Management of these effects can be accomplished by tailoring the dose and time of administration, prescribing appropriate combinations of acetaminophen, non-steroidal anti-inflammatory drugs (NSAIDs) and steroids. *See, Munschauer et al.*, 1997 *Clin.*
15 *Ther.* 19: 883-93.

Thus, combinations of drugs that can lessen the quantity of a particular drug administered may reduce adverse side effects experienced by a patient.

When administered in combination, the small compound remyelinating agents may be administered in the same formulation as these other compounds or
20 compositions, or in a separate formulation. When administered in combination, the remyelinating immunoglobulins are generally administered in a separate formulation than the other compounds and compositions. When administered in combinations, the remyelinating agents may be administered prior to, following, or concurrently with the other compounds and compositions used to treat, ameliorate, or palliate
25 symptoms.

7. Chronic Administration Dosage Regimens

The chronic treatment regimen of the present invention provides that an alpha-4 integrin agent (*e.g.*, small molecule or immunoglobulin) at a level that will
30 maintain sufficient receptor saturation to suppress pathological inflammation in a patient in need of such. The methods of the invention entails administration once

per every two weeks or once a month to once every two months, with repeated dosings taking place over a period of at least six months, and more preferably for a year or longer. The methods of the invention involve obtaining and maintaining a receptor saturation level in a human patient of a dimer comprising alpha-4 integrin (e.g., VLA-4) in a range of from about 65% to 100%, more preferably between 75%,
5 to 100%, and even more preferably between 80-100%. These receptor saturation levels are maintained at these levels chronically (e.g., over a period of 6 months or so) to allow for continued suppression of pathological inflammation.

In a specific embodiment, the remyelinating agent is an antibody, preferably a humanized or human antibody, and the dosing is on a monthly basis. In another
10 specific embodiment, the remyelinating agent is a compound of formula I, IA, IB, IC, II, IIA, or IIB as defined above. Levels of receptor saturation can be monitored to determine the efficacy of the dosing regime, and physiological markers measured to confirm the success of the dosage regime. As a confirmation, serum levels of the
15 antibody can be monitored to identify clearance of the antibody and to determine the potential effect of half-life on the efficacy of the treatment.

For treatment with an agent of the invention, the dosage ranges from about 0.0001 to 100 mg/kg, and more usually 0.01 to 5 mg/kg, of the host body weight. For example dosages can be 1 mg/kg body weight or 10 mg/kg body weight. Dosage
20 and frequency vary depending on the half-life of the agent in the patient. The dosage and frequency of administration can vary depending on whether the treatment is prophylactic or therapeutic. For immunoglobulin administration, each dosing injection is generally between 2.0 to 8.0 mg/kg dosage. For a compound
administration, each dosing injection is generally between 1.0 to 50.0 mg/kg dosage.
25 In accordance with the teachings provided herein, effective dosages can be monitored by obtaining a fluid sample from a patient. For this, generally a blood serum or cerebrospinal fluid sample is taken and integrin receptor saturation is determined using methods well known in the art. Ideally, a sample is taken prior to initial dosing; subsequent samples are taken and measured prior to and/or after each
30 treatment.

As an alternative to chronic administration comprised of repeated individual dosings, a remyelinating agent can be administered as a sustained release formulation, provided the dosage is such that the levels of receptor saturation remain sufficient to suppress inflammation. For example, controlled release systems can be used to chronically administer a remyelinating agent within the scope of this invention. Discussions of appropriate controlled release dosage forms may be found in Lesczek Krowczynski, *EXTENDED-RELEASE DOSAGE FORMS*, 1987 (CRC Press, Inc.).

The various controlled release technologies cover a very broad spectrum of drug dosage forms. Controlled release technologies include, but are not limited to physical systems and chemical systems. Physical systems include, but not limited to, reservoir systems with rate-controlling membranes, such as microencapsulation, macroencapsulation, and membrane systems; reservoir systems without rate-controlling membranes, such as hollow fibers, ultra microporous cellulose triacetate, and porous polymeric substrates and foams; monolithic systems, including those systems physically dissolved in non-porous, polymeric, or elastomeric matrices (*e.g.*, non-erodible, erodible, environmental agent ingression, and degradable), and materials physically dispersed in non-porous, polymeric, or elastomeric matrices (*e.g.*, non-erodible, erodible, environmental agent ingression, and degradable); laminated structures, including reservoir layers chemically similar or dissimilar to outer control layers; and other physical methods, such as osmotic pumps, or adsorption onto ion-exchange resins.

Chemical systems include, but are not limited to, chemical erosion of polymer matrices (*e.g.*, heterogeneous, or homogeneous erosion), or biological erosion of a polymer matrix (*e.g.*, heterogeneous, or homogeneous). Additional discussion of categories of systems for controlled release may be found in Agis F. Kydonieus, *CONTROLLED RELEASE TECHNOLOGIES: METHODS, THEORY AND APPLICATIONS*, 1980 (CRC Press, Inc.).

The methods of the invention can be used to treat a patient that is affected with a disorder involving or arising from pathological inflammation, or to prophylactically treat a patient at risk for a particular disorder. The dosage regimens

necessary for prophylactic versus therapeutic treatment can vary, and will need to be designed for the specific use and disorder treated.

In some methods, two or more agents (*e.g.*, monoclonal antibodies with different binding specificities, a monoclonal antibody and a compound as disclosed herein) are administered concurrently, in which case the dosage of each agent administered falls within the ranges indicated. Combination therapies can also occur where the agents are administered consecutively to the patient with a desired time interval between periods of administration. Intervals can also be irregular as indicated by measuring receptor saturation levels or by following other indicia of the disease process.

Those of skill will readily appreciate that dose levels can vary as a function of the specific agent, the severity of the symptoms and the susceptibility of the subject to side effects. Some of the specific agents are more potent than others. Preferred dosages for a given agent are readily determinable by those of skill in the art by a variety of means. A preferred means is to measure the physiological potency of a given agent.

In prophylactic applications, pharmaceutical compositions are chronically administered to a patient susceptible to, or otherwise at risk of, a particular disease in an amount sufficient to eliminate or reduce the risk or delay the outset of the disease. Such an amount is defined to be a prophylactically effective dose. In patients with multiple sclerosis in remission, risk may be assessed by NMR imaging or, in some cases, by pre-symptomatic indications observed by the patient.

Effective dosage regimes of the compositions of the present invention, for the treatment of the above described conditions will vary depending upon many different factors, including means of administration, target site, physiological state of the patient, and other medicaments administered. Thus, treatment dosages will need to be titrated to optimize safety and efficacy. In general, each administration of the dosage regimen will range from about 0.0001 to about 100 mg/kg, usually about 0.01 to about 50, and more usually from about 0.1 to about 30 mg/kg of the host body weight.

The remyelinating agents of the invention can be used with effective amounts of other therapeutic agents against acute and chronic inflammation. Such agents include other antagonists of adhesion molecules (*e.g.*, other integrins, selectins, and immunoglobulin (Ig) superfamily members (*see* Springer, *Nature* (1990) 346:425-433; Osborn (1990) *Cell* 62:3; and Hynes (1992) *Cell* 9:11)). Integrins are heterodimeric transmembrane glycoproteins consisting of an α chain (120-180 kDa) and a β chain (90-110 kDa), generally having short cytoplasmic domains. For example, three important integrins, LFA-1, Mac-1 and P150,95, have different alpha subunits, designated CD11a, CD11b and CD11c, and a common beta subunit designated CD18. LFA-1 ($\alpha_L\beta_2$) is expressed on lymphocytes, granulocyte and monocytes, and binds predominantly to an Ig-family member counter-receptor termed ICAM-1 and related ligands. ICAM-1 is expressed on many cells, including leukocytes and endothelial cells, and is up-regulated on vascular endothelium by cytokines such as TNF and IL-1. Mac-1 ($\alpha_M\beta_2$) is distributed on neutrophils and monocytes, and also binds to ICAM-1. The third β_2 integrin, P150,95 ($\alpha_X\beta_2$), is also found on neutrophils and monocytes. The selectins consist of L-selectin, E-selectin and P-selectin.

Other anti-inflammatory agents that can be used in combination with the remyelinating agents include antibodies and other antagonists of cytokines, such as interleukins IL-1 through IL-13, tumor necrosis factors α and β (TNF- α and TNF- β), interferons α , β and γ , tumor growth factor Beta (TGF- β), colony stimulating factor (CSF) and granulocyte monocyte colony stimulating factor (GM-CSF). Other anti-inflammatory agents include antibodies and other antagonists of chemokines such as MCP-1, MIP-1 α , MIP-1 β , RANTES, exotaxin and IL-8. Other anti-inflammatory agents include NS, steroids and other small molecule inhibitors of inflammation. Timing and sequence of administration, formulations, routes of administration and effective concentrations of agents for combined therapies are as described above for the humanized antibodies against alpha-4 integrin, the small compounds against alpha-4 integrin, and the drug combinations.

30

8. Testing Reagents

Reagents can be tested *in vitro* and *in vivo*. Many *in vitro* models exist to test whether a reagent binds to the alpha-4 subunit, as would be known in the art. Testing whether the reagent has activity *in vivo* at promoting remyelination and inhibiting demyelination can be performed using the experimental autoimmune encephalomyelitis (EAE) animal model. EAE is an inflammatory condition of the central nervous system with similarities to multiple sclerosis (Paterson, IN
5 TEXTBOOK OF IMMUNOPATHOLOGY, eds. Miescher and Mueller-Eberhard, 179-213, Grune and Stratton, N.Y. 1976).

EAE may be induced in rats by a single intraperitoneal injection of a CD4-
10 positive T-cell clone specific for myelin basic protein. Inflammation is initiated within 4 to 12 hours; endogenous monocytes and lymphocytes infiltrate inflamed vessels in the brain stem and spinal cord, leading to paralysis of the tail and hind limbs by day 4 or 5.

Sections of EAE brain can be tested for their ability to support leukocyte
15 attachment using, for example, an *in vitro* binding assay described in Stamper and Woodruff, *J. Exp. Med.* 144: 828-833 (1976). Reagents against leukocyte adhesion receptors can be examined for inhibitory activity in the *in vitro* section assay described in Example 4. As shown in Tables 12 and 13, the attachment of U937 cells (a human monocytic cell line) was almost completely blocked by antibodies
20 against human VLA-4 integrin. The remyelinating antibodies produced significantly greater blocking effect as compared to antibodies against other adhesion molecules.

Surprisingly, antibodies that selectively inhibit the fibronectin binding activity of α_4 integrin (P4G9 and HP1/7) enhanced U937 attachment to the EAE vessels. These results suggest that fibronectin-binding activity of α_4 integrin is not
25 directly involved in U937 adhesion to EAE vessels *in vitro*. Tables 12 and 13 also show that antibodies against many other leukocyte adhesion receptors were without effect on U937 or lymphocyte binding to EAE vessels.

Given the *in vitro* results using the $\alpha_4\beta_1$ reagents described above, the effect of these antibodies on the progression of EAE can also be tested *in vivo* by
30 measuring the delay in the onset of paralysis or reduction in severity of the paralysis.

The protective effect of one of the antibodies useful in the present invention, HP2/1, is provided in Example 4.

Additional reagents effective for inhibiting leukocyte binding to brain endothelial cells and thereby potentially that inhibit demyelination or promote remyelination can be identified by use of adhesion assays. Using HP2/1 or *N*-[*N*-(3-pyridinesulfonyl)-*L*-3,3-dimethyl-4-thiaprolyl]-*O*-[1-methylpiperazin-4-ylcarbonyl]-*L*-tyrosine isopropyl ester as a control for example, other antibodies or reagents can be screened for their ability to inhibit the binding of lymphocytes to a known ligand for $\alpha_4\beta_1$ integrin. Several additional reagents can be identified that inhibit adhesion by targeting the α_4 subunit of the VLA-4 leukocyte cell surface receptor.

Monoclonal antibodies useful in the methods and compositions of the present invention include for example HP2/1, TY21.6, TY21.12, and L25 as discussed in U.S. Patent No. 6,033,665, which is herein incorporated by reference in its entirety. These antibodies react with the α chain of VLA-4 and block binding to VCAM-1, fibronectin and inflamed brain endothelial cells, but do not affect the activity of the other members of the β_1 integrin family.

Other reagents which selectively react against the VLA-4/VCAM-1 target can also be used. For example, an antibody which interacts with the VCAM-1 binding domain VLA-4 (α_4) in conjunction with the β_1 chain that blocks only lymphocyte migration into sites of inflammation, such as the brain during multiple sclerosis, can be used to promote remyelination. This reagent further would not affect matrix interactions (mediated by all members of the β_1 integrins) nor would it affect normal intestinal immunity (mediated by $\alpha_4\beta_7$). The production of this and other such reagents are well within the skill of the art.

9. Examples

The following examples are put forth so as to provide those of ordinary skill in the art with a complete disclosure and description of how to make and use the present invention, and is not intended to limit the scope of what the inventors regard as their invention nor is it intended to represent that the experiments below are all or the only experiments performed. Efforts have been made to ensure accuracy with

respect to numbers used (*e.g.*, amounts, temperature, etc.) but some experimental errors and deviations should be accounted for. Unless indicated otherwise, parts are parts by weight, molecular weight is weight average molecular weight, temperature is in degrees Centigrade, and pressure is at or near atmospheric.

5

9.1. Synthesis of Compounds

In the examples below, if an abbreviation is not defined above, it has its generally accepted meaning. Further, all temperatures are in degrees Celsius (unless otherwise indicated). The following Methods were used to prepare the compounds set forth below as indicated.

10

Method 1

N-Tosylation Procedure

N-Tosylation of the appropriate amino acid was conducted via the method of Cupps, Boutin and Rapoport *J. Org. Chem.* **1985**, *50*, 3972.

15

Method 2

Methyl Ester Preparation Procedure

Amino acid methyl esters were prepared using the method of Brenner and Huber *Helv. Chim. Acta* 1953, *36*, 1109.

20

Method 3

BOP Coupling Procedure

The desired dipeptide ester was prepared by the reaction of a suitable N-protected amino acid (1 equivalent) with the appropriate amino acid ester or amino acid ester hydrochloride (1 equivalent), benzotriazol-1-yloxy-tris(dimethylamino)phosphonium hexafluorophosphate [BOP] (2.0 equivalent), triethylamine (1.1 equivalent), and DMF. The reaction mixture was stirred at room temperature overnight. The crude product is purified flash chromatography to afford the dipeptide ester.

25

30

Method 4

Hydrogenation Procedure I

Hydrogenation was performed using 10% palladium on carbon (10% by weight) in methanol at 30 psi overnight. The mixture was filtered through a pad of Celite
5 and the filtrate concentrated to yield the desired amino compound.

Method 5

Hydrolysis Procedure I

To a chilled (0°C) THF/H₂O solution (2:1, 5 - 10 mL) of the appropriate ester
10 was added LiOH (or NaOH) (0.95 equivalents). The temperature was maintained at 0°C and the reaction was complete in 1-3 hours. The reaction mixture was extracted with ethyl acetate and the aqueous phase was lyophilized resulting in the desired carboxylate salt.

15

Method 6

Ester Hydrolysis Procedure II

To a chilled (0°C) THF/H₂O solution (2:1, 5 - 10 mL) of the appropriate ester
was added LiOH (1.1 equivalents). The temperature was maintained at 0°C and the
reaction was complete in 1-3 hours. The reaction mixture was concentrated and the
20 residue was taken up into H₂O and the pH adjusted to 2-3 with aqueous HCl. The product was extracted with ethyl acetate and the combined organic phase was washed with brine, dried over MgSO₄, filtered and concentrated to yield the desired acid.

25

Method 7

Ester Hydrolysis Procedure III

The appropriate ester was dissolved in dioxane/H₂O (1:1) and 0.9 equivalents of
0.5 N NaOH was added. The reaction was stirred for 3-16 hours and then
concentrated. The resulting residue was dissolved in H₂O and extracted with ethyl
30 acetate. The aqueous phase was lyophilized to yield the desired carboxylate sodium salt.

Method 8

Sulfonylation Procedure I

To the appropriately protected aminophenylalanine analog (11.2 mmol),
5 dissolved in methylene chloride (25ml) and cooled to -78°C was added the desired
sulfonyl chloride (12 mmol) followed by dropwise addition of pyridine (2 mL). The
solution was allowed to warm to room temperature and was stirred for 48 hr. The
reaction solution was transferred to a 250 mL separatory funnel with methylene
chloride (100 mL) and extracted with 1N HCl (50 mL x 3), brine (50 mL), and water
10 (100 mL). The organic phase was dried (MgSO_4) and the solvent concentrated to
yield the desired product.

Method 9

Reductive Amination Procedure

15 Reductive amination of Tos-Pro-p-NH₂-Phe with the appropriate aldehyde was
conducted using acetic acid, sodium triacetoxyborohydride, methylene chloride and
the combined mixture was stirred at room temperature overnight. The crude product
was purified by flash chromatography.

20

Method 10

BOC Removal Procedure

Anhydrous hydrochloride (HCl) gas was bubbled through a methanolic solution
of the appropriate Boc-amino acid ester at 0°C for 15 minutes and the reaction
mixture was stirred for three hours. The solution was concentrated to a syrup and
25 dissolved in Et_2O and reconcentrated. This procedure was repeated and the resulting
solid was placed under high vacuum overnight.

Method 11

tert-Butyl Ester Hydrolysis Procedure I

The *tert*-butyl ester was dissolved in CH₂Cl₂ and treated with TFA. The reaction was complete in 1-3 hr at which time the reaction mixture was concentrated and the residue dissolved in H₂O and lyophilized to yield the desired acid.

5

Method 12

EDC Coupling Procedure I

To a CH₂Cl₂ solution (5-20 mL) of N-(toluene-4-sulfonyl)-L-proline (1 equivalent), the appropriate amino acid ester hydrochloride (1 equivalent), N-methylmorpholine (1.1-2.2 equivalents) and 1-hydroxybenzotriazole (2 equivalents) were mixed, placed in an ice bath and 1-(3-dimethylaminopropyl)-3-ethyl carbodiimide (1.1 equivalents) added. The reaction was allowed to rise to room temperature and stirred overnight. The reaction mixture was poured into H₂O and the organic phase was washed with sat. NaHCO₃, brine, dried (MgSO₄ or Na₂SO₄), filtered and concentrated. The crude product was purified by column chromatography.

10
15

Method 13

EDC Coupling Procedure II

To a DMF solution (5-20 mL) of the appropriate N-protected amino acid (1 equivalent), the appropriated amino acid ester hydrochloride (1 equivalent), Et₃N (1.1 equivalents) and 1-hydroxybenzotriazole (2 equivalents) were mixed, placed in an ice bath and 1-(3-dimethylaminopropyl)-3-ethyl carbodiimide (1.1 equivalents) added. The reaction was allowed to rise to room temperature and stirred overnight. The reaction mixture was partitioned between EtOAc and H₂O and the organic phase washed with 0.2 N citric acid, H₂O, sat. NaHCO₃, brine, dried (MgSO₄ or Na₂SO₄), filtered and concentrated. The crude product was purified by column chromatography or preparative TLC.

20

25

30

Method 14

Sulfonylation Procedure II

The appropriate sulfonyl chloride was dissolved in CH_2Cl_2 and placed in an ice bath. L-Pro-L-Phe-OMe • HCl (1 equivalent) and Et_3N (1.1 equivalent) was added and the reaction allowed to warm to room temperature and stirred overnight under an atmosphere of nitrogen. The reaction mixture was concentrated and the residue
5 partitioned between EtOAc and H_2O and the organic phase washed with sat. NaHCO_3 , brine, dried (MgSO_4 or Na_2SO_4), filtered and concentrated. The crude product was purified by column chromatography or preparative TLC.

Method 15

Sulfonylation Procedure III

To a solution of L-Pro-L-4-(3-dimethylaminopropoxy)-Phe-OMe [prepared using the procedure described in Method 10] (1 equivalent) in CH_2Cl_2 was added Et_3N (5 equivalents) followed by the appropriate sulfonyl chloride (1.1 equivalent). The reaction was allowed to warm to room temperature and stirred overnight under an
15 atmosphere of nitrogen. The mixture was concentrated, dissolved in EtOAc, washed with sat. NaHCO_3 and 0.2 N citric acid. The aqueous phase was made basic with solid NaHCO_3 and the product extracted with EtOAc. The organic phase was washed with brine, dried (MgSO_4 or Na_2SO_4), filtered and concentrated. The crude methyl ester was purified by preparative TLC. The corresponding acid was prepared
20 using the procedure described in Method 7.

Method 16

Hydrogenation Procedure II

To a methanol (10 -15 mL) solution of the azlactone was added NaOAc (1
25 equivalent) and 10% Pd/C. This mixture was placed on the hydrogenator at 40 psi H_2 . After 8 - 16 hours, the reaction mixture was filtered through a pad of Celite and the filtrate concentrated to yield the dehydrodipeptide methyl ester. The ester was dissolved in dioxane/ H_2O (5-10 mL), to which was added 0.5 N NaOH (1.05 equivalents). After stirring for 1- 3 hours, the reaction mix was concentrated and the
30 residue was redissolved in H_2O and washed with EtOAc. The aqueous phase was made acidic with 0.2 N HCl and the product was extracted with EtOAc. The

combined organic phase was washed with brine (1 x 5 mL), dried (MgSO₄ or Na₂SO₄), filtered and concentrated to yield the acid as approximately a 1:1 mixture of diastereomers.

5

Method 17

tert-Butyl Ester Hydrolysis Procedure II

The *tert*-butyl ester was dissolved in CH₂Cl₂ (5 mL) and treated with TFA (5 mL). The reaction was complete in 1-3 hours at which time the reaction mixture was concentrated and the residue dissolved in H₂O and concentrated. The residue was redissolved in H₂O and lyophilized to yield the desired product.

10

Example 1

Synthesis of

***N*-(Toluene-4-sulfonyl)-L-prolyl-L-4-(4-methylpiperazin-1-ylcarbonyloxy)phenylalanine Ethyl Ester**

15

The title compound was prepared following the procedure outlined for the preparation of Example 4 and substitution of appropriate starting materials.

NMR data was as follows:

¹H NMR (CD₃)₂SO): δ = 8.33 (d, 1H), 7.70 (d, 2H), 7.41 (d, 2H), 7.24 (d, 2H), 7.00 (d, 2H), 4.52-4.44 (m, 1H), 4.09-4.00 (m, 3H), 3.53 (bs, 2H), 3.38-3.31 (m, 3H), 3.11-3.01 (m, 3H), 2.39 (s, 3H), 2.32 (bs, 4H), 2.19 (s, 3H), 1.61-1.50 (m, 3H), 1.43-1.38 (m, 1H), 1.13 (t, 3H).

20

¹³C NMR (CD₃)₂SO): δ = 171.1, 171.1, 153.9, 149.8, 143.6, 134.1, 133.9, 130.0, 129.8, 127.4, 121.5, 61.2, 60.7, 54.2, 54.1, 53.3, 49.0, 45.7, 44.0, 43.4, 35.8, 30.5, 23.8, 21.0, 14.0.

25

Example 2

Synthesis of

***N*-(Toluene-4-sulfonyl)-L-prolyl-L-4-(*N,N*-dimethylcarbamyloxy)phenylalanine Ethyl Ester**

30

Into a reaction vial were combined 7.00 g (15.2 mmol, 1.0 eq) Ts-Pro-Tyr(H)-OEt and 1.86 g (15.2 mmol, 1.0 eq) DMAP. Methylene chloride (50 mL), triethylamine (2.12 mL -- 1.54 g, 15.2 mmol, 1.0 eq), and dimethylcarbonyl chloride (1.68 mL -- 1.96 g, 18.2 mmol, 1.2 eq) were then added. The vial was capped tightly, and the reaction solution swirled to obtain a homogeneous solution. The reaction solution was then heated to 40°C. After 48 h, TLC of the resulting colorless solution indicated complete conversion. The workup of the reaction solution was as follows: add 50 mL EtOAc and 50 mL hexanes to the reaction mixture, and wash with 3 x 50 mL 0.5 mL hexanes to the reaction mixture, and wash with 3 x 50 mL 0.5 M citric acid, 2 x 50 mL water, 2 x 50 mL 10% K₂CO₃, and 1 x 50 mL sat. NaCl. Dry with MgSO₄. Filter. Evaporate to obtain 8.00 g (99%) of the title compound as a clear oil, which solidifies upon standing. Recrystallize from 5:3:2 heptane/EtOAc/CH₂Cl₂.

NMR data was as follows:

¹H NMR (CD₃)₂SO): δ = 8.32 (d, 1H), 7.70 (d, 2H), 7.41 (d, 2H), 7.23 (d, 2H), 7.00 (d, 2H), 4.52-4.44 (m, 1H), 4.09-4.02 (m, 3H), 3.37-3.31 (m, 1H), 3.11-2.96 (m, 3H), 3.00 (s, 3H), 2.87 (s, 3H), 2.39 (s, 3H), 1.61-1.50 (m, 3H), 1.43-1.38 (m, 1H), 1.13 (t, 3H).

¹³C NMR (CD₃)₂SO): δ = 171.1, 171.1, 154.0, 150.0, 143.6, 133.9, 133.9, 130.0, 129.8, 127.4, 121.5, 61.2, 60.6, 53.3, 49.0, 36.3, 36.1, 35.8, 30.5, 23.8, 21.0, 14.0.

Example 3

Synthesis of

N-(Toluene-4-sulfonyl)-L-prolyl-L-4-(4-methylpiperazin-1-ylcarbonyloxy)phenylalanine Isopropyl Ester

The title compound was prepared following the procedure outlined for the preparation of Example 4 and substitution of appropriate starting materials.

NMR data was as follows:

¹H NMR (CDCl₃): δ = 7.72 (d, 2H), 7.36 (d, 1H), 7.33 (d, 2H), 7.16 (d, 2H), 7.03 (d, 2H), 5.07 (Sept., 1H), 4.78 (dt, 1H), 4.08-4.05 (m, 1H), 3.67 (bs, 2H), 3.57

(bs, 2H), 3.41-3.35 (m, 1H), 3.24 (dd, 1H), 3.15-3.07 (m, 1H), 3.04 (dd, 1H), 3.46-2.43 (m, 7H), 2.34 (s, 3H), 2.05-2.02 (m, 1H).

¹³C NMR (CDCl₃): δ = 170.9, 170.4, 153.6, 150.5, 144.3, 133.2, 133.1, 130.2, 130.0, 127.9, 121.7, 69.5, 62.2, 54.7, 53.4, 49.6, 46.1, 44.3, 43.7, 37.2, 29.7, 24.1, 21.6, 21.6, 21.4.

Example 4

Synthesis of

N-(Toluene-4-sulfonyl)-L-prolyl-L-4-(4-methylpiperazin-1-ylcarbonyloxy)phenylalanine *tert*-Butyl Ester

Combine 41.2 g (84.34 mmol, 1.0 eq) Ts-Pro-Tyr(H)-OtBu and 17.0 g (84.34 mmol, 1.0 eq) 4-nitrophenyl chloroformate. Add 700 mL CH₂Cl₂. Cap with a septum. Attach a N₂ line. Immerse the flask in a 4:1 water/EtOH + dry ice slurry, and stir to cool to -15°C. Add 29.38 mL (21.33 g, 210.81 mmol, 2.5 eq) Et₃N over five minutes with stirring. Stir at -10 to -15°C for 1 h. Add 9.35 mL (8.45 g, 84.34 mmol, 1.0 eq) N-methyl piperazine over 3 minutes with stirring. Stir overnight while warming to room temperature. Dilute with 700 mL hexanes. Wash repeatedly with 10% K₂CO₃, until no yellow color (4-nitrophenol) is seen in the aqueous layer. Wash with sat. NaCl. Dry over anhydrous MgSO₄. Filter. Evaporate. Dissolve in 500 mL EtOH, and evaporate, to remove Et₃N. Repeat once. Dissolve in 400 mL EtOH, and add 600 mL water with stirring, to precipitate a solid or oil. If an oil, stir vigorously to solidify. Isolate the solid by filtration. Repeat dissolution, precipitation, and filtration, once. Rinse with water to remove traces of yellow color. High vacuum to constant mass yields the title compound as a white solid.

NMR data was as follows:

¹H NMR (CDCl₃): δ = 7.72 (d, 2H), 7.33 (d, 3H), 7.17 (d, 2H), 7.02 (d, 2H), 4.71 (q, 1H), 4.09-4.06 (m, 1H), 3.67 (bs, 2H), 3.57 (bs, 2H), 3.41-3.34 (m, 1H), 3.22 (dd, 1H), 3.16-3.09 (m, 1H), 3.03 (dd, 1H), 2.46-2.43 (m, 7H), 2.34 (s, 3H), 2.05-2.02 (m, 1H), 1.57-1.43 (m, 3H), 1.47 (s, 9H).

^{13}C NMR (CDCl_3): $\delta = 171.8, 169.9, 153.6, 150.4, 144.3, 133.4, 133.1, 130.3, 130.0, 127.9, 121.6, 82.6, 62.3, 54.5, 53.8, 49.6, 46.1, 44.3, 43.7, 37.3, 29.7, 27.8, 24.1, 21.4.$

5

Example 5

Synthesis of

***N*-(Toluene-4-sulfonyl)-L-prolyl-L-4-(4-methylpiperazin-1-ylcarbonyloxy)phenylalanine**

The title compound was prepared from the product of Example 1 using the procedure described in Method 7.

10

NMR data was as follows:

15

^1H NMR (CD_3OD): $\delta = 7.74$ (d, 2H), 7.42 (d, 2H), 7.26 (d, 2H), 7.04 (d, 2H), 4.58-4.54 (m, 1H), 4.16-4.12 (m, 1H), 3.70 (bs, 2H) 3.53 (bs, 2H), 3.43-3.31 (m, 1H), 3.26-3.13 (m, 7H), 2.82 (s, 3H), 2.43 (s, 3H), 1.98-1.94 (m, 1H), 1.76-1.51 (m, 3H).

^{13}C NMR (CD_3OD): $\delta = 175.7, 173.6, 154.8, 151.6, 146.1, 136.3, 134.8, 131.9, 131.3, 129.1, 122.7, 63.6, 55.9, 53.9, 50.7, 43.5, 37.6, 31.3, 25.5, 21.5.$

20

Example 6

Synthesis of

N*-(Toluene-4-sulfonyl)-L-prolyl-L-4-**(N,N*-dimethylcarbamyloxy)phenylalanine *n*-Butyl Ester**

The title compound was prepared following the procedure outlined for the preparation of Example 2 and substitution of appropriate starting materials.

25

NMR data was as follows:

^1H NMR (CD_3) $_2\text{SO}$: $\delta = 8.31$ (d, 1H), 7.70 (d, 2H), 7.41 (d, 2H), 7.23 (d, 2H), 6.99 (d, 2H), 4.53-4.46 (m, 1H), 4.10-4.01 (m, 1H), 3.63-3.30 (m, 1H), 3.10-2.96 (m, 3H), 3.00 (s, 3H), 2.88 (s, 3H), 2.39 (s, 3H), 1.59-1.30 (m, 6H), 1.33-1.20 (m, 2H), 0.85 (t, 3H).

^{13}C NMR $(\text{CD}_3)_2\text{SO}$: $\delta = 171.4, 171.3, 154.2, 150.2, 143.7, 134.0, 130.1, 130.0, 127.6, 121.7, 64.3, 61.2, 59.2, 53.4, 49.0, 36.2, 36.0, 35.8, 30.0, 23.8, 21.0, 18.5, 13.5.$

5

Example 7

Synthesis of

N-(Toluene-4-sulfonyl)-L-prolyl-L-4-*(N,N*-dimethylcarbamyloxy)phenylalanine Cyclopentyl Ester

The title compound was prepared following the procedure outlined for the preparation of Example 2 and substitution of appropriate starting materials.

NMR data was as follows:

^1H NMR $(\text{CD}_3)_2\text{SO}$: $\delta = 8.27$ (d, 1H), 7.70 (d, 2H), 7.41 (d, 2H), 7.22 (d, 2H), 6.99 (d, 2H), 5.04 (bs, 1H), 4.48-4.40 (m, 1H), 4.08-4.05 (m, 1H), 3.34-3.30 (m, 1H), 3.09-2.95 (m, 3H), 3.00 (s, 3H), 2.88 (s, 3H), 2.39 (s, 3H), 1.76-1.74 (m, 2H), 1.57-1.40 (m, 10H).

15

^{13}C NMR $(\text{CD}_3)_2\text{SO}$: $\delta = 171.3, 171.0, 154.2, 150.2, 432.7, 134.1, 130.1, 130.0, 127.6, 121.6, 77.4, 61.2, 53.4, 49.0, 36.2, 36.1, 35.7, 32.0, 30.5, 23.8, 23.2, 21.0.$

20

Example 8

Synthesis of

N-(Toluene-4-sulfonyl)-L-prolyl-L-4-*(N,N*-dimethylcarbamyloxy)phenylalanine *tert*-Butyl Ester

The title compound was prepared following the procedure outlined for the preparation of Example 2 and substitution of appropriate starting materials.

NMR data was as follows:

^1H NMR $(\text{CD}_3)_2\text{SO}$: $\delta = 8.18$ (d, 1H), 7.71 (d, 2H), 7.41 (d, 2H), 7.23 (d, 2H), 6.99 (d, 2H), 4.42-4.38 (m, 1H), 4.10-4.07 (m, 1H), 3.37-3.30 (m, 1H), 3.09-2.95 (m, 3H), 3.00 (s, 3H), 2.88 (s, 3H), 2.39 (s, 3H), 1.58-1.50 (m, 3H), 1.40-1.30 (m, 1H), 1.36 (s, 9H).

30

^{13}C NMR $(\text{CD}_3)_2\text{SO}$: $\delta = 171.1, 170.3, 154.2, 150.2, 143.8, 134.2, 134.1, 130.2, 130.0, 127.6, 121.6, 81.0, 61.3, 53.8, 49.0, 36.3, 36.0, 35.9, 30.5, 27.5, 23.8, 21.0.$

Example 9

Synthesis of

N-(Toluene-4-sulfonyl)-L-prolyl-L-4-5 *(N,N*-dimethylcarbamyloxy)phenylalanine

The title compound was prepared from the product of Example 2 using the procedure described in Method 7.

NMR data was as follows:

¹H NMR (CD₃)₂SO: δ = 8.13 (d, 1H), 7.70 (d, 2H), 7.41 (d, 2H), 7.23 (d, 2H),
10 6.99 (d, 2H), 4.51-4.44 (m, 1H), 4.11-4.09 (m, 1H), 3.40-3.34 (m, 2H), 3.11-2.94
(m, 3H), 3.00 (s, 3H), 2.87 (s, 3H), 2.39 (s, 3H), 1.59-1.36 (m, 4H).

¹³C NMR (CD₃)₂SO: δ = 172.7, 171.2, 153.6, 150.2, 143.8, 134.3, 134.0, 130.2,
130.0, 127.6, 121.6, 61.3, 53.2, 49.0, 36.3, 36.1, 35.9, 30.4, 23.8, 21.0.

15 Example 10

Synthesis of

N-(Toluene-4-sulfonyl)-L-prolyl-L-3-*(N,N*-dimethylcarbamyloxy)phenylalanine Ethyl Ester

The title compound was prepared following the procedure outlined for the
20 preparation of Example 2 and substitution of appropriate starting materials.

NMR data was as follows:

¹H NMR (CDCl₃): δ = 7.74 (m, 2H), 7.70-7.36 (m, 4H), 7.24-7.14 (m, 3H),
6.93-4.90 (m, 1H), 4.78-4.27 (m, 3H), 4.05-3.55 (m, .5H), 3.48-3.43 (m, .5H), 3.37-
3.30 (m, 3H), 3.02-3.08 (bs, 3H), 2.99 (bs, 3H), 2.45 (s, 1.5H), 2.43 (s, 1.5H), 2.12
25 (m, 1H), 1.80 (m, .5M), 1.62-1.44 (m, 2.5H), 1.29 (t, 1.5H), 1.24 (t, 1.5H).

¹³C NMR (CDCl₃): δ = 171.1, 171.0, 170.9, 154.9, 154.8, 151.8, 151.6, 144.4,
144.3, 137.6, 137.1, 133.1, 132.9, 130.0, 129.9, 129.5, 129.2, 127.9, 127.9, 126.5,
126.1, 122.9, 122.7, 120.7, 120.5.

30 Example 11

Synthesis of

***N*-(Toluene-4-sulfonyl)-L-(5,5-dimethyl)thiaprolyl-
L-4-(*N,N*-dimethylcarbamyloxy)phenylalanine Isopropyl Ester**

The title compound was prepared following the procedure outlined for the preparation of Example 2 and substitution of appropriate starting materials.

5 NMR data was as follows:

¹H NMR (CDCl₃): δ = 7.76 (d, 2H), 7.35 (d, 2H), 7.22 (d, 2H), 7.01 (m, 3H), 5.05 (m, 1H), 4.85 (m, 1H), 4.57 (d, 1H), 4.38 (d, 1H), 3.86 (s, 1H), 3.19-3.00 (m, 2H), 3.09 (s, 3H), 3.01 (s, 3H), 2.45 (s, 3H), 1.24 (t, 6H), 1.16 (s, 3H), 1.09 (s, 3H).

10 ¹³C NMR (CDCl₃): δ = 170.3, 168.4, 154.9, 150.6, 144.8, 132.9, 132.8, 130.3, 130.0, 128.2, 121.7, 73.4, 69.5, 54.5, 53.2, 50.4, 37.7, 36.5, 36.3, 29.0, 23.8, 21.5, 21.4.

Example 12

Synthesis of

15 ***N*-(Toluene-4-sulfonyl)-L-(5,5-dimethyl)thiaprolyl-
L-4-(*N,N*-dimethylcarbamyloxy)phenylalanine *tert*-Butyl Ester**

The title compound was prepared following the procedure outlined for the preparation of Example 2 and substitution of appropriate starting materials.

NMR data was as follows:

20 ¹H NMR (CDCl₃): δ = 7.75 (d, 2H), 7.34 (d, 2H), 7.23 (d, 2H), 7.05-6.98 (m, 3H), 4.76 (m, 1H), 4.56 (d, 1H), 4.40 (d, 1H), 3.85 (s, 1H), 3.09-3.00 (m, 8H), 2.44 (s, 3H), 1.43 (s, 3H), 1.16 (s, 3H), 1.09 (s, 3H).

25 ¹³C NMR (CDCl₃): δ = 169.8, 168.3, 154.9, 150.6, 144.8, 133.2, 132.9, 130.4, 130.0, 128.2, 121.6, 82.6, 73.4, 54.6, 53.8, 50.4, 37.8, 36.5, 36.3, 29.0, 27.7, 23.8, 21.5.

Example 13

Synthesis of

30 ***N*-(Toluene-4-sulfonyl)-L-(5,5-dimethyl)thiaprolyl-
L-4-(*N,N*-dimethylcarbamyloxy)phenylalanine**

The title compound was prepared from the product of Example 11 using the procedure described in Method 7.

NMR data was as follows:

¹H NMR (CDCl₃): δ = 7.76 (d, 2H), 7.35 (d, 2H), 7.25 (d, 2H), 7.14 (d, 1H),
5 7.02 (d, 2H), 5.17 (br s, 1H), 4.89 (m, 1H), 4.56 (d, 1H), 4.40 (d, 1H), 3.90 (s, 1H),
3.30-3.00 (m, 8H), 2.43 (s, 3H), 1.09 (s, 6H).

¹³C NMR (CDCl₃): δ = 172.7, 169.3, 155.2, 150.6, 144.9, 133.1, 132.7, 130.5,
130.1, 128.1, 121.9, 73.3, 54.5, 53.3, 50.5, 36.9, 36.6, 36.4, 29.0, 23.7, 21.5.

10

Example 14

Synthesis of

***N*-(Toluene-4-sulfonyl)-*L*-[(1,1-dioxo)thiamorpholin-
3-carbonyl]-*L*-4-(*N,N*-dimethylcarbamyloxy)phenylalanine
tert-Butyl Ester**

15

L-Thiamorpholine-5-carboxylic acid was prepared by the method of Larsson and Carlson (*Acta Chemica Scan.* **1994**, 48, 517-525). *N*-(Toluene-4-sulfonyl)-*L*-thiamorpholine-5-carboxylic acid was prepared using the procedure described in Method 1 and was then coupled to *t*-butyl tyrosine in DMF in the presence of BOP and NMM, to give after aqueous workup and flash chromatography *N*-(Toluene-4-
20 sulfonyl)-*L*-[thiamorpholin-3-carbonyl]-*L*-4-phenylalanine *tert*-butyl ester.

Formation of the 4-(*N,N*-dimethylcarbamyloxy) group was per Example 2 above and oxidation of the thiamorpholino group to the 1,1-dioxo-thiamorpholino group was per Larsson and Carlson (*Acta Chemica Scan.* **1994**, 48, 522).

25

NMR data was as follows:

¹H NMR (CDCl₃): δ = 7.68 (d, 2H), 7.37 (d, 2H), 7.08 (m, 4H), 6.73 (d, 1H),
5.11 (m, 1H), 4.62 (m, 1H), 4.23 (m, 1H), 4.00 (m, 1H), 3.82 (m, 1H), 3.14 (s, 3H),
3.03 (s, 3H), 2.80 (m, 5H), 2.44 (s, 3H), 1.48 (s, 9H).

30

¹³C NMR (CDCl₃): δ = 171.3, 169.9, 164.4, 145.6, 135.4, 132.6, 130.8, 130.4,
127.3, 121.9, 83.0, 56.1, 53.8, 49.4, 48.7, 44.5, 42.0, 36.9, 36.6, 36.4, 27.8, 21.5.

Example 15

Synthesis of

***N*-(Toluene-4-sulfonyl)-L-[(1,1-dioxo)thiamorpholin-3-carbonyl]-L-4-(*N,N*-dimethylcarbamyloxy)phenylalanine**

5 The title compound was prepared from the product of Example 14 using the procedure described in Method 11.

NMR data was as follows:

¹H NMR (CD₃OD): δ = 7.77 (d, 2H), 7.40 (d, 2H), 7.22 (d, 2H), 7.00 (d, 2H), 5.19 (m, 1H), 4.65 (m, 1H), 4.30 (m, 1H), 3.95 (m, 1H), 3.61 (m, 1H), 3.20 (m, 5H), 3.09 (s, 3H), 2.97 (s, 3H), 2.43 (s, 3H).

¹³C NMR (CD₃OD): δ = 174.1, 168.0, 157.0, 152.0, 146.4, 137.7, 135.3, 131.7, 131.6, 128.8, 123.0, 57.1, 54.8, 51.1, 50.9, 48.0, 47.7, 43.2, 37.4, 36.8, 36.7, 21.5.

Example 16

Synthesis of

***N*-(Toluene-4-sulfonyl)-L-(5,5-dimethyl)thiaprolyl-L-4-(4-methylpiperazin-1-ylcarbonyloxy)phenylalanine *tert*-Butyl Ester**

15 The title compound was prepared following the procedure outlined for the preparation of Example 4 and substitution of appropriate starting materials.

NMR data was as follows:

¹H NMR (CDCl₃): δ = 7.74 (d, 2H), 7.33 (d, 2H), 7.25 (d, 2H), 7.20-7.00 (m, 3H), 4.74 (m, 1H), 4.55 (d, 1H), 4.38 (d, 1H), 3.83 (s, 1H), 3.66 (br m, 2H), 3.57 (br m, 2H), 3.08-3.05 (m, 2H), 2.45-2.42 (m, 7H), 2.33 (s, 3H), 1.42 (s, 9H), 1.15 (s, 3H), 1.08 (s, 3H).

¹³C NMR (CDCl₃): δ = 169.7, 168.2, 153.6, 150.3, 144.7, 133.3, 132.7, 130.4, 129.9, 128.1, 121.5, 82.6, 73.4, 54.5, 53.7, 50.4, 46.0, 44.2, 43.6, 37.7, 28.9, 27.7, 23.8, 21.4.

Example 17

Synthesis of

***N*-(Toluene-4-sulfonyl)-*L*-(5,5-dimethyl)thiaprolyl-
L-4-(4-methylpiperazin-1-ylcarbonyloxy)phenylalanine**

The title compound was prepared from the product Example 16 using the procedure described in Method 11.

5 NMR data was as follows:

¹H NMR (CDCl₃): δ = 8.31 (d, 1H), 7.72 (d, 2H), 7.42-7.35 (m, 4H), 7.08 (d, 2H), 4.90-4.68 (m, 1H), 4.64-4.61 (m, 1H), 4.47-4.44 (m, 1H), 4.01 (s, 1H), 3.36-3.32 (br m, 4H), 3.27-3.25 (m, 1H), 3.22-3.10 (m, 1H), 2.94 (s, 3H), 2.43 (s, 3H), 1.14 (s, 3H), 1.07 (s, 3H).

10

Example 18

Synthesis of

***N*-(Toluene-4-sulfonyl)sarcosyl-*L*-4-
(*N,N*-dimethylcarbamyloxy)phenylalanine Isopropyl Ester**

15 The title compound was prepared following the procedure outlined for the preparation of Example 2 and substitution of appropriate starting materials.

NMR data was as follows:

¹H NMR (CDCl₃): δ = 7.66 (d, 2H), 7.34 (d, 2H), 7.18 (d, 2H), 7.07 (d, 2H), 6.98 (d, 1H), 5.03 (m, 1H), 4.81 (m, 1H), 3.69 (d, 1H), 3.49 (d, 1H), 3.08 (m, 2H),
20 3.04 (s, 3H), 2.99 (s, 3H), 2.63 (s, 3H), 2.43 (s, 3H).

¹³C NMR (CDCl₃): δ = 167.4, 154.9, 150.8, 144.4, 132.6, 130.2, 130.1, 127.7, 122.0, 110.9, 69.5, 57.3, 53.9, 53.0, 37.1, 36.6, 21.6, 21.4.

Example 19

25

Synthesis of

***N*-(Toluene-4-sulfonyl)sarcosyl-*L*-4-
(*N,N*-dimethylcarbamyloxy)phenylalanine *tert*-Butyl Ester**

The title compound was prepared following the procedure for the preparation of Example 2 and substitution of appropriate starting materials.

30 NMR data was as follows:

^1H NMR (CDCl_3): $\delta = 7.67$ (d, 2H), 7.34 (d, 2H), 7.19 (d, 2H), 7.03 (d, 2H), 6.98 (d, 1H), 4.76 (m, 1H), 3.67 (q, 1H), 3.06 (m, 2H), 3.16 (s, 3H), 2.99 (s, 3H), 2.64 (s, 3H), 2.43 (s, 3H), 1.42 (s, 9H).

^{13}C NMR (CDCl_3): $\delta = 170.0, 137.2, 154.9, 150.7, 144.3, 133.2, 132.9, 130.3,$
5 130.0, 127.7, 121.9, 82.6, 83.9, 53.3, 37.2, 36.6, 36.4, 27.9, 21.4.

Example 20

Synthesis of

N-(Toluene-4-sulfonyl)sarcosyl-L-4-

10 *(N,N*-dimethylcarbamyloxy)phenylalanine

The title compound was prepared from the product of Example 18 using the procedure described in Method 7.

NMR data was as follows:

^1H NMR (CDCl_3): $\delta = 7.41$ (d, 2H), 7.10 (d, 2H), 6.98 (d, 2H), 6.75 (d, 2H),
15 4.42 (m, 1H), 3.43 (m, 2H), 3.04 (m, 2H), 2.80 (s, 3H), 2.69 (s, 3H), 2.33 (s, 3H),
2.14 (s, 3H).

^{13}C NMR (CDCl_3): $\delta = 174.2, 170.2, 156.9, 151.9, 145.6, 135.5, 135.2, 131.4,$
131.1, 128.9, 123.0, 54.6, 54.0, 37.4, 36.8, 36.7, 21.4.

20

Example 21

Synthesis of

N-(Toluene-4-sulfonyl)-L-prolyl-L-4-

(N,N-dimethylaminosulfonyloxy)phenylalanine

tert-Butyl Ester

25

Substituting dimethylsulfamoyl chloride for dimethylcarbamyl chloride, and following the method for the preparation of Example 2, gave the title compound.

NMR data was as follows:

^1H NMR (CDCl_3): $\delta = 7.72$ (d, 2H), 7.34 (d, 2H), 7.21 (s, 4H), 4.69 (m, 1H),
4.04 (m, 1H), 3.4 (m, 1H), 3.24 (m, 3H), 2.96 (s, 6H), 2.42 (s, 3H), 2.02 (m, 1H),
30 1.45 (m, 13H).

^{13}C NMR (CDCl_3): $\delta = 166.3, 165.3, 144.8, 140.0, 130.9, 126.4, 125.6, 123.5, 117.3, 95.5, 78.3, 57.8, 49.2, 45.2, 34.2, 32.9, 25.0, 23.4, 19.7, 17.1.$

Example 22

5

Synthesis of

***N*-(Toluene-4-sulfonyl)-L-prolyl-L-4-(*N,N*-dimethylaminosulfonyloxy)phenylalanine**

The title compound was prepared from the product of Example 21 using the procedure described in method 11.

10

NMR data was as follows:

^1H NMR (CD_3OD): $\delta = 7.73$ (d, 2H), 7.41 (d, 2H), 7.38 (d, 2H), 7.22 (d, 2H), 4.69 (m, 1H), 4.11 (m, 1H), 3.41 (m, 2H), 3.19 (m, 2H), 2.94 (s, 6H), 2.41 (s, 3A), 1.78 (m, 1H), 1.61 (m, 3H).

15

^{13}C NMR (CD_3OD): $\delta = 174.3, 174.0, 150.8, 145.9, 137.3, 135.1, 132.1, 131.2, 129.1, 123.1, 63.3, 54.6, 50.6, 39.1, 37.5, 31.6, 25.3, 21.5.$

Example 23

Synthesis of *N*-(Toluene-4-sulfonyl)-sarcosyl-L-(4-morpholinecarbamyloxy)phenylalanine t-butyl ester

20

Substituting sacrosine for L-proline in the preparation of Ts-Pro-Tyr(H)-O-*t*-butyl ester and substitution of 4-morpholinecarbonyl chloride for dimethylcarbonyl chloride, and following the method for the preparation of Example 2, gave the title compound as a white solid.

NMR data was as follows:

25

^1H NMR (CDCl_3): $\delta 7.61$ (d, 2H), 7.28 (d, 2H), 7.16 (d, 2H), 7.02 (d, 2H), 4.69 (m, 1H), 3.67 (m, 8H), 3.58 (m, 1H), 3.48 (m, 1H), 3.06 (m, 2H), 2.59 (s, 3H), 2.36 (s, 3H), 1.26 (s, 9H).

^{13}C NMR (CDCl_3): $\delta 169.7, 167.1, 153.5, 150.1, 144.1, 133.1, 133.0, 133.0, 130.1, 129.8, 127.4, 121.6, 82.6, 66.3, 53.6, 53.1, 44.5, 43.7, 36.9, 36.4, 27.6, 21.2.$

30

Example 24

Synthesis of
***N*-(Toluene-4-sulfonyl)sarcosyl-L-4-**
(isonipecotoxy)phenylalanine

The title compound was prepared from the product of Example 23 using the
5 procedure described in Method 11.

NMR data was as follows:

¹H NMR (CD₃OD): δ = 7.30 (d, 2H), 7.02 (d, 2H), 6.88 (d, 2H), 6.67 (d, 2H),
4.33 (m, 1H), 3.32 (m, 3H), 3.25 (m, 2H), 3.12 (m, 3H), 2.89 (m, 1H), 2.70 (m, 3H),
2.22 (s, 3H), 2.03 (s, 3H).

10 ¹³C NMR (CD₃OD): δ = 174.2, 170.3, 155.6, 151.7, 145.6, 135.8, 135.2, 131.5,
131.1, 128.9, 123.0, 67.5, 54.6, 54.0, 37.4, 36.8, 21.5.

Example 25

Synthesis of

15 ***N*-(Toluene-4-sulfonyl)-L-[(1,1-dioxo)thiamorpholin-**
3-carbonyl]-L-4-(morpholin-4-ylcarbonyloxy)phenylalanine
***tert*-Butyl Ester**

Substitution of 4-morpholinecarbonyl chloride for dimethylcarbonyl chloride,
and following the methods for the preparation of Example 2 and 14, gave the title
20 compound as a white solid.

NMR data was as follows:

¹H NMR (CDCl₃): δ = 7.76 (d, 1H), 7.68 (d, 1H), 7.37 (m, 2H), 7.14 (m, 2H),
7.05 (m, 1H), 6.97 (d, 1H), 6.80 (d, 0.5H), 6.57 (d, 0.5H), 5.09 (m, 0.5H), 4.91 (m,
0.5H), 4.75 (m, 0.5H), 4.62 (m, 0.5H), 4.25 (m, 0.5H), 4.09 (m, 2H), 3.79 (m, 4H),
25 3.65 (m, 4H), 2.91 (s, 3H), 2.44 (s, 3H), 1.69 (s, 4H), 1.44 (s, 5H).

¹³C NMR (CDCl₃): δ = 170.0, 169.8, 164.8, 164.4, 153.7, 150.4, 145.6, 145.4,
135.4, 135.3, 132.9, 130.8, 130.7, 130.5, 130.4, 127.5, 127.2, 122.1, 121.8, 83.01,
82.8, 66.4, 56.1, 56.1, 53.7, 53.6, 49.5, 49.3, 48.6, 44.7, 43.9, 42.0, 41.6, 36.9, 36.3,
27.8, 21.5.

30

Example 26

Synthesis of***N*-(Toluene-4-sulfonyl)-L-[(1,1-dioxo)thiamorpholin-3-carbonyl]-L-4-(morpholin-4-ylcarbonyloxy)phenylalanine**

The title compound was prepared from the product of Example 25 using the procedure described in Method 11.

NMR data was as follows:

¹H NMR (CD₃OD): δ = 7.67 (m, 2H), 7.32 (m, 2H), 7.08 (m, 2H), 6.93 (m, 2H), 5.09 (m, 1H), 4.54 (m, 1H), 4.19 (m, 0.5H), 4.02 (m, 0.5H), 3.81 (m, 0.5H), 3.66 (m, 8H), 2.99 (m, 7H), 2.32 (s, 3H).

¹³C NMR (CD₃OD): δ = 174.0, 168.0, 155.7, 151.9, 151.8, 146.6, 146.4, 137.5, 135.5, 135.3, 131.7, 131.6, 131.6, 128.8, 123.3, 122.9, 67.6, 57.3, 57.1, 54.8, 51.1, 50.9, 50.6, 46.0, 45.3, 45.2, 43.0, 37.4, 37.0, 21.5.

Example 27**Synthesis of*****N*-(4-Fluorobenzenesulfonyl)-L-prolyl-L-4-(*N,N*-dimethylcarbamyloxy)phenylalanine *tert*-Butyl Ester**

The title compound was prepared following the procedure outlined for the preparation of Example 2 and substitution of appropriate starting materials.

NMR data was as follows:

¹³C NMR (CDCl₃): δ = 7.87-7.83 (m, 2H), 7.26-7.13 (m, 5H), 4.74-4.69 (m, 1H), 4.05 (m, 1H), 3.36 (m, 1H), 3.24-3.17 (m, 1H), 3.11-3.01 (m, 4H), 2.97 (s, 3H), 2.05-2.02 (m, 1H), 1.60-1.47 (m, 3H), 1.46 (s, 9H).

¹³C NMR (CDCl₃): δ = 170.6, 170.0, 165.7, 154.9, 150.6, 133.2, 132.4, 130.7, 130.2, 121.7, 116.7, 82.7, 62.3, 53.7, 49.6, 37.2, 36.6, 36.4, 29.9, 27.9, 24.2.

Example 28**Synthesis of*****N*-(Toluene-4-sulfonyl)sarcosyl-L-4-(4-methylpiperazin-1-ylcarbonyloxy)phenylalanine *tert*-Butyl Ester**

The title compound was prepared following the procedure outlined for the preparation of Example 4 and substitution of appropriate starting materials.

NMR data was as follows:

¹H NMR (CDCl₃): δ = 8.17 (d, 1H), 7.59 (d, 2H), 7.26 (d, 2H), 7.13 (d, 2H),
5 7.00 (d, 2H), 4.66 (m, 1H), 3.60 (m, 6H), 3.04 (m, 2H), 2.56 (s, 3H), 2.40 (m, 7H),
2.34 (s, 3H), 1.41 (s, 9H).

¹³C NMR (CDCl₃): δ = 169.7, 167.0, 153.4, 150.2, 144.0, 133.0, 132.9, 130.1,
129.8, 127.4, 121.6, 82.2, 54.3, 53.5, 53.1, 45.8, 44.2, 43.5, 36.9, 27.6, 21.2.

10

Example 29

Synthesis of

***N*-(Toluene-4-sulfonyl)-L-(1,1-dioxo-5,5-dimethyl)-
thiaprolyl-L-4-(*N,N*-dimethylcarbamyloxy)phenylalanine
tert-Butyl Ester**

15

The product of Example 12 was oxidized by the method of Larsson and Carlson (*Acta Chemica Scan.* 1994, 48, 517-525), yielding the title compound as a white solid.

NMR data was as follows:

¹H NMR (CDCl₃): δ = 7.73 (d, 2H), 7.36 (d, 2H), 7.21 (d, 2H), 7.06-6.95 (m,
20 3H), 4.79 (m, 1H), 4.38 (dd, 2H), 4.10 (s, 1H), 3.18-2.95 (m, 8H), 2.43 (s, 3H), 1.45
(s, 9H), 1.33 (s, 3H), 1.08 (s, 3H).

¹³C NMR (CDCl₃): δ = 169.8, 166.2, 154.9, 120.7, 145.8, 133.0, 131.9, 130.2,
128.5, 121.9, 82.9, 68.0, 60.9, 59.3, 53.9, 37.5, 36.6, 36.3, 27.7, 21.6, 19.3, 18.5.

25

Example 30

Synthesis of

***N*-(1-Methylimidazolyl-4-sulfonyl)-L-prolyl-
L-4-(*N,N*-dimethylcarbamyloxy)phenylalanine**

The title compound was prepared from the product of Example 106 using the
30 procedure described in Method 11.

NMR data was as follows:

¹H NMR (CDCl₃): δ = 8.07 (d, 1H), 7.75 (s, 1H), 7.71 (s, 1H), 7.25 (d, 2H), 7.01 (d, 2H), 4.71-4.66 (m, 1H), 4.28-4.24 (m, 1H), 3.77 (s, 3H), 3.42-3.05 (m, 3H), 3.09 (s, 3H), 2.96 (s, 3H), 1.84-1.69 (m, 2H), 1.61-1.54 (m, 2H).

¹³C NMR (CDCl₃): δ = 174.4, 174.1, 156.9, 151.9, 141.8, 137.7, 135.6, 131.6,
5 127.6, 122.9, 63.7, 54.7, 50.8, 37.4, 36.8, 36.7, 34.3, 31.6, 25.4.

Preparative Example A

Synthesis of

2-(Saccharin-2-yl)propionoyl-L-4-

10 (N,N-dimethylcarbamyloxy)phenylalanine *tert*-Butyl Ester

N-(Benzisothiazolone)-L-alanyl-L-tyrosine *t*-butyl ester was prepared by first combining sodium hydride (washed free of mineral oil) in THF chilled to 0°C, and a solution of *N*-(2-methoxycarbonyl)sulfonyl-L-alanine-L-tyrosine *t*-butyl ester in THF which was added dropwise. The reaction was stirred at 0°C for one hour and then at
15 room temperature for two hours. The reaction mixture was extracted with EtOAc and 0.2 N HCl, the combined EtOAc layers were washed successively with 0.2 N HCl, sat. NaHCO₃, and sat. NaCl. The organic layer was dried over MgSO₄, filtered and concentrated. The residue was filtered by silica gel chromatography to afford *N*-(benzisothiazolone)-L-alanyl-L-tyrosine *t*-butyl ester.

20 The title compound was then prepared following the procedure described in Example 2.

NMR data was as follows:

¹H NMR (DMSO-d₆, 400 MHz) (1:1 mixture of diastereomers) δ = 8.15 (m, 2H); 8.5 (m, 3H); 7.20 (m, 2H); 6.95 (m, 2H); 4.75 (m, 1H); 4.30 (m, 1H); 3.05 (s,
25 3H); 2.95 (m, 2H); 2.90 (s, 3H); 1.75 and 1.65 (two d, 3H); 1.30 and 1.35 (two s, 9H).

Example 31

Synthesis of

30 *N*-(Toluene-4-sulfonyl)-L-(1,1-dioxo-5,5-dimethyl)-thiaprolyl-L-4-(*N,N*-dimethylcarbamyloxy)phenylalanine

The title compound was prepared from the product of Example 29 using the procedure described in Method 11.

NMR data was as follows:

¹H NMR (CDCl₃): δ = 7.75 (m, 3H), 7.29 (m, 4H), 7.08 (d, 2H), 4.95 (m, 1H),
5 4.46-4.20 (m, 3H), 3.17 (s, 3H), 3.30-3.10 (m, 2H), 3.02 (s, 3H), 2.43 (s, 3H), 1.15
(s, 3H), 0.88 (s, 3H).

¹³C NMR (CDCl₃): δ = 127.2, 167.5, 155.8, 150.3, 145.4, 133.6, 132.6, 130.8,
130.2, 128.3, 121.9, 67.9, 65.8, 60.8, 53.9, 36.8, 36.6, 35.8, 21.6, 18.8, 15.0.

10

Example 32

Synthesis of

N-(4-Fluorobenzenesulfonyl)-L-prolyl-L- 4-(*N,N*-dimethylcarbamoyloxy)phenylalanine

15 The title compound was prepared from the product of Example 27 using the
procedure described in Method 11.

NMR data was as follows:

¹³C NMR (CDCl₃): δ = 7.88-7.84 (m, 2H), 7.54 (d, 1H), 7.26-7.18 (m, 4H), 7.01
(d, 2H), 6.92 (s, 3H), 4.88-4.83 (m, 1H), 4.14-4.11 (m, 1H), 3.39-3.29 (m, 2H), 3.13
(m, 2H), 3.00 (s, 3H), 2.99 (s, 3H), 1.92-1.89 (m, 1H), 1.59-1.43 (m, 3H).

20

¹³C NMR (CDCl₃): δ = 173.1, 172.4, 165.6, 155.5, 150.4, 133.2, 131.9, 130.6,
130.3, 121.8, 116.6, 61.9, 53.1, 49.6, 36.6, 36.3, 30.2, 23.9.

Example 33

Synthesis of

25

N-(Toluene-4-sulfonyl)-D-prolyl-L-4- (4-methylpiperazin-1-yl)phenylalanine *t*-butyl Ester

The title compound was prepared following the procedure outlined for the preparation of Example 4 and substitution of appropriate starting materials.

NMR data was as follows:

30

¹³C NMR (CDCl₃): δ = 7.72 (d, 2H), 7.33 (d, 3H), 7.17 (d, 2H), 7.02 (d, 2H),
4.71 (q, 1H), 4.09-4.06 (m, 1H), 3.67 (bs, 2H), 3.57 (bs, 2H), 3.41-3.34 (m, 1H),

3.22 (dd, 1H), 3.16-3.09 (m, 1H), 3.03 (dd, 1H), 2.46-2.43 (m, 7H), 2.05-2.02 (m, 1H), 1.57-1.43 (m, 3H), 1.47 (s, 9H).

¹³C NMR (CDCl₃): δ = 170.8, 169.9, 153.6, 150.4, 144.3, 133.4, 133.1, 130.3, 130.0, 127.9, 121.6, 82.6, 62.3, 54.5, 53.8, 49.6, 46.1, 44.3, 43.7, 37.3, 29.7, 27.8, 24.1, 21.4.

Example 34

Synthesis of

N-(Toluene-4-sulfonyl)-*N*-methyl-L-alanyl-L-4-(4-methylpiperazin-1-ylcarbonyloxy)phenylalanine *t*-butyl ester

The title compound was prepared following the procedure outlined for the preparation of Example 4 and substitution of appropriate starting materials.

NMR data was as follows:

¹H NMR (CDCl₃): δ = 7.68 (d, 2H), 7.31 (d, 2H), 7.17 (d, 2H), 7.04 (d, 2H), 6.86 (d, 1H), 4.65 (m, 1H), 4.47 (q, 1H), 3.71-3.53 (m, 4H), 3.24-2.92 (m, 2H), 2.50-2.40 (m, 10H), 2.35 (s, 3H), 1.45 (s, 9H), 0.92 (d, 3H).

¹³C NMR (CDCl₃): δ = 170.1, 169.9, 153.6, 150.4, 143.9, 135.6, 133.3, 130.2, 129.9, 127.2, 121.8, 82.4, 55.4, 54.6, 53.6, 46.0, 44.2, 43.7, 37.2, 29.6, 27.8, 21.4, 11.5.

Example 35

Synthesis of

N-(4-Nitrobenzenesulfonyl)-L-prolyl-L-4-(*N,N*-dimethylcarbamyloxy)phenylalanine *tert*-Butyl Ester

The title compound was prepared following the procedure outlined for the preparation of Example 2 and substitution of appropriate starting materials.

NMR data was as follows:

¹H NMR (CDCl₃): δ = 8.38-8.34 (m, 2H), 8.05-8.00 (m, 2H), 7.16-7.12 (m, 2H), 7.03-6.94 (m, 3H), 4.74-4.68 (m, 1H), 4.15-4.14 (m, 1H), 3.41-3.32 (m, 1H), 3.23-3.14 (m, 2H), 3.08 (s, 3H), 3.03 (m, 1H), 2.98 (s, 3H), 2.05 (m, 1H), 1.66-1.48 (m, 3H), 1.47 (s, 9H).

^{13}C NMR (CDCl_3): $\delta = 170.0, 169.9, 154.8, 150.6, 150.4, 142.4, 132.9, 130.2, 129.0, 124.5, 121.6, 82.7, 62.2, 53.4, 49.4, 37.0, 36.5, 36.2, 30.1, 27.7, 24.1.$

Example 36

5

Synthesis of

***N*-(Toluene-4-sulfonyl)-L-[(1,1-dioxo)-
thiomorpholin-3-carbonyl]-L-4-**

(*N,N*-dimethylaminosulfonyloxy)phenylalanine *tert*-Butyl Ester

The title compound was prepared using the procedure described for the
10 preparation of Example 21 and substitution of appropriate starting materials.

NMR data was as follows:

^1H NMR (CDCl_3): $\delta = 7.73$ (d, 1H), 7.67 (d, 1H), 7.35 (m, 2H), 7.27 (m, 2H),
6.88 (d, 1H), 6.66 (d, 1H), 5.08 (m, 0.5H), 4.97 (m, 0.5H), 4.71 (m, 0.5H), 4.61 (m,
0.5H), 4.25 (m, 0.5H), 4.03 (m, 1H), 3.21-3.04 (m, 4H), 2.89 (s, 3H), 2.83 (s, 3H),
15 2.78 (m, 3H), 2.42 (s, 3H), 1.44 (s, 4.5H), 1.38 (s, 4.5H).

^{13}C NMR (CDCl_3): $\delta = 169.8, 169.6, 164.9, 164.5, 149.3, 149.1, 145.6, 145.4,$
135.4, 135.0, 134.6, 130.9, 130.6, 130.5, 127.4, 127.2, 122.0, 121.8, 83.0, 83.0, 56.0,
53.7, 49.2, 49.1, 48.5, 41.9, 41.4, 38.6, 36.8, 36.2, 27.7, 21.5.

20

Example 37

Synthesis of

***N*-(Toluene-4-sulfonyl)sarcosyl-L-4-**

(thiomorpholin-4-ylcarbonyloxy)phenylalanine *tert*-Butyl Ester

Substituting thiomorpholine for *N*-methylpiperazine, and following the method
25 for the preparation of Example 4, gave the title compound.

NMR data was as follows:

^1H NMR (CDCl_3): $\delta = 7.65$ (d, 2H), 7.33 (d, 2H), 7.20 (d, 2H), 7.04 (d, 2H),
4.76 (m, 1H), 3.89 (m, 4H), 3.68 (d, 1H), 3.48 (d, 1H), 3.10 (m, 2H), 2.66 (m, 7H),
2.41 (s, 3H), 1.43 (s, 9H).

30

^{13}C NMR (CDCl_3): $\delta = 169.9, 167.2, 153.5, 150.3, 144.3, 133.1, 130.3, 130.0,$
127.6, 121.8, 82.5, 53.8, 53.3, 47.0, 36.4, 37.2, 36.6, 27.8, 27.3, 27.0, 21.4.

Example 38

Synthesis of

N-(Toluene-4-sulfonyl)-*L*-*N*-methylalanyl-5 *L*-4-(4-methylpiperazin-1-ylcarbonyloxy)phenylalanine

The title compound was prepared from the product of Example 34 using the procedure described in Method 11.

NMR data was as follows:

¹H NMR (CDCl₃): δ = 7.65 (d, 2H), 7.34 (d, 2H), 7.27 (d, 2H), 7.09 (d, 2H),
10 4.64-4.50 (m, 2H), 4.48-4.23 (m, 2H), 3.60-2.96 (m, 8H), 2.92 (s, 3H), 2.55 (s, 3H),
2.40 (s, 3H), 0.93 (d, 3H).

¹³C NMR (CDCl₃): δ = 174.3, 173.1, 154.9, 151.6, 145.5, 137.0, 136.1, 131.6,
131.2, 128.5, 123.1, 56.4, 54.8, 54.0, 43.8, 37.3, 30.2, 21.5, 13.2.

15 Example 39

Synthesis of

N-(Toluene-4-sulfonyl)-*L*-prolyl-*L*-4-(1,1-dioxothiomorpholin-4-ylcarbonyloxy)phenylalanine

20 The title compound was prepared from the product of Example 81 using the
procedure described in Method 11.

NMR data was as follows:

¹H NMR (CD₃OD): δ = 8.03 (m, 1H), 7.73 (d, 2H), 7.41 (d, 2H), 7.28 (d, 2H),
7.08 (d, 2H), 4.70-4.65 (m, 1H), 4.12-4.00 (m, 5H), 3.38-3.36 (m, 1H), 3.31-3.06
(m, 7H), 2.43 (s, 3H), 1.77-1.48 (m, 5H).

25 ¹³C NMR (CD₃OD): δ = 168.4, 159.1, 130.0, 129.1, 125.6, 125.1, 123.0, 116.9,
57.2, 48.8, 46.3, 44.5, 31.5, 25.6, 19.3, 15.4.

Example 40

Synthesis of

30 *N*-(Toluene-4-sulfonyl)-*L*-prolyl-*L*-4-
(thiomorpholin-4-ylcarbonyloxy)phenylalanine

The title compound was prepared from the product of Example 82 using the procedure described in Method 11.

NMR data was as follows:

¹H NMR (CD₃OD): δ = 7.73 (d, 2H), 7.41 (d, 2H), 7.27 (d, 2H), 7.04 (d, 2H),
5 4.68-4.65 (m, 1H), 4.10-4.07 (m, 1H), 3.90 (t, 2H), 3.77 (t, 2H), 3.38-3.11 (m, 4H),
2.66 (m, 4H), 2.43 (s, 3H), 1.80-1.48 (m, 5H).

¹³C NMR (CD₃OD): δ = 168.4, 168.2, 149.4, 145.7, 139.8, 129.7, 129.0, 125.6,
125.1, 123.1, 116.9, 57.2, 48.8, 44.6, 42.1, 36.0, 31.4, 25.7, 22.1, 21.8, 19.3, 15.4.

10

Example 41

Synthesis of

***N*-(Toluene-4-sulfonyl)-L-prolyl-
L-4-(isonipecotoxy)phenylalanine**

15 The title compound was prepared from the product of Example 80 using the
procedure described in Method 11.

NMR data was as follows:

¹H NMR (CD₃OD): δ = 8.08 (m, 1H), 7.73 (d, 2H), 7.41 (d, 2H), 7.27 (d, 2H),
7.03 (d, 2H), 4.71 (m, 1H), 4.11-4.08 (m, 1H), 3.61 (t, 2H), 3.47-3.38 (m, 3H), 3.31-
3.11 (m, 4H), 2.43 (s, 3H), 1.77-1.47 (m, 10H).

20

¹³C NMR (CD₃OD): δ = 168.3, 168.1, 158.8, 149.6, 145.9, 139.8, 129.5, 129.0,
125.6, 125.1, 123.1, 116.9, 57.2, 48.6, 44.6, 40.6, 40.1, 36.0, 31.4, 25.7, 20.9, 20.6,
19.3.

25

Example 42

Synthesis of

***N*-(Toluene-4-sulfonyl)-L-prolyl-L-4-
(pyrrolidin-1-ylcarbonyloxy)phenylalanine**

The title compound was prepared from the product of Example 83 using the
procedure described in Method 11.

30

NMR data was as follows:

¹H NMR (CD₃OD): δ = 8.08 (m, 1H), 7.73 (d, 2H), 7.41 (d, 2H), 7.04 (d, 2H), 7.27 (d, 2H), 4.72-4.68 (m, 1H), 4.11-4.08 (m, 1H), 3.57-3.53 (t, 2H), 3.43-3.28 (m, 3H), 3.25-3.06 (m, 4H), 2.43 (s, 3H), 1.99-1.80 (m, 4H), 1.78-1.49 (m, 5H).

¹³C NMR (CD₃OD): δ = 168.2, 158.3, 149.2, 145.8, 139.8, 129.4, 129.1, 125.6,
5 125.1, 123.1, 116.9, 57.2, 48.7, 44.5, 41.5, 31.4, 25.7, 20.6, 19.8, 19.3, 15.4.

Example 43

Synthesis of

N-(Toluene-4-sulfonyl)-L-prolyl-L-4-

10 (morpholin-4-ylcarbonyloxy)phenylalanine

The title compound was prepared from the product of Example 108 using the procedure described in Method 11.

NMR data was as follows:

¹H NMR (CD₃OD): δ = 7.73 (d, 2H), 7.41 (d, 2H), 7.27 (d, 2H), 7.04 (d, 2H),
15 4.95-4.93 (m, 1H), 4.10-4.07 (m, 1H), 3.71-3.65 (m, 6H), 3.50 (t, 2H), 3.40-3.10 (m, 4H), 2.43 (s, 3H), 1.78-1.48 (m, 4H).

¹³C NMR (CD₃OD): δ = 168.4, 168.2, 149.6, 145.7, 139.8, 129.1, 125.6, 125.1,
123.1, 116.8, 61.5, 57.2, 44.5, 36.0, 31.4, 25.6, 19.3, 15.4.

20

Example 44

Synthesis of

N-(Toluene-4-sulfonyl)-L-prolyl-L-4-

(4-methylpiperazin-1-ylcarbonyloxy)phenylalanine Neopentyl Ester

Titanium isopropoxide (0.3 equivalents) was added to Tos-Pro-Tyr ethyl ester (1
25 equivalent) and an excess of neopentyl alcohol. The mixture was heated to reflux under an argon atmosphere overnight. Excess neopentyl alcohol was removed under reduced pressure and the residue purified by flash column chromatography (silica, hexane: EtOAc 2:1) to give the neopentyl ester a white solid (0.9g, 85%). The title compound was prepared following the procedure described in Example 4.

30

NMR data was as follows:

¹H NMR (DMSO-d₆, 400 MHz) δ = 8.29 (d, 1H, J=7.91Hz); 7.68 (d, 2H, J=8.45Hz); 7.40 (d, 2H, J=8.34Hz); 7.24 (d, 2H, J=8.57Hz); 7.00 (d, 2H, J=8.57Hz); 4.56 (m, 1H); 4.07 (m, 1H); 3.73 (s, 2H); 3.55 (br s, 2H); 3.40 (m, 3H); 3.10 (m, 3H); 2.40 (s, 3H); 2.35 (br s, 4H); 2.20 (s, 3H); 1.55 (m, 3H); 1.37 (m, 1H); 0.85 (s, 9H).

Example 45

Synthesis of

N-(Toluene-4-sulfonyl)-L-prolyl-L-4-

N,N-dimethylcarbamyloxy)phenylalanine Neopentyl Ester

Titanium isopropoxide (0.3 equivalents) was added to Tos-Pro-Tyr ethyl ester (1 equivalent) and an excess of neopentyl alcohol. The mixture was heated to reflux under an argon atmosphere overnight. Excess neopentyl alcohol was removed under reduced pressure and the residue purified by flash column chromatography (silica, hexane: EtOAc 2:1) to give the neopentyl ester a white solid (0.9g, 85%). The title compound was prepared following the procedure described in Example 2.

NMR data was as follows:

¹H NMR (DMSO-d₆, 400 MHz) δ = 8.28 (d, 1H, J=8.13Hz); 7.68 (d, 2H, J=8.4Hz); 7.40 (d, 2H, J=7.9Hz); 7.23 (d, 2H, J=8.56Hz), 6.99 (d, 2H, J=8.35Hz); 4.57 (m, 3H); 2.40 (s, 3H); 1.55 (m, 3H); 1.38 (m, 1H); 0.85 (s, 9H).

Example 46

Synthesis of

2-(Saccharin-2-yl)propionoyl-L-4-

(4-methylpiperazin-1-ylcarbonyloxy)phenylalanine

tert-Butyl Ester

The title compound was prepared following the procedure described in Preparative Example A and Example 4.

NMR data was as follows:

¹H NMR (DMSO-d₆, 400 MHz) (1:1 mixture of diastereomers) δ = 8.31 (m, 1H); 8.26 (m, 1H); 8.03 (m, 3H); 7.20 (m, 2H); 7.00 (m, 2H); 4.73 (m, 1H); 4.30 (m,

1H); 3.58 (br s, 2H); 3.40 (br s, 2H); 3.02 (m, 1H); 2.95 (m, 1H); 2.35 (br s, 4H);
2.20 (s, 3H); 2.75 and 2.65 (two d, 3H); 1.35 and 1.32 (two s, 9H).

Example 47

5

Synthesis of

**2-(Saccharin-2-yl)propionoyl-L-4-
(N,N-dimethylcarbamyloxy)phenylalanine**

The title compound was prepared from the product of Preparative Example A using the procedure described in Method 11.

10

NMR data was as follows:

¹H NMR (DMSO-d₆, 400 MHz) (1:1 mixture of diastereomers) δ = 12.75 (br s, 1H); 8.28 (m, 2H); 8.05 (m, 3H); 7.20 (m, 2H); 7.00 and 9.95 (two d, 2H); 4.75 (m, 1H); 4.40 (m, 1H); 3.10 (m, 1H); 3.05 (s, 3H); 2.95 (m, 1H); 2.90 (s, 3H); 2.75 and 2.60 (two d, 3H).

15

Example 48

Synthesis of

**N-(Toluene-4-sulfonyl)-L-N-methylalanyl-L-4-
(N,N-dimethylcarbamyloxy)phenylalanine *tert*-Butyl Ester**

20

The title compound was prepared following the procedure for the synthesis of Example 2 with the substitution of appropriate starting materials.

NMR data was as follows:

¹H NMR (CDCl₃): δ = 7.68 (d, 2H), 7.31 (d, 2H), 7.17 (d, 2H), 7.04 (d, 2H), 6.87 (d, 2H), 4.67 (m, 1H), 4.48 (q, 1H), 3.09 (s, 3H), 3.00 (s, 3H), 3.14-2.92 (m, 25
2H), 2.46 (s, 3H), 2.43 (s, 3H), 1.45 (s, 9H), 0.92 (d, 3H).

¹³C NMR (CDCl₃): δ = 170.2, 169.9, 154.9, 150.6, 143.9, 135.6, 133.2, 130.2, 130.0, 127.3, 121.9, 82.5, 55.5, 53.7, 37.2, 36.6, 36.4, 29.7, 27.8, 21.4, 11.5.

Example 49

30

Synthesis of

N-(Toluene-4-sulfonyl)-L-(thiamorpholin-3-carbonyl)-

L-4-(*N,N*-dimethylcarbamyloxy)phenylalanine *tert*-Butyl Ester

L-Thiamorpholine-3-carboxylic acid was prepared by the method of Larsson and Carlson (*Acta Chemica Scan.* 1994, 48, 517-525). *N*-(Toluene-4-sulfonyl)-L-thiamorpholine-3-carboxylic acid was prepared using the procedure described in Method 1. The title compound was prepared following the procedure for the synthesis of Example 2 with substitution of appropriate starting materials.

NMR data was as follows:

¹H NMR (CDCl₃): δ = 7.69 (d, 2H), 7.31 (d, 2H), 7.16 (d, 2H), 6.98 (d, 2H), 6.86 (d, 1H), 4.71 (m, 1H), 4.62 (m, 1H), 3.94 (m, 1H), 3.31 (m, 1H), 3.09 (m, 4H), 2.98 (s, 3H), 2.67 (m, 1H), 2.50 (m, 1H), 2.40 (s, 3H), 2.31 (m, 1H), 2.10 (m, 1H), 1.49 (s, 9H).

¹³C NMR (CDCl₃): δ = 169.9, 167.4, 154.8, 150.6, 144.2, 136.8, 132.8, 130.4, 130.2, 127.3, 121.8, 82.6, 55.2, 54.0, 43.3, 36.5, 36.3, 27.8, 25.2, 24.6, 21.4.

15

Example 50**Synthesis of*****N*-(Toluene-4-sulfonyl)sarcosyl-****L-4-(1,1-dioxothiomorpholin-4-ylcarbonyloxy)phenylalanine**

The title compound was prepared from the product of Example 121 using the procedure described in Method 11.

NMR data was as follows:

¹H NMR (CD₃OD): δ = 7.67 (d, 2H), 7.40 (d, 2H), 7.27 (d, 2H), 7.09 (d, 2H), 4.61 (m, 1H), 4.12 (m, 2H), 3.99 (m, 2H), 3.60 (m, 2H), 3.23 (m, 8H), 2.58 (s, 3H), 2.42 (s, 3H).

¹³C NMR (CD₃OD): δ = 174.2, 170.3, 155.0, 151.6, 145.6, 136.1, 135.2, 131.5, 131.1, 128.9, 123.0, 54.6, 54.0, 52.4, 52.2, 44.4, 44.0, 37.4, 36.8, 21.4.

30

Example 51**Synthesis of*****N*-(Toluene-4-sulfonyl)-L-(1,1-dioxothiomorpholin-3-carbonyl)-L-4-(*N,N*-dimethylcarbamyloxy)phenylalanine *tert*-Butyl Ester**

The title compound was prepared from the product of Example 49 following the procedure described by Larsson and Carlson (*Acta Chemica Scan.* **1994**, 48, 522).

NMR data was as follows:

¹H NMR (CDCl₃): δ = 7.76 (d, 2H), 7.37 (d, 2H), 7.08 (d, 2H), 6.98 (d, 2H),
5 6.56 (d, 1H), 4.95 (m, 1H), 4.62 (m, 1H), 3.99 (m, 2H), 3.25 (m, 1H), 3.07 (s, 3H),
2.97 (m, 8H), 2.44 (s, 3H), 1.48 (s, 9H).

¹³C NMR (CDCl₃): δ = 170.0, 164.8, 154.9, 150.7, 145.4, 135.3, 132.6, 130.7,
130.3, 127.5, 122.3, 82.8, 56.1, 53.6, 49.5, 48.6, 41.6, 36.6, 36.4, 27.9, 21.6.

10

Example 52

Synthesis of

***N*-(Toluene-4-sulfonyl)-L-(1,1-dioxothiamorpholin-3-carbonyl)- L-4-(morpholin-4-ylcarbonyloxy)phenylalanine *tert*-Butyl Ester**

The title compound was prepared following the procedure described for the
15 preparation of Example 71.

NMR data was as follows:

¹H NMR (CDCl₃): δ = 7.75 (d, 2H), 7.36 (d, 2H), 7.12 (d, 2H), 6.98 (d, 2H),
6.58 (d, 1H), 4.93 (m, 1H), 4.63 (m, 1H), 4.09 (m, 2H), 3.72 (m, 4H), 3.63 (m, 2H),
3.51 (m, 2H), 3.24 (m, 1H), 2.96 (m, 4H), 2.43 (s, 3H), 1.46 (s, 9H).

20

¹³C NMR (CDCl₃): δ = 170.0, 164.8, 153.7, 150.4, 145.4, 135.2, 132.9, 130.7,
130.4, 127.5, 122.1, 82.9, 66.4, 56.1, 53.6, 49.4, 48.5, 44.7, 43.9, 41.6, 36.3, 27.8,
21.6.

25

Example 53

Synthesis of

***N*-(Toluene-4-sulfonyl)-L-*N*-methylalanyl- L-4-(*N,N*-dimethylcarbamyloxy)phenylalanine**

The title compound was prepared from the product of Example 48 using the
procedure described in Method 11.

30

NMR data was as follows:

¹H NMR (CDCl₃): δ = 7.68 (d, 2H), 7.31 (d, 2H), 7.20 (d, 2H), 7.11-7.04 (m, 3H), 6.35 (br s, 1H), 4.81 (m, 1H), 4.52 (q, 1H), 3.35-2.98 (m, 2H), 3.09 (s, 3H), 3.00 (s, 3H), 2.45 (s, 3H), 2.43 (s, 3H), 0.91 (d, 3H).

¹³C NMR (CDCl₃): δ = 173.7, 170.8, 155.2, 150.6, 144.0, 135.4, 133.2, 130.2,
5 130.0, 127.3, 122.1, 55.5, 53.2, 36.6, 36.5, 36.4, 29.8, 21.4, 11.6.

Example 54

Synthesis of

***N*-(4-Fluorobenzenesulfonyl)-L-(thiamorpholin-3-carbonyl)- 10 L-4-(*N,N*-dimethylcarbamyloxy)phenylalanine *tert*-Butyl Ester**

L-Thiamorpholine-3-carboxylic acid was prepared by the method of Larsson and Carlson (*Acta Chemica Scan.* **1994**, 48, 517-525). *N*-(Toluene-4-sulfonyl)-L-thiamorpholine-3-carboxylic acid was prepared using the procedure described in Method 1.

15 The title compound was then prepared following the procedure for the synthesis of Example 2.

NMR data was as follows:

¹H NMR (CDCl₃): δ = 7.87-7.82 (m, 2H), 7.20 (t, 2H), 7.16 (d, 2H), 7.00 (d, 2H), 6.76 (d, 1H), 4.74 (t, 1H), 4.65 (q, 1H), 3.92 (d, 1H), 3.32 (dd, 1H), 3.17-3.00
20 (m, 2H), 3.09 (s, 3H), 2.99 (s, 3H), 2.76-2.66 (m, 1H), 2.62 (dd, 1H), 2.46 (dt, 1H), 2.22 (d, 1H), 1.49 (s, 9H).

¹³C NMR (CDCl₃): δ = 170.0, 167.2, 165.5, 154.8, 150.7, 135.8, 132.7, 130.5, 130.1, 121.9, 116.9, 82.8, 55.3, 53.9, 43.4, 36.6, 36.4, 36.3, 27.9, 25.8, 25.0.

25

Example 55

Synthesis of

***N*-(4-Fluorobenzenesulfonyl)-L-(1,1-dioxothiamorpholin-3-carbonyl)- L-4-(*N,N*-dimethylcarbamyloxy)phenylalanine *tert*-Butyl Ester**

The title compound was prepared from the product of Example 54 following the
30 procedure described by Larsson and Carlson (*Acta Chemica Scan.* **1994**, 48, 522).

NMR data was as follows:

^1H NMR (CDCl_3): $\delta = 7.92\text{-}7.88$ (m, 2H), 7.24 (t, 2H), 7.09 (d, 2H), 6.97 (d, 2H), 6.41 (d, 1H), 4.96 (d, 1H), 4.62 (d, 1H), 4.03 (d, 1H), 3.26 (dd, 1H), 3.13-2.92 (m, 6H), 3.09 (s, 3H), 2.97 (s, 3H), 1.49 (s, 9H).

^{13}C NMR (CDCl_3): $\delta = 170.1, 165.9, 164.5, 154.9, 150.7, 134.0, 132.4, 130.5,$
5 $130.4, 122.2, 117.3, 83.0, 56.1, 53.4, 50.0, 49.1, 41.7, 36.6, 36.3, 36.1, 27.9.$

Example 56

Synthesis of

N-(Pyridine-3-sulfonyl)-L-prolyl-L-4-

(*N,N*-dimethylcarbamyloxy)phenylalanine *tert*-Butyl Ester

10

N-Benzyl-L-proline was coupled to L-tyrosine *t*-butyl ester using the procedure described in Method 12. N-Benzyl-L-prolyl-L-(*N,N*-dimethylcarbamyloxy)phenylalanine *t*-butyl ester was prepared following the procedure described for the preparation of Example 2. L-Prolyl-L-(4-*N,N*-dimethylcarbamyloxy)phenylalanine
15 *t*-butyl ester was prepared from the product of the previous reaction using the procedure described in Method 4. The title compound was prepared using the procedure described for the preparation of 3-pyridine sulfonyl chloride (see Crowell *et al.*, *J. Med. Chem.*, 1989, 32, 2436-2442) and the product of the last reaction.

NMR data was as follows:

20 ^1H NMR (CDCl_3): $\delta = 9.95$ (d, 1H), 8.83 (dd, 1H), 8.14-8.10 (m, 1H), 7.51-7.47 (m, 1H), 7.16-7.13 (m, 3H), 7.02-6.99 (m, 2H), 4.72-4.69 (m, 1H), 4.09-4.06 (m, 1H), 3.41-3.39 (m, 1H), 3.23-3.17 (m, 1H), 3.13-2.98 (m, 1H), 3.07 (s, 3H), 2.97 (s, 3H), 2.04 (m, 1H), 1.59-1.47 (m, 3H), 1.45 (s, 9H).

^{13}C NMR (CDCl_3): $\delta = 170.1, 169.9, 154.8, 153.9, 150.5, 148.4, 135.5, 133.0,$
25 $130.1, 123.9, 121.6, 82.6, 52.2, 53.6, 49.5, 37.1, 36.5, 36.3, 29.9, 27.8, 24.0.$

Preparative Example B

Synthesis of

N-(Pyrimidine-2-sulfonyl)-L-prolyl-L-4-

30

(*N,N*-dimethylcarbamyloxy)phenylalanine *tert*-Butyl Ester

The title compound was prepared by substituting 2-pyrimidine sulfonyl chloride (see Skulnick *et al.*, *J. Med. Chem.*, 1997, 40, 1149-1164) and following the method for the preparation of Example 56.

NMR data was as follows:

5 ^1H NMR (CDCl_3): $\delta = 8.28$ (d, 2H), 7.39 (d, 1H), 7.02 (d, 2H), 6.88 (d, 2H), 6.54 (m, 1H), 4.76-4.69 (m, 1H), 4.57-4.55 (m, 1H), 3.64 (m, 1H), 3.55-3.52 (m, 1H), 3.09-3.03 (m, 1H), 3.08 (s, 3H), 2.99-2.95 (m, 1H), 2.98 (s, 3H), 2.32 (m, 1H), 2.01-1.97 (m, 3H), 1.37 (s, 9H).

10 ^{13}C NMR (CDCl_3): $\delta = 172.1, 170.4, 160.6, 157.7, 154.8, 150.3, 133.0, 130.1, 121.3, 110.5, 82.0, 60.7, 53.3, 47.5, 37.1, 36.5, 36.3, 28.9, 27.7, 24.1.$

Example 57

Synthesis of

15 ***N*-(4-Nitrobenzenesulfonyl)-L-prolyl-L-4-(*N,N*-dimethylcarbamoyloxy)phenylalanine**

The title compound was prepared from the product of Example 35 using the procedure described in method 11.

NMR data was as follows:

20 ^1H NMR (CDCl_3): $\delta = 8.36$ (d, 2H), 8.02 (d, 2H), 7.42 (d, 1H), 7.20 (d, 2H), 7.01 (d, 2H), 4.86 (m, 1H), 4.18-4.15 (m, 1H), 3.46-3.43 (m, 1H), 3.32-3.26 (m, 1H), 3.19-3.11 (m, 2H), 3.09 (s, 3H), 3.01 (s, 3H), 1.91 (m, 1H), 1.65-1.54 (m, 3H).

^{13}C NMR (CDCl_3): $\delta = 172.9, 171.7, 155.5, 150.4, 150.4, 142.1, 133.2, 130.5, 129.1, 124.6, 121.8, 61.9, 52.9, 49.6, 36.6, 36.3, 36.3, 30.6, 24.1.$

25

Example 58

Synthesis of

***N*-(4-Cyanobenzenesulfonyl)-L-prolyl-L-4-(*N,N*-dimethylcarbamoyloxy)phenylalanine *tert*-Butyl Ester**

30 The title compound was prepared following the procedure described for the preparation of Example 2 and substitution of appropriate starting materials.

NMR data was as follows:

¹H NMR (CDCl₃): δ = 7.94 (d, 2H), 7.82 (d, 2H), 7.13 (d, 2H), 7.05-6.99 (m, 3H), 4.71-4.66 (m, 1H), 4.12-4.09 (m, 1H), 3.36-3.35 (m, 1H), 3.22-3.11 (m, 2H), 3.07 (s, 3H), 3.06-3.01 (m, 1H), 2.97 (s, 3H), 2.05 (m, 1H), 1.63-1.37 (m, 3H), 1.46 (s, 9H).

5 ¹³C NMR (CDCl₃): δ = 170.1, 169.9, 154.8, 150.6, 140.8, 133.1, 132.9, 130.2, 128.4, 121.7, 117.1, 116.9, 82.7, 62.2, 53.4, 49.4, 37.0, 36.5, 36.3, 30.1, 27.8, 24.1.

Example 59

Synthesis of

10 ***N*-(Toluene-4-sulfonyl)-L-(1,1-dioxothiamorpholin-3-carbonyl)-
L-4-(*N,N*-dimethylaminosulfonyloxy)phenylalanine**

The title compound was prepared from the product of Example 36 using the procedure described in Method 11.

NMR data was as follows:

15 ¹H NMR (CD₃OD): δ = 7.79 (m, 2H), 7.44 (m, 2H), 7.27 (m, 2H), 7.17 (m, 2H), 5.21 (m, 1H), 4.64 (m, 1H), 4.14 (m, 1H), 3.61 (m, 2H), 3.24 (m, 2H), 3.08 (m, 2H), 2.89 (s, 6H), 2.80 (m, 2H), 2.43 (s, 3H).

¹³C NMR (CD₃OD): δ = 173.9, 168.1, 168.0, 150.8, 150.8, 146.7, 146.5, 137.6, 137.5, 137.1, 136.9, 132.2, 132.1, 131.7, 131.6, 128.8, 123.3, 123.1, 57.3, 54.8, 51.0,
20 50.8, 50.5, 47.9, 47.8, 43.2, 43.0, 39.0, 39.0, 37.4, 37.0, 21.5.

Example 60

Synthesis of

25 ***N*-(Toluene-4-sulfonyl)-L-(1,1-dioxothiamorpholin-3-carbonyl)-
L-4-(*N,N*-dimethylcarbamyloxy)phenylalanine**

The title compound was prepared from the product of Example 51 using the procedure described in Method 11.

NMR data was as follows:

30 ¹H NMR (CDCl₃): δ = 7.79 (d, 2H), 7.43 (d, 2H), 7.20 (d, 2H), 7.00 (d, 2H), 5.21 (m, 1H), 4.65 (m, 1H), 4.12 (m, 1H), 3.75 (m, 1H), 3.29 (m, 3H), 3.08 (s, 3H), 3.00 (m, 1H), 3.00 (m, 1H), 2.97 (s, 3H), 2.80 (m, 3H), 2.44 (s, 3H).

^{13}C NMR (CDCl_3): $\delta = 165.1, 159.0, 147.9, 143.1, 137.6, 128.6, 126.1, 122.7, 122.6, 119.8, 114.3, 48.3, 45.8, 41.6, 34.0, 28.0, 27.8, 27.7, 12.5.$

Example 61

Synthesis of

***N*-(Toluene-4-sulfonyl)-L-(1,1-dioxo)thiaprolyl-L-4-(*N,N*-dimethylcarbamyloxy)phenylalanine *tert*-Butyl Ester**

The title compound was prepared from *N*-(toluene-4-sulfonyl)-L-thiaprolyl-L-4-(*N,N*-dimethylcarbamyloxy)phenylalanine *tert*-butyl ester, prepared as per the examples herein, following the procedure described by Larsson and Carlson (*Acta Chemica Scan.* **1994**, 48, 522).

NMR data was as follows:

^1H NMR (CDCl_3): $\delta = 7.77$ (d, 2H), 7.38 (d, 2H), 7.18 (m, 3H), 7.09 (d, 2H), 4.83-4.57 (m, 3H), 3.77-3.60 (m, 2H), 3.36-3.23 (m, 1H), 3.15-3.00 (m, 7H), 2.85-2.73 (m, 1H), 2.46 (s, 3H), 1.50 (s, 9H).

Example 62

Synthesis of

***N*-(4-Fluorobenzenesulfonyl)-L-prolyl-L-4-(*N,N*-dimethylcarbamyloxy)phenylalanine *tert*-Butyl Ester**

The title compound was prepared following the procedure outlined for the preparation of Example 2 and substitution of appropriate starting materials.

NMR data was as follows:

^1H NMR (CDCl_3): $\delta = 7.96$ (d, 2H), 7.80 (d, 2H), 7.26-7.13 (m, 3H), 7.01 (d, 2H), 4.72-4.70 (m, 1H), 4.11-4.08 (m, 1H), 3.40-3.37 (m, 1H), 3.25-3.10 (m, 2H), 3.07 (s, 3H), 3.04-3.02 (m, 1H), 2.98 (s, 3H), 2.06 (m, 1H), 2.06-2.04 (m, 1H), 1.61-1.52 (m, 3H), 1.46 (s, 9H).

^{13}C NMR (CDCl_3): $\delta = 170.3, 169.9, 154.9, 150.6, 139.9, 134.9, 133.1, 130.2, 128.4, 126.5, 121.7, 82.7, 62.3, 5.35, 49.6, 37.2, 36.6, 36.3, 30.0, 27.8, 24.1.$

Example 63

Synthesis of***N*-(1-Methylpyrazolyl-4-sulfonyl)-L-prolyl-L-4-(*N,N*-dimethylcarbamyloxy)phenylalanine**

The title compound was prepared from the product of Example 117 using the procedure described in Method 11.

NMR data was as follows:

¹H NMR (CDCl₃): δ = 8.84 (br s, 1H), 7.93 (s, 1H), 7.79 (s, 1H), 7.68-7.65 (m, 1H), 7.18 (d, 2H), 6.99 (d, 2H), 4.88-4.81 (m, 1H), 4.08-4.06 (m, 1H), 3.92 (s, 3H), 3.45-3.40 (m, 1H), 3.34-3.27 (m, 1H), 3.11-3.01 (m, 5H), 2.97 (s, 3H), 1.82 (m, 1H), 1.66-1.57 (m, 2H), 1.45 (m, 1H).

¹³C NMR (CDCl₃): δ = 173.1, 172.9, 159.1, 158.6, 150.4, 138.8, 133.4, 133.2, 130.3, 121.9, 117.3, 62.0, 53.1, 49.7, 39.4, 36.6, 36.5, 36.4, 30.4, 23.9.

Example 64**Synthesis of*****N*-(Toluene-4-sulfonyl)-L-(1,1-dioxo)thiaprolyl-L-4-(*N,N*-dimethylcarbamyloxy)phenylalanine**

The title compound was prepared from the product of Example 61 using the procedure described in Method 11.

NMR data was as follows:

¹H NMR (CDCl₃): δ = 8.34 (d, 1H), 7.70 (d, 2H), 7.33 (d, 2H), 7.14 (d, 2H), 7.01 (d, 2H), 5.07 (m, 1H), 4.93 (m, 1H), 4.43 (d, 1H), 4.01 (d, 1H), 3.68 (m, 1H), 3.37 (m, 1H), 3.17 (s, 3H), 3.14 (m, 1H), 3.09 (s, 3H), 2.54 (m, 1H), 2.43 (s, 3H).

¹³C NMR (CDCl₃): δ = 171.5, 166.4, 156.4, 150.5, 145.5, 134.2, 134.1, 131.4, 130.3, 128.1, 121.8, 64.3, 59.2, 53.7, 50.5, 36.9, 36.5, 35.8, 21.6.

Example 65**Synthesis of*****N*-(4-Fluorobenzenesulfonyl)-L-thiaprolyl-L-4-(*N,N*-dimethylcarbamyloxy)phenylalanine**

The title compound was prepared from the product of Example 84 using the procedure described in Method 11.

NMR data was as follows:

¹H NMR (CDCl₃): δ = 7.83 (m, 2H), 7.73 (d, 1H), 7.16 (m, 4H), 6.99 (d, 2H),
5 5.57 (br s, 1H), 4.87 (m, 1H), 4.76 (m, 1H), 4.53 (d, 1H), 4.10 (d, 1H), 3.34 (m, 1H),
3.22 (d, 2H), 3.12 (s, 3H), 3.04 (s, 3H), 2.43 (m, 1H).

¹³C NMR (CDCl₃): δ = 172.1, 168.7, 155.7, 150.5, 133.6, 133.1, 130.8, 130.7,
121.7, 116.9, 116.6, 65.3, 53.3, 51.3, 36.8, 36.4, 36.1, 33.4.

10

Example 66

Synthesis of

***N*-(4-Fluorobenzenesulfonyl)-L-(5,5-dimethyl)-
thiaprolyl-L-4-(*N,N*-dimethylcarbamoyloxy)phenylalanine
tert-Butyl Ester**

15

The title compound was prepared following the procedure described for the preparation of Example 2 with the substitution of appropriate starting materials.

NMR data was as follows:

¹H NMR (CDCl₃): δ = 7.91 (m, 2H), 7.26 (m, 4H), 7.02 (d, 2H), 6.96 (d, 1H),
4.75 (m, 1H), 4.55 (d, 1H), 4.42 (d, 1H), 3.86 (s, 1H), 3.08 (s, 3H), 3.05 (m, 2H),
20 3.00 (s, 3H), 1.43 (s, 9H), 1.17 (s, 3H), 1.16 (s, 3H).

¹³C NMR (CDCl₃): δ = 169.9, 168.1, 167.6, 164.2, 154.9, 150.6, 133.1, 132.2,
131.0, 130.9, 130.4, 121.7, 116.9, 116.6, 82.7, 73.5, 54.7, 53.7, 50.5, 37.8, 36.6,
36.4, 29.1, 27.8, 23.8.

25

Example 67

Synthesis of

***N*-(4-Fluorobenzenesulfonyl)-L-(1,1-dioxothiomorpholin-
3-carbonyl)-L-4-(1,1-dioxothiomorpholin-
4-ylcarbonyloxy)phenylalanine *tert*-Butyl Ester**

30

The title compound was prepared following the procedure described for the preparation of Example 68.

NMR data was as follows:

^1H NMR (CDCl_3): $\delta = 7.91\text{-}7.87$ (m, 2H), $7.27\text{-}7.25$ (m, 2H), 7.15 (d, 2H), 6.51 (d, 1H), $4.93\text{-}4.90$ (m, 1H), $4.64\text{-}4.58$ (m, 1H), $4.14\text{-}3.99$ (m, 7H), $3.28\text{-}2.90$ (m, 10H), 1.47 (s, 9H).

5 ^{13}C NMR (CDCl_3): $\delta = 170.1, 167.6, 164.5, 153.1, 149.8, 133.9, 133.4, 130.7, 130.5, 121.7, 117.4, 117.1, 83.1, 56.1, 53.4, 51.6, 49.9, 48.9, 43.1, 41.6, 36.2, 27.8.$

Example 68

Synthesis of

10 ***N*-(Toluene-4-sulfonyl)-L-(1,1-dioxothiomorpholin-3-carbonyl)-L-4-(1,1-dioxothiomorpholin-4-ylcarbonyloxy)phenylalanine *tert*-Butyl Ester**

15 Substituting thiomorpholine for *N*-methylpiperazine, and following the method for the preparation of Example 4 and oxidation of the sulfur group in the thiomorpholino ring per by Larsson and Carlson (*Acta Chemica Scan.* **1994**, 48, 522) gave the title compound as a white solid.

NMR data was as follows:

20 ^1H NMR (CDCl_3): $\delta = 7.75$ (d, 2H), 7.35 (d, 2H), 7.17 (d, 2H), 6.99 (d, 2H), 6.65 (d, 1H), $4.92\text{-}4.90$ (m, 1H), $4.63\text{-}4.60$ (m, 1H), $4.15\text{-}3.95$ (m, 7H), $3.30\text{-}3.23$ (m, 1H), 3.14 (t, 4H), $3.07\text{-}2.80$ (m, 6H), 2.45 (s, 3H), 1.48 (s, 9H).

^{13}C NMR (CDCl_3): $\delta = 169.9, 164.8, 153.1, 149.8, 145.5, 135.1, 133.6, 130.7, 127.5, 121.8, 82.9, 60.3, 56.1, 53.7, 51.8, 49.3, 48.4, 43.1, 42.7, 41.5, 36.3, 27.8, 21.5.$

25

Example 69

Synthesis of

***N*-(4-Fluorobenzenesulfonyl)-L-prolyl-L-4-(thiomorpholin-4-ylcarbonyloxy)phenylalanine *tert*-Butyl Ester**

30 The title compound was prepared following the procedure described in Example 37 and substitution of appropriate starting materials.

NMR data was as follows:

^1H NMR (CDCl_3): $\delta = 7.88-7.83$ (m, 2H), 7.26-7.15 (m, 5H), 7.01 (d, 2H), 4.74-4.67 (m, 1H), 4.08-4.05 (m, 1H), 3.91-3.80 (m, 4H), 3.41-3.35 (m, 1H), 3.24-3.00 (m, 3H), 2.70-2.65 (t, 4H), 2.06-2.04 (m, 1H). 1.60-1.46 (m, 12H).

5 ^{13}C NMR (CDCl_3): $\delta = 170.5, 169.8, 153.4, 150.2, 133.5, 130.7, 130.5, 130.3, 121.6, 116.8, 116.5, 82.6, 62.2, 53.6, 49.6, 47.0, 46.4, 37.2, 29.8, 27.8, 27.3, 27.0, 24.1.$

Example 70

10

Synthesis of

***N*-(4-Fluorobenzenesulfonyl)-L-(5,5-dimethyl)-thiaprolyl-L-4-(*N,N*-dimethylcarbamyloxy)phenylalanine**

The title compound was prepared from the product of Example 66 using the procedure described in Method 11.

15 NMR data was as follows:

^1H NMR (CDCl_3): $\delta = 7.90$ (m, 2H), 7.30-7.14 (m, 5H), 7.02 (d, 2H), 5.83 (br s, 1H), 4.90 (m, 1H), 4.57 (d, 1H), 4.40 (d, 1H), 3.96 (s, 1H), 3.09 (s, 3H), 3.28-3.02 (m, 2H), 3.00 (s, 3H), 1.13 (s, 6H).

20 ^{13}C NMR (CDCl_3): $\delta = 173.2, 169.2, 164.2, 163.9, 155.3, 150.6, 133.1, 132.0, 131.0, 130.9, 130.6, 122.0, 117.0, 116.7, 73.3, 54.6, 53.3, 50.5, 37.0, 36.7, 36.4, 29.0, 23.7.$

Example 71

25

Synthesis of

***N*-(4-Fluorobenzenesulfonyl)-L-(1,1-dioxothiamorpholin-3-carbonyl)-L-4-(morpholin-4-ylcarbonyloxy)phenylalanine**

***tert*-Butyl Ester**

30 Substituting 4-morpholinecarbonyl chloride for dimethylcarbonyl chloride, and following the methods for the preparation of Example 2, gave the title compound as a white solid.

NMR data was as follows:

^1H NMR (CDCl_3): $\delta = 7.91-7.87$ (m, 2H), 7.26-7.20 (m, 2H), 7.11 (d, 2H), 6.98 (d, 2H), 6.43 (d, 1H), 4.95-4.92 (m, 1H), 4.62-4.60 (m, 1H), 4.05-4.00 (m, 2H), 3.74 (t, 4H), 3.66-3.52 (m, 4H), 3.30-2.92 (m, 6H), 1.48 (s, 9H).

^{13}C NMR (CDCl_3): $\delta = 170.1, 164.5, 150.4, 134.6, 132.7, 130.5, 122.0, 117.4,$
5 117.1, 83.1, 66.5, 56.1, 53.4, 49.9, 49.0, 44.7, 44.0, 41.6, 36.2, 27.8.

Example 72

Synthesis of

N-(4-Trifluoromethoxybenzenesulfonyl)-L-prolyl-

L-4-(*N,N*-dimethylcarbamyloxy)phenylalanine *tert*-Butyl Ester

10

The title compound was prepared following the procedure described for the preparation of Example 2 and substitution of appropriate starting materials.

NMR data was as follows:

^1H NMR (CDCl_3): $\delta = 7.89$ (d, 2H), 7.35 (d, 2H), 7.25-7.13 (m, 3H), 7.01 (d,
15 2H), 4.70 (m, 1H), 4.09-4.06 (m, 1H), 3.39-3.36 (m, 1H), 3.24-3.01 (m, 5H), 2.98 (s, 3H), 2.05 (m, 1H), 1.62-1.47 (m, 3H), 1.46 (s, 9H).

^{13}C NMR (CDCl_3): $\delta = 170.4, 169.9, 154.9, 152.7, 150.6, 134.6, 113.2, 130.2,$
130.1, 121.7, 120.2, 82.7, 62.2, 53.6, 49.6, 37.2, 36.6, 36.3, 29.9, 27.8, 24.1.

20

Example 73

Synthesis of

N-(Toluene-4-sulfonyl)-L-(1,1-dioxothiamorpholin-3-carbonyl)-L-4-(*N,N*-dimethylcarbamyloxy)phenylalanine Isopropyl Ester

25

Following the method for the preparation of Example 2 and oxidation of the sulfur group in the thiomorpholino ring per by Larsson and Carlson (*Acta Chemica Scan.* 1994, 48, 522) gave the title compound.

NMR data was as follows:

^1H NMR (CDCl_3): $\delta = 7.70$ (d, 2H), 7.31 (d, 2H), 7.04 (d, 2H), 6.93 (d, 2H),
30 6.59 (d, 1H), 5.01 (m, 2H), 4.65 (m, 1H), 4.01 (d, 1H), 3.90 (d, 1H), 3.25 (m, 1H), 3.00 (s, 3H), 2.82 (m, 8H), 2.37 (s, 3H), 1.22 (s, 3H), 1.20 (s, 3H).

^{13}C NMR (CDCl_3): $\delta = 170.3, 165.0, 154.6, 150.5, 145.1, 135.2, 132.3, 130.4, 130.0, 127.2, 122.1, 69.5, 55.9, 53.1, 49.1, 48.5, 41.4, 36.3, 36.1, 35.9, 21.4.$

Example 74

5

Synthesis of

***N*-(4-Fluorobenzenesulfonyl)-L-(1,1-dioxo-5,5-dimethyl)thiaprolyl-L-4-(*N,N*-dimethylcarbamoyloxy)phenylalanine *tert*-Butyl Ester**

The title compound was prepared from the product of Example 66 following the procedure described by Larsson and Carlson (*Acta Chemica Scan.* **1994**, 48, 522).

10

NMR data was as follows:

^1H NMR (CDCl_3): $\delta = 7.88$ (m, 2H), 7.24 (m, 4H), 7.05 (d, 2H), 6.95 (d, 1H), 4.80 (m, 1H), 4.40 (m, 2H), 4.10 (s, 1H), 3.17-3.03 (m, 2H), 3.10 (s, 3H), 3.01 (s, 3H), 1.47 (s, 9H), 1.36 (s, 3H), 1.11 (s, 3H).

15

^{13}C NMR (CDCl_3): $\delta = 169.8, 168.6, 166.0, 154.5, 150.8, 139.7, 133.0, 131.5, 131.4, 130.3, 122.0, 117.1, 116.8, 83.0, 68.0, 60.9, 59.3, 53.8, 37.4, 36.6, 36.4, 27.8, 18.9, 18.8.$

Example 75

Synthesis of

20

***N*-(Toluene-4-sulfonyl)-L-(1,1-dioxo-5,5-dimethyl)thiaprolyl-L-4-(*N,N*-dimethylcarbamoyloxy)phenylalanine Isopropyl Ester**

The title compound was prepared from the product of Example 11 following the procedure described by Larsson and Carlson (*Acta Chemica Scan.* **1994**, 48, 522).

NMR data was as follows:

25

^1H NMR (CDCl_3): $\delta = 7.75$ (d, 2H), 7.38 (d, 2H), 7.21 (d, 2H), 7.03 (m, 3H), 5.08 (m, 1H), 4.89 (m, 1H), 4.38 (m, 2H), 4.10 (s, 1H), 3.22-3.04 (m, 2H), 3.10 (s, 3H), 3.00 (s, 3H), 2.43 (s, 3H), 1.26 (m, 9H), 1.09 (s, 3H).

30

^{13}C NMR (CDCl_3): $\delta = 170.3, 166.3, 150.8, 145.9, 132.8, 131.9, 130.3, 128.6, 122.0, 69.8, 68.0, 60.9, 59.4, 53.4, 37.4, 36.6, 36.4, 21.6, 21.5, 19.2, 18.6.$

Example 76

Synthesis of***N*-(4-Fluorobenzenesulfonyl)-L-(5,5-dimethyl)thiaprolyl-
L-4-(*N,N*-dimethylcarbamyloxy)phenylalanine**

The title compound was prepared from the product of Example 74 using the
5 procedure described in Method 11.

NMR data was as follows:

¹³C NMR (CDCl₃): δ = 171.7, 167.9, 137.3, 164.5, 155.9, 150.4, 133.6, 131.8,
131.3, 131.2, 130.8, 121.9, 117.1, 116.8, 67.8, 60.9, 59.9, 53.8, 36.8, 36.6, 36.0,
19.1, 19.0.

10

Example 77**Synthesis of*****N*-(Pyrimidine-2-sulfonyl)-L-prolyl-L-4-
(*N,N*-dimethylcarbamyloxy)phenylalanine**

15 The title compound was prepared from the product of Preparative Example B
using the procedure described in Method 11.

NMR data was as follows:

¹H NMR (CDCl₃): δ = 8.45 (br m, 2H), 8.22 (br s, 1H), 7.55 (d, 1H), 7.11 (d,
2H), 6.95 (d, 2H), 6.81 (m, 1H), 4.80-4.74 (m, 2H), 3.70 (m, 1H), 3.55 (m, 1H),
20 3.20-3.08 (m, 4H), 2.98 (s, 3H), 2.89-2.76 (m, 1H), 2.13-1.96 (m, 3H), 1.60 (m, 1H).

¹³C NMR (CDCl₃): δ = 190.0, 173.6, 171.0, 155.2, 153.9, 150.6, 133.2, 130.1,
121.9, 110.3, 62.0, 55.1, 48.2, 36.6, 36.6, 36.3, 30.2, 23.4.

Example 78

25

Synthesis of***N*-(Toluene-4-sulfonyl)-L-(1,1-dioxothiamorpholin-3-
carbonyl)-L-4-(4-methylpiperazin-1-ylcarbonyloxy)phenylalanine
tert-Butyl Ester**

Following the method for the preparation of Example 4 and oxidation of the
30 sulfur group in the thiamorpholino ring per Larsson and Carlson (*Acta Chemica
Scan.* 1994, 48, 522) gave the title compound.

NMR data was as follows:

^1H NMR (CDCl_3): $\delta = 7.76$ (d, 2H), 7.37 (d, 2H), 7.12 (d, 2H), 6.96 (d, 2H), 6.57 (d, 1H), 4.95 (m, 1H), 4.62 (m, 1H), 4.03 (m, 2H), 3.67 (m, 4H), 3.25 (m, 1H), 2.89 (m, 4H), 2.45 (m, 6H), 2.35 (s, 3H), 1.48 (s, 9H).

5 ^{13}C NMR (CDCl_3): $\delta = 170.0, 164.8, 153.7, 150.5, 145.4, 135.3, 132.8, 130.7, 130.4, 127.5, 122.2, 82.9, 56.2, 54.6, 54.5, 53.6, 49.5, 48.6, 46.0, 44.2, 43.7, 41.6, 36.3, 27.9, 21.6.$

Example 79

10

Synthesis of

N-(4-Fluorobenzenesulfonyl)-L-

(1,1-dioxo)thiaprolyl-L-4-(*N,N*-dimethylcarbamyloxy)phenylalanine

The title compound was prepared from the product of Example 85 using the procedure described in Method 11.

15

NMR data was as follows:

^1H NMR (CDCl_3): $\delta = 4.98$, (m, 1H), 4.90 (m, 1H), 4.44 (d, 1H), 4.03 (d, 1H), 3.67 (m, 1H), 3.37(m, 1H), 3.25-3.02 (m, 1H), 3.20 (s, 3H), 3.11 (s, 3H), 2.68 (m, 1H).

20

^{13}C NMR (CDCl_3): $\delta = 171.7, 167.9, 166.3, 164.4, 157.0, 156.4, 150.5, 139.6, 134.0, 133.1, 131.3, 131.1, 130.9, 121.9, 117.2, 116.9, 64.1, 58.8, 53.7, 50.6, 36.9, 36.5, 35.6.$

Example 80

Synthesis of

25

N-(Toluene-4-sulfonyl)-L-prolyl-L-4-

(isonipecotoxy)phenylalanine *tert*-Butyl Ester

Substituting piperazine for *N*-methylpiperazine, and following the methods for the preparation of Example 4, gave the title compound as a white solid.

NMR data was as follows:

30

^{13}C NMR (CDCl_3): $\delta = 7.70$ (d, 2H), 7.32-7.26 (m, 2H), 7.14 (d, 2H), 7.01 (d, 2H), 4.72-4.68 (m, 1H), 4.07-4.05 (m, 1H), 3.60-3.49 (m, 4H), 3.37-3.31 (m, 1H),

3.22-2.98 (m, 3H), 2.42 (s, 3H), 2.02 (m, 2H), 1.61-1.55 (m, 6H), 1.50-1.45 (m, 13H).

¹³C NMR (CDCl₃): δ = 177.3, 170.7, 169.8, 150.6, 144.3, 133.1, 130.1, 129.9, 127.9, 121.6, 110.8, 82.5, 62.2, 57.2, 53.7, 49.5, 44.9, 37.2, 29.7, 27.8, 25.7, 24.1, 21.4.

Example 81

Synthesis of

N-(Toluene-4-sulfonyl)-L-prolyl-L-4-

(1,1-dioxothiomorpholin-4-ylcarbonyloxy)phenylalanine

tert-Butyl Ester

The product of Example 82 was oxidized by the method of Larsson and Carlson (*Acta Chemica Scan.* 1994, 48, 517-525), yielding the title compound as a white solid.

NMR data was as follows:

¹H NMR (CDCl₃): δ = 7.69 (d, 2H), 7.33-7.29 (m, 3H), 7.20 (d, 2H), 7.00 (d, 2H), 4.71-4.66 (m, 1H), 4.13-4.04 (m, 5H), 3.37-3.32 (m, 1H), 3.21-3.00 (m, 7H), 2.41 (s, 3H), 2.05-2.01 (m, 1H), 1.52-1.44 (m, 12H).

¹³C NMR (CDCl₃): δ = 170.7, 169.7, 149.8, 144.3, 134.4, 133.3, 130.6, 130.0, 127.9, 121.4, 82.7, 62.4, 54.0, 52.1, 49.7, 43.2, 37.6, 29.7, 28.1, 24.4, 21.7.

Example 82

Synthesis of

N-(Toluene-4-sulfonyl)-L-prolyl-L-4-

(thiomorpholin-4-ylcarbonyloxy)phenylalanine *tert*-Butyl Ester

Substituting thiomorpholine for *N*-methylpiperazine, and following the methods for the preparation of Example 4, gave the title compound as a white solid.

NMR data was as follows:

¹³C NMR (CDCl₃): δ = 7.70 (d, 2H), 7.31-7.26 (m, 2H), 7.16 (d, 2H), 7.00 (d, 2H), 4.72-4.66 (m, 1H), 4.07-4.04 (m, 1H), 3.89-3.79 (m, 4H), 3.37-3.32 (m, 1H), 3.22-2.99 (m, 3H), 2.67 (t, 4H), 2.42 (s, 3H), 2.02 (m, 2H), 1.50-1.45 (m, 12H).

^{13}C NMR (CDCl_3): $\delta = 177.2, 170.7, 169.8, 153.5, 150.2, 144.3, 133.6, 132.9, 130.3, 129.9, 127.9, 121.5, 82.5, 62.4, 53.7, 49.5, 47.0, 46.4, 37.2, 29.6, 27.8, 27.3, 24.1, 21.4.$

5

Example 83

Synthesis of

***N*-(Toluene-4-sulfonyl)-L-prolyl-L-4-(pyrrolidin-1-ylcarbonyloxy)phenylalanine *tert*-Butyl Ester**

Substituting pyrrolidinecarbonyl chloride for dimethylcarbonyl chloride, and following the methods for the preparation of Example 2, gave the title compound as a white solid.

NMR data was as follows:

^1H NMR (CDCl_3): $\delta = 7.71$ (d, 2H), 7.32 (d, 2H), 7.15 (d, 2H), 7.04 (d, 2H), 4.73 - 4.67 (m, 1H), 4.07 - 4.04 (m, 1H), 3.53 (t, 2H), 3.45 (t, 2H), 3.36 - 3.32 (m, 1H), 3.24 - 2.98 (m, 3H), 2.42 (s, 3H), 2.03 - 1.88 (m, 5H), 1.75 (s, 1H), 1.52 (1.24 (m, 12H).

15

^{13}C NMR (CDCl_3): $\delta = 170.7, 169.8, 153.1, 150.4, 144.3, 133.1, 130.1, 129.9, 127.9, 121.6, 110.8, 99.8, 82.5, 62.2, 53.7, 49.5, 46.3, 37.2, 29.7, 27.8, 25.6, 24.8, 24.0, 21.4.$

20

Example 84

Synthesis of

***N*-(4-Fluorobenzenesulfonyl)-L-thiaprolyl-L-4-(*N,N*-dimethylcarbamyloxy)phenylalanine *tert*-Butyl Ester**

The title compound was prepared following the procedures described for the preparation of Example 2 and substitution of appropriate starting materials.

NMR data was as follows:

^1H NMR (CDCl_3): $\delta = 7.87$ (m, 2H), 7.28 - 7.13 (m, 5H), 7.02 (d, 2H), 4.70 - 4.60 (m, 2H), 4.58 (d, 1H), 4.06 (d, 1H), 3.38 - 3.01 (m, 3H), 3.09 (s, 3H), 3.00 (s, 3H), 2.58 (m, 1H), 1.47 (s, 9H).

30

^{13}C NMR (CDCl_3): $\delta = 169.7, 167.8, 154.9, 150.7, 132.7, 130.9, 130.7, 130.4, 121.8, 117.1, 116.8, 82.9, 65.1, 53.9, 51.4, 36.8, 36.6, 36.4, 33.1, 27.9.$

Example 85

Synthesis of

***N*-(4-Fluorobenzenesulfonyl)-L-(1,1-dioxo)thiaprolyl-
L-4-(*N,N*-dimethylcarbamyloxy)phenylalanine *tert*-Butyl Ester**

The title compound was prepared from the product of Example 84 following the procedure oxidation procedure of Larsson and Carlson (*Acta Chemica Scan.* 1994, 48, 517-525).

NMR data was as follows:

^1H NMR (CDCl_3): $\delta = 7.90$ (m, 2H), 7.30-7.04 (m, 7H), 4.83-4.58 (m, 3H), 3.66 (m, 2H), 3.32-3.24 (m, 1H), 3.09-2.85 (m, 2H), 3.10 (s, 3H), 3.01 (s, 3H), 1.50 (s, 9H).

^{13}C NMR (CDCl_3): $\delta = 173.1, 169.8, 168.0, 165.6, 154.9, 150.9, 132.6, 131.1, 131.0, 130.3, 122.3, 117.3, 117.0, 83.2, 62.8, 57.8, 53.9, 49.0, 36.8, 36.6, 36.4, 27.9.$

Example 86

Synthesis of

***N*-(2,5-Dichlorothiophene-3-sulfonyl)-L-prolyl-
L-4-(*N,N*-dimethylcarbamyloxy)phenylalanine *tert*-Butyl Ester**

The title compound was prepared following the procedure described for the preparation of Example 2 and substitution of appropriate starting materials.

NMR data was as follows:

^1H NMR (CDCl_3): $\delta = 7.14$ (d, 2H), 7.09 (s, 1H), 7.07 (d, 1H), 7.01 (d, 2H), 4.73-4.66 (m, 1H), 4.32-4.28 (m, 1H), 3.42-3.17 (m, 3H), 3.08 (s, 3H), 3.06-3.01 (m, 1H), 2.98 (s, 3H), 2.17-2.04 (m, 1H), 1.84-1.60 (m, 2H), 1.60-1.46 (m, 1H), 1.45 (s, 9H).

^{13}C NMR (CDCl_3): $\delta = 170.2, 169.9, 154.9, 150.6, 133.4, 133.1, 131.2, 130.2, 127.9, 127.0, 121.7, 82.7, 62.2, 53.6, 49.3, 37.2, 36.6, 36.4, 30.1, 27.8, 24.2.$

Example 87

Synthesis of***N*-(4-Acetamidobenzenesulfonyl)-L-prolyl-****L-4-(*N,N*-dimethylcarbamyloxy)phenylalanine *tert*-Butyl Ester**

5 The title compound was prepared following the procedure described for the preparation of Example 2 and substitution of appropriate starting materials.

NMR data was as follows:

¹H NMR (CDCl₃): δ = 8.58 (s, 1H), 7.70-7.67 (m, 4H), 7.32 (d, 1H), 7.14 (d, 2H), 7.01 (d, 2H), 4.68 (m, 1H), 3.99 (m, 1H), 3.37-3.34 (m, 1H), 3.23-3.16 (m, 1H),
10 3.11-3.01 (m, 1H), 3.08 (s, 3H), 2.98 (s, 3H), 2.13 (s, 3H), 1.97-1.94 (m, 1H), 1.55-1.47 (m, 3H), 1.44 (s, 9H).

¹³C NMR (CDCl₃): δ = 171.1, 169.9, 169.4, 155.0, 150.6, 143.3, 133.3, 130.2, 130.0, 128.9, 121.7, 119.4, 82.7, 62.2, 53.8, 49.6, 37.2, 36.6, 36.4, 29.9, 27.8, 24.4, 24.1.

15

Example 88

Synthesis of***N*-(4-*tert*-Butylbenzenesulfonyl)-L-(1,1-dioxothiamorpholin-****3-carbonyl)-L-4-(*N,N*-dimethylcarbamyloxy)phenylalanine*****tert*-Butyl Ester**

20

The title compound was prepared following the procedure outlined for the preparation of Example 73 and substitution of appropriate starting materials.

NMR data was as follows:

¹H NMR (CDCl₃): δ = 7.81 (d, 2H), 7.59 (d, 2H), 7.07 (d, 2H), 6.97 (d, 2H),
25 6.46 (d, 1H), 4.95 (m, 1H), 4.62 (m, 1H), 4.06 (m, 2H), 3.23 (m, 1H), 3.07 (m, 4H), 2.97 (m, 4H), 2.81 (m, 4H), 1.55 (s, 9H), 1.37 (s, 9H).

¹³C NMR (CDCl₃): δ = 170.0, 164.9, 158.2, 154.8, 150.6, 135.0, 132.6, 130.2, 127.4, 126.9, 122.2, 82.7, 56.1, 53.5, 49.7, 48.8, 41.5, 36.5, 36.3, 36.1, 35.2, 30.8, 27.8.

30

Example 89

Synthesis of
***N*-(Pyridine-3-sulfonyl)-*L*-prolyl-**
***L*-4-(*N,N*-dimethylcarbamyloxy)phenylalanine**

The title compound was prepared from the product of Example 56 using the
5 procedure described in Method 11.

NMR data was as follows:

¹H NMR (CD₃OD): δ = 8.95 (s, 1H), 8.83 (d, 1H), 8.28-8.24 (m, 1H), 7.73-7.69
(m, 1H), 7.30 (d, 2H), 7.05 (d, 2H), 4.68-4.63 (m, 1H), 4.29-4.25 (m, 1H), 3.47-3.41
(m, 1H), 3.38-3.22 (m, 2H), 3.09 (s, 3H), 3.06-3.02 (m, 1H), 2.96 (s, 3H), 1.92-1.66
10 (m, 4H).

¹³C NMR (CD₃OD): δ = 174.2, 173.9, 160.6, 160.0, 156.9, 152.9, 152.0, 147.9,
139.1, 136.9, 135.7, 131.6, 126.5, 123.1, 63.1, 54.8, 50.4, 37.5, 36.8, 36.7, 32.2,
25.5.

15

Example 90

Synthesis of

***N*-(2-Fluorobenzenesulfonyl)-*L*-(1,1-dioxothiamorpholin-**
3-carbonyl)-*L*-4-(*N,N*-dimethylcarbamyloxy)phenylalanine
***tert*-Butyl Ester**

20 *L*-Thiamorpholine-3-carboxylic acid was prepared by the method of Larsson
and Carlson (*Acta Chemica Scan.* **1994**, 48, 517-525). *N*-(2-fluorobenzene-4-
sulfonyl)-*L*-thiamorpholine-3-carboxylic acid was prepared using the procedure
described in Method 1. The title compound was prepared according to the
procedures set forth above using suitable starting materials.

25

NMR data was as follows:

¹H NMR (CDCl₃): δ = 7.92 (m, 1H), 7.69 (m, 1H), 7.34 (m, 2H), 7.16 (m, 2H),
6.99 (m, 2H), 6.60 (d, 1H), 5.01 (m, 1H), 4.64 (m, 1H), 4.03 (m, 2H), 3.29 (m, 1H),
3.06 (m, 6H), 2.90 (m, 7H), 1.49 (d, 9H).

¹³C NMR (CDCl₃): δ = 169.9, 164.8, 160.3, 156.9, 154.9, 150.7, 136.6, 136.4,
30 132.7, 131.0, 130.3, 128.8, 126.4, 126.2, 125.1, 122.2, 118.1, 117.8, 82.7, 56.3, 56.7,
50.2, 49.5, 41.8, 36.5, 36.3, 27.8.

Example 91

Synthesis of

***N*-(3-Fluorobenzenesulfonyl)-L-(1,1-dioxothiamorpholin-
3-carbonyl)-L-4-(*N,N*-dimethylcarbamyloxy)phenylalanine
tert-Butyl Ester**

5 L-Thiamorpholine-5-carboxylic acid was prepared by the method of Larsson and Carlson (*Acta Chemica Scan.* 1994, 48, 517-525). *N*-(3-fluorobenzene-4-sulfonyl)-L-thiamorpholine-5-carboxylic acid was prepared using the procedure
10 described in Method 1. The title compound was prepared according to the procedures set forth above using suitable starting materials.

NMR data was as follows:

¹H NMR (CDCl₃): δ = 7.66 (m, 1H), 7.58 (m, 2H), 7.34 (m, 1H), 7.07 (d, 1H),
6.92 (d, 1H), 6.42 (d, 1H), 5.00 (m, 1H), 4.58 (m, 1H), 4.02 (m, 2H), 3.22 (m, 1H),
15 3.05 (s, 3H), 2.98 (m, 6H), 1.45 (s, 9H).

¹³C NMR (CDCl₃): δ = 170.0, 164.5, 164.4, 161.0, 154.9, 150.6, 140.3, 140.2,
132.5, 131.9, 131.8, 130.2, 123.2, 123.1, 122.2, 121.4, 121.2, 115.0, 114.7, 82.9,
56.1, 53.4, 49.9, 49.1, 41.7, 36.5, 36.3, 36.0, 27.8.

Example 92

Synthesis of

***N*-(2,4-Difluorobenzenesulfonyl)-L-(1,1-dioxothiamorpholin-
3-carbonyl)-L-4-(*N,N*-dimethylcarbamyloxy)phenylalanine
tert-Butyl Ester**

25 L-Thiamorpholine-5-carboxylic acid was prepared by the method of Larsson and Carlson (*Acta Chemica Scan.* 1994, 48, 517-525). *N*-(2,4-difluorobenzene-4-sulfonyl)-L-thiamorpholine-5-carboxylic acid was prepared using the procedure
described in Method 1. The title compound was prepared according to the
procedures set forth above using suitable starting materials.

30 NMR data was as follows:

¹H NMR (CDCl₃): δ = 7.93 (m, 1H), 7.15 (m, 2H), 7.04 (m, 4H), 6.53 (d, 1H), 4.97 (m, 1H), 4.64 (m, 1H), 4.05 (m, 2H), 3.21 (m, 3H), 3.17 (s, 3H), 2.97 (m, 5H), 1.43 (s, 9H).

¹³C NMR (CDCl₃): δ = 170.0, 164.6, 154.9, 150.7, 132.6, 132.6, 130.3, 122.6, 122.1, 112.6, 112.3, 107.0, 106.7, 106.3, 82.8, 56.3, 53.5, 50.5, 49.8, 42.0, 36.5, 36.3, 27.8.

Example 93

Synthesis of

N-(4-Acetamidobenzenesulfonyl)-L-prolyl-L-4-(*N,N*-dimethylcarbamyloxy)phenylalanine

The title compound was prepared from the product of Example 87 using the procedure described in Method 11.

NMR data was as follows:

¹H NMR (CD₃OD): δ = 8.05 (d, 1H), 7.78 (m, 4H), 7.26 (d, 2H), 7.02 (d, 2H), 4.94 (m, 1H), 4.72-4.67 (m, 1H), 4.13-4.09 (m, 1H), 3.40-3.36 (m, 1H), 3.30-3.05 (m, 3H), 3.08 (s, 3H), 2.97 (s, 3H), 2.15 (s, 3H), 1.81-1.51 (m, 4H).

¹³C NMR (CD₃OD): δ = 174.3, 174.2, 172.3, 156.9, 152.0, 144.9, 135.5, 132.4, 131.6, 130.2, 122.9, 120.7, 63.2, 54.7, 50.6, 37.5, 36.8, 36.7, 31.7, 25.4, 24.0.

Example 94

Synthesis of

N-(4-Trifluoromethoxybenzenesulfonyl)-L-prolyl-L-4-(*N,N*-dimethylcarbamyloxy)phenylalanine

The title compound was prepared from the product of Example 72 using the procedure described in Method 11.

NMR data was as follows:

¹H NMR (CD₃OD): δ = 7.93 (d, 2H), 7.48 (d, 2H), 7.28 (d, 2H), 7.03 (d, 2H), 4.72-4.68 (m, 1H), 4.17-4.13 (m, 1H), 3.45-3.42 (m, 1H), 3.28-3.11 (m, 2H), 3.14-3.07 (m, 1H), 3.09 (s, 3H), 2.97 (s, 3H), 1.85-1.69 (m, 3H), 1.59 (m, 1H).

^{13}C NMR (CD_3OD): $\delta = 174.2, 174.1, 157.0, 153.9, 152.0, 137.3, 135.6, 131.7, 131.5, 123.0, 122.5, 121.8, 63.1, 54.7, 50.6, 37.4, 36.8, 36.6, 31.9, 25.4.$

Example 95

5

Synthesis of

***N*-(4-Fluorobenzenesulfonyl)-L-(5,5-dimethyl)thiaprolyl-
L-4-(*N,N*-dimethylcarbamyloxy)phenylalanine *tert*-Butyl Ester**

The title compound was prepared using the procedure described in Example 2 and substitution of appropriate starting materials.

10

NMR data was as follows:

^1H NMR (CDCl_3): $\delta = 7.90$ (m, 2H), 7.22 (m, 4H), 7.00 (m, 3H), 5.08 (m, 1H), 4.84 (m, 1H), 4.56 (d, 1H), 4.42 (d, 1H), 3.88 (s, 1H), 3.15-2.99 (m, 2H), 3.09 (s, 3H), 3.00 (s, 3H), 1.26-1.16 (m, 12H).

15

^{13}C NMR (CDCl_3): $\delta = 170.4, 168.2, 167.5, 164.1, 154.9, 150.7, 132.8, 132.2, 132.1, 131.0, 130.8, 130.3, 121.8, 116.9, 116.6, 73.5, 69.6, 54.6, 53.2, 50.5, 37.6, 36.6, 36.3, 29.1, 23.8, 21.6, 21.5.$

Example 96

Synthesis of

20

***N*-(4-Cyanobenzenesulfonyl)-L-prolyl-
L-4-(*N,N*-dimethylcarbamyloxy)phenylalanine**

The title compound was prepared from the product of Example 58 using the procedure described in Method 11.

NMR data was as follows:

25

^1H NMR (CD_3OD): $\delta = 8.14$ (d, 1H), 7.94-7.89 (m, 4H), 7.29 (d, 2H), 7.03 (d, 2H), 4.70-4.66 (m, 1H), 4.21-4.17 (m, 1H), 3.47-3.40 (m, 1H), 3.31-3.21 (m, 2H), 3.11-3.04 (m, 1H), 3.09 (s, 3H), 2.97 (s, 3H), 1.87-1.72 (m, 3H), 1.70-1.61 (m, 1H).

^{13}C NMR (CD_3OD): $\delta = 174.2, 173.9, 157.0, 152.0, 142.9, 135.7, 134.5, 131.7, 129.7, 123.0, 118.6, 111.8, 63.0, 54.7, 50.5, 37.4, 36.8, 36.7, 32.0, 25.4.$

30

Example 97

Synthesis of***N*-(Toluene-4-sulfonyl)-*L*-(3,3-dimethyl)prolyl-*****L*-4-(*N,N*-dimethylcarbamyloxy)phenylalanine *tert*-Butyl Ester**

The title compound was prepared using the procedure described for the
5 preparation of Example 98.

NMR data was as follows:

¹H NMR (CDCl₃): δ = 7.76 (d, 1H), 7.75 (d, 1H), 7.35 (d, 1H), 7.34 (d, 1H),
7.33 (d, 1H), 7.20 (d, 1H), 7.10 (d, 1H), 7.03 (d, 1H), 6.91 (d, 0.5H), 6.08 (d, 0.5H),
4.86 (ddd, 0.5H), 4.77 (q, 0.5H), 3.61 -3.47 (m, 2H), 3.27-3.02 (m, 3H), 3.09 (s, 3H),
10 3.00 (s, 3H), 2.45 (s, 1.5H), 2.43 (s, 1.5H), 1.75-1.68 (m, 0.5H), 1.61-1.51 (m,
0.5H), 1.45 (s, 4.5H), 1.40 (s, 4.5H), 1.48-1.25 (m, 3H); 0.95 (s, 1.5H), 0.80 (s,
1.5H); 0.61 (s, 1.5H).

¹³C NMR (CDCl₃): δ = 170.4, 170.1, 170.0, 169.6, 155.0, 154.9, 150.7, 150.6,
144.3, 144.2, 133.4, 133.1, 132.8, 132.6, 130.7, 130.2, 129.9, 129.8, 128.0, 121.8,
15 121.7, 82.6, 82.2, 71.5, 71.2, 53.6, 52.7, 47.3, 47.2, 42.7, 42.5, 38.2, 38.1, 37.7, 37.5,
36.6, 36.3, 27.8, 27.8, 27.2, 23.4, 23.2, 21.5.

Example 98**Synthesis of*****N*-(Toluene-4-sulfonyl)-*L*-(3,3-dimethyl)prolyl-*****L*-4-(*N,N*-dimethylcarbamyloxy)phenylalanine Isopropyl Ester**

3,3-Dimethyl proline (see Sharma and Lubell, *J. Org. Chem.* 1996, 61, 202-209)
was N-tosylated using the procedure described in Method 1. The title compound
was then prepared following the procedure described for the preparation of Example
25 2.

NMR data was as follows:

¹H NMR (CDCl₃): δ = 7.76 (d, 1H), 7.74 (d, 1H), 7.36 (d, 1H), 7.33 (d, 2H),
7.19 (d, 1H), 7.10 (d, 1H), 7.03 (d, 1H), 6.91 (d, 0.5H), 6.89 (d, 0.5H), 5.06 (sept.,
0.5H), 4.96 (sept., 0.5H), 4.98-4.83 (m, 1H), 3.59-3.48 (m, 2H), 3.31-3.03 (m, 3H),
30 3.09 (s, 3H), 3.00 (s, 3H), 2.45 (s, 1.5H), 2.43 (s, 1.5H), 1.75-1.66 (m, 0.5), 1.62-

1.52 (m, 0.5H), 1.34-1.22 (m, 3H), 1.27 (s, 1.5H), 1.25 (s, 1.5H), 1.22 (s, 1.5H), 1.20 (s, 1.5H), 0.95 (s, 1.5H), 0.78 (s, 1.5H), 0.60 (s, 1.5H), 0.57 (s, 1.5H).

¹³C NMR (CDCl₃): δ = 170.8, 170.6, 170.0, 169.7, 154.9, 150.8, 150.6, 144.4, 144.2, 133.2, 132.5, 132.5, 130.7, 130.2, 129.9, 129.8, 128.0, 122.0, 121.8, 71.5, 17.2, 69.5, 69.3, 53.0, 52.2, 47.3, 47.2, 42.8, 42.5, 38.2, 38.1, 37.6, 37.2, 36.6, 36.3, 27.1, 23.4, 23.2, 21.6, 21.6, 21.5, 21.5.

Other compounds prepared by the methods described above include those set forth in Examples 99-137 in Table II below. In addition, Examples 101, 109, 111, 117, 132 and 137 found in Table II are exemplified as follows:

Example 101

Synthesis of

N-(Toluene-4-sulfonyl)-L-prolyl-

4-(*N,N*-dimethylcarbamyloxy)-L-phenylalanine

Isopropyl Ester

The title compound was prepared following the procedure outlined for the preparation of Example 2.

NMR data was as follows:

¹H NMR (CD₃)₂SO: δ = 8.28 (d, 1H), 7.70 (d, 2H), 7.41 (d, 2H), 7.23 (d, 2H), 6.99 (d, 2H), 4.86 (sept, 1H), 4.47 (m, 1H), 4.40 (m, 1H), 4.10 (m, 1H), 4.07 (m, 1H), 3.38 (m, 1H), 3.30 (m, 1H), 3.09 (m, 3H), 2.95 (s, 3H), 3.00 (s, 3H), 2.88 (s, 3H), 2.39 (s, 3H), 1.63 (m, 3H), 1.51 (m, 3H), 1.44 (m, 1H), 1.39 (m, 1H), 1.16 (d, 3H), 1.11 (d, 3H).

¹³C NMR (CD₃)₂SO: δ = 171.3, 170.8, 154.2, 150.2, 143.7, 134.1, 130.2, 130, 127.6, 121.6, 68.2, 61.2, 53.5, 49, 36.3, 36.1, 35.7, 30.5, 23.8, 21.4, 21.4, 21.

Example 109

Synthesis of

N-(Benzylsulfonyl)-L-(5,5-dimethyl)

thiaprolyl-L-(4-*N,N*-dimethylcarbamyloxy)phenylalanine

The title compound was prepared from the product of Example 111 using the procedure described in Method 11.

Physical data was as follows:

MS (FAB) (M+H)⁺ 550.

5 Calcd. for: C₂₅H₃₁N₃O₇S₂; C, 54.62; H, 5.68; N 7.64.

Found: C 54.51; H 5.60; N 7.63.

Example 111

Synthesis of

10 **N-(Benzylsulfonyl)-L-(5,5-dimethyl) thiaproyl-L-(4-N,N-dimethylcarbamoyloxy)phenylalanine *tert*-Butyl Ester**

The title compound was prepared following the procedure outlined for the preparation of Example 2 and by substituting the appropriate starting materials.

Physical data was as follows:

15 MS [M+H]⁺ 550.

Calcd. for: C₂₉H₃₉N₃O₇S₂; C, 57.52; H, 6.45; N, 6.94.

Found: C, 57.32; H, 6.52; N, 6.81.

Example 117

20 **Synthesis of**

***N*-(Methyl-pyrazole-4-sulfonyl)-L-proyl-L-(4-*N,N*-dimethylcarbamoyloxy)phenylalanine *tert*-Butyl Ester**

25 Substituting *N*-methyl-pyrazole sulfonyl chloride (see Dickson, US 3,665,009 (May 23, 1972) and following the method for the preparation of Example 56, gave the title compound.

NMR data was as follows:

¹H NMR (CDCl₃): δ = 7.83 (s, 1H), 7.76 (s, 1H), 7.26 (m, 1H), 7.15 (m, 2H), 7.00 (m, 2H), 4.69 (m, 1H), 3.95 (m, 1H), 3.93 (s, 3H), 3.38 (m, 1H), 3.23-3.11 (m, 30 1H), 3.10-2.99 (m, 4H), 2.99 (s, 3H), 2.05 (m, 1H), 1.66-1.46 (m, 3H), 1.44 (s, 9H).

^{13}C NMR (CDCl_3): δ 170.7, 169.9, 154.9, 150.6, 138.9, 133.2, 132.5, 130.2, 121.7, 117.9, 82.6, 62.4, 53.7, 49.7, 39.6, 37.7, 36.6, 36.4, 29.9, 27.9, 24.2.

Example 132

5

Synthesis of

***N*-(4-Fluorobenzenesulfonyl)-L-prolyl-L-
4-(1,1-dioxothiomorpholin-4-ylcarbonyloxy)-
phenylalanine *tert*-Butyl Ester**

Substituting thiamorpholine for *N*-methylpiperazine, and following the method
10 for the preparation of Example 4 and 14, gave the title compound.

NMR data was as follows:

^1H NMR (CDCl_3): δ = 7.87-7.82 (m, 2H), 7.28-7.17 (m, 5H), 7.01 (d, 2H), 4.71-
4.69 (m, 1H), 4.14-4.05 (m, 5H), 3.39-3.36 (m, 1H), 3.23-3.01 (m, 7H), 2.05-2.03
(m, 1H), 1.58-1.44 (m, 12H).

15 ^{13}C NMR (CDCl_3): δ = 170.4, 169.8, 153.0, 149.7, 134.2, 130.6, 130.5, 121.3,
116.8, 116.5, 82.6, 62.1, 53.6, 51.8, 49.5, 43.1, 42.7, 37.2, 29.7, 27.8, 24.2.

Example 137

20

Synthesis of

***N*-(Methyl-pyrazole-4-sulfonyl)-
L-prolyl-L-(4-*N,N*-dimethylcarbamyloxy)-
phenylalanine Isopropyl Ester**

The title compound was prepared following the procedure described for the
preparation of Example 117.

25

NMR data was as follows:

^1H NMR (CDCl_3): δ 7.83 (s, 1H), 7.76 (s, 1H), 7.27 (d, 1H), 7.13 (d, 2H), 7.01
(d, 2H), 5.06-5.02 (m, 1H), 4.80-4.73 (m, 1H), 3.97-3.94 (m, 1H), 3.93 (s, 3H), 3.44-
3.37 (m, 1H), 3.25-3.19 (m, 1H), 3.09-3.00 (m, 5H), 2.97 (s, 3H), 2.06-2.02 (m, 1H),
1.66-1.48 (m, 3H), 1.23 (d, 6H).

30

^{13}C NMR (CDCl_3): δ 170.8, 170.5, 154.9, 150.6, 138.9, 132.9, 32.5, 130.2,
121.7, 117.8, 69.5, 62.3, 53.2, 49.7, 39.6, 37.1, 36.6, 36.3, 29.9, 24.1, 21.6, 21.5.

Table 4

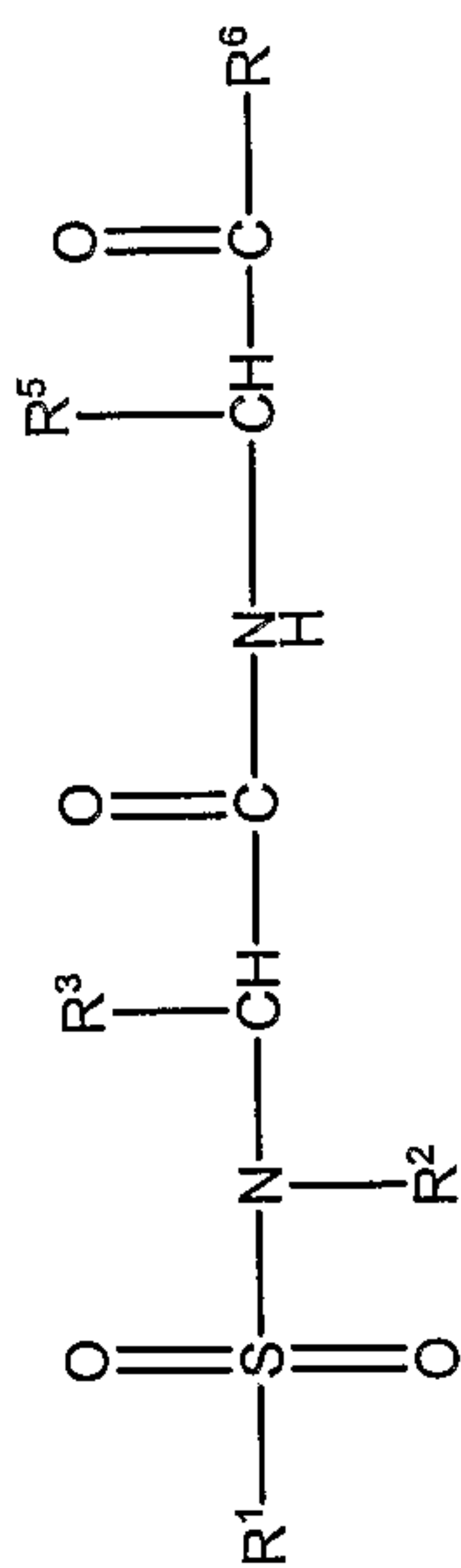

R ¹	R ²	R ³	R ⁵	R ⁶	Ex. No.
<i>p</i> -CH ₃ -φ-	R ² /R ³ = cyclic 3 carbon atoms (L-pyrrolidiny)		<i>p</i> -[(4-methylpiperazin-1-yl)C(O)O-]benzyl-	- <i>O-n</i> -butyl	99
<i>p</i> -CH ₃ -φ-	R ² /R ³ = cyclic 3 carbon atoms (L-pyrrolidiny)		<i>p</i> -[(4-methylpiperazin-1-yl)C(O)O-]benzyl-	-O-cyclopentyl	100
<i>p</i> -CH ₃ -φ-	R ² /R ³ = cyclic 3 carbon atoms (L-pyrrolidiny)		<i>p</i> -[(CH ₃) ₂ NC(O)O-]benzyl-	-OCH(CH ₃) ₂	101
<i>p</i> -CH ₃ -φ-	R ² /R ³ = cyclic 3 carbon atoms (L-pyrrolidiny)		<i>p</i> -[(piperidin-4-yl)C(O)O-]benzyl-	-OCH ₂ CH ₃	102
φ-CH ₂ -	R ² /R ³ = cyclic 3 carbon atoms (L-pyrrolidiny)		<i>p</i> -[(1-methylpiperidin-4-yl)C(O)O-]benzyl-	-OCH ₂ CH ₃	103
φ-CH ₂ -	R ² /R ³ = cyclic 3 carbon atoms (L-pyrrolidiny)		<i>p</i> -[(4-methylpiperazin-1-yl)C(O)O-]benzyl-	-OH	104
<i>p</i> -CH ₃ -φ-	R ² /R ³ = cyclic 3 carbon atoms (L-pyrrolidiny)		<i>p</i> -[(1-Boc-4-phenylpiperidin-4-yl)- C(O)O-]benzyl-	-OCH ₂ CH ₃	105

R ¹	R ²	R ³	R ⁵	R ⁶	Ex. No.
1-methylimidazol-4-yl	R ² /R ³ = cyclic 3 carbon atoms (L-pyrrolidiny)		<i>p</i> -[(CH ₃) ₂ NC(O)O-]benzyl-	-OC(CH ₃) ₃	106
<i>p</i> -NH ₂ -φ-	R ² /R ³ = cyclic 3 carbon atoms (L-pyrrolidiny)		<i>p</i> -[(CH ₃) ₂ NC(O)O-]benzyl-	-OC(CH ₃) ₃	107
<i>p</i> -CH ₃ -φ-	R ² /R ³ = cyclic 3 carbon atoms (L-pyrrolidiny)		<i>p</i> -[(morpholin-4-yl)C(O)O-]benzyl-	-OC(CH ₃) ₃	108
φ-CH ₂ -	R ² /R ³ = cyclic -CH ₂ -S-C(CH ₃) ₂ - (L-5,5- dimethylthiazolidin-4-yl)		<i>p</i> -[(CH ₃) ₂ NC(O)O-]benzyl-	-OH	109
<i>p</i> -CH ₃ -φ-	R ² /R ³ = cyclic -CH ₂ CH ₂ -NH-CH ₂ - (L-piperaziny)		<i>p</i> -[(CH ₃) ₂ NC(O)O-]benzyl-	-OH	110
φ-CH ₂ -	R ² /R ³ = cyclic -CH ₂ -S-C(CH ₃) ₂ - (L-5,5- dimethylthiazolidin-4-yl)		<i>p</i> -[(CH ₃) ₂ NC(O)O-]benzyl-	-OC(CH ₃) ₃	111
<i>p</i> -CH ₃ -φ-	R ² /R ³ = cyclic 3 carbon atoms (L-pyrrolidiny)		<i>p</i> -[(CH ₃) ₂ NC(O)O-]benzyl-	-NH-adamantyl	112
<i>p</i> -CH ₃ -φ-	R ² /R ³ = cyclic 3 carbon atoms (L-pyrrolidiny)		<i>p</i> -[(CH ₃) ₂ NC(O)O-]benzyl-	-NHCH ₂ C(O)OH	113
<i>p</i> -CH ₃ -φ-	R ² /R ³ = cyclic 3 carbon atoms (L-pyrrolidiny)		<i>p</i> -[(CH ₃) ₂ NS(O) ₂ O-]benzyl-	-OCH ₃	114

R ¹	R ²	R ³	R ⁵	R ⁶	Ex. No.
<i>p</i> -CH ₃ -φ	R ² /R ³ = cyclic -CH ₂ CH ₂ -NH-CH ₂ - (L-piperaziny)		<i>p</i> -[(CH ₃) ₂ NC(O)O-]benzyl-	-OC(CH ₃) ₃	115
<i>p</i> -CH ₃ -φ	R ² /R ³ = cyclic -CH ₂ CH ₂ -(Cbz)NHCH ₂ - [L-4-N-(Cbz)-piperaziny]		<i>p</i> -[(CH ₃) ₂ NC(O)O-]benzyl-	-OC(CH ₃) ₃	116
1-methylpyrazol-4-yl	R ² /R ³ = cyclic 3 carbon atoms (L-pyrrolidiny)		<i>p</i> -[(CH ₃) ₂ NC(O)O-]benzyl-	-OC(CH ₃) ₃	117
3-pyridyl	R ² /R ³ = cyclic 3 carbon atoms (L-pyrrolidiny)		<i>p</i> -[(CH ₃) ₂ NC(O)O-]benzyl-	-OH	118
<i>p</i> -CH ₃ -φ	R ² /R ³ = cyclic 3 carbon atoms (L-pyrrolidiny)		<i>p</i> -[(1-Boc-piperazin-4-yl)C(O)O-]benzyl-	-OCH ₂ CH ₃	119
<i>p</i> -CH ₃ -φ	R ² /R ³ = cyclic 3 carbon atoms (L-pyrrolidiny)		<i>p</i> -[(morpholin-4-yl)C(O)O-]benzyl-	-OCH ₂ CH ₃	120
<i>p</i> -CH ₃ -φ	-CH ₃	H	<i>p</i> -[(thiomorpholin-4-yl sulfone)- C(O)O-]benzyl-	-OC(CH ₃) ₃	121
<i>p</i> -CH ₃ -φ	-CH ₃	H	<i>p</i> -[(thiomorpholin-4-yl)C(O)O-]benzyl-	-OH	122
<i>p</i> -CH ₃ -φ	R ² /R ³ = cyclic 3 carbon atoms (L-pyrrolidiny)		<i>p</i> -[(CH ₃) ₂ NC(O)O-]benzyl-	2,4-dioxo- tetrahydrofuran-3-yl (3,4-enol)	123
<i>p</i> -CH ₃ -φ	R ² /R ³ = cyclic 3 carbon atoms (L-pyrrolidiny)		<i>p</i> -[(piperazin-4-yl)C(O)O-]benzyl-	-OH	124
<i>p</i> -CH ₃ -φ	R ² /R ³ = cyclic 3 carbon atoms (L-pyrrolidiny)		<i>p</i> -[(1-Boc-piperazin-4-yl)C(O)O-]benzyl-	-OC(CH ₃) ₃	125

R ¹	R ²	R ³	R ⁵	R ⁶	Ex. No.
<i>p</i> -CH ₃ -φ	R ² /R ³ = cyclic 3 carbon atoms (L-pyrrolidiny)		<i>p</i> -[(piperazin-4-yl)C(O)O-]benzyl-	-OCH ₂ CH ₃	126
<i>p</i> -CH ₃ -φ	R ² /R ³ = cyclic 3 carbon atoms (L-pyrrolidiny)		<i>p</i> -[(4-acetyl)piperazin-1-yl]C(O)O-]benzyl-	-OCH ₂ CH ₃	127
<i>p</i> -CH ₃ -φ	R ² /R ³ = cyclic 3 carbon atoms (L-pyrrolidiny)		<i>p</i> -[(4-methanesulfonylpiperazin-1-yl)- C(O)O-]benzyl-	-OCH ₂ CH ₃	128
<i>p</i> -CH ₃ -φ	R ² /R ³ = cyclic 3 carbon atoms (L-pyrrolidiny)		3-nitro-4-[(morpholin-4-yl)- C(O)O-]benzyl-	-OH	129
<i>p</i> -CH ₃ -φ	R ² /R ³ = cyclic 3 carbon atoms (L-pyrrolidiny)		<i>p</i> -[(1-Boc-piperazin-4-yl)C(O)O-]benzyl-	-OH	130
<i>p</i> -CH ₃ -φ	-CH ₃	-C(CH ₃) ₃	<i>p</i> -[(4-methylpiperazin-1-yl)C(O)O-]benzyl-	-OC(CH ₃) ₃	131
<i>p</i> -F-φ	R ² /R ³ = cyclic 3 carbon atoms (L-pyrrolidiny)		<i>p</i> -[(1,1-dioxothiomorpholin-4-yl)- C(O)O-]benzyl-	-OC(CH ₃) ₃	132
<i>p</i> -F-φ	R ² /R ³ = cyclic 3 carbon atoms (L-pyrrolidiny)		<i>p</i> -[(morpholin-4-yl)C(O)O-]benzyl-	-OC(CH ₃) ₃	133
<i>p</i> -CH ₃ -φ	R ² /R ³ = cyclic -CH ₂ -CH ₂ -SO ₂ -CH ₂ -(L- 1,1-dioxothiomorpholin-3- yl)		<i>p</i> -[(morpholin-4-yl)C(O)O-]benzyl-	-OH	134
1-methylpyrazol-4-yl	R ² /R ³ = cyclic 3 carbon atoms (L-pyrrolidiny)		<i>p</i> -[(4-methylpiperazin-1-yl)C(O)O-]benzyl-	-OC(CH ₃) ₃	135

R ¹	R ²	R ³	R ⁵	R ⁶	Ex. No.
morpholin-4-yl	R ² /R ³ = cyclic 3 carbon atoms (L-pyrrolidinyl)		<i>p</i> -[[(CH ₃) ₂ NC(O)O-]benzyl-	-OC(CH ₃) ₃	136
1-methylpyrazol-4-yl	R ² /R ³ = cyclic 3 carbon atoms (L-pyrrolidinyl)		<i>p</i> -[[(CH ₃) ₂ NC(O)O-]benzyl-	-OCH(CH ₃) ₂	137

Additional compounds prepared by the methods described above include the following:

Example 138

Synthesis of

N-(1-Methylpyrazole-4-sulfonyl)-L-(5,5-dimethyl)thiaprolyl-L-4-(N,N-dimethylcarbamyloxy)phenylalanine *tert*-Butyl Ester

The N-methylpyrazole sulfonyl chloride was prepared by adding N-methylpyrazole to chilled (0°C) chlorosulfonic acid. The reaction mixture was allowed to warm to room temperature and then heated to 100°C overnight under a stream of N₂. The reaction mixture was then cooled to room temperature and chilled to 0°C. To this solution was added thionyl chloride (2.5 eq.) and the reaction was stirred at room temperature for 30 min., then warmed to 70°C for two hours. The reaction was cooled to room temperature and then chilled in an ice bath. Water and ice were slowly added to the reaction mixture to precipitate a white solid which was collected by filtration. The desired sulfonyl chloride was washed with cold water and hexane.

The title compound was then prepared following the procedure outlined for the preparation of Example 2 by substitution of the appropriate starting materials, mp: 169-170°C.

Example 139

Synthesis of

N-(1-Methylpyrazole-4-sulfonyl)-L-(5,5-dimethyl)thiaprolyl-L-4-(N,N-dimethylcarbamyloxy)phenylalanine

The title compound was prepared from the product of Example 138 using the procedure described in Method 11.

NMR data was as follows:

¹H NMR (CDCl₃): δ = 7.94 (s, 1H); 7.79 (s, 1H); 7.25 (d, 2H, J=8.8Hz); 7.0 (d, 2H, J=8.8Hz); 5.15 (br s, 1H); 4.80 (m, 1H); 4.54 (d, 1H, J=9.8Hz); 4.39 (d, 1H,

J=9.3Hz); 3.93 (s, 3H); 3.88 (s, 1H); 3.23-3.02 (m, 2H); 3.07 (s, 3H); 2.98 (s, 3H); 1.27 (s, 3H); 1.14 (s, 3H).

¹³C NMR (CDCl₃): 173.86, 169.05, 155.23, 150.47, 139.21, 133.59, 133.15, 130.53, 121.84, 117.57, 73.58, 54.71, 53.75, 50.42, 39.60, 37.18, 36.60, 36.36, 35.11, 28.97, 23.95.

Example 140

Synthesis of

N-(Toluene-4-sulfonyl)-L-prolyl-L-4-(N-(1,4-dioxa-8-aza-spiro[4.5]decan-8-yl)carbonyloxy)phenylalanine Ethyl Ester

The title compound was prepared following the procedure outlined for Example 4 by substitution of the appropriate starting materials.

Physical data was as follows:

MS (+ESI): 630 [M+H]⁺.

Anal. Calcd. for C₃₁H₃₉N₃O₉S · 0.2 CH₂Cl₂: C, 57.94; H, 6.14; N, 6.50.

Found: C, 57.73; H, 5.90; N, 6.47.

Example 141

Synthesis of

N-(Toluene-4-sulfonyl)-L-prolyl-L-4-(N-(1,4-dioxa-8-aza-spiro[4.5]decan-8-yl)carbonyloxy)phenylalanine

The product of Example 140 was hydrolyzed using the procedure described in Method 5 but employing methanol as the solvent and running the reaction at 25 °C for 24h. The solvent was then evaporated, the residue taken up in H₂O, washed with methylene chloride and lyophilized to afford the title compound.

Physical data was as follows:

MS (+ESI): 619 [M+H]⁺.

Anal. Calcd. for C₂₉H₃₅N₃O₉SLi · 1.5 H₂O: C, 53.37; H, 6.02; N, 6.44.

Found: C, 53.40; H, 5.58; N, 6.48.

Example 142

Synthesis of

N-(Toluene-4-sulfonyl)-L-prolyl-L-4-(4'-acetylpiperazin-1-ylcarbonyloxy)phenylalanine

5 The product of Example 127 was hydrolyzed using the procedure described in Method 5 but employing methanol as the solvent and running the reaction at 25°C for 24h. The solvent was then evaporated, the residue taken up in H₂O, washed with methylene chloride and lyophilized to afford the title compound.

Physical data was as follows:

10 MS (+ESI): 587 [M+H]⁺.

Anal. Calcd. for C₂₈H₃₃N₄O₈SLi · 3H₂O: C, 52.01; H, 6.08; N, 8.66.

Found: C, 52.03; H, 5.36; N, 8.04.

Example 143

Synthesis of

N-(Toluene-4-sulfonyl)-L-prolyl-L-4-(4'-methanesulfonylpiperazin-1-ylcarbonyloxy)phenylalanine

15 The product of Example 128 was hydrolyzed using the procedure described in Example 142.

20 Physical data was as follows:

MS (+ESI): 623 [M+H]⁺.

Anal. Calcd. for C₂₇H₃₃N₄O₉S₂Li · 2 H₂O: C, 48.79; H, 5.61; N, 8.43.

Found: C, 48.66; H, 5.14; N, 8.04.

Example 144

Synthesis of

N-(Toluene-4-sulfonyl)-L-prolyl-L-4-(4'-phenylpiperazin-1-ylcarbonyloxy)phenylalanine

25 The ethyl ester of the title compound was prepared following the procedure outlined for Example 4 by substitution of the appropriate starting materials. The ethyl ester was then hydrolyzed using the procedure described in Example 142.

30

Physical data was as follows:

MS (-ESI): 619 [M-H]⁻.

Anal. Calcd. for C₃₂H₃₆N₄O₇SLi · 2H₂O: C, 58.00; H, 5.93; N, 8.45.

Found: C, 57.65; H, 5.49; N, 8.13.

5

Example 145

Synthesis of

N-(Toluene-4-sulfonyl)-L-prolyl-L-4-

(piperazin-1-ylcarbonyloxy)phenylalanine *tert*-Butyl Ester

10 The product of Example 125 (0.7 g, 1 mmol) was dissolved in methylene chloride (9 mL). The solution was cooled to 0°C and trifluoroacetic acid (1.0 mL) was added and the resulting clear solution was stirred for 4h. The reaction solution was then diluted with additional methylene chloride (50 mL), washed with saturated sodium bicarbonate solution (3 x 50 mL), dried (K₂CO₃) and the solvent stripped off
15 to give a white solid (0.465 g). Flash chromatography (9:1 CH₂Cl₂:EtOH) of this material gave a clear oil which was washed several times with hexane to give a white solid (0.289g, 48%).

Physical data was as follows:

MS (+ESI): 601.7 [M+1]⁺.

20 Anal. Calcd. for C₃₀H₄₀N₄O₇S · 0.25 CH₂Cl₂: C, 58.42; H, 6.56; N, 9.01.

Found: C, 58.79; H, 6.51; N, 8.74.

Example 146

Synthesis of

25 **2-(Saccharin-2-yl)propionyl-L-4-(4'-methylpiperazin-1-ylcarbonyloxy)phenylalanine**

The title compound was prepared from the product of Example 46 using the procedure described in Method 11, mp = 117-122°C (with foaming).

Physical data was as follows:

30 Anal. Calcd. for C₂₅H₂₈N₄O₈S · 1.5 H₂O: C, 52.53; H, 5.47; N, 9.80.

Found: C, 52.26; H, 5.36; N, 9.23.

Example 147

Synthesis of

**N-(Toluene-4-sulfonyl)-L-prolyl-L-4-(4'-methanesulfonyl
piperazin-1-ylcarbonyloxy)phenylalanine *tert*-Butyl Ester**

The title compound was prepared following the procedure outlined for Example 128 by substitution of the appropriate starting materials.

Physical data was as follows:

MS (+ESI): 696 [M+NH₄]⁺.

Anal. Calcd. for C₃₁H₄₂N₄O₉S₂ · 0.5 CH₂Cl₂: C, 51.62; H, 6.00; N, 7.76.

Found: C, 51.55; H, 6.21; N, 7.60.

Example 148

Synthesis of

**N-(Toluene-4-sulfonyl)-L-prolyl-L-4-
(N,N-dimethylcarbamyloxy)phenylalanine (N'-*tert*-
butoxycarbonyl-2-amino-2-methylpropyl) Ester**

(BOC)₂O (96 mg, 0.44 mmol) was added to a solution of the product from Example 9 (200 mg, 0.4 mmol.), N-Boc-2-amino-2-methyl-1-propanol (965 mg, 0.5 mmol) and a catalytic amount of DMAP in THF (92 mL) containing pyridine (50 μl). The mixture was stirred at room temperature under argon for 48 h. The mixture was poured into 1N HCl and extracted with ethyl acetate. The organic phase was washed (1N HCl), dried (MgSO₄) and the solvent was removed under reduced pressure. The residue was purified by flash chromatography (EtOAc:hexanes 2:1) to give the desired compound as an amorphous white foam (150 mg., 55%).

Physical data was as follows:

MS: [M+H]⁺ at 675.

MS (+ESI) : [M+ NH₄]⁺ at 692 (100%).

Example 149

Synthesis of

**N-(Toluene-4-sulfonyl)-L-prolyl-L-4-
(N,N-dimethylcarbamyloxy)phenylalanine 2-(Morpholin-4-yl)ethyl Ester**

The title compound was prepared following the procedure outlined for Example 148 by substituting 2-morpholinoethanol for N-Boc-2-amino-2-methyl-1-propanol.

5 Physical data was as follows:

Anal. Calcd. for $C_{30}H_{40}N_4O_8S \cdot 0.5 H_2O$: C, 57.58; H, 6.60; N, 8.95.

Found: C, 57.26; H, 6.29; N, 8.82.

Example 150

10

Synthesis of

N-(Toluene-4-sulfonyl)-L-prolyl-L-4-

(4'-acetylpiperazin-1-ylcarbonyloxy)phenylalanine *tert*-Butyl Ester

The title compound was prepared following the procedure outlined for Example 127 by substitution of the appropriate starting materials.

15 Physical data was as follows:

MS (+ESI) : 660.4 $[M+NH_4]^+$.

Anal. Calcd. for $C_{32}N_4O_8S \cdot 0.15 CH_2Cl_2$: C, 58.91; H, 6.50; N, 8.55.

Found: C, 58.64; H, 6.36; N, 8.40.

20

Example 151

Synthesis of

N-(Toluene-4-sulfonyl)-L-prolyl-L-4-

(4'-hydroxypiperidin-1-ylcarbonyloxy)phenylalanine *tert*-Butyl Ester

25 The title compound was prepared following the procedure outlined for Example 4 by substituting 4-piperidinol for *N*-methyl piperazine.

Physical data was as follows:

Anal. Calcd. for $C_{31}H_{41}N_3O_8S \cdot 0.6 H_2O \cdot 0.22 EtOAc$: C, 59.28; H, 6.86; N,

6.51

Found: C, 58.92; H, 6.37; N, 6.47.

30

Example 152

DEMANDE OU BREVET VOLUMINEUX

LA PRÉSENTE PARTIE DE CETTE DEMANDE OU CE BREVET COMPREND PLUS D'UN TOME.

CECI EST LE TOME 1 DE 2
CONTENANT LES PAGES 1 À 330

NOTE : Pour les tomes additionels, veuillez contacter le Bureau canadien des brevets

JUMBO APPLICATIONS/PATENTS

THIS SECTION OF THE APPLICATION/PATENT CONTAINS MORE THAN ONE VOLUME

THIS IS VOLUME 1 OF 2
CONTAINING PAGES 1 TO 330

NOTE: For additional volumes, please contact the Canadian Patent Office

NOM DU FICHER / FILE NAME :

NOTE POUR LE TOME / VOLUME NOTE:

WHAT IS CLAIMED IS:

1. A use of a compound for the preparation of a medicament in an amount to promote remyelination of nerve cells in a mammal for the treatment of a demyelinating disease, wherein the compound is of formula I below:

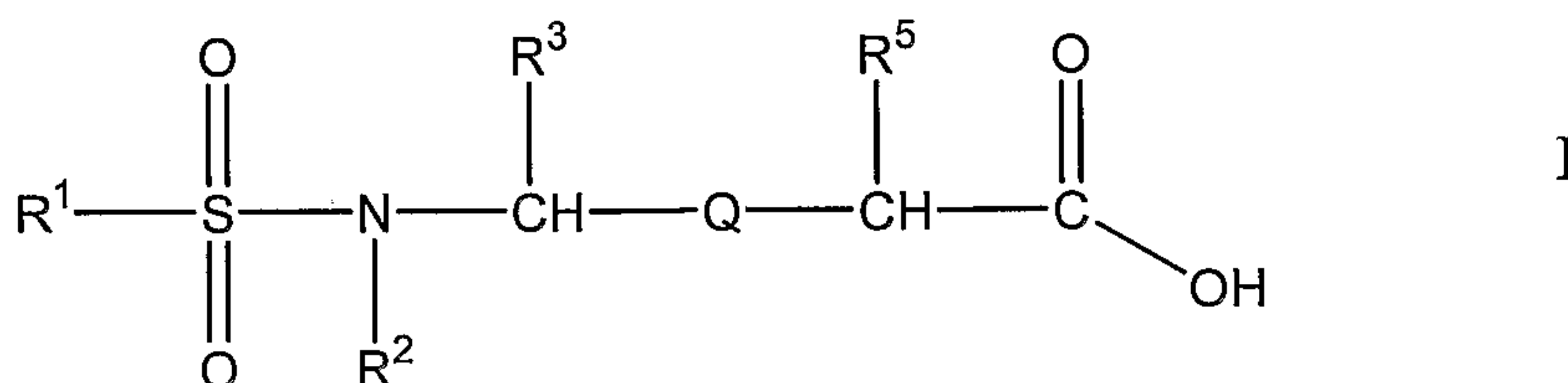

wherein

R^1 is selected from the group consisting of alkyl, substituted alkyl, aryl, substituted aryl, cycloalkyl, substituted cycloalkyl, heterocyclic, substituted heterocyclic, heteroaryl and substituted heteroaryl;

R^2 is selected from the group consisting of hydrogen, alkyl, cycloalkyl, substituted cycloalkyl, cycloalkenyl, substituted cycloalkenyl, heterocyclic, substituted heterocyclic, substituted alkyl, aryl, substituted aryl, heteroaryl, substituted heteroaryl, and R^1 and R^2 together with the nitrogen atom bound to R^2 and the SO_2 group bound to R^1 can form a heterocyclic or a substituted heterocyclic group;

R^3 is selected from the group consisting of hydrogen, alkyl, substituted alkyl, cycloalkyl, substituted cycloalkyl, aryl, substituted aryl, heteroaryl, substituted heteroaryl, heterocyclic, substituted heterocyclic and, when R^2 does not form a heterocyclic group with R^1 , R^2 and R^3 together with the nitrogen atom bound to R^2 and the carbon atom bound to R^3 can form a heterocyclic or a substituted heterocyclic group;

R^5 is $-(\text{CH}_2)_x-\text{Ar}-\text{R}^{5'}$ where $\text{R}^{5'}$ is selected from the group consisting of $-\text{O}-\text{Z}-\text{NR}^8\text{R}^{8'}$ and $-\text{O}-\text{Z}-\text{R}^{8''}$ wherein R^8 and $\text{R}^{8'}$ are independently selected from the group consisting of hydrogen, alkyl, substituted alkyl, cycloalkyl, substituted cycloalkyl, heterocyclic, substituted heterocyclic, and where R^8 and $\text{R}^{8'}$ are joined to form a heterocycle or a substituted heterocycle, $\text{R}^{8''}$ is selected from the group consisting of

heterocycle and substituted heterocycle, and Z is selected from the group consisting of -C(O)- and -SO₂-;

Ar is aryl, heteroaryl, substituted aryl or substituted heteroaryl;

x is an integer of from 1 to 4;

5 Q is -C(X)NR⁷- wherein R⁷ is selected from the group consisting of hydrogen and alkyl; and X is selected from the group consisting of oxygen and sulfur;

and pharmaceutically acceptable salts thereof.

10 2. A use of a compound for the preparation of a medicament in an amount to promote remyelination of nerve cells in a mammal for the treatment of a demyelinating disease, wherein the compound is of formula IA below:

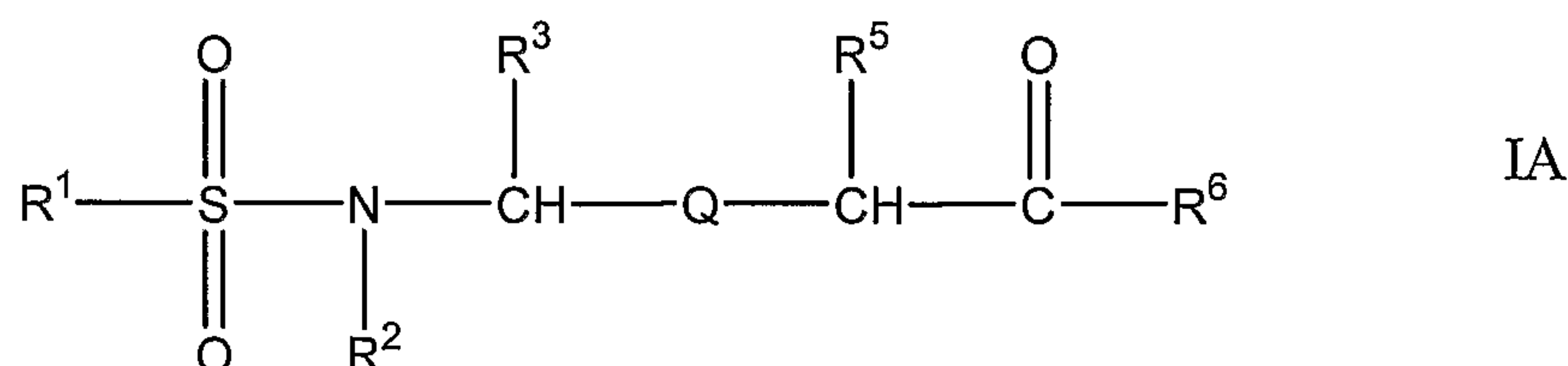

15 wherein:

R¹ is selected from the group consisting of alkyl, substituted alkyl, aryl, substituted aryl, cycloalkyl, substituted cycloalkyl, heterocyclic, substituted heterocyclic, heteroaryl and substituted heteroaryl;

20 R² is selected from the group consisting of hydrogen, alkyl, cycloalkyl, substituted cycloalkyl, cycloalkenyl, substituted cycloalkenyl, heterocyclic, substituted heterocyclic, substituted alkyl, aryl, substituted aryl, heteroaryl, substituted heteroaryl, and R¹ and R² together with the nitrogen atom bound to R² and the SO₂ group bound to R¹ can form a heterocyclic or a substituted heterocyclic group;

25 R³ is selected from the group consisting of hydrogen, alkyl, substituted alkyl, cycloalkyl, substituted cycloalkyl, aryl, substituted aryl, heteroaryl, substituted heteroaryl, heterocyclic, substituted heterocyclic and, when R² does not form a heterocyclic group with R¹, R² and R³ together with the nitrogen atom bound to R²

and the carbon atom bound to R^3 can form a heterocyclic or a substituted heterocyclic group;

R^5 is $-(CH_2)_x-Ar-R^{5'}$ where $R^{5'}$ is selected from the group consisting of $-O-Z-NR^8R^{8'}$ and $-O-Z-R^{8''}$ wherein R^8 and $R^{8'}$ are independently selected from the group consisting of hydrogen, alkyl, substituted alkyl, cycloalkyl, substituted cycloalkyl, heterocyclic, substituted heterocyclic, and where R^8 and $R^{8'}$ are joined to form a heterocycle or a substituted heterocycle, $R^{8''}$ is selected from the group consisting of heterocycle and substituted heterocycle, and Z is selected from the group consisting of $-C(O)-$ and $-SO_2-$;

10 Ar is aryl, heteroaryl, substituted aryl or substituted heteroaryl;

x is an integer of from 1 to 4;

R^6 is selected from the group consisting of 2,4-dioxo-tetrahydrofuran-3-yl (3,4-enol), amino, alkoxy, substituted alkoxy, cycloalkoxy, substituted cycloalkoxy, $-O-(N-succinimidyl)$, $-NH$ -adamantyl, $-O$ -cholest-5-en-3- β -yl, $-NHOY$ where Y is hydrogen, alkyl, substituted alkyl, aryl, and substituted aryl, $-NH(CH_2)_pCOOY$ where p is an integer of from 1 to 8 and Y is as defined above, $-OCH_2NR^9R^{10}$ where R^9 is selected from the group consisting of $-C(O)$ -aryl and $-C(O)$ -substituted aryl and R^{10} is selected from the group consisting of hydrogen and $-CH_2COOR^{11}$ where R^{11} is alkyl, and $-NHSO_2Z'$ where Z' is alkyl, substituted alkyl, cycloalkyl, substituted cycloalkyl, aryl, substituted aryl, heteroaryl, substituted heteroaryl, heterocyclic and substituted heterocyclic;

20 Q is $-C(X)NR^7-$ wherein R^7 is selected from the group consisting of hydrogen and alkyl; and X is selected from the group consisting of oxygen and sulfur;

25 and pharmaceutically acceptable salts thereof

with the following provisos

(A) when R^1 and R^2 together with the SO_2 group pendent to R^1 and the nitrogen pendent to R^2 form a saccharin-2-yl group, R^3 is $-CH_3$, R^5 is $p-[(CH_3)_2NC(O)O-]$ benzyl and Q is $-C(O)NH-$ then R^6 is not $-OC(CH_3)_3$;

30 (B) when R^1 is p -methylphenyl, R^2 and R^3 together with the nitrogen atom pendent to R^2 and the carbon atom pendent to R^3 form a pyrroldinyl ring derived

from D-proline; R⁵ is *p*-[(4-methylpiperazin-1-yl)NC(O)O-]benzyl derived from D-phenylalanine and Q is -C(O)NH- then R⁶ is not -OC(CH₃)₃;

(C) when R¹ is pyrimidin-2-yl, R² and R³ together with the nitrogen atom bound to R² and the carbon atom bound to R³ form a pyrrolidinyl ring, R⁵ is *p*-
5 [(CH₃)₂NC(O)O-]benzyl and Q is -C(O)NH- then R⁶ is not -OC(CH₃)₃; and

(D) when R¹ is *p*-methylphenyl, R² and R³ together with the nitrogen atom pendent to R² and the carbon atom pendent to R³ form a (2S)-piperazin-2-carbonyl ring; R⁵ is *p*-[(CH₃)₂NC(O)O-]benzyl and Q is -C(O)NH- then R⁶ is not -OC(CH₃)₃.

10 3. A use of a compound for the preparation of a medicament in an amount to promote remyelination of nerve cells in a mammal for the treatment of a demyelinating disease, wherein the compound is of formula II below:

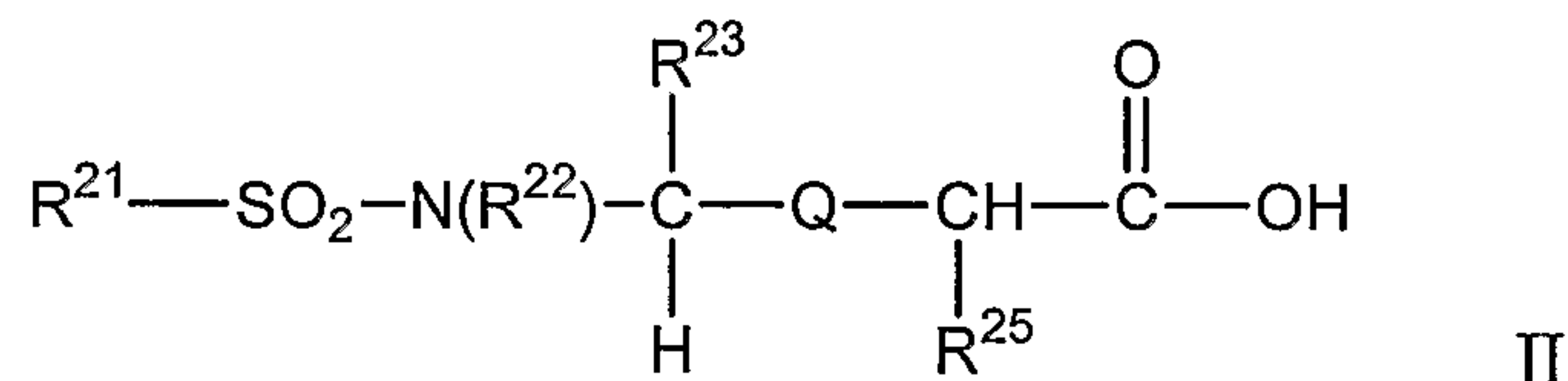

15 wherein:

R²¹ is selected from the group consisting of alkyl, substituted alkyl, aryl, substituted aryl, cycloalkyl, substituted cycloalkyl, heterocyclic, substituted heterocyclic, heteroaryl and substituted heteroaryl;

20 R²² is selected from the group consisting of hydrogen, alkyl, substituted alkyl, cycloalkyl, substituted cycloalkyl, cycloalkenyl, substituted cycloalkenyl, heterocyclic, substituted heterocyclic, aryl, substituted aryl, heteroaryl, substituted heteroaryl, and R²¹ and R²² together with the nitrogen atom bound to R²² and the SO₂ group bound to R²¹ can form a heterocyclic or a substituted heterocyclic group;

25 R²³ is selected from the group consisting of hydrogen, alkyl, substituted alkyl, cycloalkyl, substituted cycloalkyl, aryl, substituted aryl, heteroaryl, substituted heteroaryl, heterocyclic, substituted heterocyclic and where R²² and R²³ together with the nitrogen atom bound to R²² and the carbon atom bound to R²³ can form a saturated heterocyclic group or a saturated substituted heterocyclic group with the

proviso that when monosubstituted, the substituent on said saturated substituted heterocyclic group is not carboxyl;

Q is $-C(X)NR^7-$ wherein R^7 is selected from the group consisting of hydrogen and alkyl;

5 X is selected from the group consisting of oxygen and sulfur; and

R^{25} is $-CH_2Ar^{22}-R^{25'}$ where Ar^{22} is aryl or heteroaryl and $R^{25'}$ is selected from the group consisting of aryl, heteroaryl, substituted aryl, substituted heteroaryl, heterocyclic, substituted heterocyclic, aryloxy, substituted aryloxy, aralkoxy, substituted aralkoxy, heteroaryloxy, substituted heteroaryloxy, heterocyclic-O-,
10 substituted heterocyclic-O-, heteroaralkoxy, and substituted heteroaralkoxy ;
and pharmaceutically acceptable salts thereof.

4. A use of a compound for the preparation of a medicament in an amount to promote remyelination of nerve cells in a mammal for the treatment of a
15 demyelinating disease, wherein the compound is of formula IIA below:

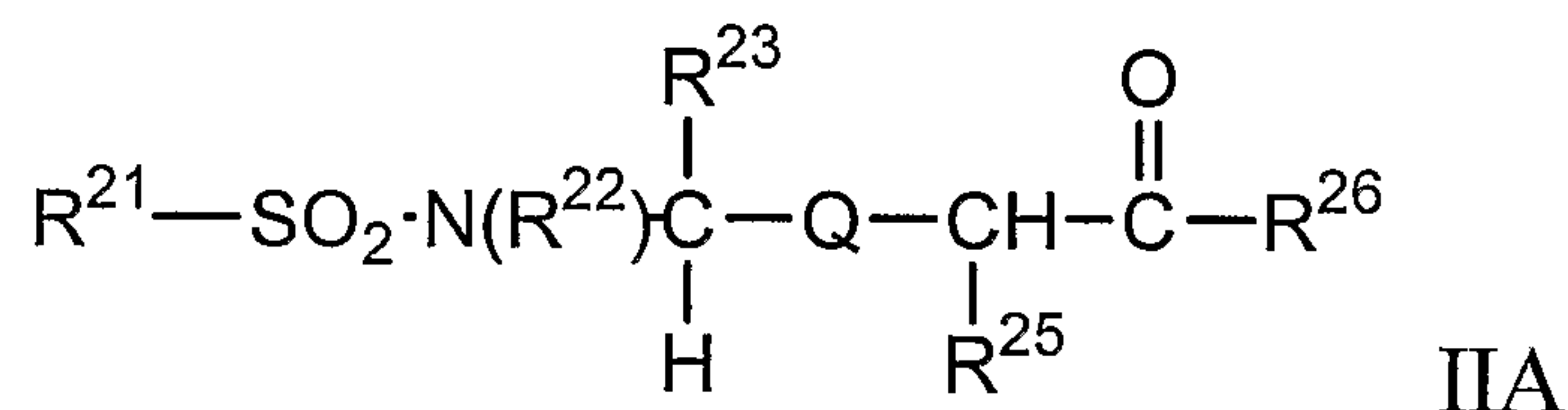

where

R^{21} is selected from the group consisting of alkyl, substituted alkyl, aryl,
20 substituted aryl, cycloalkyl, substituted cycloalkyl, heterocyclic, substituted heterocyclic, heteroaryl and substituted heteroaryl;

R^{22} is selected from the group consisting of hydrogen, alkyl, substituted alkyl, cycloalkyl, substituted cycloalkyl, cycloalkenyl, substituted cycloalkenyl, heterocyclic, substituted heterocyclic, aryl, substituted aryl, heteroaryl, and
25 substituted heteroaryl, and R^{21} and R^{22} together with the nitrogen atom bound to R^{22} and the SO_2 group bound to R^{21} can form a heterocyclic or a substituted heterocyclic group;

R^{23} is selected from the group consisting of hydrogen, alkyl, substituted alkyl, cycloalkyl, substituted cycloalkyl, aryl, substituted aryl, heteroaryl, substituted

heteroaryl, heterocyclic, and substituted heterocyclic, and R^{22} and R^{23} together with the nitrogen atom bound to R^{22} and the carbon atom bound to R^{23} can form a saturated heterocyclic group or a saturated substituted heterocyclic group with the proviso that when monosubstituted, the substituent on said saturated substituted

5 heterocyclic group is not carboxyl;

R^{25} is $-\text{CH}_2\text{Ar}^{22}-R^{25'}$ where Ar^{22} is aryl or heteroaryl and $R^{25'}$ is selected from the group consisting of aryl, heteroaryl, substituted aryl, substituted heteroaryl, heterocyclic, substituted heterocyclic, aryloxy, substituted aryloxy, aralkoxy, substituted aralkoxy, heteroaryloxy, substituted heteroaryloxy, heterocyclic-O-,

10 substituted heterocyclic-O-, heteroaralkoxy, and substituted heteroaralkoxy ;

R^{26} is selected from the group consisting of 2,4-dioxo-tetrahydrofuran-3-yl (3,4-enol), amino, alkoxy, substituted alkoxy, cycloalkoxy, substituted cycloalkoxy, -O-(N-succinimidyl), -NH-adamantyl, -O-cholest-5-en-3- β -yl, -NHOY where Y is hydrogen, alkyl, substituted alkyl, aryl, and substituted aryl, $-\text{NH}(\text{CH}_2)_p\text{COOY}$

15 where p is an integer of from 1 to 8 and Y is as defined above, $-\text{OCH}_2\text{NR}^{29}\text{R}^{30}$ where R^{29} is selected from the group consisting of -C(O)-aryl and -C(O)-substituted aryl and R^{30} is selected from the group consisting of hydrogen and $-\text{CH}_2\text{COOR}^{31}$ where R^{31} is alkyl, and $-\text{NHSO}_2\text{Z}'$ where Z' is alkyl, substituted alkyl, cycloalkyl, substituted cycloalkyl, aryl, substituted aryl, heteroaryl, substituted heteroaryl,

20 heterocyclic or substituted heterocyclic;

Q is $-\text{C}(\text{X})\text{NR}^7-$ wherein R^7 is selected from the group consisting of hydrogen and alkyl; and

X is selected from the group consisting of oxygen and sulfur;
and pharmaceutically acceptable salts thereof.

25

5. A use of a compound for the preparation of a medicament in an amount to promote remyelination of nerve cells in a mammal for the treatment of a demyelinating disease, wherein the compound is of formula IB below:

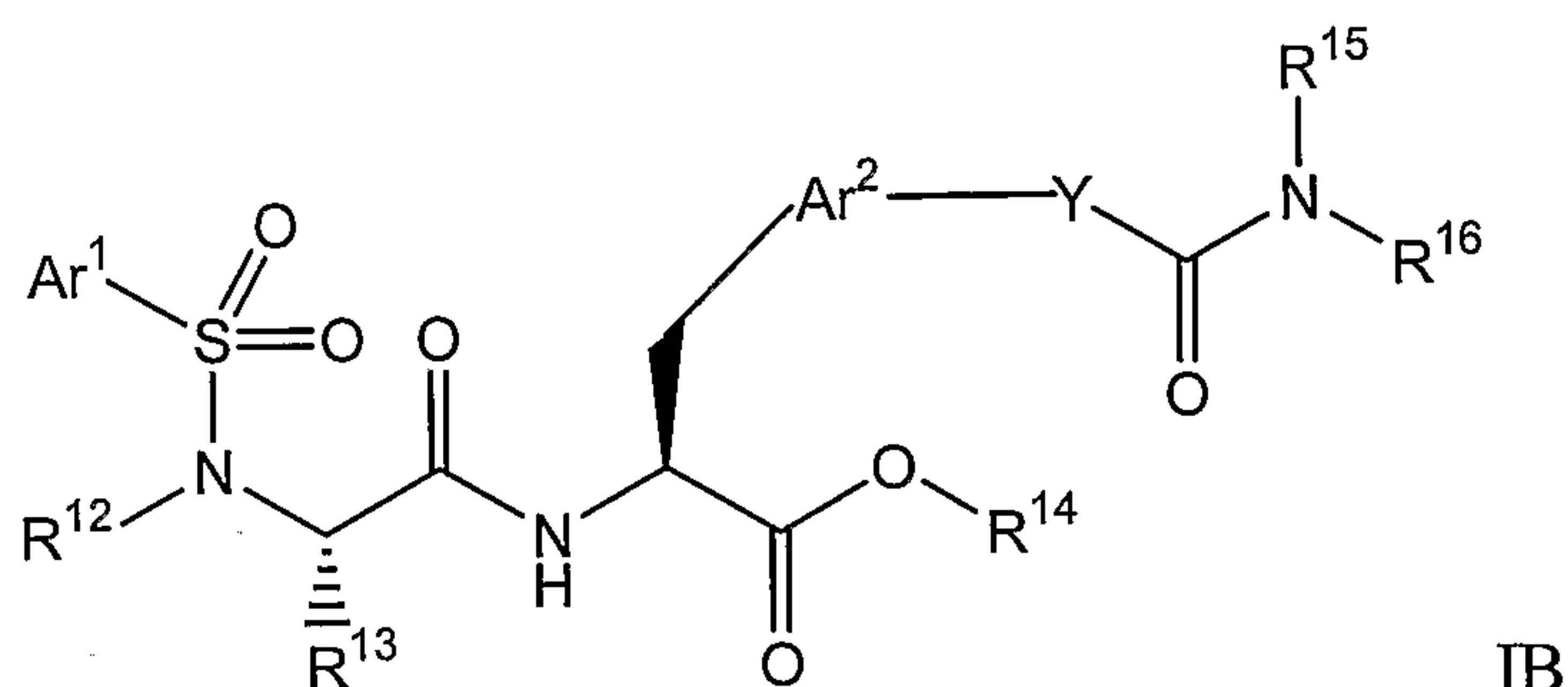

wherein:

Ar¹ is selected from the group consisting of aryl, substituted aryl, heteroaryl,
5 and substituted heteroaryl;

Ar² is selected from the group consisting of aryl, substituted aryl, heteroaryl
and substituted heteroaryl;

R¹² is selected from the group consisting of alkyl, substituted alkyl,
cycloalkyl, and substituted cycloalkyl or R¹² and R¹³ together with the nitrogen atom
10 bound to R¹² and the carbon atom bound to R¹³ form a heterocyclic or substituted
heterocyclic group;

R¹³ is selected from the group consisting of hydrogen, alkyl, and substituted
alkyl, or R¹² and R¹³ together with the nitrogen atom bound to R¹² and the carbon
atom bound to R¹³ form a heterocyclic or substituted heterocyclic group;

R¹⁴ is selected from the group consisting of hydrogen, alkyl, substituted
15 alkyl, cycloalkyl, substituted cycloalkyl, aryl, and substituted aryl;

R¹⁵ is selected from the group consisting of alkyl, and substituted alkyl, or
R¹⁵ and R¹⁶ together with the nitrogen atom to which they are bound form a
heterocyclic or substituted heterocyclic group;

R¹⁶ is selected from the group consisting of alkyl and substituted alkyl or R¹⁵
20 and R¹⁶ together with the nitrogen atom to which they are bound form a heterocyclic
or substituted heterocyclic group; and

Y is selected from the group consisting of -O-, -NR¹⁰⁰-, and -CH₂- wherein
R¹⁰⁰ is hydrogen or alkyl;

25 and pharmaceutically acceptable salts thereof.

6. The use according to claim 5, wherein R¹² is alkyl, substituted alkyl, or R¹² and R¹³ together with the nitrogen atom bound to R¹² and the carbon atom bound to R¹³ form a heterocyclic or substituted heterocyclic group; and R¹⁴ is hydrogen or alkyl.

5

7. The use according to claim 5, wherein Ar¹ is selected from the group consisting of phenyl, 4-methylphenyl, 4-*t*-butylphenyl, 2,4,6-trimethylphenyl, 2-fluorophenyl, 3-fluorophenyl, 4-fluorophenyl, 2,4-difluorophenyl, 3,4-difluorophenyl, 3,5-difluorophenyl, 2-chlorophenyl, 3-chlorophenyl, 4-chlorophenyl, 3,4-dichlorophenyl, 3,5-dichlorophenyl, 3-chloro-4-fluorophenyl, 4-bromophenyl, 2-methoxyphenyl, 3-methoxyphenyl, 4-methoxyphenyl, 3,4-dimethoxyphenyl, 4-*t*-butoxyphenyl, 4-(3'-dimethylamino-*n*-propoxy)-phenyl, 2-carboxyphenyl, 2-(methoxycarbonyl)phenyl, 4-(H₂NC(O)-)phenyl, 4-(H₂NC(S)-)phenyl, 4-cyanophenyl, 4-trifluoromethylphenyl, 4-trifluoromethoxyphenyl, 3,5-di-
 15 (trifluoromethyl)phenyl, 4-nitrophenyl, 4-aminophenyl, 4-(CH₃C(O)NH-)phenyl, 4-(PhNHC(O)NH-)phenyl, 4-amidinophenyl, 4-methylamidinophenyl, 4-[CH₃SC(=NH)-]phenyl, 4-chloro-3-[H₂NS(O)₂-]phenyl, 1-naphthyl, 2-naphthyl, pyridin-2-yl, pyridin-3-yl, pyridine-4-yl, pyrimidin-2-yl, quinolin-8-yl, 2-(trifluoroacetyl)-1,2,3,4-tetrahydroisoquinolin-7-yl, 2-thienyl, 5-chloro-2-thienyl,
 20 2,5-dichloro-4-thienyl, 1-*N*-methylimidazol-4-yl, 1-*N*-methylpyrazol-3-yl, 1-*N*-methylpyrazol-4-yl, 1-*N*-butylpyrazol-4-yl, 1-*N*-methyl-3-methyl-5-chloropyrazol-4-yl, 1-*N*-methyl-5-methyl-3-chloropyrazol-4-yl, 2-thiazolyl and 5-methyl-1,3,4-thiadiazol-2-yl.

25

8. The use according to claim 5, wherein R¹² and R¹³ together with the nitrogen atom bound to R¹² and the carbon atom bound to R¹³ form a heterocyclic or substituted heterocyclic of the formula:

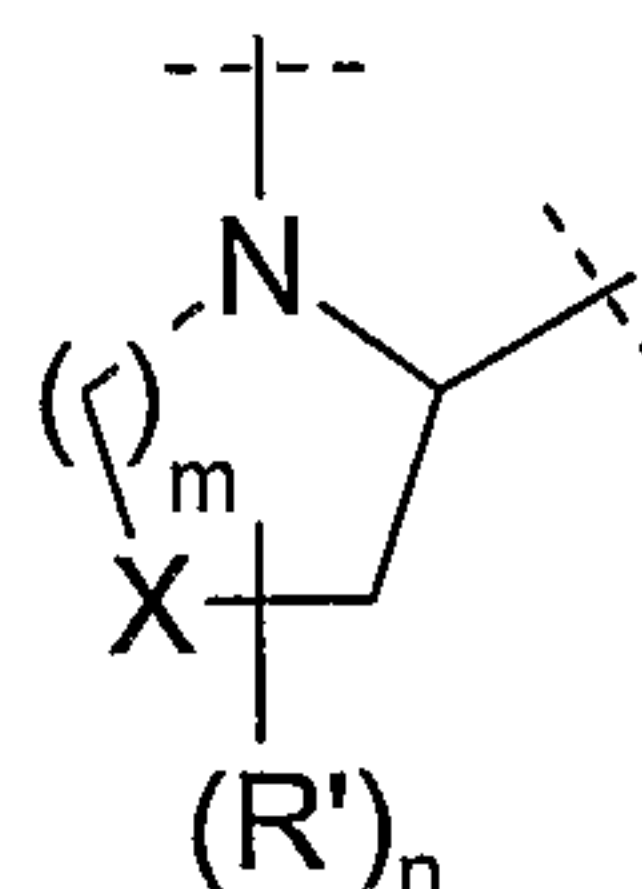

wherein

X is selected from the group consisting of -S-, -SO-, -SO₂, and optionally substituted -CH₂-;

5 *m* is an integer of 0 to 12;

n is an integer of 0 to 2; and

R' is selected from the group consisting of alkyl, substituted alkyl, and amino.

10 9. The use according to claim 8, wherein *m* is 1, X is -S- or -CH₂-, R' is alkyl or substituted alkyl.

15 10. The use according to claim 8, wherein R¹² and R¹³ together with the nitrogen atom bound to R¹² and the carbon atom bound to R¹³ form a heterocyclic or substituted heterocyclic selected from the group consisting of azetidiny, thiazolidiny, piperidiny, piperaziny, thiomorpholinyl, pyrrolidiny, 4-hydroxypyrrolidiny, 4-oxopyrrolidiny, 4-fluoropyrrolidiny, 4,4-difluoropyrrolidiny, 4-(thiomorpholin-4-ylC(O)O-)pyrrolidiny, 4-[CH₃S(O)₂O-]pyrrolidiny, 3-phenylpyrrolidiny, 3-thiophenylpyrrolidiny, 4-aminopyrrolidiny, 20 3-methoxypyrrolidiny, 4,4-dimethylpyrrolidiny, 4-N-Cbz-piperaziny, 4-[CH₃S(O)₂-]piperaziny, thiazolidin-3-yl, 5,5-dimethyl-thiazolidin-3-yl, 5,5-dimethylthiazolidin-4-yl, 1,1-dioxo-thiazolidiny, 1,1-dioxo-5,5-dimethylthiazolidin-2-yl and 1,1-dioxothiomorpholinyl.

25 11. The use according to claim 5, wherein Ar² is selected from the group consisting of phenyl, 2-pyridyl, 3-pyridyl, 4-pyridyl, and 4-pyrid-2-onyl.

30 12. The use according to claim 5, wherein Y is -O-, and when Y is -O-, the moiety -OC(O)NR¹⁵R¹⁶ is selected from the group consisting of (CH₃)₂NC(O)O-, (piperidin-1-yl)C(O)O-, (4-hydroxypiperidin-1-yl)C(O)O-, (4-formyloxypiperidin-1-yl)C(O)O-, (4-ethoxycarbonylpiperidin-1-yl)C(O)O-, (4-carboxypiperidin-1-yl)C(O)O-, (3-hydroxymethylpiperidin-1-yl)C(O)O-, (4-hydroxymethylpiperidin-1-

yl)C(O)O-, (4-piperidon-1-yl ethylene ketal)C(O)O-, (piperazin-1-yl)-C(O)O-, (1-
 Boc-piperazin-4-yl)-C(O)O-, (4-methylpiperazin-1-yl)C(O)O-, (4-
 methylhomopiperazin-1-yl)C(O)O-, (4-(2-hydroxyethyl)piperazin-1-yl)C(O)O-, (4-
 phenylpiperazin-1-yl)C(O)O-, (4-(pyridin-2-yl)piperazin-1-yl)C(O)O-, (4-(4-
 5 trifluoromethylpyridin-2-yl)piperazin-1-yl)C(O)O-, (4-(pyrimidin-2-yl)piperazin-1-
 yl)C(O)O-, (4-acetylpiperazin-1-yl)C(O)O-, (4-(phenylC(O)-)piperazin-1-yl)C(O)O-
 , (4-(pyridin-4'-ylC(O)-)piperazin-1-yl)C(O)O-, (4-(phenylNHC(O)-)piperazin-1-
 yl)C(O)O-, (4-(phenylNHC(S)-)piperazin-1-yl)C(O)O-, (4-
 methanesulfonylpiperazin-1-yl-C(O)O-, (4-trifluoromethanesulfonylpiperazin-1-yl-
 10 C(O)O-, (morpholin-4-yl)C(O)O-, (thiomorpholin-4-yl)C(O)O-, (thiomorpholin-4'-
 yl sulfone)-C(O)O-, (pyrrolidin-1-yl)C(O)O-, (2-methylpyrrolidin-1-yl)C(O)O-, (2-
 (methoxycarbonyl)pyrrolidin-1-yl)C(O)O-, (2-(hydroxymethyl)pyrrolidin-1-
 yl)C(O)O-, (2-(N,N-dimethylamino)ethyl)(CH₃)NC(O)O-, (2-(N-methyl-N-toluene-
 4-sulfonylamino)ethyl)(CH₃)N-C(O)O-, (2-(morpholin-4-yl)ethyl)(CH₃)NC(O)O-,
 15 (2-(hydroxy)ethyl)(CH₃)NC(O)O-, bis(2-(hydroxy)ethyl)NC(O)O-, (2-
 (formyloxy)ethyl)(CH₃)NC(O)O-, (CH₃OC(O)CH₂)HNC(O)O-, and 2-
 [(phenylNHC(O)O-)ethyl-]HNC(O)O-.

13. A use of a compound for the preparation of a medicament in an
 20 amount to promote remyelination of nerve cells in a mammal for the treatment of a
 demyelinating disease, wherein the compound is of formula IC below:

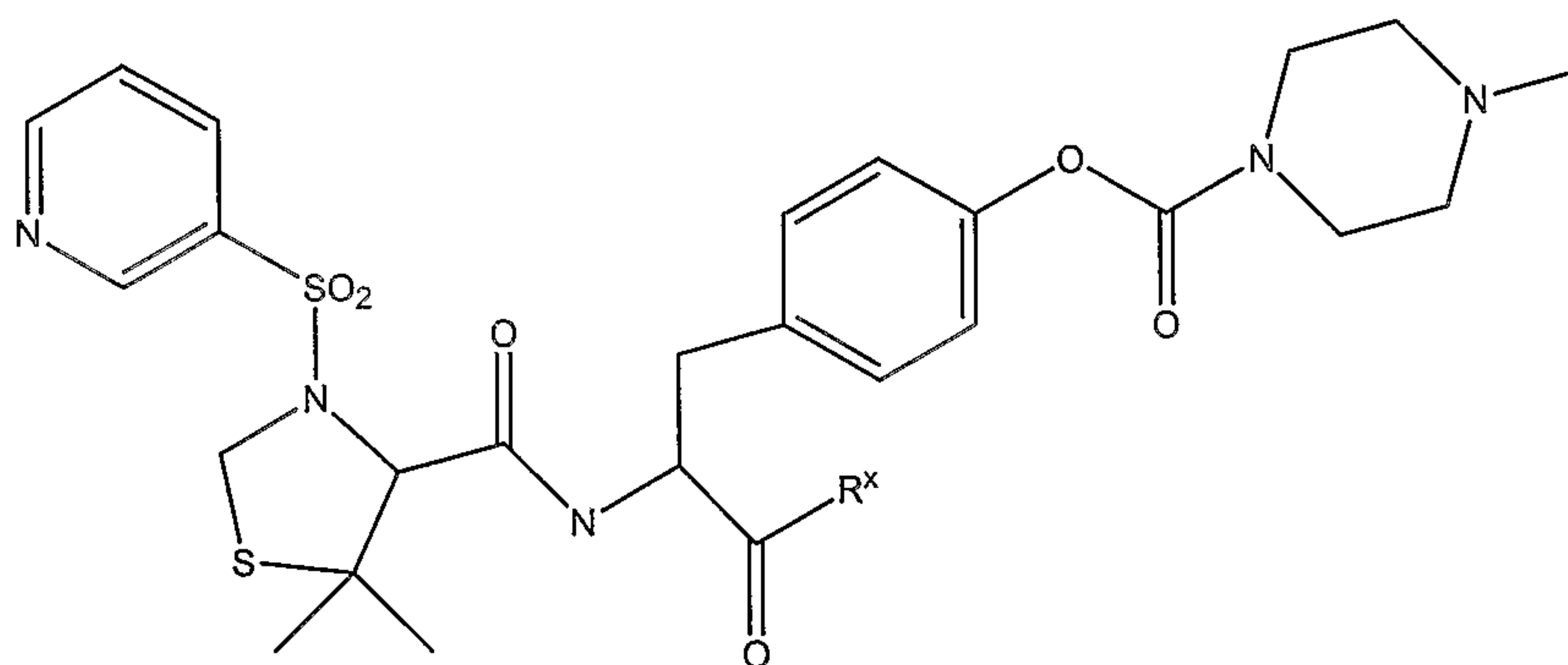

IC

25

wherein

R^x is hydroxy or C_{1-5} alkoxy; and
pharmaceutically acceptable salts thereof.

14. The use according to claim 13, wherein the compound is *N*-[*N*-(3-pyridinesulfonyl)-*L*-3,3-dimethyl-4-thiaprolyl]-*O*-[1-methylpiperazin-4-ylcarbonyl]-*L*-tyrosine isopropyl ester.

15. A use of a compound for the preparation of a medicament in an amount to promote remyelination of nerve cells in a mammal for the treatment of a demyelinating disease, wherein the compound is of formula IIB below:

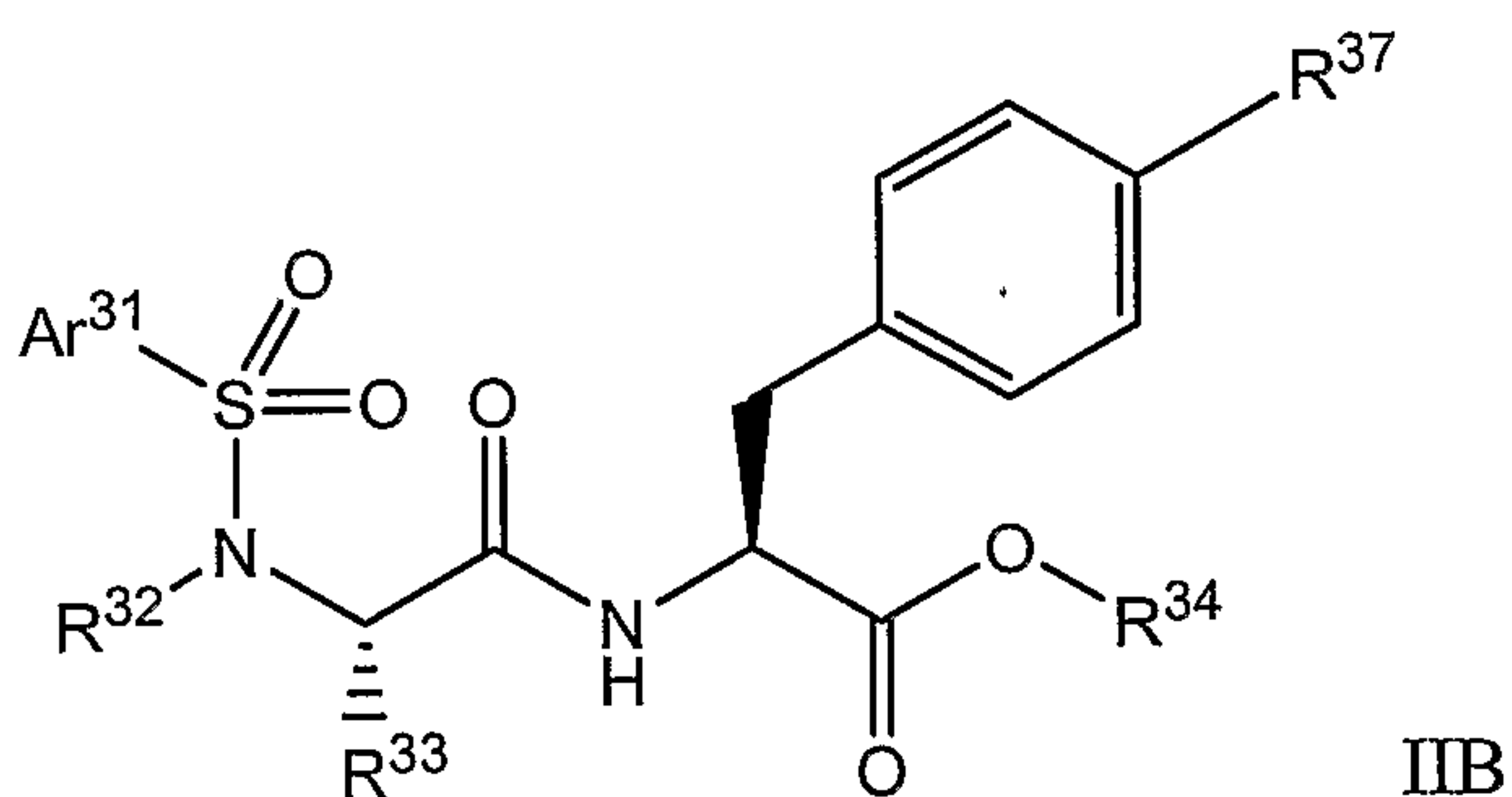

15 wherein:

Ar^{31} is selected from the group consisting of aryl, substituted aryl, heteroaryl, and substituted heteroaryl;

R^{32} is selected from the group consisting of alkyl, substituted alkyl, cycloalkyl, and substituted cycloalkyl or R^{32} and R^{33} together with the nitrogen atom bound to R^{32} and the carbon atom bound to R^{33} form a heterocyclic or substituted heterocyclic group;

R^{33} is selected from the group consisting of hydrogen, alkyl, and substituted alkyl, or R^{32} and R^{33} together with the nitrogen atom bound to R^{32} and the carbon atom bound to R^{33} form a heterocyclic or substituted heterocyclic group;

25 R^{34} is selected from the group consisting of hydrogen, alkyl, substituted alkyl, cycloalkyl, substituted cycloalkyl, aryl, and substituted aryl; and

R^{37} is aryl, heteroaryl, substituted aryl, substituted heteroaryl, heterocyclic, substituted heterocyclic, aryloxy, substituted aryloxy, aralkoxy, substituted aralkoxy, heteroaryloxy, substituted heteroaryloxy;

and pharmaceutically acceptable salts thereof.

5

16. The use according to claim 15, wherein R^{32} is alkyl, substituted alkyl, or R^{32} and R^{33} together with the nitrogen atom bound to R^{32} and the carbon atom bound to R^{33} form a heterocyclic or substituted heterocyclic group; and R^{34} is hydrogen or alkyl.

10

17. The use according to claim 15, wherein R^{37} is aryl, substituted aryl, heteroaryl, substituted heteroaryl, heterocyclic, or substituted heterocyclic.

15

18. The use according to claim 17, wherein R^{37} is substituted aryl, wherein the aryl is substituted with one to three substituents independently selected from the group consisting alkyl and alkoxy, or a substituted heteroaryl, wherein the heteroaryl is substituted with one to three substituents independently selected from the group consisting alkyl, alkoxy, and oxo.

20

19. The use according to claim 17, wherein R^{37} is substituted aryl or substituted heteroaryl wherein aryl or heteroaryl is 2,6-di-substituted.

25

20. The use according to claim 19, wherein R^{37} is selected from the group consisting of 2,6-dialkoxyaryl, 2,6-dialkoxyheteroaryl, 2-alkyl-6-alkoxyaryl, 2-alkyl-6-alkoxyheteroaryl, 2-oxo-6-alkoxyheteroaryl, 2-oxo-6-alkylheteroaryl, and optionally substituted imidazolidin-2,4-dion-3-yl.

30

21. The use according to claim 15, wherein Ar^{31} is selected from the group consisting of 4-methylphenyl, 4-chlorophenyl, 1-naphthyl, 2-naphthyl, 4-methoxyphenyl, phenyl, 2,4,6-trimethylphenyl, 2-(methoxycarbonyl)phenyl, 2-carboxyphenyl, 3,5-dichlorophenyl, 4-trifluoromethylphenyl, 3,4-dichlorophenyl, 3,4-dimethoxyphenyl, 4-($CH_3C(O)NH$ -)phenyl, 4-trifluoromethoxyphenyl, 4-

cyanophenyl, 3,5-di-(trifluoromethyl)phenyl, 4-*t*-butylphenyl, 4-*t*-butoxyphenyl, 4-
 nitrophenyl, 2-thienyl, 1-N-methyl-3-methyl-5-chloropyrazol-4-yl, 1-N-
 methylimidazol-4-yl, 4-bromophenyl, 4-amidinophenyl, 4-methylamidinophenyl, 4-
 [CH₃SC(=NH)]phenyl, 5-chloro-2-thienyl, 2,5-dichloro-4-thienyl, 1-N-methyl-4-
 5 pyrazolyl, 2-thiazolyl, 5-methyl-1,3,4-thiadiazol-2-yl, 4-[H₂NC(S)]phenyl, 4-
 aminophenyl, 4-fluorophenyl, 2-fluorophenyl, 3-fluorophenyl, 3,5-difluorophenyl,
 pyridin-3-yl, pyrimidin-2-yl, 4-(3'-dimethylamino-*n*-propoxy)-phenyl, and 1-
 methylpyrazol-4-yl.

10 22. A use of a compound for the preparation of a medicament in an
 amount to promote remyelination of nerve cells in a mammal for the treatment of a
 demyelinating disease, wherein the compound is selected from the group consisting
 of:

15 *N*-(toluene-4-sulfonyl)-L-prolyl-L-4-(4-methylpiperazin-1-
 ylcarbonyloxy)phenylalanine ethyl ester

N-(toluene-4-sulfonyl)-L-prolyl-L-4-(*N,N*-
 dimethylcarbamyloxy)phenylalanine ethyl ester

20 *N*-(toluene-4-sulfonyl)-L-prolyl-L-4-(4-methylpiperazin-1-
 ylcarbonyloxy)phenylalanine isopropyl ester

25 *N*-(toluene-4-sulfonyl)-L-prolyl-L-4-(4-methylpiperazin-1-
 ylcarbonyloxy)phenylalanine *n*-butyl ester

30 *N*-(toluene-4-sulfonyl)-L-prolyl-L-4-(4-methylpiperazin-1-
 ylcarbonyloxy)phenylalanine cyclopentyl ester

35 *N*-(toluene-4-sulfonyl)-L-prolyl-L-4-(4-methylpiperazin-1-
 ylcarbonyloxy)phenylalanine *tert*-butyl ester

40 *N*-(toluene-4-sulfonyl)-L-prolyl-L-4-(4-methylpiperazin-1-
 ylcarbonyloxy)phenylalanine

35 *N*-(toluene-4-sulfonyl)-L-prolyl-L-4-(*N,N*-
 dimethylcarbamyloxy)phenylalanine isopropyl ester

40 *N*-(toluene-4-sulfonyl)-L-prolyl-L-4-(*N,N*-
 dimethylcarbamyloxy)phenylalanine *n*-butyl ester

- N*-(toluene-4-sulfonyl)-*L*-prolyl-*L*-4-(*N,N*-dimethylcarbamyloxy)phenylalanine cyclopentyl ester
- 5 *N*-(toluene-4-sulfonyl)-*L*-prolyl-*L*-4-(*N,N*-dimethylcarbamyloxy)phenylalanine *tert*-butyl ester
- N*-(toluene-4-sulfonyl)-*L*-prolyl-*L*-4-(*N,N*-dimethylcarbamyloxy)phenylalanine
- 10 *N*-(toluene-4-sulfonyl)-*L*-prolyl-*L*-4-(isonipecotoxyloxy)phenylalanine ethyl ester
- N*-(α -toluenesulfonyl)-*L*-prolyl-*L*-4-(*N*-methylisonipecotoxyloxy)phenylalanine ethyl ester
- 15 *N*-(α -toluenesulfonyl)-*L*-prolyl-*L*-4-(4-methylpiperazin-1-ylcarbonyloxy)phenylalanine
- N*-(toluene-4-sulfonyl)-*L*-prolyl-*L*-3-(*N,N*-dimethylcarbamyloxy)phenylalanine ethyl ester
- 20 *N*-(toluene-4-sulfonyl)-*L*-prolyl-*L*-4-(1-*tert*-butylcarbonyloxy-4-phenylpiperidin-4-ylcarbonyloxy)phenylalanine ethyl ester
- N*-(toluene-4-sulfonyl)-*L*-(5,5-dimethyl)thiaprolyl-*L*-4-(*N,N*-dimethylcarbamyloxy)phenylalanine isopropyl ester
- 25 *N*-(toluene-4-sulfonyl)-*L*-(5,5-dimethyl)thiaprolyl-*L*-4-(*N,N*-dimethylcarbamyloxy)phenylalanine *tert*-butyl ester
- 30 *N*-(toluene-4-sulfonyl)-*L*-(5,5-dimethyl)thiaprolyl-*L*-4-(*N,N*-dimethylcarbamyloxy)phenylalanine
- N*-(toluene-4-sulfonyl)-*L*-[(1,1-dioxo)thiamorpholin-3-carbonyl]-*L*-4-(*N,N*-dimethylcarbamyloxy)phenylalanine *tert*-butyl ester
- 35 *N*-(toluene-4-sulfonyl)-*L*-[(1,1-dioxo)thiamorpholin-3-carbonyl]-*L*-4-(*N,N*-dimethylcarbamyloxy)phenylalanine
- N*-(toluene-4-sulfonyl)-*L*-(5,5-dimethyl)thiaprolyl-*L*-4-(4-methylpiperazin-1-ylcarbonyloxy)phenylalanine *tert*-butyl ester
- 40 *N*-(toluene-4-sulfonyl)-*L*-(5,5-dimethyl)thiaprolyl-*L*-4-(4-methylpiperazin-1-ylcarbonyloxy)phenylalanine
- 45 *N*-(toluene-4-sulfonyl)sarcosyl-*L*-4-(*N,N*-dimethylcarbamyloxy)phenylalanine isopropyl ester

- N*-(toluene-4-sulfonyl)sarcosyl-L-4-(*N,N*-dimethylcarbamyloxy)phenylalanine *tert*-butyl ester
- 5 *N*-(toluene-4-sulfonyl)sarcosyl-L-4-(*N,N*-dimethylcarbamyloxy)phenylalanine
- N*-(1-methylimidazole-4-sulfonyl)-L-prolyl-L-4-(*N,N*-dimethylcarbamyloxy)phenylalanine *tert*-butyl ester
- 10 *N*-(4-aminobenzenesulfonyl)-L-prolyl-L-4-(*N,N*-dimethylcarbamyloxy)phenylalanine *tert*-butyl ester
- N*-(toluene-4-sulfonyl)sarcosyl-L-4-(morpholin-4-ylcarbonyloxy)phenylalanine *tert*-butyl ester
- 15 *N*-(toluene-4-sulfonyl)-L-prolyl-L-4-(morpholin-4-ylcarbonyloxy)phenylalanine *tert*-butyl ester
- N*-(α -toluenesulfonyl)-L-(5,5-dimethyl)thiaprolyl-L-4-(*N,N*-dimethylcarbamyloxy)phenylalanine
- 20 *N*-(toluene-4-sulfonyl)-L-(piperazin-2-carbonyl)-L-4-(*N,N*-dimethylcarbamyloxy)phenylalanine
- 25 *N*-(α -toluenesulfonyl)-L-(5,5-dimethyl)thiaprolyl-L-4-(*N,N*-dimethylcarbamyloxy)phenylalanine *tert*-butyl ester
- N*-(toluene-4-sulfonyl)-L-(piperazin-2-carbonyl)-L-4-(*N,N*-dimethylcarbamyloxy)phenylalanine *tert*-butyl ester
- 30 *N*-(toluene-4-sulfonyl)-L-(4-benzyloxycarbonylpiperazin-2-carbonyl)-L-4-(*N,N*-dimethylcarbamyloxy)phenylalanine *tert*-butyl ester
- 35 *N*-(toluene-4-sulfonyl)sarcosyl-L-4-(isonipecotoxyloxy)phenylalanine
- N*-(toluene-4-sulfonyl)-L-[(1,1-dioxo)thiamorpholin-3-carbonyl]-L-4-(morpholin-4-ylcarbonyloxy)phenylalanine *tert*-butyl ester
- 40 *N*-(toluene-4-sulfonyl)-L-[(1,1-dioxo)thiamorpholin-3-carbonyl]-L-4-(morpholin-4-ylcarbonyloxy)phenylalanine
- N*-(1-methylpyrazole-4-sulfonyl)-L-prolyl-L-4-(*N,N*-dimethylcarbamyloxy)phenylalanine *tert*-butyl ester
- 45 *N*-(4-fluorobenzenesulfonyl)-L-prolyl-L-4-(*N,N*-dimethylcarbamyloxy)phenylalanine *tert*-butyl ester

- N*-(toluene-4-sulfonyl)sarcosyl-L-4-(4-methylpiperazin-1-ylcarbonyloxy)phenylalanine *tert*-butyl ester
- 5 *N*-(toluene-4-sulfonyl)-L-(1,1-dioxo-5,5-dimethyl)thiaprolyl-L-4-(*N,N*-dimethylcarbamyloxy)phenylalanine *tert*-butyl ester
- N*-(1-methylimidazole-4-sulfonyl)-L-prolyl-L-4-(*N,N*-dimethylcarbamyloxy)phenylalanine
- 10 *N*-(toluene-4-sulfonyl)-L-(1,1-dioxo-5,5-dimethyl)thiaprolyl-L-4-(*N,N*-dimethylcarbamyloxy)phenylalanine
- N*-(4-fluorobenzenesulfonyl)-L-prolyl-L-4-(*N,N*-dimethylcarbamyloxy)phenylalanine
- 15 *N*-(pyridine-3-sulfonyl)-L-prolyl-L-4-(*N,N*-dimethylcarbamyloxy)phenylalanine
- N*-(toluene-4-sulfonyl)-D-prolyl-L-4-(4-methylpiperazin-1-ylcarbonyloxy)phenylalanine *tert*-butyl ester
- 20 *N*-(toluene-4-sulfonyl)-L-*N*-methylalanyl-L-4-(4-methylpiperazin-1-ylcarbonyloxy)phenylalanine *tert*-butyl ester
- 25 *N*-(4-nitrobenzenesulfonyl)-L-prolyl-L-4-(*N,N*-dimethylcarbamyloxy)phenylalanine *tert*-butyl ester
- N*-(toluene-4-sulfonyl)sarcosyl-L-4-(thiomorpholin-4-ylcarbonyloxy)phenylalanine *tert*-butyl ester
- 30 *N*-(toluene-4-sulfonyl)-L-*N*-methylalanyl-L-4-(4-methylpiperazin-1-ylcarbonyloxy)phenylalanine
- N*-(toluene-4-sulfonyl)-L-prolyl-L-4-(1,1-dioxothiomorpholin-4-ylcarbonyloxy)phenylalanine
- 35 *N*-(toluene-4-sulfonyl)-L-prolyl-L-4-(thiomorpholin-4-ylcarbonyloxy)phenylalanine
- 40 *N*-(toluene-4-sulfonyl)-L-prolyl-L-4-(isonipecotoxyloxy)phenylalanine
- N*-(toluene-4-sulfonyl)-L-prolyl-L-4-(pyrrolidin-1-ylcarbonyloxy)phenylalanine
- 45 *N*-(toluene-4-sulfonyl)-L-prolyl-L-4-(morpholin-4-ylcarbonyloxy)phenylalanine

- N*-(toluene-4-sulfonyl)-*L*-prolyl-*L*-4-(4-methylpiperazin-1-ylcarbonyloxy)phenylalanine neopentyl ester
- 5 *N*-(toluene-4-sulfonyl)-*L*-prolyl-*L*-4-(*N,N*-dimethylcarbamyloxy)phenylalanine neopentyl ester
- N*-(toluene-4-sulfonyl)-*L*-prolyl-*L*-4-(4-*tert*-butyloxycarbonylpiperazin-1-ylcarbonyloxy)phenylalanine ethyl ester
- 10 *N*-(toluene-4-sulfonyl)-*L*-prolyl-*L*-4-(morpholin-4-ylcarbonyloxy)phenylalanine ethyl ester
- N*-(toluene-4-sulfonyl)sarcosyl-*L*-4-(1,1-dioxothiomorpholin-4-ylcarbonyloxy)phenylalanine *tert*-butyl ester
- 15 *N*-(toluene-4-sulfonyl)sarcosyl-*L*-4-(thiomorpholin-4-ylcarbonyloxy)phenylalanine
- N*-(toluene-4-sulfonyl)-*L-N*-methylalanyl-*L*-4-(*N,N*-dimethylcarbamyloxy)phenylalanine *tert*-butyl ester
- 20 *N*-(toluene-4-sulfonyl)-*L*-(thiamorpholin-3-carbonyl)-*L*-4-(*N,N*-dimethylcarbamyloxy)phenylalanine *tert*-butyl ester
- 25 *N*-(toluene-4-sulfonyl)sarcosyl-*L*-4-(1,1-dioxothiomorpholin-4-ylcarbonyloxy)phenylalanine
- N*-(toluene-4-sulfonyl)-*L*-(1,1-dioxothiamorpholin-3-carbonyl)-*L*-4-(*N,N*-dimethylcarbamyloxy)phenylalanine *tert*-butyl ester
- 30 *N*-(toluene-4-sulfonyl)-*L*-(1,1-dioxothiamorpholin-3-carbonyl)-*L*-4-(morpholin-4-ylcarbonyloxy)phenylalanine *tert*-butyl ester
- N*-(toluene-4-sulfonyl)-*L-N*-methylalanyl-*L*-4-(*N,N*-dimethylcarbamyloxy)phenylalanine
- 35 *N*-(4-fluorobenzenesulfonyl)-*L*-(thiamorpholin-3-carbonyl)-*L*-4-(*N,N*-dimethylcarbamyloxy)phenylalanine *tert*-butyl ester
- 40 *N*-(4-fluorobenzenesulfonyl)-*L*-(1,1-dioxothiamorpholin-3-carbonyl)-*L*-4-(*N,N*-dimethylcarbamyloxy)phenylalanine *tert*-butyl ester
- N*-(pyridine-3-sulfonyl)-*L*-prolyl-*L*-4-(*N,N*-dimethylcarbamyloxy)phenylalanine *tert*-butyl ester
- 45

- N*-(pyrimidine-2-sulfonyl)-*L*-prolyl-*L*-4-(*N,N*-dimethylcarbamyloxy)phenylalanine *tert*-butyl ester
- 5 *N*-(4-nitrobenzenesulfonyl)-*L*-prolyl-*L*-4-(*N,N*-dimethylcarbamyloxy)phenylalanine
- N*-(4-cyanobenzenesulfonyl)-*L*-prolyl-*L*-4-(*N,N*-dimethylcarbamyloxy)phenylalanine *tert*-butyl ester
- 10 *N*-(toluene-4-sulfonyl)-*L*-(1,1-dioxothiamorpholin-3-carbonyl)-*L*-4-(*N,N*-dimethylcarbamyloxy)phenylalanine
- N*-(toluene-4-sulfonyl)-*L*-(1,1-dioxo)thiaprolyl-*L*-4-(*N,N*-dimethylcarbamyloxy)phenylalanine *tert*-butyl ester
- 15 *N*-(4-fluorobenzenesulfonyl)-*L*-prolyl-*L*-4-(*N,N*-dimethylcarbamyloxy)phenylalanine *tert*-butyl ester
- N*-(1-methylpyrazole-4-sulfonyl)-*L*-prolyl-*L*-4-(*N,N*-dimethylcarbamyloxy)phenylalanine
- 20 *N*-(toluene-4-sulfonyl)-*L*-(1,1-dioxo)thiaprolyl-*L*-4-(*N,N*-dimethylcarbamyloxy)phenylalanine
- N*-(4-fluorobenzenesulfonyl)-*L*-thiaprolyl-*L*-4-(*N,N*-dimethylcarbamyloxy)phenylalanine
- 25 *N*-(toluene-4-sulfonyl)-*L*-prolyl-*L*-4-(piperazin-1-ylcarbonyloxy)phenylalanine
- 30 *N*-(toluene-4-sulfonyl)-*L*-prolyl-*L*-4-(1-*tert*-butyloxycarbonylpiperazin-1-ylcarbonyloxy)phenylalanine *tert*-butyl ester
- N*-(toluene-4-sulfonyl)-*L*-prolyl-*L*-4-(piperazin-1-ylcarbonyloxy)phenylalanine ethyl ester
- 35 *N*-(toluene-4-sulfonyl)-*L*-prolyl-*L*-4-(4-acetylpiperazin-1-ylcarbonyloxy)phenylalanine ethyl ester
- N*-(toluene-4-sulfonyl)-*L*-prolyl-*L*-4-(4-methanesulfonylpiperazin-1-ylcarbonyloxy)phenylalanine ethyl ester
- 40 *N*-(toluene-4-sulfonyl)-*L*-prolyl-*L*-4-(morpholin-4-ylcarbonyloxy)-3-nitrophenylalanine
- 45 *N*-(toluene-4-sulfonyl)-*L*-prolyl-*L*-4-(1-*tert*-butyloxycarbonylpiperazin-1-ylcarbonyloxy)phenylalanine

- N*-(toluene-4-sulfonyl)-*L*-*N*-methyl-2-(*tert*-butyl)glycinyll-*L*-4-(4-methylpiperazin-1-ylcarbonyloxy)phenylalanine *tert*-butyl ester
- 5 *N*-(4-fluorobenzenesulfonyl)-*L*-(5,5-dimethyl)thiaprolyl-*L*-4-(*N,N*-dimethylcarbamyloxy)phenylalanine *tert*-butyl ester
- N*-(4-fluorobenzenesulfonyl)-*L*-(1,1-dioxothiamorpholin-3-carbonyl)-*L*-4-(1,1-dioxothiomorpholin-4-ylcarbonyloxy)phenylalanine *tert*-butyl ester
- 10 *N*-(toluene-4-sulfonyl)-*L*-(1,1-dioxothiamorpholin-3-carbonyl)-*L*-4-(1,1-dioxothiomorpholin-4-ylcarbonyloxy)phenylalanine *tert*-butyl ester
- N*-(4-fluorobenzenesulfonyl)-*L*-prolyl-*L*-4-(1,1-dioxothiomorpholin-4-ylcarbonyloxy)phenylalanine *tert*-butyl ester
- 15 *N*-(4-fluorobenzenesulfonyl)-*L*-prolyl-*L*-4-(thiomorpholin-4-ylcarbonyloxy)phenylalanine *tert*-butyl ester
- N*-(4-fluorobenzenesulfonyl)-*L*-prolyl-*L*-4-(morpholin-4-ylcarbonyloxy)phenylalanine *tert*-butyl ester
- 20 *N*-(4-fluorobenzenesulfonyl)-*L*-(5,5-dimethyl)thiaprolyl-*L*-4-(*N,N*-dimethylcarbamyloxy)phenylalanine
- 25 *N*-(4-fluorobenzenesulfonyl)-*L*-(1,1-dioxothiamorpholin-3-carbonyl)-*L*-4-(morpholin-4-ylcarbonyloxy)phenylalanine *tert*-butyl ester
- N*-(4-trifluoromethoxybenzenesulfonyl)-*L*-prolyl-*L*-4-(*N,N*-dimethylcarbamyloxy)phenylalanine *tert*-butyl ester
- 30 *N*-(toluene-4-sulfonyl)-*L*-(1,1-dioxothiamorpholin-3-carbonyl)-*L*-4-(*N,N*-dimethylcarbamyloxy)phenylalanine isopropyl ester
- 35 3-[*N*-(toluene-4-sulfonyl)-*N*-methylamino]-1-[1-*tert*-butyloxycarbonyl-2-(*N,N*-dimethylcarbamyloxy)phenylethyl]azetid-2-one
- N*-(4-fluorobenzenesulfonyl)-*L*-(1,1-dioxo-5,5-dimethyl)thiaprolyl-*L*-4-(*N,N*-dimethylcarbamyloxy)phenylalanine *tert*-butyl ester
- 40 *N*-(toluene-4-sulfonyl)-*L*-(1,1-dioxo-5,5-dimethyl)thiaprolyl-*L*-4-(*N,N*-dimethylcarbamyloxy)phenylalanine isopropyl ester
- N*-(toluene-4-sulfonyl)-*L*-(1,1-dioxothiamorpholin-3-carbonyl)-*L*-4-(morpholin-4-ylcarbonyloxy)phenylalanine
- 45

- N*-(4-fluorobenzenesulfonyl)-*L*-(5,5-dimethyl)thiaprolyl-*L*-4-(*N,N*-dimethylcarbamyloxy)phenylalanine
- 5 *N*-(pyrimidine-2-sulfonyl)-*L*-prolyl-*L*-4-(*N,N*-dimethylcarbamyloxy)phenylalanine
- N*-(toluene-4-sulfonyl)-*L*-(1,1-dioxothiomorpholin-3-carbonyl)-*L*-4-(4-methylpiperazin-1-ylcarbonyloxy)phenylalanine *tert*-butyl ester
- 10 3-[*N*-(toluene-4-sulfonyl)-*N*-methylamino]-1-[1-carboxy-2-(*N,N*-dimethylcarbamyloxy)phenylethyl]azetidin-2-one
- N*-(1-methylpyrazole-4-sulfonyl)-*L*-prolyl-*L*-4-(4-methylpiperazin-1-ylcarbonyloxy)phenylalanine *tert*-butyl ester
- 15 *N*-(4-fluorobenzenesulfonyl)-*L*-(1,1-dioxo)thiaprolyl-*L*-4-(*N,N*-dimethylcarbamyloxy)phenylalanine
- N*-(toluene-4-sulfonyl)-*L*-prolyl-*L*-4-(isonipecotoyloxy)phenylalanine *tert*-butyl ester
- 20 *N*-(toluene-4-sulfonyl)-*L*-prolyl-*L*-4-(1,1-dioxothiomorpholin-4-ylcarbonyloxy)phenylalanine *tert*-butyl ester
- N*-(toluene-4-sulfonyl)-*L*-prolyl-*L*-4-(thiomorpholin-4-ylcarbonyloxy)phenylalanine *tert*-butyl ester
- 25 *N*-(toluene-4-sulfonyl)-*L*-prolyl-*L*-4-(pyrrolidin-1-ylcarbonyloxy)phenylalanine *tert*-butyl ester
- 30 *N*-(4-fluorobenzenesulfonyl)-*L*-thiaprolyl-*L*-4-(*N,N*-dimethylcarbamyloxy)phenylalanine *tert*-butyl ester
- N*-(4-fluorobenzenesulfonyl)-*L*-(1,1-dioxo)thiaprolyl-*L*-4-(*N,N*-dimethylcarbamyloxy)phenylalanine *tert*-butyl ester
- 35 *N*-(2,5-dichlorothiophene-3-sulfonyl)-*L*-prolyl-*L*-4-(*N,N*-dimethylcarbamyloxy)phenylalanine *tert*-butyl ester
- N*-(4-acetamidobenzenesulfonyl)-*L*-prolyl-*L*-4-(*N,N*-dimethylcarbamyloxy)phenylalanine *tert*-butyl ester
- 40 *N*-(4-*tert*-butylbenzenesulfonyl)-*L*-(1,1-dioxothiomorpholin-3-carbonyl)-*L*-4-(*N,N*-dimethylcarbamyloxy)phenylalanine *tert*-butyl ester
- 45 *N*-(pyridine-2-sulfonyl)-*L*-prolyl-*L*-4-(*N,N*-dimethylcarbamyloxy)phenylalanine

- N*-(2-fluorobenzenesulfonyl)-L-(1,1-dioxothiomorpholin-3-carbonyl)-L-4-(*N,N*-dimethylcarbamyloxy)phenylalanine *tert*-butyl ester
- 5 *N*-(3-fluorobenzenesulfonyl)-L-(1,1-dioxothiomorpholin-3-carbonyl)-L-4-(*N,N*-dimethylcarbamyloxy)phenylalanine *tert*-butyl ester
- N*-(2,4-difluorobenzenesulfonyl)-L-(1,1-dioxothiomorpholin-3-carbonyl)-L-4-(*N,N*-dimethylcarbamyloxy)phenylalanine *tert*-butyl ester
- 10 *N*-(4-acetamidobenzenesulfonyl)-L-prolyl-L-4-(*N,N*-dimethylcarbamyloxy)phenylalanine
- N*-(4-trifluoromethoxybenzenesulfonyl)-L-prolyl-L-4-(*N,N*-dimethylcarbamyloxy)phenylalanine
- 15 *N*-(4-fluorobenzenesulfonyl)-L-(5,5-dimethyl)thiaprolyl-L-4-(*N,N*-dimethylcarbamyloxy)phenylalanine *tert*-butyl ester
- N*-(4-cyanobenzenesulfonyl)-L-prolyl-L-4-(*N,N*-dimethylcarbamyloxy)phenylalanine
- 20 *N*-(toluene-4-sulfonyl)-L-(3,3-dimethyl)prolyl-L-4-(*N,N*-dimethylcarbamyloxy)phenylalanine *tert*-butyl ester
- N*-(toluene-4-sulfonyl)-L-(3,3-dimethyl)prolyl-L-4-(*N,N*-dimethylcarbamyloxy)phenylalanine isopropyl ester
- 25 *N*-(1-methylpyrazole-4-sulfonyl)-L-prolyl-L-4-(*N,N*-dimethylcarbamyloxy)phenylalanine *iso*-propyl ester
- 30 *N*-(1-methylpyrazole-4-sulfonyl)-L-(5,5-dimethyl)thiaprolyl-L-4-(*N,N*-dimethylcarbamyloxy)phenylalanine *tert*-butyl ester
- N*-(1-methylpyrazole-4-sulfonyl)-L-(5,5-dimethyl)thiaprolyl-L-4-(*N,N*-dimethylcarbamyloxy)phenylalanine
- 35 *N*-(toluene-4-sulfonyl)-L-prolyl-L-4-(*N*-(1,4-dioxa-8-aza-spiro[4.5]decan-8-yl)carbonyloxy)phenylalanine ethyl ester
- 40 *N*-(toluene-4-sulfonyl)-L-prolyl-L-4-(*N*-(1,4-dioxa-8-aza-spiro[4.5]decan-8-yl)carbonyloxy)phenylalanine
- N*-(toluene-4-sulfonyl)-L-prolyl-L-4-(4'-acetylpiperazin-1-ylcarbonyloxy)phenylalanine
- 45

- N-(toluene-4-sulfonyl)-L-prolyl-L-4-(4'-methanesulfonylpiperazin-1-ylcarbonyloxy)phenylalanine
- 5 N-(toluene-4-sulfonyl)-L-prolyl-L-4-(4'-phenylpiperazin-1-ylcarbonyloxy)phenylalanine
- N-(toluene-4-sulfonyl)-L-prolyl-L-4-(piperazin-1-ylcarbonyloxy)phenylalanine *tert*-butyl ester
- 10 N-(toluene-4-sulfonyl)-L-prolyl-L-4-(4'-methanesulfonylpiperazin-1-ylcarbonyloxy)phenylalanine *tert*-butyl ester
- 15 N-(toluene-4-sulfonyl)-L-prolyl-L-4-(N,N-dimethylcarbamyloxy)phenylalanine (N'-*tert*-butoxycarbonyl-2-amino-2-methylpropyl) ester
- N-(toluene-4-sulfonyl)-L-prolyl-L-4-(4'-acetylpiperazin-1-ylcarbonyloxy)phenylalanine *tert*-butyl ester
- 20 N-(toluene-4-sulfonyl)-L-prolyl-L-4-(4'-hydroxypiperidin-1-ylcarbonyloxy)phenylalanine *tert*-butyl ester
- 25 N-(toluene-4-sulfonyl)-L-prolyl-L-4-(N-(2'-(morpholin-4'-yl)ethyl)carbamyloxy)phenylalanine *tert*-butyl ester
- N-(toluene-4-sulfonyl)-L-prolyl-L-4-(N-(1,4-dioxa-8-aza-spiro[4.5]decan-8-yl)carbonyloxy)phenylalanine *tert*-butyl ester
- 30 N-(toluene-4-sulfonyl)-L-prolyl-L-4-(N-(2'-hydroxyethyl)-N-methylcarbamyloxy)phenylalanine *tert*-butyl ester
- N-(toluene-4-sulfonyl)-L-prolyl-L-4-(4'-(2-hydroxyethyl)piperazin-1-ylcarbonyloxy)-L-phenylalanine *tert*-butyl ester
- 35 N-(toluene-4-sulfonyl)-L-prolyl-L-4-(N-(2'-formyloxyethyl)-N-methylcarbamyloxy)phenylalanine
- 40 N-(toluene-4-sulfonyl)-L-prolyl-L-4-(N-(2'-hydroxyethyl)-N-methylcarbamyloxy)phenylalanine isopropyl ester
- N-(toluene-4-sulfonyl)-L-prolyl-L-4-(N-(methoxycarbonylmethyl)carbamyloxy)phenylalanine *tert*-butyl ester
- 45 N-(1-methylpyrazole-4-sulfonyl)-L-(5,5-dimethyl)thiaprolyl-L-(4-N,N-dimethylcarbamyloxy)phenylalanine isopropyl ester

- N-(toluene-4-sulfonyl)-L-prolyl-L-4-(4'-methoxypiperidin-1-ylcarbonyloxy)phenylalanine isopropyl ester
- 5 N-(toluene-4-sulfonyl)-L-prolyl-L-4-(4'-methoxypiperidin-1-ylcarbonyloxy)phenylalanine
- N-(toluene-4-sulfonyl)-L-4-oxoprolyl-L-4-(N,N-dimethylcarbamyloxy)phenylalanine *tert*-butyl ester
- 10 N-(toluene-4-sulfonyl)-L-*trans*-4-hydroxyprolyl-L-4-(N,N-dimethylcarbamyloxy)phenylalanine *tert*-butyl ester
- N-(3-fluorobenzenesulfonyl)-L-prolyl-L-4-(N,N-dimethylcarbamyloxy)phenylalanine *tert*-butyl ester
- 15 N-(morpholino-sulfonyl)-L-prolyl-L-(4-N,N-dimethylcarbamyloxy)phenylalanine *tert*-butyl ester
- N-(morpholino-sulfonyl)-L-prolyl-L-(4-N,N-dimethylcarbamyloxy)phenylalanine
- 20 N-(1-methylpyrazole-4-sulfonyl)-L-(1,1-dioxothiamorpholin-3-carbonyl)-L-4-(N,N-dimethylcarbamyloxy)phenylalanine *tert*-butyl ester
- 25 N-(2-fluorobenzenesulfonyl)-L-(1,1-dioxothiamorpholin-3-carbonyl)-L-4-(N,N-dimethylcarbamyloxy)phenylalanine
- N-(2,4-difluorobenzenesulfonyl)-L-(1,1-dioxothiamorpholin-3-carbonyl)-L-4-(N,N-dimethylcarbamyloxy)phenylalanine
- 30 N-(toluene-4-sulfonyl)-L-(thiamorpholin-3-carbonyl)-L-4-(N,N-dimethylcarbamyloxy)phenylalanine
- N-(pyridine-3-sulfonyl)-L-(5,5-dimethyl-thiaprolyl-L-4-(N,N-dimethylcarbamyloxy)phenylalanine isopropyl ester
- 35 N-(3-fluorobenzenesulfonyl)-L-(1,1-dioxothiamorpholin-3-carbonyl)-L-4-(N,N-dimethylcarbamyloxy)phenylalanine
- 40 N-(1-methylpyrazole-4-sulfonyl)-L-(1,1-dioxothiamorpholin-3-carbonyl)-L-4-(N,N-dimethylcarbamyloxy)phenylalanine
- N-(4-*tert*-butylbenzenesulfonyl)-L-(1,1-dioxothiamorpholin-3-carbonyl)-L-4-(N,N-dimethylcarbamyloxy)phenylalanine
- 45 N-(toluene-4-sulfonyl)-(3,3-dimethyl)prolyl-L-4-(N,N-dimethylcarbamyloxy)phenylalanine

- N*-(2,5-dichlorothiophene-3-sulfonyl)-L-prolyl-L-4-(*N,N*-dimethylcarbamyloxy)phenylalanine
- 5 *N*-(4-methoxybenzenesulfonyl)-L-prolyl-L-4-(*N,N*-dimethylcarbamyloxy)phenylalanine
- N*-(4-methoxybenzenesulfonyl)-L-prolyl-L-4-(*N,N*-dimethylcarbamyloxy)phenylalanine isopropyl ester
- 10 *N*-(toluene-4-sulfonyl)-L-(1-oxo-thiomorpholin-3-carbonyl)-L-4-(*N,N*-dimethylcarbamyloxy)phenylalanine
- N*-(toluene-4-sulfonyl)-L-(1-oxo-thiomorpholin-3-carbonyl)-L-4-(*N,N*-dimethylcarbamyloxy)phenylalanine *tert*-butyl ester
- 15 *N*-(3,4-difluorobenzenesulfonyl)-L-prolyl-4-(*N,N*-dimethylcarbamyloxy)phenylalanine isopropyl ester
- N*-(3,4-difluorobenzenesulfonyl)-L-prolyl-4-(*N,N*-dimethylcarbamyloxy)phenylalanine
- 20 *N*-(3,4-difluorobenzenesulfonyl)-L-(1,1-dioxothiomorpholin-3-carbonyl)-L-4-(*N,N*-dimethylcarbamyloxy)phenylalanine *tert*-butyl ester
- N*-(3,4-difluorobenzenesulfonyl)-L-(1,1-dioxothiomorpholin-3-carbonyl)-L-4-(*N,N*-dimethylcarbamyloxy)phenylalanine
- 25 *N*-(toluene-4-sulfonyl)-L-(5,5-dimethyl)thiaprolyl-L-(thiomorpholin-4-ylcarbonyloxy)phenylalanine *tert*-butyl ester
- N*-(toluene-4-sulfonyl)-L-(5,5-dimethyl)thiaprolyl-L-(thiomorpholin-4-ylcarbonyloxy)phenylalanine
- 30 *N*-(1-methylpyrazole-4-sulfonyl)-L-(5,5-dimethyl)thiaprolyl-L-4-(*N,N*-dimethylcarbamyloxy)phenylalanine ethyl ester
- N*-(pyridine-3-sulfonyl)-L-(5,5-dimethyl)thiaprolyl-L-4-(*N,N*-dimethylcarbamyloxy)phenylalanine
- 40 *N*-(pyridine-2-sulfonyl)-L-prolyl-L-4-(*N,N*-dimethylcarbamyloxy)phenylalanine isopropyl ester
- N*-(pyridine-2-sulfonyl)-L-prolyl-L-4-(*N,N*-dimethylcarbamyloxy)phenylalanine
- 45

- N*-(pyridine-2-sulfonyl)-L-(5,5-dimethyl)thiaprolyl-L-4-(*N,N*-dimethylcarbamyloxy)phenylalanine isopropyl ester
- 5 *N*-(pyridine-2-sulfonyl)-L-(5,5-dimethyl)thiaprolyl-L-4-(*N,N*-dimethylcarbamyloxy)phenylalanine
- N*-(toluene-4-sulfonyl)-L-(thiamorpholin-3-carbonyl)-L-4-(*N,N*-dimethylcarbamyloxy)phenylalanine isopropyl ester
- 10 *N*-(3-fluorobenzenesulfonyl)-L-(5,5-dimethyl)thiaprolyl-L-4-(*N,N*-dimethylcarbamyloxy)phenylalanine isopropyl ester
- N*-(2-fluorobenzenesulfonyl)-L-(5,5-dimethyl)thiaprolyl-L-4-(*N,N*-dimethylcarbamyloxy)phenylalanine isopropyl ester
- 15 *N*-(3,4-difluorobenzenesulfonyl)-L-(5,5-dimethyl)thiaprolyl-L-4-(*N,N*-dimethylcarbamyloxy)phenylalanine isopropyl ester
- N*-(3,5-difluorobenzenesulfonyl)-L-(5,5-dimethyl)thiaprolyl-L-4-(*N,N*-dimethylcarbamyloxy)phenylalanine isopropyl ester
- 20 *N*-(2,4-difluorobenzenesulfonyl)-L-(5,5-dimethyl)thiaprolyl-L-4-(*N,N*-dimethylcarbamyloxy)phenylalanine isopropyl ester
- N*-(4-chlorobenzenesulfonyl)-L-(5,5-dimethyl)thiaprolyl-L-4-(*N,N*-dimethylcarbamyloxy)phenylalanine isopropyl ester
- 25 *N*-(3-chlorobenzenesulfonyl)-L-(5,5-dimethyl)thiaprolyl-L-4-(*N,N*-dimethylcarbamyloxy)phenylalanine isopropyl ester
- 30 *N*-(2-chlorobenzenesulfonyl)-L-(5,5-dimethyl)thiaprolyl-L-4-(*N,N*-dimethylcarbamyloxy)phenylalanine isopropyl ester
- N*-(3,4-dichlorobenzenesulfonyl)-L-(5,5-dimethyl)thiaprolyl-L-4-(*N,N*-dimethylcarbamyloxy)phenylalanine isopropyl ester
- 35 *N*-(3,5-dichlorobenzenesulfonyl)-L-(5,5-dimethyl)thiaprolyl-L-4-(*N,N*-dimethylcarbamyloxy)phenylalanine isopropyl ester
- N*-(3-chlorobenzenesulfonyl)-L-(1,1-dioxothiamorpholin-3-carbonyl)-L-4-(*N,N*-dimethylcarbamyloxy)phenylalanine *tert*-butyl ester
- 40 *N*-(3,4-dichlorobenzenesulfonyl)-L-(1,1-dioxothiamorpholin-3-carbonyl)-L-4-(*N,N*-dimethylcarbamyloxy)phenylalanine *tert*-butyl ester
- 45 *N*-(4-methoxybenzenesulfonyl)-L-(5,5-dimethyl)thiaprolyl-L-4-(*N,N*-dimethylcarbamyloxy)phenylalanine isopropyl ester

- N*-(3-methoxybenzenesulfonyl)-L-(5,5-dimethyl)thiaprolyl-L-4-(*N,N*-dimethylcarbamoyloxy)phenylalanine isopropyl ester
- 5 *N*-(2-methoxybenzenesulfonyl)-L-(5,5-dimethyl)thiaprolyl-L-4-(*N,N*-dimethylcarbamoyloxy)phenylalanine isopropyl ester
- N*-(3,4-dimethoxybenzenesulfonyl)-L-(5,5-dimethyl)thiaprolyl-L-4-(*N,N*-dimethylcarbamoyloxy)phenylalanine isopropyl ester
- 10 *N*-(2,4-difluorobenzenesulfonyl)-L-(thiamorpholin-3-carbonyl)-L-4-(*N,N*-dimethylcarbamoyloxy)phenylalanine isopropyl ester
- N*-(3,4-dichlorobenzenesulfonyl)-L-(1,1-dioxothiamorpholin-3-carbonyl)-L-4-(*N,N*-dimethylcarbamoyloxy)phenylalanine
- 15 *N*-(3-chlorobenzenesulfonyl)-L-(1,1-dioxothiamorpholin-3-carbonyl)-L-4-(*N,N*-dimethylcarbamoyloxy)phenylalanine
- N*-(3-chloro-4-fluorobenzenesulfonyl)-L-(1,1-dioxothiamorpholin-3-carbonyl)-L-4-(*N,N*-dimethylcarbamoyloxy)phenylalanine *tert*-butyl ester
- 20 *N*-(1-methylpyrazole-4-sulfonyl)-L-(thiamorpholin-3-carbonyl)-L-4-(*N,N*-dimethylcarbamoyloxy)phenylalanine *tert*-butyl ester
- 25 *N*-(3,4-difluorobenzenesulfonyl)-L-(thiamorpholin-3-carbonyl)-L-4-(*N,N*-dimethylcarbamoyloxy)phenylalanine *tert*-butyl ester
- N*-(toluene-4-sulfonyl)-L-(5,5-dimethyl)thioprolyl-L-(thiomorpholin-4-ylcarbonyloxy)phenylalanine isopropyl ester
- 30 *N*-(3,4-difluorobenzenesulfonyl)-L-(thiamorpholin-3-carbonyl)-L-4-(*N,N*-dimethylcarbamoyloxy)phenylalanine
- N*-(2,5-dichlorothiophene-3-sulfonyl)-L-(5,5-dimethyl)thiaprolyl-L-4-(*N,N*-dimethylcarbamoyloxy)phenylalanine isopropyl ester
- 35 *N*-(1-methylpyrazole-4-sulfonyl)-L-(5,5-dimethyl)thiaprolyl-L-4-(thiomorpholin-4-ylcarbonyloxy)phenylalanine isopropyl ester
- 40 *N*-(8-quinolinesulfonyl)-L-prolyl-L-4-(*N,N*-dimethylcarbamoyloxy)phenylalanine isopropyl ester
- N*-(8-quinolinesulfonyl)-L-prolyl-L-4-(*N,N*-dimethylcarbamoyloxy)phenylalanine
- 45

- N*-(8-quinolinesulfonyl)-*L*-(5,5-dimethyl)thiaprolyl-*L*-4-(*N,N*-dimethylcarbamyloxy)phenylalanine isopropyl ester
- 5 *N*-(8-quinolinesulfonyl)-*L*-(5,5-dimethyl)thiaprolyl-*L*-4-(*N,N*-dimethylcarbamyloxy)phenylalanine
- N*-(toluene-4-sulfonyl)-*L*-prolyl-*L*-4-(4-phenylpiperazin-1-ylcarbonyloxy)phenylalanine *tert*-butyl ester
- 10 *N*-(toluene-4-sulfonyl)-*L*-prolyl-*L*-4-(4'-(ethoxycarbonyl)piperidin-1-ylcarbonyloxy)phenylalanine *tert*-butyl ester
- N*-(pyridine-3-sulfonyl)-*L*-(5,5-dimethyl)thiaprolyl-*L*-4-(*N,N*-dimethylcarbamyloxy)phenylalanine *tert*-butyl ester
- 15 *N*-(3-sulfonamido-4-chloro-benzenesulfonyl)-*L*-prolyl-*L*-4-(*N,N*-dimethylcarbamyloxy)phenylalanine isopropyl ester
- N*-(toluene-4-sulfonyl)-*L*-(1-oxothiomorpholin-3-carbonyl)-*L*-4-(*N,N*-dimethylcarbamyloxy)phenylalanine isopropyl ester
- 20 *N*-(2,4-difluorobenzenesulfonyl)-*L*-(1-oxothiomorpholin-3-carbonyl)-*L*-4-(*N,N*-dimethylcarbamyloxy)phenylalanine *tert*-butyl ester
- N*-(1-methylpyrazole-4-sulfonyl)-*L*-(5,5-dimethyl)thiaprolyl-*L*-4-(*N,N*-dimethylcarbamyloxy)phenylalanine 2,2-dimethylpropyl ester
- 25 *N*-(pyridine-3-sulfonyl)-*L*-(5,5-dimethyl)thiaprolyl-*L*-4-(*N,N*-dimethylcarbamyloxy)phenylalanine 2,2-dimethylpropyl ester
- 30 *N*-(1-methylpyrazole-4-sulfonyl)-*L*-(5,5-dimethyl)thiaprolyl-*L*-4-(*N,N*-dimethylcarbamyloxy)phenylalanine cyclopropylmethyl ester
- N*-(1-methylpyrazole-4-sulfonyl)-*L*-(5,5-dimethyl)thiaprolyl-*L*-4-(*N,N*-dimethylcarbamyloxy)phenylalanine methyl ester
- 35 *N*-(pyridine-3-sulfonyl)-*L*-(5,5-dimethyl)thiaprolyl-*L*-4-(*N,N*-dimethylcarbamyloxy)phenylalanine ethyl ester
- N*-(pyridine-3-sulfonyl)-*L*-(5,5-dimethyl)thiaprolyl-*L*-4-(*N,N*-dimethylcarbamyloxy)phenylalanine cyclopropylmethyl ester
- 40 *N*-(1-methylpyrazole-4-sulfonyl)-*L*-(5,5-dimethyl)thiaprolyl-*L*-4-(*N,N*-dimethylcarbamyloxy)phenylalanine 2-methoxyphenyl ester
- 45 *N*-(1-methylpyrazole-4-sulfonyl)-*L*-(5,5-dimethyl)thiaprolyl-*L*-4-(*N,N*-dimethylcarbamyloxy)phenylalanine *n*-butyl ester

- N*-(1-methylpyrazole-4-sulfonyl)-*L*-(5,5-dimethyl)thiaprolyl-*L*-4-(*N,N*-dimethylcarbamyloxy)phenylalanine *n*-propyl ester
- 5 *N*-(1-methylpyrazole-4-sulfonyl)-*L*-(5,5-dimethyl)thiaprolyl-*L*-4-(*N,N*-dimethylcarbamyloxy)phenylalanine 2,2-dimethylpropionyloxymethyl ester
- N*-(toluene-4-sulfonyl)-*L*-prolyl-*L*-4-(*N*-(4'-(2'-aminoethyl)morpholino)carbamyloxy)phenylalanine
- 10 *N*-(toluene-4-sulfonyl)-*L*-prolyl-*L*-4-[4-(carboxy)piperidin-1-ylcarbonyloxy]phenylalanine
- N*-(toluene-4-sulfonyl)-*L*-prolyl-*L*-4-(*N,N*-bis-(2-hydroxyethyl)carbamyloxy)phenylalanine isopropyl ester
- 15 *N*-(toluene-4-sulfonyl)-*L*-prolyl-*L*-4-[3-(hydroxymethyl)piperidin-1-ylcarbonyloxy]phenylalanine isopropyl ester
- N*-(toluene-4-sulfonyl)-*L*-prolyl-*L*-4-(4-trifluoromethanesulfonylpiperazin-1-ylcarbonyloxy)phenylalanine *tert*-butyl ester
- 20 *N*-(4-(*N*-phenylurea)benzenesulfonyl)-*L*-prolyl-*L*-4-(*N,N*-dimethylcarbamyloxy)phenylalanine *tert*-butyl ester
- 25 *N*-(2-trifluoroacetyl-1,2,3,4-tetrahydroisoquinolin-7-sulfonyl)-*L*-prolyl-*L*-4-(*N,N*-dimethylcarbamyloxy)phenylalanine isopropyl ester
- N*-(1-methylpyrazole-3-sulfonyl)-*L*-(5,5-dimethyl)thiaprolyl-*L*-4-(*N,N*-dimethylcarbamyloxy)phenylalanine isopropyl ester
- 30 *N*-(1-methylpyrazole-3-sulfonyl)-*L*-(5,5-dimethyl)thiaprolyl-*L*-4-(*N,N*-dimethylcarbamyloxy)phenylalanine
- N*-(pyridine-4-sulfonyl)-*L*-(5,5-dimethyl)thiaprolyl-*L*-4-(*N,N*-dimethylcarbamyloxy)phenylalanine isopropyl ester
- 35 *N*-(pyridine-4-sulfonyl)-*L*-(5,5-dimethyl)thiaprolyl-*L*-4-(*N,N*-dimethylcarbamyloxy)phenylalanine
- 40 *N*-(toluene-4-sulfonyl)-*L*-(5,5-dimethyl)thiaprolyl-*L*-4-(*N*-methyl-*N*-(2-dimethylaminoethyl)carbamyloxy)phenylalanine *tert*-butyl ester
- N*-(toluene-4-sulfonyl)-*L*-prolyl-*L*-4-(*N*-methyl-*N*-(2-dimethylaminoethyl)carbamyloxy)phenylalanine *tert*-butyl ester
- 45

- N*-(toluene-4-sulfonyl)-*L*-(5,5-dimethyl)thiaprolyl-*L*-4-(*N*-methyl-*N*-(2-dimethylaminoethyl)carbamyloxy)phenylalanine
- 5 *N*-(toluene-4-sulfonyl)-*L*-prolyl-*L*-4-(*N*-methyl-*N*-(2-dimethylaminoethyl)carbamyloxy)phenylalanine
- N*-(4-fluorobenzenesulfonyl)-*L*-(5,5-dimethyl)thiaprolyl-*L*-3-chloro-4-(4-methylpiperazin-1-ylcarbonyloxy)phenylalanine *tert*-butyl ester
- 10 *N*-(4-fluorobenzenesulfonyl)-*L*-(5,5-dimethyl)thiaprolyl-*L*-3-chloro-4-(*N,N*-dimethylcarbamyloxy)phenylalanine
- N*-(4-fluorobenzenesulfonyl)-*L*-(5,5-dimethyl)thiaprolyl-*L*-3-chloro-4-(thiomorpholin-4-ylcarbonyloxy)phenylalanine *tert*-butyl ester
- 15 *N*-(4-fluorobenzenesulfonyl)-*L*-(5,5-dimethyl)thiaprolyl-*L*-3-chloro-4-(thiomorpholin-4-ylcarbonyloxy)phenylalanine isopropyl ester
- N*-(4-fluorobenzenesulfonyl)-*L*-(5,5-dimethyl)thiaprolyl-*L*-3-chloro-4-(*N,N*-dimethylcarbamyloxy)]phenylalanine isopropyl ester
- 20 *N*-(toluene-4-sulfonyl)-*L*-(5,5-dimethyl)thiaprolyl-*L*-3-chloro-4-(*N,N*-dimethylcarbamyloxy)phenylalanine isopropyl ester
- N*-(4-fluorobenzenesulfonyl)-*L*-(5,5-dimethyl)thiaprolyl-*L*-3-chloro-4-(4-methylpiperazin-1-ylcarbonyloxy)]phenylalanine isopropyl ester
- 25 *N*-(toluene-4-sulfonyl)-*L*-prolyl-*L*-3-chloro-4-(*N,N*-dimethylcarbamyloxy)]phenylalanine isopropyl ester
- 30 *N*-(4-fluorobenzenesulfonyl)-*L*-(5,5-dimethyl)thiaprolyl-*L*-3-chloro-4-(4-(2'-pyridyl)-piperazin-1-ylcarbonyloxy)]phenylalanine isopropyl ester
- N*-(4-fluorobenzenesulfonyl)-*L*-(5,5-dimethyl)thiaprolyl-*L*-3-chloro-4-(4-(2'-pyridyl)-piperazin-1-ylcarbonyloxy)]phenylalanine *tert*-butyl ester
- 35 *N*-(4-nitrobenzenesulfonyl)-*L*-prolyl-*L*-4-(*N,N*-dimethylcarbamyloxy)phenylalanine isopropyl ester
- N*-(4-aminobenzenesulfonyl)-*L*-prolyl-*L*-4-(*N,N*-dimethylcarbamyloxy)phenylalanine isopropyl ester
- 40 *N*-(toluene-4-sulfonyl)-*L*-prolyl-*L*-4-(thiomorpholin-4-ylcarbonyloxy)phenylalanine isopropyl ester
- 45 *N*-(toluene-4-sulfonyl)-*L*-prolyl-*L*-4-(4-phenylcarbonylpiperazin-1-ylcarbonyloxy)phenylalanine isopropyl ester

- N*-(toluene-4-sulfonyl)-*L*-prolyl-*L*-4-(4-phenylcarbamyloxy)piperazin-1-ylcarbonyloxy)phenylalanine
- 5 *N*-(1-*n*-butylpyrazole-4-sulfonyl)-*L*-(5,5-dimethyl)thiaprolyl-*L*-4-(*N,N*-dimethylcarbamyloxy)phenylalanine isopropyl ester
- N*-(toluene-4-sulfonyl)-*L*-prolyl-*L*-4-(pyridin-4-ylcarbonyl)piperazin-1-ylcarbonyloxy)phenylalanine isopropyl ester
- 10 *N*-(toluene-4-sulfonyl)-*L*-4-oxoprolyl-*L*-4-(*N,N*-dimethylcarbamyloxy)phenylalanine
- N*-(toluene-4-sulfonyl)-*L-trans*-4-hydroxyprolyl-*L*-4-(*N,N*-dimethylcarbamyloxy)phenylalanine
- 15 *N*-(4-cyanobenzenesulfonyl)-*L*-prolyl-*L*-4-(*N,N*-dimethylcarbamyloxy)phenylalanine isopropyl ester
- N*-(4-aminobenzenesulfonyl)-*L*-prolyl-*L*-4-(*N,N*-dimethylcarbamyloxy)phenylalanine
- 20 *N*-(toluene-4-sulfonyl)-*L*-4-oxoprolyl-*L*-4-(4-methylpiperazin-1-ylcarbonyloxy)phenylalanine *tert*-butyl ester
- 25 *N*-(toluene-4-sulfonyl)-*L*-prolyl-*L*-4-[3-(hydroxymethyl)piperidin-1-ylcarbonyloxy]phenylalanine
- N*-(toluene-4-sulfonyl)-*L*-(4,4-difluoro)prolyl-*L*-4-(*N,N*-dimethylcarbamyloxy)phenylalanine isopropyl ester
- 30 *N*-(toluene-4-sulfonyl)-*L*-(4,4-difluoro)prolyl-*L*-4-(*N,N*-dimethylcarbamyloxy)phenylalanine
- N*-(toluene-4-sulfonyl)-*L*-prolyl-*L*-(4-benzoylpiperazin-1-ylcarbonyloxy)phenylalanine isopropyl ester
- 35 *N*-(1-methyl-1*H*-imidazole-4-sulfonyl)-*L*-prolyl-*L*-4-(*N,N*-dimethylcarbamyloxy)phenylalanine isopropyl ester
- 40 *N*-(toluene-4-sulfonyl)-*L*-4-(thiomorpholin-4-ylcarbonyloxy)prolyl-*L*-4-(thiomorpholin-4-ylcarbonyloxy)phenylalanine
- N*-(4-cyanobenzenesulfonyl)-*L*-prolyl-*L*-4-(thiomorpholin-4-ylcarbonyloxy)phenylalanine isopropyl ester
- 45

- N*-(4-amidinobenzenesulfonyl)-L-prolyl-L-4-(*N,N*-dimethylcarbamyloxy)phenylalanine methyl ester
- 5 *N*-(toluene-4-sulfonyl)-L-4-oxoprolyl-L-4-(thiomorpholin-4-ylcarbonyloxy)phenylalanine *tert*-butyl ester
- N*-(toluene-4-sulfonyl)-L-4-hydroxyprolyl-L-4-(thiomorpholin-4-ylcarbonyloxy)phenylalanine
- 10 *N*-(toluene-4-sulfonyl)-L-prolyl-L-(4-benzoylpiperazin-1-ylcarbonyloxy)phenylalanine
- N*-(4-amidinobenzenesulfonyl)-L-prolyl-L-4-(thiomorpholin-4-ylcarbonyloxy)phenylalanine methyl ester
- 15 *N*-(3-fluorobenzenesulfonyl)-L-prolyl-L-4-(*N,N*-dimethylcarbonyloxy)phenylalanine
- N*-(toluene-4-sulfonyl)-L-prolyl-L-4-[*N*-methyl-*N*-(2-(*N'*-methyl-*N'*-toluenesulfonyl-amino)ethyl)carbamyloxy]phenylalanine isopropyl ester
- 20 *N*-(toluene-4-sulfonyl)-L-prolyl-L-4-[*N*-(2-(*N'*-phenylaminocarbonyloxy)ethyl)carbamyloxy]phenylalanine isopropyl ester
- N*-(4-fluorobenzenesulfonyl)-L-4-(*trans*-hydroxy)prolyl-L-4-(*N,N*-dimethylcarbamyloxy)phenylalanine isopropyl ester
- 25 *N*-(4-fluorobenzenesulfonyl)-L-4-(*trans*-hydroxy)prolyl-L-4-(*N,N*-dimethylcarbamyloxy)phenylalanine *tert*-butyl ester
- 30 *N*-(4-amidinobenzenesulfonyl)-L-prolyl-L-4-(*N,N*-dimethylcarbamyloxy)phenylalanine
- N*-(toluene-4-sulfonyl)-L-(pyrazin-3-carbonyl)-L-4-(*N,N*-dimethylcarbamyloxy)phenylalanine *tert*-butyl ester
- 35 *N*-(4-fluorobenzenesulfonyl)-L-(5,5-dimethyl)thiaprolyl-L-4-(2-hydroxymethylpyrrolidin-1-ylcarbonyloxy)phenylalanine *tert*-butyl ester
- N*-(4-fluorobenzenesulfonyl)-L-(5,5-dimethyl)thiaprolyl-L-4-(2-hydroxymethylpyrrolidin-1-ylcarbonyloxy)phenylalanine
- 40 *N*-(toluene-4-sulfonyl)-L-prolyl-L-4-(2-methoxycarbonylpyrrolidin-1-ylcarbonyloxy)phenylalanine *tert*-butyl ester
- 45 *N*-(4-fluorobenzenesulfonyl)-L-(5,5-dimethyl)thiaprolyl-L-3-chloro-4-(thiomorpholin-4-ylcarbonyloxy)phenylalanine

- N*-(4-fluorobenzenesulfonyl)-L-(5,5-dimethyl)thiaprolyl-L-4-(4-(2-pyridyl)piperazin-1-ylcarbonyloxy)]phenylalanine
- 5 *N*-(4-fluorobenzenesulfonyl)-L-(5,5-dimethyl)thiaprolyl-L-4-(4-(2-pyridyl)piperazin-1-ylcarbonyloxy)]phenylalanine *tert*-butyl ester
- N*-(toluene-4-sulfonyl)-L-(4-hydroxy)prolyl-L-4-(thiomorpholin-4-ylcarbonyloxy)phenylalanine *tert*-butyl ester
- 10 *N*-(toluene-4-sulfonyl)-L-prolyl-L-4-(*N,N*-dimethylcarbamyloxy)phenylalanine 2-(2-methoxyethoxy)ethyl ester
- N*-(4-fluorobenzenesulfonyl)-L-(5,5-dimethyl)thiaprolyl-L-4-(4-(2-pyrimidyl)piperazin-1-ylcarbonyloxy)]phenylalanine *tert*-butyl ester
- 15 *N*-(4-fluorobenzenesulfonyl)-L-(5,5-dimethyl)thiaprolyl-L-3-fluoro-4-(*N,N*-dimethylcarbamyloxy)phenylalanine isopropyl ester
- N*-(toluene-4-sulfonyl)-L-(1-methanesulfonylpyrazin-3-carbonyl)-L-4-(*N,N*-dimethylcarbamyloxy)phenylalanine *tert*-butyl ester
- 20 *N*-(4-bromobenzenesulfonyl)-L-(5,5-dimethyl)thiaprolyl-L-4-(*N,N*-dimethylcarbamyloxy)phenylalanine *tert*-butyl ester
- 25 *N*-(4-bromobenzenesulfonyl)-L-(5,5-dimethyl)thiaprolyl-L-4-(*N,N*-dimethylcarbamyloxy)phenylalanine
- N*-(toluene-4-sulfonyl)-L-(4-hydroxy)prolyl-L-4-(4-methylpiperazin-1-ylcarbonyloxy)phenylalanine
- 30 *N*-(4-fluorobenzenesulfonyl)-L-(5,5-dimethyl)thiaprolyl-L-4-(4-(2-pyrimidyl)piperazin-1-ylcarbonyloxy)]phenylalanine
- N*-(4-fluorobenzenesulfonyl)-L-(5,5-dimethyl)thiaprolyl-L-4-(4-(2-pyridyl)piperazin-1-ylcarbonyloxy)]phenylalanine isopropyl ester
- 35 *N*-(4-fluorobenzenesulfonyl)thiazolidinyl-2-carbonyl-L-4-(*N,N*-dimethylcarbamyloxy)phenylalanine
- 40 *N*-(4-fluorobenzenesulfonyl)thiazolidinyl-2-carbonyl-L-4-(*N,N*-dimethylcarbamyloxy)phenylalanine *tert*-butyl ester
- N*-(toluene-4-sulfonyl)-L-(4-oxo)prolyl-L-4-(thiomorpholin-4-ylcarbonyloxy)phenylalanine
- 45

- N*-(toluene-4-sulfonyl)-*L*-(4-oxo)prolyl-*L*-4-(4-methylpiperazin-1-ylcarbonyloxy)phenylalanine
- 5 *N*-(4-fluorobenzenesulfonyl)thiazolidinyl-2-carbonyl-*L*-4-(4-(2-pyridyl)piperazin-1-ylcarbonyloxy)]phenylalanine
- 10 *N*-(4-nitrobenzenesulfonyl)-*L*-prolyl-*L*-4-(4-(2-pyridyl)piperazin-1-ylcarbonyloxy)]phenylalanine *tert*-butyl ester
- 15 *N*-(4-bromobenzenesulfonyl)-*L*-(5,5-dimethyl)thiaprolyl-*L*-4-(4-(2-pyridyl)piperazin-1-ylcarbonyloxy)]phenylalanine
- N*-(toluene-4-sulfonyl)-*L*-prolyl-*L*-4-(4-(*N*-phenylthiocarbonyl)piperazin-1-ylcarbonyloxy)]phenylalanine isopropyl ester
- 20 *N*-(4-fluorobenzenesulfonyl)thiazolidinyl-2-carbonyl-*L*-4-(4-methylhomopiperazin-1-ylcarbonyloxy)phenylalanine *tert*-butyl ester
- N*-(toluene-4-sulfonyl)-*L*-4-(methanesulfonyloxy)prolyl-*L*-4-(*N,N*-dimethylcarbamyloxy)phenylalanine *tert*-butyl ester
- 25 *N*-(4-aminocarbonylbenzenesulfonyl)-*L*-prolyl-*L*-4-(*N,N*-dimethylcarbamyloxy)phenylalanine
- 30 *N*-(4-aminocarbonylbenzenesulfonyl)-*L*-prolyl-*L*-4-(thiomorpholin-4-ylcarbonyloxy)phenylalanine
- N*-(4-amidinobenzenesulfonyl)-*L*-prolyl-*L*-4-(thiomorpholin-4-ylcarbonyloxy)phenylalanine
- 35 *N*-(4-nitrobenzenesulfonyl)-*L*-prolyl-*L*-4-(4-(2-pyridyl)piperazin-1-ylcarbonyloxy)]phenylalanine
- N*-(4-fluorobenzenesulfonyl)-*L*-(5,5-dimethyl)thiaprolyl-*L*-3-chloro-4-(4-(2-pyridyl)piperazin-1-ylcarbonyloxy)]phenylalanine ethyl ester
- 40 *N*-(4-fluorobenzenesulfonyl)-*L*-(5,5-dimethyl)thiaprolyl-*L*-3-chloro-4-(4-(2-pyridyl)piperazin-1-ylcarbonyloxy)phenylalanine
- 45 *N*-(4-fluorobenzenesulfonyl)thiazolidinyl-2-carbonyl-*L*-4-(4-methylhomopiperazin-1-ylcarbonyloxy)phenylalanine
- N*-(1-methylpyrazole-3-sulfonyl)-*L*-(5,5-dimethyl)thiaprolyl-*L*-3-chloro-4-(*N,N*-dimethylcarbamyloxy)phenylalanine isopropyl ester

- N*-(1-methylimidazole-4-sulfonyl)-*L*-prolyl-*L*-4-(4-(2-pyridyl)piperazin-1-ylcarbonyloxy)phenylalanine isopropyl ester
- 5 *N*-(1-methylimidazole-4-sulfonyl)-*L*-prolyl-*L*-4-(4-(2-pyridyl)piperazin-1-ylcarbonyloxy)phenylalanine *tert*-butyl ester
- N*-(toluene-4-sulfonyl)-*L*-prolyl-*L*-4-(4-(2-pyridyl)piperazin-1-ylcarbonyloxy)phenylalanine
- 10 *N*-(toluene-4-sulfonyl)-*L*-prolyl-*L*-4-(4-(2-pyridyl)piperazin-1-ylcarbonyloxy)phenylalanine *tert*-butyl ester
- N*-(toluene-4-sulfonyl)-*L*-prolyl-*L*-4-(4-(2-pyridyl)piperazin-1-ylcarbonyloxy)phenylalanine isopropyl ester
- 15 *N*-(4-fluorobenzenesulfonyl)-*L*-prolyl-*L*-4-(4-(2-pyridyl)piperazin-1-ylcarbonyloxy)phenylalanine isopropyl ester
- N*-(4-fluorobenzenesulfonyl)-*L*-prolyl-*L*-4-(4-(2-pyridyl)piperazin-1-ylcarbonyloxy)phenylalanine *tert*-butyl ester
- 20 *N*-(4-fluorobenzenesulfonyl)-*L*-prolyl-*L*-4-(4-(2-pyridyl)piperazin-1-ylcarbonyloxy)phenylalanine *tert*-butyl ester
- N*-(toluene-4-sulfonyl)-*L*-(1-methanesulfonylpyrazin-3-carbonyl)-*L*-4-(*N,N*-dimethylcarbamyloxy)phenylalanine
- 25 *N*-(toluene-4-sulfonyl)-*L*-4-(methanesulfonyloxy)prolyl-*L*-4-(*N,N*-dimethylcarbamyloxy)phenylalanine
- N*-(4-bromobenzenesulfonyl)-*L*-(5,5-dimethyl)thiaprolyl-*L*-4-(4-(2-pyridyl)piperazin-1-ylcarbonyloxy)phenylalanine *tert*-butyl ester
- 30 *N*-(4-trifluoromethoxybenzenesulfonyl)-*L*-(5,5-dimethyl)thiaprolyl-*L*-4-(*N,N*-dimethylcarbamyloxy)phenylalanine
- N*-(4-trifluoromethoxybenzenesulfonyl)-*L*-(5,5-dimethyl)thiaprolyl-*L*-4-(*N,N*-dimethylcarbamyloxy)phenylalanine *tert*-butyl ester
- 35 *N*-(4-trifluoromethoxybenzenesulfonyl)-*L*-(5,5-dimethyl)thiaprolyl-*L*-4-(4-(2-pyridyl)piperazin-1-ylcarbonyloxy)phenylalanine *tert*-butyl ester
- N*-(4-fluorobenzenesulfonyl)-*L*-prolyl-*L*-4-(4-(2-pyridyl)piperazin-1-ylcarbonyloxy)phenylalanine
- 40 *N*-(4-fluorobenzenesulfonyl)-*L*-(4-hydroxy)prolyl-*L*-4-(4-(2-pyridyl)piperazin-1-ylcarbonyloxy)phenylalanine
- 45 *N*-(4-fluorobenzenesulfonyl)-*L*-(4-hydroxy)prolyl-*L*-4-(4-(2-pyridyl)piperazin-1-ylcarbonyloxy)phenylalanine

- 5 *N*-(4-trifluoromethoxybenzenesulfonyl)-*L*-(5,5-dimethyl)thiaprolyl-*L*-4-(4-(2-pyridyl)piperazin-1-ylcarbonyloxy)phenylalanine
- 5 *N*-(1-methylimidazole-4-sulfonyl)-*L*-prolyl-*L*-3-chloro-4-(*N,N*-dimethylcarbamyloxy)phenylalanine
- 10 *N*-(1-methylimidazole-4-sulfonyl)-*L*-prolyl-*L*-3-chloro-4-(*N,N*-dimethylcarbamyloxy)phenylalanine isopropyl ester
- 10 *N*-(1-methylimidazole-4-sulfonyl)-*L*-prolyl-*L*-4-(4-(2-pyridyl)piperazin-1-ylcarbonyloxy)phenylalanine
- 15 *N*-(1-methylimidazole-4-sulfonyl)-*L*-(5,5-dimethyl)thiaprolyl-*L*-4-(4-(2-pyridyl)piperazin-1-ylcarbonyloxy)phenylalanine
- 15 *N*-(1-methylpyrazole-3-sulfonyl)-*L*-prolyl-*L*-4-(4-(2-pyridyl)piperazin-1-ylcarbonyloxy)phenylalanine
- 20 *N*-(1-methylpyrazole-3-sulfonyl)-*L*-prolyl-*L*-4-(4-(2-pyridyl)piperazin-1-ylcarbonyloxy)phenylalanine isopropyl ester
- 20 *N*-(1-methylpyrazole-3-sulfonyl)-*L*-prolyl-*L*-4-(4-(2-pyridyl)piperazin-1-ylcarbonyloxy)phenylalanine *tert*-butyl ester
- 25 *N*-(1-methylpyrazole-3-sulfonyl)-*L*-(5,5-dimethyl)thiaprolyl-*L*-4-(4-(2-pyridyl)piperazin-1-ylcarbonyloxy)phenylalanine *tert*-butyl ester
- 30 *N*-(1-methylimidazole-4-sulfonyl)-*L*-prolyl-*L*-3-chloro-4-(4-(2-pyridyl)piperazin-1-ylcarbonyloxy)phenylalanine isopropyl ester
- 30 *N*-(1-methylpyrazole-3-sulfonyl)-*L*-(5,5-dimethyl)thiaprolyl-*L*-4-(*N,N*-dimethylcarbamyloxy)phenylalanine 2-phenoxyethyl ester
- 35 *N*-(1-methylpyrazole-3-sulfonyl)-*L*-(5,5-dimethyl)thiaprolyl-*L*-3-chloro-4-(4-(2-pyridyl)piperazin-1-ylcarbonyloxy)phenylalanine
- 40 *N*-(1-methylpyrazole-3-sulfonyl)-*L*-(5,5-dimethyl)thiaprolyl-*L*-3-chloro-4-(4-(2-pyridyl)piperazin-1-ylcarbonyloxy)phenylalanine ethyl ester
- 40 *N*-(3-chloro-1,5-dimethylpyrazole-3-sulfonyl)-*L*-(5,5-dimethyl)thiaprolyl-*L*-3-chloro-4-(4-(5-trifluoromethyl-2-pyridyl)piperazin-1-ylcarbonyloxy)phenylalanine

and pharmaceutically acceptable salts thereof.

45

23. The use according to any one of claims 1 to 5, 13, 15, and 22, wherein the mammal is a human.

24. The use according to any one of claims 1 to 5, 13, 15, and 22, wherein the human suffers from a condition which demyelinate cells, and wherein said condition is multiple sclerosis, a congenital metabolic disorder, a neuropathy with abnormal myelination, drug induced demyelination, radiation induced demyelination, a hereditary demyelinating condition, a prion induced demyelinating condition, encephalitis induced demyelination, or a spinal cord injury.

10

25. The use according to claim 24, wherein the human suffers from multiple sclerosis.

26. The use according to any one of claims 1 to 5, 13, 15, and 22, wherein the compound is administered parenterally.

15

27. The use according to any one of claims 1 to 5, 13, 15, and 22, wherein the compound is administered chronically to the mammal in need thereof.

28. The use according to claim 27, wherein the chronic administration of the compound is weekly or monthly over a period of at least one year.

20

29. The use according to any one of claims 1 to 5, 13, 15, and 22, wherein an anti-inflammatory agent is co-administered with the compound to the mammal.

25

30. The use according to claim 29, wherein an anti-inflammatory agent is co-administered with the compound to the mammal.

31. The use according to claim 30, wherein the anti-inflammatory agent is adrenocorticotrophic hormone, a corticosteroid, an interferon, glatiramer acetate, or a non-steroidal anti-inflammatory drug.

30

32. The use according to claim 31, wherein the interferon is interferon beta-1b or interferon beta-1a.

5 33. The use according to claim 31, wherein the corticosteroid is prednisone, methylprednisolone, dexamethasone, cortisol, cortisone, fludrocortisone, prednisolone, 6 α -methylprednisolone, triamcinolone, or betamethasone.

10 34. The use according to claim 33, wherein the corticosteroid is prednisone.

15 35. The use according to claim 31, wherein the non-steroidal anti-inflammatory drug is aspirin, a sodium salicylate, choline magnesium trisalicylate, salsalate, diflunisal, sulfasalazine, olsalazine, a para-aminophenol derivatives, an indole, an indene acetic acid, a heteroaryl acetic acid, an anthranilic acid, an enolic acid, an alkanones, a diaryl-substituted furanone, a diaryl-substituted pyrazoles, an indole acetic acids, or a sulfonanilide.

20 36. The use according to any one of claims 1 to 5, 13, 15, and 22, wherein the compound is administered intravenously or subcutaneously.

25 37. The use according to claim 36, wherein the compound is administered intravenously to a mammal, and wherein the administration results in an effective blood level of the compound in the mammal of ≥ 10 ng/ml.

30 38. The use according to claim 36, wherein the compound is administered intravenously in an amount of 20 μ g to about 500 μ g per kilogram body weight of the mammal.

39. A combination therapy comprising a therapeutically effective amount of a compound, which prevents demyelination and promotes remyelination when administered to a subject in need thereof, and an anti-inflammatory agent.

5 40. The combination therapy according to claim 39, wherein the compound is of formula I below:

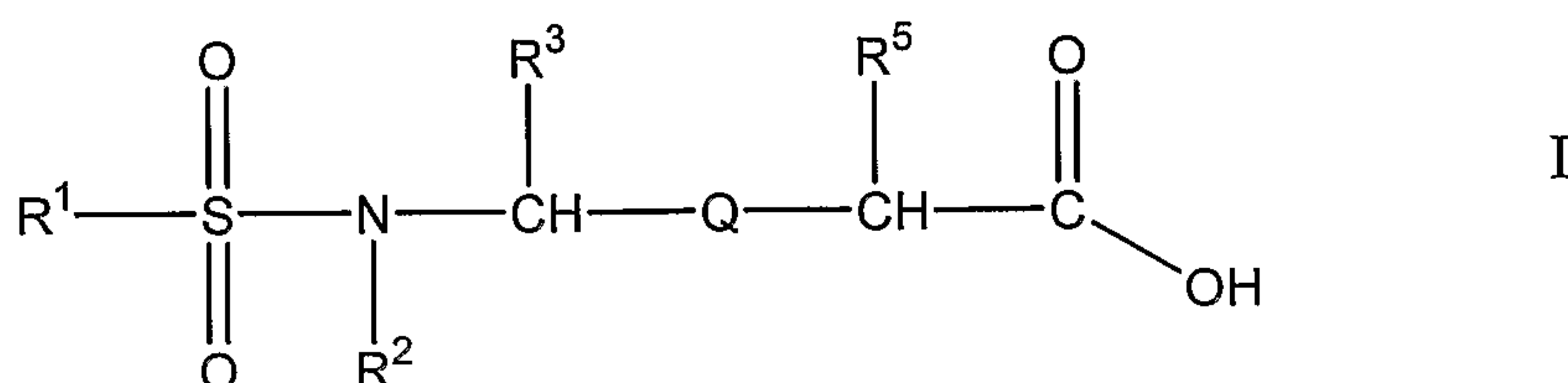

wherein

10 R^1 is selected from the group consisting of alkyl, substituted alkyl, aryl, substituted aryl, cycloalkyl, substituted cycloalkyl, heterocyclic, substituted heterocyclic, heteroaryl and substituted heteroaryl;

R^2 is selected from the group consisting of hydrogen, alkyl, cycloalkyl, substituted cycloalkyl, cycloalkenyl, substituted cycloalkenyl, heterocyclic, substituted heterocyclic, substituted alkyl, aryl, substituted aryl, heteroaryl, substituted heteroaryl, and R^1 and R^2 together with the nitrogen atom bound to R^2 and the SO_2 group bound to R^1 can form a heterocyclic or a substituted heterocyclic group;

20 R^3 is selected from the group consisting of hydrogen, alkyl, substituted alkyl, cycloalkyl, substituted cycloalkyl, aryl, substituted aryl, heteroaryl, substituted heteroaryl, heterocyclic, substituted heterocyclic and, when R^2 does not form a heterocyclic group with R^1 , R^2 and R^3 together with the nitrogen atom bound to R^2 and the carbon atom bound to R^3 can form a heterocyclic or a substituted heterocyclic group;

25 R^5 is $-(\text{CH}_2)_x-\text{Ar}-\text{R}^{5'}$ where $\text{R}^{5'}$ is selected from the group consisting of $-\text{O}-\text{Z}-\text{NR}^8\text{R}^{8'}$ and $-\text{O}-\text{Z}-\text{R}^{8''}$ wherein R^8 and $\text{R}^{8'}$ are independently selected from the group consisting of hydrogen, alkyl, substituted alkyl, cycloalkyl, substituted cycloalkyl, heterocyclic, substituted heterocyclic, and where R^8 and $\text{R}^{8'}$ are joined to form a heterocycle or a substituted heterocycle, $\text{R}^{8''}$ is selected from the group consisting of

heterocycle and substituted heterocycle, and Z is selected from the group consisting of -C(O)- and -SO₂-;

Ar is aryl, heteroaryl, substituted aryl or substituted heteroaryl;

x is an integer of from 1 to 4;

5 Q is -C(X)NR⁷- wherein R⁷ is selected from the group consisting of hydrogen and alkyl; and X is selected from the group consisting of oxygen and sulfur;

and pharmaceutically acceptable salts thereof.

10 41. The combination therapy according to claim 39, wherein the compound is of formula IA below:

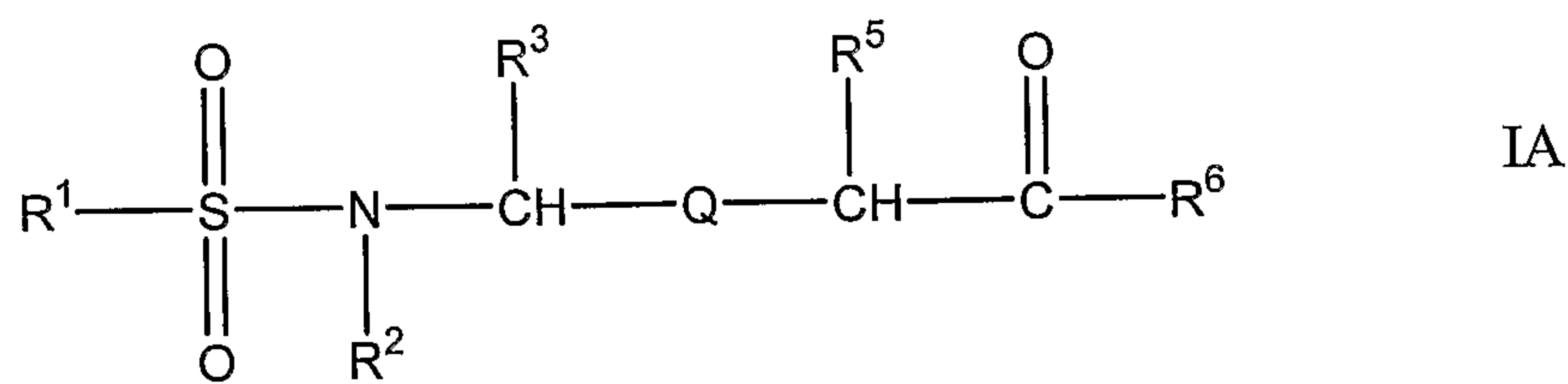

wherein:

15 R¹ is selected from the group consisting of alkyl, substituted alkyl, aryl, substituted aryl, cycloalkyl, substituted cycloalkyl, heterocyclic, substituted heterocyclic, heteroaryl and substituted heteroaryl;

20 R² is selected from the group consisting of hydrogen, alkyl, cycloalkyl, substituted cycloalkyl, cycloalkenyl, substituted cycloalkenyl, heterocyclic, substituted heterocyclic, substituted alkyl, aryl, substituted aryl, heteroaryl, substituted heteroaryl, and R¹ and R² together with the nitrogen atom bound to R² and the SO₂ group bound to R¹ can form a heterocyclic or a substituted heterocyclic group;

25 R³ is selected from the group consisting of hydrogen, alkyl, substituted alkyl, cycloalkyl, substituted cycloalkyl, aryl, substituted aryl, heteroaryl, substituted heteroaryl, heterocyclic, substituted heterocyclic and, when R² does not form a heterocyclic group with R¹, R² and R³ together with the nitrogen atom bound to R² and the carbon atom bound to R³ can form a heterocyclic or a substituted heterocyclic group;

R^5 is $-(CH_2)_x-Ar-R^{5'}$ where $R^{5'}$ is selected from the group consisting of $-O-Z-NR^8R^{8'}$ and $-O-Z-R^{8''}$ wherein R^8 and $R^{8'}$ are independently selected from the group consisting of hydrogen, alkyl, substituted alkyl, cycloalkyl, substituted cycloalkyl, heterocyclic, substituted heterocyclic, and where R^8 and $R^{8'}$ are joined to
 5 form a heterocycle or a substituted heterocycle, $R^{8''}$ is selected from the group consisting of heterocycle and substituted heterocycle, and Z is selected from the group consisting of $-C(O)-$ and $-SO_2-$;

Ar is aryl, heteroaryl, substituted aryl or substituted heteroaryl;

x is an integer of from 1 to 4;

10 R^6 is selected from the group consisting of 2,4-dioxo-tetrahydrofuran-3-yl (3,4-enol), amino, alkoxy, substituted alkoxy, cycloalkoxy, substituted cycloalkoxy, $-O-(N\text{-succinimidyl})$, $-NH\text{-adamantyl}$, $-O\text{-cholest-5-en-3-}\beta\text{-yl}$, $-NHOY$ where Y is hydrogen, alkyl, substituted alkyl, aryl, and substituted aryl, $-NH(CH_2)_pCOOY$ where p is an integer of from 1 to 8 and Y is as defined above, $-OCH_2NR^9R^{10}$ where
 15 R^9 is selected from the group consisting of $-C(O)\text{-aryl}$ and $-C(O)\text{-substituted aryl}$ and R^{10} is selected from the group consisting of hydrogen and $-CH_2COOR^{11}$ where R^{11} is alkyl, and $-NH\text{SO}_2Z'$ where Z' is alkyl, substituted alkyl, cycloalkyl, substituted cycloalkyl, aryl, substituted aryl, heteroaryl, substituted heteroaryl, heterocyclic and substituted heterocyclic;

20 Q is $-C(X)NR^7-$ wherein R^7 is selected from the group consisting of hydrogen and alkyl; and X is selected from the group consisting of oxygen and sulfur;

and pharmaceutically acceptable salts thereof

with the following provisos

25 (A) when R^1 and R^2 together with the SO_2 group pendent to R^1 and the nitrogen pendent to R^2 form a saccharin-2-yl group, R^3 is $-CH_3$, R^5 is $p\text{-}[(CH_3)_2NC(O)O\text{-}]benzyl$ and Q is $-C(O)NH\text{-}$ then R^6 is not $-OC(CH_3)_3$;

(B) when R^1 is $p\text{-methylphenyl}$, R^2 and R^3 together with the nitrogen atom pendent to R^2 and the carbon atom pendent to R^3 form a pyrrodinyl ring derived
 30 from D-proline; R^5 is $p\text{-}[(4\text{-methylpiperazin-1-yl})NC(O)O\text{-}]benzyl$ derived from D-phenylalanine and Q is $-C(O)NH\text{-}$ then R^6 is not $-OC(CH_3)_3$;

(C) when R¹ is pyrimidin-2-yl, R² and R³ together with the nitrogen atom bound to R² and the carbon atom bound to R³ form a pyrrolidinyl ring, R⁵ is *p*-[(CH₃)₂NC(O)O-]benzyl and Q is -C(O)NH- then R⁶ is not -OC(CH₃)₃; and

(D) when R¹ is *p*-methylphenyl, R² and R³ together with the nitrogen atom pendent to R² and the carbon atom pendent to R³ form a (2S)-piperazin-2-carbonyl ring; R⁵ is *p*-[(CH₃)₂NC(O)O-]benzyl and Q is -C(O)NH- then R⁶ is not -OC(CH₃)₃.

42. The combination therapy according to claim 39, wherein the compound is of formula II below:

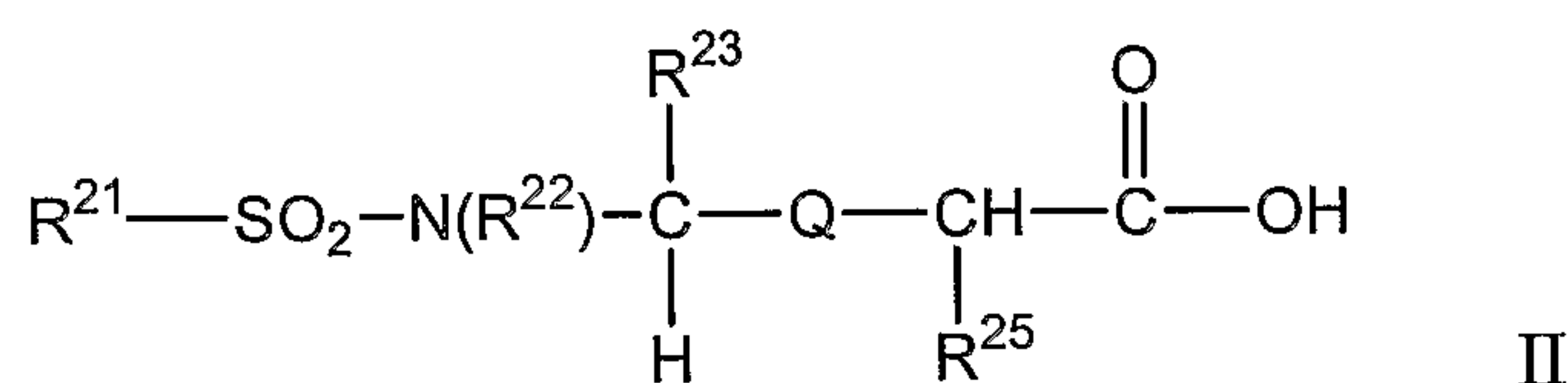

wherein:

R²¹ is selected from the group consisting of alkyl, substituted alkyl, aryl, substituted aryl, cycloalkyl, substituted cycloalkyl, heterocyclic, substituted heterocyclic, heteroaryl and substituted heteroaryl;

R²² is selected from the group consisting of hydrogen, alkyl, substituted alkyl, cycloalkyl, substituted cycloalkyl, cycloalkenyl, substituted cycloalkenyl, heterocyclic, substituted heterocyclic, aryl, substituted aryl, heteroaryl, substituted heteroaryl, and R²¹ and R²² together with the nitrogen atom bound to R²² and the SO₂ group bound to R²¹ can form a heterocyclic or a substituted heterocyclic group;

R²³ is selected from the group consisting of hydrogen, alkyl, substituted alkyl, cycloalkyl, substituted cycloalkyl, aryl, substituted aryl, heteroaryl, substituted heteroaryl, heterocyclic, substituted heterocyclic and where R²² and R²³ together with the nitrogen atom bound to R²² and the carbon atom bound to R²³ can form a saturated heterocyclic group or a saturated substituted heterocyclic group with the proviso that when monosubstituted, the substituent on said saturated substituted heterocyclic group is not carboxyl;

Q is -C(X)NR⁷- wherein R⁷ is selected from the group consisting of hydrogen and alkyl;

X is selected from the group consisting of oxygen and sulfur; and

R²⁵ is -CH₂Ar²²-R^{25'} where Ar²² is aryl or heteroaryl and R^{25'} is selected from the group consisting of aryl, heteroaryl, substituted aryl, substituted heteroaryl, heterocyclic, substituted heterocyclic, aryloxy, substituted aryloxy, aralkoxy, substituted aralkoxy, heteroaryloxy, substituted heteroaryloxy, heterocyclic-O-, substituted heterocyclic-O-, heteroaralkoxy, and substituted heteroaralkoxy ;
 5 and pharmaceutically acceptable salts thereof.

10 43. The combination therapy according to claim 39, wherein the compound is of formula IIA below:

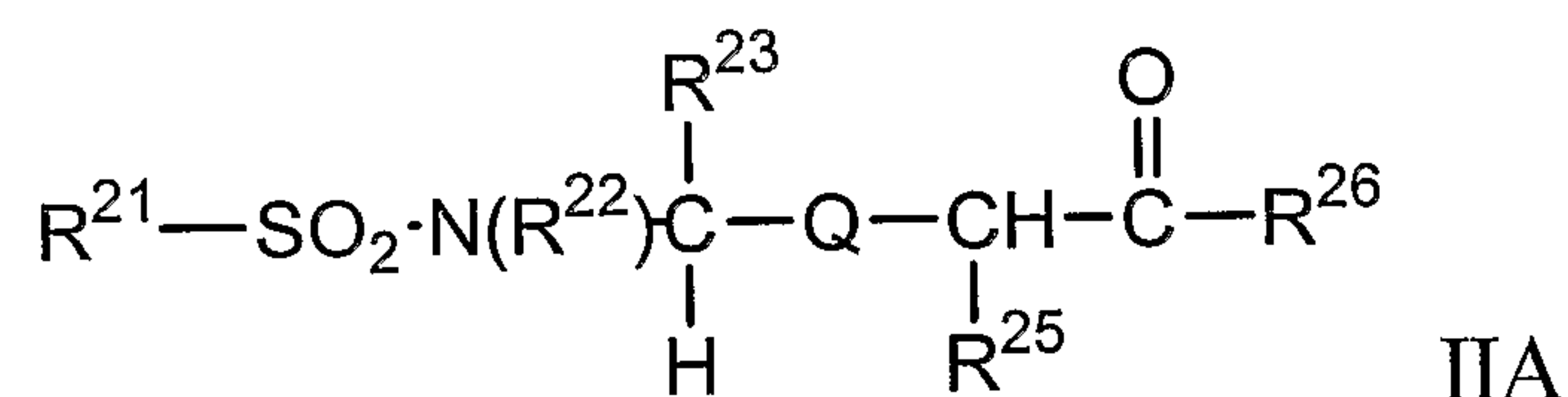

where

15 R²¹ is selected from the group consisting of alkyl, substituted alkyl, aryl, substituted aryl, cycloalkyl, substituted cycloalkyl, heterocyclic, substituted heterocyclic, heteroaryl and substituted heteroaryl;

R²² is selected from the group consisting of hydrogen, alkyl, substituted alkyl, cycloalkyl, substituted cycloalkyl, cycloalkenyl, substituted cycloalkenyl, heterocyclic, substituted heterocyclic, aryl, substituted aryl, heteroaryl, and substituted heteroaryl, and R²¹ and R²² together with the nitrogen atom bound to R²² and the SO₂ group bound to R²¹ can form a heterocyclic or a substituted heterocyclic group;

20 R²³ is selected from the group consisting of hydrogen, alkyl, substituted alkyl, cycloalkyl, substituted cycloalkyl, aryl, substituted aryl, heteroaryl, substituted heteroaryl, heterocyclic, and substituted heterocyclic, and R²² and R²³ together with the nitrogen atom bound to R²² and the carbon atom bound to R²³ can form a saturated heterocyclic group or a saturated substituted heterocyclic group with the

proviso that when monosubstituted, the substituent on said saturated substituted heterocyclic group is not carboxyl;

R^{25} is $-\text{CH}_2\text{Ar}^{22}-R^{25'}$ where Ar^{22} is aryl or heteroaryl and $R^{25'}$ is selected from the group consisting of aryl, heteroaryl, substituted aryl, substituted heteroaryl, heterocyclic, substituted heterocyclic, aryloxy, substituted aryloxy, aralkoxy, substituted aralkoxy, heteroaryloxy, substituted heteroaryloxy, heterocyclic-O-, substituted heterocyclic-O-, heteroaralkoxy, and substituted heteroaralkoxy ;

R^{26} is selected from the group consisting of 2,4-dioxo-tetrahydrofuran-3-yl (3,4-enol), amino, alkoxy, substituted alkoxy, cycloalkoxy, substituted cycloalkoxy, -O-(N-succinimidyl), -NH-adamantyl, -O-cholest-5-en-3- β -yl, -NHOY where Y is hydrogen, alkyl, substituted alkyl, aryl, and substituted aryl, $-\text{NH}(\text{CH}_2)_p\text{COOY}$ where p is an integer of from 1 to 8 and Y is as defined above, $-\text{OCH}_2\text{NR}^{29}\text{R}^{30}$ where R^{29} is selected from the group consisting of -C(O)-aryl and -C(O)-substituted aryl and R^{30} is selected from the group consisting of hydrogen and $-\text{CH}_2\text{COOR}^{31}$ where R^{31} is alkyl, and $-\text{NHSO}_2\text{Z}'$ where Z' is alkyl, substituted alkyl, cycloalkyl, substituted cycloalkyl, aryl, substituted aryl, heteroaryl, substituted heteroaryl, heterocyclic or substituted heterocyclic;

Q is $-\text{C}(\text{X})\text{NR}^7-$ wherein R^7 is selected from the group consisting of hydrogen and alkyl; and

X is selected from the group consisting of oxygen and sulfur; and pharmaceutically acceptable salts thereof.

44. The combination therapy according to claim 39, wherein the compound is of formula IB below:

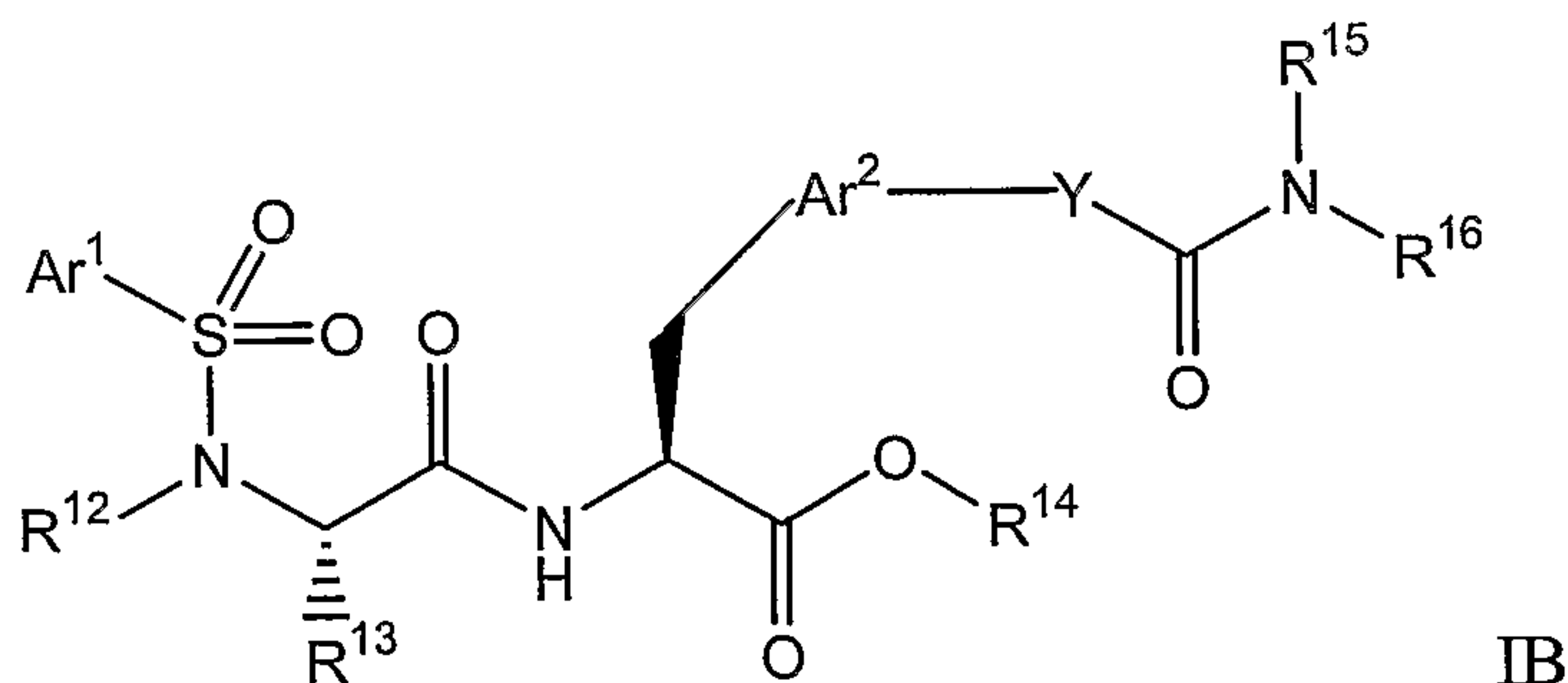

25

wherein:

Ar^1 is selected from the group consisting of aryl, substituted aryl, heteroaryl, and substituted heteroaryl;

5 Ar^2 is selected from the group consisting of aryl, substituted aryl, heteroaryl and substituted heteroaryl;

R^{12} is selected from the group consisting of alkyl, substituted alkyl, cycloalkyl, and substituted cycloalkyl or R^{12} and R^{13} together with the nitrogen atom bound to R^{12} and the carbon atom bound to R^{13} form a heterocyclic or substituted heterocyclic group;

10 R^{13} is selected from the group consisting of hydrogen, alkyl, and substituted alkyl, or R^{12} and R^{13} together with the nitrogen atom bound to R^{12} and the carbon atom bound to R^{13} form a heterocyclic or substituted heterocyclic group;

R^{14} is selected from the group consisting of hydrogen, alkyl, substituted alkyl, cycloalkyl, substituted cycloalkyl, aryl, and substituted aryl;

15 R^{15} is selected from the group consisting of alkyl, and substituted alkyl, or R^{15} and R^{16} together with the nitrogen atom to which they are bound form a heterocyclic or substituted heterocyclic group;

20 R^{16} is selected from the group consisting of alkyl and substituted alkyl or R^{15} and R^{16} together with the nitrogen atom to which they are bound form a heterocyclic or substituted heterocyclic group; and

Y is selected from the group consisting of -O-, -NR¹⁰⁰-, and -CH₂- wherein R^{100} is hydrogen or alkyl;

and pharmaceutically acceptable salts thereof.

25 45. The combination therapy according to claim 44, wherein R^{12} is alkyl, substituted alkyl, or R^{12} and R^{13} together with the nitrogen atom bound to R^{12} and the carbon atom bound to R^{13} form a heterocyclic or substituted heterocyclic group; and R^{14} is hydrogen or alkyl.

30 46. The combination therapy according to claim 44, wherein Ar^1 is selected from the group consisting of phenyl, 4-methylphenyl, 4-*t*-butylphenyl, 2,4,6-trimethylphenyl, 2-fluorophenyl, 3-fluorophenyl, 4-fluorophenyl, 2,4-

difluorophenyl, 3,4-difluorophenyl, 3,5-difluorophenyl, 2-chlorophenyl, 3-
 chlorophenyl, 4-chlorophenyl, 3,4-dichlorophenyl, 3,5-dichlorophenyl, 3-chloro-4-
 fluorophenyl, 4-bromophenyl, 2-methoxyphenyl, 3-methoxyphenyl, 4-
 methoxyphenyl, 3,4-dimethoxyphenyl, 4-*t*-butoxyphenyl, 4-(3'-dimethylamino-*n*-
 5 propoxy)-phenyl, 2-carboxyphenyl, 2-(methoxycarbonyl)phenyl, 4-(H₂NC(O)-
)phenyl, 4-(H₂NC(S)-)phenyl, 4-cyanophenyl, 4-trifluoromethylphenyl, 4-
 trifluoromethoxyphenyl, 3,5-di-(trifluoromethyl)phenyl, 4-nitrophenyl, 4-
 aminophenyl, 4-(CH₃C(O)NH-)phenyl, 4-(PhNHC(O)NH-)phenyl, 4-
 amidinophenyl, 4-methylamidinophenyl, 4-[CH₃SC(=NH)-]phenyl, 4-chloro-3-
 10 [H₂NS(O)₂-]phenyl, 1-naphthyl, 2-naphthyl, pyridin-2-yl, pyridin-3-yl, pyridine-4-
 yl, pyrimidin-2-yl, quinolin-8-yl, 2-(trifluoroacetyl)-1,2,3,4-tetrahydroisoquinolin-7-
 yl, 2-thienyl, 5-chloro-2-thienyl, 2,5-dichloro-4-thienyl, 1-*N*-methylimidazol-4-yl, 1-
N-methylpyrazol-3-yl, 1-*N*-methylpyrazol-4-yl, 1-*N*-butylpyrazol-4-yl, 1-*N*-methyl-
 3-methyl-5-chloropyrazol-4-yl, 1-*N*-methyl-5-methyl-3-chloropyrazol-4-yl, 2-
 15 thiazolyl and 5-methyl-1,3,4-thiadiazol-2-yl.

47. The combination therapy according to claim 44, wherein R¹² and R¹³
 together with the nitrogen atom bound to R¹² and the carbon atom bound to R¹³ form
 a heterocyclic or substituted heterocyclic of the formula:

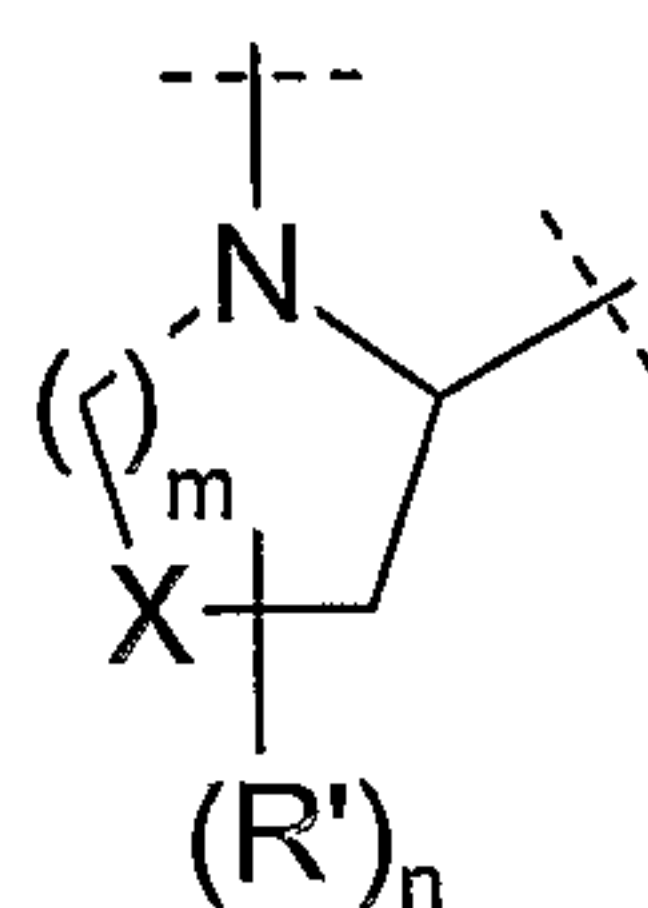

20

wherein

X is selected from the group consisting of -S-, -SO-, -SO₂, and optionally substituted -CH₂-;

25

m is an integer of 0 to 12;

n is an integer of 0 to 2; and

R' is selected from the group consisting of alkyl, substituted alkyl, and amino.

48. The combination therapy according to claim 47, wherein m is 1, X is -S- or -CH₂-, R' is alkyl or substituted alkyl.

5 49. The combination therapy according to claim 47, wherein R^{12} and R^{13}
together with the nitrogen atom bound to R^{12} and the carbon atom bound to R^{13} form
a heterocyclic or substituted heterocyclic selected from the group consisting of
azetidiny, thiazolidiny, piperidiny, piperaziny, thiomorpholinyl, pyrrolidiny, 4-
hydroxypyrrolidiny, 4-oxopyrrolidiny, 4-fluoropyrrolidiny, 4,4-
10 difluoropyrrolidiny, 4-(thiomorpholin-4-ylC(O)O-)pyrrolidiny, 4-[CH₃S(O)₂O-
]pyrrolidiny, 3-phenylpyrrolidiny, 3-thiophenylpyrrolidiny, 4-aminopyrrolidiny,
3-methoxypyrrolidiny, 4,4-dimethylpyrrolidiny, 4-*N*-Cbz-piperaziny, 4-
[CH₃S(O)₂-]piperaziny, thiazolidin-3-yl, 5,5-dimethyl-thiazolidin-3-yl, 5,5-
15 dimethylthiazolidin-4-yl, 1,1-dioxo-thiazolidiny, 1,1-dioxo-5,5-
dimethylthiazolidin-2-yl and 1,1-dioxothiomorpholinyl.

50. The combination therapy according to claim 44, wherein Ar^2 is
selected from the group consisting of phenyl, 2-pyridyl, 3-pyridyl, 4-pyridyl, and 4-
pyrid-2-onyl.

20

51. The combination therapy according to claim 44, wherein Y is -O-,
and when Y is -O-, the moiety -OC(O)NR¹⁵R¹⁶ is selected from the group consisting
of (CH₃)₂NC(O)O-, (piperidin-1-yl)C(O)O-, (4-hydroxypiperidin-1-yl)C(O)O-, (4-
formyloxypiperidin-1-yl)C(O)O-, (4-ethoxycarbonylpiperidin-1-yl)C(O)O-, (4-
25 carboxypiperidin-1-yl)C(O)O-, (3-hydroxymethylpiperidin-1-yl)C(O)O-, (4-
hydroxymethylpiperidin-1-yl)C(O)O-, (4-piperidon-1-yl ethylene ketal)C(O)O-,
(piperazin-1-yl)-C(O)O-, (1-Boc-piperazin-4-yl)-C(O)O-, (4-methylpiperazin-1-
yl)C(O)O-, (4-methylhomopiperazin-1-yl)C(O)O-, (4-(2-hydroxyethyl)piperazin-1-
yl)C(O)O-, (4-phenylpiperazin-1-yl)C(O)O-, (4-(pyridin-2-yl)piperazin-1-]
30 yl)C(O)O-, (4-(4-trifluoromethylpyridin-2-yl)piperazin-1-yl)C(O)O-, (4-(pyrimidin-
2-yl)piperazin-1-yl)C(O)O-, (4-acetylpiperazin-1-yl)C(O)O-, (4-(phenylC(O)-
)piperazin-1-yl)C(O)O-, (4-(pyridin-4'-ylC(O)-)piperazin-1-yl)C(O)O, (4-

(phenylNHC(O)-)piperazin-1-yl)C(O)O-, (4-(phenylNHC(S)-)piperazin-1-yl)C(O)O-, (4-methanesulfonylpiperazin-1-yl)C(O)O-, (4-trifluoromethanesulfonylpiperazin-1-yl)C(O)O-, (morpholin-4-yl)C(O)O-, (thiomorpholin-4-yl)C(O)O-, (thiomorpholin-4'-yl sulfone)-C(O)O-, (pyrrolidin-1-yl)C(O)O-, (2-methylpyrrolidin-1-yl)C(O)O-, (2-(methoxycarbonyl)pyrrolidin-1-yl)C(O)O-, (2-(hydroxymethyl)pyrrolidin-1-yl)C(O)O-, (2-(N,N-dimethylamino)ethyl)(CH₃)NC(O)O-, (2-(N-methyl-N-toluene-4-sulfonylamino)ethyl)(CH₃)N-C(O)O-, (2-(morpholin-4-yl)ethyl)(CH₃)NC(O)O-, (2-(hydroxy)ethyl)(CH₃)NC(O)O-, bis(2-(hydroxy)ethyl)NC(O)O-, (2-(formyloxy)ethyl)(CH₃)NC(O)O-, (CH₃OC(O)CH₂)HNC(O)O-, and 2-[(phenylNHC(O)O-)ethyl-]HNC(O)O-.

52. The combination therapy according to claim 39, wherein the compound is of formula IC below:

15

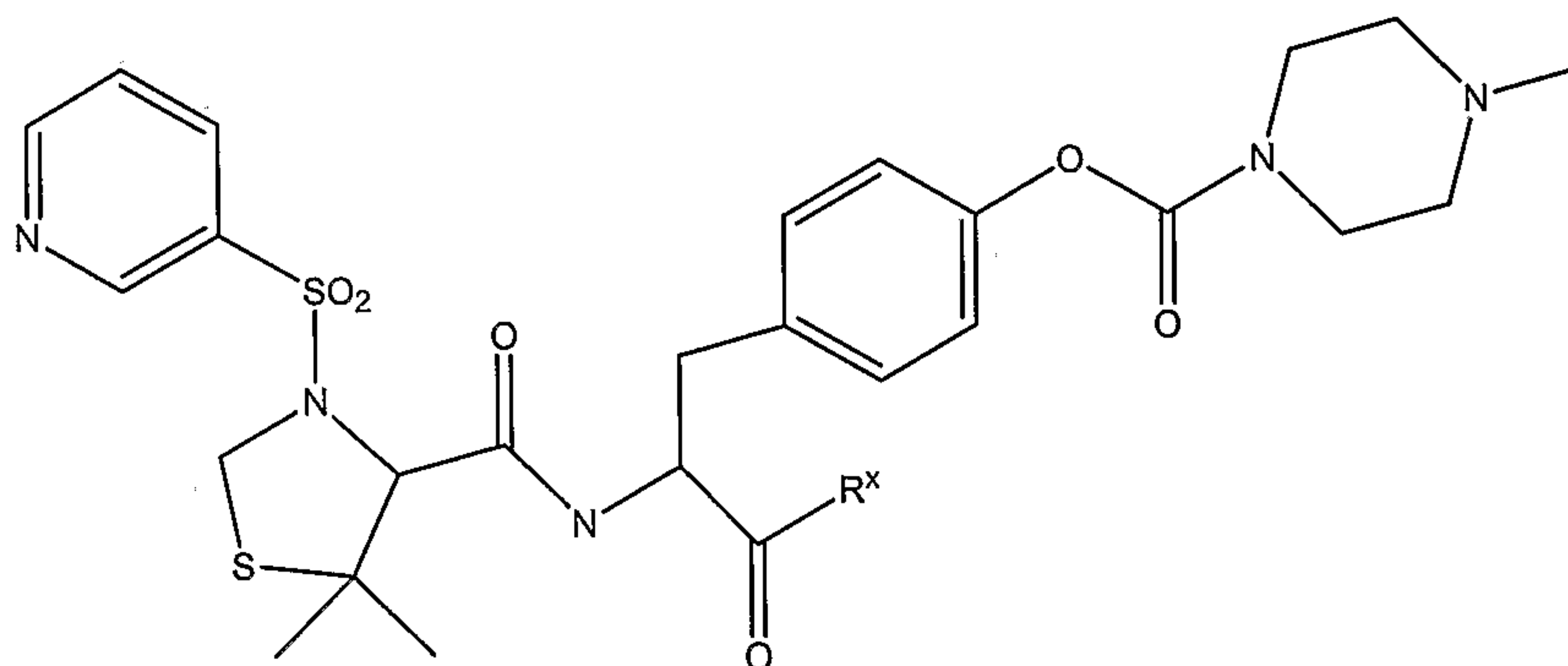

IC

wherein

20

R^x is hydroxy or C₁₋₅ alkoxy; and
pharmaceutically acceptable salts thereof.

25

53. The combination therapy according to claim 52, wherein the compound is *N*-[*N*-(3-pyridinesulfonyl)-*L*-3,3-dimethyl-4-thiaprolyl]-*O*-[1-methylpiperazin-4-ylcarbonyl]-*L*-tyrosine isopropyl ester.

54. The combination therapy according to claim 39, wherein the compound is of formula IIB below:

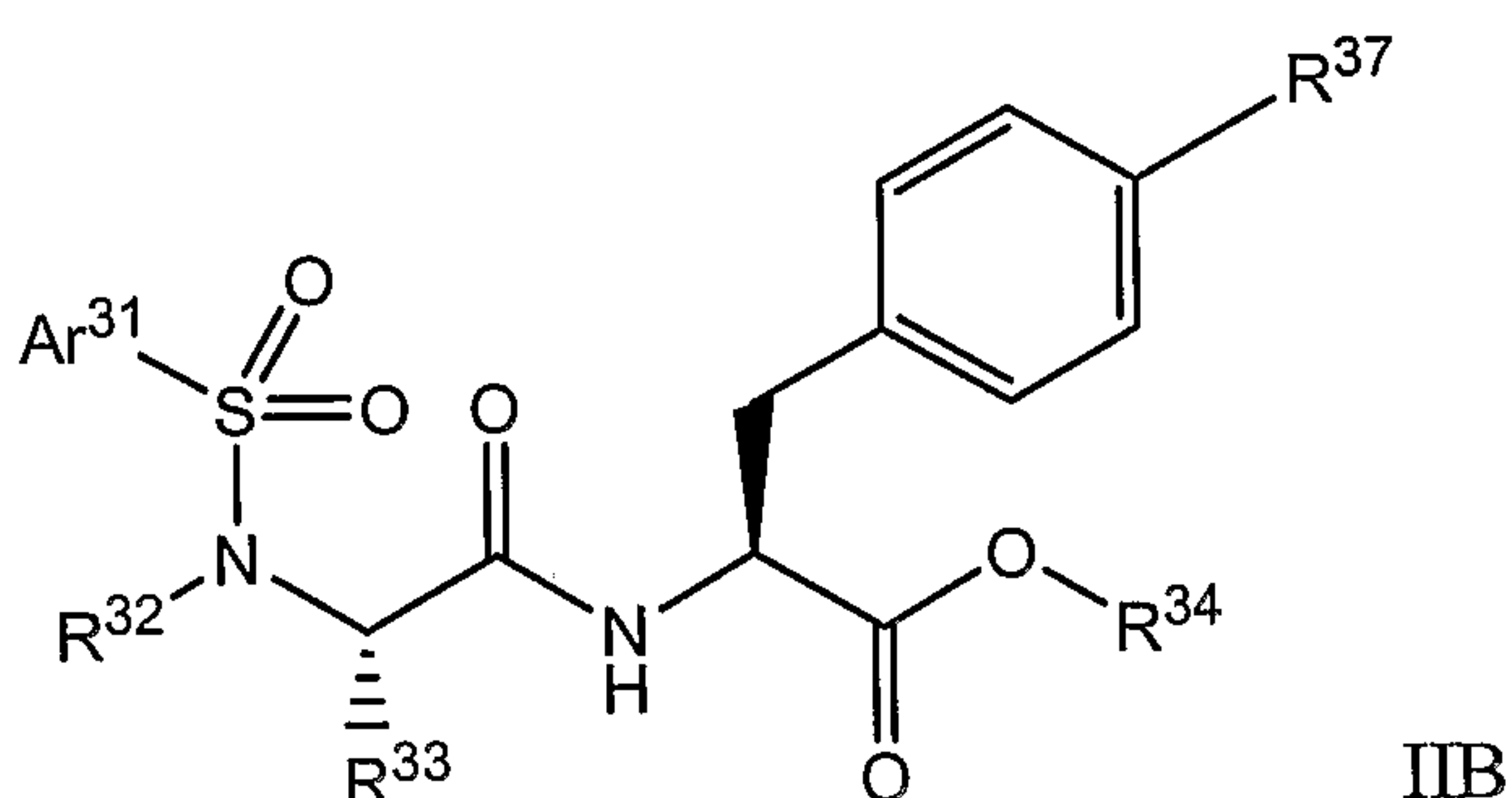

wherein:

Ar^{31} is selected from the group consisting of aryl, substituted aryl, heteroaryl, and substituted heteroaryl;

10 R^{32} is selected from the group consisting of alkyl, substituted alkyl, cycloalkyl, and substituted cycloalkyl or R^{32} and R^{33} together with the nitrogen atom bound to R^{32} and the carbon atom bound to R^{33} form a heterocyclic or substituted heterocyclic group;

15 R^{33} is selected from the group consisting of hydrogen, alkyl, and substituted alkyl, or R^{32} and R^{33} together with the nitrogen atom bound to R^{32} and the carbon atom bound to R^{33} form a heterocyclic or substituted heterocyclic group;

R^{34} is selected from the group consisting of hydrogen, alkyl, substituted alkyl, cycloalkyl, substituted cycloalkyl, aryl, and substituted aryl; and

20 R^{37} is aryl, heteroaryl, substituted aryl, substituted heteroaryl, heterocyclic, substituted heterocyclic, aryloxy, substituted aryloxy, aralkoxy, substituted aralkoxy, heteroaryloxy, substituted heteroaryloxy;

and pharmaceutically acceptable salts thereof.

55. The combination therapy according to claim 54, wherein R^{32} is alkyl, substituted alkyl, or R^{32} and R^{33} together with the nitrogen atom bound to R^{32} and the carbon atom bound to R^{33} form a heterocyclic or substituted heterocyclic group; and R^{34} is hydrogen or alkyl.

25

56. The combination therapy according to claim 54, wherein R³⁷ is aryl, substituted aryl, heteroaryl, substituted heteroaryl, heterocyclic, or substituted heterocyclic.

5

57. The combination therapy according to claim 56, wherein R³⁷ is substituted aryl, wherein the aryl is substituted with one to three substituents independently selected from the group consisting alkyl and alkoxy, or a substituted heteroaryl, wherein the heteroaryl is substituted with one to three substituents independently selected from the group consisting alkyl, alkoxy, and oxo.

10

58. The combination therapy according to claim 56, wherein R³⁷ is substituted aryl or substituted heteroaryl wherein aryl or heteroaryl is 2,6-disubstituted.

15

59. The combination therapy according to claim 58, wherein R³⁷ is selected from the group consisting of 2,6-dialkoxyaryl, 2,6-dialkoxyheteroaryl, 2-alkyl-6-alkoxyaryl, 2-alkyl-6-alkoxyheteroaryl, 2-oxo-6-alkoxyheteroaryl, 2-oxo-6-alkylheteroaryl, and optionally substituted imidazolidin-2,4-dion-3-yl.

20

60. The combination therapy according to claim 58, wherein Ar³¹ is selected from the group consisting of 4-methylphenyl, 4-chlorophenyl, 1-naphthyl, 2-naphthyl, 4-methoxyphenyl, phenyl, 2,4,6-trimethylphenyl, 2-(methoxycarbonyl)phenyl, 2-carboxyphenyl, 3,5-dichlorophenyl, 4-trifluoromethylphenyl, 3,4-dichlorophenyl, 3,4-dimethoxyphenyl, 4-(CH₃C(O)NH-)phenyl, 4-trifluoromethoxyphenyl, 4-cyanophenyl, 3,5-di-(trifluoromethyl)phenyl, 4-*t*-butylphenyl, 4-*t*-butoxyphenyl, 4-nitrophenyl, 2-thienyl, 1-N-methyl-3-methyl-5-chloropyrazol-4-yl, 1-N-methylimidazol-4-yl, 4-bromophenyl, 4-amidinophenyl, 4-methylamidinophenyl, 4-[CH₃SC(=NH)]phenyl, 5-chloro-2-thienyl, 2,5-dichloro-4-thienyl, 1-N-methyl-4-pyrazolyl, 2-thiazolyl, 5-methyl-1,3,4-thiadiazol-2-yl, 4-[H₂NC(S)]phenyl, 4-aminophenyl, 4-fluorophenyl,

25
30

2-fluorophenyl, 3-fluorophenyl, 3,5-difluorophenyl, pyridin-3-yl, pyrimidin-2-yl, 4-(3'-dimethylamino-*n*-propoxy)-phenyl, and 1-methylpyrazol-4-yl.

61. The combination therapy according to any one of claims 40 to 44, 52, and 54, wherein the subject in need of remyelination suffers from multiple sclerosis, a congenital metabolic disorder, a neuropathy with abnormal myelination, drug induced demyelination, radiation induced demyelination, a hereditary demyelinating condition, a prion induced demyelinating condition, encephalitis induced demyelination, or a spinal cord injury.

10

62. A use of a compound in an amount sufficient to inhibit lymphocyte infiltration of immune cells in the spinal cord to promote remyelination of nerve cells in the spinal cord and thereby treating paralysis in said subject in need thereof for the preparation of a medicament to reduce paralysis in said subject, wherein the compound is of formula I below

15

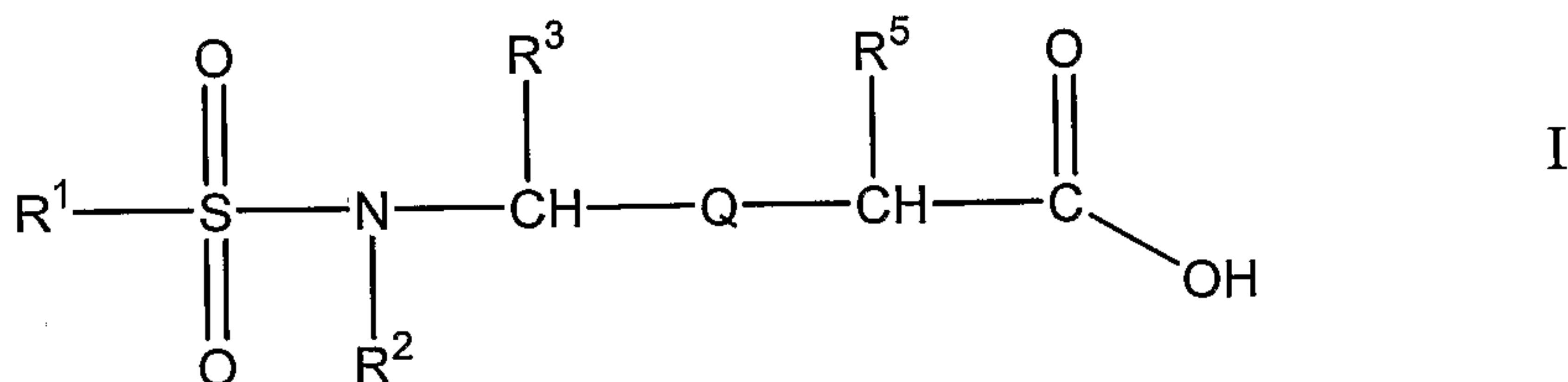

wherein

20 R^1 is selected from the group consisting of alkyl, substituted alkyl, aryl, substituted aryl, cycloalkyl, substituted cycloalkyl, heterocyclic, substituted heterocyclic, heteroaryl and substituted heteroaryl;

25 R^2 is selected from the group consisting of hydrogen, alkyl, cycloalkyl, substituted cycloalkyl, cycloalkenyl, substituted cycloalkenyl, heterocyclic, substituted heterocyclic, substituted alkyl, aryl, substituted aryl, heteroaryl, substituted heteroaryl, and R^1 and R^2 together with the nitrogen atom bound to R^2 and the SO_2 group bound to R^1 can form a heterocyclic or a substituted heterocyclic group;

R^3 is selected from the group consisting of hydrogen, alkyl, substituted alkyl, cycloalkyl, substituted cycloalkyl, aryl, substituted aryl, heteroaryl, substituted

heteroaryl, heterocyclic, substituted heterocyclic and, when R² does not form a heterocyclic group with R¹, R² and R³ together with the nitrogen atom bound to R² and the carbon atom bound to R³ can form a heterocyclic or a substituted heterocyclic group;

5 R⁵ is -(CH₂)_x-Ar-R^{5'} where R^{5'} is selected from the group consisting of -O-Z-NR⁸R^{8'} and -O-Z-R^{8''} wherein R⁸ and R^{8'} are independently selected from the group consisting of hydrogen, alkyl, substituted alkyl, cycloalkyl, substituted cycloalkyl, heterocyclic, substituted heterocyclic, and where R⁸ and R^{8'} are joined to form a heterocycle or a substituted heterocycle, R^{8''} is selected from the group consisting of
 10 heterocycle and substituted heterocycle, and Z is selected from the group consisting of -C(O)- and -SO₂-;

Ar is aryl, heteroaryl, substituted aryl or substituted heteroaryl;

x is an integer of from 1 to 4;

15 Q is -C(X)NR⁷- wherein R⁷ is selected from the group consisting of hydrogen and alkyl; and X is selected from the group consisting of oxygen and sulfur;

and pharmaceutically acceptable salts thereof.

63. A use of a compound in an amount sufficient to inhibit lymphocyte
 20 infiltration of immune cells in the spinal cord to promote remyelination of nerve cells in the spinal cord and thereby treating paralysis in said subject in need thereof for the preparation of a medicament to reduce paralysis in said subject, wherein the compound is of formula IA below

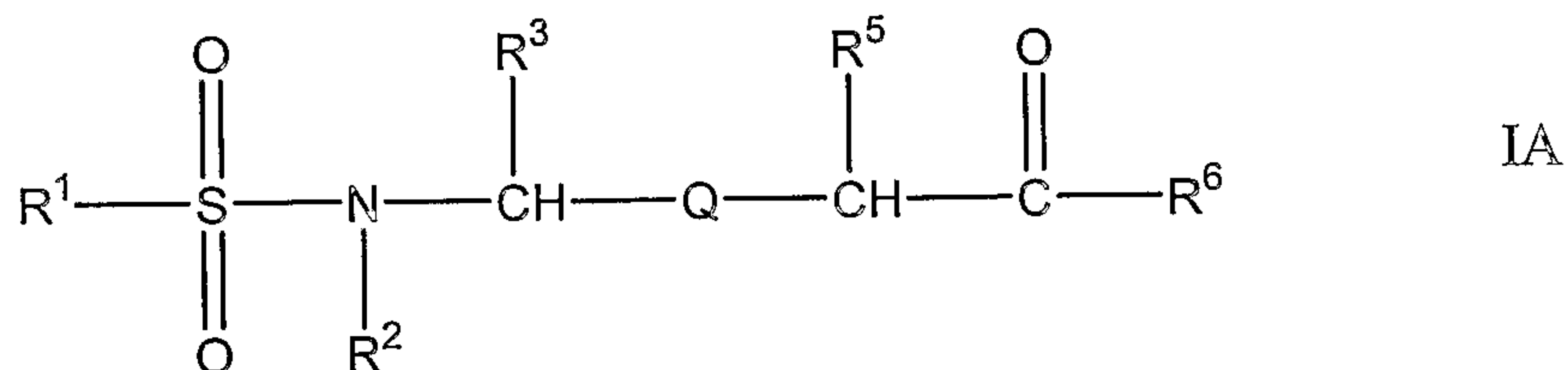

25

wherein:

R¹ is selected from the group consisting of alkyl, substituted alkyl, aryl, substituted aryl, cycloalkyl, substituted cycloalkyl, heterocyclic, substituted heterocyclic, heteroaryl and substituted heteroaryl;

R^2 is selected from the group consisting of hydrogen, alkyl, cycloalkyl, substituted cycloalkyl, cycloalkenyl, substituted cycloalkenyl, heterocyclic, substituted heterocyclic, substituted alkyl, aryl, substituted aryl, heteroaryl, substituted heteroaryl, and R^1 and R^2 together with the nitrogen atom bound to R^2 and the SO_2 group bound to R^1 can form a heterocyclic or a substituted heterocyclic group;

R^3 is selected from the group consisting of hydrogen, alkyl, substituted alkyl, cycloalkyl, substituted cycloalkyl, aryl, substituted aryl, heteroaryl, substituted heteroaryl, heterocyclic, substituted heterocyclic and, when R^2 does not form a heterocyclic group with R^1 , R^2 and R^3 together with the nitrogen atom bound to R^2 and the carbon atom bound to R^3 can form a heterocyclic or a substituted heterocyclic group;

R^5 is $-(CH_2)_x-Ar-R^{5'}$ where $R^{5'}$ is selected from the group consisting of $-O-Z-NR^8R^{8'}$ and $-O-Z-R^{8''}$ wherein R^8 and $R^{8'}$ are independently selected from the group consisting of hydrogen, alkyl, substituted alkyl, cycloalkyl, substituted cycloalkyl, heterocyclic, substituted heterocyclic, and where R^8 and $R^{8'}$ are joined to form a heterocycle or a substituted heterocycle, $R^{8''}$ is selected from the group consisting of heterocycle and substituted heterocycle, and Z is selected from the group consisting of $-C(O)-$ and $-SO_2-$;

Ar is aryl, heteroaryl, substituted aryl or substituted heteroaryl;

x is an integer of from 1 to 4;

R^6 is selected from the group consisting of 2,4-dioxo-tetrahydrofuran-3-yl (3,4-enol), amino, alkoxy, substituted alkoxy, cycloalkoxy, substituted cycloalkoxy, $-O-(N\text{-succinimidyl})$, $-NH\text{-adamantyl}$, $-O\text{-cholest-5-en-3-}\beta\text{-yl}$, $-NHOY$ where Y is hydrogen, alkyl, substituted alkyl, aryl, and substituted aryl, $-NH(CH_2)_pCOOY$ where p is an integer of from 1 to 8 and Y is as defined above, $-OCH_2NR^9R^{10}$ where R^9 is selected from the group consisting of $-C(O)\text{-aryl}$ and $-C(O)\text{-substituted aryl}$ and R^{10} is selected from the group consisting of hydrogen and $-CH_2COOR^{11}$ where R^{11} is alkyl, and $-NH\text{SO}_2Z'$ where Z' is alkyl, substituted alkyl, cycloalkyl, substituted cycloalkyl, aryl, substituted aryl, heteroaryl, substituted heteroaryl, heterocyclic and substituted heterocyclic;

Q is $-C(X)NR^7-$ wherein R^7 is selected from the group consisting of hydrogen and alkyl; and X is selected from the group consisting of oxygen and sulfur;

and pharmaceutically acceptable salts thereof

5 with the following provisos

(A) when R^1 and R^2 together with the SO_2 group pendent to R^1 and the nitrogen pendent to R^2 form a saccharin-2-yl group, R^3 is $-CH_3$, R^5 is $p-[(CH_3)_2NC(O)O-]$ benzyl and Q is $-C(O)NH-$ then R^6 is not $-OC(CH_3)_3$;

10 (B) when R^1 is p -methylphenyl, R^2 and R^3 together with the nitrogen atom pendent to R^2 and the carbon atom pendent to R^3 form a pyrrolidinyl ring derived from D-proline; R^5 is $p-[(4\text{-methylpiperazin-1-yl})NC(O)O-]$ benzyl derived from D-phenylalanine and Q is $-C(O)NH-$ then R^6 is not $-OC(CH_3)_3$;

15 (C) when R^1 is pyrimidin-2-yl, R^2 and R^3 together with the nitrogen atom bound to R^2 and the carbon atom bound to R^3 form a pyrrolidinyl ring, R^5 is $p-[(CH_3)_2NC(O)O-]$ benzyl and Q is $-C(O)NH-$ then R^6 is not $-OC(CH_3)_3$; and

20 (D) when R^1 is p -methylphenyl, R^2 and R^3 together with the nitrogen atom pendent to R^2 and the carbon atom pendent to R^3 form a (2S)-piperazin-2-carbonyl ring; R^5 is $p-[(CH_3)_2NC(O)O-]$ benzyl and Q is $-C(O)NH-$ then R^6 is not $-OC(CH_3)_3$.

64. A use of a compound in an amount sufficient to inhibit lymphocyte infiltration of immune cells in the spinal cord to promote remyelination of nerve cells in the spinal cord and thereby treating paralysis in said subject in need thereof for the preparation of a medicament to reduce paralysis in said subject, wherein the
25 compound is of formula II below

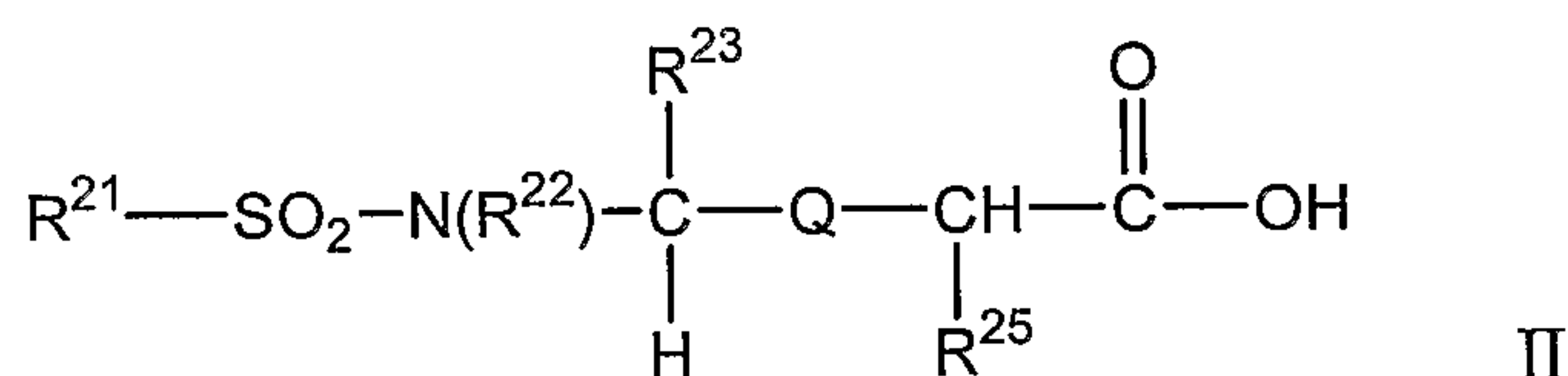

wherein:

R^{21} is selected from the group consisting of alkyl, substituted alkyl, aryl, substituted aryl, cycloalkyl, substituted cycloalkyl, heterocyclic, substituted heterocyclic, heteroaryl and substituted heteroaryl;

R^{22} is selected from the group consisting of hydrogen, alkyl, substituted alkyl, cycloalkyl, substituted cycloalkyl, cycloalkenyl, substituted cycloalkenyl, heterocyclic, substituted heterocyclic, aryl, substituted aryl, heteroaryl, substituted heteroaryl, and R^{21} and R^{22} together with the nitrogen atom bound to R^{22} and the SO_2 group bound to R^{21} can form a heterocyclic or a substituted heterocyclic group;

R^{23} is selected from the group consisting of hydrogen, alkyl, substituted alkyl, cycloalkyl, substituted cycloalkyl, aryl, substituted aryl, heteroaryl, substituted heteroaryl, heterocyclic, substituted heterocyclic and where R^{22} and R^{23} together with the nitrogen atom bound to R^{22} and the carbon atom bound to R^{23} can form a saturated heterocyclic group or a saturated substituted heterocyclic group with the proviso that when monosubstituted, the substituent on said saturated substituted heterocyclic group is not carboxyl;

Q is $-C(X)NR^7-$ wherein R^7 is selected from the group consisting of hydrogen and alkyl;

X is selected from the group consisting of oxygen and sulfur; and

R^{25} is $-CH_2Ar^{22}-R^{25'}$ where Ar^{22} is aryl or heteroaryl and $R^{25'}$ is selected from the group consisting of aryl, heteroaryl, substituted aryl, substituted heteroaryl, heterocyclic, substituted heterocyclic, aryloxy, substituted aryloxy, aralkoxy, substituted aralkoxy, heteroaryloxy, substituted heteroaryloxy, heterocyclic-O-, substituted heterocyclic-O-, heteroaralkoxy, and substituted heteroaralkoxy ;
and pharmaceutically acceptable salts thereof.

25

65. A use of a compound in an amount sufficient to inhibit lymphocyte infiltration of immune cells in the spinal cord to promote remyelination of nerve cells in the spinal cord and thereby treating paralysis in said subject in need thereof for the preparation of a medicament to reduce paralysis in said subject, wherein the compound is of formula IIA below

30

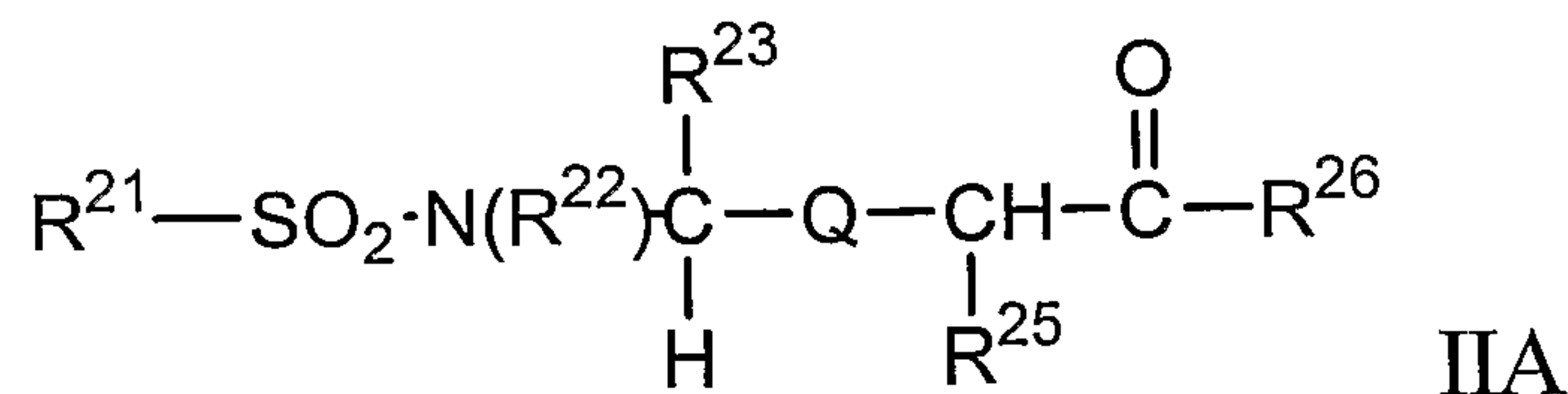

where

R^{21} is selected from the group consisting of alkyl, substituted alkyl, aryl, substituted aryl, cycloalkyl, substituted cycloalkyl, heterocyclic, substituted heterocyclic, heteroaryl and substituted heteroaryl;

R^{22} is selected from the group consisting of hydrogen, alkyl, substituted alkyl, cycloalkyl, substituted cycloalkyl, cycloalkenyl, substituted cycloalkenyl, heterocyclic, substituted heterocyclic, aryl, substituted aryl, heteroaryl, and substituted heteroaryl, and R^{21} and R^{22} together with the nitrogen atom bound to R^{22} and the SO_2 group bound to R^{21} can form a heterocyclic or a substituted heterocyclic group;

R^{23} is selected from the group consisting of hydrogen, alkyl, substituted alkyl, cycloalkyl, substituted cycloalkyl, aryl, substituted aryl, heteroaryl, substituted heteroaryl, heterocyclic, and substituted heterocyclic, and R^{22} and R^{23} together with the nitrogen atom bound to R^{22} and the carbon atom bound to R^{23} can form a saturated heterocyclic group or a saturated substituted heterocyclic group with the proviso that when monosubstituted, the substituent on said saturated substituted heterocyclic group is not carboxyl;

R^{25} is $-\text{CH}_2\text{Ar}^{22}-\text{R}^{25'}$ where Ar^{22} is aryl or heteroaryl and $\text{R}^{25'}$ is selected from the group consisting of aryl, heteroaryl, substituted aryl, substituted heteroaryl, heterocyclic, substituted heterocyclic, aryloxy, substituted aryloxy, aralkoxy, substituted aralkoxy, heteroaryloxy, substituted heteroaryloxy, heterocyclic-O-, substituted heterocyclic-O-, heteroaralkoxy, and substituted heteroaralkoxy ;

R^{26} is selected from the group consisting of 2,4-dioxo-tetrahydrofuran-3-yl (3,4-enol), amino, alkoxy, substituted alkoxy, cycloalkoxy, substituted cycloalkoxy, -O-(N-succinimidyl), -NH-adamantyl, -O-cholest-5-en-3- β -yl, -NHOY where Y is hydrogen, alkyl, substituted alkyl, aryl, and substituted aryl, $-\text{NH}(\text{CH}_2)_p\text{COOY}$ where p is an integer of from 1 to 8 and Y is as defined above, $-\text{OCH}_2\text{NR}^{29}\text{R}^{30}$

where R^{29} is selected from the group consisting of -C(O)-aryl and -C(O)-substituted aryl and R^{30} is selected from the group consisting of hydrogen and -CH₂COOR³¹ where R^{31} is alkyl, and -NHSO₂Z' where Z' is alkyl, substituted alkyl, cycloalkyl, substituted cycloalkyl, aryl, substituted aryl, heteroaryl, substituted heteroaryl, heterocyclic or substituted heterocyclic;

Q is -C(X)NR⁷- wherein R⁷ is selected from the group consisting of hydrogen and alkyl; and

X is selected from the group consisting of oxygen and sulfur; and pharmaceutically acceptable salts thereof.

10

66. A use of a compound in an amount sufficient to inhibit lymphocyte infiltration of immune cells in the spinal cord to promote remyelination of nerve cells in the spinal cord and thereby treating paralysis in said subject in need thereof for the preparation of a medicament to reduce paralysis in said subject, wherein the compound is of formula IB below

15

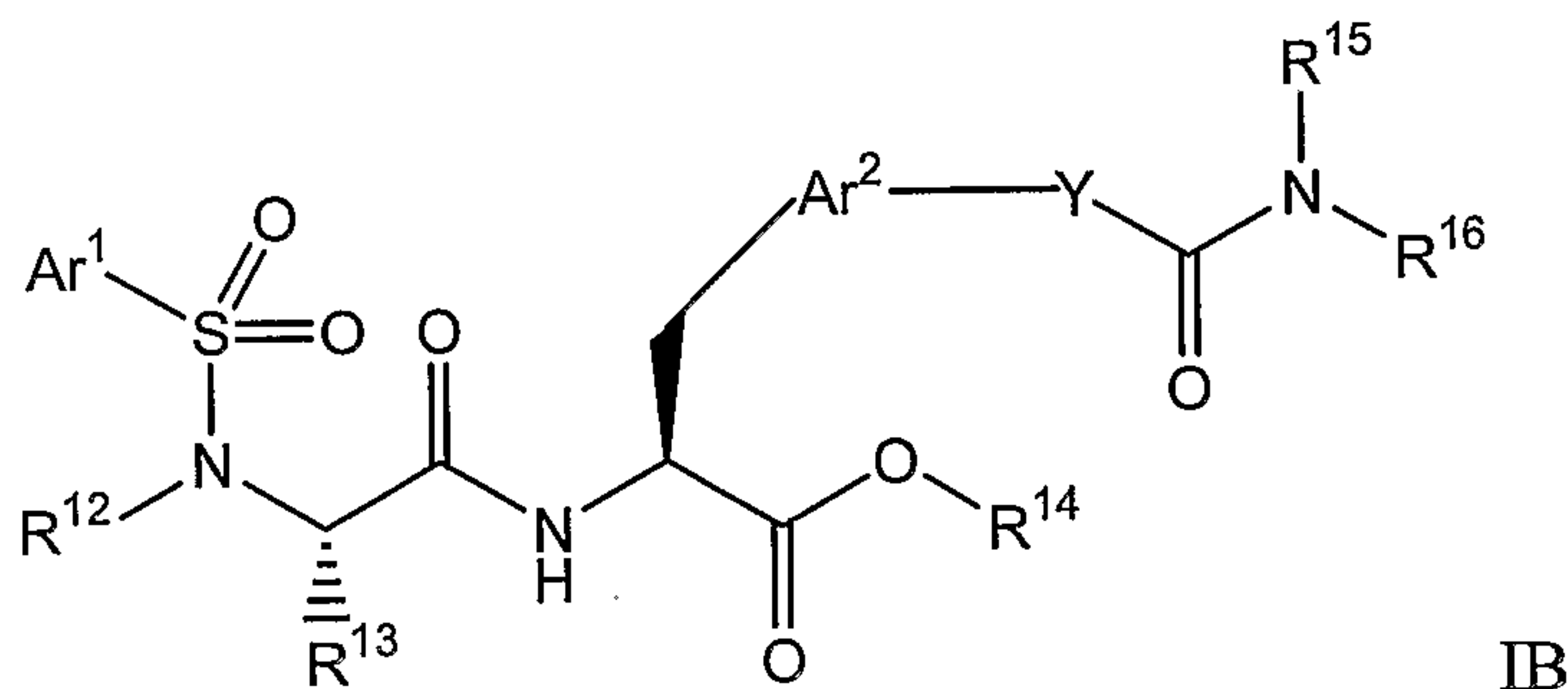

20 wherein:

Ar¹ is selected from the group consisting of aryl, substituted aryl, heteroaryl, and substituted heteroaryl;

Ar² is selected from the group consisting of aryl, substituted aryl, heteroaryl and substituted heteroaryl;

25 R¹² is selected from the group consisting of alkyl, substituted alkyl, cycloalkyl, and substituted cycloalkyl or R¹² and R¹³ together with the nitrogen atom

bound to R^{12} and the carbon atom bound to R^{13} form a heterocyclic or substituted heterocyclic group;

R^{13} is selected from the group consisting of hydrogen, alkyl, and substituted alkyl, or R^{12} and R^{13} together with the nitrogen atom bound to R^{12} and the carbon atom bound to R^{13} form a heterocyclic or substituted heterocyclic group;

R^{14} is selected from the group consisting of hydrogen, alkyl, substituted alkyl, cycloalkyl, substituted cycloalkyl, aryl, and substituted aryl;

R^{15} is selected from the group consisting of alkyl, and substituted alkyl, or R^{15} and R^{16} together with the nitrogen atom to which they are bound form a heterocyclic or substituted heterocyclic group;

R^{16} is selected from the group consisting of alkyl and substituted alkyl or R^{15} and R^{16} together with the nitrogen atom to which they are bound form a heterocyclic or substituted heterocyclic group; and

Y is selected from the group consisting of -O-, $-NR^{100}-$, and $-CH_2-$ wherein R^{100} is hydrogen or alkyl; and pharmaceutically acceptable salts thereof.

67. The use according to claim 66, wherein R^{12} is alkyl, substituted alkyl, or R^{12} and R^{13} together with the nitrogen atom bound to R^{12} and the carbon atom bound to R^{13} form a heterocyclic or substituted heterocyclic group; and R^{14} is hydrogen or alkyl.

68. The use according to claim 66, wherein

Ar^1 is selected from the group consisting of phenyl, 4-methylphenyl, 4-*t*-butylphenyl, 2,4,6-trimethylphenyl, 2-fluorophenyl, 3-fluorophenyl, 4-fluorophenyl, 2,4-difluorophenyl, 3,4-difluorophenyl, 3,5-difluorophenyl, 2-chlorophenyl, 3-chlorophenyl, 4-chlorophenyl, 3,4-dichlorophenyl, 3,5-dichlorophenyl, 3-chloro-4-fluorophenyl, 4-bromophenyl, 2-methoxyphenyl, 3-methoxyphenyl, 4-methoxyphenyl, 3,4-dimethoxyphenyl, 4-*t*-butoxyphenyl, 4-(3'-dimethylamino-*n*-propoxy)-phenyl, 2-carboxyphenyl, 2-(methoxycarbonyl)phenyl, 4-($H_2NC(O)-$)phenyl, 4-($H_2NC(S)-$)phenyl, 4-cyanophenyl, 4-trifluoromethylphenyl, 4-trifluoromethoxyphenyl, 3,5-di-(trifluoromethyl)phenyl, 4-nitrophenyl, 4-

aminophenyl, 4-(CH₃C(O)NH-)phenyl, 4-(PhNHC(O)NH-)phenyl, 4-amidinophenyl, 4-methylamidinophenyl, 4-[CH₃SC(=NH)-]phenyl, 4-chloro-3-[H₂NS(O)₂-]phenyl, 1-naphthyl, 2-naphthyl, pyridin-2-yl, pyridin-3-yl, pyridine-4-yl, pyrimidin-2-yl, quinolin-8-yl, 2-(trifluoroacetyl)-1,2,3,4-tetrahydroisoquinolin-7-yl, 2-thienyl, 5-chloro-2-thienyl, 2,5-dichloro-4-thienyl, 1-*N*-methylimidazol-4-yl, 1-*N*-methylpyrazol-3-yl, 1-*N*-methylpyrazol-4-yl, 1-*N*-butylpyrazol-4-yl, 1-*N*-methyl-3-methyl-5-chloropyrazol-4-yl, 1-*N*-methyl-5-methyl-3-chloropyrazol-4-yl, 2-thiazolyl and 5-methyl-1,3,4-thiadiazol-2-yl; and

Ar² is selected from the group consisting of phenyl, 2-pyridyl, 3-pyridyl, 4-pyridyl, and 4-pyrid-2-onyl.

69. The use according to claim 66, wherein R¹² and R¹³ together with the nitrogen atom bound to R¹² and the carbon atom bound to R¹³ form a heterocyclic or substituted heterocyclic of the formula:

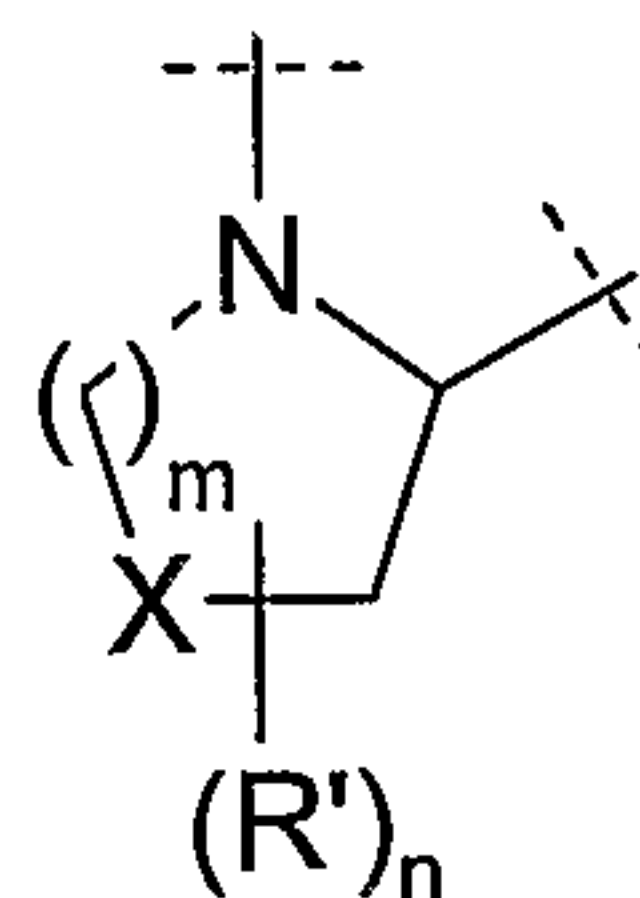

15

wherein

X is selected from the group consisting of -S-, -SO-, -SO₂, and optionally substituted -CH₂-;

20 *m* is an integer of 0 to 12;

n is an integer of 0 to 2; and

R' is selected from the group consisting of alkyl, substituted alkyl, and amino.

25 70. The use according to claim 69, wherein *m* is 1, X is -S- or -CH₂-, R' is alkyl or substituted alkyl.

71. The use according to claim 69, wherein R¹² and R¹³ together with the nitrogen atom bound to R¹² and the carbon atom bound to R¹³ form a heterocyclic or substituted heterocyclic selected from the group consisting of azetidiny, thiazolidiny, piperidiny, piperaziny, thiomorpholinyl, pyrrolidiny, 4-
 5 hydroxypyrrolidiny, 4-oxopyrrolidiny, 4-fluoropyrrolidiny, 4,4-difluoropyrrolidiny, 4-(thiomorpholin-4-ylC(O)O-)pyrrolidiny, 4-[CH₃S(O)₂O-]pyrrolidiny, 3-phenylpyrrolidiny, 3-thiophenylpyrrolidiny, 4-aminopyrrolidiny, 3-methoxypyrrolidiny, 4,4-dimethylpyrrolidiny, 4-N-Cbz-piperaziny, 4-
 10 [CH₃S(O)₂-]piperaziny, thiazolidin-3-yl, 5,5-dimethyl-thiazolidin-3-yl, 5,5-dimethylthiazolidin-4-yl, 1,1-dioxo-thiazolidiny, 1,1-dioxo-5,5-dimethylthiazolidin-2-yl and 1,1-dioxothiomorpholinyl.

72. The use according to claim 66, wherein Y is -O-, and when Y is -O-, the moiety -OC(O)NR¹⁵R¹⁶ is selected from the group consisting of (CH₃)₂NC(O)O-,
 15 , (piperidin-1-yl)C(O)O-, (4-hydroxypiperidin-1-yl)C(O)O-, (4-formyloxypiperidin-1-yl)C(O)O-, (4-ethoxycarbonylpiperidin-1-yl)C(O)O-, (4-carboxypiperidin-1-yl)C(O)O-, (3-hydroxymethylpiperidin-1-yl)C(O)O-, (4-hydroxymethylpiperidin-1-yl)C(O)O-, (4-piperidon-1-yl ethylene ketal)C(O)O-, (piperazin-1-yl)-C(O)O-, (1-Boc-piperazin-4-yl)-C(O)O-, (4-methylpiperazin-1-yl)C(O)O-, (4-
 20 methylhomopiperazin-1-yl)C(O)O-, (4-(2-hydroxyethyl)piperazin-1-yl)C(O)O-, (4-phenylpiperazin-1-yl)C(O)O-, (4-(pyridin-2-yl)piperazin-1-yl)C(O)O-, (4-(4-trifluoromethylpyridin-2-yl)piperazin-1-yl)C(O)O-, (4-(pyrimidin-2-yl)piperazin-1-yl)C(O)O-, (4-acetylpiperazin-1-yl)C(O)O-, (4-(phenylC(O)-)piperazin-1-yl)C(O)O-, (4-(pyridin-4'-ylC(O)-)piperazin-1-yl)C(O)O-, (4-(phenylNHC(O)-)piperazin-1-yl)C(O)O-, (4-(phenylNHC(S)-)piperazin-1-yl)C(O)O-, (4-
 25 methanesulfonylpiperazin-1-yl-C(O)O-, (4-trifluoromethanesulfonylpiperazin-1-yl-C(O)O-, (morpholin-4-yl)C(O)O-, (thiomorpholin-4-yl)C(O)O-, (thiomorpholin-4'-yl sulfone)-C(O)O-, (pyrrolidin-1-yl)C(O)O-, (2-methylpyrrolidin-1-yl)C(O)O-, (2-(methoxycarbonyl)pyrrolidin-1-yl)C(O)O-, (2-(hydroxymethyl)pyrrolidin-1-yl)C(O)O-, (2-(N,N-dimethylamino)ethyl)(CH₃)NC(O)O-, (2-(N-methyl-N-toluene-4-sulfonylamino)ethyl)(CH₃)N-C(O)O-, (2-(morpholin-4-yl)ethyl)(CH₃)NC(O)O-, (2-(hydroxy)ethyl)(CH₃)NC(O)O-, bis(2-(hydroxy)ethyl)NC(O)O-, (2-

(formyloxy)ethyl)(CH₃)NC(O)O-, (CH₃OC(O)CH₂)HNC(O)O-, and 2-[(phenyl)NHC(O)O-]ethyl-]HNC(O)O-.

73. A use of a compound in an amount sufficient to inhibit lymphocyte
 5 infiltration of immune cells in the spinal cord to promote remyelination of nerve cells in the spinal cord and thereby treating paralysis in said subject in need thereof for the preparation of a medicament to reduce paralysis in said subject, wherein the compound is of formula IC below

10

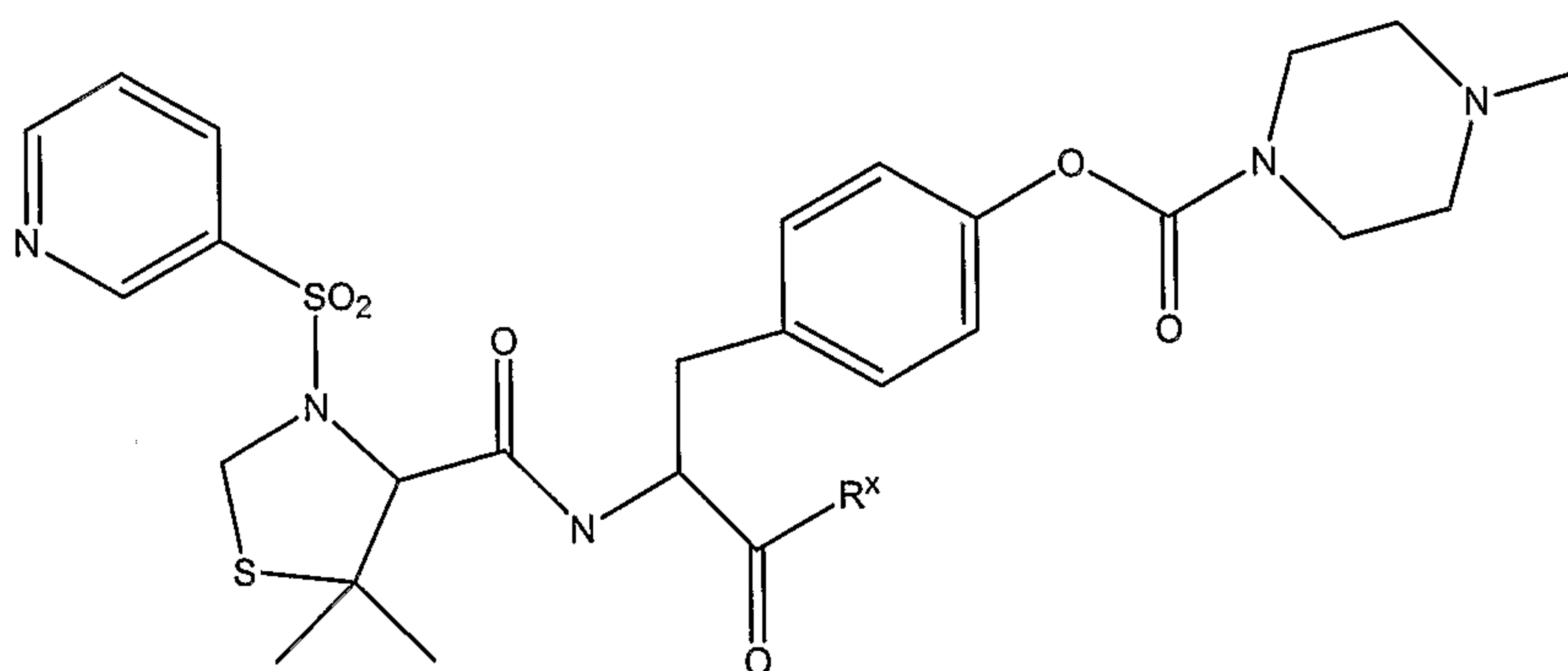

IC

wherein

15 R^x is hydroxy or C₁₋₅ alkoxy; and
 pharmaceutically acceptable salts thereof.

74. The use according to claim 73, wherein the compound is *N*-[*N*-(3-pyridinesulfonyl)-*L*-3,3-dimethyl-4-thiaprolyl]-*O*-[1-methylpiperazin-4-ylcarbonyl]-*L*-tyrosine isopropyl ester.
 20

75. A use of a compound in an amount sufficient to inhibit lymphocyte
 infiltration of immune cells in the spinal cord to promote remyelination of nerve cells in the spinal cord and thereby treating paralysis in said subject in need thereof
 25 for the preparation of a medicament to reduce paralysis in said subject, wherein the compound is of formula IIB below

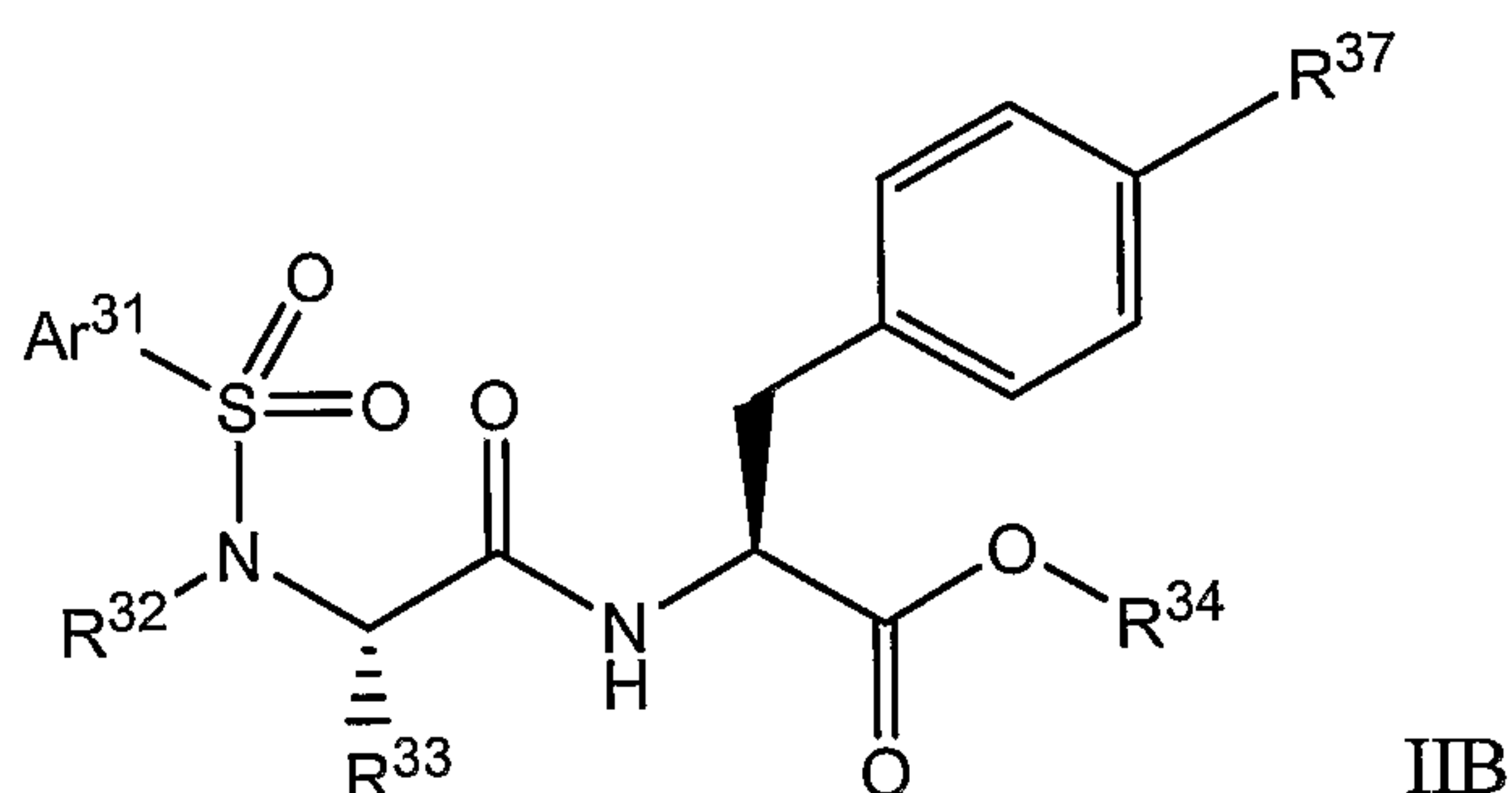

5 wherein:

Ar^{31} is selected from the group consisting of aryl, substituted aryl, heteroaryl, and substituted heteroaryl;

10 R^{32} is selected from the group consisting of alkyl, substituted alkyl, cycloalkyl, and substituted cycloalkyl or R^{32} and R^{33} together with the nitrogen atom bound to R^{32} and the carbon atom bound to R^{33} form a heterocyclic or substituted heterocyclic group;

R^{33} is selected from the group consisting of hydrogen, alkyl, and substituted alkyl, or R^{32} and R^{33} together with the nitrogen atom bound to R^{32} and the carbon atom bound to R^{33} form a heterocyclic or substituted heterocyclic group;

15 R^{34} is selected from the group consisting of hydrogen, alkyl, substituted alkyl, cycloalkyl, substituted cycloalkyl, aryl, and substituted aryl; and

R^{37} is aryl, heteroaryl, substituted aryl, substituted heteroaryl, heterocyclic, substituted heterocyclic, aryloxy, substituted aryloxy, aralkoxy, substituted aralkoxy, heteroaryloxy, substituted heteroaryloxy;

20 and pharmaceutically acceptable salts thereof.

76. The use according to claim 75, wherein R^{32} is alkyl, substituted alkyl, or R^{32} and R^{33} together with the nitrogen atom bound to R^{32} and the carbon atom bound to R^{33} form a heterocyclic or substituted heterocyclic group; R^{34} is hydrogen or alkyl; and R^{37} is aryl, substituted aryl, heteroaryl, substituted heteroaryl, heterocyclic, or substituted heterocyclic.

25

77. The use according to claim 75, wherein R³⁷ is substituted aryl, wherein the aryl is substituted with one to three substituents independently selected from the group consisting alkyl and alkoxy, or a substituted heteroaryl, wherein the heteroaryl is substituted with one to three substituents independently selected from the group consisting alkyl, alkoxy, and oxo.

78. The use according to claim 77, wherein R³⁷ is substituted aryl or substituted heteroaryl wherein aryl or heteroaryl is 2,6-di-substituted.

79. The use according to claim 78, wherein R³⁷ is selected from the group consisting of 2,6-dialkoxyaryl, 2,6-dialkoxyheteroaryl, 2-alkyl-6-alkoxyaryl, 2-alkyl-6-alkoxyheteroaryl, 2-oxo-6-alkoxyheteroaryl, 2-oxo-6-alkylheteroaryl, and optionally substituted imidazolidin-2,4-dion-3-yl.

80. The use according to claim 75, wherein Ar³¹ is selected from the group consisting of 4-methylphenyl, 4-chlorophenyl, 1-naphthyl, 2-naphthyl, 4-methoxyphenyl, phenyl, 2,4,6-trimethylphenyl, 2-(methoxycarbonyl)phenyl, 2-carboxyphenyl, 3,5-dichlorophenyl, 4-trifluoromethylphenyl, 3,4-dichlorophenyl, 3,4-dimethoxyphenyl, 4-(CH₃C(O)NH-)phenyl, 4-trifluoromethoxyphenyl, 4-cyanophenyl, 3,5-di-(trifluoromethyl)phenyl, 4-*t*-butylphenyl, 4-*t*-butoxyphenyl, 4-nitrophenyl, 2-thienyl, 1-N-methyl-3-methyl-5-chloropyrazol-4-yl, 1-N-methylimidazol-4-yl, 4-bromophenyl, 4-amidinophenyl, 4-methylamidinophenyl, 4-[CH₃SC(=NH)]phenyl, 5-chloro-2-thienyl, 2,5-dichloro-4-thienyl, 1-N-methyl-4-pyrazolyl, 2-thiazolyl, 5-methyl-1,3,4-thiadiazol-2-yl, 4-[H₂NC(S)]phenyl, 4-aminophenyl, 4-fluorophenyl, 2-fluorophenyl, 3-fluorophenyl, 3,5-difluorophenyl, pyridin-3-yl, pyrimidin-2-yl, 4-(3'-dimethylamino-*n*-propoxy)-phenyl, and 1-methylpyrazol-4-yl.

81. A use of a compound in an amount sufficient to inhibit lymphocyte infiltration of immune cells in the spinal cord to promote remyelination of nerve cells in the spinal cord and thereby treating paralysis in said subject in need thereof

for the preparation of a medicament to reduce paralysis in said subject, wherein the compound is selected from the group consisting of:

- 5 *N*-[*N*-(3-pyridinesulfonyl)-*L*-3,3-dimethyl-4-thiaprolyl]-*O*-[1-methylpiperazin-4-ylcarbonyl]-*L*-tyrosine isopropyl ester;
- N*-(toluene-4-sulfonyl)-*L*-prolyl-*L*-4-(4-methylpiperazin-1-ylcarbonyloxy)phenylalanine ethyl ester
- 10 *N*-(toluene-4-sulfonyl)-*L*-prolyl-*L*-4-(*N,N*-dimethylcarbamyloxy)phenylalanine ethyl ester
- N*-(toluene-4-sulfonyl)-*L*-prolyl-*L*-4-(4-methylpiperazin-1-ylcarbonyloxy)phenylalanine isopropyl ester
- 15 *N*-(toluene-4-sulfonyl)-*L*-prolyl-*L*-4-(4-methylpiperazin-1-ylcarbonyloxy)phenylalanine *n*-butyl ester
- N*-(toluene-4-sulfonyl)-*L*-prolyl-*L*-4-(4-methylpiperazin-1-ylcarbonyloxy)phenylalanine cyclopentyl ester
- 20 *N*-(toluene-4-sulfonyl)-*L*-prolyl-*L*-4-(4-methylpiperazin-1-ylcarbonyloxy)phenylalanine *tert*-butyl ester
- N*-(toluene-4-sulfonyl)-*L*-prolyl-*L*-4-(4-methylpiperazin-1-ylcarbonyloxy)phenylalanine
- 25 *N*-(toluene-4-sulfonyl)-*L*-prolyl-*L*-4-(*N,N*-dimethylcarbamyloxy)phenylalanine isopropyl ester
- N*-(toluene-4-sulfonyl)-*L*-prolyl-*L*-4-(*N,N*-dimethylcarbamyloxy)phenylalanine *n*-butyl ester
- 30 *N*-(toluene-4-sulfonyl)-*L*-prolyl-*L*-4-(*N,N*-dimethylcarbamyloxy)phenylalanine cyclopentyl ester
- 35 *N*-(toluene-4-sulfonyl)-*L*-prolyl-*L*-4-(*N,N*-dimethylcarbamyloxy)phenylalanine *tert*-butyl ester
- N*-(toluene-4-sulfonyl)-*L*-prolyl-*L*-4-(*N,N*-dimethylcarbamyloxy)phenylalanine
- 40 *N*-(toluene-4-sulfonyl)-*L*-prolyl-*L*-4-(isonipecotoxyloxy)phenylalanine ethyl ester
- 45 *N*-(α -toluenesulfonyl)-*L*-prolyl-*L*-4-(*N*-methylisonipecotoxyloxy)phenylalanine ethyl ester

- N*-(α -toluenesulfonyl)-L-prolyl-L-4-(4-methylpiperazin-1-ylcarbonyloxy)phenylalanine
- 5 *N*-(toluene-4-sulfonyl)-L-prolyl-L-3-(*N,N*-dimethylcarbamyloxy)phenylalanine ethyl ester
- N*-(toluene-4-sulfonyl)-L-prolyl-L-4-(1-*tert*-butylcarbonyloxy-4-phenylpiperidin-4-ylcarbonyloxy)phenylalanine ethyl ester
- 10 *N*-(toluene-4-sulfonyl)-L-(5,5-dimethyl)thiaprolyl-L-4-(*N,N*-dimethylcarbamyloxy)phenylalanine isopropyl ester
- N*-(toluene-4-sulfonyl)-L-(5,5-dimethyl)thiaprolyl-L-4-(*N,N*-dimethylcarbamyloxy)phenylalanine *tert*-butyl ester
- 15 *N*-(toluene-4-sulfonyl)-L-(5,5-dimethyl)thiaprolyl-L-4-(*N,N*-dimethylcarbamyloxy)phenylalanine
- N*-(toluene-4-sulfonyl)-L-[(1,1-dioxo)thiamorpholin-3-carbonyl]-L-4-(*N,N*-dimethylcarbamyloxy)phenylalanine *tert*-butyl ester
- 20 *N*-(toluene-4-sulfonyl)-L-[(1,1-dioxo)thiamorpholin-3-carbonyl]-L-4-(*N,N*-dimethylcarbamyloxy)phenylalanine
- N*-(toluene-4-sulfonyl)-L-(5,5-dimethyl)thiaprolyl-L-4-(4-methylpiperazin-1-ylcarbonyloxy)phenylalanine *tert*-butyl ester
- 25 *N*-(toluene-4-sulfonyl)-L-(5,5-dimethyl)thiaprolyl-L-4-(4-methylpiperazin-1-ylcarbonyloxy)phenylalanine
- 30 *N*-(toluene-4-sulfonyl)sarcosyl-L-4-(*N,N*-dimethylcarbamyloxy)phenylalanine isopropyl ester
- N*-(toluene-4-sulfonyl)sarcosyl-L-4-(*N,N*-dimethylcarbamyloxy)phenylalanine *tert*-butyl ester
- 35 *N*-(toluene-4-sulfonyl)sarcosyl-L-4-(*N,N*-dimethylcarbamyloxy)phenylalanine
- 40 *N*-(1-methylimidazole-4-sulfonyl)-L-prolyl-L-4-(*N,N*-dimethylcarbamyloxy)phenylalanine *tert*-butyl ester
- N*-(4-aminobenzenesulfonyl)-L-prolyl-L-4-(*N,N*-dimethylcarbamyloxy)phenylalanine *tert*-butyl ester
- 45

- N*-(toluene-4-sulfonyl)sarcosyl-L-4-(morpholin-4-ylcarbonyloxy)phenylalanine *tert*-butyl ester
- 5 *N*-(toluene-4-sulfonyl)-L-prolyl-L-4-(morpholin-4-ylcarbonyloxy)phenylalanine *tert*-butyl ester
- N*-(α -toluenesulfonyl)-L-(5,5-dimethyl)thiaprolyl-L-4-(*N,N*-dimethylcarbamyloxy)phenylalanine
- 10 *N*-(toluene-4-sulfonyl)-L-(piperazin-2-carbonyl)-L-4-(*N,N*-dimethylcarbamyloxy)phenylalanine
- N*-(α -toluenesulfonyl)-L-(5,5-dimethyl)thiaprolyl-L-4-(*N,N*-dimethylcarbamyloxy)phenylalanine *tert*-butyl ester
- 15 *N*-(toluene-4-sulfonyl)-L-(piperazin-2-carbonyl)-L-4-(*N,N*-dimethylcarbamyloxy)phenylalanine *tert*-butyl ester
- N*-(toluene-4-sulfonyl)-L-(4-benzyloxycarbonylpiperazin-2-carbonyl)-L-4-(*N,N*-dimethylcarbamyloxy)phenylalanine *tert*-butyl ester
- 20 *N*-(toluene-4-sulfonyl)sarcosyl-L-4-(isonipecotoyloxy)phenylalanine
- N*-(toluene-4-sulfonyl)-L-[(1,1-dioxo)thiamorpholin-3-carbonyl]-L-4-(morpholin-4-ylcarbonyloxy)phenylalanine *tert*-butyl ester
- 25 *N*-(toluene-4-sulfonyl)-L-[(1,1-dioxo)thiamorpholin-3-carbonyl]-L-4-(morpholin-4-ylcarbonyloxy)phenylalanine
- N*-(1-methylpyrazole-4-sulfonyl)-L-prolyl-L-4-(*N,N*-dimethylcarbamyloxy)phenylalanine *tert*-butyl ester
- 30 *N*-(4-fluorobenzenesulfonyl)-L-prolyl-L-4-(*N,N*-dimethylcarbamyloxy)phenylalanine *tert*-butyl ester
- 35 *N*-(toluene-4-sulfonyl)sarcosyl-L-4-(4-methylpiperazin-1-ylcarbonyloxy)phenylalanine *tert*-butyl ester
- N*-(toluene-4-sulfonyl)-L-(1,1-dioxo-5,5-dimethyl)thiaprolyl-L-4-(*N,N*-dimethylcarbamyloxy)phenylalanine *tert*-butyl ester
- 40 *N*-(1-methylimidazole-4-sulfonyl)-L-prolyl-L-4-(*N,N*-dimethylcarbamyloxy)phenylalanine
- N*-(toluene-4-sulfonyl)-L-(1,1-dioxo-5,5-dimethyl)thiaprolyl-L-4-(*N,N*-dimethylcarbamyloxy)phenylalanine
- 45

- N*-(4-fluorobenzenesulfonyl)-*L*-prolyl-*L*-4-(*N,N*-dimethylcarbamyloxy)phenylalanine
- 5 *N*-(pyridine-3-sulfonyl)-*L*-prolyl-*L*-4-(*N,N*-dimethylcarbamyloxy)phenylalanine
- N*-(toluene-4-sulfonyl)-*D*-prolyl-*L*-4-(4-methylpiperazin-1-ylcarbonyloxy)phenylalanine *tert*-butyl ester
- 10 *N*-(toluene-4-sulfonyl)-*L-N*-methylalanyl-*L*-4-(4-methylpiperazin-1-ylcarbonyloxy)phenylalanine *tert*-butyl ester
- N*-(4-nitrobenzenesulfonyl)-*L*-prolyl-*L*-4-(*N,N*-dimethylcarbamyloxy)phenylalanine *tert*-butyl ester
- 15 *N*-(toluene-4-sulfonyl)sarcosyl-*L*-4-(thiomorpholin-4-ylcarbonyloxy)phenylalanine *tert*-butyl ester
- N*-(toluene-4-sulfonyl)-*L-N*-methylalanyl-*L*-4-(4-methylpiperazin-1-ylcarbonyloxy)phenylalanine
- 20 *N*-(toluene-4-sulfonyl)-*L*-prolyl-*L*-4-(1,1-dioxothiomorpholin-4-ylcarbonyloxy)phenylalanine
- N*-(toluene-4-sulfonyl)-*L*-prolyl-*L*-4-(thiomorpholin-4-ylcarbonyloxy)phenylalanine
- 25 *N*-(toluene-4-sulfonyl)-*L*-prolyl-*L*-4-(isonipecotoyloxy)phenylalanine
- N*-(toluene-4-sulfonyl)-*L*-prolyl-*L*-4-(pyrrolidin-1-ylcarbonyloxy)phenylalanine
- 30 *N*-(toluene-4-sulfonyl)-*L*-prolyl-*L*-4-(morpholin-4-ylcarbonyloxy)phenylalanine
- 35 *N*-(toluene-4-sulfonyl)-*L*-prolyl-*L*-4-(4-methylpiperazin-1-ylcarbonyloxy)phenylalanine neopentyl ester
- N*-(toluene-4-sulfonyl)-*L*-prolyl-*L*-4-(*N,N*-dimethylcarbamyloxy)phenylalanine neopentyl ester
- 40 *N*-(toluene-4-sulfonyl)-*L*-prolyl-*L*-4-(4-*tert*-butyloxycarbonylpiperazin-1-ylcarbonyloxy)phenylalanine ethyl ester
- 45 *N*-(toluene-4-sulfonyl)-*L*-prolyl-*L*-4-(morpholin-4-ylcarbonyloxy)phenylalanine ethyl ester

- N*-(toluene-4-sulfonyl)sarcosyl-L-4-(1,1-dioxothiomorpholin-4-ylcarbonyloxy)phenylalanine *tert*-butyl ester
- 5 *N*-(toluene-4-sulfonyl)sarcosyl-L-4-(thiomorpholin-4-ylcarbonyloxy)phenylalanine
- N*-(toluene-4-sulfonyl)-L-*N*-methylalanyl-L-4-(*N,N*-dimethylcarbamyloxy)phenylalanine *tert*-butyl ester
- 10 *N*-(toluene-4-sulfonyl)-L-(thiamorpholin-3-carbonyl)-L-4-(*N,N*-dimethylcarbamyloxy)phenylalanine *tert*-butyl ester
- N*-(toluene-4-sulfonyl)sarcosyl-L-4-(1,1-dioxothiomorpholin-4-ylcarbonyloxy)phenylalanine
- 15 *N*-(toluene-4-sulfonyl)-L-(1,1-dioxothiamorpholin-3-carbonyl)-L-4-(*N,N*-dimethylcarbamyloxy)phenylalanine *tert*-butyl ester
- N*-(toluene-4-sulfonyl)-L-(1,1-dioxothiamorpholin-3-carbonyl)-L-4-(morpholin-4-ylcarbonyloxy)phenylalanine *tert*-butyl ester
- 20 *N*-(toluene-4-sulfonyl)-L-*N*-methylalanyl-L-4-(*N,N*-dimethylcarbamyloxy)phenylalanine
- N*-(4-fluorobenzenesulfonyl)-L-(thiamorpholin-3-carbonyl)-L-4-(*N,N*-dimethylcarbamyloxy)phenylalanine *tert*-butyl ester
- 25 *N*-(4-fluorobenzenesulfonyl)-L-(1,1-dioxothiamorpholin-3-carbonyl)-L-4-(*N,N*-dimethylcarbamyloxy)phenylalanine *tert*-butyl ester
- 30 *N*-(pyridine-3-sulfonyl)-L-prolyl-L-4-(*N,N*-dimethylcarbamyloxy)phenylalanine *tert*-butyl ester
- N*-(pyrimidine-2-sulfonyl)-L-prolyl-L-4-(*N,N*-dimethylcarbamyloxy)phenylalanine *tert*-butyl ester
- 35 *N*-(4-nitrobenzenesulfonyl)-L-prolyl-L-4-(*N,N*-dimethylcarbamyloxy)phenylalanine
- N*-(4-cyanobenzenesulfonyl)-L-prolyl-L-4-(*N,N*-dimethylcarbamyloxy)phenylalanine *tert*-butyl ester
- 40 *N*-(toluene-4-sulfonyl)-L-(1,1-dioxothiamorpholin-3-carbonyl)-L-4-(*N,N*-dimethylcarbamyloxy)phenylalanine
- 45 *N*-(toluene-4-sulfonyl)-L-(1,1-dioxo)thiaprolyl-L-4-(*N,N*-dimethylcarbamyloxy)phenylalanine *tert*-butyl ester

- N*-(4-fluorobenzenesulfonyl)-*L*-prolyl-*L*-4-(*N,N*-dimethylcarbamyloxy)phenylalanine *tert*-butyl ester
- 5 *N*-(1-methylpyrazole-4-sulfonyl)-*L*-prolyl-*L*-4-(*N,N*-dimethylcarbamyloxy)phenylalanine
- N*-(toluene-4-sulfonyl)-*L*-(1,1-dioxo)thiaprolyl-*L*-4-(*N,N*-dimethylcarbamyloxy)phenylalanine
- 10 *N*-(4-fluorobenzenesulfonyl)-*L*-thiaprolyl-*L*-4-(*N,N*-dimethylcarbamyloxy)phenylalanine
- N*-(toluene-4-sulfonyl)-*L*-prolyl-*L*-4-(piperazin-1-ylcarbonyloxy)phenylalanine
- 15 *N*-(toluene-4-sulfonyl)-*L*-prolyl-*L*-4-(1-*tert*-butyloxycarbonylpiperazin-1-ylcarbonyloxy)phenylalanine *tert*-butyl ester
- N*-(toluene-4-sulfonyl)-*L*-prolyl-*L*-4-(piperazin-1-ylcarbonyloxy)phenylalanine ethyl ester
- 20 *N*-(toluene-4-sulfonyl)-*L*-prolyl-*L*-4-(4-acetylpiperazin-1-ylcarbonyloxy)phenylalanine ethyl ester
- 25 *N*-(toluene-4-sulfonyl)-*L*-prolyl-*L*-4-(4-methanesulfonylpiperazin-1-ylcarbonyloxy)phenylalanine ethyl ester
- N*-(toluene-4-sulfonyl)-*L*-prolyl-*L*-4-(morpholin-4-ylcarbonyloxy)-3-nitrophenylalanine
- 30 *N*-(toluene-4-sulfonyl)-*L*-prolyl-*L*-4-(1-*tert*-butyloxycarbonylpiperazin-1-ylcarbonyloxy)phenylalanine
- N*-(toluene-4-sulfonyl)-*L-N*-methyl-2-(*tert*-butyl)glycinyl-*L*-4-(4-methylpiperazin-1-ylcarbonyloxy)phenylalanine *tert*-butyl ester
- 35 *N*-(4-fluorobenzenesulfonyl)-*L*-(5,5-dimethyl)thiaprolyl-*L*-4-(*N,N*-dimethylcarbamyloxy)phenylalanine *tert*-butyl ester
- 40 *N*-(4-fluorobenzenesulfonyl)-*L*-(1,1-dioxothiomorpholin-3-carbonyl)-*L*-4-(1,1-dioxothiomorpholin-4-ylcarbonyloxy)phenylalanine *tert*-butyl ester
- N*-(toluene-4-sulfonyl)-*L*-(1,1-dioxothiomorpholin-3-carbonyl)-*L*-4-(1,1-dioxothiomorpholin-4-ylcarbonyloxy)phenylalanine *tert*-butyl ester
- 45

- N*-(4-fluorobenzenesulfonyl)-*L*-prolyl-*L*-4-(1,1-dioxothiomorpholin-4-ylcarbonyloxy)phenylalanine *tert*-butyl ester
- 5 *N*-(4-fluorobenzenesulfonyl)-*L*-prolyl-*L*-4-(thiomorpholin-4-ylcarbonyloxy)phenylalanine *tert*-butyl ester
- N*-(4-fluorobenzenesulfonyl)-*L*-prolyl-*L*-4-(morpholin-4-ylcarbonyloxy)phenylalanine *tert*-butyl ester
- 10 *N*-(4-fluorobenzenesulfonyl)-*L*-(5,5-dimethyl)thiaprolyl-*L*-4-(*N,N*-dimethylcarbamyloxy)phenylalanine
- N*-(4-fluorobenzenesulfonyl)-*L*-(1,1-dioxothiamorpholin-3-carbonyl)-*L*-4-(morpholin-4-ylcarbonyloxy)phenylalanine *tert*-butyl ester
- 15 *N*-(4-trifluoromethoxybenzenesulfonyl)-*L*-prolyl-*L*-4-(*N,N*-dimethylcarbamyloxy)phenylalanine *tert*-butyl ester
- N*-(toluene-4-sulfonyl)-*L*-(1,1-dioxothiamorpholin-3-carbonyl)-*L*-4-(*N,N*-dimethylcarbamyloxy)phenylalanine isopropyl ester
- 20 3-[*N*-(toluene-4-sulfonyl)-*N*-methylamino]-1-[1-*tert*-butyloxycarbonyl-2-(*N,N*-dimethylcarbamyloxy)phenylethyl]azetidin-2-one
- N*-(4-fluorobenzenesulfonyl)-*L*-(1,1-dioxo-5,5-dimethyl)thiaprolyl-*L*-4-(*N,N*-dimethylcarbamyloxy)phenylalanine *tert*-butyl ester
- 25 *N*-(toluene-4-sulfonyl)-*L*-(1,1-dioxo-5,5-dimethyl)thiaprolyl-*L*-4-(*N,N*-dimethylcarbamyloxy)phenylalanine isopropyl ester
- 30 *N*-(toluene-4-sulfonyl)-*L*-(1,1-dioxothiamorpholin-3-carbonyl)-*L*-4-(morpholin-4-ylcarbonyloxy)phenylalanine
- N*-(4-fluorobenzenesulfonyl)-*L*-(5,5-dimethyl)thiaprolyl-*L*-4-(*N,N*-dimethylcarbamyloxy)phenylalanine
- 35 *N*-(pyrimidine-2-sulfonyl)-*L*-prolyl-*L*-4-(*N,N*-dimethylcarbamyloxy)phenylalanine
- N*-(toluene-4-sulfonyl)-*L*-(1,1-dioxothiamorpholin-3-carbonyl)-*L*-4-(4-methylpiperazin-1-ylcarbonyloxy)phenylalanine *tert*-butyl ester
- 40 3-[*N*-(toluene-4-sulfonyl)-*N*-methylamino]-1-[1-carboxy-2-(*N,N*-dimethylcarbamyloxy)phenylethyl]azetidin-2-one
- 45 *N*-(1-methylpyrazole-4-sulfonyl)-*L*-prolyl-*L*-4-(4-methylpiperazin-1-ylcarbonyloxy)phenylalanine *tert*-butyl ester

- N*-(4-fluorobenzenesulfonyl)-L-(1,1-dioxo)thiaprolyl-L-4-(*N,N*-dimethylcarbamyloxy)phenylalanine
- 5 *N*-(toluene-4-sulfonyl)-L-prolyl-L-4-(isonipecotoxyloxy)phenylalanine *tert*-butyl ester
- N*-(toluene-4-sulfonyl)-L-prolyl-L-4-(1,1-dioxothiomorpholin-4-ylcarbonyloxy)phenylalanine *tert*-butyl ester
- 10 *N*-(toluene-4-sulfonyl)-L-prolyl-L-4-(thiomorpholin-4-ylcarbonyloxy)phenylalanine *tert*-butyl ester
- N*-(toluene-4-sulfonyl)-L-prolyl-L-4-(pyrrolidin-1-ylcarbonyloxy)phenylalanine *tert*-butyl ester
- 15 *N*-(4-fluorobenzenesulfonyl)-L-thiaprolyl-L-4-(*N,N*-dimethylcarbamyloxy)phenylalanine *tert*-butyl ester
- N*-(4-fluorobenzenesulfonyl)-L-(1,1-dioxo)thiaprolyl-L-4-(*N,N*-dimethylcarbamyloxy)phenylalanine *tert*-butyl ester
- 20 *N*-(2,5-dichlorothiophene-3-sulfonyl)-L-prolyl-L-4-(*N,N*-dimethylcarbamyloxy)phenylalanine *tert*-butyl ester
- 25 *N*-(4-acetamidobenzenesulfonyl)-L-prolyl-L-4-(*N,N*-dimethylcarbamyloxy)phenylalanine *tert*-butyl ester
- N*-(4-*tert*-butylbenzenesulfonyl)-L-(1,1-dioxothiamorpholin-3-carbonyl)-L-4-(*N,N*-dimethylcarbamyloxy)phenylalanine *tert*-butyl ester
- 30 *N*-(pyridine-2-sulfonyl)-L-prolyl-L-4-(*N,N*-dimethylcarbamyloxy)phenylalanine
- N*-(2-fluorobenzenesulfonyl)-L-(1,1-dioxothiamorpholin-3-carbonyl)-L-4-(*N,N*-dimethylcarbamyloxy)phenylalanine *tert*-butyl ester
- 35 *N*-(3-fluorobenzenesulfonyl)-L-(1,1-dioxothiamorpholin-3-carbonyl)-L-4-(*N,N*-dimethylcarbamyloxy)phenylalanine *tert*-butyl ester
- 40 *N*-(2,4-difluorobenzenesulfonyl)-L-(1,1-dioxothiamorpholin-3-carbonyl)-L-4-(*N,N*-dimethylcarbamyloxy)phenylalanine *tert*-butyl ester
- N*-(4-acetamidobenzenesulfonyl)-L-prolyl-L-4-(*N,N*-dimethylcarbamyloxy)phenylalanine
- 45

- N*-(4-trifluoromethoxybenzenesulfonyl)-L-prolyl-L-4-(*N,N*-dimethylcarbamyloxy)phenylalanine
- 5 *N*-(4-fluorobenzenesulfonyl)-L-(5,5-dimethyl)thiaprolyl-L-4-(*N,N*-dimethylcarbamyloxy)phenylalanine *tert*-butyl ester
- N*-(4-cyanobenzenesulfonyl)-L-prolyl-L-4-(*N,N*-dimethylcarbamyloxy)phenylalanine
- 10 *N*-(toluene-4-sulfonyl)-L-(3,3-dimethyl)prolyl-L-4-(*N,N*-dimethylcarbamyloxy)phenylalanine *tert*-butyl ester
- N*-(toluene-4-sulfonyl)-L-(3,3-dimethyl)prolyl-L-4-(*N,N*-dimethylcarbamyloxy)phenylalanine isopropyl ester
- 15 *N*-(1-methylpyrazole-4-sulfonyl)-L-prolyl-L-4-(*N,N*-dimethylcarbamyloxy)phenylalanine *iso*-propyl ester
- N*-(1-methylpyrazole-4-sulfonyl)-L-(5,5-dimethyl)thiaprolyl-L-4-(*N,N*-dimethylcarbamyloxy)phenylalanine *tert*-butyl ester
- 20 *N*-(1-methylpyrazole-4-sulfonyl)-L-(5,5-dimethyl)thiaprolyl-L-4-(*N,N*-dimethylcarbamyloxy)phenylalanine
- N*-(toluene-4-sulfonyl)-L-prolyl-L-4-(*N*-(1,4-dioxa-8-aza-spiro[4.5]decan-8-yl)carbonyloxy)phenylalanine ethyl ester
- 25 *N*-(toluene-4-sulfonyl)-L-prolyl-L-4-(*N*-(1,4-dioxa-8-aza-spiro[4.5]decan-8-yl)carbonyloxy)phenylalanine
- 30 *N*-(toluene-4-sulfonyl)-L-prolyl-L-4-(4'-acetylpiperazin-1-ylcarbonyloxy)phenylalanine
- N*-(toluene-4-sulfonyl)-L-prolyl-L-4-(4'-methanesulfonylpiperazin-1-ylcarbonyloxy)phenylalanine
- 35 *N*-(toluene-4-sulfonyl)-L-prolyl-L-4-(4'-phenylpiperazin-1-ylcarbonyloxy)phenylalanine
- N*-(toluene-4-sulfonyl)-L-prolyl-L-4-(piperazin-1-ylcarbonyloxy)phenylalanine *tert*-butyl ester
- 40 *N*-(toluene-4-sulfonyl)-L-prolyl-L-4-(4'-methanesulfonylpiperazin-1-ylcarbonyloxy)phenylalanine *tert*-butyl ester
- 45

- N-(toluene-4-sulfonyl)-L-prolyl-L-4-(N,N-dimethylcarbamyloxy)phenylalanine (N'-*tert*-butoxycarbonyl-2-amino-2-methylpropyl) ester
- 5 N-(toluene-4-sulfonyl)-L-prolyl-L-4-(4'-acetylpiperazin-1-ylcarbonyloxy)phenylalanine *tert*-butyl ester
- N-(toluene-4-sulfonyl)-L-prolyl-L-4-(4'-hydroxypiperidin-1-ylcarbonyloxy)phenylalanine *tert*-butyl ester
- 10 N-(toluene-4-sulfonyl)-L-prolyl-L-4-(N-(2'-(morpholin-4'-yl)ethyl)carbamyloxy)phenylalanine *tert*-butyl ester
- N-(toluene-4-sulfonyl)-L-prolyl-L-4-(N-(1,4-dioxa-8-aza-spiro[4.5]decan-8-yl)carbonyloxy)phenylalanine *tert*-butyl ester
- 15 N-(toluene-4-sulfonyl)-L-prolyl-L-4-(N-(2'-hydroxyethyl)-N-methylcarbamyloxy)phenylalanine *tert*-butyl ester
- 20 N-(toluene-4-sulfonyl)-L-prolyl-L-4-(4'-(2-hydroxyethyl)piperazin-1-ylcarbonyloxy)-L-phenylalanine *tert*-butyl ester
- N-(toluene-4-sulfonyl)-L-prolyl-L-4-(N-(2'-formyloxyethyl)-N-methylcarbamyloxy)phenylalanine
- 25 N-(toluene-4-sulfonyl)-L-prolyl-L-4-(N-(2'-hydroxyethyl)-N-methylcarbamyloxy)phenylalanine isopropyl ester
- N-(toluene-4-sulfonyl)-L-prolyl-L-4-(N-(methoxycarbonylmethyl)carbamyloxy)phenylalanine *tert*-butyl ester
- 30 N-(1-methylpyrazole-4-sulfonyl)-L-(5,5-dimethyl)thiaprolyl-L-(4-N,N-dimethylcarbamyloxy)phenylalanine isopropyl ester
- 35 N-(toluene-4-sulfonyl)-L-prolyl-L-4-(4'-methoxypiperidin-1-ylcarbonyloxy)phenylalanine isopropyl ester
- N-(toluene-4-sulfonyl)-L-prolyl-L-4-(4'-methoxypiperidin-1-ylcarbonyloxy)phenylalanine
- 40 N-(toluene-4-sulfonyl)-L-4-oxoprolyl-L-4-(N,N-dimethylcarbamyloxy)phenylalanine *tert*-butyl ester
- N-(toluene-4-sulfonyl)-L-*trans*-4-hydroxyprolyl-L-4-(N,N-dimethylcarbamyloxy)phenylalanine *tert*-butyl ester
- 45

- N-(3-fluorobenzenesulfonyl)-L-prolyl-L-4-(*N,N*-dimethylcarbamyloxy)phenylalanine *tert*-butyl ester
- 5 N-(morpholino-sulfonyl)-L-prolyl-L-(4-*N,N*-dimethylcarbamyloxy)phenylalanine *tert*-butyl ester
- N-(morpholino-sulfonyl)-L-prolyl-L-(4-*N,N*-dimethylcarbamyloxy)phenylalanine
- 10 N-(1-methylpyrazole-4-sulfonyl)-L-(1,1-dioxothiomorpholin-3-carbonyl)-L-4-(*N,N*-dimethylcarbamyloxy)phenylalanine *tert*-butyl ester
- N-(2-fluorobenzenesulfonyl)-L-(1,1-dioxothiomorpholin-3-carbonyl)-L-4-(*N,N*-dimethylcarbamyloxy)phenylalanine
- 15 N-(2,4-difluorobenzenesulfonyl)-L-(1,1-dioxothiomorpholin-3-carbonyl)-L-4-(*N,N*-dimethylcarbamyloxy)phenylalanine
- N-(toluene-4-sulfonyl)-L-(thiomorpholin-3-carbonyl)-L-4-(*N,N*-dimethylcarbamyloxy)phenylalanine
- 20 N-(pyridine-3-sulfonyl)-L-(5,5-dimethyl-thiaprolyl-L-4-(*N,N*-dimethylcarbamyloxy)phenylalanine isopropyl ester
- 25 N-(3-fluorobenzenesulfonyl)-L-(1,1-dioxothiomorpholin-3-carbonyl)-L-4-(*N,N*-dimethylcarbamyloxy)phenylalanine
- N-(1-methylpyrazole-4-sulfonyl)-L-(1,1-dioxothiomorpholin-3-carbonyl)-L-4-(*N,N*-dimethylcarbamyloxy)phenylalanine
- 30 N-(4-*tert*-butylbenzenesulfonyl)-L-(1,1-dioxothiomorpholin-3-carbonyl)-L-4-(*N,N*-dimethylcarbamyloxy)phenylalanine
- N-(toluene-4-sulfonyl)-(3,3-dimethyl)prolyl-L-4-(*N,N*-dimethylcarbamyloxy)phenylalanine
- 35 N-(2,5-dichlorothiophene-3-sulfonyl)-L-prolyl-L-4-(*N,N*-dimethylcarbamyloxy)phenylalanine
- 40 N-(4-methoxybenzenesulfonyl)-L-prolyl-L-4-(*N,N*-dimethylcarbamyloxy)phenylalanine
- N-(4-methoxybenzenesulfonyl)-L-prolyl-L-4-(*N,N*-dimethylcarbamyloxy)phenylalanine isopropyl ester
- 45 N-(toluene-4-sulfonyl)-L-(1-oxo-thiomorpholin-3-carbonyl)-L-4-(*N,N*-dimethylcarbamyloxy)phenylalanine

- N*-(toluene-4-sulfonyl)-*L*-(1-oxo-thiomorpholin-3-carbonyl)-*L*-4-(*N,N*-dimethylcarbamyloxy)phenylalanine *tert*-butyl ester
- 5 *N*-(3,4-difluorobenzenesulfonyl)-*L*-prolyl-4-(*N,N*-dimethylcarbamyloxy)phenylalanine isopropyl ester
- N*-(3,4-difluorobenzenesulfonyl)-*L*-prolyl-4-(*N,N*-dimethylcarbamyloxy)phenylalanine
- 10 *N*-(3,4-difluorobenzenesulfonyl)-*L*-(1,1-dioxothiomorpholin-3-carbonyl)-*L*-4-(*N,N*-dimethylcarbamyloxy)phenylalanine *tert*-butyl ester
- N*-(3,4-difluorobenzenesulfonyl)-*L*-(1,1-dioxothiomorpholin-3-carbonyl)-*L*-4-(*N,N*-dimethylcarbamyloxy)phenylalanine
- 15 *N*-(toluene-4-sulfonyl)-*L*-(5,5-dimethyl)thiaprolyl-*L*-(thiomorpholin-4-ylcarbonyloxy)phenylalanine *tert*-butyl ester
- 20 *N*-(toluene-4-sulfonyl)-*L*-(5,5-dimethyl)thiaprolyl-*L*-(thiomorpholin-4-ylcarbonyloxy)phenylalanine
- N*-(1-methylpyrazole-4-sulfonyl)-*L*-(5,5-dimethyl)thiaprolyl-*L*-4-(*N,N*-dimethylcarbamyloxy)phenylalanine ethyl ester
- 25 *N*-(pyridine-3-sulfonyl)-*L*-(5,5-dimethyl)thiaprolyl-*L*-4-(*N,N*-dimethylcarbamyloxy)phenylalanine
- N*-(pyridine-2-sulfonyl)-*L*-prolyl-*L*-4-(*N,N*-dimethylcarbamyloxy)phenylalanine isopropyl ester
- 30 *N*-(pyridine-2-sulfonyl)-*L*-prolyl-*L*-4-(*N,N*-dimethylcarbamyloxy)phenylalanine
- N*-(pyridine-2-sulfonyl)-*L*-(5,5-dimethyl)thiaprolyl-*L*-4-(*N,N*-dimethylcarbamyloxy)phenylalanine isopropyl ester
- 35 *N*-(pyridine-2-sulfonyl)-*L*-(5,5-dimethyl)thiaprolyl-*L*-4-(*N,N*-dimethylcarbamyloxy)phenylalanine
- 40 *N*-(toluene-4-sulfonyl)-*L*-(thiomorpholin-3-carbonyl)-*L*-4-(*N,N*-dimethylcarbamyloxy)phenylalanine isopropyl ester
- N*-(3-fluorobenzenesulfonyl)-*L*-(5,5-dimethyl)thiaprolyl-*L*-4-(*N,N*-dimethylcarbamyloxy)phenylalanine isopropyl ester
- 45

- N*-(2-fluorobenzenesulfonyl)-L-(5,5-dimethyl)thiaprolyl-L-4-(*N,N*-dimethylcarbamyloxy)phenylalanine isopropyl ester
- 5 *N*-(3,4-difluorobenzenesulfonyl)-L-(5,5-dimethyl)thiaprolyl-L-4-(*N,N*-dimethylcarbamyloxy)phenylalanine isopropyl ester
- N*-(3,5-difluorobenzenesulfonyl)-L-(5,5-dimethyl)thiaprolyl-L-4-(*N,N*-dimethylcarbamyloxy)phenylalanine isopropyl ester
- 10 *N*-(2,4-difluorobenzenesulfonyl)-L-(5,5-dimethyl)thiaprolyl-L-4-(*N,N*-dimethylcarbamyloxy)phenylalanine isopropyl ester
- N*-(4-chlorobenzenesulfonyl)-L-(5,5-dimethyl)thiaprolyl-L-4-(*N,N*-dimethylcarbamyloxy)phenylalanine isopropyl ester
- 15 *N*-(3-chlorobenzenesulfonyl)-L-(5,5-dimethyl)thiaprolyl-L-4-(*N,N*-dimethylcarbamyloxy)phenylalanine isopropyl ester
- N*-(2-chlorobenzenesulfonyl)-L-(5,5-dimethyl)thiaprolyl-L-4-(*N,N*-dimethylcarbamyloxy)phenylalanine isopropyl ester
- 20 *N*-(3,4-dichlorobenzenesulfonyl)-L-(5,5-dimethyl)thiaprolyl-L-4-(*N,N*-dimethylcarbamyloxy)phenylalanine isopropyl ester
- N*-(3,5-dichlorobenzenesulfonyl)-L-(5,5-dimethyl)thiaprolyl-L-4-(*N,N*-dimethylcarbamyloxy)phenylalanine isopropyl ester
- 25 *N*-(3-chlorobenzenesulfonyl)-L-(1,1-dioxothiamorpholin-3-carbonyl)-L-4-(*N,N*-dimethylcarbamyloxy)phenylalanine *tert*-butyl ester
- 30 *N*-(3,4-dichlorobenzenesulfonyl)-L-(1,1-dioxothiamorpholin-3-carbonyl)-L-4-(*N,N*-dimethylcarbamyloxy)phenylalanine *tert*-butyl ester
- N*-(4-methoxybenzenesulfonyl)-L-(5,5-dimethyl)thiaprolyl-L-4-(*N,N*-dimethylcarbamyloxy)phenylalanine isopropyl ester
- 35 *N*-(3-methoxybenzenesulfonyl)-L-(5,5-dimethyl)thiaprolyl-L-4-(*N,N*-dimethylcarbamyloxy)phenylalanine isopropyl ester
- N*-(2-methoxybenzenesulfonyl)-L-(5,5-dimethyl)thiaprolyl-L-4-(*N,N*-dimethylcarbamyloxy)phenylalanine isopropyl ester
- 40 *N*-(3,4-dimethoxybenzenesulfonyl)-L-(5,5-dimethyl)thiaprolyl-L-4-(*N,N*-dimethylcarbamyloxy)phenylalanine isopropyl ester
- 45 *N*-(2,4-difluorobenzenesulfonyl)-L-(thiamorpholin-3-carbonyl)-L-4-(*N,N*-dimethylcarbamyloxy)phenylalanine isopropyl ester

- N*-(3,4-dichlorobenzenesulfonyl)-L-(1,1-dioxothiomorpholin-3-carbonyl)-L-4-(*N,N*-dimethylcarbamyloxy)phenylalanine
- 5 *N*-(3-chlorobenzenesulfonyl)-L-(1,1-dioxothiomorpholin-3-carbonyl)-L-4-(*N,N*-dimethylcarbamyloxy)phenylalanine
- N*-(3-chloro-4-fluorobenzenesulfonyl)-L-(1,1-dioxothiomorpholin-3-carbonyl)-L-4-(*N,N*-dimethylcarbamyloxy)phenylalanine *tert*-butyl ester
- 10 *N*-(1-methylpyrazole-4-sulfonyl)-L-(thiomorpholin-3-carbonyl)-L-4-(*N,N*-dimethylcarbamyloxy)phenylalanine *tert*-butyl ester
- N*-(3,4-difluorobenzenesulfonyl)-L-(thiomorpholin-3-carbonyl)-L-4-(*N,N*-dimethylcarbamyloxy)phenylalanine *tert*-butyl ester
- 15 *N*-(toluene-4-sulfonyl)-L-(5,5-dimethyl)thiopropyl-L-(thiomorpholin-4-ylcarbonyloxy)phenylalanine isopropyl ester
- N*-(3,4-difluorobenzenesulfonyl)-L-(thiomorpholin-3-carbonyl)-L-4-(*N,N*-dimethylcarbamyloxy)phenylalanine
- 20 *N*-(2,5-dichlorothiophene-3-sulfonyl)-L-(5,5-dimethyl)thiopropyl-L-4-(*N,N*-dimethylcarbamyloxy)phenylalanine isopropyl ester
- 25 *N*-(1-methylpyrazole-4-sulfonyl)-L-(5,5-dimethyl)thiopropyl-L-4-(thiomorpholin-4-ylcarbonyloxy)phenylalanine isopropyl ester
- N*-(8-quinolinesulfonyl)-L-propyl-L-4-(*N,N*-dimethylcarbamyloxy)phenylalanine isopropyl ester
- 30 *N*-(8-quinolinesulfonyl)-L-propyl-L-4-(*N,N*-dimethylcarbamyloxy)phenylalanine
- N*-(8-quinolinesulfonyl)-L-(5,5-dimethyl)thiopropyl-L-4-(*N,N*-dimethylcarbamyloxy)phenylalanine isopropyl ester
- 35 *N*-(8-quinolinesulfonyl)-L-(5,5-dimethyl)thiopropyl-L-4-(*N,N*-dimethylcarbamyloxy)phenylalanine
- 40 *N*-(toluene-4-sulfonyl)-L-propyl-L-4-(4-phenylpiperazin-1-ylcarbonyloxy)phenylalanine *tert*-butyl ester
- N*-(toluene-4-sulfonyl)-L-propyl-L-4-(4'-(ethoxycarbonyl)piperidin-1-ylcarbonyloxy)phenylalanine *tert*-butyl ester
- 45

- N*-(pyridine-3-sulfonyl)-*L*-(5,5-dimethyl)thiaprolyl-*L*-4-(*N,N*-dimethylcarbamyloxy)phenylalanine *tert*-butyl ester
- 5 *N*-(3-sulfonamido-4-chloro-benzenesulfonyl)-*L*-prolyl-*L*-4-(*N,N*-dimethylcarbamyloxy)phenylalanine isopropyl ester
- N*-(toluene-4-sulfonyl)-*L*-(1-oxothiomorpholin-3-carbonyl)-*L*-4-(*N,N*-dimethylcarbamyloxy)phenylalanine isopropyl ester
- 10 *N*-(2,4-difluorobenzenesulfonyl)-*L*-(1-oxothiomorpholin-3-carbonyl)-*L*-4-(*N,N*-dimethylcarbamyloxy)phenylalanine *tert*-butyl ester
- N*-(1-methylpyrazole-4-sulfonyl)-*L*-(5,5-dimethyl)thiaprolyl-*L*-4-(*N,N*-dimethylcarbamyloxy)phenylalanine 2,2-dimethylpropyl ester
- 15 *N*-(pyridine-3-sulfonyl)-*L*-(5,5-dimethyl)thiaprolyl-*L*-4-(*N,N*-dimethylcarbamyloxy)phenylalanine 2,2-dimethylpropyl ester
- N*-(1-methylpyrazole-4-sulfonyl)-*L*-(5,5-dimethyl)thiaprolyl-*L*-4-(*N,N*-dimethylcarbamyloxy)phenylalanine cyclopropylmethyl ester
- 20 *N*-(1-methylpyrazole-4-sulfonyl)-*L*-(5,5-dimethyl)thiaprolyl-*L*-4-(*N,N*-dimethylcarbamyloxy)phenylalanine methyl ester
- N*-(1-methylpyrazole-4-sulfonyl)-*L*-(5,5-dimethyl)thiaprolyl-*L*-4-(*N,N*-dimethylcarbamyloxy)phenylalanine ethyl ester
- 25 *N*-(pyridine-3-sulfonyl)-*L*-(5,5-dimethyl)thiaprolyl-*L*-4-(*N,N*-dimethylcarbamyloxy)phenylalanine cyclopropylmethyl ester
- 30 *N*-(1-methylpyrazole-4-sulfonyl)-*L*-(5,5-dimethyl)thiaprolyl-*L*-4-(*N,N*-dimethylcarbamyloxy)phenylalanine 2-methoxyphenyl ester
- N*-(1-methylpyrazole-4-sulfonyl)-*L*-(5,5-dimethyl)thiaprolyl-*L*-4-(*N,N*-dimethylcarbamyloxy)phenylalanine *n*-butyl ester
- 35 *N*-(1-methylpyrazole-4-sulfonyl)-*L*-(5,5-dimethyl)thiaprolyl-*L*-4-(*N,N*-dimethylcarbamyloxy)phenylalanine *n*-propyl ester
- N*-(1-methylpyrazole-4-sulfonyl)-*L*-(5,5-dimethyl)thiaprolyl-*L*-4-(*N,N*-dimethylcarbamyloxy)phenylalanine 2,2-dimethylpropionyloxymethyl ester
- 40 *N*-(toluene-4-sulfonyl)-*L*-prolyl-*L*-4-(*N*-(4'-(2'-aminoethyl)morpholino)carbamyloxy)phenylalanine
- 45 *N*-(toluene-4-sulfonyl)-*L*-prolyl-*L*-4-[4-(carboxy)piperidin-1-ylcarbonyloxy]phenylalanine

- N*-(toluene-4-sulfonyl)-*L*-prolyl-*L*-4-(*N,N*-bis-(2-hydroxyethyl)carbamyloxy)phenylalanine isopropyl ester
- 5 *N*-(toluene-4-sulfonyl)-*L*-prolyl-*L*-4-[3-(hydroxymethyl)piperidin-1-ylcarbonyloxy]phenylalanine isopropyl ester
- N*-(toluene-4-sulfonyl)-*L*-prolyl-*L*-4-(4-trifluoromethanesulfonylpiperazin-1-ylcarbonyloxy)phenylalanine *tert*-butyl ester
- 10 *N*-(4-(*N*-phenylurea)benzenesulfonyl)-*L*-prolyl-*L*-4-(*N,N*-dimethylcarbamyloxy)phenylalanine *tert*-butyl ester
- N*-(2-trifluoroacetyl-1,2,3,4-tetrahydroisoquinolin-7-sulfonyl)-*L*-prolyl-*L*-4-(*N,N*-dimethylcarbamyloxy)phenylalanine isopropyl ester
- 15 *N*-(1-methylpyrazole-3-sulfonyl)-*L*-(5,5-dimethyl)thiaprolyl-*L*-4-(*N,N*-dimethylcarbamyloxy)phenylalanine isopropyl ester
- N*-(1-methylpyrazole-3-sulfonyl)-*L*-(5,5-dimethyl)thiaprolyl-*L*-4-(*N,N*-dimethylcarbamyloxy)phenylalanine
- 20 *N*-(pyridine-4-sulfonyl)-*L*-(5,5-dimethyl)thiaprolyl-*L*-4-(*N,N*-dimethylcarbamyloxy)phenylalanine isopropyl ester
- 25 *N*-(pyridine-4-sulfonyl)-*L*-(5,5-dimethyl)thiaprolyl-*L*-4-(*N,N*-dimethylcarbamyloxy)phenylalanine
- N*-(toluene-4-sulfonyl)-*L*-(5,5-dimethyl)thiaprolyl-*L*-4-(*N*-methyl-*N*-(2-dimethylaminoethyl)carbamyloxy)phenylalanine *tert*-butyl ester
- 30 *N*-(toluene-4-sulfonyl)-*L*-prolyl-*L*-4-(*N*-methyl-*N*-(2-dimethylaminoethyl)carbamyloxy)phenylalanine *tert*-butyl ester
- N*-(toluene-4-sulfonyl)-*L*-(5,5-dimethyl)thiaprolyl-*L*-4-(*N*-methyl-*N*-(2-dimethylaminoethyl)carbamyloxy)phenylalanine
- 35 *N*-(toluene-4-sulfonyl)-*L*-prolyl-*L*-4-(*N*-methyl-*N*-(2-dimethylaminoethyl)carbamyloxy)phenylalanine
- N*-(4-fluorobenzenesulfonyl)-*L*-(5,5-dimethyl)thiaprolyl-*L*-3-chloro-4-(4-methylpiperazin-1-ylcarbonyloxy)phenylalanine *tert*-butyl ester
- 40 *N*-(4-fluorobenzenesulfonyl)-*L*-(5,5-dimethyl)thiaprolyl-*L*-3-chloro-4-(*N,N*-dimethylcarbamyloxy)phenylalanine
- 45 *N*-(4-fluorobenzenesulfonyl)-*L*-(5,5-dimethyl)thiaprolyl-*L*-3-chloro-4-(*N,N*-dimethylcarbamyloxy)phenylalanine

- N*-(4-fluorobenzenesulfonyl)-L-(5,5-dimethyl)thiaprolyl-L-3-chloro-4-(thiomorpholin-4-ylcarbonyloxy)phenylalanine *tert*-butyl ester
- 5 *N*-(4-fluorobenzenesulfonyl)-L-(5,5-dimethyl)thiaprolyl-L-3-chloro-4-(thiomorpholin-4-ylcarbonyloxy)phenylalanine isopropyl ester
- N*-(4-fluorobenzenesulfonyl)-L-(5,5-dimethyl)thiaprolyl-L-3-chloro-4-(*N,N*-dimethylcarbamyloxy)]phenylalanine isopropyl ester
- 10 *N*-(toluene-4-sulfonyl)-L-(5,5-dimethyl)thiaprolyl-L-3-chloro-4-(*N,N*-dimethylcarbamyloxy)phenylalanine isopropyl ester
- N*-(4-fluorobenzenesulfonyl)-L-(5,5-dimethyl)thiaprolyl-L-3-chloro-4-(4-methylpiperazin-1-ylcarbonyloxy)]phenylalanine isopropyl ester
- 15 *N*-(toluene-4-sulfonyl)-L-prolyl-L-3-chloro-4-(*N,N*-dimethylcarbamyloxy)]phenylalanine isopropyl ester
- N*-(4-fluorobenzenesulfonyl)-L-(5,5-dimethyl)thiaprolyl-L-3-chloro-4-(4-(2'-pyridyl)-piperazin-1-ylcarbonyloxy)]phenylalanine isopropyl ester
- 20 *N*-(4-fluorobenzenesulfonyl)-L-(5,5-dimethyl)thiaprolyl-L-3-chloro-4-(4-(2'-pyridyl)-piperazin-1-ylcarbonyloxy)]phenylalanine *tert*-butyl ester
- N*-(4-nitrobenzenesulfonyl)-L-prolyl-L-4-(*N,N*-dimethylcarbamyloxy)phenylalanine isopropyl ester
- 25 *N*-(4-aminobenzenesulfonyl)-L-prolyl-L-4-(*N,N*-dimethylcarbamyloxy)phenylalanine isopropyl ester
- 30 *N*-(toluene-4-sulfonyl)-L-prolyl-L-4-(thiomorpholin-4-ylcarbonyloxy)phenylalanine isopropyl ester
- N*-(toluene-4-sulfonyl)-L-prolyl-L-4-(4-phenylcarbamyloxy)piperazin-1-ylcarbonyloxy)phenylalanine isopropyl ester
- 35 *N*-(toluene-4-sulfonyl)-L-prolyl-L-4-(4-phenylcarbamyloxy)piperazin-1-ylcarbonyloxy)phenylalanine
- N*-(1-*n*-butylpyrazole-4-sulfonyl)-L-(5,5-dimethyl)thiaprolyl-L-4-(*N,N*-dimethylcarbamyloxy)phenylalanine isopropyl ester
- 40 *N*-(toluene-4-sulfonyl)-L-prolyl-L-4-(pyridin-4-ylcarbonyl)piperazin-1-ylcarbonyloxy)phenylalanine isopropyl ester
- 45 *N*-(toluene-4-sulfonyl)-L-4-oxoprolyl-L-4-(*N,N*-dimethylcarbamyloxy)phenylalanine

- N*-(toluene-4-sulfonyl)-*L-trans*-4-hydroxypropyl-*L*-4-(*N,N*-dimethylcarbamoyloxy)phenylalanine
- 5 *N*-(4-cyanobenzenesulfonyl)-*L*-propyl-*L*-4-(*N,N*-dimethylcarbamoyloxy)phenylalanine isopropyl ester
- N*-(4-aminobenzenesulfonyl)-*L*-propyl-*L*-4-(*N,N*-dimethylcarbamoyloxy)phenylalanine
- 10 *N*-(toluene-4-sulfonyl)-*L*-4-oxopropyl-*L*-4-(4-methylpiperazin-1-ylcarbonyloxy)phenylalanine *tert*-butyl ester
- N*-(toluene-4-sulfonyl)-*L*-propyl-*L*-4-[3-(hydroxymethyl)piperidin-1-ylcarbonyloxy]phenylalanine
- 15 *N*-(toluene-4-sulfonyl)-*L*-(4,4-difluoro)propyl-*L*-4-(*N,N*-dimethylcarbamoyloxy)phenylalanine isopropyl ester
- 20 *N*-(toluene-4-sulfonyl)-*L*-(4,4-difluoro)propyl-*L*-4-(*N,N*-dimethylcarbamoyloxy)phenylalanine
- N*-(toluene-4-sulfonyl)-*L*-propyl-*L*-(4-benzoylpiperazin-1-ylcarbonyloxy)phenylalanine isopropyl ester
- 25 *N*-(1-methyl-1H-imidazole-4-sulfonyl)-*L*-propyl-*L*-4-(*N,N*-dimethylcarbamoyloxy)phenylalanine isopropyl ester
- N*-(toluene-4-sulfonyl)-*L*-4-(thiomorpholin-4-ylcarbonyloxy)propyl-*L*-4-(thiomorpholin-4-ylcarbonyloxy)phenylalanine
- 30 *N*-(4-cyanobenzenesulfonyl)-*L*-propyl-*L*-4-(thiomorpholin-4-ylcarbonyloxy)phenylalanine isopropyl ester
- 35 *N*-(4-amidinobenzenesulfonyl)-*L*-propyl-*L*-4-(*N,N*-dimethylcarbamoyloxy)phenylalanine methyl ester
- N*-(toluene-4-sulfonyl)-*L*-4-oxopropyl-*L*-4-(thiomorpholin-4-ylcarbonyloxy)phenylalanine *tert*-butyl ester
- 40 *N*-(toluene-4-sulfonyl)-*L*-4-hydroxypropyl-*L*-4-(thiomorpholin-4-ylcarbonyloxy)phenylalanine
- N*-(toluene-4-sulfonyl)-*L*-propyl-*L*-(4-benzoylpiperazin-1-ylcarbonyloxy)phenylalanine
- 45

- N*-(4-amidinobenzenesulfonyl)-L-prolyl-L-4-(thiomorpholin-4-ylcarbonyloxy)phenylalanine methyl ester
- 5 *N*-(3-fluorobenzenesulfonyl)-L-prolyl-L-4-(*N,N*-dimethylcarbonyloxy)phenylalanine
- N*-(toluene-4-sulfonyl)-L-prolyl-L-4-[*N*-methyl-*N*-(2-(*N'*-methyl-*N'*-toluenesulfonyl-amino)ethyl)carbamyloxy]phenylalanine isopropyl ester
- 10 *N*-(toluene-4-sulfonyl)-L-prolyl-L-4-[*N*-(2-(*N'*-phenylaminocarbonyloxy)ethyl)carbamyloxy]phenylalanine isopropyl ester
- N*-(4-fluorobenzenesulfonyl)-L-4-(*trans*-hydroxy)prolyl-L-4-(*N,N*-dimethylcarbamyloxy)phenylalanine isopropyl ester
- 15 *N*-(4-fluorobenzenesulfonyl)-L-4-(*trans*-hydroxy)prolyl-L-4-(*N,N*-dimethylcarbamyloxy)phenylalanine *tert*-butyl ester
- N*-(4-amidinobenzenesulfonyl)-L-prolyl-L-4-(*N,N*-dimethylcarbamyloxy)phenylalanine
- 20 *N*-(toluene-4-sulfonyl)-L-(pyrazin-3-carbonyl)-L-4-(*N,N*-dimethylcarbamyloxy)phenylalanine *tert*-butyl ester
- N*-(4-fluorobenzenesulfonyl)-L-(5,5-dimethyl)thiaprolyl-L-4-(2-hydroxymethylpyrrolidin-1-ylcarbonyloxy)phenylalanine *tert*-butyl ester
- 25 *N*-(4-fluorobenzenesulfonyl)-L-(5,5-dimethyl)thiaprolyl-L-4-(2-hydroxymethylpyrrolidin-1-ylcarbonyloxy)phenylalanine
- 30 *N*-(toluene-4-sulfonyl)-L-prolyl-L-4-(2-methoxycarbonylpyrrolidin-1-ylcarbonyloxy)phenylalanine *tert*-butyl ester
- N*-(4-fluorobenzenesulfonyl)-L-(5,5-dimethyl)thiaprolyl-L-3-chloro-4-(thiomorpholin-4-ylcarbonyloxy)phenylalanine
- 35 *N*-(4-fluorobenzenesulfonyl)-L-(5,5-dimethyl)thiaprolyl-L-4-(4-(2-pyridyl)piperazin-1-ylcarbonyloxy)]phenylalanine
- N*-(4-fluorobenzenesulfonyl)-L-(5,5-dimethyl)thiaprolyl-L-4-(4-(2-pyridyl)piperazin-1-ylcarbonyloxy)]phenylalanine *tert*-butyl ester
- 40 *N*-(toluene-4-sulfonyl)-L-(4-hydroxy)prolyl-L-4-(thiomorpholin-4-ylcarbonyloxy)phenylalanine *tert*-butyl ester
- 45 *N*-(toluene-4-sulfonyl)-L-prolyl-L-4-(*N,N*-dimethylcarbamyloxy)phenylalanine 2-(2-methoxyethoxy)ethyl ester

- N*-(4-fluorobenzenesulfonyl)-*L*-(5,5-dimethyl)thiaprolyl-*L*-4-(4-(2-pyrimidyl)piperazin-1-ylcarbonyloxy)]phenylalanine *tert*-butyl ester
- 5 *N*-(4-fluorobenzenesulfonyl)-*L*-(5,5-dimethyl)thiaprolyl-*L*-3-fluoro-4-(*N,N*-dimethylcarbamyloxy)phenylalanine isopropyl ester
- N*-(toluene-4-sulfonyl)-*L*-(1-methanesulfonylpyrazin-3-carbonyl)-*L*-4-(*N,N*-dimethylcarbamyloxy)phenylalanine *tert*-butyl ester
- 10 *N*-(4-bromobenzenesulfonyl)-*L*-(5,5-dimethyl)thiaprolyl-*L*-4-(*N,N*-dimethylcarbamyloxy)phenylalanine *tert*-butyl ester
- N*-(4-bromobenzenesulfonyl)-*L*-(5,5-dimethyl)thiaprolyl-*L*-4-(*N,N*-dimethylcarbamyloxy)phenylalanine
- 15 *N*-(toluene-4-sulfonyl)-*L*-(4-hydroxy)prolyl-*L*-4-(4-methylpiperazin-1-ylcarbonyloxy)phenylalanine
- N*-(4-fluorobenzenesulfonyl)-*L*-(5,5-dimethyl)thiaprolyl-*L*-4-(4-(2-pyrimidyl)piperazin-1-ylcarbonyloxy)]phenylalanine
- 20 *N*-(4-fluorobenzenesulfonyl)-*L*-(5,5-dimethyl)thiaprolyl-*L*-4-(4-(2-pyridyl)piperazin-1-ylcarbonyloxy)]phenylalanine isopropyl ester
- 25 *N*-(4-fluorobenzenesulfonyl)thiazolidinyl-2-carbonyl-*L*-4-(*N,N*-dimethylcarbamyloxy)phenylalanine
- N*-(4-fluorobenzenesulfonyl)thiazolidinyl-2-carbonyl-*L*-4-(*N,N*-dimethylcarbamyloxy)phenylalanine *tert*-butyl ester
- 30 *N*-(toluene-4-sulfonyl)-*L*-(4-oxo)prolyl-*L*-4-(thiomorpholin-4-ylcarbonyloxy)phenylalanine
- N*-(toluene-4-sulfonyl)-*L*-(4-oxo)prolyl-*L*-4-(4-methylpiperazin-1-ylcarbonyloxy)phenylalanine
- 35 *N*-(4-fluorobenzenesulfonyl)thiazolidinyl-2-carbonyl-*L*-4-(4-(2-pyridyl)piperazin-1-ylcarbonyloxy)]phenylalanine
- 40 *N*-(4-nitrobenzenesulfonyl)-*L*-prolyl-*L*-4-(4-(2-pyridyl)piperazin-1-ylcarbonyloxy)]phenylalanine *tert*-butyl ester
- N*-(4-fluorobenzenesulfonyl)thiazolidinyl-2-carbonyl-*L*-4-(4-(2-pyridyl)piperazin-1-ylcarbonyloxy)]phenylalanine *tert*-butyl ester
- 45

- N*-(4-bromobenzenesulfonyl)-*L*-(5,5-dimethyl)thiaprolyl-*L*-4-(4-(2-pyridyl)piperazin-1-ylcarbonyloxy)]phenylalanine
- 5 *N*-(toluene-4-sulfonyl)-*L*-prolyl-*L*-4-(4-(*N*-phenylthiocarbonyl)piperazin-1-ylcarbonyloxy)]phenylalanine isopropyl ester
- N*-(4-fluorobenzenesulfonyl)thiazolidinyl-2-carbonyl-*L*-4-(4-methylhomopiperazin-1-ylcarbonyloxy)phenylalanine *tert*-butyl ester
- 10 *N*-(toluene-4-sulfonyl)-*L*-4-(methanesulfonyloxy)prolyl-*L*-4-(*N,N*-dimethylcarbamyloxy)phenylalanine *tert*-butyl ester
- N*-(4-aminocarbonylbenzenesulfonyl)-*L*-prolyl-*L*-4-(*N,N*-dimethylcarbamyloxy)phenylalanine
- 15 *N*-(4-aminocarbonylbenzenesulfonyl)-*L*-prolyl-*L*-4-(thiomorpholin-4-ylcarbonyloxy)phenylalanine
- N*-(4-amidinobenzenesulfonyl)-*L*-prolyl-*L*-4-(thiomorpholin-4-ylcarbonyloxy)phenylalanine
- 20 *N*-(4-nitrobenzenesulfonyl)-*L*-prolyl-*L*-4-(4-(2-pyridyl)piperazin-1-ylcarbonyloxy)]phenylalanine
- N*-(4-fluorobenzenesulfonyl)-*L*-(5,5-dimethyl)thiaprolyl-*L*-3-chloro-4-(4-(2-pyridyl)piperazin-1-ylcarbonyloxy)]phenylalanine ethyl ester
- 25 *N*-(4-fluorobenzenesulfonyl)-*L*-(5,5-dimethyl)thiaprolyl-*L*-3-chloro-4-(4-(2-pyridyl)piperazin-1-ylcarbonyloxy)phenylalanine
- 30 *N*-(4-fluorobenzenesulfonyl)thiazolidinyl-2-carbonyl-*L*-4-(4-methylhomopiperazin-1-ylcarbonyloxy)phenylalanine
- N*-(1-methylpyrazole-3-sulfonyl)-*L*-(5,5-dimethyl)thiaprolyl-*L*-3-chloro-4-(*N,N*-dimethylcarbamyloxy)phenylalanine isopropyl ester
- 35 *N*-(1-methylimidazole-4-sulfonyl)-*L*-prolyl-*L*-4-(4-(2-pyridyl)piperazin-1-ylcarbonyloxy)phenylalanine isopropyl ester
- N*-(1-methylimidazole-4-sulfonyl)-*L*-prolyl-*L*-4-(4-(2-pyridyl)piperazin-1-ylcarbonyloxy)phenylalanine *tert*-butyl ester
- 40 *N*-(toluene-4-sulfonyl)-*L*-prolyl-*L*-4-(4-(2-pyridyl)piperazin-1-ylcarbonyloxy)phenylalanine
- 45 *N*-(toluene-4-sulfonyl)-*L*-prolyl-*L*-4-(4-(2-pyridyl)piperazin-1-ylcarbonyloxy)phenylalanine *tert*-butyl ester

- N*-(toluene-4-sulfonyl)-*L*-prolyl-*L*-4-(4-(2-pyridyl)piperazin-1-ylcarbonyloxy)phenylalanine isopropyl ester
- 5 *N*-(4-fluorobenzenesulfonyl)-*L*-prolyl-*L*-4-(4-(2-pyridyl)piperazin-1-ylcarbonyloxy)phenylalanine isopropyl ester
- N*-(4-fluorobenzenesulfonyl)-*L*-prolyl-*L*-4-(4-(2-pyridyl)piperazin-1-ylcarbonyloxy)phenylalanine *tert*-butyl ester
- 10 *N*-(toluene-4-sulfonyl)-*L*-(1-methanesulfonylpyrazin-3-carbonyl)-*L*-4-(*N,N*-dimethylcarbamyloxy)phenylalanine
- N*-(toluene-4-sulfonyl)-*L*-4-(methanesulfonyloxy)prolyl-*L*-4-(*N,N*-dimethylcarbamyloxy)phenylalanine
- 15 *N*-(4-bromobenzenesulfonyl)-*L*-(5,5-dimethyl)thiaprolyl-*L*-4-(4-(2-pyridyl)piperazin-1-ylcarbonyloxy)phenylalanine *tert*-butyl ester
- N*-(4-trifluoromethoxybenzenesulfonyl)-*L*-(5,5-dimethyl)thiaprolyl-*L*-4-(*N,N*-dimethylcarbamyloxy)phenylalanine
- 20 *N*-(4-trifluoromethoxybenzenesulfonyl)-*L*-(5,5-dimethyl)thiaprolyl-*L*-4-(*N,N*-dimethylcarbamyloxy)phenylalanine *tert*-butyl ester
- 25 *N*-(4-trifluoromethoxybenzenesulfonyl)-*L*-(5,5-dimethyl)thiaprolyl-*L*-4-(4-(2-pyridyl)piperazin-1-ylcarbonyloxy)phenylalanine *tert*-butyl ester
- N*-(4-fluorobenzenesulfonyl)-*L*-prolyl-*L*-4-(4-(2-pyridyl)piperazin-1-ylcarbonyloxy)phenylalanine
- 30 *N*-(4-fluorobenzenesulfonyl)-*L*-(4-hydroxy)prolyl-*L*-4-(4-(2-pyridyl)piperazin-1-ylcarbonyloxy)phenylalanine
- N*-(4-trifluoromethoxybenzenesulfonyl)-*L*-(5,5-dimethyl)thiaprolyl-*L*-4-(4-(2-pyridyl)piperazin-1-ylcarbonyloxy)phenylalanine
- 35 *N*-(1-methylimidazole-4-sulfonyl)-*L*-prolyl-*L*-3-chloro-4-(*N,N*-dimethylcarbamyloxy)phenylalanine
- 40 *N*-(1-methylimidazole-4-sulfonyl)-*L*-prolyl-*L*-3-chloro-4-(*N,N*-dimethylcarbamyloxy)phenylalanine isopropyl ester
- N*-(1-methylimidazole-4-sulfonyl)-*L*-prolyl-*L*-4-(4-(2-pyridyl)piperazin-1-ylcarbonyloxy)phenylalanine
- 45

- 5 *N*-(1-methylimidazole-4-sulfonyl)-L-(5,5-dimethyl)thiaprolyl-L-4-(4-(2-pyridyl)piperazin-1-ylcarbonyloxy)phenylalanine
- 5 *N*-(1-methylpyrazole-3-sulfonyl)-L-prolyl-L-4-(4-(2-pyridyl)piperazin-1-ylcarbonyloxy)phenylalanine
- 10 *N*-(1-methylpyrazole-3-sulfonyl)-L-prolyl-L-4-(4-(2-pyridyl)piperazin-1-ylcarbonyloxy)phenylalanine isopropyl ester
- 10 *N*-(1-methylpyrazole-3-sulfonyl)-L-prolyl-L-4-(4-(2-pyridyl)piperazin-1-ylcarbonyloxy)phenylalanine *tert*-butyl ester
- 15 *N*-(1-methylpyrazole-3-sulfonyl)-L-(5,5-dimethyl)thiaprolyl-L-4-(4-(2-pyridyl)piperazin-1-ylcarbonyloxy)phenylalanine *tert*-butyl ester
- 15 *N*-(1-methylimidazole-4-sulfonyl)-L-prolyl-L-3-chloro-4-(4-(2-pyridyl)piperazin-1-ylcarbonyloxy)phenylalanine isopropyl ester
- 20 *N*-(1-methylpyrazole-3-sulfonyl)-L-(5,5-dimethyl)thiaprolyl-L-4-(*N,N*-dimethylcarbamyloxy)phenylalanine 2-phenoxyethyl ester
- 25 *N*-(1-methylpyrazole-3-sulfonyl)-L-(5,5-dimethyl)thiaprolyl-L-3-chloro-4-(4-(2-pyridyl)piperazin-1-ylcarbonyloxy)phenylalanine
- 25 *N*-(1-methylpyrazole-3-sulfonyl)-L-(5,5-dimethyl)thiaprolyl-L-3-chloro-4-(4-(2-pyridyl)piperazin-1-ylcarbonyloxy)phenylalanine ethyl ester
- 30 *N*-(3-chloro-1,5-dimethylpyrazole-3-sulfonyl)-L-(5,5-dimethyl)thiaprolyl-L-3-chloro-4-(4-(5-trifluoromethyl-2-pyridyl)piperazin-1-ylcarbonyloxy)phenylalanine

and pharmaceutically acceptable salts thereof.

35 82. The use according to any one of claims 62 to 66, 73, 75, and 82 wherein the subject with paralysis suffers from multiple sclerosis, a congenital metabolic disorder, a neuropathy with abnormal myelination, drug induced demyelination, radiation induced demyelination, a hereditary demyelinating condition, a prion induced demyelinating condition, encephalitis induced demyelination, or a spinal cord injury.

40

83. The use according to claim 82, wherein the subject is human.

84. The use according to any one of claims 62 to 66, 73, 75, and 82 further comprising co-administering an immunosuppressant.

5 85. The use according to any one of claims 62 to 66, 73, 75, and 82, wherein the compound is administered chronically to the subject in need thereof.

86. The use according to claim 85, wherein the chronic administration of the compound occurs weekly or monthly for at least 12 months.

10 87. The use according to claim 84, wherein the immunosuppressant is adrenocorticotrophic hormone, a corticosteroid, or an interferon.

88. The use according to claim 87, wherein the interferon is interferon beta-1b or interferon beta-1a.

15

89. The use according to claim 87, wherein the corticosteroid is prednisone, methylprednisolone, dexamethasone cortisol, cortisone, fludrocortisone, prednisolone, 6 α -methylprednisolone, triamcinolone, or betamethasone.

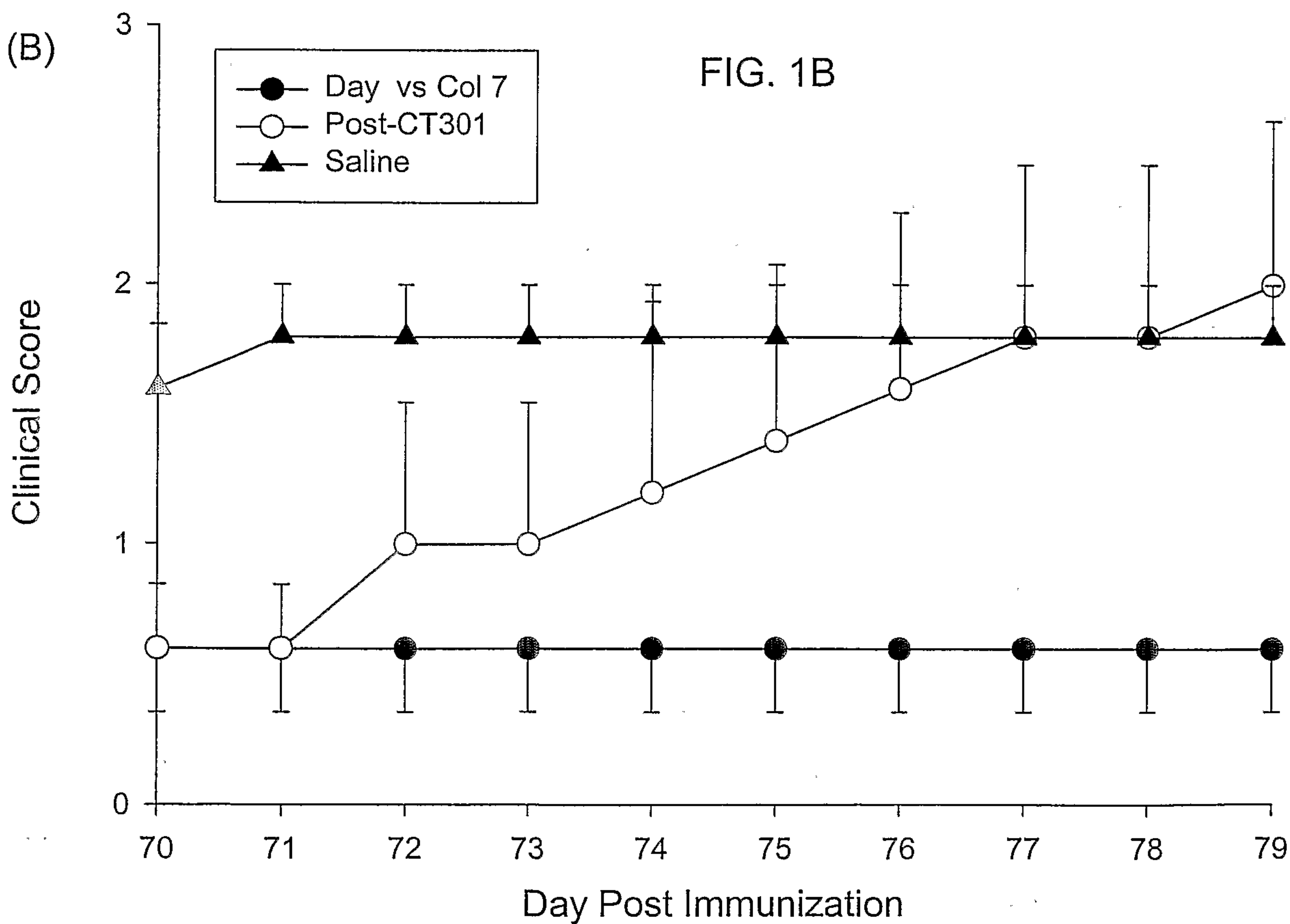
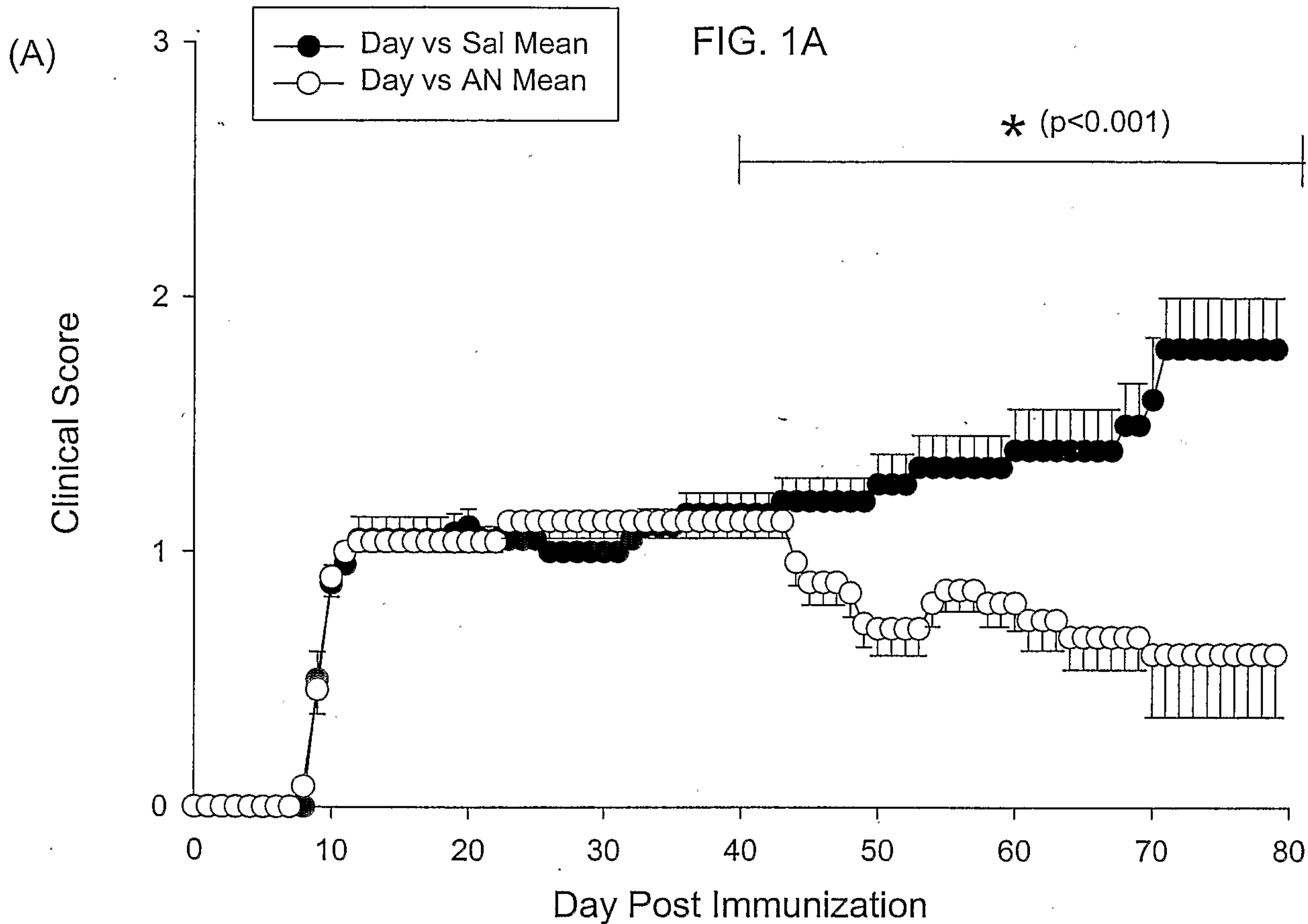

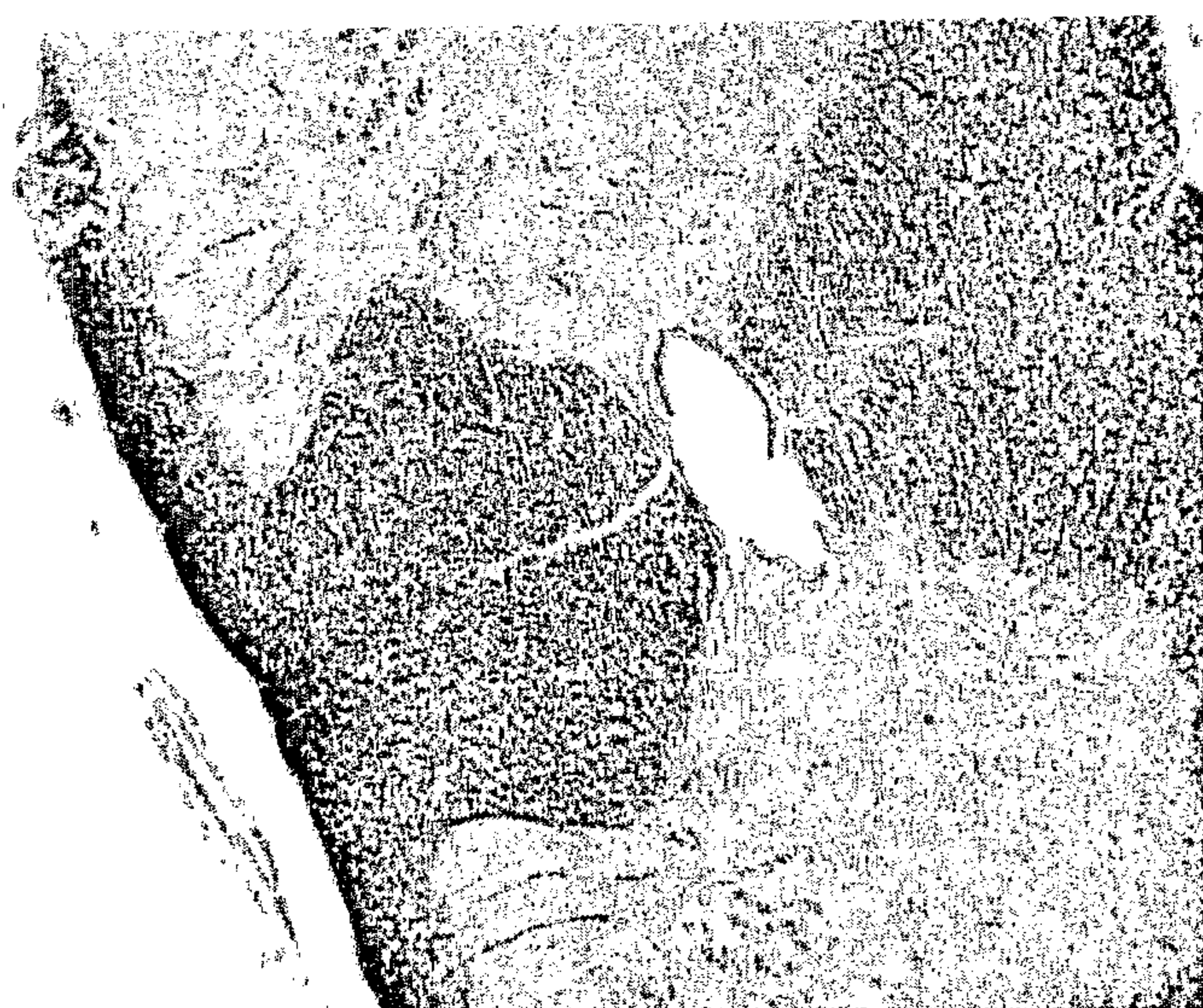

FIG. 2A

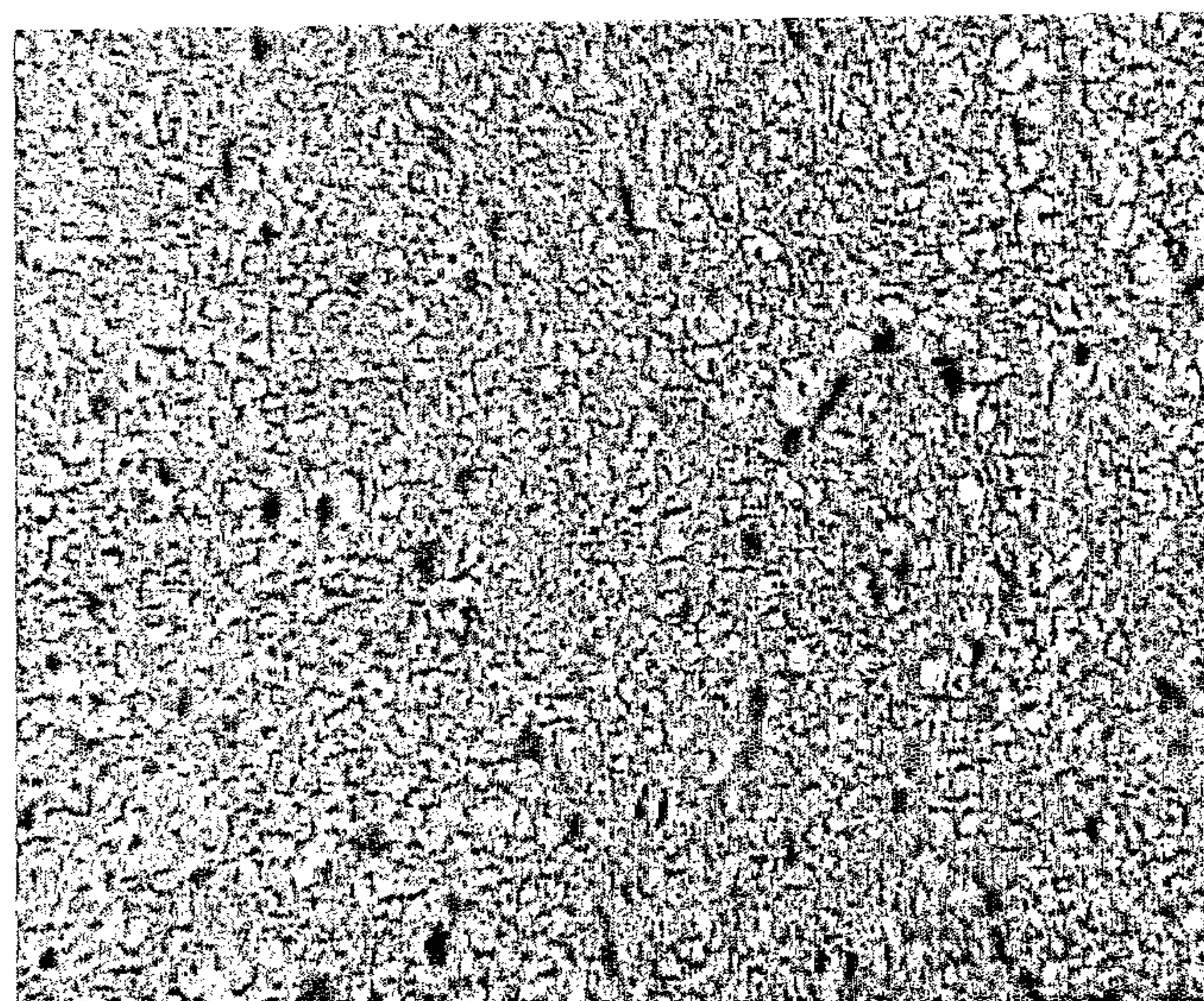

FIG. 2B



FIG. 2C

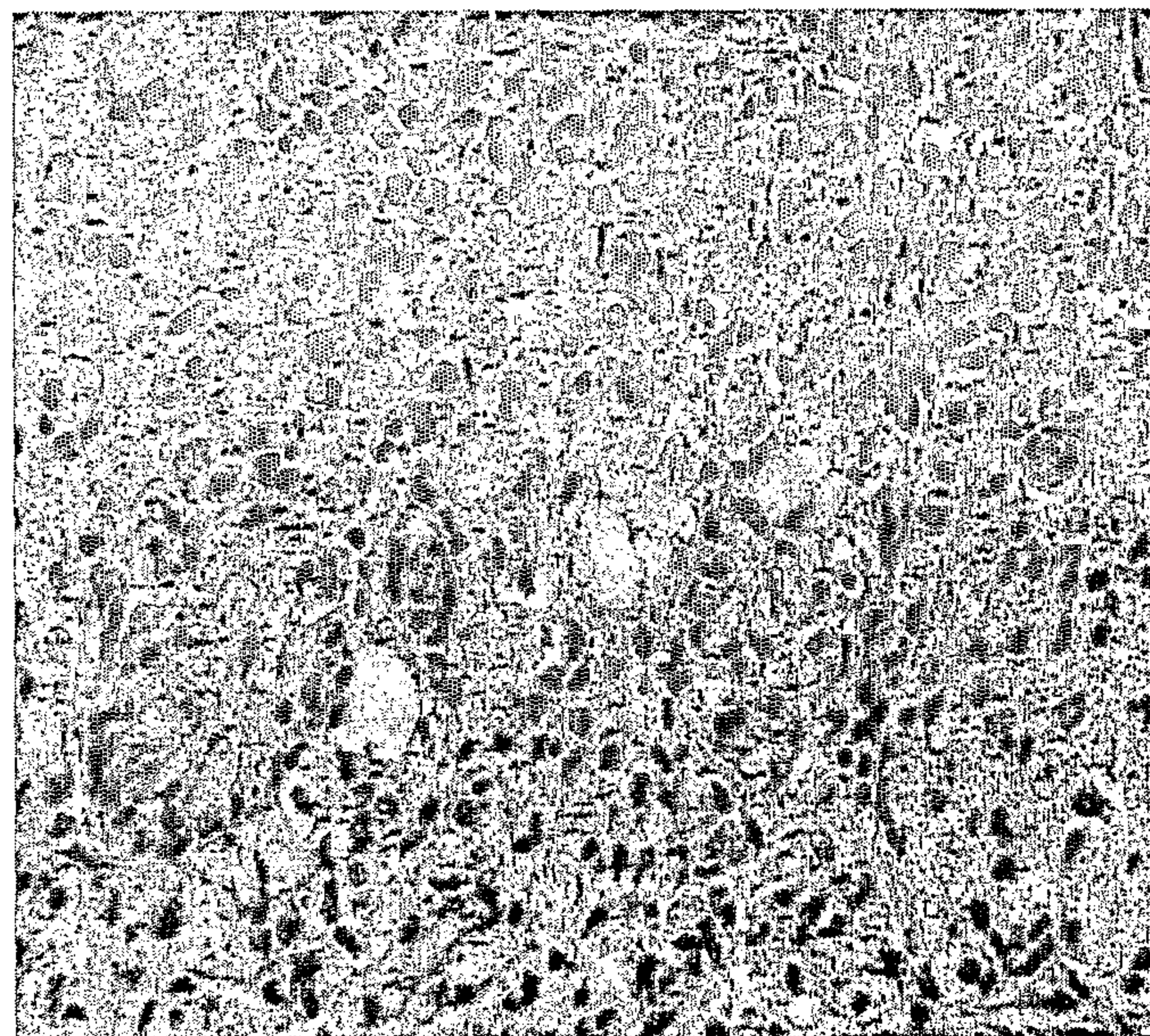

FIG. 2D



FIG. 2E

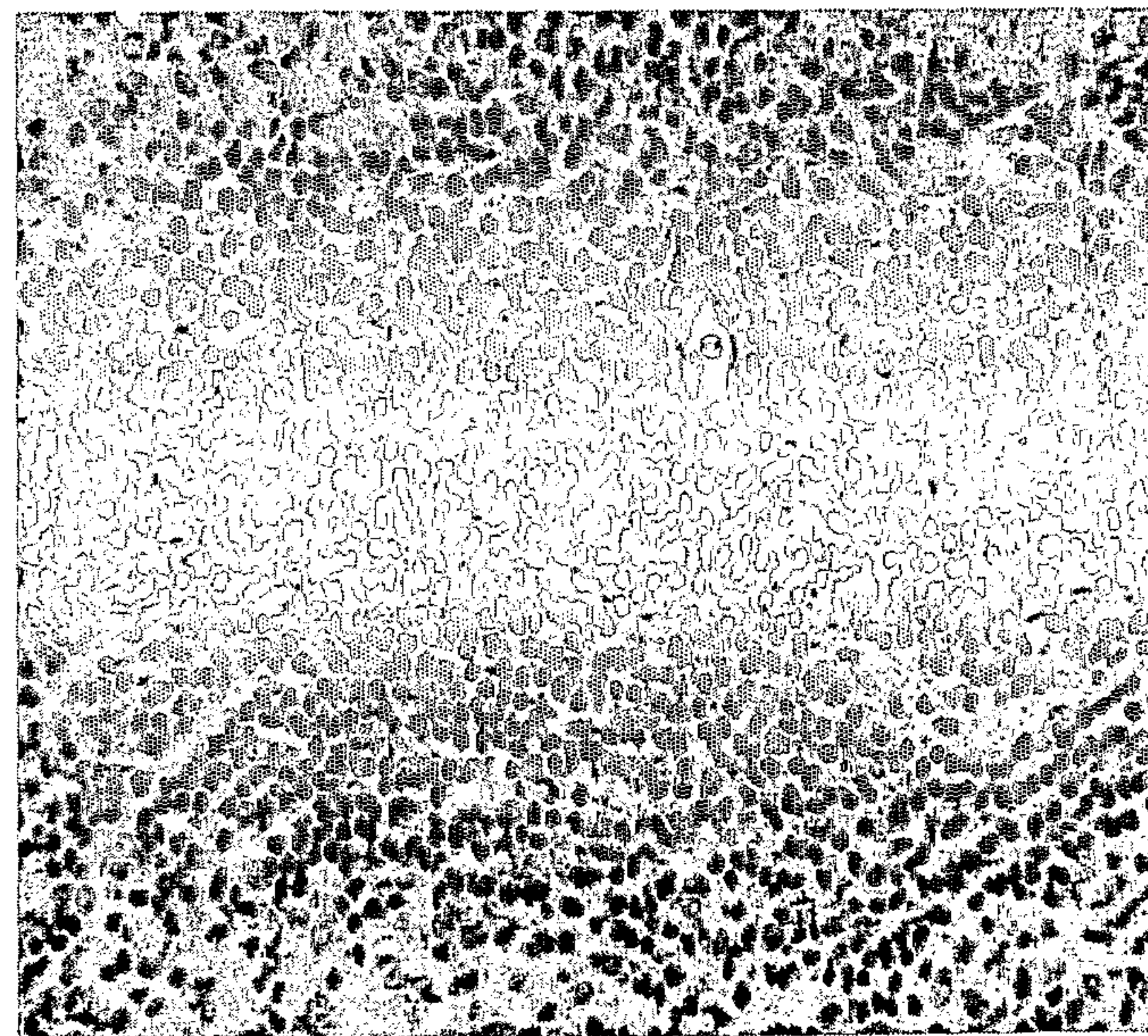

FIG. 2F



FIG. 2G

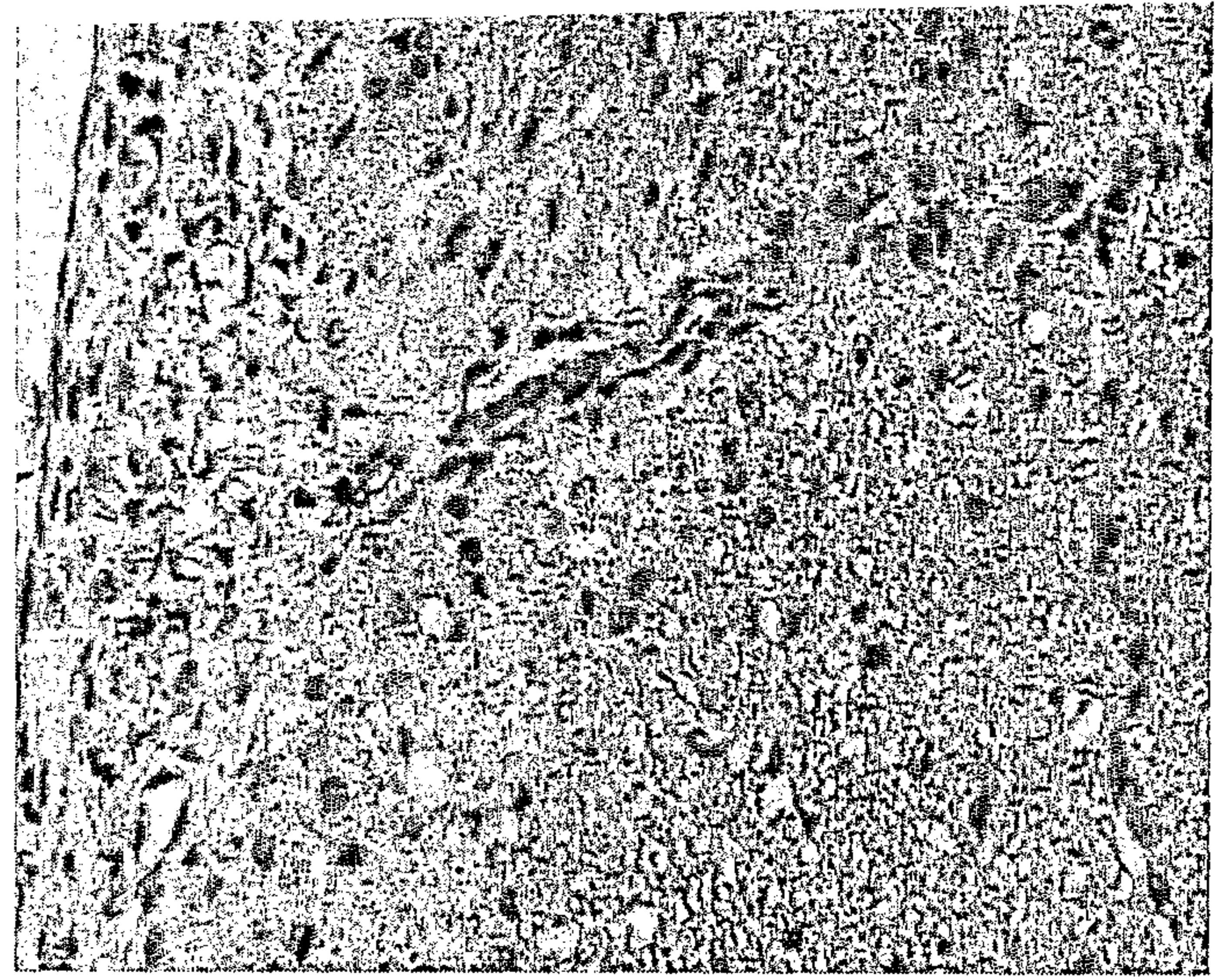

FIG. 2H

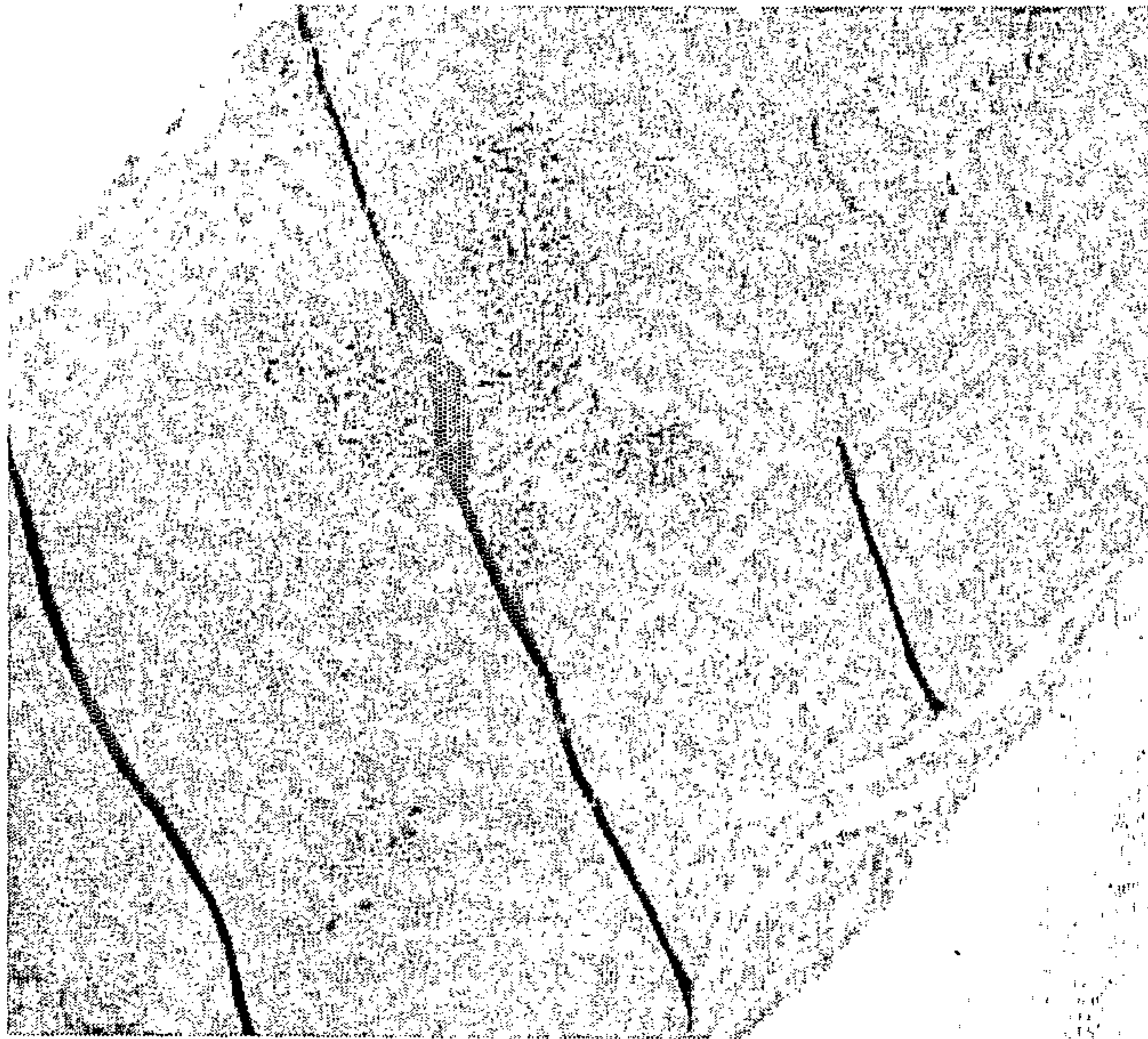

FIG. 2I

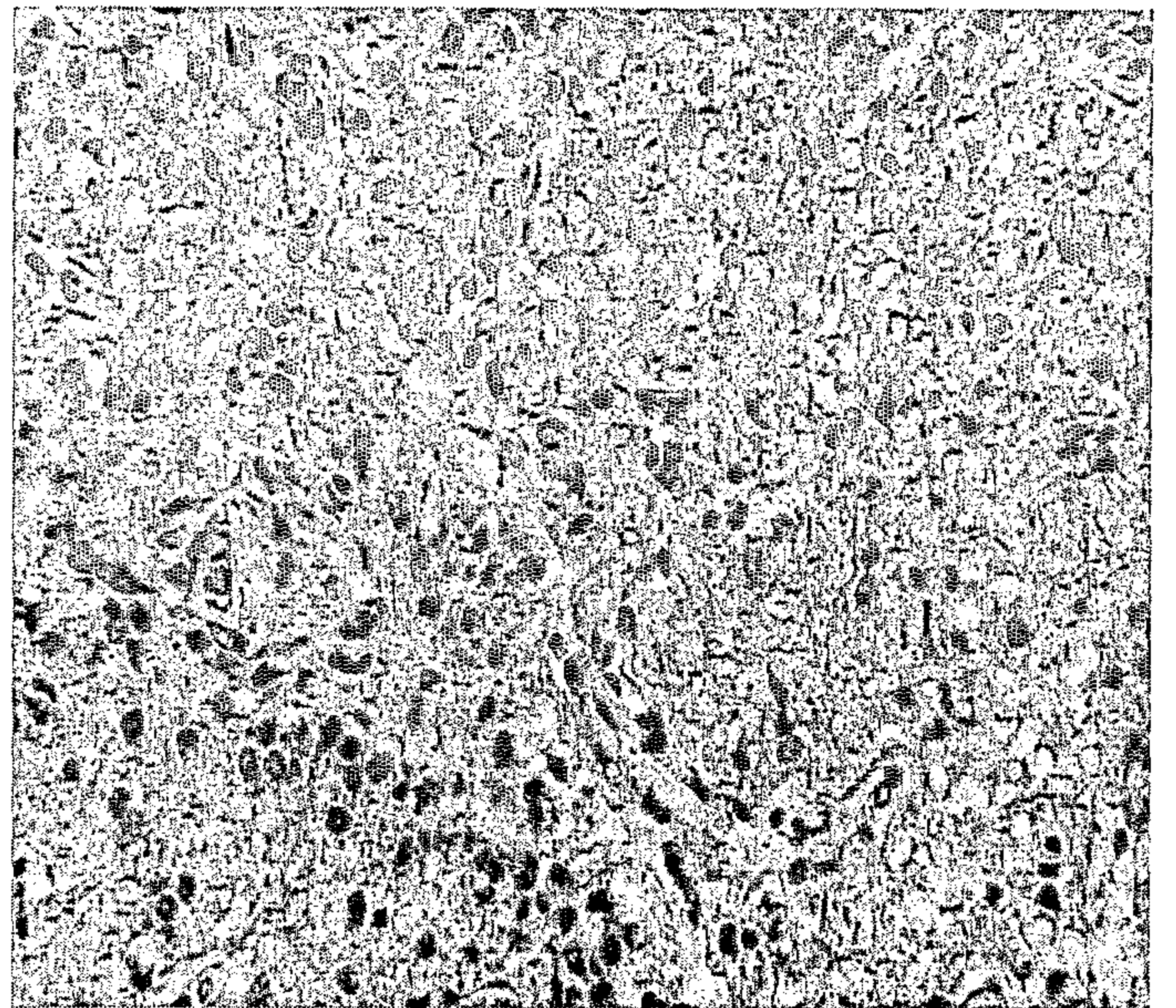

FIG. 2J



FIG. 2K

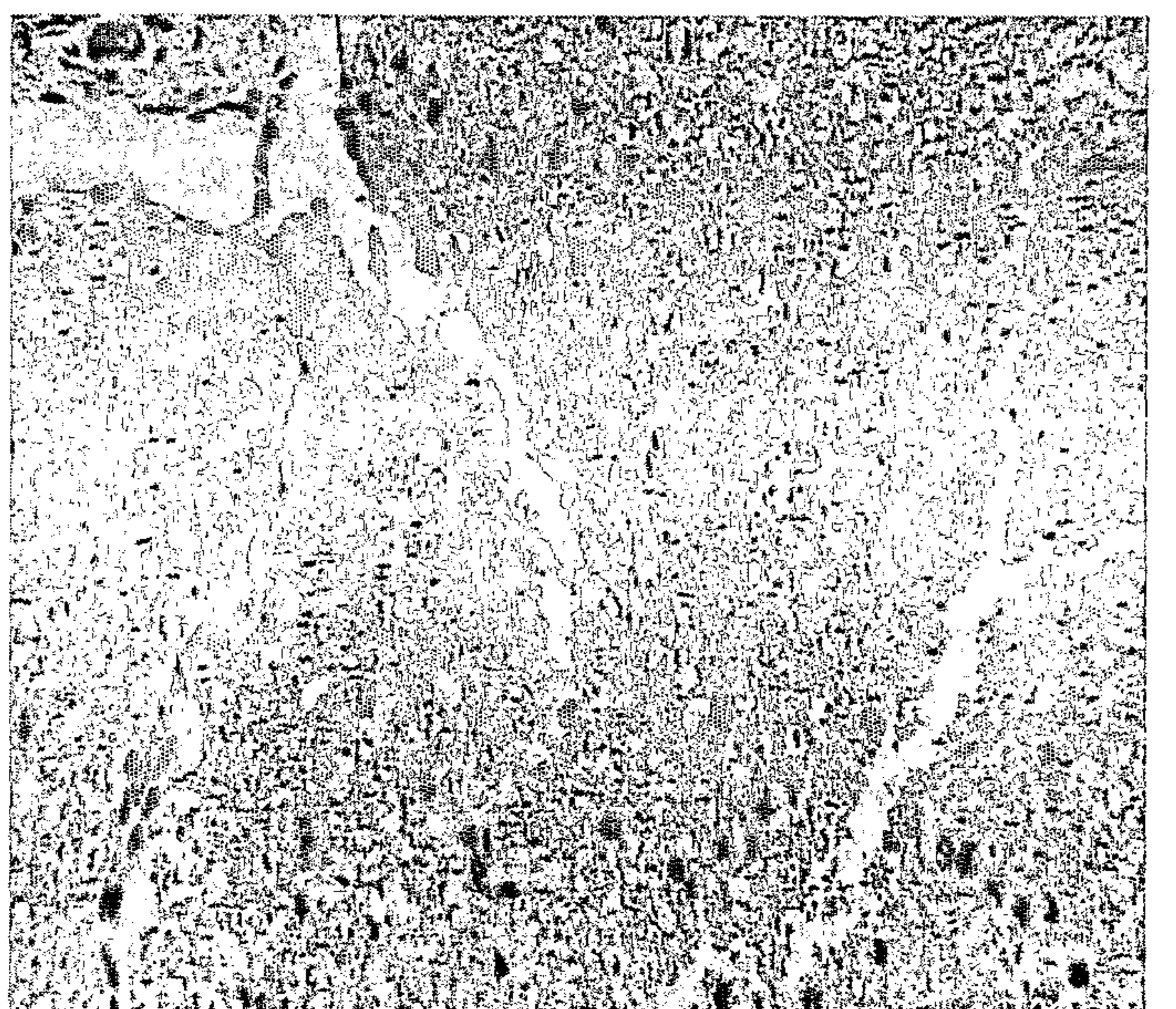
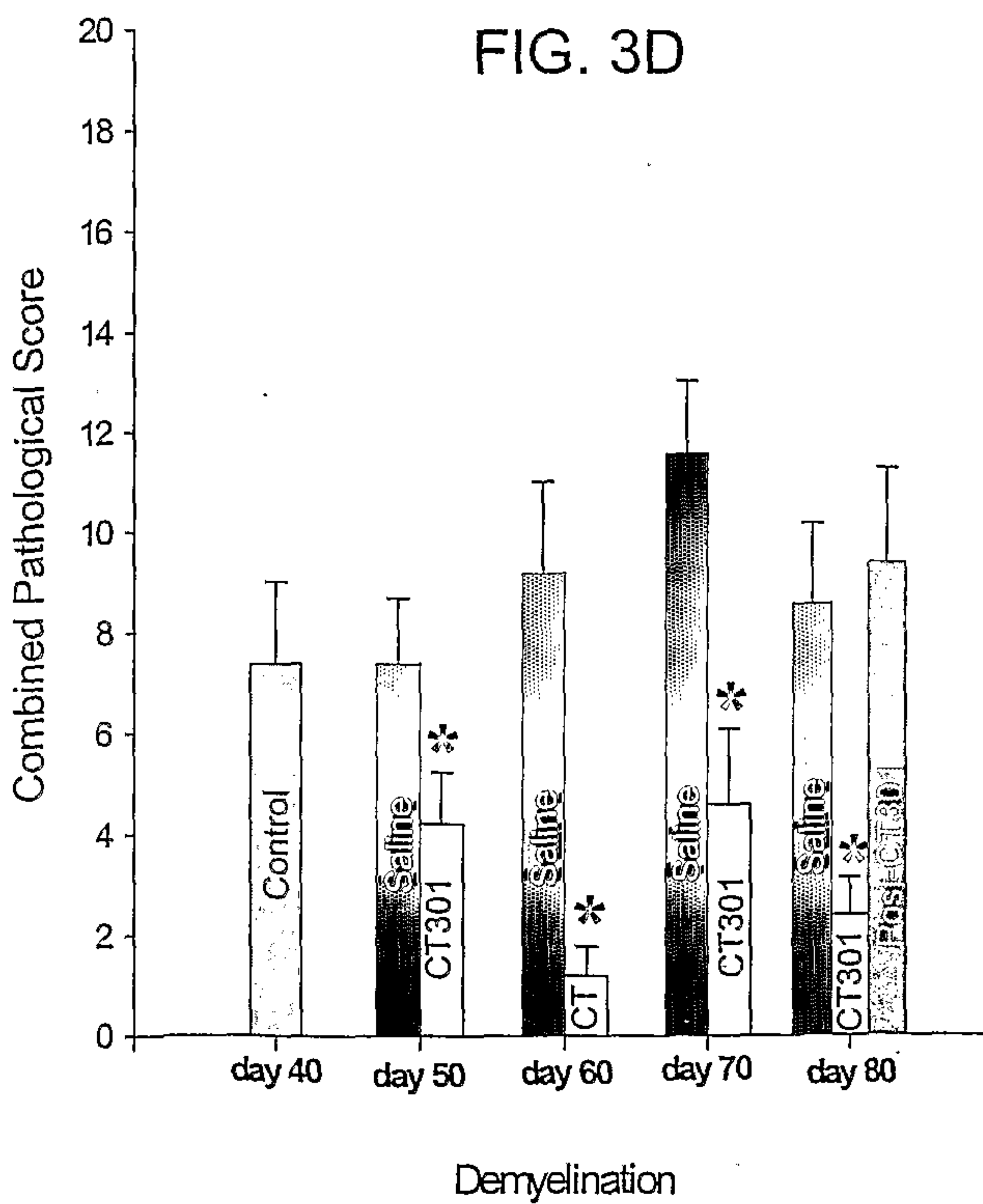
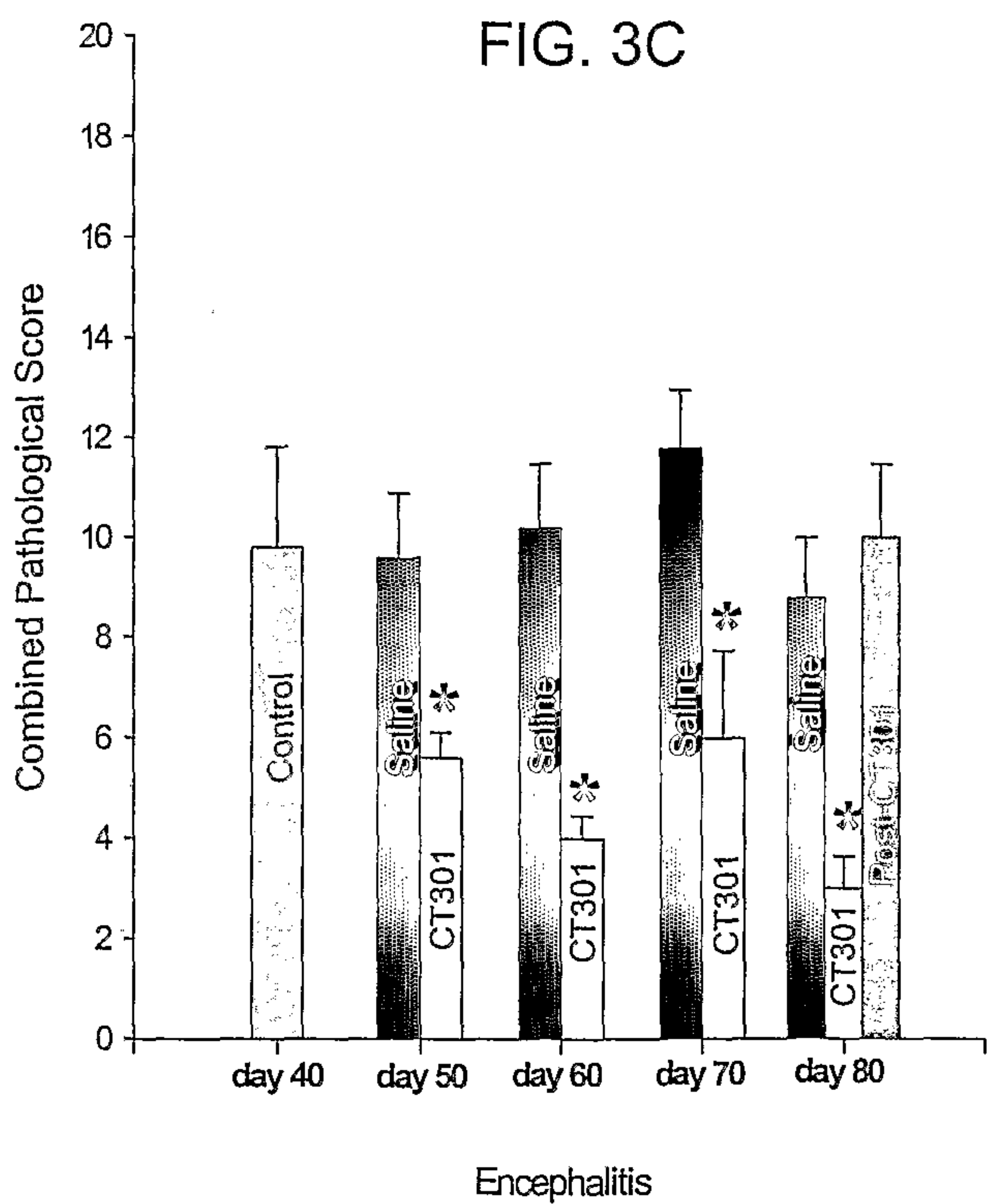
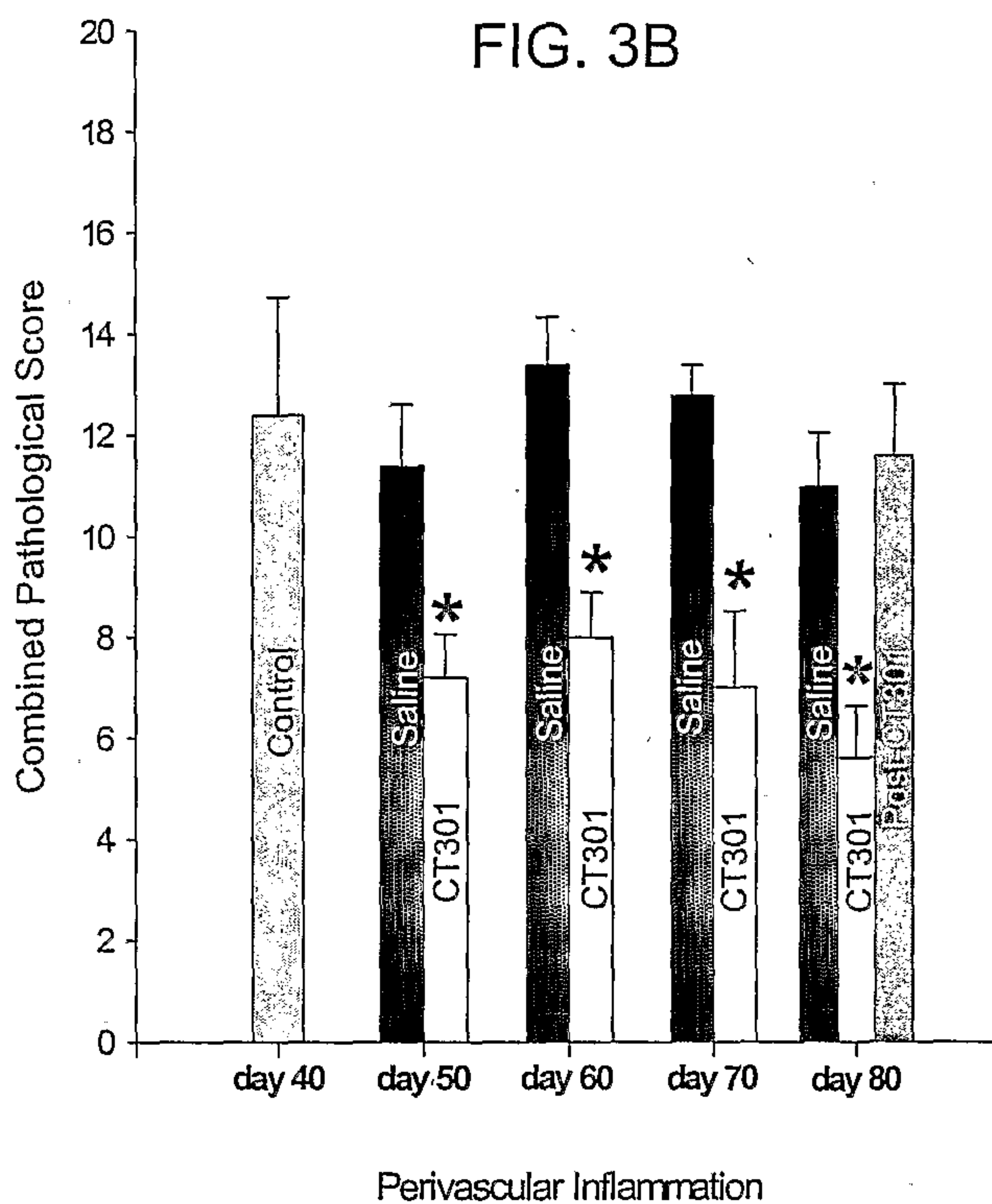
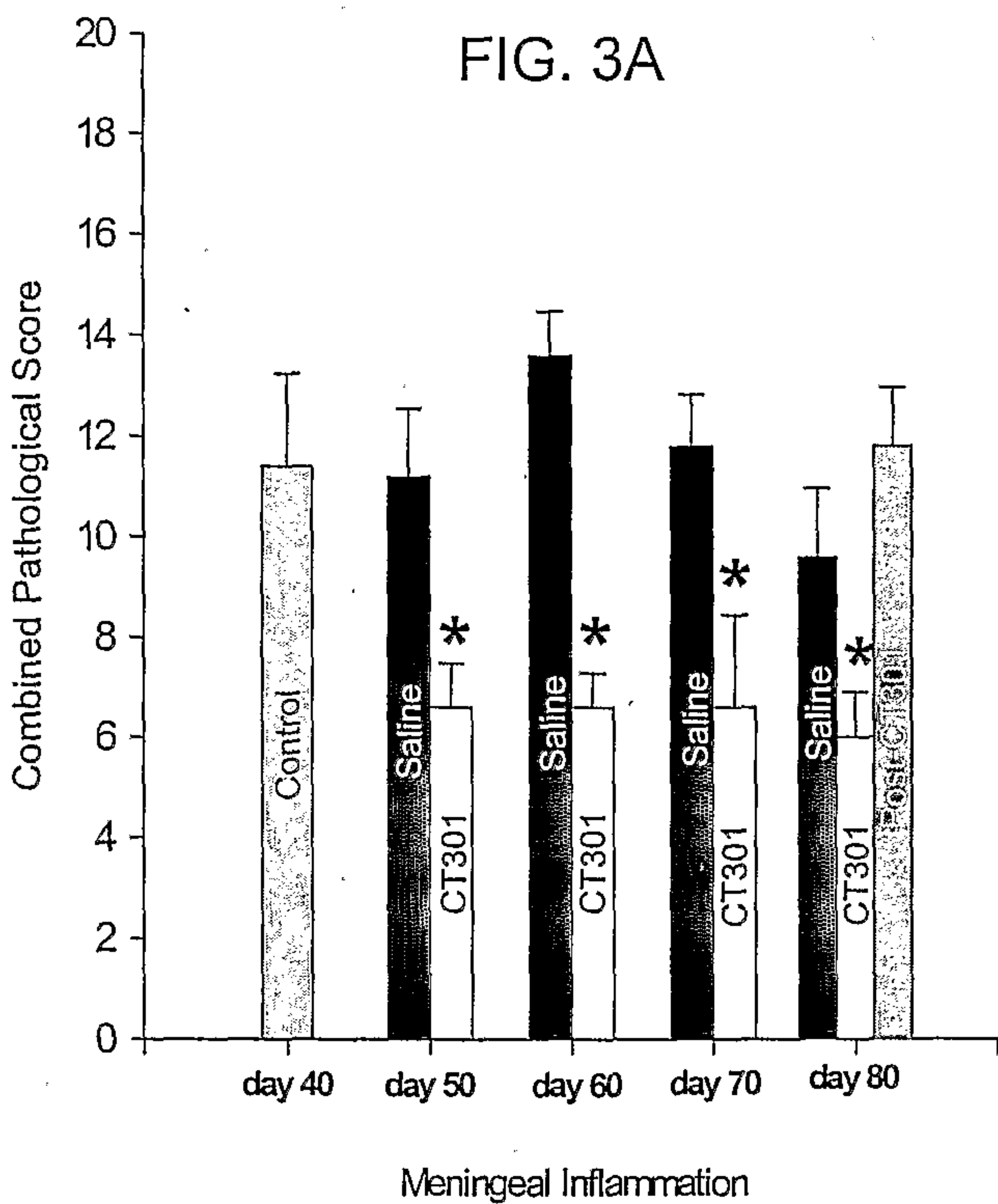

FIG. 2L



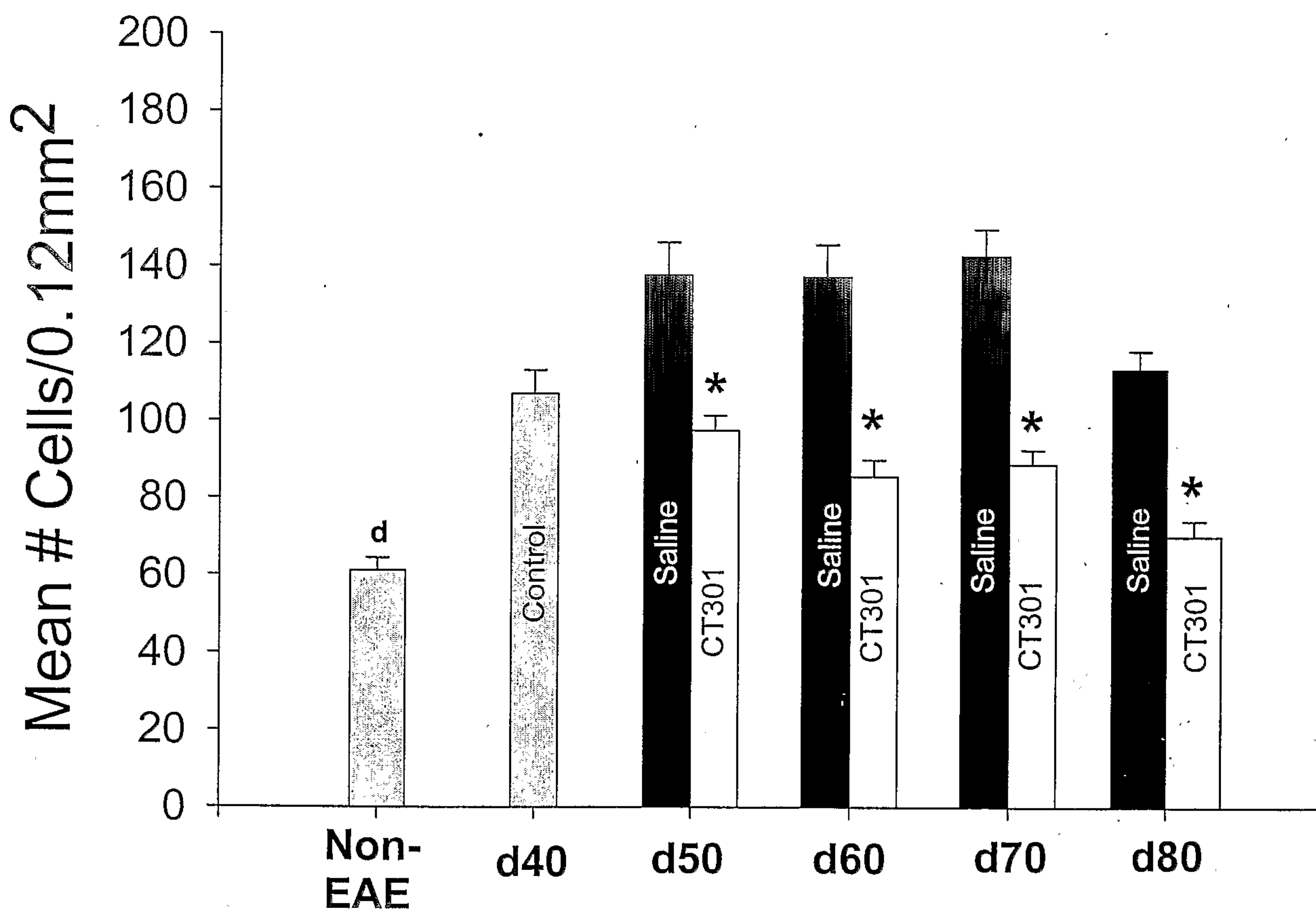
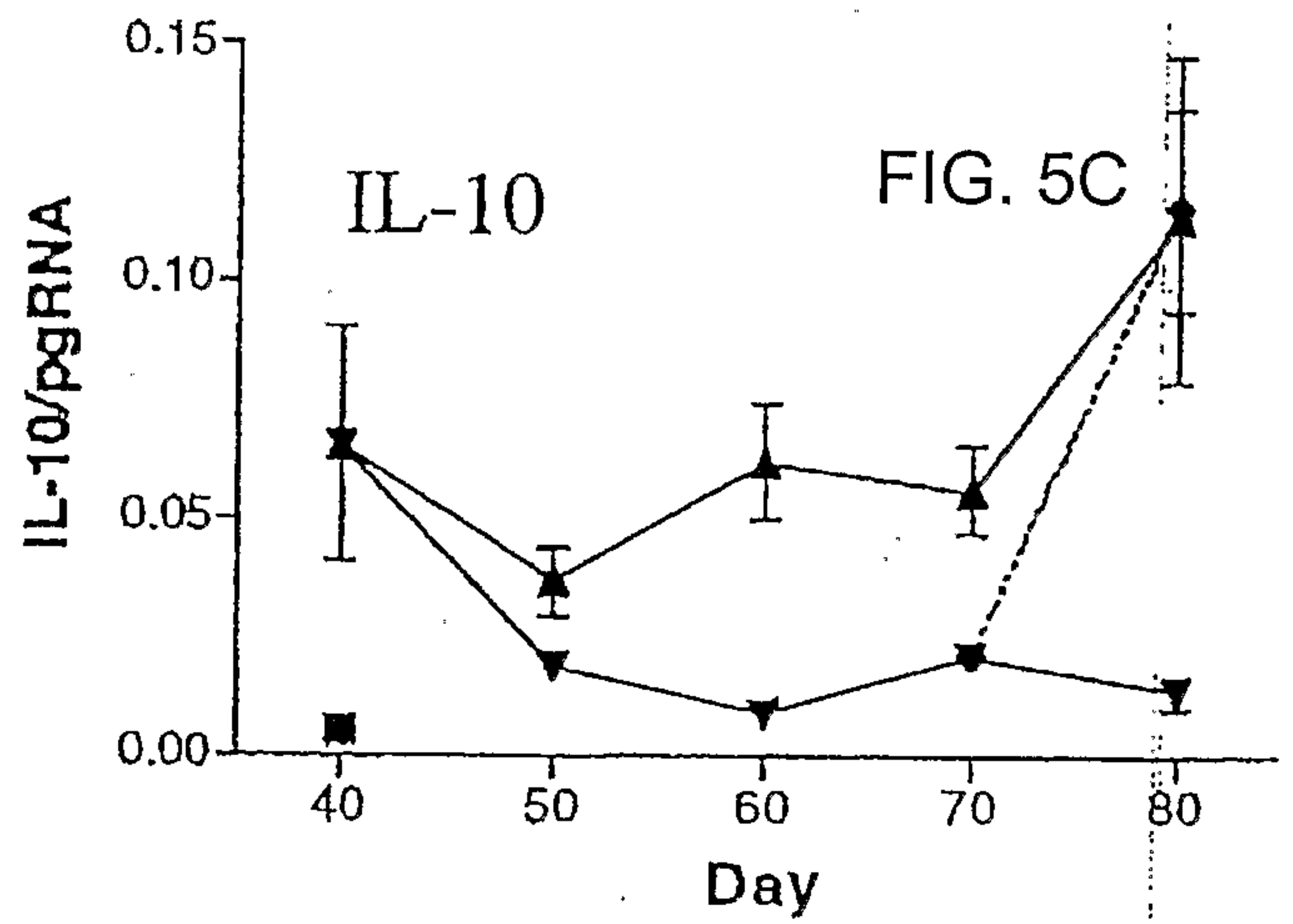
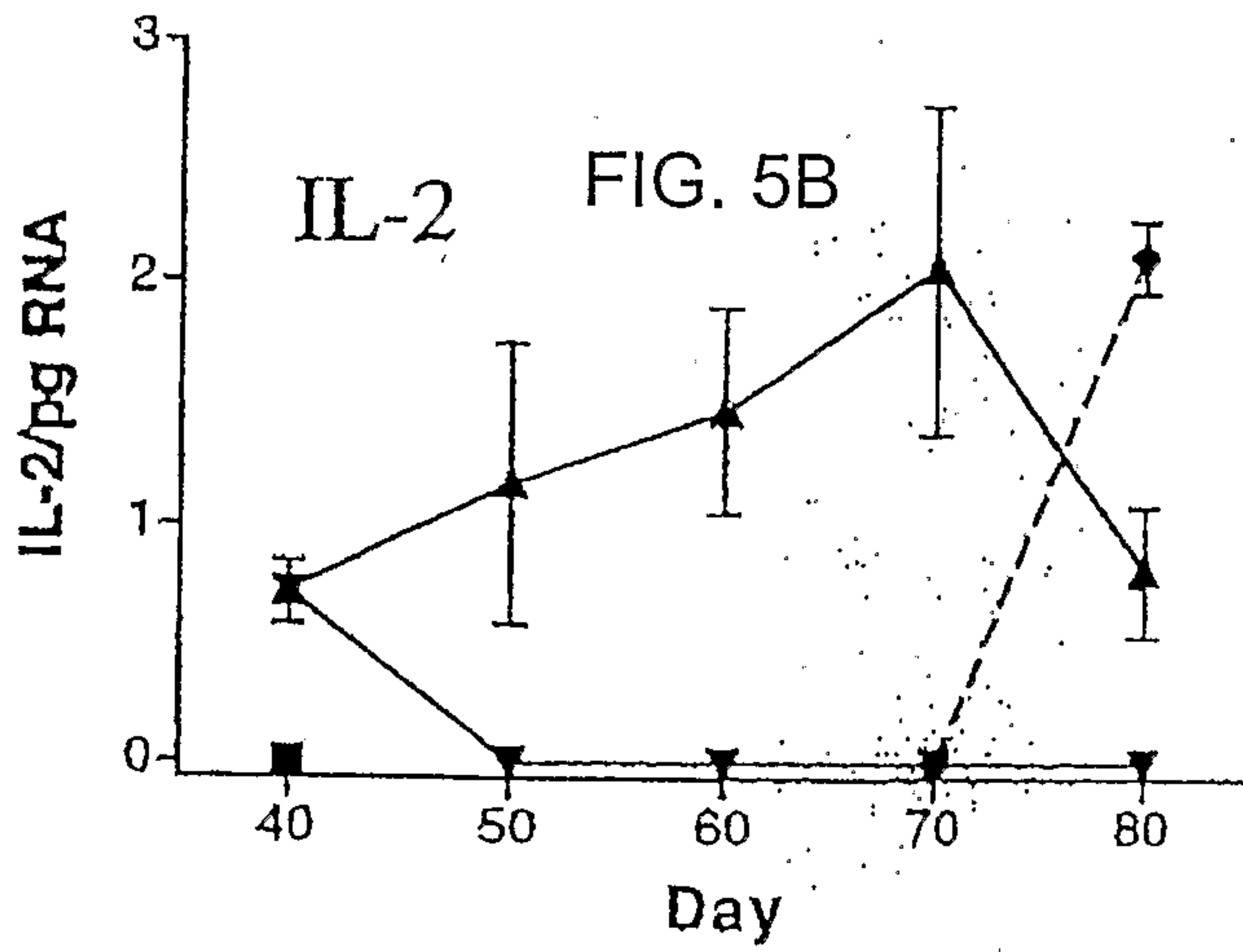
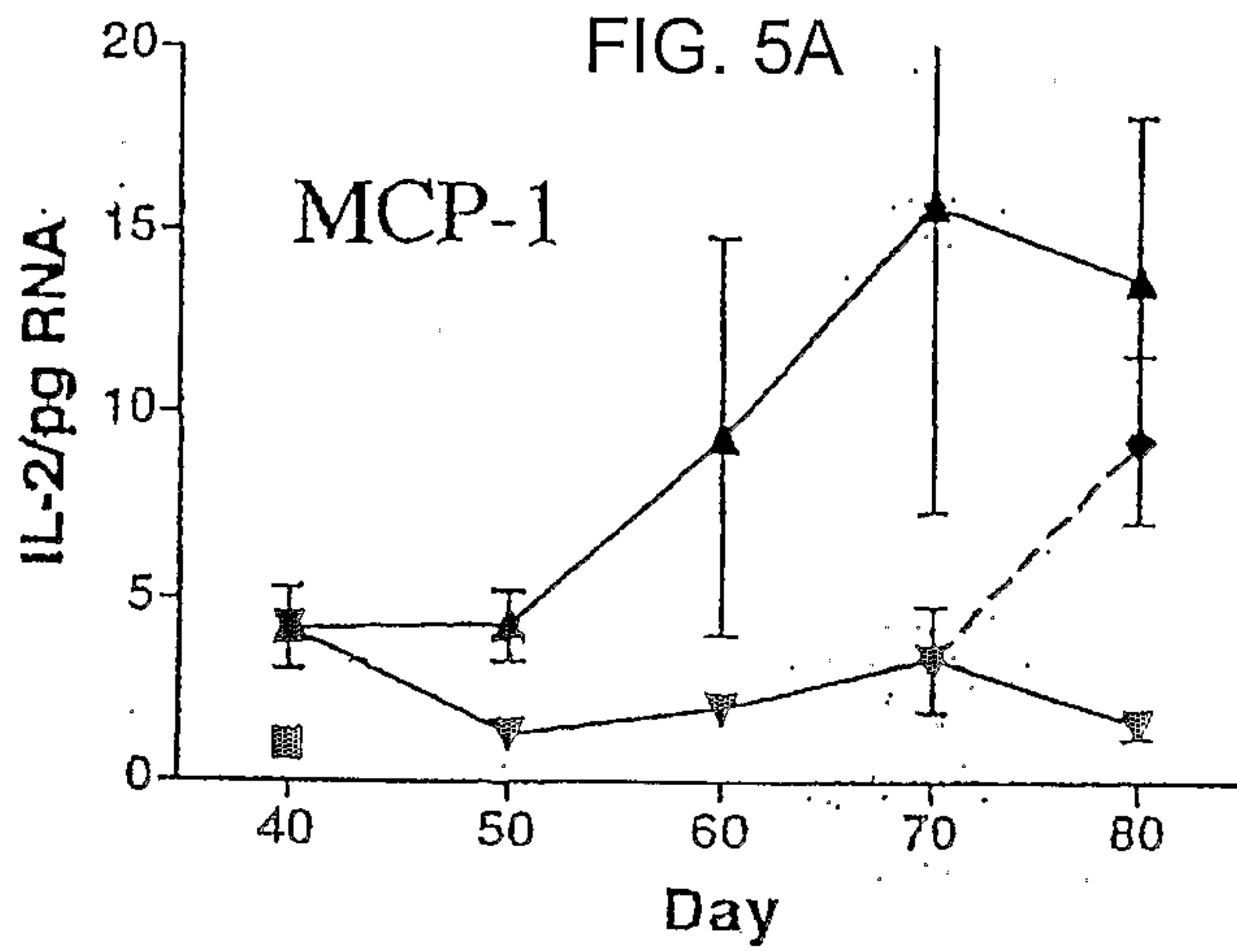
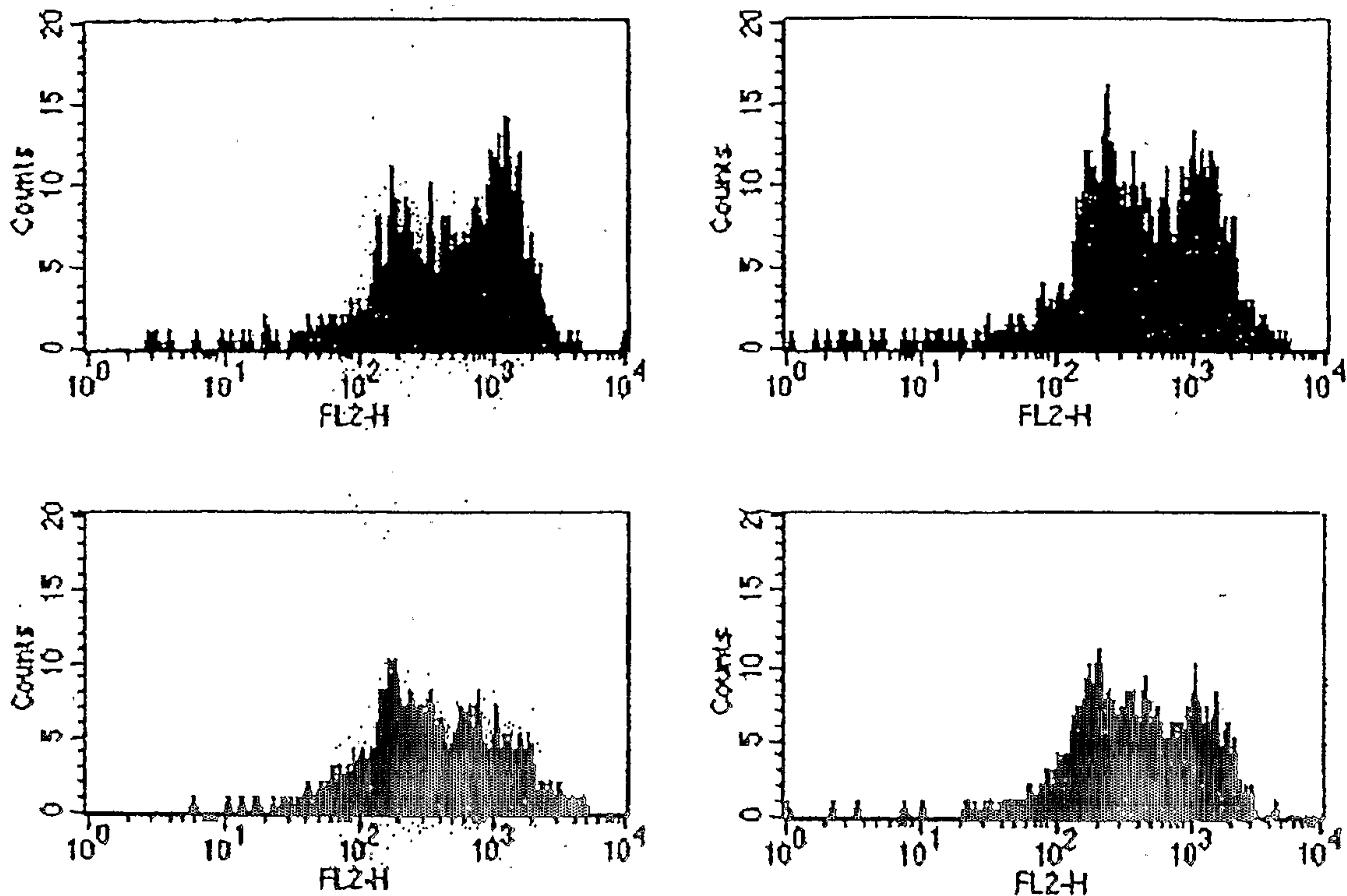

FIG. 4





Saline

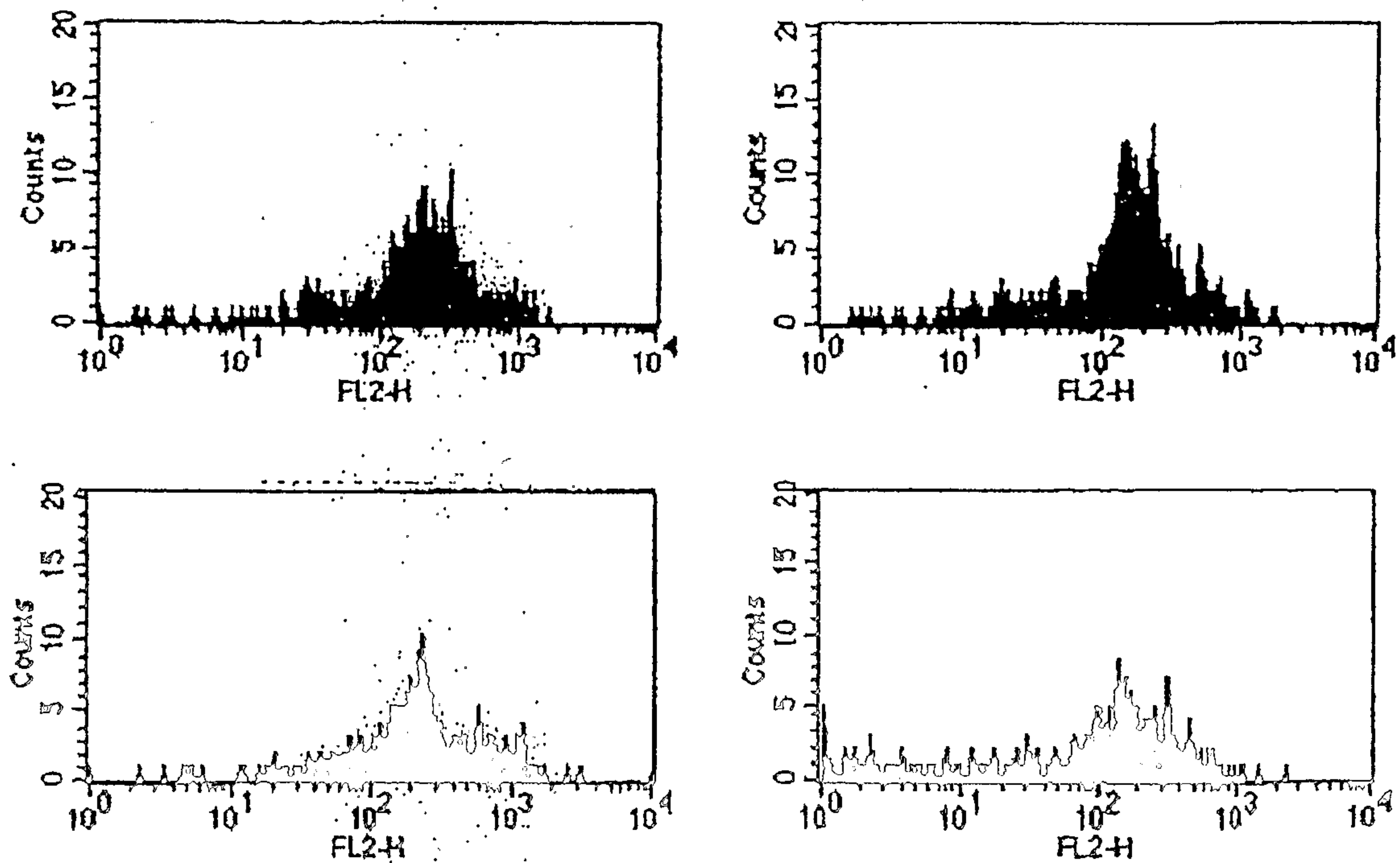

FIG. 6

Percentage $\alpha 4$ Integrin-High Blood Lymphocytes

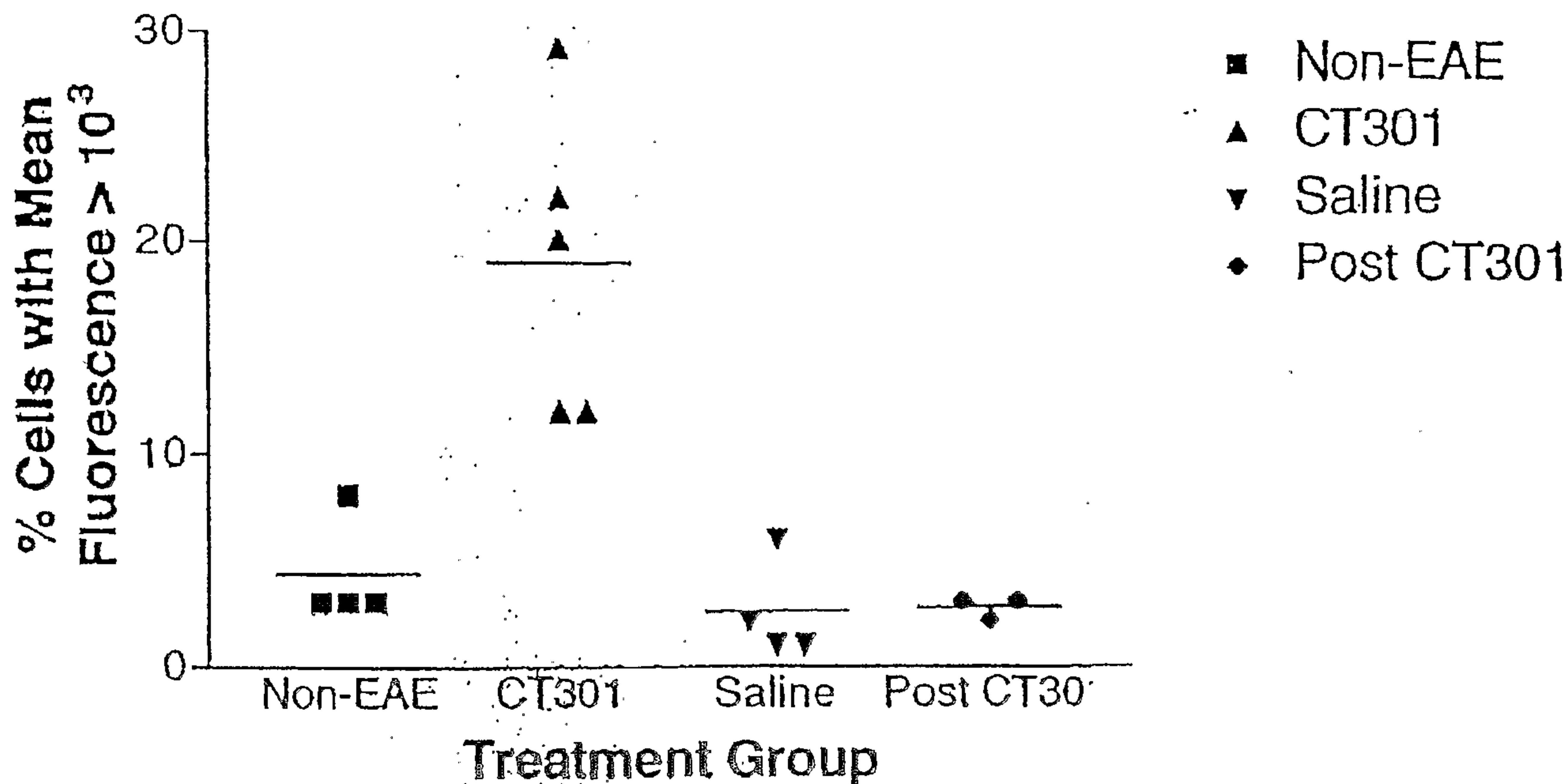

FIG. 7A

Expression of $\alpha 4$ Integrin on Blood Monocytes

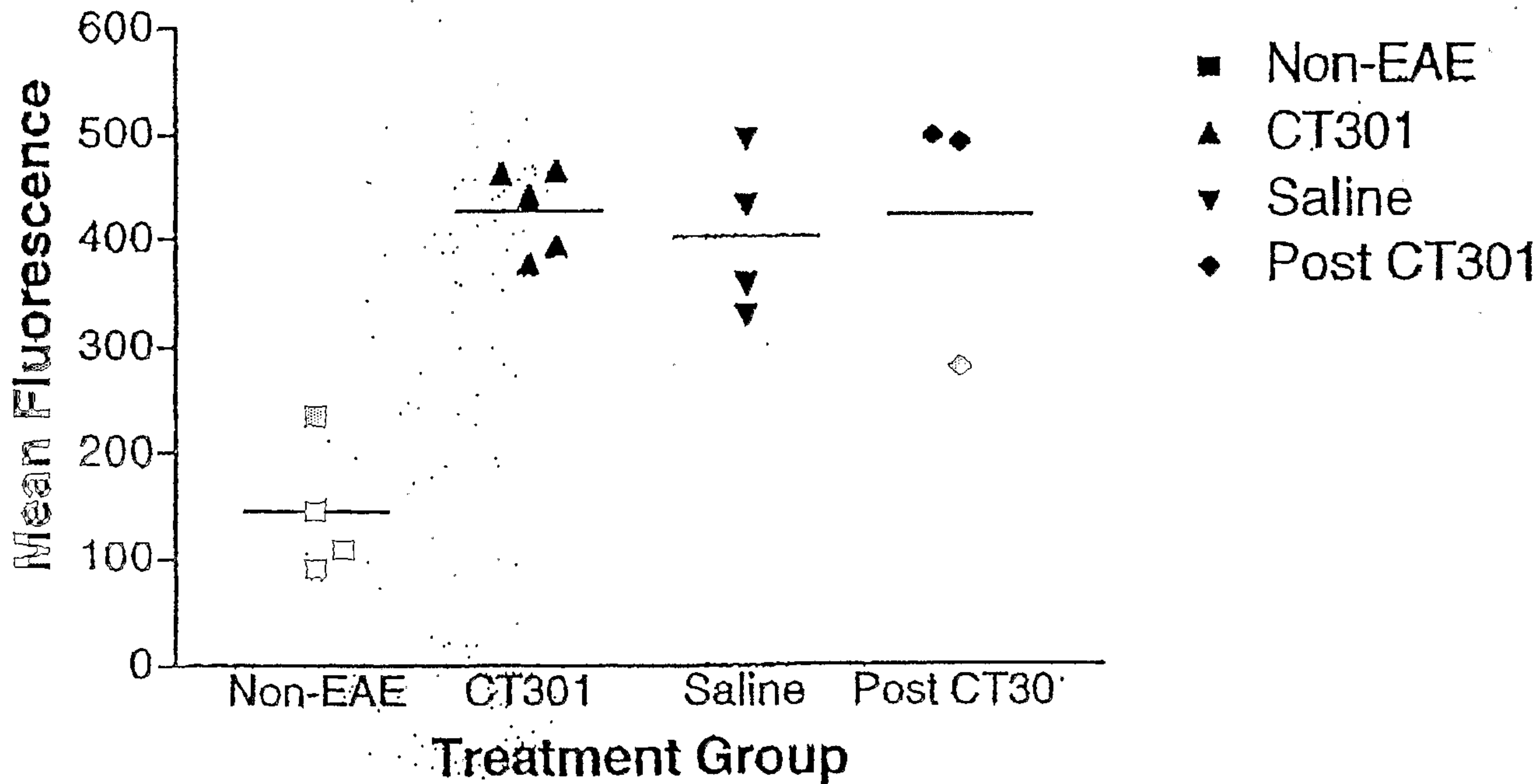

FIG. 7B

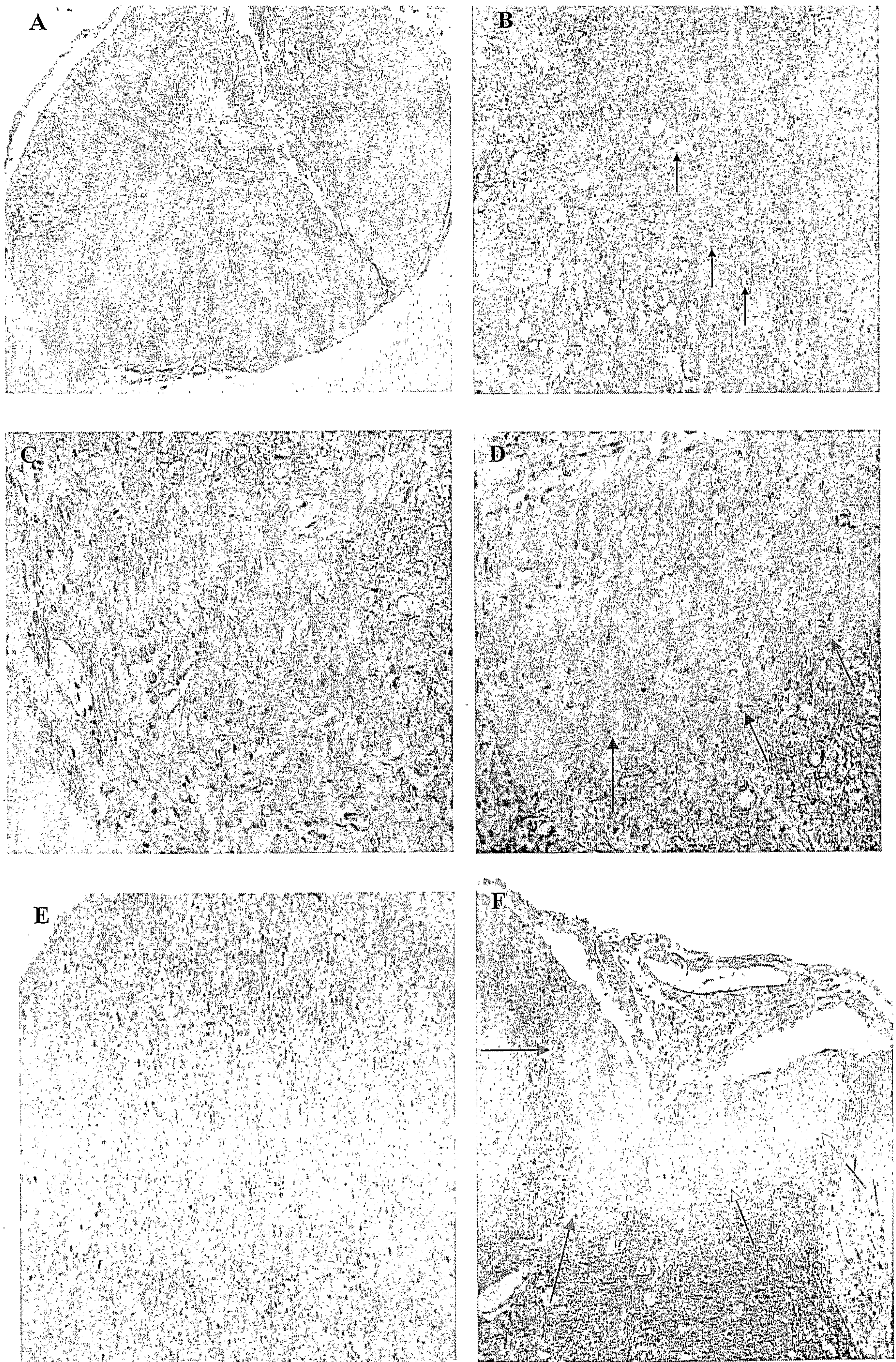

FIG. 8

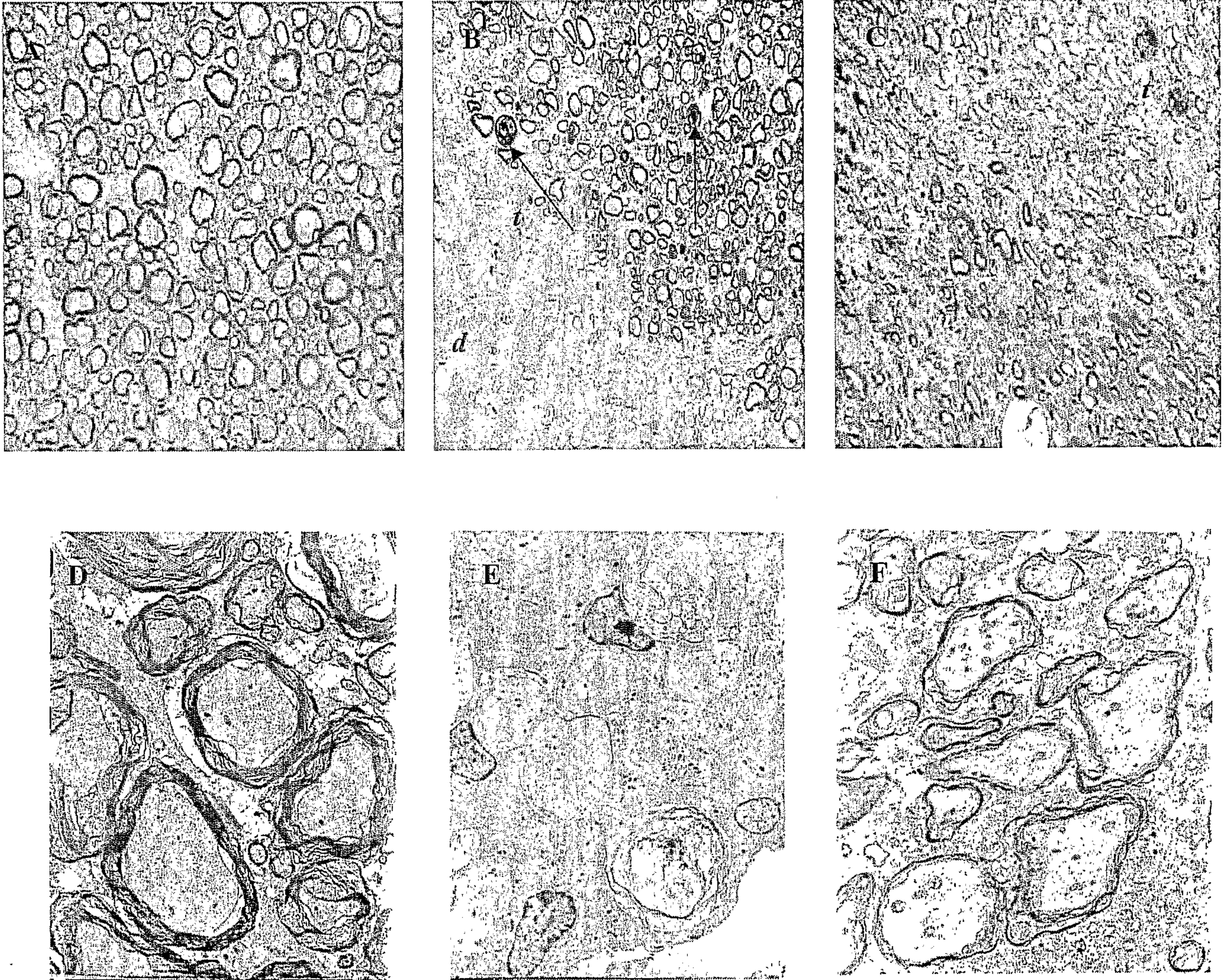

FIG. 9

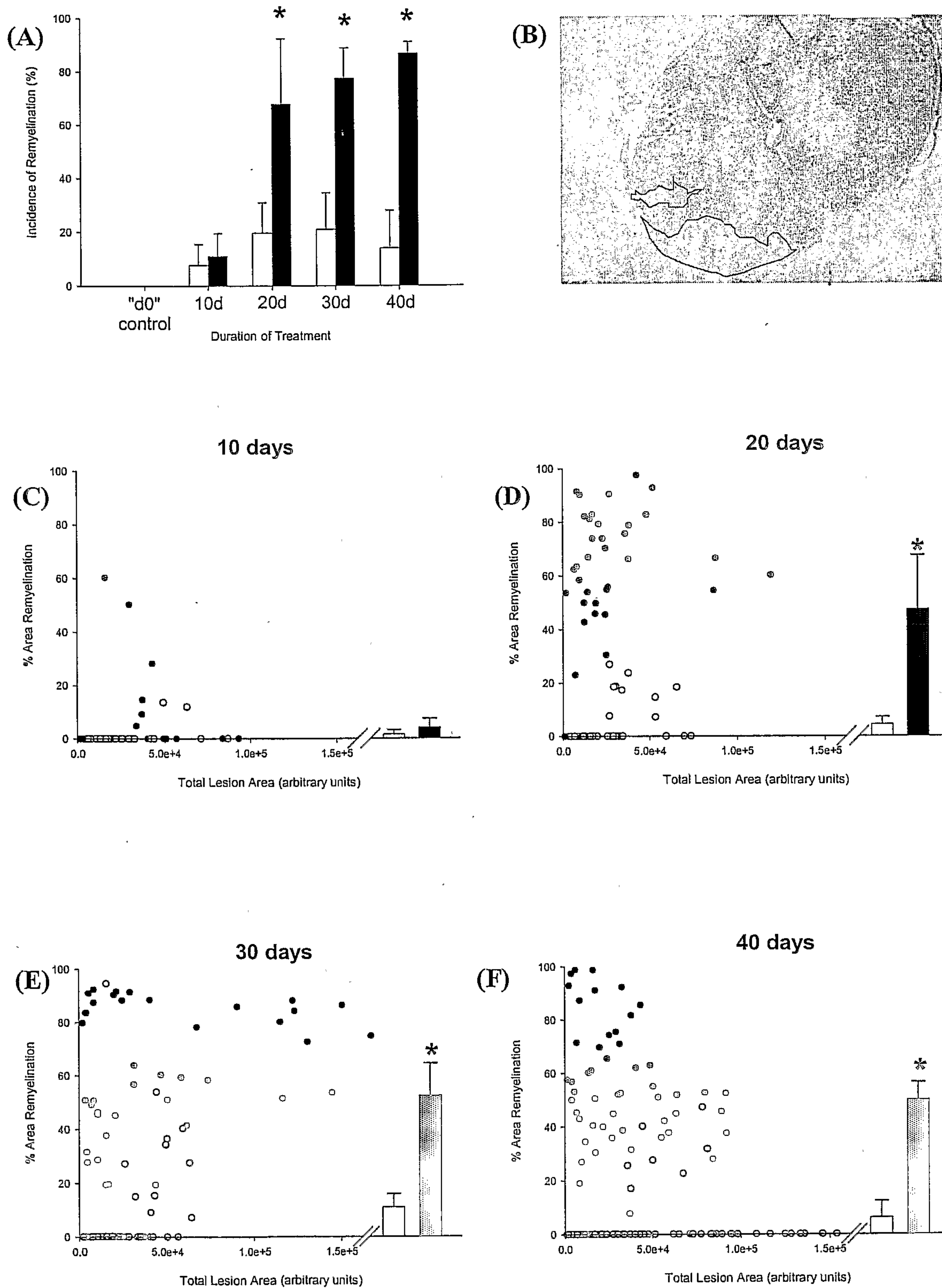

FIG. 10

atgagggccccctgctcagatTTTTGGattcttggtcaggagacgttgt
 1 -----
 tactcccggggacgagtctaaaaacctaagaaccagtcctctgcaaca

agaaatgagaccgtctattcagttcctggggctcttgttgttctggcttcatgg
 49 -----
 tctttactctggcagataagtcaaggaccccgagaacaacaagaccgaagtacc

[M R P S I Q F L G L L L F W L H G
 LEADER

tgctcagtgtagacatccagatgacacagttccatcctcactgtctgcatctct
 103 -----
 acgagtcacactgtaggtctactgtgtcagaggtaggagtgacagacgtagaga

A Q C][D I Q M T Q S P S S L S A S L
 FR1

gggaggcaaagtcaccatcacttgcaagacaagccaagacattaacaagtatat
 157 -----
 cctccgtttcagtggttagtgaacgttctgttcggttctgtaattgttcatata

G G K V T I T C][K T S Q D I N K Y M
 CDR1

ggcttggtaccaacacaagcctggaaaacgtcctaggctgctcatacattacac
 211 -----
 ccgaaccatggttgtgttcggaccttttgcaggatccgacgagtatgtaatgtg

A][W Y Q H K P G K R P R L L I H][Y T
 FR2

atctgcattacagccaggcatcccatcaaggttcagtggaagtgggtctgggag
 265 -----
 tagacgtaatgtcgggtccgtagggtagttccaagtcaccttcacccagaccctc

S A L Q P][G I P S R F S G S G S G R
 CDR2

FIG. 11 A

319 agattattccttcaacatcagcaacctggagcctgaagatattgcaacttatta

 tctaataaggaagttgtagtcggtggacctcggacttctataacggttgaataat

D Y S F N I S N L E P E D I A T Y Y
 FR3

373 ttgtctacagtatgataatctgtggacggttcggtggaggcaccaagctggaaat

 aacagatgtcatactattagacacctgcaagccacctccgtgggttcgaccttta

C][L Q Y D N L W T][F G G G T K L E I
 CDR3 FR4

427 caaacgggctgatgctgcaccaactgtatccatcttcccaccatccaccgga

 gtttgcccgactacgacgtgggtgacataggtagaagggtggtaggtgggcct

K]

AGG-5'

tcc

481 ---

agg

FIG. 11B

```

      atgaaatgcagctgggtcatgttcttcctgatggcagtggttacaggg
1  -----
      tactttacgtcgacccagttacaagaaggactaccgtcaccaatgtccc

      [M K C S W V M F F L M A V V T G
      LEADER

      gtcaattcagaggttcagctgcagcagctctggggcagagcttgtgaagccaggg
49 -----
      cagttaagtctccaagtcgacgtcgtcagaccccgctctcgaacacttcggtccc

      V N S][E V Q L Q Q S G A E L V K P G
      FR1

      gcctcagtcagttgtcctgcacagcttctggcttcaacattaaagacacctat
103 -----
      cggagtcagttcaacaggacgtgtcgaagaccgaagttgtaatttctgtggata

      A S V K L S C T A S G F N I K][D T Y
      CDR1

      atacactgtgtgaagcagaggcctgaacagggcctggagtgattggaaggatt
157 -----
      tatgtgacacacttcgtctccggacttgtcccggacctcacctaaccttcctaa

      I H][C V K Q R P E Q G L E W I G][R I
      FR2

      gatcctgcgaatggttataactaaatatgacccgaagttccagggcaaggccact
211 -----
      ctaggacgcttaccaatatgatttatactgggcttcaaggtcccgttccggtga

      D P A N G Y T K Y D P K F Q G][K A T
      CDR2

      ataacagctgacacatcctccaacacagcctacctgcagctcagcagcctgaca
265 -----
      tattgtcgactgtgtaggagggttgtgtcggatggacgtcgagtcgtcggactgt

      I T A D T S S N T A Y L Q L S S L T
      FR3

```

FIG. 12A

319 tctgaggacactgccgtctatctgtgctagagagggatattatggtaactac

agactcctgtgacggcagataaagacacgatctctccctataataaccattgatg
S E D T A V Y F C A R][E G Y Y G N Y
CDR3

373 ggggtctatgctatggactactgggggtcaaggaacctcagtcaccgtctcctca

ccccagatacagatacctgatgaccccagttccttggagtcagtggcagaggagt
G V Y A M D Y][W G Q C T S V T V S S]

427 gccaaaacgacacccccatctgtctatccactggcccgggatcc

cggttttgctgtgggggtagacagataggtgaccgggcccctagg
S S]

FIG. 12B

	FR1	CDR1	FR2	CDR2
	1	2	3	4
	5	6	7	8
	12345678901234567890123	45678901234	567890123456789	0123456
	*	*****	*	***
21.6	DIQMTQSPSSLSASLGKVTITC	KTSQDINKYMA	WYQHKPGKRPRLLIH	YTSALQP
REI	DIQMTQSPSSLSASVGDRVTITC	QASQDIKYLN	WYQQTPGKAPKLLIY	EASNLQA
La	DIQMTQSPSSLSASVGDRVTITC	KTSQDINKYMA	WYQQTPGKAPRLLIH	YTSALQP
Lb	-----R-----			

	FR3	CDR3	FR4
	6	7	8
	9	10	11
	78901234567890123456789012345678	901234567	8901234567
	*	*	*****
21.6	GIPSRFSGSGSGRDISFNISNLEPEDIATYYC	LQYDNL-WT	FGGGTKLEIK
REI	GVPSRFSGSGSGTDYFTISSLQPEDIAATYYC	QQYQSLPYT	FGQGTKLQIT
La	GIPSRFSGSGSGRDISFNISNLEPEDIATYYC	LQYDNL-WT	FGQGTKVEIK
Lb	-I-----R-----VE-K		

FIG. 13

	FR1			CDR1	FR2			CDR2		
	1	2	3	4	5	6				
	123456789012345678901234567890	12345678901234567890	1234567890	12345	67890123456789	012A3456789012345				
			*****	** *		****				
21.6	EVQLQQSGAELVKPGASVKLSCTASGFNIK			DTYIH	CVKQRPEQGLEWIG	RIDPANGYTKYDPKFQG				
2*CL	QVQLVQSGAEVKKPGASVKVSCKASGYTFT			SYAMH	WVRQAPGQRLEWVG	WINAGNGNTKYDQKFQG				
Ha	QVQLVQSGAEVKKPGASVKVSCKASGFNIK			DTYIH	WVRQAPGQRLEWMB	RIDPANGYTKYDPKFQG				
Hb	-----			FNIK	-----	G-----				
Hc	-----			FNIK	-----	-----				

	FR3			CDR3	FR4		
	7	8	9	10		11	
	67890123456789012ABC345678901234	567890ABCDEF12	34567890123				
	*		*				
21.6	KATITADTSSNTAYLQLSSLTSEDVAVYFCAR			EGYYGNYGVYAMDY	WGQGTSVTVSS		
2*CL	RVTITRDTSASTAYMELSSLRSEDVAVYYCAR			GGYYGSGS----	NY WGQGTLVTVSS		
Ha	RVTITADTSASTAYMELSSLRSEDVAVYYCAR			EGYYGNYGVYAMDY	WGQGTLVTVSS		
Hb	-----A-----			-----	-----		
Hc	-----A-----			-----F-----	-----		

FIG. 14

HindIII KOZAK SEQUENCE

aagcttgcccgccaccatgagaccgctcattcagttcctggggctcttggtgttc
 1 -----
 ttcgaacggcggtggtactctggcagataagtcaaggaccccggagaacaacaag

 [M R P S I Q F L G L L L F
 LEADER

 tggcttcatgggtgctcagtggtgacatccagatgacacagtcctccatcctcactg
 55 -----
 accgaagtaccacgagtcacactgtaggtctactgtgtcagaggtaggagtgac

 W L H G A Q C][D I Q M T Q S P S S L
 FR1

 tctgcatctGTAggaGATAGagtcaccatcacttgcaagacaagccaagacatt
 109 -----
 agacgtagaCATcctCTATCTcagtggttagtgaacgttctgttcggttctgtaa

 S A S V G D R V T I T C][K T S Q D I
 CDR1

 aacaagtatatggcttggtaccaaCAGACAcctggaaaaGCTcctaggctgctc
 163 -----
 ttgttcatataaccgaaccatgggtGTCTGTggaccttttCGAggatccgacgag

 N K Y M A][W Y Q Q T P G K A P R L L
 FR2

 atacattacacatctgcattacagccaggcatcccatcaagggtcagtggaagt
 217 -----
 tatgtaatgtgtagacgtaatgtcggtccgtagggtagttccaagtcaccttca

 I H][Y T S A L Q P][G I P S R F S G S
 CDR2

 gggctctgggagagattataCTttcACCatcagcAGCctgCAGcctgaagatatt
 271 -----
 cccagaccctctctaataTGAAagTGGtagtcgTCGgacGTCggacttctataa

 G S F R D Y T F T I S S L Q P E D I
 FR3

FIG. 15A

gcaacttattattgtctacagtatgataatctgtggacggtcCAAggcacc
 325 -----
 cgttgaataataaacagatgtcatactattagacacctgcaagccaGTTccgtgg

 A T Y Y C][L Q Y D N L W T][F G Q G T
CDR3FR4

SPLICE DONOR SITE BamHI
 aagGTGgaaatcaaaccgtgagtgatcc
 379 -----
 ttcCACcttttagtttgcactcacctagg

 K V E I K]

FIG. 15B

HindIII KOZAK SEQUENCE
 AAGCTTGCCGCCACCATGGACTGGACCTGGCGCGTGTTTTGCCTGCTCGCCGTG
 1 -----
 TTCGAACGGCGGTGGTACCTGACCTGGACCGCGCACAAAACGGACGAGCGGCAC
 [M D W T W R V F C L L A V
 LEADER
 GCTCCTGGGGCCCACAGCCAGGTGCAACTAGTGCAGTCCGGCGCCGAAGTGAAG
 55 -----
 CGAGGACCCCGGGTGTCTGGTCCACGTTGATCACGTCAGGCCGCGGCTTCACTTC
 A P G A H S][Q V Q L V Q S G A E V K
 AAACCCGGTGCTTCCGTGAAAGTCAGCTGTAAAGCTAGCGGTttcaacattaaa
 109 -----
 TTTGGGCCACGAAGGCACTTTCAGTCGACATTTTCGATCGCCAaagttgtaattt
 K P G A S V K V S C K A S G F N I K][
 FR1
 gacacctatatacacTGGGTTAGACAGGCCCCctGGCCAAaGGCTgGAGTGGATg
 163 -----
 ctgtggatataatgtgACCCAATCTGTCCGGgGaCCGGTTtCCGAcCTCACCTAc
 D T Y I H][W V R Q A P G Q R L E W M
 CDR1 FR2

FIG. 16A

217 G Gaaggattgatcctgcgaatggttataactaaatatgacccgaagttccagggc

 C Cttcctaactaggacgcttaccaatatgatttataactgggcttcaagggtcccg
 G][R I D P A N G Y T K Y D P K F Q G][
 CDR2

271 cgggtcACCatcACCgcaGACACCTCTgccagcACCGCCTACATGGAACTGTCC

 gcccagTGGtagTGGcgtCTGTGGAGAcggtcgTGGCGGATGTACCTTGACAGG
 R V T I T A D T S A S T A Y M E L S
 FR3

325 AGCCTGCGCTCCGAGGACACTGCAGTCTACTACTGCGCCagagagggatattat

 TCGGACGCGAGGCTCCTGTGACGTCAGATGATGACGCGGtctctccctataata
 S L R S E D T A V Y Y C A R][E G Y Y

379 ggtaactacgggggtctatgctatgGACTAcTGGGGtCAaGGaACCCTTGTCACC

 ccattgatgccccagatacagatacCTGATgACCCCaGtCCtTGGGAACAGTGG
 G N Y G V Y A M D Y][W G Q G T L V T
 CDR3 FR4

433 SPLICE DONOR SITE BamHI
 GTctccTCAGGTGAGTGGATCC

 CAGaggAGTCCACTCACCTAGG
 V S S]

FIG. 16B

(i) SEQUENCE CHARACTERISTICS:

(A) LENGTH: 109 amino acids

(B) TYPE: amino acid

(C) STRANDEDNESS: single

(D) TOPOLOGY: linear

(ii) MOLECULE TYPE: protein

N - Asp Ile Gln Met Thr Gln Ser Pro Ser Ser Leu Ser Ala Ser Leu Gly
Asp Arg Val Thr Ile Thr Cys Arg Ala Ser Gln Asp Asp Ile Ser Asn
Tyr Leu Asn Trp Tyr Gln Gln Lys Pro Gly Gly Ser Pro Lys Leu Leu
Ile Tyr Tyr Ala Ser Arg Leu His Ser Gly Val Pro Ser Arg Phe Ser
Gly Ser Gly Ser Gly Thr Asp Tyr Ser Leu Thr Ile Ser Asn Leu Glu
Gln Glu Asp Ile Ala Thr Tyr Phe Cys Gln Gln Gly Asn Thr Leu Pro
Pro Arg Thr Phe Gly Gly Gly Thr Lys Leu Glu Ile Lys - C

FIG. 17A

(i) SEQUENCE CHARACTERISTICS:

(A) LENGTH: 114 amino acids

(B) TYPE: amino acid

(C) STRANDEDNESS: single

(D) TOPOLOGY: linear

(ii) MOLECULE TYPE: protein

N - Asp Ile Gln Met Thr Gln Ser Pro Ser Ser Leu Ser Ala Ser Val Gly
Asp Arg Val Thr Ile Thr Cys Arg Ala Ser Gln Asp Ser Leu Val Xaa
Xaa Ser Ile Ser Asn Tyr Leu Asn Trp Tyr Gln Gln Lys Pro Gly Lys
Ala Pro Lys Leu Leu Ile Tyr Ala Ala Ser Ser Leu Glu Ser Gly Val
Pro Ser Arg Phe Ser Gly Ser Gly Ser Gly Thr Asp Phe Thr Leu Thr
Ile Ser Ser Leu Gln Pro Glu Asp Phe Ala Thr Tyr Tyr Cys Gln Gln
Tyr Asn Ser Leu Pro Glu Trp Thr Phe Gly Gln Gly Thr Lys Val Glu
Ile Lys - C

FIG. 17B

- (i) SEQUENCE CHARACTERISTICS:
 (A) LENGTH: 125 amino acids
 (B) TYPE: amino acid
 (C) STRANDEDNESS: single
 (D) TOPOLOGY: linear
- (ii) MOLECULE TYPE: protein

N - Glu Val Gln Leu Gln Gln Ser Gly Ala Glu Leu Val Lys Pro Gly Ala
Ser Val Lys Leu Ser Cys Thr Ala Ser Gly Phe Asn Ile Lys Asp Thr
Tyr Met His Trp Val Lys Gln Arg Pro Glu Gln Gly Leu Glu Trp Ile
Gly Arg Ile Asp Pro Ala Asn Gly Asn Thr Lys Tyr Asp Pro Lys Phe
Gln Gly Lys Ala Thr Ile Thr Ala Asp Thr Ser Ser Asn Thr Ala Tyr
Leu Gln Leu Ser Ser Leu Thr Ser Glu Asp Thr Ala Val Tyr Tyr Cys
Ala Arg Gly Tyr Tyr Tyr Tyr Asp Ser Xaa Val Gly Tyr Tyr Ala Met
Asp Tyr Trp Gly Gln Gly Thr Xaa Val Thr Val Ser Ser - C

FIG. 18A

(i) SEQUENCE CHARACTERISTICS:

- (A) LENGTH: 129 amino acids
- (B) TYPE: amino acid
- (C) STRANDEDNESS: single
- (D) TOPOLOGY: linear

(ii) MOLECULE TYPE: protein

N - Gln Val Gln Leu Val Gln Ser Gly Ala Glu Val Lys Lys Pro Gly Ala
Ser Val Lys Val Ser Cys Lys Ala Ser Gly Tyr Thr Phe Thr Ser Tyr
Ala Ile Ser Trp Val Arg Gln Ala Pro Gly Gln Gly Leu Glu Trp Met
Gly Trp Ile Asn Pro Tyr Gly Asn Gly Asp Thr Asn Tyr Ala Gln Lys
Phe Gln Gly Arg Val Thr Ile Thr Ala Asp Thr Ser Thr Ser Thr Ala
Tyr Met Glu Leu Ser Ser Leu Arg Ser Glu Asp Thr Ala Val Tyr Tyr
Cys Ala Arg Ala Pro Gly Tyr Gly Ser Gly Gly Gly Cys Tyr Arg Gly Asp
Tyr Xaa Phe Asp Tyr Trp Gly Gln Gly Thr Leu Val Thr Val Ser Ser - C

FIG. 18B