



US00D66997S

(12) **United States Design Patent**
Crockford

(10) **Patent No.:** **US D669,997 S**

(45) **Date of Patent:** **** Oct. 30, 2012**

(54) **PELVIC FLOOR EXERCISER**

(76) Inventor: **Renee L. Crockford**, Houston, TX (US)

(**) Term: **14 Years**

(21) Appl. No.: **29/397,181**

(22) Filed: **Jul. 13, 2011**

(51) **LOC (9) Cl.** **28-03**

(52) **U.S. Cl.** **D24/215**

(58) **Field of Classification Search** D24/200,
D24/211-215, 141; 601/27, 28, 33, 40, 46,
601/47, 48, 63, 80, 99, 104, 112, 113, 114,
601/119, 122, 125, 129, 134, 135, 137, DIG. 12,
601/DIG. 13, DIG. 14, DIG. 15, DIG. 16,
601/DIG. 17

See application file for complete search history.

(56) **References Cited**

U.S. PATENT DOCUMENTS

D266,532	S	*	10/1982	Grube	D24/211
D272,649	S	*	2/1984	Bloch	D24/211
D374,084	S	*	9/1996	Chen	D24/211
D385,965	S	*	11/1997	Wallesen	D24/212
D446,308	S	*	8/2001	Schmittmeyer	D24/200
D510,628	S	*	10/2005	Talbot et al.	D24/215
D556,333	S	*	11/2007	Hoffman et al.	D24/206
D567,952	S	*	4/2008	Fink	D24/200
D567,954	S	*	4/2008	Fink	D24/200
D567,955	S	*	4/2008	Fink	D24/200
D628,577	S	*	12/2010	Marks et al.	D14/412
D649,656	S	*	11/2011	Petersen	D24/215
2008/0195181	A1	*	8/2008	Cole	607/74

* cited by examiner

Primary Examiner — Sandra Snapp

(74) *Attorney, Agent, or Firm* — Kenneth A. Roddy

(57) **CLAIM**

The ornamental design for a pelvic floor exerciser, as shown and described.

DESCRIPTION

FIG. 1 is a perspective view of a pelvic floor exerciser showing my new design from the forward end and two adjacent sides;

FIG. 2 is a perspective view thereof shown from the rearward end and two adjacent sides opposite the sides shown in FIG. 1;

FIG. 3 is an exploded perspective view thereof similar to FIG. 2, shown with the end cap at the rearward end removed;

FIG. 4 is a side elevation view thereof shown from one side; FIG. 5 is a cross sectional view taken along line 5-5 of FIG. 4.

FIG. 6 is a side elevation view thereof, rotated 45 degrees from the side shown in FIG. 4;

FIG. 7 is a cross sectional view taken along line 7-7 of FIG. 6. FIG. 8 is a side elevation view thereof, rotated 90 degrees from the side shown in FIG. 4;

FIG. 9 is a side elevation view thereof, rotated 135 degrees from the side shown in FIG. 4;

FIG. 10 is side elevation view thereof, rotated 180 degrees from the side shown in FIG. 4;

FIG. 11 is side elevation view thereof, rotated 225 degrees from the side shown in FIG. 4;

FIG. 12 is side elevation view thereof, rotated 270 degrees from the side shown in FIG. 4; and,

FIG. 13 is side elevation view thereof, rotated 315 degrees from the side shown in FIG. 4.

1 Claim, 4 Drawing Sheets

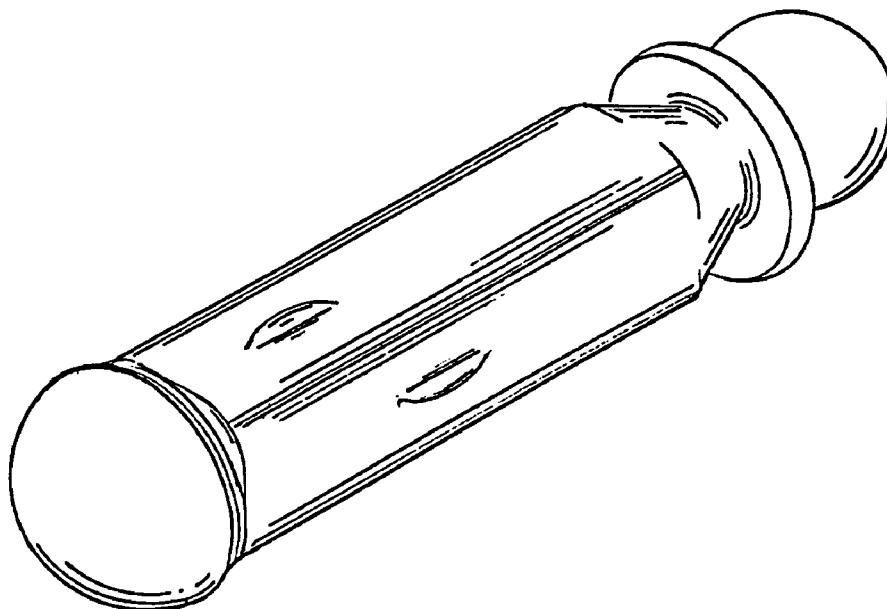

Fig. 1

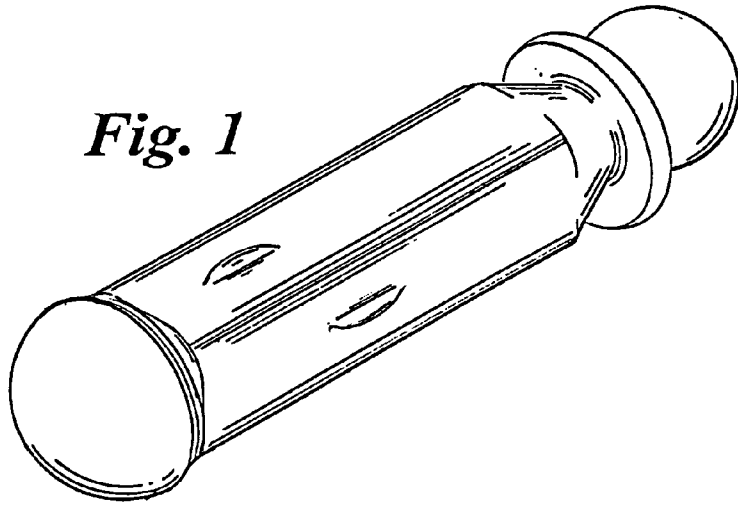

Fig. 2

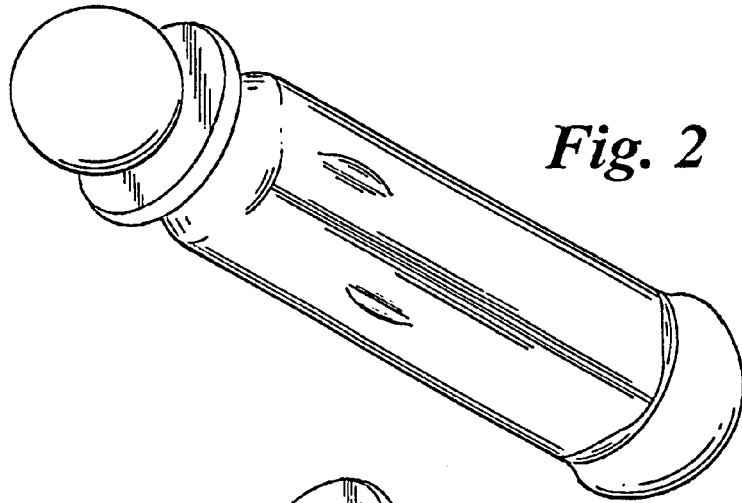
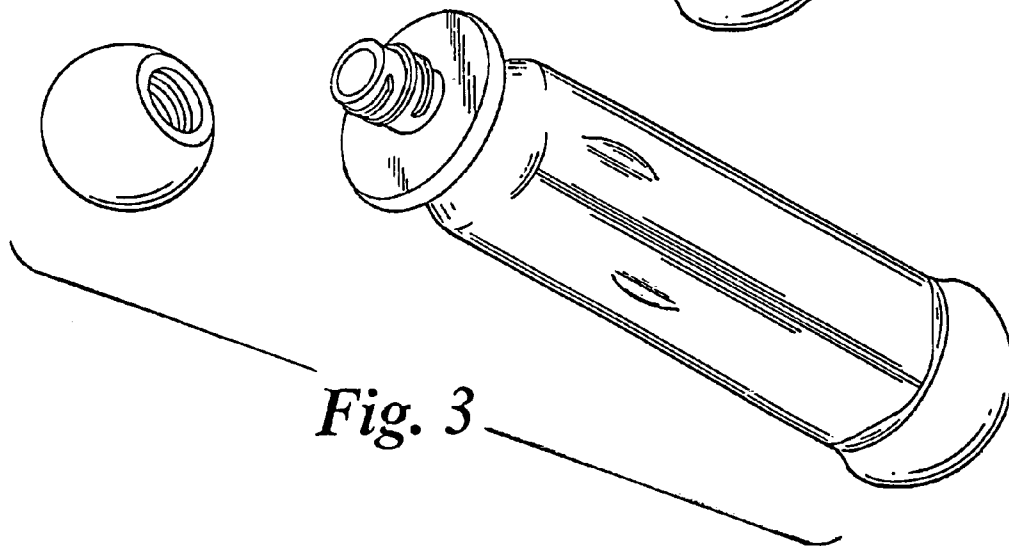

Fig. 3



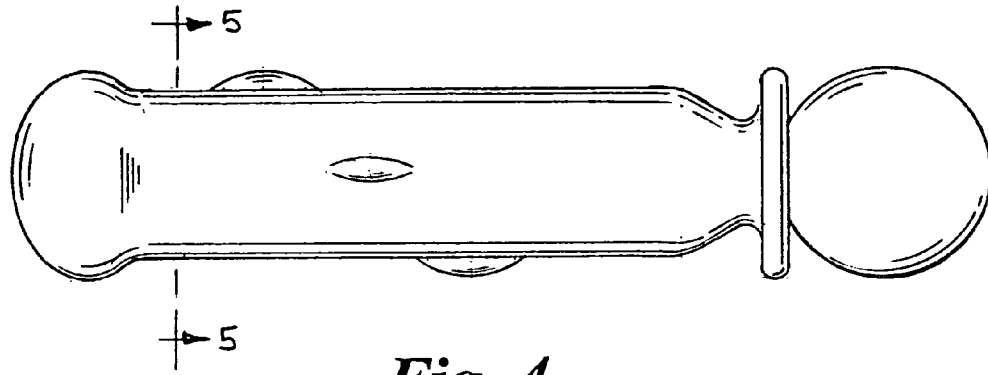

Fig. 4

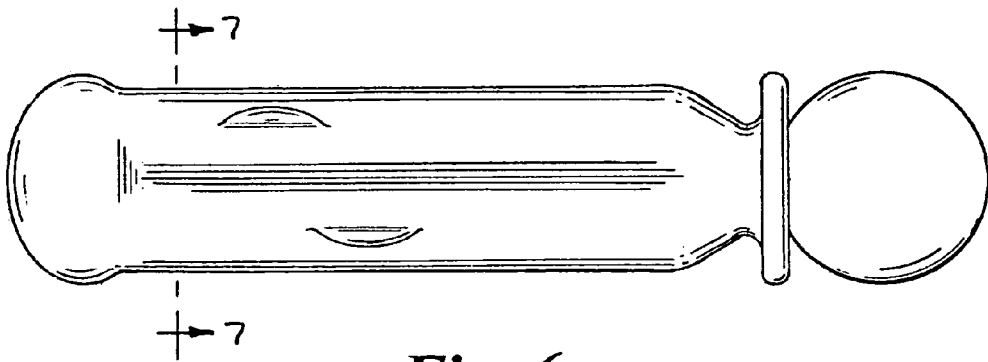

Fig. 6

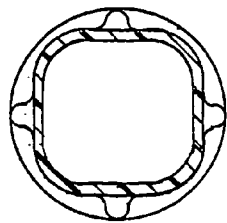

Fig. 5

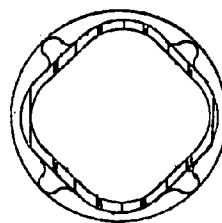

Fig. 7

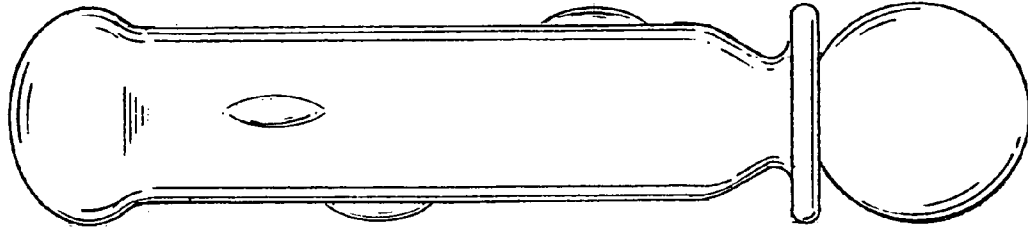

Fig. 8

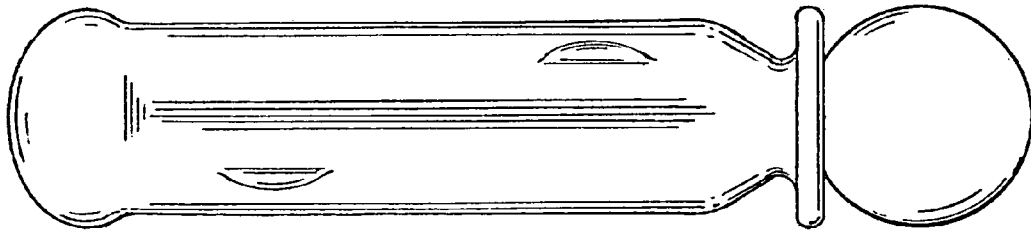

Fig. 9

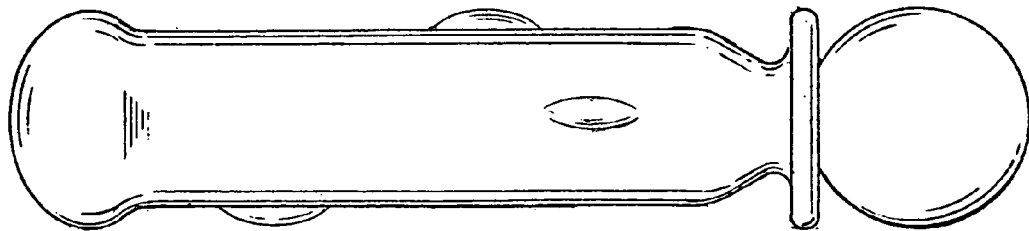

Fig. 10

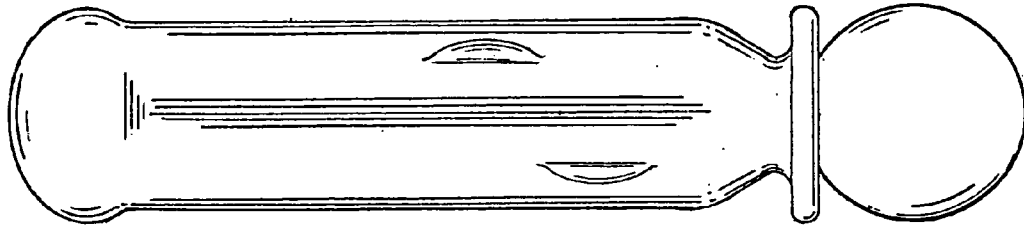

Fig. 11

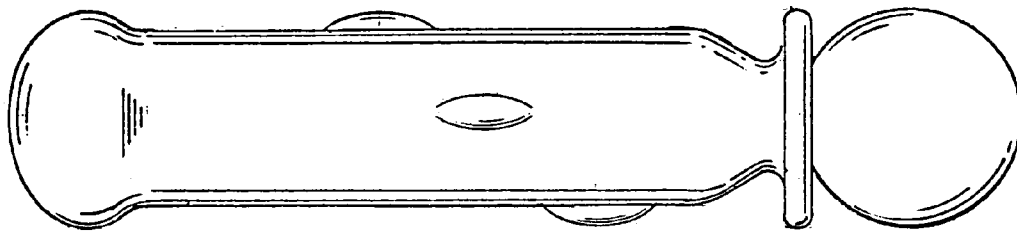

Fig. 12

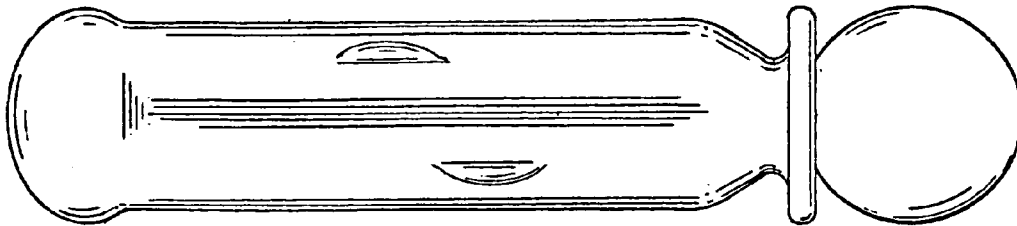

Fig. 13