



US00D702278S

(12) **United States Design Patent**
Kim et al.

(10) **Patent No.:** **US D702,278 S**

(45) **Date of Patent:** **** Apr. 8, 2014**

(54) **UV FILTER FOR DIGITAL CAMERA**

(75) Inventors: **Joo-Hyung Kim**, Seoul (KR); **Kim InShik**, Seoul (KR)

(73) Assignee: **Samsung Electronics Co., Ltd.**, Gyeonggi-do (KR)

(**) Term: **14 Years**

(21) Appl. No.: **29/410,300**

(22) Filed: **Jan. 6, 2012**

(51) **LOC (10) Cl.** **16-05**

(52) **U.S. Cl.**
USPC **D16/237**

(58) **Field of Classification Search**
USPC D16/134, 202-204, 208, 214, 219, 235, D16/237, 242-245, 250; D14/217, 251, D14/511; 248/176.1, 177.1, 178.1, 179.1, 248/180.1, 183.1, 187.1, 683; 348/373, 348/375; 396/419-428; D8/14, 354, D8/394-395

See application file for complete search history.

(56) **References Cited**

U.S. PATENT DOCUMENTS

D181,908 S * 1/1958 Hertzler D16/134
D252,833 S * 9/1979 Bowser D26/85

D339,599 S * 9/1993 Tiffen D16/219
D417,681 S * 12/1999 Hayashi D16/134
D529,065 S * 9/2006 Watanabe D16/219
D537,744 S * 3/2007 Wu D10/102
D560,247 S * 1/2008 Alm D16/219
7,712,907 B2 * 5/2010 Zyka 362/16
D650,821 S * 12/2011 Verhey D16/219

* cited by examiner

Primary Examiner — Susan Bennett Hattan

Assistant Examiner — Vy Koenig

(74) *Attorney, Agent, or Firm* — Harness, Dickey & Pierce

(57) **CLAIM**

We claim the ornamental design for an UV filter for digital camera, as shown and described.

DESCRIPTION

FIG. 1 is a front/right-side/top perspective view of an UV filter for digital camera showing our new design; FIG. 2 is a front-side elevational view thereof; FIG. 3 is a rear-side elevational view thereof; FIG. 4 is a left-side elevational view thereof; FIG. 5 is a right-side elevational view thereof; FIG. 6 is a top plan view thereof; FIG. 7 is a bottom plan view thereof; and, FIG. 8 is a front/right-side/top perspective view of the UV filter applied to a digital camera.

The broken lines showing in FIG. 8 are for environmental purposes only and form no part of the claimed design.

1 Claim, 7 Drawing Sheets

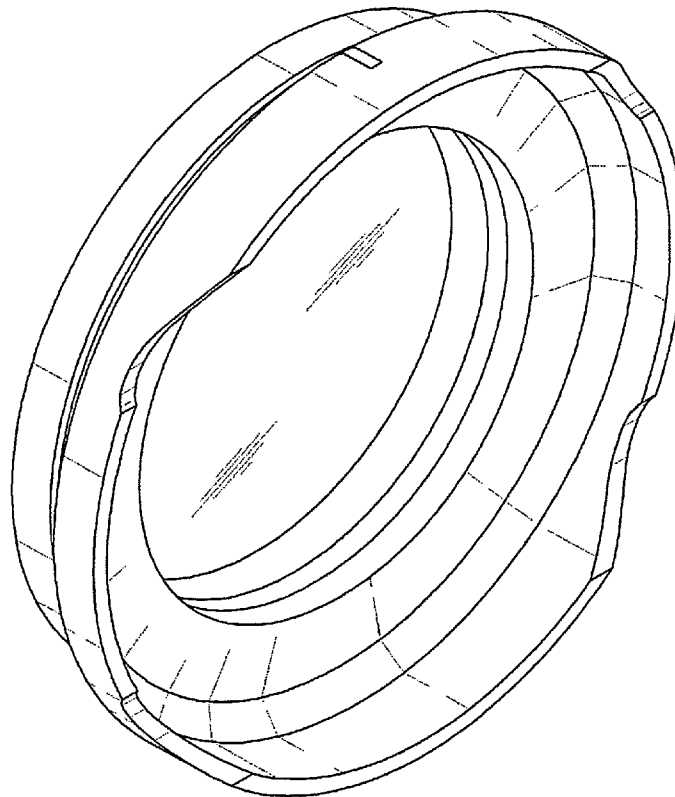

FIG. 1

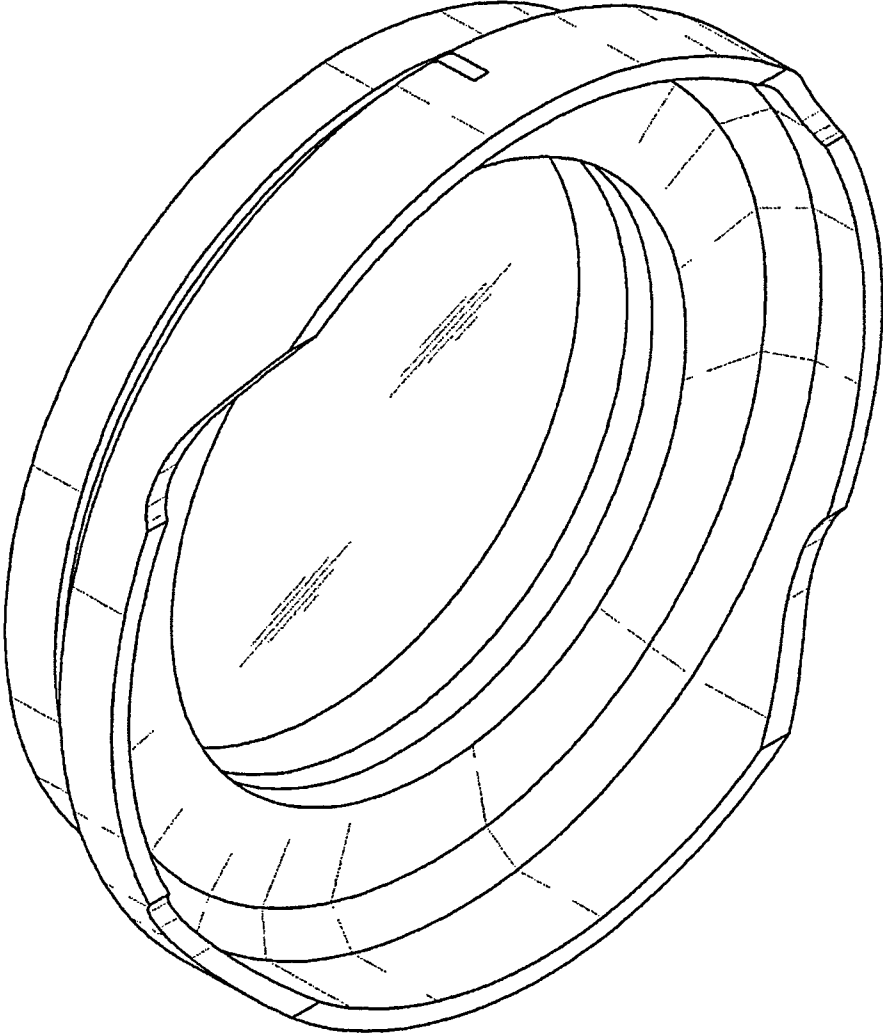

FIG.2

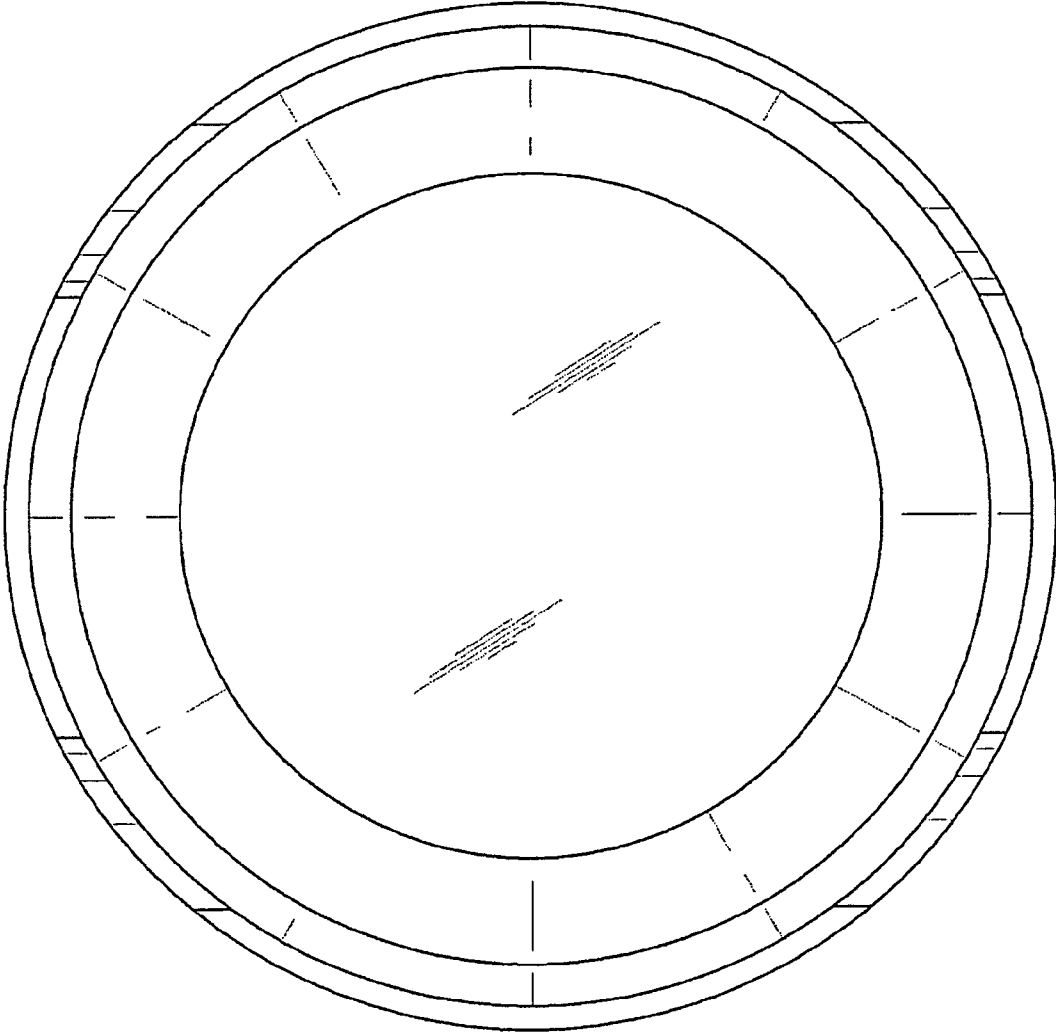

FIG.3

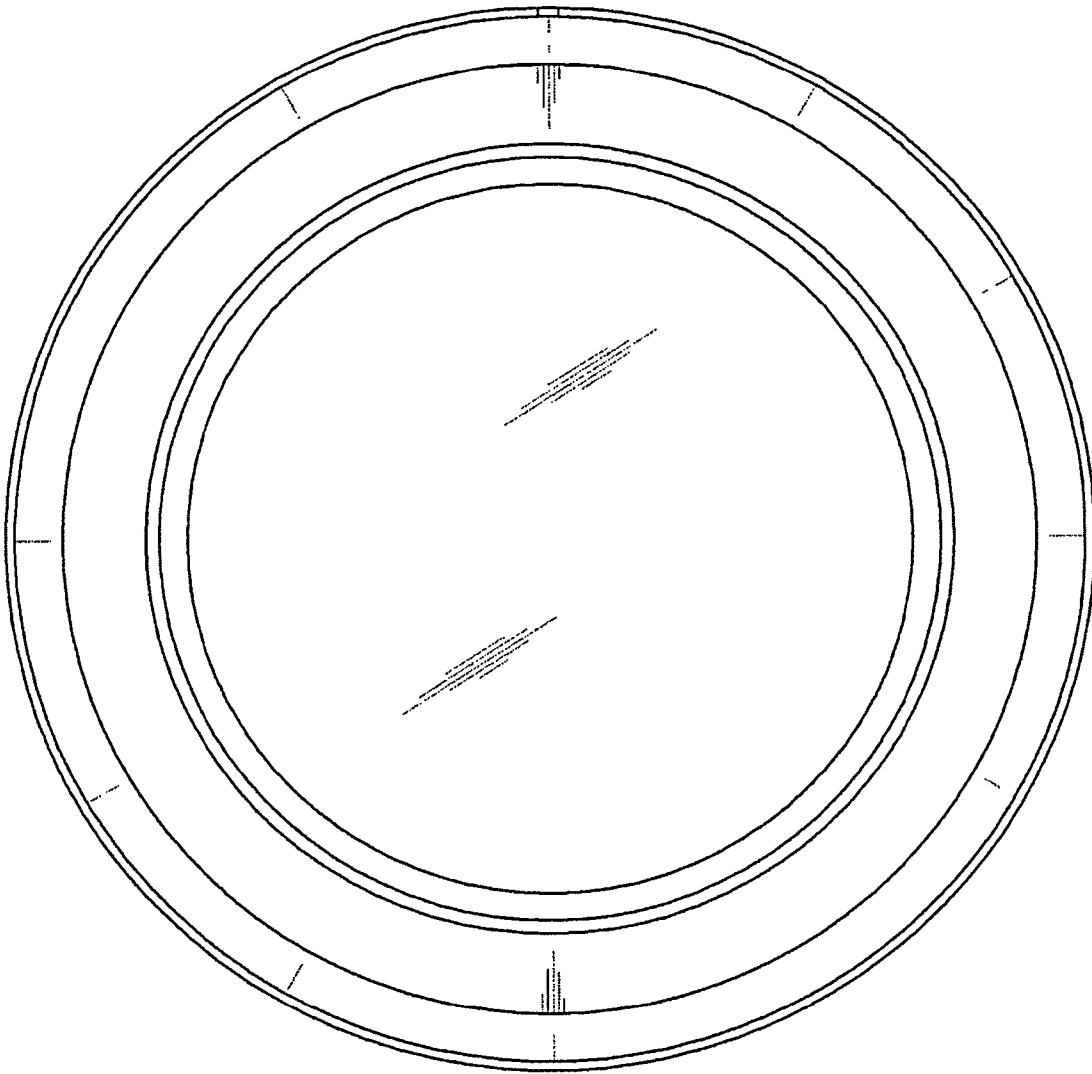

FIG.4

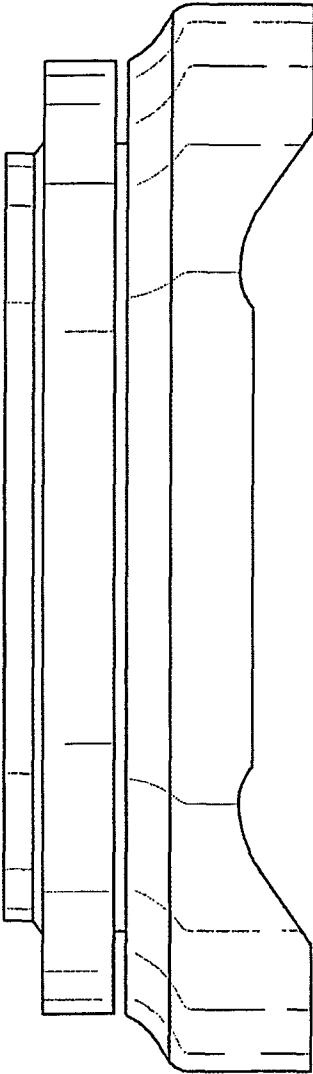

FIG.5

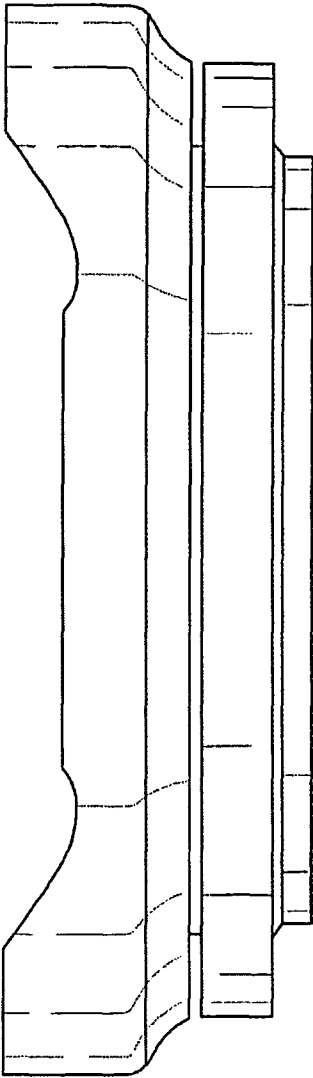

FIG.6

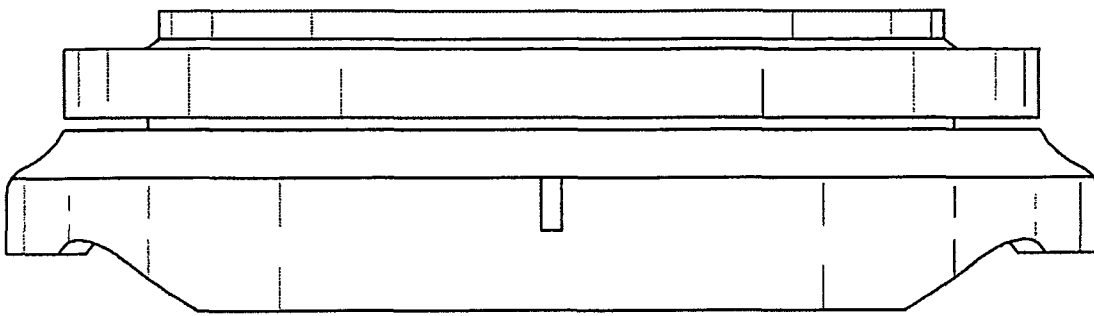

FIG.7

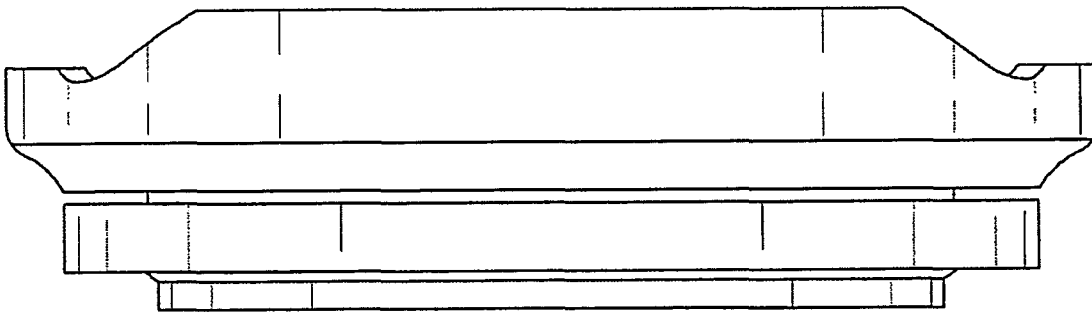

FIG. 8

