



US00D759475S

(12) **United States Design Patent**
Banno

(10) **Patent No.:** **US D759,475 S**

(45) **Date of Patent:** **** Jun. 21, 2016**

(54) **CLIP**

(71) Applicant: **DAIWA KASEI KOGYO**
KABUSHIKI KAISHA, Okazaki-shi,
Aichi-ken (JP)

(72) Inventor: **Kazuhiro Banno**, Kariya (JP)

(73) Assignee: **DAIWA KASEI KOGYO**
KABUSHIKI KAISHA, Okazaki-shi,
Aichi-ken (JP)

(**) Term: **14 Years**

(21) Appl. No.: **29/515,034**

(22) Filed: **Jan. 20, 2015**

(30) **Foreign Application Priority Data**

Jul. 24, 2014 (JP) 2014-016058

(51) **LOC (10) Cl.** **08-08**

(52) **U.S. Cl.**

USPC **D8/395**

(58) **Field of Classification Search**

USPC D8/394-396, 71-74, 499, 354-355;
D11/78.1, 200, 237

CPC A61F 5/01; A42B 3/08; A47D 15/00;
A01D 90/00; H01R 43/01; H02G 1/00;
H02G 1/04; H02G 1/06; B25B 7/02; B25B
7/123; B25B 5/12; E05B 73/00; E05B 11/00

See application file for complete search history.

(56) **References Cited**

U.S. PATENT DOCUMENTS

- 881,757 A * 3/1908 Winsor A45F 5/022
24/10 A
- 1,668,429 A * 5/1928 Simon B42F 9/00
24/67.11
- 3,205,546 A * 9/1965 Nelson F16B 5/125
24/292
- 4,157,152 A * 6/1979 Blastic A63B 57/00
224/247
- D268,848 S * 5/1983 Lorber D19/65

- 4,630,338 A * 12/1986 Osterland F16B 5/123
24/293
- 4,840,341 A * 6/1989 Hasegawa B42F 1/02
211/89.01
- 5,201,799 A * 4/1993 Johnson F16B 21/18
24/563
- 5,263,233 A * 11/1993 Kim B05C 19/002
24/289
- D363,453 S * 10/1995 Herdt D11/78.1

(Continued)

FOREIGN PATENT DOCUMENTS

- JP 1067403 12/1998
- JP 1201368 7/2003

(Continued)

OTHER PUBLICATIONS

VW Audi Seat Skoda Metal Spring Clips Interior | eBay, online, website copyright 2016, <http://www.ebay.co.uk/itm/VW-AUDI-SEAT-SKODA-TRIM-PANEL-LINING-UPHOLSTERY-METAL-SPRING-CLIPS-INTERIOR-400651044291>, [site visited Jan. 6, 2016 4:43:11 PM].*

Primary Examiner — John Windmuller

Assistant Examiner — John R Yeh

(74) *Attorney, Agent, or Firm* — Ladas & Parry LLP

(57) **CLAIM**

The ornamental design for a clip, as shown and described.

DESCRIPTION

FIG. 1 is a perspective view of a clip showing our new design; FIG. 2 is a perspective view thereof; FIG. 3 is a perspective view thereof; FIG. 4 is a front elevation view thereof; FIG. 5 is a rear elevation view thereof; FIG. 6 is a right side elevation view thereof; FIG. 7 is a left side elevation view thereof; FIG. 8 is a top plan view thereof; FIG. 9 is a bottom plan view thereof; and, FIG. 10 is an elevation view showing a state of use thereof.

1 Claim, 5 Drawing Sheets

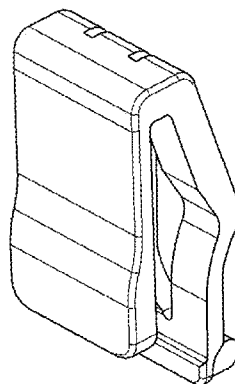
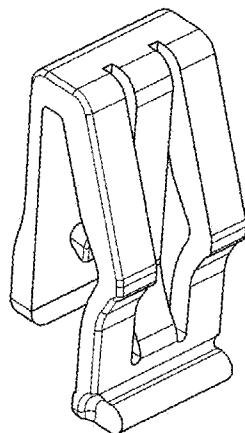

(56)

References Cited

U.S. PATENT DOCUMENTS

D393,797 S * 4/1998 Kostigian D32/64
D490,298 S * 5/2004 Maskell D8/395
D521,705 S * 5/2006 Kent D32/54
7,120,971 B2 * 10/2006 Osterland B60R 13/0206
24/295
D548,668 S * 8/2007 Walton D12/317
D549,566 S * 8/2007 Kamiya D8/395
D615,263 S * 5/2010 Kent D32/54
7,784,159 B2 * 8/2010 Dickinson F16B 5/0614
24/289

D636,293 S * 4/2011 Dolce D11/222
8,370,999 B2 * 2/2013 Camus F16B 19/081
24/292
D716,137 S * 10/2014 Szymanski D8/395
D722,493 S * 2/2015 Ramsauer D8/395

FOREIGN PATENT DOCUMENTS

KR 300399328.0000 * 11/2005
KR 300540867.0001 * 9/2009
KR 300707549.0000 * 9/2013
KR 300710430.0001 * 12/2013

* cited by examiner

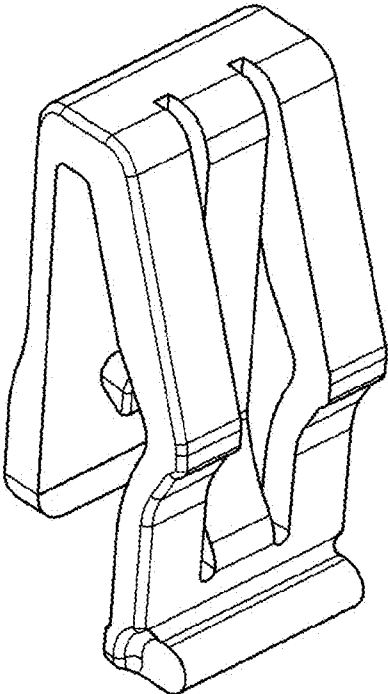

FIG. 1

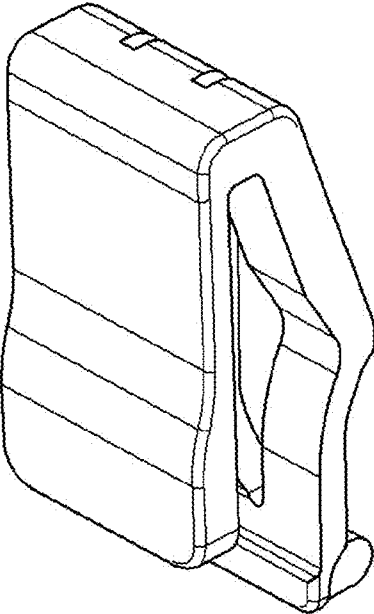

FIG. 2

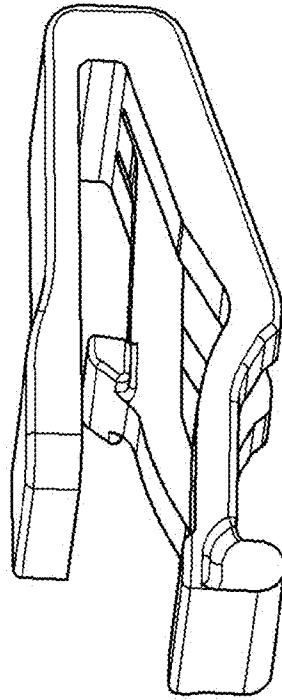

FIG. 3

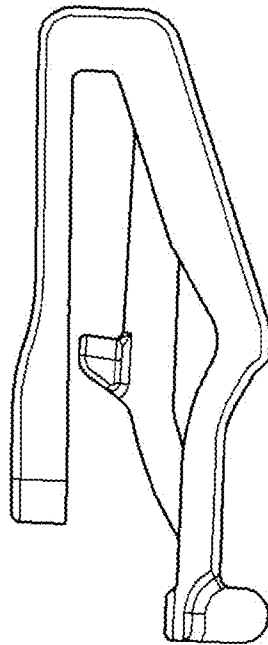

FIG. 4

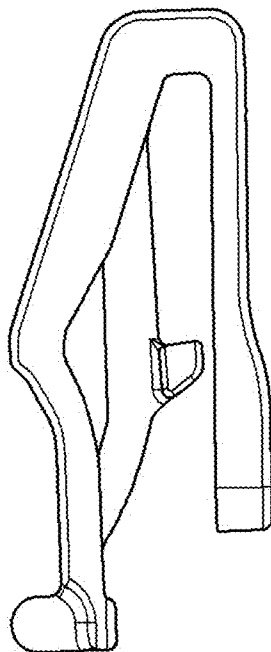

FIG. 5

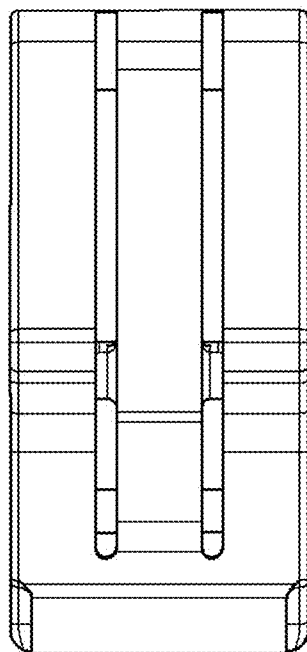

FIG. 6

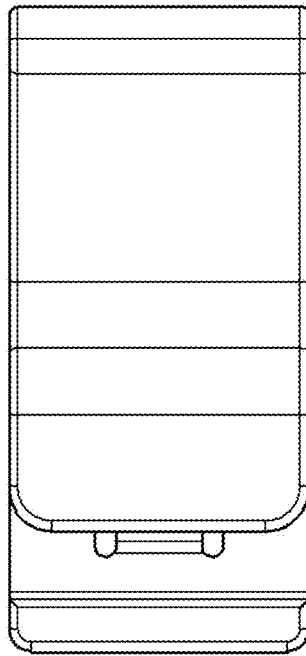

FIG. 7

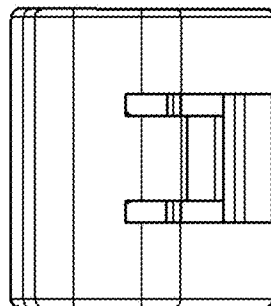

FIG. 8

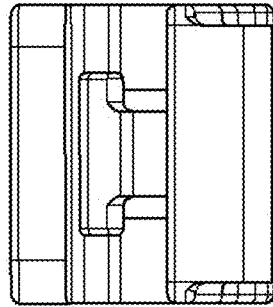

FIG. 9

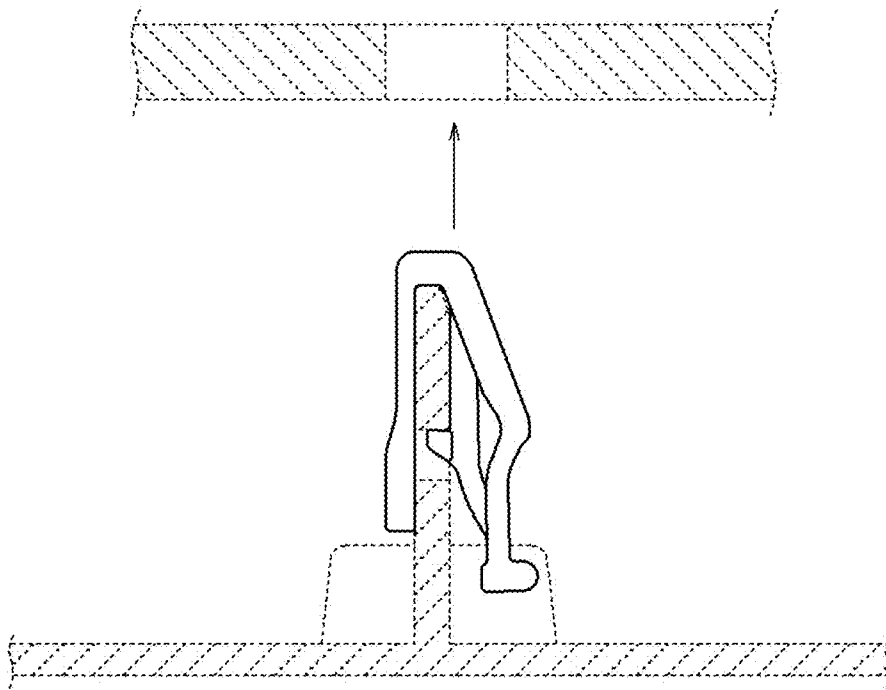

FIG. 10