



(12) **United States Design Patent**
Yum et al.

(10) **Patent No.:** **US D924,872 S**
(45) **Date of Patent:** **** Jul. 13, 2021**

(54) **KEYBOARD FOR ELECTRONIC DEVICE**

OTHER PUBLICATIONS

(71) Applicant: **SAMSUNG ELECTRONICS CO., LTD.**, Suwon-si (KR)

Galaxy Tab S6, Samsung, samsung.com, author and date unlisted © 1995-2020 Samsung, online, site visited Dec. 15, 2020. Available from Internet, URL: <https://www.samsung.com/us/mobile/tablets/galaxy-tab-s/galaxy-tab-s6-10-5-128gb-cloud-blue-wi-fi-s-pen-included-sm-t860nzbaxar/#benefits> (Year: 2020).*

(72) Inventors: **Sung-Jin Yum**, Suwon-si (KR); **Min-Ah Koh**, Suwon-si (KR); **Hak-Do Kim**, Suwon-si (KR)

(Continued)

(73) Assignee: **SAMSUNG ELECTRONICS CO., LTD.**, Gyeonggi-Do (KR)

Primary Examiner — Marissa J Cash
Assistant Examiner — Altaira J Swangin

(**) Term: **15 Years**

(74) *Attorney, Agent, or Firm* — Cantor Colburn LLP

(21) Appl. No.: **29/722,372**

(22) Filed: **Jan. 29, 2020**

(57) **CLAIM**

(30) **Foreign Application Priority Data**

The ornamental design for a keyboard for electronic device, as shown and described.

Aug. 16, 2019 (KR) 30-2019-0039213

(51) **LOC (13) Cl.** **14-02**

(52) **U.S. Cl.**

USPC **D14/392**

(58) **Field of Classification Search**

USPC D14/247, 315-327, 331-333, 338, D14/345-347, 387, 390-401, 406, 429, D14/455-457, 460-461, 447, 459, 203.8, D14/209.1; D18/1-2, 4.1-4.6, 7, 11, D18/12.2, 52; D21/324, 409; 341/22-23, (Continued)

DESCRIPTION

FIG. 1 is a front perspective view of a keyboard for electronic device, showing our new design; FIG. 2 is a front view thereof; FIG. 3 is a rear view thereof; FIG. 4 is a left-side view thereof; FIG. 5 is a right-side view thereof; FIG. 6 is a top view thereof; FIG. 7 is a bottom view thereof; FIG. 8 is a rear perspective view thereof; FIG. 9 is an enlarged view of the encircled portion 9 in FIG. 4; and, FIG. 10 is an enlarged view of the encircled portion 10 in FIG. 8.

(56) **References Cited**

U.S. PATENT DOCUMENTS

D678,277 S 3/2013 Groene et al.
D678,300 S * 3/2013 Groene D14/455
(Continued)

The even-dash broken lines illustrating portions of the keyboard for electronic device form no part of the claimed design. The dot-dash broken lines showing enlarged detail views are for annotative purposes only and form no part of the claimed design.

FOREIGN PATENT DOCUMENTS

CN 302973976 * 10/2014
CN 303113814 * 5/2015
(Continued)

1 Claim, 10 Drawing Sheets

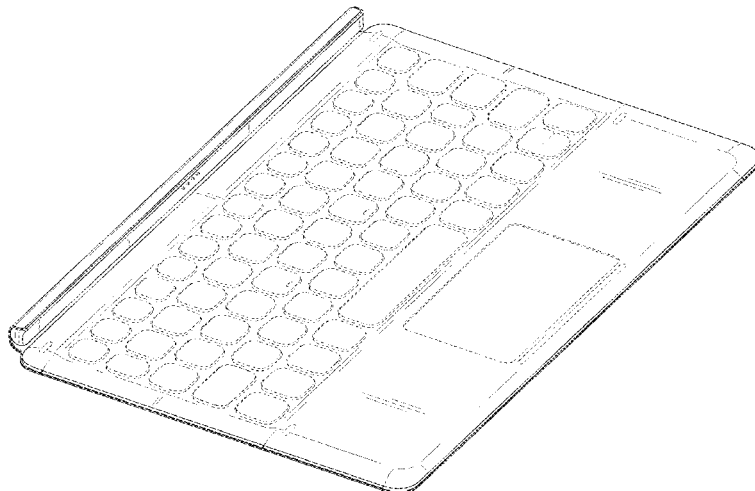

(58) **Field of Classification Search**
 USPC 341/26; 345/168-173; 361/679.08,
 361/679.09, 679.11, 679.14, 679.17,
 361/679.26, 679.27, 786; 708/142-146;
 235/8, 12, 15, 26-27, 145 A, 145 R, 146,
 235/61 PE
 CPC B41J 5/00; B41J 5/10; B41J 5/12; G06F
 3/021; G06F 3/0216; G06F 3/0219; G06F
 3/02
 See application file for complete search history.

(56) **References Cited**

U.S. PATENT DOCUMENTS

D689,059	S	*	9/2013	Tak	D14/457
D705,227	S		5/2014	Groene et al.		
D717,806	S	*	11/2014	Yum	D14/455
D729,767	S	*	5/2015	Lee	D14/209.1
D731,486	S		6/2015	Kim et al.		
D733,153	S	*	6/2015	Longo	D14/440
D746,293	S	*	12/2015	Park	D14/455
D756,364	S	*	5/2016	Hong	D14/440
D775,130	S		12/2016	Otani		
D791,135	S	*	7/2017	Jung	D14/391
D791,780	S		7/2017	Bailey et al.		
D819,639	S	*	6/2018	Raken	D14/391
D822,025	S	*	7/2018	Kim	D14/392
10,429,948	B2	*	10/2019	Tsuji	G06F 3/0346
D870,117	S	*	12/2019	Akana	D14/457
D898,028	S	*	10/2020	Kang	D14/391
2003/0142472	A1	*	7/2003	Park	G06F 1/1681 361/679.08
2009/0268392	A1	*	10/2009	Cheng	G06F 1/203 361/679.52
2010/0091442	A1	*	4/2010	Theobald	G06F 1/1679 361/679.09
2011/0038116	A1	*	2/2011	Tseng	B29C 43/12 361/679.09
2011/0062008	A1	*	3/2011	Cheng	G06F 1/1662 200/5 A
2012/0099264	A1	*	4/2012	Degner	F16B 41/005 361/679.09
2012/0224316	A1	*	9/2012	Shulenberger	G06F 1/1628 361/679.09
2013/0022382	A1	*	1/2013	Raff	G06F 1/1662 400/472
2013/0088826	A1	*	4/2013	Kim	G06F 1/1669 361/679.09
2013/0188304	A1	*	7/2013	Lee	G06F 1/1662 361/679.12
2014/0029187	A1	*	1/2014	Okuley	G06F 1/1662 361/679.09

2014/0043744	A1	*	2/2014	Matsuoka	G06F 1/1616 361/679.09
2014/0146445	A1	*	5/2014	Lai	G06F 3/0202 361/679.1
2014/0203665	A1	*	7/2014	Goodman	H02H 5/083 307/118
2014/0355191	A1	*	12/2014	Lin	G06F 1/1679 361/679.17
2015/0116224	A1	*	4/2015	Chen	G06F 1/1662 345/169
2015/0153771	A1	*	6/2015	Lin	G06F 1/1654 361/679.09
2015/0185784	A1	*	7/2015	Watabe	G06F 1/1656 361/679.09
2015/0277499	A1	*	10/2015	MacDonald	G01L 19/00 361/679.09
2015/0332874	A1	*	11/2015	Brock	H01H 13/83 200/5 A
2016/0048173	A1	*	2/2016	Lyles	G06F 1/1656 361/679.17
2016/0062411	A1	*	3/2016	Morrison	G06F 1/1632 361/679.08
2016/0062413	A1	*	3/2016	Sano	E05D 11/10 361/679.09
2016/0065690	A1	*	3/2016	Hanyu	H04L 67/303 715/746
2016/0091934	A1	*	3/2016	Oakley	G06F 1/1632 361/679.55
2016/0314559	A1	*	10/2016	Kimura	G06T 3/4092
2017/0153665	A1	*	6/2017	Tsai	G06F 1/1616
2017/0220076	A1	*	8/2017	Gerbus	G06F 1/1632
2017/0255230	A1	*	9/2017	Regimbal	G06F 1/1658
2018/0019081	A1	*	1/2018	Ascorra	H01H 13/83
2018/0101193	A1	*	4/2018	Tragatschnig	G06F 1/1643
2018/0226210	A1	*	8/2018	Varghese	A61B 5/318
2019/0296497	A1	*	9/2019	Chang	H01R 12/725
2019/0371543	A1	*	12/2019	Chiang	G06F 1/1656
2020/0183462	A1	*	6/2020	Li	F16C 11/04

FOREIGN PATENT DOCUMENTS

KR	300678943.0001	*	6/2013
KR	301058081.0000	*	5/2020

OTHER PUBLICATIONS

Tab P11, Lenovo, notebookcheck.net, published by Alex Alderson on Oct. 20, 2020 © 2020 Alex Alderson, online, site visited Feb. 10, 2021. Available from URL: <https://www.notebookcheck.net/Leaked-Lenovo-Tab-P11-details-confirm-design-and-specifications-of-upcoming-budget-tablet.498728.0.html> (Year: 2020).*

* cited by examiner

FIG. 1

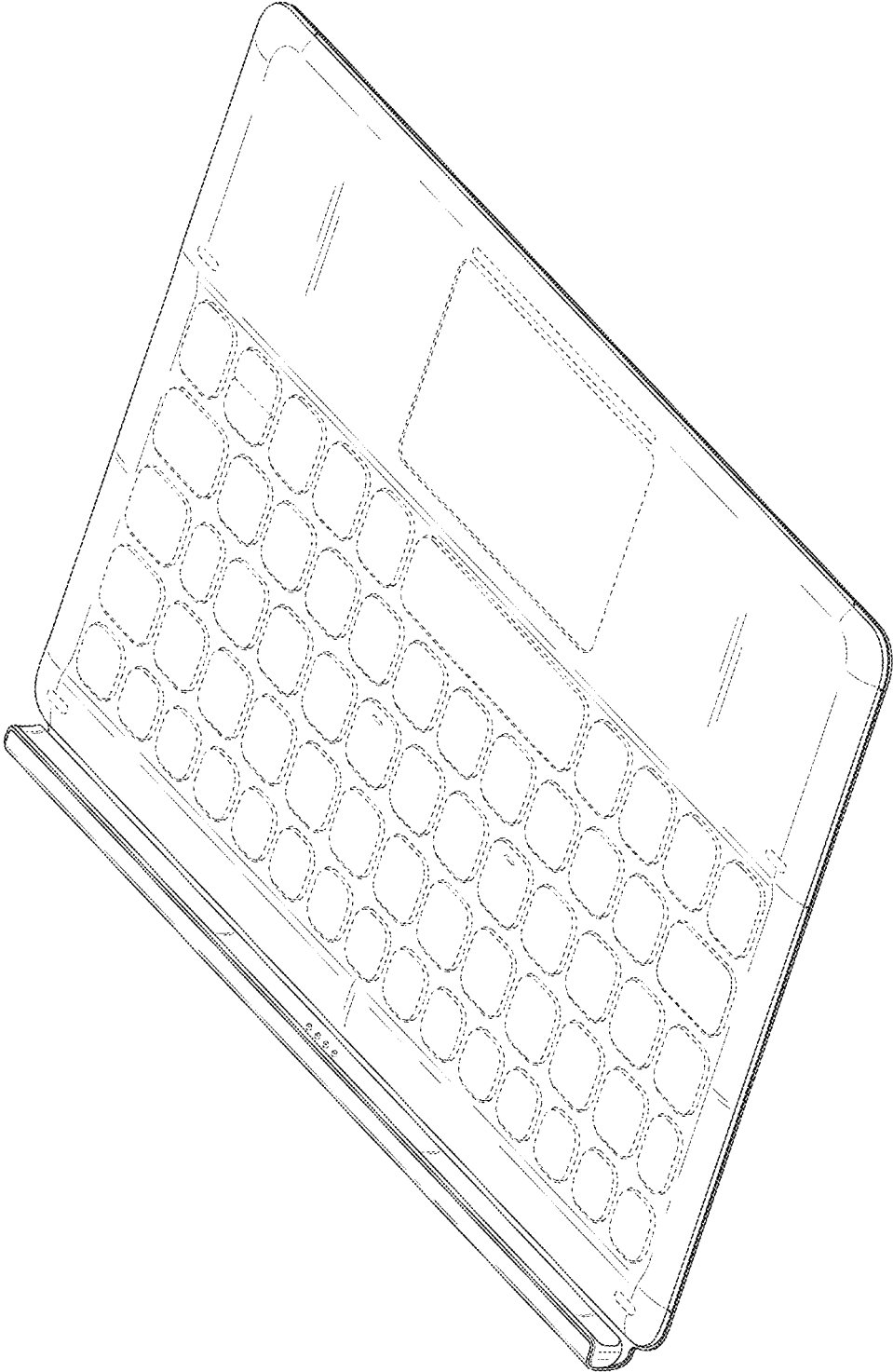

FIG. 2

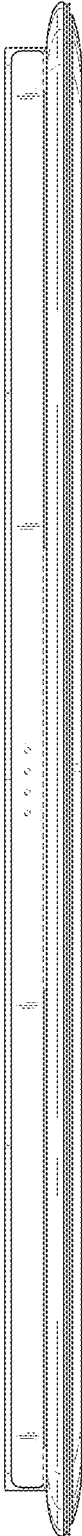

FIG. 3



FIG. 4

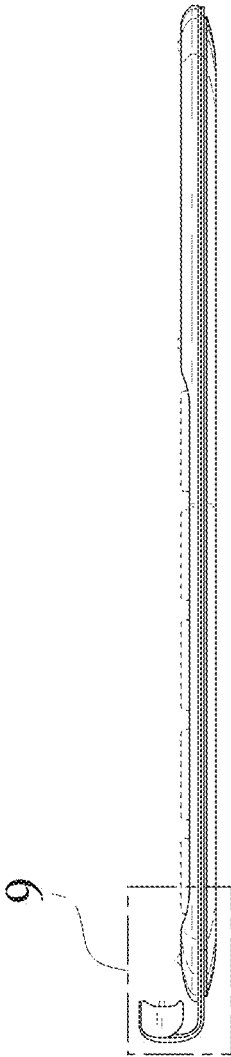

FIG. 5

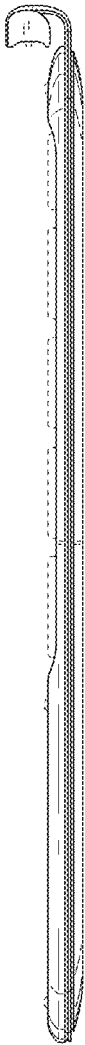

FIG. 6

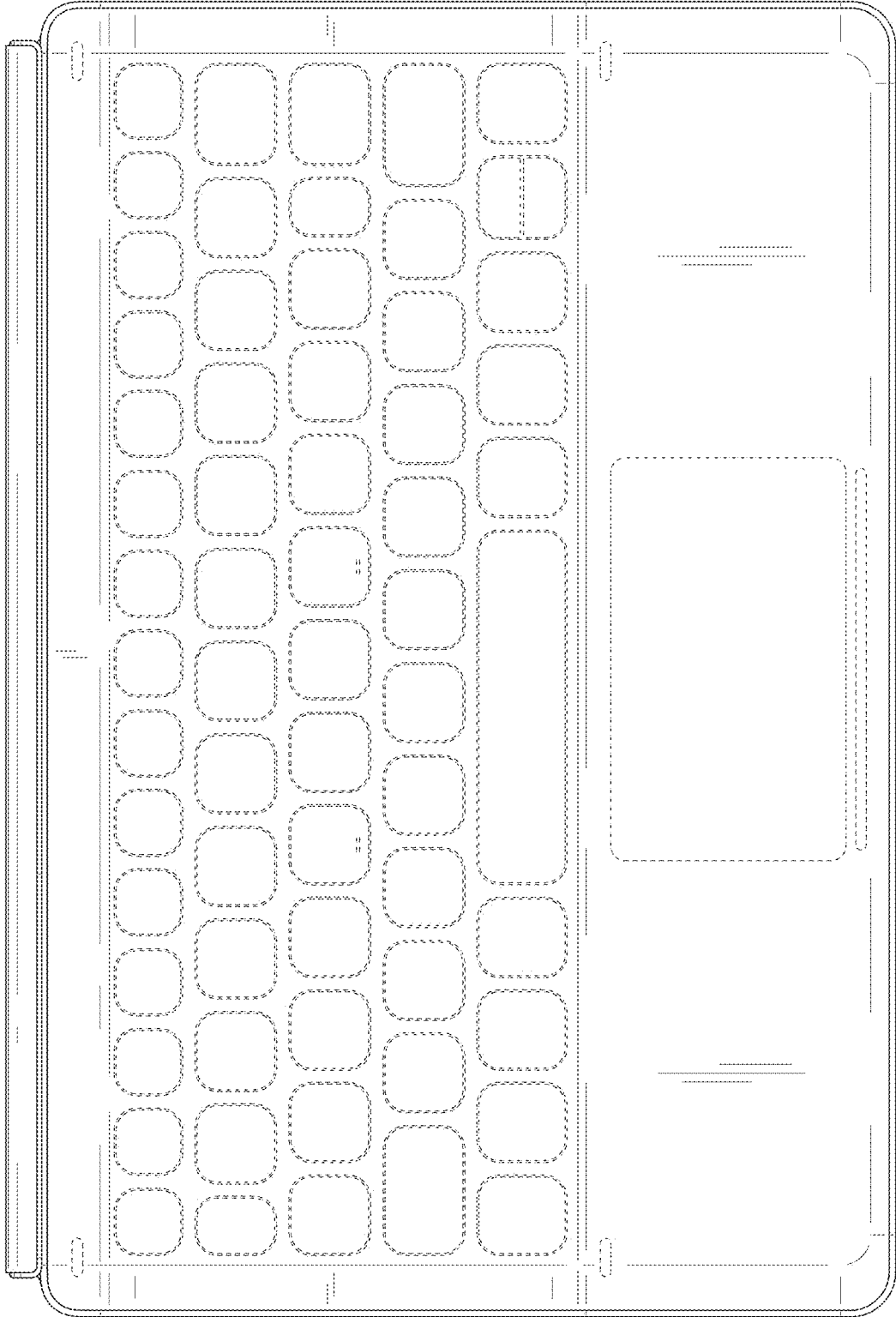

FIG. 7

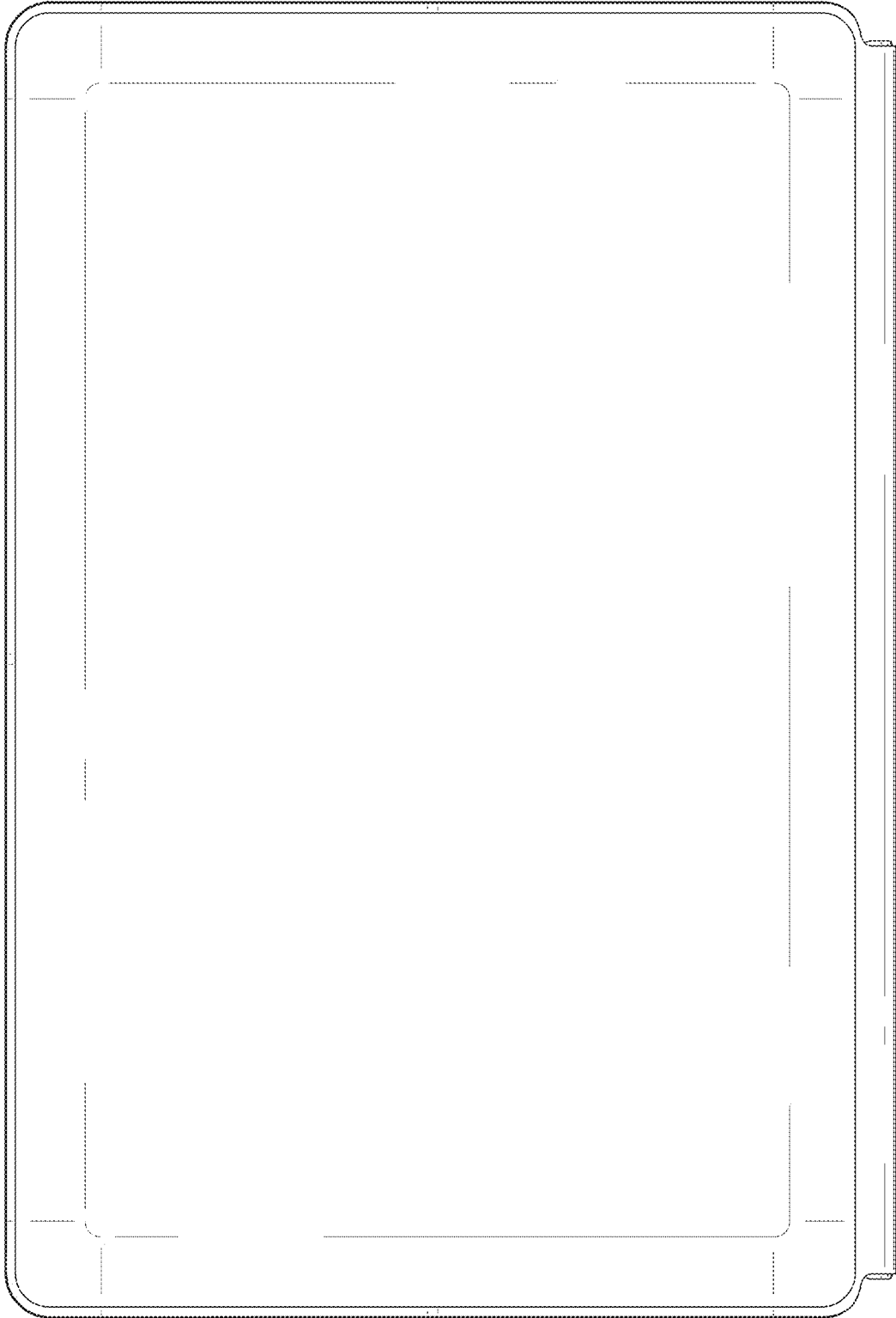

FIG. 8

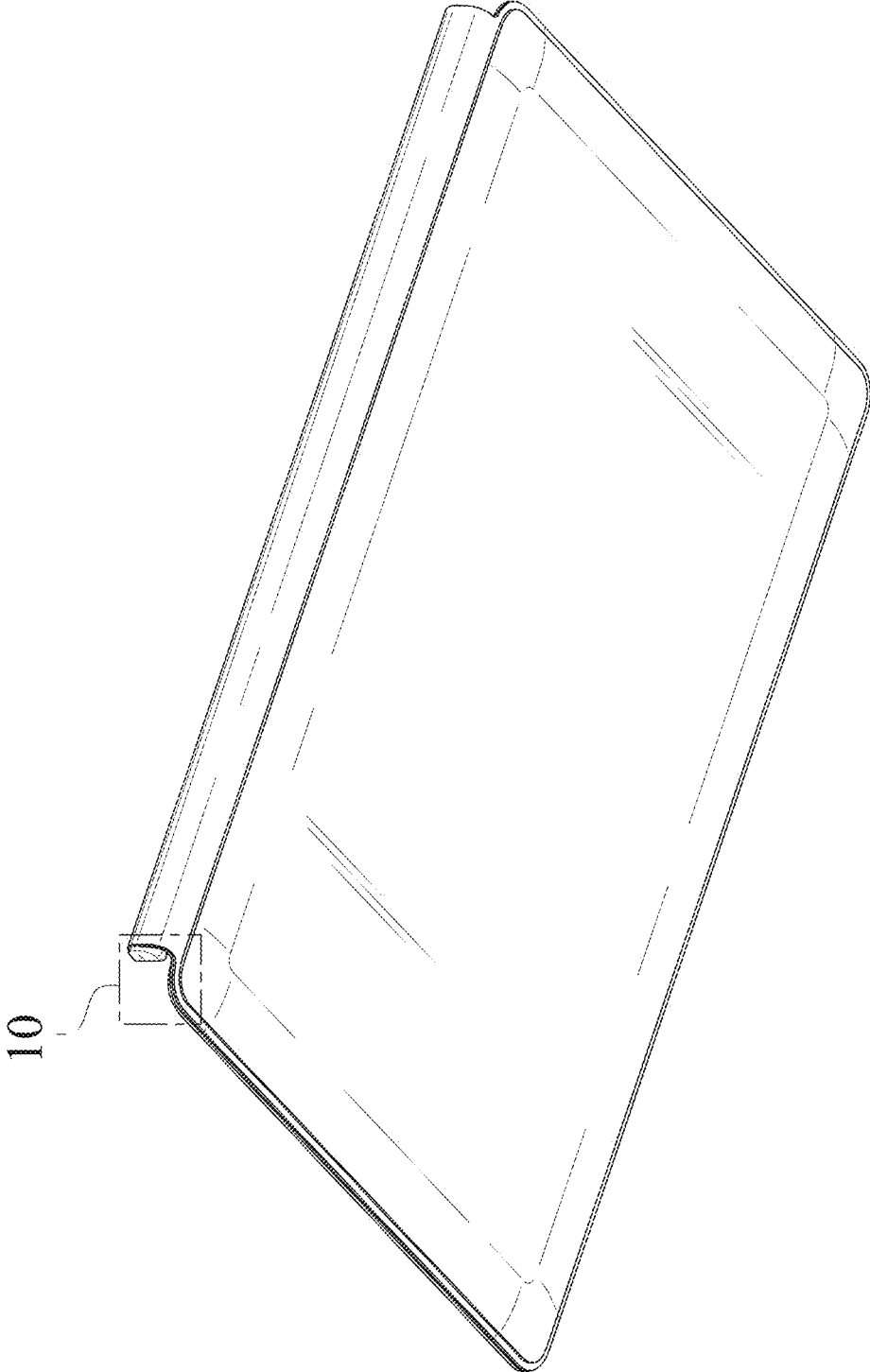

FIG. 9

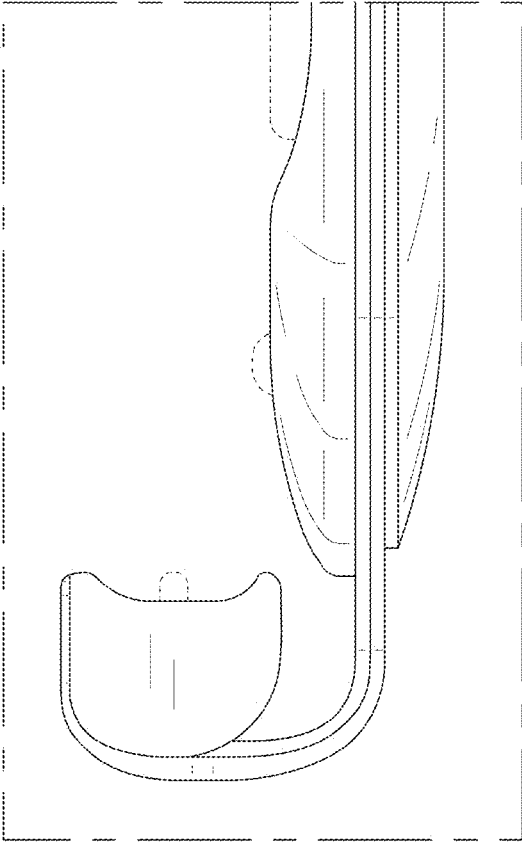

FIG. 10

