



(51) International Patent Classification:

C09J 4/06 (2006.01) C08F 222/10 (2006.01)  
A61K 6/08 (2006.01) C08F 292/00 (2006.01)

(21) International Application Number:

PCT/US2016/015300

(22) International Filing Date:

28 January 2016 (28.01.2016)

(25) Filing Language:

English

(26) Publication Language:

English

(30) Priority Data:

62/118,505 20 February 2015 (20.02.2015) US

(71) Applicant: **3M INNOVATIVE PROPERTIES COMPANY** [US/US]; 3M Center, Post Office Box 33427, Saint Paul, Minnesota 55133-3427 (US).

(72) Inventors: **MOSER, William, H.**; 3M Center, Post Office Box 33427, Saint Paul, Minnesota 55133-3427 (US). **FORNOF, Ann, R.**; 3M Center, Post Office Box 33427, Saint Paul, Minnesota 55133-3427 (US). **JOLY, Guy, D.**; 3M Center, Post Office Box 33427, Saint Paul, Minnesota 55133-3427 (US). **YURT, Serkan**; 3M Center, Post Office Box 33427, Saint Paul, Minnesota 55133-3427 (US). **KREPSKI, Larry, R.**; 3M Center, Post Office Box 33427, Saint Paul, Minnesota 55133-3427 (US). **ABUELYAMAN, Ahmed, S.**; 3M Center, Post Office Box 33427, Saint Paul, Minnesota 55133-3427 (US). **FALSAFI, Afshin**; 3M Center, Post Office Box 33427, Saint Paul, Minnesota 55133-3427 (US). **CRAIG, Bradley, D.**; 3M Center, Post Office Box 33427, Saint Paul, Minnesota 55133-3427 (US). **OXMAN, Joel, D.**; 3M Center, Post Office Box 33427, Saint Paul, Minnesota 55133-3427 (US). **GADDAM, Babu, N.**; 3M Center, Post Office Box 33427, Saint Paul, Minnesota 55133-3427 (US).

(74) Agents: **KOKKO, Kent, S.** et al.; 3M Center, Office of Intellectual Property Counsel, Post Office Box 33427, Saint Paul, Minnesota 55133-3427 (US).

(81) Designated States (unless otherwise indicated, for every kind of national protection available): AE, AG, AL, AM, AO, AT, AU, AZ, BA, BB, BG, BH, BN, BR, BW, BY, BZ, CA, CH, CL, CN, CO, CR, CU, CZ, DE, DK, DM, DO, DZ, EC, EE, EG, ES, FI, GB, GD, GE, GH, GM, GT, HN, HR, HU, ID, IL, IN, IR, IS, JP, KE, KG, KN, KP, KR, KZ, LA, LC, LK, LR, LS, LU, LY, MA, MD, ME, MG, MK, MN, MW, MX, MY, MZ, NA, NG, NI, NO, NZ, OM, PA, PE, PG, PH, PL, PT, QA, RO, RS, RU, RW, SA, SC, SD, SE, SG, SK, SL, SM, ST, SV, SY, TH, TJ, TM, TN, TR, TT, TZ, UA, UG, US, UZ, VC, VN, ZA, ZM, ZW.

(84) Designated States (unless otherwise indicated, for every kind of regional protection available): ARIPO (BW, GH, GM, KE, LR, LS, MW, MZ, NA, RW, SD, SL, ST, SZ, TZ, UG, ZM, ZW), Eurasian (AM, AZ, BY, KG, KZ, RU, TJ, TM), European (AL, AT, BE, BG, CH, CY, CZ, DE, DK, EE, ES, FI, FR, GB, GR, HR, HU, IE, IS, IT, LT, LU, LV, MC, MK, MT, NL, NO, PL, PT, RO, RS, SE, SI, SK, SM, TR), OAPI (BF, BJ, CF, CG, CI, CM, GA, GN, GQ, GW, KM, ML, MR, NE, SN, TD, TG).

Declarations under Rule 4.17:

- as to applicant's entitlement to apply for and be granted a patent (Rule 4.17(ii))
- as to the applicant's entitlement to claim the priority of the earlier application (Rule 4.17(iii))

Published:

- with international search report (Art. 21(3))
- before the expiration of the time limit for amending the claims and to be republished in the event of receipt of amendments (Rule 48.2(h))

(54) Title: ADDITION-FRAGMENTATION OLIGOMERS

(57) Abstract: Novel stress-reducing crosslinking oligomers that have application in dental restoratives, thin films, hardcoats, composites, adhesives, and other uses subject to stress reduction are described. The addition-fragmentation process of crosslinking results in a chain-transfer event that provides novel polymers that may be further functionalized. In addition, the addition-fragmentation oligomer comprises pendent functional groups that bond to a substrate by forming an ionic or covalent bond, or etch the substrate by chemically removing some material from the substrate.



## ADDITION-FRAGMENTATION OLIGOMERS

5

### Background

The present disclosure provides novel addition-fragmentation oligomers for use in low-stress polymerizable compositions. Free-radical polymerization is typically accompanied by a reduction in volume as monomers are converted to polymer. The volumetric shrinkage produces stress in the cured composition, leading to microcracks and deformation. Stress transferred to an interface between the cured composition and a substrate can cause failure in adhesion and can affect the durability of the cured composition.

The crosslinking oligomers of this disclosure provide stress relief by including labile crosslinks that can cleave and reform during the polymerization process. Crosslink cleavage may provide a mechanism to allow for network reorganization, relieve polymerization stress, and prevent the development of high stress regions. The instant crosslinking oligomer may further provide stress relief by delaying the gel point, the point at which the polymerizable composition transitions from a viscous material to a viscoelastic solid. The longer the polymerizable mixture remains viscous, the more time available during which material flow can act to alleviate stress during the polymerization process.

Curable polymeric materials are used in a wide variety of dental applications, including restoratives, cements, adhesives, and the like. Often, such materials shrink upon curing. This is particularly problematic when the material is in a constrained environment, as in a dental filling or restorative, for example. Dimensional changes upon shrinkage while in a constrained environment can generate a strain within the material that is typically converted into a stress on the surrounding environment (e.g., tooth). Such forces can result in interfacial failures between the tooth and the polymeric material resulting in a physical gap and subsequent microleakage into the tooth cavity. Alternatively, such forces can lead to fractures within the tooth and/or the composite.

Generally, conventional processes of curing polymeric dental materials involve a composite held in place on an oral surface with an adhesive and involve curing the adhesive and then subsequently curing the composite material. More specifically, conventional methods utilize one or more of the following steps: surface treatment of the tooth (e.g., etching, priming), application of a curable adhesive to the tooth surface, curing of the adhesive, placement of a composite material (e.g., restorative) on the cured adhesive, and curing of the composite material. There is a need for dental materials, e.g., dental adhesives and dental composites that reduce the amount of stress placed on the dental material and the surrounding environment during or after curing.

Although various curable dental compositions have been described, industry would find advantage in compositions having improved properties such as reduced stress deflection and/or reduced shrinkage while maintaining sufficient mechanical properties and depth of cure.

## Summary

The addition-fragmentation crosslinking oligomers provide novel stress-reducing crosslinking oligomers that have application in dental restoratives, thin films, hardcoats, composites, adhesives, and other uses subject to stress reduction. The addition-fragmentation process of crosslinking results in a chain-transfer event that provides novel polymers that may be further functionalized. In addition, the addition-fragmentation oligomer comprises pendent functional groups that bond to a substrate by forming an ionic or covalent bond, or etch the substrate by chemically removing some material from the substrate.

The present disclosure provides addition-fragmentation oligomers of the general formula:

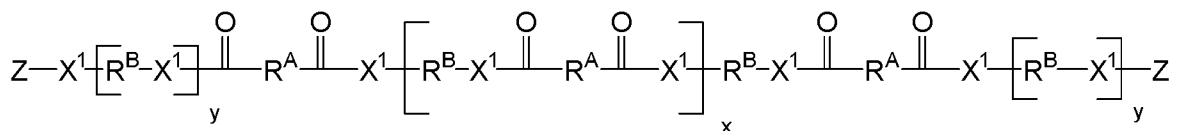

wherein

$R^A$  is non-directionally a 1-methylene-3,3-dimethyl propyl group:

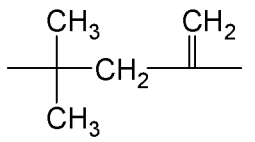

$R^B$  is hydrocarbyl group that optionally further comprises a pendent functional group D that bonds or etches a substrate to which it adheres, wherein at least two  $R^B$  units are substituted with an D group;

- 5  $X^1$  is  $-\text{O}-$  or  $\text{NR}^5-$ , where  $R^5$  is H or  $\text{C}_1\text{-C}_4$  alkyl;  
 Z comprises an ethylenically unsaturated polymerizable group;  
 y is 0 or 1;  
 x is 0 to 60, preferably 0 to 20.

When x and y are both zero, the oligomer will have three monomer units.

- 10 Preferably y is 1 or x is at least 1. In some embodiments  $x+y$  is zero to 60, and preferably 0 to 20. It will be appreciated that Formula I may be a mixture of oligomers, so the average value of x and y may be non-integral.

In some preferred embodiments the  $R^B$  may comprise a 1-methylene-3,3-dimethyl propyl group.

- 15 It is preferred that at least 50% of the  $R^A$  and/or  $R^B$  units are substituted by pendent D groups, and more preferred that at least 75% of the  $R^A$  and/or  $R^B$  units are substituted by pendent D groups.

- 20 This disclosure further provides a polymerizable composition comprising the addition-fragmentation oligomer and one or more free-radically polymerizable monomers, the addition-fragmentation oligomer providing a reduction in shrinkage and stress of the resultant polymers. The addition-fragmentation oligomers act as chain-transfer oligomers *via* an addition-fragmentation process whereby the crosslinks are labile during polymerization and continuously cleave and reform, providing a reduction in polymerization-based stress.

- 25 In some embodiments, the polymerizable composition may be used in coatings, particularly hardcoats.

In some embodiments, the present disclosure provides curable dental compositions that are self-adhesive, and require no separate etchant or etching step.

- 30 The restoration of dental structures including caries, decayed dentin or decayed enamel, is often accomplished by the sequential application of a dental adhesive and then

a dental material (e.g., a restorative material) to the relevant dental structures. Similarly, adhesives are also used in the bonding of dental materials (e.g., orthodontic appliances, generally utilizing an orthodontic adhesive) to a dental structure. Often various pretreatment processes are used to promote the bonding of dental adhesives to dentin or enamel. Typically, such pretreatment steps include etching, for example, using inorganic or organic acids, followed by priming to improve the bonding between the tooth structure and the overlying adhesive.

Whether for application of dental restoratives (e.g., cured or uncured composites such as resin-modified glass ionomers, etc.; fillings; sealants; inlays; onlays; crowns; bridges; etc.) or orthodontic appliances to a dental structure surface, the etchants, primers, and adhesives are typically applied in a step-wise fashion. One or more rinsing and drying steps may be used. As a result, dental restoration and the application of orthodontic appliances typically involve multi-step procedures.

To simplify conventional restorative and/or orthodontic procedures, for example, it would be desirable to provide a single composition that accomplishes both etching and priming. Thus, there is a need for a self-etching primer, particularly a self-etching dental primer, for improved bonding of an adhesive (e.g., a dental adhesive) to a substrate surface (e.g., dental structure, such as dentin, enamel, bone, or other hard tissue) and that could eliminate the conventional post-etching rinsing and drying steps. Furthermore, there is still a need for new compositions that can serve as self-etching adhesives, i.e., dental compositions with priming and etching properties that can be applied in a single pretreatment step. In yet other dental and orthodontic procedures, there is a need for restorative compositions (e.g., filling materials and orthodontic adhesives) that can serve as self-adhesive compositions (preferably i.e., one-part, shelf-stable compositions) that can bond to an untreated dental structure (i.e., a structure not pre-treated with an etchant, primer, or bonding agent). Preferred embodiments of the present disclosure meet these needs.

As used herein, "dental composition" refers to a material, optionally comprising filler, capable of adhering or being bonded to an oral surface. A curable dental composition can be used to bond a dental article to a tooth structure, form a coating (e.g., a sealant or varnish) on a tooth surface, be used as a restorative that is placed directly into

the mouth and cured in-situ, or alternatively be used to fabricate a prosthesis outside the mouth that is subsequently adhered within the mouth.

Curable dental compositions include, for example, adhesives (e.g., dental and/or orthodontic adhesives), cements (e.g., resin-modified glass ionomer cements, and/or orthodontic cements), primers (e.g., orthodontic primers), liners (applied to the base of a cavity to reduce tooth sensitivity), coatings such as sealants (e.g., pit and fissure), and varnishes; and resin restoratives (also referred to as direct composites) such as dental fillings, as well as crowns, bridges, and articles for dental implants. Highly filled dental compositions are also used for mill blanks, from which a crown may be milled. A composite is a highly filled paste designed to be suitable for filling substantial defects in tooth structure. Dental cements are somewhat less filled and less viscous materials than composites, and typically act as a bonding agent for additional materials, such as inlays, onlays and the like, or act as the filling material itself if applied and cured in layers. Dental cements are also used for permanently bonding dental restorations such as a crown or bridge to a tooth surface or an implant abutment.

As used herein:

"dental article" refers to an article that can be adhered (e.g., bonded) to a tooth structure or dental implant. Dental articles include, for example, crowns, bridges, veneers, inlays, onlays, fillings, orthodontic appliances and devices.

"orthodontic appliance" refers to any device intended to be bonded to a tooth structure, including, but not limited to, orthodontic brackets, buccal tubes, lingual retainers, orthodontic bands, bite openers, buttons, and cleats. The appliance has a base for receiving adhesive and it can be a flange made of metal, plastic, ceramic, or combinations thereof. Alternatively, the base can be a custom base formed from cured adhesive layer(s) (i.e. single or multi-layer adhesives).

"oral surface" refers to a soft or hard surface in the oral environment. Hard surfaces typically include tooth structure including, for example, natural and artificial tooth surfaces, bone, and the like.

"curable" is descriptive of a material or composition that can be polymerized or crosslinked by a free-radical means such as by irradiating with actinic irradiation to induce polymerization and/or crosslinking; "hardened" refers to a material or composition that has been cured (e.g., polymerized or crosslinked).

"initiator" refers to something that initiates curing of a resin. An initiator may include, for example, a polymerization initiator system, a photoinitiator system, a thermal initiator and/or a redox initiator system.

5 "self-etching" composition refers to a composition that bonds to a dental structure surface without pretreating the dental structure surface with an etchant. Preferably, a self-etching composition can also function as a self-primer wherein no separate etchant or primer are used.

10 a "self-adhesive" composition refers to a composition that is capable of bonding to a dental structure surface without pretreating the dental structure surface with a primer or bonding agent. Preferably, a self-adhesive composition is also a self-etching composition wherein no separate etchant is used.

a "dental structure surface" refers to tooth structures (e.g., enamel, dentin, and cementum) and bone.

15 an "uncut" dental structure surface refers to a dental structure surface that has not been prepared by cutting, grinding, drilling, etc.

an "untreated" dental structure surface refers to a tooth or bone surface that has not been treated with an etchant, primer, or bonding agent prior to application of a self-etching adhesive or a self-adhesive composition of the present invention.

20 an "unetched" dental structure surface refers to a tooth or bone surface that has not been treated with an etchant prior to application of a self-etching adhesive or a self-adhesive composition of the present invention.

25 "(meth)acrylate" is a shorthand reference to acrylate, methacrylate, or combinations thereof; "(meth)acrylic" is a shorthand reference to acrylic, methacrylic, or combinations thereof; and "(meth)acryl" is a shorthand reference to acryl, methacryl, or combinations thereof.

"acryloyl" is used in a generic sense and mean not only derivatives of acrylic acid, but also amine, and alcohol derivatives, respectively;

"(meth)acryloyl" includes both acryloyl and methacryloyl groups; i.e. is inclusive of both esters and amides.

30 "alkyl" includes straight-chained, branched, and cycloalkyl groups and includes both unsubstituted and substituted alkyl groups. Unless otherwise indicated, the alkyl

groups typically contain from 1 to 20 carbon atoms. Examples of "alkyl" as used herein include, but are not limited to, methyl, ethyl, n-propyl, n-butyl, n-pentyl, isobutyl, t-butyl, isopropyl, n-octyl, n-heptyl, ethylhexyl, cyclopentyl, cyclohexyl, cycloheptyl, adamantyl, and norbornyl, and the like. Unless otherwise noted, alkyl groups may be mono- or  
5 polyvalent, i.e monvalent alkyl or polyvalent alkylene.

"heteroalkyl" includes both straight-chained, branched, and cyclic alkyl groups with one or more heteroatoms independently selected from S, O, and N with both unsubstituted and substituted alkyl groups. Unless otherwise indicated, the heteroalkyl groups typically contain from 1 to 20 carbon atoms. "Heteroalkyl" is a subset of  
10 "hydrocarbyl containing one or more S, N, O, P, or Si atoms" described below. Examples of "heteroalkyl" as used herein include, but are not limited to, methoxy, ethoxy, propoxy, 3,6-dioxaheptyl, 3-(trimethylsilyl)-propyl, 4-dimethylaminobutyl, and the like. Unless otherwise noted, heteroalkyl groups may be mono- or polyvalent, i.e. monovalent heteroalkyl or polyvalent heteroalkylene.

"aryl" is an aromatic group containing 5-18 ring atoms and can contain optional fused rings, which may be saturated, unsaturated, or aromatic. Examples of an aryl groups include phenyl, naphthyl, biphenyl, phenanthryl, and anthracyl. Heteroaryl is aryl containing 1-3 heteroatoms such as nitrogen, oxygen, or sulfur and can contain fused  
15 rings. Some examples of heteroaryl groups are pyridyl, furanyl, pyrrolyl, thienyl, thiazolyl, oxazolyl, imidazolyl, indolyl, benzofuranyl, and benzthiazolyl. Unless  
20 otherwise noted, aryl and heteroaryl groups may be mono- or polyvalent, i.e. monovalent aryl or polyvalent arylene.

"hydrocarbyl" is inclusive of alkyl and aryl groups, including alkyl-substituted aryl groups (alkaryl) and aryl substituted alkyl groups (aralkyl).

"(hetero)hydrocarbyl" is inclusive of hydrocarbyl alkyl and aryl groups, and heterohydrocarbyl heteroalkyl and heteroaryl groups, the later comprising one or more catenary (in-chain) oxygen heteroatoms such as ether or amino groups. Heterohydrocarbyl may optionally contain one or more catenary (in-chain) functional groups including ester, amide, urea, urethane, and carbonate functional groups. Unless  
25 otherwise indicated, the non-polymeric (hetero)hydrocarbyl groups typically contain from  
30 1 to 60 carbon atoms. Some examples of such heterohydrocarbyls as used herein include,



but are not limited to, methoxy, ethoxy, propoxy, 4-diphenylaminobutyl, 2-(2'-phenoxyethoxy)ethyl, 3,6-dioxaheptyl, 3,6-dioxahexyl-6-phenyl, in addition to those described for "alkyl", "heteroalkyl", "aryl", and "heteroaryl" *supra*.

5 "Bonding" in the context of surface-binding functional groups refers to the formation of a covalent or ionic bond between the addition-fragmentation oligomer and the substrate.

"Etching" refers to the removal of substrate material by chemical means by the D functional groups, for example the etching of a dental substrate by an acidic D group.

## 10 **Detailed Description**

The present disclosure provides addition-fragmentation oligomers of Formula I having the following functional groups: 1) a labile addition-fragmentation group that can cleave and reform to relieve strain, 2) at least two free-radically polymerizable groups Z, and 3) at least two functional groups D that bonds to or etches a substrate to which it is adhered. In addition, the addition-fragmentation oligomers may crosslink a polymer through the Z groups. The crosslinked polymer may be crosslinked *in situ* by polymerizing the addition-fragmentation oligomer in the presence of free-radically polymerizable monomers, or an extant polymer having polymerizable groups may be combined with the addition-fragmentation oligomer and crosslinked.

20 The addition-fragmentation oligomers may be added to polymerizable monomer mixtures to reduce the polymerization-induced stresses. In some embodiments, the oligomers further function as addition-fragmentation crosslinking oligomers, where the crosslinks are labile. This disclosure further provides a method of preparing the addition-fragmentation oligomers of Formula I, as further disclosed herein.

25 This disclosure further provides a curable composition comprising the addition-fragmentation oligomers and one or more free-radically polymerizable monomers, the addition-fragmentation oligomer providing a reduction in stress of the resultant polymers. The addition-fragmentation oligomers act as chain-transfer oligomers *via* an addition-fragmentation process whereby the crosslinks are labile during polymerization and continuously cleave and reform, providing a reduction in polymerization-based stress.

30

In many embodiments effect of the addition-fragmentation functionality (stress relief) can be independent of the crosslink density by controlling the molecular weight of the oligomer. In some embodiments, the weight of addition fragmentation oligomers needed is less than a structurally equivalent (i.e. linking groups and end groups) non-oligomeric addition-fragmentation oligomer for the same level of stress relaxation. Further, the instant addition-fragmentation oligomers have higher viscosity than comparable non-oligomeric addition-fragmentation oligomer, which may be used to modify viscosity, which can be desirable for certain coating techniques, for example.

The present disclosure further provides dental compositions, dental articles, and methods of use. The dental composition comprises at least one addition-fragmentation oligomer having the following functional groups: 1) a labile addition-fragmentation group that can cleave and reform to relieve strain, 2) at least two free-radically polymerizable groups Z, and 3) at least two functional groups D that bonds to or etches a substrate to which it is adhered (such as a dental structure or article) by forming a covalent or ionic bond. Included in surface-binding groups are those that etch the dental structure or articles, such as the etching of dentin by an acidic functional group.

The addition-fragmentation oligomer is labile and free-radically cleavable. In some embodiments, the dental compositions are self-adhesive, i.e., do not require a separate step of etching with an acid to promote bonding of the dental composition to a dental structure.

In a favored embodiment, the addition-fragmentation materials ("AFM") of Formula I may be added to a dental composition comprising at least one ethylenically unsaturated monomer or oligomer.

Without intending to be bound by theory, it is surmised that the inclusion of such addition-fragmentation material reduces the polymerization-induced stresses, as it follows an addition fragmentation pathway as shown in the following Scheme 1. In this scheme the addition-fragmentation oligomeric crosslinking oligomer of Formula I is shown in simplified form with "Oligo" representing the oligomeric chain. In the step 1, a free radical species P· adds to the crosslinking oligomer. The crosslinking oligomer then fragments as shown in step 2 to form the relatively stable  $\alpha$ -carbonyl tertiary radical and the  $\alpha,\beta$ -unsaturated ester bearing the residue of the free radical species P. This  $\alpha,\beta$ -

unsaturated ester can undergo radical addition as shown in step 5. The radical addition may be initiated by an initiator or a polymer radical.

5 Concurrently the  $\alpha$ -carbonyl tertiary radical can initiate polymerization of monomer as shown in step 3. For purposes of illustration, a methacrylate monomer is illustrated. On monomer addition, a methacrylate terminated radical intermediate is produced. In the presence of the crosslinking oligomer of Formula 1 (as shown in step 4) both addition, and fragmentation, yielding a tertiary radical, occurs.

10 The bonds between the ethylenically unsaturated Z groups will form labile bonds. Fragmentation of the addition-fragmentation crosslinking oligomer provides a mechanism for crosslink cleavage. The cleavage of labile addition-fragmentation groups may allow the polymeric network to relax or reorganize, especially in high stress regions, providing a potential mechanism for stress relief.

15 Stress relief could also be a result of attenuated reaction rates (slower cure rates) in the presence of addition-fragmentation oligomers. The addition of a radical to the addition-fragmentation oligomer generates a potentially long-lived, tertiary radical (the product of step 1, Scheme 1). This long-lived radical intermediate can revert back to starting materials, add to monomer, or fragment. If fragmentation, retro-addition and monomer addition are slow relative to addition, the intermediate tertiary radical will be relatively long-lived. This long-lived radical intermediate will then act as a radical reservoir, slowing down the overall polymerization process. Attenuated cure rates could serve to delay the transition of a material from a viscous material to an elastic or viscoelastic solid, delaying the gel point. Post-gel shrinkage is a major component in stress development; therefore, delaying the gel point even slightly may lead to stress relief by allowing additional time for material to flow during the curing process. Therefore, 20 even compounds of Formula I may be used to reduce polymerization stress. 25

Scheme 1

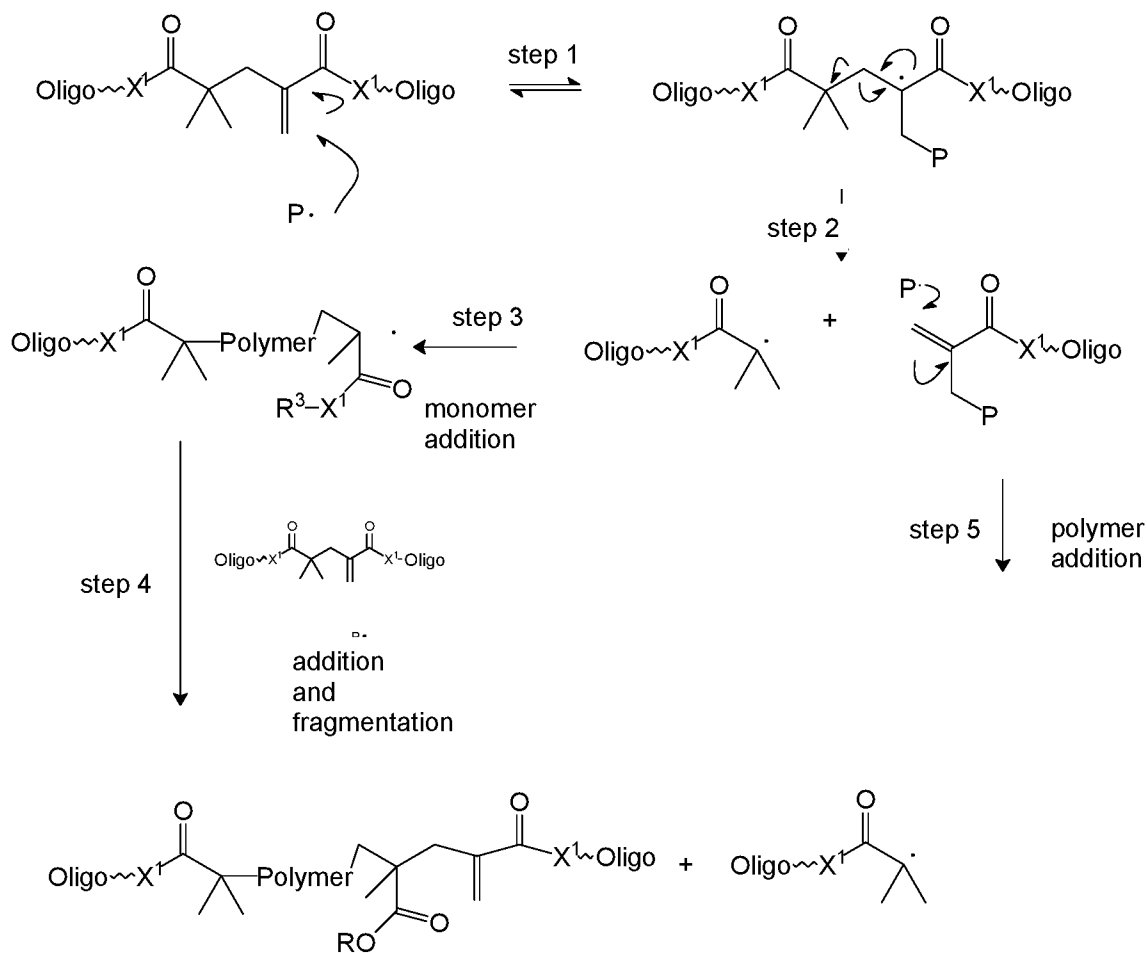

Stress relief could also be a result of attenuated reaction rates (slower cure rates) in the presence of addition-fragmentation materials. The addition of a radical to the addition-fragmentation crosslinking oligomer generates a potentially long-lived, tertiary radical (the product of step 1, Scheme 1). This long-lived radical intermediate can revert back to starting materials, add to monomer, or fragment. If fragmentation, retro-addition and monomer addition are slow relative to addition, the intermediate tertiary radical will be relatively long-lived. This long-lived radical intermediate will then act as a radical reservoir, slowing down the overall polymerization process. Attenuated cure rates could serve to delay the transition of a material from a viscous material to a viscoelastic solid, delaying the gel point. Post-gel shrinkage is a major component in stress development; therefore, delaying the gel point even slightly may lead to stress relief by allowing additional time for material to flow during the curing process.

In addition, the groups D (not shown) bond to or etch the surface of the substrate to which it as adhered.

The compounds of Formula I may be prepared from (meth)acrylate dimers by substitution, displacement or condensation reactions. The starting (meth)acrylate dimers and trimers  
 5 may be prepared by free radical addition of a (meth)acryloyl monomer in the presence of a free radical initiator and a cobalt (II) complex catalyst using the process of U.S. 4,547,323, incorporated herein by reference. Alternatively, the (meth)acryloyl dimers and trimers may be prepared using a cobalt chelate complex using the processes of U.S. 4,886,861 (Janowicz) or U.S. 5,324,879 (Hawthorne), incorporated herein by reference. In either  
 10 process, the reaction mixture can contain a complex mixture of dimers, trimers, higher oligomers and polymers and the desired dimer or trimer can be separated from the mixture by distillation. Such syntheses are further described in U.S. US2014/0113823 (Joly et al.), incorporated herein by reference and the forthcoming examples. The dimers may be described as 2,2-dimethyl-4-methylene-pentanedioic acid or derivatives thereof (or: 2,2-  
 15 dimethyl-4-methyleneglutaric acid) CAS: 10297-25-3

The addition-fragmentation oligomers of Formula I may be prepared by reaction between compounds of the formula:

a)  $R^1-O-CO-R^A-CO-O-R^1$ , "A compound" wherein  $R^A$  is a 1-methylene-3,3-dimethyl propyl group and  $R^1$  is H, an alkyl an aryl or alkyl, and is optionally substituted with a  
 20 reactive nucleophilic or electrophilic functional group, i.e.,  $R^1$  is  $R^{FG}$  (as further described herein);

and a compound of the formula:

b)  $X^2-R^B-X^2$ , "B compound", wherein  $R^B$  is a (hetero)hydrocarbyl group and  $X^2$  comprises a functional group reactive with the functional groups of the D compound,  
 25 where the B compound may comprises a bonding/etching group D, or contains a functional group that may be further reacted to provide D groups. At least two of the B groups are subsequently substituted with the etching/bonding D groups.

In some embodiments the  $R^1$  group of the A compound is  $R^{FG}$ , where  $R^{FG}$  contains a reactive functional group, reactive with the  $X^2$  groups of the B compounds and/or the  $X^3$   
 30 groups of the C compounds. More particularly,  $R^{FG}$  is an aryl or an alkyl further substituted with a nucleophilic or electrophilic functional group, such as a alkylenes or arylenes having a hydroxyl, amino, isocyanate, and other nucleophilic or electrophilic

reactive functional groups described with respect to the  $X^2$  and  $X^3$  groups. In some preferred embodiments, the A compound comprises a bis-glycidyl ester, and the B compound comprises a diol or diamine.

In some embodiments, the A compound comprises a reactive functional group,  $R^{RF}$ , comprising an epoxy group or an aziridine group, such as glycidyl esters or alkylaziridine esters of the A compounds. The B compound may be selected as having nucleophilic functional groups. Reaction between these results in a hydroxyalkyl group (from a glycidyl ester) or an aminoalkyl group (from the alkylaziridine). The amine or hydroxyl then may be further functionalized with the bonding/etching D group.

Depending on the relative amounts of the A and B monomers, the intermediate will be terminated in either  $-CO_2R^1$  groups (acid, ester or other functional group), or  $X^2$  groups. Simply, the intermediate oligomer may have the structure A-(B-A)-B-A or B-(A-B)-A-B. The functional groups of the end-capping compounds are selected to be reactive with the terminal functional groups of the intermediate.

Reaction between the A compounds and B compounds yields an intermediate oligomer of the formula:

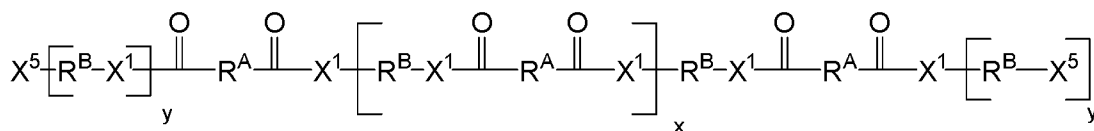

wherein

$R^A$  is non-directionally

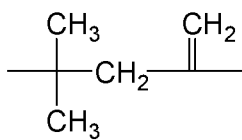

$R^B$  is a hydrocarbyl group that optionally further comprising a functional group D that bonds or etches a substrate to which it adheres, wherein at least two  $R^B$  groups are substituted with an D group;

$X^1$  is  $-O-$  or  $NR^5-$ , where  $R^5$  is H or  $C_1$ - $C_4$  alkyl;

Z comprises an ethylenically unsaturated polymerizable group;

$X^5$  is a terminal functional group selected from  $-OR^1$  of the A compounds or  $X^2$  of the B compounds;

y is 0 or 1;

x is 0 to 60.

In some embodiments, an excess of A compounds having nucleophilic functional groups are reacted with B compounds having electrophilic functional groups to provide an oligomeric intermediate having terminal nucleophilic functional groups. This  
5 intermediate is reacted with a C compound of the formula  $(Z)_d-X^3$ , where  $X^3$  is an epoxy or aziridine group. Ring-opening of the  $X^3$  group yields a hydroxy or amine group that may be further functionalized to provide the A groups.

In another embodiment, A compounds having nucleophilic functional groups are reacted with an excess of B compounds having electrophilic functional groups to provide  
10 an oligomeric intermediate having terminal electrophilic groups. This may be functionalized with C compounds having nucleophilic  $X^3$  groups. In some embodiments these terminal electrophilic functional groups are aziridine or epoxy functional groups.

In other embodiments, an excess of A compounds having electrophilic functional groups are reacted with B compounds having nucleophilic functional groups to provide an  
15 oligomeric intermediate having terminal electrophilic functional groups. This may be functionalized with C compounds having nucleophilic  $X^3$  groups. In some embodiments these terminal electrophilic functional groups are aziridine or epoxy functional groups.

In other embodiments, A compounds having electrophilic functional groups are reacted with an excess of B compounds having nucleophilic functional groups to provide  
20 an oligomeric intermediate having terminal nucleophilic functional groups. This may be reacted with C compounds having electrophilic functional groups. In some embodiments, the electrophilic functional groups of the C compound may be epoxy or aziridine functional groups.

25 In one embodiment, the A compound is a diacid, and the B compound is selected from a diisocyanate, including diisocyanate esters and amides of diacids. In another embodiment the A compound is a diacid, and the B compound is a diepoxy compound, including diepoxy esters of diacids, such as diglycidyl esters of diacids. In another  
30 embodiment, the A compound is a diacid and the B compound is a bis-aziridine compound. In another embodiment the A compound is a diester and the B compounds selected from diamines and diols.

In some embodiments the A compound comprises the diacid functional dimer of methacrylic acid 2,2-dimethyl-4-methylene-pentanedioic acid) and the B compound comprises a bis-glycidyl ester of the diacid or a bis-hydroxyalkyl ester of the diacid.

In some preferred embodiments, the reaction of an acid-functional A compound with an epoxy-functional B compound will yield a hydroxy-functional linking group. For example, reaction with a bis-glycidyl group will yield a two 2-hydroxypropyl groups, corresponding to  $R^B$  of Formula I. These pendent hydroxyl groups may be further functionalized with the bonding or etching D groups as shown in the Examples. In such cases RB may be represented as  $-\text{CH}_2-\text{CH}(\text{OH})-\text{CH}_2-\text{R}^{10}-\text{CH}_2-\text{CH}(\text{OH})-\text{CH}_2-$ , where  $R^{10}$  is a hydrocarbyl group, including alkylene and arylene. It will be understood that ring opening of the epoxide groups can also yield the isomer  $-\text{CH}(\text{CH}_2\text{OH})-\text{CH}_2-\text{R}^{10}-\text{CH}_2-\text{CH}(\text{CH}_2\text{OH})-$ , or mixtures of the two isomers.

Following preparation of the oligomeric chain by reaction between the A and B compounds, the oligomer is subsequently provided with the terminal Z groups and the pendent D groups. With functionalization of the end groups, the addition fragmentation oligomers have the general structures  $Z-A-(B-A)-B-A-Z$  or  $Z-B-(A-B)-A-B-Z$ . The ethylenically unsaturated Z groups may be provided by reaction of the A-B oligomers with a compound of the formula:

c)  $(Z)_d-X^3$ , where Z comprises an ethylenically unsaturated group, and  $X^3$  is a reactive functional group, reactive with the acid or ester groups, or the  $X^2$  groups (“C compound”) and d is 1 or 2.

The ethylenically unsaturated “Z” group may be incorporated into the A-B oligomer intermediate by means including addition, condensation, substitution and displacement reaction. The ethylenically unsaturated moiety, Z, may include, but is not limited to the following structures, including (meth)acryloyl, vinyl, styrenic and ethynyl, that are more fully described in reference to the preparation of the compounds below.

In general, the terminal ethylenically unsaturated functional groups of the oligomer is provided with the Z- group of Formula I by reaction with a compound of the general formula  $(Z)_d-X^3$  (“C compound”), where Z comprises an ethylenically unsaturated group, and  $X^3$  is reactive functional group, reactive with the acid or ester groups of the A compound, or the  $X^2$  groups of the B compound and d is 1 or 2.

More particularly, the “C” compound may be of the formula:



Y<sup>1</sup>-R<sup>3</sup>-O-CO-CR<sup>2</sup>=CH<sub>2</sub>, where Y<sup>1</sup> is an electrophilic functional group reactive with carboxylic acid groups, R<sup>3</sup> is a (hetero)hydrocarbyl group, preferably alkylene, R<sup>2</sup> is H or CH<sub>3</sub>, or of the formula Y<sup>2</sup>-R<sup>3</sup>-O-CO-CR<sup>2</sup>=CH<sub>2</sub>, where Y<sup>2</sup> is an nucleophilic functional group reactive with carboxylic ester groups or electrophilic functional groups, R<sup>3</sup> is  
 5 (hetero)hydrocarbyl group, preferably alkylene, and R<sup>2</sup> is H or CH<sub>3</sub>.

Generally, the oligomeric intermediate is reacted with an unsaturated compound of the formula:

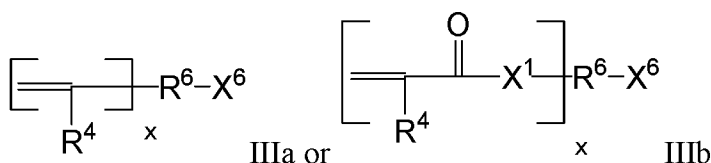

wherein

10 X<sup>6</sup> is a functional group that is co-reactive with functional group of the A or B compound, R<sup>4</sup> is hydrogen, a C<sub>1</sub> to C<sub>4</sub> alkyl group, R<sup>6</sup> is a single bond or a divalent (hetero)hydrocarbyl linking group that joins the ethylenically unsaturated group to reactive functional group X<sup>6</sup>, and x is 1 or 2.

More specifically, R<sup>6</sup> is a single bond or a divalent linking group that joins an  
 15 ethylenically unsaturated group to co-reactive functional group X<sup>6</sup> and preferably contains up to 34, preferably up to 18, more preferably up to 10, carbon atoms and, optionally, oxygen and nitrogen atoms, optional catenary ester, amide, urea, urethane and carbonate groups. When R<sup>6</sup> may further include linking groups selected from -O-, -S-, -NR<sup>4</sup>-, -SO<sub>2</sub>-, -PO<sub>2</sub>-, -CO-, -OCO-, -NR<sup>5</sup>-CO-, NR<sup>5</sup>-CO-O-, NR<sup>5</sup>-CO-NR<sup>4</sup>-, -R<sup>7</sup>- and  
 20 combinations thereof, such as -CO-O-R<sup>7</sup>-, -CO-NR<sup>5</sup>-R<sup>7</sup>-, and -R<sup>7</sup>-CO-O-R<sup>7</sup>-, wherein each R<sup>5</sup> is hydrogen, a C<sub>1</sub> to C<sub>4</sub> alkyl group, or aryl group, each R<sup>7</sup> is an alkylene group having 1 to 6 carbon atoms, a 5- or 6-membered cycloalkylene group having 5 to 10 carbon atoms, or a divalent aromatic group having 6 to 16 carbon atoms; and X<sup>6</sup> is a reactive functional group capable of reacting with a co-reactive functional group for the  
 25 incorporation of a free-radically polymerizable functional "Z" group.

It will be understood that reaction between the terminal functional groups of the oligomeric intermediate and the X<sup>6</sup> group of Formulas III will form the Z-X<sup>1</sup>- moiety of Formula I, with the proviso that -X<sup>1</sup>-Z does not contain peroxidic linkages, i.e. O-O, N-O, S-O, N-N, N-S bonds.

In reference to Formula I, particularly useful Z-X<sup>1</sup>- groups include  
 H<sub>2</sub>C=C(CH<sub>3</sub>)C(O)-O-CH<sub>2</sub>-CH(OH)-CH<sub>2</sub>-O-, H<sub>2</sub>C=C(CH<sub>3</sub>)C(O)-O-CH<sub>2</sub>-CH(O-  
 (O)C(CH<sub>3</sub>)=CH<sub>2</sub>)-CH<sub>2</sub>-O-, H<sub>2</sub>C=C(CH<sub>3</sub>)C(O)-O-CH(CH<sub>2</sub>OPh)-CH<sub>2</sub>-O-,  
 H<sub>2</sub>C=C(CH<sub>3</sub>)C(O)-O-CH<sub>2</sub>CH<sub>2</sub>-N(H)-C(O)-O-CH(CH<sub>2</sub>OPh)-CH<sub>2</sub>-O-, H<sub>2</sub>C=C(CH<sub>3</sub>)C(O)-  
 5 O-CH<sub>2</sub>-CH(O-(O)C-N(H)-CH<sub>2</sub>CH<sub>2</sub>-O-(O)C(CH<sub>3</sub>)C=CH<sub>2</sub>)-CH<sub>2</sub>-O-, H<sub>2</sub>C=C(H)C(O)-O-  
 (CH<sub>2</sub>)<sub>4</sub>-O-CH<sub>2</sub>-CH(OH)-CH<sub>2</sub>-O-, H<sub>2</sub>C=C(CH<sub>3</sub>)C(O)-O-CH<sub>2</sub>-CH(O-(O)C-N(H)-CH<sub>2</sub>CH<sub>2</sub>-  
 O-(O)C(CH<sub>3</sub>)C=CH<sub>2</sub>)-CH<sub>2</sub>-O-, CH<sub>3</sub>-(CH<sub>2</sub>)<sub>7</sub>-CH(O-(O)C-N(H)-CH<sub>2</sub>CH<sub>2</sub>-O-  
 (O)C(CH<sub>3</sub>)C=CH<sub>2</sub>)-CH<sub>2</sub>-O-, H<sub>2</sub>C=C(H)C(O)-O-(CH<sub>2</sub>)<sub>4</sub>-O-CH<sub>2</sub>-CH(-O-(O)C(H)=CH<sub>2</sub>)-  
 CH<sub>2</sub>-O- and H<sub>2</sub>C=C(H)C(O)-O-CH<sub>2</sub>-CH(OH)-CH<sub>2</sub>-O-. H<sub>2</sub>C=C(H)C(O)-O-(CH<sub>2</sub>)<sub>4</sub>-O-  
 10 CH<sub>2</sub>-CH(-O-(O)C(H)=CH<sub>2</sub>)-CH<sub>2</sub>-O-, and CH<sub>3</sub>-(CH<sub>2</sub>)<sub>7</sub>-CH(O-(O)C-N(H)-CH<sub>2</sub>CH<sub>2</sub>-O-  
 (O)C(CH<sub>3</sub>)C=CH<sub>2</sub>)-CH<sub>2</sub>-O- .

In many embodiments, R<sup>6</sup> is a 2-hydroxypropyl group derived from a glycidyl  
 group. The hydroxy group thereof may be further (meth)acrylated to provided additional  
 polymerizable groups to the oligomer. Such (meth)acrylate groups may be provided by  
 15 reaction of the hydroxyl with (meth)acrylate esters, or with hydroxy-reactive functional  
 esters such as isocyanatoalkyl esters.

In some embodiments, the intermediate oligomer from the A and B compounds has  
 terminal epoxy groups, such as when a nucleophilic functional A compound is reacted  
 with an excess of diepoxy B compound. This oligomeric intermediate may be represented  
 20 as Epoxy-B-(A-B)-A-B-Epoxy. This intermediate may be functionalized with a C  
 compound of the formula (Z)<sub>d</sub>-X<sup>3</sup>, where the X<sup>3</sup> group is a nucleophilic group reactive  
 with the terminal epoxy groups and may be further functionalized to provide the requisite  
 D groups. Reaction between the oligomeric intermediate and the nucleophilic C  
 compound ring-open the terminal epoxy groups, provide the requisite terminal Z groups,  
 25 and further provide a pendent hydroxy group, that may be further functionalized with  
 electrophilic D compounds to provide the D groups.

Similarly, an excess of diaziridine B compound may be so reacted to provide an  
 intermediate oligomer having terminal aziridine groups that may be reacted with a C  
 compound having nucleophilic functional groups, which ring-open the aziridine to provide  
 30 amine groups that may be further functionalized to provide the A groups.

With respect to the oligomer in which compound A is in excess, the terminal  
 carboxylic acids (when R<sup>1</sup> = H) may first be reacted with an epoxy or aziridinyl

compound, and subsequently (meth)acrylated, or, reacted with an aziridine- or epoxy-functional (meth)acrylate, as illustrated in the following Scheme II. It will be understood that different isomers from those depicted may result from the ring-opening. In Scheme III, transverse methyl groups are indicated as attached to either of the adjacent carbon atoms. Note also the reaction with methylaziridine may result in a mixture of acrylate and acrylamide products.

Scheme II

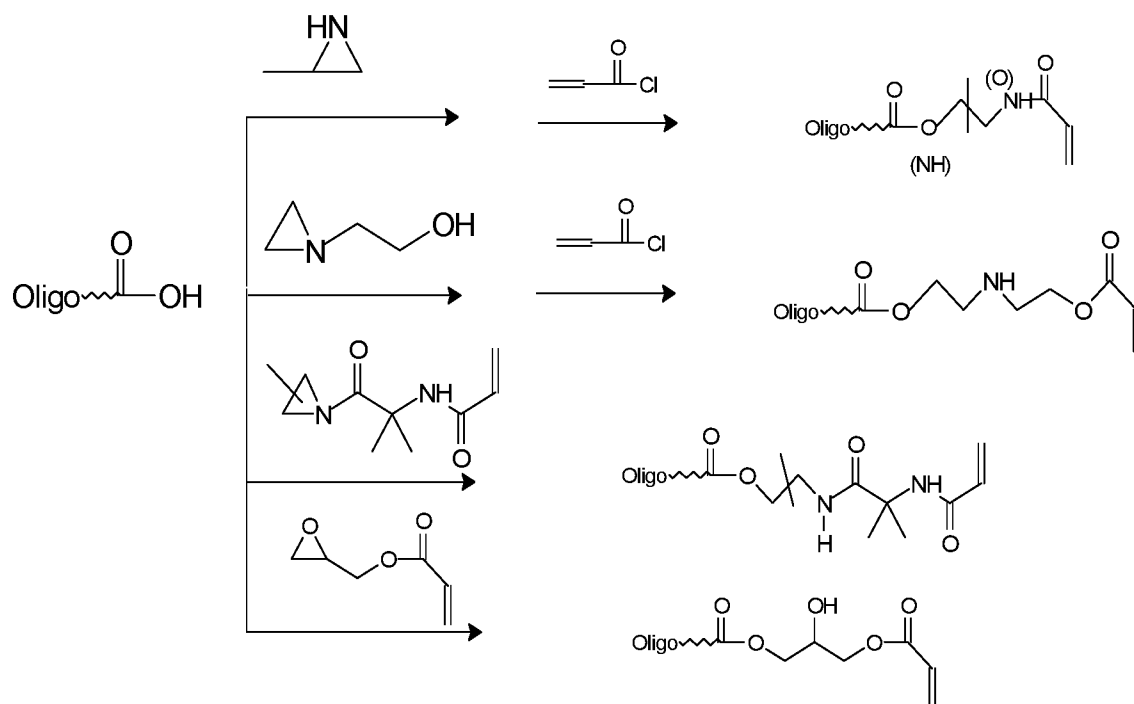

Representative examples of useful ethylenically unsaturated “C” compounds having co-reactive functional groups include hydroxyalkyl (meth)acrylates such as 2-hydroxyethyl (meth)acrylate, 3-hydroxypropyl (meth)acrylate, 2, 3-dihydroxypropyl (meth)acrylate, 4-hydroxybutyl (meth)acrylate and 2-(2-hydroxyethoxy)ethyl (meth)acrylate; aminoalkyl (meth)acrylates such as 3-aminopropyl (meth)acrylate and 4-aminostyrene; oxazolanyl compounds such as 2-ethenyl-1,3-oxazolin-5-one, 2-vinyl-4,4-dimethyl-1,3-oxazolin-5-one, 2-isopropenyl-4,4-dimethyl-1,3-oxazolin-5-one and 2-propenyl-4,4-dimethyl-1,3-oxazolin-5-one; carboxy-substituted compounds such as (meth)acrylic acid and 4-carboxybenzyl (meth)acrylate; isocyanato-substituted compounds such as isocyanatoethyl (meth)acrylate and 4-isocyanatocyclohexyl (meth)acrylate; epoxy-substituted compounds such as glycidyl (meth)acrylate and 4-

hydroxybutyl (meth)acrylate; aziridinyl-substituted compounds such as N-acryloylaziridine and 1-(2-propenyl)-aziridine; and acryloyl halides such as (meth)acryloyl chloride.

5 Representative hydroxyl group-substituted functional compounds of Formula III include the hydroxyalkyl acrylates and hydroxyalkyl acrylamides such as 2-hydroxyethyl (meth)acrylate, 4-hydroxybutyl (meth)acrylate, 2-hydroxypropyl (meth)acrylate, 3-chloro-2-hydroxypropylmethyl (meth)acrylate, 2-hydroxyethyl (meth)acrylamide, 4-hydroxycyclohexyl (meth)acrylate, 3-acryloyloxyphenol, 2-(4-(meth)acryloyloxyphenyl)-2-(4-hydroxyphenyl)propane (also called bisphenol A mono(meth)acrylate), 2-propyn-1-ol, and 3-butyn-1-ol.

10 Representative amino group-substituted functional compounds of Formula III include 2-methyl aminoethyl (meth)acrylate, 3-aminopropyl (meth)acrylate, 4-aminocyclohexyl (meth)acrylate, N-(3-aminophenyl) (meth)acrylamide, N-(meth)acryloylethylenediamine, and 4-aminophenyl-4-acrylamidophenylsulfone.

15 Representative azlactone group-substituted functional compounds of Formula III include: 2-ethenyl-1,3-oxazolin-5-one; 2-ethenyl-4-methyl-1,3-oxazolin-5-one; 2-isopropenyl-1,3-oxazolin-5-one; 2-isopropenyl-4-methyl-1,3-oxazolin-5-one; 2-ethenyl-4,4-dimethyl-1,3-oxazolin-5-one; 2-isopropenyl-4,4-dimethyl-1,3-oxazolin-5-one; 2-ethenyl-4-methyl-4-ethyl-1,3-oxazolin-5-one; 2-isopropenyl-3-oxa-1-aza[4.5]spirodec-1-ene-4-one; 2-ethenyl-5,6-dihydro-4H-1,3-oxazin-6-one; 2-ethenyl-4,5,6,7-tetrahydro-1,3-oxazepin-7-one; 2-isopropenyl-5,6-dihydro-5,5-di(2-methylphenyl)-4H-1,3-oxazin-6-one; 2-acryloyloxy-1,3-oxazolin-5-one; 2-(2-acryloyloxy)ethyl-4,4-dimethyl-1,3-oxazolin-5-one; 2-ethenyl-4,5-dihydro-6H-1,3-oxazin-6-one; and 2-ethenyl-4,5-dihydro-4,4-dimethyl-6H-1,3-oxazin-6-one.

25 Representative oxazolinyl group-substituted functional compounds of Formula III include 2-vinyl-2-oxazoline, 2-isopropenyl-2-oxazoline, 2-(5-hexenyl)-2-oxazoline, 2-acryloxy-2-oxazoline, 2-(4-acryloxyphenyl)-2-oxazoline, and 2-methacryloxy-2-oxazoline.

30 Representative acetoacetyl group-substituted functional compounds of Formula III include 2-(acetoacetoxy)ethyl acrylate.

Representative carboxyl group-substituted functional compounds of Formula III include (meth)acrylic acid, 3-(meth)acryloyloxy-propionic acid, 4-(meth)acryloyloxy-

butyric acid, 2-(meth)acryloyloxy-benzoic acid, 3- (meth)acryloyloxy-5-methyl benzoic acid, 4-(meth)acryloyloxymethyl-benzoic acid, phthalic acid mono-[2-(meth)acryloyloxy-ethyl]ester, 2-butynoic acid, and 4-pentynoic acid.

5 Representative isocyanate group-substituted functional compounds of Formula III include 2-isocyanatoethyl (meth)acrylate, 3-isocyanatopropyl (meth)acrylate, 4-isocyanatocyclohexyl (meth)acrylate, 4-isocyanatostyrene, 2- methyl-2-propenoyl isocyanate, 4-(2-(meth)acryloyloxyethoxycarbonylamino) phenylisocyanate, allyl 2-isocyanatoethylether, and 3-isocyanato-1-propene.

10 Representative epoxy group-substituted functional compounds of Formula III include glycidyl (meth)acrylate, thioglycidyl (meth)acrylate, 3-(2,3- epoxypropoxy)phenyl (meth)acrylate, 2-[4-(2,3-epoxypropoxy)phenyl]-2-(4- (meth)acryloyloxy-phenyl)propane, 4-(2,3-epoxypropoxy)cyclohexyl (meth)acrylate, 2,3-epoxycyclohexyl (meth)acrylate, 4-hydroxybutyl (meth)acrylate and 3,4-epoxycyclohexyl (meth)acrylate.

15 Representative aziridinyl group-substituted functional compounds of Formula III include N-(meth)acryloylaziridine, 2-(1-aziridinyl)ethyl (meth)acrylate, 4-(1-aziridinyl)butyl acrylate, 2-[2-(1-aziridinyl)ethoxy]ethyl (meth)acrylate, 2-[2-(1-aziridinyl)ethoxycarbonylamino]ethyl (meth)acrylate, 12-[2-(2,2,3,3-tetramethyl-1-aziridinyl)ethoxycarbonylamino] dodecyl (meth)acrylate, and 1-(2-propenyl)aziridine.

20 Representative acyl halide group-substituted functional compounds of Formula III include (meth)acryloyl chloride,  $\alpha$ -chloro(meth)acryloyl chloride, (meth)acryloyloxyacetyl chloride, 5-hexenoyl chloride, 2-(acryloyloxy) propionyl chloride, 3-(acryloylthioxy) propionoyl chloride, and 3-(N- acryloyl-N-methylamino) propionoyl chloride.

25 Representative anhydride group-substituted functional monomers include maleic anhydride, (meth)acrylic anhydride, itaconic anhydride, 3- (meth)acryloyloxyphthalic anhydride, and 2-(meth)acryloxycyclohexanedicarboxylic acid anhydride.

30 Preferred ethylenically unsaturated compounds having a reactive functional group (“functional acryl compounds”) include hydroxyalkyl acrylates such as 2-hydroxyethyl (meth)acrylate and 2-(2-hydroxyethoxy)ethyl (meth)acrylate; aminoalkyl (meth)acrylates such as 3-aminopropyl (meth)acrylate, 3-aminopropyl meth(acrylamide) and 4-aminostyrene; oxazolinyll compounds such as 2-ethenyl-1,3-oxazolin-5-one and 2-propenyl-4,4-dimethyl-1,3-oxazolin-5-one; carboxy-substituted compounds such as

(meth)acrylic acid and 4-carboxybenzyl (meth)acrylate; isocyanato-substituted compounds such as isocyanatoethyl (meth)acrylate and 4-isocyanatocyclohexyl (meth)acrylate; epoxy-substituted compounds such as glycidyl (meth)acrylate; aziridinyl-substituted compounds such as N-acryloylaziridine and 1-(2-propenyl)-aziridine; and  
 5 acryloyl halides such as (meth)acryloyl chloride.

Similar to incorporation of the Z group, a portion of the R<sup>B</sup> units may be reacted with a compound of the formula: D-X<sup>4</sup> (Formula VI, Compound D), where D comprises the bonding or etching group and X<sup>4</sup> is a reactive functional group, reactive with the reactive functional groups on the B monomer units of the oligomer. As described for the Z  
 10 group, the requisite D group may be incorporated into the intermediate by means including addition, condensation, substitution and displacement reaction. Once functionalized, the pendent D groups may be represented as D-X<sup>4\*</sup>, where X<sup>4\*</sup> represents the linking groups resulting from reaction between the electrophilic and nucleophilic functional groups.

More particularly, the D compound of Formula VI may be of the formula:

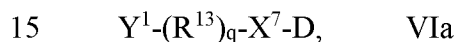

where Y<sup>1</sup> is an electrophilic functional group reactive with nucleophilic X<sup>2</sup> groups or nucleophilic groups on the B units, R<sup>13</sup> is a (hetero)hydrocarbyl group, preferably alkylene, q is 0 or 1, X<sup>7</sup> is selected from a covalent bond or a divalent linking group including -O-, -O-CO-, -O-CO-NH-, -S-, -NH-, -NH-CO-, -NH-CO-NH-, -NH-CO-O-, -  
 20 O-CO-NH

and D is a functional group that bonds or etches the underlying substrate;  
 or is of the formula.

Alternatively, the D compound is of the formula

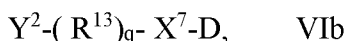

where Y<sup>2</sup> is a nucleophilic functional group reactive with electrophilic X<sup>2</sup> groups or electrophilic groups on the B units, R<sup>13</sup> is (hetero)hydrocarbyl group, preferably alkylene, q is 0 or 1, X<sup>7</sup> is selected from a covalent bond or a divalent linking group including -O-, -O-CO-, -O-CO-NH-, -S-, -NH-, -NH-CO-, -NH-CO-NH-, -NH-CO-O-, -O-CO-NH  
 and D is a functional group that bonds or etches the underlying substrate.

30 As will be understood, functionalization with the compounds of Formulas VIa,b will yield pendent D groups with the linking group Y<sup>1\*</sup> or Y<sup>2\*</sup>, where Y<sup>1\*</sup> or Y<sup>2\*</sup> represents

the linking groups resulting from reaction between the electrophilic and nucleophilic functional groups.

Useful  $Y^1$  and  $Y^2$  groups of compounds of formula VIa,b include hydroxyl, amino, oxazolinyl, oxazolonyl, acetyl, acetonyl, carboxyl, isocyanato, epoxy, aziridinyl, acyl halide, halide and cyclic anhydride groups. Where the reactive functional group  $X^2$  is an isocyanato functional group, the co-reactive functional  $Y^2$  group preferably comprises a amino or hydroxyl group. Where the pendent reactive functional group  $X^2$  comprises a hydroxyl group, the co-reactive functional group  $Y^1$  preferably comprises a carboxyl, ester, acyl halide, isocyanato, epoxy, anhydride, azlactonyl or oxazolinyl group. Where the pendent reactive functional group comprises a  $X^2$  carboxyl group, the co-reactive functional  $Y^2$  group preferably comprises a hydroxyl, amino, epoxy, isocyanate, or oxazolinyl group.

With further respect to Formulas VIa,b, useful D groups that may bond or self-etch include a monophosphate, a phosphonate, a phosphonic acid, a hydroxamic acid, a carboxylic acid, and acetoacetate, an anhydride, an isonitrile group, a silyl, a disulfide, a sulfinic acid, a sulfonic acid, or a phosphine. Of particular interest in dental applications are those D groups that can bond to, etch, or otherwise associated with a dental structure. Preferred D groups include a monophosphate, a phosphonate, a phosphonic acid, and a carboxylic acid.

In another embodiment, D is a silyl group of the formula  $-\text{SiR}^7_3$ , wherein each  $R^7$  group is independently selected from the group of alkoxy, acetoxy, and halide. Such silyl-functional addition fragmentation oligomers may bond to silica fillers or other ceramic materials of dental devices and compositions.

The present disclosure further provides a polymerizable composition comprising the addition-fragmentation oligomer of Formula I, and at least one polymerizable monomer, such as (meth)acryloyl monomers, including acrylate esters, amides, and acids to produce (meth)acrylate homo- and copolymers. Generally, the addition-fragmentation oligomer of Formula I is used in amounts of 0.1 to 10 parts by weight, preferably 0.1 to 5 parts by weight, based on 100 parts by weight of total monomer.

The (meth)acrylate ester monomer useful in preparing the (meth)acrylate polymer is a monomeric (meth)acrylic ester of a non-tertiary alcohol, which alcohol contains from 1 to 14 carbon atoms and preferably an average of from 4 to 12 carbon atoms.

Examples of monomers suitable for use as the (meth)acrylate ester monomer include the esters of either acrylic acid or methacrylic acid with non-tertiary alcohols such as ethanol, 1-propanol, 2-propanol, 1-butanol, 2-butanol, 1-pentanol, 2-pentanol, 3-pentanol, 2-methyl-1-butanol, 3-methyl-1-butanol, 1-hexanol, 2-hexanol, 2-methyl-1-pentanol, 3-methyl-1-pentanol, 2-ethyl-1-butanol, 3,5,5-trimethyl-1-hexanol, 3-heptanol, 1-octanol, 2-octanol, isooctylalcohol, 2-ethyl-1-hexanol, 1-decanol, 2-propylheptanol, 1-dodecanol, 1-tridecanol, 1-tetradecanol, citronellol, dihydrocitronellol, and the like. In some embodiments, the preferred (meth)acrylate ester monomer is the ester of (meth)acrylic acid with butyl alcohol or isooctyl alcohol, or a combination thereof, although combinations of two or more different (meth)acrylate ester monomer are suitable. In some embodiments, the preferred (meth)acrylate ester monomer is the ester of (meth)acrylic acid with an alcohol derived from a renewable source, such as 2-octanol, citronellol, or dihydrocitronellol.

In some embodiments it is desirable for the (meth)acrylic acid ester monomer to include a high  $T_g$  monomer. The homopolymers of these high  $T_g$  monomers have a  $T_g$  of at least 25°C, and preferably at least 50°C. Examples of suitable monomers useful in the present invention include, but are not limited to, t-butyl acrylate, methyl methacrylate, ethyl methacrylate, isopropyl methacrylate, n-butyl methacrylate, isobutyl methacrylate, s-butyl methacrylate, t-butyl methacrylate, stearyl methacrylate, phenyl methacrylate, cyclohexyl methacrylate, isobornyl acrylate, isobornyl methacrylate, benzyl methacrylate, 3,3,5 trimethylcyclohexyl acrylate, cyclohexyl acrylate, N-octyl acrylamide, and propyl methacrylate or combinations.

The (meth)acrylate ester monomer is present in an amount of up to 100 parts by weight, preferably 85 to 99.5 parts by weight based on 100 parts total monomer content used to prepare the polymer, exclusive of the amount of multifunctional (meth)acrylates. Preferably (meth)acrylate ester monomer is present in an amount of 90 to 95 parts by weight based on 100 parts total monomer content. When high  $T_g$  monomers are included, the copolymer may include up to 50 parts by weight, preferably up to 20 parts by weight of the (meth)acrylate ester monomer component.

The polymer may further comprise an acid functional monomer, where the acid functional group may be an acid *per se*, such as a carboxylic acid, or a portion may be a salt thereof, such as an alkali metal carboxylate. Useful acid functional monomers



include, but are not limited to, those selected from ethylenically unsaturated carboxylic acids, ethylenically unsaturated sulfonic acids, ethylenically unsaturated phosphonic or phosphoric acids, and mixtures thereof. Examples of such compounds include those selected from acrylic acid, methacrylic acid, itaconic acid, fumaric acid, crotonic acid, 5 citraconic acid, maleic acid, oleic acid,  $\beta$ -carboxyethyl (meth)acrylate, 2-sulfoethyl methacrylate, styrene sulfonic acid, 2-acrylamido-2-methylpropanesulfonic acid, vinylphosphonic acid, and mixtures thereof.

Due to their availability, acid functional monomers of the acid functional copolymer are generally selected from ethylenically unsaturated carboxylic acids, i.e. 10 (meth)acrylic acids. When even stronger acids are desired, acidic monomers include the ethylenically unsaturated sulfonic acids and ethylenically unsaturated phosphonic acids. The acid functional monomer is generally used in amounts of 0.5 to 15 parts by weight, preferably 1 to 15 parts by weight, most preferably 5 to 10 parts by weight, based on 100 parts by weight total monomer.

15 The polymer may further comprise a polar monomer. The polar monomers useful in preparing the copolymer are both somewhat oil soluble and water soluble, resulting in a distribution of the polar monomer between the aqueous and oil phases in an emulsion polymerization. As used herein the term "polar monomers" are exclusive of acid functional monomers.

20 Representative examples of suitable polar monomers include but are not limited to 2-hydroxyethyl (meth)acrylate; N-vinylpyrrolidone; N-vinylcaprolactam; acrylamide; mono- or di-N-alkyl substituted acrylamide; t-butyl acrylamide; dimethylaminoethyl acrylamide; N-octyl acrylamide; poly(alkoxyalkyl) (meth)acrylates including 2-(2-ethoxyethoxy)ethyl (meth)acrylate, 2-ethoxyethyl (meth)acrylate, 2-methoxyethoxyethyl 25 (meth)acrylate, 2-methoxyethyl methacrylate, polyethylene glycol mono(meth)acrylates; alkyl vinyl ethers, including vinyl methyl ether; and mixtures thereof. Preferred polar monomers include those selected from the group consisting of 2-hydroxyethyl (meth)acrylate and N-vinylpyrrolidinone. The polar monomer may be present in amounts of 0 to 10 parts by weight, preferably 0.5 to 5 parts by weight, based on 100 parts by 30 weight total monomer.

The polymer may further comprise a vinyl monomer. When used, vinyl monomers useful in the (meth)acrylate polymer include vinyl esters (e.g., vinyl acetate and vinyl

propionate), styrene, substituted styrene (e.g.,  $\alpha$ -methyl styrene), vinyl halide, and mixtures thereof. As used herein vinyl monomers are exclusive of acid functional monomers, acrylate ester monomers and polar monomers. Such vinyl monomers are generally used at 0 to 5 parts by weight, preferably 1 to 5 parts by weight, based on 100 parts by weight total monomer.

A multifunctional (meth)acrylate may be incorporated into the blend of polymerizable monomers. Examples of useful multifunctional (meth)acrylates include, but are not limited to, di(meth)acrylates, tri(meth)acrylates, and tetra(meth)acrylates, such as 1,6-hexanediol di(meth)acrylate, poly(ethylene glycol) di(meth)acrylates, polybutadiene di(meth)acrylate, polyurethane di(meth)acrylates, and propoxylated glycerin tri(meth)acrylate, and mixtures thereof. The amount and identity of multifunctional (meth)acrylate is tailored depending upon application of the adhesive composition, for example, adhesives, hardcoats or dental resins. Typically, the multifunctional (meth)acrylate is present in amounts up to 100 parts based on the weight of remaining polymerizable composition. In some embodiments the multifunctional (meth)acrylate is used in amounts of 50 parts by weight or more, based on the weight of remaining polymerizable composition. In some embodiments, the crosslinker may be present in amounts from 0.01 to 5 parts, preferably 0.05 to 1 parts, based on 100 parts total monomers of the adhesive composition for adhesive applications, and greater amounts for hardcoats or dental resins, as described herein.

In such embodiments, the copolymer may comprise:

- i. up to 100 parts by weight, preferably 85 to 99.5 parts by weight of an (meth)acrylic acid ester;
  - ii. 0 to 15 parts by weight, preferably 0.5 to 15 parts by weight of an acid functional ethylenically unsaturated monomer;
  - iii. 0 to 15 parts by weight of a non-acid functional, ethylenically unsaturated polar monomer;
  - iv. 0 to 5 parts vinyl monomer;
  - v. 0 to 100 parts of a multifunctional (meth)acrylate, relative to i-iv;
  - vi. 0 to 5 parts of a polymerizable photoinitiator.
- based on 100 parts by weight total monomer.

The composition may be polymerized with either a thermal initiator or photoinitiator. Any conventional free radical initiator may be used to generate the initial radical. Examples of suitable thermal initiators include peroxides such as benzoyl peroxide, dibenzoyl peroxide, dilauryl peroxide, cyclohexane peroxide, methyl ethyl ketone peroxide, hydroperoxides, e.g., tert-butyl hydroperoxide and cumene hydroperoxide, dicyclohexyl peroxydicarbonate, 2,2'-azo-bis(isobutyronitrile), and t-butyl perbenzoate. Examples of commercially available thermal initiators include initiators available from DuPont Specialty Chemical (Wilmington, Del.) under the VAZO trade designation including VAZO™ 67 (2,2'-azo-bis(2-methylbutyronitrile)) VAZO™ 64 (2,2'-azo-bis(isobutyronitrile)) and VAZO™ 52 (2,2'-azo-bis(2,2-dimethylvaleronitrile)), and Lucidol™ 70 from Elf Atochem North America, Philadelphia, Pa.

Useful photoinitiators include benzoin ethers such as benzoin methyl ether and benzoin isopropyl ether; substituted acetophenones such as 2, 2-dimethoxyacetophenone, available as Irgacure™ 651 photoinitiator (Ciba Specialty Chemicals), 2,2 dimethoxy-2-phenyl-1-phenylethanone, available as Esacure™ KB-1 photoinitiator (Sartomer Co.; West Chester, PA), and dimethoxyhydroxyacetophenone; substituted  $\alpha$ -ketols such as 2-methyl-2-hydroxy propiophenone; aromatic sulfonyl chlorides such as 2-naphthalene-sulfonyl chloride; and photoactive oximes such as 1-phenyl-1,2-propanedione-2-(O-ethoxy-carbonyl)oxime. Particularly preferred among these are the substituted acetophenones.

The initiator is used in an amount effective to facilitate free radical addition to the addition-fragmentation crosslinking oligomer and the amount will vary depending upon, e.g., the type of initiator, and the molecular weight of the polymer and the degree of functionalization desired. The initiators can be used in amounts from about 0.001 part by weight to about 5 parts by weight based on 100 parts total monomer.

The curable composition may also include other additives. Examples of suitable additives include tackifiers (e.g., rosin esters, terpenes, phenols, and aliphatic, aromatic, or mixtures of aliphatic and aromatic synthetic hydrocarbon resins), surfactants, plasticizers (other than physical blowing agents), nucleating agents (e.g., talc, silica, or TiO<sub>2</sub>), pigments, dyes, reinforcing agents, solid fillers, stabilizers (e.g., UV stabilizers), and combinations thereof. The additives may be added in amounts sufficient to obtain the

desired properties for the cured composition being produced. The desired properties are largely dictated by the intended application of the resultant polymeric article.

Adjuvants may optionally be added to the compositions such as colorants, abrasive granules, anti-oxidant stabilizers, thermal degradation stabilizers, light stabilizers, 5  
conductive particles, tackifiers, flow agents, bodying agents, flattening agents, inert fillers, binders, blowing agents, fungicides, bactericides, surfactants, plasticizers, rubber tougheners and other additives known to those skilled in the art. They also can be substantially unreactive, such as fillers, both inorganic and organic. These adjuvants, if present, are added in an amount effective for their intended purpose.

10 In some embodiments, a toughening agent may be used. The toughening agents which are useful in the present invention are polymeric compounds having both a rubbery phase and a thermoplastic phase such as: graft polymers having a polymerized, diene, rubbery core and a polyacrylate, polymethacrylate shell; graft polymers having a rubbery, polyacrylate core with a polyacrylate or polymethacrylate shell; and elastomeric particles 15  
polymerized in situ in the epoxide from free radical polymerizable monomers and a copolymerizable polymeric stabilizer.

Examples of useful toughening agents of the first type include graft copolymers having a polymerized, diene, rubbery backbone or core to which is grafted a shell of an acrylic acid ester or methacrylic acid ester, monovinyl aromatic hydrocarbon, or a mixture 20  
thereof, such as disclosed in U.S. 3,496,250 (Czerwinski), incorporated herein by reference. Preferable rubbery backbones comprise polymerized butadiene or a polymerized mixture of butadiene and styrene. Preferable shells comprising polymerized methacrylic acid esters are lower alkyl (C<sub>1</sub>-C<sub>4</sub>) substituted methacrylates. Preferable monovinyl aromatic hydrocarbons are styrene, alphasubstituted styrene, vinyltoluene, 25  
vinylxylene, ethylvinylbenzene, isopropylstyrene, chlorostyrene, dichlorostyrene, and ethylchlorostyrene. It is important that the graft copolymer contain no functional groups that would poison the catalyst.

Examples of useful toughening agents of the second type are acrylate core-shell graft copolymers wherein the core or backbone is a polyacrylate polymer having a glass 30  
transition temperature below about 0° C, such as polybutyl acrylate or polyisooctyl acrylate to which is grafted a polymethacrylate polymer (shell) having a glass transition above about 25° C, such as polymethylmethacrylate.

The third class of toughening agents useful in the invention comprises elastomeric particles that have a glass transition temperature ( $T_g$ ) below about 25 ° C before mixing with the other components of the composition. These elastomeric particles are polymerized from free radical polymerizable monomers and a copolymerizable polymeric stabilizer that is soluble in the resins. The free radical polymerizable monomers are ethylenically unsaturated monomers or diisocyanates combined with coreactive difunctional hydrogen compounds such as diols, diamines, and alkanolamines.

Useful toughening agents include core/shell polymers such as methacrylate-butadiene-styrene (MBS) copolymer wherein the core is crosslinked styrene/butadiene rubber and the shell is polymethylacrylate (for example, ACRYLOID KM653 and KM680, available from Rohm and Haas, Philadelphia, PA), those having a core comprising polybutadiene and a shell comprising poly(methyl methacrylate) (for example, KANE ACE M511, M521, B11A, B22, B31, and M901 available from Kaneka Corporation, Houston, TX and CLEARSTRENGTH C223 available from ATOFINA, Philadelphia, PA), those having a polysiloxane core and a polyacrylate shell (for example, CLEARSTRENGTH S-2001 available from ATOFINA and GENIOPERL P22 available from Wacker-Chemie GmbH, Wacker Silicones, Munich, Germany), those having a polyacrylate core and a poly(methyl methacrylate) shell (for example, PARALOID EXL2330 available from Rohm and Haas and STAPHYLOID AC3355 and AC3395 available from Takeda Chemical Company, Osaka, Japan), those having an MBS core and a poly(methyl methacrylate) shell (for example, PARALOID EXL2691A, EXL2691, and EXL2655 available from Rohm and Haas) and the like and mixtures thereof. Preferred modifiers include the above-listed ACRYLOID and PARALOID modifiers and the like, and mixtures thereof.

The toughening agent is useful in an amount equal to about 1-35%, preferably about 3-25%, based on the weight of the curable composition. The toughening agents of the instant invention add strength to the composition after curing without reacting with the component of the curable composition or interfering with curing.

In some embodiments, the partially cured composition may be disposed between two substrates (or adherends), and subsequently fully cured to effect a structural or semistructural bond between the substrates. Therefore the present disclosure provides structural and semi-structural adhesives. "Semi-structural adhesives" are those cured

adhesives that have an overlap shear strength of at least about 0.5 MPa, more preferably at least about 1.0 MPa, and most preferably at least about 1.5 MPa. Those cured adhesives having particularly high overlap shear strength, however, are referred to as structural adhesives. "Structural adhesives" are those cured adhesives that have an overlap shear strength of at least about 3.5 MPa, more preferably at least about 5 MPa, and most preferably at least about 7 MPa.

#### Fillers

In some embodiments the crosslinkable composition may include filler. In some embodiments the total amount of filler is at most 50 wt.%, preferably at most 30 wt.%, and more preferably at most 10 wt.% filler. Fillers may be selected from one or more of a wide variety of materials, as known in the art, and include organic and inorganic filler. Inorganic filler particles include silica, submicron silica, zirconia, submicron zirconia, and non-vitreous microparticles of the type described in U.S. Pat. No. 4,503,169 (Randklev).

Filler components include nanosized silica particles, nanosized metal oxide particles, and combinations thereof. Nanofillers are also described in U.S. 7,090,721 (Craig et al.), 7,090,722 (Budd et al.), 7,156,911(Kangas et al.), and 7,649,029 (Kolb et al.).

In some embodiments the filler may be surface modified. A variety of conventional methods are available for modifying the surface of nanoparticles including, e.g., adding a surface-modifying agent to nanoparticles (e.g., in the form of a powder or a colloidal dispersion) and allowing the surface-modifying agent to react with the nanoparticles. Other useful surface-modification processes are described in, e.g., U.S. Pat. No. 2,801,185 (Iler), U.S. Pat. No. 4,522,958 (Das et al.) U.S. 6,586,483 (Kolb et al.), each incorporated herein by reference.

Surface-modifying groups may be derived from surface-modifying agents. Schematically, surface-modifying agents can be represented by the formula X-Y, where the X group is capable of attaching to the surface of the particle (i.e., the silanol groups of a silica particle) and the Y group is a reactive or non-reactive functional group. A non-functional group does not react with other components in the system (e.g. the substrate). Non-reactive functional groups can be selected to render the particle relatively more polar, relatively less polar or relatively non-polar. In some embodiments the non-reactive functional group "B" is a hydrophilic group such as an acid group (including carboxylate,

sulfonate and phosphonate groups), ammonium group or poly(oxyethylene) group, or hydroxyl group. In other embodiments, "B" may be a reactive functional groups such as an ethylenically unsaturated polymerizable group, including vinyl, allyl, vinyloxy, allyloxy, and (meth)acryloyl, that may be free-radically polymerized with the  
5 polymerizable resin or monomers.

Such optional surface-modifying agents may be used in amounts such that 0 to 100%, generally 1 to 90% (if present) of the surface functional groups (Si-OH groups) of the silica nanoparticles are functionalized. The number of functional groups is experimentally determined where quantities of nanoparticles are reacted with an excess of  
10 surface modifying agent so that all available reactive sites are functionalized with a surface modifying agent. Lower percentages of functionalization may then be calculated from the result. Generally, the amount of surface modifying agent is used in amount sufficient to provide up to twice the equal weight of surface modifying agent relative to the weight of inorganic nanoparticles. When used, the weight ratio of surface modifying  
15 agent to inorganic nanoparticles is preferably 2:1 to 1:10. If surface-modified silica nanoparticles are desired, it is preferred to modify the nanoparticles prior to incorporation into the coating composition.

In some embodiments the surface modified filler may be selected from the addition-fragmentation agent modified fillers as described in Applicant's copending  
20 applications U.S. 2012/050718 and 2013/068207, each incorporated herein by reference.

The present addition fragmentation agents are also useful in the preparation of hardcoats. The term "hardcoat" or "hardcoat layer" means a layer or coating that is located on the external surface of an object, where the layer or coating has been designed to at least protect the object from abrasion. The present disclosure provides hardcoat  
25 compositions comprising the addition-fragmentation oligomer of Formula I and, a multi-functional (meth)acrylate monomer comprising three or more (meth)acrylate groups, and/or a multi-functional (meth)acrylate oligomer and optionally a (meth)acrylate-functional diluent.

Useful multifunctional (meth)acrylate monomers comprise three or more  
30 (meth)acrylate groups. Multifunctional (meth)acrylate monomers are useful in the practice of the present invention because they add abrasion resistance to the hard coat

layer. Preferred multifunctional (meth)acrylate monomers comprising three or more (meth)acrylate groups include trimethylol propane tri(meth)acrylate (TMPTA), pentaerythritol tri(meth)acrylate, pentaerythritol tetra(meth)acrylate, dipentritol tri(meth)acrylate (Sartomer 355), dipentaerythritol penta(meth)acrylate (Sartomer 399),  
5 dipentaerythritol hydroxy penta(meth)acrylate (DHPHA), glyceryl propoxy tri(meth)acrylate, trimethylpropane tri(meth)acrylate, and mixtures thereof. Another useful radiation-curable component of the present invention is the class of multifunctional (meth)acrylate oligomers, having two or more (meth)acrylate groups, and having an average molecular weight (Mw) in the range from about 400 to 2000.

10 Useful multi-functional (meth)acrylate oligomers include polyester (meth)acrylates, polyurethane (meth)acrylates, and (meth)acrylated epoxy (meth)acrylates. (Meth)acrylated epoxy (meth)acrylates and polyester(meth)acrylates are most preferred because they tend to have a relatively low viscosity and therefore allow a more uniform layer to be applied by the spin coating method. Specifically, preferred multifunctional  
15 (meth)acrylate oligomers include those commercially available from UCB Radcure, Inc. of Smyrna, Georgia and sold under the trade name Ebecryl (Eb): Eb40 (tetrafunctional acrylated polyester oligomer), ENO (polyester tetra-functional (meth)acrylate oligomer), Eb81 (multifunctional (meth)acrylated polyester oligomer), Eb600 (bisphenol A epoxy di(meth)acrylate), Eb605 (bisphenol A epoxy di(meth)acrylate diluted with 25%  
20 tripropylene glycol di(meth)acrylate), Eb639 (novolac polyester oligomer), Eb2047 (trifunctional acrylated polyester oligomer), Eb3500 (di-functional Bisphenol-A oligomer acrylate), Eb3604 (multi-functional polyester oligomer acrylate), Eb6602 (trifunctional aromatic urethane acrylate oligomer), Eb8301 (hexafunctional aliphatic urethane acrylate), EbW2 (difunctional aliphatic urethane acrylate oligomer), and mixtures thereof. Of these,  
25 the most preferred are, Eb 600, Eb605, Eb80, and Eb81.

The (meth)acrylate-functional diluents, also referred to herein as "reactive diluents", are relatively low molecular weight mono- or di-functional, non-aromatic, (meth)acrylate monomers. These relatively low molecular weight reactive diluents are advantageously of a relatively low viscosity, e.g., less than about 30 centipoise (cps) at  
30 25C. Di-functional, non-aromatic (meth)acrylates are generally preferred over mono-functional non-aromatic (meth)acrylates because di-functional non-aromatic



(meth)acrylates allow for quicker cure time. Preferred reactive diluents include 1,6-hexanediol di(meth)acrylate (HDDA from UCB Radcure, Inc. of Smyrna, Georgia), tripropylene glycol di(meth)acrylate, isobornyl (meth)acrylate (1130A, Radcure), 2-(2-ethoxyethoxy) ethyl (meth)acrylate (sold under the trade name Sartomer 256 from  
5 SARTOMER Company, Inc. of Exton, Pennsylvania), n-vinyl formamide (Sartomer 497), tetrahydrofurfuryl (meth)acrylate (Sartomer 285), polyethylene glycol di(meth)acrylate (Sartomer 344), tripropylene glycol di(meth)acrylate (Radcure), neopentyl glycol dialkoxy di(meth)acrylate, polyethyleneglycol di(meth)acrylate, and mixtures thereof.

The hardcoat composition may comprise:

- 10 0.1 – 10 wt.% of the addition fragmentation oligomer of Formula I;  
20-80 wt.% of multifunctional (meth)acrylate monomers and/or multifunctional (meth)acrylate oligomers,  
0 to 25 wt.% range of (meth)acrylate diluent, (0-25 wt.%)  
20 to 75 wt.% of silica. The weight ranges referring to the silica *per se*, whether or  
15 not functionalized.

In some embodiments the amount of silica, including the silica modified with conventional surface modifying oligomers and unmodified silica is 20-75 wt.%, preferably 50-70 wt.%.

20 Filler components include nanosized silica particles, nanosized metal oxide particles, and combinations thereof. Nanofillers are also described in U.S. Pat. Nos. 7,090,721 (Craig et al.), 7,090,722 (Budd et al.), 7,156,911 (Kangas et al.), and 7,649,029 (Kolb et al.).

25 The present disclosure further provides curable dental compositions comprising the addition-fragmentation oligomer of Formula I. Although various curable dental compositions have been described, industry would find advantage in compositions having improved properties such as reduced stress deflection and/or reduced shrinkage while maintaining sufficient mechanical properties and depth of cure.

30 As used herein, "dental composition" refers to a material, optionally comprising filler, capable of adhering or being bonded to an oral surface. A curable dental composition can be used to bond a dental article to a tooth structure, form a coating (e.g., a

sealant or varnish) on a tooth surface, be used as a restorative that is placed directly into the mouth and cured in-situ, or alternatively be used to fabricate a prosthesis outside the mouth that is subsequently adhered within the mouth.

Curable dental compositions include, for example, adhesives (e.g., dental and/or  
5 orthodontic adhesives), cements (e.g., resin-modified glass ionomer cements, and/or  
orthodontic cements), primers (e.g., orthodontic primers), liners (applied to the base of a  
cavity to reduce tooth sensitivity), coatings such as sealants (e.g., pit and fissure), and  
varnishes; and resin restoratives (also referred to as direct composites) such as dental  
10 fillings, as well as crowns, bridges, and articles for dental implants. Highly filled dental  
compositions are also used for mill blanks, from which a crown may be milled. A  
composite is a highly filled paste designed to be suitable for filling substantial defects in  
tooth structure. Dental cements are somewhat less filled and less viscous materials than  
composites, and typically act as a bonding agent for additional materials, such as inlays,  
onlays and the like, or act as the filling material itself if applied and cured in layers.  
15 Dental cements are also used for permanently bonding dental restorations such as a crown  
or bridge to a tooth surface or an implant abutment.

As used herein:

"dental article" refers to an article that can be adhered (e.g., bonded) to a tooth  
structure or dental implant. Dental articles include, for example, crowns, bridges, veneers,  
20 inlays, onlays, fillings, orthodontic appliances and devices.

"orthodontic appliance" refers to any device intended to be bonded to a tooth  
structure, including, but not limited to, orthodontic brackets, buccal tubes, lingual  
retainers, orthodontic bands, bite openers, buttons, and cleats. The appliance has a base  
for receiving adhesive and it can be a flange made of metal, plastic, ceramic, or  
25 combinations thereof. Alternatively, the base can be a custom base formed from cured  
adhesive layer(s) (i.e. single or multi-layer adhesives).

"oral surface" refers to a soft or hard surface in the oral environment. Hard  
surfaces typically include tooth structure including, for example, natural and artificial  
tooth surfaces, bone, and the like.

30 "curable" is descriptive of a material or composition that can be polymerized or  
crosslinked by a free-radical means such as by irradiating with actinic irradiation to induce

polymerization and/or crosslinking; "hardened" refers to a material or composition that has been cured (e.g., polymerized or crosslinked).

5 "initiator" refers to something that initiates curing of a resin. An initiator may include, for example, a polymerization initiator system, a photoinitiator system, a thermal initiator and/or a redox initiator system.

"self-etching" composition refers to a composition that bonds to a dental structure surface without pretreating the dental structure surface with an etchant. Preferably, a self-etching composition can also function as a self-primer wherein no separate etchant or primer are used.

10 a "self-adhesive" composition refers to a composition that is capable of bonding to a dental structure surface without pretreating the dental structure surface with a primer or bonding agent. Preferably, a self-adhesive composition is also a self-etching composition wherein no separate etchant is used.

15 a "dental structure surface" refers to tooth structures (e.g., enamel, dentin, and cementum) and bone.

an "uncut" dental structure surface refers to a dental structure surface that has not been prepared by cutting, grinding, drilling, etc.

20 an "untreated" dental structure surface refers to a tooth or bone surface that has not been treated with an etchant, primer, or bonding agent prior to application of a self-etching adhesive or a self-adhesive composition of the present invention.

an "unetched" dental structure surface refers to a tooth or bone surface that has not been treated with an etchant prior to application of a self-etching adhesive or a self-adhesive composition of the present invention.

25 The total amount of addition-fragmentation oligomer(s) in the polymerizable resin portion of the unfilled curable dental composition is typically no greater than 15 wt.%. As the concentration of the addition-fragmentation monomer increases, the stress deflection and Watts Shrinkage typically decrease. However, when the amount of addition-fragmentation oligomer exceeds an optimal amount, mechanical properties such as Diametral tensile strength and/or Barcol hardness, or depth of cure may be insufficient.

30 The polymerizable resin portion of the curable dental composition described herein comprises at least 0.1 wt.%, of addition-fragmentation oligomer(s). Generally, the amount

of addition-fragmentation oligomer is from about 0.5 to 10wt.% of the polymerizable portion of the unfilled dental composition.

The filled curable dental composition described herein typically comprises at least 0.1 wt.% of addition-fragmentation oligomer(s). The total amount of addition-  
5 fragmentation oligomer(s) in the filled curable dental composition is typically no greater than 5 wt.%.

Materials with high polymerization stress upon curing generate strain in the tooth structure. One clinical consequence of such stress can be a decrease in the longevity of the restoration. The stress present in the composite passes through the adhesive interface  
10 to the tooth structure generating cuspal deflection and cracks in the surrounding dentin and enamel which can lead to postoperative sensitivity as described in R. R. Cara et al, Particulate Science and Technology 28; 191-206 (2010). Preferred (e.g. filled) dental compositions (useful for restorations such as fillings and crowns) described herein typically exhibit a stress deflection of no greater than 2.0, or 1.8, or 1.6, or 1.4, or 1.2 or  
15 1.0 or 0.8 or 0.6 microns.

The curable compositions described herein further comprise at least one ethylenically unsaturated resin monomer or oligomer in combination with the addition-fragmentation oligomer. In some embodiments, such as primers, the ethylenically unsaturated monomer may be monofunctional, having a single (e.g. terminal) ethylenically  
20 unsaturated group. In other embodiments, such as dental restorations the ethylenically unsaturated monomer is multifunctional. The phrase “multifunctional ethylenically unsaturated” means that the monomers each comprise at least two ethylenically unsaturated (e.g. free radically) polymerizable groups, such as (meth)acrylate groups.

The amount of curable resin in the dental composition is a function of the desired  
25 end use (adhesives, cements, restoratives, etc.) and can be expressed with respect to the (i.e. unfilled) polymerizable resin portion of the dental composition. For favored embodiments, wherein the composition further comprises filler, the concentration of monomer can also be expressed with respect to the total (i.e. filled) composition. When the composition is free of filler, the polymerizable resin portion is the same as the total  
30 composition.

In favored embodiments, such ethylenically unsaturated groups of the curable dental resin includes (meth)acryloyl such as (meth)acrylamide and (meth)acrylate.

Other ethylenically unsaturated polymerizable groups include vinyl and vinyl ethers. The ethylenically unsaturated terminal polymerizable group(s) is preferably a (meth)acrylate group, particularly for compositions that are hardened by exposure to actinic (e.g. UV and visible) radiation. Further, methacrylate functionality is typically preferred over the acrylate functionality in curable dental compositions. The ethylenically unsaturated monomer may comprise various ethylenically unsaturated monomers, as known in the art, for use in dental compositions.

In favored embodiments, the (e.g. dental) composition comprises one or more dental resins having a low volume shrinkage monomer. Preferred (e.g. filled) curable dental compositions (useful for restorations such as fillings and crowns) comprise one or more low volume shrinkage resins such that the composition exhibits a Watts Shrinkage of less than about 2%, preferably no greater than 1.80%, more no greater than 1.60%. In favored embodiments, the Watts Shrinkage is no greater than 1.50%, or no greater than 1.40%, or no greater than 1.30%, and in some embodiments no greater than 1.25%, or no greater than 1.20%, or no greater than 1.15%, or no greater than 1.10%.

Preferred low volume shrinkage monomers include isocyanurate resins, such as described in U.S.S.N. 2011/027523 (Abuelyaman et al.) ; tricyclodecane resins, such as described in U.S.S.N 2011/041736; polymerizable resins having at least one cyclic allylic sulfide moiety such as described in U.S. 7,888,400 (Abuelyaman et al.); methylene dithiepane silane resins as described in US 6,794,520 (Moszner et al.); and di-, tri, and/or tetra-(meth)acryloyl-containing resins such as described in U.S. 2010/021869 (Abuelyaman et al.); each of which are incorporated herein by reference.

In favored embodiments, the majority of the (e.g. unfilled) polymerizable resin composition comprises one or more low volume shrinkage monomers ("Low shrinkage monomers"). For example, at least 50%, 60%, 70%, 80%, 90% or more of the (e.g. unfilled) polymerizable resin may comprise low volume shrinkage monomer(s).

In one embodiment, the dental composition comprises at least one isocyanurate resin. The isocyanurate resin comprises a trivalent isocyanuric acid ring as an isocyanurate core structure and at least two ethylenically unsaturated (e.g. free radically) polymerizable groups bonded to at least two of the nitrogen atoms of the isocyanurate core structure via a (e.g. divalent) linking group. The linking group is the entire chain of atoms between the nitrogen atom of the isocyanurate core structure and the terminal

ethylenically unsaturated group. The ethylenically unsaturated (e.g. free radically) polymerizable groups are generally bonded to the core or backbone unit via a (e.g. divalent) linking group.

The trivalent isocyanurate core structure generally has the formula:

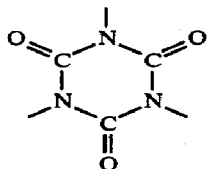

5

The divalent linking group comprises at least one nitrogen, oxygen or sulfur atom. Such nitrogen, oxygen or sulfur atom forms an urethane, ester, thioester, ether, or thioether linkage. Ether and especially ester linkages can be beneficial over isocyanurate resin comprising urethane linkages for providing improved properties such as reduced shrinkage, and/or increased mechanical properties, e.g., diametral tensile strength (DTS). Thus, in some embodiments, the divalent linking groups of the isocyanurate resin are free of urethane linkages. In some favored embodiments, the divalent linking group comprises an ester linkage such as an aliphatic or aromatic diester linkage.

10

The isocyanurate monomer typically has the general structure:

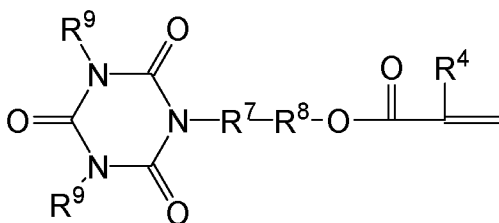

15

wherein R<sup>7</sup> is a (hetero)hydrocarbyl group including straight chain, branched or cyclic alkylene, arylene, or alkarylene, and optionally including a heteroatom (e.g. oxygen, nitrogen, or sulfur); R<sup>4</sup> is hydrogen or C1-C4 alkyl; R<sup>8</sup> is heterohydrocarbyl group including alkylene, arylene, or alkarylene linking group comprising at least one moiety selected from urethane, ester, thioester, ether, or thioether, and combinations of such moieties; and at least one of the R<sup>9</sup> groups is

20

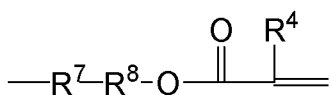

R<sup>7</sup> is typically a straight chain, branched or cyclic alkylene, optionally including a heteroatom, having no greater than 12 carbons atoms. In some favored embodiments, R<sup>7</sup> has no greater than 8, 6, or 4 carbon atoms. In some favored embodiments, R<sub>7</sub> comprises at least one hydroxyl moiety.

5 In some embodiments, R<sup>8</sup> comprises an aliphatic or aromatic ester linkage such as a diester linkage.

In some embodiment, R<sup>8</sup> further comprises one or more ether moieties. Hence, the linking group may comprise a combination of ester or diester moieties and one or more ether moieties.

10 For embodiments, wherein the isocyanurate monomer is a di(meth)acrylate monomer, R<sup>9</sup> is hydrogen, alkyl, aryl, or alkaryl, optionally including a heteroatom.

The polymerizable resin portion of the curable unfilled dental composition described herein may comprise at least 10 wt.%, 15 wt.%, 20 wt.%, or 25 wt.%, multifunctional ethylenically unsaturated isocyanurate resin(s). The isocyanurate resin  
15 may comprise a single monomer or a blend of two or more isocyanurate resins. The total amount of isocyanurate resin(s) in the unfilled polymerizable resin portion of the curable dental composition is typically no greater than 90 wt.%, 85 wt.%, 80 wt.%, or 75 wt.%.

The filled curable dental composition described herein typically comprises at least 5 wt.%, 6 wt.%, 7 wt.%, 8 wt.%, or 9 wt.% of multifunctional  
20 ethylenically unsaturated isocyanurate resin(s). The total amount of isocyanurate resin(s) of the filled hardenable (i.e. polymerizable) dental composition is typically no greater than 20 wt.%, or 19 wt.%, or 18 wt.%, or 17 wt.%, or 16 wt.%, or 15 wt.%.

In another embodiment, the dental composition comprises at least one tricyclodecane resin. The tricyclodecane resin may comprise a single monomer or a blend  
25 of two or more tricyclodecane resins. The concentration of multifunctional ethylenically unsaturated tricyclodecane monomer in the (i.e. unfilled) polymerizable resin portion or filled hardenable (i.e. polymerizable) composition can be the same as just described for the multifunctional ethylenically unsaturated isocyanurate monomer.

Tricyclodecane monomers generally have the core structure (i.e. backbone unit  
30 (U):

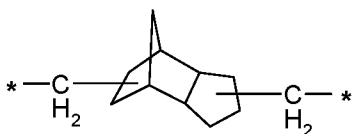

The backbone unit (U) of the tricyclodecane resin typically comprises one or two spacer unit(s) (S) bonded to the backbone unit (U) via an ether linkage. At least one spacer unit (S) comprises a CH(R<sup>10</sup>)-OG chain, wherein each group G comprises a (meth)acrylate moiety and R<sup>10</sup> (comprises at least one group selected from hydrogen, alkyl, aryl, alkaryl and combinations thereof. In some embodiments, R<sup>10</sup> is hydrogen, methyl, phenyl, phenoxyethyl, and combinations thereof. G may be bonded to the spacer unit(s) (S) via a urethane moiety.

In some embodiments, the spacer unit(s) (S) typically comprise

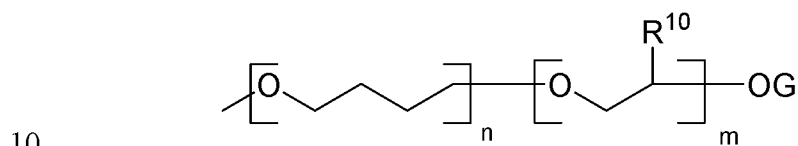

wherein m is 1 to 3; n is 1 to 3; and R<sup>10</sup> is hydrogen, methyl, phenyl, phenoxyethyl.

In other embodiments, the spacer unit(s) (S) typically comprise

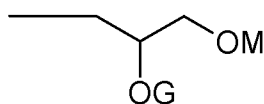

wherein M = aryl.

In some embodiments the composition comprises a multifunctional ethylenically unsaturated isocyanurate monomer and multifunctional ethylenically unsaturated tricyclodecane monomer at a weight ratio ranging from about 1.5:1 to 1:1.5.

In some embodiments, the curable dental composition comprises a polymerizable resin having at least one cyclic allylic sulfide moiety with at least one (meth)acryloyl moiety.

The cyclic allylic sulfide moiety typically comprises at least one 7- or 8-membered ring that has two heteroatoms in the ring, one of which is sulfur. Most typically both of the heteroatoms are sulfur, which may optionally be present as part of an SO, SO<sub>2</sub>, or S-S moiety. In other embodiments, the ring may comprise a sulfur atom plus a second, different heteroatom in the ring, such as oxygen or nitrogen. In addition, the cyclic allylic moiety may comprise multiple ring structures, i.e. may have two or more cyclic allylic



sulfide moieties. The (meth)acryloyl moiety is preferably a (meth)acryloyloxy (i.e. a (meth)acrylate moiety) or a (meth)acryloylamino (i.e., a (meth)acrylamide moiety).

In one embodiment, the low shrinkage resin includes those represented by the formulae:

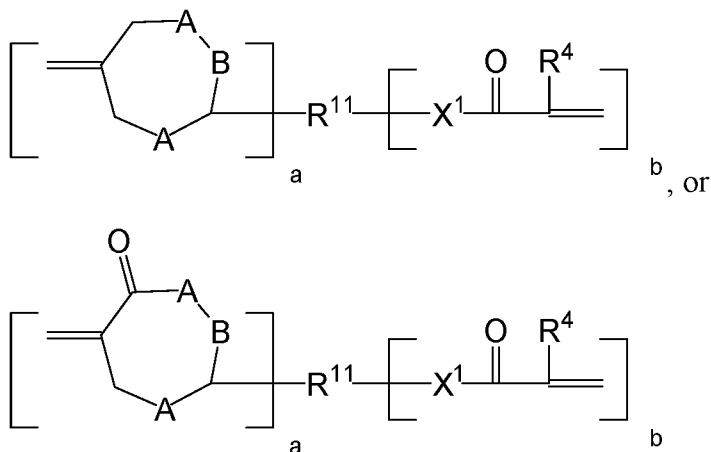

5            In the above formulae, each A can be independently selected from S, O, N, C (e.g., C(R<sup>10</sup>)<sub>2</sub>, where each R<sup>10</sup> is independently a H or an organic group), SO, SO<sub>2</sub>, N-alkyl, N-acyl, NH, N-aryl, carboxyl or carbonyl group, provided that at least one X is S or a group comprising S. Preferably, each A is sulfur.

10            B is either alkylene (e.g., methylene, ethylene, etc.) optionally including a heteroatom, carbonyl, or acyl; or is absent, thereby indicating the size of the ring, typically 7- to 10-membered rings, however larger rings are also contemplated. Preferably, the ring is either a 7- or 8-membered ring with Y thus being either absent or methylene, respectively. In some embodiments, Y is either absent or is a C1 to C3 alkylene, optionally including a heteroatom, carbonyl, acyl, or combinations thereof.

15            X<sup>1</sup> is independently -O- or -NR<sup>4</sup>-, where R<sup>4</sup> is H or C<sub>1</sub>-C<sub>4</sub> alkyl.

20            The R<sup>11</sup> group represents a linker selected from alkylene (typically having more than one carbon atom, i.e. excluding methylene), alkylene optionally including a heteroatom (e.g., O, N, S, S-S, SO, SO<sub>2</sub>), arylene, cycloaliphatic, carbonyl, siloxane, amido (-CO-NH-), acyl (-CO-O-), urethane (-O-CO-NH-), and urea (-NH-CO-NH-) groups, and combinations thereof. In certain embodiments, R' comprises an alkylene group, typically a methylene or longer group, that may be either straight chain or branched, and which can be either unsubstituted, or substituted with aryl, cycloalkyl,

halogen, nitrile, alkoxy, alkylamino, dialkylamino, alkylthio, carbonyl, acyl, acyloxy, amido, urethane group, urea group, a cyclic allylic sulfide moiety, or combinations thereof.

$R^4$  is H or  $C_1$ - $C_4$  alkyl, and "a" and "b" are independently 1 to 3.

5            Optionally the cyclic allylic sulfide moiety can further be substituted on the ring with one or more groups selected from straight or branched chain alkyl, aryl, cycloalkyl, halogen, nitrile, alkoxy, alkylamino, dialkylamino, alkylthio, carbonyl, acyl, acyloxy, amido, urethane group, and urea group. Preferably the selected substituents do not interfere with the hardening reaction. Preferred are cyclic allylic sulfide structures that  
10            comprise unsubstituted methylene members.

                 A typical low shrinkage monomer can comprise an 8-membered cyclic allylic sulfide moiety with two sulfur atoms in the ring and with the linker attached directly to the 3-position of the ring with an acyl group (i.e., Ring-OC(O)-). Typically the weight average molecular weight (MW) of the hybrid monomer ranges from about 400 to about 900 and  
15            in some embodiments is at least 250, more typically at least 500, and most typically at least 800.

                 The inclusion of a polymerizable compound having at least one cyclic allylic sulfide moiety can result in a synergistic combination of low volume shrinkage in combination with high diametral tensile strength.

20            In another embodiment, the dental composition comprises a low shrinkage resin that includes at least one di-, tri-, and/or tetra (meth)acryloyl-containing resins having the general formula:

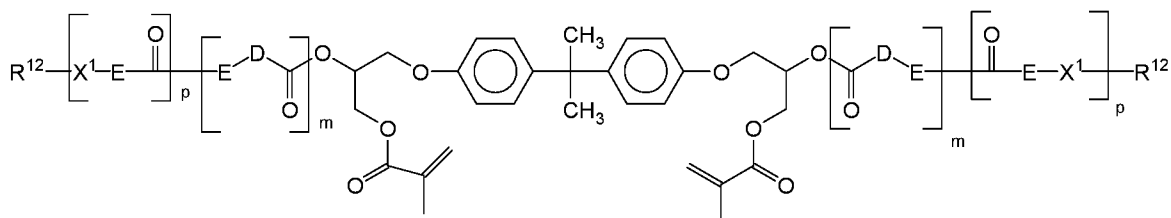

wherein: each  $X^1$  is independently  $-O-$  or  $-NR^4-$ , where  $R^4$  is H or  $C_1$ - $C_4$  alkyl;

25            D and E each independently represent an organic group, and  $R^{12}$  represents  $-C(O)C(CH_3)=CH_2$ , and/or  $p=0$  and  $R^{12}$  represents H,  $-C(O)CH=CH_2$ , or  $-C(O)C(CH_3)=CH_2$ , with the proviso that at least one  $R^{12}$  is a (meth)acrylate; each m is 1 to 5; p and q are independently 0 or 1. Although, this material is a derivative of bisphenol

A, when other low volume shrinkage monomer are employed, such as the isocyanurate and/or tricyclodecane monomer, the dental composition is free of (meth)acrylate monomers derived from bisphenol A. Such resins are described in WO 2008/082881 (Abuelyaman et al.)

5 In another embodiment, the low shrinkage dental resin may be selected from methylene dithiepane silane resins described in U.S. 6,794,520 (Moszner et al.), incorporated herein by reference. Such resins have the general formula

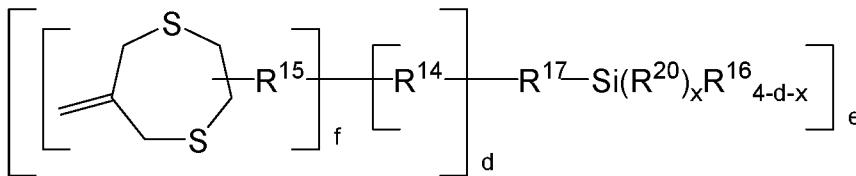

10 in which  $\text{R}^{14}$  is a saturated or unsaturated aliphatic or alicyclic hydrocarbon radical with 1 to 10 carbon atoms, which can be interrupted by one or more oxygen and/or sulfur atoms and can contain one or more ester, carbonyl, amide and/or urethane groups, or is an aromatic or heteroaromatic hydrocarbon radical with 6 to 18 carbon atoms, the hydrocarbon radicals being able to be substituted or unsubstituted;  $\text{R}^{15}$  has one of the meanings given for  $\text{R}^{14}$  or is absent;  $\text{R}^{16}$  has one of the meanings given for  $\text{R}^{14}$  or is absent;  $\text{R}^{17}$  is equal to  $-(\text{CHR}^{19})_n-$ ,  $-\text{W}-\text{CO}-\text{NH}-(\text{CHR}^{19})_n-$ ,  $-\text{Y}-\text{CO}-\text{NH}-\text{R}^{18}-$ ,  $-(\text{CHR}^{19})_n-$ ,  $-\text{SR}^{18}-$ ,  $-\text{CO}-\text{O}-\text{R}^{18}-$  or is absent, with  $n$  being equal to 1 to 4,  $\text{R}^{19}$  is hydrogen,  $\text{C}_1$  to  $\text{C}_{10}$  alkyl or  $\text{C}_6$  to  $\text{C}_{10}$  aryl,  $\text{R}^{18}$  has one of the meanings given for  $\text{R}^{14}$  and  $\text{W}$  stands for an O or S atom or is absent; with  $\text{R}^{18}$  and  $\text{R}^{19}$  being able to be substituted or unsubstituted;  $\text{R}^{20}$  is a hydrolyzable group;  $d$ ,  $e$ ,  $f$  and  $x$  each independently of each other being 1, 2 or 3; and the sum of  $d+x=2$  to 4.

25 The multifunctional low shrink resins are (e.g. highly) viscous liquids at about 25°C, yet are flowable. The viscosity as can be measured with a Haake RotoVisco RV1 device, as described in EP Application No. 10168240.9, filed July 2, 2010 is typically at least 300, or 400, or 500 Pa\*s and no greater than 10,000 Pascal-seconds (Pa\*s). In some embodiments, the viscosity is no greater than 5000 or 2500 Pa\*s.

The ethylenically unsaturated resins of the dental composition are typically stable liquids at about 25°C meaning that the resins do not substantially polymerize, crystallize, or otherwise solidify when stored at room temperature (about 25°C) for a typical shelf life

of at least 30, 60, or 90 days. The viscosity of the resins typically does not change (e.g. increase) by more than 10% of the initial viscosity.

5 Particularly for dental restoration compositions, the ethylenically unsaturated resins generally have a refractive index of at least 1.50. In some embodiments, the refractive index is at least 1.51, 1.52, 1.53, or greater. The inclusion of sulfur atoms and/or the present of one or more aromatic moieties can raise the refractive index (relative to the same molecular weight resin lacking such substituents).

10 In some embodiments, the (unfilled) polymerizable resin may comprise solely one or more low shrink resins in combination with the addition fragmentation oligomer(s). In other embodiments, the (unfilled) polymerizable resin comprises a small concentration of other monomer(s). By “other” is it meant an ethylenically unsaturated monomer such as a (meth)acrylate monomer that is not a low volume shrinkage monomer.

15 The concentration of such other monomer(s) is typically no greater than 20 wt.%, 19 wt.%, 18 wt.%, 17 wt.%, 16 wt.%, or 15 wt.% of the (unfilled) polymerizable resin portion. The concentration of such other monomers is typically no greater than 5 wt.%, 4 wt.%, 3 wt.%, or 2 wt.% of the filled polymerizable dental composition.

20 In some embodiments, the “other monomers” of the dental composition comprise a low viscosity reactive (i.e. polymerizable) diluent. Reactive diluents typically have a viscosity of no greater than 300 Pa\*s and preferably no greater than 100 Pa\*s, or 50 Pa\*s, or 10 Pa\*s. In some embodiments, the reactive diluent has a viscosity no greater than 1 or 0.5 Pa\*s. Reactive diluents are typically relatively low in molecular weight, having a molecular weight less than 600 g/mole, or 550 g/mol, or 500 g/mole. Reactive diluents typically comprise one or two ethylenically unsaturated groups such as in the case of mono(meth)acrylate or di(meth)acrylate monomers.

25 In some embodiments, the reactive diluent is an isocyanurate or tricyclodecane monomer. Tricyclodecane reactive diluent may have the same generally structure as previously described. In favored embodiments, the tricyclodecane reactive diluent comprises one or two spacer unit(s) (S) being connected to the backbone unit (U) via an ether linkage; such as described in U.S. 2011/041736 (Eckert et al.); incorporated herein by reference.

30 Although the inclusion of an addition fragmentation oligomer in a low volume shrinkage composition typically provides the lowest stress and/or lowest shrinkage, the

addition fragmentation oligomers described herein can also reduce the stress of dental composition comprising conventional hardenable (meth)acrylate monomers, such as ethoxylated bisphenol A dimethacrylate (BisEMA6), 2-hydroxyethyl methacrylate (HEMA), bisphenol A diglycidyl dimethacrylate (bisGMA), urethane dimethacrylate (UDMA), triethlyene glycol dimethacrylate (TEGDMA), glycerol dimethacrylate (GDMA), ethyleneglycol dimethacrylate, neopentylglycol dimethacrylate (NPGDMA), and polyethyleneglycol dimethacrylate (PEGDMA).

The curable component of the curable dental composition can include a wide variety of “other” ethylenically unsaturated compounds (with or without acid functionality), epoxy-functional (meth)acrylate resins, vinyl ethers, and the like.

The (e.g., photopolymerizable) dental compositions may include free radically polymerizable monomers, oligomers, and polymers having one or more ethylenically unsaturated groups. Suitable compounds contain at least one ethylenically unsaturated bond and are capable of undergoing addition polymerization. Examples of useful ethylenically unsaturated compounds include acrylic acid esters, methacrylic acid esters, hydroxy-functional acrylic acid esters, hydroxy-functional methacrylic acid esters, and combinations thereof.

Such free radically polymerizable compounds include mono-, di- or poly-(meth)acrylates (i.e., acrylates and methacrylates) such as, methyl (meth)acrylate, ethyl (meth)acrylate, isopropyl (meth)acrylate, n-hexyl (meth)acrylate, stearyl (meth)acrylate, allyl (meth)acrylate, glycerol tri(meth)acrylate, ethyleneglycol di(meth)acrylate, diethyleneglycol di(meth)acrylate, triethyleneglycol di(meth)acrylate, 1,3-propanediol di(meth)acrylate, trimethylolpropane tri(meth)acrylate, 1,2,4-butanetriol tri(meth)acrylate, 1,4-cyclohexanediol di(meth)acrylate, pentaerythritol tetra(meth)acrylate, sorbitol hex(meth)acrylate, tetrahydrofurfuryl (meth)acrylate, bis[l-(2-acryloxy)]-p-ethoxyphenyldimethylmethane, bis[l-(3-acryloxy-2-hydroxy)]-p-propoxyphenyldimethylmethane, ethoxylated bisphenolA di(meth)acrylate, and trishydroxyethyl-isocyanurate tri(meth)acrylate; (meth)acrylamides (i.e., acrylamides and methacrylamides) such as (meth)acrylamide, methylene bis-(meth)acrylamide, and diacetone (meth)acrylamide; urethane (meth)acrylates; the bis-(meth)acrylates of polyethylene glycols (preferably of molecular weight 200-500); and vinyl compounds such as styrene, diallyl phthalate, divinyl succinate, divinyl adipate and divinyl phthalate.

Other suitable free radically polymerizable compounds include siloxane-functional (meth)acrylates. Mixtures of two or more free radically polymerizable compounds can be used if desired.

5 The curable dental composition may also contain a monomer having hydroxyl groups and ethylenically unsaturated groups as an example of an “other monomer”. Examples of such materials include hydroxyalkyl (meth)acrylates, such as 2-hydroxyethyl (meth)acrylate and 2-hydroxypropyl (meth)acrylate; glycerol mono- or di-(meth)acrylate; trimethylolpropane mono- or di-(meth)acrylate; pentaerythritol mono-, di-, and tri- (meth)acrylate; sorbitol mono-, di-, tri-, tetra-, or penta-(meth)acrylate; and 2,2-bis[4-(2-  
10 hydroxy-3-methacryloxypropoxy)phenyl]propane (bisGMA). Suitable ethylenically unsaturated compounds are available from a wide variety of commercial sources, such as Sigma-Aldrich, St. Louis.

The curable dental compositions can include at least 1 wt.%, at least 3 wt.%, or at least 5 wt.% ethylenically unsaturated compounds with hydroxyl functionality, based on  
15 the total weight of the unfilled composition. The compositions can include at most 80 wt.%, at most 70 wt.%, or at most 60 wt.% ethylenically unsaturated compounds with hydroxyl functionality.

The dental compositions described herein may include one or more curable components in the form of ethylenically unsaturated compounds with acid functionality as  
20 an example of an “other” monomer. When present, the polymerizable component optionally comprises an ethylenically unsaturated compound with acid functionality. Preferably, the acid functionality includes an oxyacid (i.e., an oxygen-containing acid) of carbon, sulfur, phosphorous, or boron. Such acid-functional “other” monomers contribute to the self-adhesion or self-etching of the dental compositions as described in U.S.  
25 2005/017966 (Falsafi et al.), incorporated herein by reference.

As used herein, ethylenically unsaturated compounds with acid functionality is meant to include monomers, oligomers, and polymers having ethylenic unsaturation and acid and/or acid-precursor functionality. Acid-precursor functionalities include, for example, anhydrides, acid halides, and pyrophosphates. The acid functionality can  
30 include carboxylic acid functionality, phosphoric acid functionality, phosphonic acid functionality, sulfonic acid functionality, or combinations thereof.

Ethylenically unsaturated compounds with acid functionality include, for example,  $\alpha,\beta$ -unsaturated acidic compounds such as glycerol phosphate mono(meth)acrylates, glycerol phosphate di(meth)acrylates, hydroxyethyl (meth)acrylate (e.g., HEMA) phosphates, bis((meth)acryloxyethyl) phosphate, bis((meth)acryloxypropyl) phosphate, 5 bis((meth)acryloxy)propyloxy phosphate, (meth)acryloxyhexyl phosphate, bis((meth)acryloxyhexyl) phosphate, (meth)acryloxyoctyl phosphate, bis((meth)acryloxyoctyl) phosphate, (meth)acryloxydecyl phosphate, bis((meth)acryloxydecyl) phosphate, caprolactone methacrylate phosphate, citric acid di- or tri-methacrylates, poly(meth)acrylated oligomaleic acid, poly(meth)acrylated 10 polymaleic acid, poly(meth)acrylated poly(meth)acrylic acid, poly(meth)acrylated polycarboxyl-polyphosphonic acid, poly(meth)acrylated polychlorophosphoric acid, poly(meth)acrylated polysulfonate, poly(meth)acrylated polyboric acid, and the like, may be used as components. Also monomers, oligomers, and polymers of unsaturated carbonic acids such as (meth)acrylic acids, itaconic acid, aromatic (meth)acrylated acids (e.g., 15 methacrylated trimellitic acids), and anhydrides thereof can be used.

The dental compositions can include an ethylenically unsaturated compound with acid functionality having at least one P-OH moiety. Such compositions are self-adhesive and are non-aqueous. For example, such compositions can include: a first compound including at least one (meth)acryloxy group and at least one -O-P(O)(OH)<sub>x</sub> group, wherein 20 x=1 or 2, and wherein the at least one -O-P(O)(OH)<sub>x</sub> group and the at least one (meth)acryloxy group are linked together by a C<sub>1</sub>-C<sub>4</sub> hydrocarbon group; a second compound including at least one (meth)acryloxy group and at least one -O-P(O)(OH)<sub>x</sub> group, wherein x=1 or 2, and wherein the at least one -O-P(O)(OH)<sub>x</sub> group and the at least one (meth)acryloxy group are linked together by a C<sub>5</sub>-C<sub>12</sub> hydrocarbon group; an 25 ethylenically unsaturated compound without acid functionality; an initiator system; and a filler.

The curable dental compositions can include at least 1 wt.%, at least 3 wt.%, or at least 5 wt.% ethylenically unsaturated compounds with acid functionality, based on the total weight of the unfilled composition. The compositions can include at most 80 wt.%, 30 at most 70 wt.%, or at most 60 wt.% ethylenically unsaturated compounds with acid functionality.

The curable dental compositions may include resin-modified glass ionomer cements such as those described in U.S. 5130347 (Mitra), U.S. 5154762 (Mitra), U.S. 5925715 (Mitra et al.) and 5962550 (Akahane). Such compositions can be powder-liquid, paste-liquid or paste-paste systems. Alternatively, copolymer formulations such as those  
5 described in US 6126922 (Rozzi) are included in the scope of the invention.

An initiator is typically added to the mixture of polymerizable ingredients (i.e. curable resins and the addition-fragmentation oligomer of Formula I). The initiator is sufficiently miscible with the resin system to permit ready dissolution in (and discourage separation from) the polymerizable composition. Typically, the initiator is present in the  
10 composition in effective amounts, such as from about 0.1 weight percent to about 5.0 weight percent, based on the total weight of the composition.

The addition-fragmentation oligomer is generally free-radically cleavable. Although photopolymerization is one mechanism for generating free radicals, other curing mechanisms also generate free radicals. Thus, the addition-fragmentation oligomer does  
15 not require irradiation with actinic radiation (e.g. photocuring) in order to provide the reduction in stress during curing.

In some embodiments, the mixture of resins is photopolymerizable and the composition contains a photoinitiator (i.e., a photoinitiator system) that upon irradiation with actinic radiation initiates the polymerization (or hardening) of the composition. Such  
20 photopolymerizable compositions can be free radically polymerizable. The photoinitiator typically has a functional wavelength range from about 250 nm to about 800 nm.

Suitable photoinitiators (i.e., photoinitiator systems that include one or more compounds) for polymerizing free radically photopolymerizable compositions include binary and tertiary systems. Typical tertiary photoinitiators include an iodonium salt, a  
25 photosensitizer, and an electron donor compound as described in U.S. 5,545,676 (Palazzotto et al.). Iodonium salts include diaryl iodonium salts, e.g., diphenyliodonium chloride, diphenyliodonium hexafluorophosphate, and diphenyliodonium tetrafluoroborate. Some preferred photosensitizers may include monoketones and diketones (e.g. alpha diketones) that absorb some light within a range of about 300 nm to  
30 about 800 nm (preferably, about 400 nm to about 500 nm) such as camphorquinone, 1-phenyl-1,2-propanedione, benzil, furil, 3,3,6,6-tetramethylcyclohexanedione, phenanthraquinone and other cyclic alpha diketones. Of these camphorquinone is



typically preferred. Preferred electron donor compounds include substituted amines, e.g., ethyl 4-(N,N-dimethylamino)benzoate.

Other suitable photoinitiators for polymerizing free radically photopolymerizable compositions include the class of phosphine oxides that typically have a functional  
5 wavelength range of about 380 nm to about 1200 nm. Preferred phosphine oxide free radical initiators with a functional wavelength range of about 380 nm to about 450 nm are acyl and bisacyl phosphine oxides.

Commercially available phosphine oxide photoinitiators capable of free-radical initiation when irradiated at wavelength ranges of greater than about 380 nm to about 450  
10 nm include bis(2,4,6-trimethylbenzoyl)phenyl phosphine oxide (IRGACURE 819, Ciba Specialty Chemicals, Tarrytown, N.Y.), bis(2,6-dimethoxybenzoyl)-(2,4,4-trimethylpentyl) phosphine oxide (CGI 403, Ciba Specialty Chemicals), a 25:75 mixture, by weight, of bis(2,6-dimethoxybenzoyl)-2,4,4-trimethylpentyl phosphine oxide and 2-hydroxy-2-methyl-1-phenylpropan-1-one (IRGACURE 1700, Ciba Specialty Chemicals),  
15 a 1:1 mixture, by weight, of bis(2,4,6-trimethylbenzoyl)phenyl phosphine oxide and 2-hydroxy-2-methyl-1-phenylpropane-1-one (DAROCUR 4265, Ciba Specialty Chemicals), and ethyl 2,4,6-trimethylbenzylphenyl phosphinate (LUCIRIN LR8893X, BASF Corp., Charlotte, N.C.).

For this embodiment, suitable photoinitiators include those available under the  
20 trade designations IRGACURE and DAROCUR from Ciba Speciality Chemical Corp., Tarrytown, N.Y. and include 1-hydroxy cyclohexyl phenyl ketone (IRGACURE 184), 2,2-dimethoxy-1,2-diphenylethan-1-one (IRGACURE 651), bis(2,4,6-trimethylbenzoyl)phenylphosphineoxide (IRGACURE 819), 1-[4-(2-hydroxyethoxy)phenyl]-2-hydroxy-2-methyl-1-propane-1-one (IRGACURE 2959), 2-benzyl-2-dimethylamino-1-(4-morpholinophenyl)butanone (IRGACURE 369), 2-methyl-1-[4-(methylthio)phenyl]-2-morpholinopropan-1-one (IRGACURE 907), and 2-hydroxy-2-methyl-1-phenyl propan-1-one (DAROCUR 1173).

The photoinitiator may also be a polymerizable photoinitiator having a free-radically polymerizable groups and a photoinitiator group. Such polymerizable  
30 photoinitiators include 4-benzoylphenyl acrylate, 2-(4-benzoylphenoxy)ethyl acrylate and 2-[4-(2-hydroxy-2-methylpropanoyl)phenoxy]ethyl-N-acryloyl-2-methylalinate, and are described in U.S. 7838110 (Zhu et al.), U.S. 5506279 (Babu et al.), incorporated herein by

reference, and also Temel et al. "Photopolymerization and photophysical properties of amine linked benzophenone photoinitiators for free radical polymerization", Journal of Photochemistry and Photobiology A, Chemistry 219 (2011), pp. 26-31.

5 The initiator is used in an amount effective to facilitate free radical addition to the addition-fragmentation crosslinking oligomer and the amount will vary depending upon, e.g., the type of initiator and the molecular weight of the polymer and the degree of functionalization desired. The initiators can be used in amounts from about 0.001 part by weight to about 5 parts by weight based on 100 parts total monomer.

10 The photopolymerizable compositions are typically prepared by admixing the various components of the compositions. For embodiments wherein the photopolymerizable compositions are not cured in the presence of air, the photoinitiator is combined under "safe light" conditions (i.e., conditions that do not cause premature hardening of the composition). Suitable inert solvents may be employed if desired when preparing the mixture.

15 Curing is affected by exposing the composition to a radiation source, preferably a visible light source. It is convenient to employ light sources that emit actinic radiation light between 250 nm and 800 nm (particularly blue light of a wavelength of 380-520 nm) such as quartz halogen lamps, tungsten-halogen lamps, mercury arcs, carbon arcs, low-, medium-, and high-pressure mercury lamps, plasma arcs, light emitting diodes, and lasers. 20 In general, useful light sources have intensities in the range of 500-1500 mW/cm<sup>2</sup>. A variety of conventional lights for hardening such compositions can be used.

The exposure may be accomplished in several ways. For example, the polymerizable composition may be continuously exposed to radiation throughout the entire hardening process (e.g., about 2 seconds to about 60 seconds). It is also possible to 25 expose the composition to a single dose of radiation, and then remove the radiation source, thereby allowing polymerization to occur. In some cases materials can be subjected to light sources that ramp from low intensity to high intensity. Where dual exposures are employed, the intensity of each dosage may be the same or different. Similarly, the total energy of each exposure may be the same or different.

30 The dental compositions comprising the multifunctional ethylenically unsaturated monomers may be chemically curable, i.e., the compositions contain a chemical initiator

(i.e., initiator system) that can polymerize, cure, or otherwise harden the composition without dependence on irradiation with actinic radiation. Such chemically curable (e.g., polymerizable or curable) composition are sometimes referred to as "self-cure" compositions and may include redox cure systems, thermally curing systems and combinations thereof. Further, the polymerizable composition may comprise a combination of different initiators, at least one of which is suitable for initiating free radical polymerization.

The chemically hardenable compositions may include redox cure systems that include a polymerizable component (e.g., an ethylenically unsaturated polymerizable component) and redox agents that include an oxidizing agent and a reducing agent.

The reducing and oxidizing agents react with or otherwise cooperate with one another to produce free-radicals capable of initiating polymerization of the resin system (e.g., the ethylenically unsaturated component). This type of cure is a dark reaction, that is, it is not dependent on the presence of light and can proceed in the absence of light. The reducing and oxidizing agents are preferably sufficiently shelf-stable and free of undesirable colorization to permit their storage and use under typical conditions.

Useful reducing agents include ascorbic acid, ascorbic acid derivatives, and metal complexed ascorbic acid compounds as described in U.S. Pat. No. 5,501,727 (Wang et al.); amines, especially tertiary amines, such as 4-tert-butyl dimethylaniline; aromatic sulfinic salts, such as p-toluenesulfinic salts and benzenesulfinic salts; thioureas, such as 1-ethyl-2-thiourea, tetraethyl thiourea, tetramethyl thiourea, 1,1-dibutyl thiourea, and 1,3-dibutyl thiourea; and mixtures thereof. Other secondary reducing agents may include cobalt (II) chloride, ferrous chloride, ferrous sulfate, hydrazine, hydroxylamine (depending on the choice of oxidizing agent), salts of a dithionite or sulfite anion, and mixtures thereof. Preferably, the reducing agent is an amine.

Suitable oxidizing agents will also be familiar to those skilled in the art, and include but are not limited to persulfuric acid and salts thereof, such as sodium, potassium, ammonium, cesium, and alkyl ammonium salts. Additional oxidizing agents include peroxides such as benzoyl peroxides, hydroperoxides such as cumyl hydroperoxide, t-butyl hydroperoxide, and amyl hydroperoxide, as well as salts of transition metals such as cobalt (III) chloride and ferric chloride, cerium (IV) sulfate, perboric acid and salts

thereof, permanganic acid and salts thereof, perphosphoric acid and salts thereof, and mixtures thereof.

It may be desirable to use more than one oxidizing agent or more than one reducing agent. Small quantities of transition metal compounds may also be added to accelerate the rate of redox cure. The reducing or oxidizing agents can be microencapsulated as described in U.S. 5,154,762 (Mitra et al.). This will generally enhance shelf stability of the polymerizable composition, and if necessary permit packaging the reducing and oxidizing agents together. For example, through appropriate selection of an encapsulant, the oxidizing and reducing agents can be combined with an acid-functional component and optional filler and kept in a storage-stable state.

Curable dental compositions can also be cured with a thermally or heat activated free radical initiator. Typical thermal initiators include peroxides such as benzoyl peroxide and azo compounds such as azobisisobutyronitrile, as well as dicumyl peroxide, which is favored for mill blanks.

In favored embodiments, such as when the dental composition is employed as a dental restorative (e.g. dental filling or crown) or an orthodontic cement, the dental composition typically comprises appreciable amounts of (e.g. nanoparticle) filler. The amount of such fillers is a function of the end use as further described herein. Such compositions preferably include at least 40 wt.%, more preferably at least 45 wt.%, and most preferably at least 50 wt.% filler, based on the total weight of the composition. In some embodiments the total amount of filler is at most 90 wt.%, preferably at most 80 wt.%, and more preferably at most 75 wt.% filler.

The (e.g. filled) dental composite materials typically exhibit a diametral tensile strength (DTS) of at least about 70, 75, or 80 MPa and/or a Barcol Hardness of at least about 60, or 65, or 70. The ISO 4049 depth of cure ranges from about 4 to about 5mm and is comparable to commercially available (e.g. filled) dental compositions suitable for restorations.

Dental compositions suitable for use as dental adhesives can optionally also include filler in an amount of at least 1 wt.%, 2 wt.%, 3 wt.%, 4 wt.%, or 5 wt.% based on the total weight of the composition. For such embodiments, the total concentration of filler is at most 40 wt.%, preferably at most 20 wt.%, and more preferably at most 15 wt.% filler, based on the total weight of the composition.

Fillers may be selected from one or more of a wide variety of materials suitable for incorporation in compositions used for dental applications, such as fillers currently used in dental restorative compositions, and the like.

5 The filler can be an inorganic material. It can also be a crosslinked organic material that is insoluble in the polymerizable resin, and is optionally filled with inorganic filler. The filler is generally non-toxic and suitable for use in the mouth. The filler can be radiopaque, radiolucent, or nonradiopaque. Fillers as used in dental applications are typically ceramic in nature.

10 Suitable inorganic filler particles include quartz (i.e., silica), submicron silica, zirconia, submicron zirconia, and non-vitreous microparticles of the type described in U.S. 4,503,169 (Randklev).

15 The filler can also be an acid-reactive filler. Suitable acid-reactive fillers include metal oxides, glasses, and metal salts. Typical metal oxides include barium oxide, calcium oxide, magnesium oxide, and zinc oxide. Typical glasses include borate glasses, phosphate glasses, and fluoroaluminosilicate ("FAS") glasses. The FAS glass typically contains sufficient elutable cations so that a hardened dental composition will form when the glass is mixed with the components of the hardenable composition. The glass also typically contains sufficient elutable fluoride ions so that the hardened composition will have cariostatic properties. The glass can be made from a melt containing fluoride,  
20 alumina, and other glass-forming ingredients using techniques familiar to those skilled in the FAS glassmaking art. The FAS glass typically is in the form of particles that are sufficiently finely divided so that they can conveniently be mixed with the other cement components and will perform well when the resulting mixture is used in the mouth.

25 Generally, the average particle size (typically, diameter) for the FAS glass is no greater than 12 micrometers, typically no greater than 10 micrometers, and more typically no greater than 5 micrometers as measured using, for example, a sedimentation particle size analyzer. Suitable FAS glasses will be familiar to those skilled in the art, and are available from a wide variety of commercial sources, and many are found in currently available glass ionomer cements such as those commercially available under the trade  
30 designations VITREMER, VITREBOND, RELY X LUTING CEMENT, RELY X LUTING PLUS CEMENT, PHOTAC-FIL QUICK, KETAC-MOLAR, and KETAC-FIL PLUS (3M ESPE Dental Products, St. Paul, MN), FUJI II LC and FUJI IX (G-C Dental

Industrial Corp., Tokyo, Japan) and CHEMFIL Superior (Dentsply International, York, PA). Mixtures of fillers can be used if desired.

Other suitable fillers are disclosed in U.S. Pat. Nos. 6,387,981 (Zhang et al.) and 6,572,693 (Wu et al.) as well as PCT International Publication Nos. WO 01/30305 (Zhang et al.), U.S. Patent No. 6,730,156 (Windisch et al.), WO 01/30307 (Zhang et al.), and WO 03/063804 (Wu et al.). Filler components described in these references include nanosized silica particles, nanosized metal oxide particles, and combinations thereof. Nanofillers are also described in U.S. Pat. Nos. 7,090,721 (Craig et al.), 7,090,722 (Budd et al.) and 7,156,911; and U.S. Patent No. 7,649,029 (Kolb et al.).

Examples of suitable organic filler particles include filled or unfilled pulverized polycarbonates, polyepoxides, poly(meth)acrylates and the like. Commonly employed dental filler particles are quartz, submicron silica, and non-vitreous microparticles of the type described in U.S. Pat. No. 4,503,169 (Randklev).

Mixtures of these fillers can also be used, as well as combination fillers made from organic and inorganic materials.

Fillers may be either particulate or fibrous in nature. Particulate fillers may generally be defined as having a length to width ratio, or aspect ratio, of 20:1 or less, and more commonly 10:1 or less. Fibers can be defined as having aspect ratios greater than 20:1, or more commonly greater than 100:1. The shape of the particles can vary, ranging from spherical to ellipsoidal, or more planar such as flakes or discs. The macroscopic properties can be highly dependent on the shape of the filler particles, in particular the uniformity of the shape.

Micron-size particles are very effective for improving post-cure wear properties. In contrast, nanoscopic fillers are commonly used as viscosity and thixotropy modifiers. Due to their small size, high surface area, and associated hydrogen bonding, these materials are known to assemble into aggregated networks.

In some embodiments, the dental composition preferably comprise a nanoscopic particulate filler (i.e., a filler that comprises nanoparticles) having an average primary particle size of less than about 0.100 micrometers (i.e., microns), and more preferably less than 0.075 microns. As used herein, the term "primary particle size" refers to the size of a non-associated single particle. The average primary particle size can be determined by cutting a thin sample of hardened dental composition and measuring the particle diameter

of about 50-100 particles using a transmission electron micrograph at a magnification of 300,000 and calculating the average. The filler can have a unimodal or polymodal (e.g., bimodal) particle size distribution. The nanoscopic particulate material typically has an average primary particle size of at least about 2 nanometers (nm), and preferably at least about 7 nm. Preferably, the nanoscopic particulate material has an average primary particle size of no greater than about 75 nm, and more preferably no greater than about 20 nm in size. The average surface area of such a filler is preferably at least about 20 square meters per gram (m<sup>2</sup>/g), more preferably, at least about 50 m<sup>2</sup>/g, and most preferably, at least about 100 m<sup>2</sup>/g.

In some preferred embodiments, the dental composition comprises silica nanoparticles. Suitable nano-sized silicas are commercially available from Nalco Chemical Co. (Naperville, IL) under the product designation NALCO COLLOIDAL SILICAS. For example, preferred silica particles can be obtained from using NALCO products 1040, 1041, 1042, 1050, 1060, 2327 and 2329.

Silica particles are preferably made from an aqueous colloidal dispersion of silica (i.e., a sol or aquasol). The colloidal silica is typically in the concentration of about 1 to 50 weight percent in the silica sol. Colloidal silica sols that can be used are available commercially having different colloid sizes, see Surface & Colloid Science, Vol. 6, ed. Matijevic, E., Wiley Interscience, 1973. Preferred silica sols for use making the fillers are supplied as a dispersion of amorphous silica in an aqueous medium (such as the Nalco colloidal silicas made by Nalco Chemical Company) and those which are low in sodium concentration and can be acidified by admixture with a suitable acid (e.g. Ludox colloidal silica made by E. I. Dupont de Nemours & Co. or Nalco 2326 from Nalco Chemical Co.).

Preferably, the silica particles in the sol have an average particle diameter of about 5-100 nm, more preferably 10-50 nm, and most preferably 12-40 nm. A particularly preferred silica sol is NALCO<sup>™</sup> 1042 or 2327.

In some embodiments, the dental composition comprises zirconia nanoparticles. Suitable nano-sized zirconia nanoparticles can be prepared using hydrothermal technology as described in U.S. 7,241,437 (Davidson et al.).

In some embodiments, lower refractive index (e.g. silica) nanoparticles are employed in combination with high refractive index (e.g. zirconia) nanoparticles in order

to index match (refractive index within 0.02) the filler to the refractive index of the polymerizable resin.

In some embodiments, the nanoparticles are in the form of nanoclusters, i.e. a group of two or more particles associated by relatively weak intermolecular forces that cause the particles to clump together, even when dispersed in a hardenable resin.

Preferred nanoclusters can comprise a substantially amorphous cluster of non-heavy (e.g. silica) particles, and amorphous heavy metal oxide (i.e. having an atomic number greater than 28) particles such as zirconia. The primary particles of the nanocluster preferably have an average diameter of less than about 100 nm. Suitable nanocluster fillers are described in U.S. 6,730,156 (Windisch et al.); incorporated herein by reference.

In some preferred embodiments, the dental composition comprises nanoparticles and/or nanoclusters surface treated with an organometallic coupling agent to enhance the bond between the filler and the resin. The organometallic coupling agent may be functionalized with reactive curing groups, such as acrylates, methacrylates, vinyl groups and the like and may comprise silane, zirconate or titanate coupling agents. Preferred coupling agents include gamma-methacryloxypropyltrimethoxysilane, gamma-mercaptopropyltriethoxysilane, gamma-aminopropyltrimethoxysilane, and the like.

Suitable copolymerizable or reactive organometallic compounds may have the general formulas:  $\text{CH}_2=\text{C}(\text{R}^{22})-\text{R}^{21}\text{Si}(\text{OR})_n\text{R}_{3-n}$  or  $\text{CH}_2=\text{C}(\text{R}^{22})-\text{C}=\text{OOR}^{21}\text{Si}(\text{OR})_n\text{R}_{3-n}$ ; wherein R is an C<sub>1</sub>-C<sub>4</sub> alkyl, R<sup>21</sup> is a divalent organic heterohydrocarbyl linking group, preferably alkylene; R<sup>22</sup> is H or C<sub>1</sub>-C<sub>4</sub> alkyl; and n is from 1 to 3. Preferred coupling agents include gamma-methacryloxypropyltrimethoxysilane, gamma-mercaptopropyltriethoxysilane, gamma-aminopropyltrimethoxysilane, and the like.

In some embodiments, the silica particulate filler may be surface modified by an addition-fragmentation agent, such as are described in Applicant's copending applications U.S. 2014/0206788 (Joly et al.) and U.S. 2013/067638 (Joly et al.) each incorporated herein by reference.

In some embodiments, the disclosure provides a universal restorative composite comprising:

- a) 15-30 wt.% of a curable dental resin comprising at least two polymerizable, ethylenically unsaturated groups;
- b) 70-85 wt.% of an inorganic filler, preferably a surface modified filler;



c) 0.1 to 10 parts by weight of the addition-fragmentation oligomer, relative to 100 parts by weight of a) and b), said curable composition further comprising an initiator and < 2%, stabilizers, pigments, etc.

In some embodiments, the disclosure provides a flowable restorative (flowable) composite comprising:

- a) 25-50 wt.% of a curable dental resin comprising at least two polymerizable, ethylenically unsaturated groups;
- b) 30-75wt.% of an inorganic filler, preferably a surface modified filler;
- c) 0.1 to 10 parts by weight of the addition-fragmentation oligomer, relative to 100 parts by weight of a) and b), said curable composition further comprising an initiator and < 2% initiators, stabilizers, pigments, etc.

In some embodiments, the disclosure provides a resin modified glass-ionomer adhesive comprising:

- a) 10-25 wt.% of a partially (meth)acrylated poly(meth) acrylic acid, which includes acrylic acids such as itaconic acid;
- b) 5-20% of a hydroxyalkyl (meth)acrylate;
- c) 30-60% of fluoroaluminosilicate (FAS) acid reactive glass
- d) 0-20% non-acid reactive fillers, preferably surface-treated;
- e) 10-20% water; and
- f) 0.1 to 10 wt.% of the addition-fragmentation oligomer, relative to 100 parts by weight of a) and b),
- g) said curable composition further comprising an initiator and < 2% stabilizers, pigments, etc.

Preferably the fluoroaluminosilicate is a silane methacrylate surface-treated fluoroaluminosilicate.

In some embodiments, the disclosure provides a dental adhesive comprising:

- a) 30-80 wt.% mono (meth)acrylate monomers;
- b) 1-10 wt.% polyfunctional (meth)acrylate monomers;
- c) 5-60 wt.%% monomers having a acid- functional group (including phosphate, phosphonate, carboxylate, sulfonic acids)
- d) 0-10, preferably 1-10 wt.% poly(meth)acrylic acid methacrylate monomers;

- e) 0.1 to 10 wt.% of the addition-fragmentation oligomer, relative to 100 parts by weight of a) to d);
- f) an initiator,
- g) 0-30% inorganic filler, preferably surface modified, relative to 100 parts by weight of a) to d);
- h) 0 to 25 wt.% solvent relative to 100 parts by weight of a) to d);
- i) 0 to 25 wt.% water relative to 100 parts by weight of a) to d); and
- < 2% stabilizers, pigments, etc.

In some embodiments, the dental compositions can have an initial color different than the cured dental structures. Color can be imparted to the composition through the use of a photobleachable or thermochromic dye. As used herein, "photobleachable" refers to loss of color upon exposure to actinic radiation. The composition can include at least 0.001 wt.% photobleachable or thermochromic dye, and typically at least 0.002 wt.% photobleachable or thermochromic dye, based on the total weight of the composition. The composition typically includes at most 1wt.% photobleachable or thermochromic dye, and more typically at most 0.1 wt.% photobleachable or thermochromic dye, based on the total weight of the composition. The amount of photobleachable and/or thermochromic dye may vary depending on its extinction coefficient, the ability of the human eye to discern the initial color, and the desired color change. Suitable thermochromic dyes are disclosed, for example, in U.S. 6,670,436 (Burgath et al.).

For embodiments including a photobleachable dye, the color formation and bleaching characteristics of the photobleachable dye varies depending on a variety of factors including, for example, acid strength, dielectric constant, polarity, amount of oxygen, and moisture content in the atmosphere. However, the bleaching properties of the dye can be readily determined by irradiating the composition and evaluating the change in color. The photobleachable dye is generally at least partially soluble in a hardenable resin.

Photobleachable dyes include, for example, Rose Bengal, Methylene Violet, Methylene Blue, Fluorescein, Eosin Yellow, Eosin Y, Ethyl Eosin, Eosin bluish, Eosin B, Erythrosin B, Erythrosin Yellowish Blend, Toluidine Blue, 4',5'-Dibromofluorescein, and combinations thereof.

The color change can be initiated by actinic radiation such as provided by a dental curing light which emits visible or near infrared (IR) light for a sufficient amount of time.

The mechanism that initiates the color change in the compositions may be separate from or substantially simultaneous with the hardening mechanism that hardens the resin. For example, a composition may harden when polymerization is initiated chemically (e.g., redox initiation) or thermally, and the color change from an initial color to a final color may occur subsequent to the hardening process upon exposure to actinic radiation.

Optionally, compositions may contain solvents (e.g., alcohols (e.g., propanol, ethanol), ketones (e.g., acetone, methyl ethyl ketone), esters (e.g., ethyl acetate), other nonaqueous solvents (e.g., dimethylformamide, dimethylacetamide, dimethylsulfoxide, 1-methyl-2-pyrrolidinone)), and water.

If desired, the compositions can contain additives such as indicators, dyes, pigments, inhibitors, accelerators, viscosity modifiers, wetting agents, buffering agents, radical and cationic stabilizers (for example BHT,), and other similar ingredients that will be apparent to those skilled in the art.

Additionally, medicaments or other therapeutic substances can be optionally added to the dental compositions. Examples include, but are not limited to, fluoride sources, whitening agents, anticaries agents (e.g., xylitol), calcium sources, phosphorus sources, remineralizing agents (e.g., calcium phosphate compounds), enzymes, breath fresheners, anesthetics, clotting agents, acid neutralizers, chemotherapeutic agents, immune response modifiers, thixotropes, polyols, anti-inflammatory agents, antimicrobial agents (in addition to the antimicrobial lipid component), antifungal agents, agents for treating xerostomia, desensitizers, and the like, of the type often used in dental compositions. Combinations of any of the above additives may also be employed. The selection and amount of any one such additive can be selected by one of skill in the art to accomplish the desired result without undue experimentation.

The curable dental composition can be used to treat an oral surface such as tooth, as known in the art. In some embodiments, the compositions can be hardened by curing after applying the dental composition. For example, when the curable dental composition is used as a restorative such as a dental filling, the method generally comprises applying the curable composition to an oral surface (e.g. cavity); and curing the composition. In some embodiments, a dental adhesive may be applied prior to application of the curable dental restoration material described herein. Dental adhesives are also typically hardened by curing concurrently with curing the highly filled dental restoration composition. The

method of treating an oral surface may comprise providing a dental article and adhering the dental article to an oral (e.g. tooth) surface.

In other embodiments, the compositions can be cured into dental articles prior to applying. For example, a dental article such as a crown may be pre-formed from the curable dental composition described herein. Dental composite (e.g. crowns) articles can be made from the curable composition described herein by casting the curable composition in contact with a mold and curing the composition. Alternatively, dental composites or articles (e.g. crowns) can be made by first curing the composition forming a mill blank and then mechanically milling the composition into the desired article.

Another method of treating a tooth surface comprises providing a dental composition as described herein wherein the composition is in the form of a (partially cured) curable, self-supporting, malleable structure having a first semi-finished shape; placing the curable dental composition on a tooth surface in the mouth of a subject; customizing the shape of the curable dental composition; and hardening the curable dental composition. The customization can occur in the patient's mouth or on a model outside the patient mouth such as described in U.S. 7,674,850 (Karim et al.); incorporated herein by reference.

### **Examples**

As used herein, AFO refers to addition fragmentation oligomers. All parts and percentages are by weight unless otherwise specified.

General Procedures. All reactions were performed in round-bottomed flasks or glass jars or vials using unpurified commercial reagents.

Materials. Commercial reagents were used as received. Toluene was obtained from EMD Chemicals Inc. (Gibbstown, NJ, USA). Glycidyl methacrylate, cobalt(II) acetate tetrahydrate, pyridine, dimethylglyoxime, triphenyl phosphine, dibutyltin dilaurate (DBTDL), and acetone were obtained from Alfa Aesar (Ward Hill, MA, USA). Triphenyl antimony, glutaric anhydride, butylated hydroxytoluene (BHT), methacrylic acid, phosphorous pentoxide phenothiazine, and sodium bicarbonate were obtained from Sigma

Aldrich (St. Louis, MO, USA). **Diacid 1** and **AFM-1** were obtained as described in U.S. Patent Application Publication No. 2012/0208965 (Joly, G. D. et al.).

#### Material Acronyms

- 5 • BisGMA - (2,2-Bis[4-(2-hydroxy-3-methacryloyloxy- propoxy)phenyl]propane, Sigma Aldrich, St. Louis, MO, USA
- CPQ - Camphorquinone, Sigma Aldrich, St. Louis, MO, USA
- DPIHFP - Diphenyliodonium hexafluorophosphate ( $\geq 98\%$ ), Sigma Aldrich, St. Louis, MO, USA
- 10 • EDMAB - Ethyl 4-N,N-dimethylamino benzoate, Sigma Aldrich, St. Louis, MO, USA
- HEMA - Hydroxyethyl methacrylate, Sigma Aldrich, St. Louis, MO, USA
- MHP – 6-methacryloyloxyhexyl phosphate – compound preparation described in U.S. Patent Publication No. 2009-0011388 (Craig, et al.)
- UDMA - ROHAMERE 6661-0 (diurethane dimethacrylate, CAS No. 41 137-60-4),  
15 Rohm Tech, Inc., Malden, MA
- VAZO 67 - free radical initiator, DuPont, Wilmington, DE
- Z250 - FILTEK Z250 UNIVERSAL RESTORATIVE – 3M ESPE
- YbF<sub>3</sub> – Ytterbium(III) fluoride, Sigma Aldrich, St. Louis, MO, USA
- 4-meta-4-Methacryloxyethyl trimellitic anhydride, Polysciences, Inc., Warrington, PA,  
20 US

#### Depth of Cure Test Method

A depth of cure (DOC) was measured for a test sample composition after curing. A test fixture with an open 8 millimeter stainless steel mold cavity was placed on a polyester film and filled with the sample composition. A second polyester film placed atop the resin and fixture was pressed to provide a level surface on the composition. The filled test  
25 fixture was placed on a white background surface and the composition was irradiated for 20 seconds using a dental curing light (3M Dental Products Curing Light 2500 or 3M ESPE Elipar FreeLight2, all made by 3M ESPE Dental Products). After curing, the sample removed was from the mold and the uncured resin was gently removed, e.g.,  
30 gently scraping materials from the bottom of the sample which was the side that was not

irradiated with the curing light. The thickness of the remaining cured material was measured. The reported depths are the actual cured thickness in millimeters divided by 2.

#### Stress Test Method (Cusp Deflection)

5 To measure stress development during the curing process, a slot was machined into a rectangular 15 x 8 x 8 mm aluminum block. The slot was 8 mm long, 2.5 mm deep, and 2 mm across, and was located 2 mm from an edge, thus forming a 2 mm wide aluminum cusp adjacent to a 2 mm wide cavity containing dental compositions being tested. A linear variable displacement transducer (MODEL GT 1000, used with an E309 analog amplifier,  
10 both from RDP Electronics, United Kingdom) was positioned to measure the displacement of the cusp tip as the dental composition photocured at room temperature. Prior to testing, the slot in the aluminum block was sandblasted using ROCATEC PLUS SPECIAL SURFACE COATING BLASTING MATERIAL (3M ESPE), treated with RELYX CERAMIC PRIMER (3M ESPE), and finally treated with a dental adhesive, ADPER  
15 EASY BOND (3M ESPE).

The slot was fully packed with the dental compositions, which equaled approximately 100 mg of material. The material was irradiated for 1 minute with a dental curing lamp (ELIPAR S-10, 3M ESPE) positioned almost in contact (<1 mm) with the material in the slot, then the displacement of the cusp in micrometers was recorded 9 minutes after the  
20 lamp was extinguished.

Instrumentation. Nuclear magnetic resonance spectra (proton –  $^1\text{H}$  NMR; carbon –  $^{13}\text{C}$ ; phosphorus –  $^{31}\text{P}$  NMR) were analyzed and recorded using an NMR spectrometer (ULTRASHIELD PLUS 400 MHz NMR spectrometer; Bruker Corporation, Billerica,  
25 MA). Attenuated Total Internal Reflectance-Fourier Transform Infrared (ATR-FTIR) spectroscopy and analysis were performed on a NEXUS 670 FT-IR E.S.P. instrument, Thermo Nicolet Corp.; Madison, WI.

Glycidyl Methacrylate Dimer. An oven-dried, three-neck 250 mL round-bottomed flask  
30 was equipped with a magnetic stir bar, gas inlet adapter, and 50 mL pressure-equalizing addition funnel capped with a rubber septum, and a rubber septum. The apparatus was

allowed to cool to room temperature under nitrogen. All ground-glass joints were coated with vacuum grease. Glycidyl methacrylate (25 mL, 26.95 g, 189.6 mmol) and VAZO 67 (0.0495 g, 0.257 mmol) were added to the reaction flask and the mixture was stirred. The addition funnel was charged with glycidyl methacrylate (50 mL, 53.90 g, 379.2 mmol) and VAZO 67 (0.0990 g, 0.515 mmol). The solutions of VAZO 67 in glycidyl methacrylate were sparged with nitrogen for 30 minutes after which the reaction was maintained under nitrogen. Next, cobalt(II) acetate tetrahydrate (0.0240 g, 0.0964 mmol), dimethyl glyoxime (0.0360 g, 0.310 mmol), and pyridine (0.060 mL, 0.059 g, 0.74 mmol) were added to the pot. With stirring, the reaction was heated to 75 °C in an oil bath. The solution of glycidyl methacrylate and VAZO 67 were added to the pot dropwise over 1.5 hours. After an additional hour, VAZO 67 (0.0038 g, 0.0198 mmol) was added to the pot. The reaction was allowed to stir at 75 °C for an additional 18 hours. The reaction was then allowed to cool to room temperature. Residual glycidyl methacrylate monomer was removed under reduced pressure (approximately 0.16 mm Hg) with gentle heating in an oil bath at 45 °C gently ramped to 95 °C. Then, the dimer product was distilled from the reaction mixture using a short-path distillation apparatus. The dimer distilled at approximately 140 °C at a pressure of 0.15 mm Hg. The glycidyl methacrylate dimer was obtained as a colorless to pale yellow, clear viscous liquid (17.60 g, 21.8 %).

## 20 Preparation of AFO-1

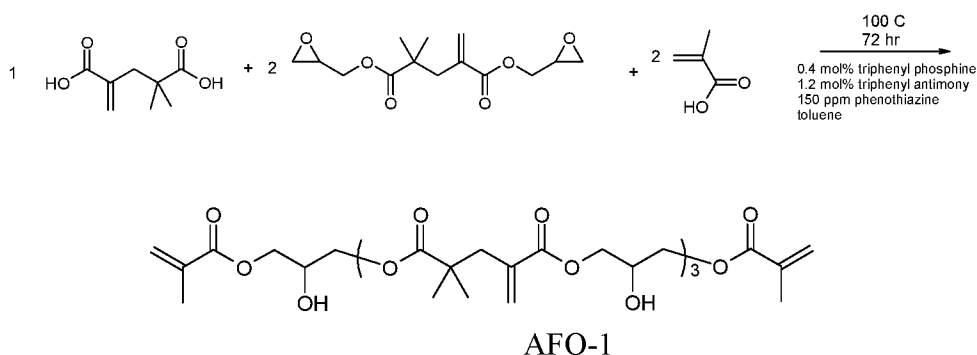

30 An 8 oz. (~237 mL) jar equipped with a magnetic stir bar was charged with Diacid 1 (3.028 g, 17.5 mmol), glycidyl methacrylate dimer (10 g, 35 mmol), methacrylic acid (3.028 g, 35 mmol), toluene (39 g), triphenyl phosphine (0.017 g, 0.06 mmol), triphenyl

antimony (0.076, 0.2 mmol). The reaction was sealed with a plastic cap. With stirring, the mixture was heated to 100 °C in an oil bath. The reaction was sampled after 72 h and the <sup>1</sup>H NMR spectrum was consistent with the desired product as a mixture of isomers. The reaction was cooled to room temperature and phenothiazine (2 mg, 150 ppm) was added. The solution was dried *in vacuo* with air bubbled through to provide AFO-1, a yellow, viscous material.

### Preparation of AFO-2

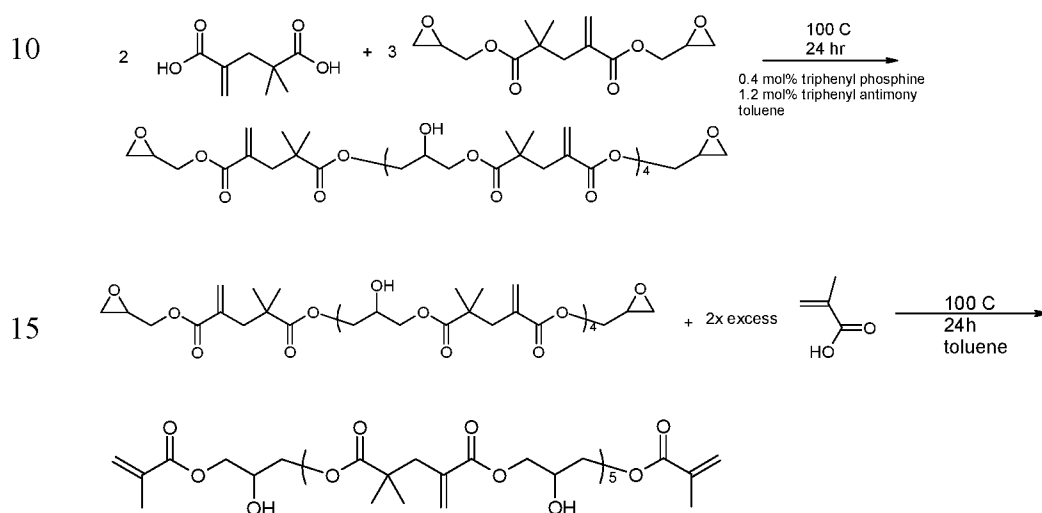

AFO-2

20

An 8 oz (~237 mL) jar equipped with a magnetic stir bar was charged with Diacid 1 (9.05 g, 52 mmol), glycidyl methacrylate dimer (22.4 g, 79 mmol), triphenyl phosphine (0.09 g, 0.3 mmol), triphenyl antimony (0.76, 0.9 mmol), and toluene (93 g). The reaction was sealed with a plastic cap. With stirring, the mixture was heated to 100 °C in an oil bath. After 24 h, the reaction was sampled and the <sup>1</sup>H NMR spectrum was consistent with the desired intermediate as a mixture of isomers. An excess of methacrylic acid (9.05 g, 79 mmol) was added to the reaction. With stirring, the mixture was heated to 100 °C in an oil bath. After an additional 36 h, the reaction was sampled and the <sup>1</sup>H NMR spectrum was consistent with the desired product as a mixture of isomers. The reaction was cooled to room temperature and rinsed with saturated sodium bicarbonate to remove the excess methacrylic acid. The solution was then washed three times with water to remove any

30



remaining salt. The solution was dried *in vacuo* with air bubbled through to provide AFO-2, a yellow, viscous material.

### Preparation of AFO-7 and AFO-8

5

10

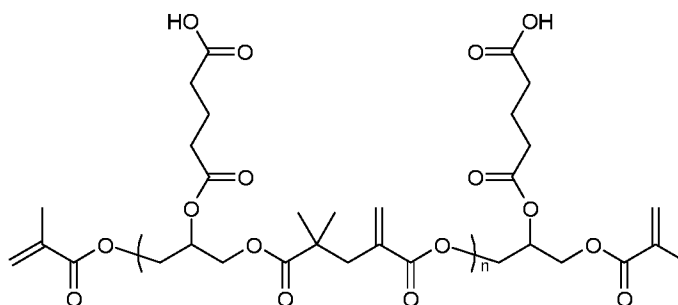

AFO-7:  $n = 3$   
 AFO-8:  $n = 5$

15

An 8 oz (~237 mL) jar equipped with a magnetic stir bar was charged with AFO-1 (5.34 g, 6 mmol), glutaric anhydride (2.7 g, 24 mmol), toluene (25 g), and butylated hydroxytoluene (0.3 mg, 0.0014 mmol). The reaction was sealed with a plastic cap. The mixture was heated to 100 °C in an oil bath. After 24 h, the reaction was sampled and the <sup>1</sup>H NMR spectrum was consistent with the desired intermediate as a mixture of isomers. The solution was decanted and dried *in vacuo*. The reaction yielded AFO-7 as a viscous, yellow liquid.

20

The same procedure was used to synthesize AFO-8, where AFO-2 was used in place of AFO-1, and adjustments in amount of reactants to maintain stoichiometric amounts.

25

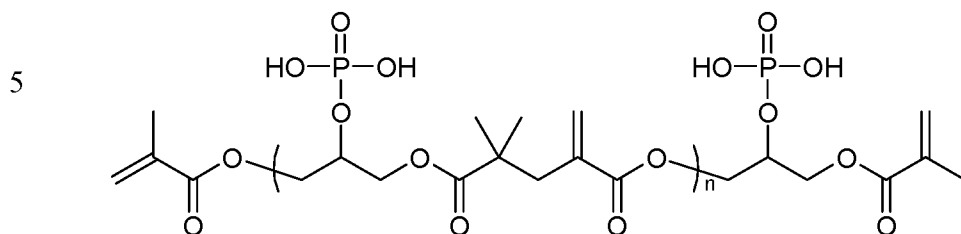
Preparation of AFO-9 and AFO-10

For AFO-9: n = 3  
For AFO-10: n = 5

10

Phosphorous pentoxide ( $P_4O_{10}$ , 2.2 g, 16 mmol) was suspended in 50 mL of acetone in a 500 mL 3-neck round bottom flask. The flask was equipped with a magnetic stir bar and nitrogen streaming through the flask into a nearby bubbler and an addition funnel. The flask was placed in an ice water bath. A solution of AFO-1 (7.4 g, 8 mmol) in 50 mL acetone was added dropwise to the suspension over about 30 minutes. The reaction was stirred for an additional 30 minutes. The flask was then removed from the ice bath and allowed to warm to room temperature. After 6 hours stirring at room temperature, the mixture was decanted, then concentrated to yellow oil with 90% yield.  $^{31}P$  NMR confirmed the presence of P nuclei.

20

The same procedure was used to synthesize AFO-10, where AFO-2 was used in place of AFO-1 and adjustments in reactants to maintain stoichiometric amounts.

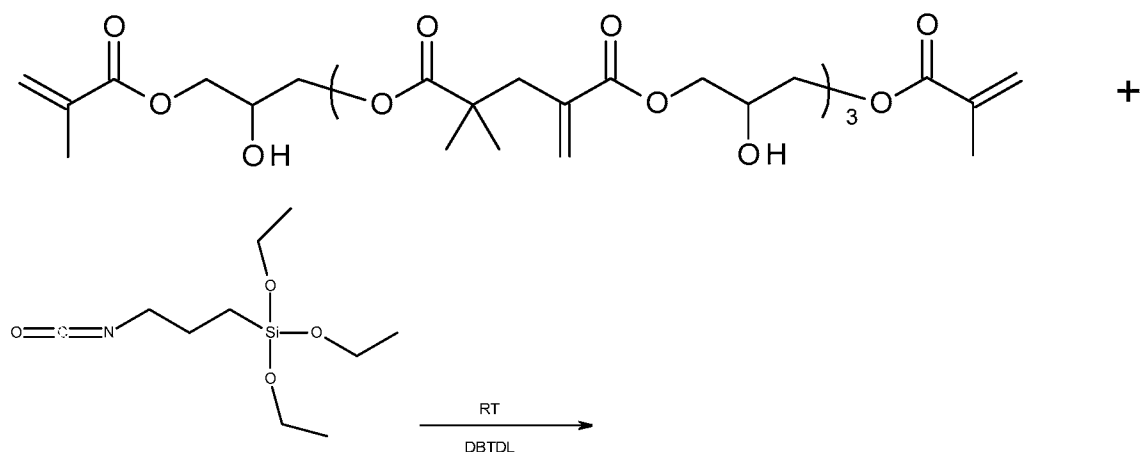
Preparation of AFM-11

5

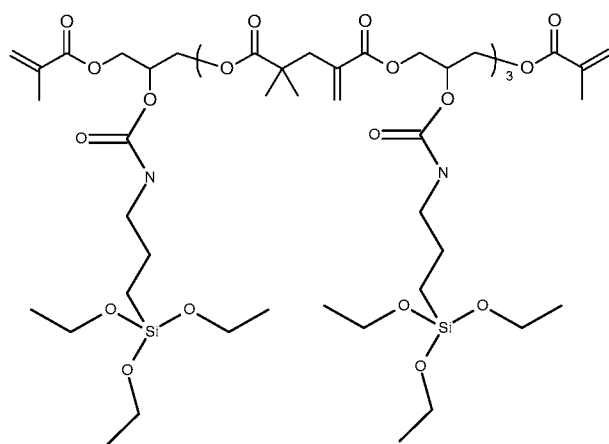

AFM-11

10

An 8 oz (~237 mL) jar equipped with a magnetic stir bar was charged with AFO-1 (2.5 g, 2.8 mmol), isocyanatotriethoxysilane (2.7 g, 11 mmol), tetrahydrofuran (15 g), and 2 drops of dibutyltin dilaurate. The reaction was sealed with a plastic cap. The mixture was stirred at room temperature. After 96 h, the reaction was sampled and an FTIR spectrum of the product taken. Consumption of the isocyanate was confirmed. The solution was decanted and dried with air bubbled through the solution. The reaction yielded a viscous, yellow liquid.

15

Pastes for the above examples were prepared according to the amounts summarized in Tables 1 to 3. Samples of the pastes were then tested for the rate of shrinkage in the Watts Shrinkage Test Method and for DOC in millimeters (mm), all according to the test procedures described above, with results as summarized in Table 4.

5

TABLE 1. Formulations with AFO-7 and control for AFO-7

Material, all amounts are wt.%	0 wt.% AFO-7	2 wt.% AFO-7	4 wt.% AFO-7	6 wt.% AFO-7	8 wt.% AFO-7	10 wt.% AFO-7
DPIPF6	0.20	0.20	0.20	0.20	0.20	0.20
CPQ	0.32	0.32	0.32	0.32	0.32	0.32
EDMAB	0.48	0.48	0.48	0.48	0.48	0.48
MHP	10.00	9.50	8.97	8.46	7.95	7.44
HEMA	11.60	11.00	10.41	9.82	9.22	8.62
BisGMA	17.40	16.50	15.62	14.72	13.83	12.94
AFO-7	0.00	2.00	4.00	6.00	8.00	10.00
Z250 filler	60.00	60.00	60.00	60.00	60.00	60.00
Total wt.%	100.00	100.00	100.00	100.00	100.00	100.00

TABLE 2. Formulations with AFO-8 and control for AFO-8

Material, all amounts are wt.%	0 wt.% AFO-8	1 wt.% AFO-8
DPIPF6	0.18	0.18
CPQ	0.14	0.14
EDMAB	0.40	0.40
MHP	9.35	9.09
UDMA	1.27	1.24
HEMA	10.85	10.55
BisGMA	14.81	14.40
AFO-7	0.00	1.00
YbF3	5.00	5.00
Z250 filler	58.00	58.00
Total wt.%	100.00	100.00

TABLE 3. Formulations with AFO-9 and control for AFO-9

Material, all amounts are wt.%	0 wt.% AFO-9	1 wt.% AFO-9	2 wt.% AFO-9	3 wt.% AFO-9
DPIPF6	0.18	0.18	0.18	0.18
CPQ	0.14	0.14	0.14	0.14
EDMAB	0.40	0.40	0.40	0.40
MHP	9.35	9.09	8.83	8.57
UDMA	1.27	1.24	1.20	1.16
HEMA	10.85	10.55	10.25	9.95
BisGMA	14.81	14.40	14.00	13.60
AFO-9	0.00	1.00	2.00	3.00
YbF3	5.00	5.00	5.00	5.00
Z250 filler	58.00	58.00	58.00	58.00
Total wt.%	100.00	100.00	100.00	100.00

TABLE 4: Stress test and depth of cure results

Description	Cusp deflection, micrometers	Standard deviation, micrometers	ISO Depth of Cure, mm	Standard deviation, mm
0 wt.% AFO-7	6.20	0.30	3.16	0.09
2 wt.% AFO-7	4.35	0.37	3.11	0.03
4 wt.% AFO-7	3.39	0.29	2.96	0.07
6 wt.% AFO-7	2.54	0.01	2.91	0.07
8 wt.% AFO-7	1.78	0.04	2.80	0.05
10 wt.% AFO-7	1.34	0.04	2.71	0.03
0 wt.% AFO-8, 10 seconds	6.18	0.16	3.23	0.03
1 wt.% AFO-8, 10 seconds	5.31	0.24	3.18	0.13
0 wt.% AFO-8; 20 seconds	NA	NA	3.97	0.09
1 wt.% AFO-8; 20 seconds	NA	NA	3.88	0.02
0 wt.% AFO-9, 10 seconds	6.18	0.16	3.23	0.03
1 wt.% AFO-9, 10 seconds	4.68	0.48	2.97	0.01
2 wt.% AFO-9, 10 seconds	3.14	0.03	2.74	0.11
3 wt.% AFO-9, 10 seconds	2.21	0.04	2.59	0.05
0 wt.% AFO-9, 20 seconds	NA	NA	3.97	0.09
1 wt.% AFO-9, 20 seconds	NA	NA	3.52	0.04
2 wt.% AFO-9, 20 seconds	NA	NA	3.30	0.06
3 wt.% AFO-9, 20 seconds	NA	NA	3.07	0.01

What is claimed is:

1. An addition-fragmentation oligomers of the formula:

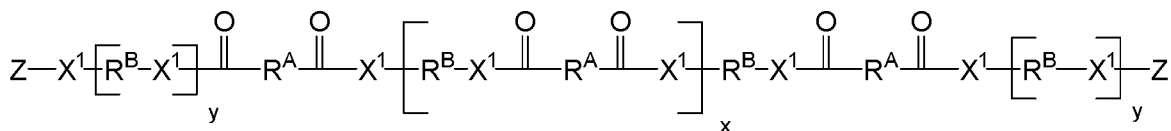

5

wherein

$R^A$  is non-directionally a 1-methylene-3,3-dimethyl propyl group,

$R^B$  is hydrocarbyl group that optionally further comprising a functional group D that bonds or etches a substrate to which it adheres, wherein at least two  $R^A$  and/or  $R^B$  groups are substituted with an D group;

10

$X^1$  is  $-O-$  or  $NR^5-$ , where  $R^5$  is H or  $C_1-C_4$  alkyl;

Z comprises an ethylenically unsaturated polymerizable group;

y is 0 or 1;

x is 0 to 60.

15

2. The addition-fragmentation oligomer of claim 1 wherein the  $R^B$  units comprise a 1-methylene-3,3-dimethyl propyl group.

3. The addition-fragmentation oligomer of claim 1, wherein at least 50% of the  $R^A$  and/or  $R^B$  units are substituted by a D group.

20

4. The addition-fragmentation oligomer of claim 1, wherein at least 75% of the  $R^A$  and/or  $R^B$  units are substituted by a D group.

25

5. The addition-fragmentation oligomer of claim 1, wherein the D group that bonds or etches a substrate is selected from monophosphate, a phosphonate, a phosphonic acid, a hydroxamic acid, a carboxylic acid, and acetoacetate, an anhydride, an isonitrile group, a silyl, a disulfide, a thiol, an amino, a sulfinic acid, a sulfonic acid, and a phosphine.

6. The addition-fragmentation oligomer of claim 1 wherein Z comprises a (meth)acrylate or vinyl group.

7. The addition-fragmentation oligomer of claim 1 derived from A compounds of the formula:

$R^1-O-CO-R^A-CO-O-R^1$ , wherein  $R^A$  is a 1-methylene-3,3-dimethylpropyl group and  $R^1$  is H, alkyl, aryl or  $R^{FG}$ , where  $R^{FG}$  is an aryl or an alkyl further substituted with a nucleophilic or electrophilic functional group.

8. The addition-fragmentation oligomer of claim 7 derived from B compounds of the formula:

$X^2-R^B-X^2$ , wherein  $R^B$  is a hydrocarbyl group that optionally further comprising a functional group D and  $X^2$  is functional group reactive with the functional groups of the A compound.

9. The addition-fragmentation oligomer of claim 8 wherein R is derived from a bis-hydroxyalkyl ester of the dimer of methacrylic acid.

10. The addition-fragmentation oligomer of claim 8 wherein R is derived from a bis-glycidyl ester of the dimer of methacrylic acid

11. The addition-fragmentation oligomer of claim 8 wherein the compound of the formula  $X^2-R^B-X^2$  is selected from difunctional epoxides, diols, aziridines, isocyanates and diamines.

12. The addition fragmentation of claim 8 where reaction between the A compounds and B compounds yields an intermediate oligomer of the formula:

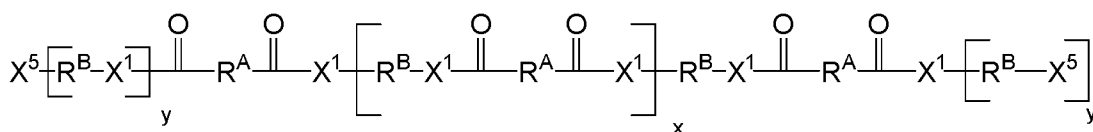

wherein

$R^A$  is non-directionally a 1-methylene-3,3-dimethyl propyl group;



$R^B$  is a hydrocarbyl group that optionally further comprising a functional group D that bonds or etches a substrate to which it adheres, wherein at least two  $R^B$  groups are substituted with an D group;

$X^1$  is -O- or  $NR^5$ -, where  $R^5$  is H or  $C_1$ - $C_4$  alkyl;

5  $X^5$  is a terminal functional group selected from  $-OR^1$  of the A compounds or  $X^2$  of the B compounds;

y is 0 or 1;

x is 0 to 60.

10 13. The addition-fragmentation oligomer of claim 1 where y is 1.

14. The addition-fragmentation oligomer of claim 1 where y is 0.

15. The addition-fragmentation oligomer of claim 1 where x + y is 0 to 60.

15

16. The addition-fragmentation oligomer of claim 1 where x + y is 0 to 20.

17. The addition-fragmentation oligomer of claim 1 where the Z group is derived from an ethylenically unsaturated compound of the formula:

20  $(Z)_d-X^3$ , where Z comprises an ethylenically unsaturated group, and  $X^3$  is a functional group reactive with the terminal functional groups of the intermediate oligomer.

18. The addition-fragmentation oligomer of claim 17 wherein the compound of the formula  $(Z)_d-X^3$  is of the formula:

25  $Y^1-R^3-O-CO-CR^2=CH_2$ , where  $Y^1$  is an electrophilic functional group reactive with terminal electrophilic functional groups of the intermediate oligomer,  $R^3$  is an alkylene,  $R^2$  is H or  $CH_3$ .

19. The addition-fragmentation oligomer of claim 18 wherein the compound of the formula  $(Z)_d-X^3$  is of the formula:

30

$Y^2-R^3-O-CO-CR^2=CH_2$ , where  $Y^2$  is an nucleophilic functional group reactive with the electrophilic functional groups of the intermediate oligomer,  $R^3$  is an alkylene,  $R^2$  is H or  $CH_3$ .

5 20. The addition-fragmentation oligomer of claim 1 wherein the D group is derived from a compound of the formula:  $Y^1-(R^{13})_q-X^7-D$ , or

$Y^2-(R^{13})_q-X^7-D$ ,

where

$Y^1$  is an electrophilic functional group reactive with nucleophilic  $X^2$  groups on the B units,

10  $Y^2$  is an nucleophilic functional group reactive with electrophilic  $X^2$  on the B units

$R^{13}$  is a (hetero)hydrocarbyl group,

q is 0 or 1,

$X^7$  is selected from a covalent bond or a divalent linking group

and D is a functional group that bonds or etches the underlying substrate.

15

21. The addition-fragmentation oligomer of claim 1 wherein the pendent D units may be represented by  $Y^*- (R^{13})_q-X^7-D$ , where

$Y^*$  is a functional group formed from the reaction between the electrophilic and nucleophilic groups of the B units and the D compounds comprising a groups that bonds or etches the surface of a substrate,

20

$R^{13}$  is a (hetero)hydrocarbyl group,

q is 0 or 1,

$X^7$  is selected from a covalent bond or a divalent linking group, and

D is a functional group that bonds or etches the underlying substrate.

25

22. A polymerizable composition comprising the addition-fragmentation oligomer of any of claims 1-21, at least one free-radically polymerizable monomer, and an initiator.

23. The polymerizable composition of claim 22 comprising:

30

a) 85 to 100 parts by weight of an (meth)acrylic acid ester;

b) 0 to 15 parts by weight of an acid functional ethylenically unsaturated monomer;

- c) 0 to 10 parts by weight of a non-acid functional, ethylenically unsaturated polar monomer;
- d) 0 to 5 parts vinyl monomer; and
- e) 0 to 100 parts of a multifunctional (meth)acrylate;
- 5 based on 100 parts by weight total monomer a) to d), and
- f) 0.1 to 12 parts by weight of the addition-fragmentation oligomer, based on 100 parts by weight of a) to e), and
- g) an initiator.
- 10 24. The polymerizable composition of claim 23 further comprising 0.01 to 100 parts of a multifunctional (meth)acrylate.
25. The polymerizable composition of claims 22 to 24 comprising a photoinitiator.
- 15 26. The polymerizable composition of any of claims 22 to 24 wherein the initiator is a thermal initiator.
27. The polymerizable composition of any of claims 22 to 26 containing less than 0.01 wt.% cobalt compounds.
- 20 28. The polymerizable composition of any of claims 22-27 further comprising an inorganic filler.
- 25 29. The polymerizable composition of claim 28 wherein the filler is a surface-modified silica filler.
30. An article comprising a layer of the polymerizable composition of any of claims 22-29 on a substrate.
- 30 31. An article comprising the cured polymerizable composition of any of claims 22-29 on a substrate.

32. A method of bonding two substrates together comprising the steps of coating the polymerizable composition of any of claims 22-29 to a surface of one or both substrates, contacting the coated surfaces, optionally with pressure, and curing the polymerizable compositions.

5

33. A method of bonding two substrates together comprising the steps of coating the polymerizable composition of any of claims 22-29 to a surface of one or both substrates, wherein the coating of polymerizable composition is at least partially cured, contacting the coated surfaces optionally with pressure, and further curing the polymerizable compositions if necessary.

10

34. A hardcoat composition comprising one or more multifunctional (meth)acrylate monomers or (meth)acrylate oligomers, and the addition-fragmentation oligomer of any of claims 1 to 21.

15

35. The hardcoat composition of claim 34 comprising:

- a) 0.1 – 10 wt.% of the addition fragmentation oligomer of Formula I;
- b) 20-80 wt.% of multifunctional (meth)acrylate monomers and/or multifunctional (meth)acrylate oligomers,
- c) 0 to 25 wt.% (meth)acrylate diluent; and
- d) 20 to 75 wt.% of silica.

20

36. A curable dental composition comprising:

- a) at least one dental resin comprising at least two ethylenically unsaturated group;
- b) an addition-fragmentation oligomer of any of claims 1-21; and
- c) optionally an inorganic oxide filler.

25

37. The dental composition of claim 36 wherein the ethylenically unsaturated groups of the dental resin are (meth)acrylate groups.

30

38. The dental composition of any of the preceding claims 36-37 wherein the dental resin comprises an aromatic monomer having a refractive index of at least 1.50.

5 39. The dental composition of any of the preceding claims 36-37 wherein the dental resin is a low volume shrinkage resin.

10 40. The dental composition of any of the preceding claims 36-39 wherein the dental resin is an isocyanurate resin, a tricyclodecane resin, cyclic allylic sulfide resins; methylene dithiepane silane resins; and poly(meth)acryloyl-containing resins, or mixtures thereof.

41. The dental composition of any of the preceding claims 36-40 wherein the hardened dental composition exhibits a stress deflection no greater than 4.0.

15 42. The dental composition of any of the preceding claims 36-41 wherein the dental composition further comprises at least one other (meth)acrylate monomer is selected from ethoxylated bisphenol A dimethacrylate, 2-hydroxyethyl methacrylate, bisphenol A diglycidyl dimethacrylate, urethane dimethacrylate, triethlyene glycol dimethacrylate, glycerol dimethacrylate, ethylenegylcol dimethacrylate, neopentylglycol dimethacrylate  
20 (NPGDMA), polyethyleneglycol dimethacrylate, and mixtures thereof.

43. The dental composition of any of the preceding claims 36-42 wherein the inorganic oxide filler comprises nanoparticles.

25 44. The dental composition of claim 43 wherein the inorganic oxide nanoparticles comprise silica, zirconia, or mixtures thereof.

45. The dental composition of claims 43 or 44 wherein the inorganic oxide nanoparticles are in the form of nanoclusters.

30

46. The dental composition of any of the preceding claims 36-45 comprising a surface modified inorganic oxide filler.

47. A method of treating a tooth surface, the method comprising
- a) providing a curable dental resin of any of claims 36-46;
  - b) placing the dental composition on a tooth surface in the mouth of a subject;
- 5 and
- c) hardening the hardenable dental composition.
48. The method of claim 47 wherein the dental composition is a dental restoration composition.
- 10
49. A dental article comprising the curable dental composition of claims 36-48 at least partially cured.
50. A method of treating a tooth surface, the method comprising
- 15 providing an at least partially hardened dental article according to claim 49, adhering the dental article on a tooth surface in the mouth of a subject.
51. A universal dental restorative comprising:
- a) 15-30 wt.% of a curable dental resin comprising at least two polymerizable,
- 20 ethylenically unsaturated groups;
- b) 70-85 wt.% of an inorganic filler, preferably a surface modified filler;
  - c) 0.1 to 10 parts by weight of the addition-fragmentation oligomer of any of claim 1-21, relative to 100 parts by weight of a) and b),
- said curable composition further comprising an initiator and;
- 25 < 2%, stabilizers, pigments, etc.
52. A flowable restorative composite comprising:
- a) 25-50 wt.% of a curable dental resin comprising at least two polymerizable,
- 30 ethylenically unsaturated groups;
- b) 30-75 wt. % of an inorganic filler;
  - c) 0.1 to 10 parts by weight of the addition-fragmentation oligomer of any of claims 1-21, relative to 100 parts by weight of a) and b).

- d) an initiator;
  - e) < 2% stabilizers and pigments, and
  - f) optionally 5-60 wt.% monomers having an acid- functional group.
- 5 53. A resin-modified glass-ionomer adhesive comprising:
- a) 10-25 wt.% of a partially (meth)acrylated poly(meth) acrylic acid;
  - b) 5-20% of a hydroxyalkyl (meth)acrylate;
  - c) 30-60% of fluoroaluminosilicate (FAS) acid reactive glass);
  - d) 0-20% non-acid reactive fillers;
  - 10 e) 10-20% water; and
  - f) 0.1 to 10 wt.% of the addition-fragmentation oligomer of any of claims 1-21, relative to 100 parts by weight of a) and b)
  - g) an initiator.
- 15 54. The resin-modified glass ionomer adhesive of claim 53 wherein the fluoroaluminosilicate is a silane methacrylate surface-treated fluoroaluminosilicate.
55. A dental adhesive comprising:
- a) 30-80 wt.% mono (meth)acrylate) monomers;
  - 20 b) 1-10 wt.% polyfunctional (meth)acrylate monomers;
  - c) 5-60 wt.% monomers having a acid- functional group;
  - d) 0-10 wt.% poly(meth)acrylic acid methacrylate monomers;
  - e) 0.1 to 10 wt.% of the addition-fragmentation oligomer of any of claims 1-21, relative to 100 parts by weight of a) to d);
  - 25 f) an initiator,
  - g) 0-30% inorganic filler, preferably surface modified, relative to 100 parts by weight of a) to d);
  - h) 0 to 25 wt.% solvent relative to 100 parts by weight of a) to d);
  - i) 0 to 25 wt.% water relative to 100 parts by weight of a) to d); and
  - 30 < 2% stabilizers and pigments.

INTERNATIONAL SEARCH REPORT

International application No  
PCT/US2016/015300

A. CLASSIFICATION OF SUBJECT MATTER  
INV. C09J4/06 A61K6/08 C08F222/10 C08F292/00  
ADD.  
According to International Patent Classification (IPC) or to both national classification and IPC

B. FIELDS SEARCHED  
Minimum documentation searched (classification system followed by classification symbols)  
C09J A61K C08L C08F  
Documentation searched other than minimum documentation to the extent that such documents are included in the fields searched

Electronic data base consulted during the international search (name of data base and, where practicable, search terms used)  
EPO-Internal, WPI Data, CHEM ABS Data

C. DOCUMENTS CONSIDERED TO BE RELEVANT		
Category*	Citation of document, with indication, where appropriate, of the relevant passages	Relevant to claim No.
X	WO 2014/099317 A1 (3M INNOVATIVE PROPERTIES CO [US]) 26 June 2014 (2014-06-26) page 55 - page 57; claims 34-53 -----	1-55
X,P	WO 2015/126657 A1 (3M INNOVATIVE PROPERTIES CO [US]) 27 August 2015 (2015-08-27)  page 59; claims 33-51 -----	1-4,6-8, 10-12, 14-25, 27-55
A	US 2012/208965 A1 (JOLY GUY D [US] ET AL) 16 August 2012 (2012-08-16) cited in the application paragraph [0045] - paragraph [0070]; claims 1-18; examples 1, 3, 5-7 -----  -/--	1-55

Further documents are listed in the continuation of Box C.

See patent family annex.

\* Special categories of cited documents :

- "A" document defining the general state of the art which is not considered to be of particular relevance
- "E" earlier application or patent but published on or after the international filing date
- "L" document which may throw doubts on priority claim(s) or which is cited to establish the publication date of another citation or other special reason (as specified)
- "O" document referring to an oral disclosure, use, exhibition or other means
- "P" document published prior to the international filing date but later than the priority date claimed

- "T" later document published after the international filing date or priority date and not in conflict with the application but cited to understand the principle or theory underlying the invention
- "X" document of particular relevance; the claimed invention cannot be considered novel or cannot be considered to involve an inventive step when the document is taken alone
- "Y" document of particular relevance; the claimed invention cannot be considered to involve an inventive step when the document is combined with one or more other such documents, such combination being obvious to a person skilled in the art
- "&" document member of the same patent family

Date of the actual completion of the international search  28 June 2016	Date of mailing of the international search report  05/07/2016
Name and mailing address of the ISA/ European Patent Office, P.B. 5818 Patentlaan 2 NL - 2280 HV Rijswijk Tel. (+31-70) 340-2040, Fax: (+31-70) 340-3016	Authorized officer  Parry, Julian



## INTERNATIONAL SEARCH REPORT

International application No  
PCT/US2016/015300

C(Continuation). DOCUMENTS CONSIDERED TO BE RELEVANT		
Category*	Citation of document, with indication, where appropriate, of the relevant passages	Relevant to claim No.
A	<p>WO 2012/112350 A2 (3M INNOVATIVE PROPERTIES CO [US]; JOLY GUY D [US]; KREPSKI LARRY R [US])  23 August 2012 (2012-08-23)  page 4, line 17 - page 7, line 11  page 21, line 25 - page 30, line 13  page 34, line 27 - page 37, line 12;  claims 1-34</p> <p style="text-align: center;">-----</p>	1-55
Y	<p>WO 2013/028397 A2 (3M INNOVATIVE PROPERTIES CO [US]; JOLY GUY D [US]; ABUELYAMAN AHMED S)  28 February 2013 (2013-02-28)  cited in the application  page 44 - page 51  point 36;  page 61</p> <p style="text-align: center;">-----</p>	1-55
Y	<p>WO 2013/028401 A1 (3M INNOVATIVE PROPERTIES CO [US]; JOLY GUY D [US]; ABUELYAMAN AHMED S)  28 February 2013 (2013-02-28)  page 1, line 9 - line 34  page 3, line 25 - page 4, line 24  page 15, line 3 - line 10  page 17, line 31 - page 23, line 30;  claims 1-23; examples 17-18</p> <p style="text-align: center;">-----</p>	1-55

# INTERNATIONAL SEARCH REPORT

International application No.  
PCT/US2016/015300

## Box No. II Observations where certain claims were found unsearchable (Continuation of item 2 of first sheet)

This international search report has not been established in respect of certain claims under Article 17(2)(a) for the following reasons:

1.  Claims Nos.: **43-46**  
because they relate to subject matter not required to be searched by this Authority, namely:
  
2.  Claims Nos.:  
because they relate to parts of the international application that do not comply with the prescribed requirements to such an extent that no meaningful international search can be carried out, specifically:
  
3.  Claims Nos.:  
because they are dependent claims and are not drafted in accordance with the second and third sentences of Rule 6.4(a).

## Box No. III Observations where unity of invention is lacking (Continuation of item 3 of first sheet)

This International Searching Authority found multiple inventions in this international application, as follows:

see additional sheet

1.  As all required additional search fees were timely paid by the applicant, this international search report covers all searchable claims.
  
2.  As all searchable claims could be searched without effort justifying an additional fees, this Authority did not invite payment of additional fees.
  
3.  As only some of the required additional search fees were timely paid by the applicant, this international search report covers only those claims for which fees were paid, specifically claims Nos.:  
**1-55**
  
4.  No required additional search fees were timely paid by the applicant. Consequently, this international search report is restricted to the invention first mentioned in the claims; it is covered by claims Nos.:

### Remark on Protest

- The additional search fees were accompanied by the applicant's protest and, where applicable, the payment of a protest fee.
- The additional search fees were accompanied by the applicant's protest but the applicable protest fee was not paid within the time limit specified in the invitation.
- No protest accompanied the payment of additional search fees.

**FURTHER INFORMATION CONTINUED FROM PCT/ISA/ 210**

This International Searching Authority found multiple (groups of) inventions in this international application, as follows:

1. claims: 1-4, 6-55(all partially)

The subject matter of claims 1-4 and 6-55 (all in part) excluding claim 5

---

2. claims: 1-55(partially)

The subject matter of claims 1-55 (in part) for the part referring to claim 5 where the D group encompasses (mono)phosphate, phosphonate, phosphonic acid or phosphine groups.

---

3. claims: 1-55(partially)

The subject matter of claims 1-55 (in part) for the part referring to claim 5 where the D group encompasses a hydroxamic acid, a carboxylic acid, acetoacetate, or anhydride groups

---

4. claims: 1-55(partially)

The subject matter of claims 1-55 (in part) for the part referring to claim 5 where the D group encompasses an isonitrile group

---

5. claims: 1-55(partially)

The subject matter of claims 1-55 (in part) for the part referring to claim 5 where the D group encompasses a silyl group

---

6. claims: 1-55(partially)

The subject matter of claims 1-55 (in part) for the part referring to claim 5 where the D group encompasses a disulfide, thiol, sulfinic acid or sulfonic acid groups

---

7. claims: 1-55(partially)

The subject matter of claims 1-55 (in part) for the part referring to claim 5 where the D group encompasses an amino group

---

# INTERNATIONAL SEARCH REPORT

Information on patent family members

International application No PCT/US2016/015300
---

Patent document cited in search report	Publication date	Patent family member(s)	Publication date
WO 2014099317 A1	26-06-2014	CN 104870484 A	26-08-2015
		EP 2931756 A1	21-10-2015
		JP 2016513071 A	12-05-2016
		KR 20150096479 A	24-08-2015
		US 2015328086 A1	19-11-2015
		WO 2014099317 A1	26-06-2014
-----			
WO 2015126657 A1	27-08-2015	TW 201609832 A	16-03-2016
		WO 2015126657 A1	27-08-2015
-----			
US 2012208965 A1	16-08-2012	CN 103328437 A	25-09-2013
		EP 2675783 A1	25-12-2013
		JP 5925218 B2	25-05-2016
		JP 2014513154 A	29-05-2014
		KR 20140010396 A	24-01-2014
		US 2012208965 A1	16-08-2012
		US 2015203658 A1	23-07-2015
		WO 2012112304 A1	23-08-2012
-----			
WO 2012112350 A2	23-08-2012	CN 103370041 A	23-10-2013
		EP 2675422 A2	25-12-2013
		EP 2965742 A1	13-01-2016
		JP 2014505105 A	27-02-2014
		RU 2013136505 A	27-03-2015
		US 2013316307 A1	28-11-2013
		US 2015238389 A1	27-08-2015
		WO 2012112350 A2	23-08-2012
		-----	
WO 2013028397 A2	28-02-2013	CN 103732203 A	16-04-2014
		EP 2747737 A2	02-07-2014
		JP 2014529608 A	13-11-2014
		RU 2014105684 A	27-09-2015
		US 2016008234 A1	14-01-2016
		WO 2013028397 A2	28-02-2013
-----			
WO 2013028401 A1	28-02-2013	CN 103732629 A	16-04-2014
		EP 2748206 A1	02-07-2014
		JP 2014529655 A	13-11-2014
		KR 20140068076 A	05-06-2014
		US 2014206788 A1	24-07-2014
		WO 2013028401 A1	28-02-2013
-----			