



US0D1023254S

(12) **United States Design Patent**  
**Chen**

(10) **Patent No.:** **US D1,023,254 S**

(45) **Date of Patent:** **\*\* Apr. 16, 2024**

(54) <b>CATCH BASIN DRAIN</b>	5,733,445 A *	3/1998	Fanelli .....	E03F 1/00 210/489
(71) Applicant: <b>Wenyan Chen</b> , Shenzhen (CN)	6,272,804 B1 *	8/2001	Leis .....	E03F 5/0407 52/302.1
(72) Inventor: <b>Wenyan Chen</b> , Shenzhen (CN)	D847,878 S *	5/2019	Cullen .....	D15/89
(**) Term: <b>15 Years</b>	10,683,647 B2 *	6/2020	Cullen .....	E03C 1/182
	2007/0177942 A1 *	8/2007	Meyers .....	E03F 3/046 405/40

(21) Appl. No.: **35/516,983**

(22) Filed: **Apr. 14, 2023**

(80) **Hague Agreement Data**

Int. Filing Date: **Apr. 14, 2023**  
 Int. Reg. No.: **DM/228218**  
 Int. Reg. Date: **Apr. 14, 2023**  
 Int. Reg. Pub. Date: **Apr. 28, 2023**

(51) **LOC (14) Cl.** ..... **23-01**

(52) **U.S. Cl.**  
USPC ..... **D23/267**

(58) **Field of Classification Search**

USPC ..... D23/200, 202-206, 209, 259, 261,  
D23/262-263, 266-269, 322; D15/89  
 CPC ..... E04D 13/08; E04D 2013/082; E04D  
2013/0846; E04D 2013/0873; E04D  
2013/0413; E04D 2013/086; E04D  
2013/0813; E04D 13/0645; E04D  
13/0481; E04D 2013/0826; E03B 3/00;  
E03B 3/02; B65D 1/12; B65D 1/16

See application file for complete search history.

(56) **References Cited**

**U.S. PATENT DOCUMENTS**

D276,839 S \* 12/1984 McCoy ..... D23/261  
 5,032,264 A \* 7/1991 Geiger ..... E03F 5/041  
210/163  
 5,230,188 A \* 7/1993 Nurse ..... E03F 5/0407  
52/177  
 5,529,431 A \* 6/1996 Walsh ..... E02D 29/124  
210/164  
 5,575,925 A \* 11/1996 Logue, Jr. .... E03F 5/0404  
404/5

**OTHER PUBLICATIONS**

Naacoo Gutter Downspout Extensions, Upgraded 12x12in Catch Basin Low Profile Downspout Extender | No Deep Dig French Drain, Flexible Pipe Extension to 8.2ft, Protect House Foundation, available in Amazon.com, date first available Jul. 12, 2022[online], [site visited Feb. 5, 2024], Available from the internet URL: <https://www.amazon.com/dp/B0B6C6479D> (Year: 2022).\*  
 Prestantious Square Catch Basin Drain Kit, available in Amazon.com, retrieved on Aug. 25, 2022 [online] from URL: <https://www.amazon.com/dp/B0BBYSXDR5>.

\* cited by examiner

*Primary Examiner* — Dana K Weiland  
*Assistant Examiner* — Kathryn Elizabeth Zieno

(57) **CLAIM**

The ornamental design for a catch basin drain, as shown and described.

**DESCRIPTION**

1. Catch basin drain
- 1.1 : Perspective
- 1.2 : Perspective
- 1.3 : Front
- 1.4 : Back
- 1.5 : Left
- 1.6 : Right
- 1.7 : Top
- 1.8 : Bottom

The parts shown by means of broken lines in the reproductions are not part of the claimed design.

**1 Claim, 8 Drawing Sheets**

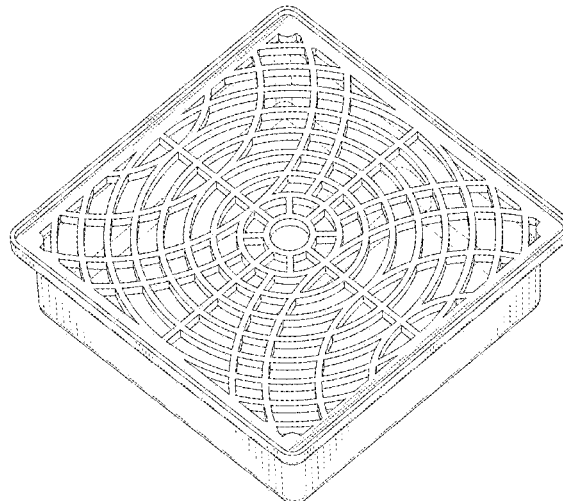

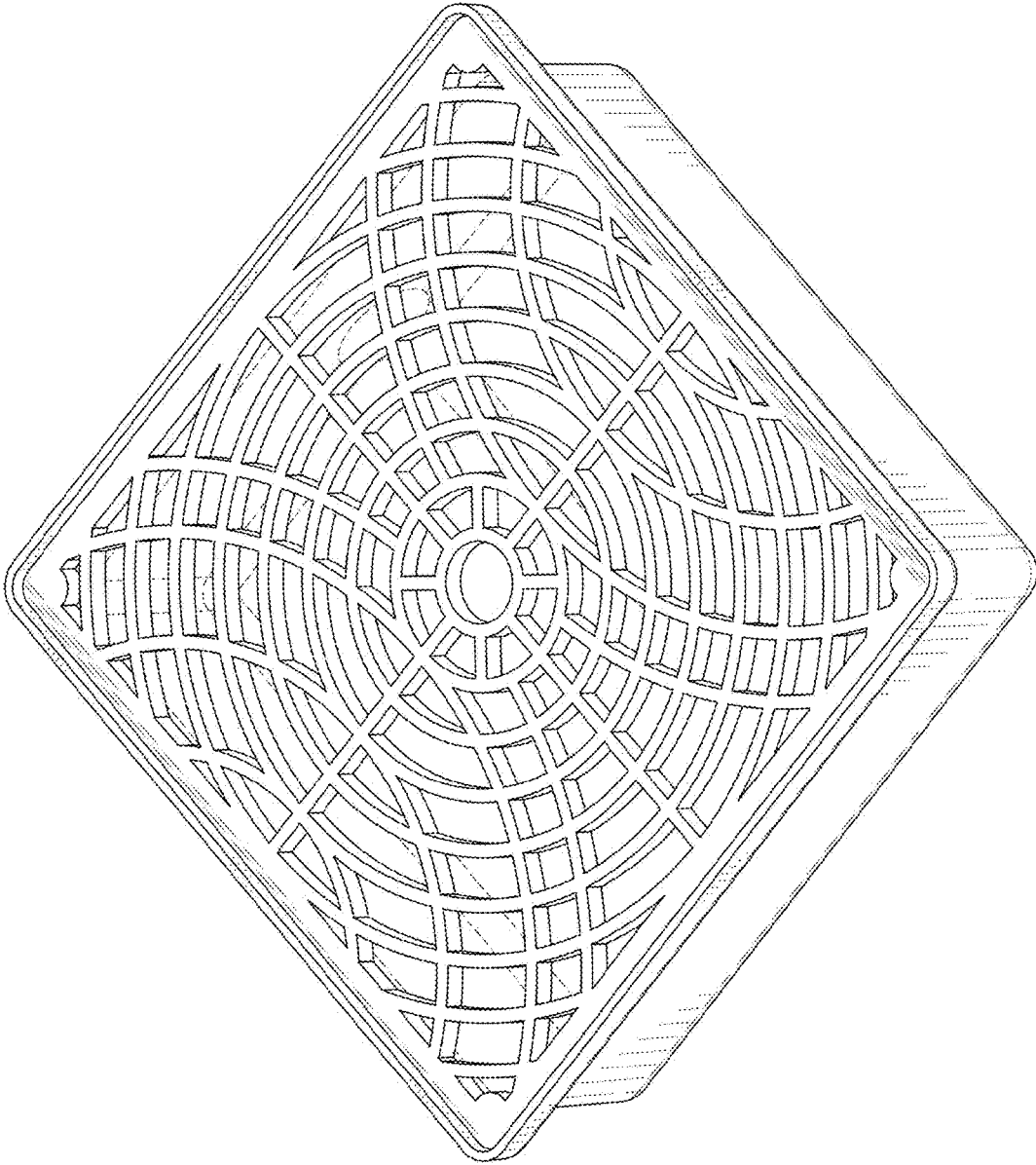

1.1

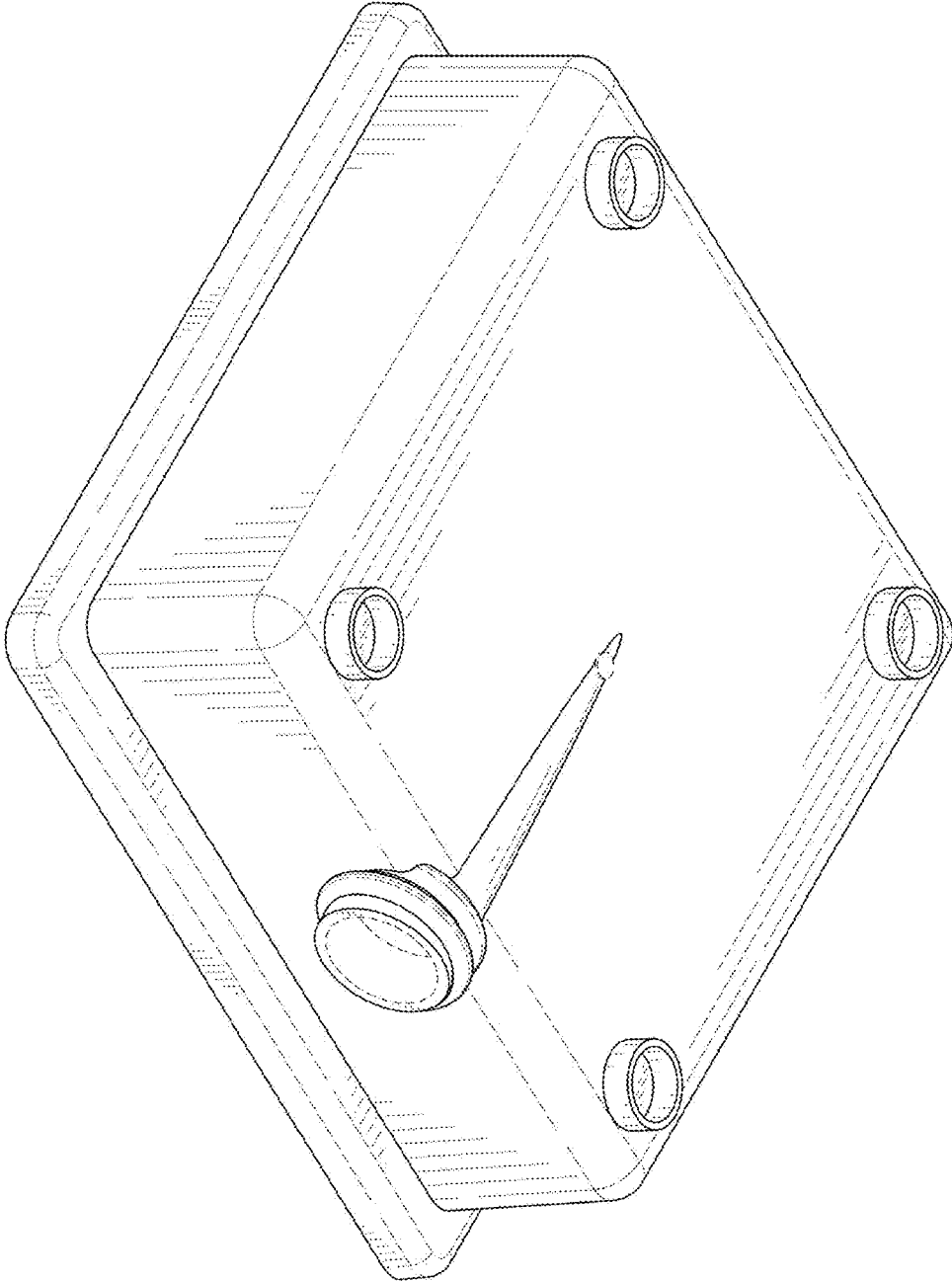

1.2

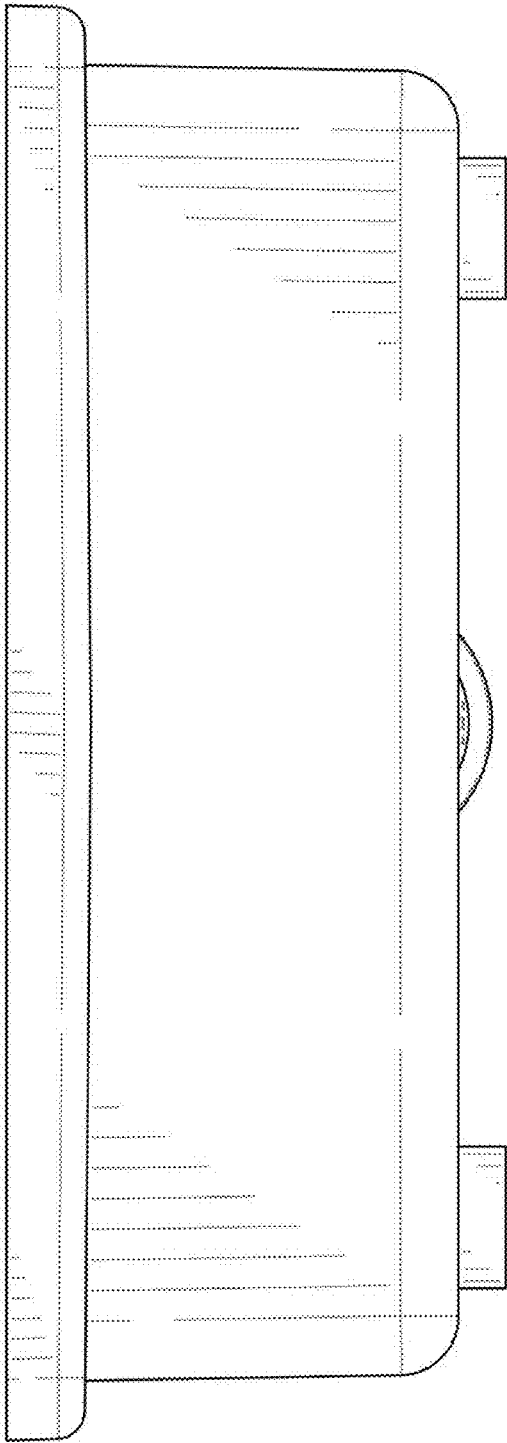

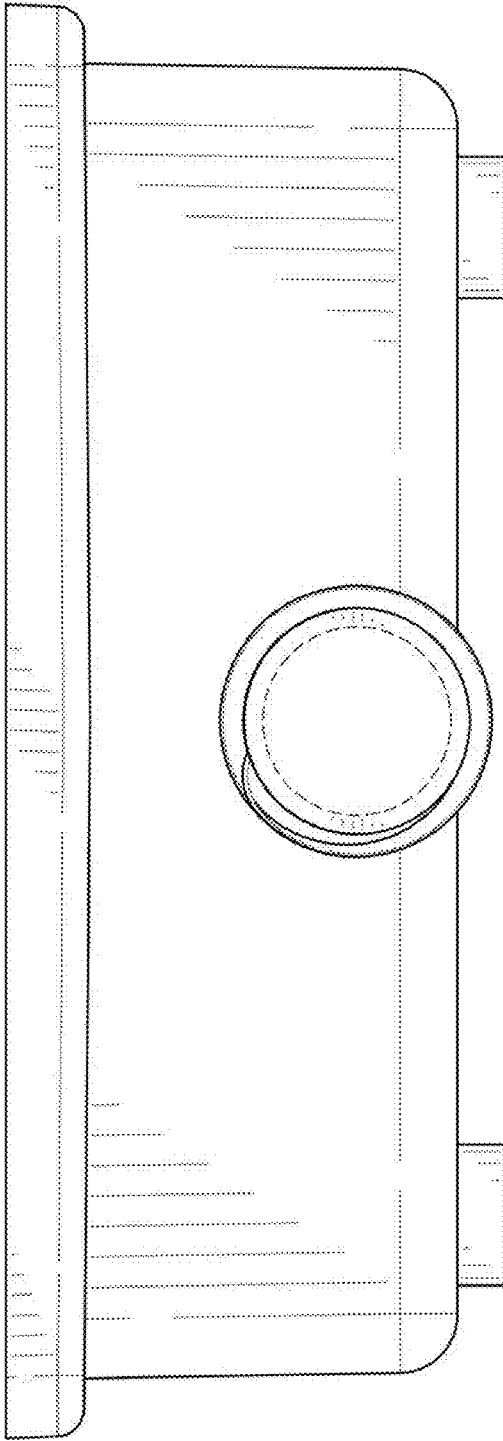

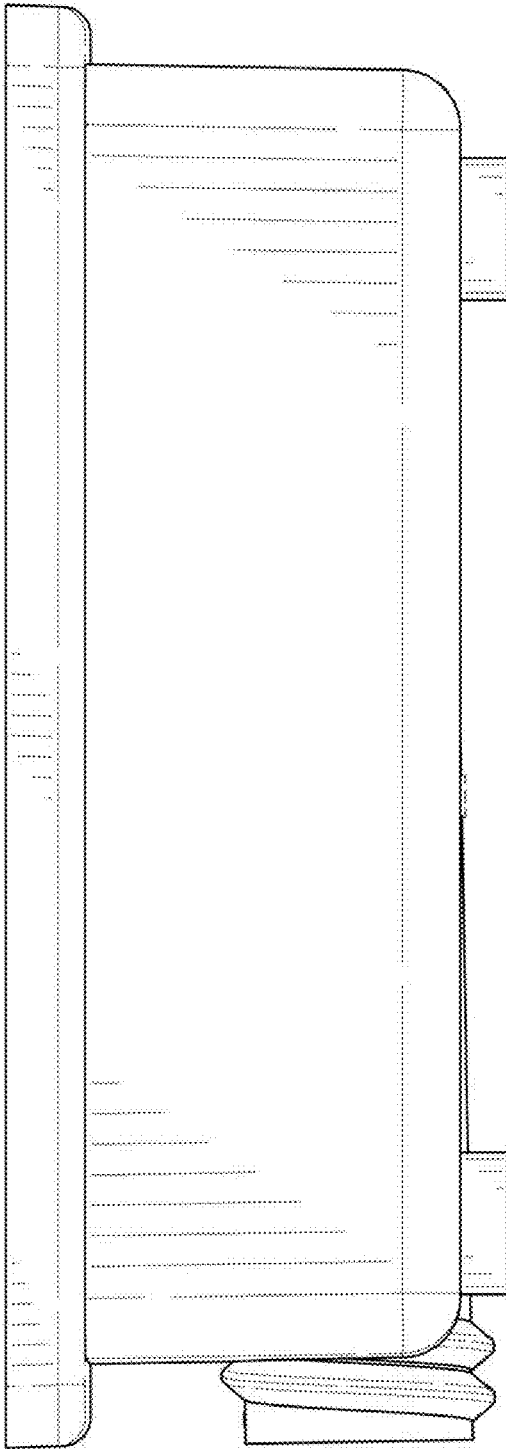

1.5

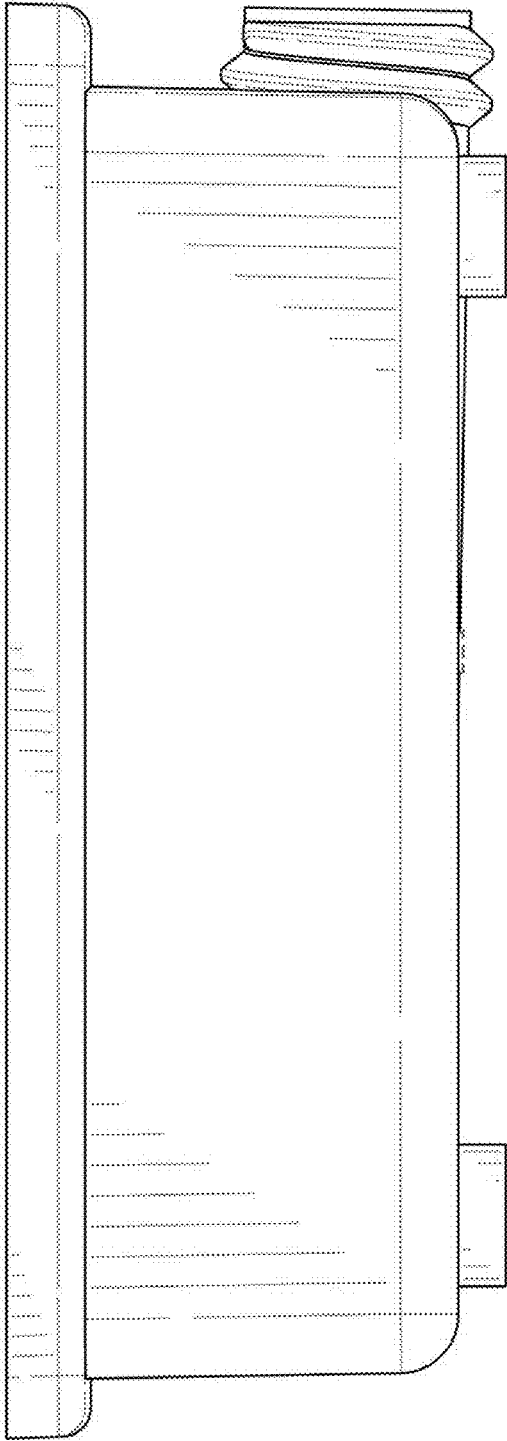

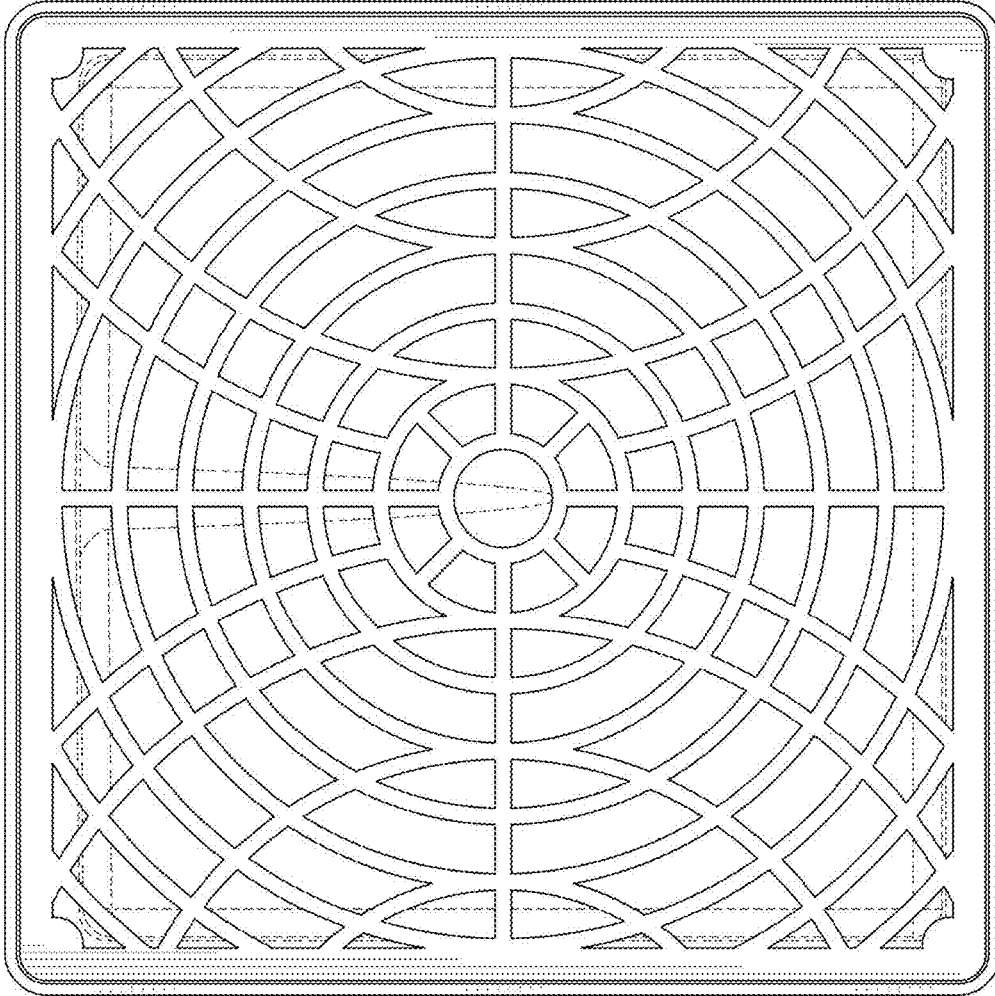

1.7



