



US00D946380S

(12) **United States Design Patent**  
**Raymond et al.**

(10) **Patent No.:** **US D946,380 S**  
(45) **Date of Patent:** **\*\* Mar. 22, 2022**

- (54) **RECTANGULAR FLOOR GROMMET**
- (71) Applicant: **Raymond & Lae Engineering, Inc.**,  
Fort Collins, CO (US)
- (72) Inventors: **Donald M. Raymond**, Fort Collins, CO  
(US); **Jeremy D. Swanner**, Fort  
Collins, CO (US); **Timothy L.**  
**Hirschenhofer**, Fort Collins, CO (US);  
**James M. Schneider**, Fort Collins, CO  
(US)
- (73) Assignee: **RAYMOND & LAE ENGINEERING,**  
**INC.**, Fort Collins, CO (US)
- (\*\*) Term: **15 Years**
- (21) Appl. No.: **29/718,184**
- (22) Filed: **Dec. 20, 2019**
- (51) **LOC (13) Cl.** ..... **09-06**
- (52) **U.S. Cl.**  
USPC ..... **D8/356**
- (58) **Field of Classification Search**  
USPC ..... D8/356, 354, 349, 367, 394, 395, 396;  
248/74.1, 74.2, 74.3, 74.4; 174/650  
CPC . B65D 63/16; F16B 2/08; A44B 11/04; A44B  
6/00; F16G 11/14; B60R 22/24; H02G  
3/22; E04F 15/02405  
See application file for complete search history.

- D443,811 S \* 6/2001 Tisbo ..... D8/356
- 7,121,829 B2 \* 10/2006 Day ..... A61C 8/0087  
433/163
- D542,123 S \* 5/2007 Symons ..... D8/356
- D559,660 S \* 1/2008 DeCosta ..... D8/356
- D569,349 S \* 5/2008 Preston ..... D13/156
- D569,711 S \* 5/2008 Young, IV ..... D13/154
- D571,641 S \* 6/2008 Sempliner ..... D8/356
- D579,762 S \* 11/2008 Sempliner ..... D8/356
- 7,507,912 B1 \* 3/2009 Sempliner ..... H02G 3/185  
16/2.1
- D631,730 S \* 2/2011 Skillman ..... B65H 75/143  
D8/356
- 8,347,906 B1 \* 1/2013 Ismert ..... E03F 5/0407  
137/15.01
- 8,357,853 B1 \* 1/2013 Gretz ..... H02G 3/14  
174/67
- D682,909 S \* 5/2013 Kim ..... D16/219

(Continued)

*Primary Examiner* — Cynthia R Underwood  
(74) *Attorney, Agent, or Firm* — Cochran Freund &  
Young LLC; William W. Cochran

(57) **CLAIM**  
The ornamental design for a rectangular floor grommet, as  
shown and described.

**DESCRIPTION**

FIG. 1 is a top isometric view of a rectangular floor grommet  
showing my design.  
FIG. 2 is a bottom isometric view of the rectangular floor  
grommet.  
FIG. 3 is a top view of the rectangular floor grommet.  
FIG. 4 is a bottom view of the rectangular floor grommet  
FIG. 5 is a front view of the rectangular floor grommet.  
FIG. 6 is a back view of the rectangular floor grommet.  
FIG. 7 is a left side view of the rectangular floor grommet;  
and,  
FIG. 8 is a right side view of the rectangular floor grommet.

**1 Claim, 8 Drawing Sheets**

- (56) **References Cited**  
U.S. PATENT DOCUMENTS  
D173,629 S \* 12/1954 Schlage ..... D8/353  
3,066,372 A \* 12/1962 Parker ..... A01K 91/04  
24/128  
D257,321 S \* 10/1980 Voorhees, Jr. .... D8/356  
D313,340 S \* 1/1991 Stathis ..... D8/356  
D334,921 S \* 4/1993 Basara ..... D14/447  
D428,796 S \* 8/2000 van Ochten ..... D8/349

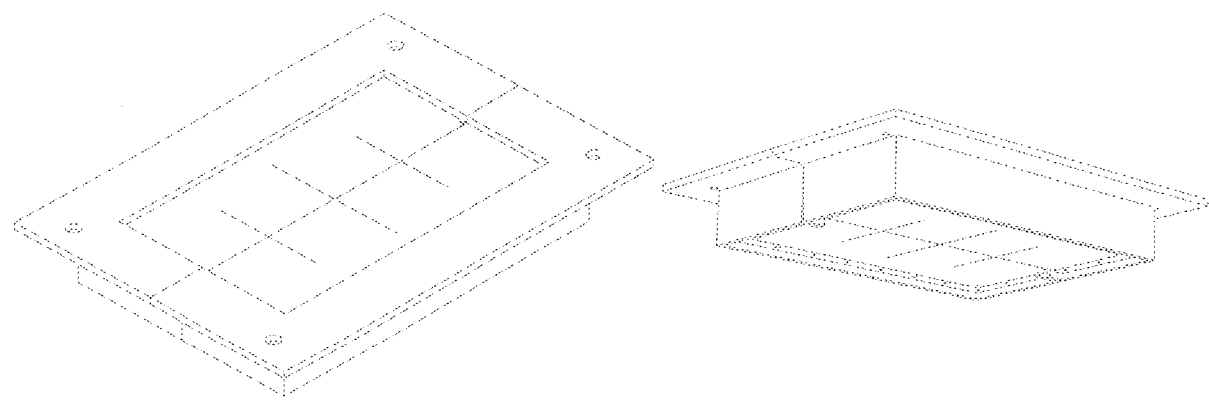

(56)

## References Cited

## U.S. PATENT DOCUMENTS

D707,106 S \* 6/2014 Crouse ..... D8/356  
D707,107 S \* 6/2014 Crouse ..... D8/356  
8,791,376 B2 \* 7/2014 Endt ..... H02G 3/22  
174/663  
8,969,741 B2 \* 3/2015 Aldrich ..... H02G 3/083  
174/653  
D731,555 S \* 6/2015 Lee ..... D15/5  
D735,020 S \* 7/2015 Bradford ..... D8/356  
D736,833 S \* 8/2015 Lee ..... D15/5  
9,109,357 B2 \* 8/2015 Moreno ..... E01D 19/04  
D752,339 S \* 3/2016 Hoover ..... D3/23  
D754,078 S \* 4/2016 Baldwin ..... D13/156  
9,326,428 B2 \* 4/2016 Reynolds ..... F24F 13/068  
D758,836 S \* 6/2016 Symons ..... D8/383  
9,593,492 B2 \* 3/2017 Ohshima ..... H02G 3/185  
D803,666 S \* 11/2017 Morley ..... D8/356  
D813,015 S \* 3/2018 O'Brien ..... D8/356  
D814,273 S \* 4/2018 Karpanty ..... D8/356  
D831,468 S \* 10/2018 Morley ..... D8/356  
D841,443 S \* 2/2019 Foster, II ..... D8/360.1  
10,573,436 B2 \* 2/2020 Coyle ..... H01B 17/30  
D889,936 S \* 7/2020 DeCosta ..... D8/353  
10,969,037 B2 \* 4/2021 Vaughn ..... F16L 5/00  
D924,813 S \* 7/2021 Bailey ..... D13/155  
11,056,869 B2 \* 7/2021 Ferderer ..... H02G 3/088  
D926,707 S \* 8/2021 Campos ..... D13/155  
11,088,525 B2 \* 8/2021 Nakamura ..... H01M 50/20  
11,097,673 B2 \* 8/2021 Yokoyama ..... H02G 3/22  
2008/0115955 A1 \* 5/2008 Gorin ..... H02G 3/085  
174/66

\* cited by examiner

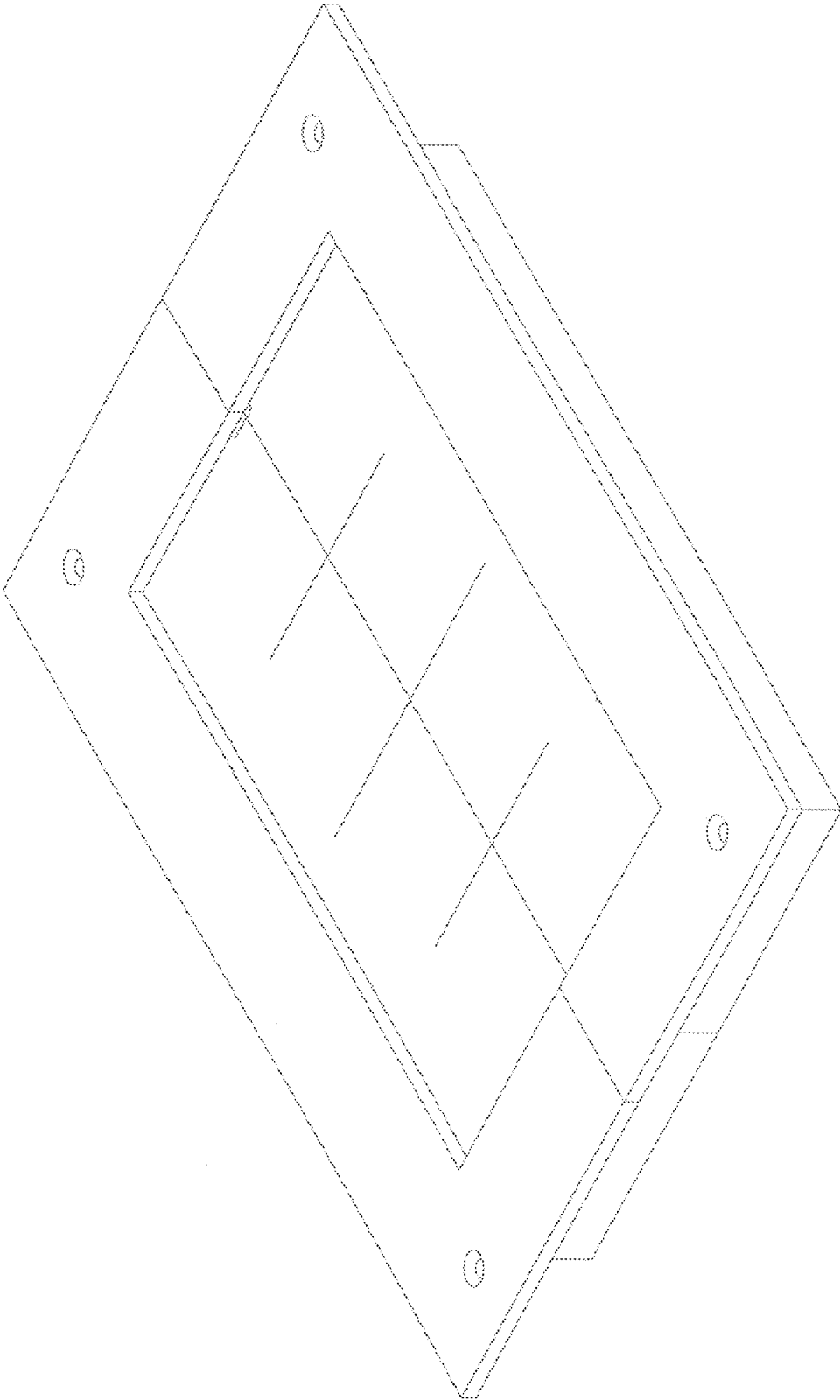

FIG. 1

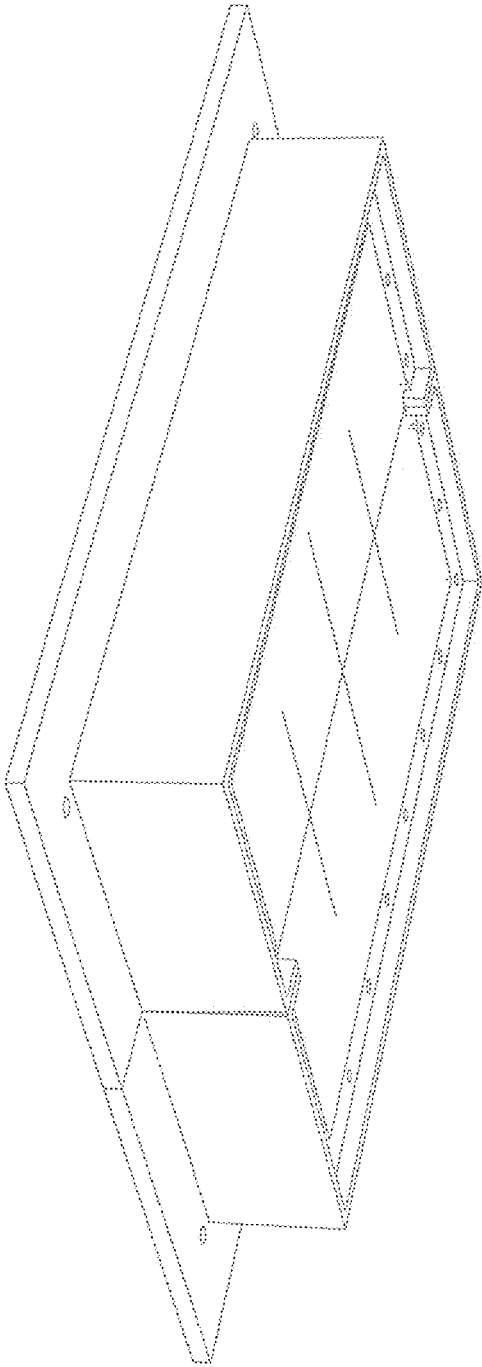

FIG. 2

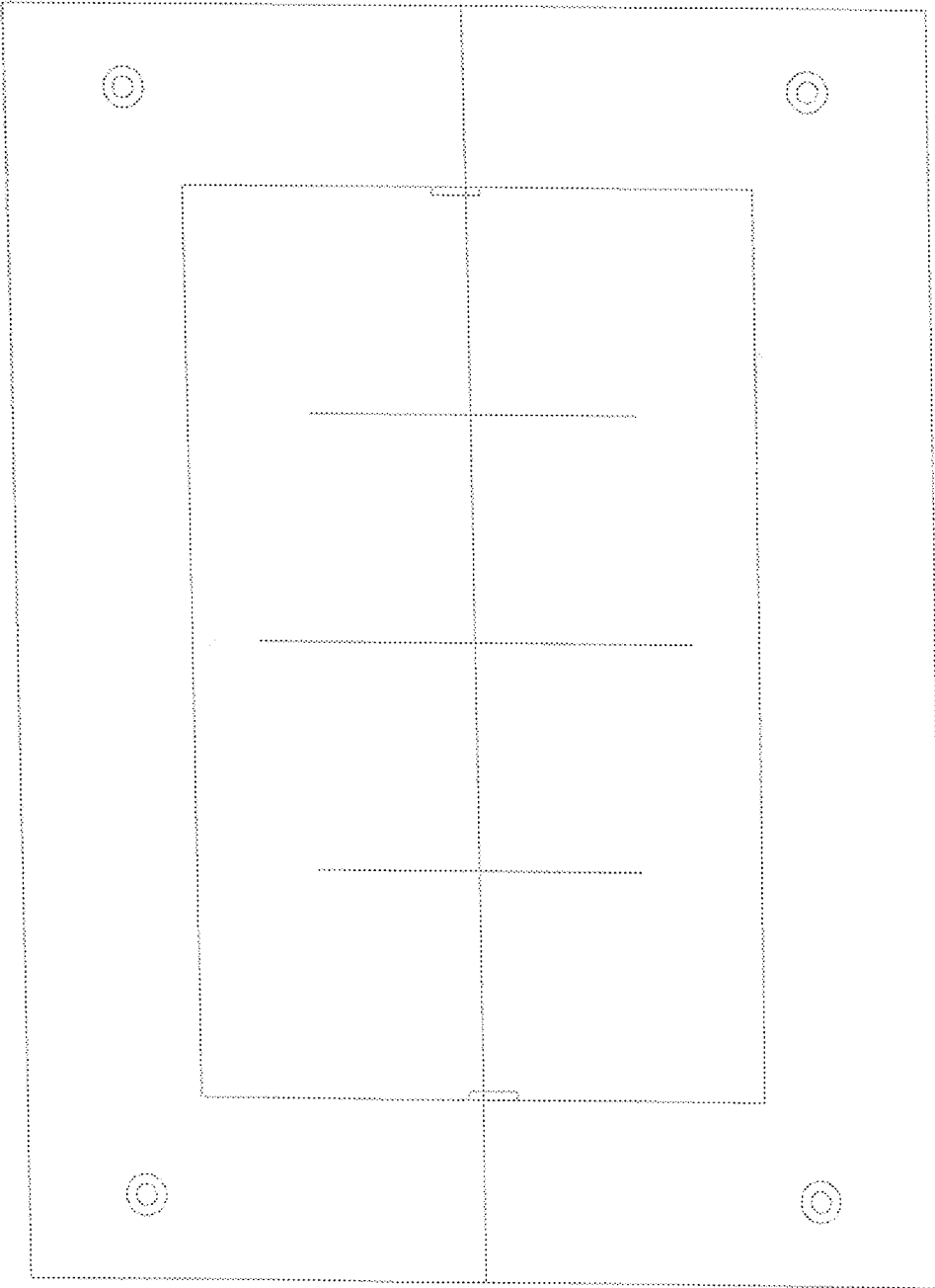

FIG. 3

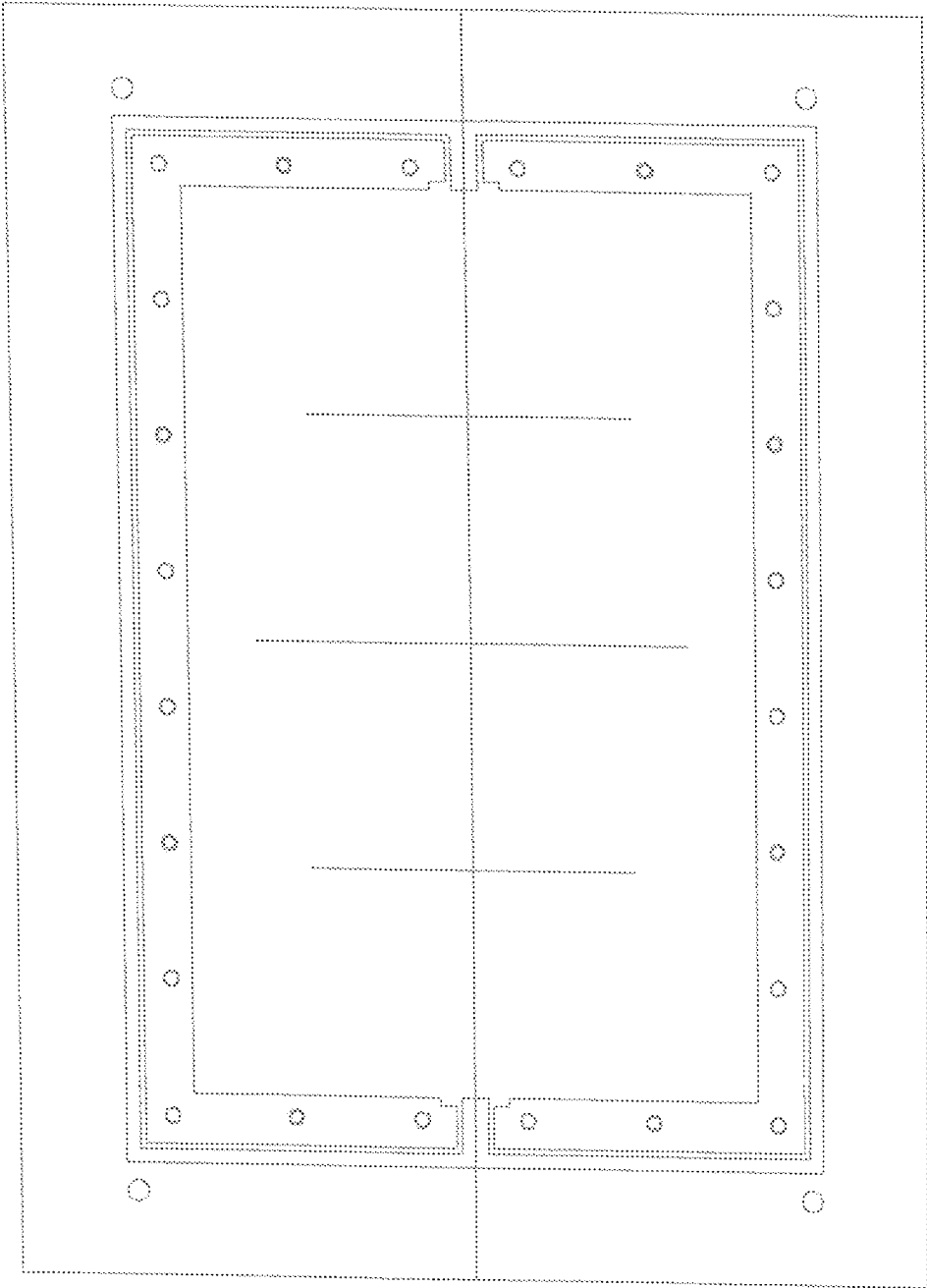

FIG. 4

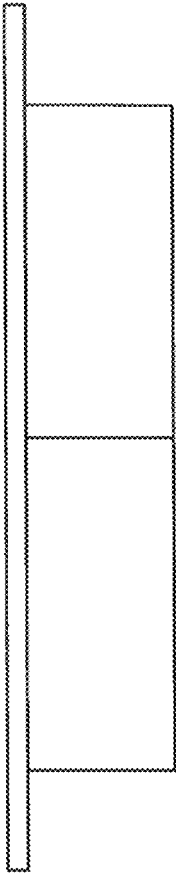

FIG. 5

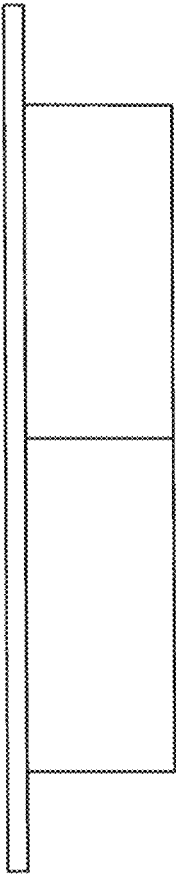

FIG. 6



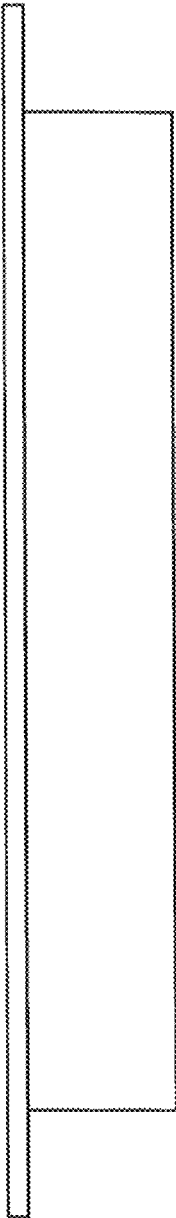

Fig. 7

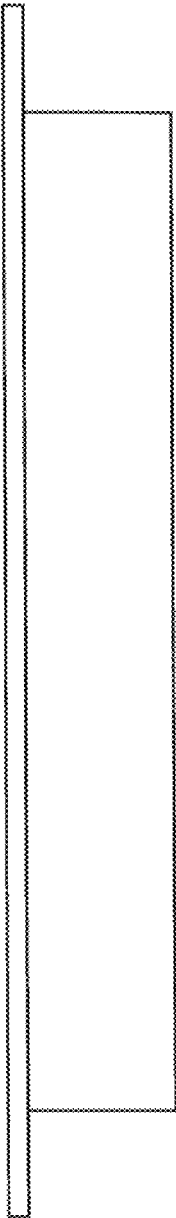

Fig. 8