



(12) **United States Design Patent**
Harris et al.

(10) **Patent No.:** **US D623,740 S**
(45) **Date of Patent:** **** Sep. 14, 2010**

(54) **WOUND DRESSING APPLICATOR**

(75) Inventors: **Christopher Harris**, Oakham (GB); **Ian Dera**, Kingston-upon-Thames (GB); **Dimitrios Scoutas**, Kingston-upon-Thames (GB); **Matthew Hannant**, Kingston-upon-Thames (GB); **Graeme Maisey**, Kingston-upon-Thames (GB); **Philip Dunn**, Kingston-upon-Thames (GB); **Barry Sandbank**, Wythenshawe (GB); **Sushma Jassal**, Wythenshawe (GB)

(73) Assignee: **DFB Technology Holdings, LLC**, San Antonio, TX (US)

(**) Term: **14 Years**

(21) Appl. No.: **29/320,067**

(22) Filed: **Jun. 19, 2008**

(30) **Foreign Application Priority Data**

Dec. 21, 2007 (EP) 000851878
Dec. 21, 2007 (GB) 0725087

(51) **LOC (9) Cl.** **24-02**
(52) **U.S. Cl.** **D24/133; D24/145**
(58) **Field of Classification Search** D24/108,
D24/133, 145-147, 190, 189; 604/307, 313,
604/317, 327, 543, 540, 174, 288.01, 306;
602/41-43, 52, 57, 54, 56, 79; 128/888-889;
424/445

See application file for complete search history.

(56) **References Cited**

U.S. PATENT DOCUMENTS

4,126,130 A * 11/1978 Cowden et al. D24/189
D264,755 S * 6/1982 Olson D24/189
D267,510 S * 1/1983 Golub D24/189
4,564,010 A * 1/1986 Coughlan et al. 604/307
5,000,741 A * 3/1991 Kalt 604/307
5,160,315 A * 11/1992 Heinecke et al. 602/57

D352,782 S * 11/1994 Kirk et al. D24/189
5,447,492 A * 9/1995 Cartmell et al. 602/41
5,501,661 A * 3/1996 Cartmell et al. 602/42
D377,529 S * 1/1997 Nyqvist-Mayer D24/189
D384,745 S * 10/1997 Lattin et al. D24/189
5,713,842 A * 2/1998 Kay 602/57
6,149,614 A * 11/2000 Dunshee et al. 602/57
6,293,917 B1 * 9/2001 Augustine et al. 602/41
6,841,715 B2 * 1/2005 Roberts 602/54
7,118,545 B2 * 10/2006 Boyde 602/79
7,220,889 B2 * 5/2007 Sigurjonsson et al. 602/41
D544,092 S * 6/2007 Lewis D24/108
D544,607 S * 6/2007 Henry et al. D24/189
7,601,129 B2 * 10/2009 Aali 602/2
2007/0282271 A1 * 12/2007 Kaplan et al. 604/174
2009/0187130 A1 * 7/2009 Asmus et al. 602/57

* cited by examiner

Primary Examiner—Ian Simmons

Assistant Examiner—Wan Laymon

(74) *Attorney, Agent, or Firm*—Fulbright & Jaworski L.L.P.

(57) **CLAIM**

The ornamental design for a wound dressing applicator, as shown and described.

DESCRIPTION

FIG. 1 is a top and side perspective view of a wound dressing applicator showing our invention.

FIG. 2 is a bottom and side perspective view thereof.

FIG. 3 is a top and side perspective view thereof, showing the body of the wound dressing application and the removable lid in an open condition.

FIG. 4 is a bottom and side perspective view thereof, showing the body of the wound dressing application and the removable lid in an open condition.

FIG. 5 is a top plan view thereof.

FIG. 6 is a bottom plan view thereof; and,

FIG. 7 is a side elevation view thereof.

1 Claim, 3 Drawing Sheets

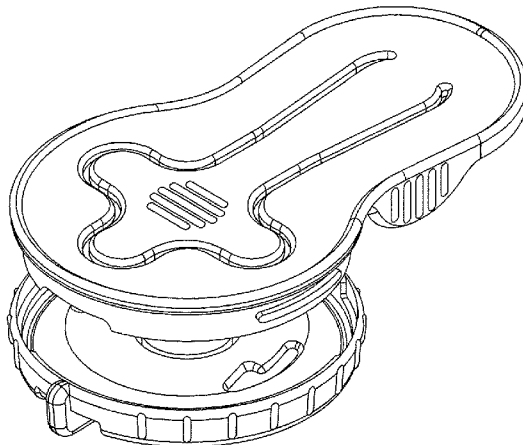
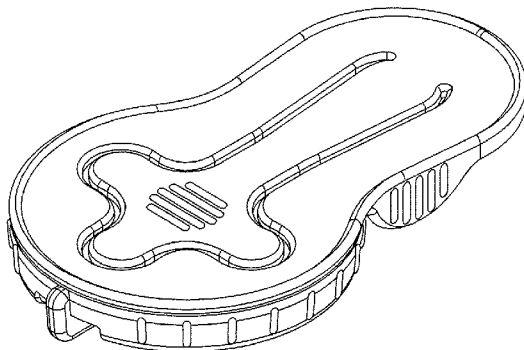

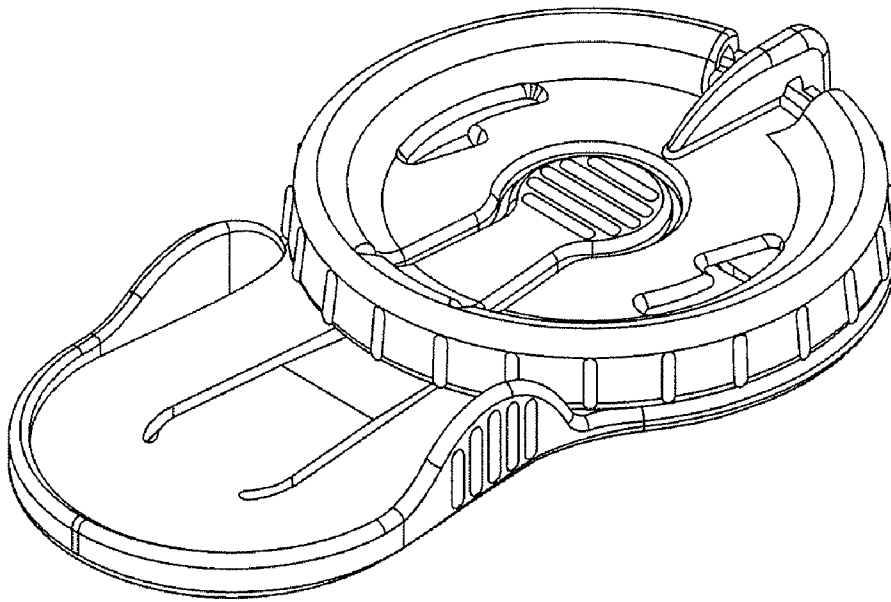

FIG. 1

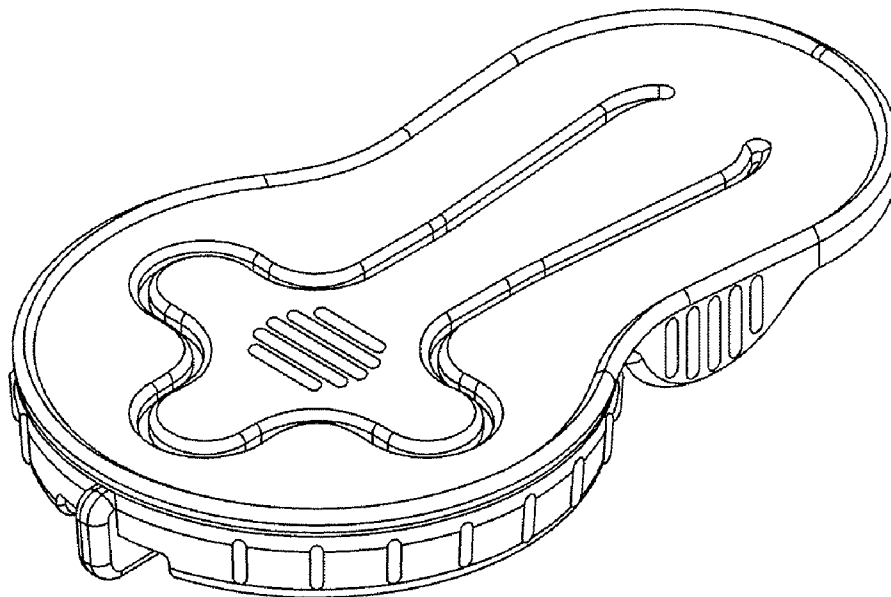

FIG. 2

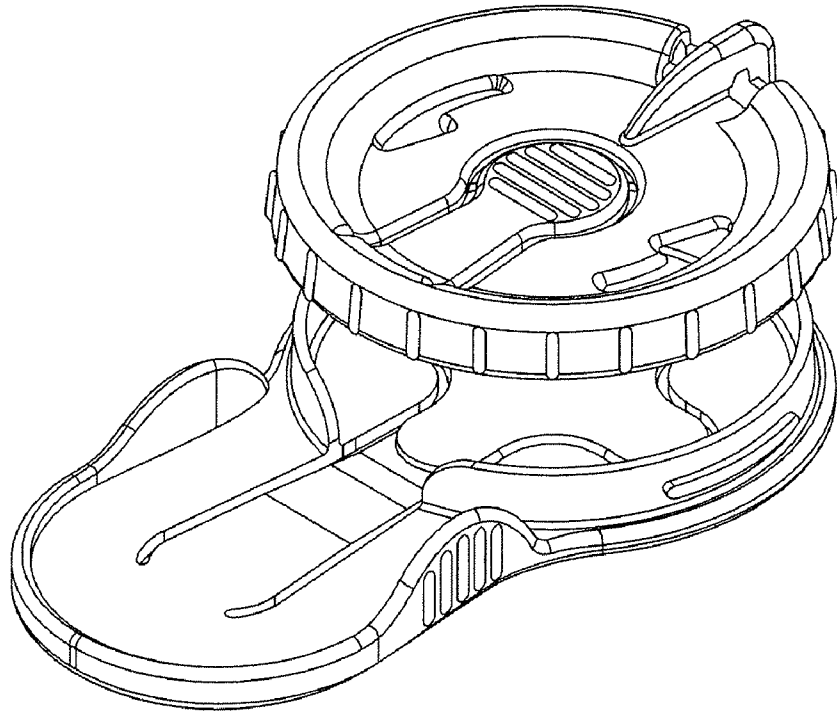

FIG. 3

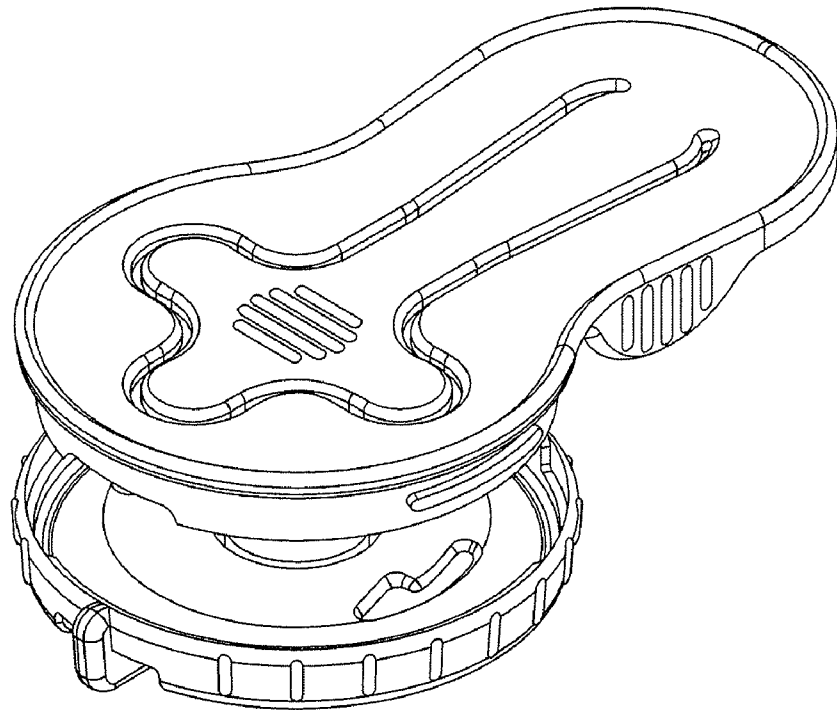

FIG. 4

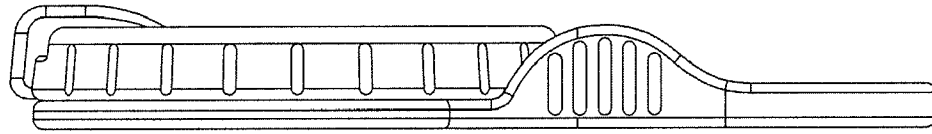

FIG. 7

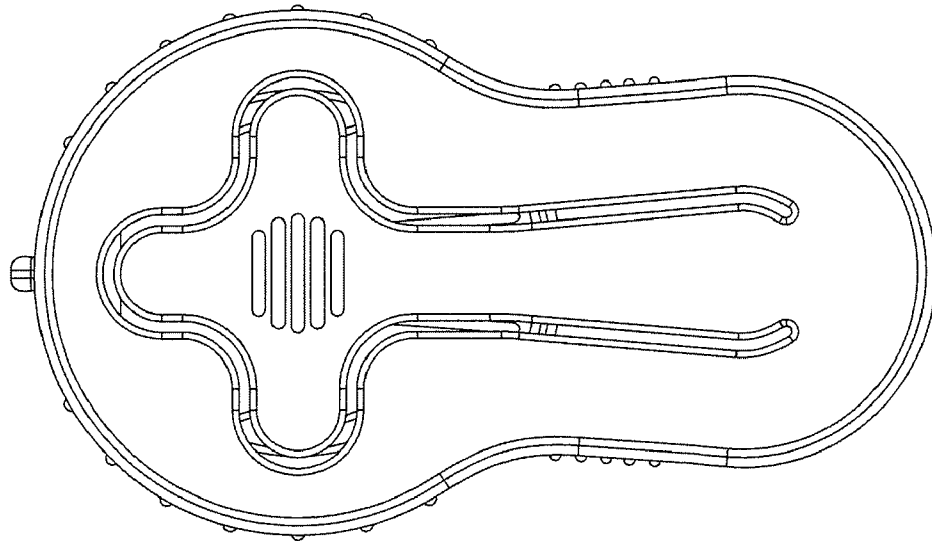

FIG. 6

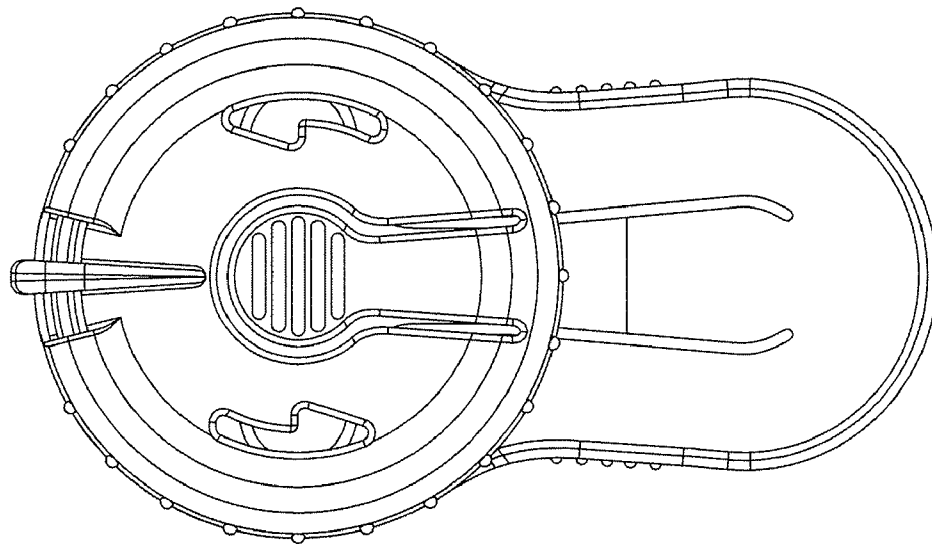

FIG. 5