



US00D704706S

(12) **United States Design Patent**
Serota

(10) **Patent No.:** **US D704,706 S**

(45) **Date of Patent:** **** May 13, 2014**

(54) **HEADSET WITH DISPLAY**

(71) Applicant: **Lee Serota**, Oswego, IL (US)

(72) Inventor: **Lee Serota**, Oswego, IL (US)

(**) Term: **14 Years**

(21) Appl. No.: **29/472,797**

(22) Filed: **Nov. 15, 2013**

(51) **LOC (10) Cl.** **14-02**

(52) **U.S. Cl.**
USPC **D14/372**

(58) **Field of Classification Search**
USPC D14/372, 496, 432, 371, 125, 126, 129,
D14/299; D16/300-342; 351/158, 153, 144;
345/7-9, 905; 455/344; 348/115, 53,
348/121, 739
See application file for complete search history.

(56) **References Cited**

U.S. PATENT DOCUMENTS

D338,514 S *	8/1993	Holmes	D14/372
D369,595 S *	5/1996	Kober et al.	D14/372
D440,967 S *	4/2001	Jung	D14/372
D571,366 S *	6/2008	Lee et al.	D14/372

D578,120 S *	10/2008	Lowe et al.	D14/372
D601,641 S *	10/2009	Yeung	D21/483
D645,862 S *	9/2011	Paul	D14/372
D669,471 S *	10/2012	Hwang et al.	D14/372
D687,434 S *	8/2013	Serota	D14/372
D695,739 S *	12/2013	Kumagai et al.	D14/372
2002/0171605 A1 *	11/2002	Kim et al.	345/8

* cited by examiner

Primary Examiner — Austin Murphy

(57) **CLAIM**

The ornamental design for a headset with display, as shown and described.

DESCRIPTION

FIG. 1 is a perspective view of a headset with display; FIG. 2 is a front elevational view thereof; FIG. 3 is a rear elevational view thereof; FIG. 4 is a top plan view thereof; FIG. 5 is a bottom plan view thereof; FIG. 6 is a left-side elevational view thereof; and, FIG. 7 is a right-side elevational view thereof. The broken line showing in FIGS. 1-7 is included for the purpose of showing environmental structure and forms no part of the claimed design.

1 Claim, 7 Drawing Sheets

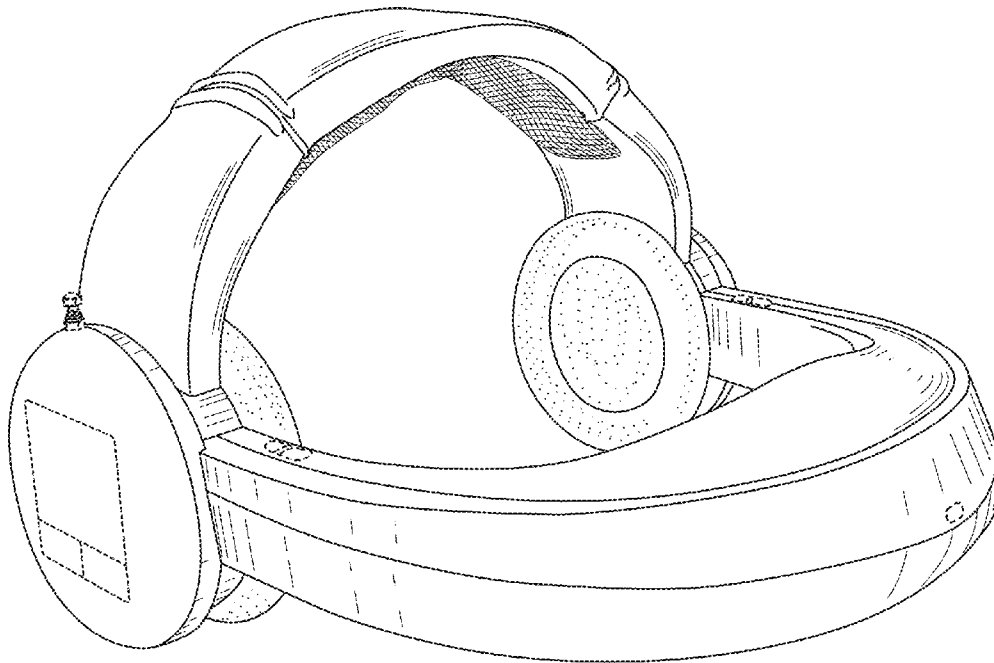

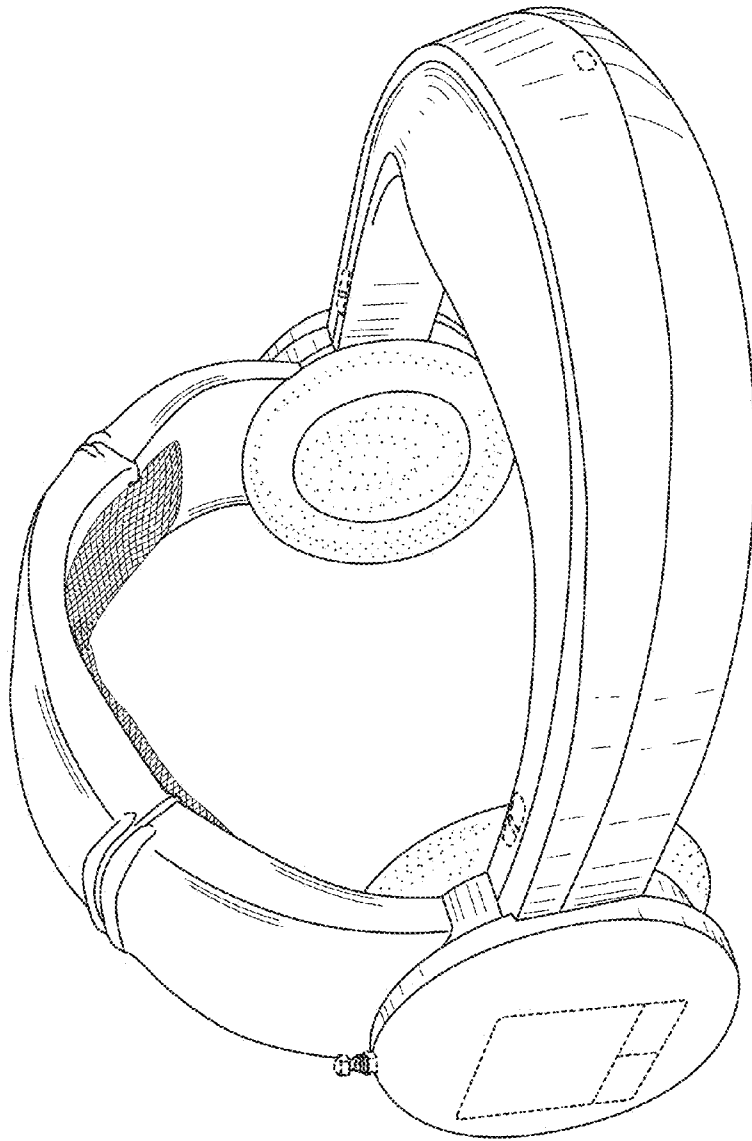

FIG. 1

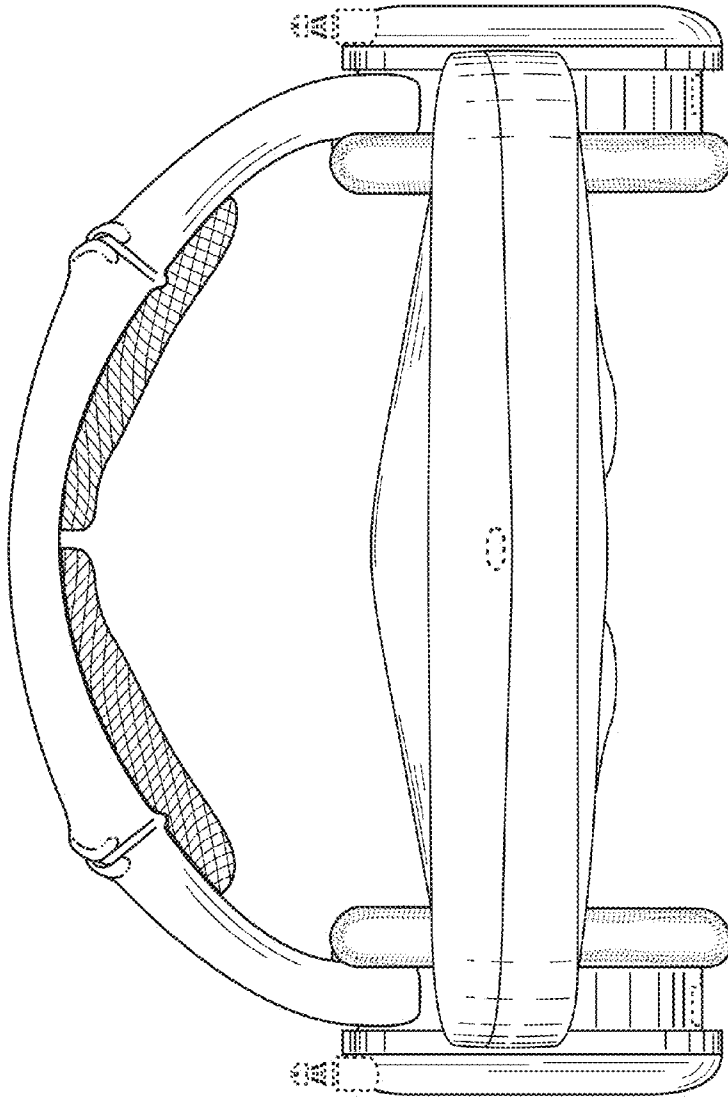

FIG. 2

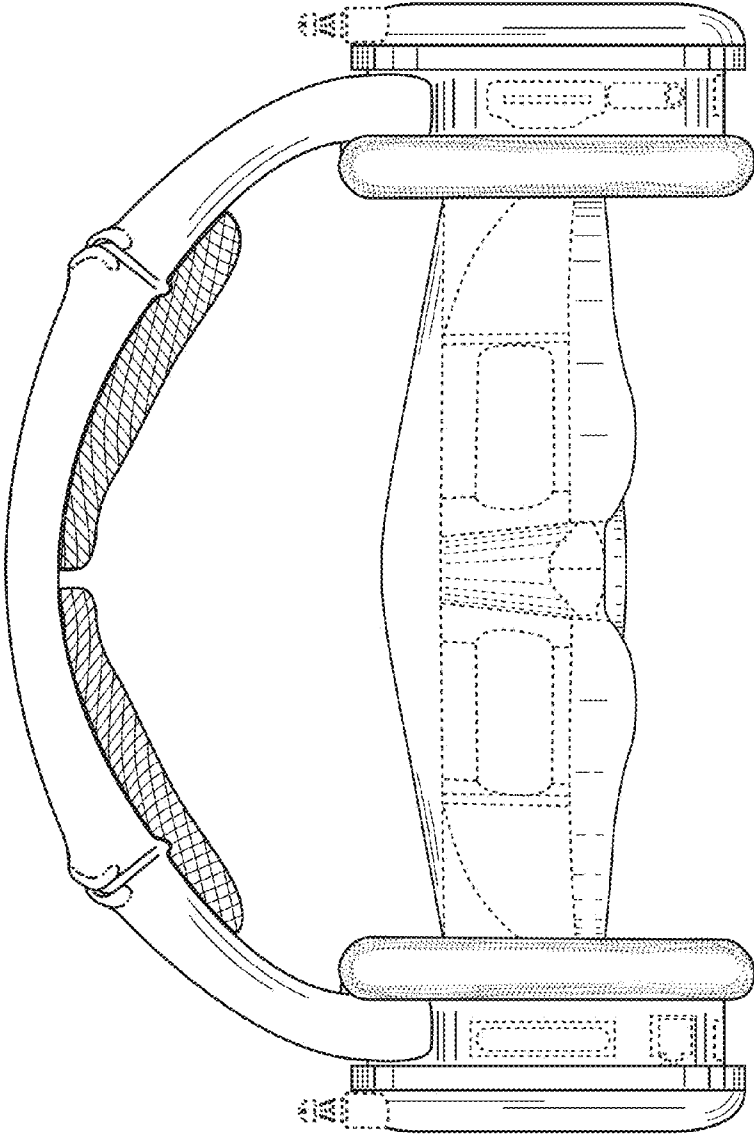

FIG. 3

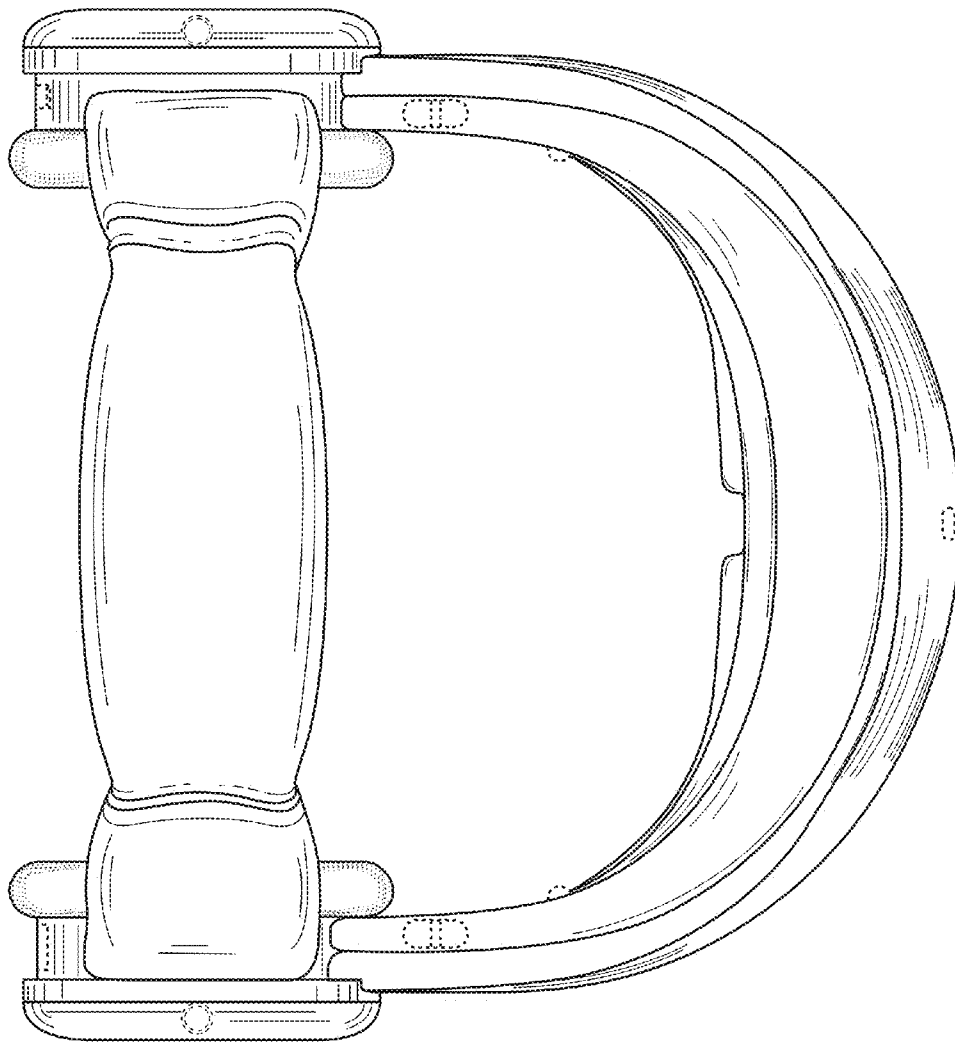

FIG. 4

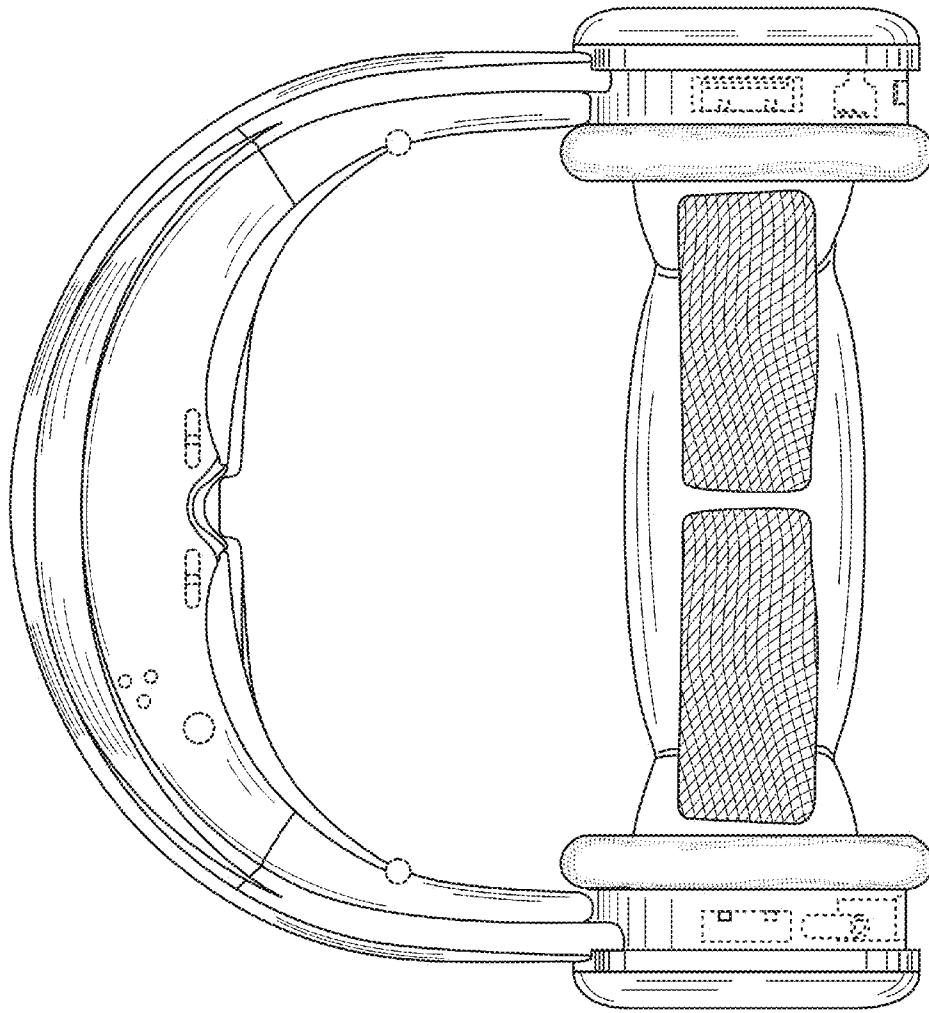

FIG. 5

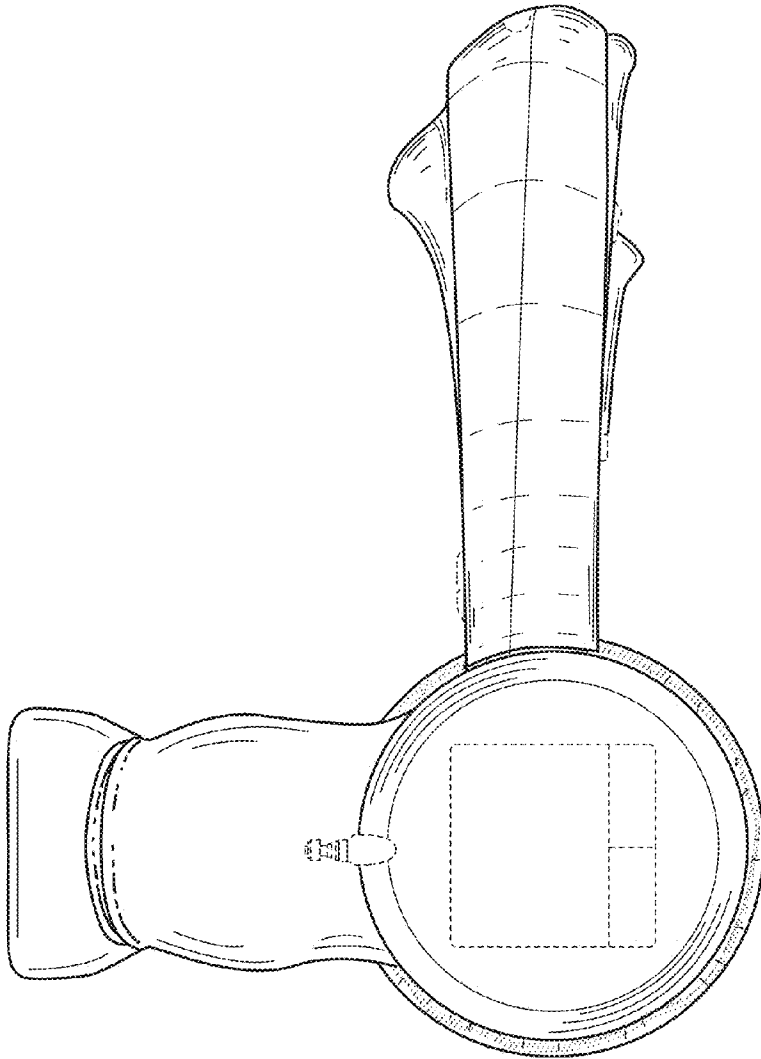

FIG. 6

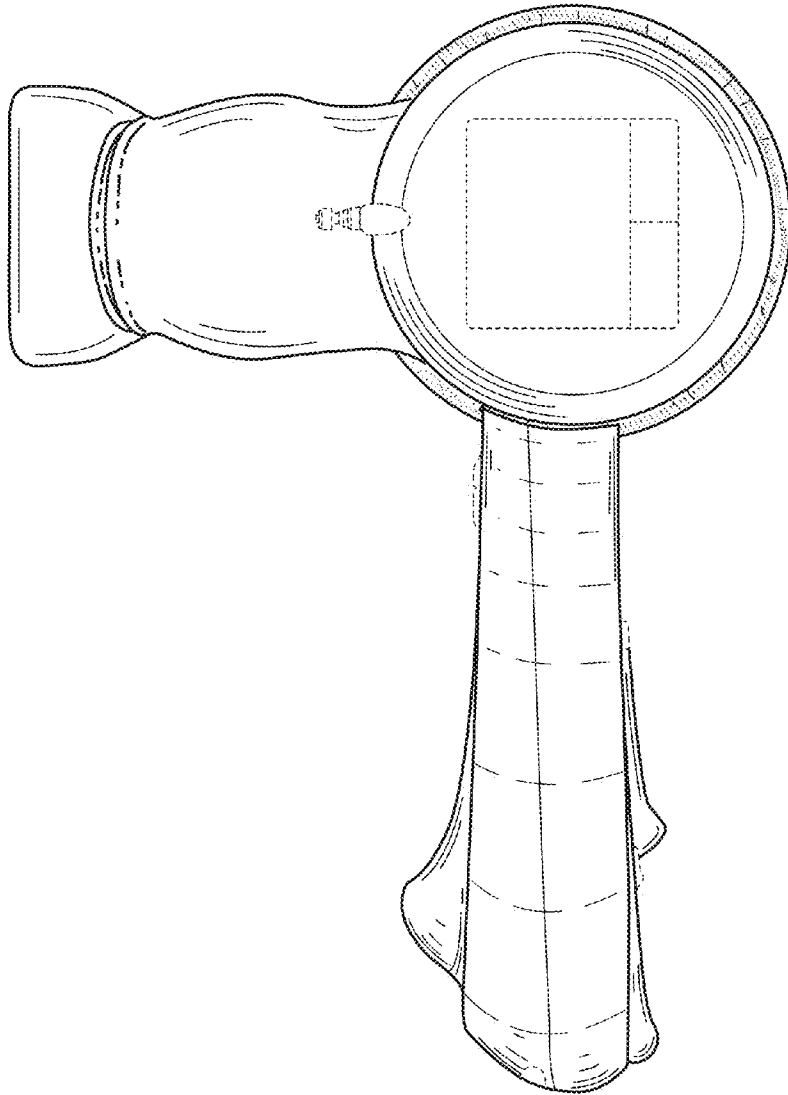

FIG. 7