



US00D426446S

United States Patent [19] Chau

[11] Patent Number: Des. 426,446
[45] Date of Patent: ** Jun. 13, 2000

[54] MULTI-FUNCTION TOOL

6,038,723 3/2000 Nabors et al. 7/128

[75] Inventor: **Lap Yan Chau**, Quarry Bay, The Hong Kong Special Administrative Region of the People's Republic of China

[73] Assignee: **Alltrade Inc.**, Long Beach, Calif.

[**] Term: **14 Years**

[21] Appl. No.: **29/110,885**

[22] Filed: **Sep. 15, 1999**

[51] LOC (7) Cl. **08-05**

[52] U.S. Cl. **D8/105; D8/55**

[58] Field of Search D8/105, 26, 99, D8/55, 81, 87; 30/161, 164, 153, 152; 7/118, 125-135, 138, 143, 164, 170; 81/177.1, 177.2, 177.6, 427.5

[56] **References Cited**

U.S. PATENT DOCUMENTS

| | | | | |
|------------|---------|-------------------|-------|---------|
| D. 368,634 | 4/1996 | Frazer | | D8/105 |
| D. 382,182 | 8/1997 | Seber et al. | | D8/55 |
| D. 384,872 | 10/1997 | Yeh | | D8/105 |
| D. 401,133 | 11/1998 | Gardiner et al. | | D8/105 |
| D. 406,997 | 3/1999 | Robbins | | D8/55 |
| D. 407,286 | 3/1999 | Seber et al. | | D8/55 |
| D. 407,621 | 4/1999 | Koon et al. | | D8/105 |
| 4,744,272 | 5/1988 | Leatherman | | 7/128 X |
| 4,888,869 | 12/1989 | Leatherman | | 30/161 |
| 5,142,721 | 9/1992 | Sessions et al. | | 7/128 |
| 5,267,366 | 12/1993 | Frazer | | 7/128 |
| 5,697,114 | 12/1997 | McIntosh et al. | | 7/129 |
| 5,745,997 | 5/1998 | Berg et al. | | 30/155 |
| 5,791,002 | 8/1998 | Gardiner et al. | | 7/128 |
| 5,809,599 | 9/1998 | Frazer | | 7/128 |
| 5,963,999 | 10/1999 | Gardiner et al. | | 7/128 |
| 5,978,993 | 11/1999 | Rivera | | 7/128 |
| 5,979,059 | 11/1999 | Leatherman et al. | | 30/161 |
| 5,979,959 | 11/1999 | Rivera | | 7/168 X |
| 6,003,180 | 12/1999 | Frazer | | 7/128 |
| 6,014,787 | 1/2000 | Rivera | | 7/128 |

OTHER PUBLICATIONS

Gorilla & Sons, Inc., rec'd Jun. 1997, pp. 80-82 Multi tools. Gorilla & Sons, Inc., rec'd Jun. 1997, rear cover, Schrade Tough Tool.

Primary Examiner—Jeffrey Asch
Attorney, Agent, or Firm—Robert R. Thornton

[57] **CLAIM**

The ornamental design for a multi-function tool, as shown and described.

DESCRIPTION

FIG. 1 is a bottom, right, front perspective view of a multi-function tool showing my new design, when in a partially open disposition;
FIG. 2 is a rear plan view thereof in another partially open disposition;
FIG. 3 is a rear plan view thereof when in the disposition of FIG. 1;
FIG. 4 is a front plan view thereof when in the disposition of FIG. 1;
FIG. 5 is a bottom plan view thereof when in the disposition of FIG. 1;
FIG. 6 is a top plan view thereof when in the disposition of FIG. 1;
FIG. 7 is a right side elevational view thereof when in the disposition of FIG. 1;
FIG. 8 is a left side elevational view thereof when in the disposition of FIG. 1;
FIG. 9 is a front plan view thereof in a folded disposition, and with a knife blade extended;
FIG. 10 is a front plan view thereof in the folded disposition of FIG. 9, but with the knife blade retracted;
FIG. 11 is a rear plan view thereof in the folded disposition of FIG. 9, and with its various tools extended; and,
FIG. 12 is a rear plan view thereof in another different unfolded disposition, and with its various tools extended.

1 Claim, 7 Drawing Sheets

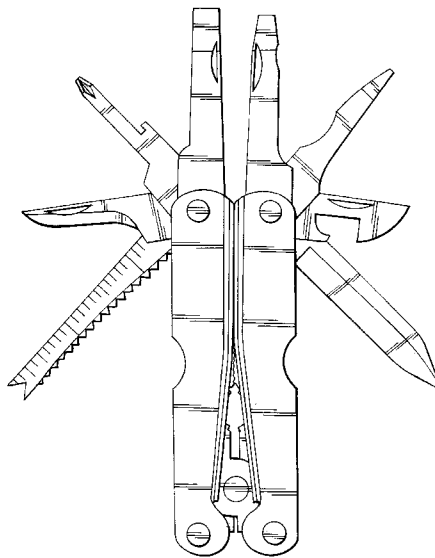
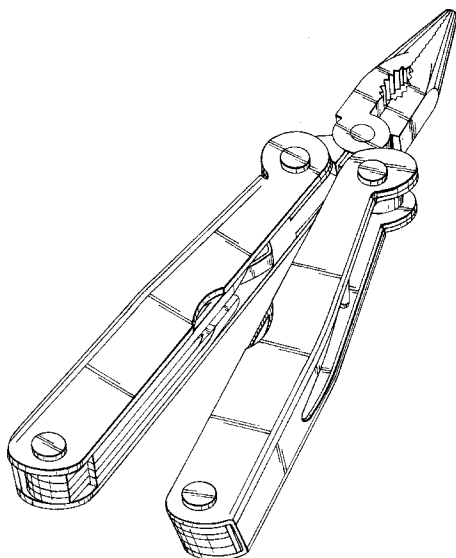

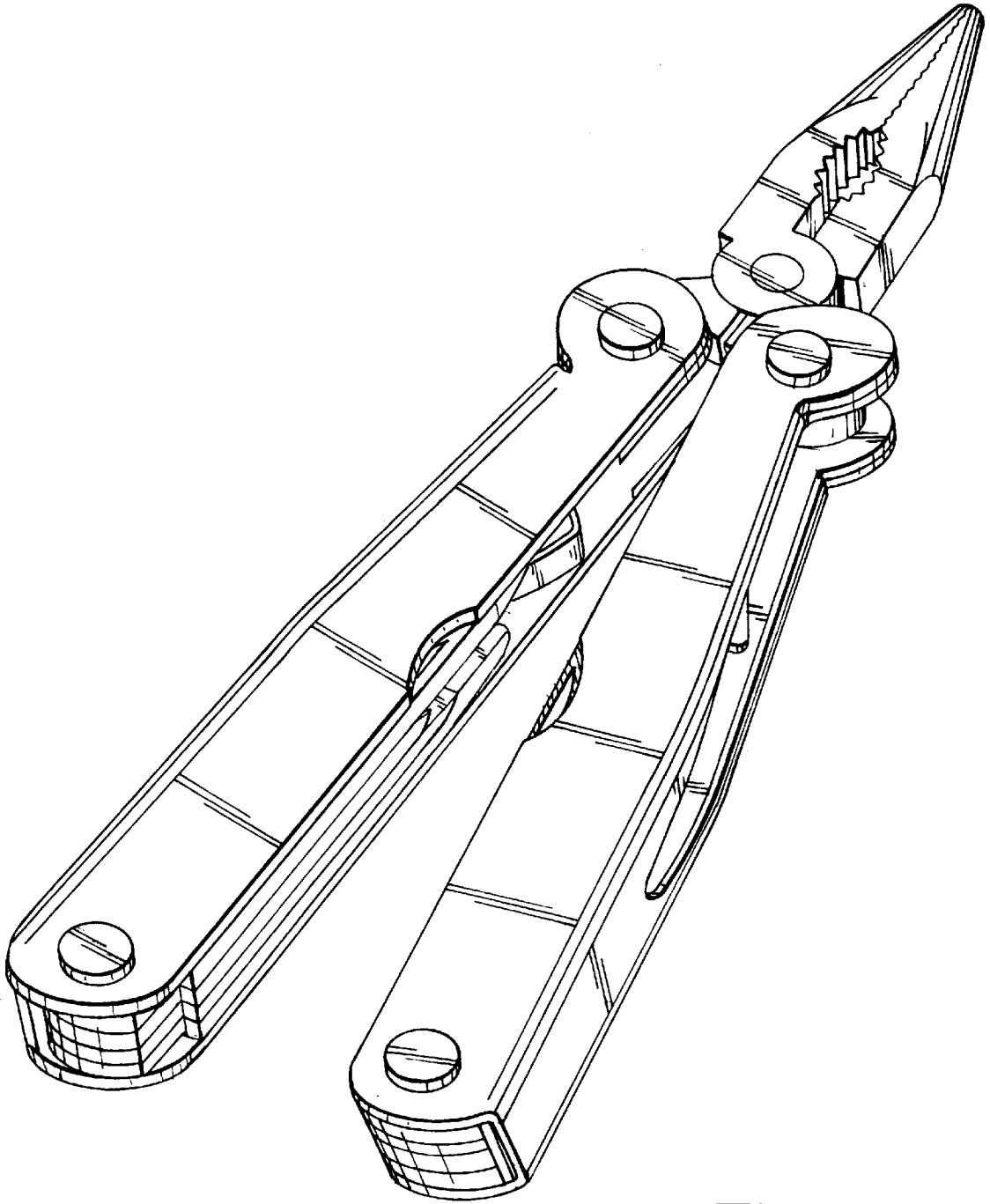

Fig. 1

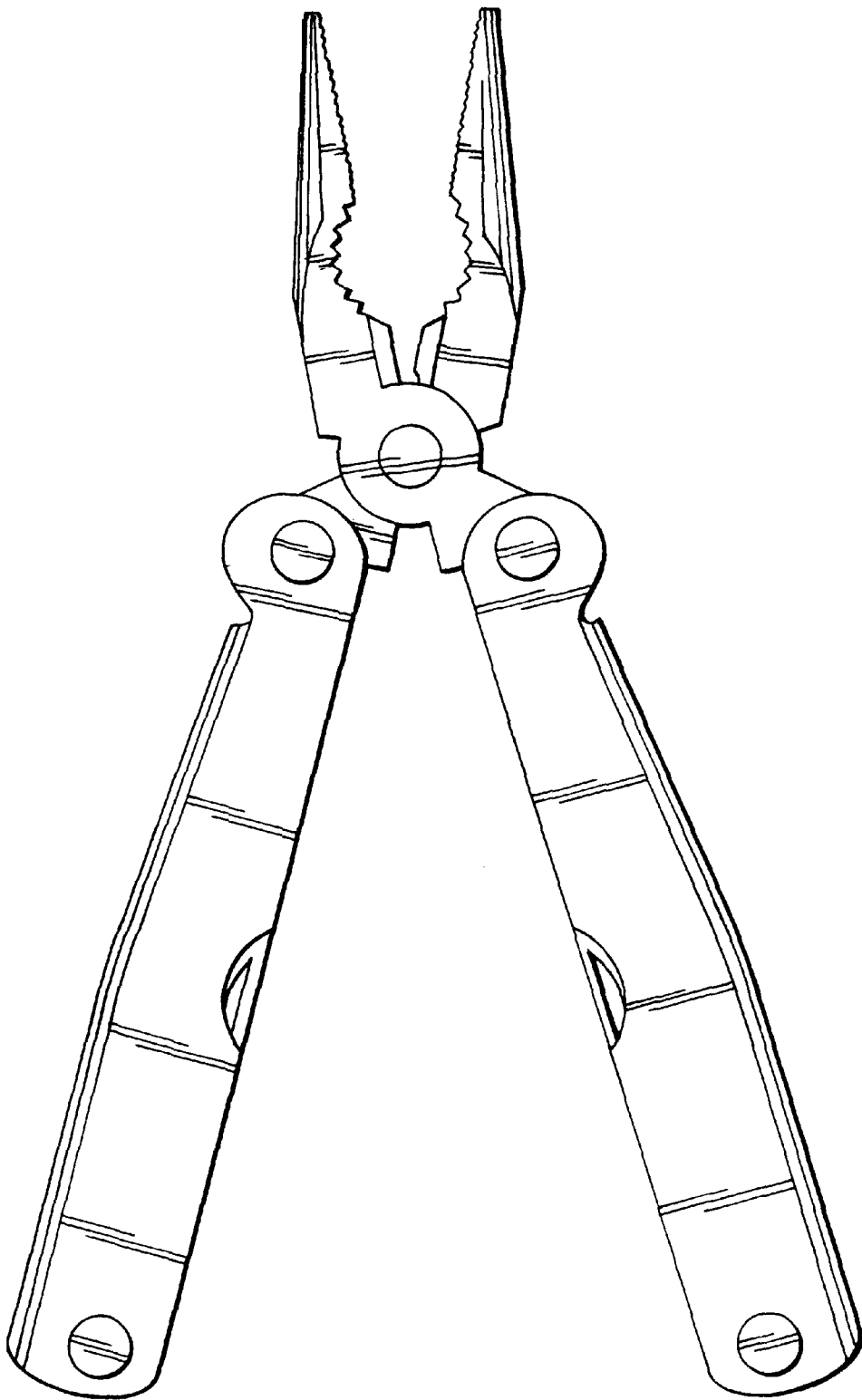

Fig. 2

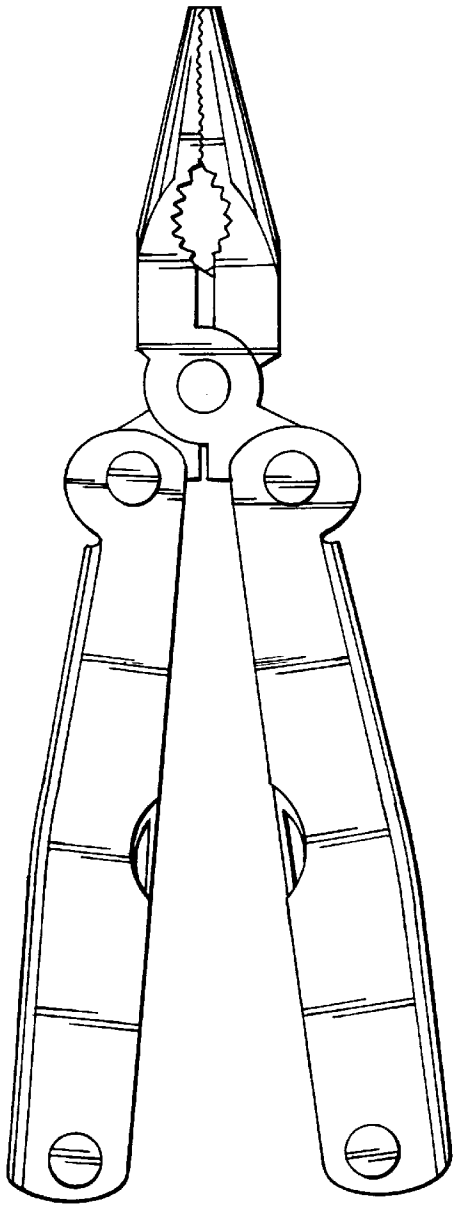

Fig. 3

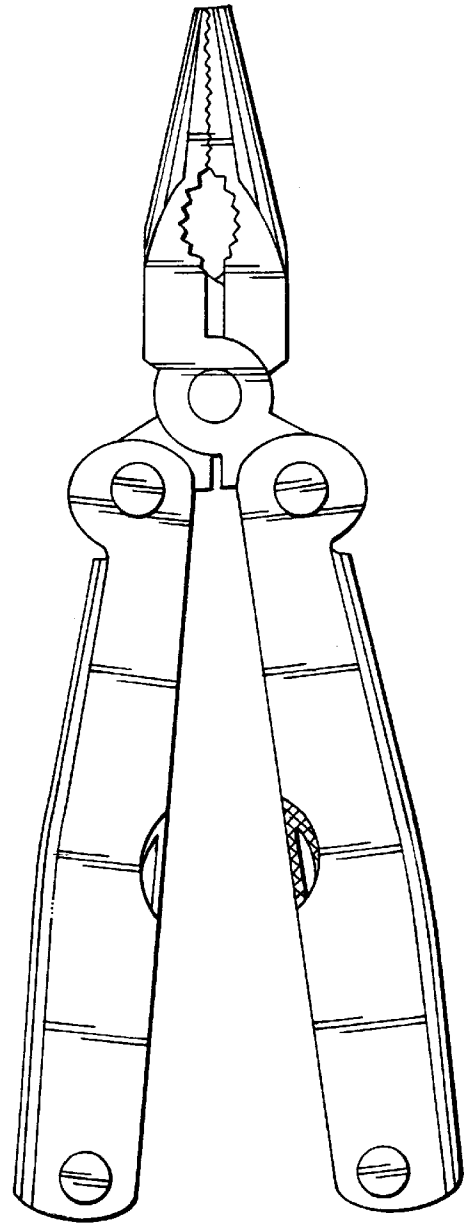

Fig. 4

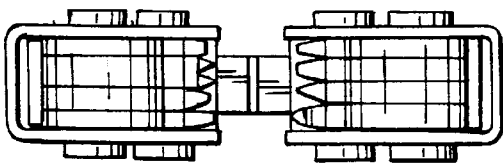

Fig. 5

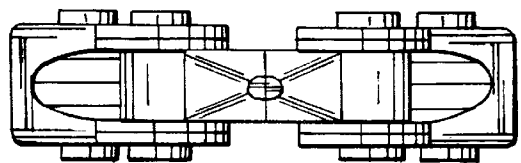

Fig. 6

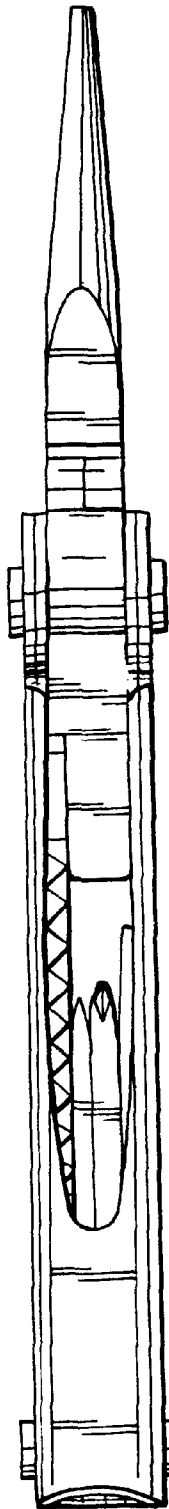

Fig. 7

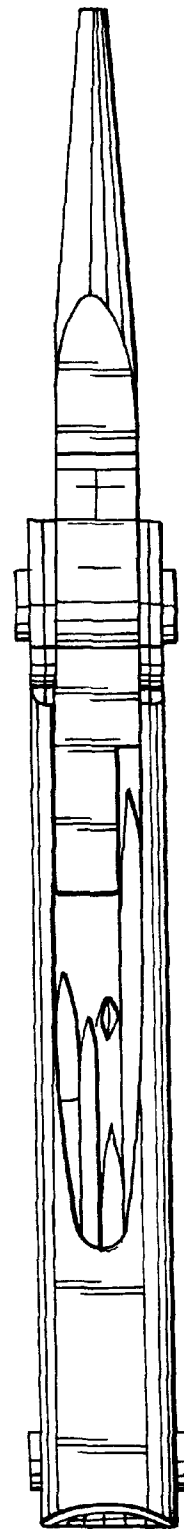

Fig. 8

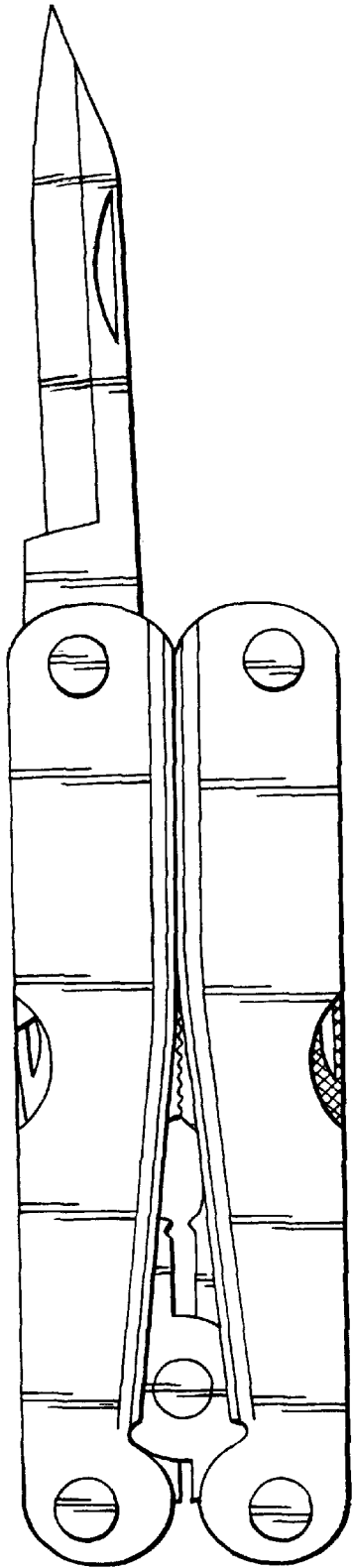

Fig. 9

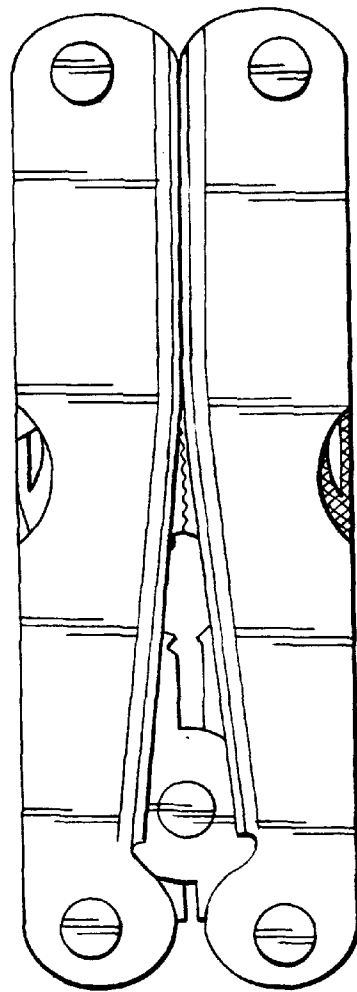

Fig. 10

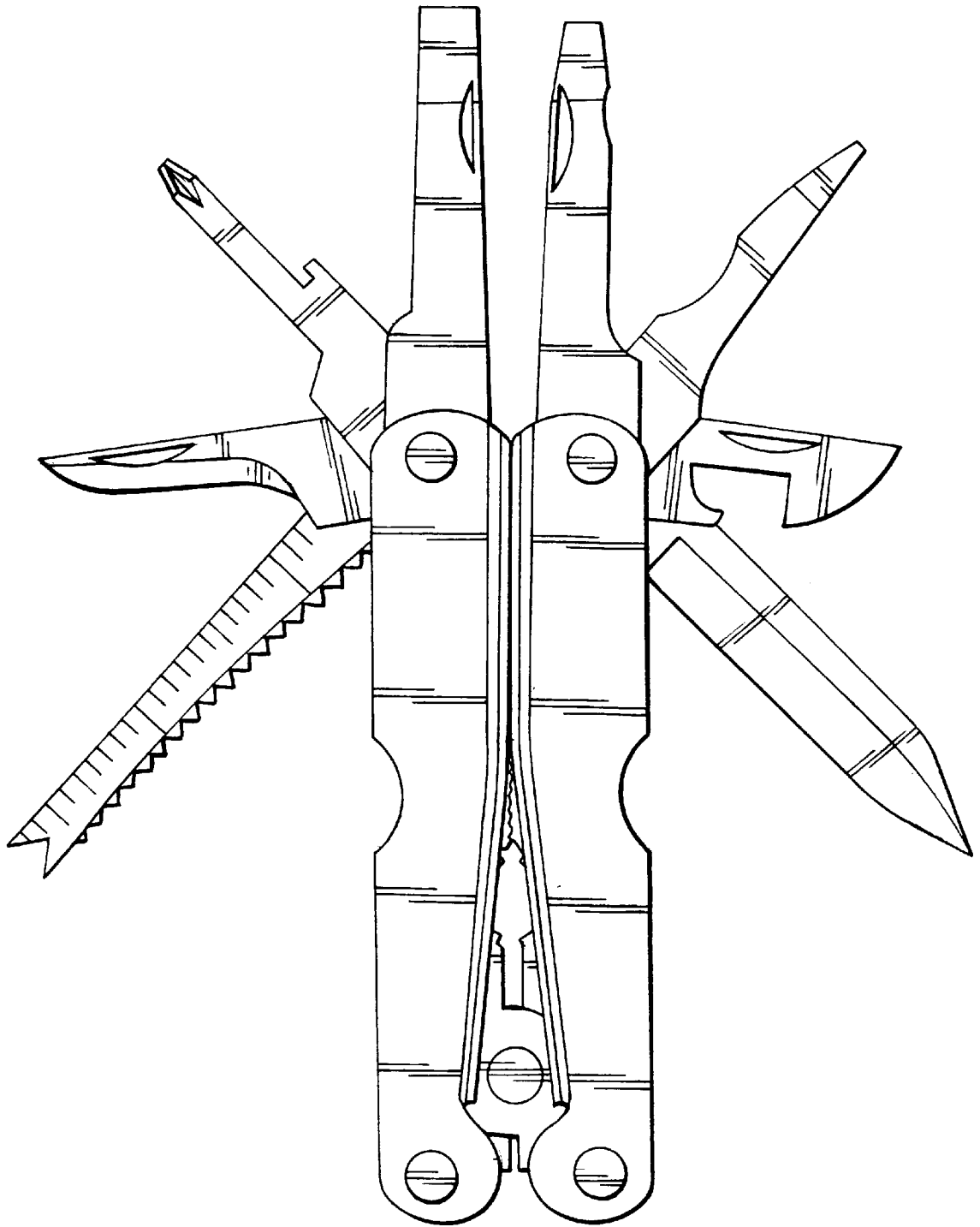

Fig. 11

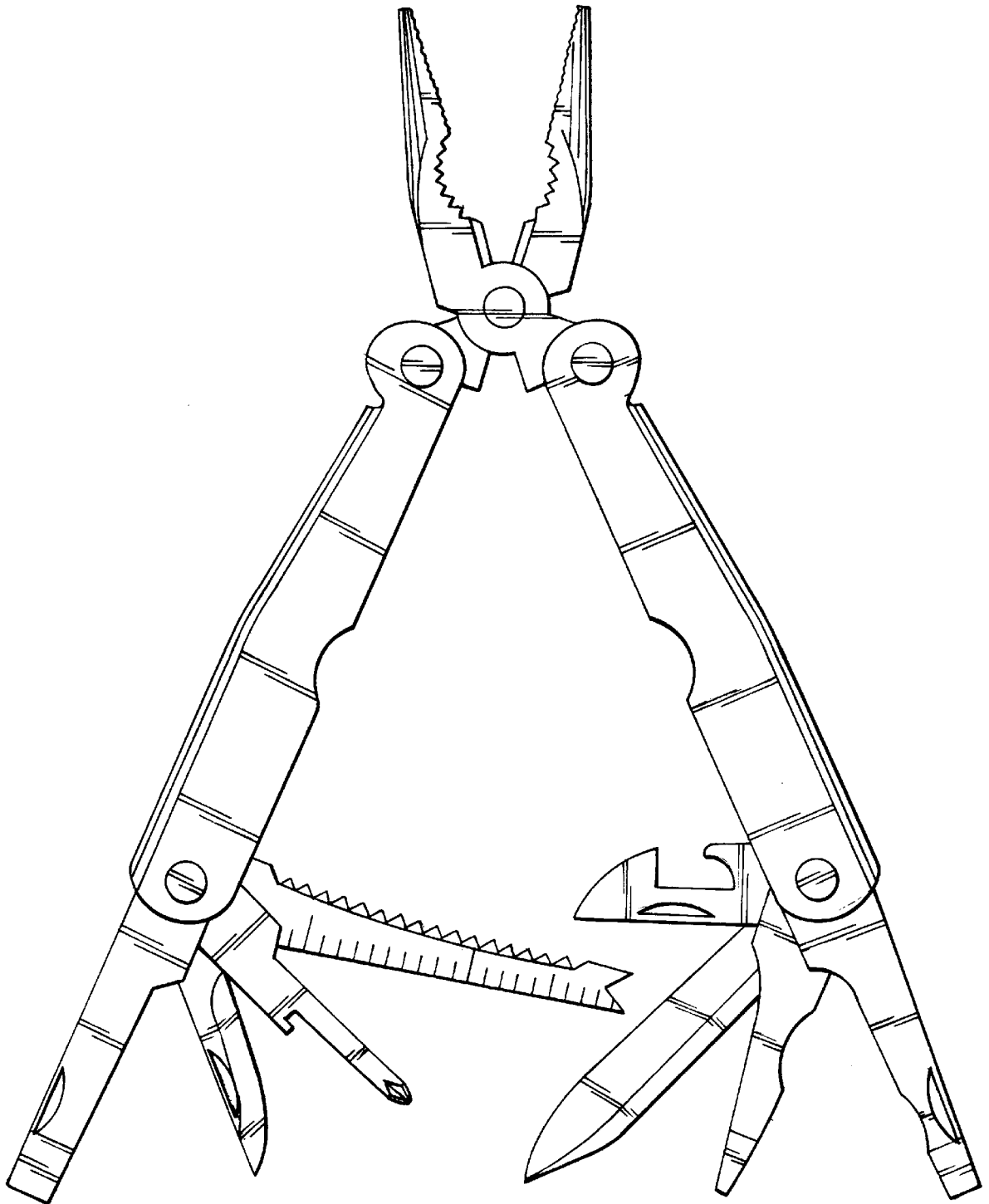

Fig. 12