



- (51) International Patent Classification:
G06F 19/16 (2011.01) C12N 9/22 (2006.01)
- (21) International Application Number:
PCT/US2014/069925
- (22) International Filing Date:
12 December 2014 (12.12.2014)
- (25) Filing Language: English
- (26) Publication Language: English
- (30) Priority Data:
61/915,251 12 December 2013 (12.12.2013) US
61/930,214 22 January 2014 (22.01.2014) US
- (71) Applicants: THE BROAD INSTITUTE INC. [US/US];
415 Main Street, Cambridge, MA 02142 (US). MAS-
SACHUSETTS INSTITUTE OF TECHNOLOGY
[US/US]; 77 Massachusetts Ave., Cambridge, MA 02142
(US). UNIVERSITY OF TOKYO [JP/JP]; 3-1, Hongo 7-
chome, Bunkyo-ku, Tokyo, 113-8651 (JP).

- (72) Inventors: ZHANG, Feng; 100 Pacific Street, Apt. 11,
Cambridge, MA 02139 (US). NUREKI, Osamu; 5-23-8
Kirigaoka, Midori-ku, Yokohama-shi, Kanagawa, 226-
0011 (JP). NISHIMASU, Hiroshi; 2-91-3 Sendagi,
Bunkyo-ku, Tokyo, 113-0022 (JP). ISHITANI, Ry-
uichiro; Arakawa 1-35-1, Arakawa-ku, Tokyo, 116-0002
(JP).
- (74) Agents: KOWALSKI, Thomas, J. et al.; Vedder Price
P.C., 1633 Broadway, New York, NY 10019 (US).
- (81) Designated States (unless otherwise indicated, for every
kind of national protection available): AE, AG, AL, AM,
AO, AT, AU, AZ, BA, BB, BG, BH, BN, BR, BW, BY,
BZ, CA, CH, CL, CN, CO, CR, CU, CZ, DE, DK, DM,
DO, DZ, EC, EE, EG, ES, FI, GB, GD, GE, GH, GM, GT,
HN, HR, HU, ID, IL, IN, IR, IS, JP, KE, KG, KN, KP, KR,
KZ, LA, LC, LK, LR, LS, LU, LY, MA, MD, ME, MG,
MK, MN, MW, MX, MY, MZ, NA, NG, NI, NO, NZ, OM,
PA, PE, PG, PH, PL, PT, QA, RO, RS, RU, RW, SA, SC,
SD, SE, SG, SK, SL, SM, ST, SV, SY, TH, TJ, TM, TN,
TR, TT, TZ, UA, UG, US, UZ, VC, VN, ZA, ZM, ZW.

[Continued on next page]

(54) Title: CRYSTAL STRUCTURE OF A CRISPR-CAS SYSTEM, AND USES THEREOF

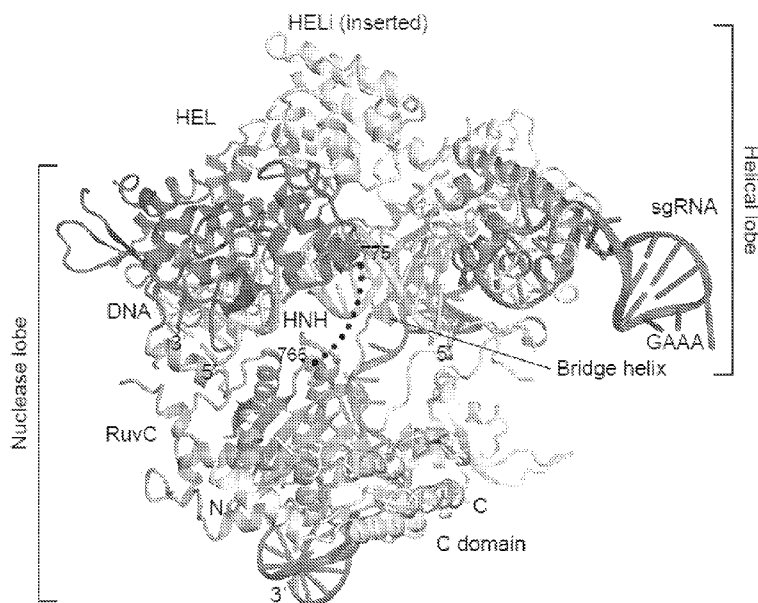

(57) Abstract: The invention provides for systems, methods, and compositions for altering expression of target gene sequences and related gene products. Provided are structural information on the Cas protein of the CRISPR-Cas system, use of this information in generating modified components of the CRISPR complex, vectors and vector systems which encode one or more components or modified components of a CRISPR complex, as well as methods for the design and use of such vectors and components. Also provided are methods of directing CRISPR complex formation in eukaryotic cells and methods for utilizing the CRISPR-Cas system.

FIG. 1A

- (84) Designated States** (*unless otherwise indicated, for every kind of regional protection available*): ARIPO (BW, GH, GM, KE, LR, LS, MW, MZ, NA, RW, SD, SL, ST, SZ, TZ, UG, ZM, ZW), Eurasian (AM, AZ, BY, KG, KZ, RU, TJ, TM), European (AL, AT, BE, BG, CH, CY, CZ, DE, DK, EE, ES, FI, FR, GB, GR, HR, HU, IE, IS, IT, LT, LU, LV, MC, MK, MT, NL, NO, PL, PT, RO, RS, SE, SI, SK, SM, TR), OAPI (BF, BJ, CF, CG, CI, CM, GA, GN, GQ, GW, KM, ML, MR, NE, SN, TD, TG).
- Published:**
- *with international search report (Art. 21(3))*
 - *before the expiration of the time limit for amending the claims and to be republished in the event of receipt of amendments (Rule 48.2(h))*

CRYSTAL STRUCTURE OF A CRISPR-CAS SYSTEM, AND USES THEREOF

RELATED APPLICATIONS AND INCORPORATION BY REFERENCE

[0001] This application claims priority from US provisional patent applications: 61/915,251, filed December 12, 2013; and 61/930,214 filed January 22, 2014.

[0002] The foregoing applications, and all documents cited therein or during their prosecution (“appln cited documents”) and all documents cited or referenced in the appln cited documents, and all documents cited or referenced herein (“herein cited documents”), and all documents cited or referenced in herein cited documents, together with any manufacturer’s instructions, descriptions, product specifications, and product sheets for any products mentioned herein or in any document incorporated by reference herein, are hereby incorporated herein by reference, and may be employed in the practice of the invention. More specifically, all referenced documents are incorporated by reference to the same extent as if each individual document was specifically and individually indicated to be incorporated by reference.

FIELD OF THE INVENTION

[0003] The present invention generally relates to systems, methods and compositions used for the control of gene expression involving sequence targeting, such as genome perturbation or gene-editing, that may use vector systems related to Clustered Regularly Interspaced Short Palindromic Repeats (CRISPR) and components thereof.

STATEMENT AS TO FEDERALLY SPONSORED RESEARCH

[0004] This invention was made with government support under NIH Pioneer Award 1DP1MH100706, awarded by the National Institutes of Health. The government has certain rights in the invention.

[0005] This invention was made with government support under PRESTO (Precursory Research for Embryonic Science and Technology, Sakigake) in the field of “Structural life science and advanced core technologies for innovative life science research”, awarded by JST (Japan Science and Technology Agency) in 2012. JST has certain rights in the invention.

[0006] This invention was made with government support under CREST in the field of “Creation of Basic Medical Technologies to Clarify and Control the Mechanisms Underlying

Chronic Inflammation”, awarded by JST (Japan Science and Technology Agency) in 2013. JST has certain rights in the invention.

BACKGROUND OF THE INVENTION

[0007] Recent advances in genome sequencing techniques and analysis methods have significantly accelerated the ability to catalog and map genetic factors associated with a diverse range of biological functions and diseases. Precise genome targeting technologies are needed to enable systematic reverse engineering of causal genetic variations by allowing selective perturbation of individual genetic elements, as well as to advance synthetic biology, biotechnological, and medical applications. Although genome-editing techniques such as designer zinc fingers, transcription activator-like effectors (TALEs), or homing meganucleases are available for producing targeted genome perturbations, there remains a need for new genome engineering technologies that are affordable, easy to set up, scalable, and amenable to targeting multiple positions within the eukaryotic genome.

SUMMARY OF THE INVENTION

[0008] There exists a pressing need for alternative and robust systems and techniques for sequence targeting with a wide array of applications. This invention addresses this need and provides related advantages. The CRISPR/Cas or the CRISPR-Cas system (both terms are used interchangeably throughout this application) does not require the generation of customized proteins to target specific sequences but rather a single Cas enzyme can be programmed by a short RNA molecule to recognize a specific DNA target, in other words the Cas enzyme can be recruited to a specific DNA target using said short RNA molecule. Adding the CRISPR-Cas system to the repertoire of genome sequencing techniques and analysis methods may significantly simplify the methodology and accelerate the ability to catalog and map genetic factors associated with a diverse range of biological functions and diseases. To utilize the CRISPR-Cas system effectively for genome editing without deleterious effects, it is critical to understand aspects of engineering and optimization of these genome engineering tools, which are aspects of the claimed invention.

[0009] In one aspect, the invention provides a method for altering or modifying expression of a gene product. The said method may comprise introducing into a cell containing and expressing a DNA molecule encoding the gene product an engineered, non-naturally occurring CRISPR-Cas

system comprising a Cas protein and guide RNA that targets the DNA molecule, whereby the guide RNA targets the DNA molecule encoding the gene product and the Cas protein cleaves the DNA molecule encoding the gene product, whereby expression of the gene product is altered; and, wherein the Cas protein and the guide RNA do not naturally occur together. The invention comprehends the guide RNA comprising a guide sequence fused to a tracr sequence. The invention further comprehends the Cas protein being codon optimized for expression in a Eukaryotic cell. In a preferred embodiment the Eukaryotic cell is a mammalian cell and in a more preferred embodiment the mammalian cell is a human cell. In a further embodiment of the invention, the expression of the gene product is decreased.

[0010] In one aspect, the invention provides an engineered, non-naturally occurring CRISPR-Cas system comprising a Cas protein and a guide RNA that targets a DNA molecule encoding a gene product in a cell, whereby the guide RNA targets the DNA molecule encoding the gene product and the Cas protein cleaves the DNA molecule encoding the gene product, whereby expression of the gene product is altered; and, wherein the Cas protein and the guide RNA do not naturally occur together. The invention comprehends the guide RNA comprising a guide sequence fused to a tracr sequence. In an embodiment of the invention the Cas protein is a type II CRISPR-Cas protein and in a preferred embodiment the Cas protein is a Cas9 protein. The invention further comprehends the Cas protein being codon optimized for expression in a Eukaryotic cell. In a preferred embodiment the Eukaryotic cell is a mammalian cell and in a more preferred embodiment the mammalian cell is a human cell. In a further embodiment of the invention, the expression of the gene product is decreased.

[0011] In another aspect, the invention provides an engineered, non-naturally occurring vector system comprising one or more vectors comprising a first regulatory element operably linked to a CRISPR-Cas system guide RNA that targets a DNA molecule encoding a gene product and a second regulatory element operably linked to a Cas protein. Components (a) and (b) may be located on same or different vectors of the system. The guide RNA targets the DNA molecule encoding the gene product in a cell and the Cas protein cleaves the DNA molecule encoding the gene product, whereby expression of the gene product is altered; and, wherein the Cas protein and the guide RNA do not naturally occur together. The invention comprehends the guide RNA comprising a guide sequence fused to a tracr sequence. In an embodiment of the invention the Cas protein is a type II CRISPR-Cas protein and in a preferred embodiment the Cas

protein is a Cas9 protein. The invention further comprehends the Cas protein being codon optimized for expression in a Eukaryotic cell. In a preferred embodiment the Eukaryotic cell is a mammalian cell and in a more preferred embodiment the mammalian cell is a human cell. In a further embodiment of the invention, the expression of the gene product is decreased.

[0012] In one aspect, the invention provides a vector system comprising one or more vectors. In some embodiments, the system comprises: (a) a first regulatory element operably linked to a tracr mate sequence and one or more insertion sites for inserting one or more guide sequences upstream of the tracr mate sequence, wherein when expressed, the guide sequence directs sequence-specific binding of a CRISPR complex to a target sequence in a eukaryotic cell, wherein the CRISPR complex comprises a CRISPR enzyme complexed with (1) the guide sequence that is hybridized to the target sequence, and (2) the tracr mate sequence that is hybridized to the tracr sequence; and (b) a second regulatory element operably linked to an enzyme-coding sequence encoding said CRISPR enzyme comprising a nuclear localization sequence; wherein components (a) and (b) are located on the same or different vectors of the system. In some embodiments, component (a) further comprises the tracr sequence downstream of the tracr mate sequence under the control of the first regulatory element. In some embodiments, component (a) further comprises two or more guide sequences operably linked to the first regulatory element, wherein when expressed, each of the two or more guide sequences direct sequence specific binding of a CRISPR complex to a different target sequence in a eukaryotic cell. In some embodiments, the system comprises the tracr sequence under the control of a third regulatory element, such as a polymerase III promoter. In some embodiments, the tracr sequence exhibits at least 50%, 60%, 70%, 80%, 90%, 95%, or 99% of sequence complementarity along the length of the tracr mate sequence when optimally aligned. Determining optimal alignment is within the purview of one of skill in the art. For example, there are publically and commercially available alignment algorithms and programs such as, but not limited to, ClustalW, Smith-Waterman in matlab, Bowtie, Geneious, Biopython and SeqMan. In some embodiments, the CRISPR complex comprises one or more nuclear localization sequences of sufficient strength to drive accumulation of said CRISPR complex in a detectable amount in the nucleus of a eukaryotic cell. Without wishing to be bound by theory, it is believed that a nuclear localization sequence is not necessary for CRISPR complex activity in eukaryotes, but that including such sequences enhances activity of the system, especially as to targeting

nucleic acid molecules in the nucleus. In some embodiments, the CRISPR enzyme is a type II CRISPR system enzyme. In some embodiments, the CRISPR enzyme is a Cas9 enzyme. In some embodiments, the Cas9 enzyme is *S. pneumoniae*, *S. pyogenes*, or *S. thermophilus* Cas9, and may include mutated Cas9 derived from these organisms. The enzyme may be a Cas9 homolog or ortholog. In some embodiments, the CRISPR enzyme is codon-optimized for expression in a eukaryotic cell. In some embodiments, the CRISPR enzyme directs cleavage of one or two strands at the location of the target sequence. In some embodiments, the first regulatory element is a polymerase III promoter. In some embodiments, the second regulatory element is a polymerase II promoter. In some embodiments, the guide sequence is at least 15, 16, 17, 18, 19, 20, 25 nucleotides, or between 10-30, or between 15-25, or between 15-20 nucleotides in length. In general, and throughout this specification, the term "vector" refers to a nucleic acid molecule capable of transporting another nucleic acid to which it has been linked. Vectors include, but are not limited to, nucleic acid molecules that are single-stranded, double-stranded, or partially double-stranded; nucleic acid molecules that comprise one or more free ends, no free ends (e.g. circular); nucleic acid molecules that comprise DNA, RNA, or both; and other varieties of polynucleotides known in the art. One type of vector is a "plasmid," which refers to a circular double stranded DNA loop into which additional DNA segments can be inserted, such as by standard molecular cloning techniques. Another type of vector is a viral vector, wherein virally-derived DNA or RNA sequences are present in the vector for packaging into a virus (e.g. retroviruses, replication defective retroviruses, adenoviruses, replication defective adenoviruses, and adeno-associated viruses). Viral vectors also include polynucleotides carried by a virus for transfection into a host cell. Certain vectors are capable of autonomous replication in a host cell into which they are introduced (e.g. bacterial vectors having a bacterial origin of replication and episomal mammalian vectors). Other vectors (e.g., non-episomal mammalian vectors) are integrated into the genome of a host cell upon introduction into the host cell, and thereby are replicated along with the host genome. Moreover, certain vectors are capable of directing the expression of genes to which they are operatively-linked. Such vectors are referred to herein as "expression vectors." Common expression vectors of utility in recombinant DNA techniques are often in the form of plasmids.

[0013] Recombinant expression vectors can comprise a nucleic acid of the invention in a form suitable for expression of the nucleic acid in a host cell, which means that the recombinant

expression vectors include one or more regulatory elements, which may be selected on the basis of the host cells to be used for expression, that is operatively-linked to the nucleic acid sequence to be expressed. Within a recombinant expression vector, “operably linked” is intended to mean that the nucleotide sequence of interest is linked to the regulatory element(s) in a manner that allows for expression of the nucleotide sequence (e.g. in an in vitro transcription/translation system or in a host cell when the vector is introduced into the host cell).

[0014] The term “regulatory element” is intended to include promoters, enhancers, internal ribosomal entry sites (IRES), and other expression control elements (e.g. transcription termination signals, such as polyadenylation signals and poly-U sequences). Such regulatory elements are described, for example, in Goeddel, GENE EXPRESSION TECHNOLOGY: METHODS IN ENZYMOLOGY 185, Academic Press, San Diego, Calif. (1990). Regulatory elements include those that direct constitutive expression of a nucleotide sequence in many types of host cell and those that direct expression of the nucleotide sequence only in certain host cells (e.g., tissue-specific regulatory sequences). A tissue-specific promoter may direct expression primarily in a desired tissue of interest, such as muscle, neuron, bone, skin, blood, specific organs (e.g. liver, pancreas), or particular cell types (e.g. lymphocytes). Regulatory elements may also direct expression in a temporal-dependent manner, such as in a cell-cycle dependent or developmental stage-dependent manner, which may or may not also be tissue or cell-type specific. In some embodiments, a vector comprises one or more pol III promoter (e.g. 1, 2, 3, 4, 5, or more pol I promoters), one or more pol II promoters (e.g. 1, 2, 3, 4, 5, or more pol II promoters), one or more pol I promoters (e.g. 1, 2, 3, 4, 5, or more pol I promoters), or combinations thereof. Examples of pol III promoters include, but are not limited to, U6 and H1 promoters. Examples of pol II promoters include, but are not limited to, the retroviral Rous sarcoma virus (RSV) LTR promoter (optionally with the RSV enhancer), the cytomegalovirus (CMV) promoter (optionally with the CMV enhancer) [see, e.g., Boshart et al, Cell, 41:521-530 (1985)], the SV40 promoter, the dihydrofolate reductase promoter, the β -actin promoter, the phosphoglycerol kinase (PGK) promoter, and the EF1 α promoter. Also encompassed by the term “regulatory element” are enhancer elements, such as WPRE; CMV enhancers; the R-U5' segment in LTR of HTLV-I (Mol. Cell. Biol., Vol. 8(1), p. 466-472, 1988); SV40 enhancer; and the intron sequence between exons 2 and 3 of rabbit β -globin (Proc. Natl. Acad. Sci. USA., Vol. 78(3), p. 1527-31, 1981). It will be appreciated by those skilled in the art that the design of the

expression vector can depend on such factors as the choice of the host cell to be transformed, the level of expression desired, etc. A vector can be introduced into host cells to thereby produce transcripts, proteins, or peptides, including fusion proteins or peptides, encoded by nucleic acids as described herein (e.g., clustered regularly interspersed short palindromic repeats (CRISPR) transcripts, proteins, enzymes, mutant forms thereof, fusion proteins thereof, etc.).

[0015] Advantageous vectors include lentiviruses and adeno-associated viruses, and types of such vectors can also be selected for targeting particular types of cells.

[0016] In one aspect, the invention provides a eukaryotic host cell comprising (a) a first regulatory element operably linked to a tracr mate sequence and one or more insertion sites for inserting one or more guide sequences upstream of the tracr mate sequence, wherein when expressed, the guide sequence directs sequence-specific binding of a CRISPR complex to a target sequence in a eukaryotic cell, wherein the CRISPR complex comprises a CRISPR enzyme complexed with (1) the guide sequence that is hybridized to the target sequence, and (2) the tracr mate sequence that is hybridized to the tracr sequence; and/or (b) a second regulatory element operably linked to an enzyme-coding sequence encoding said CRISPR enzyme comprising a nuclear localization sequence. In some embodiments, the host cell comprises components (a) and (b). In some embodiments, component (a), component (b), or components (a) and (b) are stably integrated into a genome of the host eukaryotic cell. In some embodiments, component (a) further comprises the tracr sequence downstream of the tracr mate sequence under the control of the first regulatory element. In some embodiments, component (a) further comprises two or more guide sequences operably linked to the first regulatory element, wherein when expressed, each of the two or more guide sequences direct sequence specific binding of a CRISPR complex to a different target sequence in a eukaryotic cell. In some embodiments, the eukaryotic host cell further comprises a third regulatory element, such as a polymerase III promoter, operably linked to said tracr sequence. In some embodiments, the tracr sequence exhibits at least 50%, 60%, 70%, 80%, 90%, 95%, or 99% of sequence complementarity along the length of the tracr mate sequence when optimally aligned. The enzyme may be a Cas9 homolog or ortholog. In some embodiments, the CRISPR enzyme is codon-optimized for expression in a eukaryotic cell. In some embodiments, the CRISPR enzyme directs cleavage of one or two strands at the location of the target sequence. In some embodiments, the CRISPR enzyme lacks DNA strand cleavage activity. In some embodiments, the first regulatory element is a polymerase III promoter. In

some embodiments, the second regulatory element is a polymerase II promoter. In some embodiments, the guide sequence is at least 15, 16, 17, 18, 19, 20, 25 nucleotides, or between 10-30, or between 15-25, or between 15-20 nucleotides in length. In an aspect, the invention provides a non-human eukaryotic organism; preferably a multicellular eukaryotic organism, comprising a eukaryotic host cell according to any of the described embodiments. In other aspects, the invention provides a eukaryotic organism; preferably a multicellular eukaryotic organism, comprising a eukaryotic host cell according to any of the described embodiments. The organism in some embodiments of these aspects may be an animal; for example a mammal. Also, the organism may be an arthropod such as an insect. The organism also may be a plant. Further, the organism may be a fungus.

[0017] In one aspect, the invention provides a kit comprising one or more of the components described herein. In some embodiments, the kit comprises a vector system and instructions for using the kit. In some embodiments, the vector system comprises (a) a first regulatory element operably linked to a tracr mate sequence and one or more insertion sites for inserting one or more guide sequences upstream of the tracr mate sequence, wherein when expressed, the guide sequence directs sequence-specific binding of a CRISPR complex to a target sequence in a eukaryotic cell, wherein the CRISPR complex comprises a CRISPR enzyme complexed with (1) the guide sequence that is hybridized to the target sequence, and (2) the tracr mate sequence that is hybridized to the tracr sequence; and/or (b) a second regulatory element operably linked to an enzyme-coding sequence encoding said CRISPR enzyme comprising a nuclear localization sequence. In some embodiments, the kit comprises components (a) and (b) located on the same or different vectors of the system. In some embodiments, component (a) further comprises the tracr sequence downstream of the tracr mate sequence under the control of the first regulatory element. In some embodiments, component (a) further comprises two or more guide sequences operably linked to the first regulatory element, wherein when expressed, each of the two or more guide sequences direct sequence specific binding of a CRISPR complex to a different target sequence in a eukaryotic cell. In some embodiments, the system further comprises a third regulatory element, such as a polymerase III promoter, operably linked to said tracr sequence. In some embodiments, the tracr sequence exhibits at least 50%, 60%, 70%, 80%, 90%, 95%, or 99% of sequence complementarity along the length of the tracr mate sequence when optimally aligned. In some embodiments, the CRISPR enzyme comprises one or more nuclear localization

sequences of sufficient strength to drive accumulation of said CRISPR enzyme in a detectable amount in the nucleus of a eukaryotic cell. In some embodiments, the CRISPR enzyme is a type II CRISPR system enzyme. In some embodiments, the CRISPR enzyme is a Cas9 enzyme. In some embodiments, the Cas9 enzyme is *S. pneumoniae*, *S. pyogenes* or *S. thermophilus* Cas9, and may include mutated Cas9 derived from these organisms. The enzyme may be a Cas9 homolog or ortholog. In some embodiments, the CRISPR enzyme is codon-optimized for expression in a eukaryotic cell. In some embodiments, the CRISPR enzyme directs cleavage of one or two strands at the location of the target sequence. In some embodiments, the CRISPR enzyme lacks DNA strand cleavage activity. In some embodiments, the first regulatory element is a polymerase III promoter. In some embodiments, the second regulatory element is a polymerase II promoter. In some embodiments, the guide sequence is at least 15, 16, 17, 18, 19, 20, 25 nucleotides, or between 10-30, or between 15-25, or between 15-20 nucleotides in length.

[0018] In one aspect, the invention provides a method of modifying a target polynucleotide in a eukaryotic cell. In some embodiments, the method comprises allowing a CRISPR complex to bind to the target polynucleotide to effect cleavage of said target polynucleotide thereby modifying the target polynucleotide, wherein the CRISPR complex comprises a CRISPR enzyme complexed with a guide sequence hybridized to a target sequence within said target polynucleotide, wherein said guide sequence is linked to a tracr mate sequence which in turn hybridizes to a tracr sequence. In some embodiments, said cleavage comprises cleaving one or two strands at the location of the target sequence by said CRISPR enzyme. In some embodiments, said cleavage results in decreased transcription of a target gene. In some embodiments, the method further comprises repairing said cleaved target polynucleotide by homologous recombination with an exogenous template polynucleotide, wherein said repair results in a mutation comprising an insertion, deletion, or substitution of one or more nucleotides of said target polynucleotide. In some embodiments, said mutation results in one or more amino acid changes in a protein expressed from a gene comprising the target sequence. In some embodiments, the method further comprises delivering one or more vectors to said eukaryotic cell, wherein the one or more vectors drive expression of one or more of: the CRISPR enzyme, the guide sequence linked to the tracr mate sequence, and the tracr sequence. In some embodiments, said vectors are delivered to the eukaryotic cell in a subject. In some embodiments, said modifying takes place in said eukaryotic cell in a cell culture. In some

embodiments, the method further comprises isolating said eukaryotic cell from a subject prior to said modifying. In some embodiments, the method further comprises returning said eukaryotic cell and/or cells derived therefrom to said subject.

[0019] In one aspect, the invention provides a method of modifying expression of a polynucleotide in a eukaryotic cell. In some embodiments, the method comprises allowing a CRISPR complex to bind to the polynucleotide such that said binding results in increased or decreased expression of said polynucleotide; wherein the CRISPR complex comprises a CRISPR enzyme complexed with a guide sequence hybridized to a target sequence within said polynucleotide, wherein said guide sequence is linked to a tracr mate sequence which in turn hybridizes to a tracr sequence. In some embodiments, the method further comprises delivering one or more vectors to said eukaryotic cells, wherein the one or more vectors drive expression of one or more of: the CRISPR enzyme, the guide sequence linked to the tracr mate sequence, and the tracr sequence.

[0020] In one aspect, the invention provides a method of generating a model eukaryotic cell comprising a mutated disease gene. In some embodiments, a disease gene is any gene associated an increase in the risk of having or developing a disease. In some embodiments, the method comprises (a) introducing one or more vectors into a eukaryotic cell, wherein the one or more vectors drive expression of one or more of: a CRISPR enzyme, a guide sequence linked to a tracr mate sequence, and a tracr sequence; and (b) allowing a CRISPR complex to bind to a target polynucleotide to effect cleavage of the target polynucleotide within said disease gene, wherein the CRISPR complex comprises the CRISPR enzyme complexed with (1) the guide sequence that is hybridized to the target sequence within the target polynucleotide, and (2) the tracr mate sequence that is hybridized to the tracr sequence, thereby generating a model eukaryotic cell comprising a mutated disease gene. In some embodiments, said cleavage comprises cleaving one or two strands at the location of the target sequence by said CRISPR enzyme. In some embodiments, said cleavage results in decreased transcription of a target gene. In some embodiments, the method further comprises repairing said cleaved target polynucleotide by homologous recombination with an exogenous template polynucleotide, wherein said repair results in a mutation comprising an insertion, deletion, or substitution of one or more nucleotides of said target polynucleotide. In some embodiments, said mutation results in one or more amino acid changes in a protein expression from a gene comprising the target sequence.

[0021] In one aspect, the invention provides a method for developing a biologically active agent that modulates a cell signaling event associated with a disease gene. In some embodiments, a disease gene is any gene associated an increase in the risk of having or developing a disease. In some embodiments, the method comprises (a) contacting a test compound with a model cell of any one of the described embodiments; and (b) detecting a change in a readout that is indicative of a reduction or an augmentation of a cell signaling event associated with said mutation in said disease gene, thereby developing said biologically active agent that modulates said cell signaling event associated with said disease gene.

[0022] In one aspect, the invention provides a recombinant polynucleotide comprising a guide sequence upstream of a tracr mate sequence, wherein the guide sequence when expressed directs sequence-specific binding of a CRISPR complex to a corresponding target sequence present in a eukaryotic cell. In some embodiments, the target sequence is a viral sequence present in a eukaryotic cell. In some embodiments, the target sequence is a proto-oncogene or an oncogene.

[0023] In one aspect the invention provides for a method of selecting one or more cell(s) by introducing one or more mutations in a gene in the one or more cell (s), the method comprising: introducing one or more vectors into the cell (s), wherein the one or more vectors drive expression of one or more of: a CRISPR enzyme, a guide sequence linked to a tracr mate sequence, a tracr sequence, and an editing template; wherein the editing template comprises the one or more mutations that abolish CRISPR enzyme cleavage; allowing homologous recombination of the editing template with the target polynucleotide in the cell(s) to be selected; allowing a CRISPR complex to bind to a target polynucleotide to effect cleavage of the target polynucleotide within said gene, wherein the CRISPR complex comprises the CRISPR enzyme complexed with (1) the guide sequence that is hybridized to the target sequence within the target polynucleotide, and (2) the tracr mate sequence that is hybridized to the tracr sequence, wherein binding of the CRISPR complex to the target polynucleotide induces cell death, thereby allowing one or more cell(s) in which one or more mutations have been introduced to be selected. In a preferred embodiment, the CRISPR enzyme is Cas9. In another preferred embodiment of the invention the cell to be selected may be a eukaryotic cell. Aspects of the invention allow for selection of specific cells without requiring a selection marker or a two-step process that may include a counter-selection system.

[0024] In another aspect the invention comprehends a CRISPR-cas9 (*S. pyogenes*) system having an X-ray diffraction pattern corresponding to or resulting from any or all of the foregoing and/or a crystal having the structure defined by the co-ordinates of the Crystal Structure Table in Example 1 (the CRISPR-cas9 crystal structure).

[0025] In a further aspect, the invention involves a computer-assisted method for identifying or designing potential compounds to fit within or bind to CRISPR-cas9 system or a functional portion thereof or vice versa (a computer-assisted method for identifying or designing potential CRISPR-cas9 systems or a functional portion thereof for binding to desired compounds) or a computer-assisted method for identifying or designing potential CRISPR-cas9 systems (e.g., with regard to predicting areas of the CRISPR-cas9 system to be able to be manipulated—for instance, based on crystal structure data or based on data of cas9 orthologs, or with respect to where a functional group such as an activator or repressor can be attached to the CRISPR-cas9 system, or as to cas9 truncations or as to designing nickases), said method comprising:

using a computer system, e.g., a programmed computer comprising a processor, a data storage system, an input device, and an output device, the steps of:

(a) inputting into the programmed computer through said input device data comprising the three-dimensional co-ordinates of a subset of the atoms from or pertaining to the CRISPR-cas9 crystal structure, e.g., in the CRISPR-cas9 system binding domain or alternatively or additionally in domains that vary based on variance among cas9 orthologs or as to cas9s or as to nickases or as to functional groups, optionally with structural information from CRISPR-cas9 system complex(es), thereby generating a data set;

(b) comparing, using said processor, said data set to a computer database of structures stored in said computer data storage system, e.g., structures of compounds that bind or putatively bind or that are desired to bind to a CRISPR-cas9 system or as to cas9 orthologs (e.g., as cas9s or as to domains or regions that vary amongst cas9 orthologs) or as to the CRISPR-cas9 crystal structure or as to nickases or as to functional groups;

(c) selecting from said database, using computer methods, structure(s)—e.g., CRISPR-cas9 structures that may bind to desired structures, desired structures that may bind to certain CRISPR-cas9 structures, portions of the CRISPR-cas9 system that may be manipulated, e.g., based on data from other portions of the CRISPR-cas9 crystal structure and/or from cas9

orthologs, truncated cas9s, novel nickases or particular functional groups, or positions for attaching functional groups or functional-group-CRISPR-cas9 systems;

(d) constructing, using computer methods, a model of the selected structure(s); and

(e) outputting to said output device the selected structure(s);

and optionally synthesizing one or more of the selected structure(s);

and further optionally testing said synthesized selected structure(s) as or in a CRISPR-cas9 system;

or, said method comprising: providing the co-ordinates of at least two atoms of the CRISPR-cas9 crystal structure, e.g., at least two atoms of the herein Crystal Structure Table of the CRISPR-cas9 crystal structure or co-ordinates of at least a sub-domain of the CRISPR-cas9 crystal structure ("selected co-ordinates"), providing the structure of a candidate comprising a binding molecule or of portions of the CRISPR-cas9 system that may be manipulated, e.g., based on data from other portions of the CRISPR-cas9 crystal structure and/or from cas9 orthologs, or the structure of functional groups, and fitting the structure of the candidate to the selected co-ordinates, to thereby obtain product data comprising CRISPR-cas9 structures that may bind to desired structures, desired structures that may bind to certain CRISPR-cas9 structures, portions of the CRISPR-cas9 system that may be manipulated, truncated cas9s, novel nickases, or particular functional groups, or positions for attaching functional groups or functional-group-CRISPR-cas9 systems, with output thereof; and optionally synthesizing compound(s) from said product data and further optionally comprising testing said synthesized compound(s) as or in a CRISPR-cas9 system.

[0026] The testing can comprise analyzing the CRISPR-cas9 system resulting from said synthesized selected structure(s), e.g., with respect to binding, or performing a desired function.

[0027] The output in the foregoing methods can comprise data transmission, e.g., transmission of information via telecommunication, telephone, video conference, mass communication, e.g., presentation such as a computer presentation (eg POWERPOINT), internet, email, documentary communication such as a computer program (eg WORD) document and the like. Accordingly, the invention also comprehends computer readable media containing: atomic co-ordinate data according to the herein Crystal Structure Table and/or the Figures, said data defining the three dimensional structure of CRISPR-cas9 or at least one sub-domain thereof, or structure factor data for CRISPR-cas9, said structure factor data being derivable from the atomic

co-ordinate data of herein Crystal Structure Table and/or the Figures. The computer readable media can also contain any data of the foregoing methods. The invention further comprehends methods a computer system for generating or performing rational design as in the foregoing methods containing either: atomic co-ordinate data according to herein Crystal Structure Table and/or the Figures, said data defining the three dimensional structure of CRISPR-cas9 or at least one sub-domain thereof, or structure factor data for CRISPR-cas9, said structure factor data being derivable from the atomic co-ordinate data of herein Crystal Structure Table and/or the Figures. The invention further comprehends a method of doing business comprising providing to a user the computer system or the media or the three dimensional structure of CRISPR-cas9 or at least one sub-domain thereof, or structure factor data for CRISPR-cas9, said structure set forth in and said structure factor data being derivable from the atomic co-ordinate data of herein Crystal Structure Table and/or the Figures, or the herein computer media or a herein data transmission.

[0028] A “binding site” or an “active site” comprises or consists essentially of a site (such as an atom, a functional group of an amino acid residue or a plurality of such atoms and/or groups) in a binding cavity or region, which may bind to a compound such as a nucleic acid molecule, which is/are involved in binding.

[0029] By “fitting”, is meant determining by automatic, or semi-automatic means, interactions between one or more atoms of a candidate molecule and at least one atom of a structure of the invention, and calculating the extent to which such interactions are stable. Interactions include attraction and repulsion, brought about by charge, steric considerations and the like. Various computer-based methods for fitting are described further

[0030] By “root mean square (or rms) deviation”, we mean the square root of the arithmetic mean of the squares of the deviations from the mean.

[0031] By a “computer system”, is meant the hardware means, software means and data storage means used to analyze atomic coordinate data. The minimum hardware means of the computer-based systems of the present invention typically comprises a central processing unit (CPU), input means, output means and data storage means. Desirably a display or monitor is provided to visualize structure data. The data storage means may be RAM or means for accessing computer readable media of the invention. Examples of such systems are computer and tablet devices running Unix, Windows or Apple operating systems.

[0032] By "computer readable media", is meant any medium or media, which can be read and accessed directly or indirectly by a computer e.g. so that the media is suitable for use in the above-mentioned computer system. Such media include, but are not limited to: magnetic storage media such as floppy discs, hard disc storage medium and magnetic tape; optical storage media such as optical discs or CD-ROM; electrical storage media such as RAM and ROM; thumb drive devices; cloud storage devices and hybrids of these categories such as magnetic/optical storage media.

[0033] Accordingly, it is an object of the invention not to encompass within the invention any previously known product, process of making the product, or method of using the product such that Applicants reserve the right and hereby disclose a disclaimer of any previously known product, process, or method. It is further noted that the invention does not intend to encompass within the scope of the invention any product, process, or making of the product or method of using the product, which does not meet the written description and enablement requirements of the USPTO (35 U.S.C. §112, first paragraph) or the EPO (Article 83 of the EPC), such that Applicants reserve the right and hereby disclose a disclaimer of any previously described product, process of making the product, or method of using the product.

[0034] It is noted that in this disclosure and particularly in the claims and/or paragraphs, terms such as "comprises", "comprised", "comprising" and the like can have the meaning attributed to it in U.S. Patent law; e.g., they can mean "includes", "included", "including", and the like; and that terms such as "consisting essentially of" and "consists essentially of" have the meaning ascribed to them in U.S. Patent law, e.g., they allow for elements not explicitly recited, but exclude elements that are found in the prior art or that affect a basic or novel characteristic of the invention. It may be advantageous in the practice of the invention to be in compliance with Art. 53(c) EPC and Rule 28(b) and (c) EPC. Nothing herein is to be construed as a promise.

[0035] These and other embodiments are disclosed or are obvious from and encompassed by, the following Detailed Description.

BRIEF DESCRIPTION OF THE DRAWINGS

[0036] The novel features of the invention are set forth with particularity in the appended claims. A better understanding of the features and advantages of the present invention will be

obtained by reference to the following detailed description that sets forth illustrative embodiments, in which the principles of the invention are utilized, and the accompanying drawings of which:

[0037] **Figures 1A-M** provide: a diagram showing the topology of the Cas9 protein. Helices are shown as tubes and beta sheets are shown as arrows and various views of the CRISPR-cas complex crystal structure (A-I), chimeric RNA architecture from the crystal structure (J-K), an interaction schematic from the crystal structure (L) and a topology schematic from the crystal structure (M).

[0038] **Figures 2A-C** show, from the crystal structure, a schematic of showing catalytic domains of SpCas9, sites of mutagenesis for new nickases (A), a schematic showing locations of sgRNAs for testing double nicking (B), and results of a Surveyor gel test results showing 1 HNH mutant N854A that retains nickase activity, and 1 HNH mutant that shows nickase activity (N863A), and 2 RuvCIII mutants that show nickase activity (H983A, D986A) (C).

[0039] **Figures 3A-B** show Surveyor gel test results of SpCas9 truncation mutants from the crystal structure that retain cleavage activity (A) and a table showing the amino acid truncations and flexible (GGGS) or rigid (A(EAAAK)) linker substitutions of the lanes of the gels of Figure 25A (B).

[0040] **Figures 4A-B** show SpCas9 sgRNAs from the crystal structure including those mutated to investigate contribution to activity of specific bases or groups to bases.

[0041] **Figures 5A-C** show truncation and creation of chimeric (*S. pyogenes*) Cas9s based on the herein crystal structure, including mutants for mapping essential functional domains (A), chimeras that contain regions from *S. thermophilus* Cas9 (B), and designs for chemically inducible dimerization of SpCas9 (C).

[0042] **Figure 6** shows a picture of Cas9 crystals (0.2 mm).

[0043] **Figure 7** shows a structural figure of showing Cas9 in a surface representation; red, sgRNA; cyan, the guide region of sgRNA; gold, target DNA.

[0044] **Figure 8A-D** shows the overall structure. (A) Domain organization of *S. pyogenes* Cas9, and schematic of the sgRNA:target DNA complex. (B) Ribbon representation of the Cas9–sgRNA–DNA complex. Disordered linkers are shown as red dotted lines. (C) Surface representation of the Cas9–sgRNA–DNA complex. The active sites of the RuvC (D10A) and HNH (H840A) domains are indicated by dashed yellow circles. (D) Electrostatic surface

potential of the Cas9–sgRNA–DNA complex. The HNH domain is omitted for clarity. Molecular graphic images were prepared using CueMol (see website at cuemol.org). Also refer to Figs. 37 and 38.

[0045] **Figure 9A-E** shows the REC lobe and PI domain. (A) Structure of the REC lobe. The REC2 domain and Bridge helix are colored dark gray and green, respectively. The REC1 domain is colored gray, with the repeat-interacting and anti-repeat-interacting regions colored pale blue and pink, respectively. The bound sgRNA:DNA is shown as semi-transparent ribbon representation. (B) Schematics indicating positions of SpCas9 truncations in the REC1 and REC2 domains. Bars on the right show indel mutations generated by the truncation mutants, measured by SURVEYOR assay ($n = 3$, error bars show mean \pm S.E.M., N.D., not detectable). (C) Western blot showing expression of truncation mutants in HEK 293FT cells. (D) Structure of the PI domain. The bound sgRNA is shown as semi-transparent ribbon representation. (E) Schematics showing wild-type SpCas9 and St3Cas9, chimeric Cas9, as well as SpCas9 PI domain truncation constructs. Cas9s are assayed for indel generation at target sites upstream of either NGG (left bar graph) or NGGNG (right bar graph) PAMs ($n = 3$, error bars show mean \pm S.E.M., N.D., not detectable). See also Figs. 39–41.

[0046] **Figure 10A-F** shows the NUC lobe. (A) Structure of the RuvC domain. The core structure of the RNase H fold core is highlighted in cyan. The active-site residues are shown as stick models. (B) Structure of the *T. thermophilus* RuvC dimer in complex with a Holliday junction (PDB ID 4LD0). The two protomers are colored cyan and gray, respectively. (C) Sequence (top) illustrates Cas9 nicking targets on opposite strands of DNA. Targets 1 and 2 are offset by a distance of 4-bp in between. Heatmap (bottom) shows the ability of each catalytic mutant to induce double- (with either sgRNA 1 or 2) or single-stranded breaks (only with both sgRNA together). Gray boxes: not assayed. (D) Indel formation by Cas9 nickases depends on off-set distance between sgRNA pairs (right panel). Off-set distance is defined as the number of base pairs between the PAM-distal (5') ends of the guide sequence of a given sgRNA pair ($n = 3$, error bars show mean \pm S.E.M., N.D., not detectable). (E) Structure of the HNH domain. The core structure of the $\beta\beta\alpha$ -metal fold is highlighted in magenta. The active-site residues are shown as stick models. (F) Structure of the T4 Endo VII dimer in complex with a Holliday junction (PDB ID 2QNC). The two protomers are colored pink and gray, respectively, with the $\beta\beta\alpha$ -metal fold core highlighted in magenta. The bound Mg^{2+} ion is shown as an orange sphere.

[0047] **Figure 11A-D** shows sgRNA and its target DNA. (A) Schematic of the sgRNA:DNA complex. The guide and repeat regions of the crRNA sequence are colored skyblue and blue, respectively. The tracrRNA sequence is colored red, with the linker region colored violet. The target DNA and tetraloop are colored yellow and black, respectively. The numbering of the 3' tails of tracrRNA is shown on red background. Watson-Crick and non-Watson-Crick base pairs are indicated by black and gray lines, respectively. Disordered nucleotides are boxed by dashed lines. (B) Structure of the sgRNA:DNA complex. (C) Structure of the repeat:anti-repeat duplex and three-way junction. Key interactions are shown as gray dashed lines. (D) Effect of sgRNA mutations on ability to induce indels. Base changes from the +83 sgRNA scaffold are shown at respective positions, with dashes indicating unaltered bases ($n = 3$, error bars show mean \pm S.E.M., p values based on unpaired Student's t-test, N.D., not detectable). See also Fig. 42.

[0048] **Figure 12A-K** shows Recognition of the sgRNA:DNA. (A) Schematic of sgRNA:DNA recognition by Cas9. Residues that interact with the sgRNA:DNA via their main chain are shown in parentheses. (B and C-K) Recognition of the guide (B), guide:DNA duplex (D), repeat (E), anti-repeat (F), three-way junction (G), stem loop 1 (H), linker (I), stem loop 2 (J) and stem loop 3 (K). Hydrogen bonds and salt bridges are shown as dashed lines. (C) Effect of Cas9 (top) and sgRNA (bottom) mutations on ability to induce indels ($n = 3$, error bars show mean \pm S.E.M., p values based on unpaired Student's t-test. N.D., not detectable).

[0049] **Figure 13A-D** shows Structural flexibility of the complex. (A) Structural comparison of Mol A and Mol B. In Mol A (left), disordered linker between the RuvC and HNH domain is indicated by a dotted line. In Mol B (right), the disordered HNH domain is shown as a dashed circle. The flexible connecting segment ($\alpha 40$ and $\alpha 41$) in the RuvC domain is highlighted in orange. (B) Superimposition of the Cas9 proteins in Mol A and Mol B. The two complexes are superimposed based on the core β -sheet of their RuvC domains. The HNH domain and bound sgRNA:DNA are omitted for clarity. (C) Superimposition of the bound sgRNA:DNA in Mol A and Mol B. After superimposition of the two complexes as in (B), the Cas9 proteins are omitted to show the sgRNA:DNA. (D) Molecular surface of Cas9. The HNH domain and bound sgRNA:DNA complex are omitted for clarity. Note that there is no direct contact between the REC and NUC lobes, except for the interactions between the $\alpha 2$ - $\alpha 3$ loop and $\beta 17$ - $\beta 18$ loop.

[0050] **Figure 14** shows a Model of RNA-guided DNA cleavage by Cas9.

[0051] Figure 15 shows Electron density map. The $2mF_o - DF_c$ electron density map around the three-way junction is shown as a gray mesh (contoured at 2.5σ).

[0052] Figure 16A-C shows Di-cysteine mutant (C80L/C574E) is functional in HEK 293FT cells. (A) Schematic illustrating positions of cysteine mutations (C80L and C574E) in Cas9. (B) Sequence of the target site used to test the function of the C80L/C574E mutant of Cas9. (C) SURVEYOR nuclease assay showing indels generated by either the wild-type or C80L/C574E mutant ($n = 3$).

[0053] Figure 17 shows a schematic drawing of the secondary structural elements of Cas9.

[0054] Figure 18A-B shows the sequence alignment of Cas9 orthologs in families II-A and II-C. The catalytic residues are shown in red triangles. Critical arginine residues on Bridge helix are shown in green triangles. The secondary structure of *S. pyogenes* Cas9 is shown above the sequences. The figure was prepared using Toffee (Notredame et al., 2000) and ESPript (Gouet et al., 1999). Sp, *S. pyogenes*; Sm, *Streptococcus mutans*; St3, *Streptococcus thermophilus* CRISPR-3; St1, *Streptococcus thermophilus* CRISPR-1; Cj, *Campylobacter jejuni*; Mm; *Neisseria meningitidis*.

[0055] Figure 19 shows the sequence alignment of Cas9 orthologs in families II-A, II-B and II-C. 35 Cas9 orthologs from families IIA, IIB and IIC are aligned (BLOSUM62) and clustered (Jukes-Cantor model Neighbor-Joining method, with *S. pyogenes* Cas9 as outgroup). Bars on top show conservation by amino acid. In each line, black bars show residues with at least 75% consensus, and gray bars non-conserved residues.

[0056] Figure 20 shows the comparison of the sgRNA:DNA heteroduplex with a canonical A-form RNA duplex. The sgRNA:DNA heteroduplex are superimposed on an A-form RNA duplex based on their phosphorus atoms. The A-form RNA duplex is colored dark gray. Nucleotides 51–97 of the sgRNA are omitted for clarity.

[0057] The figures herein are for illustrative purposes only and are not necessarily drawn to scale.

DETAILED DESCRIPTION OF THE INVENTION

[0058] With respect to general information on CRISPR-Cas Systems, components thereof, and delivery of such components, including methods, materials, delivery vehicles, vectors, particles, AAV, and making and using thereof, including as to amounts and formulations, all

useful in the practice of the instant invention, reference is made to: US Patents Nos. 8,697,359, 8,771,945, 8,795,965, 8,865,406, 8,871,445, 8,889,356, 8,889,418 and 8,895,308; US Patent Publications US 2014-0310830 (US APP. Ser. No. 14/105,031), US 2014-0287938 A1 (U.S. App. Ser. No. 14/213,991), US 2014-0273234 A1 (U.S. App. Ser. No. 14/293,674), US2014-0273232 A1 (U.S. App. Ser. No. 14/290,575), US 2014-0273231 (U.S. App. Ser. No. 14/259,420), US 2014-0256046 A1 (U.S. App. Ser. No. 14/226,274), US 2014-0248702 A1 (U.S. App. Ser. No. 14/258,458), US 2014-0242700 A1 (U.S. App. Ser. No. 14/222,930), US 2014-0242699 A1 (U.S. App. Ser. No. 14/183,512), US 2014-0242664 A1 (U.S. App. Ser. No. 14/104,990), US 2014-0234972 A1 (U.S. App. Ser. No. 14/183,471), US 2014-0227787 A1 (U.S. App. Ser. No. 14/256,912), US 2014-0189896 A1 (U.S. App. Ser. No. 14/105,035), US 2014-0186958 (U.S. App. Ser. No. 14/105,017), US 2014-0186919 A1 (U.S. App. Ser. No. 14/104,977), US 2014-0186843 A1 (U.S. App. Ser. No. 14/104,900), US 2014-0179770 A1 (U.S. App. Ser. No. 14/104,837) and US 2014-0179006 A1 (U.S. App. Ser. No. 14/183,486), US 2014-0170753 (US App Ser No 14/183,429); European Patent Applications EP 2 771 468 (EP13818570.7), EP 2 764 103 (EP13824232.6), and EP 2 784 162 (EP14170383.5); and PCT Patent Publications WO 2014/093661 (PCT/US2013/074743), WO 2014/093694 (PCT/US2013/074790), WO 2014/093595 (PCT/US2013/074611), WO 2014/093718 (PCT/US2013/074825), WO 2014/093709 (PCT/US2013/074812), WO 2014/093622 (PCT/US2013/074667), WO 2014/093635 (PCT/US2013/074691), WO 2014/093655 (PCT/US2013/074736), WO 2014/093712 (PCT/US2013/074819), WO2014/093701 (PCT/US2013/074800), and WO2014/018423 (PCT/US2013/051418). Reference is also made to US provisional patent applications 61/758,468; 61/802,174; 61/806,375; 61/814,263; 61/819,803 and 61/828,130, filed on January 30, 2013; March 15, 2013; March 28, 2013; April 20, 2013; May 6, 2013 and May 28, 2013 respectively. Reference is also made to US provisional patent application 61/836,123, filed on June 17, 2013. Reference is additionally made to US provisional patent applications 61/835,931, 61/835,936, 61/836,127, 61/836, 101, 61/836,080 and 61/835,973, each filed June 17, 2013. Further reference is made to US provisional patent applications 61/862,468 and 61/862,355 filed on August 5, 2013; 61/871,301 filed on August 28, 2013; 61/960,777 filed on September 25, 2013 and 61/961,980 filed on October 28, 2013. Reference is yet further made to: PCT Patent applications Nos: PCT/US2014/041803, PCT/US2014/041800, PCT/US2014/041809, PCT/US2014/041804 and PCT/US2014/041806,

each filed June 10, 2014 6/10/14; PCT/US2014/041808 filed June 11, 2014; and PCT/US2014/62558 filed October 28, 2014, and US Provisional Patent Applications Serial Nos.: 61/915,150, 61/915,301, 61/915,267 and 61/915,260, each filed December 12, 2013; 61/757,972 and 61/768,959, filed on January 29, 2013 and February 25, 2013; 61/835,936, 61/836,127, 61/836,101, 61/836,080, 61/835,973, and 61/835,931, filed June 17, 2013; 62/010,888 and 62/010,879, both filed June 11, 2014; 62/010,329 and 62/010,441, each filed June 10, 2014; 61/939,228 and 61/939,242, each filed February 12, 2014; 61/980,012, filed April 15, 2014; 62/038,358, filed August 17, 2014; 62/054,490, 62/055,484, 62/055,460 and 62/055,487, each filed September 25, 2014; and 62/069,243, filed October 27, 2014. Each of these patents, patent publications, and applications, and all documents cited therein or during their prosecution (“appln cited documents”) and all documents cited or referenced in the appln cited documents, together with any instructions, descriptions, product specifications, and product sheets for any products mentioned therein or in any document therein and incorporated by reference herein, are hereby incorporated herein by reference, and may be employed in the practice of the invention. All documents (e.g., these patents, patent publications and applications and the appln cited documents) are incorporated herein by reference to the same extent as if each individual document was specifically and individually indicated to be incorporated by reference.

[0059] Also with respect to general information on CRISPR-Cas Systems, mention is made of:

- *Multiplex genome engineering using CRISPR/Cas systems.* Cong, L., Ran, F.A., Cox, D., Lin, S., Barretto, R., Habib, N., Hsu, P.D., Wu, X., Jiang, W., Marraffini, L.A., & Zhang, F. *Science* Feb 15;339(6121):819-23 (2013);
- *RNA-guided editing of bacterial genomes using CRISPR-Cas systems.* Jiang W., Bikard D., Cox D., Zhang F, Marraffini LA. *Nat Biotechnol* Mar;31(3):233-9 (2013);
- *One-Step Generation of Mice Carrying Mutations in Multiple Genes by CRISPR/Cas-Mediated Genome Engineering.* Wang H., Yang H., Shivalila CS., Dawlaty MM., Cheng AW., Zhang F., Jaenisch R. *Cell* May 9;153(4):910-8 (2013);
- *Optical control of mammalian endogenous transcription and epigenetic states.* Konermann S, Brigham MD, Trevino AE, Hsu PD, Heidenreich M, Cong L, Platt RJ, Scott DA, Church GM, Zhang F. *Nature*. 2013 Aug 22;500(7463):472-6. doi: 10.1038/Nature12466. Epub 2013 Aug 23;

- *Double Nicking by RNA-Guided CRISPR Cas9 for Enhanced Genome Editing Specificity.* Ran, FA., Hsu, PD., Lin, CY., Gootenberg, JS., Konermann, S., Trevino, AE., Scott, DA., Inoue, A., Matoba, S., Zhang, Y., & Zhang, F. *Cell* Aug 28. pii: S0092-8674(13)01015-5. (2013);
- *DNA targeting specificity of RNA-guided Cas9 nucleases.* Hsu, P., Scott, D., Weinstein, J., Ran, FA., Konermann, S., Agarwala, V., Li, Y., Fine, E., Wu, X., Shalem, O., Cradick, TJ., Marraffini, LA., Bao, G., & Zhang, F. *Nat Biotechnol* doi:10.1038/nbt.2647 (2013);
- *Genome engineering using the CRISPR-Cas9 system.* Ran, FA., Hsu, PD., Wright, J., Agarwala, V., Scott, DA., Zhang, F. *Nature Protocols* Nov;8(11):2281-308. (2013);
- *Genome-Scale CRISPR-Cas9 Knockout Screening in Human Cells.* Shalem, O., Sanjana, NE., Hartenian, E., Shi, X., Scott, DA., Mikkelsen, T., Heckl, D., Ebert, BL., Root, DE., Doench, JG., Zhang, F. *Science* Dec 12. (2013). [Epub ahead of print];
- *Crystal structure of cas9 in complex with guide RNA and target DNA.* Nishimasu, H., Ran, FA., Hsu, PD., Konermann, S., Shehata, SI., Dohmae, N., Ishitani, R., Zhang, F., Nureki, O. *Cell* Feb 27. (2014). 156(5):935-49;
- *Genome-wide binding of the CRISPR endonuclease Cas9 in mammalian cells.* Wu X., Scott DA., Kriz AJ., Chiu AC., Hsu PD., Dadon DB., Cheng AW., Trevino AE., Konermann S., Chen S., Jaenisch R., Zhang F., Sharp PA. *Nat Biotechnol.* (2014) Apr 20. doi: 10.1038/nbt.2889,
- *CRISPR-Cas9 Knockin Mice for Genome Editing and Cancer Modeling,* Platt et al., *Cell* 159(2): 440-455 (2014) DOI: 10.1016/j.cell.2014.09.014,
- *Development and Applications of CRISPR-Cas9 for Genome Engineering,* Hsu et al, *Cell* 157, 1262-1278 (June 5, 2014) (Hsu 2014),
- *Genetic screens in human cells using the CRISPR/Cas9 system,* Wang et al., *Science.* 2014 January 3; 343(6166): 80–84. doi:10.1126/science.1246981,
- *Rational design of highly active sgrNAs for CRISPR-Cas9-mediated gene inactivation,* Doench et al., *Nature Biotechnology* published online 3 September 2014; doi:10.1038/nbt.3026, and
- *In vivo interrogation of gene function in the mammalian brain using CRISPR-Cas9,* Swiech et al, *Nature Biotechnology* ; published online 19 October 2014; doi:10.1038/nbt.3055.

each of which is incorporated herein by reference, and discussed briefly below:

- Cong *et al.* engineered type II CRISPR-Cas systems for use in eukaryotic cells based on both *Streptococcus thermophilus* Cas9 and also *Streptococcus pyogenes* Cas9 and demonstrated that Cas9 nucleases can be directed by short RNAs to induce precise cleavage of DNA in human and mouse cells. Their study further showed that Cas9 as converted into a nicking enzyme can be used to facilitate homology-directed repair in eukaryotic cells with minimal mutagenic activity. Additionally, their study demonstrated that multiple guide sequences can be encoded into a single CRISPR array to enable simultaneous editing of several at endogenous genomic loci sites within the mammalian genome, demonstrating easy programmability and wide applicability of the RNA-guided nuclease technology. This ability to use RNA to program sequence specific DNA cleavage in cells defined a new class of genome engineering tools. These studies further showed that other CRISPR loci are likely to be transplantable into mammalian cells and can also mediate mammalian genome cleavage. Importantly, it can be envisaged that several aspects of the CRISPR-Cas system can be further improved to increase its efficiency and versatility.
- Jiang *et al.* used the clustered, regularly interspaced, short palindromic repeats (CRISPR)-associated Cas9 endonuclease complexed with dual-RNAs to introduce precise mutations in the genomes of *Streptococcus pneumoniae* and *Escherichia coli*. The approach relied on dual-RNA:Cas9-directed cleavage at the targeted genomic site to kill unmutated cells and circumvents the need for selectable markers or counter-selection systems. The study reported reprogramming dual-RNA:Cas9 specificity by changing the sequence of short CRISPR RNA (crRNA) to make single- and multinucleotide changes carried on editing templates. The study showed that simultaneous use of two crRNAs enabled multiplex mutagenesis. Furthermore, when the approach was used in combination with recombineering, in *S. pneumoniae*, nearly 100% of cells that were recovered using the described approach contained the desired mutation, and in *E. coli*, 65% that were recovered contained the mutation.
- Konermann *et al.* addressed the need in the art for versatile and robust technologies that enable optical and chemical modulation of DNA-binding domains based CRISPR Cas9 enzyme and also Transcriptional Activator Like Effectors

- As discussed in the present specification, the Cas9 nuclease from the microbial CRISPR-Cas system is targeted to specific genomic loci by a 20 nt guide sequence, which can tolerate certain mismatches to the DNA target and thereby promote undesired off-target mutagenesis. To address this, Ran *et al.* described an approach that combined a Cas9 nickase mutant with paired guide RNAs to introduce targeted double-strand breaks. Because individual nicks in the genome are repaired with high fidelity, simultaneous nicking *via* appropriately offset guide RNAs is required for double-stranded breaks and extends the number of specifically recognized bases for target cleavage. The authors demonstrated that using paired nicking can reduce off-target activity by 50- to 1,500-fold in cell lines and to facilitate gene knockout in mouse zygotes without sacrificing on-target cleavage efficiency. This versatile strategy enables a wide variety of genome editing applications that require high specificity.
- Hsu *et al.* characterized SpCas9 targeting specificity in human cells to inform the selection of target sites and avoid off-target effects. The study evaluated >700 guide RNA variants and SpCas9-induced indel mutation levels at >100 predicted genomic off-target loci in 293T and 293FT cells. The authors show that SpCas9 tolerates mismatches between guide RNA and target DNA at different positions in a sequence-dependent manner, sensitive to the number, position and distribution of mismatches. The authors further showed that SpCas9-mediated cleavage is unaffected by DNA methylation and that the dosage of SpCas9 and sgRNA can be titrated to minimize off-target modification. Additionally, to facilitate mammalian genome engineering applications, the authors reported providing a web-based software tool to guide the selection and validation of target sequences as well as off-target analyses.
- Ran *et al.* described a set of tools for Cas9-mediated genome editing *via* non-homologous end joining (NHEJ) or homology-directed repair (HDR) in mammalian cells, as well as generation of modified cell lines for downstream functional studies. To minimize off-target cleavage, the authors further described a double-nicking strategy using the Cas9 nickase mutant with paired guide RNAs. The protocol provided by the authors experimentally derived guidelines for the selection of target sites, evaluation of cleavage efficiency and analysis of off-target activity. The studies showed that beginning with

target design, gene modifications can be achieved within as little as 1–2 weeks, and modified clonal cell lines can be derived within 2–3 weeks.

- Shalem *et al.* described a new way to interrogate gene function on a genome-wide scale. Their studies showed that delivery of a genome-scale CRISPR-Cas9 knockout (GeCKO) library targeted 18,080 genes with 64,751 unique guide sequences enabled both negative and positive selection screening in human cells. First, the authors showed use of the GeCKO library to identify genes essential for cell viability in cancer and pluripotent stem cells. Next, in a melanoma model, the authors screened for genes whose loss is involved in resistance to vemurafenib, a therapeutic that inhibits mutant protein kinase BRAF. Their studies showed that the highest-ranking candidates included previously validated genes NF1 and MED12 as well as novel hits NF2, CUL3, TADA2B, and TADA1. The authors observed a high level of consistency between independent guide RNAs targeting the same gene and a high rate of hit confirmation, and thus demonstrated the promise of genome-scale screening with Cas9.
- Nishimasu *et al.* reported the crystal structure of *Streptococcus pyogenes* Cas9 in complex with sgRNA and its target DNA at 2.5 Å resolution. The structure revealed a bilobed architecture composed of target recognition and nuclease lobes, accommodating the sgRNA:DNA heteroduplex in a positively charged groove at their interface. Whereas the recognition lobe is essential for binding sgRNA and DNA, the nuclease lobe contains the HNH and RuvC nuclease domains, which are properly positioned for cleavage of the complementary and non-complementary strands of the target DNA, respectively. The nuclease lobe also contains a carboxyl-terminal domain responsible for the interaction with the protospacer adjacent motif (PAM). This high-resolution structure and accompanying functional analyses have revealed the molecular mechanism of RNA-guided DNA targeting by Cas9, thus paving the way for the rational design of new, versatile genome-editing technologies.
- Wu *et al.* mapped genome-wide binding sites of a catalytically inactive Cas9 (dCas9) from *Streptococcus pyogenes* loaded with single guide RNAs (sgRNAs) in mouse embryonic stem cells (mESCs). The authors showed that each of the four sgRNAs tested targets dCas9 to between tens and thousands of genomic sites, frequently characterized by a 5-nucleotide seed region in the sgRNA and an NGG protospacer adjacent motif

(PAM). Chromatin inaccessibility decreases dCas9 binding to other sites with matching seed sequences; thus 70% of off-target sites are associated with genes. The authors showed that targeted sequencing of 295 dCas9 binding sites in mESCs transfected with catalytically active Cas9 identified only one site mutated above background levels. The authors proposed a two-state model for Cas9 binding and cleavage, in which a seed match triggers binding but extensive pairing with target DNA is required for cleavage.

- Hsu 2014 is a review article that discusses generally CRISPR-Cas9 history from yogurt to genome editing, including genetic screening of cells, that is in the information, data and findings of the applications in the lineage of this specification filed prior to June 5, 2014. The general teachings of Hsu 2014 do not involve the specific models, animals of the instant specification.

[0060] In general, the CRISPR-Cas or CRISPR system is as used in the foregoing documents, such as WO 2014/093622 (PCT/US2013/074667) and refers collectively to transcripts and other elements involved in the expression of or directing the activity of CRISPR-associated (“Cas”) genes, including sequences encoding a Cas gene, a tracr (trans-activating CRISPR) sequence (e.g. tracrRNA or an active partial tracrRNA), a tracr-mate sequence (encompassing a “direct repeat” and a tracrRNA-processed partial direct repeat in the context of an endogenous CRISPR system), a guide sequence (also referred to as a “spacer” in the context of an endogenous CRISPR system), or “RNA(s)” as that term is herein used (e.g., RNA(s) to guide Cas9, e.g. CRISPR RNA and transactivating (tracr) RNA or a single guide RNA (sgRNA) (chimeric RNA)) or other sequences and transcripts from a CRISPR locus. In general, a CRISPR system is characterized by elements that promote the formation of a CRISPR complex at the site of a target sequence (also referred to as a protospacer in the context of an endogenous CRISPR system). In the context of formation of a CRISPR complex, “target sequence” refers to a sequence to which a guide sequence is designed to have complementarity, where hybridization between a target sequence and a guide sequence promotes the formation of a CRISPR complex. A target sequence may comprise any polynucleotide, such as DNA or RNA polynucleotides. In some embodiments, a target sequence is located in the nucleus or cytoplasm of a cell. In some embodiments, direct repeats may be identified *in silico* by searching for repetitive motifs that fulfill any or all of the following criteria: 1. found in a 2Kb window of genomic sequence flanking the type II CRISPR locus; 2. span from 20 to 50 bp; and 3. interspaced by 20 to 50 bp.

In some embodiments, 2 of these criteria may be used, for instance 1 and 2, 2 and 3, or 1 and 3. In some embodiments, all 3 criteria may be used. In some embodiments it may be preferred in a CRISPR complex that the tracr sequence has one or more hairpins and is 30 or more nucleotides in length, 40 or more nucleotides in length, or 50 or more nucleotides in length; the guide sequence is between 10 to 30 nucleotides in length, the CRISPR/Cas enzyme is a Type II Cas9 enzyme.

[0061] In embodiments of the invention the terms guide sequence and guide RNA are used interchangeably as in foregoing cited documents such as WO 2014/093622 (PCT/US2013/074667). In general, a guide sequence is any polynucleotide sequence having sufficient complementarity with a target polynucleotide sequence to hybridize with the target sequence and direct sequence-specific binding of a CRISPR complex to the target sequence. In some embodiments, the degree of complementarity between a guide sequence and its corresponding target sequence, when optimally aligned using a suitable alignment algorithm, is about or more than about 50%, 60%, 75%, 80%, 85%, 90%, 95%, 97.5%, 99%, or more. Optimal alignment may be determined with the use of any suitable algorithm for aligning sequences, non-limiting example of which include the Smith-Waterman algorithm, the Needleman-Wunsch algorithm, algorithms based on the Burrows-Wheeler Transform (e.g. the Burrows Wheeler Aligner), ClustalW, Clustal X, BLAT, Novoalign (Novocraft Technologies; available at www.novocraft.com), ELAND (Illumina, San Diego, CA), SOAP (available at soap.genomics.org.cn), and Maq (available at maq.sourceforge.net). In some embodiments, a guide sequence is about or more than about 5, 10, 11, 12, 13, 14, 15, 16, 17, 18, 19, 20, 21, 22, 23, 24, 25, 26, 27, 28, 29, 30, 35, 40, 45, 50, 75, or more nucleotides in length. In some embodiments, a guide sequence is less than about 75, 50, 45, 40, 35, 30, 25, 20, 15, 12, or fewer nucleotides in length. The ability of a guide sequence to direct sequence-specific binding of a CRISPR complex to a target sequence may be assessed by any suitable assay. For example, the components of a CRISPR system sufficient to form a CRISPR complex, including the guide sequence to be tested, may be provided to a host cell having the corresponding target sequence, such as by transfection with vectors encoding the components of the CRISPR sequence, followed by an assessment of preferential cleavage within the target sequence, such as by Surveyor assay as described herein. Similarly, cleavage of a target polynucleotide sequence may be evaluated in a test tube by providing the target sequence, components of a CRISPR complex, including the

guide sequence to be tested and a control guide sequence different from the test guide sequence, and comparing binding or rate of cleavage at the target sequence between the test and control guide sequence reactions. Other assays are possible, and will occur to those skilled in the art.

[0062] A guide sequence may be selected to target any target sequence. In some embodiments, the target sequence is a sequence within a genome of a cell. Exemplary target sequences include those that are unique in the target genome. In some embodiments, a guide sequence is selected to reduce the degree secondary structure within the guide sequence. In some embodiments, about or less than about 75%, 50%, 40%, 30%, 25%, 20%, 15%, 10%, 5%, 1%, or fewer of the nucleotides of the guide sequence participate in self-complementary base pairing when optimally folded. Optimal folding may be determined by any suitable polynucleotide folding algorithm. Some programs are based on calculating the minimal Gibbs free energy. An example of one such algorithm is mFold, as described by Zuker and Stiegler (Nucleic Acids Res. 9 (1981), 133-148). Another example folding algorithm is the online webserver RNAfold, developed at Institute for Theoretical Chemistry at the University of Vienna, using the centroid structure prediction algorithm (see e.g. A.R. Gruber *et al.*, 2008, *Cell* 106(1): 23-24; and PA Carr and GM Church, 2009, *Nature Biotechnology* 27(12): 1151-62).

[0063] In general, a tracr mate sequence includes any sequence that has sufficient complementarity with a tracr sequence to promote one or more of: (1) excision of a guide sequence flanked by tracr mate sequences in a cell containing the corresponding tracr sequence; and (2) formation of a CRISPR complex at a target sequence, wherein the CRISPR complex comprises the tracr mate sequence hybridized to the tracr sequence. In general, degree of complementarity is with reference to the optimal alignment of the tracr mate sequence and tracr sequence, along the length of the shorter of the two sequences. Optimal alignment may be determined by any suitable alignment algorithm, and may further account for secondary structures, such as self-complementarity within either the tracr sequence or tracr mate sequence. In some embodiments, the degree of complementarity between the tracr sequence and tracr mate sequence along the length of the shorter of the two when optimally aligned is about or more than about 25%, 30%, 40%, 50%, 60%, 70%, 80%, 90%, 95%, 97.5%, 99%, or higher. In some embodiments, the tracr sequence is about or more than about 5, 6, 7, 8, 9, 10, 11, 12, 13, 14, 15, 16, 17, 18, 19, 20, 25, 30, 40, 50, or more nucleotides in length. In some embodiments, the tracr sequence and tracr mate sequence are contained within a single transcript, such that hybridization

between the two produces a transcript having a secondary structure, such as a hairpin. In an embodiment of the invention, the transcript or transcribed polynucleotide sequence has at least two or more hairpins. In preferred embodiments, the transcript has two, three, four or five hairpins. In a further embodiment of the invention, the transcript has at most five hairpins. In a hairpin structure the portion of the sequence 5' of the final "N" and upstream of the loop corresponds to the tracr mate sequence, and the portion of the sequence 3' of the loop corresponds to the tracr sequence. Further non-limiting examples of single polynucleotides comprising a guide sequence, a tracr mate sequence, and a tracr sequence are as follows (listed 5' to 3'), where "N" represents a base of a guide sequence, the first block of lower case letters represent the tracr mate sequence, and the second block of lower case letters represent the tracr sequence, and the final poly-T sequence represents the transcription terminator: (1) NNNNNNNNNNNNNNNNNNNNNNNNNggttttgactctcaagatttaGAAAtaatcttgcagaagctacaaagataa ggcttcatgccgaaatcaacaccctgcattttatggcaggggtgtttcgttatttaaTTTTTT; (2) NNNNNNNNNNNNNNNNNNNNNNNNggttttgactctcaGAAAtgcagaagctacaaagataaggcttcatgccg aaatcaacaccctgcattttatggcaggggtgtttcgttatttaaTTTTTT; (3) NNNNNNNNNNNNNNNNNNNNNNNNggttttgactctcaGAAAtgcagaagctacaaagataaggcttcatgccg aaatcaacaccctgcattttatggcaggggtgtTTTTTT; (4) NNNNNNNNNNNNNNNNNNNNNNNNggttttagagctaGAAAtagcaagttaaataaggctagtcggttatcaactt gaaaaagtggcaccgagtcggtgcTTTTTT; (5) NNNNNNNNNNNNNNNNNNNNNNNNggttttagagctaGAAATAGcaagttaaataaggctagtcggttatcaac ttgaaaaagtgtTTTTTT; and (6) NNNNNNNNNNNNNNNNNNNNNNNNggttttagagctagAAATAGcaagttaaataaggctagtcggttatcaTT TTTTTT. In some embodiments, sequences (1) to (3) are used in combination with Cas9 from *S. thermophilus* CRISPR1. In some embodiments, sequences (4) to (6) are used in combination with Cas9 from *S. pyogenes*. In some embodiments, the tracr sequence is a separate transcript from a transcript comprising the tracr mate sequence.

[0064] In some embodiments, candidate tracrRNA may be subsequently predicted by sequences that fulfill any or all of the following criteria: 1. sequence homology to direct repeats (motif search in Geneious with up to 18-bp mismatches); 2. presence of a predicted Rho-independent transcriptional terminator in direction of transcription; and 3. stable hairpin secondary structure between tracrRNA and direct repeat. In some embodiments, 2 of these

criteria may be used, for instance 1 and 2, 2 and 3, or 1 and 3. In some embodiments, all 3 criteria may be used.

[0065] In some embodiments, chimeric synthetic guide RNAs (sgRNAs) designs may incorporate at least 12 bp of duplex structure between the direct repeat and tracrRNA.

[0066] For minimization of toxicity and off-target effect, it will be important to control the concentration of CRISPR enzyme mRNA and guide RNA delivered. Optimal concentrations of CRISPR enzyme mRNA and guide RNA can be determined by testing different concentrations in a cellular or non-human eukaryote animal model and using deep sequencing to analyze the extent of modification at potential off-target genomic loci. For example, for the guide sequence targeting 5'-GAGTCCGAGCAGAAGAAGAA-3' in the EMX1 gene of the human genome, deep sequencing can be used to assess the level of modification at the following two off-target loci, 1: 5'-GAGTCCTAGCAGGAGAAGAA-3' and 2: 5'-GAGTCTAAGCAGAAGAAGAA-3'. The concentration that gives the highest level of on-target modification while minimizing the level of off-target modification should be chosen for in vivo delivery. Alternatively, to minimize the level of toxicity and off-target effect, CRISPR enzyme nickase mRNA (for example *S. pyogenes* Cas9 with the D10A mutation) can be delivered with a pair of guide RNAs targeting a site of interest. The two guide RNAs need to be spaced as follows. Guide sequences and strategies to minimize toxicity and off-target effects can be as in WO 2014/093622 (PCT/US2013/074667).

[0067] The CRISPR system is derived advantageously from a type II CRISPR system. In some embodiments, one or more elements of a CRISPR system is derived from a particular organism comprising an endogenous CRISPR system, such as *Streptococcus pyogenes*. In preferred embodiments of the invention, the CRISPR system is a type II CRISPR system and the Cas enzyme is Cas9, which catalyzes DNA cleavage. Non-limiting examples of Cas proteins include Cas1, Cas1B, Cas2, Cas3, Cas4, Cas5, Cas6, Cas7, Cas8, Cas9 (also known as Csn1 and Csx12), Cas10, Csy1, Csy2, Csy3, Cse1, Cse2, Cse1, Csc2, Csa5, Csn2, Csm2, Csm3, Csm4, Csm5, Csm6, Cmr1, Cmr3, Cmr4, Cmr5, Cmr6, Csb1, Csb2, Csb3, Csx17, Csx14, Csx10, Csx16, CsaX, Csx3, Csx1, Csx15, Csf1, Csf2, Csf3, Csf4, homologues thereof, or modified versions thereof.

[0068] In some embodiments, the unmodified CRISPR enzyme has DNA cleavage activity, such as Cas9. In some embodiments, the CRISPR enzyme directs cleavage of one or both

strands at the location of a target sequence, such as within the target sequence and/or within the complement of the target sequence. In some embodiments, the CRISPR enzyme directs cleavage of one or both strands within about 1, 2, 3, 4, 5, 6, 7, 8, 9, 10, 15, 20, 25, 50, 100, 200, 500, or more base pairs from the first or last nucleotide of a target sequence. In some embodiments, a vector encodes a CRISPR enzyme that is mutated to with respect to a corresponding wild-type enzyme such that the mutated CRISPR enzyme lacks the ability to cleave one or both strands of a target polynucleotide containing a target sequence. For example, an aspartate-to-alanine substitution (D10A) in the RuvC I catalytic domain of Cas9 from *S. pyogenes* converts Cas9 from a nuclease that cleaves both strands to a nickase (cleaves a single strand). Other examples of mutations that render Cas9 a nickase include, without limitation, H840A, N854A, and N863A. As a further example, two or more catalytic domains of Cas9 (RuvC I, RuvC II, and RuvC III or the HNH domain) may be mutated to produce a mutated Cas9 substantially lacking all DNA cleavage activity. In some embodiments, a D10A mutation is combined with one or more of H840A, N854A, or N863A mutations to produce a Cas9 enzyme substantially lacking all DNA cleavage activity. In some embodiments, a CRISPR enzyme is considered to substantially lack all DNA cleavage activity when the DNA cleavage activity of the mutated enzyme is about no more than 25%, 10%, 5%, 1%, 0.1%, 0.01%, or less of the DNA cleavage activity of the non-mutated form of the enzyme; an example can be when the DNA cleavage activity of the mutated form is nil or negligible as compared with the non-mutated form. Where the enzyme is not SpCas9, mutations may be made at any or all residues corresponding to positions 10, 762, 840, 854, 863 and/or 986 of SpCas9 (which may be ascertained for instance by standard sequence comparison tools). In particular, any or all of the following mutations are preferred in SpCas9: D10A, E762A, H840A, N854A, N863A and/or D986A; as well as conservative substitution for any of the replacement amino acids is also envisaged. The same (or conservative substitutions of these mutations) at corresponding positions in other Cas9s are also preferred. Particularly preferred are D10 and H840 in SpCas9. However, in other Cas9s, residues corresponding to SpCas9 D10 and H840 are also preferred. Orthologs of SpCas9 can be used in the practice of the invention. A Cas enzyme may be identified Cas9 as this can refer to the general class of enzymes that share homology to the biggest nuclease with multiple nuclease domains from the type II CRISPR system. Most preferably, the Cas9 enzyme is from, or is derived from, spCas9 (*S. pyogenes* Cas9) or saCas9 (*S. aureus* Cas9). StCas9” refers to wild type Cas9 from *S.*

thermophilus, the protein sequence of which is given in the SwissProt database under accession number G3ECR1. Similarly, *S. pyogenes* Cas9 or spCas9 is included in SwissProt under accession number Q99ZW2. By derived, Applicants mean that the derived enzyme is largely based, in the sense of having a high degree of sequence homology with, a wildtype enzyme, but that it has been mutated (modified) in some way as described herein. It will be appreciated that the terms Cas and CRISPR enzyme are generally used herein interchangeably, unless otherwise apparent. As mentioned above, many of the residue numberings used herein refer to the Cas9 enzyme from the type II CRISPR locus in *Streptococcus pyogenes*. However, it will be appreciated that this invention includes many more Cas9s from other species of microbes, such as SpCas9, SaCa9, St1Cas9 and so forth. Enzymatic action by Cas9 derived from *Streptococcus pyogenes* or any closely related Cas9 generates double stranded breaks at target site sequences which hybridize to 20 nucleotides of the guide sequence and that have a protospacer-adjacent motif (PAM) sequence (examples include NGG/NRG or a PAM that can be determined as described herein) following the 20 nucleotides of the target sequence. CRISPR activity through Cas9 for site-specific DNA recognition and cleavage is defined by the guide sequence, the tracr sequence that hybridizes in part to the guide sequence and the PAM sequence. More aspects of the CRISPR system are described in Karginov and Hannon, The CRISPR system: small RNA-guided defence in bacteria and archaea, *Mole Cell* 2010, January 15; 37(1): 7. The type II CRISPR locus from *Streptococcus pyogenes* SF370, which contains a cluster of four genes Cas9, Cas1, Cas2, and Csn1, as well as two non-coding RNA elements, tracrRNA and a characteristic array of repetitive sequences (direct repeats) interspaced by short stretches of non-repetitive sequences (spacers, about 30bp each). In this system, targeted DNA double-strand break (DSB) is generated in four sequential steps. First, two non-coding RNAs, the pre-crRNA array and tracrRNA, are transcribed from the CRISPR locus. Second, tracrRNA hybridizes to the direct repeats of pre-crRNA, which is then processed into mature crRNAs containing individual spacer sequences. Third, the mature crRNA:tracrRNA complex directs Cas9 to the DNA target consisting of the protospacer and the corresponding PAM via heteroduplex formation between the spacer region of the crRNA and the protospacer DNA. Finally, Cas9 mediates cleavage of target DNA upstream of PAM to create a DSB within the protospacer. A pre-crRNA array consisting of a single spacer flanked by two direct repeats (DRs) is also encompassed by the term "tracr-mate sequences"). In certain embodiments, Cas9 may be constitutively present or

inducibly present or conditionally present or administered or delivered. Cas9 optimization may be used to enhance function or to develop new functions, one can generate chimeric Cas9 proteins. And Cas9 may be used as a generic DNA binding protein.

[0069] With respect to mutations of the CRISPR enzyme, when the enzyme is not SpCas9, mutations may be made at any or all residues corresponding to positions 10, 762, 840, 854, 863 and/or 986 of SpCas9 (which may be ascertained for instance by standard sequence comparison tools). In particular, any or all of the following mutations are preferred in SpCas9: D10A, E762A, H840A, N854A, N863A and/or D986A; as well as conservative substitution for any of the replacement amino acids is also envisaged. In an aspect the invention provides as to any or each or all embodiments herein-discussed wherein the CRISPR enzyme comprises at least one or more, or at least two or more mutations, wherein the at least one or more mutation or the at least two or more mutations is as to D10, E762, H840, N854, N863, or D986 according to SpCas9 protein, e.g., D10A, E762A, H840A, N854A, N863A and/or D986A as to SpCas9, or N580 according to SaCas9, e.g., N580A as to SaCas9, or any corresponding mutation(s) in a Cas9 of an ortholog to Sp or Sa, or the CRISPR enzyme comprises at least one mutation wherein at least H840 or N863A as to Sp Cas9 or N580A as to Sa Cas9 is mutated; e.g., wherein the CRISPR enzyme comprises H840A, or D10A and H840A, or D10A and N863A, according to SpCas9 protein, or any corresponding mutation(s) in a Cas9 of an ortholog to Sp protein or Sa protein.

[0070] Typically, in the context of an endogenous CRISPR system, formation of a CRISPR complex (comprising a guide sequence hybridized to a target sequence and complexed with one or more Cas proteins) results in cleavage of one or both strands in or near (e.g. within 1, 2, 3, 4, 5, 6, 7, 8, 9, 10, 20, 50, or more base pairs from) the target sequence. Without wishing to be bound by theory, the tracr sequence, which may comprise or consist of all or a portion of a wild-type tracr sequence (e.g. about or more than about 20, 26, 32, 45, 48, 54, 63, 67, 85, or more nucleotides of a wild-type tracr sequence), may also form part of a CRISPR complex, such as by hybridization along at least a portion of the tracr sequence to all or a portion of a tracr mate sequence that is operably linked to the guide sequence.

[0071] An example of a codon optimized sequence, is in this instance a sequence optimized for expression in a eukaryote, e.g., humans (i.e. being optimized for expression in humans), or for another eukaryote, animal or mammal as herein discussed; see, e.g., SaCas9 human codon optimized sequence in WO 2014/093622 (PCT/US2013/074667). Whilst this is preferred, it will

be appreciated that other examples are possible and codon optimization for a host species other than human, or for codon optimization for specific organs is known. In some embodiments, an enzyme coding sequence encoding a CRISPR enzyme is codon optimized for expression in particular cells, such as eukaryotic cells. The eukaryotic cells may be those of or derived from a particular organism, such as a mammal, including but not limited to human, or non-human eukaryote or animal or mammal as herein discussed, e.g., mouse, rat, rabbit, dog, livestock, or non-human mammal or primate. In some embodiments, processes for modifying the germ line genetic identity of human beings and/or processes for modifying the genetic identity of animals which are likely to cause them suffering without any substantial medical benefit to man or animal, and also animals resulting from such processes, may be excluded. In general, codon optimization refers to a process of modifying a nucleic acid sequence for enhanced expression in the host cells of interest by replacing at least one codon (e.g. about or more than about 1, 2, 3, 4, 5, 10, 15, 20, 25, 50, or more codons) of the native sequence with codons that are more frequently or most frequently used in the genes of that host cell while maintaining the native amino acid sequence. Various species exhibit particular bias for certain codons of a particular amino acid. Codon bias (differences in codon usage between organisms) often correlates with the efficiency of translation of messenger RNA (mRNA), which is in turn believed to be dependent on, among other things, the properties of the codons being translated and the availability of particular transfer RNA (tRNA) molecules. The predominance of selected tRNAs in a cell is generally a reflection of the codons used most frequently in peptide synthesis. Accordingly, genes can be tailored for optimal gene expression in a given organism based on codon optimization. Codon usage tables are readily available, for example, at the "Codon Usage Database" available at www.kazusa.or.jp/codon/ and these tables can be adapted in a number of ways. See Nakamura, Y., et al. "Codon usage tabulated from the international DNA sequence databases: status for the year 2000" *Nucl. Acids Res.* 28:292 (2000). Computer algorithms for codon optimizing a particular sequence for expression in a particular host cell are also available, such as Gene Forge (Aptagen; Jacobus, PA), are also available. In some embodiments, one or more codons (e.g. 1, 2, 3, 4, 5, 10, 15, 20, 25, 50, or more, or all codons) in a sequence encoding a CRISPR enzyme correspond to the most frequently used codon for a particular amino acid.

[0072] In some embodiments, a vector encodes a CRISPR enzyme comprising one or more nuclear localization sequences (NLSs), such as about or more than about 1, 2, 3, 4, 5, 6, 7, 8, 9,

10, or more NLSs. In some embodiments, the CRISPR enzyme comprises about or more than about 1, 2, 3, 4, 5, 6, 7, 8, 9, 10, or more NLSs at or near the amino-terminus, about or more than about 1, 2, 3, 4, 5, 6, 7, 8, 9, 10, or more NLSs at or near the carboxy-terminus, or a combination of these (e.g. zero or at least one or more NLS at the amino-terminus and zero or at one or more NLS at the carboxy terminus). When more than one NLS is present, each may be selected independently of the others, such that a single NLS may be present in more than one copy and/or in combination with one or more other NLSs present in one or more copies. In a preferred embodiment of the invention, the CRISPR enzyme comprises at most 6 NLSs. In some embodiments, an NLS is considered near the N- or C-terminus when the nearest amino acid of the NLS is within about 1, 2, 3, 4, 5, 10, 15, 20, 25, 30, 40, 50, or more amino acids along the polypeptide chain from the N- or C-terminus. Non-limiting examples of NLSs include an NLS sequence derived from: the NLS of the SV40 virus large T-antigen, having the amino acid sequence PKKKRKV; the NLS from nucleoplasmin (e.g. the nucleoplasmin bipartite NLS with the sequence KRPAATKKAGQAKKKK); the c-myc NLS having the amino acid sequence PAAKRVKLD or RQRRNELKRSP; the hRNPA1 M9 NLS having the sequence NQSSNFGPMKGGNFGGRSSGPYGGGGQYFAKPRNQGGY; the sequence RMRIZFKNKGKDTAELRRRRVEVSVELRKAKKDEQILKRRNV of the IBB domain from importin-alpha; the sequences VSRKRPRP and PPKKARED of the myoma T protein; the sequence POPKKKPL of human p53; the sequence SALIKKKKKMAP of mouse c-abl IV; the sequences DRLRR and PKQKKRK of the influenza virus NS1; the sequence RKLKKKIKKL of the Hepatitis virus delta antigen; the sequence REKKKFLKRR of the mouse Mx1 protein; the sequence KRKGDEVDGVDEVAKKKSKK of the human poly(ADP-ribose) polymerase; and the sequence RKCLQAGMNLEARKTKK of the steroid hormone receptors (human) glucocorticoid. In general, the one or more NLSs are of sufficient strength to drive accumulation of the CRISPR enzyme in a detectable amount in the nucleus of a eukaryotic cell. In general, strength of nuclear localization activity may derive from the number of NLSs in the CRISPR enzyme, the particular NLS(s) used, or a combination of these factors. Detection of accumulation in the nucleus may be performed by any suitable technique. For example, a detectable marker may be fused to the CRISPR enzyme, such that location within a cell may be visualized, such as in combination with a means for detecting the location of the nucleus (e.g. a stain specific for the nucleus such as DAPI). Cell nuclei may also be isolated from cells, the

contents of which may then be analyzed by any suitable process for detecting protein, such as immunohistochemistry, Western blot, or enzyme activity assay. Accumulation in the nucleus may also be determined indirectly, such as by an assay for the effect of CRISPR complex formation (e.g. assay for DNA cleavage or mutation at the target sequence, or assay for altered gene expression activity affected by CRISPR complex formation and/or CRISPR enzyme activity), as compared to a control not exposed to the CRISPR enzyme or complex, or exposed to a CRISPR enzyme lacking the one or more NLSs.

[0073] Aspects of the invention relate to the expression of the gene product being decreased or a template polynucleotide being further introduced into the DNA molecule encoding the gene product or an intervening sequence being excised precisely by allowing the two 5' overhangs to reanneal and ligate or the activity or function of the gene product being altered or the expression of the gene product being increased. In an embodiment of the invention, the gene product is a protein. sgRNA pairs creating 5' overhangs with less than 8bp overlap between the guide sequences (offset greater than -8 bp) were able to mediate detectable indel formation. Importantly, each guide used in these assays is able to efficiently induce indels when paired with wildtype Cas9, indicating that the relative positions of the guide pairs are the most important parameters in predicting double nicking activity. Since Cas9n and Cas9H840A nick opposite strands of DNA, substitution of Cas9n with Cas9H840A with a given sgRNA pair should have resulted in the inversion of the overhang type; but no indel formation is observed as with Cas9H840A indicating that Cas9H840A is a CRISPR enzyme substantially lacking all DNA cleavage activity (which is when the DNA cleavage activity of the mutated enzyme is about no more than 25%, 10%, 5%, 1%, 0.1%, 0.01%, or less of the DNA cleavage activity of the non-mutated form of the enzyme; whereby an example can be when the DNA cleavage activity of the mutated form is nil or negligible as compared with the non-mutated form, e.g., when no indel formation is observed as with Cas9H840A in the eukaryotic system in contrast to the biochemical or prokaryotic systems). Nonetheless, a pair of sgRNAs that will generate a 5' overhang with Cas9n should in principle generate the corresponding 3' overhang instead, and double nicking. Therefore, sgRNA pairs that lead to the generation of a 3' overhang with Cas9n can be used with another mutated Cas9 to generate a 5' overhang, and double nicking. Accordingly, in some embodiments, a recombination template is also provided. A recombination template may be a component of another vector as described herein, contained in a separate

vector, or provided as a separate polynucleotide. In some embodiments, a recombination template is designed to serve as a template in homologous recombination, such as within or near a target sequence nicked or cleaved by a CRISPR enzyme as a part of a CRISPR complex. A template polynucleotide may be of any suitable length, such as about or more than about 10, 15, 20, 25, 50, 75, 100, 150, 200, 500, 1000, or more nucleotides in length. In some embodiments, the template polynucleotide is complementary to a portion of a polynucleotide comprising the target sequence. When optimally aligned, a template polynucleotide might overlap with one or more nucleotides of a target sequences (e.g. about or more than about 1, 5, 10, 15, 20, or more nucleotides). In some embodiments, when a template sequence and a polynucleotide comprising a target sequence are optimally aligned, the nearest nucleotide of the template polynucleotide is within about 1, 5, 10, 15, 20, 25, 50, 75, 100, 200, 300, 400, 500, 1000, 5000, 10000, or more nucleotides from the target sequence.

[0074] In some embodiments, one or more vectors driving expression of one or more elements of a CRISPR system are introduced into a host cell such that expression of the elements of the CRISPR system direct formation of a CRISPR complex at one or more target sites. For example, a Cas enzyme, a guide sequence linked to a tracr-mate sequence, and a tracr sequence could each be operably linked to separate regulatory elements on separate vectors. Or, RNA(s) of the CRISPR System can be delivered to a transgenic Cas9 animal or mammal, e.g., an animal or mammal that constitutively or inducibly or conditionally expresses Cas9; or an animal or mammal that is otherwise expressing Cas9 or has cells containing Cas9, such as by way of prior administration thereto of a vector or vectors that code for and express *in vivo* Cas9. Alternatively, two or more of the elements expressed from the same or different regulatory elements, may be combined in a single vector, with one or more additional vectors providing any components of the CRISPR system not included in the first vector. CRISPR system elements that are combined in a single vector may be arranged in any suitable orientation, such as one element located 5' with respect to ("upstream" of) or 3' with respect to ("downstream" of) a second element. The coding sequence of one element may be located on the same or opposite strand of the coding sequence of a second element, and oriented in the same or opposite direction. In some embodiments, a single promoter drives expression of a transcript encoding a CRISPR enzyme and one or more of the guide sequence, tracr mate sequence (optionally operably linked to the guide sequence), and a tracr sequence embedded within one or more intron

sequences (e.g. each in a different intron, two or more in at least one intron, or all in a single intron). In some embodiments, the CRISPR enzyme, guide sequence, tracr mate sequence, and tracr sequence are operably linked to and expressed from the same promoter. Delivery vehicles, vectors, particles, nanoparticles, formulations and components thereof for expression of one or more elements of a CRISPR system are as used in the foregoing documents, such as WO 2014/093622 (PCT/US2013/074667). In some embodiments, a vector comprises one or more insertion sites, such as a restriction endonuclease recognition sequence (also referred to as a "cloning site"). In some embodiments, one or more insertion sites (e.g. about or more than about 1, 2, 3, 4, 5, 6, 7, 8, 9, 10, or more insertion sites) are located upstream and/or downstream of one or more sequence elements of one or more vectors. In some embodiments, a vector comprises an insertion site upstream of a tracr mate sequence, and optionally downstream of a regulatory element operably linked to the tracr mate sequence, such that following insertion of a guide sequence into the insertion site and upon expression the guide sequence directs sequence-specific binding of a CRISPR complex to a target sequence in a eukaryotic cell. In some embodiments, a vector comprises two or more insertion sites, each insertion site being located between two tracr mate sequences so as to allow insertion of a guide sequence at each site. In such an arrangement, the two or more guide sequences may comprise two or more copies of a single guide sequence, two or more different guide sequences, or combinations of these. When multiple different guide sequences are used, a single expression construct may be used to target CRISPR activity to multiple different, corresponding target sequences within a cell. For example, a single vector may comprise about or more than about 1, 2, 3, 4, 5, 6, 7, 8, 9, 10, 15, 20, or more guide sequences. In some embodiments, about or more than about 1, 2, 3, 4, 5, 6, 7, 8, 9, 10, or more such guide-sequence-containing vectors may be provided, and optionally delivered to a cell. In some embodiments, a vector comprises a regulatory element operably linked to an enzyme-coding sequence encoding a CRISPR enzyme, such as a Cas protein. CRISPR enzyme or CRISPR enzyme mRNA or CRISPR guide RNA or RNA(s) can be delivered separately; and advantageously at least one of these is delivered via a nanoparticle complex. CRISPR enzyme mRNA can be delivered prior to the guide RNA to give time for CRISPR enzyme to be expressed. CRISPR enzyme mRNA might be administered 1-12 hours (preferably around 2-6 hours) prior to the administration of guide RNA. Alternatively, CRISPR enzyme mRNA and guide RNA can be administered together. Advantageously, a second booster dose of guide RNA

can be administered 1-12 hours (preferably around 2-6 hours) after the initial administration of CRISPR enzyme mRNA + guide RNA. Additional administrations of CRISPR enzyme mRNA and/or guide RNA might be useful to achieve the most efficient levels of genome modification.

[0075] In one aspect, the invention provides methods for using one or more elements of a CRISPR system. The CRISPR complex of the invention provides an effective means for modifying a target polynucleotide. The CRISPR complex of the invention has a wide variety of utility including modifying (e.g., deleting, inserting, translocating, inactivating, activating) a target polynucleotide in a multiplicity of cell types. As such the CRISPR complex of the invention has a broad spectrum of applications in, e.g., gene therapy, drug screening, disease diagnosis, and prognosis. An exemplary CRISPR complex comprises a CRISPR enzyme complexed with a guide sequence hybridized to a target sequence within the target polynucleotide. The guide sequence is linked to a tracr mate sequence, which in turn hybridizes to a tracr sequence. In one embodiment, this invention provides a method of cleaving a target polynucleotide. The method comprises modifying a target polynucleotide using a CRISPR complex that binds to the target polynucleotide and effect cleavage of said target polynucleotide. Typically, the CRISPR complex of the invention, when introduced into a cell, creates a break (e.g., a single or a double strand break) in the genome sequence. For example, the method can be used to cleave a disease gene in a cell. The break created by the CRISPR complex can be repaired by a repair processes such as the error prone non-homologous end joining (NHEJ) pathway or the high fidelity homology-directed repair (HDR). During these repair process, an exogenous polynucleotide template can be introduced into the genome sequence. In some methods, the HDR process is used modify genome sequence. For example, an exogenous polynucleotide template comprising a sequence to be integrated flanked by an upstream sequence and a downstream sequence is introduced into a cell. The upstream and downstream sequences share sequence similarity with either side of the site of integration in the chromosome. Where desired, a donor polynucleotide can be DNA, e.g., a DNA plasmid, a bacterial artificial chromosome (BAC), a yeast artificial chromosome (YAC), a viral vector, a linear piece of DNA, a PCR fragment, a naked nucleic acid, or a nucleic acid complexed with a delivery vehicle such as a liposome or poloxamer. The exogenous polynucleotide template comprises a sequence to be integrated (e.g., a mutated gene). The sequence for integration may be a sequence endogenous or exogenous to the cell. Examples of a sequence to be integrated include polynucleotides

encoding a protein or a non-coding RNA (e.g., a microRNA). Thus, the sequence for integration may be operably linked to an appropriate control sequence or sequences. Alternatively, the sequence to be integrated may provide a regulatory function. The upstream and downstream sequences in the exogenous polynucleotide template are selected to promote recombination between the chromosomal sequence of interest and the donor polynucleotide. The upstream sequence is a nucleic acid sequence that shares sequence similarity with the genome sequence upstream of the targeted site for integration. Similarly, the downstream sequence is a nucleic acid sequence that shares sequence similarity with the chromosomal sequence downstream of the targeted site of integration. The upstream and downstream sequences in the exogenous polynucleotide template can have 75%, 80%, 85%, 90%, 95%, or 100% sequence identity with the targeted genome sequence. Preferably, the upstream and downstream sequences in the exogenous polynucleotide template have about 95%, 96%, 97%, 98%, 99%, or 100% sequence identity with the targeted genome sequence. In some methods, the upstream and downstream sequences in the exogenous polynucleotide template have about 99% or 100% sequence identity with the targeted genome sequence. An upstream or downstream sequence may comprise from about 20 bp to about 2500 bp, for example, about 50, 100, 200, 300, 400, 500, 600, 700, 800, 900, 1000, 1100, 1200, 1300, 1400, 1500, 1600, 1700, 1800, 1900, 2000, 2100, 2200, 2300, 2400, or 2500 bp. In some methods, the exemplary upstream or downstream sequence have about 200 bp to about 2000 bp, about 600 bp to about 1000 bp, or more particularly about 700 bp to about 1000 bp. In some methods, the exogenous polynucleotide template may further comprise a marker. Such a marker may make it easy to screen for targeted integrations. Examples of suitable markers include restriction sites, fluorescent proteins, or selectable markers. The exogenous polynucleotide template of the invention can be constructed using recombinant techniques (see, for example, Sambrook et al., 2001 and Ausubel et al., 1996). In a method for modifying a target polynucleotide by integrating an exogenous polynucleotide template, a double stranded break is introduced into the genome sequence by the CRISPR complex, the break is repaired via homologous recombination an exogenous polynucleotide template such that the template is integrated into the genome. The presence of a double-stranded break facilitates integration of the template. In other embodiments, this invention provides a method of modifying expression of a polynucleotide in a eukaryotic cell. The method comprises increasing or decreasing expression of a target polynucleotide by using a CRISPR complex that

binds to the polynucleotide. In some methods, a target polynucleotide can be inactivated to effect the modification of the expression in a cell. For example, upon the binding of a CRISPR complex to a target sequence in a cell, the target polynucleotide is inactivated such that the sequence is not transcribed, the coded protein is not produced, or the sequence does not function as the wild-type sequence does. For example, a protein or microRNA coding sequence may be inactivated such that the protein or microRNA or pre-microRNA transcript is not produced. In some methods, a control sequence can be inactivated such that it no longer functions as a control sequence. As used herein, "control sequence" refers to any nucleic acid sequence that effects the transcription, translation, or accessibility of a nucleic acid sequence. Examples of a control sequence include, a promoter, a transcription terminator, and an enhancer are control sequences. The target polynucleotide of a CRISPR complex can be any polynucleotide endogenous or exogenous to the eukaryotic cell. For example, the target polynucleotide can be a polynucleotide residing in the nucleus of the eukaryotic cell. The target polynucleotide can be a sequence coding a gene product (e.g., a protein) or a non-coding sequence (e.g., a regulatory polynucleotide or a junk DNA). Examples of target polynucleotides include a sequence associated with a signaling biochemical pathway, e.g., a signaling biochemical pathway-associated gene or polynucleotide. Examples of target polynucleotides include a disease associated gene or polynucleotide. A "disease-associated" gene or polynucleotide refers to any gene or polynucleotide which is yielding transcription or translation products at an abnormal level or in an abnormal form in cells derived from a disease-affected tissues compared with tissues or cells of a non disease control. It may be a gene that becomes expressed at an abnormally high level; it may be a gene that becomes expressed at an abnormally low level, where the altered expression correlates with the occurrence and/or progression of the disease. A disease-associated gene also refers to a gene possessing mutation(s) or genetic variation that is directly responsible or is in linkage disequilibrium with a gene(s) that is responsible for the etiology of a disease. The transcribed or translated products may be known or unknown, and may be at a normal or abnormal level. The target polynucleotide of a CRISPR complex can be any polynucleotide endogenous or exogenous to the eukaryotic cell. For example, the target polynucleotide can be a polynucleotide residing in the nucleus of the eukaryotic cell. The target polynucleotide can be a sequence coding a gene product (e.g., a protein) or a non-coding sequence (e.g., a regulatory polynucleotide or a junk DNA). Without wishing to be bound by

theory, it is believed that the target sequence should be associated with a PAM (protospacer adjacent motif); that is, a short sequence recognized by the CRISPR complex. The precise sequence and length requirements for the PAM differ depending on the CRISPR enzyme used, but PAMs are typically 2-5 base pair sequences adjacent the protospacer (that is, the target sequence). Examples of PAM sequences are given in the examples section below, and the skilled person will be able to identify further PAM sequences for use with a given CRISPR enzyme. In some embodiments, the method comprises allowing a CRISPR complex to bind to the target polynucleotide to effect cleavage of said target polynucleotide thereby modifying the target polynucleotide, wherein the CRISPR complex comprises a CRISPR enzyme complexed with a guide sequence hybridized to a target sequence within said target polynucleotide, wherein said guide sequence is linked to a tracr mate sequence which in turn hybridizes to a tracr sequence. In one aspect, the invention provides a method of modifying expression of a polynucleotide in a eukaryotic cell. In some embodiments, the method comprises allowing a CRISPR complex to bind to the polynucleotide such that said binding results in increased or decreased expression of said polynucleotide; wherein the CRISPR complex comprises a CRISPR enzyme complexed with a guide sequence hybridized to a target sequence within said polynucleotide, wherein said guide sequence is linked to a tracr mate sequence which in turn hybridizes to a tracr sequence. Similar considerations and conditions apply as above for methods of modifying a target polynucleotide. In fact, these sampling, culturing and re-introduction options apply across the aspects of the present invention. In one aspect, the invention provides for methods of modifying a target polynucleotide in a eukaryotic cell, which may be *in vivo*, *ex vivo* or *in vitro*. In some embodiments, the method comprises sampling a cell or population of cells from a human or non-human animal, and modifying the cell or cells. Culturing may occur at any stage *ex vivo*. The cell or cells may even be re-introduced into the non-human animal or plant. For re-introduced cells it is particularly preferred that the cells are stem cells.

[0076] Indeed, in any aspect of the invention, the CRISPR complex may comprise a CRISPR enzyme complexed with a guide sequence hybridized to a target sequence, wherein said guide sequence may be linked to a tracr mate sequence which in turn may hybridize to a tracr sequence.

[0077] The invention relates to the engineering and optimization of systems, methods and compositions used for the control of gene expression involving sequence targeting, such as

genome perturbation or gene-editing, that relate to the CRISPR-Cas system and components thereof. In advantageous embodiments, the Cas enzyme is Cas9. An advantage of the present methods is that the CRISPR system minimizes or avoids off-target binding and its resulting side effects. This is achieved using systems arranged to have a high degree of sequence specificity for the target DNA.

Crystallization of CRISPR-Cas9 and Crystal Structure

[0078] Crystallization of CRISPR-cas9 and Characterization of Crystal Structure: The crystals of the invention can be obtained by techniques of protein crystallography, including batch, liquid bridge, dialysis, vapor diffusion and hanging drop methods. Generally, the crystals of the invention are grown by dissolving substantially pure CRISPR-cas9 and a nucleic acid molecule to which it binds in an aqueous buffer containing a precipitant at a concentration just below that necessary to precipitate. Water is removed by controlled evaporation to produce precipitating conditions, which are maintained until crystal growth ceases.

[0079] Uses of the Crystals, Crystal Structure and Atomic Structure Co-Ordinates: The crystals of the invention, and particularly the atomic structure co-ordinates obtained therefrom, have a wide variety of uses. The crystals and structure co-ordinates are particularly useful for identifying compounds (nucleic acid molecules) that bind to CRISPR-cas9, and CRISPR-cas9s that can bind to particular compounds (nucleic acid molecules). Thus, the structure co-ordinates described herein can be used as phasing models in determining the crystal structures of additional synthetic or mutated CRISPR-cas9s, cas9s, nickases, binding domains. The provision of the crystal structure of CRISPR-cas9 complexed with a nucleic acid molecule as in the herein Crystal Structure Table and the Figures provide the skilled artisan with a detailed insight into the mechanisms of action of CRISPR-cas9. This insight provides a means to design modified CRISPR-cas9s, such as by attaching thereto a functional group, such as a repressor or activator. While one can attach a functional group such as a repressor or activator to the N or C terminal of CRISPR-cas9, the crystal structure demonstrates that the N terminal seems obscured or hidden, whereas the C terminal is more available for a functional group such as repressor or activator. Moreover, the crystal structure demonstrates that there is a flexible loop between approximately CRISPR-cas9 (*S. pyogenes*) residues 534-676 which is suitable for attachment of a functional group such as an activator or repressor. Attachment can be via a linker, e.g., a flexible glycine-serine (GlyGlyGlySer) or (GGGS)₃ or a rigid alpha-helical linker such as

(Ala(GluAlaAlaAlaLys)Ala). In addition to the flexible loop there is also a nuclease or H3 region, an H2 region and a helical region. By “helix” or “helical”, is meant a helix as known in the art, including, but not limited to an alpha-helix. Additionally, the term helix or helical may also be used to indicate a c-terminal helical element with an N-terminal turn.

[0080] The provision of the crystal structure of CRISPR-cas9 complexed with a nucleic acid molecule allows a novel approach for drug or compound discovery, identification, and design for compounds that can bind to CRISPR-cas9 and thus the invention provides tools useful in diagnosis, treatment, or prevention of conditions or diseases of multicellular organisms, e.g., algae, plants, invertebrates, fish, amphibians, reptiles, avians, mammals; for example domesticated plants, animals (e.g., production animals such as swine, bovine, chicken; companion animal such as felines, canines, rodents (rabbit, gerbil, hamster); laboratory animals such as mouse, rat), and humans. Accordingly, the invention provides a computer-based method of rational design of CRISPR-cas9 complexes. This rational design can comprise: providing the structure of the CRISPR-cas9 complex as defined by some or all (e.g., at least 2 or more, e.g., at least 5, advantageously at least 10, more advantageously at least 50 and even more advantageously at least 100 atoms of the structure) co-ordinates in the herein Crystal Structure Table and/or in Figure(s); providing a structure of a desired nucleic acid molecule as to which a CRISPR-cas9 complex is desired; and fitting the structure of the CRISPR-cas9 complex as defined by some or all co-ordinates in the herein Crystal Structure Table and/or in Figures to the desired nucleic acid molecule, including in said fitting obtaining putative modification(s) of the CRISPR-cas9 complex as defined by some or all co-ordinates in the herein Crystal Structure Table and/or in Figures for said desired nucleic acid molecule to bind for CRISPR-cas9 complex(es) involving the desired nucleic acid molecule. The method or fitting of the method may use the co-ordinates of atoms of interest of the CRISPR-cas9 complex as defined by some or all co-ordinates in the herein Crystal Structure Table and/or in Figures which are in the vicinity of the active site or binding region (e.g., at least 2 or more, e.g., at least 5, advantageously at least 10, more advantageously at least 50 and even more advantageously at least 100 atoms of the structure) in order to model the vicinity of the active site or binding region. These co-ordinates may be used to define a space which is then screened “in silico” against a desired or candidate nucleic acid molecule. Thus, the invention provides a computer-based method of rational design of CRISPR-cas9 complexes. This method may include:

providing the co-ordinates of at least two atoms of the herein Crystal Structure Table (“selected co-ordinates”); providing the structure of a candidate or desired nucleic acid molecule; and fitting the structure of the candidate to the selected co-ordinates. In this fashion, the skilled person may also fit a functional group and a candidate or desired nucleic acid molecule. For example, providing the structure of the CRISPR-cas9 complex as defined by some or all (e.g., at least 2 or more, e.g., at least 5, advantageously at least 10, more advantageously at least 50 and even more advantageously at least 100 atoms of the structure) co-ordinates in the herein Crystal Structure Table and/or in Figure(s); providing a structure of a desired nucleic acid molecule as to which a CRISPR-cas9 complex is desired; fitting the structure of the CRISPR-cas9 complex as defined by some or all co-ordinates in the herein Crystal Structure Table and/or in Figures to the desired nucleic acid molecule, including in said fitting obtaining putative modification(s) of the CRISPR-cas9 complex as defined by some or all co-ordinates in the herein Crystal Structure Table and/or in Figures for said desired nucleic acid molecule to bind for CRISPR-cas9 complex(es) involving the desired nucleic acid molecule; selecting putative fit CRISPR-cas9—desired nucleic acid molecule complex(es), fitting such putative fit CRISPR-cas9—desired nucleic acid molecule complex(es) to the functional group (e.g., activator, repressor), e.g., as to locations for situating the functional group (e.g., positions within the flexible loop) and/or putative modifications of the putative fit CRISPR-cas9—desired nucleic acid molecule complex(es) for creating locations for situating the functional group. As alluded to, the invention can be practiced using co-ordinates in the herein Crystal Structure Table and/or in Figures which are in the vicinity of the active site or binding region; and therefore, the methods of the invention can employ a sub-domain of interest of the CRISPR-cas9 complex. Methods of the invention can be practiced using coordinates of a domain or sub-domain. The methods can optionally include synthesizing the candidate or desired nucleic acid molecule and/or the CRISPR-cas9 systems from the “in silico” output and testing binding and/or activity of “wet” or actual a functional group linked to a “wet” or actual CRISPR-cas9 system bound to a “wet” or actual candidate or desired nucleic acid molecule. The methods can include synthesizing the CRISPR-cas9 systems (including a functional group) from the “in silico” output and testing binding and/or activity of “wet” or actual a functional group linked to a “wet” or actual CRISPR-cas9 system bound to an *in vivo* “wet” or actual candidate or desired nucleic acid molecule, e.g., contacting “wet” or actual CRISPR-cas9 system including a functional group from the “in silico” output with a cell

containing the desired or candidate nucleic acid molecule. These methods can include observing the cell or an organism containing the cell for a desired reaction, e.g., reduction of symptoms or condition or disease. The step of providing the structure of a candidate nucleic acid molecule may involve selecting the compound by computationally screening a database containing nucleic acid molecule data, e.g., such data as to conditions or diseases. A 3-D descriptor for binding of the candidate nucleic acid molecule may be derived from geometric and functional constraints derived from the architecture and chemical nature of the CRISPR-cas9 complex or domains or regions thereof from the herein crystal structure. In effect, the descriptor can be a type of virtual modification(s) of the CRISPR-cas9 complex crystal structure herein for binding CRISPR-cas9 to the candidate or desired nucleic acid molecule. The descriptor may then be used to interrogate the nucleic acid molecule database to ascertain those nucleic acid molecules of the database that have putatively good binding to the descriptor. The herein “wet” steps can then be performed using the descriptor and nucleic acid molecules that have putatively good binding.

[0081] “Fitting” can mean determining, by automatic or semi-automatic means, interactions between at least one atom of the candidate and at least one atom of the CRISPR-cas9 complex and calculating the extent to which such an interaction is stable. Interactions can include attraction, repulsion, brought about by charge, steric considerations, and the like. A “sub-domain” can mean at least one, e.g., one, two, three, or four, complete element(s) of secondary structure. Particular regions or domains of the CRISPR-cas9 include those identified in the herein Crystal Structure Table and the Figures.

[0082] In any event, the determination of the three-dimensional structure of CRISPR-cas 9 (*S. pyogenes* cas9) complex provides a basis for the design of new and specific nucleic acid molecules that bind to CRISPR-cas 9 (e.g., *S. pyogenes* cas9), as well as the design of new CRISPR-cas9 systems, such as by way of modification of the CRISPR-cas9 system to bind to various nucleic acid molecules, by way of modification of the CRISPR-cas9 system to have linked thereto to any one or more of various functional groups that may interact with each other, with the CRISPR-cas9 (e.g., an inducible system that provides for self-activation and/or self-termination of function), with the nucleic acid molecule nucleic acid molecules (e.g., the functional group may be a regulatory or functional domain which may be selected from the group consisting of a transcriptional repressor, a transcriptional activator, a nuclease domain, a DNA methyl transferase, a protein acetyltransferase, a protein deacetylase, a protein

methyltransferase, a protein deaminase, a protein kinase, and a protein phosphatase; and, in some aspects, the functional domain is an epigenetic regulator; see, e.g., Zhang et al., US Patent No. 8,507,272, and it is again mentioned that it and all documents cited herein and all appln cited documents are hereby incorporated herein by reference), by way of modification of cas9, by way of novel nickases). Indeed, the herewith CRISPR-cas9 (*S. pyogenes* cas9) crystal structure has a multitude of uses. For example, from knowing the three-dimensional structure of CRISPR-cas9 (*S. pyogenes* cas9) crystal structure, computer modelling programs may be used to design or identify different molecules expected to interact with possible or confirmed sites such as binding sites or other structural or functional features of the CRISPR-cas9 system (e.g., *S. pyogenes* cas9). Compound that potentially bind (“binder”) can be examined through the use of computer modeling using a docking program. Docking programs are known; for example GRAM, DOCK or AUTODOCK (see Walters et al. Drug Discovery Today, vol. 3, no. 4 (1998), 160-178, and Dunbrack et al. Folding and Design 2 (1997), 27-42). This procedure can include computer fitting of potential binders ascertain how well the shape and the chemical structure of the potential binder will bind to a CRISPR-cas9 system (e.g., *S. pyogenes* cas9). Computer-assisted, manual examination of the active site or binding site of a CRISPR-cas9 system (e.g., *S. pyogenes* cas9) may be performed. Programs such as GRID (P. Goodford, J. Med. Chem, 1985, 28, 849-57)—a program that determines probable interaction sites between molecules with various functional groups—may also be used to analyze the active site or binding site to predict partial structures of binding compounds. Computer programs can be employed to estimate the attraction, repulsion or steric hindrance of the two binding partners, e.g., CRISPR-cas9 system (e.g., *S. pyogenes* cas9) and a candidate nucleic acid molecule or a nucleic acid molecule and a candidate CRISPR-cas9 system (e.g., *S. pyogenes* cas9); and the CRISPR-cas9 crystal structure (*S. pyogenes* cas9) herewith enables such methods. Generally, the tighter the fit, the fewer the steric hindrances, and the greater the attractive forces, the more potent the potential binder, since these properties are consistent with a tighter binding constant. Furthermore, the more specificity in the design of a candidate CRISPR-cas9 system (e.g., *S. pyogenes* cas9), the more likely it is that it will not interact with off-target molecules as well. Also, “wet” methods are enabled by the instant invention. For example, in an aspect, the invention provides for a method for determining the structure of a binder (e.g., target nucleic acid molecule) of a candidate CRISPR-cas9 system (e.g., *S. pyogenes* cas9) bound to the candidate CRISPR-cas9 system (e.g., *S. pyogenes* cas9),

said method comprising, (a) providing a first crystal of a candidate CRISPR-cas9 system (*S. pyogenes* cas9) according to the invention or a second crystal of a candidate a candidate CRISPR-cas9 system (e.g., *S. pyogenes* cas9), (b) contacting the first crystal or second crystal with said binder under conditions whereby a complex may form; and (c) determining the structure of said a candidate (e.g., CRISPR-cas9 system (e.g., *S. pyogenes* cas9) or CRISPR-cas9 system (*S. pyogenes* cas9) complex. The second crystal may have essentially the same coordinates discussed herein, however due to minor alterations in CRISPR-cas9 system (e.g., from the cas9 of such a system being e.g., *S. pyogenes* cas9 versus being *S. pyogenes* cas9), wherein “e.g., *S. pyogenes* cas9” indicates that the cas9 is a cas9 and can be of or derived from *S. pyogenes* or an ortholog thereof), the crystal may form in a different space group.

[0083] The invention further involves, in place of or in addition to “in silico” methods, other “wet” methods, including high throughput screening of a binder (e.g., target nucleic acid molecule) and a candidate CRISPR-cas9 system (e.g., *S. pyogenes* cas9), or a candidate binder (e.g., target nucleic acid molecule) and a CRISPR-cas9 system (e.g., *S. pyogenes* cas9), or a candidate binder (e.g., target nucleic acid molecule) and a candidate CRISPR-cas9 system (e.g., *S. pyogenes* cas9) (the foregoing CRISPR-cas9 system(s) with or without one or more functional group(s)), to select compounds with binding activity. Those pairs of binder and CRISPR-cas9 system which show binding activity may be selected and further crystallized with the CRISPR-cas9 crystal having a structure herein, e.g., by co-crystallization or by soaking, for X-ray analysis. The resulting X-ray structure may be compared with that of the herein Crystal Structure Table and the information in the Figures for a variety of purposes, e.g., for areas of overlap. Having designed, identified, or selected possible pairs of binder and CRISPR-cas9 system by determining those which have favorable fitting properties, e.g., predicted strong attraction based on the pairs of binder and CRISPR-cas9 crystal structure data herein, these possible pairs can then be screened by “wet” methods for activity. Consequently, in an aspect the invention can involve: obtaining or synthesizing the possible pairs; and contacting a binder (e.g., target nucleic acid molecule) and a candidate CRISPR-cas9 system (e.g., *S. pyogenes* cas9), or a candidate binder (e.g., target nucleic acid molecule) and a CRISPR-cas9 system (e.g., *S. pyogenes* cas9), or a candidate binder (e.g., target nucleic acid molecule) and a candidate CRISPR-cas9 system (e.g., *S. pyogenes* cas9) (the foregoing CRISPR-cas9 system(s) with or without one or more functional group(s)) to determine ability to bind. In the latter step, the contacting is

advantageously under conditions to determine function. Instead of, or in addition to, performing such an assay, the invention may comprise: obtaining or synthesizing complex(es) from said contacting and analyzing the complex(es), e.g., by X-ray diffraction or NMR or other means, to determine the ability to bind or interact. Detailed structural information can then be obtained about the binding, and in light of this information, adjustments can be made to the structure or functionality of a candidate CRISPR-cas9 system or components thereof. These steps may be repeated and re-repeated as necessary. Alternatively or additionally, potential CRISPR-cas9 systems from or in the foregoing methods can be with nucleic acid molecules in vivo, including without limitation by way of administration to an organism (including non-human animal and human) to ascertain or confirm function, including whether a desired outcome (e.g., reduction of symptoms, treatment) results therefrom.

[0084] The invention further involves a method of determining three dimensional structures of CRISPR-cas systems or complex(es) of unknown structure by using the structural co-ordinates of the herein Crystal Structure Table and the information in the Figures. For example, if X-ray crystallographic or NMR spectroscopic data are provided for a CRISPR-cas system or complex of unknown crystal structure, the structure of a CRISPR-cas9 complex as defined in the herein Crystal Structure Table and the Figures may be used to interpret that data to provide a likely structure for the unknown system or complex by such techniques as by phase modeling in the case of X-ray crystallography. Thus, an inventive method can comprise: aligning a representation of the CRISPR-cas system or complex having an unknown crystal structure with an analogous representation of the CRISPR-cas(9) system and complex of the crystal structure herein to match homologous or analogous regions (e.g., homologous or analogous sequences); modeling the structure of the matched homologous or analogous regions (e.g., sequences) of the CRISPR-cas system or complex of unknown crystal structure based on the structure as defined in the herein Crystal Structure Table and/or in the Figures of the corresponding regions (e.g., sequences); and, determining a conformation (e.g. taking into consideration favorable interactions should be formed so that a low energy conformation is formed) for the unknown crystal structure which substantially preserves the structure of said matched homologous regions. "Homologous regions" describes, for example as to amino acids, amino acid residues in two sequences that are identical or have similar, e.g., aliphatic, aromatic, polar, negatively charged, or positively charged, side-chain chemical groups. Homologous regions as of nucleic acid molecules can

include at least 85% or 86% or 87% or 88% or 89% or 90% or 91% or 92% or 93% or 94% or 95% or 96% or 97% or 98% or 99% homology or identity. Identical and similar regions are sometimes described as being respectively “invariant” and “conserved” by those skilled in the art. Advantageously, the first and third steps are performed by computer modeling. Homology modeling is a technique that is well known to those skilled in the art (see, e.g., Greer, *Science* vol. 228 (1985) 1055, and Blundell et al. *Eur J Biochem* vol 172 (1988), 513). The computer representation of the conserved regions of the CRISPR-cas9 crystal structure herein and those of a CRISPR-cas system of unknown crystal structure aid in the prediction and determination of the crystal structure of the CRISPR-cas system of unknown crystal structure. Further still, the aspects of the invention which employ the CRISPR-cas9 crystal structure *in silico* may be equally applied to new CRISPR-cas crystal structures divined by using the herein CRISPR-cas9 crystal structure. In this fashion, a library of CRISPR-cas crystal structures can be obtained. Rational CRISPR-cas system design is thus provided by the instant invention. For instance, having determined a conformation or crystal structure of a CRISPR-cas system or complex, by the methods described herein, such a conformation may be used in a computer-based methods herein for determining the conformation or crystal structure of other CRISPR-cas systems or complexes whose crystal structures are yet unknown. Data from all of these crystal structures can be in a database, and the herein methods can be more robust by having herein comparisons involving the herein crystal structure or portions thereof be with respect to one or more crystal structures in the library. The invention further provides systems, such as computer systems, intended to generate structures and/or perform rational design of a CRISPR-cas system or complex. The system can contain: atomic co-ordinate data according to the herein Crystal Structure Table and the Figures or be derived therefrom e.g., by modeling, said data defining the three-dimensional structure of a CRISPR-cas system or complex or at least one domain or sub-domain thereof, or structure factor data therefor, said structure factor data being derivable from the atomic co-ordinate data of the herein Crystal Structure Table and the Figures. The invention also involves computer readable media with: atomic co-ordinate data according to the herein Crystal Structure Table and/or the Figures or derived therefrom e.g., by homology modeling, said data defining the three-dimensional structure of a CRISPR-cas system or complex or at least one domain or sub-domain thereof, or structure factor data therefor, said structure factor data being derivable from the atomic co-ordinate data of the herein Crystal Structure Table and/or the

Figures. "Computer readable media" refers to any media which can be read and accessed directly by a computer, and includes, but is not limited to: magnetic storage media; optical storage media; electrical storage media; cloud storage and hybrids of these categories. By providing such computer readable media, the atomic co-ordinate data can be routinely accessed for modeling or other "in silico" methods. The invention further comprehends methods of doing business by providing access to such computer readable media, for instance on a subscription basis, via the Internet or a global communication/computer network; or, the computer system can be available to a user, on a subscription basis. A "computer system" refers to the hardware means, software means and data storage means used to analyze the atomic co-ordinate data of the present invention. The minimum hardware means of computer-based systems of the invention may comprise a central processing unit (CPU), input means, output means, and data storage means. Desirably, a display or monitor is provided to visualize structure data. The invention further comprehends methods of transmitting information obtained in any method or step thereof described herein or any information described herein, e.g., via telecommunications, telephone, mass communications, mass media, presentations, internet, email, etc. The crystal structures of the invention can be analyzed to generate Fourier electron density map(s) of CRISPR-cas systems or complexes; advantageously, the three-dimensional structure being as defined by the atomic co-ordinate data according to the herein Crystal Structure Table and/or the Figures. Fourier electron density maps can be calculated based on X-ray diffraction patterns. These maps can then be used to determine aspects of binding or other interactions. Electron density maps can be calculated using known programs such as those from the CCP4 computer package (Collaborative Computing Project, No. 4. The CCP4 Suite: Programs for Protein Crystallography, Acta Crystallographica, D50, 1994, 760-763). For map visualization and model building programs such as "QUANTA" (1994, San Diego, Calif.: Molecular Simulations, Jones et al., Acta Crystallography A47 (1991), 110-119) can be used.

[0085] The herein Crystal Structure Table (see Example 1) gives atomic co-ordinate data for a CRISPR-cas9 (*S. pyogenes*), and lists each atom by a unique number; the chemical element and its position for each amino acid residue (as determined by electron density maps and antibody sequence comparisons), the amino acid residue in which the element is located, the chain identifier, the number of the residue, co-ordinates (e.g., X, Y, Z) which define with respect to the crystallographic axes the atomic position (in angstroms) of the respective atom, the occupancy of

the atom in the respective position, "B", isotropic displacement parameter (in angstroms²) which accounts for movement of the atom around its atomic center, and atomic number. See also the text herein and the Figures.

Nucleic acids, amino acids and proteins, Regulatory sequences, Vectors, etc

[0086] Nucleic acids, amino acids and proteins: The invention uses nucleic acids to bind target DNA sequences. This is advantageous as nucleic acids are much easier and cheaper to produce than proteins, and the specificity can be varied according to the length of the stretch where homology is sought. Complex 3-D positioning of multiple fingers, for example is not required. The terms "polynucleotide", "nucleotide", "nucleotide sequence", "nucleic acid" and "oligonucleotide" are used interchangeably. They refer to a polymeric form of nucleotides of any length, either deoxyribonucleotides or ribonucleotides, or analogs thereof. Polynucleotides may have any three dimensional structure, and may perform any function, known or unknown. The following are non-limiting examples of polynucleotides: coding or non-coding regions of a gene or gene fragment, loci (locus) defined from linkage analysis, exons, introns, messenger RNA (mRNA), transfer RNA, ribosomal RNA, short interfering RNA (siRNA), short-hairpin RNA (shRNA), micro-RNA (miRNA), ribozymes, cDNA, recombinant polynucleotides, branched polynucleotides, plasmids, vectors, isolated DNA of any sequence, isolated RNA of any sequence, nucleic acid probes, and primers. The term also encompasses nucleic-acid-like structures with synthetic backbones, see, e.g., Eckstein, 1991; Baserga et al., 1992; Milligan, 1993; WO 97/03211; WO 96/39154; Mata, 1997; Strauss-Soukup, 1997; and Samstag, 1996. A polynucleotide may comprise one or more modified nucleotides, such as methylated nucleotides and nucleotide analogs. If present, modifications to the nucleotide structure may be imparted before or after assembly of the polymer. The sequence of nucleotides may be interrupted by non-nucleotide components. A polynucleotide may be further modified after polymerization, such as by conjugation with a labeling component. As used herein the term "wild type" is a term of the art understood by skilled persons and means the typical form of an organism, strain, gene or characteristic as it occurs in nature as distinguished from mutant or variant forms. A "wild type" can be a base line. As used herein the term "variant" should be taken to mean the exhibition of qualities that have a pattern that deviates from what occurs in nature. The terms "non-naturally occurring" or "engineered" are used interchangeably and indicate the involvement of the hand of man. The terms, when referring to nucleic acid molecules or polypeptides mean

that the nucleic acid molecule or the polypeptide is at least substantially free from at least one other component with which they are naturally associated in nature and as found in nature. "Complementarity" refers to the ability of a nucleic acid to form hydrogen bond(s) with another nucleic acid sequence by either traditional Watson-Crick base pairing or other non-traditional types. A percent complementarity indicates the percentage of residues in a nucleic acid molecule which can form hydrogen bonds (e.g., Watson-Crick base pairing) with a second nucleic acid sequence (e.g., 5, 6, 7, 8, 9, 10 out of 10 being 50%, 60%, 70%, 80%, 90%, and 100% complementary). "Perfectly complementary" means that all the contiguous residues of a nucleic acid sequence will hydrogen bond with the same number of contiguous residues in a second nucleic acid sequence. "Substantially complementary" as used herein refers to a degree of complementarity that is at least 60%, 65%, 70%, 75%, 80%, 85%, 90%, 95%, 97%, 98%, 99%, or 100% over a region of 8, 9, 10, 11, 12, 13, 14, 15, 16, 17, 18, 19, 20, 21, 22, 23, 24, 25, 30, 35, 40, 45, 50, or more nucleotides, or refers to two nucleic acids that hybridize under stringent conditions. As used herein, "stringent conditions" for hybridization refer to conditions under which a nucleic acid having complementarity to a target sequence predominantly hybridizes with the target sequence, and substantially does not hybridize to non-target sequences. Stringent conditions are generally sequence-dependent, and vary depending on a number of factors. In general, the longer the sequence, the higher the temperature at which the sequence specifically hybridizes to its target sequence. Non-limiting examples of stringent conditions are described in detail in Tijssen (1993), *Laboratory Techniques In Biochemistry And Molecular Biology-Hybridization With Nucleic Acid Probes Part I, Second Chapter "Overview of principles of hybridization and the strategy of nucleic acid probe assay"*, Elsevier, N.Y. Where reference is made to a polynucleotide sequence, then complementary or partially complementary sequences are also envisaged. These are preferably capable of hybridising to the reference sequence under highly stringent conditions. Generally, in order to maximize the hybridization rate, relatively low-stringency hybridization conditions are selected: about 20 to 25° C lower than the thermal melting point (T_m). The T_m is the temperature at which 50% of specific target sequence hybridizes to a perfectly complementary probe in solution at a defined ionic strength and pH. Generally, in order to require at least about 85% nucleotide complementarity of hybridized sequences, highly stringent washing conditions are selected to be about 5 to 15° C lower than the T_m . In order to require at least about 70% nucleotide complementarity of hybridized sequences,

moderately-stringent washing conditions are selected to be about 15 to 30° C lower than the T_m . Highly permissive (very low stringency) washing conditions may be as low as 50° C below the T_m , allowing a high level of mis-matching between hybridized sequences. Those skilled in the art will recognize that other physical and chemical parameters in the hybridization and wash stages can also be altered to affect the outcome of a detectable hybridization signal from a specific level of homology between target and probe sequences. Preferred highly stringent conditions comprise incubation in 50% formamide, 5×SSC, and 1% SDS at 42° C, or incubation in 5×SSC and 1% SDS at 65° C, with wash in 0.2×SSC and 0.1% SDS at 65° C. “Hybridization” refers to a reaction in which one or more polynucleotides react to form a complex that is stabilized via hydrogen bonding between the bases of the nucleotide residues. The hydrogen bonding may occur by Watson Crick base pairing, Hoogsteen binding, or in any other sequence specific manner. The complex may comprise two strands forming a duplex structure, three or more strands forming a multi stranded complex, a single self-hybridizing strand, or any combination of these. A hybridization reaction may constitute a step in a more extensive process, such as the initiation of PCR, or the cleavage of a polynucleotide by an enzyme. A sequence capable of hybridizing with a given sequence is referred to as the “complement” of the given sequence. As used herein, the term “genomic locus” or “locus” (plural loci) is the specific location of a gene or DNA sequence on a chromosome. A “gene” refers to stretches of DNA or RNA that encode a polypeptide or an RNA chain that has functional role to play in an organism and hence is the molecular unit of heredity in living organisms. For the purpose of this invention it may be considered that genes include regions which regulate the production of the gene product, whether or not such regulatory sequences are adjacent to coding and/or transcribed sequences. Accordingly, a gene includes, but is not necessarily limited to, promoter sequences, terminators, translational regulatory sequences such as ribosome binding sites and internal ribosome entry sites, enhancers, silencers, insulators, boundary elements, replication origins, matrix attachment sites and locus control regions. As used herein, “expression of a genomic locus” or “gene expression” is the process by which information from a gene is used in the synthesis of a functional gene product. The products of gene expression are often proteins, but in non-protein coding genes such as rRNA genes or tRNA genes, the product is functional RNA. The process of gene expression is used by all known life - eukaryotes (including multicellular organisms), prokaryotes (bacteria and archaea) and viruses to generate functional products to

survive. As used herein "expression" of a gene or nucleic acid encompasses not only cellular gene expression, but also the transcription and translation of nucleic acid(s) in cloning systems and in any other context. As used herein, "expression" also refers to the process by which a polynucleotide is transcribed from a DNA template (such as into and mRNA or other RNA transcript) and/or the process by which a transcribed mRNA is subsequently translated into peptides, polypeptides, or proteins. Transcripts and encoded polypeptides may be collectively referred to as "gene product." If the polynucleotide is derived from genomic DNA, expression may include splicing of the mRNA in a eukaryotic cell. The terms "polypeptide", "peptide" and "protein" are used interchangeably herein to refer to polymers of amino acids of any length. The polymer may be linear or branched, it may comprise modified amino acids, and it may be interrupted by non amino acids. The terms also encompass an amino acid polymer that has been modified; for example, disulfide bond formation, glycosylation, lipidation, acetylation, phosphorylation, or any other manipulation, such as conjugation with a labeling component. As used herein the term "amino acid" includes natural and/or unnatural or synthetic amino acids, including glycine and both the D or L optical isomers, and amino acid analogs and peptidomimetics. As used herein, the term "domain" or "protein domain" refers to a part of a protein sequence that may exist and function independently of the rest of the protein chain. As described in aspects of the invention, sequence identity is related to sequence homology. Homology comparisons may be conducted by eye, or more usually, with the aid of readily available sequence comparison programs. These commercially available computer programs may calculate percent (%) homology between two or more sequences and may also calculate the sequence identity shared by two or more amino acid or nucleic acid sequences. In some preferred embodiments, the capping region of the dTALEs described herein have sequences that are at least 95% identical or share identity to the capping region amino acid sequences provided herein. Sequence homologies may be generated by any of a number of computer programs known in the art, for example BLAST or FASTA, etc. A suitable computer program for carrying out such an alignment is the GCG Wisconsin Bestfit package (University of Wisconsin, U.S.A; Devereux et al., 1984, *Nucleic Acids Research* 12:387). Examples of other software than may perform sequence comparisons include, but are not limited to, the BLAST package (see Ausubel et al., 1999 *ibid* – Chapter 18), FASTA (Atschul et al., 1990, *J. Mol. Biol.*, 403-410) and the GENWORKS suite of comparison tools. Both BLAST and FASTA are available for offline and

online searching (see Ausubel et al., 1999 *ibid*, pages 7-58 to 7-60). However it is preferred to use the GCG Bestfit program. Percentage (%) sequence homology may be calculated over contiguous sequences, i.e., one sequence is aligned with the other sequence and each amino acid or nucleotide in one sequence is directly compared with the corresponding amino acid or nucleotide in the other sequence, one residue at a time. This is called an “ungapped” alignment. Typically, such ungapped alignments are performed only over a relatively short number of residues. Although this is a very simple and consistent method, it fails to take into consideration that, for example, in an otherwise identical pair of sequences, one insertion or deletion may cause the following amino acid residues to be put out of alignment, thus potentially resulting in a large reduction in % homology when a global alignment is performed. Consequently, most sequence comparison methods are designed to produce optimal alignments that take into consideration possible insertions and deletions without unduly penalizing the overall homology or identity score. This is achieved by inserting “gaps” in the sequence alignment to try to maximize local homology or identity. However, these more complex methods assign “gap penalties” to each gap that occurs in the alignment so that, for the same number of identical amino acids, a sequence alignment with as few gaps as possible - reflecting higher relatedness between the two compared sequences - may achieve a higher score than one with many gaps. “Affinity gap costs” are typically used that charge a relatively high cost for the existence of a gap and a smaller penalty for each subsequent residue in the gap. This is the most commonly used gap scoring system. High gap penalties may, of course, produce optimized alignments with fewer gaps. Most alignment programs allow the gap penalties to be modified. However, it is preferred to use the default values when using such software for sequence comparisons. For example, when using the GCG Wisconsin Bestfit package the default gap penalty for amino acid sequences is -12 for a gap and -4 for each extension. Calculation of maximum % homology therefore first requires the production of an optimal alignment, taking into consideration gap penalties. A suitable computer program for carrying out such an alignment is the GCG Wisconsin Bestfit package (Devereux et al., 1984 *Nuc. Acids Research* 12 p387). Examples of other software than may perform sequence comparisons include, but are not limited to, the BLAST package (see Ausubel et al., 1999 *Short Protocols in Molecular Biology*, 4th Ed. -- Chapter 18), FASTA (Altschul et al., 1990 *J. Mol. Biol.* 403-410) and the GENWORKS suite of comparison tools. Both BLAST and FASTA are available for offline and online searching (see Ausubel et al., 1999, *Short Protocols in Molecular*

Biology, pages 7-58 to 7-60). However, for some applications, it is preferred to use the GCG Bestfit program. A new tool, called BLAST 2 Sequences is also available for comparing protein and nucleotide sequences (see *FEMS Microbiol Lett.* 1999 174(2): 247-50; *FEMS Microbiol Lett.* 1999 177(1): 187-8 and the website of the National Center for Biotechnology information at the website of the National Institutes for Health). Although the final % homology may be measured in terms of identity, the alignment process itself is typically not based on an all-or-nothing pair comparison. Instead, a scaled similarity score matrix is generally used that assigns scores to each pair-wise comparison based on chemical similarity or evolutionary distance. An example of such a matrix commonly used is the BLOSUM62 matrix - the default matrix for the BLAST suite of programs. GCG Wisconsin programs generally use either the public default values or a custom symbol comparison table, if supplied (see user manual for further details). For some applications, it is preferred to use the public default values for the GCG package, or in the case of other software, the default matrix, such as BLOSUM62. Alternatively, percentage homologies may be calculated using the multiple alignment feature in DNASIS™ (Hitachi Software), based on an algorithm, analogous to CLUSTAL (Higgins DG & Sharp PM (1988), *Gene* 73(1), 237-244). Once the software has produced an optimal alignment, it is possible to calculate % homology, preferably % sequence identity. The software typically does this as part of the sequence comparison and generates a numerical result. The sequences may also have deletions, insertions or substitutions of amino acid residues which produce a silent change and result in a functionally equivalent substance. Deliberate amino acid substitutions may be made on the basis of similarity in amino acid properties (such as polarity, charge, solubility, hydrophobicity, hydrophilicity, and/or the amphipathic nature of the residues) and it is therefore useful to group amino acids together in functional groups. Amino acids may be grouped together based on the properties of their side chains alone. However, it is more useful to include mutation data as well. The sets of amino acids thus derived are likely to be conserved for structural reasons. These sets may be described in the form of a Venn diagram (Livingstone C.D. and Barton G.J. (1993) "Protein sequence alignments: a strategy for the hierarchical analysis of residue conservation" *Comput. Appl. Biosci.* 9: 745-756) (Taylor W.R. (1986) "The classification of amino acid conservation" *J. Theor. Biol.* 119; 205-218). Conservative substitutions may be made, for example according to the table below which describes a generally accepted Venn diagram grouping of amino acids.

Set		Sub-set	
Hydrophobic	F W Y H K M I L V A G C	Aromatic	F W Y H
		Aliphatic	I L V
Polar	W Y H K R E D C S T N Q	Charged	H K R E D
		Positively charged	H K R
		Negatively charged	E D
Small	V C A G S P T N D	Tiny	A G S

[0087] Embodiments of the invention include sequences (both polynucleotide or polypeptide) which may comprise homologous substitution (substitution and replacement are both used herein to mean the interchange of an existing amino acid residue or nucleotide, with an alternative residue or nucleotide) that may occur i.e., like-for-like substitution in the case of amino acids such as basic for basic, acidic for acidic, polar for polar, etc. Non-homologous substitution may also occur i.e., from one class of residue to another or alternatively involving the inclusion of unnatural amino acids such as ornithine (hereinafter referred to as Z), diaminobutyric acid ornithine (hereinafter referred to as B), norleucine ornithine (hereinafter referred to as O), pyriylalanine, thienylalanine, naphthylalanine and phenylglycine. Variant amino acid sequences may include suitable spacer groups that may be inserted between any two amino acid residues of the sequence including alkyl groups such as methyl, ethyl or propyl groups in addition to amino acid spacers such as glycine or β -alanine residues. A further form of variation, which involves the presence of one or more amino acid residues in peptoid form, may be well understood by those skilled in the art. For the avoidance of doubt, "the peptoid form" is used to refer to variant amino acid residues wherein the α -carbon substituent group is on the residue's nitrogen atom rather than the α -carbon. Processes for preparing peptides in the peptoid form are known in the art, for example Simon RJ et al., *PNAS* (1992) 89(20), 9367-9371 and Horwell DC, *Trends Biotechnol.* (1995) 13(4), 132-134.

[0088] For purpose of this invention, amplification means any method employing a primer and a polymerase capable of replicating a target sequence with reasonable fidelity.

Amplification may be carried out by natural or recombinant DNA polymerases such as TaqGold™, T7 DNA polymerase, Klenow fragment of E.coli DNA polymerase, and reverse transcriptase. A preferred amplification method is PCR.

[0089] In certain aspects the invention involves vectors. A used herein, a “vector” is a tool that allows or facilitates the transfer of an entity from one environment to another. It is a replicon, such as a plasmid, phage, or cosmid, into which another DNA segment may be inserted so as to bring about the replication of the inserted segment. Generally, a vector is capable of replication when associated with the proper control elements. In general, the term “vector” refers to a nucleic acid molecule capable of transporting another nucleic acid to which it has been linked. Vectors include, but are not limited to, nucleic acid molecules that are single-stranded, double-stranded, or partially double-stranded; nucleic acid molecules that comprise one or more free ends, no free ends (e.g. circular); nucleic acid molecules that comprise DNA, RNA, or both; and other varieties of polynucleotides known in the art. One type of vector is a “plasmid,” which refers to a circular double stranded DNA loop into which additional DNA segments can be inserted, such as by standard molecular cloning techniques. Another type of vector is a viral vector, wherein virally-derived DNA or RNA sequences are present in the vector for packaging into a virus (e.g. retroviruses, replication defective retroviruses, adenoviruses, replication defective adenoviruses, and adeno-associated viruses (AAVs)). Viral vectors also include polynucleotides carried by a virus for transfection into a host cell. Certain vectors are capable of autonomous replication in a host cell into which they are introduced (e.g. bacterial vectors having a bacterial origin of replication and episomal mammalian vectors). Other vectors (e.g., non-episomal mammalian vectors) are integrated into the genome of a host cell upon introduction into the host cell, and thereby are replicated along with the host genome. Moreover, certain vectors are capable of directing the expression of genes to which they are operatively-linked. Such vectors are referred to herein as “expression vectors.” Common expression vectors of utility in recombinant DNA techniques are often in the form of plasmids.

[0090] Recombinant expression vectors can comprise a nucleic acid of the invention in a form suitable for expression of the nucleic acid in a host cell, which means that the recombinant expression vectors include one or more regulatory elements, which may be selected on the basis of the host cells to be used for expression, that is operatively-linked to the nucleic acid sequence to be expressed. Within a recombinant expression vector, “operably linked” is intended to mean

that the nucleotide sequence of interest is linked to the regulatory element(s) in a manner that allows for expression of the nucleotide sequence (e.g. in an in vitro transcription/translation system or in a host cell when the vector is introduced into the host cell). With regards to recombination and cloning methods, mention is made of U.S. patent application 10/815,730, published September 2, 2004 as US 2004-0171156 A1, the contents of which are herein incorporated by reference in their entirety.

[0091] Aspects of the invention relate to bicistronic vectors for chimeric RNA and Cas9. Bicistronic expression vectors for chimeric RNA and Cas9 are preferred. In general and particularly in this embodiment Cas9 is preferably driven by the CBh promoter. The chimeric RNA may preferably be driven by a Pol III promoter, such as a U6 promoter. Ideally the two are combined. The chimeric guide RNA typically consists of a 20bp guide sequence (Ns) and this may be joined to the tracr sequence (running from the first “U” of the lower strand to the end of the transcript). The tracr sequence may be truncated at various positions as indicated. The guide and tracr sequences are separated by the tracr-mate sequence, which may be GUUUUAGAGCUA. This may be followed by the loop sequence GAAA as shown. Both of these are preferred examples. Applicants have demonstrated Cas9-mediated indels at the human *EMXI* and *PVALB* loci by SURVEYOR assays. ChiRNAs are indicated by their “+n” designation, and crRNA refers to a hybrid RNA where guide and tracr sequences are expressed as separate transcripts. Throughout this application, chimeric RNA may also be called single guide, or synthetic guide RNA (sgRNA). The loop is preferably GAAA, but it is not limited to this sequence or indeed to being only 4bp in length. Indeed, preferred loop forming sequences for use in hairpin structures are four nucleotides in length, and most preferably have the sequence GAAA. However, longer or shorter loop sequences may be used, as may alternative sequences. The sequences preferably include a nucleotide triplet (for example, AAA), and an additional nucleotide (for example C or G). Examples of loop forming sequences include CAAA and AAAG. In practicing any of the methods disclosed herein, a suitable vector can be introduced to a cell or an embryo via one or more methods known in the art, including without limitation, microinjection, electroporation, sonoporation, biolistics, calcium phosphate-mediated transfection, cationic transfection, liposome transfection, dendrimer transfection, heat shock transfection, nucleofection transfection, magnetofection, lipofection, impalefection, optical transfection, proprietary agent-enhanced uptake of nucleic acids, and delivery via liposomes,

immunoliposomes, virosomes, or artificial virions. In some methods, the vector is introduced into an embryo by microinjection. The vector or vectors may be microinjected into the nucleus or the cytoplasm of the embryo. In some methods, the vector or vectors may be introduced into a cell by nucleofection.

[0092] The term “regulatory element” is intended to include promoters, enhancers, internal ribosomal entry sites (IRES), and other expression control elements (e.g. transcription termination signals, such as polyadenylation signals and poly-U sequences). Such regulatory elements are described, for example, in Goeddel, GENE EXPRESSION TECHNOLOGY: METHODS IN ENZYMOLOGY 185, Academic Press, San Diego, Calif. (1990). Regulatory elements include those that direct constitutive expression of a nucleotide sequence in many types of host cell and those that direct expression of the nucleotide sequence only in certain host cells (e.g., tissue-specific regulatory sequences). A tissue-specific promoter may direct expression primarily in a desired tissue of interest, such as muscle, neuron, bone, skin, blood, specific organs (e.g. liver, pancreas), or particular cell types (e.g. lymphocytes). Regulatory elements may also direct expression in a temporal-dependent manner, such as in a cell-cycle dependent or developmental stage-dependent manner, which may or may not also be tissue or cell-type specific. In some embodiments, a vector comprises one or more pol III promoter (e.g. 1, 2, 3, 4, 5, or more pol III promoters), one or more pol II promoters (e.g. 1, 2, 3, 4, 5, or more pol II promoters), one or more pol I promoters (e.g. 1, 2, 3, 4, 5, or more pol I promoters), or combinations thereof. Examples of pol III promoters include, but are not limited to, U6 and H1 promoters. Examples of pol II promoters include, but are not limited to, the retroviral Rous sarcoma virus (RSV) LTR promoter (optionally with the RSV enhancer), the cytomegalovirus (CMV) promoter (optionally with the CMV enhancer) [see, e.g., Boshart et al, Cell, 41:521-530 (1985)], the SV40 promoter, the dihydrofolate reductase promoter, the β -actin promoter, the phosphoglycerol kinase (PGK) promoter, and the EF1 α promoter. Also encompassed by the term “regulatory element” are enhancer elements, such as WPRE; CMV enhancers; the R-U5' segment in LTR of HTLV-I (Mol. Cell. Biol., Vol. 8(1), p. 466-472, 1988); SV40 enhancer; and the intron sequence between exons 2 and 3 of rabbit β -globin (Proc. Natl. Acad. Sci. USA., Vol. 78(3), p. 1527-31, 1981). It will be appreciated by those skilled in the art that the design of the expression vector can depend on such factors as the choice of the host cell to be transformed, the level of expression desired, etc. A vector can be introduced into host cells to thereby produce

transcripts, proteins, or peptides, including fusion proteins or peptides, encoded by nucleic acids as described herein (e.g., clustered regularly interspersed short palindromic repeats (CRISPR) transcripts, proteins, enzymes, mutant forms thereof, fusion proteins thereof, etc.). With regards to regulatory sequences, mention is made of U.S. patent application 10/491,026, the contents of which are incorporated by reference herein in their entirety. With regards to promoters, mention is made of PCT publication WO 2011/028929 and U.S. application 12/511,940, the contents of which are incorporated by reference herein in their entirety.

[0093] Vectors can be designed for expression of CRISPR transcripts (e.g. nucleic acid transcripts, proteins, or enzymes) in prokaryotic or eukaryotic cells. For example, CRISPR transcripts can be expressed in bacterial cells such as *Escherichia coli*, insect cells (using baculovirus expression vectors), yeast cells, or mammalian cells. Suitable host cells are discussed further in Goeddel, *GENE EXPRESSION TECHNOLOGY: METHODS IN ENZYMOLOGY* 185, Academic Press, San Diego, Calif. (1990). Alternatively, the recombinant expression vector can be transcribed and translated in vitro, for example using T7 promoter regulatory sequences and T7 polymerase.

[0094] Vectors may be introduced and propagated in a prokaryote or prokaryotic cell. In some embodiments, a prokaryote is used to amplify copies of a vector to be introduced into a eukaryotic cell or as an intermediate vector in the production of a vector to be introduced into a eukaryotic cell (e.g. amplifying a plasmid as part of a viral vector packaging system). In some embodiments, a prokaryote is used to amplify copies of a vector and express one or more nucleic acids, such as to provide a source of one or more proteins for delivery to a host cell or host organism. Expression of proteins in prokaryotes is most often carried out in *Escherichia coli* with vectors containing constitutive or inducible promoters directing the expression of either fusion or non-fusion proteins. Fusion vectors add a number of amino acids to a protein encoded therein, such as to the amino terminus of the recombinant protein. Such fusion vectors may serve one or more purposes, such as: (i) to increase expression of recombinant protein; (ii) to increase the solubility of the recombinant protein; and (iii) to aid in the purification of the recombinant protein by acting as a ligand in affinity purification. Often, in fusion expression vectors, a proteolytic cleavage site is introduced at the junction of the fusion moiety and the recombinant protein to enable separation of the recombinant protein from the fusion moiety subsequent to purification of the fusion protein. Such enzymes, and their cognate recognition

sequences, include Factor Xa, thrombin and enterokinase. Example fusion expression vectors include pGEX (Pharmacia Biotech Inc; Smith and Johnson, 1988. *Gene* 67: 31-40), pMAL (New England Biolabs, Beverly, Mass.) and pRIT5 (Pharmacia, Piscataway, N.J.) that fuse glutathione S-transferase (GST), maltose E binding protein, or protein A, respectively, to the target recombinant protein. Examples of suitable inducible non-fusion *E. coli* expression vectors include pTrc (Amrann et al., (1988) *Gene* 69:301-315) and pET 11d (Studier et al., *GENE EXPRESSION TECHNOLOGY: METHODS IN ENZYMOLOGY* 185, Academic Press, San Diego, Calif. (1990) 60-89). In some embodiments, a vector is a yeast expression vector. Examples of vectors for expression in yeast *Saccharomyces cerevisiae* include pYepSec1 (Baldari, et al., 1987. *EMBO J.* 6: 229-234), pMFa (Kuijan and Herskowitz, 1982. *Cell* 30: 933-943), pJRY88 (Schultz et al., 1987. *Gene* 54: 113-123), pYES2 (Invitrogen Corporation, San Diego, Calif.), and picZ (Invitrogen Corp, San Diego, Calif.). In some embodiments, a vector drives protein expression in insect cells using baculovirus expression vectors. Baculovirus vectors available for expression of proteins in cultured insect cells (e.g., SF9 cells) include the pAc series (Smith, et al., 1983. *Mol. Cell. Biol.* 3: 2156-2165) and the pVL series (Lucklow and Summers, 1989. *Virology* 170: 31-39).

[0095] In some embodiments, a vector is capable of driving expression of one or more sequences in mammalian cells using a mammalian expression vector. Examples of mammalian expression vectors include pCDM8 (Seed, 1987. *Nature* 329: 840) and pMT2PC (Kaufman, et al., 1987. *EMBO J.* 6: 187-195). When used in mammalian cells, the expression vector's control functions are typically provided by one or more regulatory elements. For example, commonly used promoters are derived from polyoma, adenovirus 2, cytomegalovirus, simian virus 40, and others disclosed herein and known in the art. For other suitable expression systems for both prokaryotic and eukaryotic cells see, e.g., Chapters 16 and 17 of Sambrook, et al., *MOLECULAR CLONING: A LABORATORY MANUAL*. 2nd ed., Cold Spring Harbor Laboratory, Cold Spring Harbor Laboratory Press, Cold Spring Harbor, N.Y., 1989.

[0096] In some embodiments, the recombinant mammalian expression vector is capable of directing expression of the nucleic acid preferentially in a particular cell type (e.g., tissue-specific regulatory elements are used to express the nucleic acid). Tissue-specific regulatory elements are known in the art. Non-limiting examples of suitable tissue-specific promoters include the albumin promoter (liver-specific; Pinkert, et al., 1987. *Genes Dev.* 1: 268-277),

lymphoid-specific promoters (Calame and Eaton, 1988. *Adv. Immunol.* 43: 235-275), in particular promoters of T cell receptors (Winoto and Baltimore, 1989. *EMBO J.* 8: 729-733) and immunoglobulins (Banciji, et al., 1983. *Cell* 33: 729-740; Queen and Baltimore, 1983. *Cell* 33: 741-748), neuron-specific promoters (e.g., the neurofilament promoter; Byrne and Ruddle, 1989. *Proc. Natl. Acad. Sci. USA* 86: 5473-5477), pancreas-specific promoters (Edlund, et al., 1985. *Science* 230: 912-916), and mammary gland-specific promoters (e.g., milk whey promoter; U.S. Pat. No. 4,873,316 and European Application Publication No. 264,166). Developmentally-regulated promoters are also encompassed, e.g., the murine hox promoters (Kessel and Gruss, 1990. *Science* 249: 374-379) and the α -fetoprotein promoter (Campes and Tilghman, 1989. *Genes Dev.* 3: 537-546). With regards to these prokaryotic and eukaryotic vectors, mention is made of U.S. Patent 6,750,059, the contents of which are incorporated by reference herein in their entirety. Other embodiments of the invention may relate to the use of viral vectors, with regards to which mention is made of U.S. Patent application 13/092,085, the contents of which are incorporated by reference herein in their entirety. Tissue-specific regulatory elements are known in the art and in this regard, mention is made of U.S. Patent 7,776,321, the contents of which are incorporated by reference herein in their entirety. In some embodiments, a regulatory element is operably linked to one or more elements of a CRISPR system so as to drive expression of the one or more elements of the CRISPR system. In general, CRISPRs (Clustered Regularly Interspaced Short Palindromic Repeats), also known as SPIDRs (SPacer Interspersed Direct Repeats), constitute a family of DNA loci that are usually specific to a particular bacterial species. The CRISPR locus comprises a distinct class of interspersed short sequence repeats (SSRs) that were recognized in *E. coli* (Ishino et al., *J. Bacteriol.*, 169:5429-5433 [1987]; and Nakata et al., *J. Bacteriol.*, 171:3553-3556 [1989]), and associated genes. Similar interspersed SSRs have been identified in *Haloferax mediterranei*, *Streptococcus pyogenes*, *Anabaena*, and *Mycobacterium tuberculosis* (See, Groenen et al., *Mol. Microbiol.*, 10:1057-1065 [1993]; Hoe et al., *Emerg. Infect. Dis.*, 5:254-263 [1999]; Masepohl et al., *Biochim. Biophys. Acta* 1307:26-30 [1996]; and Mojica et al., *Mol. Microbiol.*, 17:85-93 [1995]). The CRISPR loci typically differ from other SSRs by the structure of the repeats, which have been termed short regularly spaced repeats (SRSRs) (Janssen et al., *OMICS J. Integ. Biol.*, 6:23-33 [2002]; and Mojica et al., *Mol. Microbiol.*, 36:244-246 [2000]). In general, the repeats are short elements that occur in clusters that are regularly spaced by unique intervening sequences with a substantially constant length

(Mojica et al., [2000], supra). Although the repeat sequences are highly conserved between strains, the number of interspersed repeats and the sequences of the spacer regions typically differ from strain to strain (van Embden et al., *J. Bacteriol.*, 182:2393-2401 [2000]). CRISPR loci have been identified in more than 40 prokaryotes (See e.g., Jansen et al., *Mol. Microbiol.*, 43:1565-1575 [2002]; and Mojica et al., [2005]) including, but not limited to *Aeropyrum*, *Pyrobaculum*, *Sulfolobus*, *Archaeoglobus*, *Halocarcula*, *Methanobacterium*, *Methanococcus*, *Methanosarcina*, *Methanopyrus*, *Pyrococcus*, *Picrophilus*, *Thermoplasma*, *Corynebacterium*, *Mycobacterium*, *Streptomyces*, *Aquifex*, *Porphyromonas*, *Chlorobium*, *Thermus*, *Bacillus*, *Listeria*, *Staphylococcus*, *Clostridium*, *Thermoanaerobacter*, *Mycoplasma*, *Fusobacterium*, *Azarcus*, *Chromobacterium*, *Neisseria*, *Nitrosomonas*, *Desulfovibrio*, *Geobacter*, *Myxococcus*, *Campylobacter*, *Wolinella*, *Acinetobacter*, *Erwinia*, *Escherichia*, *Legionella*, *Methylococcus*, *Pasteurella*, *Photobacterium*, *Salmonella*, *Xanthomonas*, *Yersinia*, *Treponema*, and *Thermotoga*.

[0097] In some embodiments, the CRISPR enzyme is part of a fusion protein comprising one or more heterologous protein domains (e.g. about or more than about 1, 2, 3, 4, 5, 6, 7, 8, 9, 10, or more domains in addition to the CRISPR enzyme). A CRISPR enzyme fusion protein may comprise any additional protein sequence, and optionally a linker sequence between any two domains. Examples of protein domains that may be fused to a CRISPR enzyme include, without limitation, epitope tags, reporter gene sequences, and protein domains having one or more of the following activities: methylase activity, demethylase activity, transcription activation activity, transcription repression activity, transcription release factor activity, histone modification activity, RNA cleavage activity and nucleic acid binding activity. Non-limiting examples of epitope tags include histidine (His) tags, V5 tags, FLAG tags, influenza hemagglutinin (HA) tags, Myc tags, VSV-G tags, and thioredoxin (Trx) tags. Examples of reporter genes include, but are not limited to, glutathione-S-transferase (GST), horseradish peroxidase (HRP), chloramphenicol acetyltransferase (CAT) beta-galactosidase, beta-glucuronidase, luciferase, green fluorescent protein (GFP), HcRed, DsRed, cyan fluorescent protein (CFP), yellow fluorescent protein (YFP), and autofluorescent proteins including blue fluorescent protein (BFP). A CRISPR enzyme may be fused to a gene sequence encoding a protein or a fragment of a protein that bind DNA molecules or bind other cellular molecules, including but not limited to maltose binding protein (MBP), S-tag, Lex A DNA binding domain (DBD) fusions, GAL4 DNA binding domain fusions, and herpes simplex virus (HSV) BP16 protein fusions. Additional

domains that may form part of a fusion protein comprising a CRISPR enzyme are described in US20110059502, incorporated herein by reference. In some embodiments, a tagged CRISPR enzyme is used to identify the location of a target sequence.

[0098] In some embodiments, a CRISPR enzyme may form a component of an inducible system. The inducible nature of the system would allow for spatiotemporal control of gene editing or gene expression using a form of energy. The form of energy may include but is not limited to electromagnetic radiation, sound energy, chemical energy and thermal energy. Examples of inducible system include tetracycline inducible promoters (Tet-On or Tet-Off), small molecule two-hybrid transcription activations systems (FKBP, ABA, etc), or light inducible systems (Phytochrome, LOV domains, or cryptochrome). In one embodiment, the CRISPR enzyme may be a part of a Light Inducible Transcriptional Effector (LITE) to direct changes in transcriptional activity in a sequence-specific manner. The components of a light may include a CRISPR enzyme, a light-responsive cytochrome heterodimer (e.g. from *Arabidopsis thaliana*), and a transcriptional activation/repression domain. Further examples of inducible DNA binding proteins and methods for their use are provided in US 61/736465 and US 61/721,283, which is hereby incorporated by reference in its entirety.

[0099] The practice of the present invention employs, unless otherwise indicated, conventional techniques of immunology, biochemistry, chemistry, molecular biology, microbiology, cell biology, genomics and recombinant DNA, which are within the skill of the art. See Sambrook, Fritsch and Maniatis, *MOLECULAR CLONING: A LABORATORY MANUAL*, 2nd edition (1989); *CURRENT PROTOCOLS IN MOLECULAR BIOLOGY* (F. M. Ausubel, et al. eds., (1987)); the series *METHODS IN ENZYMOLOGY* (Academic Press, Inc.): *PCR 2: A PRACTICAL APPROACH* (M.J. MacPherson, B.D. Hames and G.R. Taylor eds. (1995)), Harlow and Lane, eds. (1988) *ANTIBODIES, A LABORATORY MANUAL*, and *ANIMAL CELL CULTURE* (R.I. Freshney, ed. (1987)).

EXAMPLES

[00100] The following examples are given for the purpose of illustrating various embodiments of the invention and are not meant to limit the present invention in any fashion. The present examples, along with the methods described herein are presently representative of preferred embodiments, are exemplary, and are not intended as limitations on the scope of the invention.

Changes therein and other uses which are encompassed within the spirit of the invention as defined by the scope of the claims will occur to those skilled in the art.

Example 1: Crystal Structure

[00101] Figures 1A-M provide: various views of the CRISPR-cas complex crystal structure (A-I), chemieric RNA architecture from the crystal structure (J-K), an interaction schematic from the crystal structure (L) and a topology schematic from the crystal structure (M).

[00102] Figures 1J-K concern a SpCas9 sgRNA structural study, and Figures 4A-B also pertain to sgRNA mutations. SpCas9 sgRNAs were mutated to investigate contribution of specific bases or groups of bases to activity. These include mutations in the direct repeat (DR) and tracrRNA regions of the sgRNA, divided into: stem 1 (base-pairing region between DR and tracrRNA), bulge (un-paired bases between DR and tracrRNA), loop 1 (artificial GAAA connector between DR and tracrRNA), linker 1 (between stem 1 and stem 2), stem 2 (first hairpin formed by tracrRNA tail), loop 2 (loop in between stem 2), stem 3 (second, or last hairpin formed by tracrRNA tail), and loop 3 (loop in between stem 3). Mutations were chosen based on predicted secondary structure as well as secondary structure as illustrated in Figures 1A-M, especially Figure 1J. In addition, three (3) sgRNA scaffolds were designed to incorporate MS2 loops in loop regions for interaction/binding to recruit functional domains fused to MBP. sgRNAs were synthesized as U6::PCR amplicon and tested in co-transfection with wildtype SpCas9.

[00103] 400ng of Cas9 plasmid, 100ng of sgRNA into 200,000 HEK 293FT cells with Lipofectamine 2000; DNA was harvested 3 days post-transfection for SURVEYOR analysis.

[00104] The invention thus comprehends the invention comprehends a CRISPR-cas9 (*S. pyogenes*) system having a crystal having the structure defined by the co-ordinates of following Cystral Structure Table (the CRISPR-cas9 crystal structure).

```

REMARK PHENIX refinement
REMARK
REMARK ***** INPUT FILES AND LABELS *****
REMARK Reflections:
REMARK file name      :
/net6/nisimasu/cas9/native03_24/phx/Refine_4/cas9_23_refine_data.mtz
REMARK labels        : ['I-obs,SIGI-obs']
REMARK R-free flags:
REMARK file name      :
/net6/nisimasu/cas9/native03_24/phx/Refine_4/cas9_23_refine_data.mtz
REMARK label         : R-free-flags
REMARK test_flag_value: 1
REMARK Model file name(s):
REMARK /net6/nisimasu/cas9/native03_24/phx/cas9_23_refine_5-coot-1.pdb
REMARK
REMARK ***** REFINEMENT SUMMARY: QUICK FACTS *****
REMARK Start: r_work = 0.2333 r_free = 0.2681 bonds = 0.009 angles = 1.224
REMARK Final: r_work = 0.2287 r_free = 0.2727 bonds = 0.008 angles = 1.195
REMARK *****
REMARK
REMARK ***** REFINEMENT STATISTICS STEP BY STEP *****
REMARK leading digit, like 1_, means number of macro-cycle
REMARK 0 : statistics at the very beginning when nothing is done yet
REMARK 1_bss: bulk solvent correction and/or (anisotropic) scaling
REMARK 1_xyz: refinement of coordinates
REMARK 1_adp: refinement of ADPs (Atomic Displacement Parameters)
REMARK -----
REMARK R-factors, x-ray target values and norm of gradient of x-ray target
REMARK stage      r-work r-free xray_target_w xray_target_t
REMARK 0 : 0.4183 0.3996 3.183623e+00 3.249901e+00
REMARK 1_bss: 0.2333 0.2681 2.986992e+00 3.103838e+00
REMARK 1_settarget: 0.2333 0.2681 5.570105e-02 7.188160e-02
REMARK 1_addcbetar: 0.2333 0.2681 5.570105e-02 7.188160e-02
REMARK 1_weight: 0.2333 0.2681 5.570105e-02 7.188160e-02
REMARK 1_xyzrec: 0.2301 0.2756 5.160978e-02 7.597045e-02
REMARK 1_adp: 0.2297 0.2750 5.053688e-02 7.559149e-02
REMARK 2_bss: 0.2304 0.2755 5.085887e-02 7.576964e-02
REMARK 2_settarget: 0.2304 0.2755 3.030450e+00 3.133267e+00
REMARK 2_weight: 0.2304 0.2755 3.030450e+00 3.133267e+00
REMARK 2_xyzrec: 0.2319 0.2724 3.002038e+00 3.114623e+00
REMARK 2_adp: 0.2308 0.2735 2.983982e+00 3.111742e+00
REMARK 3_bss: 0.2301 0.2722 2.986422e+00 3.113812e+00
REMARK 3_settarget: 0.2301 0.2722 2.986422e+00 3.113812e+00
REMARK 3_weight: 0.2301 0.2722 2.986422e+00 3.113812e+00
REMARK 3_xyzrec: 0.2296 0.2720 2.982246e+00 3.112724e+00
REMARK 3_adp: 0.2311 0.2740 2.983885e+00 3.113561e+00
REMARK end: 0.2287 0.2727 2.980889e+00 3.114524e+00
REMARK -----
REMARK stage      <pher>      fom      alpha      beta
REMARK 0 : 40.667 0.6489 0.0924 375.058
REMARK 1_bss: 34.679 0.7169 0.8687 159.107
REMARK 1_settarget: 34.679 0.7169 0.8687 159.107
REMARK 1_addcbetar: 34.679 0.7169 0.8687 159.107
REMARK 1_weight: 34.679 0.7169 0.8687 159.107
REMARK 1_xyzrec: 35.930 0.7024 0.8546 168.565
REMARK 1_adp: 35.994 0.7018 0.8670 168.273
REMARK 2_bss: 36.236 0.6986 0.8407 168.452
REMARK 2_settarget: 36.236 0.6986 0.8407 168.452
REMARK 2_weight: 36.236 0.6986 0.8407 168.452
REMARK 2_xyzrec: 35.526 0.7068 0.8488 163.909
REMARK 2_adp: 35.506 0.7069 0.8267 164.124
REMARK 3_bss: 35.216 0.7106 0.8544 164.060
REMARK 3_settarget: 35.216 0.7106 0.8544 164.060

```

REMARK 3_weight: 35.216 0.7106 0.8544 164.060
 REMARK 3_xyzrec: 35.053 0.7127 0.8566 164.509
 REMARK 3_adp: 35.140 0.7117 0.8257 165.334
 REMARK end: 35.132 0.7117 0.8548 163.891

REMARK -----
 REMARK stage angl bond chir dihe plan repu geom target
 REMARK 0 : 1.224 0.009 0.053 16.866 0.005 4.103 1.3661e-01
 REMARK 1_bss: 1.224 0.009 0.053 16.866 0.005 4.103 1.3661e-01
 REMARK 1_settarget: 1.224 0.009 0.053 16.866 0.005 4.103 1.3661e-01
 REMARK 1_addcbetar: 1.224 0.009 0.053 16.866 0.005 4.103 1.3753e-01
 REMARK 1_weight: 1.224 0.009 0.053 16.866 0.005 4.103 1.3753e-01
 REMARK 1_xyzrec: 1.197 0.009 0.046 16.893 0.005 4.102 1.2487e-01
 REMARK 1_adp: 1.197 0.009 0.046 16.893 0.005 4.102 1.2487e-01
 REMARK 2_bss: 1.197 0.009 0.046 16.893 0.005 4.102 1.2487e-01
 REMARK 2_settarget: 1.197 0.009 0.046 16.893 0.005 4.102 1.2487e-01
 REMARK 2_weight: 1.197 0.009 0.046 16.893 0.005 4.102 1.2485e-01
 REMARK 2_xyzrec: 1.200 0.008 0.047 16.800 0.005 4.105 1.1966e-01
 REMARK 2_adp: 1.200 0.008 0.047 16.800 0.005 4.105 1.1966e-01
 REMARK 3_bss: 1.200 0.008 0.047 16.800 0.005 4.105 1.1966e-01
 REMARK 3_settarget: 1.200 0.008 0.047 16.800 0.005 4.105 1.1966e-01
 REMARK 3_weight: 1.200 0.008 0.047 16.800 0.005 4.105 1.1992e-01
 REMARK 3_xyzrec: 1.195 0.008 0.047 16.785 0.005 4.106 1.1995e-01
 REMARK 3_adp: 1.195 0.008 0.047 16.785 0.005 4.106 1.1995e-01
 REMARK end: 1.195 0.008 0.047 16.785 0.005 4.106 1.1995e-01

REMARK -----
 REMARK Maximal deviations:
 REMARK stage angl bond chir dihe plan repu |grad|
 REMARK 0 : 16.300 0.091 0.409170.819 0.060 1.791 3.5898e-02
 REMARK 1_bss: 16.300 0.091 0.409170.819 0.060 1.791 3.5898e-02
 REMARK 1_settarget: 16.300 0.091 0.409170.819 0.060 1.791 3.5898e-02
 REMARK 1_addcbetar: 16.300 0.091 0.409170.819 0.060 1.791 3.5821e-02
 REMARK 1_weight: 16.300 0.091 0.409170.819 0.060 1.791 3.5821e-02
 REMARK 1_xyzrec: 13.201 0.098 0.380173.670 0.070 2.099 2.2688e-02
 REMARK 1_adp: 13.201 0.098 0.380173.670 0.070 2.099 2.2688e-02
 REMARK 2_bss: 13.201 0.098 0.380173.670 0.070 2.099 2.2688e-02
 REMARK 2_settarget: 13.201 0.098 0.380173.670 0.070 2.099 2.2688e-02
 REMARK 2_weight: 13.201 0.098 0.380173.670 0.070 2.099 2.2685e-02
 REMARK 2_xyzrec: 13.522 0.083 0.397172.158 0.058 2.078 2.2398e-02
 REMARK 2_adp: 13.522 0.083 0.397172.158 0.058 2.078 2.2398e-02
 REMARK 3_bss: 13.522 0.083 0.397172.158 0.058 2.078 2.2398e-02
 REMARK 3_settarget: 13.522 0.083 0.397172.158 0.058 2.078 2.2398e-02
 REMARK 3_weight: 13.522 0.083 0.397172.158 0.058 2.078 2.2446e-02
 REMARK 3_xyzrec: 14.311 0.081 0.393172.025 0.057 2.054 2.2726e-02
 REMARK 3_adp: 14.311 0.081 0.393172.025 0.057 2.054 2.2726e-02
 REMARK end: 14.311 0.081 0.393172.025 0.057 2.054 2.2726e-02

REMARK -----
 REMARK |-----overall-----|---macromolecule---|-----solvent-----|
 REMARK stage b_max b_min b_ave b_max b_min b_ave b_max b_min b_ave
 REMARK 0 : 160.43 28.85 71.22 160.43 28.85 71.30 81.67 30.00 51.94
 REMARK 1_bss: 160.43 28.85 71.22 160.43 28.85 71.30 81.67 30.00 51.94
 REMARK 1_settarget: 160.43 28.85 71.22 160.43 28.85 71.30 81.67 30.00 51.94
 REMARK 1_addcbetar: 160.43 28.85 71.22 160.43 28.85 71.30 81.67 30.00 51.94
 REMARK 1_weight: 160.43 28.85 71.22 160.43 28.85 71.30 81.67 30.00 51.94
 REMARK 1_xyzrec: 160.43 28.85 71.22 160.43 28.85 71.30 81.67 30.00 51.94
 REMARK 1_adp: 161.86 28.35 71.48 161.86 28.35 71.56 76.67 37.13 51.11
 REMARK 2_bss: 161.86 28.35 71.48 161.86 28.35 71.56 76.67 37.13 51.11
 REMARK 2_settarget: 161.86 28.35 71.48 161.86 28.35 71.56 76.67 37.13 51.11
 REMARK 2_weight: 161.86 28.35 71.48 161.86 28.35 71.56 76.67 37.13 51.11
 REMARK 2_xyzrec: 161.86 28.35 71.48 161.86 28.35 71.56 76.67 37.13 51.11
 REMARK 2_adp: 161.72 27.70 70.86 161.72 27.70 70.95 83.20 35.10 51.05
 REMARK 3_bss: 161.72 27.70 70.86 161.72 27.70 70.95 83.20 35.10 51.05
 REMARK 3_settarget: 161.72 27.70 70.86 161.72 27.70 70.95 83.20 35.10 51.05
 REMARK 3_weight: 161.72 27.70 70.86 161.72 27.70 70.95 83.20 35.10 51.05

```

REMARK 3_xyzrec: 161.72 27.70 70.86 161.72 27.70 70.95 83.20 35.10 51.05
REMARK 3_adp: 160.38 27.42 69.33 160.38 27.42 69.42 81.92 31.44 49.95
REMARK end: 160.38 27.42 69.33 160.38 27.42 69.42 81.92 31.44 49.95
REMARK -----
REMARK stage Deviation of refined
REMARK model from start model
REMARK max min mean
REMARK 0 : 0.000 0.000 0.000
REMARK 1_bss: 0.000 0.000 0.000
REMARK 1_settarget: 0.000 0.000 0.000
REMARK 1_addcbetar: 0.000 0.000 0.000
REMARK 1_weight: 0.000 0.000 0.000
REMARK 1_xyzrec: 1.645 0.002 0.094
REMARK 1_adp: 1.645 0.002 0.094
REMARK 2_bss: 1.645 0.002 0.094
REMARK 2_settarget: 1.645 0.002 0.094
REMARK 2_weight: 1.645 0.002 0.094
REMARK 2_xyzrec: 1.564 0.001 0.062
REMARK 2_adp: 1.564 0.001 0.062
REMARK 3_bss: 1.564 0.001 0.062
REMARK 3_settarget: 1.564 0.001 0.062
REMARK 3_weight: 1.564 0.001 0.062
REMARK 3_xyzrec: 1.660 0.001 0.068
REMARK 3_adp: 1.660 0.001 0.068
REMARK end: 1.660 0.001 0.068
REMARK -----

```

REMARK MODEL CONTENT.

ELEMENT	ATOM RECORD COUNT	OCCUPANCY SUM
P	234	234.00
C	14252	14252.00
S	37	37.00
O	5241	5241.00
N	4105	4105.00
TOTAL	23869	23869.00

REMARK r_free_flags.md5.hexdigest 52486022afbadd1892776b3e20d1fccb4

REMARK IF THIS FILE IS FOR PDB DEPOSITION: REMOVE ALL FROM THIS LINE UP.

```

REMARK 3
REMARK 3 REFINEMENT.
REMARK 3 PROGRAM : PHENIX (phenix.refine: 1.8.3_1479)
REMARK 3 AUTHORS : Adams,Afonine,Burnley,Chen,Davis,Echois,Gildea,
REMARK 3 : Gopal,Gros,Grosse-Kunstleve,Headd,Hung,Immormino,
REMARK 3 : Ioerger,McCoy,McKee,Moriarty,Pai,Read,Richardson,
REMARK 3 : Richardson,Romo,Sacchettini,Sauter,Smith,Storoni,
REMARK 3 : Terwilliger,Zwart
REMARK 3
REMARK 3 REFINEMENT TARGET : ML
REMARK 3
REMARK 3 DATA USED IN REFINEMENT.
REMARK 3 RESOLUTION RANGE HIGH (ANGSTROMS) : 2.400
REMARK 3 RESOLUTION RANGE LOW (ANGSTROMS) : 46.701
REMARK 3 MIN(FOBS/SIGMA_FOBS) : 1.96
REMARK 3 COMPLETENESS FOR RANGE (%) : 98.45
REMARK 3 NUMBER OF REFLECTIONS : 147138
REMARK 3 NUMBER OF REFLECTIONS (NON-ANOMALOUS) : 147138
REMARK 3
REMARK 3 FIT TO DATA USED IN REFINEMENT.
REMARK 3 R VALUE (WORKING + TEST SET) : 0.2292
REMARK 3 R VALUE (WORKING SET) : 0.2287
REMARK 3 FREE R VALUE : 0.2727
REMARK 3 FREE R VALUE TEST SET SIZE (%) : 1.20
REMARK 3 FREE R VALUE TEST SET COUNT : 1764

```

```

REMARK 3
REMARK 3 FIT TO DATA USED IN REFINEMENT (IN BINS).
REMARK 3 BIN RESOLUTION RANGE COMPL. NWORK NFREE RWORK RFREE
REMARK 3 1 46.7097 - 5.6402 0.98 11173 136 0.1784 0.1955
REMARK 3 2 5.6402 - 4.4779 0.99 11296 136 0.1963 0.2500
REMARK 3 3 4.4779 - 3.9122 0.99 11265 137 0.2028 0.2244
REMARK 3 4 3.9122 - 3.5546 0.99 11271 137 0.2226 0.3028
REMARK 3 5 3.5546 - 3.2999 0.99 11153 136 0.2451 0.3052
REMARK 3 6 3.2999 - 3.1054 0.99 11275 136 0.2661 0.3084
REMARK 3 7 3.1054 - 2.9499 0.99 11123 136 0.2853 0.3308
REMARK 3 8 2.9499 - 2.8215 0.98 11224 135 0.2929 0.3928
REMARK 3 9 2.8215 - 2.7129 0.98 11150 136 0.2981 0.3419
REMARK 3 10 2.7129 - 2.6193 0.98 11162 136 0.3059 0.3756
REMARK 3 11 2.6193 - 2.5374 0.98 11133 135 0.3217 0.3694
REMARK 3 12 2.5374 - 2.4649 0.98 11116 135 0.3351 0.3945
REMARK 3 13 2.4649 - 2.4000 0.98 11033 133 0.3470 0.3895
REMARK 3
REMARK 3 BULK SOLVENT MODELLING.
REMARK 3 METHOD USED : FLAT BULK SOLVENT MODEL
REMARK 3 SOLVENT RADIUS : 1.11
REMARK 3 SHRINKAGE RADIUS : 0.90
REMARK 3 GRID STEP FACTOR : 4.00
REMARK 3
REMARK 3 ERROR ESTIMATES.
REMARK 3 COORDINATE ERROR (MAXIMUM-LIKELIHOOD BASED) : 0.45
REMARK 3 PHASE ERROR (DEGREES, MAXIMUM-LIKELIHOOD BASED) : 35.13
REMARK 3
REMARK 3 STRUCTURE FACTORS CALCULATION ALGORITHM : FFT
REMARK 3
REMARK 3 DEVIATIONS FROM IDEAL VALUES.
REMARK 3 RMSD MAX COUNT
REMARK 3 BOND : 0.008 0.081 24696
REMARK 3 ANGLE : 1.195 14.311 34572
REMARK 3 CHIRALITY : 0.047 0.393 4125
REMARK 3 PLANARITY : 0.005 0.057 3568
REMARK 3 DIHEDRAL : 16.785 172.025 9579
REMARK 3 MIN NONBONDED DISTANCE : 2.054
REMARK 3
REMARK 3 MOLPROBITY STATISTICS.
REMARK 3 ALL-ATOM CLASHSCORE : 9.29
REMARK 3 RAMACHANDRAN PLOT:
REMARK 3 OUTLIERS : 0.79 %
REMARK 3 ALLOWED : 7.27 %
REMARK 3 FAVORED : 91.94 %
REMARK 3 ROTAMER OUTLIERS : 7.46 %
REMARK 3 CBETA DEVIATIONS : 0
REMARK 3
REMARK 3 ATOMIC DISPLACEMENT PARAMETERS.
REMARK 3 WILSON B : 59.56
REMARK 3 RMS(B_ISO_OR_EQUIVALENT_BONDED) : 4.09
REMARK 3 ATOMS NUMBER OF ATOMS
REMARK 3 ISO. ANISO.
REMARK 3 ALL : 23869 0
REMARK 3 ALL (NO H) : 23869 0
REMARK 3 SOLVENT : 101 0
REMARK 3 NON-SOLVENT : 23768 0
REMARK 3 HYDROGENS : 0 0
REMARK 3
CRYST1 76.711 105.692 126.815 97.68 98.43 100.31 P 1
SCALE1 0.013036 0.002370 0.002353 0.00000
SCALE2 0.000000 0.009617 0.001602 0.00000
SCALE3 0.000000 0.000000 0.008081 0.00000
ATOM 1 O LYS A 3 -6.852 51.606 -17.925 1.00 84.57 0

```

ATOM	2	N	LYS	A	3	-6.495	49.272	-16.515	1.00	86.17	N
ATOM	3	CA	LYS	A	3	-7.583	49.348	-17.492	1.00	87.06	C
ATOM	4	C	LYS	A	3	-7.504	50.633	-18.320	1.00	84.64	C
ATOM	5	CB	LYS	A	3	-8.949	49.249	-16.801	1.00	77.43	C
ATOM	6	O	LYS	A	4	-10.418	52.058	-20.996	1.00	82.35	O
ATOM	7	N	LYS	A	4	-8.178	50.622	-19.469	1.00	81.04	N
ATOM	8	CA	LYS	A	4	-8.087	51.707	-20.442	1.00	78.21	C
ATOM	9	C	LYS	A	4	-9.376	52.528	-20.508	1.00	78.42	C
ATOM	10	CB	LYS	A	4	-7.751	51.144	-21.829	1.00	74.60	C
ATOM	11	O	TYR	A	5	-9.289	56.162	-21.449	1.00	61.89	O
ATOM	12	N	TYR	A	5	-9.295	53.764	-20.035	1.00	73.68	N
ATOM	13	CA	TYR	A	5	-10.461	54.641	-19.995	1.00	65.53	C
ATOM	14	C	TYR	A	5	-10.380	55.757	-21.025	1.00	62.17	C
ATOM	15	CB	TYR	A	5	-10.618	55.250	-18.601	1.00	60.26	C
ATOM	16	CG	TYR	A	5	-9.626	56.352	-18.318	1.00	63.62	C
ATOM	17	CD1	TYR	A	5	-8.270	56.078	-18.205	1.00	61.48	C
ATOM	18	CD2	TYR	A	5	-10.043	57.680	-18.178	1.00	60.86	C
ATOM	19	CE1	TYR	A	5	-7.350	57.087	-17.948	1.00	64.63	C
ATOM	20	CE2	TYR	A	5	-9.126	58.697	-17.922	1.00	58.87	C
ATOM	21	CZ	TYR	A	5	-7.783	58.396	-17.808	1.00	63.09	C
ATOM	22	OH	TYR	A	5	-6.860	59.392	-17.564	1.00	63.66	O
ATOM	23	N	SER	A	6	-11.540	56.275	-21.410	1.00	64.32	N
ATOM	24	CA	SER	A	6	-11.563	57.487	-22.218	1.00	64.81	C
ATOM	25	C	SER	A	6	-12.416	58.627	-21.624	1.00	57.95	C
ATOM	26	O	SER	A	6	-13.393	58.397	-20.903	1.00	54.94	O
ATOM	27	CB	SER	A	6	-12.033	57.149	-23.633	1.00	62.65	C
ATOM	28	OG	SER	A	6	-10.907	56.947	-24.478	1.00	65.58	O
ATOM	29	N	ILE	A	7	-12.022	59.856	-21.943	1.00	59.93	N
ATOM	30	CA	ILE	A	7	-12.723	61.054	-21.488	1.00	53.57	C
ATOM	31	C	ILE	A	7	-13.332	61.844	-22.634	1.00	55.81	C
ATOM	32	O	ILE	A	7	-12.625	62.274	-23.543	1.00	57.60	O
ATOM	33	CB	ILE	A	7	-11.789	62.011	-20.753	1.00	57.06	C
ATOM	34	CG1	ILE	A	7	-10.974	61.286	-19.703	1.00	51.86	C
ATOM	35	CG2	ILE	A	7	-12.577	63.182	-20.135	1.00	61.29	C
ATOM	36	CD1	ILE	A	7	-9.788	62.098	-19.278	1.00	59.83	C
ATOM	37	N	GLY	A	8	-14.636	62.063	-22.582	1.00	52.53	N
ATOM	38	CA	GLY	A	8	-15.256	63.038	-23.466	1.00	54.40	C
ATOM	39	C	GLY	A	8	-15.432	64.411	-22.817	1.00	56.88	C
ATOM	40	O	GLY	A	8	-15.439	64.528	-21.592	1.00	52.45	O
ATOM	41	N	LEU	A	9	-15.587	65.446	-23.644	1.00	55.80	N
ATOM	42	CA	LEU	A	9	-15.687	66.827	-23.163	1.00	52.69	C
ATOM	43	C	LEU	A	9	-16.695	67.669	-23.958	1.00	54.15	C
ATOM	44	O	LEU	A	9	-16.631	67.732	-25.186	1.00	55.12	O
ATOM	45	CB	LEU	A	9	-14.316	67.508	-23.216	1.00	48.99	C
ATOM	46	CG	LEU	A	9	-13.189	66.869	-22.396	1.00	48.86	C
ATOM	47	CD1	LEU	A	9	-11.839	67.478	-22.758	1.00	37.45	C
ATOM	48	CD2	LEU	A	9	-13.464	66.995	-20.900	1.00	46.82	C
ATOM	49	N	ALA	A	10	-17.612	68.332	-23.265	1.00	45.53	N
ATOM	50	CA	ALA	A	10	-18.543	69.213	-23.942	1.00	49.53	C
ATOM	51	C	ALA	A	10	-18.347	70.661	-23.500	1.00	49.91	C
ATOM	52	O	ALA	A	10	-18.857	71.085	-22.469	1.00	47.09	O
ATOM	53	CB	ALA	A	10	-19.961	68.765	-23.694	1.00	52.67	C
ATOM	54	N	ILE	A	11	-17.587	71.410	-24.286	1.00	51.48	N
ATOM	55	CA	ILE	A	11	-17.288	72.796	-23.954	1.00	50.46	C
ATOM	56	C	ILE	A	11	-18.343	73.795	-24.455	1.00	50.05	C
ATOM	57	O	ILE	A	11	-18.650	73.845	-25.643	1.00	56.39	O
ATOM	58	CB	ILE	A	11	-15.932	73.206	-24.522	1.00	48.70	C
ATOM	59	CG1	ILE	A	11	-14.955	72.038	-24.434	1.00	47.33	C
ATOM	60	CG2	ILE	A	11	-15.402	74.390	-23.774	1.00	49.00	C
ATOM	61	CD1	ILE	A	11	-13.580	72.392	-24.901	1.00	50.66	C
ATOM	62	N	GLY	A	12	-18.892	74.578	-23.531	1.00	47.11	N
ATOM	63	CA	GLY	A	12	-19.804	75.669	-23.848	1.00	47.61	C
ATOM	64	C	GLY	A	12	-19.322	76.965	-23.213	1.00	46.13	C

ATOM	65	O	GLY	A	12	-18.211	77.029	-22.707	1.00	48.69	O
ATOM	66	O	THR	A	13	-19.618	80.244	-20.510	1.00	55.02	O
ATOM	67	N	THR	A	13	-20.140	78.006	-23.249	1.00	51.65	N
ATOM	68	CA	THR	A	13	-19.742	79.308	-22.692	1.00	48.23	C
ATOM	69	C	THR	A	13	-20.136	79.411	-21.227	1.00	45.99	C
ATOM	70	CB	THR	A	13	-20.360	80.490	-23.463	1.00	50.01	C
ATOM	71	OG1	THR	A	13	-21.715	80.189	-23.808	1.00	51.86	O
ATOM	72	CG2	THR	A	13	-19.594	80.752	-24.726	1.00	55.66	C
ATOM	73	O	ASN	A	14	-21.794	76.775	-17.708	1.00	43.59	O
ATOM	74	N	ASN	A	14	-21.031	78.542	-20.783	1.00	43.11	N
ATOM	75	CA	ASN	A	14	-21.357	78.465	-19.380	1.00	40.57	C
ATOM	76	C	ASN	A	14	-21.268	77.047	-18.781	1.00	40.89	C
ATOM	77	CB	ASN	A	14	-22.740	79.067	-19.195	1.00	43.14	C
ATOM	78	CG	ASN	A	14	-22.808	80.469	-19.747	1.00	44.19	C
ATOM	79	OD1	ASN	A	14	-23.083	80.673	-20.930	1.00	55.09	O
ATOM	80	ND2	ASN	A	14	-22.480	81.444	-18.915	1.00	42.57	N
ATOM	81	O	SER	A	15	-19.101	74.060	-20.763	1.00	45.29	O
ATOM	82	N	SER	A	15	-20.584	76.138	-19.461	1.00	41.88	N
ATOM	83	CA	SER	A	15	-20.547	74.767	-18.970	1.00	42.67	C
ATOM	84	C	SER	A	15	-19.429	73.928	-19.586	1.00	42.48	C
ATOM	85	CB	SER	A	15	-21.900	74.072	-19.199	1.00	43.19	C
ATOM	86	OG	SER	A	15	-22.297	74.133	-20.565	1.00	48.23	O
ATOM	87	O	VAL	A	16	-18.556	70.366	-17.594	1.00	39.92	O
ATOM	88	N	VAL	A	16	-18.831	73.082	-18.760	1.00	37.38	N
ATOM	89	CA	VAL	A	16	-17.993	71.999	-19.265	1.00	43.04	C
ATOM	90	C	VAL	A	16	-18.555	70.673	-18.790	1.00	41.68	C
ATOM	91	CB	VAL	A	16	-16.529	72.108	-18.828	1.00	36.60	C
ATOM	92	CG1	VAL	A	16	-15.751	70.931	-19.383	1.00	43.90	C
ATOM	93	CG2	VAL	A	16	-15.932	73.399	-19.303	1.00	34.97	C
ATOM	94	N	GLY	A	17	-19.082	69.916	-19.742	1.00	48.15	N
ATOM	95	CA	GLY	A	17	-19.490	68.547	-19.488	1.00	49.97	C
ATOM	96	C	GLY	A	17	-18.327	67.577	-19.647	1.00	45.61	C
ATOM	97	O	GLY	A	17	-17.479	67.743	-20.536	1.00	46.12	O
ATOM	98	N	TRP	A	18	-18.272	66.582	-18.771	1.00	46.44	N
ATOM	99	CA	TRP	A	18	-17.190	65.592	-18.831	1.00	54.14	C
ATOM	100	C	TRP	A	18	-17.684	64.206	-18.416	1.00	52.40	C
ATOM	101	O	TRP	A	18	-18.591	64.080	-17.594	1.00	53.51	O
ATOM	102	CB	TRP	A	18	-16.014	66.023	-17.940	1.00	51.68	C
ATOM	103	CG	TRP	A	18	-16.447	66.257	-16.544	1.00	51.86	C
ATOM	104	CD1	TRP	A	18	-16.954	67.407	-16.032	1.00	47.72	C
ATOM	105	CD2	TRP	A	18	-16.460	65.305	-15.481	1.00	51.80	C
ATOM	106	NE1	TRP	A	18	-17.275	67.238	-14.707	1.00	50.21	N
ATOM	107	CE2	TRP	A	18	-16.979	65.952	-14.346	1.00	52.39	C
ATOM	108	CE3	TRP	A	18	-16.084	63.964	-15.382	1.00	55.41	C
ATOM	109	CZ2	TRP	A	18	-17.124	65.308	-13.124	1.00	53.43	C
ATOM	110	CZ3	TRP	A	18	-16.231	63.327	-14.167	1.00	53.37	C
ATOM	111	CH2	TRP	A	18	-16.739	63.992	-13.057	1.00	49.43	C
ATOM	112	N	ALA	A	19	-17.077	63.168	-18.981	1.00	53.20	N
ATOM	113	CA	ALA	A	19	-17.430	61.797	-18.629	1.00	51.14	C
ATOM	114	C	ALA	A	19	-16.259	60.869	-18.865	1.00	54.16	C
ATOM	115	O	ALA	A	19	-15.529	61.013	-19.847	1.00	56.96	O
ATOM	116	CB	ALA	A	19	-18.628	61.329	-19.414	1.00	54.56	C
ATOM	117	N	VAL	A	20	-16.075	59.937	-17.937	1.00	52.67	N
ATOM	118	CA	VAL	A	20	-15.041	58.920	-18.038	1.00	58.65	C
ATOM	119	C	VAL	A	20	-15.656	57.594	-18.510	1.00	59.05	C
ATOM	120	O	VAL	A	20	-16.689	57.145	-17.999	1.00	57.31	O
ATOM	121	CB	VAL	A	20	-14.335	58.715	-16.699	1.00	56.98	C
ATOM	122	CG1	VAL	A	20	-13.279	57.626	-16.817	1.00	58.12	C
ATOM	123	CG2	VAL	A	20	-13.714	60.006	-16.247	1.00	54.28	C
ATOM	124	N	ILE	A	21	-15.024	56.972	-19.489	1.00	57.13	N
ATOM	125	CA	ILE	A	21	-15.646	55.834	-20.159	1.00	62.37	C
ATOM	126	C	ILE	A	21	-14.721	54.620	-20.228	1.00	63.65	C
ATOM	127	O	ILE	A	21	-13.518	54.777	-20.455	1.00	64.09	O

ATOM	128	CB	ILE	A	21	-16.104	56.264	-21.559	1.00	60.20	C
ATOM	129	CG1	ILE	A	21	-17.598	56.562	-21.535	1.00	63.28	C
ATOM	130	CG2	ILE	A	21	-15.763	55.243	-22.622	1.00	63.73	C
ATOM	131	CD1	ILE	A	21	-18.091	57.207	-22.802	1.00	69.12	C
ATOM	132	N	THR	A	22	-15.285	53.431	-19.984	1.00	65.26	N
ATOM	133	CA	THR	A	22	-14.577	52.146	-20.154	1.00	68.63	C
ATOM	134	C	THR	A	22	-14.847	51.514	-21.512	1.00	70.08	C
ATOM	135	O	THR	A	22	-15.743	51.945	-22.238	1.00	67.79	O
ATOM	136	CB	THR	A	22	-14.980	51.092	-19.096	1.00	65.50	C
ATOM	137	OG1	THR	A	22	-16.404	50.896	-19.125	1.00	64.92	O
ATOM	138	CG2	THR	A	22	-14.530	51.507	-17.714	1.00	60.20	C
ATOM	139	O	ASP	A	23	-16.082	49.313	-24.533	1.00	75.47	O
ATOM	140	N	ASP	A	23	-14.092	50.457	-21.814	1.00	77.30	N
ATOM	141	CA	ASP	A	23	-14.230	49.677	-23.057	1.00	73.77	C
ATOM	142	C	ASP	A	23	-15.670	49.320	-23.382	1.00	70.82	C
ATOM	143	CB	ASP	A	23	-13.433	48.370	-22.975	1.00	75.99	C
ATOM	144	CG	ASP	A	23	-11.950	48.585	-22.745	1.00	77.77	C
ATOM	145	OD1	ASP	A	23	-11.349	49.478	-23.386	1.00	80.48	O
ATOM	146	OD2	ASP	A	23	-11.385	47.831	-21.922	1.00	78.63	O
ATOM	147	N	GLU	A	24	-16.431	49.010	-22.347	1.00	72.11	N
ATOM	148	CA	GLU	A	24	-17.793	48.540	-22.509	1.00	72.21	C
ATOM	149	C	GLU	A	24	-18.746	49.719	-22.687	1.00	73.94	C
ATOM	150	O	GLU	A	24	-19.972	49.548	-22.728	1.00	75.11	O
ATOM	151	CB	GLU	A	24	-18.186	47.680	-21.302	1.00	82.71	C
ATOM	152	CG	GLU	A	24	-17.173	47.715	-20.118	1.00	83.09	C
ATOM	153	CD	GLU	A	24	-15.960	46.787	-20.303	1.00	83.44	C
ATOM	154	OE1	GLU	A	24	-16.162	45.563	-20.508	1.00	84.34	O
ATOM	155	OE2	GLU	A	24	-14.808	47.285	-20.234	1.00	78.82	O
ATOM	156	N	TYR	A	25	-18.152	50.910	-22.809	1.00	70.52	N
ATOM	157	CA	TYR	A	25	-18.863	52.179	-22.894	1.00	66.59	C
ATOM	158	C	TYR	A	25	-19.612	52.486	-21.614	1.00	68.56	C
ATOM	159	O	TYR	A	25	-20.615	53.201	-21.633	1.00	70.19	O
ATOM	160	CB	TYR	A	25	-19.842	52.198	-24.058	1.00	70.51	C
ATOM	161	CG	TYR	A	25	-19.201	51.985	-25.394	1.00	72.08	C
ATOM	162	CD1	TYR	A	25	-18.312	52.910	-25.916	1.00	67.16	C
ATOM	163	CD2	TYR	A	25	-19.497	50.857	-26.145	1.00	75.88	C
ATOM	164	CE1	TYR	A	25	-17.725	52.709	-27.149	1.00	69.95	C
ATOM	165	CE2	TYR	A	25	-18.918	50.647	-27.372	1.00	77.42	C
ATOM	166	CZ	TYR	A	25	-18.038	51.571	-27.872	1.00	75.92	C
ATOM	167	OH	TYR	A	25	-17.478	51.337	-29.103	1.00	77.63	O
ATOM	168	O	LYS	A	26	-17.918	53.803	-18.781	1.00	58.18	O
ATOM	169	N	LYS	A	26	-19.106	51.959	-20.506	1.00	64.18	N
ATOM	170	CA	LYS	A	26	-19.680	52.197	-19.191	1.00	66.21	C
ATOM	171	C	LYS	A	26	-19.058	53.411	-18.493	1.00	61.37	C
ATOM	172	CB	LYS	A	26	-19.500	50.958	-18.310	1.00	70.89	C
ATOM	173	N	VAL	A	27	-19.803	53.987	-17.558	1.00	56.80	N
ATOM	174	CA	VAL	A	27	-19.226	54.972	-16.658	1.00	51.50	C
ATOM	175	C	VAL	A	27	-18.874	54.348	-15.308	1.00	50.09	C
ATOM	176	O	VAL	A	27	-19.748	53.920	-14.566	1.00	57.58	O
ATOM	177	CB	VAL	A	27	-20.169	56.164	-16.438	1.00	59.58	C
ATOM	178	CG1	VAL	A	27	-19.545	57.151	-15.472	1.00	56.56	C
ATOM	179	CG2	VAL	A	27	-20.496	56.849	-17.773	1.00	57.39	C
ATOM	180	N	PRO	A	28	-17.579	54.311	-14.981	1.00	47.31	N
ATOM	181	CA	PRO	A	28	-17.073	53.892	-13.669	1.00	49.84	C
ATOM	182	C	PRO	A	28	-17.778	54.524	-12.476	1.00	58.91	C
ATOM	183	O	PRO	A	28	-18.527	55.492	-12.607	1.00	63.78	O
ATOM	184	CB	PRO	A	28	-15.605	54.350	-13.692	1.00	56.48	C
ATOM	185	CG	PRO	A	28	-15.231	54.388	-15.142	1.00	51.55	C
ATOM	186	CD	PRO	A	28	-16.495	54.626	-15.932	1.00	51.28	C
ATOM	187	N	SER	A	29	-17.535	53.936	-11.306	1.00	67.86	N
ATOM	188	CA	SER	A	29	-17.815	54.546	-10.007	1.00	50.68	C
ATOM	189	C	SER	A	29	-16.514	54.517	-9.244	1.00	55.70	C
ATOM	190	O	SER	A	29	-15.679	53.667	-9.503	1.00	66.74	O

ATOM	191	CB	SER	A	29	-18.864	53.776	-9.199	1.00	59.20	C
ATOM	192	OG	SER	A	29	-20.096	53.630	-9.859	1.00	61.34	O
ATOM	193	N	LYS	A	30	-16.337	55.440	-8.308	1.00	63.00	N
ATOM	194	CA	LYS	A	30	-15.332	55.290	-7.260	1.00	59.60	C
ATOM	195	C	LYS	A	30	-15.900	55.849	-5.949	1.00	62.28	C
ATOM	196	O	LYS	A	30	-16.714	56.799	-5.945	1.00	64.22	O
ATOM	197	CB	LYS	A	30	-14.013	55.978	-7.624	1.00	54.09	C
ATOM	198	CG	LYS	A	30	-13.254	55.332	-8.773	1.00	59.72	C
ATOM	199	CD	LYS	A	30	-11.879	55.956	-8.946	1.00	65.70	C
ATOM	200	CE	LYS	A	30	-11.052	55.249	-10.017	1.00	68.34	C
ATOM	201	NZ	LYS	A	30	-11.310	53.777	-10.050	1.00	79.94	N
ATOM	202	N	LYS	A	31	-15.510	55.218	-4.847	1.00	55.63	N
ATOM	203	CA	LYS	A	31	-15.774	55.740	-3.522	1.00	54.54	C
ATOM	204	C	LYS	A	31	-14.723	56.792	-3.266	1.00	60.61	C
ATOM	205	O	LYS	A	31	-13.524	56.542	-3.469	1.00	61.06	O
ATOM	206	CB	LYS	A	31	-15.714	54.652	-2.458	1.00	62.25	C
ATOM	207	CG	LYS	A	31	-16.856	53.650	-2.510	1.00	70.86	C
ATOM	208	CD	LYS	A	31	-16.433	52.317	-1.913	1.00	76.14	C
ATOM	209	CE	LYS	A	31	-17.556	51.319	-1.988	1.00	84.96	C
ATOM	210	NZ	LYS	A	31	-18.543	51.529	-0.900	1.00	89.99	N
ATOM	211	N	PHE	A	32	-15.172	57.971	-2.843	1.00	56.46	N
ATOM	212	CA	PHE	A	32	-14.275	59.111	-2.682	1.00	59.34	C
ATOM	213	C	PHE	A	32	-14.196	59.558	-1.249	1.00	59.21	C
ATOM	214	O	PHE	A	32	-15.211	59.643	-0.564	1.00	61.45	O
ATOM	215	CB	PHE	A	32	-14.723	60.290	-3.551	1.00	53.77	C
ATOM	216	CG	PHE	A	32	-14.391	60.126	-5.003	1.00	53.60	C
ATOM	217	CD1	PHE	A	32	-13.125	60.410	-5.466	1.00	49.20	C
ATOM	218	CD2	PHE	A	32	-15.344	59.671	-5.899	1.00	52.67	C
ATOM	219	CE1	PHE	A	32	-12.813	60.255	-6.804	1.00	51.77	C
ATOM	220	CE2	PHE	A	32	-15.037	59.516	-7.227	1.00	52.47	C
ATOM	221	CE	PHE	A	32	-13.771	59.812	-7.680	1.00	51.06	C
ATOM	222	N	LYS	A	33	-12.986	59.862	-0.804	1.00	56.96	N
ATOM	223	CA	LYS	A	33	-12.795	60.388	0.540	1.00	60.18	C
ATOM	224	C	LYS	A	33	-13.470	61.770	0.727	1.00	60.08	C
ATOM	225	O	LYS	A	33	-13.386	62.658	-0.126	1.00	52.61	O
ATOM	226	CB	LYS	A	33	-11.301	60.469	0.850	1.00	56.72	C
ATOM	227	CG	LYS	A	33	-10.955	61.178	2.143	1.00	62.76	C
ATOM	228	CD	LYS	A	33	-9.468	61.476	2.200	1.00	64.89	C
ATOM	229	CE	LYS	A	33	-8.669	60.191	2.167	1.00	69.92	C
ATOM	230	NZ	LYS	A	33	-8.891	59.406	3.407	1.00	67.46	N
ATOM	231	N	VAL	A	34	-14.137	61.917	1.864	1.00	59.95	N
ATOM	232	CA	VAL	A	34	-14.727	63.178	2.292	1.00	61.22	C
ATOM	233	C	VAL	A	34	-13.930	63.814	3.453	1.00	62.61	C
ATOM	234	O	VAL	A	34	-13.510	63.123	4.382	1.00	61.47	O
ATOM	235	CB	VAL	A	34	-16.173	62.963	2.732	1.00	63.44	C
ATOM	236	CG1	VAL	A	34	-16.801	64.271	3.163	1.00	64.10	C
ATOM	237	CG2	VAL	A	34	-16.964	62.302	1.614	1.00	60.59	C
ATOM	238	N	LEU	A	35	-13.707	65.124	3.395	1.00	55.62	N
ATOM	239	CA	LEU	A	35	-12.986	65.802	4.466	1.00	58.70	C
ATOM	240	C	LEU	A	35	-13.952	66.562	5.368	1.00	58.12	C
ATOM	241	O	LEU	A	35	-15.173	66.372	5.284	1.00	60.33	O
ATOM	242	CB	LEU	A	35	-11.919	66.729	3.891	1.00	53.22	C
ATOM	243	CG	LEU	A	35	-10.932	65.921	3.051	1.00	51.60	C
ATOM	244	CD1	LEU	A	35	-9.777	66.744	2.543	1.00	43.94	C
ATOM	245	CD2	LEU	A	35	-10.436	64.765	3.889	1.00	58.53	C
ATOM	246	O	GLY	A	36	-14.235	66.549	8.874	1.00	64.24	O
ATOM	247	N	GLY	A	36	-13.404	67.368	6.273	1.00	56.38	N
ATOM	248	CA	GLY	A	36	-14.225	68.202	7.139	1.00	61.11	C
ATOM	249	C	GLY	A	36	-14.577	67.663	8.513	1.00	61.85	C
ATOM	250	O	ASN	A	37	-17.396	67.054	11.818	1.00	66.00	O
ATOM	251	N	ASN	A	37	-15.282	68.471	9.291	1.00	66.08	N
ATOM	252	CA	ASN	A	37	-15.583	68.111	10.666	1.00	62.97	C
ATOM	253	C	ASN	A	37	-16.720	67.098	10.794	1.00	61.51	C

ATOM	254	CB	ASN	A	37	-15.919	69.383	11.469	1.00	52.12	C
ATOM	255	CG	ASN	A	37	-17.202	70.089	10.980	1.00	60.09	C
ATOM	256	OD1	ASN	A	37	-17.867	69.638	10.052	1.00	61.31	O
ATOM	257	ND2	ASN	A	37	-17.550	71.200	11.628	1.00	62.05	N
ATOM	258	O	THR	A	38	-17.264	63.412	9.966	1.00	61.03	O
ATOM	259	N	THR	A	38	-16.937	66.277	9.770	1.00	64.19	N
ATOM	260	CA	THR	A	38	-18.238	65.598	9.636	1.00	72.01	C
ATOM	261	C	THR	A	38	-18.285	64.070	9.875	1.00	64.77	C
ATOM	262	CB	THR	A	38	-18.826	65.874	8.225	1.00	73.63	C
ATOM	263	OG1	THR	A	38	-20.228	65.586	8.215	1.00	68.57	O
ATOM	264	CG2	THR	A	38	-18.092	65.043	7.150	1.00	65.04	C
ATOM	265	O	ASP	A	39	-20.784	60.455	8.649	1.00	77.75	O
ATOM	266	N	ASP	A	39	-19.511	63.550	9.971	1.00	74.66	N
ATOM	267	CA	ASP	A	39	-19.824	62.121	10.125	1.00	79.95	C
ATOM	268	C	ASP	A	39	-19.941	61.353	8.791	1.00	79.13	C
ATOM	269	CB	ASP	A	39	-21.147	61.956	10.895	1.00	78.92	C
ATOM	270	CG	ASP	A	39	-20.945	61.555	12.348	1.00	89.07	C
ATOM	271	OD1	ASP	A	39	-20.090	62.164	13.030	1.00	93.56	O
ATOM	272	OD2	ASP	A	39	-21.648	60.626	12.808	1.00	90.20	O
ATOM	273	O	ARG	A	40	-17.196	62.195	5.758	1.00	66.06	O
ATOM	274	N	ARG	A	40	-19.111	61.710	7.819	1.00	73.55	N
ATOM	275	CA	ARG	A	40	-19.158	61.090	6.503	1.00	69.26	C
ATOM	276	C	ARG	A	40	-17.763	61.124	5.931	1.00	65.29	C
ATOM	277	CB	ARG	A	40	-20.142	61.823	5.603	1.00	71.78	C
ATOM	278	CG	ARG	A	40	-20.332	61.218	4.221	1.00	69.94	C
ATOM	279	CD	ARG	A	40	-21.472	61.952	3.512	1.00	72.19	C
ATOM	280	NE	ARG	A	40	-22.276	61.069	2.673	1.00	70.45	N
ATOM	281	CZ	ARG	A	40	-23.536	61.310	2.333	1.00	67.59	C
ATOM	282	NH1	ARG	A	40	-24.146	62.412	2.753	1.00	68.58	N
ATOM	283	NH2	ARG	A	40	-24.187	60.444	1.572	1.00	68.15	N
ATOM	284	O	HIS	A	41	-14.280	59.593	3.559	1.00	57.93	O
ATOM	285	N	HIS	A	41	-17.187	59.960	5.660	1.00	70.29	N
ATOM	286	CA	HIS	A	41	-15.743	59.910	5.431	1.00	68.54	C
ATOM	287	C	HIS	A	41	-15.415	59.458	4.025	1.00	62.35	C
ATOM	288	CB	HIS	A	41	-15.075	59.009	6.483	1.00	69.24	C
ATOM	289	CG	HIS	A	41	-15.380	59.422	7.895	1.00	76.82	C
ATOM	290	ND1	HIS	A	41	-16.501	58.986	8.573	1.00	80.98	N
ATOM	291	CD2	HIS	A	41	-14.741	60.271	8.735	1.00	75.54	C
ATOM	292	CE1	HIS	A	41	-16.532	59.540	9.773	1.00	77.96	C
ATOM	293	NE2	HIS	A	41	-15.475	60.324	9.896	1.00	78.42	N
ATOM	294	O	SER	A	42	-18.624	58.332	2.009	1.00	56.23	O
ATOM	295	N	SER	A	42	-16.430	58.948	3.342	1.00	59.48	N
ATOM	296	CA	SER	A	42	-16.262	58.493	1.980	1.00	54.83	C
ATOM	297	C	SER	A	42	-17.617	58.465	1.318	1.00	53.91	C
ATOM	298	CB	SER	A	42	-15.594	57.117	1.948	1.00	57.20	C
ATOM	299	OG	SER	A	42	-16.369	56.176	1.227	1.00	58.88	O
ATOM	300	O	ILE	A	43	-17.809	57.981	-2.710	1.00	55.52	O
ATOM	301	N	ILE	A	43	-17.659	58.606	-0.007	1.00	49.28	N
ATOM	302	CA	ILE	A	43	-18.941	58.661	-0.707	1.00	58.17	C
ATOM	303	C	ILE	A	43	-18.886	58.032	-2.105	1.00	56.13	C
ATOM	304	CB	ILE	A	43	-19.438	60.140	-0.815	1.00	58.31	C
ATOM	305	CG1	ILE	A	43	-20.957	60.205	-0.991	1.00	55.77	C
ATOM	306	CG2	ILE	A	43	-18.699	60.871	-1.913	1.00	57.70	C
ATOM	307	CD1	ILE	A	43	-21.508	61.630	-0.987	1.00	60.72	C
ATOM	308	O	LYS	A	44	-21.587	58.529	-5.014	1.00	68.90	O
ATOM	309	N	LYS	A	44	-20.038	57.560	-2.604	1.00	47.79	N
ATOM	310	CA	LYS	A	44	-20.122	56.951	-3.937	1.00	57.38	C
ATOM	311	C	LYS	A	44	-20.519	57.909	-5.056	1.00	59.03	C
ATOM	312	CE	LYS	A	44	-21.112	55.778	-3.932	1.00	62.75	C
ATOM	313	O	LYS	A	45	-18.506	57.728	-8.787	1.00	54.37	O
ATOM	314	N	LYS	A	45	-19.674	58.003	-6.078	1.00	64.23	N
ATOM	315	CA	LYS	A	45	-19.955	58.888	-7.214	1.00	62.03	C
ATOM	316	C	LYS	A	45	-19.580	58.328	-8.593	1.00	60.01	C

ATOM	317	CB	LYS	A	45	-19.246	60.230	-7.001	1.00	61.22	C
ATOM	318	CG	LYS	A	45	-20.094	61.224	-6.210	1.00	61.31	C
ATOM	319	CD	LYS	A	45	-19.232	62.192	-5.451	1.00	60.33	C
ATOM	320	CE	LYS	A	45	-20.092	63.082	-4.556	1.00	56.47	C
ATOM	321	NZ	LYS	A	45	-19.217	64.134	-3.989	1.00	64.49	N
ATOM	322	O	ASN	A	46	-19.275	60.338	-11.387	1.00	57.94	O
ATOM	323	N	ASN	A	46	-20.476	58.563	-9.549	1.00	58.04	N
ATOM	324	CA	ASN	A	46	-20.252	58.207	-10.941	1.00	52.55	C
ATOM	325	C	ASN	A	46	-19.241	59.136	-11.601	1.00	54.06	C
ATOM	326	CB	ASN	A	46	-21.576	58.228	-11.699	1.00	54.31	C
ATOM	327	CG	ASN	A	46	-22.566	57.199	-11.173	1.00	63.30	C
ATOM	328	OD1	ASN	A	46	-22.192	56.067	-10.826	1.00	63.20	O
ATOM	329	ND2	ASN	A	46	-23.838	57.577	-11.127	1.00	57.76	N
ATOM	330	O	LEU	A	47	-17.367	59.967	-15.416	1.00	59.46	O
ATOM	331	N	LEU	A	47	-18.333	58.584	-12.393	1.00	56.16	N
ATOM	332	CA	LEU	A	47	-17.337	59.396	-13.077	1.00	52.49	C
ATOM	333	C	LEU	A	47	-17.909	60.085	-14.317	1.00	56.35	C
ATOM	334	CB	LEU	A	47	-16.131	58.532	-13.449	1.00	56.67	C
ATOM	335	CG	LEU	A	47	-14.915	58.664	-12.533	1.00	52.62	C
ATOM	336	CD1	LEU	A	47	-15.311	58.439	-11.087	1.00	59.35	C
ATOM	337	CD2	LEU	A	47	-13.782	57.727	-12.938	1.00	60.51	C
ATOM	338	O	ILE	A	48	-20.494	62.980	-13.241	1.00	56.45	O
ATOM	339	N	ILE	A	48	-19.022	60.790	-14.116	1.00	55.08	N
ATOM	340	CA	ILE	A	48	-19.606	61.705	-15.093	1.00	54.82	C
ATOM	341	C	ILE	A	48	-20.062	63.008	-14.390	1.00	55.35	C
ATOM	342	CB	ILE	A	48	-20.802	61.061	-15.808	1.00	52.21	C
ATOM	343	CG1	ILE	A	48	-21.241	61.897	-17.002	1.00	52.54	C
ATOM	344	CG2	ILE	A	48	-21.969	60.859	-14.847	1.00	51.65	C
ATOM	345	CD1	ILE	A	48	-22.408	61.295	-17.766	1.00	51.89	C
ATOM	346	O	GLY	A	49	-20.543	66.504	-16.572	1.00	51.38	O
ATOM	347	N	GLY	A	49	-19.963	64.150	-15.056	1.00	47.85	N
ATOM	348	CA	GLY	A	49	-20.457	65.368	-14.447	1.00	52.18	C
ATOM	349	C	GLY	A	49	-20.546	66.596	-15.341	1.00	52.12	C
ATOM	350	O	ALA	A	50	-20.887	70.353	-13.440	1.00	47.79	O
ATOM	351	N	ALA	A	50	-20.615	67.762	-14.708	1.00	49.90	N
ATOM	352	CA	ALA	A	50	-20.743	69.018	-15.431	1.00	45.63	C
ATOM	353	C	ALA	A	50	-20.384	70.213	-14.555	1.00	44.78	C
ATOM	354	CB	ALA	A	50	-22.143	69.159	-15.962	1.00	48.99	C
ATOM	355	O	LEU	A	51	-19.878	73.686	-16.249	1.00	41.52	O
ATOM	356	N	LEU	A	51	-19.490	71.052	-15.057	1.00	41.63	N
ATOM	357	CA	LEU	A	51	-19.159	72.304	-14.400	1.00	44.88	C
ATOM	358	C	LEU	A	51	-19.957	73.478	-15.041	1.00	44.40	C
ATOM	359	CB	LEU	A	51	-17.647	72.565	-14.476	1.00	40.73	C
ATOM	360	CG	LEU	A	51	-17.206	73.884	-13.853	1.00	43.83	C
ATOM	361	CD1	LEU	A	51	-17.433	73.853	-12.338	1.00	42.55	C
ATOM	362	CD2	LEU	A	51	-15.768	74.206	-14.216	1.00	37.81	C
ATOM	363	O	LEU	A	52	-20.371	76.695	-13.037	1.00	43.12	O
ATOM	364	N	LEU	A	52	-20.744	74.203	-14.235	1.00	41.48	N
ATOM	365	CA	LEU	A	52	-21.484	75.391	-14.709	1.00	40.32	C
ATOM	366	C	LEU	A	52	-20.815	76.645	-14.189	1.00	40.91	C
ATOM	367	CB	LEU	A	52	-22.951	75.371	-14.260	1.00	35.83	C
ATOM	368	CG	LEU	A	52	-23.629	73.999	-14.340	1.00	49.14	C
ATOM	369	CD1	LEU	A	52	-25.104	74.014	-13.861	1.00	40.87	C
ATOM	370	CD2	LEU	A	52	-23.499	73.412	-15.751	1.00	43.19	C
ATOM	371	O	PHE	A	53	-21.435	79.906	-16.422	1.00	40.66	O
ATOM	372	N	PHE	A	53	-20.733	77.659	-15.035	1.00	41.51	N
ATOM	373	CA	PHE	A	53	-20.205	78.952	-14.619	1.00	39.56	C
ATOM	374	C	PHE	A	53	-20.889	80.088	-15.335	1.00	43.04	C
ATOM	375	CB	PHE	A	53	-18.706	79.024	-14.874	1.00	40.25	C
ATOM	376	CG	PHE	A	53	-18.288	78.494	-16.212	1.00	35.14	C
ATOM	377	CD1	PHE	A	53	-18.014	77.150	-16.385	1.00	41.67	C
ATOM	378	CD2	PHE	A	53	-18.128	79.342	-17.288	1.00	41.06	C
ATOM	379	CE1	PHE	A	53	-17.605	76.647	-17.609	1.00	38.99	C

ATOM	380	CE2	PHE	A	53	-17.724	78.850	-18.529	1.00	42.29	C
ATOM	381	CZ	PHE	A	53	-17.461	77.496	-18.682	1.00	40.95	C
ATOM	382	O	ASP	A	54	-19.006	82.497	-16.247	1.00	42.43	O
ATOM	383	N	ASP	A	54	-20.835	81.260	-14.715	1.00	42.24	N
ATOM	384	CA	ASP	A	54	-21.216	82.508	-15.334	1.00	36.55	C
ATOM	385	C	ASP	A	54	-20.182	82.866	-16.381	1.00	40.45	C
ATOM	386	CB	ASP	A	54	-21.309	83.625	-14.286	1.00	40.10	C
ATOM	387	CG	ASP	A	54	-22.365	83.357	-13.260	1.00	46.92	C
ATOM	388	OD1	ASP	A	54	-23.263	82.548	-13.553	1.00	53.11	O
ATOM	389	OD2	ASP	A	54	-22.317	83.939	-12.161	1.00	52.18	O
ATOM	390	O	SER	A	55	-18.811	85.815	-17.561	1.00	41.56	O
ATOM	391	N	SER	A	55	-20.599	83.626	-17.390	1.00	41.06	N
ATOM	392	CA	SER	A	55	-19.776	83.905	-18.566	1.00	45.09	C
ATOM	393	C	SER	A	55	-18.643	84.861	-18.298	1.00	44.11	C
ATOM	394	CB	SER	A	55	-20.643	84.480	-19.697	1.00	43.53	C
ATOM	395	OG	SER	A	55	-22.006	84.287	-19.399	1.00	47.20	O
ATOM	396	O	GLY	A	56	-17.390	86.701	-20.831	1.00	51.53	O
ATOM	397	N	GLY	A	56	-17.495	84.613	-18.935	1.00	48.39	N
ATOM	398	CA	GLY	A	56	-16.400	85.565	-18.956	1.00	42.08	C
ATOM	399	C	GLY	A	56	-16.743	86.794	-19.782	1.00	51.38	C
ATOM	400	O	GLU	A	57	-14.259	89.551	-20.417	1.00	46.34	O
ATOM	401	N	GLU	A	57	-16.294	87.956	-19.318	1.00	44.47	N
ATOM	402	CA	GLU	A	57	-16.595	89.211	-19.975	1.00	40.45	C
ATOM	403	C	GLU	A	57	-15.414	89.767	-20.758	1.00	40.57	C
ATOM	404	CB	GLU	A	57	-17.055	90.249	-18.931	1.00	41.06	C
ATOM	405	CG	GLU	A	57	-18.239	89.752	-18.112	1.00	44.02	C
ATOM	406	CD	GLU	A	57	-18.741	90.754	-17.060	1.00	50.78	C
ATOM	407	OE1	GLU	A	57	-18.026	91.713	-16.687	1.00	54.86	O
ATOM	408	OE2	GLU	A	57	-19.871	90.573	-16.583	1.00	58.67	O
ATOM	409	O	THR	A	58	-14.899	92.797	-20.522	1.00	42.18	O
ATOM	410	N	THR	A	58	-15.717	90.506	-21.807	1.00	40.48	N
ATOM	411	CA	THR	A	58	-14.731	91.351	-22.458	1.00	43.49	C
ATOM	412	C	THR	A	58	-14.285	92.504	-21.561	1.00	41.40	C
ATOM	413	CB	THR	A	58	-15.292	91.947	-23.767	1.00	42.70	C
ATOM	414	OG1	THR	A	58	-16.410	92.787	-23.452	1.00	37.65	O
ATOM	415	CG2	THR	A	58	-15.744	90.828	-24.706	1.00	35.12	C
ATOM	416	O	ALA	A	59	-12.832	96.677	-21.260	1.00	43.43	O
ATOM	417	N	ALA	A	59	-13.217	93.157	-21.992	1.00	38.31	N
ATOM	418	CA	ALA	A	59	-12.639	94.263	-21.260	1.00	42.21	C
ATOM	419	C	ALA	A	59	-13.237	95.610	-21.724	1.00	41.54	C
ATOM	420	CB	ALA	A	59	-11.125	94.253	-21.420	1.00	32.33	C
ATOM	421	O	GLU	A	60	-15.181	98.885	-22.217	1.00	37.80	O
ATOM	422	N	GLU	A	60	-14.217	95.539	-22.618	1.00	41.38	N
ATOM	423	CA	GLU	A	60	-14.806	96.730	-23.235	1.00	46.21	C
ATOM	424	C	GLU	A	60	-15.504	97.714	-22.252	1.00	39.53	C
ATOM	425	CE	GLU	A	60	-15.801	96.314	-24.315	1.00	41.05	C
ATOM	426	CG	GLU	A	60	-16.653	97.478	-24.766	1.00	41.17	C
ATOM	427	CD	GLU	A	60	-17.068	97.385	-26.222	1.00	53.23	C
ATOM	428	OE1	GLU	A	60	-16.456	96.599	-26.978	1.00	56.84	O
ATOM	429	OE2	GLU	A	60	-18.002	98.114	-26.610	1.00	61.87	O
ATOM	430	N	ALA	A	61	-16.456	97.212	-21.479	1.00	36.79	N
ATOM	431	CA	ALA	A	61	-17.125	98.006	-20.472	1.00	39.93	C
ATOM	432	C	ALA	A	61	-16.117	98.647	-19.488	1.00	38.65	C
ATOM	433	O	ALA	A	61	-16.326	99.750	-19.015	1.00	44.78	O
ATOM	434	CB	ALA	A	61	-18.155	97.136	-19.720	1.00	31.90	C
ATOM	435	N	THR	A	62	-15.027	97.950	-19.199	1.00	43.26	N
ATOM	436	CA	THR	A	62	-14.042	98.400	-18.238	1.00	34.47	C
ATOM	437	C	THR	A	62	-13.208	99.500	-18.871	1.00	36.56	C
ATOM	438	O	THR	A	62	-12.857	100.479	-18.214	1.00	40.82	O
ATOM	439	CB	THR	A	62	-13.179	97.204	-17.751	1.00	38.66	C
ATOM	440	OG1	THR	A	62	-13.987	96.330	-16.951	1.00	40.08	O
ATOM	441	CG2	THR	A	62	-11.981	97.641	-16.931	1.00	39.48	C
ATOM	442	N	ARG	A	63	-12.943	99.383	-20.162	1.00	39.49	N

ATOM	443	CA	ARG	A	63	-12.166	100.396	-20.892	1.00	38.82	C
ATOM	444	C	ARG	A	63	-12.943	101.717	-21.158	1.00	35.71	C
ATOM	445	O	ARG	A	63	-12.378	102.803	-21.011	1.00	41.90	O
ATOM	446	CB	ARG	A	63	-11.656	99.801	-22.223	1.00	37.49	C
ATOM	447	CG	ARG	A	63	-10.953	100.786	-23.133	1.00	36.55	C
ATOM	448	CD	ARG	A	63	-10.527	100.162	-24.460	1.00	38.38	C
ATOM	449	NE	ARG	A	63	-11.647	99.917	-25.370	1.00	40.81	N
ATOM	450	CZ	ARG	A	63	-12.133	98.719	-25.719	1.00	42.16	C
ATOM	451	NH1	ARG	A	63	-13.154	98.652	-26.557	1.00	43.21	N
ATOM	452	NH2	ARG	A	63	-11.623	97.588	-25.244	1.00	39.23	N
ATOM	453	N	LEU	A	64	-14.208	101.631	-21.560	1.00	35.90	N
ATOM	454	CA	LEU	A	64	-15.050	102.846	-21.713	1.00	34.46	C
ATOM	455	C	LEU	A	64	-15.092	103.653	-20.438	1.00	32.10	C
ATOM	456	O	LEU	A	64	-14.871	104.853	-20.453	1.00	39.98	O
ATOM	457	CB	LEU	A	64	-16.463	102.475	-22.140	1.00	32.44	C
ATOM	458	CG	LEU	A	64	-16.415	101.823	-23.536	1.00	46.06	C
ATOM	459	CD1	LEU	A	64	-17.759	101.276	-23.961	1.00	45.31	C
ATOM	460	CD2	LEU	A	64	-15.864	102.781	-24.595	1.00	37.94	C
ATOM	461	N	LYS	A	65	-15.296	102.990	-19.307	1.00	39.07	N
ATOM	462	CA	LYS	A	65	-15.323	103.704	-18.031	1.00	34.09	C
ATOM	463	C	LYS	A	65	-13.966	104.307	-17.672	1.00	38.35	C
ATOM	464	O	LYS	A	65	-13.912	105.457	-17.227	1.00	38.38	O
ATOM	465	CB	LYS	A	65	-15.828	102.787	-16.927	1.00	33.01	C
ATOM	466	CG	LYS	A	65	-17.265	102.428	-17.148	1.00	27.42	C
ATOM	467	CD	LYS	A	65	-17.790	101.402	-16.195	1.00	37.88	C
ATOM	468	CE	LYS	A	65	-19.282	101.227	-16.424	1.00	45.14	C
ATOM	469	NZ	LYS	A	65	-19.730	99.896	-15.984	1.00	55.32	N
ATOM	470	N	ARG	A	66	-12.879	103.571	-17.929	1.00	38.13	N
ATOM	471	CA	ARG	A	66	-11.527	104.055	-17.648	1.00	35.44	C
ATOM	472	C	ARG	A	66	-11.278	105.395	-18.341	1.00	37.39	C
ATOM	473	O	ARG	A	66	-10.807	106.378	-17.737	1.00	41.01	O
ATOM	474	CB	ARG	A	66	-10.479	103.009	-18.095	1.00	38.31	C
ATOM	475	CG	ARG	A	66	-9.020	103.333	-17.749	1.00	38.94	C
ATOM	476	CD	ARG	A	66	-7.967	102.329	-18.393	1.00	43.06	C
ATOM	477	NE	ARG	A	66	-8.465	100.962	-18.470	1.00	36.24	N
ATOM	478	CZ	ARG	A	66	-8.503	100.265	-19.586	1.00	39.15	C
ATOM	479	NH1	ARG	A	66	-8.987	99.044	-19.588	1.00	41.23	N
ATOM	480	NH2	ARG	A	66	-8.050	100.789	-20.705	1.00	40.65	N
ATOM	481	N	THR	A	67	-11.617	105.417	-19.616	1.00	34.83	N
ATOM	482	CA	THR	A	67	-11.419	106.564	-20.474	1.00	34.78	C
ATOM	483	C	THR	A	67	-12.357	107.742	-20.097	1.00	40.97	C
ATOM	484	O	THR	A	67	-11.960	108.901	-20.123	1.00	41.32	O
ATOM	485	CB	THR	A	67	-11.632	106.114	-21.914	1.00	38.48	C
ATOM	486	OG1	THR	A	67	-10.369	106.107	-22.580	1.00	54.40	O
ATOM	487	CG2	THR	A	67	-12.578	106.978	-22.641	1.00	36.99	C
ATOM	488	N	ALA	A	68	-13.583	107.415	-19.699	1.00	39.04	N
ATOM	489	CA	ALA	A	68	-14.510	108.390	-19.164	1.00	35.74	C
ATOM	490	C	ALA	A	68	-14.016	108.949	-17.838	1.00	39.54	C
ATOM	491	O	ALA	A	68	-14.246	110.123	-17.526	1.00	38.51	O
ATOM	492	CB	ALA	A	68	-15.892	107.767	-18.993	1.00	31.84	C
ATOM	493	N	ARG	A	69	-13.340	108.118	-17.038	1.00	38.94	N
ATOM	494	CA	ARG	A	69	-12.782	108.626	-15.784	1.00	38.97	C
ATOM	495	C	ARG	A	69	-11.686	109.646	-16.091	1.00	36.83	C
ATOM	496	O	ARG	A	69	-11.639	110.715	-15.482	1.00	44.81	O
ATOM	497	CB	ARG	A	69	-12.237	107.511	-14.924	1.00	39.94	C
ATOM	498	CG	ARG	A	69	-13.169	106.966	-13.888	1.00	34.99	C
ATOM	499	CD	ARG	A	69	-12.341	105.999	-13.061	1.00	42.20	C
ATOM	500	NE	ARG	A	69	-12.626	104.617	-13.413	1.00	47.45	N
ATOM	501	CZ	ARG	A	69	-11.784	103.773	-13.960	1.00	38.38	C
ATOM	502	NH1	ARG	A	69	-10.525	104.121	-14.205	1.00	46.89	N
ATOM	503	NH2	ARG	A	69	-12.214	102.566	-14.234	1.00	42.76	N
ATOM	504	N	ARG	A	70	-10.852	109.365	-17.079	1.00	36.24	N
ATOM	505	CA	ARG	A	70	-9.819	110.338	-17.399	1.00	39.81	C

ATOM	506	C	ARG	A	70	-10.430	111.663	-17.828	1.00	43.34	C
ATOM	507	O	ARG	A	70	-9.946	112.723	-17.468	1.00	47.29	O
ATOM	508	CB	ARG	A	70	-8.885	109.819	-18.495	1.00	36.89	C
ATOM	509	CG	ARG	A	70	-8.058	108.608	-18.058	1.00	35.18	C
ATOM	510	CD	ARG	A	70	-7.032	108.198	-19.130	1.00	42.28	C
ATOM	511	NE	ARG	A	70	-6.282	106.986	-18.747	1.00	46.73	N
ATOM	512	CZ	ARG	A	70	-6.253	105.857	-19.461	1.00	43.84	C
ATOM	513	NH1	ARG	A	70	-6.928	105.764	-20.591	1.00	41.51	N
ATOM	514	NH2	ARG	A	70	-5.557	104.812	-19.039	1.00	46.30	N
ATOM	515	N	ARG	A	71	-11.500	111.584	-18.598	1.00	42.61	N
ATOM	516	CA	ARG	A	71	-12.014	112.733	-19.298	1.00	41.12	C
ATOM	517	C	ARG	A	71	-12.744	113.697	-18.357	1.00	38.30	C
ATOM	518	O	ARG	A	71	-12.587	114.903	-18.463	1.00	43.33	O
ATOM	519	CB	ARG	A	71	-12.908	112.268	-20.444	1.00	39.89	C
ATOM	520	CG	ARG	A	71	-12.165	112.226	-21.749	1.00	33.95	C
ATOM	521	CD	ARG	A	71	-13.091	112.034	-22.876	1.00	34.75	C
ATOM	522	NE	ARG	A	71	-13.850	110.801	-22.703	1.00	49.32	N
ATOM	523	CZ	ARG	A	71	-15.041	110.570	-23.255	1.00	54.97	C
ATOM	524	NH1	ARG	A	71	-15.651	109.401	-23.037	1.00	50.26	N
ATOM	525	NH2	ARG	A	71	-15.623	111.512	-24.017	1.00	47.26	N
ATOM	526	N	TYR	A	72	-13.485	113.155	-17.404	1.00	35.85	N
ATOM	527	CA	TYR	A	72	-13.994	113.942	-16.304	1.00	35.00	C
ATOM	528	C	TYR	A	72	-12.889	114.626	-15.466	1.00	43.12	C
ATOM	529	O	TYR	A	72	-13.018	115.798	-15.117	1.00	47.30	O
ATOM	530	CB	TYR	A	72	-14.882	113.078	-15.413	1.00	35.43	C
ATOM	531	CG	TYR	A	72	-16.292	112.847	-15.957	1.00	42.40	C
ATOM	532	CD1	TYR	A	72	-17.075	113.911	-16.457	1.00	35.36	C
ATOM	533	CD2	TYR	A	72	-16.841	111.573	-15.975	1.00	40.74	C
ATOM	534	CE1	TYR	A	72	-18.352	113.690	-16.940	1.00	34.07	C
ATOM	535	CE2	TYR	A	72	-18.110	111.356	-16.452	1.00	41.64	C
ATOM	536	CZ	TYR	A	72	-18.862	112.424	-16.927	1.00	39.72	C
ATOM	537	OH	TYR	A	72	-20.108	112.157	-17.391	1.00	37.40	O
ATOM	538	N	THR	A	73	-11.802	113.920	-15.158	1.00	44.82	N
ATOM	539	CA	THR	A	73	-10.663	114.548	-14.494	1.00	41.92	C
ATOM	540	C	THR	A	73	-10.156	115.733	-15.325	1.00	42.58	C
ATOM	541	O	THR	A	73	-10.022	116.842	-14.817	1.00	44.27	O
ATOM	542	CB	THR	A	73	-9.548	113.506	-14.221	1.00	47.98	C
ATOM	543	OG1	THR	A	73	-9.777	112.932	-12.933	1.00	53.84	O
ATOM	544	CG2	THR	A	73	-8.134	114.108	-14.253	1.00	43.19	C
ATOM	545	N	ARG	A	74	-9.942	115.506	-16.613	1.00	43.70	N
ATOM	546	C	ARG	A	74	-10.442	117.683	-17.796	1.00	50.38	C
ATOM	547	CA	ARG	A	74	-9.429	116.534	-17.508	1.00	40.30	C
ATOM	548	O	ARG	A	74	-10.042	118.836	-17.969	1.00	50.62	O
ATOM	549	CB	ARG	A	74	-8.971	115.881	-18.816	1.00	37.97	C
ATOM	550	CG	ARG	A	74	-7.722	114.961	-18.658	1.00	45.02	C
ATOM	551	CD	ARG	A	74	-7.443	114.014	-19.860	1.00	44.64	C
ATOM	552	NE	ARG	A	74	-6.388	113.053	-19.554	1.00	46.01	N
ATOM	553	CZ	ARG	A	74	-6.079	111.984	-20.289	1.00	50.55	C
ATOM	554	NH1	ARG	A	74	-6.743	111.685	-21.404	1.00	46.01	N
ATOM	555	NH2	ARG	A	74	-5.096	111.190	-19.892	1.00	53.43	N
ATOM	556	N	ARG	A	75	-11.738	117.392	-17.854	1.00	45.18	N
ATOM	557	C	ARG	A	75	-12.639	119.373	-16.795	1.00	44.11	C
ATOM	558	CA	ARG	A	75	-12.708	118.482	-18.032	1.00	45.86	C
ATOM	559	O	ARG	A	75	-12.524	120.583	-16.894	1.00	47.22	O
ATOM	560	CB	ARG	A	75	-14.132	117.951	-18.246	1.00	38.78	C
ATOM	561	CG	ARG	A	75	-15.116	118.963	-18.800	1.00	39.15	C
ATOM	562	CD	ARG	A	75	-16.564	118.443	-18.792	1.00	35.65	C
ATOM	563	NE	ARG	A	75	-17.063	118.117	-17.455	1.00	34.90	N
ATOM	564	CZ	ARG	A	75	-18.275	117.626	-17.219	1.00	36.55	C
ATOM	565	NH1	ARG	A	75	-19.100	117.437	-18.229	1.00	35.62	N
ATOM	566	NH2	ARG	A	75	-18.662	117.298	-15.994	1.00	27.92	N
ATOM	567	N	LYS	A	76	-12.660	118.763	-15.623	1.00	41.82	N
ATOM	568	C	LYS	A	76	-11.212	120.319	-14.422	1.00	54.95	C

ATOM	569	CA	LYS	A	76	-12.512	119.525	-14.412	1.00	42.56	C
ATOM	570	O	LYS	A	76	-11.208	121.494	-14.052	1.00	56.29	O
ATOM	571	CB	LYS	A	76	-12.568	118.610	-13.202	1.00	48.12	C
ATOM	572	CG	LYS	A	76	-11.894	119.163	-11.969	1.00	47.39	C
ATOM	573	CD	LYS	A	76	-12.600	118.646	-10.724	1.00	48.57	C
ATOM	574	CE	LYS	A	76	-12.948	117.144	-10.812	1.00	50.97	C
ATOM	575	NZ	LYS	A	76	-14.169	116.806	-9.964	1.00	45.03	N
ATOM	576	N	ASN	A	77	-10.115	119.706	-14.874	1.00	52.37	N
ATOM	577	C	ASN	A	77	-8.933	121.708	-15.772	1.00	52.46	C
ATOM	578	CA	ASN	A	77	-8.860	120.450	-14.923	1.00	50.20	C
ATOM	579	O	ASN	A	77	-8.489	122.756	-15.336	1.00	58.17	O
ATOM	580	CB	ASN	A	77	-7.731	119.557	-15.403	1.00	49.88	C
ATOM	581	CG	ASN	A	77	-7.297	118.603	-14.336	1.00	52.71	C
ATOM	582	OD1	ASN	A	77	-7.737	118.734	-13.197	1.00	57.83	O
ATOM	583	ND2	ASN	A	77	-6.441	117.633	-14.678	1.00	51.04	N
ATOM	584	N	ARG	A	78	-9.510	121.591	-16.965	1.00	53.34	N
ATOM	585	C	ARG	A	78	-10.305	123.922	-17.191	1.00	55.27	C
ATOM	586	CA	ARG	A	78	-9.711	122.701	-17.888	1.00	45.41	C
ATOM	587	O	ARG	A	78	-9.881	125.057	-17.410	1.00	60.02	O
ATOM	588	CB	ARG	A	78	-10.646	122.281	-19.022	1.00	53.93	C
ATOM	589	CG	ARG	A	78	-9.991	121.769	-20.296	1.00	47.40	C
ATOM	590	CD	ARG	A	78	-10.979	121.829	-21.452	1.00	45.55	C
ATOM	591	NE	ARG	A	78	-11.355	120.493	-21.849	1.00	59.54	N
ATOM	592	CZ	ARG	A	78	-12.585	120.001	-21.824	1.00	52.87	C
ATOM	593	NH1	ARG	A	78	-13.606	120.748	-21.455	1.00	56.71	N
ATOM	594	NH2	ARG	A	78	-12.783	118.752	-22.199	1.00	56.21	N
ATOM	595	N	ILE	A	79	-11.304	123.679	-16.356	1.00	55.59	N
ATOM	596	C	ILE	A	79	-10.984	125.351	-14.613	1.00	55.71	C
ATOM	597	CA	ILE	A	79	-11.946	124.748	-15.616	1.00	54.11	C
ATOM	598	O	ILE	A	79	-10.828	126.576	-14.543	1.00	57.15	O
ATOM	599	CB	ILE	A	79	-13.194	124.249	-14.899	1.00	54.24	C
ATOM	600	CG1	ILE	A	79	-14.254	123.918	-15.933	1.00	49.28	C
ATOM	601	CG2	ILE	A	79	-13.754	125.338	-13.993	1.00	50.58	C
ATOM	602	CD1	ILE	A	79	-14.717	125.169	-16.680	1.00	53.44	C
ATOM	603	N	LEU	A	80	-10.339	124.470	-13.851	1.00	56.13	N
ATOM	604	C	LEU	A	80	-8.188	125.645	-13.499	1.00	59.98	C
ATOM	605	CA	LEU	A	80	-9.328	124.843	-12.866	1.00	59.97	C
ATOM	606	O	LEU	A	80	-7.633	126.540	-12.867	1.00	57.07	O
ATOM	607	CB	LEU	A	80	-8.758	123.598	-12.180	1.00	54.23	C
ATOM	608	CG	LEU	A	80	-9.637	122.797	-11.224	1.00	54.58	C
ATOM	609	CD1	LEU	A	80	-8.849	121.605	-10.656	1.00	57.30	C
ATOM	610	CD2	LEU	A	80	-10.187	123.661	-10.112	1.00	53.16	C
ATOM	611	N	TYR	A	81	-7.834	125.308	-14.735	1.00	57.27	N
ATOM	612	C	TYR	A	81	-7.294	127.479	-15.696	1.00	64.98	C
ATOM	613	CA	TYR	A	81	-6.807	126.049	-15.449	1.00	59.30	C
ATOM	614	O	TYR	A	81	-6.499	128.418	-15.767	1.00	71.65	O
ATOM	615	CB	TYR	A	81	-6.456	125.386	-16.783	1.00	55.68	C
ATOM	616	CG	TYR	A	81	-5.720	124.051	-16.717	1.00	62.39	C
ATOM	617	CD1	TYR	A	81	-4.960	123.687	-15.612	1.00	64.66	C
ATOM	618	CD2	TYR	A	81	-5.764	123.169	-17.789	1.00	58.53	C
ATOM	619	CE1	TYR	A	81	-4.284	122.466	-15.577	1.00	60.78	C
ATOM	620	CE2	TYR	A	81	-5.097	121.963	-17.765	1.00	56.32	C
ATOM	621	CZ	TYR	A	81	-4.358	121.609	-16.666	1.00	62.22	C
ATOM	622	OH	TYR	A	81	-3.695	120.387	-16.667	1.00	61.93	O
ATOM	623	N	LEU	A	82	-8.603	127.650	-15.832	1.00	62.56	N
ATOM	624	C	LEU	A	82	-9.397	129.717	-14.874	1.00	62.15	C
ATOM	625	CA	LEU	A	82	-9.133	128.963	-16.153	1.00	60.44	C
ATOM	626	O	LEU	A	82	-9.342	130.943	-14.851	1.00	65.37	O
ATOM	627	CB	LEU	A	82	-10.409	128.859	-16.981	1.00	60.34	C
ATOM	628	CG	LEU	A	82	-11.150	130.143	-17.400	1.00	58.21	C
ATOM	629	CD1	LEU	A	82	-10.556	130.761	-18.664	1.00	51.12	C
ATOM	630	CD2	LEU	A	82	-12.625	129.843	-17.586	1.00	53.67	C
ATOM	631	N	GLN	A	83	-9.683	128.981	-13.806	1.00	60.66	N

ATOM	632	C	GLN	A	83	-8.638	130.129	-11.939	1.00	70.27	C
ATOM	633	CA	GLN	A	83	-9.937	129.604	-12.515	1.00	61.28	C
ATOM	634	O	GLN	A	83	-8.632	131.099	-11.173	1.00	69.13	O
ATOM	635	CB	GLN	A	83	-10.597	128.625	-11.543	1.00	57.98	C
ATOM	636	CG	GLN	A	83	-12.078	128.453	-11.805	1.00	59.33	C
ATOM	637	CD	GLN	A	83	-12.741	127.516	-10.833	1.00	59.45	C
ATOM	638	OE1	GLN	A	83	-12.149	127.122	-9.836	1.00	63.22	O
ATOM	639	NE2	GLN	A	83	-13.982	127.148	-11.117	1.00	60.18	N
ATOM	640	N	GLU	A	84	-7.539	129.482	-12.319	1.00	65.73	N
ATOM	641	C	GLU	A	84	-5.988	131.317	-12.521	1.00	66.92	C
ATOM	642	CA	GLU	A	84	-6.223	129.942	-11.922	1.00	65.50	C
ATOM	643	O	GLU	A	84	-5.784	132.284	-11.800	1.00	69.29	O
ATOM	644	CB	GLU	A	84	-5.131	128.966	-12.367	1.00	59.00	C
ATOM	645	N	ILE	A	85	-6.052	131.389	-13.844	1.00	65.11	N
ATOM	646	C	ILE	A	85	-6.618	133.781	-14.058	1.00	67.42	C
ATOM	647	CA	ILE	A	85	-5.788	132.615	-14.576	1.00	66.00	C
ATOM	648	O	ILE	A	85	-6.167	134.912	-14.068	1.00	72.70	O
ATOM	649	CB	ILE	A	85	-6.034	132.398	-16.076	1.00	64.79	C
ATOM	650	CG1	ILE	A	85	-4.948	131.469	-16.638	1.00	72.07	C
ATOM	651	CG2	ILE	A	85	-6.060	133.716	-16.833	1.00	67.91	C
ATOM	652	CD1	ILE	A	85	-5.088	131.164	-18.126	1.00	71.79	C
ATOM	653	O	PHE	A	86	-9.116	135.753	-11.058	1.00	74.19	O
ATOM	654	N	PHE	A	86	-7.806	133.480	-13.550	1.00	70.81	N
ATOM	655	CA	PHE	A	86	-8.728	134.487	-13.043	1.00	71.34	C
ATOM	656	C	PHE	A	86	-8.540	134.796	-11.558	1.00	72.85	C
ATOM	657	CB	PHE	A	86	-10.181	134.037	-13.262	1.00	68.97	C
ATOM	658	CG	PHE	A	86	-10.810	134.584	-14.502	1.00	67.34	C
ATOM	659	CD2	PHE	A	86	-11.934	135.384	-14.422	1.00	65.77	C
ATOM	660	CD1	PHE	A	86	-10.298	134.284	-15.748	1.00	69.34	C
ATOM	661	CE2	PHE	A	86	-12.528	135.883	-15.562	1.00	64.27	C
ATOM	662	CE1	PHE	A	86	-10.891	134.785	-16.892	1.00	66.89	C
ATOM	663	CZ	PHE	A	86	-12.007	135.583	-16.795	1.00	62.14	C
ATOM	664	O	SER	A	87	-8.247	135.933	-8.008	1.00	82.74	O
ATOM	665	N	SER	A	87	-7.757	133.980	-10.860	1.00	71.63	N
ATOM	666	CA	SER	A	87	-7.672	134.036	-9.390	1.00	76.88	C
ATOM	667	C	SER	A	87	-7.443	135.438	-8.810	1.00	81.48	C
ATOM	668	CB	SER	A	87	-6.550	133.127	-8.898	1.00	76.37	C
ATOM	669	OG	SER	A	87	-5.288	133.700	-9.213	1.00	76.86	O
ATOM	670	O	ASN	A	88	-7.623	138.928	-7.998	1.00	81.24	O
ATOM	671	N	ASN	A	88	-6.333	136.055	-9.212	1.00	79.26	N
ATOM	672	CA	ASN	A	88	-5.944	137.373	-8.720	1.00	83.29	C
ATOM	673	C	ASN	A	88	-7.026	138.404	-8.943	1.00	81.57	C
ATOM	674	CB	ASN	A	88	-4.660	137.850	-9.404	1.00	79.60	C
ATOM	675	CG	ASN	A	88	-3.453	137.038	-9.007	1.00	76.96	C
ATOM	676	OD1	ASN	A	88	-3.380	136.513	-7.893	1.00	78.48	O
ATOM	677	ND2	ASN	A	88	-2.489	136.933	-9.916	1.00	79.80	N
ATOM	678	O	GLU	A	89	-10.437	140.367	-10.218	1.00	85.50	O
ATOM	679	N	GLU	A	89	-7.268	138.676	-10.218	1.00	79.47	N
ATOM	680	CA	GLU	A	89	-8.182	139.718	-10.629	1.00	74.74	C
ATOM	681	C	GLU	A	89	-9.630	139.444	-10.228	1.00	78.97	C
ATOM	682	CB	GLU	A	89	-8.067	139.923	-12.135	1.00	71.64	C
ATOM	683	CG	GLU	A	89	-6.708	140.483	-12.563	1.00	78.23	C
ATOM	684	CD	GLU	A	89	-6.612	142.017	-12.474	1.00	79.90	C
ATOM	685	OE1	GLU	A	89	-7.570	142.676	-12.002	1.00	80.77	O
ATOM	686	OE2	GLU	A	89	-5.572	142.565	-12.888	1.00	77.09	O
ATOM	687	O	MET	A	90	-12.416	138.490	-7.321	1.00	83.45	O
ATOM	688	N	MET	A	90	-9.965	138.200	-9.878	1.00	81.51	N
ATOM	689	CA	MET	A	90	-11.313	137.899	-9.370	1.00	82.05	C
ATOM	690	C	MET	A	90	-11.378	138.114	-7.864	1.00	82.31	C
ATOM	691	CB	MET	A	90	-11.748	136.462	-9.697	1.00	74.64	C
ATOM	692	CG	MET	A	90	-12.751	136.329	-10.855	1.00	76.41	C
ATOM	693	SD	MET	A	90	-14.360	137.157	-10.633	1.00	72.38	S
ATOM	694	CE	MET	A	90	-14.756	136.696	-8.955	1.00	66.62	C

ATOM	695	O	ALA	A	91	-10.863	139.885	-4.289	1.00	80.18	O
ATOM	696	N	ALA	A	91	-10.261	137.877	-7.187	1.00	83.70	N
ATOM	697	CA	ALA	A	91	-10.211	138.078	-5.749	1.00	86.16	C
ATOM	698	C	ALA	A	91	-10.491	139.553	-5.413	1.00	83.22	C
ATOM	699	CB	ALA	A	91	-8.868	137.634	-5.209	1.00	77.59	C
ATOM	700	O	LYS	A	92	-12.624	143.022	-5.807	1.00	82.38	O
ATOM	701	N	LYS	A	92	-10.327	140.417	-6.414	1.00	79.94	N
ATOM	702	CA	LYS	A	92	-10.584	141.848	-6.281	1.00	83.43	C
ATOM	703	C	LYS	A	92	-12.057	142.203	-6.525	1.00	79.48	C
ATOM	704	CB	LYS	A	92	-9.691	142.640	-7.248	1.00	81.94	C
ATOM	705	CG	LYS	A	92	-8.191	142.423	-7.052	1.00	74.45	C
ATOM	706	CD	LYS	A	92	-7.368	143.145	-8.116	1.00	75.05	C
ATOM	707	CE	LYS	A	92	-5.876	142.843	-7.965	1.00	73.95	C
ATOM	708	NZ	LYS	A	92	-5.023	143.405	-9.059	1.00	73.13	N
ATOM	709	O	VAL	A	93	-16.024	141.724	-6.475	1.00	72.30	O
ATOM	710	N	VAL	A	93	-12.672	141.589	-7.533	1.00	78.25	N
ATOM	711	CA	VAL	A	93	-14.070	141.869	-7.870	1.00	80.12	C
ATOM	712	C	VAL	A	93	-15.063	141.135	-6.961	1.00	80.79	C
ATOM	713	CB	VAL	A	93	-14.372	141.499	-9.331	1.00	78.07	C
ATOM	714	CG1	VAL	A	93	-15.814	141.831	-9.677	1.00	76.06	C
ATOM	715	CG2	VAL	A	93	-13.421	142.226	-10.254	1.00	81.49	C
ATOM	716	O	ASP	A	94	-14.237	137.123	-5.931	1.00	86.98	O
ATOM	717	N	ASP	A	94	-14.834	139.841	-6.752	1.00	82.06	N
ATOM	718	CA	ASP	A	94	-15.655	139.045	-5.838	1.00	80.61	C
ATOM	719	C	ASP	A	94	-14.794	137.955	-5.229	1.00	81.82	C
ATOM	720	CB	ASP	A	94	-16.866	138.429	-6.550	1.00	78.18	C
ATOM	721	CG	ASP	A	94	-17.911	137.883	-5.573	1.00	79.36	C
ATOM	722	OD1	ASP	A	94	-17.576	137.638	-4.388	1.00	79.34	O
ATOM	723	OD2	ASP	A	94	-19.073	137.692	-5.997	1.00	78.77	O
ATOM	724	O	ASP	A	95	-13.550	134.726	-2.902	1.00	87.46	O
ATOM	725	N	ASP	A	95	-14.689	137.958	-3.913	1.00	81.35	N
ATOM	726	CA	ASP	A	95	-13.733	137.092	-3.254	1.00	85.44	C
ATOM	727	C	ASP	A	95	-14.302	135.695	-3.016	1.00	81.99	C
ATOM	728	CB	ASP	A	95	-13.292	137.723	-1.930	1.00	88.44	C
ATOM	729	CG	ASP	A	95	-14.458	137.956	-0.983	1.00	91.17	C
ATOM	730	OD2	ASP	A	95	-14.228	138.012	0.245	1.00	97.92	O
ATOM	731	OD1	ASP	A	95	-15.608	138.081	-1.470	1.00	90.99	O
ATOM	732	O	SER	A	96	-17.781	132.730	-3.556	1.00	77.24	O
ATOM	733	N	SER	A	96	-15.625	135.591	-2.947	1.00	76.94	N
ATOM	734	CA	SER	A	96	-16.264	134.330	-2.586	1.00	78.49	C
ATOM	735	C	SER	A	96	-17.047	133.701	-3.748	1.00	77.97	C
ATOM	736	CB	SER	A	96	-17.190	134.548	-1.398	1.00	70.20	C
ATOM	737	OG	SER	A	96	-18.279	135.366	-1.774	1.00	73.46	O
ATOM	738	O	PHE	A	97	-18.018	131.469	-6.468	1.00	68.80	O
ATOM	739	N	PHE	A	97	-16.890	134.275	-4.940	1.00	75.64	N
ATOM	740	CA	PHE	A	97	-17.556	133.803	-6.153	1.00	70.22	C
ATOM	741	C	PHE	A	97	-17.170	132.365	-6.499	1.00	71.54	C
ATOM	742	CB	PHE	A	97	-17.222	134.724	-7.319	1.00	68.97	C
ATOM	743	CG	PHE	A	97	-17.717	134.238	-8.656	1.00	64.27	C
ATOM	744	CD1	PHE	A	97	-19.063	134.058	-8.884	1.00	63.91	C
ATOM	745	CD2	PHE	A	97	-16.829	134.004	-9.698	1.00	69.78	C
ATOM	746	CE1	PHE	A	97	-19.516	133.637	-10.122	1.00	65.28	C
ATOM	747	CE2	PHE	A	97	-17.264	133.576	-10.943	1.00	60.63	C
ATOM	748	CE	PHE	A	97	-18.609	133.394	-11.156	1.00	64.83	C
ATOM	749	N	PHE	A	98	-15.894	132.151	-6.821	1.00	67.06	N
ATOM	750	CA	PHE	A	98	-15.397	130.810	-7.121	1.00	62.35	C
ATOM	751	C	PHE	A	98	-15.786	129.832	-6.029	1.00	66.02	C
ATOM	752	O	PHE	A	98	-16.159	128.706	-6.316	1.00	65.97	O
ATOM	753	CB	PHE	A	98	-13.890	130.823	-7.320	1.00	56.09	C
ATOM	754	CG	PHE	A	98	-13.473	131.308	-8.677	1.00	55.78	C
ATOM	755	CD1	PHE	A	98	-14.332	131.189	-9.761	1.00	55.35	C
ATOM	756	CD2	PHE	A	98	-12.231	131.891	-8.873	1.00	53.89	C
ATOM	757	CE1	PHE	A	98	-13.950	131.634	-11.027	1.00	56.62	C

ATOM	758	CE2	PHE	A	98	-11.843	132.345	-10.127	1.00	57.44	C
ATOM	759	CZ	PHE	A	98	-12.700	132.215	-11.206	1.00	57.21	C
ATOM	760	N	HIS	A	99	-15.758	130.279	-4.781	1.00	71.75	N
ATOM	761	CA	HIS	A	99	-16.207	129.445	-3.675	1.00	70.15	C
ATOM	762	C	HIS	A	99	-17.687	129.120	-3.785	1.00	67.63	C
ATOM	763	O	HIS	A	99	-18.123	128.044	-3.394	1.00	65.35	O
ATOM	764	CB	HIS	A	99	-15.944	130.131	-2.339	1.00	79.57	C
ATOM	765	CG	HIS	A	99	-14.527	130.036	-1.869	1.00	80.82	C
ATOM	766	ND1	HIS	A	99	-14.165	129.324	-0.745	1.00	84.05	N
ATOM	767	CD2	HIS	A	99	-13.386	130.580	-2.356	1.00	84.02	C
ATOM	768	CE1	HIS	A	99	-12.860	129.427	-0.566	1.00	92.57	C
ATOM	769	NE2	HIS	A	99	-12.363	130.183	-1.530	1.00	89.70	N
ATOM	770	N	ARG	A	100	-18.465	130.060	-4.311	1.00	69.47	N
ATOM	771	CA	ARG	A	100	-19.915	129.880	-4.378	1.00	66.99	C
ATOM	772	C	ARG	A	100	-20.282	128.914	-5.508	1.00	58.86	C
ATOM	773	O	ARG	A	100	-21.242	128.159	-5.398	1.00	58.20	O
ATOM	774	CB	ARG	A	100	-20.623	131.235	-4.541	1.00	60.64	C
ATOM	775	CG	ARG	A	100	-21.514	131.602	-3.339	1.00	69.85	C
ATOM	776	CD	ARG	A	100	-22.151	133.012	-3.453	1.00	69.32	C
ATOM	777	NE	ARG	A	100	-21.129	134.046	-3.581	1.00	71.02	N
ATOM	778	CZ	ARG	A	100	-21.009	134.860	-4.623	1.00	69.49	C
ATOM	779	NH1	ARG	A	100	-21.869	134.787	-5.622	1.00	70.59	N
ATOM	780	NH2	ARG	A	100	-20.033	135.755	-4.663	1.00	71.07	N
ATOM	781	N	LEU	A	101	-19.500	128.938	-6.582	1.00	58.15	N
ATOM	782	CA	LEU	A	101	-19.615	127.953	-7.655	1.00	60.14	C
ATOM	783	C	LEU	A	101	-19.395	126.519	-7.177	1.00	59.73	C
ATOM	784	O	LEU	A	101	-20.186	125.621	-7.478	1.00	58.19	O
ATOM	785	CB	LEU	A	101	-18.610	128.233	-8.756	1.00	60.68	C
ATOM	786	CG	LEU	A	101	-18.626	129.547	-9.500	1.00	57.57	C
ATOM	787	CD1	LEU	A	101	-17.613	129.440	-10.613	1.00	62.72	C
ATOM	788	CD2	LEU	A	101	-19.996	129.807	-10.050	1.00	61.41	C
ATOM	789	N	GLU	A	102	-18.312	126.306	-6.443	1.00	57.10	N
ATOM	790	CA	GLU	A	102	-17.973	124.972	-5.989	1.00	60.91	C
ATOM	791	C	GLU	A	102	-18.786	124.513	-4.812	1.00	57.73	C
ATOM	792	O	GLU	A	102	-18.490	123.479	-4.237	1.00	66.84	O
ATOM	793	CB	GLU	A	102	-16.493	124.883	-5.634	1.00	68.79	C
ATOM	794	CG	GLU	A	102	-15.628	124.580	-6.839	1.00	73.87	C
ATOM	795	CD	GLU	A	102	-15.483	125.780	-7.748	1.00	75.09	C
ATOM	796	OE1	GLU	A	102	-16.069	125.788	-8.869	1.00	69.33	O
ATOM	797	OE2	GLU	A	102	-14.763	126.711	-7.329	1.00	73.87	O
ATOM	798	N	GLU	A	103	-19.818	125.255	-4.457	1.00	54.26	N
ATOM	799	CA	GLU	A	103	-20.702	124.828	-3.375	1.00	58.02	C
ATOM	800	C	GLU	A	103	-22.151	124.776	-3.849	1.00	56.67	C
ATOM	801	O	GLU	A	103	-23.038	124.414	-3.075	1.00	58.17	O
ATOM	802	CB	GLU	A	103	-20.563	125.759	-2.167	1.00	68.02	C
ATOM	803	CG	GLU	A	103	-19.169	125.737	-1.548	1.00	71.82	C
ATOM	804	CD	GLU	A	103	-18.860	126.939	-0.646	1.00	79.27	C
ATOM	805	OE1	GLU	A	103	-19.731	127.840	-0.505	1.00	79.00	O
ATOM	806	OE2	GLU	A	103	-17.726	126.970	-0.088	1.00	77.83	O
ATOM	807	N	SER	A	104	-22.366	125.110	-5.126	1.00	51.07	N
ATOM	808	CA	SER	A	104	-23.698	125.195	-5.738	1.00	46.92	C
ATOM	809	C	SER	A	104	-24.645	124.009	-5.467	1.00	52.70	C
ATOM	810	O	SER	A	104	-25.862	124.203	-5.390	1.00	55.19	O
ATOM	811	CB	SER	A	104	-23.545	125.397	-7.252	1.00	55.22	C
ATOM	812	OG	SER	A	104	-23.115	124.213	-7.944	1.00	51.31	O
ATOM	813	O	PHE	A	105	-26.512	120.845	-3.437	1.00	50.19	O
ATOM	814	N	PHE	A	105	-24.094	122.798	-5.326	1.00	49.74	N
ATOM	815	CA	PHE	A	105	-24.869	121.575	-5.064	1.00	52.12	C
ATOM	816	C	PHE	A	105	-25.485	121.499	-3.662	1.00	53.27	C
ATOM	817	CB	PHE	A	105	-23.962	120.349	-5.269	1.00	49.91	C
ATOM	818	CG	PHE	A	105	-24.702	119.032	-5.411	1.00	50.94	C
ATOM	819	CD2	PHE	A	105	-24.754	118.132	-4.362	1.00	51.06	C
ATOM	820	CD1	PHE	A	105	-25.295	118.674	-6.619	1.00	56.73	C

ATOM	821	CE2	PHE	A	105	-25.417	116.902	-4.510	1.00	57.47	C
ATOM	822	CE1	PHE	A	105	-25.949	117.439	-6.779	1.00	51.91	C
ATOM	823	CZ	PHE	A	105	-26.014	116.556	-5.727	1.00	49.07	C
ATOM	824	O	LEU	A	106	-26.912	123.659	-1.474	1.00	65.82	O
ATOM	825	N	LEU	A	106	-24.827	122.157	-2.716	1.00	60.77	N
ATOM	826	CA	LEU	A	106	-25.170	122.027	-1.303	1.00	62.74	C
ATOM	827	C	LEU	A	106	-26.521	122.604	-0.963	1.00	64.26	C
ATOM	828	CB	LEU	A	106	-24.109	122.694	-0.435	1.00	62.67	C
ATOM	829	CG	LEU	A	106	-22.792	121.940	-0.416	1.00	65.31	C
ATOM	830	CD1	LEU	A	106	-21.755	122.681	0.407	1.00	63.79	C
ATOM	831	CD2	LEU	A	106	-23.026	120.528	0.102	1.00	63.48	C
ATOM	832	O	VAL	A	107	-26.965	123.771	1.816	1.00	70.20	O
ATOM	833	N	VAL	A	107	-27.230	121.886	-0.103	1.00	64.84	N
ATOM	834	CA	VAL	A	107	-28.448	122.393	0.493	1.00	68.01	C
ATOM	835	C	VAL	A	107	-28.085	123.661	1.285	1.00	72.21	C
ATOM	836	CB	VAL	A	107	-29.112	121.309	1.373	1.00	70.23	C
ATOM	837	CG1	VAL	A	107	-29.918	121.911	2.480	1.00	73.78	C
ATOM	838	CG2	VAL	A	107	-29.984	120.395	0.516	1.00	67.15	C
ATOM	839	O	GLU	A	108	-27.037	126.581	3.365	1.00	74.43	O
ATOM	840	N	GLU	A	108	-29.014	124.623	1.306	1.00	73.46	N
ATOM	841	CA	GLU	A	108	-28.802	125.956	1.880	1.00	74.12	C
ATOM	842	C	GLU	A	108	-28.063	125.927	3.217	1.00	73.51	C
ATOM	843	CB	GLU	A	108	-30.151	126.668	2.039	1.00	72.78	C
ATOM	844	CG	GLU	A	108	-30.089	128.178	2.262	1.00	67.57	C
ATOM	845	CD	GLU	A	108	-31.486	128.795	2.231	1.00	78.65	C
ATOM	846	OE1	GLU	A	108	-32.431	128.025	1.964	1.00	80.16	O
ATOM	847	OE2	GLU	A	108	-31.649	130.022	2.463	1.00	72.05	O
ATOM	848	O	GLU	A	109	-25.558	125.264	5.878	1.00	80.33	O
ATOM	849	N	GLU	A	109	-28.572	125.160	4.178	1.00	71.35	N
ATOM	850	CA	GLU	A	109	-27.905	125.023	5.477	1.00	80.06	C
ATOM	851	C	GLU	A	109	-26.443	124.589	5.347	1.00	77.58	C
ATOM	852	CB	GLU	A	109	-28.649	124.040	6.397	1.00	84.36	C
ATOM	853	CG	GLU	A	109	-29.635	123.099	5.724	1.00	84.38	C
ATOM	854	CD	GLU	A	109	-30.887	123.813	5.229	1.00	84.43	C
ATOM	855	OE1	GLU	A	109	-30.822	124.428	4.141	1.00	80.57	O
ATOM	856	OE2	GLU	A	109	-31.927	123.760	5.922	1.00	88.74	O
ATOM	857	O	ASP	A	110	-22.746	124.085	3.890	1.00	73.82	O
ATOM	858	N	ASP	A	110	-26.182	123.488	4.644	1.00	71.46	N
ATOM	859	CA	ASP	A	110	-24.801	123.010	4.500	1.00	74.13	C
ATOM	860	C	ASP	A	110	-23.968	124.017	3.731	1.00	72.82	C
ATOM	861	CB	ASP	A	110	-24.750	121.656	3.793	1.00	71.03	C
ATOM	862	CG	ASP	A	110	-25.631	120.624	4.452	1.00	76.13	C
ATOM	863	OD1	ASP	A	110	-26.300	120.967	5.451	1.00	83.40	O
ATOM	864	OD2	ASP	A	110	-25.676	119.474	3.962	1.00	68.86	O
ATOM	865	O	LYS	A	111	-24.090	127.433	3.935	1.00	75.71	O
ATOM	866	N	LYS	A	111	-24.639	124.784	2.880	1.00	71.24	N
ATOM	867	CA	LYS	A	111	-23.979	125.835	2.120	1.00	76.91	C
ATOM	868	C	LYS	A	111	-23.384	126.864	3.089	1.00	78.41	C
ATOM	869	CB	LYS	A	111	-24.964	126.501	1.147	1.00	72.42	C
ATOM	870	CG	LYS	A	111	-24.375	126.833	-0.221	1.00	71.96	C
ATOM	871	CD	LYS	A	111	-25.315	127.727	-1.039	1.00	61.15	C
ATOM	872	CE	LYS	A	111	-26.630	127.033	-1.392	1.00	63.78	C
ATOM	873	NZ	LYS	A	111	-26.488	126.099	-2.558	1.00	65.97	N
ATOM	874	O	LYS	A	112	-22.201	130.217	4.329	1.00	75.76	O
ATOM	875	N	LYS	A	112	-22.078	127.079	2.974	1.00	77.79	N
ATOM	876	CA	LYS	A	112	-21.370	128.017	3.833	1.00	70.05	C
ATOM	877	C	LYS	A	112	-21.736	129.448	3.480	1.00	77.08	C
ATOM	878	CB	LYS	A	112	-19.854	127.825	3.714	1.00	69.70	C
ATOM	879	O	HIS	A	113	-24.077	130.409	1.782	1.00	61.30	O
ATOM	880	N	HIS	A	113	-21.521	129.798	2.215	1.00	76.84	N
ATOM	881	CA	HIS	A	113	-21.810	131.136	1.730	1.00	63.25	C
ATOM	882	C	HIS	A	113	-23.282	131.262	1.418	1.00	60.47	C
ATOM	883	CB	HIS	A	113	-20.975	131.468	0.501	1.00	67.99	C

ATOM	884	CG	HIS	A	113	-19.498	131.382	0.732	1.00	75.70	C
ATOM	885	ND1	HIS	A	113	-18.896	130.301	1.343	1.00	79.38	N
ATOM	886	CD2	HIS	A	113	-18.498	132.241	0.421	1.00	77.23	C
ATOM	887	CE1	HIS	A	113	-17.591	130.500	1.402	1.00	82.03	C
ATOM	888	NE2	HIS	A	113	-17.323	131.670	0.849	1.00	77.88	N
ATOM	889	O	GLU	A	114	-24.867	131.774	-1.702	1.00	68.15	O
ATOM	890	N	GLU	A	114	-23.655	132.345	0.759	1.00	66.58	N
ATOM	891	CA	GLU	A	114	-25.067	132.617	0.557	1.00	69.69	C
ATOM	892	C	GLU	A	114	-25.586	131.923	-0.715	1.00	68.09	C
ATOM	893	CB	GLU	A	114	-25.302	134.125	0.519	1.00	67.10	C
ATOM	894	CG	GLU	A	114	-26.737	134.527	0.731	1.00	69.15	C
ATOM	895	CD	GLU	A	114	-27.260	135.243	-0.476	1.00	71.51	C
ATOM	896	OE1	GLU	A	114	-28.432	135.671	-0.490	1.00	76.52	O
ATOM	897	OE2	GLU	A	114	-26.476	135.365	-1.427	1.00	70.05	O
ATOM	898	O	ARG	A	115	-27.801	130.181	-3.955	1.00	66.28	O
ATOM	899	N	ARG	A	115	-26.848	131.516	-0.681	1.00	67.25	N
ATOM	900	CA	ARG	A	115	-27.377	130.549	-1.628	1.00	63.48	C
ATOM	901	C	ARG	A	115	-27.406	130.972	-3.101	1.00	68.22	C
ATOM	902	CB	ARG	A	115	-28.793	130.144	-1.186	1.00	62.15	C
ATOM	903	CG	ARG	A	115	-29.856	131.178	-1.409	1.00	59.81	C
ATOM	904	CD	ARG	A	115	-31.219	130.713	-0.907	1.00	60.38	C
ATOM	905	NE	ARG	A	115	-32.242	131.675	-1.303	1.00	73.62	N
ATOM	906	CZ	ARG	A	115	-33.272	131.414	-2.108	1.00	75.13	C
ATOM	907	NH1	ARG	A	115	-34.125	132.397	-2.413	1.00	73.02	N
ATOM	908	NH2	ARG	A	115	-33.464	130.183	-2.597	1.00	58.34	N
ATOM	909	O	HIS	A	116	-24.864	133.594	-4.980	1.00	67.36	O
ATOM	910	N	HIS	A	116	-26.992	132.198	-3.411	1.00	67.97	N
ATOM	911	CA	HIS	A	116	-27.080	132.693	-4.785	1.00	64.20	C
ATOM	912	C	HIS	A	116	-25.684	132.794	-5.402	1.00	64.39	C
ATOM	913	CB	HIS	A	116	-27.820	134.044	-4.823	1.00	67.12	C
ATOM	914	CG	HIS	A	116	-29.226	133.973	-4.304	1.00	66.24	C
ATOM	915	ND1	HIS	A	116	-29.556	134.271	-3.000	1.00	69.66	N
ATOM	916	CD2	HIS	A	116	-30.384	133.608	-4.908	1.00	66.78	C
ATOM	917	CE1	HIS	A	116	-30.858	134.106	-2.827	1.00	70.36	C
ATOM	918	NE2	HIS	A	116	-31.382	133.698	-3.969	1.00	63.64	N
ATOM	919	O	PRO	A	117	-22.224	133.253	-7.301	1.00	59.93	O
ATOM	920	N	PRO	A	117	-25.402	131.948	-6.400	1.00	66.71	N
ATOM	921	CA	PRO	A	117	-23.988	131.777	-6.749	1.00	63.94	C
ATOM	922	C	PRO	A	117	-23.395	132.948	-7.508	1.00	58.84	C
ATOM	923	CB	PRO	A	117	-23.979	130.507	-7.627	1.00	55.62	C
ATOM	924	CG	PRO	A	117	-25.295	129.862	-7.427	1.00	60.15	C
ATOM	925	CD	PRO	A	117	-26.266	130.959	-7.071	1.00	64.81	C
ATOM	926	O	ILE	A	118	-21.999	136.293	-8.387	1.00	61.34	O
ATOM	927	N	ILE	A	118	-24.148	133.595	-8.382	1.00	59.17	N
ATOM	928	CA	ILE	A	118	-23.496	134.606	-9.211	1.00	67.17	C
ATOM	929	C	ILE	A	118	-23.160	135.884	-8.444	1.00	64.51	C
ATOM	930	CB	ILE	A	118	-24.340	134.969	-10.436	1.00	63.73	C
ATOM	931	CG1	ILE	A	118	-24.791	133.690	-11.130	1.00	58.35	C
ATOM	932	CG2	ILE	A	118	-23.524	135.829	-11.391	1.00	59.01	C
ATOM	933	CD1	ILE	A	118	-25.290	133.899	-12.517	1.00	62.03	C
ATOM	934	O	PHE	A	119	-23.604	138.850	-5.156	1.00	74.63	O
ATOM	935	N	PHE	A	119	-24.168	136.495	-7.831	1.00	71.86	N
ATOM	936	CA	PHE	A	119	-23.995	137.839	-7.278	1.00	69.36	C
ATOM	937	C	PHE	A	119	-24.100	137.911	-5.764	1.00	68.58	C
ATOM	938	CB	PHE	A	119	-24.999	138.777	-7.912	1.00	63.20	C
ATOM	939	CG	PHE	A	119	-24.699	139.090	-9.341	1.00	62.35	C
ATOM	940	CD1	PHE	A	119	-23.604	139.865	-9.674	1.00	63.97	C
ATOM	941	CD2	PHE	A	119	-25.507	138.610	-10.352	1.00	63.48	C
ATOM	942	CE1	PHE	A	119	-23.314	140.156	-10.989	1.00	60.99	C
ATOM	943	CE2	PHE	A	119	-25.221	138.892	-11.674	1.00	60.76	C
ATOM	944	CZ	PHE	A	119	-24.118	139.668	-11.987	1.00	60.98	C
ATOM	945	O	GLY	A	120	-25.830	137.781	-1.816	1.00	76.41	O
ATOM	946	N	GLY	A	120	-24.731	136.916	-5.154	1.00	69.37	N

ATOM	947	CA	GLY	A	120	-24.751	136.831	-3.709	1.00	68.58	C
ATOM	948	C	GLY	A	120	-25.892	137.548	-3.019	1.00	71.94	C
ATOM	949	O	ASN	A	121	-29.155	138.086	-5.288	1.00	68.23	O
ATOM	950	N	ASN	A	121	-26.938	137.893	-3.762	1.00	71.17	N
ATOM	951	CA	ASN	A	121	-28.163	138.392	-3.152	1.00	68.11	C
ATOM	952	C	ASN	A	121	-29.334	138.125	-4.074	1.00	67.02	C
ATOM	953	CB	ASN	A	121	-28.048	139.886	-2.851	1.00	69.39	C
ATOM	954	CG	ASN	A	121	-27.829	140.713	-4.100	1.00	68.97	C
ATOM	955	OD1	ASN	A	121	-28.787	141.122	-4.767	1.00	68.03	O
ATOM	956	ND2	ASN	A	121	-26.567	140.960	-4.431	1.00	67.50	N
ATOM	957	N	ILE	A	122	-30.527	137.961	-3.509	1.00	65.79	N
ATOM	958	CA	ILE	A	122	-31.699	137.588	-4.298	1.00	61.17	C
ATOM	959	C	ILE	A	122	-32.003	138.566	-5.421	1.00	63.82	C
ATOM	960	O	ILE	A	122	-32.450	138.151	-6.487	1.00	63.34	O
ATOM	961	CB	ILE	A	122	-32.958	137.463	-3.429	1.00	66.47	C
ATOM	962	CG1	ILE	A	122	-32.624	136.820	-2.080	1.00	73.06	C
ATOM	963	CG2	ILE	A	122	-34.019	136.643	-4.149	1.00	60.64	C
ATOM	964	CD1	ILE	A	122	-32.314	137.794	-0.964	1.00	76.88	C
ATOM	965	N	VAL	A	123	-31.745	139.855	-5.184	1.00	64.40	N
ATOM	966	CA	VAL	A	123	-32.168	140.930	-6.097	1.00	65.97	C
ATOM	967	C	VAL	A	123	-31.353	140.971	-7.401	1.00	64.13	C
ATOM	968	O	VAL	A	123	-31.912	141.167	-8.490	1.00	61.74	O
ATOM	969	CB	VAL	A	123	-32.098	142.352	-5.393	1.00	69.18	C
ATOM	970	CG1	VAL	A	123	-31.897	143.466	-6.410	1.00	54.08	C
ATOM	971	CG2	VAL	A	123	-33.340	142.610	-4.543	1.00	52.67	C
ATOM	972	N	ASP	A	124	-30.039	140.812	-7.291	1.00	61.99	N
ATOM	973	CA	ASP	A	124	-29.186	140.778	-8.475	1.00	66.30	C
ATOM	974	C	ASP	A	124	-29.428	139.498	-9.298	1.00	64.89	C
ATOM	975	O	ASP	A	124	-29.532	139.541	-10.528	1.00	62.53	O
ATOM	976	CB	ASP	A	124	-27.712	140.872	-8.069	1.00	69.92	C
ATOM	977	CG	ASP	A	124	-27.391	142.148	-7.311	1.00	71.87	C
ATOM	978	OD1	ASP	A	124	-27.931	143.206	-7.701	1.00	79.12	O
ATOM	979	OD2	ASP	A	124	-26.595	142.096	-6.344	1.00	69.93	O
ATOM	980	N	GLU	A	125	-29.526	138.369	-8.603	1.00	61.95	N
ATOM	981	CA	GLU	A	125	-29.644	137.066	-9.255	1.00	68.95	C
ATOM	982	C	GLU	A	125	-30.878	137.005	-10.154	1.00	66.72	C
ATOM	983	O	GLU	A	125	-30.771	136.665	-11.338	1.00	68.62	O
ATOM	984	CB	GLU	A	125	-29.691	135.939	-8.212	1.00	66.10	C
ATOM	985	CG	GLU	A	125	-29.072	134.622	-8.669	1.00	67.06	C
ATOM	986	CD	GLU	A	125	-27.573	134.572	-8.477	1.00	67.08	C
ATOM	987	OE1	GLU	A	125	-26.998	135.558	-7.977	1.00	64.46	O
ATOM	988	OE2	GLU	A	125	-26.964	133.534	-8.819	1.00	67.73	O
ATOM	989	N	VAL	A	126	-32.036	137.349	-9.592	1.00	65.94	N
ATOM	990	CA	VAL	A	126	-33.301	137.313	-10.327	1.00	66.15	C
ATOM	991	C	VAL	A	126	-33.227	138.239	-11.539	1.00	63.79	C
ATOM	992	O	VAL	A	126	-33.766	137.944	-12.613	1.00	64.71	O
ATOM	993	CB	VAL	A	126	-34.490	137.708	-9.417	1.00	64.41	C
ATOM	994	CG1	VAL	A	126	-35.766	137.882	-10.223	1.00	66.07	C
ATOM	995	CG2	VAL	A	126	-34.693	136.666	-8.322	1.00	63.77	C
ATOM	996	N	ALA	A	127	-32.512	139.342	-11.367	1.00	61.76	N
ATOM	997	CA	ALA	A	127	-32.333	140.301	-12.441	1.00	64.57	C
ATOM	998	C	ALA	A	127	-31.587	139.635	-13.585	1.00	60.44	C
ATOM	999	O	ALA	A	127	-32.010	139.704	-14.746	1.00	54.66	O
ATOM	1000	CB	ALA	A	127	-31.581	141.551	-11.937	1.00	56.79	C
ATOM	1001	N	TYR	A	128	-30.487	138.971	-13.231	1.00	62.32	N
ATOM	1002	CA	TYR	A	128	-29.643	138.276	-14.192	1.00	55.57	C
ATOM	1003	C	TYR	A	128	-30.424	137.253	-15.014	1.00	53.29	C
ATOM	1004	O	TYR	A	128	-30.412	137.288	-16.250	1.00	52.11	O
ATOM	1005	CB	TYR	A	128	-28.480	137.594	-13.475	1.00	63.32	C
ATOM	1006	CG	TYR	A	128	-27.743	136.667	-14.393	1.00	60.55	C
ATOM	1007	CD1	TYR	A	128	-26.808	137.160	-15.293	1.00	64.36	C
ATOM	1008	CD2	TYR	A	128	-28.016	135.302	-14.401	1.00	62.43	C
ATOM	1009	CE1	TYR	A	128	-26.142	136.316	-16.165	1.00	64.75	C

ATOM	1010	CE2	TYR	A	128	-27.352	134.445	-15.272	1.00	61.26	C
ATOM	1011	CZ	TYR	A	128	-26.419	134.961	-16.147	1.00	60.92	C
ATOM	1012	OH	TYR	A	128	-25.768	134.125	-17.016	1.00	59.27	O
ATOM	1013	N	HIS	A	129	-31.100	136.341	-14.329	1.00	54.68	N
ATOM	1014	CA	HIS	A	129	-31.927	135.343	-15.004	1.00	57.77	C
ATOM	1015	C	HIS	A	129	-33.040	135.983	-15.850	1.00	61.42	C
ATOM	1016	O	HIS	A	129	-33.564	135.354	-16.791	1.00	59.08	O
ATOM	1017	CB	HIS	A	129	-32.562	134.388	-13.995	1.00	55.58	O
ATOM	1018	CG	HIS	A	129	-31.599	133.446	-13.342	1.00	60.77	C
ATOM	1019	ND1	HIS	A	129	-31.012	132.398	-14.017	1.00	57.63	N
ATOM	1020	CD2	HIS	A	129	-31.150	133.369	-12.067	1.00	62.90	C
ATOM	1021	CE1	HIS	A	129	-30.229	131.726	-13.192	1.00	55.84	C
ATOM	1022	NE2	HIS	A	129	-30.294	132.292	-12.002	1.00	59.57	N
ATOM	1023	N	GLU	A	130	-33.421	137.218	-15.503	1.00	59.60	N
ATOM	1024	CA	GLU	A	130	-34.421	137.940	-16.289	1.00	58.61	C
ATOM	1025	C	GLU	A	130	-33.792	138.617	-17.508	1.00	54.13	C
ATOM	1026	O	GLU	A	130	-34.327	138.523	-18.597	1.00	52.95	O
ATOM	1027	CB	GLU	A	130	-35.159	138.958	-15.428	1.00	63.49	C
ATOM	1028	CG	GLU	A	130	-36.340	139.582	-16.148	1.00	74.37	C
ATOM	1029	CD	GLU	A	130	-37.520	139.854	-15.225	1.00	87.68	O
ATOM	1030	OE1	GLU	A	130	-37.579	139.233	-14.130	1.00	81.54	C
ATOM	1031	OE2	GLU	A	130	-38.381	140.692	-15.601	1.00	92.65	O
ATOM	1032	N	LYS	A	131	-32.653	139.284	-17.337	1.00	50.66	N
ATOM	1033	CA	LYS	A	131	-31.886	139.756	-18.497	1.00	51.48	C
ATOM	1034	C	LYS	A	131	-31.298	138.597	-19.341	1.00	59.62	C
ATOM	1035	O	LYS	A	131	-31.286	138.672	-20.576	1.00	60.59	O
ATOM	1036	CB	LYS	A	131	-30.755	140.685	-18.055	1.00	50.85	C
ATOM	1037	N	TYR	A	132	-30.813	137.533	-18.698	1.00	51.95	N
ATOM	1038	CA	TYR	A	132	-30.233	136.419	-19.477	1.00	59.18	C
ATOM	1039	C	TYR	A	132	-30.833	135.047	-19.156	1.00	55.25	C
ATOM	1040	O	TYR	A	132	-30.292	134.298	-18.353	1.00	54.70	O
ATOM	1041	CB	TYR	A	132	-28.725	136.355	-19.272	1.00	53.16	C
ATOM	1042	CG	TYR	A	132	-28.002	137.661	-19.485	1.00	57.50	C
ATOM	1043	CD1	TYR	A	132	-27.728	138.137	-20.765	1.00	57.66	C
ATOM	1044	CD2	TYR	A	132	-27.567	138.410	-18.396	1.00	60.53	C
ATOM	1045	CE1	TYR	A	132	-27.048	139.342	-20.945	1.00	60.58	C
ATOM	1046	CE2	TYR	A	132	-26.890	139.597	-18.561	1.00	57.58	C
ATOM	1047	CZ	TYR	A	132	-26.632	140.064	-19.827	1.00	59.62	C
ATOM	1048	OH	TYR	A	132	-25.948	141.257	-19.955	1.00	61.77	O
ATOM	1049	O	PRO	A	133	-32.072	131.193	-19.210	1.00	52.84	O
ATOM	1050	N	PRO	A	133	-31.962	134.720	-19.792	1.00	55.37	N
ATOM	1051	CA	PRO	A	133	-32.706	133.489	-19.520	1.00	50.68	C
ATOM	1052	C	PRO	A	133	-31.855	132.252	-19.787	1.00	52.74	C
ATOM	1053	CB	PRO	A	133	-33.874	133.558	-20.502	1.00	55.81	C
ATOM	1054	CG	PRO	A	133	-33.943	134.974	-20.960	1.00	57.30	C
ATOM	1055	CD	PRO	A	133	-32.569	135.520	-20.869	1.00	57.80	C
ATOM	1056	O	THR	A	134	-28.313	133.068	-21.267	1.00	47.88	O
ATOM	1057	N	THR	A	134	-30.908	132.393	-20.703	1.00	54.97	N
ATOM	1058	CA	THR	A	134	-29.965	131.332	-20.984	1.00	49.94	C
ATOM	1059	C	THR	A	134	-28.529	131.874	-21.068	1.00	48.48	C
ATOM	1060	CB	THR	A	134	-30.326	130.601	-22.278	1.00	46.62	C
ATOM	1061	OG1	THR	A	134	-29.984	131.414	-23.395	1.00	45.58	O
ATOM	1062	CG2	THR	A	134	-31.800	130.230	-22.317	1.00	45.30	C
ATOM	1063	O	ILE	A	135	-24.898	132.698	-22.516	1.00	49.28	O
ATOM	1064	N	ILE	A	135	-27.550	130.977	-20.911	1.00	47.86	N
ATOM	1065	CA	ILE	A	135	-26.126	131.324	-20.976	1.00	40.28	C
ATOM	1066	C	ILE	A	135	-25.808	131.885	-22.356	1.00	43.64	C
ATOM	1067	CB	ILE	A	135	-25.207	130.064	-20.638	1.00	45.11	C
ATOM	1068	CG1	ILE	A	135	-23.700	130.423	-20.557	1.00	42.61	C
ATOM	1069	CG2	ILE	A	135	-25.427	128.951	-21.633	1.00	37.83	C
ATOM	1070	CD1	ILE	A	135	-23.294	131.166	-19.277	1.00	42.29	C
ATOM	1071	N	TYR	A	136	-26.562	131.461	-23.363	1.00	44.72	N
ATOM	1072	CA	TYR	A	136	-26.308	131.931	-24.718	1.00	48.11	C

ATOM	1073	C	TYR	A	136	-26.698	133.415	-24.882	1.00	52.78	C
ATOM	1074	O	TYR	A	136	-26.056	134.130	-25.646	1.00	53.93	O
ATOM	1075	CB	TYR	A	136	-27.028	131.045	-25.740	1.00	49.80	C
ATOM	1076	CG	TYR	A	136	-26.648	129.578	-25.618	1.00	50.50	C
ATOM	1077	CD1	TYR	A	136	-25.468	129.075	-26.189	1.00	52.33	C
ATOM	1078	CD2	TYR	A	136	-27.439	128.704	-24.902	1.00	50.20	C
ATOM	1079	CE1	TYR	A	136	-25.116	127.740	-26.046	1.00	43.85	C
ATOM	1080	CE2	TYR	A	136	-27.100	127.370	-24.763	1.00	46.62	C
ATOM	1081	CZ	TYR	A	136	-25.949	126.897	-25.335	1.00	47.52	C
ATOM	1082	OH	TYR	A	136	-25.651	125.567	-25.167	1.00	50.53	O
ATOM	1083	N	HIS	A	137	-27.718	133.883	-24.159	1.00	51.94	N
ATOM	1084	CA	HIS	A	137	-28.025	135.322	-24.151	1.00	53.50	C
ATOM	1085	C	HIS	A	137	-26.790	136.104	-23.696	1.00	52.88	C
ATOM	1086	O	HIS	A	137	-26.331	137.014	-24.383	1.00	58.19	O
ATOM	1087	CB	HIS	A	137	-29.222	135.639	-23.245	1.00	50.69	C
ATOM	1088	CG	HIS	A	137	-30.543	135.204	-23.803	1.00	52.61	C
ATOM	1089	ND1	HIS	A	137	-31.074	133.954	-23.575	1.00	49.21	N
ATOM	1090	CD2	HIS	A	137	-31.450	135.863	-24.566	1.00	52.55	C
ATOM	1091	CE1	HIS	A	137	-32.241	133.851	-24.183	1.00	51.70	C
ATOM	1092	NE2	HIS	A	137	-32.495	134.998	-24.789	1.00	57.46	N
ATOM	1093	N	LEU	A	138	-26.237	135.721	-22.553	1.00	51.45	N
ATOM	1094	CA	LEU	A	138	-24.987	136.312	-22.074	1.00	53.47	C
ATOM	1095	C	LEU	A	138	-23.818	136.163	-23.066	1.00	57.64	C
ATOM	1096	O	LEU	A	138	-23.104	137.120	-23.331	1.00	58.33	O
ATOM	1097	CB	LEU	A	138	-24.598	135.698	-20.735	1.00	50.23	C
ATOM	1098	CG	LEU	A	138	-23.256	136.229	-20.247	1.00	59.10	C
ATOM	1099	CD1	LEU	A	138	-23.373	137.724	-20.096	1.00	58.07	C
ATOM	1100	CD2	LEU	A	138	-22.768	135.559	-18.931	1.00	55.53	C
ATOM	1101	N	ARG	A	139	-23.618	134.963	-23.602	1.00	56.66	N
ATOM	1102	CA	ARG	A	139	-22.551	134.738	-24.566	1.00	57.26	C
ATOM	1103	C	ARG	A	139	-22.649	135.700	-25.733	1.00	56.81	C
ATOM	1104	O	ARG	A	139	-21.699	136.416	-26.029	1.00	60.54	O
ATOM	1105	CB	ARG	A	139	-22.568	133.289	-25.092	1.00	56.76	C
ATOM	1106	CG	ARG	A	139	-22.033	132.272	-24.109	1.00	52.51	C
ATOM	1107	CD	ARG	A	139	-22.301	130.845	-24.545	1.00	47.37	C
ATOM	1108	NE	ARG	A	139	-21.635	130.486	-25.796	1.00	52.52	N
ATOM	1109	CZ	ARG	A	139	-21.254	129.248	-26.124	1.00	50.14	C
ATOM	1110	NH1	ARG	A	139	-21.462	128.233	-25.297	1.00	40.24	N
ATOM	1111	NH2	ARG	A	139	-20.670	129.022	-27.291	1.00	52.16	N
ATOM	1112	N	LYS	A	140	-23.791	135.691	-26.412	1.00	60.03	N
ATOM	1113	CA	LYS	A	140	-24.028	136.609	-27.528	1.00	61.80	C
ATOM	1114	C	LYS	A	140	-23.877	138.056	-27.102	1.00	65.26	C
ATOM	1115	O	LYS	A	140	-23.351	138.879	-27.847	1.00	67.31	O
ATOM	1116	CB	LYS	A	140	-25.417	136.416	-28.115	1.00	57.25	C
ATOM	1117	CG	LYS	A	140	-25.649	137.255	-29.349	1.00	63.16	C
ATOM	1118	CD	LYS	A	140	-26.871	138.145	-29.176	1.00	68.63	C
ATOM	1119	CE	LYS	A	140	-27.103	139.027	-30.397	1.00	70.73	C
ATOM	1120	NZ	LYS	A	140	-28.336	139.871	-30.252	1.00	82.67	N
ATOM	1121	N	LYS	A	141	-24.348	138.363	-25.900	1.00	59.49	N
ATOM	1122	CA	LYS	A	141	-24.179	139.695	-25.375	1.00	61.83	C
ATOM	1123	C	LYS	A	141	-22.700	140.056	-25.373	1.00	63.90	C
ATOM	1124	O	LYS	A	141	-22.312	141.108	-25.868	1.00	67.40	O
ATOM	1125	CB	LYS	A	141	-24.776	139.796	-23.973	1.00	59.91	C
ATOM	1126	CG	LYS	A	141	-24.768	141.193	-23.378	1.00	65.31	C
ATOM	1127	CD	LYS	A	141	-23.440	141.514	-22.713	1.00	67.19	C
ATOM	1128	CE	LYS	A	141	-23.488	142.823	-21.945	1.00	66.00	C
ATOM	1129	NZ	LYS	A	141	-23.481	142.539	-20.479	1.00	72.59	N
ATOM	1130	N	LEU	A	142	-21.870	139.179	-24.825	1.00	62.80	N
ATOM	1131	CA	LEU	A	142	-20.465	139.509	-24.628	1.00	57.01	C
ATOM	1132	C	LEU	A	142	-19.682	139.469	-25.926	1.00	57.69	C
ATOM	1133	O	LEU	A	142	-18.654	140.099	-26.054	1.00	64.67	O
ATOM	1134	CB	LEU	A	142	-19.844	138.573	-23.603	1.00	61.20	C
ATOM	1135	CG	LEU	A	142	-20.412	138.646	-22.185	1.00	57.22	C

ATOM	1136	CD1	LEU	A	142	-19.742	137.634	-21.295	1.00	59.50	C
ATOM	1137	CD2	LEU	A	142	-20.282	140.036	-21.595	1.00	64.20	C
ATOM	1138	N	VAL	A	143	-20.177	138.737	-26.904	1.00	63.11	N
ATOM	1139	CA	VAL	A	143	-19.546	138.724	-28.211	1.00	60.79	C
ATOM	1140	C	VAL	A	143	-19.733	140.057	-28.955	1.00	72.93	C
ATOM	1141	O	VAL	A	143	-18.765	140.632	-29.480	1.00	71.61	O
ATOM	1142	CB	VAL	A	143	-20.106	137.580	-29.064	1.00	62.88	C
ATOM	1143	CG1	VAL	A	143	-19.725	137.756	-30.531	1.00	62.35	C
ATOM	1144	CG2	VAL	A	143	-19.620	136.232	-28.513	1.00	67.08	C
ATOM	1145	N	ASP	A	144	-20.974	140.549	-28.977	1.00	66.63	N
ATOM	1146	CA	ASP	A	144	-21.352	141.703	-29.795	1.00	70.47	C
ATOM	1147	C	ASP	A	144	-21.068	143.098	-29.174	1.00	72.42	C
ATOM	1148	O	ASP	A	144	-20.672	144.020	-29.886	1.00	76.62	O
ATOM	1149	CB	ASP	A	144	-22.847	141.593	-30.162	1.00	68.60	C
ATOM	1150	CG	ASP	A	144	-23.115	140.575	-31.285	1.00	69.92	C
ATOM	1151	OD1	ASP	A	144	-22.224	140.373	-32.131	1.00	69.60	O
ATOM	1152	OD2	ASP	A	144	-24.220	139.988	-31.332	1.00	62.39	O
ATOM	1153	N	SER	A	145	-21.253	143.253	-27.864	1.00	75.46	N
ATOM	1154	CA	SER	A	145	-21.234	144.584	-27.228	1.00	69.50	C
ATOM	1155	C	SER	A	145	-19.844	145.093	-26.808	1.00	75.27	C
ATOM	1156	O	SER	A	145	-18.945	144.308	-26.502	1.00	75.46	O
ATOM	1157	CB	SER	A	145	-22.157	144.577	-26.011	1.00	62.41	C
ATOM	1158	OG	SER	A	145	-21.471	145.004	-24.847	1.00	74.59	O
ATOM	1159	O	THR	A	146	-17.155	147.960	-24.642	1.00	76.34	O
ATOM	1160	N	THR	A	146	-19.690	146.418	-26.766	1.00	79.35	N
ATOM	1161	CA	THR	A	146	-18.398	147.053	-26.475	1.00	75.38	C
ATOM	1162	C	THR	A	146	-18.235	147.528	-25.032	1.00	77.16	C
ATOM	1163	CB	THR	A	146	-18.164	148.260	-27.382	1.00	76.28	C
ATOM	1164	OG1	THR	A	146	-19.409	148.950	-27.585	1.00	80.84	O
ATOM	1165	CG2	THR	A	146	-17.596	147.823	-28.719	1.00	70.96	C
ATOM	1166	O	ASP	A	147	-18.472	145.863	-22.117	1.00	81.69	O
ATOM	1167	N	ASP	A	147	-19.301	147.439	-24.247	1.00	74.97	N
ATOM	1168	CA	ASP	A	147	-19.305	147.964	-22.887	1.00	72.68	C
ATOM	1169	C	ASP	A	147	-18.508	147.075	-21.942	1.00	78.80	C
ATOM	1170	CB	ASP	A	147	-20.740	148.100	-22.397	1.00	75.16	C
ATOM	1171	CG	ASP	A	147	-21.672	148.683	-23.461	1.00	84.72	C
ATOM	1172	OD2	ASP	A	147	-22.844	148.990	-23.127	1.00	79.89	O
ATOM	1173	OD1	ASP	A	147	-21.238	148.818	-24.633	1.00	85.85	O
ATOM	1174	O	LYS	A	148	-18.742	146.513	-18.302	1.00	80.77	O
ATOM	1175	N	LYS	A	148	-17.869	147.673	-20.940	1.00	77.24	N
ATOM	1176	CA	LYS	A	148	-17.074	146.904	-19.982	1.00	75.59	C
ATOM	1177	C	LYS	A	148	-17.956	146.014	-19.108	1.00	78.81	C
ATOM	1178	CB	LYS	A	148	-16.244	147.826	-19.087	1.00	76.79	C
ATOM	1179	CG	LYS	A	148	-15.503	147.078	-17.992	1.00	77.68	C
ATOM	1180	CD	LYS	A	148	-15.053	147.990	-16.862	1.00	79.15	C
ATOM	1181	CE	LYS	A	148	-14.539	147.189	-15.659	1.00	73.81	C
ATOM	1182	NZ	LYS	A	148	-14.866	147.809	-14.322	1.00	67.01	N
ATOM	1183	O	ALA	A	149	-16.909	143.206	-17.102	1.00	67.04	O
ATOM	1184	N	ALA	A	149	-17.806	144.698	-19.247	1.00	81.49	N
ATOM	1185	CA	ALA	A	149	-18.699	143.755	-18.575	1.00	74.22	C
ATOM	1186	C	ALA	A	149	-18.125	143.263	-17.263	1.00	69.19	C
ATOM	1187	CB	ALA	A	149	-19.003	142.583	-19.471	1.00	72.17	C
ATOM	1188	N	ASP	A	150	-19.025	142.932	-16.334	1.00	66.75	N
ATOM	1189	CA	ASP	A	150	-18.687	142.326	-15.051	1.00	66.91	C
ATOM	1190	C	ASP	A	150	-17.820	141.089	-15.295	1.00	67.27	C
ATOM	1191	O	ASP	A	150	-18.118	140.285	-16.178	1.00	66.43	O
ATOM	1192	CB	ASP	A	150	-19.976	141.976	-14.291	1.00	64.74	C
ATOM	1193	CG	ASP	A	150	-19.723	141.390	-12.896	1.00	73.24	C
ATOM	1194	OD2	ASP	A	150	-20.452	141.780	-11.940	1.00	72.08	O
ATOM	1195	OD1	ASP	A	150	-18.819	140.532	-12.749	1.00	69.21	O
ATOM	1196	N	LEU	A	151	-16.752	140.935	-14.518	1.00	65.49	N
ATOM	1197	CA	LEU	A	151	-15.789	139.867	-14.781	1.00	70.70	C
ATOM	1198	C	LEU	A	151	-16.408	138.500	-14.496	1.00	67.99	C

ATOM	1199	O	LEU	A	151	-16.117	137.526	-15.189	1.00	67.49	O
ATOM	1200	CB	LEU	A	151	-14.512	140.061	-13.954	1.00	69.13	C
ATOM	1201	CG	LEU	A	151	-13.247	139.354	-14.456	1.00	65.24	C
ATOM	1202	CD1	LEU	A	151	-12.894	139.773	-15.872	1.00	62.07	C
ATOM	1203	CD2	LEU	A	151	-12.082	139.622	-13.519	1.00	70.58	C
ATOM	1204	N	ARG	A	152	-17.258	138.437	-13.475	1.00	66.07	N
ATOM	1205	CA	ARG	A	152	-17.971	137.213	-13.158	1.00	64.29	C
ATOM	1206	C	ARG	A	152	-18.769	136.691	-14.363	1.00	69.69	C
ATOM	1207	O	ARG	A	152	-18.833	135.476	-14.602	1.00	62.89	O
ATOM	1208	CB	ARG	A	152	-18.896	137.432	-11.961	1.00	61.71	C
ATOM	1209	CG	ARG	A	152	-18.156	137.564	-10.631	1.00	69.68	C
ATOM	1210	CD	ARG	A	152	-19.052	138.082	-9.500	1.00	69.20	C
ATOM	1211	NE	ARG	A	152	-19.499	139.450	-9.756	1.00	69.30	N
ATOM	1212	CZ	ARG	A	152	-20.174	140.196	-8.884	1.00	73.64	C
ATOM	1213	NH1	ARG	A	152	-20.482	139.709	-7.685	1.00	67.64	N
ATOM	1214	NH2	ARG	A	152	-20.537	141.435	-9.214	1.00	63.70	N
ATOM	1215	N	LEU	A	153	-19.364	137.601	-15.130	1.00	60.50	N
ATOM	1216	CA	LEU	A	153	-20.157	137.175	-16.274	1.00	61.41	C
ATOM	1217	C	LEU	A	153	-19.252	136.837	-17.452	1.00	64.84	C
ATOM	1218	O	LEU	A	153	-19.627	136.053	-18.324	1.00	65.01	O
ATOM	1219	CB	LEU	A	153	-21.189	138.246	-16.650	1.00	63.87	C
ATOM	1220	CG	LEU	A	153	-22.211	138.485	-15.529	1.00	65.13	C
ATOM	1221	CD1	LEU	A	153	-23.406	139.351	-15.967	1.00	62.18	C
ATOM	1222	CD2	LEU	A	153	-22.687	137.150	-14.970	1.00	63.83	C
ATOM	1223	N	ILE	A	154	-18.052	137.414	-17.461	1.00	63.75	N
ATOM	1224	CA	ILE	A	154	-17.009	137.024	-18.409	1.00	61.96	C
ATOM	1225	C	ILE	A	154	-16.429	135.648	-18.069	1.00	64.46	C
ATOM	1226	O	ILE	A	154	-16.126	134.847	-18.966	1.00	58.52	O
ATOM	1227	CB	ILE	A	154	-15.858	138.040	-18.441	1.00	62.63	C
ATOM	1228	CG1	ILE	A	154	-16.419	139.450	-18.662	1.00	68.52	C
ATOM	1229	CG2	ILE	A	154	-14.827	137.672	-19.521	1.00	50.49	C
ATOM	1230	CD1	ILE	A	154	-15.457	140.562	-18.304	1.00	67.29	C
ATOM	1231	N	TYR	A	155	-16.263	135.367	-16.779	1.00	58.79	N
ATOM	1232	CA	TYR	A	155	-15.803	134.053	-16.418	1.00	55.06	C
ATOM	1233	C	TYR	A	155	-16.842	133.015	-16.865	1.00	57.64	C
ATOM	1234	O	TYR	A	155	-16.527	132.136	-17.676	1.00	53.49	O
ATOM	1235	CB	TYR	A	155	-15.525	133.937	-14.920	1.00	59.86	C
ATOM	1236	CG	TYR	A	155	-15.344	132.502	-14.525	1.00	58.68	C
ATOM	1237	CD1	TYR	A	155	-14.166	131.820	-14.811	1.00	57.22	C
ATOM	1238	CD2	TYR	A	155	-16.376	131.802	-13.921	1.00	60.53	C
ATOM	1239	CE1	TYR	A	155	-14.022	130.478	-14.481	1.00	55.47	C
ATOM	1240	CE2	TYR	A	155	-16.237	130.485	-13.584	1.00	52.60	C
ATOM	1241	CZ	TYR	A	155	-15.063	129.825	-13.870	1.00	57.37	C
ATOM	1242	OH	TYR	A	155	-14.960	128.507	-13.527	1.00	52.56	O
ATOM	1243	N	LEU	A	156	-18.081	133.134	-16.373	1.00	58.70	N
ATOM	1244	CA	LEU	A	156	-19.126	132.158	-16.695	1.00	46.46	C
ATOM	1245	C	LEU	A	156	-19.297	131.958	-18.199	1.00	51.24	C
ATOM	1246	O	LEU	A	156	-19.398	130.814	-18.651	1.00	58.40	O
ATOM	1247	CB	LEU	A	156	-20.453	132.535	-16.066	1.00	46.09	C
ATOM	1248	CG	LEU	A	156	-20.430	132.540	-14.528	1.00	54.21	C
ATOM	1249	CD1	LEU	A	156	-21.648	133.226	-13.940	1.00	58.99	C
ATOM	1250	CD2	LEU	A	156	-20.306	131.161	-13.956	1.00	49.70	C
ATOM	1251	N	ALA	A	157	-19.291	133.018	-18.996	1.00	50.11	N
ATOM	1252	CA	ALA	A	157	-19.397	132.797	-20.443	1.00	54.32	C
ATOM	1253	C	ALA	A	157	-18.224	131.982	-21.036	1.00	55.27	C
ATOM	1254	O	ALA	A	157	-18.416	131.209	-21.981	1.00	52.74	O
ATOM	1255	CB	ALA	A	157	-19.522	134.095	-21.167	1.00	51.60	C
ATOM	1256	N	LEU	A	158	-17.018	132.162	-20.500	1.00	53.52	N
ATOM	1257	CA	LEU	A	158	-15.840	131.468	-21.030	1.00	51.64	C
ATOM	1258	C	LEU	A	158	-15.789	130.018	-20.514	1.00	51.46	C
ATOM	1259	O	LEU	A	158	-15.512	129.106	-21.269	1.00	49.92	O
ATOM	1260	CB	LEU	A	158	-14.549	132.211	-20.657	1.00	51.36	C
ATOM	1261	CG	LEU	A	158	-14.322	133.630	-21.183	1.00	44.13	C

ATOM	1262	CD1	LEU	A	158	-13.152	134.247	-20.464	1.00	52.20	C
ATOM	1263	CD2	LEU	A	158	-14.112	133.689	-22.675	1.00	47.11	C
ATOM	1264	N	ALA	A	159	-16.072	129.844	-19.224	1.00	50.47	N
ATOM	1265	CA	ALA	A	159	-16.204	128.547	-18.579	1.00	44.87	C
ATOM	1266	C	ALA	A	159	-17.143	127.610	-19.324	1.00	51.86	C
ATOM	1267	O	ALA	A	159	-16.848	126.413	-19.514	1.00	44.96	O
ATOM	1268	CB	ALA	A	159	-16.694	128.727	-17.155	1.00	46.80	C
ATOM	1269	N	HIS	A	160	-18.289	128.162	-19.713	1.00	43.12	N
ATOM	1270	CA	HIS	A	160	-19.321	127.412	-20.415	1.00	44.61	C
ATOM	1271	C	HIS	A	160	-18.761	126.860	-21.708	1.00	41.47	C
ATOM	1272	O	HIS	A	160	-19.135	125.788	-22.141	1.00	41.11	O
ATOM	1273	CB	HIS	A	160	-20.537	128.307	-20.722	1.00	39.84	C
ATOM	1274	CG	HIS	A	160	-21.711	127.566	-21.265	1.00	34.41	C
ATOM	1275	ND1	HIS	A	160	-21.989	127.506	-22.608	1.00	36.14	N
ATOM	1276	CD2	HIS	A	160	-22.667	126.831	-20.647	1.00	37.98	C
ATOM	1277	CE1	HIS	A	160	-23.057	126.753	-22.800	1.00	42.49	C
ATOM	1278	NE2	HIS	A	160	-23.502	126.350	-21.623	1.00	39.74	N
ATOM	1279	N	MET	A	161	-17.908	127.658	-22.337	1.00	43.78	N
ATOM	1280	CA	MET	A	161	-17.332	127.317	-23.620	1.00	45.25	C
ATOM	1281	C	MET	A	161	-16.209	126.304	-23.411	1.00	47.84	C
ATOM	1282	O	MET	A	161	-16.053	125.361	-24.187	1.00	44.66	O
ATOM	1283	CB	MET	A	161	-16.801	128.564	-24.325	1.00	47.06	C
ATOM	1284	CG	MET	A	161	-17.881	129.511	-24.836	1.00	51.65	C
ATOM	1285	SD	MET	A	161	-17.237	131.171	-25.174	1.00	56.22	S
ATOM	1286	CE	MET	A	161	-18.741	132.013	-25.605	1.00	61.27	C
ATOM	1287	N	ILE	A	162	-15.449	126.500	-22.340	1.00	40.27	N
ATOM	1288	CA	ILE	A	162	-14.329	125.634	-22.083	1.00	52.31	C
ATOM	1289	C	ILE	A	162	-14.837	124.246	-21.701	1.00	46.07	C
ATOM	1290	O	ILE	A	162	-14.340	123.255	-22.182	1.00	42.77	O
ATOM	1291	CB	ILE	A	162	-13.412	126.178	-20.963	1.00	48.29	C
ATOM	1292	CG1	ILE	A	162	-12.700	127.459	-21.396	1.00	48.89	C
ATOM	1293	CG2	ILE	A	162	-12.405	125.147	-20.586	1.00	47.29	C
ATOM	1294	CD1	ILE	A	162	-12.033	127.371	-22.712	1.00	52.36	C
ATOM	1295	N	LYS	A	163	-15.841	124.211	-20.833	1.00	44.86	N
ATOM	1296	CA	LYS	A	163	-16.310	122.984	-20.230	1.00	40.12	C
ATOM	1297	C	LYS	A	163	-17.112	122.173	-21.222	1.00	46.62	C
ATOM	1298	O	LYS	A	163	-17.129	120.938	-21.140	1.00	42.88	O
ATOM	1299	CB	LYS	A	163	-17.148	123.260	-18.984	1.00	36.96	C
ATOM	1300	CG	LYS	A	163	-17.603	122.007	-18.245	1.00	40.81	C
ATOM	1301	CD	LYS	A	163	-18.558	122.346	-17.125	1.00	39.52	C
ATOM	1302	CE	LYS	A	163	-18.560	121.288	-16.024	1.00	37.42	C
ATOM	1303	NZ	LYS	A	163	-19.487	121.660	-14.906	1.00	38.57	N
ATOM	1304	N	PHE	A	164	-17.732	122.860	-22.186	1.00	41.79	N
ATOM	1305	CA	PHE	A	164	-18.472	122.178	-23.245	1.00	40.99	C
ATOM	1306	C	PHE	A	164	-18.000	122.607	-24.638	1.00	46.13	C
ATOM	1307	O	PHE	A	164	-18.696	123.356	-25.342	1.00	47.85	O
ATOM	1308	CB	PHE	A	164	-19.964	122.448	-23.073	1.00	45.20	C
ATOM	1309	CG	PHE	A	164	-20.484	122.105	-21.702	1.00	42.52	C
ATOM	1310	CD1	PHE	A	164	-20.526	120.791	-21.277	1.00	28.69	C
ATOM	1311	CD2	PHE	A	164	-20.943	123.108	-20.844	1.00	34.60	C
ATOM	1312	CE1	PHE	A	164	-21.006	120.485	-20.022	1.00	37.41	C
ATOM	1313	CE2	PHE	A	164	-21.413	122.805	-19.581	1.00	30.69	C
ATOM	1314	CZ	PHE	A	164	-21.460	121.523	-19.165	1.00	34.86	C
ATOM	1315	O	ARG	A	165	-15.758	122.942	-28.415	1.00	44.58	O
ATOM	1316	N	ARG	A	165	-16.839	122.101	-25.057	1.00	43.89	N
ATOM	1317	CA	ARG	A	165	-16.061	122.790	-26.079	1.00	39.10	C
ATOM	1318	C	ARG	A	165	-16.312	122.356	-27.503	1.00	38.80	C
ATOM	1319	CB	ARG	A	165	-14.573	122.661	-25.752	1.00	42.79	C
ATOM	1320	CG	ARG	A	165	-14.094	121.213	-25.601	1.00	51.72	C
ATOM	1321	CD	ARG	A	165	-12.628	121.170	-25.219	1.00	52.06	C
ATOM	1322	NE	ARG	A	165	-12.160	119.813	-25.027	1.00	49.01	N
ATOM	1323	CZ	ARG	A	165	-10.879	119.441	-25.042	1.00	50.35	C
ATOM	1324	NH1	ARG	A	165	-9.916	120.323	-25.260	1.00	52.65	N

ATOM	1325	NH2	ARG	A	165	-10.569	118.174	-24.859	1.00	46.16	N
ATOM	1326	O	GLY	A	166	-15.317	119.758	-28.997	1.00	45.03	O
ATOM	1327	N	GLY	A	166	-17.153	121.355	-27.717	1.00	40.73	N
ATOM	1328	CA	GLY	A	166	-17.427	120.894	-29.073	1.00	40.92	C
ATOM	1329	C	GLY	A	166	-16.341	119.983	-29.634	1.00	44.56	C
ATOM	1330	O	HIS	A	167	-14.197	119.961	-32.281	1.00	49.73	O
ATOM	1331	N	HIS	A	167	-16.538	119.480	-30.839	1.00	38.69	N
ATOM	1332	CA	HIS	A	167	-15.715	118.383	-31.262	1.00	47.30	C
ATOM	1333	C	HIS	A	167	-14.455	118.788	-32.031	1.00	48.38	C
ATOM	1334	CB	HIS	A	167	-16.555	117.396	-32.059	1.00	42.00	C
ATOM	1335	CG	HIS	A	167	-16.945	117.864	-33.424	1.00	53.00	C
ATOM	1336	ND1	HIS	A	167	-16.022	118.178	-34.402	1.00	51.37	N
ATOM	1337	CD2	HIS	A	167	-18.166	118.007	-33.996	1.00	47.40	C
ATOM	1338	CE1	HIS	A	167	-16.658	118.516	-35.512	1.00	50.00	C
ATOM	1339	NE2	HIS	A	167	-17.959	118.417	-35.292	1.00	52.73	N
ATOM	1340	O	PHE	A	168	-11.409	116.212	-34.350	1.00	54.57	O
ATOM	1341	N	PHE	A	168	-13.645	117.784	-32.332	1.00	45.25	N
ATOM	1342	CA	PHE	A	168	-12.357	117.957	-32.998	1.00	46.93	C
ATOM	1343	C	PHE	A	168	-12.292	117.065	-34.236	1.00	48.23	C
ATOM	1344	CB	PHE	A	168	-11.215	117.607	-32.038	1.00	47.04	C
ATOM	1345	CG	PHE	A	168	-11.052	118.573	-30.933	1.00	46.58	C
ATOM	1346	CD2	PHE	A	168	-10.059	119.527	-30.986	1.00	45.56	C
ATOM	1347	CD1	PHE	A	168	-11.931	118.570	-29.851	1.00	48.42	C
ATOM	1348	CE2	PHE	A	168	-9.931	120.456	-29.961	1.00	51.49	C
ATOM	1349	CE1	PHE	A	168	-11.807	119.493	-28.833	1.00	45.33	C
ATOM	1350	CZ	PHE	A	168	-10.801	120.437	-28.888	1.00	49.16	C
ATOM	1351	O	LEU	A	169	-12.681	116.484	-38.582	1.00	54.77	O
ATOM	1352	N	LEU	A	169	-13.244	117.228	-35.136	1.00	43.09	N
ATOM	1353	CA	LEU	A	169	-13.343	116.350	-36.271	1.00	48.70	C
ATOM	1354	C	LEU	A	169	-12.920	117.092	-37.529	1.00	51.47	C
ATOM	1355	CB	LEU	A	169	-14.760	115.794	-36.404	1.00	44.06	C
ATOM	1356	CG	LEU	A	169	-15.208	114.818	-35.304	1.00	50.03	C
ATOM	1357	CD1	LEU	A	169	-16.620	114.342	-35.563	1.00	45.22	C
ATOM	1358	CD2	LEU	A	169	-14.264	113.610	-35.144	1.00	45.57	C
ATOM	1359	O	ILE	A	170	-11.021	120.751	-37.306	1.00	59.00	O
ATOM	1360	N	ILE	A	170	-12.812	118.409	-37.410	1.00	53.31	N
ATOM	1361	CA	ILE	A	170	-12.363	119.237	-38.515	1.00	54.38	C
ATOM	1362	C	ILE	A	170	-11.061	119.871	-38.150	1.00	58.72	C
ATOM	1363	CB	ILE	A	170	-13.345	120.343	-38.857	1.00	55.42	C
ATOM	1364	CG1	ILE	A	170	-14.681	119.749	-39.282	1.00	53.94	C
ATOM	1365	CG2	ILE	A	170	-12.777	121.209	-39.950	1.00	54.17	C
ATOM	1366	CD1	ILE	A	170	-15.821	120.672	-39.011	1.00	56.20	C
ATOM	1367	O	GLU	A	171	-9.210	121.359	-40.458	1.00	65.13	O
ATOM	1368	N	GLU	A	171	-9.992	119.403	-38.777	1.00	63.37	N
ATOM	1369	CA	GLU	A	171	-8.682	120.001	-38.595	1.00	63.31	C
ATOM	1370	C	GLU	A	171	-8.688	121.297	-39.356	1.00	61.88	C
ATOM	1371	CB	GLU	A	171	-7.561	119.070	-39.096	1.00	61.43	C
ATOM	1372	O	GLY	A	172	-9.883	124.293	-38.244	1.00	73.05	O
ATOM	1373	N	GLY	A	172	-8.125	122.345	-38.779	1.00	62.79	N
ATOM	1374	CA	GLY	A	172	-8.018	123.583	-39.519	1.00	61.56	C
ATOM	1375	C	GLY	A	172	-9.010	124.600	-39.043	1.00	69.00	C
ATOM	1376	O	ASP	A	173	-10.818	126.411	-41.265	1.00	75.57	O
ATOM	1377	N	ASP	A	173	-8.867	125.827	-39.518	1.00	72.97	N
ATOM	1378	CA	ASP	A	173	-9.806	126.876	-39.161	1.00	75.72	C
ATOM	1379	C	ASP	A	173	-10.957	126.885	-40.145	1.00	73.15	C
ATOM	1380	CB	ASP	A	173	-9.108	128.230	-39.140	1.00	78.72	C
ATOM	1381	CG	ASP	A	173	-7.755	128.170	-38.465	1.00	85.85	C
ATOM	1382	OD2	ASP	A	173	-6.832	128.879	-38.926	1.00	94.13	O
ATOM	1383	OD1	ASP	A	173	-7.615	127.405	-37.482	1.00	80.17	O
ATOM	1384	O	LEU	A	174	-13.263	129.853	-39.819	1.00	81.69	O
ATOM	1385	N	LEU	A	174	-12.103	127.402	-39.730	1.00	75.39	N
ATOM	1386	CA	LEU	A	174	-13.172	127.639	-40.682	1.00	76.83	C
ATOM	1387	C	LEU	A	174	-13.376	129.130	-40.803	1.00	78.46	C

ATOM	1388	CB	LEU	A	174	-14.463	126.935	-40.267	1.00	76.67	C
ATOM	1389	CG	LEU	A	174	-14.997	127.119	-38.845	1.00	79.65	C
ATOM	1390	CD1	LEU	A	174	-15.925	128.343	-38.721	1.00	81.50	C
ATOM	1391	CD2	LEU	A	174	-15.711	125.839	-38.405	1.00	72.25	C
ATOM	1392	O	ASN	A	175	-16.235	130.774	-42.326	1.00	83.87	O
ATOM	1393	N	ASN	A	175	-13.659	129.597	-42.012	1.00	81.52	N
ATOM	1394	CA	ASN	A	175	-13.866	131.022	-42.209	1.00	84.75	C
ATOM	1395	C	ASN	A	175	-15.290	131.394	-41.848	1.00	82.91	C
ATOM	1396	CB	ASN	A	175	-13.550	131.435	-43.646	1.00	83.43	C
ATOM	1397	CG	ASN	A	175	-13.122	132.885	-43.748	1.00	85.48	C
ATOM	1398	OD1	ASN	A	175	-13.688	133.750	-43.086	1.00	85.69	O
ATOM	1399	ND2	ASN	A	175	-12.098	133.153	-44.556	1.00	85.88	N
ATOM	1400	O	PRO	A	176	-18.716	133.534	-41.868	1.00	83.25	O
ATOM	1401	N	PRO	A	176	-15.446	132.383	-40.960	1.00	84.07	N
ATOM	1402	CA	PRO	A	176	-16.769	132.910	-40.597	1.00	86.28	C
ATOM	1403	C	PRO	A	176	-17.477	133.582	-41.786	1.00	88.71	C
ATOM	1404	CB	PRO	A	176	-16.451	133.931	-39.497	1.00	83.46	C
ATOM	1405	CG	PRO	A	176	-15.143	133.491	-38.937	1.00	90.13	C
ATOM	1406	CD	PRO	A	176	-14.379	132.923	-40.102	1.00	85.60	C
ATOM	1407	O	ASP	A	177	-19.055	134.593	-45.316	1.00	82.55	O
ATOM	1408	N	ASP	A	177	-16.684	134.180	-42.683	1.00	88.45	N
ATOM	1409	CA	ASP	A	177	-17.177	134.909	-43.862	1.00	87.54	C
ATOM	1410	C	ASP	A	177	-18.094	134.078	-44.752	1.00	84.56	C
ATOM	1411	CB	ASP	A	177	-16.005	135.418	-44.717	1.00	87.93	C
ATOM	1412	CG	ASP	A	177	-15.258	136.575	-44.076	1.00	91.02	C
ATOM	1413	OD1	ASP	A	177	-15.903	137.406	-43.395	1.00	94.18	O
ATOM	1414	OD2	ASP	A	177	-14.022	136.654	-44.267	1.00	89.30	O
ATOM	1415	O	ASN	A	178	-19.801	130.294	-44.592	1.00	72.37	O
ATOM	1416	N	ASN	A	178	-17.780	132.794	-44.883	1.00	83.61	N
ATOM	1417	CA	ASN	A	178	-18.499	131.925	-45.798	1.00	79.13	C
ATOM	1418	C	ASN	A	178	-19.792	131.367	-45.209	1.00	80.53	C
ATOM	1419	CB	ASN	A	178	-17.576	130.798	-46.247	1.00	75.70	C
ATOM	1420	CG	ASN	A	178	-16.334	131.324	-46.945	1.00	80.91	C
ATOM	1421	OD1	ASN	A	178	-16.383	132.352	-47.627	1.00	84.39	O
ATOM	1422	ND2	ASN	A	178	-15.215	130.637	-46.768	1.00	78.54	N
ATOM	1423	O	SER	A	179	-24.098	130.604	-45.733	1.00	87.69	O
ATOM	1424	N	SER	A	179	-20.884	132.105	-45.420	1.00	78.11	N
ATOM	1425	CA	SER	A	179	-22.181	131.751	-44.852	1.00	77.85	C
ATOM	1426	C	SER	A	179	-23.227	131.461	-45.918	1.00	82.08	C
ATOM	1427	CB	SER	A	179	-22.674	132.870	-43.939	1.00	73.38	C
ATOM	1428	OG	SER	A	179	-22.516	134.124	-44.571	1.00	74.46	O
ATOM	1429	N	ASP	A	180	-23.142	132.179	-47.033	1.00	81.85	N
ATOM	1430	CA	ASP	A	180	-24.127	132.054	-48.111	1.00	84.94	C
ATOM	1431	C	ASP	A	180	-23.928	130.767	-48.913	1.00	82.97	C
ATOM	1432	O	ASP	A	180	-23.040	130.695	-49.756	1.00	84.62	O
ATOM	1433	CB	ASP	A	180	-24.038	133.266	-49.047	1.00	85.00	C
ATOM	1434	CG	ASP	A	180	-25.362	133.598	-49.718	1.00	85.68	C
ATOM	1435	OD1	ASP	A	180	-26.269	132.734	-49.760	1.00	85.84	O
ATOM	1436	OD2	ASP	A	180	-25.486	134.741	-50.210	1.00	92.06	O
ATOM	1437	N	VAL	A	181	-24.757	129.759	-48.663	1.00	82.94	N
ATOM	1438	CA	VAL	A	181	-24.694	128.519	-49.436	1.00	75.45	C
ATOM	1439	C	VAL	A	181	-24.950	128.790	-50.922	1.00	80.94	C
ATOM	1440	O	VAL	A	181	-24.505	128.039	-51.785	1.00	76.88	O
ATOM	1441	CB	VAL	A	181	-25.705	127.479	-48.915	1.00	73.22	C
ATOM	1442	CG1	VAL	A	181	-25.507	126.136	-49.601	1.00	75.01	C
ATOM	1443	CG2	VAL	A	181	-25.564	127.321	-47.413	1.00	77.34	C
ATOM	1444	N	ASP	A	182	-25.640	129.887	-51.216	1.00	80.36	N
ATOM	1445	CA	ASP	A	182	-25.963	130.233	-52.592	1.00	78.68	C
ATOM	1446	C	ASP	A	182	-24.839	130.963	-53.325	1.00	79.15	C
ATOM	1447	O	ASP	A	182	-24.401	130.519	-54.385	1.00	79.83	O
ATOM	1448	CB	ASP	A	182	-27.228	131.084	-52.628	1.00	82.51	C
ATOM	1449	CG	ASP	A	182	-28.454	130.319	-52.185	1.00	87.21	C
ATOM	1450	OD1	ASP	A	182	-28.557	129.115	-52.506	1.00	87.25	O

ATOM	1451	OD2	ASP	A	182	-29.320	130.925	-51.515	1.00	93.36	O
ATOM	1452	N	LYS	A	183	-24.380	132.086	-52.771	1.00	82.24	N
ATOM	1453	CA	LYS	A	183	-23.384	132.924	-53.444	1.00	80.77	C
ATOM	1454	C	LYS	A	183	-22.075	132.169	-53.597	1.00	79.27	C
ATOM	1455	O	LYS	A	183	-21.222	132.533	-54.409	1.00	78.52	O
ATOM	1456	CB	LYS	A	183	-23.153	134.231	-52.680	1.00	77.52	C
ATOM	1457	N	LEU	A	184	-21.933	131.114	-52.802	1.00	79.22	N
ATOM	1458	CA	LEU	A	184	-20.781	130.240	-52.872	1.00	78.03	C
ATOM	1459	C	LEU	A	184	-21.042	129.110	-53.842	1.00	79.32	C
ATOM	1460	O	LEU	A	184	-20.159	128.760	-54.625	1.00	79.59	O
ATOM	1461	CB	LEU	A	184	-20.434	129.697	-51.495	1.00	76.94	C
ATOM	1462	CG	LEU	A	184	-19.989	130.814	-50.556	1.00	78.14	C
ATOM	1463	CD1	LEU	A	184	-19.450	130.234	-49.266	1.00	76.52	C
ATOM	1464	CD2	LEU	A	184	-18.961	131.709	-51.232	1.00	72.26	C
ATOM	1465	N	PHE	A	185	-22.249	128.546	-53.801	1.00	78.52	N
ATOM	1466	CA	PHE	A	185	-22.627	127.525	-54.775	1.00	75.43	C
ATOM	1467	C	PHE	A	185	-22.478	128.076	-56.181	1.00	77.06	C
ATOM	1468	O	PHE	A	185	-21.874	127.443	-57.046	1.00	74.18	O
ATOM	1469	CB	PHE	A	185	-24.058	127.045	-54.563	1.00	74.00	C
ATOM	1470	CG	PHE	A	185	-24.522	126.056	-55.593	1.00	73.70	C
ATOM	1471	CD1	PHE	A	185	-24.247	124.707	-55.448	1.00	68.81	C
ATOM	1472	CD2	PHE	A	185	-25.236	126.473	-56.704	1.00	72.27	C
ATOM	1473	CE1	PHE	A	185	-24.672	123.796	-56.391	1.00	69.23	C
ATOM	1474	CE2	PHE	A	185	-25.661	125.569	-57.640	1.00	72.51	C
ATOM	1475	CZ	PHE	A	185	-25.378	124.226	-57.486	1.00	71.24	C
ATOM	1476	N	ILE	A	186	-23.028	129.266	-56.402	1.00	76.29	N
ATOM	1477	CA	ILE	A	186	-22.947	129.896	-57.711	1.00	76.61	C
ATOM	1478	C	ILE	A	186	-21.489	130.217	-58.032	1.00	79.71	C
ATOM	1479	O	ILE	A	186	-21.031	130.009	-59.170	1.00	77.70	O
ATOM	1480	CB	ILE	A	186	-23.819	131.164	-57.785	1.00	80.95	C
ATOM	1481	CG1	ILE	A	186	-25.196	130.825	-58.364	1.00	78.12	C
ATOM	1482	CG2	ILE	A	186	-23.159	132.228	-58.655	1.00	81.23	C
ATOM	1483	CD1	ILE	A	186	-25.960	129.751	-57.620	1.00	76.51	C
ATOM	1484	N	GLN	A	187	-20.752	130.681	-57.021	1.00	77.28	N
ATOM	1485	CA	GLN	A	187	-19.314	130.902	-57.168	1.00	77.29	C
ATOM	1486	C	GLN	A	187	-18.602	129.585	-57.474	1.00	75.80	C
ATOM	1487	O	GLN	A	187	-17.559	129.579	-58.113	1.00	77.12	O
ATOM	1488	CB	GLN	A	187	-18.718	131.548	-55.915	1.00	77.58	C
ATOM	1489	N	LEU	A	188	-19.172	128.467	-57.035	1.00	73.93	N
ATOM	1490	CA	LEU	A	188	-18.586	127.162	-57.343	1.00	75.35	C
ATOM	1491	C	LEU	A	188	-18.884	126.742	-58.778	1.00	73.83	C
ATOM	1492	O	LEU	A	188	-17.988	126.304	-59.509	1.00	75.19	O
ATOM	1493	CB	LEU	A	188	-19.091	126.088	-56.377	1.00	68.65	C
ATOM	1494	CG	LEU	A	188	-18.761	124.656	-56.813	1.00	70.77	C
ATOM	1495	CD1	LEU	A	188	-17.246	124.422	-56.871	1.00	63.71	C
ATOM	1496	CD2	LEU	A	188	-19.440	123.645	-55.901	1.00	70.89	C
ATOM	1497	N	VAL	A	189	-20.150	126.870	-59.164	1.00	75.20	N
ATOM	1498	CA	VAL	A	189	-20.607	126.503	-60.498	1.00	74.61	C
ATOM	1499	C	VAL	A	189	-19.922	127.334	-61.579	1.00	74.69	C
ATOM	1500	O	VAL	A	189	-19.556	126.825	-62.637	1.00	72.31	O
ATOM	1501	CB	VAL	A	189	-22.119	126.670	-60.619	1.00	73.13	C
ATOM	1502	CG1	VAL	A	189	-22.581	126.288	-62.001	1.00	73.64	C
ATOM	1503	CG2	VAL	A	189	-22.803	125.817	-59.593	1.00	77.15	C
ATOM	1504	N	GLN	A	190	-19.732	128.616	-61.305	1.00	77.93	N
ATOM	1505	CA	GLN	A	190	-19.091	129.491	-62.272	1.00	80.01	C
ATOM	1506	C	GLN	A	190	-17.611	129.164	-62.512	1.00	80.58	C
ATOM	1507	O	GLN	A	190	-17.178	129.095	-63.659	1.00	84.60	O
ATOM	1508	CB	GLN	A	190	-19.253	130.941	-61.839	1.00	82.12	C
ATOM	1509	CG	GLN	A	190	-20.639	131.483	-62.145	1.00	84.25	C
ATOM	1510	CD	GLN	A	190	-20.861	132.848	-61.560	1.00	81.20	C
ATOM	1511	OE1	GLN	A	190	-19.999	133.373	-60.856	1.00	80.63	O
ATOM	1512	NE2	GLN	A	190	-22.023	133.434	-61.838	1.00	89.99	N
ATOM	1513	N	THR	A	191	-16.835	128.963	-61.452	1.00	79.39	N

ATOM	1514	CA	THR	A	191	-15.431	128.598	-61.624	1.00	78.77	C
ATOM	1515	C	THR	A	191	-15.288	127.283	-62.384	1.00	80.05	C
ATOM	1516	O	THR	A	191	-14.317	127.070	-63.116	1.00	81.67	O
ATOM	1517	CB	THR	A	191	-14.715	128.449	-60.286	1.00	82.85	C
ATOM	1518	OG1	THR	A	191	-15.253	127.315	-59.584	1.00	85.12	O
ATOM	1519	CG2	THR	A	191	-14.865	129.726	-59.455	1.00	73.87	C
ATOM	1520	N	TYR	A	192	-16.251	126.394	-62.180	1.00	74.66	N
ATOM	1521	CA	TYR	A	192	-16.327	125.170	-62.955	1.00	75.29	C
ATOM	1522	C	TYR	A	192	-16.518	125.504	-64.433	1.00	80.55	C
ATOM	1523	O	TYR	A	192	-15.746	125.057	-65.292	1.00	81.37	O
ATOM	1524	CB	TYR	A	192	-17.468	124.300	-62.452	1.00	73.34	C
ATOM	1525	CG	TYR	A	192	-17.623	122.996	-63.180	1.00	70.83	C
ATOM	1526	CD1	TYR	A	192	-18.503	122.873	-64.243	1.00	75.96	C
ATOM	1527	CD2	TYR	A	192	-16.899	121.880	-62.795	1.00	74.30	C
ATOM	1528	CE1	TYR	A	192	-18.651	121.672	-64.906	1.00	75.01	C
ATOM	1529	CE2	TYR	A	192	-17.040	120.675	-63.449	1.00	70.88	C
ATOM	1530	CZ	TYR	A	192	-17.918	120.579	-64.503	1.00	72.15	C
ATOM	1531	OH	TYR	A	192	-18.064	119.382	-65.154	1.00	71.57	O
ATOM	1532	N	ASN	A	193	-17.545	126.303	-64.714	1.00	78.56	N
ATOM	1533	CA	ASN	A	193	-17.845	126.737	-66.073	1.00	79.43	C
ATOM	1534	C	ASN	A	193	-16.688	127.519	-66.686	1.00	76.55	C
ATOM	1535	O	ASN	A	193	-16.453	127.446	-67.883	1.00	81.05	O
ATOM	1536	CB	ASN	A	193	-19.131	127.578	-66.102	1.00	76.65	C
ATOM	1537	CG	ASN	A	193	-20.380	126.746	-65.866	1.00	77.66	C
ATOM	1538	OD1	ASN	A	193	-20.358	125.521	-66.001	1.00	80.84	O
ATOM	1539	ND2	ASN	A	193	-21.478	127.408	-65.518	1.00	76.39	N
ATOM	1540	N	GLN	A	194	-15.955	128.252	-65.864	1.00	73.84	N
ATOM	1541	CA	GLN	A	194	-14.780	128.955	-66.351	1.00	78.71	C
ATOM	1542	C	GLN	A	194	-13.739	127.946	-66.842	1.00	84.17	C
ATOM	1543	O	GLN	A	194	-12.950	128.230	-67.748	1.00	85.83	O
ATOM	1544	CB	GLN	A	194	-14.191	129.851	-65.257	1.00	81.16	C
ATOM	1545	CG	GLN	A	194	-12.915	130.561	-65.664	1.00	81.73	C
ATOM	1546	CD	GLN	A	194	-13.080	131.327	-66.962	1.00	88.51	C
ATOM	1547	OE1	GLN	A	194	-12.354	131.097	-67.933	1.00	85.22	O
ATOM	1548	NE2	GLN	A	194	-14.047	132.241	-66.988	1.00	90.21	N
ATOM	1549	N	LEU	A	195	-13.751	126.759	-66.249	1.00	78.40	N
ATOM	1550	CA	LEU	A	195	-12.774	125.745	-66.587	1.00	78.29	C
ATOM	1551	C	LEU	A	195	-13.246	124.914	-67.753	1.00	78.20	C
ATOM	1552	O	LEU	A	195	-12.442	124.361	-68.498	1.00	79.04	O
ATOM	1553	CB	LEU	A	195	-12.500	124.849	-65.386	1.00	80.42	C
ATOM	1554	CG	LEU	A	195	-11.122	124.992	-64.765	1.00	74.33	C
ATOM	1555	CD1	LEU	A	195	-11.201	124.563	-63.329	1.00	71.85	C
ATOM	1556	CD2	LEU	A	195	-10.138	124.135	-65.535	1.00	77.57	C
ATOM	1557	N	PHE	A	196	-14.558	124.828	-67.913	1.00	78.62	N
ATOM	1558	CA	PHE	A	196	-15.131	123.968	-68.937	1.00	80.22	C
ATOM	1559	C	PHE	A	196	-16.212	124.696	-69.736	1.00	82.91	C
ATOM	1560	O	PHE	A	196	-17.402	124.583	-69.443	1.00	82.51	O
ATOM	1561	CB	PHE	A	196	-15.684	122.687	-68.293	1.00	82.66	C
ATOM	1562	CG	PHE	A	196	-14.676	121.963	-67.426	1.00	79.65	C
ATOM	1563	CD1	PHE	A	196	-13.797	121.046	-67.977	1.00	76.50	C
ATOM	1564	CD2	PHE	A	196	-14.600	122.216	-66.064	1.00	81.56	C
ATOM	1565	CE1	PHE	A	196	-12.867	120.392	-67.184	1.00	79.24	C
ATOM	1566	CE2	PHE	A	196	-13.669	121.569	-65.269	1.00	77.44	C
ATOM	1567	CE	PHE	A	196	-12.805	120.656	-65.831	1.00	78.15	C
ATOM	1568	O	GLU	A	197	-18.750	125.428	-72.626	1.00	89.00	O
ATOM	1569	N	GLU	A	197	-15.777	125.454	-70.739	1.00	83.48	N
ATOM	1570	CA	GLU	A	197	-16.683	126.157	-71.635	1.00	80.82	C
ATOM	1571	C	GLU	A	197	-17.563	125.179	-72.422	1.00	87.62	C
ATOM	1572	CB	GLU	A	197	-15.895	127.049	-72.597	1.00	74.74	C
ATOM	1573	O	GLU	A	198	-19.953	122.348	-73.664	1.00	89.14	O
ATOM	1574	N	GLU	A	198	-16.983	124.059	-72.844	1.00	85.00	N
ATOM	1575	CA	GLU	A	198	-17.676	123.105	-73.707	1.00	85.35	C
ATOM	1576	C	GLU	A	198	-18.896	122.459	-73.050	1.00	87.95	C

ATOM	1577	CB	GLU	A	198	-16.706	122.013	-74.166	1.00	88.67	C
ATOM	1578	O	ASN	A	199	-20.036	121.658	-68.729	1.00	80.89	O
ATOM	1579	N	ASN	A	199	-18.751	122.022	-71.807	1.00	90.94	N
ATOM	1580	CA	ASN	A	199	-19.864	121.395	-71.097	1.00	91.06	C
ATOM	1581	C	ASN	A	199	-20.243	122.156	-69.834	1.00	87.11	C
ATOM	1582	CB	ASN	A	199	-19.519	119.953	-70.728	1.00	89.40	C
ATOM	1583	CG	ASN	A	199	-19.092	119.143	-71.916	1.00	92.91	C
ATOM	1584	OD1	ASN	A	199	-19.886	118.395	-72.486	1.00	101.03	O
ATOM	1585	ND2	ASN	A	199	-17.831	119.287	-72.310	1.00	92.78	N
ATOM	1586	O	PRO	A	200	-22.509	122.412	-68.022	1.00	84.54	O
ATOM	1587	N	PRO	A	200	-20.819	123.358	-69.991	1.00	88.09	N
ATOM	1588	CA	PRO	A	200	-21.097	124.193	-68.818	1.00	86.83	C
ATOM	1589	C	PRO	A	200	-22.020	123.525	-67.804	1.00	85.44	C
ATOM	1590	CB	PRO	A	200	-21.773	125.434	-69.419	1.00	79.32	C
ATOM	1591	CG	PRO	A	200	-21.361	125.442	-70.846	1.00	81.57	C
ATOM	1592	CD	PRO	A	200	-21.271	124.003	-71.236	1.00	83.74	C
ATOM	1593	N	ILE	A	201	-22.241	124.202	-66.687	1.00	82.57	N
ATOM	1594	CA	ILE	A	201	-23.285	123.786	-65.772	1.00	81.15	C
ATOM	1595	C	ILE	A	201	-24.151	125.000	-65.487	1.00	79.98	C
ATOM	1596	O	ILE	A	201	-23.646	126.082	-65.177	1.00	77.98	O
ATOM	1597	CB	ILE	A	201	-22.719	123.178	-64.478	1.00	80.54	C
ATOM	1598	CG1	ILE	A	201	-22.145	121.789	-64.773	1.00	84.66	C
ATOM	1599	CG2	ILE	A	201	-23.799	123.073	-63.424	1.00	80.04	C
ATOM	1600	CD1	ILE	A	201	-21.809	120.958	-63.538	1.00	76.90	C
ATOM	1601	N	ASN	A	202	-25.458	124.820	-65.645	1.00	82.67	N
ATOM	1602	CA	ASN	A	202	-26.408	125.902	-65.466	1.00	76.09	C
ATOM	1603	C	ASN	A	202	-27.225	125.667	-64.189	1.00	79.39	C
ATOM	1604	O	ASN	A	202	-27.945	124.673	-64.050	1.00	82.28	O
ATOM	1605	CB	ASN	A	202	-27.278	126.043	-66.732	1.00	83.28	C
ATOM	1606	CG	ASN	A	202	-28.754	125.762	-66.492	1.00	85.31	C
ATOM	1607	OD1	ASN	A	202	-29.478	126.590	-65.927	1.00	71.63	O
ATOM	1608	ND2	ASN	A	202	-29.211	124.595	-66.946	1.00	87.73	N
ATOM	1609	N	ALA	A	203	-27.070	126.581	-63.237	1.00	79.24	N
ATOM	1610	CA	ALA	A	203	-27.642	126.405	-61.911	1.00	80.92	C
ATOM	1611	C	ALA	A	203	-28.828	127.318	-61.658	1.00	81.11	C
ATOM	1612	O	ALA	A	203	-29.160	127.598	-60.505	1.00	83.17	O
ATOM	1613	CB	ALA	A	203	-26.579	126.639	-60.859	1.00	84.27	C
ATOM	1614	O	SER	A	204	-31.926	128.904	-60.677	1.00	84.71	O
ATOM	1615	N	SER	A	204	-29.453	127.778	-62.738	1.00	84.54	N
ATOM	1616	CA	SER	A	204	-30.583	128.705	-62.669	1.00	80.14	C
ATOM	1617	C	SER	A	204	-31.648	128.238	-61.683	1.00	82.39	C
ATOM	1618	CB	SER	A	204	-31.198	128.881	-64.064	1.00	77.52	C
ATOM	1619	OG	SER	A	204	-32.321	129.746	-64.053	1.00	75.40	O
ATOM	1620	O	GLY	A	205	-33.578	126.700	-58.795	1.00	89.28	O
ATOM	1621	N	GLY	A	205	-32.225	127.078	-61.967	1.00	82.38	N
ATOM	1622	CA	GLY	A	205	-33.310	126.562	-61.156	1.00	89.16	C
ATOM	1623	C	GLY	A	205	-32.940	126.216	-59.727	1.00	88.07	C
ATOM	1624	O	VAL	A	206	-30.764	126.569	-56.956	1.00	82.22	O
ATOM	1625	N	VAL	A	206	-31.899	125.400	-59.566	1.00	88.85	N
ATOM	1626	CA	VAL	A	206	-31.584	124.737	-58.297	1.00	89.21	C
ATOM	1627	C	VAL	A	206	-31.565	125.633	-57.064	1.00	88.62	C
ATOM	1628	CB	VAL	A	206	-30.216	124.023	-58.359	1.00	87.03	C
ATOM	1629	CG1	VAL	A	206	-30.323	122.726	-59.125	1.00	88.74	C
ATOM	1630	CG2	VAL	A	206	-29.178	124.919	-58.987	1.00	88.82	C
ATOM	1631	N	ASP	A	207	-32.470	125.326	-56.140	1.00	88.10	N
ATOM	1632	CA	ASP	A	207	-32.422	125.879	-54.798	1.00	87.94	C
ATOM	1633	C	ASP	A	207	-31.373	125.107	-53.989	1.00	84.54	C
ATOM	1634	O	ASP	A	207	-31.698	124.190	-53.237	1.00	81.57	O
ATOM	1635	CB	ASP	A	207	-33.797	125.805	-54.131	1.00	84.84	C
ATOM	1636	CG	ASP	A	207	-33.901	126.694	-52.913	1.00	85.80	C
ATOM	1637	OD1	ASP	A	207	-32.859	126.947	-52.266	1.00	86.46	O
ATOM	1638	OD2	ASP	A	207	-35.025	127.138	-52.592	1.00	93.25	O
ATOM	1639	N	ALA	A	208	-30.112	125.488	-54.161	1.00	83.47	N

ATOM	1640	CA	ALA	A	208	-29.001	124.818	-53.499	1.00	82.85	C
ATOM	1641	C	ALA	A	208	-29.102	124.889	-51.973	1.00	82.86	C
ATOM	1642	O	ALA	A	208	-29.066	123.853	-51.304	1.00	80.94	O
ATOM	1643	CB	ALA	A	208	-27.676	125.411	-53.968	1.00	77.52	C
ATOM	1644	N	LYS	A	209	-29.226	126.100	-51.431	1.00	80.66	N
ATOM	1645	CA	LYS	A	209	-29.310	126.277	-49.982	1.00	82.60	C
ATOM	1646	C	LYS	A	209	-30.387	125.387	-49.380	1.00	80.99	C
ATOM	1647	O	LYS	A	209	-30.190	124.796	-48.325	1.00	80.67	O
ATOM	1648	CB	LYS	A	209	-29.581	127.737	-49.619	1.00	85.12	C
ATOM	1649	CG	LYS	A	209	-30.063	127.917	-48.191	1.00	85.05	C
ATOM	1650	CD	LYS	A	209	-29.902	129.353	-47.691	1.00	90.83	C
ATOM	1651	CE	LYS	A	209	-28.543	129.565	-47.021	1.00	93.41	C
ATOM	1652	NZ	LYS	A	209	-28.538	130.754	-46.119	1.00	93.43	N
ATOM	1653	N	ALA	A	210	-31.520	125.276	-50.063	1.00	80.58	N
ATOM	1654	CA	ALA	A	210	-32.567	124.373	-49.609	1.00	82.10	C
ATOM	1655	C	ALA	A	210	-32.127	122.919	-49.736	1.00	81.76	C
ATOM	1656	O	ALA	A	210	-32.301	122.133	-48.809	1.00	79.41	O
ATOM	1657	CB	ALA	A	210	-33.839	124.597	-50.383	1.00	78.21	C
ATOM	1658	N	ILE	A	211	-31.562	122.571	-50.890	1.00	80.20	N
ATOM	1659	CA	ILE	A	211	-31.165	121.196	-51.170	1.00	78.02	C
ATOM	1660	C	ILE	A	211	-29.986	120.757	-50.295	1.00	80.52	C
ATOM	1661	O	ILE	A	211	-29.992	119.662	-49.720	1.00	78.25	O
ATOM	1662	CB	ILE	A	211	-30.797	121.019	-52.651	1.00	73.71	C
ATOM	1663	CG1	ILE	A	211	-32.053	120.998	-53.508	1.00	76.38	C
ATOM	1664	CG2	ILE	A	211	-30.047	119.721	-52.875	1.00	80.04	C
ATOM	1665	CD1	ILE	A	211	-31.760	120.850	-54.974	1.00	79.69	C
ATOM	1666	N	LEU	A	212	-28.984	121.621	-50.183	1.00	76.79	N
ATOM	1667	CA	LEU	A	212	-27.757	121.262	-49.487	1.00	79.85	C
ATOM	1668	C	LEU	A	212	-27.896	121.323	-47.965	1.00	81.11	C
ATOM	1669	O	LEU	A	212	-27.183	120.612	-47.254	1.00	79.56	O
ATOM	1670	CB	LEU	A	212	-26.602	122.163	-49.942	1.00	75.88	C
ATOM	1671	CG	LEU	A	212	-26.186	122.010	-51.403	1.00	70.50	C
ATOM	1672	CD1	LEU	A	212	-25.075	122.978	-51.765	1.00	62.35	C
ATOM	1673	CD2	LEU	A	212	-25.779	120.586	-51.680	1.00	64.68	C
ATOM	1674	N	SER	A	213	-28.799	122.159	-47.458	1.00	76.91	N
ATOM	1675	CA	SER	A	213	-28.953	122.267	-46.013	1.00	79.25	C
ATOM	1676	C	SER	A	213	-30.143	121.472	-45.493	1.00	81.46	C
ATOM	1677	O	SER	A	213	-30.533	121.608	-44.331	1.00	84.46	O
ATOM	1678	CB	SER	A	213	-29.070	123.727	-45.593	1.00	84.05	C
ATOM	1679	CG	SER	A	213	-27.783	124.306	-45.499	1.00	86.20	C
ATOM	1680	N	ALA	A	214	-30.698	120.631	-46.357	1.00	78.64	N
ATOM	1681	CA	ALA	A	214	-31.746	119.698	-45.969	1.00	78.65	C
ATOM	1682	C	ALA	A	214	-31.311	118.833	-44.779	1.00	82.43	C
ATOM	1683	O	ALA	A	214	-30.116	118.589	-44.578	1.00	84.08	O
ATOM	1684	CB	ALA	A	214	-32.124	118.826	-47.151	1.00	75.30	C
ATOM	1685	O	ARG	A	215	-31.252	115.279	-42.436	1.00	91.86	O
ATOM	1686	N	ARG	A	215	-32.279	118.377	-43.988	1.00	81.29	N
ATOM	1687	CA	ARG	A	215	-31.972	117.541	-42.831	1.00	85.42	C
ATOM	1688	C	ARG	A	215	-31.644	116.106	-43.259	1.00	87.35	C
ATOM	1689	CB	ARG	A	215	-33.134	117.549	-41.834	1.00	81.84	C
ATOM	1690	O	LEU	A	216	-29.128	115.083	-44.732	1.00	74.73	O
ATOM	1691	N	LEU	A	216	-31.789	115.820	-44.550	1.00	85.13	N
ATOM	1692	CA	LEU	A	216	-31.451	114.505	-45.086	1.00	84.13	C
ATOM	1693	C	LEU	A	216	-29.950	114.229	-45.090	1.00	80.71	C
ATOM	1694	CB	LEU	A	216	-31.985	114.338	-46.517	1.00	84.14	C
ATOM	1695	CG	LEU	A	216	-33.492	114.351	-46.756	1.00	77.46	C
ATOM	1696	CD1	LEU	A	216	-33.919	115.739	-47.161	1.00	79.56	C
ATOM	1697	CD2	LEU	A	216	-33.882	113.325	-47.810	1.00	80.61	C
ATOM	1698	N	SER	A	217	-29.615	113.016	-45.521	1.00	86.34	N
ATOM	1699	CA	SER	A	217	-28.239	112.527	-45.553	1.00	81.82	C
ATOM	1700	C	SER	A	217	-27.367	113.333	-46.501	1.00	81.12	C
ATOM	1701	O	SER	A	217	-27.868	114.027	-47.393	1.00	82.43	O
ATOM	1702	CB	SER	A	217	-28.222	111.050	-45.963	1.00	84.25	C

ATOM	1703	OG	SER	A	217	-26.939	110.650	-46.421	1.00	87.65	O
ATOM	1704	N	LYS	A	218	-26.059	113.244	-46.300	1.00	77.06	N
ATOM	1705	CA	LYS	A	218	-25.119	113.774	-47.274	1.00	81.92	C
ATOM	1706	C	LYS	A	218	-25.389	113.121	-48.633	1.00	84.54	C
ATOM	1707	O	LYS	A	218	-25.588	113.816	-49.638	1.00	81.37	O
ATOM	1708	CB	LYS	A	218	-23.669	113.527	-46.842	1.00	77.35	C
ATOM	1709	CG	LYS	A	218	-23.213	114.303	-45.617	1.00	71.24	C
ATOM	1710	CD	LYS	A	218	-21.770	113.942	-45.277	1.00	70.50	C
ATOM	1711	CE	LYS	A	218	-21.361	114.455	-43.902	1.00	64.92	C
ATOM	1712	NZ	LYS	A	218	-21.516	115.927	-43.823	1.00	67.13	N
ATOM	1713	N	SER	A	219	-25.411	111.788	-48.647	1.00	82.19	N
ATOM	1714	CA	SER	A	219	-25.673	111.031	-49.867	1.00	82.36	C
ATOM	1715	C	SER	A	219	-27.021	111.388	-50.483	1.00	81.54	C
ATOM	1716	O	SER	A	219	-27.146	111.482	-51.704	1.00	83.78	O
ATOM	1717	CB	SER	A	219	-25.622	109.530	-49.588	1.00	82.42	C
ATOM	1718	OG	SER	A	219	-24.498	109.198	-48.804	1.00	84.67	O
ATOM	1719	N	ARG	A	220	-28.036	111.571	-49.646	1.00	82.96	N
ATOM	1720	CA	ARG	A	220	-29.337	111.991	-50.151	1.00	83.99	C
ATOM	1721	C	ARG	A	220	-29.254	113.413	-50.719	1.00	82.30	C
ATOM	1722	O	ARG	A	220	-29.769	113.686	-51.799	1.00	81.38	O
ATOM	1723	CB	ARG	A	220	-30.398	111.909	-49.057	1.00	82.13	C
ATOM	1724	N	ARG	A	221	-28.588	114.314	-50.006	1.00	81.11	N
ATOM	1725	CA	ARG	A	221	-28.453	115.686	-50.485	1.00	81.44	C
ATOM	1726	C	ARG	A	221	-27.626	115.806	-51.776	1.00	83.68	C
ATOM	1727	O	ARG	A	221	-27.936	116.634	-52.635	1.00	83.21	O
ATOM	1728	CB	ARG	A	221	-27.849	116.564	-49.401	1.00	76.60	C
ATOM	1729	CG	ARG	A	221	-28.855	116.989	-48.373	1.00	78.81	C
ATOM	1730	CD	ARG	A	221	-28.181	117.688	-47.218	1.00	76.10	C
ATOM	1731	NE	ARG	A	221	-27.344	116.773	-46.454	1.00	75.39	N
ATOM	1732	CZ	ARG	A	221	-26.652	117.128	-45.382	1.00	75.44	C
ATOM	1733	NH1	ARG	A	221	-26.701	118.381	-44.943	1.00	84.08	N
ATOM	1734	NH2	ARG	A	221	-25.914	116.234	-44.749	1.00	70.85	N
ATOM	1735	N	LEU	A	222	-26.576	114.997	-51.906	1.00	80.65	N
ATOM	1736	CA	LEU	A	222	-25.828	114.911	-53.161	1.00	79.88	C
ATOM	1737	C	LEU	A	222	-26.767	114.451	-54.266	1.00	80.83	C
ATOM	1738	O	LEU	A	222	-26.766	114.999	-55.376	1.00	78.38	O
ATOM	1739	CB	LEU	A	222	-24.637	113.952	-53.031	1.00	77.97	C
ATOM	1740	CG	LEU	A	222	-23.801	113.591	-54.260	1.00	73.22	C
ATOM	1741	CD2	LEU	A	222	-22.750	112.567	-53.882	1.00	75.68	C
ATOM	1742	CD1	LEU	A	222	-23.148	114.807	-54.890	1.00	72.95	C
ATOM	1743	N	GLU	A	223	-27.582	113.451	-53.944	1.00	81.65	N
ATOM	1744	CA	GLU	A	223	-28.576	112.941	-54.879	1.00	83.29	C
ATOM	1745	C	GLU	A	223	-29.554	114.036	-55.267	1.00	84.28	C
ATOM	1746	O	GLU	A	223	-29.777	114.287	-56.452	1.00	84.22	O
ATOM	1747	CB	GLU	A	223	-29.331	111.753	-54.283	1.00	83.05	C
ATOM	1748	CG	GLU	A	223	-30.504	111.293	-55.136	1.00	85.68	C
ATOM	1749	CD	GLU	A	223	-30.092	110.900	-56.546	1.00	90.18	C
ATOM	1750	OE1	GLU	A	223	-30.068	111.788	-57.434	1.00	85.40	O
ATOM	1751	OE2	GLU	A	223	-29.800	109.699	-56.766	1.00	89.56	O
ATOM	1752	N	ASN	A	224	-30.119	114.688	-54.254	1.00	83.89	N
ATOM	1753	CA	ASN	A	224	-31.074	115.770	-54.451	1.00	81.31	C
ATOM	1754	C	ASN	A	224	-30.610	116.783	-55.484	1.00	81.56	C
ATOM	1755	O	ASN	A	224	-31.369	117.165	-56.375	1.00	82.45	O
ATOM	1756	CB	ASN	A	224	-31.344	116.490	-53.130	1.00	81.02	C
ATOM	1757	CG	ASN	A	224	-32.076	115.623	-52.126	1.00	84.57	C
ATOM	1758	OD1	ASN	A	224	-32.576	114.552	-52.466	1.00	85.57	O
ATOM	1759	ND2	ASN	A	224	-32.154	116.091	-50.880	1.00	82.89	N
ATOM	1760	N	LEU	A	225	-29.349	117.189	-55.375	1.00	79.96	N
ATOM	1761	CA	LEU	A	225	-28.843	118.327	-56.136	1.00	83.13	C
ATOM	1762	C	LEU	A	225	-28.484	118.042	-57.607	1.00	84.46	C
ATOM	1763	O	LEU	A	225	-28.904	118.787	-58.495	1.00	85.85	O
ATOM	1764	CB	LEU	A	225	-27.622	118.927	-55.433	1.00	74.57	C
ATOM	1765	CG	LEU	A	225	-27.163	120.220	-56.109	1.00	73.32	C

ATOM	1766	CD1	LEU	A	225	-27.027	121.322	-55.087	1.00	73.04	C
ATOM	1767	CD2	LEU	A	225	-25.864	120.039	-56.882	1.00	69.09	C
ATOM	1768	N	ILE	A	226	-27.693	117.006	-57.880	1.00	78.57	N
ATOM	1769	CA	ILE	A	226	-27.277	116.791	-59.258	1.00	83.02	C
ATOM	1770	C	ILE	A	226	-28.493	116.323	-60.058	1.00	90.28	C
ATOM	1771	O	ILE	A	226	-28.563	116.524	-61.273	1.00	90.82	O
ATOM	1772	CB	ILE	A	226	-26.092	115.769	-59.406	1.00	84.20	C
ATOM	1773	CG1	ILE	A	226	-26.533	114.343	-59.095	1.00	82.14	C
ATOM	1774	CG2	ILE	A	226	-24.887	116.179	-58.573	1.00	75.56	C
ATOM	1775	CD1	ILE	A	226	-26.531	113.454	-60.304	1.00	89.26	C
ATOM	1776	N	ALA	A	227	-29.471	115.737	-59.371	1.00	89.35	N
ATOM	1777	CA	ALA	A	227	-30.680	115.278	-60.041	1.00	87.18	C
ATOM	1778	C	ALA	A	227	-31.627	116.446	-60.303	1.00	90.22	C
ATOM	1779	O	ALA	A	227	-32.764	116.256	-60.726	1.00	95.75	C
ATOM	1780	CB	ALA	A	227	-31.366	114.201	-59.231	1.00	87.93	O
ATOM	1781	N	GLN	A	228	-31.157	117.659	-60.048	1.00	88.90	N
ATOM	1782	CA	GLN	A	228	-31.855	118.846	-60.513	1.00	88.86	C
ATOM	1783	C	GLN	A	228	-30.982	119.492	-61.585	1.00	89.86	C
ATOM	1784	O	GLN	A	228	-31.157	120.654	-61.950	1.00	92.81	O
ATOM	1785	CB	GLN	A	228	-32.152	119.809	-59.359	1.00	86.55	C
ATOM	1786	CG	GLN	A	228	-33.222	120.840	-59.686	1.00	93.67	C
ATOM	1787	CD	GLN	A	228	-33.760	121.554	-58.455	1.00	100.57	C
ATOM	1788	OE1	GLN	A	228	-33.793	120.988	-57.363	1.00	101.91	O
ATOM	1789	NE2	GLN	A	228	-34.198	122.802	-58.631	1.00	93.95	N
ATOM	1790	N	LEU	A	229	-30.041	118.709	-62.099	1.00	89.77	N
ATOM	1791	CA	LEU	A	229	-29.143	119.172	-63.149	1.00	88.66	C
ATOM	1792	C	LEU	A	229	-29.136	118.230	-64.351	1.00	92.50	C
ATOM	1793	O	LEU	A	229	-28.830	117.039	-64.219	1.00	91.13	O
ATOM	1794	CB	LEU	A	229	-27.722	119.326	-62.614	1.00	84.27	C
ATOM	1795	CG	LEU	A	229	-27.437	120.504	-61.692	1.00	85.39	C
ATOM	1796	CD1	LEU	A	229	-26.006	120.408	-61.179	1.00	80.87	C
ATOM	1797	CD2	LEU	A	229	-27.668	121.812	-62.430	1.00	84.96	C
ATOM	1798	O	PRO	A	230	-27.160	117.730	-67.251	1.00	88.40	O
ATOM	1799	N	PRO	A	230	-29.469	118.775	-65.532	1.00	90.87	N
ATOM	1800	CA	PRO	A	230	-29.495	118.093	-66.827	1.00	89.69	C
ATOM	1801	C	PRO	A	230	-28.273	117.214	-67.107	1.00	90.82	C
ATOM	1802	CB	PRO	A	230	-29.550	119.255	-67.817	1.00	91.30	C
ATOM	1803	CG	PRO	A	230	-30.300	120.307	-67.092	1.00	96.99	C
ATOM	1804	CD	PRO	A	230	-29.892	120.182	-65.650	1.00	94.81	C
ATOM	1805	O	GLY	A	231	-25.148	114.475	-67.490	1.00	84.87	O
ATOM	1806	N	GLY	A	231	-28.494	115.901	-67.173	1.00	88.56	N
ATOM	1807	CA	GLY	A	231	-27.494	114.952	-67.640	1.00	92.58	C
ATOM	1808	C	GLY	A	231	-26.144	114.962	-66.943	1.00	91.24	C
ATOM	1809	O	GLU	A	232	-25.930	113.970	-63.419	1.00	86.45	O
ATOM	1810	N	GLU	A	232	-26.115	115.526	-65.739	1.00	91.66	N
ATOM	1811	CA	GLU	A	232	-24.914	115.551	-64.914	1.00	86.62	C
ATOM	1812	C	GLU	A	232	-24.903	114.327	-64.001	1.00	84.03	C
ATOM	1813	CB	GLU	A	232	-24.854	116.846	-64.097	1.00	82.70	C
ATOM	1814	CG	GLU	A	232	-23.628	116.981	-63.226	1.00	81.75	C
ATOM	1815	CD	GLU	A	232	-22.340	117.116	-64.024	1.00	81.30	C
ATOM	1816	OE1	GLU	A	232	-22.382	117.707	-65.120	1.00	81.28	O
ATOM	1817	OE2	GLU	A	232	-21.287	116.635	-63.546	1.00	75.77	O
ATOM	1818	O	LYS	A	233	-22.369	113.671	-61.440	1.00	78.33	O
ATOM	1819	N	LYS	A	233	-23.745	113.679	-63.888	1.00	82.85	N
ATOM	1820	CA	LYS	A	233	-23.630	112.455	-63.098	1.00	76.30	C
ATOM	1821	C	LYS	A	233	-23.122	112.719	-61.677	1.00	79.94	C
ATOM	1822	CB	LYS	A	233	-22.713	111.460	-63.808	1.00	82.90	C
ATOM	1823	O	LYS	A	234	-20.892	112.289	-58.472	1.00	79.27	O
ATOM	1824	N	LYS	A	234	-23.543	111.871	-60.736	1.00	83.36	N
ATOM	1825	CA	LYS	A	234	-23.112	111.976	-59.342	1.00	81.53	C
ATOM	1826	C	LYS	A	234	-21.634	111.605	-59.177	1.00	78.84	C
ATOM	1827	CB	LYS	A	234	-23.984	111.094	-58.450	1.00	84.44	C
ATOM	1828	O	ASN	A	235	-17.757	110.969	-60.779	1.00	74.94	O

ATOM	1829	N	ASN	A	235	-21.209	110.531	-59.836	1.00	75.99	N
ATOM	1830	CA	ASN	A	235	-19.799	110.150	-59.840	1.00	77.54	C
ATOM	1831	C	ASN	A	235	-18.973	111.094	-60.704	1.00	75.14	C
ATOM	1832	CB	ASN	A	235	-19.625	108.709	-60.330	1.00	71.41	C
ATOM	1833	O	GLY	A	236	-18.303	114.095	-60.259	1.00	76.38	O
ATOM	1834	N	GLY	A	236	-19.645	112.043	-61.351	1.00	76.90	N
ATOM	1835	CA	GLY	A	236	-18.999	112.995	-62.245	1.00	72.27	C
ATOM	1836	C	GLY	A	236	-18.172	114.004	-61.478	1.00	74.88	C
ATOM	1837	N	LEU	A	237	-17.329	114.765	-62.178	1.00	72.21	N
ATOM	1838	CA	LEU	A	237	-16.399	115.679	-61.514	1.00	68.94	C
ATOM	1839	C	LEU	A	237	-17.110	116.705	-60.645	1.00	68.40	C
ATOM	1840	O	LEU	A	237	-16.660	116.982	-59.537	1.00	75.57	O
ATOM	1841	CB	LEU	A	237	-15.503	116.403	-62.522	1.00	66.48	C
ATOM	1842	CG	LEU	A	237	-14.729	117.599	-61.943	1.00	66.09	C
ATOM	1843	CD1	LEU	A	237	-13.740	117.181	-60.850	1.00	62.94	C
ATOM	1844	CD2	LEU	A	237	-14.027	118.408	-63.027	1.00	66.42	C
ATOM	1845	N	PHE	A	238	-18.221	117.258	-61.121	1.00	66.26	N
ATOM	1846	CA	PHE	A	238	-18.952	118.234	-60.318	1.00	69.71	C
ATOM	1847	C	PHE	A	238	-19.718	117.548	-59.185	1.00	72.26	C
ATOM	1848	O	PHE	A	238	-19.854	118.102	-58.090	1.00	71.32	O
ATOM	1849	CB	PHE	A	238	-19.916	119.050	-61.179	1.00	71.65	C
ATOM	1850	CG	PHE	A	238	-20.500	120.238	-60.463	1.00	70.98	C
ATOM	1851	CD1	PHE	A	238	-19.826	121.450	-60.443	1.00	67.72	C
ATOM	1852	CD2	PHE	A	238	-21.712	120.142	-59.800	1.00	68.19	C
ATOM	1853	CE1	PHE	A	238	-20.353	122.543	-59.782	1.00	64.01	C
ATOM	1854	CE2	PHE	A	238	-22.239	121.236	-59.135	1.00	66.05	C
ATOM	1855	CZ	PHE	A	238	-21.559	122.433	-59.130	1.00	65.45	C
ATOM	1856	N	GLY	A	239	-20.224	116.347	-59.461	1.00	71.56	N
ATOM	1857	CA	GLY	A	239	-20.871	115.547	-58.442	1.00	71.28	C
ATOM	1858	C	GLY	A	239	-19.928	115.347	-57.275	1.00	72.58	C
ATOM	1859	O	GLY	A	239	-20.323	115.523	-56.120	1.00	73.32	O
ATOM	1860	N	ASN	A	240	-18.671	115.026	-57.587	1.00	67.48	N
ATOM	1861	CA	ASN	A	240	-17.646	114.797	-56.572	1.00	70.85	C
ATOM	1862	C	ASN	A	240	-17.212	116.053	-55.856	1.00	69.79	C
ATOM	1863	O	ASN	A	240	-16.824	116.007	-54.693	1.00	69.04	O
ATOM	1864	CB	ASN	A	240	-16.422	114.128	-57.186	1.00	71.00	C
ATOM	1865	CG	ASN	A	240	-16.667	112.680	-57.500	1.00	74.60	C
ATOM	1866	OD1	ASN	A	240	-17.633	112.091	-57.008	1.00	79.24	O
ATOM	1867	ND2	ASN	A	240	-15.800	112.089	-58.320	1.00	72.32	N
ATOM	1868	N	LEU	A	241	-17.272	117.179	-56.548	1.00	72.14	N
ATOM	1869	CA	LEU	A	241	-16.954	118.438	-55.909	1.00	68.98	C
ATOM	1870	C	LEU	A	241	-18.061	118.829	-54.923	1.00	74.03	C
ATOM	1871	O	LEU	A	241	-17.810	119.564	-53.963	1.00	76.72	O
ATOM	1872	CB	LEU	A	241	-16.731	119.522	-56.957	1.00	69.31	C
ATOM	1873	CG	LEU	A	241	-15.467	119.344	-57.797	1.00	60.07	C
ATOM	1874	CD1	LEU	A	241	-15.447	120.336	-58.940	1.00	62.87	C
ATOM	1875	CD2	LEU	A	241	-14.233	119.507	-56.947	1.00	62.15	C
ATOM	1876	N	ILE	A	242	-19.278	118.329	-55.143	1.00	74.33	N
ATOM	1877	CA	ILE	A	242	-20.372	118.584	-54.200	1.00	73.38	C
ATOM	1878	C	ILE	A	242	-20.248	117.671	-52.973	1.00	68.57	C
ATOM	1879	O	ILE	A	242	-20.350	118.139	-51.832	1.00	67.29	O
ATOM	1880	CB	ILE	A	242	-21.759	118.397	-54.854	1.00	70.99	C
ATOM	1881	CG1	ILE	A	242	-22.002	119.464	-55.921	1.00	68.59	C
ATOM	1882	CG2	ILE	A	242	-22.856	118.470	-53.806	1.00	67.60	C
ATOM	1883	CD1	ILE	A	242	-22.200	120.870	-55.365	1.00	71.32	C
ATOM	1884	N	ALA	A	243	-20.015	116.381	-53.215	1.00	67.98	N
ATOM	1885	CA	ALA	A	243	-19.719	115.417	-52.150	1.00	68.57	C
ATOM	1886	C	ALA	A	243	-18.627	115.933	-51.210	1.00	68.23	C
ATOM	1887	O	ALA	A	243	-18.778	115.920	-49.987	1.00	67.17	O
ATOM	1888	CB	ALA	A	243	-19.304	114.081	-52.746	1.00	68.81	C
ATOM	1889	N	LEU	A	244	-17.534	116.402	-51.794	1.00	67.52	N
ATOM	1890	CA	LEU	A	244	-16.454	117.007	-51.027	1.00	69.49	C
ATOM	1891	C	LEU	A	244	-16.967	118.160	-50.156	1.00	65.96	C

ATOM	1892	O	LEU	A	244	-16.696	118.212	-48.958	1.00	61.47	O
ATOM	1893	CB	LEU	A	244	-15.349	117.496	-51.966	1.00	67.65	C
ATOM	1894	CG	LEU	A	244	-14.104	118.038	-51.280	1.00	66.20	C
ATOM	1895	CD1	LEU	A	244	-13.522	116.948	-50.405	1.00	70.54	C
ATOM	1896	CD2	LEU	A	244	-13.079	118.527	-52.291	1.00	63.22	C
ATOM	1897	N	SER	A	245	-17.716	119.077	-50.766	1.00	70.35	N
ATOM	1898	CA	SER	A	245	-18.330	120.180	-50.040	1.00	60.76	C
ATOM	1899	C	SER	A	245	-19.295	119.667	-48.988	1.00	61.32	C
ATOM	1900	O	SER	A	245	-19.518	120.319	-47.979	1.00	59.94	O
ATOM	1901	CB	SER	A	245	-19.063	121.106	-50.996	1.00	67.97	C
ATOM	1902	OG	SER	A	245	-18.179	121.579	-51.985	1.00	71.45	O
ATOM	1903	N	LEU	A	246	-19.862	118.487	-49.223	1.00	61.68	N
ATOM	1904	CA	LEU	A	246	-20.810	117.904	-48.280	1.00	61.64	C
ATOM	1905	C	LEU	A	246	-20.156	117.228	-47.066	1.00	62.87	C
ATOM	1906	O	LEU	A	246	-20.815	116.955	-46.067	1.00	58.34	O
ATOM	1907	CB	LEU	A	246	-21.715	116.903	-49.002	1.00	64.77	C
ATOM	1908	CG	LEU	A	246	-22.898	117.548	-49.732	1.00	62.60	C
ATOM	1909	CD1	LEU	A	246	-23.859	116.504	-50.253	1.00	70.43	C
ATOM	1910	CD2	LEU	A	246	-23.599	118.511	-48.793	1.00	58.03	C
ATOM	1911	O	GLY	A	247	-17.656	114.075	-45.370	1.00	68.00	O
ATOM	1912	N	GLY	A	247	-18.861	116.960	-47.146	1.00	67.12	N
ATOM	1913	CA	GLY	A	247	-18.179	116.310	-46.044	1.00	65.25	C
ATOM	1914	C	GLY	A	247	-18.004	114.824	-46.285	1.00	65.31	C
ATOM	1915	O	LEU	A	248	-15.749	113.767	-48.345	1.00	68.73	O
ATOM	1916	N	LEU	A	248	-18.252	114.397	-47.519	1.00	67.93	N
ATOM	1917	CA	LEU	A	248	-17.988	113.016	-47.931	1.00	69.08	C
ATOM	1918	C	LEU	A	248	-16.542	112.834	-48.396	1.00	68.58	C
ATOM	1919	CB	LEU	A	248	-18.952	112.606	-49.041	1.00	68.43	C
ATOM	1920	CG	LEU	A	248	-20.404	112.465	-48.591	1.00	72.82	C
ATOM	1921	CD1	LEU	A	248	-21.356	112.367	-49.781	1.00	74.87	C
ATOM	1922	CD2	LEU	A	248	-20.519	111.241	-47.706	1.00	71.87	C
ATOM	1923	O	THR	A	249	-14.956	109.601	-50.958	1.00	81.34	O
ATOM	1924	N	THR	A	249	-16.195	111.626	-48.833	1.00	68.88	N
ATOM	1925	CA	THR	A	249	-14.848	111.383	-49.339	1.00	74.38	C
ATOM	1926	C	THR	A	249	-14.933	110.821	-50.763	1.00	78.27	C
ATOM	1927	CB	THR	A	249	-14.019	110.407	-48.418	1.00	70.84	C
ATOM	1928	OG1	THR	A	249	-14.083	110.830	-47.050	1.00	66.85	O
ATOM	1929	CG2	THR	A	249	-12.555	110.379	-48.827	1.00	61.76	C
ATOM	1930	O	PRO	A	250	-12.647	111.330	-53.146	1.00	75.05	O
ATOM	1931	N	PRO	A	250	-15.001	111.721	-51.762	1.00	74.24	N
ATOM	1932	CA	PRO	A	250	-15.032	111.377	-53.192	1.00	72.56	C
ATOM	1933	C	PRO	A	250	-13.663	110.951	-53.728	1.00	74.27	C
ATOM	1934	CB	PRO	A	250	-15.486	112.684	-53.852	1.00	73.79	C
ATOM	1935	CG	PRO	A	250	-14.994	113.756	-52.929	1.00	71.28	C
ATOM	1936	CD	PRO	A	250	-15.095	113.178	-51.540	1.00	70.99	C
ATOM	1937	O	ASN	A	251	-12.948	109.844	-57.812	1.00	72.80	O
ATOM	1938	N	ASN	A	251	-13.638	110.176	-54.812	1.00	78.51	N
ATOM	1939	CA	ASN	A	251	-12.376	109.814	-55.466	1.00	75.87	C
ATOM	1940	C	ASN	A	251	-12.303	110.358	-56.895	1.00	73.13	C
ATOM	1941	CB	ASN	A	251	-12.174	108.294	-55.475	1.00	74.02	C
ATOM	1942	CG	ASN	A	251	-10.710	107.890	-55.709	1.00	74.52	C
ATOM	1943	OD1	ASN	A	251	-9.806	108.728	-55.742	1.00	72.67	O
ATOM	1944	ND2	ASN	A	251	-10.478	106.594	-55.845	1.00	76.84	N
ATOM	1945	O	PHE	A	252	-10.129	111.750	-60.420	1.00	73.38	O
ATOM	1946	N	PHE	A	252	-11.491	111.394	-57.069	1.00	69.05	N
ATOM	1947	CA	PHE	A	252	-11.330	112.052	-58.353	1.00	73.09	C
ATOM	1948	C	PHE	A	252	-10.453	111.255	-59.342	1.00	74.43	C
ATOM	1949	CB	PHE	A	252	-10.726	113.445	-58.148	1.00	73.10	C
ATOM	1950	CG	PHE	A	252	-11.510	114.334	-57.210	1.00	72.88	C
ATOM	1951	CD2	PHE	A	252	-12.309	115.344	-57.703	1.00	72.64	C
ATOM	1952	CD1	PHE	A	252	-11.408	114.185	-55.831	1.00	73.64	C
ATOM	1953	CE2	PHE	A	252	-13.015	116.174	-56.844	1.00	74.34	C
ATOM	1954	CE1	PHE	A	252	-12.111	115.008	-54.972	1.00	68.59	C

ATOM	1955	CZ	PHE	A	252	-12.911	116.004	-55.478	1.00	72.07	C
ATOM	1956	O	LYS	A	253	-9.151	109.225	-62.211	1.00	75.97	O
ATOM	1957	N	LYS	A	253	-10.064	110.035	-58.977	1.00	73.20	N
ATOM	1958	CA	LYS	A	253	-9.165	109.250	-59.815	1.00	75.78	C
ATOM	1959	C	LYS	A	253	-9.789	108.996	-61.182	1.00	75.08	C
ATOM	1960	CB	LYS	A	253	-8.802	107.927	-59.142	1.00	77.43	C
ATOM	1961	O	SER	A	254	-11.499	109.798	-64.358	1.00	77.60	O
ATOM	1962	N	SER	A	254	-11.035	108.539	-61.194	1.00	69.22	N
ATOM	1963	CA	SER	A	254	-11.759	108.375	-62.453	1.00	71.00	C
ATOM	1964	C	SER	A	254	-11.894	109.701	-63.199	1.00	73.78	C
ATOM	1965	CB	SER	A	254	-13.143	107.776	-62.211	1.00	70.70	C
ATOM	1966	OG	SER	A	254	-13.707	107.304	-63.424	1.00	61.79	O
ATOM	1967	O	ASN	A	255	-11.683	113.429	-64.821	1.00	76.29	O
ATOM	1968	N	ASN	A	255	-12.425	110.722	-62.523	1.00	73.47	N
ATOM	1969	CA	ASN	A	255	-12.662	112.036	-63.135	1.00	73.95	C
ATOM	1970	C	ASN	A	255	-11.492	112.594	-63.933	1.00	74.91	C
ATOM	1971	CB	ASN	A	255	-13.030	113.078	-62.076	1.00	70.03	C
ATOM	1972	CG	ASN	A	255	-14.347	112.798	-61.402	1.00	69.74	C
ATOM	1973	OD1	ASN	A	255	-14.616	113.312	-60.314	1.00	70.01	O
ATOM	1974	ND2	ASN	A	255	-15.173	111.977	-62.031	1.00	67.57	N
ATOM	1975	O	PHE	A	256	-7.163	111.805	-65.402	1.00	83.16	O
ATOM	1976	N	PHE	A	256	-10.286	112.153	-63.601	1.00	72.49	N
ATOM	1977	CA	PHE	A	256	-9.082	112.657	-64.246	1.00	74.77	C
ATOM	1978	C	PHE	A	256	-8.298	111.566	-64.981	1.00	80.57	C
ATOM	1979	CB	PHE	A	256	-8.165	113.324	-63.218	1.00	71.39	C
ATOM	1980	CG	PHE	A	256	-8.740	114.553	-62.594	1.00	75.06	C
ATOM	1981	CD1	PHE	A	256	-8.854	115.725	-63.318	1.00	77.16	C
ATOM	1982	CD2	PHE	A	256	-9.144	114.550	-61.273	1.00	77.07	C
ATOM	1983	CE1	PHE	A	256	-9.380	116.865	-62.741	1.00	75.86	C
ATOM	1984	CE2	PHE	A	256	-9.670	115.689	-60.693	1.00	72.83	C
ATOM	1985	CZ	PHE	A	256	-9.788	116.843	-61.432	1.00	76.48	C
ATOM	1986	O	ASP	A	257	-5.967	108.430	-65.709	1.00	87.39	O
ATOM	1987	N	ASP	A	257	-8.899	110.384	-65.134	1.00	78.90	N
ATOM	1988	CA	ASP	A	257	-8.234	109.217	-65.737	1.00	84.17	C
ATOM	1989	C	ASP	A	257	-6.904	108.890	-65.053	1.00	85.94	C
ATOM	1990	CB	ASP	A	257	-7.966	109.421	-67.244	1.00	90.48	C
ATOM	1991	CG	ASP	A	257	-9.072	110.205	-67.960	1.00	86.78	C
ATOM	1992	OD1	ASP	A	257	-10.084	109.590	-68.363	1.00	85.85	O
ATOM	1993	OD2	ASP	A	257	-8.907	111.432	-68.154	1.00	82.92	O
ATOM	1994	O	LEU	A	258	-6.295	106.620	-62.772	1.00	87.37	O
ATOM	1995	N	LEU	A	258	-6.810	109.135	-63.747	1.00	86.75	N
ATOM	1996	CA	LEU	A	258	-5.560	108.892	-63.023	1.00	85.50	C
ATOM	1997	C	LEU	A	258	-5.337	107.396	-62.812	1.00	86.76	C
ATOM	1998	CB	LEU	A	258	-5.554	109.627	-61.674	1.00	79.48	C
ATOM	1999	CG	LEU	A	258	-5.636	111.161	-61.692	1.00	79.44	C
ATOM	2000	CD1	LEU	A	258	-5.056	111.791	-60.421	1.00	74.23	C
ATOM	2001	CD2	LEU	A	258	-4.963	111.744	-62.918	1.00	77.36	C
ATOM	2002	O	ALA	A	259	-4.468	104.251	-60.561	1.00	86.24	O
ATOM	2003	N	ALA	A	259	-4.075	106.994	-62.686	1.00	83.00	N
ATOM	2004	CA	ALA	A	259	-3.748	105.594	-62.414	1.00	86.05	C
ATOM	2005	C	ALA	A	259	-3.871	105.263	-60.932	1.00	85.16	C
ATOM	2006	CB	ALA	A	259	-2.352	105.269	-62.901	1.00	86.53	C
ATOM	2007	O	GLU	A	260	-4.963	107.713	-58.676	1.00	81.87	O
ATOM	2008	N	GLU	A	260	-3.297	106.118	-60.089	1.00	83.66	N
ATOM	2009	CA	GLU	A	260	-3.376	105.933	-58.642	1.00	84.74	C
ATOM	2010	C	GLU	A	260	-4.515	106.747	-58.062	1.00	81.17	C
ATOM	2011	CB	GLU	A	260	-2.058	106.321	-57.966	1.00	83.87	C
ATOM	2012	O	ASP	A	261	-4.648	108.932	-55.658	1.00	78.89	O
ATOM	2013	N	ASP	A	261	-4.973	106.363	-56.873	1.00	82.37	N
ATOM	2014	CA	ASP	A	261	-6.079	107.055	-56.205	1.00	75.74	C
ATOM	2015	C	ASP	A	261	-5.801	108.513	-55.823	1.00	78.50	C
ATOM	2016	CB	ASP	A	261	-6.489	106.301	-54.946	1.00	73.20	C
ATOM	2017	CG	ASP	A	261	-7.582	105.309	-55.207	1.00	78.37	C

ATOM	2018	OD1	ASP	A	261	-8.131	105.329	-56.325	1.00	78.78	O
ATOM	2019	OD2	ASP	A	261	-7.900	104.521	-54.296	1.00	84.12	O
ATOM	2020	O	ALA	A	262	-8.926	111.788	-55.002	1.00	73.93	O
ATOM	2021	N	ALA	A	262	-6.884	109.273	-55.678	1.00	71.01	N
ATOM	2022	CA	ALA	A	262	-6.810	110.671	-55.293	1.00	70.30	C
ATOM	2023	C	ALA	A	262	-8.060	111.055	-54.507	1.00	76.86	C
ATOM	2024	CB	ALA	A	262	-6.654	111.555	-56.515	1.00	70.31	C
ATOM	2025	O	LYS	A	263	-7.979	112.249	-51.097	1.00	72.33	O
ATOM	2026	N	LYS	A	263	-8.157	110.545	-53.284	1.00	75.89	N
ATOM	2027	CA	LYS	A	263	-9.327	110.787	-52.453	1.00	72.74	C
ATOM	2028	C	LYS	A	263	-9.092	112.004	-51.573	1.00	72.87	C
ATOM	2029	CB	LYS	A	263	-9.652	109.551	-51.619	1.00	71.00	C
ATOM	2030	CG	LYS	A	263	-9.769	108.283	-52.454	1.00	68.03	C
ATOM	2031	CD	LYS	A	263	-9.995	107.079	-51.576	1.00	63.53	C
ATOM	2032	CE	LYS	A	263	-10.259	105.847	-52.407	1.00	73.23	C
ATOM	2033	NZ	LYS	A	263	-10.482	104.653	-51.543	1.00	75.47	N
ATOM	2034	O	LEU	A	264	-12.308	114.047	-49.980	1.00	76.52	O
ATOM	2035	N	LEU	A	264	-10.144	112.778	-51.375	1.00	68.29	N
ATOM	2036	CA	LEU	A	264	-10.009	114.067	-50.720	1.00	72.51	C
ATOM	2037	C	LEU	A	264	-11.135	114.285	-49.689	1.00	74.38	C
ATOM	2038	CB	LEU	A	264	-9.999	115.180	-51.780	1.00	73.53	C
ATOM	2039	CG	LEU	A	264	-8.726	115.983	-52.074	1.00	72.95	C
ATOM	2040	CD1	LEU	A	264	-7.500	115.100	-52.198	1.00	73.81	C
ATOM	2041	CD2	LEU	A	264	-8.904	116.828	-53.335	1.00	65.73	C
ATOM	2042	O	GLN	A	265	-10.306	116.238	-45.934	1.00	70.38	O
ATOM	2043	N	GLN	A	265	-10.772	114.720	-48.483	1.00	72.33	N
ATOM	2044	CA	GLN	A	265	-11.740	114.996	-47.420	1.00	65.92	C
ATOM	2045	C	GLN	A	265	-11.308	116.257	-46.652	1.00	67.52	C
ATOM	2046	CB	GLN	A	265	-11.866	113.792	-46.476	1.00	61.76	C
ATOM	2047	CG	GLN	A	265	-12.923	113.965	-45.382	1.00	68.74	C
ATOM	2048	CD	GLN	A	265	-12.802	112.938	-44.249	1.00	75.23	C
ATOM	2049	OE1	GLN	A	265	-12.033	111.976	-44.331	1.00	72.10	O
ATOM	2050	NE2	GLN	A	265	-13.563	113.149	-43.185	1.00	73.47	N
ATOM	2051	O	LEU	A	266	-10.586	119.408	-44.217	1.00	60.76	O
ATOM	2052	N	LEU	A	266	-12.059	117.347	-46.804	1.00	69.27	N
ATOM	2053	CA	LEU	A	266	-11.676	118.653	-46.235	1.00	68.37	C
ATOM	2054	C	LEU	A	266	-11.419	118.648	-44.710	1.00	64.56	C
ATOM	2055	CB	LEU	A	266	-12.744	119.702	-46.572	1.00	63.50	C
ATOM	2056	CG	LEU	A	266	-12.996	120.074	-48.039	1.00	62.94	C
ATOM	2057	CD1	LEU	A	266	-14.445	120.384	-48.228	1.00	65.14	C
ATOM	2058	CD2	LEU	A	266	-12.184	121.272	-48.470	1.00	66.42	C
ATOM	2059	O	SER	A	267	-9.964	117.369	-41.131	1.00	68.75	O
ATOM	2060	N	SER	A	267	-12.111	117.782	-43.974	1.00	68.41	N
ATOM	2061	CA	SER	A	267	-11.900	117.662	-42.526	1.00	70.04	C
ATOM	2062	C	SER	A	267	-10.554	117.019	-42.153	1.00	68.90	C
ATOM	2063	CB	SER	A	267	-13.037	116.852	-41.884	1.00	66.51	C
ATOM	2064	OG	SER	A	267	-13.014	115.500	-42.326	1.00	69.85	O
ATOM	2065	O	LYS	A	268	-7.533	117.174	-43.374	1.00	71.61	O
ATOM	2066	N	LYS	A	268	-10.082	116.077	-42.969	1.00	66.29	N
ATOM	2067	CA	LYS	A	268	-8.875	115.316	-42.644	1.00	68.52	C
ATOM	2068	C	LYS	A	268	-7.664	116.256	-42.573	1.00	69.18	C
ATOM	2069	CB	LYS	A	268	-8.658	114.200	-43.676	1.00	68.68	C
ATOM	2070	CG	LYS	A	268	-8.036	112.913	-43.148	1.00	72.58	C
ATOM	2071	CD	LYS	A	268	-7.225	112.238	-44.254	1.00	76.79	C
ATOM	2072	CE	LYS	A	268	-6.533	110.969	-43.795	1.00	71.11	C
ATOM	2073	NZ	LYS	A	268	-7.482	109.817	-43.778	1.00	75.44	N
ATOM	2074	O	ASP	A	269	-3.774	117.878	-42.515	1.00	72.55	O
ATOM	2075	N	ASP	A	269	-6.788	116.035	-41.600	1.00	73.21	N
ATOM	2076	CA	ASP	A	269	-5.664	116.946	-41.345	1.00	76.26	C
ATOM	2077	C	ASP	A	269	-4.591	116.953	-42.447	1.00	77.31	C
ATOM	2078	CB	ASP	A	269	-5.013	116.617	-39.990	1.00	76.67	C
ATOM	2079	CG	ASP	A	269	-4.396	115.219	-39.937	1.00	82.13	C
ATOM	2080	OD2	ASP	A	269	-3.688	114.936	-38.940	1.00	85.20	O

ATOM	2081	OD1	ASP	A	269	-4.612	114.404	-40.868	1.00	78.83	O
ATOM	2082	O	THR	A	270	-3.949	115.834	-46.838	1.00	83.45	O
ATOM	2083	N	THR	A	270	-4.607	115.928	-43.301	1.00	73.55	N
ATOM	2084	CA	THR	A	270	-3.708	115.843	-44.449	1.00	73.77	C
ATOM	2085	C	THR	A	270	-4.365	116.275	-45.764	1.00	79.01	C
ATOM	2086	CB	THR	A	270	-3.189	114.415	-44.656	1.00	73.78	C
ATOM	2087	OG1	THR	A	270	-4.302	113.528	-44.834	1.00	75.34	O
ATOM	2088	CG2	THR	A	270	-2.341	113.959	-43.473	1.00	75.07	C
ATOM	2089	N	TYR	A	271	-5.386	117.121	-45.693	1.00	70.44	N
ATOM	2090	CA	TYR	A	271	-6.104	117.501	-46.898	1.00	74.23	C
ATOM	2091	C	TYR	A	271	-5.314	118.456	-47.779	1.00	77.95	C
ATOM	2092	O	TYR	A	271	-5.318	118.329	-49.004	1.00	77.87	O
ATOM	2093	CB	TYR	A	271	-7.441	118.148	-46.565	1.00	69.51	C
ATOM	2094	CG	TYR	A	271	-8.061	118.805	-47.775	1.00	67.68	C
ATOM	2095	CD1	TYR	A	271	-8.642	118.041	-48.774	1.00	66.87	C
ATOM	2096	CD2	TYR	A	271	-8.041	120.193	-47.931	1.00	68.73	C
ATOM	2097	CE1	TYR	A	271	-9.206	118.633	-49.890	1.00	70.32	C
ATOM	2098	CE2	TYR	A	271	-8.594	120.796	-49.043	1.00	66.64	C
ATOM	2099	CZ	TYR	A	271	-9.180	120.011	-50.023	1.00	71.33	C
ATOM	2100	OH	TYR	A	271	-9.743	120.595	-51.142	1.00	72.54	O
ATOM	2101	N	ASP	A	272	-4.680	119.441	-47.157	1.00	77.62	N
ATOM	2102	CA	ASP	A	272	-3.895	120.407	-47.903	1.00	75.84	C
ATOM	2103	C	ASP	A	272	-2.770	119.694	-48.664	1.00	84.15	C
ATOM	2104	O	ASP	A	272	-2.405	120.095	-49.771	1.00	83.60	O
ATOM	2105	CB	ASP	A	272	-3.342	121.477	-46.965	1.00	71.71	C
ATOM	2106	CG	ASP	A	272	-4.379	122.538	-46.624	1.00	84.92	C
ATOM	2107	OD2	ASP	A	272	-4.220	123.222	-45.589	1.00	89.34	O
ATOM	2108	OD1	ASP	A	272	-5.351	122.697	-47.397	1.00	81.98	O
ATOM	2109	N	ASP	A	273	-2.252	118.619	-48.074	1.00	78.15	N
ATOM	2110	CA	ASP	A	273	-1.204	117.828	-48.697	1.00	81.39	C
ATOM	2111	C	ASP	A	273	-1.751	117.036	-49.880	1.00	82.46	C
ATOM	2112	O	ASP	A	273	-1.297	117.217	-51.007	1.00	84.50	O
ATOM	2113	CB	ASP	A	273	-0.561	116.870	-47.678	1.00	88.35	C
ATOM	2114	CG	ASP	A	273	0.571	117.518	-46.874	1.00	93.63	C
ATOM	2115	OD1	ASP	A	273	0.530	118.749	-46.640	1.00	87.26	O
ATOM	2116	OD2	ASP	A	273	1.502	116.781	-46.461	1.00	91.84	O
ATOM	2117	N	ASP	A	274	-2.715	116.155	-49.621	1.00	82.15	N
ATOM	2118	CA	ASP	A	274	-3.262	115.272	-50.656	1.00	82.17	C
ATOM	2119	C	ASP	A	274	-3.839	116.019	-51.845	1.00	79.62	C
ATOM	2120	O	ASP	A	274	-3.887	115.488	-52.954	1.00	80.43	O
ATOM	2121	CB	ASP	A	274	-4.339	114.375	-50.067	1.00	79.84	C
ATOM	2122	CG	ASP	A	274	-3.786	113.415	-49.071	1.00	81.89	C
ATOM	2123	OD2	ASP	A	274	-4.521	113.024	-48.138	1.00	81.64	O
ATOM	2124	OD1	ASP	A	274	-2.602	113.055	-49.228	1.00	89.85	O
ATOM	2125	N	LEU	A	275	-4.292	117.243	-51.595	1.00	77.66	N
ATOM	2126	CA	LEU	A	275	-4.796	118.111	-52.649	1.00	81.14	C
ATOM	2127	C	LEU	A	275	-3.627	118.624	-53.484	1.00	82.07	C
ATOM	2128	O	LEU	A	275	-3.654	118.554	-54.717	1.00	81.40	O
ATOM	2129	CB	LEU	A	275	-5.597	119.283	-52.071	1.00	72.84	C
ATOM	2130	CG	LEU	A	275	-5.875	120.408	-53.069	1.00	73.76	C
ATOM	2131	CD1	LEU	A	275	-6.771	119.910	-54.182	1.00	72.92	C
ATOM	2132	CD2	LEU	A	275	-6.468	121.631	-52.391	1.00	67.37	C
ATOM	2133	N	ASP	A	276	-2.599	119.132	-52.807	1.00	81.26	N
ATOM	2134	CA	ASP	A	276	-1.388	119.596	-53.481	1.00	80.08	C
ATOM	2135	C	ASP	A	276	-0.679	118.419	-54.154	1.00	81.80	C
ATOM	2136	O	ASP	A	276	0.099	118.596	-55.087	1.00	80.32	O
ATOM	2137	CB	ASP	A	276	-0.454	120.290	-52.494	1.00	82.63	C
ATOM	2138	CG	ASP	A	276	0.783	120.847	-53.159	1.00	87.28	C
ATOM	2139	OD1	ASP	A	276	0.665	121.389	-54.279	1.00	90.53	O
ATOM	2140	OD2	ASP	A	276	1.875	120.736	-52.564	1.00	81.84	O
ATOM	2141	N	ASN	A	277	-0.965	117.218	-53.657	1.00	80.45	N
ATOM	2142	CA	ASN	A	277	-0.543	115.974	-54.272	1.00	75.76	C
ATOM	2143	C	ASN	A	277	-1.315	115.711	-55.567	1.00	80.71	C

ATOM	2144	O	ASN	A	277	-0.744	115.283	-56.573	1.00	81.65	O
ATOM	2145	CB	ASN	A	277	-0.744	114.824	-53.280	1.00	80.58	C
ATOM	2146	CG	ASN	A	277	-0.267	113.491	-53.812	1.00	77.73	C
ATOM	2147	OD1	ASN	A	277	-0.948	112.848	-54.611	1.00	73.77	O
ATOM	2148	ND2	ASN	A	277	0.901	113.052	-53.345	1.00	86.42	N
ATOM	2149	N	LEU	A	278	-2.619	115.966	-55.536	1.00	80.24	N
ATOM	2150	CA	LEU	A	278	-3.457	115.820	-56.719	1.00	77.50	C
ATOM	2151	C	LEU	A	278	-3.142	116.876	-57.765	1.00	72.75	C
ATOM	2152	O	LEU	A	278	-2.939	116.560	-58.925	1.00	69.90	O
ATOM	2153	CB	LEU	A	278	-4.933	115.909	-56.346	1.00	76.58	C
ATOM	2154	CG	LEU	A	278	-5.873	115.963	-57.550	1.00	75.10	C
ATOM	2155	CD1	LEU	A	278	-5.902	114.612	-58.246	1.00	66.25	C
ATOM	2156	CD2	LEU	A	278	-7.269	116.418	-57.142	1.00	69.37	C
ATOM	2157	N	LEU	A	279	-3.120	118.134	-57.331	1.00	76.22	N
ATOM	2158	CA	LEU	A	279	-2.908	119.280	-58.215	1.00	75.17	C
ATOM	2159	C	LEU	A	279	-1.513	119.288	-58.820	1.00	76.00	C
ATOM	2160	O	LEU	A	279	-1.269	119.953	-59.828	1.00	75.20	O
ATOM	2161	CB	LEU	A	279	-3.139	120.596	-57.470	1.00	74.60	C
ATOM	2162	CG	LEU	A	279	-4.562	120.951	-57.049	1.00	74.12	C
ATOM	2163	CD1	LEU	A	279	-4.575	122.300	-56.358	1.00	75.92	C
ATOM	2164	CD2	LEU	A	279	-5.486	120.968	-58.240	1.00	70.30	C
ATOM	2165	N	ALA	A	280	-0.594	118.571	-58.188	1.00	74.06	N
ATOM	2166	CA	ALA	A	280	0.708	118.346	-58.784	1.00	75.47	C
ATOM	2167	C	ALA	A	280	0.520	117.510	-60.040	1.00	76.36	C
ATOM	2168	O	ALA	A	280	1.169	117.753	-61.050	1.00	71.45	O
ATOM	2169	CB	ALA	A	280	1.644	117.651	-57.814	1.00	73.54	C
ATOM	2170	N	GLN	A	281	-0.396	116.549	-59.967	1.00	71.67	N
ATOM	2171	CA	GLN	A	281	-0.630	115.623	-61.059	1.00	71.44	C
ATOM	2172	C	GLN	A	281	-1.659	116.110	-62.080	1.00	72.26	C
ATOM	2173	O	GLN	A	281	-1.378	116.145	-63.275	1.00	70.91	O
ATOM	2174	CB	GLN	A	281	-1.062	114.267	-60.506	1.00	71.72	C
ATOM	2175	CG	GLN	A	281	0.086	113.320	-60.281	1.00	74.93	C
ATOM	2176	CD	GLN	A	281	-0.154	111.970	-60.931	1.00	86.76	C
ATOM	2177	OE1	GLN	A	281	-1.217	111.365	-60.751	1.00	86.52	O
ATOM	2178	NE2	GLN	A	281	0.827	111.494	-61.707	1.00	80.70	N
ATOM	2179	N	ILE	A	282	-2.855	116.471	-61.634	1.00	77.63	N
ATOM	2180	CA	ILE	A	282	-3.868	116.896	-62.592	1.00	72.54	C
ATOM	2181	C	ILE	A	282	-3.529	118.266	-63.138	1.00	70.21	C
ATOM	2182	O	ILE	A	282	-3.605	118.478	-64.339	1.00	75.95	O
ATOM	2183	CB	ILE	A	282	-5.282	116.902	-61.992	1.00	71.70	C
ATOM	2184	CG1	ILE	A	282	-5.351	117.741	-60.722	1.00	72.11	C
ATOM	2185	CG2	ILE	A	282	-5.698	115.497	-61.689	1.00	74.90	C
ATOM	2186	CD1	ILE	A	282	-6.733	118.187	-60.392	1.00	71.77	C
ATOM	2187	N	GLY	A	283	-3.126	119.186	-62.269	1.00	72.68	N
ATOM	2188	C	GLY	A	283	-3.202	121.631	-61.756	1.00	80.01	C
ATOM	2189	CA	GLY	A	283	-2.774	120.525	-62.702	1.00	72.13	C
ATOM	2190	O	GLY	A	283	-4.301	121.617	-61.190	1.00	78.01	O
ATOM	2191	N	ASP	A	284	-2.326	122.618	-61.613	1.00	80.06	N
ATOM	2192	CA	ASP	A	284	-2.575	123.780	-60.776	1.00	74.91	C
ATOM	2193	C	ASP	A	284	-3.603	124.713	-61.383	1.00	76.75	C
ATOM	2194	O	ASP	A	284	-3.747	125.850	-60.948	1.00	77.52	O
ATOM	2195	CB	ASP	A	284	-1.279	124.543	-60.559	1.00	78.89	C
ATOM	2196	CG	ASP	A	284	-1.242	125.257	-59.245	1.00	88.48	C
ATOM	2197	OD2	ASP	A	284	-0.726	124.665	-58.268	1.00	92.72	O
ATOM	2198	OD1	ASP	A	284	-1.717	126.412	-59.194	1.00	91.29	O
ATOM	2199	N	GLN	A	285	-4.300	124.242	-62.407	1.00	76.94	N
ATOM	2200	CA	GLN	A	285	-5.345	125.027	-63.040	1.00	72.27	C
ATOM	2201	C	GLN	A	285	-6.652	124.791	-62.300	1.00	76.50	C
ATOM	2202	O	GLN	A	285	-7.581	125.591	-62.387	1.00	80.25	O
ATOM	2203	CB	GLN	A	285	-5.486	124.662	-64.519	1.00	72.03	C
ATOM	2204	CG	GLN	A	285	-6.030	123.267	-64.765	1.00	74.39	C
ATOM	2205	CD	GLN	A	285	-5.753	122.741	-66.172	1.00	75.96	C
ATOM	2206	OE1	GLN	A	285	-5.175	121.665	-66.340	1.00	76.06	O

ATOM	2207	NE2	GLN	A	285	-6.178	123.488	-67.182	1.00	73.58	N
ATOM	2208	N	TYR	A	286	-6.703	123.685	-61.560	1.00	77.12	N
ATOM	2209	CA	TYR	A	286	-7.867	123.320	-60.754	1.00	78.54	C
ATOM	2210	C	TYR	A	286	-7.766	123.791	-59.301	1.00	76.97	C
ATOM	2211	O	TYR	A	286	-8.519	123.334	-58.441	1.00	73.79	O
ATOM	2212	CB	TYR	A	286	-8.056	121.806	-60.770	1.00	74.68	C
ATOM	2213	CG	TYR	A	286	-8.177	121.234	-62.149	1.00	78.77	C
ATOM	2214	CD1	TYR	A	286	-9.392	121.263	-62.823	1.00	81.65	C
ATOM	2215	CD2	TYR	A	286	-7.079	120.663	-62.788	1.00	78.39	C
ATOM	2216	CE1	TYR	A	286	-9.514	120.735	-64.099	1.00	84.07	C
ATOM	2217	CE2	TYR	A	286	-7.186	120.137	-64.060	1.00	74.50	C
ATOM	2218	CZ	TYR	A	286	-8.406	120.174	-64.714	1.00	81.43	C
ATOM	2219	OH	TYR	A	286	-8.534	119.648	-65.982	1.00	82.10	O
ATOM	2220	N	ALA	A	287	-6.819	124.684	-59.032	1.00	79.95	N
ATOM	2221	CA	ALA	A	287	-6.589	125.176	-57.679	1.00	80.65	C
ATOM	2222	C	ALA	A	287	-7.809	125.926	-57.163	1.00	78.73	C
ATOM	2223	O	ALA	A	287	-8.355	125.605	-56.110	1.00	80.49	O
ATOM	2224	CB	ALA	A	287	-5.364	126.071	-57.640	1.00	78.10	C
ATOM	2225	N	ASP	A	288	-8.247	126.917	-57.924	1.00	76.25	N
ATOM	2226	CA	ASP	A	288	-9.369	127.736	-57.508	1.00	75.90	C
ATOM	2227	C	ASP	A	288	-10.698	126.977	-57.582	1.00	77.99	C
ATOM	2228	O	ASP	A	288	-11.733	127.476	-57.118	1.00	73.27	O
ATOM	2229	CB	ASP	A	288	-9.418	129.009	-58.348	1.00	70.09	C
ATOM	2230	CG	ASP	A	288	-8.372	130.029	-57.912	1.00	79.78	C
ATOM	2231	OD1	ASP	A	288	-7.964	130.014	-56.726	1.00	68.74	O
ATOM	2232	OD2	ASP	A	288	-7.958	130.849	-58.758	1.00	86.74	O
ATOM	2233	N	LEU	A	289	-10.668	125.765	-58.137	1.00	74.30	N
ATOM	2234	CA	LEU	A	289	-11.871	124.943	-58.205	1.00	71.19	C
ATOM	2235	C	LEU	A	289	-12.086	124.216	-56.893	1.00	69.60	C
ATOM	2236	O	LEU	A	289	-13.223	124.026	-56.464	1.00	69.36	O
ATOM	2237	CB	LEU	A	289	-11.801	123.936	-59.351	1.00	68.49	C
ATOM	2238	CG	LEU	A	289	-13.133	123.221	-59.588	1.00	67.95	C
ATOM	2239	CD2	LEU	A	289	-13.054	122.339	-60.811	1.00	70.67	C
ATOM	2240	CD1	LEU	A	289	-14.240	124.236	-59.739	1.00	68.06	C
ATOM	2241	N	PHE	A	290	-10.995	123.810	-56.252	1.00	68.89	N
ATOM	2242	CA	PHE	A	290	-11.107	123.160	-54.952	1.00	69.56	C
ATOM	2243	C	PHE	A	290	-11.280	124.196	-53.843	1.00	73.98	C
ATOM	2244	O	PHE	A	290	-11.941	123.931	-52.837	1.00	73.78	O
ATOM	2245	CB	PHE	A	290	-9.901	122.274	-54.693	1.00	68.36	C
ATOM	2246	CG	PHE	A	290	-9.924	121.005	-55.478	1.00	67.56	C
ATOM	2247	CD1	PHE	A	290	-10.605	119.902	-55.006	1.00	63.68	C
ATOM	2248	CD2	PHE	A	290	-9.284	120.920	-56.702	1.00	68.00	C
ATOM	2249	CE1	PHE	A	290	-10.631	118.732	-55.735	1.00	64.24	C
ATOM	2250	CE2	PHE	A	290	-9.305	119.756	-57.430	1.00	62.50	C
ATOM	2251	CZ	PHE	A	290	-9.977	118.663	-56.950	1.00	62.84	C
ATOM	2252	N	LEU	A	291	-10.695	125.375	-54.042	1.00	69.53	N
ATOM	2253	CA	LEU	A	291	-10.943	126.510	-53.166	1.00	72.27	C
ATOM	2254	C	LEU	A	291	-12.445	126.833	-53.136	1.00	75.76	C
ATOM	2255	O	LEU	A	291	-13.017	127.025	-52.070	1.00	77.78	O
ATOM	2256	CB	LEU	A	291	-10.145	127.729	-53.626	1.00	74.96	C
ATOM	2257	CG	LEU	A	291	-10.019	128.922	-52.674	1.00	79.02	C
ATOM	2258	CD2	LEU	A	291	-10.339	130.257	-53.373	1.00	75.90	C
ATOM	2259	CD1	LEU	A	291	-8.632	128.956	-52.040	1.00	82.61	C
ATOM	2260	N	ALA	A	292	-13.083	126.877	-54.304	1.00	73.84	N
ATOM	2261	CA	ALA	A	292	-14.522	127.119	-54.371	1.00	68.28	C
ATOM	2262	C	ALA	A	292	-15.307	125.977	-53.735	1.00	68.67	C
ATOM	2263	O	ALA	A	292	-16.347	126.197	-53.124	1.00	68.89	O
ATOM	2264	CB	ALA	A	292	-14.962	127.327	-55.811	1.00	71.09	C
ATOM	2265	N	ALA	A	293	-14.806	124.754	-53.867	1.00	70.26	N
ATOM	2266	CA	ALA	A	293	-15.417	123.640	-53.164	1.00	70.95	C
ATOM	2267	C	ALA	A	293	-15.180	123.767	-51.660	1.00	71.61	C
ATOM	2268	O	ALA	A	293	-16.060	123.440	-50.862	1.00	71.13	O
ATOM	2269	CB	ALA	A	293	-14.882	122.327	-53.675	1.00	69.57	C

ATOM	2270	N	LYS	A	294	-13.994	124.248	-51.284	1.00	70.41	N
ATOM	2271	CA	LYS	A	294	-13.644	124.453	-49.876	1.00	70.71	C
ATOM	2272	C	LYS	A	294	-14.613	125.420	-49.213	1.00	69.41	C
ATOM	2273	O	LYS	A	294	-15.210	125.114	-48.187	1.00	73.35	O
ATOM	2274	CB	LYS	A	294	-12.208	124.971	-49.734	1.00	67.52	C
ATOM	2275	N	ASN	A	295	-14.775	126.584	-49.822	1.00	70.61	N
ATOM	2276	CA	ASN	A	295	-15.664	127.607	-49.294	1.00	77.26	C
ATOM	2277	C	ASN	A	295	-17.089	127.109	-49.122	1.00	77.99	C
ATOM	2278	O	ASN	A	295	-17.730	127.407	-48.114	1.00	78.76	O
ATOM	2279	CB	ASN	A	295	-15.667	128.844	-50.198	1.00	71.68	C
ATOM	2280	CG	ASN	A	295	-14.311	129.499	-50.290	1.00	75.43	C
ATOM	2281	OD1	ASN	A	295	-13.510	129.447	-49.352	1.00	74.07	O
ATOM	2282	ND2	ASN	A	295	-14.034	130.113	-51.434	1.00	75.98	N
ATOM	2283	N	LEU	A	296	-17.589	126.362	-50.106	1.00	76.49	N
ATOM	2284	CA	LEU	A	296	-18.981	125.928	-50.063	1.00	71.69	C
ATOM	2285	C	LEU	A	296	-19.209	125.068	-48.826	1.00	68.25	C
ATOM	2286	O	LEU	A	296	-20.222	125.218	-48.161	1.00	65.68	O
ATOM	2287	CB	LEU	A	296	-19.373	125.175	-51.338	1.00	69.39	C
ATOM	2288	CG	LEU	A	296	-20.842	124.735	-51.426	1.00	71.16	C
ATOM	2289	CD1	LEU	A	296	-21.791	125.924	-51.335	1.00	69.00	C
ATOM	2290	CD2	LEU	A	296	-21.093	123.941	-52.699	1.00	67.44	C
ATOM	2291	N	SER	A	297	-18.248	124.206	-48.491	1.00	71.35	N
ATOM	2292	CA	SER	A	297	-18.393	123.323	-47.329	1.00	70.81	C
ATOM	2293	C	SER	A	297	-18.371	124.117	-46.024	1.00	70.52	C
ATOM	2294	O	SER	A	297	-19.013	123.728	-45.049	1.00	68.72	O
ATOM	2295	CB	SER	A	297	-17.302	122.249	-47.310	1.00	67.58	C
ATOM	2296	OG	SER	A	297	-16.021	122.790	-47.051	1.00	69.27	O
ATOM	2297	N	ASP	A	298	-17.624	125.221	-46.019	1.00	68.07	N
ATOM	2298	CA	ASP	A	298	-17.642	126.169	-44.907	1.00	70.04	C
ATOM	2299	C	ASP	A	298	-19.072	126.698	-44.685	1.00	74.39	C
ATOM	2300	O	ASP	A	298	-19.539	126.816	-43.544	1.00	70.16	O
ATOM	2301	CB	ASP	A	298	-16.680	127.343	-45.167	1.00	73.81	C
ATOM	2302	CG	ASP	A	298	-15.245	127.087	-44.671	1.00	79.77	C
ATOM	2303	OD1	ASP	A	298	-14.820	125.911	-44.558	1.00	77.89	O
ATOM	2304	OD2	ASP	A	298	-14.535	128.086	-44.400	1.00	78.28	O
ATOM	2305	N	ALA	A	299	-19.765	127.007	-45.782	1.00	71.60	N
ATOM	2306	CA	ALA	A	299	-21.126	127.533	-45.710	1.00	72.73	C
ATOM	2307	C	ALA	A	299	-22.152	126.437	-45.446	1.00	71.62	C
ATOM	2308	O	ALA	A	299	-23.148	126.672	-44.765	1.00	72.02	O
ATOM	2309	CB	ALA	A	299	-21.479	128.281	-46.986	1.00	74.84	C
ATOM	2310	N	ILE	A	300	-21.916	125.244	-45.982	1.00	67.71	N
ATOM	2311	CA	ILE	A	300	-22.827	124.137	-45.753	1.00	65.23	C
ATOM	2312	C	ILE	A	300	-22.804	123.791	-44.276	1.00	69.82	C
ATOM	2313	O	ILE	A	300	-23.839	123.504	-43.676	1.00	72.83	O
ATOM	2314	CB	ILE	A	300	-22.462	122.899	-46.601	1.00	66.25	C
ATOM	2315	CG1	ILE	A	300	-22.659	123.189	-48.094	1.00	66.93	C
ATOM	2316	CG2	ILE	A	300	-23.301	121.697	-46.204	1.00	61.04	C
ATOM	2317	CD1	ILE	A	300	-22.207	122.052	-49.015	1.00	66.82	C
ATOM	2318	N	LEU	A	301	-21.622	123.863	-43.678	1.00	72.67	N
ATOM	2319	CA	LEU	A	301	-21.453	123.447	-42.293	1.00	72.27	C
ATOM	2320	C	LEU	A	301	-22.177	124.378	-41.326	1.00	73.10	C
ATOM	2321	O	LEU	A	301	-22.910	123.926	-40.452	1.00	76.47	O
ATOM	2322	CB	LEU	A	301	-19.969	123.380	-41.930	1.00	74.11	C
ATOM	2323	CG	LEU	A	301	-19.638	122.407	-40.797	1.00	70.01	C
ATOM	2324	CD1	LEU	A	301	-19.398	121.008	-41.360	1.00	73.40	C
ATOM	2325	CD2	LEU	A	301	-18.450	122.885	-39.990	1.00	67.92	C
ATOM	2326	N	LEU	A	302	-21.958	125.675	-41.480	1.00	69.46	N
ATOM	2327	CA	LEU	A	302	-22.604	126.653	-40.619	1.00	78.82	C
ATOM	2328	C	LEU	A	302	-24.126	126.551	-40.691	1.00	83.62	C
ATOM	2329	O	LEU	A	302	-24.796	126.439	-39.668	1.00	87.64	O
ATOM	2330	CB	LEU	A	302	-22.169	128.072	-40.989	1.00	76.93	C
ATOM	2331	CG	LEU	A	302	-21.017	128.709	-40.213	1.00	75.69	C
ATOM	2332	CD1	LEU	A	302	-19.726	127.927	-40.387	1.00	77.42	C

ATOM	2333	CD2	LEU	A	302	-20.826	130.148	-40.663	1.00	81.28	C
ATOM	2334	N	SER	A	303	-24.654	126.571	-41.910	1.00	84.39	N
ATOM	2335	CA	SER	A	303	-26.088	126.684	-42.161	1.00	80.24	C
ATOM	2336	C	SER	A	303	-26.896	125.617	-41.442	1.00	82.43	C
ATOM	2337	O	SER	A	303	-28.003	125.876	-40.965	1.00	84.25	O
ATOM	2338	CB	SER	A	303	-26.355	126.618	-43.665	1.00	79.04	C
ATOM	2339	OG	SER	A	303	-27.746	126.627	-43.941	1.00	96.85	O
ATOM	2340	N	ASP	A	304	-26.323	124.423	-41.365	1.00	82.33	N
ATOM	2341	C	ASP	A	304	-26.940	123.388	-39.197	1.00	83.67	C
ATOM	2342	CA	ASP	A	304	-26.962	123.280	-40.723	1.00	84.94	C
ATOM	2343	O	ASP	A	304	-27.868	122.955	-38.512	1.00	84.79	O
ATOM	2344	CB	ASP	A	304	-26.264	121.988	-41.161	1.00	84.03	C
ATOM	2345	CG	ASP	A	304	-27.224	120.826	-41.326	1.00	94.92	C
ATOM	2346	OD1	ASP	A	304	-28.316	120.854	-40.707	1.00	97.71	O
ATOM	2347	OD2	ASP	A	304	-26.877	119.878	-42.075	1.00	98.12	O
ATOM	2348	N	ILE	A	305	-25.868	123.975	-38.677	1.00	84.34	N
ATOM	2349	C	ILE	A	305	-26.049	125.224	-36.598	1.00	85.60	C
ATOM	2350	CA	ILE	A	305	-25.561	123.930	-37.245	1.00	85.02	C
ATOM	2351	O	ILE	A	305	-26.135	125.346	-35.371	1.00	86.49	O
ATOM	2352	CB	ILE	A	305	-24.022	123.665	-37.025	1.00	81.83	C
ATOM	2353	CG1	ILE	A	305	-23.761	122.157	-36.887	1.00	73.86	C
ATOM	2354	CG2	ILE	A	305	-23.441	124.398	-35.820	1.00	73.99	C
ATOM	2355	CD1	ILE	A	305	-24.315	121.316	-38.029	1.00	68.29	C
ATOM	2356	O	LEU	A	306	-26.871	128.192	-39.291	1.00	87.21	O
ATOM	2357	N	LEU	A	306	-26.434	126.167	-37.451	1.00	83.54	N
ATOM	2358	CA	LEU	A	306	-26.920	127.458	-37.008	1.00	80.17	C
ATOM	2359	C	LEU	A	306	-27.405	128.293	-38.189	1.00	86.70	C
ATOM	2360	CB	LEU	A	306	-25.826	128.206	-36.239	1.00	77.44	C
ATOM	2361	CG	LEU	A	306	-24.382	128.185	-36.749	1.00	79.87	C
ATOM	2362	CD2	LEU	A	306	-23.431	128.506	-35.619	1.00	74.99	C
ATOM	2363	CD1	LEU	A	306	-24.153	129.140	-37.918	1.00	82.69	C
ATOM	2364	O	ARG	A	307	-29.059	131.594	-37.194	1.00	87.18	O
ATOM	2365	N	ARG	A	307	-28.428	129.111	-37.959	1.00	85.51	N
ATOM	2366	CA	ARG	A	307	-28.900	130.027	-38.984	1.00	89.40	C
ATOM	2367	C	ARG	A	307	-29.457	131.266	-38.312	1.00	88.26	C
ATOM	2368	CB	ARG	A	307	-29.953	129.363	-39.878	1.00	95.36	C
ATOM	2369	O	LYS	A	314	-19.749	135.915	-33.734	1.00	72.88	O
ATOM	2370	N	LYS	A	314	-22.292	137.906	-35.360	1.00	67.51	N
ATOM	2371	CA	LYS	A	314	-20.940	137.721	-34.841	1.00	68.30	C
ATOM	2372	C	LYS	A	314	-20.821	136.535	-33.859	1.00	75.94	C
ATOM	2373	CB	LYS	A	314	-20.460	139.002	-34.167	1.00	69.88	C
ATOM	2374	O	ALA	A	315	-24.226	134.040	-32.201	1.00	60.16	O
ATOM	2375	N	ALA	A	315	-21.922	136.225	-33.172	1.00	75.54	N
ATOM	2376	CA	ALA	A	315	-22.041	135.015	-32.341	1.00	63.14	C
ATOM	2377	C	ALA	A	315	-23.182	134.137	-32.843	1.00	61.19	C
ATOM	2378	CB	ALA	A	315	-22.269	135.375	-30.885	1.00	56.95	C
ATOM	2379	N	PRO	A	316	-22.974	133.479	-33.990	1.00	63.69	N
ATOM	2380	CA	PRO	A	316	-23.989	132.725	-34.743	1.00	63.21	C
ATOM	2381	C	PRO	A	316	-24.688	131.600	-33.957	1.00	66.16	C
ATOM	2382	O	PRO	A	316	-25.905	131.440	-34.090	1.00	69.01	O
ATOM	2383	CB	PRO	A	316	-23.189	132.132	-35.905	1.00	69.56	C
ATOM	2384	CG	PRO	A	316	-21.962	132.957	-35.997	1.00	69.08	C
ATOM	2385	CD	PRO	A	316	-21.644	133.382	-34.611	1.00	66.19	C
ATOM	2386	N	LEU	A	317	-23.936	130.831	-33.171	1.00	62.71	N
ATOM	2387	CA	LEU	A	317	-24.505	129.720	-32.405	1.00	60.38	C
ATOM	2388	C	LEU	A	317	-25.397	130.222	-31.293	1.00	60.62	C
ATOM	2389	O	LEU	A	317	-26.550	129.806	-31.173	1.00	55.04	O
ATOM	2390	CB	LEU	A	317	-23.407	128.848	-31.796	1.00	59.29	C
ATOM	2391	CG	LEU	A	317	-23.930	127.698	-30.937	1.00	57.81	C
ATOM	2392	CD1	LEU	A	317	-24.424	126.567	-31.824	1.00	55.29	C
ATOM	2393	CD2	LEU	A	317	-22.867	127.196	-29.967	1.00	53.80	C
ATOM	2394	N	SER	A	318	-24.832	131.100	-30.464	1.00	59.04	N
ATOM	2395	CA	SER	A	318	-25.556	131.669	-29.349	1.00	55.54	C

ATOM	2396	C	SER	A	318	-26.812	132.386	-29.828	1.00	57.81	C
ATOM	2397	O	SER	A	318	-27.846	132.316	-29.173	1.00	53.42	O
ATOM	2398	CB	SER	A	318	-24.666	132.620	-28.566	1.00	55.64	C
ATOM	2399	OG	SER	A	318	-23.720	131.880	-27.835	1.00	58.34	O
ATOM	2400	N	ALA	A	319	-26.720	133.046	-30.981	1.00	53.45	N
ATOM	2401	CA	ALA	A	319	-27.880	133.696	-31.560	1.00	57.22	C
ATOM	2402	C	ALA	A	319	-28.895	132.649	-32.003	1.00	55.71	C
ATOM	2403	O	ALA	A	319	-30.098	132.797	-31.794	1.00	60.92	O
ATOM	2404	CB	ALA	A	319	-27.474	134.582	-32.713	1.00	56.53	C
ATOM	2405	N	SER	A	320	-28.406	131.579	-32.608	1.00	60.92	N
ATOM	2406	CA	SER	A	320	-29.271	130.482	-32.998	1.00	59.27	C
ATOM	2407	C	SER	A	320	-29.972	129.877	-31.781	1.00	57.40	C
ATOM	2408	O	SER	A	320	-31.147	129.537	-31.834	1.00	58.70	O
ATOM	2409	CB	SER	A	320	-28.465	129.429	-33.741	1.00	63.24	C
ATOM	2410	OG	SER	A	320	-29.249	128.276	-33.996	1.00	76.85	O
ATOM	2411	N	MET	A	321	-29.252	129.771	-30.673	1.00	57.15	N
ATOM	2412	CA	MET	A	321	-29.824	129.225	-29.452	1.00	54.45	C
ATOM	2413	C	MET	A	321	-30.809	130.220	-28.862	1.00	56.07	C
ATOM	2414	O	MET	A	321	-31.793	129.835	-28.232	1.00	57.64	O
ATOM	2415	CB	MET	A	321	-28.726	128.885	-28.438	1.00	56.04	C
ATOM	2416	CG	MET	A	321	-27.847	127.702	-28.840	1.00	48.23	C
ATOM	2417	SD	MET	A	321	-28.774	126.185	-28.727	1.00	56.87	S
ATOM	2418	CE	MET	A	321	-27.630	124.977	-29.388	1.00	55.95	C
ATOM	2419	N	ILE	A	322	-30.549	131.506	-29.068	1.00	56.26	N
ATOM	2420	CA	ILE	A	322	-31.479	132.519	-28.602	1.00	54.62	C
ATOM	2421	C	ILE	A	322	-32.772	132.485	-29.424	1.00	54.60	C
ATOM	2422	O	ILE	A	322	-33.875	132.502	-28.867	1.00	56.65	O
ATOM	2423	CB	ILE	A	322	-30.871	133.906	-28.655	1.00	53.12	C
ATOM	2424	CG1	ILE	A	322	-29.825	134.034	-27.569	1.00	49.34	C
ATOM	2425	CG2	ILE	A	322	-31.953	134.970	-28.411	1.00	51.29	C
ATOM	2426	CD1	ILE	A	322	-28.977	135.269	-27.711	1.00	53.81	C
ATOM	2427	N	LYS	A	323	-32.635	132.420	-30.739	1.00	52.18	N
ATOM	2428	CA	LYS	A	323	-33.805	132.337	-31.594	1.00	54.95	C
ATOM	2429	C	LYS	A	323	-34.691	131.197	-31.118	1.00	57.55	C
ATOM	2430	O	LYS	A	323	-35.880	131.383	-30.907	1.00	59.84	O
ATOM	2431	CB	LYS	A	323	-33.408	132.138	-33.056	1.00	54.90	C
ATOM	2432	N	ARG	A	324	-34.077	130.036	-30.897	1.00	60.44	N
ATOM	2433	CA	ARG	A	324	-34.759	128.820	-30.449	1.00	54.80	C
ATOM	2434	C	ARG	A	324	-35.495	128.970	-29.118	1.00	53.39	C
ATOM	2435	O	ARG	A	324	-36.574	128.425	-28.921	1.00	55.83	O
ATOM	2436	CB	ARG	A	324	-33.738	127.686	-30.342	1.00	58.31	C
ATOM	2437	CG	ARG	A	324	-34.173	126.527	-29.493	1.00	55.01	C
ATOM	2438	CD	ARG	A	324	-33.121	125.449	-29.499	1.00	55.87	C
ATOM	2439	NE	ARG	A	324	-32.803	125.003	-30.846	1.00	55.38	N
ATOM	2440	CZ	ARG	A	324	-32.004	123.973	-31.122	1.00	66.60	C
ATOM	2441	NH1	ARG	A	324	-31.436	123.272	-30.143	1.00	58.13	N
ATOM	2442	NH2	ARG	A	324	-31.775	123.639	-32.386	1.00	69.90	N
ATOM	2443	N	TYR	A	325	-34.899	129.708	-28.202	1.00	52.06	N
ATOM	2444	CA	TYR	A	325	-35.535	129.981	-26.932	1.00	58.17	C
ATOM	2445	C	TYR	A	325	-36.766	130.902	-27.117	1.00	60.13	C
ATOM	2446	O	TYR	A	325	-37.809	130.702	-26.467	1.00	53.25	O
ATOM	2447	CB	TYR	A	325	-34.513	130.593	-25.970	1.00	54.34	C
ATOM	2448	CG	TYR	A	325	-35.108	131.172	-24.716	1.00	56.44	C
ATOM	2449	CD1	TYR	A	325	-35.269	130.397	-23.581	1.00	56.00	C
ATOM	2450	CD2	TYR	A	325	-35.507	132.506	-24.665	1.00	62.46	C
ATOM	2451	CE1	TYR	A	325	-35.809	130.927	-22.422	1.00	59.10	C
ATOM	2452	CE2	TYR	A	325	-36.054	133.049	-23.516	1.00	64.85	C
ATOM	2453	CZ	TYR	A	325	-36.203	132.254	-22.395	1.00	66.33	C
ATOM	2454	OH	TYR	A	325	-36.746	132.794	-21.248	1.00	70.14	O
ATOM	2455	N	ASP	A	326	-36.628	131.895	-28.001	1.00	59.86	N
ATOM	2456	CA	ASP	A	326	-37.731	132.806	-28.359	1.00	60.19	C
ATOM	2457	C	ASP	A	326	-38.895	132.047	-28.987	1.00	61.70	C
ATOM	2458	O	ASP	A	326	-40.041	132.162	-28.541	1.00	57.96	O

ATOM	2459	CB	ASP	A	326	-37.262	133.890	-29.333	1.00	50.58	C
ATOM	2460	CG	ASP	A	326	-36.349	134.902	-28.688	1.00	51.03	C
ATOM	2461	OD1	ASP	A	326	-36.443	135.081	-27.461	1.00	54.84	O
ATOM	2462	OD2	ASP	A	326	-35.541	135.532	-29.408	1.00	52.65	O
ATOM	2463	N	GLU	A	327	-38.593	131.271	-30.024	1.00	57.18	N
ATOM	2464	CA	GLU	A	327	-39.613	130.472	-30.699	1.00	63.04	C
ATOM	2465	C	GLU	A	327	-40.283	129.479	-29.761	1.00	63.61	C
ATOM	2466	O	GLU	A	327	-41.495	129.261	-29.850	1.00	67.00	O
ATOM	2467	CB	GLU	A	327	-39.017	129.731	-31.890	1.00	56.85	C
ATOM	2468	CG	GLU	A	327	-38.327	130.660	-32.838	1.00	61.40	C
ATOM	2469	CD	GLU	A	327	-38.235	130.098	-34.224	1.00	66.07	C
ATOM	2470	OE1	GLU	A	327	-38.896	129.065	-34.479	1.00	66.09	O
ATOM	2471	OE2	GLU	A	327	-37.505	130.696	-35.051	1.00	65.42	O
ATOM	2472	N	HIS	A	328	-39.501	128.875	-28.870	1.00	60.06	N
ATOM	2473	CA	HIS	A	328	-40.065	127.977	-27.868	1.00	62.05	C
ATOM	2474	C	HIS	A	328	-41.078	128.785	-27.056	1.00	58.42	C
ATOM	2475	O	HIS	A	328	-42.139	128.288	-26.712	1.00	58.96	O
ATOM	2476	CB	HIS	A	328	-38.959	127.356	-26.984	1.00	57.18	C
ATOM	2477	CG	HIS	A	328	-39.463	126.498	-25.856	1.00	55.16	C
ATOM	2478	ND1	HIS	A	328	-38.987	125.228	-25.621	1.00	60.92	N
ATOM	2479	CD2	HIS	A	328	-40.366	126.741	-24.875	1.00	55.18	C
ATOM	2480	CE1	HIS	A	328	-39.588	124.716	-24.561	1.00	54.20	C
ATOM	2481	NE2	HIS	A	328	-40.430	125.614	-24.089	1.00	56.54	N
ATOM	2482	N	HIS	A	329	-40.768	130.044	-26.784	1.00	57.87	N
ATOM	2483	CA	HIS	A	329	-41.709	130.868	-26.045	1.00	64.59	C
ATOM	2484	C	HIS	A	329	-42.983	131.218	-26.832	1.00	62.79	C
ATOM	2485	O	HIS	A	329	-44.082	131.056	-26.310	1.00	57.22	O
ATOM	2486	CB	HIS	A	329	-41.065	132.160	-25.582	1.00	61.07	C
ATOM	2487	CG	HIS	A	329	-42.025	133.068	-24.880	1.00	67.93	C
ATOM	2488	ND1	HIS	A	329	-42.657	134.119	-25.510	1.00	63.64	N
ATOM	2489	CD2	HIS	A	329	-42.486	133.058	-23.607	1.00	65.85	C
ATOM	2490	CE1	HIS	A	329	-43.447	134.733	-24.649	1.00	61.37	C
ATOM	2491	NE2	HIS	A	329	-43.362	134.109	-23.487	1.00	68.54	N
ATOM	2492	N	GLN	A	330	-42.826	131.705	-28.064	1.00	62.85	N
ATOM	2493	CA	GLN	A	330	-43.969	131.974	-28.930	1.00	63.07	C
ATOM	2494	C	GLN	A	330	-44.870	130.770	-28.942	1.00	68.41	C
ATOM	2495	O	GLN	A	330	-46.037	130.838	-28.555	1.00	70.23	O
ATOM	2496	CB	GLN	A	330	-43.549	132.265	-30.369	1.00	67.42	C
ATOM	2497	CG	GLN	A	330	-42.665	133.467	-30.567	1.00	69.62	C
ATOM	2498	CD	GLN	A	330	-41.883	133.385	-31.867	1.00	74.50	C
ATOM	2499	OE1	GLN	A	330	-42.014	132.415	-32.634	1.00	73.84	O
ATOM	2500	NE2	GLN	A	330	-41.052	134.397	-32.119	1.00	70.16	N
ATOM	2501	N	ASP	A	331	-44.291	129.658	-29.377	1.00	65.68	N
ATOM	2502	CA	ASP	A	331	-45.036	128.437	-29.627	1.00	66.33	C
ATOM	2503	C	ASP	A	331	-45.632	127.841	-28.360	1.00	65.68	C
ATOM	2504	O	ASP	A	331	-46.586	127.087	-28.439	1.00	65.38	O
ATOM	2505	CB	ASP	A	331	-44.135	127.419	-30.324	1.00	61.45	C
ATOM	2506	CG	ASP	A	331	-43.710	127.873	-31.712	1.00	70.46	C
ATOM	2507	OD1	ASP	A	331	-43.759	129.095	-32.005	1.00	73.88	O
ATOM	2508	OD2	ASP	A	331	-43.330	127.003	-32.517	1.00	68.92	O
ATOM	2509	N	LEU	A	332	-45.075	128.170	-27.196	1.00	66.64	N
ATOM	2510	CA	LEU	A	332	-45.666	127.708	-25.944	1.00	63.05	C
ATOM	2511	C	LEU	A	332	-46.876	128.590	-25.678	1.00	64.36	C
ATOM	2512	O	LEU	A	332	-47.945	128.097	-25.340	1.00	65.04	O
ATOM	2513	CB	LEU	A	332	-44.669	127.756	-24.775	1.00	55.74	C
ATOM	2514	CG	LEU	A	332	-45.121	127.222	-23.397	1.00	59.30	C
ATOM	2515	CD1	LEU	A	332	-45.591	125.775	-23.461	1.00	53.39	C
ATOM	2516	CD2	LEU	A	332	-44.046	127.375	-22.317	1.00	49.14	C
ATOM	2517	N	THR	A	333	-46.692	129.896	-25.848	1.00	61.67	N
ATOM	2518	CA	THR	A	333	-47.762	130.875	-25.641	1.00	63.81	C
ATOM	2519	C	THR	A	333	-48.998	130.551	-26.483	1.00	68.10	C
ATOM	2520	O	THR	A	333	-50.096	130.406	-25.947	1.00	71.80	O
ATOM	2521	CB	THR	A	333	-47.291	132.298	-25.971	1.00	61.39	C

ATOM	2522	OG1	THR	A	333	-46.327	132.718	-25.000	1.00	57.81	O
ATOM	2523	CG2	THR	A	333	-48.481	133.285	-25.977	1.00	61.31	C
ATOM	2524	N	LEU	A	334	-48.804	130.422	-27.793	1.00	64.21	N
ATOM	2525	CA	LEU	A	334	-49.870	130.006	-28.696	1.00	69.99	C
ATOM	2526	C	LEU	A	334	-50.512	128.709	-28.230	1.00	72.35	C
ATOM	2527	O	LEU	A	334	-51.733	128.554	-28.291	1.00	77.26	O
ATOM	2528	CB	LEU	A	334	-49.345	129.825	-30.128	1.00	67.01	C
ATOM	2529	CG	LEU	A	334	-50.434	129.373	-31.107	1.00	71.46	C
ATOM	2530	CD1	LEU	A	334	-51.467	130.493	-31.242	1.00	67.67	C
ATOM	2531	CD2	LEU	A	334	-49.889	128.955	-32.469	1.00	62.07	C
ATOM	2532	N	LEU	A	335	-49.676	127.789	-27.757	1.00	75.07	N
ATOM	2533	CA	LEU	A	335	-50.095	126.431	-27.408	1.00	73.85	C
ATOM	2534	C	LEU	A	335	-50.969	126.384	-26.159	1.00	72.32	C
ATOM	2535	O	LEU	A	335	-51.872	125.559	-26.062	1.00	71.19	O
ATOM	2536	CB	LEU	A	335	-48.863	125.543	-27.211	1.00	73.72	C
ATOM	2537	CG	LEU	A	335	-48.993	124.026	-27.208	1.00	77.58	C
ATOM	2538	CD1	LEU	A	335	-49.237	123.520	-25.805	1.00	74.79	C
ATOM	2539	CD2	LEU	A	335	-50.102	123.594	-28.151	1.00	78.11	C
ATOM	2540	O	LYS	A	336	-53.908	127.344	-23.907	1.00	77.83	O
ATOM	2541	N	LYS	A	336	-50.689	127.248	-25.192	1.00	68.82	N
ATOM	2542	CA	LYS	A	336	-51.507	127.268	-23.998	1.00	72.59	C
ATOM	2543	C	LYS	A	336	-52.881	127.787	-24.419	1.00	77.37	C
ATOM	2544	CB	LYS	A	336	-50.863	128.120	-22.895	1.00	70.30	C
ATOM	2545	CG	LYS	A	336	-49.953	127.323	-21.941	1.00	68.73	C
ATOM	2546	CD	LYS	A	336	-48.942	128.218	-21.239	1.00	64.22	C
ATOM	2547	CE	LYS	A	336	-48.167	127.483	-20.163	1.00	58.47	C
ATOM	2548	NZ	LYS	A	336	-47.266	128.421	-19.410	1.00	60.89	N
ATOM	2549	O	ALA	A	337	-56.172	128.093	-26.111	1.00	82.21	O
ATOM	2550	N	ALA	A	337	-52.885	128.680	-25.404	1.00	75.11	N
ATOM	2551	CA	ALA	A	337	-54.115	129.293	-25.894	1.00	79.74	C
ATOM	2552	C	ALA	A	337	-55.037	128.274	-26.554	1.00	80.12	C
ATOM	2553	CB	ALA	A	337	-53.798	130.424	-26.868	1.00	73.66	C
ATOM	2554	O	LEU	A	338	-57.136	125.187	-27.656	1.00	79.17	O
ATOM	2555	N	LEU	A	338	-54.555	127.613	-27.605	1.00	77.70	N
ATOM	2556	CA	LEU	A	338	-55.379	126.658	-28.349	1.00	76.72	C
ATOM	2557	C	LEU	A	338	-56.023	125.643	-27.410	1.00	79.07	C
ATOM	2558	CB	LEU	A	338	-54.562	125.934	-29.428	1.00	74.21	C
ATOM	2559	CG	LEU	A	338	-53.791	126.823	-30.411	1.00	77.85	C
ATOM	2560	CD1	LEU	A	338	-53.342	126.047	-31.630	1.00	80.16	C
ATOM	2561	CD2	LEU	A	338	-54.600	128.024	-30.829	1.00	76.74	C
ATOM	2562	O	VAL	A	339	-57.954	124.535	-24.137	1.00	74.97	O
ATOM	2563	N	VAL	A	339	-55.338	125.314	-26.319	1.00	78.17	N
ATOM	2564	CA	VAL	A	339	-55.887	124.390	-25.335	1.00	78.68	C
ATOM	2565	C	VAL	A	339	-56.907	125.091	-24.457	1.00	74.87	C
ATOM	2566	CB	VAL	A	339	-54.777	123.768	-24.451	1.00	80.05	C
ATOM	2567	CG1	VAL	A	339	-55.360	123.146	-23.163	1.00	72.40	C
ATOM	2568	CG2	VAL	A	339	-53.981	122.745	-25.258	1.00	73.59	C
ATOM	2569	O	ARG	A	340	-59.881	127.397	-23.431	1.00	75.10	O
ATOM	2570	N	ARG	A	340	-56.601	126.317	-24.066	1.00	72.02	N
ATOM	2571	CA	ARG	A	340	-57.515	127.055	-23.222	1.00	78.68	C
ATOM	2572	C	ARG	A	340	-58.793	127.389	-23.996	1.00	79.22	C
ATOM	2573	CB	ARG	A	340	-56.845	128.315	-22.686	1.00	74.00	C
ATOM	2574	CG	ARG	A	340	-55.991	128.062	-21.458	1.00	73.92	C
ATOM	2575	CD	ARG	A	340	-56.375	129.027	-20.354	1.00	79.49	C
ATOM	2576	NE	ARG	A	340	-55.596	128.868	-19.126	1.00	80.14	N
ATOM	2577	CZ	ARG	A	340	-55.761	127.879	-18.254	1.00	76.12	C
ATOM	2578	NH1	ARG	A	340	-56.660	126.932	-18.488	1.00	74.03	N
ATOM	2579	NH2	ARG	A	340	-55.019	127.833	-17.154	1.00	70.19	N
ATOM	2580	O	GLN	A	341	-61.761	126.814	-26.756	1.00	89.98	O
ATOM	2581	N	GLN	A	341	-58.645	127.624	-25.298	1.00	80.10	N
ATOM	2582	CA	GLN	A	341	-59.756	127.974	-26.171	1.00	76.02	C
ATOM	2583	C	GLN	A	341	-60.540	126.756	-26.653	1.00	79.23	C
ATOM	2584	CB	GLN	A	341	-59.253	128.762	-27.385	1.00	75.86	C

ATOM	2585	O	GLN	A	342	-61.599	122.558	-26.700	1.00	83.65	O
ATOM	2586	N	GLN	A	342	-59.857	125.658	-26.958	1.00	74.55	N
ATOM	2587	CA	GLN	A	342	-60.542	124.517	-27.547	1.00	70.98	C
ATOM	2588	C	GLN	A	342	-60.624	123.297	-26.645	1.00	79.54	C
ATOM	2589	CB	GLN	A	342	-59.871	124.110	-28.851	1.00	71.13	C
ATOM	2590	CG	GLN	A	342	-59.584	125.247	-29.811	1.00	69.39	C
ATOM	2591	CD	GLN	A	342	-58.972	124.748	-31.106	1.00	78.38	C
ATOM	2592	OE1	GLN	A	342	-59.113	123.578	-31.463	1.00	80.68	O
ATOM	2593	NE2	GLN	A	342	-58.287	125.629	-31.814	1.00	79.87	N
ATOM	2594	O	LEU	A	343	-58.408	121.111	-23.097	1.00	81.99	O
ATOM	2595	N	LEU	A	343	-59.605	123.062	-25.825	1.00	82.95	N
ATOM	2596	CA	LEU	A	343	-59.538	121.799	-25.087	1.00	81.17	C
ATOM	2597	C	LEU	A	343	-59.216	121.897	-23.593	1.00	81.26	C
ATOM	2598	CB	LEU	A	343	-58.502	120.886	-25.747	1.00	74.32	C
ATOM	2599	CG	LEU	A	343	-59.001	119.608	-26.424	1.00	86.01	C
ATOM	2600	CD1	LEU	A	343	-60.524	119.470	-26.315	1.00	94.03	C
ATOM	2601	CD2	LEU	A	343	-58.554	119.533	-27.879	1.00	79.35	C
ATOM	2602	O	PRO	A	344	-59.215	121.640	-19.497	1.00	79.00	O
ATOM	2603	N	PRO	A	344	-59.874	122.817	-22.855	1.00	82.10	N
ATOM	2604	CA	PRO	A	344	-59.502	123.019	-21.444	1.00	81.14	C
ATOM	2605	C	PRO	A	344	-59.704	121.753	-20.623	1.00	80.04	C
ATOM	2606	CB	PRO	A	344	-60.449	124.135	-20.976	1.00	81.02	C
ATOM	2607	CG	PRO	A	344	-60.968	124.755	-22.229	1.00	79.73	C
ATOM	2608	CD	PRO	A	344	-61.034	123.642	-23.228	1.00	78.47	C
ATOM	2609	N	GLU	A	345	-60.412	120.796	-21.211	1.00	79.24	N
ATOM	2610	CA	GLU	A	345	-60.541	119.463	-20.643	1.00	84.45	C
ATOM	2611	C	GLU	A	345	-59.177	118.777	-20.488	1.00	82.95	C
ATOM	2612	O	GLU	A	345	-59.079	117.693	-19.907	1.00	87.55	O
ATOM	2613	CB	GLU	A	345	-61.460	118.604	-21.522	1.00	84.24	C
ATOM	2614	N	LYS	A	346	-58.122	119.398	-21.004	1.00	81.61	N
ATOM	2615	CA	LYS	A	346	-56.819	118.736	-21.037	1.00	80.28	C
ATOM	2616	C	LYS	A	346	-55.675	119.520	-20.372	1.00	76.15	C
ATOM	2617	O	LYS	A	346	-54.638	118.938	-20.061	1.00	75.94	O
ATOM	2618	CB	LYS	A	346	-56.453	118.417	-22.489	1.00	70.62	C
ATOM	2619	N	TYR	A	347	-55.873	120.817	-20.130	1.00	76.01	N
ATOM	2620	CA	TYR	A	347	-54.803	121.696	-19.633	1.00	74.44	C
ATOM	2621	C	TYR	A	347	-54.071	121.201	-18.364	1.00	73.61	C
ATOM	2622	O	TYR	A	347	-52.850	121.279	-18.313	1.00	76.22	O
ATOM	2623	CB	TYR	A	347	-55.356	123.115	-19.388	1.00	70.55	C
ATOM	2624	CG	TYR	A	347	-54.306	124.214	-19.217	1.00	69.11	C
ATOM	2625	CD1	TYR	A	347	-53.639	124.391	-18.006	1.00	66.87	C
ATOM	2626	CD2	TYR	A	347	-54.005	125.092	-20.259	1.00	68.99	C
ATOM	2627	CE1	TYR	A	347	-52.689	125.396	-17.841	1.00	62.28	C
ATOM	2628	CE2	TYR	A	347	-53.047	126.098	-20.102	1.00	63.47	C
ATOM	2629	CZ	TYR	A	347	-52.395	126.239	-18.892	1.00	63.42	C
ATOM	2630	OH	TYR	A	347	-51.446	127.224	-18.724	1.00	69.38	O
ATOM	2631	N	LYS	A	348	-54.775	120.702	-17.348	1.00	73.12	N
ATOM	2632	CA	LYS	A	348	-54.086	120.337	-16.098	1.00	72.77	C
ATOM	2633	C	LYS	A	348	-53.130	119.171	-16.309	1.00	78.00	C
ATOM	2634	O	LYS	A	348	-52.063	119.107	-15.697	1.00	77.41	O
ATOM	2635	CB	LYS	A	348	-55.077	119.980	-14.987	1.00	71.74	C
ATOM	2636	N	GLU	A	349	-53.519	118.237	-17.167	1.00	75.53	N
ATOM	2637	CA	GLU	A	349	-52.657	117.099	-17.452	1.00	77.67	C
ATOM	2638	C	GLU	A	349	-51.409	117.629	-18.132	1.00	74.83	C
ATOM	2639	O	GLU	A	349	-50.321	117.591	-17.560	1.00	75.01	O
ATOM	2640	CB	GLU	A	349	-53.370	116.068	-18.335	1.00	76.54	C
ATOM	2641	CG	GLU	A	349	-52.725	114.686	-18.351	1.00	82.49	C
ATOM	2642	CD	GLU	A	349	-53.572	113.650	-19.094	1.00	89.55	C
ATOM	2643	OE1	GLU	A	349	-54.708	113.992	-19.497	1.00	87.73	O
ATOM	2644	OE2	GLU	A	349	-53.103	112.499	-19.272	1.00	87.56	O
ATOM	2645	N	ILE	A	350	-51.617	118.180	-19.327	1.00	70.85	N
ATOM	2646	CA	ILE	A	350	-50.586	118.722	-20.208	1.00	65.08	C
ATOM	2647	C	ILE	A	350	-49.551	119.645	-19.560	1.00	68.47	C

ATOM	2648	O	ILE	A	350	-48.377	119.605	-19.926	1.00	71.04	O
ATOM	2649	CB	ILE	A	350	-51.240	119.497	-21.366	1.00	66.46	C
ATOM	2650	CG1	ILE	A	350	-52.157	118.585	-22.179	1.00	66.96	C
ATOM	2651	CG2	ILE	A	350	-50.203	120.097	-22.270	1.00	66.56	C
ATOM	2652	CD1	ILE	A	350	-52.768	119.261	-23.384	1.00	67.92	C
ATOM	2653	N	PHE	A	351	-49.948	120.460	-18.590	1.00	68.37	N
ATOM	2654	CA	PHE	A	351	-49.015	121.457	-18.066	1.00	66.81	C
ATOM	2655	C	PHE	A	351	-48.655	121.327	-16.590	1.00	66.37	C
ATOM	2656	O	PHE	A	351	-47.813	122.080	-16.085	1.00	64.73	O
ATOM	2657	CB	PHE	A	351	-49.574	122.842	-18.341	1.00	65.62	C
ATOM	2658	CG	PHE	A	351	-49.696	123.141	-19.795	1.00	68.65	C
ATOM	2659	CD1	PHE	A	351	-48.561	123.387	-20.557	1.00	65.40	C
ATOM	2660	CD2	PHE	A	351	-50.935	123.150	-20.410	1.00	65.50	C
ATOM	2661	CE1	PHE	A	351	-48.665	123.657	-21.908	1.00	66.73	C
ATOM	2662	CE2	PHE	A	351	-51.051	123.418	-21.752	1.00	64.69	C
ATOM	2663	CZ	PHE	A	351	-49.916	123.669	-22.507	1.00	67.67	C
ATOM	2664	N	PHE	A	352	-49.256	120.353	-15.913	1.00	69.25	N
ATOM	2665	CA	PHE	A	352	-49.021	120.159	-14.479	1.00	70.06	C
ATOM	2666	C	PHE	A	352	-48.613	118.737	-14.098	1.00	65.14	C
ATOM	2667	O	PHE	A	352	-47.922	118.530	-13.096	1.00	64.26	O
ATOM	2668	CB	PHE	A	352	-50.276	120.531	-13.690	1.00	67.01	C
ATOM	2669	CG	PHE	A	352	-50.440	121.999	-13.462	1.00	65.80	C
ATOM	2670	CD2	PHE	A	352	-49.910	122.593	-12.329	1.00	64.67	C
ATOM	2671	CD1	PHE	A	352	-51.140	122.778	-14.369	1.00	66.45	C
ATOM	2672	CE2	PHE	A	352	-50.061	123.940	-12.107	1.00	72.29	C
ATOM	2673	CE1	PHE	A	352	-51.299	124.123	-14.159	1.00	64.86	C
ATOM	2674	CZ	PHE	A	352	-50.759	124.711	-13.025	1.00	73.23	C
ATOM	2675	N	ASP	A	353	-49.080	117.768	-14.884	1.00	65.01	N
ATOM	2676	CA	ASP	A	353	-48.899	116.364	-14.562	1.00	67.97	C
ATOM	2677	C	ASP	A	353	-47.537	115.890	-15.063	1.00	69.50	C
ATOM	2678	O	ASP	A	353	-47.342	115.650	-16.256	1.00	66.30	O
ATOM	2679	CB	ASP	A	353	-50.023	115.505	-15.159	1.00	65.25	C
ATOM	2680	CG	ASP	A	353	-50.140	114.140	-14.475	1.00	76.77	C
ATOM	2681	OD1	ASP	A	353	-49.944	114.076	-13.239	1.00	77.59	O
ATOM	2682	OD2	ASP	A	353	-50.421	113.131	-15.163	1.00	78.63	O
ATOM	2683	O	GLN	A	354	-44.216	113.420	-15.425	1.00	74.03	O
ATOM	2684	N	GLN	A	354	-46.599	115.768	-14.134	1.00	67.57	N
ATOM	2685	CA	GLN	A	354	-45.258	115.323	-14.466	1.00	73.32	C
ATOM	2686	C	GLN	A	354	-45.193	113.848	-14.831	1.00	71.75	C
ATOM	2687	CB	GLN	A	354	-44.310	115.598	-13.308	1.00	69.09	C
ATOM	2688	CG	GLN	A	354	-44.199	117.056	-12.972	1.00	71.53	C
ATOM	2689	CD	GLN	A	354	-43.185	117.299	-11.886	1.00	76.32	C
ATOM	2690	OE1	GLN	A	354	-42.413	116.400	-11.540	1.00	63.72	O
ATOM	2691	NE2	GLN	A	354	-43.183	118.517	-11.325	1.00	75.88	N
ATOM	2692	O	SER	A	355	-46.536	110.197	-16.641	1.00	74.09	O
ATOM	2693	N	SER	A	355	-46.221	113.076	-14.486	1.00	71.16	N
ATOM	2694	CA	SER	A	355	-46.218	111.640	-14.760	1.00	63.85	C
ATOM	2695	C	SER	A	355	-46.606	111.339	-16.197	1.00	68.16	C
ATOM	2696	CB	SER	A	355	-47.166	110.913	-13.814	1.00	70.82	C
ATOM	2697	OG	SER	A	355	-48.514	111.250	-14.088	1.00	74.96	O
ATOM	2698	O	LYS	A	356	-45.832	113.797	-18.869	1.00	61.81	O
ATOM	2699	N	LYS	A	356	-47.025	112.367	-16.920	1.00	67.46	N
ATOM	2700	CA	LYS	A	356	-47.505	112.190	-18.281	1.00	68.53	C
ATOM	2701	C	LYS	A	356	-46.549	112.874	-19.244	1.00	65.65	C
ATOM	2702	CB	LYS	A	356	-48.932	112.744	-18.432	1.00	69.91	C
ATOM	2703	O	ASN	A	357	-45.635	114.254	-23.369	1.00	65.49	O
ATOM	2704	N	ASN	A	357	-46.543	112.427	-20.492	1.00	67.41	N
ATOM	2705	CA	ASN	A	357	-45.515	112.865	-21.429	1.00	64.88	C
ATOM	2706	C	ASN	A	357	-45.873	114.140	-22.166	1.00	67.33	C
ATOM	2707	CB	ASN	A	357	-45.209	111.755	-22.431	1.00	65.90	C
ATOM	2708	CG	ASN	A	357	-44.433	110.609	-21.807	1.00	62.73	C
ATOM	2709	OD1	ASN	A	357	-43.979	110.701	-20.663	1.00	59.72	O
ATOM	2710	ND2	ASN	A	357	-44.266	109.530	-22.559	1.00	65.07	N

ATOM	2711	O	GLY	A	358	-44.638	116.961	-21.113	1.00	67.96	O
ATOM	2712	N	GLY	A	358	-46.436	115.097	-21.430	1.00	66.67	N
ATOM	2713	CA	GLY	A	358	-46.765	116.404	-21.972	1.00	64.30	C
ATOM	2714	C	GLY	A	358	-45.688	117.385	-21.577	1.00	64.13	C
ATOM	2715	O	TYR	A	359	-43.248	119.758	-19.801	1.00	64.42	O
ATOM	2716	N	TYR	A	359	-45.947	118.682	-21.747	1.00	62.55	N
ATOM	2717	CA	TYR	A	359	-44.962	119.713	-21.455	1.00	56.59	C
ATOM	2718	C	TYR	A	359	-44.432	119.556	-20.047	1.00	61.93	C
ATOM	2719	CB	TYR	A	359	-45.563	121.109	-21.638	1.00	60.85	C
ATOM	2720	CG	TYR	A	359	-44.541	122.222	-21.627	1.00	58.42	C
ATOM	2721	CD1	TYR	A	359	-43.698	122.430	-22.720	1.00	55.18	C
ATOM	2722	CD2	TYR	A	359	-44.410	123.061	-20.528	1.00	57.39	C
ATOM	2723	CE1	TYR	A	359	-42.750	123.453	-22.718	1.00	53.25	C
ATOM	2724	CE2	TYR	A	359	-43.466	124.079	-20.515	1.00	59.00	C
ATOM	2725	CZ	TYR	A	359	-42.636	124.268	-21.613	1.00	57.68	C
ATOM	2726	OH	TYR	A	359	-41.696	125.273	-21.597	1.00	56.23	O
ATOM	2727	O	ALA	A	360	-42.876	118.100	-16.959	1.00	63.50	O
ATOM	2728	N	ALA	A	360	-45.313	119.170	-19.129	1.00	66.01	N
ATOM	2729	CA	ALA	A	360	-44.943	118.997	-17.729	1.00	60.66	C
ATOM	2730	C	ALA	A	360	-43.907	117.903	-17.589	1.00	63.50	C
ATOM	2731	CB	ALA	A	360	-46.158	118.677	-16.892	1.00	55.45	C
ATOM	2732	O	GLY	A	361	-40.914	115.523	-18.533	1.00	63.87	O
ATOM	2733	N	GLY	A	361	-44.197	116.744	-18.168	1.00	61.88	N
ATOM	2734	CA	GLY	A	361	-43.277	115.625	-18.120	1.00	64.39	C
ATOM	2735	C	GLY	A	361	-42.016	115.949	-18.891	1.00	64.83	C
ATOM	2736	O	TYR	A	362	-38.926	117.958	-20.186	1.00	61.53	O
ATOM	2737	N	TYR	A	362	-42.203	116.719	-19.958	1.00	63.84	N
ATOM	2738	CA	TYR	A	362	-41.131	117.216	-20.806	1.00	63.14	C
ATOM	2739	C	TYR	A	362	-40.134	118.078	-20.021	1.00	63.34	C
ATOM	2740	CB	TYR	A	362	-41.750	118.010	-21.950	1.00	61.76	C
ATOM	2741	CG	TYR	A	362	-40.803	118.544	-22.978	1.00	59.70	C
ATOM	2742	CD1	TYR	A	362	-39.848	117.720	-23.565	1.00	64.33	C
ATOM	2743	CD2	TYR	A	362	-40.877	119.866	-23.389	1.00	56.43	C
ATOM	2744	CE1	TYR	A	362	-38.981	118.202	-24.529	1.00	58.47	C
ATOM	2745	CE2	TYR	A	362	-40.020	120.367	-24.355	1.00	59.09	C
ATOM	2746	CZ	TYR	A	362	-39.071	119.525	-24.922	1.00	60.47	C
ATOM	2747	OH	TYR	A	362	-38.203	119.994	-25.885	1.00	58.85	O
ATOM	2748	O	ILE	A	363	-38.197	119.587	-16.723	1.00	58.58	O
ATOM	2749	N	ILE	A	363	-40.646	118.926	-19.141	1.00	63.49	N
ATOM	2750	CA	ILE	A	363	-39.815	119.902	-18.447	1.00	60.13	C
ATOM	2751	C	ILE	A	363	-39.355	119.429	-17.081	1.00	54.13	C
ATOM	2752	CB	ILE	A	363	-40.576	121.250	-18.281	1.00	57.63	C
ATOM	2753	CG1	ILE	A	363	-40.872	121.853	-19.649	1.00	56.20	C
ATOM	2754	CG2	ILE	A	363	-39.795	122.230	-17.422	1.00	51.42	C
ATOM	2755	CD1	ILE	A	363	-39.652	122.213	-20.418	1.00	57.87	C
ATOM	2756	O	ASP	A	364	-39.478	116.573	-13.629	1.00	62.67	O
ATOM	2757	N	ASP	A	364	-40.271	118.872	-16.304	1.00	59.61	N
ATOM	2758	CA	ASP	A	364	-39.997	118.543	-14.908	1.00	59.99	C
ATOM	2759	C	ASP	A	364	-39.931	117.039	-14.679	1.00	63.76	C
ATOM	2760	CB	ASP	A	364	-41.071	119.161	-14.003	1.00	66.55	C
ATOM	2761	CG	ASP	A	364	-41.116	120.687	-14.094	1.00	71.01	C
ATOM	2762	OD1	ASP	A	364	-40.038	121.312	-14.012	1.00	71.18	O
ATOM	2763	OD2	ASP	A	364	-42.225	121.255	-14.246	1.00	70.89	O
ATOM	2764	O	GLY	A	365	-38.247	114.877	-16.572	1.00	68.73	O
ATOM	2765	N	GLY	A	365	-40.393	116.280	-15.665	1.00	59.76	N
ATOM	2766	CA	GLY	A	365	-40.407	114.844	-15.545	1.00	66.14	C
ATOM	2767	C	GLY	A	365	-39.258	114.226	-16.305	1.00	66.10	C
ATOM	2768	O	GLY	A	366	-37.528	113.213	-19.468	1.00	77.66	O
ATOM	2769	N	GLY	A	366	-39.407	112.959	-16.649	1.00	64.37	N
ATOM	2770	CA	GLY	A	366	-38.398	112.311	-17.452	1.00	72.83	C
ATOM	2771	C	GLY	A	366	-38.514	112.789	-18.881	1.00	72.16	C
ATOM	2772	O	ALA	A	367	-38.537	114.453	-21.635	1.00	63.38	O
ATOM	2773	N	ALA	A	367	-39.746	112.780	-19.387	1.00	66.61	N

ATOM	2774	CA	ALA	A	367	-40.066	112.769	-20.819	1.00	70.90	C
ATOM	2775	C	ALA	A	367	-38.999	113.313	-21.768	1.00	64.42	C
ATOM	2776	CB	ALA	A	367	-41.387	113.523	-21.059	1.00	65.57	C
ATOM	2777	N	SER	A	368	-38.631	112.490	-22.739	1.00	55.94	N
ATOM	2778	CA	SER	A	368	-37.730	112.936	-23.792	1.00	61.36	C
ATOM	2779	C	SER	A	368	-38.490	113.749	-24.824	1.00	62.87	C
ATOM	2780	O	SER	A	368	-39.717	113.777	-24.827	1.00	62.44	O
ATOM	2781	CB	SER	A	368	-37.050	111.749	-24.472	1.00	59.76	C
ATOM	2782	OG	SER	A	368	-37.930	111.101	-25.364	1.00	61.31	O
ATOM	2783	N	GLN	A	369	-37.761	114.414	-25.708	1.00	59.63	N
ATOM	2784	CA	GLN	A	369	-38.404	115.186	-26.754	1.00	57.28	C
ATOM	2785	C	GLN	A	369	-39.274	114.288	-27.616	1.00	64.74	C
ATOM	2786	O	GLN	A	369	-40.341	114.698	-28.079	1.00	63.06	O
ATOM	2787	CB	GLN	A	369	-37.375	115.894	-27.616	1.00	53.86	C
ATOM	2788	CG	GLN	A	369	-37.950	116.514	-28.849	1.00	56.62	C
ATOM	2789	CD	GLN	A	369	-36.886	117.090	-29.733	1.00	58.17	C
ATOM	2790	OE1	GLN	A	369	-36.138	117.982	-29.318	1.00	59.98	O
ATOM	2791	NE2	GLN	A	369	-36.780	116.570	-30.954	1.00	54.50	N
ATOM	2792	N	GLU	A	370	-38.819	113.057	-27.827	1.00	65.56	N
ATOM	2793	CA	GLU	A	370	-39.561	112.143	-28.666	1.00	62.98	C
ATOM	2794	C	GLU	A	370	-40.853	111.725	-27.983	1.00	64.55	C
ATOM	2795	O	GLU	A	370	-41.888	111.633	-28.631	1.00	68.73	O
ATOM	2796	CB	GLU	A	370	-38.734	110.909	-29.019	1.00	68.06	C
ATOM	2797	CG	GLU	A	370	-39.385	110.050	-30.095	1.00	64.93	C
ATOM	2798	CD	GLU	A	370	-38.554	108.836	-30.485	1.00	82.49	C
ATOM	2799	OE1	GLU	A	370	-37.771	108.337	-29.645	1.00	87.66	O
ATOM	2800	OE2	GLU	A	370	-38.694	108.376	-31.639	1.00	87.88	O
ATOM	2801	N	GLU	A	371	-40.796	111.474	-26.682	1.00	61.10	N
ATOM	2802	CA	GLU	A	371	-41.976	111.032	-25.949	1.00	63.03	C
ATOM	2803	C	GLU	A	371	-43.025	112.153	-25.868	1.00	66.33	C
ATOM	2804	O	GLU	A	371	-44.235	111.923	-25.934	1.00	65.36	O
ATOM	2805	CB	GLU	A	371	-41.575	110.552	-24.554	1.00	63.50	C
ATOM	2806	CG	GLU	A	371	-40.571	109.401	-24.604	1.00	66.07	C
ATOM	2807	CD	GLU	A	371	-40.222	108.841	-23.239	1.00	68.14	C
ATOM	2808	OE1	GLU	A	371	-40.140	107.605	-23.121	1.00	72.14	O
ATOM	2809	OE2	GLU	A	371	-40.011	109.625	-22.291	1.00	73.51	O
ATOM	2810	N	PHE	A	372	-42.530	113.371	-25.739	1.00	63.62	N
ATOM	2811	CA	PHE	A	372	-43.360	114.550	-25.743	1.00	64.83	C
ATOM	2812	C	PHE	A	372	-44.047	114.703	-27.097	1.00	67.85	C
ATOM	2813	O	PHE	A	372	-45.260	114.890	-27.171	1.00	68.88	O
ATOM	2814	CB	PHE	A	372	-42.504	115.774	-25.405	1.00	62.59	C
ATOM	2815	CG	PHE	A	372	-43.205	117.077	-25.569	1.00	63.24	C
ATOM	2816	CD1	PHE	A	372	-44.316	117.388	-24.800	1.00	63.79	C
ATOM	2817	CD2	PHE	A	372	-42.734	118.010	-26.463	1.00	63.87	C
ATOM	2818	CE1	PHE	A	372	-44.954	118.596	-24.935	1.00	61.69	C
ATOM	2819	CE2	PHE	A	372	-43.368	119.226	-26.603	1.00	64.95	C
ATOM	2820	CZ	PHE	A	372	-44.483	119.518	-25.836	1.00	64.09	C
ATOM	2821	N	TYR	A	373	-43.271	114.598	-28.167	1.00	65.72	N
ATOM	2822	CA	TYR	A	373	-43.805	114.775	-29.501	1.00	62.96	C
ATOM	2823	C	TYR	A	373	-44.895	113.765	-29.826	1.00	70.77	C
ATOM	2824	O	TYR	A	373	-45.905	114.136	-30.434	1.00	70.16	O
ATOM	2825	CB	TYR	A	373	-42.704	114.677	-30.541	1.00	60.48	C
ATOM	2826	CG	TYR	A	373	-41.871	115.927	-30.692	1.00	65.84	C
ATOM	2827	CD1	TYR	A	373	-42.180	117.099	-30.009	1.00	58.80	C
ATOM	2828	CD2	TYR	A	373	-40.774	115.934	-31.538	1.00	63.36	C
ATOM	2829	CE1	TYR	A	373	-41.399	118.234	-30.165	1.00	58.91	C
ATOM	2830	CE2	TYR	A	373	-40.007	117.053	-31.705	1.00	60.62	C
ATOM	2831	CZ	TYR	A	373	-40.309	118.195	-31.021	1.00	62.11	C
ATOM	2832	OH	TYR	A	373	-39.497	119.288	-31.221	1.00	63.67	O
ATOM	2833	N	LYS	A	374	-44.704	112.502	-29.432	1.00	69.49	N
ATOM	2834	CA	LYS	A	374	-45.678	111.451	-29.761	1.00	70.38	C
ATOM	2835	C	LYS	A	374	-46.973	111.636	-28.962	1.00	78.94	C
ATOM	2836	O	LYS	A	374	-48.072	111.339	-29.454	1.00	77.15	O

ATOM	2837	CB	LYS	A	374	-45.108	110.052	-29.510	1.00	58.86	C
ATOM	2838	N	PHE	A	375	-46.831	112.131	-27.735	1.00	72.05	N
ATOM	2839	CA	PHE	A	375	-47.967	112.386	-26.864	1.00	72.29	C
ATOM	2840	C	PHE	A	375	-48.796	113.580	-27.316	1.00	73.36	C
ATOM	2841	O	PHE	A	375	-50.023	113.518	-27.386	1.00	76.93	O
ATOM	2842	CB	PHE	A	375	-47.473	112.615	-25.439	1.00	70.65	C
ATOM	2843	CG	PHE	A	375	-48.512	113.165	-24.511	1.00	69.70	C
ATOM	2844	CD1	PHE	A	375	-48.718	114.539	-24.397	1.00	73.69	C
ATOM	2845	CD2	PHE	A	375	-49.256	112.318	-23.717	1.00	70.13	C
ATOM	2846	CE1	PHE	A	375	-49.670	115.054	-23.519	1.00	74.23	C
ATOM	2847	CE2	PHE	A	375	-50.205	112.827	-22.833	1.00	76.25	C
ATOM	2848	CZ	PHE	A	375	-50.409	114.197	-22.735	1.00	71.77	C
ATOM	2849	N	ILE	A	376	-48.118	114.681	-27.594	1.00	72.91	N
ATOM	2850	CA	ILE	A	376	-48.807	115.926	-27.861	1.00	75.93	C
ATOM	2851	C	ILE	A	376	-49.276	116.003	-29.310	1.00	75.54	C
ATOM	2852	O	ILE	A	376	-50.070	116.868	-29.666	1.00	78.07	O
ATOM	2853	CB	ILE	A	376	-47.910	117.140	-27.545	1.00	74.95	C
ATOM	2854	CG1	ILE	A	376	-48.772	118.342	-27.141	1.00	70.75	C
ATOM	2855	CG2	ILE	A	376	-46.992	117.469	-28.740	1.00	70.92	C
ATOM	2856	CD1	ILE	A	376	-48.953	119.342	-28.232	1.00	67.98	C
ATOM	2857	N	LYS	A	377	-48.786	115.096	-30.144	1.00	75.72	N
ATOM	2858	CA	LYS	A	377	-49.142	115.115	-31.562	1.00	79.33	C
ATOM	2859	C	LYS	A	377	-50.657	114.995	-31.792	1.00	83.47	C
ATOM	2860	O	LYS	A	377	-51.235	115.860	-32.457	1.00	81.26	O
ATOM	2861	CB	LYS	A	377	-48.403	114.013	-32.332	1.00	77.08	C
ATOM	2862	N	PRO	A	378	-51.308	113.947	-31.238	1.00	81.44	N
ATOM	2863	CA	PRO	A	378	-52.738	113.802	-31.549	1.00	79.03	C
ATOM	2864	C	PRO	A	378	-53.586	114.964	-31.018	1.00	81.84	C
ATOM	2865	O	PRO	A	378	-54.623	115.291	-31.606	1.00	80.56	O
ATOM	2866	CB	PRO	A	378	-53.114	112.484	-30.858	1.00	82.38	C
ATOM	2867	CG	PRO	A	378	-51.810	111.770	-30.635	1.00	83.55	C
ATOM	2868	CD	PRO	A	378	-50.842	112.864	-30.353	1.00	75.93	C
ATOM	2869	N	ILE	A	379	-53.139	115.568	-29.919	1.00	78.43	N
ATOM	2870	CA	ILE	A	379	-53.780	116.752	-29.357	1.00	75.35	C
ATOM	2871	C	ILE	A	379	-53.768	117.869	-30.389	1.00	80.85	C
ATOM	2872	O	ILE	A	379	-54.777	118.533	-30.626	1.00	81.62	O
ATOM	2873	CB	ILE	A	379	-53.069	117.230	-28.071	1.00	69.81	C
ATOM	2874	CG1	ILE	A	379	-53.529	116.424	-26.855	1.00	71.23	C
ATOM	2875	CG2	ILE	A	379	-53.307	118.700	-27.838	1.00	72.38	C
ATOM	2876	CD1	ILE	A	379	-53.012	114.986	-26.815	1.00	72.73	C
ATOM	2877	N	LEU	A	380	-52.607	118.058	-31.005	1.00	83.58	N
ATOM	2878	CA	LEU	A	380	-52.427	119.046	-32.058	1.00	81.01	C
ATOM	2879	C	LEU	A	380	-53.454	118.857	-33.171	1.00	81.34	C
ATOM	2880	O	LEU	A	380	-54.184	119.787	-33.514	1.00	83.32	O
ATOM	2881	CB	LEU	A	380	-51.003	118.963	-32.623	1.00	78.43	C
ATOM	2882	CG	LEU	A	380	-50.170	120.245	-32.549	1.00	78.97	C
ATOM	2883	CD1	LEU	A	380	-50.288	120.860	-31.168	1.00	76.86	C
ATOM	2884	CD2	LEU	A	380	-48.710	119.981	-32.887	1.00	73.84	C
ATOM	2885	O	GLU	A	381	-56.618	117.992	-35.443	1.00	78.74	O
ATOM	2886	N	GLU	A	381	-53.519	117.641	-33.707	1.00	80.18	N
ATOM	2887	CA	GLU	A	381	-54.370	117.323	-34.856	1.00	84.30	C
ATOM	2888	C	GLU	A	381	-55.881	117.503	-34.584	1.00	84.31	C
ATOM	2889	CB	GLU	A	381	-54.077	115.888	-35.322	1.00	80.01	C
ATOM	2890	CG	GLU	A	381	-52.640	115.680	-35.835	1.00	78.62	C
ATOM	2891	CD	GLU	A	381	-52.234	114.202	-35.933	1.00	78.36	C
ATOM	2892	OE1	GLU	A	381	-52.635	113.402	-35.063	1.00	76.07	O
ATOM	2893	OE2	GLU	A	381	-51.510	113.840	-36.883	1.00	79.82	O
ATOM	2894	O	LYS	A	382	-59.372	118.980	-33.095	1.00	91.96	O
ATOM	2895	N	LYS	A	382	-56.324	117.118	-33.387	1.00	86.27	N
ATOM	2896	CA	LYS	A	382	-57.728	117.226	-32.991	1.00	80.75	C
ATOM	2897	C	LYS	A	382	-58.187	118.683	-32.976	1.00	86.68	C
ATOM	2898	CB	LYS	A	382	-57.946	116.592	-31.613	1.00	76.43	C
ATOM	2899	O	MET	A	383	-56.711	120.939	-35.082	1.00	79.33	O

ATOM	2900	N	MET	A	383	-57.231	119.587	-32.822	1.00	85.70	N
ATOM	2901	CA	MET	A	383	-57.501	121.005	-32.827	1.00	79.91	C
ATOM	2902	C	MET	A	383	-57.168	121.619	-34.169	1.00	80.46	C
ATOM	2903	CB	MET	A	383	-56.691	121.698	-31.746	1.00	81.12	C
ATOM	2904	CG	MET	A	383	-56.825	121.074	-30.394	1.00	77.97	C
ATOM	2905	SD	MET	A	383	-55.841	122.005	-29.216	1.00	84.32	S
ATOM	2906	CE	MET	A	383	-54.200	121.700	-29.882	1.00	81.18	C
ATOM	2907	O	ASP	A	384	-56.509	125.363	-33.813	1.00	89.43	O
ATOM	2908	N	ASP	A	384	-57.404	122.920	-34.269	1.00	82.81	N
ATOM	2909	CA	ASP	A	384	-57.063	123.695	-35.451	1.00	86.75	C
ATOM	2910	C	ASP	A	384	-56.394	124.985	-34.985	1.00	89.25	C
ATOM	2911	CB	ASP	A	384	-58.307	123.986	-36.300	1.00	92.31	C
ATOM	2912	CG	ASP	A	384	-59.518	124.327	-35.453	1.00	94.30	C
ATOM	2913	OD2	ASP	A	384	-60.401	125.074	-35.930	1.00	98.36	O
ATOM	2914	OD1	ASP	A	384	-59.578	123.847	-34.299	1.00	94.88	O
ATOM	2915	N	GLY	A	385	-55.697	125.660	-35.893	1.00	85.61	N
ATOM	2916	CA	GLY	A	385	-54.824	126.749	-35.506	1.00	81.70	C
ATOM	2917	C	GLY	A	385	-53.479	126.157	-35.135	1.00	83.35	C
ATOM	2918	O	GLY	A	385	-52.531	126.868	-34.809	1.00	84.82	O
ATOM	2919	N	THR	A	386	-53.412	124.831	-35.185	1.00	79.85	N
ATOM	2920	CA	THR	A	386	-52.180	124.092	-34.965	1.00	81.88	C
ATOM	2921	C	THR	A	386	-51.500	123.876	-36.310	1.00	81.60	C
ATOM	2922	O	THR	A	386	-50.897	122.832	-36.565	1.00	77.04	O
ATOM	2923	CB	THR	A	386	-52.447	122.737	-34.290	1.00	81.18	C
ATOM	2924	OG1	THR	A	386	-52.969	121.811	-35.254	1.00	77.41	O
ATOM	2925	CG2	THR	A	386	-53.443	122.897	-33.162	1.00	80.83	C
ATOM	2926	N	GLU	A	387	-51.628	124.875	-37.175	1.00	84.74	N
ATOM	2927	CA	GLU	A	387	-51.120	124.801	-38.535	1.00	82.57	C
ATOM	2928	C	GLU	A	387	-49.606	124.716	-38.533	1.00	82.36	C
ATOM	2929	O	GLU	A	387	-49.023	123.673	-38.848	1.00	82.47	O
ATOM	2930	CB	GLU	A	387	-51.582	126.019	-39.339	1.00	84.47	C
ATOM	2931	N	GLU	A	388	-48.978	125.823	-38.156	1.00	77.76	N
ATOM	2932	CA	GLU	A	388	-47.533	125.929	-38.173	1.00	76.42	C
ATOM	2933	C	GLU	A	388	-46.902	125.009	-37.125	1.00	79.86	C
ATOM	2934	O	GLU	A	388	-45.755	124.579	-37.282	1.00	75.32	O
ATOM	2935	CB	GLU	A	388	-47.105	127.379	-37.949	1.00	72.09	C
ATOM	2936	N	LEU	A	389	-47.660	124.705	-36.070	1.00	79.07	N
ATOM	2937	CA	LEU	A	389	-47.198	123.820	-35.001	1.00	72.88	C
ATOM	2938	C	LEU	A	389	-46.882	122.433	-35.527	1.00	76.50	C
ATOM	2939	O	LEU	A	389	-45.792	121.903	-35.303	1.00	78.71	O
ATOM	2940	CB	LEU	A	389	-48.246	123.714	-33.893	1.00	73.85	C
ATOM	2941	CG	LEU	A	389	-47.990	124.507	-32.610	1.00	68.35	C
ATOM	2942	CD1	LEU	A	389	-47.878	126.002	-32.879	1.00	65.04	C
ATOM	2943	CD2	LEU	A	389	-49.085	124.227	-31.606	1.00	70.25	C
ATOM	2944	N	LEU	A	390	-47.845	121.841	-36.219	1.00	78.90	N
ATOM	2945	CA	LEU	A	390	-47.676	120.501	-36.768	1.00	77.38	C
ATOM	2946	C	LEU	A	390	-46.502	120.419	-37.742	1.00	77.28	C
ATOM	2947	O	LEU	A	390	-45.772	119.435	-37.739	1.00	79.44	O
ATOM	2948	CB	LEU	A	390	-48.954	120.051	-37.463	1.00	79.10	C
ATOM	2949	CG	LEU	A	390	-48.909	118.642	-38.049	1.00	77.06	C
ATOM	2950	CD1	LEU	A	390	-49.872	117.726	-37.301	1.00	74.51	C
ATOM	2951	CD2	LEU	A	390	-49.187	118.652	-39.562	1.00	75.67	C
ATOM	2952	N	VAL	A	391	-46.325	121.446	-38.575	1.00	76.44	N
ATOM	2953	CA	VAL	A	391	-45.181	121.519	-39.484	1.00	74.55	C
ATOM	2954	C	VAL	A	391	-43.876	121.428	-38.708	1.00	78.28	C
ATOM	2955	O	VAL	A	391	-43.021	120.573	-38.982	1.00	77.43	O
ATOM	2956	CB	VAL	A	391	-45.173	122.828	-40.296	1.00	81.41	C
ATOM	2957	CG1	VAL	A	391	-43.810	123.039	-40.969	1.00	80.40	C
ATOM	2958	CG2	VAL	A	391	-46.306	122.832	-41.320	1.00	80.97	C
ATOM	2959	N	LYS	A	392	-43.749	122.328	-37.736	1.00	77.14	N
ATOM	2960	CA	LYS	A	392	-42.638	122.355	-36.793	1.00	74.38	C
ATOM	2961	C	LYS	A	392	-42.378	121.017	-36.090	1.00	71.78	C
ATOM	2962	O	LYS	A	392	-41.231	120.607	-35.980	1.00	76.53	O

ATOM	2963	CB	LYS	A	392	-42.876	123.448	-35.745	1.00	69.56	C
ATOM	2964	CG	LYS	A	392	-42.606	124.842	-36.255	1.00	70.74	C
ATOM	2965	CD	LYS	A	392	-42.431	125.804	-35.107	1.00	70.45	C
ATOM	2966	CE	LYS	A	392	-42.291	127.231	-35.588	1.00	62.71	C
ATOM	2967	NZ	LYS	A	392	-41.960	128.121	-34.448	1.00	72.21	N
ATOM	2968	N	LEU	A	393	-43.426	120.340	-35.623	1.00	69.96	N
ATOM	2969	CA	LEU	A	393	-43.257	119.078	-34.900	1.00	67.43	C
ATOM	2970	C	LEU	A	393	-42.742	117.967	-35.815	1.00	72.00	C
ATOM	2971	O	LEU	A	393	-42.076	117.025	-35.368	1.00	76.88	O
ATOM	2972	CB	LEU	A	393	-44.571	118.652	-34.253	1.00	64.77	C
ATOM	2973	CG	LEU	A	393	-44.531	117.466	-33.294	1.00	61.86	C
ATOM	2974	CD1	LEU	A	393	-45.574	117.653	-32.224	1.00	63.38	C
ATOM	2975	CD2	LEU	A	393	-44.757	116.142	-34.008	1.00	61.69	C
ATOM	2976	N	ASN	A	394	-43.038	118.085	-37.099	1.00	73.02	N
ATOM	2977	CA	ASN	A	394	-42.626	117.077	-38.059	1.00	75.44	C
ATOM	2978	C	ASN	A	394	-41.197	117.297	-38.560	1.00	73.51	C
ATOM	2979	O	ASN	A	394	-40.513	116.348	-38.943	1.00	71.18	O
ATOM	2980	CB	ASN	A	394	-43.604	117.049	-39.232	1.00	81.55	C
ATOM	2981	CG	ASN	A	394	-44.076	115.650	-39.552	1.00	84.58	C
ATOM	2982	OD1	ASN	A	394	-44.837	115.049	-38.783	1.00	85.53	O
ATOM	2983	ND2	ASN	A	394	-43.623	115.117	-40.687	1.00	78.09	N
ATOM	2984	N	ARG	A	395	-40.751	118.550	-38.554	1.00	71.90	N
ATOM	2985	CA	ARG	A	395	-39.353	118.853	-38.827	1.00	72.67	C
ATOM	2986	C	ARG	A	395	-38.556	118.807	-37.518	1.00	73.43	C
ATOM	2987	O	ARG	A	395	-37.455	119.345	-37.444	1.00	70.20	O
ATOM	2988	CB	ARG	A	395	-39.209	120.220	-39.502	1.00	57.66	C
ATOM	2989	N	GLU	A	396	-39.125	118.143	-36.507	1.00	71.98	N
ATOM	2990	CA	GLU	A	396	-38.619	118.144	-35.130	1.00	70.09	C
ATOM	2991	C	GLU	A	396	-38.053	119.503	-34.701	1.00	69.05	C
ATOM	2992	O	GLU	A	396	-36.886	119.621	-34.335	1.00	68.40	O
ATOM	2993	CB	GLU	A	396	-37.564	117.058	-34.954	1.00	68.79	C
ATOM	2994	CG	GLU	A	396	-38.123	115.645	-35.018	1.00	71.06	C
ATOM	2995	CD	GLU	A	396	-37.051	114.601	-35.303	1.00	80.42	C
ATOM	2996	OE1	GLU	A	396	-36.081	114.904	-36.040	1.00	74.84	O
ATOM	2997	OE2	GLU	A	396	-37.181	113.471	-34.784	1.00	86.65	O
ATOM	2998	O	ASP	A	397	-39.293	123.838	-33.387	1.00	65.61	O
ATOM	2999	N	ASP	A	397	-38.901	120.526	-34.736	1.00	72.22	N
ATOM	3000	CA	ASP	A	397	-38.468	121.903	-34.521	1.00	69.71	C
ATOM	3001	C	ASP	A	397	-39.287	122.612	-33.457	1.00	67.74	C
ATOM	3002	CB	ASP	A	397	-38.557	122.679	-35.827	1.00	72.54	C
ATOM	3003	CG	ASP	A	397	-37.231	123.241	-36.253	1.00	79.64	C
ATOM	3004	OD1	ASP	A	397	-36.572	123.877	-35.400	1.00	78.00	O
ATOM	3005	OD2	ASP	A	397	-36.845	123.041	-37.432	1.00	82.34	O
ATOM	3006	O	LEU	A	398	-40.650	121.279	-29.695	1.00	67.59	O
ATOM	3007	N	LEU	A	398	-39.957	121.835	-32.616	1.00	66.87	N
ATOM	3008	CA	LEU	A	398	-41.022	122.369	-31.782	1.00	62.07	C
ATOM	3009	C	LEU	A	398	-40.748	122.347	-30.287	1.00	58.16	C
ATOM	3010	CB	LEU	A	398	-42.308	121.593	-32.055	1.00	66.98	C
ATOM	3011	CG	LEU	A	398	-43.483	121.930	-31.148	1.00	60.90	C
ATOM	3012	CD2	LEU	A	398	-44.552	120.874	-31.262	1.00	54.96	C
ATOM	3013	CD1	LEU	A	398	-44.001	123.315	-31.474	1.00	57.66	C
ATOM	3014	O	LEU	A	399	-39.076	122.338	-26.854	1.00	53.96	O
ATOM	3015	N	LEU	A	399	-40.683	123.536	-29.690	1.00	57.79	N
ATOM	3016	CA	LEU	A	399	-40.470	123.721	-28.260	1.00	55.58	C
ATOM	3017	C	LEU	A	399	-39.142	123.087	-27.825	1.00	58.74	C
ATOM	3018	CB	LEU	A	399	-41.646	123.138	-27.463	1.00	54.95	C
ATOM	3019	CG	LEU	A	399	-43.053	123.749	-27.619	1.00	60.03	C
ATOM	3020	CD1	LEU	A	399	-44.084	122.894	-26.885	1.00	53.93	C
ATOM	3021	CD2	LEU	A	399	-43.122	125.215	-27.139	1.00	51.21	C
ATOM	3022	O	ARG	A	400	-36.072	124.639	-26.977	1.00	50.51	O
ATOM	3023	N	ARG	A	400	-38.080	123.398	-28.555	1.00	58.40	N
ATOM	3024	CA	ARG	A	400	-36.803	122.759	-28.305	1.00	51.87	C
ATOM	3025	C	ARG	A	400	-36.032	123.410	-27.170	1.00	52.55	C

ATOM	3026	CB	ARG	A	400	-35.958	122.738	-29.578	1.00	51.48	C
ATOM	3027	CG	ARG	A	400	-36.289	121.544	-30.444	1.00	56.91	C
ATOM	3028	CD	ARG	A	400	-35.427	121.468	-31.679	1.00	65.23	C
ATOM	3029	NE	ARG	A	400	-34.084	120.958	-31.416	1.00	63.00	N
ATOM	3030	CZ	ARG	A	400	-33.816	119.692	-31.105	1.00	62.07	C
ATOM	3031	NH1	ARG	A	400	-34.805	118.823	-30.997	1.00	70.18	N
ATOM	3032	NH2	ARG	A	400	-32.569	119.294	-30.893	1.00	52.49	N
ATOM	3033	O	LYS	A	401	-32.865	122.927	-27.223	1.00	49.41	O
ATOM	3034	N	LYS	A	401	-35.357	122.559	-26.396	1.00	49.23	N
ATOM	3035	CA	LYS	A	401	-34.418	123.014	-25.390	1.00	44.19	C
ATOM	3036	C	LYS	A	401	-33.078	123.298	-26.065	1.00	49.52	C
ATOM	3037	CB	LYS	A	401	-34.267	121.985	-24.291	1.00	46.17	C
ATOM	3038	CG	LYS	A	401	-35.524	121.217	-23.994	1.00	51.17	C
ATOM	3039	CD	LYS	A	401	-35.338	120.409	-22.743	1.00	48.77	C
ATOM	3040	CE	LYS	A	401	-36.445	119.402	-22.528	1.00	55.43	C
ATOM	3041	NZ	LYS	A	401	-36.218	118.679	-21.241	1.00	57.56	N
ATOM	3042	O	GLN	A	402	-29.052	123.075	-26.727	1.00	39.33	O
ATOM	3043	N	GLN	A	402	-32.178	123.978	-25.365	1.00	47.99	N
ATOM	3044	CA	GLN	A	402	-30.933	124.368	-26.007	1.00	45.77	C
ATOM	3045	C	GLN	A	402	-29.884	123.257	-25.852	1.00	46.32	C
ATOM	3046	CB	GLN	A	402	-30.416	125.679	-25.448	1.00	41.98	C
ATOM	3047	CG	GLN	A	402	-31.169	126.920	-25.932	1.00	50.68	C
ATOM	3048	CD	GLN	A	402	-32.599	127.017	-25.391	1.00	48.33	C
ATOM	3049	OE1	GLN	A	402	-32.814	127.082	-24.184	1.00	48.65	O
ATOM	3050	NE2	GLN	A	402	-33.573	127.008	-26.291	1.00	47.79	N
ATOM	3051	O	ARG	A	403	-30.591	119.530	-24.057	1.00	42.55	O
ATOM	3052	N	ARG	A	403	-29.969	122.534	-24.734	1.00	46.69	N
ATOM	3053	CA	ARG	A	403	-29.132	121.386	-24.414	1.00	44.26	C
ATOM	3054	C	ARG	A	403	-29.770	120.059	-24.795	1.00	41.57	C
ATOM	3055	CB	ARG	A	403	-28.827	121.396	-22.929	1.00	46.80	C
ATOM	3056	CG	ARG	A	403	-28.051	122.605	-22.550	1.00	42.56	C
ATOM	3057	CD	ARG	A	403	-26.687	122.541	-23.176	1.00	45.85	C
ATOM	3058	NE	ARG	A	403	-25.746	122.917	-22.152	1.00	52.37	N
ATOM	3059	CZ	ARG	A	403	-24.792	122.149	-21.648	1.00	48.77	C
ATOM	3060	NH1	ARG	A	403	-24.057	122.651	-20.675	1.00	54.15	N
ATOM	3061	NH2	ARG	A	403	-24.577	120.914	-22.073	1.00	43.06	N
ATOM	3062	N	THR	A	404	-29.405	119.538	-25.959	1.00	42.47	N
ATOM	3063	CA	THR	A	404	-30.014	118.309	-26.449	1.00	44.21	C
ATOM	3064	C	THR	A	404	-29.025	117.454	-27.183	1.00	42.56	C
ATOM	3065	O	THR	A	404	-27.946	117.916	-27.547	1.00	44.30	O
ATOM	3066	CB	THR	A	404	-31.204	118.548	-27.427	1.00	46.00	C
ATOM	3067	OG1	THR	A	404	-30.824	119.471	-28.452	1.00	41.84	O
ATOM	3068	CG2	THR	A	404	-32.413	119.051	-26.683	1.00	52.96	C
ATOM	3069	N	PHE	A	405	-29.471	116.230	-27.450	1.00	46.30	N
ATOM	3070	CA	PHE	A	405	-28.669	115.107	-27.951	1.00	45.99	C
ATOM	3071	C	PHE	A	405	-27.993	115.337	-29.299	1.00	49.85	C
ATOM	3072	O	PHE	A	405	-27.184	114.514	-29.723	1.00	55.82	O
ATOM	3073	CB	PHE	A	405	-29.561	113.860	-28.062	1.00	49.00	C
ATOM	3074	CG	PHE	A	405	-30.787	114.066	-28.927	1.00	55.41	C
ATOM	3075	CD2	PHE	A	405	-30.813	113.609	-30.235	1.00	55.60	C
ATOM	3076	CD1	PHE	A	405	-31.913	114.744	-28.433	1.00	58.05	C
ATOM	3077	CE2	PHE	A	405	-31.938	113.817	-31.032	1.00	59.07	C
ATOM	3078	CE1	PHE	A	405	-33.033	114.959	-29.222	1.00	48.41	C
ATOM	3079	CE	PHE	A	405	-33.048	114.500	-30.514	1.00	59.91	C
ATOM	3080	N	ASP	A	406	-28.323	116.426	-29.987	1.00	46.36	N
ATOM	3081	CA	ASP	A	406	-27.780	116.621	-31.322	1.00	46.34	C
ATOM	3082	C	ASP	A	406	-26.879	117.822	-31.375	1.00	43.21	C
ATOM	3083	O	ASP	A	406	-26.408	118.195	-32.437	1.00	47.00	O
ATOM	3084	CB	ASP	A	406	-28.891	116.732	-32.378	1.00	46.60	C
ATOM	3085	CG	ASP	A	406	-29.824	117.905	-32.141	1.00	52.37	C
ATOM	3086	OD1	ASP	A	406	-30.106	118.223	-30.967	1.00	54.81	O
ATOM	3087	OD2	ASP	A	406	-30.284	118.505	-33.137	1.00	58.67	O
ATOM	3088	N	ASN	A	407	-26.587	118.410	-30.226	1.00	43.33	N

ATOM	3089	CA	ASN	A	407	-25.534	119.414	-30.187	1.00	41.80	C
ATOM	3090	C	ASN	A	407	-24.145	118.823	-30.569	1.00	43.81	C
ATOM	3091	O	ASN	A	407	-23.191	119.559	-30.781	1.00	43.03	O
ATOM	3092	CB	ASN	A	407	-25.471	120.046	-28.815	1.00	41.91	C
ATOM	3093	CG	ASN	A	407	-26.665	120.980	-28.524	1.00	51.70	C
ATOM	3094	OD1	ASN	A	407	-27.443	121.329	-29.417	1.00	52.98	O
ATOM	3095	ND2	ASN	A	407	-26.789	121.401	-27.265	1.00	42.13	N
ATOM	3096	N	GLY	A	408	-24.071	117.494	-30.685	1.00	41.01	N
ATOM	3097	CA	GLY	A	408	-22.842	116.782	-30.980	1.00	43.70	C
ATOM	3098	C	GLY	A	408	-22.143	117.193	-32.255	1.00	50.34	C
ATOM	3099	O	GLY	A	408	-20.932	116.975	-32.421	1.00	46.00	O
ATOM	3100	N	SER	A	409	-22.905	117.818	-33.148	1.00	51.64	N
ATOM	3101	CA	SER	A	409	-22.415	118.168	-34.472	1.00	49.18	C
ATOM	3102	C	SER	A	409	-21.628	119.466	-34.447	1.00	50.83	C
ATOM	3103	O	SER	A	409	-21.004	119.831	-35.437	1.00	59.46	O
ATOM	3104	CB	SER	A	409	-23.585	118.274	-35.453	1.00	45.92	C
ATOM	3105	OG	SER	A	409	-24.369	119.407	-35.154	1.00	57.17	O
ATOM	3106	O	ILE	A	410	-18.993	120.741	-32.098	1.00	49.76	O
ATOM	3107	N	ILE	A	410	-21.637	120.152	-33.310	1.00	44.08	N
ATOM	3108	CA	ILE	A	410	-20.994	121.456	-33.219	1.00	45.49	C
ATOM	3109	C	ILE	A	410	-19.475	121.317	-33.089	1.00	51.14	C
ATOM	3110	CB	ILE	A	410	-21.537	122.263	-32.006	1.00	41.60	C
ATOM	3111	CG1	ILE	A	410	-23.044	122.454	-32.097	1.00	50.48	C
ATOM	3112	CG2	ILE	A	410	-20.860	123.589	-31.885	1.00	40.91	C
ATOM	3113	CD1	ILE	A	410	-23.598	123.296	-30.954	1.00	47.79	C
ATOM	3114	N	PRO	A	411	-18.710	121.858	-34.063	1.00	55.86	N
ATOM	3115	CA	PRO	A	411	-17.239	121.817	-33.984	1.00	54.02	C
ATOM	3116	C	PRO	A	411	-16.715	122.780	-32.923	1.00	51.89	C
ATOM	3117	O	PRO	A	411	-17.420	123.728	-32.533	1.00	52.91	O
ATOM	3118	CB	PRO	A	411	-16.779	122.266	-35.381	1.00	50.24	C
ATOM	3119	CG	PRO	A	411	-18.026	122.477	-36.181	1.00	52.81	C
ATOM	3120	CD	PRO	A	411	-19.157	122.645	-35.217	1.00	49.02	C
ATOM	3121	N	HIS	A	412	-15.490	122.552	-32.471	1.00	48.91	N
ATOM	3122	CA	HIS	A	412	-14.936	123.328	-31.370	1.00	50.27	C
ATOM	3123	C	HIS	A	412	-14.528	124.708	-31.840	1.00	53.88	C
ATOM	3124	O	HIS	A	412	-14.484	125.644	-31.048	1.00	51.37	O
ATOM	3125	CB	HIS	A	412	-13.739	122.617	-30.731	1.00	48.21	C
ATOM	3126	CG	HIS	A	412	-12.492	122.651	-31.564	1.00	55.27	C
ATOM	3127	ND1	HIS	A	412	-12.252	121.755	-32.585	1.00	47.75	N
ATOM	3128	CD2	HIS	A	412	-11.410	123.468	-31.517	1.00	53.91	C
ATOM	3129	CE1	HIS	A	412	-11.090	122.036	-33.146	1.00	49.28	C
ATOM	3130	NE2	HIS	A	412	-10.553	123.063	-32.511	1.00	48.81	N
ATOM	3131	N	GLN	A	413	-14.224	124.826	-33.129	1.00	52.60	N
ATOM	3132	CA	GLN	A	413	-13.940	126.129	-33.728	1.00	52.42	C
ATOM	3133	C	GLN	A	413	-15.045	127.173	-33.422	1.00	57.78	C
ATOM	3134	O	GLN	A	413	-14.759	128.333	-33.085	1.00	56.28	O
ATOM	3135	CB	GLN	A	413	-13.765	125.985	-35.241	1.00	56.64	C
ATOM	3136	CG	GLN	A	413	-12.446	125.360	-35.673	1.00	59.77	C
ATOM	3137	CD	GLN	A	413	-12.520	123.855	-35.775	1.00	56.11	C
ATOM	3138	OE1	GLN	A	413	-13.412	123.233	-35.216	1.00	59.90	O
ATOM	3139	NE2	GLN	A	413	-11.586	123.265	-36.495	1.00	56.83	N
ATOM	3140	N	ILE	A	414	-16.301	126.756	-33.519	1.00	50.91	N
ATOM	3141	CA	ILE	A	414	-17.417	127.666	-33.282	1.00	51.72	C
ATOM	3142	C	ILE	A	414	-17.427	128.272	-31.862	1.00	53.36	C
ATOM	3143	O	ILE	A	414	-17.462	129.493	-31.717	1.00	57.45	O
ATOM	3144	CB	ILE	A	414	-18.718	126.966	-33.555	1.00	49.56	C
ATOM	3145	CG1	ILE	A	414	-18.986	126.988	-35.052	1.00	52.93	C
ATOM	3146	CG2	ILE	A	414	-19.833	127.614	-32.804	1.00	55.91	C
ATOM	3147	CD1	ILE	A	414	-20.257	126.265	-35.436	1.00	62.45	C
ATOM	3148	N	HIS	A	415	-17.359	127.442	-30.821	1.00	55.44	N
ATOM	3149	CA	HIS	A	415	-17.199	127.957	-29.460	1.00	51.05	C
ATOM	3150	C	HIS	A	415	-15.932	128.797	-29.389	1.00	57.13	C
ATOM	3151	O	HIS	A	415	-15.837	129.718	-28.581	1.00	59.51	O

ATOM	3152	CB	HIS	A	415	-17.112	126.833	-28.412	1.00	50.11	C
ATOM	3153	CG	HIS	A	415	-18.320	125.954	-28.346	1.00	50.29	C
ATOM	3154	ND1	HIS	A	415	-19.545	126.397	-27.889	1.00	48.47	N
ATOM	3155	CD2	HIS	A	415	-18.485	124.650	-28.665	1.00	41.98	C
ATOM	3156	CE1	HIS	A	415	-20.413	125.403	-27.937	1.00	44.64	C
ATOM	3157	NE2	HIS	A	415	-19.798	124.336	-28.414	1.00	47.68	N
ATOM	3158	N	LEU	A	416	-14.951	128.459	-30.224	1.00	55.29	N
ATOM	3159	CA	LEU	A	416	-13.660	129.138	-30.193	1.00	58.69	C
ATOM	3160	C	LEU	A	416	-13.800	130.561	-30.720	1.00	58.67	C
ATOM	3161	O	LEU	A	416	-13.284	131.501	-30.121	1.00	61.69	O
ATOM	3162	CB	LEU	A	416	-12.621	128.368	-31.008	1.00	56.71	C
ATOM	3163	CG	LEU	A	416	-11.241	128.995	-31.128	1.00	54.89	C
ATOM	3164	CD1	LEU	A	416	-10.637	129.181	-29.754	1.00	52.36	C
ATOM	3165	CD2	LEU	A	416	-10.356	128.105	-32.000	1.00	61.77	C
ATOM	3166	N	GLY	A	417	-14.492	130.702	-31.842	1.00	53.67	N
ATOM	3167	CA	GLY	A	417	-14.832	132.008	-32.372	1.00	54.97	C
ATOM	3168	C	GLY	A	417	-15.418	132.895	-31.292	1.00	60.53	C
ATOM	3169	O	GLY	A	417	-14.875	133.969	-31.018	1.00	63.41	O
ATOM	3170	N	GLU	A	418	-16.493	132.424	-30.653	1.00	60.59	N
ATOM	3171	CA	GLU	A	418	-17.162	133.169	-29.585	1.00	55.35	C
ATOM	3172	C	GLU	A	418	-16.215	133.488	-28.433	1.00	59.51	C
ATOM	3173	O	GLU	A	418	-16.248	134.595	-27.894	1.00	65.40	O
ATOM	3174	CB	GLU	A	418	-18.409	132.408	-29.062	1.00	55.80	C
ATOM	3175	CG	GLU	A	418	-19.583	132.273	-30.087	1.00	58.24	C
ATOM	3176	CD	GLU	A	418	-20.981	132.011	-29.455	1.00	59.19	C
ATOM	3177	OE1	GLU	A	418	-21.110	132.014	-28.212	1.00	55.93	O
ATOM	3178	OE2	GLU	A	418	-21.963	131.803	-30.212	1.00	57.23	O
ATOM	3179	N	LEU	A	419	-15.367	132.536	-28.051	1.00	61.01	N
ATOM	3180	CA	LEU	A	419	-14.453	132.748	-26.920	1.00	60.25	C
ATOM	3181	C	LEU	A	419	-13.453	133.844	-27.241	1.00	67.71	C
ATOM	3182	O	LEU	A	419	-13.156	134.728	-26.415	1.00	63.50	O
ATOM	3183	CB	LEU	A	419	-13.718	131.474	-26.585	1.00	51.05	C
ATOM	3184	CG	LEU	A	419	-12.662	131.498	-25.481	1.00	59.15	C
ATOM	3185	CD1	LEU	A	419	-13.061	130.661	-24.258	1.00	48.83	C
ATOM	3186	CD2	LEU	A	419	-11.346	131.002	-26.059	1.00	64.55	C
ATOM	3187	N	HIS	A	420	-12.944	133.759	-28.464	1.00	64.54	N
ATOM	3188	CA	HIS	A	420	-12.017	134.727	-29.021	1.00	64.70	C
ATOM	3189	C	HIS	A	420	-12.582	136.147	-28.951	1.00	72.51	C
ATOM	3190	O	HIS	A	420	-12.011	137.035	-28.285	1.00	72.35	O
ATOM	3191	CB	HIS	A	420	-11.708	134.337	-30.465	1.00	63.93	C
ATOM	3192	CG	HIS	A	420	-10.734	135.240	-31.142	1.00	65.89	C
ATOM	3193	ND1	HIS	A	420	-9.448	135.423	-30.683	1.00	65.18	N
ATOM	3194	CD2	HIS	A	420	-10.854	136.003	-32.255	1.00	62.02	C
ATOM	3195	CE1	HIS	A	420	-8.816	136.262	-31.483	1.00	69.65	C
ATOM	3196	NE2	HIS	A	420	-9.648	136.628	-32.444	1.00	74.25	N
ATOM	3197	N	ALA	A	421	-13.713	136.336	-29.636	1.00	70.22	N
ATOM	3198	CA	ALA	A	421	-14.450	137.594	-29.632	1.00	65.36	C
ATOM	3199	C	ALA	A	421	-14.604	138.179	-28.236	1.00	66.36	C
ATOM	3200	O	ALA	A	421	-14.219	139.317	-28.009	1.00	76.97	O
ATOM	3201	CB	ALA	A	421	-15.810	137.398	-30.268	1.00	66.89	C
ATOM	3202	N	ILE	A	422	-15.161	137.417	-27.304	1.00	66.27	N
ATOM	3203	CA	ILE	A	422	-15.380	137.942	-25.961	1.00	68.30	C
ATOM	3204	C	ILE	A	422	-14.067	138.418	-25.389	1.00	69.75	C
ATOM	3205	O	ILE	A	422	-14.004	139.455	-24.732	1.00	73.27	O
ATOM	3206	CB	ILE	A	422	-16.000	136.905	-25.003	1.00	59.63	C
ATOM	3207	CG1	ILE	A	422	-17.411	136.546	-25.456	1.00	61.40	C
ATOM	3208	CG2	ILE	A	422	-16.038	137.435	-23.573	1.00	52.83	C
ATOM	3209	CD1	ILE	A	422	-18.087	135.541	-24.554	1.00	62.54	C
ATOM	3210	N	LEU	A	423	-13.002	137.679	-25.666	1.00	72.33	N
ATOM	3211	CA	LEU	A	423	-11.717	138.028	-25.074	1.00	76.05	C
ATOM	3212	C	LEU	A	423	-11.200	139.334	-25.661	1.00	79.38	C
ATOM	3213	O	LEU	A	423	-10.669	140.176	-24.931	1.00	75.82	O
ATOM	3214	CB	LEU	A	423	-10.704	136.908	-25.262	1.00	70.55	C

ATOM	3215	CG	LEU	A	423	-10.702	135.937	-24.085	1.00	70.07	C
ATOM	3216	CD1	LEU	A	423	-9.705	134.825	-24.311	1.00	68.93	C
ATOM	3217	CD2	LEU	A	423	-10.395	136.682	-22.803	1.00	68.22	C
ATOM	3218	N	ARG	A	424	-11.379	139.500	-26.972	1.00	76.39	N
ATOM	3219	CA	ARG	A	424	-11.055	140.757	-27.645	1.00	79.93	C
ATOM	3220	C	ARG	A	424	-11.790	141.948	-27.002	1.00	80.66	C
ATOM	3221	O	ARG	A	424	-11.153	142.819	-26.402	1.00	81.63	O
ATOM	3222	CB	ARG	A	424	-11.389	140.666	-29.144	1.00	72.95	O
ATOM	3223	N	ARG	A	425	-13.121	141.957	-27.117	1.00	81.00	N
ATOM	3224	CA	ARG	A	425	-13.981	143.002	-26.547	1.00	77.55	C
ATOM	3225	C	ARG	A	425	-13.512	143.509	-25.189	1.00	82.66	C
ATOM	3226	O	ARG	A	425	-13.487	144.714	-24.940	1.00	89.83	O
ATOM	3227	CB	ARG	A	425	-15.420	142.499	-26.392	1.00	74.08	C
ATOM	3228	CG	ARG	A	425	-16.092	142.033	-27.661	1.00	74.68	C
ATOM	3229	CD	ARG	A	425	-15.902	143.038	-28.763	1.00	78.82	C
ATOM	3230	NE	ARG	A	425	-17.124	143.242	-29.524	1.00	75.68	N
ATOM	3231	CZ	ARG	A	425	-17.195	143.979	-30.627	1.00	79.54	C
ATOM	3232	NH1	ARG	A	425	-16.106	144.576	-31.097	1.00	79.47	N
ATOM	3233	NH2	ARG	A	425	-18.354	144.115	-31.263	1.00	73.73	N
ATOM	3234	N	GLN	A	426	-13.143	142.590	-24.309	1.00	77.98	N
ATOM	3235	C	GLN	A	426	-11.390	142.941	-22.606	1.00	82.59	C
ATOM	3236	CA	GLN	A	426	-12.876	142.962	-22.931	1.00	79.97	C
ATOM	3237	O	GLN	A	426	-10.996	143.092	-21.445	1.00	82.52	O
ATOM	3238	CB	GLN	A	426	-13.666	142.043	-21.991	1.00	76.48	C
ATOM	3239	CG	GLN	A	426	-14.854	142.734	-21.284	1.00	84.12	C
ATOM	3240	CD	GLN	A	426	-15.966	143.235	-22.228	1.00	77.26	C
ATOM	3241	OE1	GLN	A	426	-15.790	143.342	-23.434	1.00	76.47	C
ATOM	3242	NE2	GLN	A	426	-17.115	143.535	-21.661	1.00	72.07	N
ATOM	3243	O	GLU	A	427	-7.710	144.273	-22.220	1.00	89.17	O
ATOM	3244	N	GLU	A	427	-10.565	142.780	-23.640	1.00	81.53	N
ATOM	3245	CA	GLU	A	427	-9.117	142.788	-23.455	1.00	82.55	C
ATOM	3246	C	GLU	A	427	-8.657	144.161	-22.988	1.00	87.23	C
ATOM	3247	CB	GLU	A	427	-8.391	142.398	-24.746	1.00	81.85	O
ATOM	3248	O	ASP	A	428	-8.541	147.435	-20.888	1.00	84.77	C
ATOM	3249	N	ASP	A	428	-9.342	145.205	-23.447	1.00	92.31	N
ATOM	3250	CA	ASP	A	428	-8.985	146.576	-23.084	1.00	89.98	C
ATOM	3251	C	ASP	A	428	-9.370	146.936	-21.646	1.00	86.41	C
ATOM	3252	CB	ASP	A	428	-9.626	147.562	-24.057	1.00	90.09	C
ATOM	3253	CG	ASP	A	428	-8.870	147.654	-25.371	1.00	102.14	C
ATOM	3254	OD2	ASP	A	428	-8.890	148.747	-25.985	1.00	107.45	O
ATOM	3255	OD1	ASP	A	428	-8.255	146.641	-25.785	1.00	99.99	O
ATOM	3256	N	PHE	A	429	-10.616	146.678	-21.270	1.00	82.95	N
ATOM	3257	CA	PHE	A	429	-11.085	147.049	-19.946	1.00	78.13	C
ATOM	3258	C	PHE	A	429	-10.477	146.156	-18.871	1.00	78.68	C
ATOM	3259	O	PHE	A	429	-10.493	146.491	-17.686	1.00	77.25	O
ATOM	3260	CB	PHE	A	429	-12.607	146.985	-19.890	1.00	77.92	C
ATOM	3261	CG	PHE	A	429	-13.272	147.467	-21.138	1.00	78.86	C
ATOM	3262	CD1	PHE	A	429	-13.333	148.817	-21.428	1.00	80.89	C
ATOM	3263	CD2	PHE	A	429	-13.834	146.573	-22.026	1.00	80.93	C
ATOM	3264	CE1	PHE	A	429	-13.943	149.268	-22.576	1.00	78.86	C
ATOM	3265	CE2	PHE	A	429	-14.453	147.018	-23.179	1.00	82.30	C
ATOM	3266	CZ	PHE	A	429	-14.502	148.366	-23.457	1.00	83.31	C
ATOM	3267	N	TYR	A	430	-9.940	145.014	-19.278	1.00	83.99	N
ATOM	3268	CA	TYR	A	430	-9.362	144.088	-18.313	1.00	78.33	C
ATOM	3269	C	TYR	A	430	-7.940	143.754	-18.676	1.00	82.49	C
ATOM	3270	O	TYR	A	430	-7.667	143.343	-19.799	1.00	79.84	O
ATOM	3271	CB	TYR	A	430	-10.200	142.820	-18.212	1.00	75.62	C
ATOM	3272	CG	TYR	A	430	-11.501	143.055	-17.494	1.00	72.55	C
ATOM	3273	CD1	TYR	A	430	-11.544	143.092	-16.104	1.00	68.46	C
ATOM	3274	CD2	TYR	A	430	-12.679	143.272	-18.200	1.00	69.13	C
ATOM	3275	CE1	TYR	A	430	-12.721	143.320	-15.435	1.00	65.45	C
ATOM	3276	CE2	TYR	A	430	-13.866	143.511	-17.537	1.00	69.78	C
ATOM	3277	CZ	TYR	A	430	-13.879	143.527	-16.155	1.00	66.88	C

ATOM	3278	OH	TYR	A	430	-15.050	143.756	-15.479	1.00	71.04	O
ATOM	3279	N	PRO	A	431	-7.026	143.922	-17.708	1.00	87.02	N
ATOM	3280	CA	PRO	A	431	-5.589	143.814	-17.967	1.00	84.92	C
ATOM	3281	C	PRO	A	431	-5.205	142.438	-18.500	1.00	82.43	C
ATOM	3282	O	PRO	A	431	-4.983	142.265	-19.702	1.00	81.89	O
ATOM	3283	CB	PRO	A	431	-4.964	144.062	-16.587	1.00	82.17	C
ATOM	3284	CG	PRO	A	431	-6.029	143.696	-15.615	1.00	79.37	C
ATOM	3285	CD	PRO	A	431	-7.323	144.056	-16.268	1.00	81.03	C
ATOM	3286	O	PHE	A	432	-4.617	138.562	-19.585	1.00	83.88	O
ATOM	3287	N	PHE	A	432	-5.168	141.475	-17.587	1.00	83.19	N
ATOM	3288	CA	PHE	A	432	-4.614	140.154	-17.816	1.00	82.36	C
ATOM	3289	C	PHE	A	432	-5.259	139.410	-18.977	1.00	80.79	C
ATOM	3290	CB	PHE	A	432	-4.725	139.328	-16.533	1.00	81.15	C
ATOM	3291	CG	PHE	A	432	-6.119	138.912	-16.200	1.00	79.49	C
ATOM	3292	CD2	PHE	A	432	-6.468	137.572	-16.194	1.00	79.74	C
ATOM	3293	CD1	PHE	A	432	-7.080	139.851	-15.885	1.00	78.76	C
ATOM	3294	CE2	PHE	A	432	-7.760	137.179	-15.884	1.00	80.58	C
ATOM	3295	CE1	PHE	A	432	-8.374	139.475	-15.568	1.00	78.84	C
ATOM	3296	CZ	PHE	A	432	-8.720	138.134	-15.570	1.00	77.97	C
ATOM	3297	N	LEU	A	433	-6.512	139.718	-19.289	1.00	77.96	N
ATOM	3298	CA	LEU	A	433	-7.148	139.144	-20.475	1.00	78.63	C
ATOM	3299	C	LEU	A	433	-6.322	139.277	-21.770	1.00	81.69	C
ATOM	3300	O	LEU	A	433	-6.258	138.337	-22.555	1.00	84.40	O
ATOM	3301	CB	LEU	A	433	-8.527	139.771	-20.704	1.00	81.47	C
ATOM	3302	CG	LEU	A	433	-9.754	139.085	-20.095	1.00	81.09	C
ATOM	3303	CD1	LEU	A	433	-9.785	139.277	-18.602	1.00	78.12	C
ATOM	3304	CD2	LEU	A	433	-11.048	139.596	-20.727	1.00	79.00	C
ATOM	3305	N	LYS	A	434	-5.700	140.431	-22.004	1.00	86.36	N
ATOM	3306	CA	LYS	A	434	-4.984	140.659	-23.264	1.00	83.95	C
ATOM	3307	C	LYS	A	434	-3.751	139.793	-23.328	1.00	78.82	C
ATOM	3308	O	LYS	A	434	-3.363	139.320	-24.394	1.00	79.93	O
ATOM	3309	CB	LYS	A	434	-4.590	142.130	-23.426	1.00	86.69	C
ATOM	3310	N	ASP	A	435	-3.136	139.595	-22.170	1.00	79.16	N
ATOM	3311	CA	ASP	A	435	-1.965	138.740	-22.064	1.00	82.82	C
ATOM	3312	C	ASP	A	435	-2.341	137.269	-22.233	1.00	85.04	C
ATOM	3313	O	ASP	A	435	-1.657	136.523	-22.930	1.00	85.92	O
ATOM	3314	CB	ASP	A	435	-1.265	138.950	-20.718	1.00	85.65	C
ATOM	3315	N	ASN	A	436	-3.444	136.871	-21.605	1.00	84.08	N
ATOM	3316	CA	ASN	A	436	-3.839	135.471	-21.522	1.00	76.50	C
ATOM	3317	C	ASN	A	436	-4.601	134.935	-22.720	1.00	75.42	C
ATOM	3318	O	ASN	A	436	-4.976	133.764	-22.728	1.00	76.39	O
ATOM	3319	CB	ASN	A	436	-4.690	135.256	-20.274	1.00	75.79	C
ATOM	3320	CG	ASN	A	436	-3.918	135.501	-19.001	1.00	78.92	C
ATOM	3321	OD1	ASN	A	436	-3.108	134.676	-18.587	1.00	77.53	O
ATOM	3322	ND2	ASN	A	436	-4.161	136.641	-18.373	1.00	82.73	N
ATOM	3323	N	ARG	A	437	-4.834	135.781	-23.719	1.00	74.86	N
ATOM	3324	CA	ARG	A	437	-5.736	135.427	-24.811	1.00	74.78	C
ATOM	3325	C	ARG	A	437	-5.308	134.121	-25.472	1.00	69.46	C
ATOM	3326	O	ARG	A	437	-6.124	133.219	-25.643	1.00	71.89	O
ATOM	3327	CB	ARG	A	437	-5.821	136.556	-25.851	1.00	70.14	C
ATOM	3328	N	GLU	A	438	-4.033	134.005	-25.820	1.00	67.79	N
ATOM	3329	CA	GLU	A	438	-3.557	132.786	-26.461	1.00	70.83	C
ATOM	3330	C	GLU	A	438	-3.589	131.627	-25.463	1.00	71.10	C
ATOM	3331	O	GLU	A	438	-3.770	130.466	-25.839	1.00	67.12	O
ATOM	3332	CB	GLU	A	438	-2.144	132.975	-27.022	1.00	69.88	C
ATOM	3333	N	LYS	A	439	-3.432	131.966	-24.186	1.00	70.41	N
ATOM	3334	CA	LYS	A	439	-3.327	130.977	-23.125	1.00	66.22	C
ATOM	3335	C	LYS	A	439	-4.673	130.316	-22.900	1.00	69.85	C
ATOM	3336	O	LYS	A	439	-4.780	129.081	-22.829	1.00	64.84	O
ATOM	3337	CB	LYS	A	439	-2.839	131.635	-21.835	1.00	67.58	C
ATOM	3338	CG	LYS	A	439	-2.062	130.740	-20.899	1.00	68.05	C
ATOM	3339	CD	LYS	A	439	-1.860	131.415	-19.555	1.00	73.27	C
ATOM	3340	CE	LYS	A	439	-1.075	130.546	-18.586	1.00	74.69	C

ATOM	3341	NZ	LYS	A	439	-1.051	131.151	-17.215	1.00	82.44	N
ATOM	3342	N	ILE	A	440	-5.697	131.160	-22.784	1.00	66.75	N
ATOM	3343	CA	ILE	A	440	-7.045	130.705	-22.517	1.00	62.55	C
ATOM	3344	C	ILE	A	440	-7.577	129.951	-23.728	1.00	60.06	C
ATOM	3345	O	ILE	A	440	-8.241	128.935	-23.590	1.00	62.95	O
ATOM	3346	CB	ILE	A	440	-7.961	131.886	-22.150	1.00	63.87	C
ATOM	3347	CG1	ILE	A	440	-7.848	132.182	-20.652	1.00	63.69	C
ATOM	3348	CG2	ILE	A	440	-9.400	131.592	-22.516	1.00	55.89	C
ATOM	3349	CD1	ILE	A	440	-8.231	133.605	-20.285	1.00	65.88	C
ATOM	3350	N	GLU	A	441	-7.261	130.434	-24.916	1.00	58.67	N
ATOM	3351	CA	GLU	A	441	-7.651	129.739	-26.124	1.00	58.80	C
ATOM	3352	C	GLU	A	441	-7.015	128.336	-26.205	1.00	62.92	C
ATOM	3353	O	GLU	A	441	-7.654	127.390	-26.661	1.00	60.09	O
ATOM	3354	CB	GLU	A	441	-7.274	130.562	-27.353	1.00	63.83	C
ATOM	3355	N	LYS	A	442	-5.772	128.193	-25.748	1.00	63.98	N
ATOM	3356	CA	LYS	A	442	-5.091	126.896	-25.837	1.00	62.70	C
ATOM	3357	C	LYS	A	442	-5.814	125.854	-24.983	1.00	60.76	C
ATOM	3358	O	LYS	A	442	-6.028	124.716	-25.431	1.00	56.62	O
ATOM	3359	CB	LYS	A	442	-3.622	127.011	-25.418	1.00	60.09	C
ATOM	3360	CG	LYS	A	442	-2.833	125.719	-25.578	1.00	61.88	C
ATOM	3361	CD	LYS	A	442	-2.923	125.201	-26.991	1.00	61.53	C
ATOM	3362	CE	LYS	A	442	-1.604	124.625	-27.475	1.00	65.76	C
ATOM	3363	NZ	LYS	A	442	-0.596	125.679	-27.819	1.00	73.09	N
ATOM	3364	N	ILE	A	443	-6.190	126.265	-23.767	1.00	61.65	N
ATOM	3365	CA	ILE	A	443	-7.018	125.467	-22.860	1.00	57.82	C
ATOM	3366	C	ILE	A	443	-8.238	124.907	-23.579	1.00	64.09	C
ATOM	3367	O	ILE	A	443	-8.564	123.729	-23.452	1.00	64.95	O
ATOM	3368	CB	ILE	A	443	-7.518	126.279	-21.665	1.00	59.82	C
ATOM	3369	CG1	ILE	A	443	-6.356	126.740	-20.790	1.00	63.06	C
ATOM	3370	CG2	ILE	A	443	-8.515	125.466	-20.837	1.00	55.69	C
ATOM	3371	CD1	ILE	A	443	-6.810	127.503	-19.545	1.00	63.20	C
ATOM	3372	N	LEU	A	444	-8.925	125.742	-24.344	1.00	61.78	N
ATOM	3373	CA	LEU	A	444	-10.040	125.209	-25.098	1.00	58.82	C
ATOM	3374	C	LEU	A	444	-9.500	124.223	-26.137	1.00	61.18	C
ATOM	3375	O	LEU	A	444	-9.978	123.090	-26.233	1.00	62.70	O
ATOM	3376	CB	LEU	A	444	-10.862	126.328	-25.760	1.00	54.54	C
ATOM	3377	CG	LEU	A	444	-12.164	125.911	-26.462	1.00	56.88	C
ATOM	3378	CD1	LEU	A	444	-13.409	126.601	-25.898	1.00	51.58	C
ATOM	3379	CD2	LEU	A	444	-12.069	126.151	-27.958	1.00	56.95	C
ATOM	3380	N	THR	A	445	-8.478	124.629	-26.880	1.00	56.92	N
ATOM	3381	CA	THR	A	445	-8.085	123.881	-28.062	1.00	56.77	C
ATOM	3382	C	THR	A	445	-7.217	122.641	-27.821	1.00	61.11	C
ATOM	3383	O	THR	A	445	-7.133	121.793	-28.696	1.00	52.46	O
ATOM	3384	CB	THR	A	445	-7.320	124.764	-29.041	1.00	58.64	C
ATOM	3385	OG1	THR	A	445	-6.253	125.415	-28.343	1.00	61.60	O
ATOM	3386	CG2	THR	A	445	-8.249	125.795	-29.664	1.00	56.51	C
ATOM	3387	N	PHE	A	446	-6.564	122.525	-26.669	1.00	61.72	N
ATOM	3388	CA	PHE	A	446	-5.538	121.489	-26.569	1.00	57.56	C
ATOM	3389	C	PHE	A	446	-6.112	120.096	-26.450	1.00	57.92	C
ATOM	3390	O	PHE	A	446	-6.834	119.768	-25.514	1.00	60.31	O
ATOM	3391	CB	PHE	A	446	-4.587	121.729	-25.395	1.00	61.74	C
ATOM	3392	CG	PHE	A	446	-3.698	120.537	-25.098	1.00	64.15	C
ATOM	3393	CD1	PHE	A	446	-2.804	120.067	-26.057	1.00	64.54	C
ATOM	3394	CD2	PHE	A	446	-3.785	119.862	-23.880	1.00	57.60	C
ATOM	3395	CE1	PHE	A	446	-2.003	118.960	-25.798	1.00	58.67	C
ATOM	3396	CE2	PHE	A	446	-2.991	118.757	-23.624	1.00	57.96	C
ATOM	3397	CZ	PHE	A	446	-2.095	118.313	-24.578	1.00	57.43	C
ATOM	3398	O	ARG	A	447	-4.229	116.888	-28.328	1.00	56.56	O
ATOM	3399	N	ARG	A	447	-5.739	119.253	-27.392	1.00	56.27	N
ATOM	3400	CA	ARG	A	447	-6.166	117.879	-27.334	1.00	51.82	C
ATOM	3401	C	ARG	A	447	-4.976	116.938	-27.346	1.00	52.70	C
ATOM	3402	CB	ARG	A	447	-7.091	117.586	-28.493	1.00	50.56	C
ATOM	3403	CG	ARG	A	447	-7.502	116.181	-28.534	1.00	48.23	C

ATOM	3404	CD	ARG	A	447	-8.148	115.905	-29.835	1.00	46.40	C
ATOM	3405	NE	ARG	A	447	-8.493	114.498	-29.904	1.00	53.98	N
ATOM	3406	CZ	ARG	A	447	-9.034	113.938	-30.972	1.00	55.04	C
ATOM	3407	NH1	ARG	A	447	-9.303	114.696	-32.025	1.00	58.53	N
ATOM	3408	NH2	ARG	A	447	-9.314	112.640	-30.983	1.00	56.29	N
ATOM	3409	O	ILE	A	448	-4.851	113.602	-27.393	1.00	47.64	O
ATOM	3410	N	ILE	A	448	-4.790	116.232	-26.233	1.00	52.13	N
ATOM	3411	CA	ILE	A	448	-3.745	115.217	-26.072	1.00	46.77	C
ATOM	3412	C	ILE	A	448	-3.813	114.221	-27.207	1.00	48.53	C
ATOM	3413	CB	ILE	A	448	-3.908	114.410	-24.767	1.00	46.96	C
ATOM	3414	CG1	ILE	A	448	-3.869	115.292	-23.537	1.00	49.02	C
ATOM	3415	CG2	ILE	A	448	-2.828	113.358	-24.653	1.00	56.69	C
ATOM	3416	CD1	ILE	A	448	-3.999	114.491	-22.233	1.00	44.89	C
ATOM	3417	O	PRO	A	449	-2.554	111.286	-27.602	1.00	52.42	O
ATOM	3418	N	PRO	A	449	-2.712	114.046	-27.957	1.00	51.67	N
ATOM	3419	CA	PRO	A	449	-2.788	113.152	-29.111	1.00	51.98	C
ATOM	3420	C	PRO	A	449	-2.979	111.687	-28.687	1.00	49.03	C
ATOM	3421	CB	PRO	A	449	-1.437	113.363	-29.807	1.00	56.08	C
ATOM	3422	CG	PRO	A	449	-0.868	114.621	-29.180	1.00	51.82	C
ATOM	3423	CD	PRO	A	449	-1.351	114.577	-27.786	1.00	50.67	C
ATOM	3424	O	TYR	A	450	-2.600	107.682	-28.397	1.00	55.65	O
ATOM	3425	N	TYR	A	450	-3.645	110.913	-29.530	1.00	46.85	N
ATOM	3426	CA	TYR	A	450	-3.897	109.508	-29.244	1.00	52.67	C
ATOM	3427	C	TYR	A	450	-2.608	108.674	-29.114	1.00	52.49	C
ATOM	3428	CB	TYR	A	450	-4.802	108.905	-30.330	1.00	49.09	C
ATOM	3429	CG	TYR	A	450	-4.141	108.753	-31.670	1.00	50.06	C
ATOM	3430	CD1	TYR	A	450	-3.360	107.637	-31.950	1.00	55.73	C
ATOM	3431	CD2	TYR	A	450	-4.297	109.714	-32.666	1.00	54.01	C
ATOM	3432	CE1	TYR	A	450	-2.738	107.474	-33.163	1.00	52.07	C
ATOM	3433	CE2	TYR	A	450	-3.683	109.562	-33.903	1.00	59.78	C
ATOM	3434	CZ	TYR	A	450	-2.895	108.421	-34.136	1.00	63.14	C
ATOM	3435	OH	TYR	A	450	-2.268	108.201	-35.341	1.00	62.02	O
ATOM	3436	O	TYR	A	451	1.698	108.081	-28.487	1.00	62.07	O
ATOM	3437	N	TYR	A	451	-1.537	109.072	-29.806	1.00	51.28	N
ATOM	3438	CA	TYR	A	451	-0.281	108.305	-29.819	1.00	52.59	C
ATOM	3439	C	TYR	A	451	0.618	108.659	-28.647	1.00	56.91	C
ATOM	3440	CB	TYR	A	451	0.491	108.525	-31.114	1.00	51.85	C
ATOM	3441	CG	TYR	A	451	0.900	109.964	-31.350	1.00	54.10	C
ATOM	3442	CD2	TYR	A	451	0.261	110.739	-32.314	1.00	57.27	C
ATOM	3443	CD1	TYR	A	451	1.934	110.540	-30.624	1.00	50.38	C
ATOM	3444	CE2	TYR	A	451	0.631	112.057	-32.531	1.00	58.72	C
ATOM	3445	CE1	TYR	A	451	2.304	111.843	-30.825	1.00	60.72	C
ATOM	3446	CZ	TYR	A	451	1.652	112.602	-31.780	1.00	60.80	C
ATOM	3447	OH	TYR	A	451	2.044	113.907	-31.968	1.00	62.73	O
ATOM	3448	O	VAL	A	452	-1.272	109.157	-25.553	1.00	57.50	O
ATOM	3449	N	VAL	A	452	0.185	109.635	-27.856	1.00	52.95	N
ATOM	3450	CA	VAL	A	452	0.775	109.893	-26.550	1.00	52.79	C
ATOM	3451	C	VAL	A	452	-0.039	109.139	-25.506	1.00	55.49	C
ATOM	3452	CB	VAL	A	452	0.787	111.401	-26.223	1.00	46.95	C
ATOM	3453	CG1	VAL	A	452	1.235	111.647	-24.806	1.00	49.41	C
ATOM	3454	CG2	VAL	A	452	1.669	112.137	-27.193	1.00	48.65	C
ATOM	3455	O	GLY	A	453	-1.265	109.993	-23.151	1.00	46.23	O
ATOM	3456	N	GLY	A	453	0.601	108.470	-24.556	1.00	55.43	N
ATOM	3457	CA	GLY	A	453	-0.205	107.845	-23.518	1.00	62.69	C
ATOM	3458	C	GLY	A	453	-1.137	108.827	-22.780	1.00	54.89	C
ATOM	3459	O	PRO	A	454	0.323	109.147	-20.272	1.00	53.85	O
ATOM	3460	N	PRO	A	454	-1.789	108.346	-21.717	1.00	44.49	N
ATOM	3461	CA	PRO	A	454	-2.040	109.264	-20.616	1.00	47.96	C
ATOM	3462	C	PRO	A	454	-0.716	109.785	-20.082	1.00	56.00	C
ATOM	3463	CB	PRO	A	454	-2.733	108.392	-19.575	1.00	51.52	C
ATOM	3464	CG	PRO	A	454	-2.384	107.006	-19.954	1.00	45.73	C
ATOM	3465	CD	PRO	A	454	-2.321	107.008	-21.434	1.00	44.77	C
ATOM	3466	O	LEU	A	455	0.939	111.901	-16.731	1.00	58.40	O

ATOM	3467	N	LEU	A	455	-0.752	110.930	-19.414	1.00	57.93	N
ATOM	3468	CA	LEU	A	455	0.466	111.635	-19.044	1.00	56.49	C
ATOM	3469	C	LEU	A	455	0.948	111.150	-17.697	1.00	54.49	C
ATOM	3470	CB	LEU	A	455	0.208	113.144	-19.012	1.00	56.18	C
ATOM	3471	CG	LEU	A	455	-0.618	113.722	-20.152	1.00	47.30	C
ATOM	3472	CD1	LEU	A	455	-0.762	115.203	-19.949	1.00	57.27	C
ATOM	3473	CD2	LEU	A	455	-0.002	113.441	-21.527	1.00	51.85	C
ATOM	3474	O	ALA	A	456	3.972	109.650	-16.723	1.00	65.53	O
ATOM	3475	N	ALA	A	456	1.355	109.886	-17.631	1.00	61.29	N
ATOM	3476	CA	ALA	A	456	1.632	109.241	-16.347	1.00	61.48	C
ATOM	3477	C	ALA	A	456	3.081	109.390	-15.909	1.00	69.34	C
ATOM	3478	CB	ALA	A	456	1.266	107.774	-16.398	1.00	51.56	C
ATOM	3479	O	ARG	A	457	5.474	107.610	-12.451	1.00	67.91	O
ATOM	3480	N	ARG	A	457	3.279	109.216	-14.604	1.00	71.34	N
ATOM	3481	CA	ARG	A	457	4.573	109.313	-13.938	1.00	74.03	C
ATOM	3482	C	ARG	A	457	5.016	107.880	-13.558	1.00	71.44	C
ATOM	3483	CB	ARG	A	457	4.454	110.248	-12.720	1.00	69.46	C
ATOM	3484	CG	ARG	A	457	5.706	110.443	-11.852	1.00	79.69	C
ATOM	3485	CD	ARG	A	457	6.643	111.578	-12.312	1.00	80.92	C
ATOM	3486	NE	ARG	A	457	6.381	112.886	-11.701	1.00	79.06	N
ATOM	3487	CZ	ARG	A	457	6.386	113.147	-10.391	1.00	82.15	C
ATOM	3488	NH1	ARG	A	457	6.148	114.383	-9.959	1.00	73.50	N
ATOM	3489	NH2	ARG	A	457	6.625	112.186	-9.505	1.00	86.83	N
ATOM	3490	O	GLY	A	458	4.864	103.789	-12.685	1.00	69.19	O
ATOM	3491	N	GLY	A	458	4.832	106.953	-14.490	1.00	66.05	N
ATOM	3492	CA	GLY	A	458	5.191	105.570	-14.257	1.00	73.75	C
ATOM	3493	C	GLY	A	458	4.383	104.795	-13.224	1.00	71.42	C
ATOM	3494	O	ASN	A	459	0.082	103.475	-12.262	1.00	55.12	O
ATOM	3495	N	ASN	A	459	3.161	105.240	-12.945	1.00	66.54	N
ATOM	3496	CA	ASN	A	459	2.264	104.467	-12.081	1.00	61.55	C
ATOM	3497	C	ASN	A	459	1.066	103.931	-12.847	1.00	54.95	C
ATOM	3498	CB	ASN	A	459	1.794	105.301	-10.891	1.00	64.99	C
ATOM	3499	CG	ASN	A	459	2.947	105.782	-10.024	1.00	72.10	C
ATOM	3500	OD1	ASN	A	459	3.965	106.254	-10.531	1.00	73.68	O
ATOM	3501	ND2	ASN	A	459	2.797	105.651	-8.713	1.00	71.64	N
ATOM	3502	O	SER	A	460	1.396	102.390	-16.558	1.00	60.37	O
ATOM	3503	N	SER	A	460	1.153	103.957	-14.164	1.00	48.14	N
ATOM	3504	CA	SER	A	460	0.026	103.490	-14.943	1.00	54.94	C
ATOM	3505	C	SER	A	460	0.428	102.309	-15.797	1.00	56.96	C
ATOM	3506	CB	SER	A	460	-0.551	104.623	-15.813	1.00	53.01	C
ATOM	3507	OG	SER	A	460	-1.407	104.115	-16.816	1.00	51.82	O
ATOM	3508	O	ARG	A	461	-0.103	99.328	-18.739	1.00	57.07	O
ATOM	3509	N	ARG	A	461	-0.325	101.215	-15.681	1.00	53.04	N
ATOM	3510	CA	ARG	A	461	-0.021	100.027	-16.454	1.00	51.75	C
ATOM	3511	C	ARG	A	461	-0.396	100.200	-17.917	1.00	58.06	C
ATOM	3512	CB	ARG	A	461	-0.724	98.809	-15.862	1.00	54.89	C
ATOM	3513	CG	ARG	A	461	-2.170	98.627	-16.242	1.00	55.94	C
ATOM	3514	CD	ARG	A	461	-2.692	97.333	-15.611	1.00	46.98	C
ATOM	3515	NE	ARG	A	461	-4.017	96.981	-16.098	1.00	52.88	N
ATOM	3516	CZ	ARG	A	461	-4.232	96.416	-17.282	1.00	60.10	C
ATOM	3517	NH1	ARG	A	461	-3.198	96.149	-18.073	1.00	61.45	N
ATOM	3518	NH2	ARG	A	461	-5.469	96.112	-17.678	1.00	56.03	N
ATOM	3519	O	PHE	A	462	-0.651	102.758	-21.541	1.00	60.73	O
ATOM	3520	N	PHE	A	462	-1.030	101.332	-18.241	1.00	56.41	N
ATOM	3521	CA	PHE	A	462	-1.469	101.602	-19.612	1.00	53.02	C
ATOM	3522	C	PHE	A	462	-0.577	102.626	-20.315	1.00	56.83	C
ATOM	3523	CB	PHE	A	462	-2.934	102.105	-19.646	1.00	52.16	C
ATOM	3524	CG	PHE	A	462	-3.906	101.273	-18.827	1.00	46.77	C
ATOM	3525	CD1	PHE	A	462	-4.476	100.114	-19.353	1.00	41.28	C
ATOM	3526	CD2	PHE	A	462	-4.240	101.656	-17.537	1.00	37.40	C
ATOM	3527	CE1	PHE	A	462	-5.369	99.357	-18.597	1.00	41.25	C
ATOM	3528	CE2	PHE	A	462	-5.116	100.906	-16.777	1.00	39.67	C
ATOM	3529	CZ	PHE	A	462	-5.683	99.755	-17.307	1.00	40.87	C

ATOM	3530	O	ALA	A	463	2.768	102.930	-20.729	1.00	64.76	O
ATOM	3531	N	ALA	A	463	0.259	103.352	-19.562	1.00	57.23	N
ATOM	3532	CA	ALA	A	463	1.023	104.484	-20.138	1.00	55.94	C
ATOM	3533	C	ALA	A	463	2.288	104.050	-20.896	1.00	58.28	C
ATOM	3534	CB	ALA	A	463	1.385	105.468	-19.055	1.00	51.61	C
ATOM	3535	O	TRP	A	464	5.839	105.760	-23.545	1.00	59.88	O
ATOM	3536	N	TRP	A	464	2.820	104.933	-21.735	1.00	56.58	N
ATOM	3537	CA	TRP	A	464	3.999	104.604	-22.527	1.00	55.37	C
ATOM	3538	C	TRP	A	464	4.755	105.843	-22.944	1.00	59.30	C
ATOM	3539	CB	TRP	A	464	3.613	103.825	-23.775	1.00	62.16	C
ATOM	3540	CG	TRP	A	464	2.838	104.640	-24.799	1.00	56.15	C
ATOM	3541	CD1	TRP	A	464	3.346	105.508	-25.726	1.00	58.46	C
ATOM	3542	CD2	TRP	A	464	1.434	104.602	-25.017	1.00	56.06	C
ATOM	3543	NE1	TRP	A	464	2.335	106.030	-26.501	1.00	58.15	N
ATOM	3544	CE2	TRP	A	464	1.148	105.489	-26.081	1.00	61.25	C
ATOM	3545	CE3	TRP	A	464	0.381	103.913	-24.409	1.00	54.54	C
ATOM	3546	CZ2	TRP	A	464	-0.148	105.704	-26.541	1.00	55.33	C
ATOM	3547	CZ3	TRP	A	464	-0.895	104.121	-24.870	1.00	51.34	C
ATOM	3548	CH2	TRP	A	464	-1.152	105.008	-25.924	1.00	54.56	C
ATOM	3549	O	MET	A	465	6.201	107.984	-21.068	1.00	56.56	O
ATOM	3550	N	MET	A	465	4.145	106.989	-22.665	1.00	52.53	N
ATOM	3551	CA	MET	A	465	4.739	108.285	-22.946	1.00	57.18	C
ATOM	3552	C	MET	A	465	6.062	108.455	-22.196	1.00	59.55	C
ATOM	3553	CB	MET	A	465	3.743	109.401	-22.563	1.00	62.92	C
ATOM	3554	CG	MET	A	465	4.254	110.833	-22.710	1.00	59.25	C
ATOM	3555	SD	MET	A	465	4.731	111.593	-21.146	1.00	69.16	S
ATOM	3556	CE	MET	A	465	4.275	110.327	-19.947	1.00	61.69	C
ATOM	3557	O	THR	A	466	8.206	111.807	-23.018	1.00	67.92	O
ATOM	3558	N	THR	A	466	7.035	109.110	-22.828	1.00	61.95	N
ATOM	3559	CA	THR	A	466	8.240	109.543	-22.108	1.00	68.06	C
ATOM	3560	C	THR	A	466	8.361	111.081	-22.025	1.00	65.98	C
ATOM	3561	CB	THR	A	466	9.535	108.962	-22.744	1.00	65.32	C
ATOM	3562	OG1	THR	A	466	9.457	109.059	-24.170	1.00	69.07	O
ATOM	3563	CG2	THR	A	466	9.726	107.497	-22.350	1.00	59.31	C
ATOM	3564	O	ARG	A	467	11.175	112.729	-20.660	1.00	74.64	O
ATOM	3565	N	ARG	A	467	8.631	111.548	-20.812	1.00	70.20	N
ATOM	3566	CA	ARG	A	467	8.805	112.958	-20.482	1.00	65.03	C
ATOM	3567	C	ARG	A	467	10.206	113.465	-20.823	1.00	75.06	C
ATOM	3568	CB	ARG	A	467	8.549	113.137	-18.989	1.00	69.67	C
ATOM	3569	CG	ARG	A	467	7.678	114.321	-18.601	1.00	77.83	C
ATOM	3570	CD	ARG	A	467	7.184	114.185	-17.154	1.00	74.81	C
ATOM	3571	NE	ARG	A	467	6.290	113.041	-17.021	1.00	78.33	N
ATOM	3572	CZ	ARG	A	467	4.993	113.129	-16.735	1.00	77.75	C
ATOM	3573	NH1	ARG	A	467	4.252	112.026	-16.651	1.00	71.62	N
ATOM	3574	NH2	ARG	A	467	4.439	114.317	-16.520	1.00	73.86	N
ATOM	3575	O	LYS	A	468	13.335	116.312	-20.019	1.00	86.42	O
ATOM	3576	N	LYS	A	468	10.325	114.719	-21.269	1.00	81.27	N
ATOM	3577	CA	LYS	A	468	11.642	115.365	-21.437	1.00	79.35	C
ATOM	3578	C	LYS	A	468	12.156	115.993	-20.138	1.00	80.10	C
ATOM	3579	CB	LYS	A	468	11.600	116.452	-22.517	1.00	71.91	C
ATOM	3580	CG	LYS	A	468	11.431	115.938	-23.931	1.00	73.63	C
ATOM	3581	CD	LYS	A	468	10.605	116.905	-24.779	1.00	69.64	C
ATOM	3582	CE	LYS	A	468	11.439	117.992	-25.427	1.00	66.51	C
ATOM	3583	NZ	LYS	A	468	10.626	118.774	-26.418	1.00	74.03	N
ATOM	3584	O	SER	A	469	10.067	115.367	-16.961	1.00	85.37	O
ATOM	3585	N	SER	A	469	11.269	116.186	-19.173	1.00	76.96	N
ATOM	3586	CA	SER	A	469	11.646	116.842	-17.932	1.00	81.10	C
ATOM	3587	C	SER	A	469	10.860	116.279	-16.780	1.00	86.13	C
ATOM	3588	CB	SER	A	469	11.408	118.338	-18.027	1.00	77.79	C
ATOM	3589	OG	SER	A	469	11.146	118.691	-19.370	1.00	85.27	O
ATOM	3590	O	GLU	A	470	9.225	117.958	-12.926	1.00	100.09	O
ATOM	3591	N	GLU	A	470	11.075	116.822	-15.591	1.00	88.97	N
ATOM	3592	CA	GLU	A	470	10.257	116.433	-14.459	1.00	91.12	C

ATOM	3593	C	GLU	A	470	9.385	117.611	-14.093	1.00	90.99	C
ATOM	3594	CB	GLU	A	470	11.111	115.982	-13.274	1.00	97.08	C
ATOM	3595	CG	GLU	A	470	10.319	115.239	-12.203	1.00	98.07	C
ATOM	3596	CD	GLU	A	470	11.038	114.014	-11.678	1.00	104.50	C
ATOM	3597	OE1	GLU	A	470	12.216	114.142	-11.261	1.00	105.08	O
ATOM	3598	OE2	GLU	A	470	10.416	112.925	-11.686	1.00	102.56	O
ATOM	3599	O	GLU	A	471	6.261	118.316	-16.256	1.00	81.34	O
ATOM	3600	N	GLU	A	471	8.828	118.251	-15.106	1.00	85.82	N
ATOM	3601	CA	GLU	A	471	7.920	119.341	-14.836	1.00	87.24	C
ATOM	3602	C	GLU	A	471	6.493	118.954	-15.224	1.00	85.73	C
ATOM	3603	CB	GLU	A	471	8.368	120.610	-15.558	1.00	82.80	C
ATOM	3604	CG	GLU	A	471	8.932	121.661	-14.618	1.00	87.61	C
ATOM	3605	CD	GLU	A	471	8.510	123.066	-15.001	1.00	93.53	C
ATOM	3606	OE1	GLU	A	471	7.540	123.206	-15.782	1.00	90.19	O
ATOM	3607	OE2	GLU	A	471	9.150	124.031	-14.525	1.00	91.64	O
ATOM	3608	O	THR	A	472	3.843	120.743	-16.256	1.00	70.64	O
ATOM	3609	N	THR	A	472	5.555	119.327	-14.360	1.00	79.45	N
ATOM	3610	CA	THR	A	472	4.139	119.076	-14.561	1.00	71.48	C
ATOM	3611	C	THR	A	472	3.669	119.571	-15.924	1.00	69.57	C
ATOM	3612	CB	THR	A	472	3.326	119.747	-13.451	1.00	72.16	C
ATOM	3613	OG1	THR	A	472	3.563	119.056	-12.218	1.00	73.66	O
ATOM	3614	CG2	THR	A	472	1.862	119.714	-13.764	1.00	67.93	C
ATOM	3615	O	ILE	A	473	0.462	119.502	-17.264	1.00	62.14	O
ATOM	3616	N	ILE	A	473	3.093	118.658	-16.709	1.00	65.65	N
ATOM	3617	CA	ILE	A	473	2.641	118.947	-18.072	1.00	67.21	C
ATOM	3618	C	ILE	A	473	1.350	119.760	-18.063	1.00	60.71	C
ATOM	3619	CB	ILE	A	473	2.398	117.653	-18.882	1.00	67.39	C
ATOM	3620	CG1	ILE	A	473	3.610	116.717	-18.805	1.00	72.20	C
ATOM	3621	CG2	ILE	A	473	2.043	117.989	-20.325	1.00	65.91	C
ATOM	3622	CD1	ILE	A	473	3.361	115.323	-19.368	1.00	67.49	C
ATOM	3623	O	THR	A	474	0.457	121.558	-21.324	1.00	62.29	O
ATOM	3624	N	THR	A	474	1.254	120.752	-18.939	1.00	60.64	N
ATOM	3625	CA	THR	A	474	0.093	121.634	-18.966	1.00	61.46	C
ATOM	3626	C	THR	A	474	-0.298	121.898	-20.418	1.00	62.38	C
ATOM	3627	CB	THR	A	474	0.362	122.979	-18.238	1.00	61.06	C
ATOM	3628	OG1	THR	A	474	1.317	123.745	-18.978	1.00	63.25	O
ATOM	3629	CG2	THR	A	474	0.809	122.765	-16.787	1.00	55.94	C
ATOM	3630	O	PRO	A	475	-0.631	123.484	-23.981	1.00	67.40	O
ATOM	3631	N	PRO	A	475	-1.474	122.513	-20.651	1.00	64.78	N
ATOM	3632	CA	PRO	A	475	-1.819	122.717	-22.061	1.00	63.53	C
ATOM	3633	C	PRO	A	475	-0.825	123.621	-22.772	1.00	60.94	C
ATOM	3634	CB	PRO	A	475	-3.204	123.376	-21.993	1.00	63.14	C
ATOM	3635	CG	PRO	A	475	-3.710	123.065	-20.641	1.00	59.81	C
ATOM	3636	CD	PRO	A	475	-2.539	122.998	-19.752	1.00	56.84	C
ATOM	3637	O	TRP	A	476	2.774	125.018	-23.846	1.00	64.86	O
ATOM	3638	N	TRP	A	476	-0.190	124.515	-22.019	1.00	59.69	N
ATOM	3639	CA	TRP	A	476	0.773	125.462	-22.590	1.00	68.42	C
ATOM	3640	C	TRP	A	476	2.166	124.850	-22.793	1.00	63.22	C
ATOM	3641	CB	TRP	A	476	0.862	126.706	-21.703	1.00	61.19	C
ATOM	3642	CG	TRP	A	476	-0.456	127.051	-21.168	1.00	61.15	C
ATOM	3643	CD1	TRP	A	476	-1.516	127.559	-21.866	1.00	64.17	C
ATOM	3644	CD2	TRP	A	476	-0.906	126.873	-19.828	1.00	64.10	C
ATOM	3645	NE1	TRP	A	476	-2.591	127.721	-21.036	1.00	62.66	N
ATOM	3646	CE2	TRP	A	476	-2.243	127.312	-19.776	1.00	63.85	C
ATOM	3647	CE3	TRP	A	476	-0.304	126.396	-18.662	1.00	66.95	C
ATOM	3648	CZ2	TRP	A	476	-2.990	127.288	-18.606	1.00	66.77	C
ATOM	3649	CZ3	TRP	A	476	-1.043	126.371	-17.498	1.00	67.89	C
ATOM	3650	CH2	TRP	A	476	-2.377	126.814	-17.478	1.00	70.00	C
ATOM	3651	O	ASN	A	477	5.142	121.577	-22.371	1.00	72.99	O
ATOM	3652	N	ASN	A	477	2.674	124.138	-21.797	1.00	61.52	N
ATOM	3653	CA	ASN	A	477	4.025	123.616	-21.926	1.00	68.82	C
ATOM	3654	C	ASN	A	477	4.102	122.202	-22.498	1.00	69.12	C
ATOM	3655	CB	ASN	A	477	4.740	123.651	-20.569	1.00	66.10	C

ATOM	3656	CG	ASN	A	477	4.211	122.618	-19.594	1.00	69.07	C
ATOM	3657	OD1	ASN	A	477	3.522	121.671	-19.975	1.00	70.50	O
ATOM	3658	ND2	ASN	A	477	4.539	122.794	-18.319	1.00	68.61	N
ATOM	3659	O	PHE	A	478	4.861	118.937	-23.917	1.00	69.23	O
ATOM	3660	N	PHE	A	478	3.015	121.696	-23.087	1.00	66.78	N
ATOM	3661	CA	PHE	A	478	2.944	120.276	-23.440	1.00	66.39	C
ATOM	3662	C	PHE	A	478	4.125	119.839	-24.304	1.00	70.44	C
ATOM	3663	CB	PHE	A	478	1.631	119.940	-24.153	1.00	60.98	C
ATOM	3664	CG	PHE	A	478	1.528	118.491	-24.609	1.00	62.08	C
ATOM	3665	CD1	PHE	A	478	1.220	117.479	-23.707	1.00	61.13	C
ATOM	3666	CD2	PHE	A	478	1.713	118.150	-25.947	1.00	55.26	C
ATOM	3667	CE1	PHE	A	478	1.112	116.150	-24.131	1.00	61.84	C
ATOM	3668	CE2	PHE	A	478	1.609	116.827	-26.375	1.00	60.87	C
ATOM	3669	CZ	PHE	A	478	1.314	115.826	-25.469	1.00	59.60	C
ATOM	3670	O	GLU	A	479	7.683	119.477	-26.053	1.00	69.95	O
ATOM	3671	N	GLU	A	479	4.316	120.487	-25.452	1.00	67.49	N
ATOM	3672	CA	GLU	A	479	5.379	120.114	-26.373	1.00	65.11	C
ATOM	3673	C	GLU	A	479	6.763	120.233	-25.727	1.00	73.62	C
ATOM	3674	CB	GLU	A	479	5.312	120.975	-27.622	1.00	63.81	C
ATOM	3675	CG	GLU	A	479	5.357	120.201	-28.911	1.00	70.92	C
ATOM	3676	CD	GLU	A	479	4.796	120.997	-30.081	1.00	83.38	C
ATOM	3677	OE1	GLU	A	479	5.145	122.196	-30.206	1.00	81.63	O
ATOM	3678	OE2	GLU	A	479	3.996	120.430	-30.868	1.00	81.53	O
ATOM	3679	O	GLU	A	480	9.512	119.492	-23.297	1.00	83.03	O
ATOM	3680	N	GLU	A	480	6.907	121.177	-24.805	1.00	70.97	N
ATOM	3681	CA	GLU	A	480	8.158	121.312	-24.071	1.00	72.48	C
ATOM	3682	C	GLU	A	480	8.440	120.085	-23.202	1.00	76.01	C
ATOM	3683	CB	GLU	A	480	8.143	122.566	-23.196	1.00	72.68	C
ATOM	3684	O	VAL	A	481	8.279	116.281	-21.568	1.00	76.40	O
ATOM	3685	N	VAL	A	481	7.494	119.691	-22.358	1.00	71.87	N
ATOM	3686	CA	VAL	A	481	7.775	118.628	-21.399	1.00	73.01	C
ATOM	3687	C	VAL	A	481	7.645	117.236	-22.023	1.00	74.41	C
ATOM	3688	CB	VAL	A	481	6.857	118.736	-20.158	1.00	74.21	C
ATOM	3689	CG1	VAL	A	481	7.330	117.800	-19.061	1.00	70.31	C
ATOM	3690	CG2	VAL	A	481	6.838	120.172	-19.632	1.00	72.34	C
ATOM	3691	O	VAL	A	482	7.361	116.198	-25.934	1.00	68.45	O
ATOM	3692	N	VAL	A	482	6.857	117.118	-23.086	1.00	74.49	N
ATOM	3693	CA	VAL	A	482	6.601	115.803	-23.664	1.00	73.05	C
ATOM	3694	C	VAL	A	482	7.441	115.521	-24.900	1.00	69.25	C
ATOM	3695	CB	VAL	A	482	5.093	115.603	-24.017	1.00	67.19	C
ATOM	3696	CG1	VAL	A	482	4.899	114.378	-24.938	1.00	61.41	C
ATOM	3697	CG2	VAL	A	482	4.284	115.441	-22.745	1.00	61.98	C
ATOM	3698	N	ASP	A	483	8.251	114.488	-24.769	1.00	69.17	N
ATOM	3699	CA	ASP	A	483	8.946	113.942	-25.900	1.00	68.97	C
ATOM	3700	C	ASP	A	483	7.915	113.237	-26.738	1.00	70.71	C
ATOM	3701	O	ASP	A	483	7.570	112.080	-26.469	1.00	67.84	O
ATOM	3702	CB	ASP	A	483	10.040	112.981	-25.462	1.00	69.17	C
ATOM	3703	CG	ASP	A	483	10.809	112.386	-26.642	1.00	69.93	C
ATOM	3704	OD1	ASP	A	483	10.492	112.669	-27.827	1.00	65.48	O
ATOM	3705	OD2	ASP	A	483	11.741	111.615	-26.363	1.00	73.47	O
ATOM	3706	N	LYS	A	484	7.415	113.940	-27.745	1.00	67.20	N
ATOM	3707	CA	LYS	A	484	6.414	113.366	-28.616	1.00	65.80	C
ATOM	3708	C	LYS	A	484	6.995	112.156	-29.303	1.00	68.37	C
ATOM	3709	O	LYS	A	484	6.355	111.105	-29.376	1.00	70.08	O
ATOM	3710	CB	LYS	A	484	5.932	114.375	-29.653	1.00	73.38	C
ATOM	3711	CG	LYS	A	484	4.958	115.412	-29.136	1.00	68.17	C
ATOM	3712	CD	LYS	A	484	4.283	116.063	-30.331	1.00	66.35	C
ATOM	3713	CE	LYS	A	484	3.523	117.289	-29.954	1.00	69.55	C
ATOM	3714	NZ	LYS	A	484	3.021	117.974	-31.188	1.00	84.62	N
ATOM	3715	N	GLY	A	485	8.228	112.312	-29.774	1.00	71.42	N
ATOM	3716	CA	GLY	A	485	8.897	111.303	-30.567	1.00	65.02	C
ATOM	3717	C	GLY	A	485	8.919	109.930	-29.941	1.00	66.57	C
ATOM	3718	O	GLY	A	485	8.335	108.985	-30.462	1.00	68.05	O

ATOM	3719	N	ALA	A	486	9.598	109.829	-28.808	1.00	67.80	N
ATOM	3720	CA	ALA	A	486	9.755	108.563	-28.107	1.00	70.92	C
ATOM	3721	C	ALA	A	486	8.416	108.047	-27.604	1.00	66.32	C
ATOM	3722	O	ALA	A	486	8.264	106.870	-27.256	1.00	60.23	O
ATOM	3723	CB	ALA	A	486	10.731	108.720	-26.942	1.00	66.61	C
ATOM	3724	N	SER	A	487	7.454	108.957	-27.546	1.00	67.51	N
ATOM	3725	CA	SER	A	487	6.110	108.616	-27.155	1.00	59.69	C
ATOM	3726	C	SER	A	487	5.427	107.970	-28.352	1.00	59.59	C
ATOM	3727	O	SER	A	487	4.923	106.853	-28.246	1.00	59.32	O
ATOM	3728	CB	SER	A	487	5.372	109.860	-26.657	1.00	62.81	C
ATOM	3729	OG	SER	A	487	6.046	110.415	-25.529	1.00	64.89	O
ATOM	3730	N	ALA	A	488	5.449	108.645	-29.497	1.00	52.22	N
ATOM	3731	CA	ALA	A	488	4.888	108.062	-30.710	1.00	55.95	C
ATOM	3732	C	ALA	A	488	5.622	106.787	-31.108	1.00	65.93	C
ATOM	3733	O	ALA	A	488	5.007	105.843	-31.608	1.00	67.90	O
ATOM	3734	CB	ALA	A	488	4.924	109.054	-31.858	1.00	56.28	C
ATOM	3735	N	GLN	A	489	6.936	106.746	-30.901	1.00	67.85	N
ATOM	3736	CA	GLN	A	489	7.668	105.587	-31.373	1.00	65.39	C
ATOM	3737	C	GLN	A	489	7.226	104.400	-30.555	1.00	62.58	C
ATOM	3738	O	GLN	A	489	6.787	103.400	-31.129	1.00	64.87	O
ATOM	3739	CB	GLN	A	489	9.181	105.779	-31.301	1.00	69.97	C
ATOM	3740	CG	GLN	A	489	9.912	105.071	-32.440	1.00	74.89	C
ATOM	3741	CD	GLN	A	489	11.330	104.658	-32.076	1.00	85.40	C
ATOM	3742	OE1	GLN	A	489	12.296	105.282	-32.515	1.00	89.38	O
ATOM	3743	NE2	GLN	A	489	11.462	103.600	-31.274	1.00	75.40	N
ATOM	3744	N	SER	A	490	7.287	104.523	-29.225	1.00	60.13	N
ATOM	3745	CA	SER	A	490	6.897	103.411	-28.356	1.00	59.51	C
ATOM	3746	C	SER	A	490	5.442	103.026	-28.585	1.00	60.81	C
ATOM	3747	O	SER	A	490	5.074	101.886	-28.352	1.00	60.86	O
ATOM	3748	CB	SER	A	490	7.115	103.730	-26.872	1.00	54.86	C
ATOM	3749	OG	SER	A	490	7.890	104.891	-26.686	1.00	60.33	O
ATOM	3750	N	PHE	A	491	4.629	103.982	-29.040	1.00	62.58	N
ATOM	3751	CA	PHE	A	491	3.225	103.729	-29.368	1.00	60.81	C
ATOM	3752	C	PHE	A	491	3.116	102.536	-30.311	1.00	58.49	C
ATOM	3753	O	PHE	A	491	2.544	101.523	-29.943	1.00	61.16	O
ATOM	3754	CB	PHE	A	491	2.570	104.982	-29.976	1.00	56.55	C
ATOM	3755	CG	PHE	A	491	1.149	104.778	-30.459	1.00	55.76	C
ATOM	3756	CD2	PHE	A	491	0.820	104.986	-31.790	1.00	54.37	C
ATOM	3757	CD1	PHE	A	491	0.134	104.415	-29.579	1.00	55.51	C
ATOM	3758	CE2	PHE	A	491	-0.487	104.816	-32.244	1.00	52.93	C
ATOM	3759	CE1	PHE	A	491	-1.176	104.242	-30.027	1.00	47.98	C
ATOM	3760	CZ	PHE	A	491	-1.481	104.453	-31.356	1.00	49.78	C
ATOM	3761	N	ILE	A	492	3.687	102.641	-31.505	1.00	60.79	N
ATOM	3762	CA	ILE	A	492	3.630	101.540	-32.466	1.00	62.77	C
ATOM	3763	C	ILE	A	492	4.522	100.343	-32.088	1.00	61.94	C
ATOM	3764	O	ILE	A	492	4.160	99.192	-32.330	1.00	65.27	O
ATOM	3765	CB	ILE	A	492	4.009	102.024	-33.876	1.00	63.12	C
ATOM	3766	CG1	ILE	A	492	3.113	103.206	-34.285	1.00	66.02	C
ATOM	3767	CG2	ILE	A	492	3.923	100.890	-34.891	1.00	60.24	C
ATOM	3768	CD1	ILE	A	492	1.974	102.876	-35.261	1.00	62.04	C
ATOM	3769	N	GLU	A	493	5.676	100.597	-31.481	1.00	65.60	N
ATOM	3770	CA	GLU	A	493	6.644	99.514	-31.251	1.00	60.98	C
ATOM	3771	C	GLU	A	493	6.189	98.583	-30.127	1.00	64.65	C
ATOM	3772	O	GLU	A	493	6.653	97.436	-30.032	1.00	60.25	O
ATOM	3773	CB	GLU	A	493	8.037	100.089	-30.941	1.00	62.42	C
ATOM	3774	CG	GLU	A	493	8.352	100.238	-29.444	1.00	66.44	C
ATOM	3775	CD	GLU	A	493	9.442	101.280	-29.146	1.00	73.91	C
ATOM	3776	OE1	GLU	A	493	9.552	101.695	-27.969	1.00	71.29	O
ATOM	3777	OE2	GLU	A	493	10.183	101.682	-30.078	1.00	80.44	O
ATOM	3778	N	ARG	A	494	5.276	99.069	-29.282	1.00	62.07	N
ATOM	3779	CA	ARG	A	494	4.795	98.278	-28.148	1.00	60.78	C
ATOM	3780	C	ARG	A	494	3.723	97.293	-28.594	1.00	57.29	C
ATOM	3781	O	ARG	A	494	3.277	96.443	-27.819	1.00	58.04	O

ATOM	3782	CB	ARG	A	494	4.245	99.178	-27.039	1.00	64.07	C
ATOM	3783	CG	ARG	A	494	2.968	99.960	-27.412	1.00	61.21	C
ATOM	3784	CD	ARG	A	494	2.522	100.871	-26.276	1.00	59.11	C
ATOM	3785	NE	ARG	A	494	1.523	100.192	-25.454	1.00	66.96	N
ATOM	3786	CZ	ARG	A	494	1.610	100.011	-24.143	1.00	58.94	C
ATOM	3787	NH1	ARG	A	494	0.646	99.361	-23.505	1.00	58.78	N
ATOM	3788	NH2	ARG	A	494	2.655	100.473	-23.471	1.00	60.67	N
ATOM	3789	N	MET	A	495	3.317	97.404	-29.851	1.00	54.93	N
ATOM	3790	CA	MET	A	495	2.266	96.538	-30.367	1.00	56.54	C
ATOM	3791	C	MET	A	495	2.724	95.644	-31.538	1.00	50.19	C
ATOM	3792	O	MET	A	495	2.115	94.605	-31.798	1.00	45.69	O
ATOM	3793	CB	MET	A	495	1.051	97.377	-30.820	1.00	49.56	C
ATOM	3794	CG	MET	A	495	0.537	98.421	-29.805	1.00	53.35	C
ATOM	3795	SD	MET	A	495	-0.985	99.288	-30.339	1.00	49.44	S
ATOM	3796	CE	MET	A	495	-0.443	100.405	-31.617	1.00	48.15	C
ATOM	3797	O	THR	A	496	5.226	93.607	-32.228	1.00	51.60	O
ATOM	3798	N	THR	A	496	3.743	96.060	-32.276	1.00	47.01	N
ATOM	3799	CA	THR	A	496	4.102	95.315	-33.495	1.00	53.09	C
ATOM	3800	C	THR	A	496	4.584	93.887	-33.228	1.00	47.29	C
ATOM	3801	CB	THR	A	496	5.172	96.029	-34.307	1.00	52.24	C
ATOM	3802	OG1	THR	A	496	5.944	96.870	-33.443	1.00	63.03	O
ATOM	3803	CG2	THR	A	496	4.516	96.876	-35.355	1.00	54.55	C
ATOM	3804	O	ASN	A	497	6.872	92.317	-34.532	1.00	49.05	O
ATOM	3805	N	ASN	A	497	4.230	92.975	-34.120	1.00	46.94	N
ATOM	3806	CA	ASN	A	497	4.662	91.590	-33.984	1.00	51.99	C
ATOM	3807	C	ASN	A	497	6.165	91.471	-33.979	1.00	50.80	C
ATOM	3808	CB	ASN	A	497	4.102	90.726	-35.104	1.00	45.53	C
ATOM	3809	CG	ASN	A	497	2.869	89.967	-34.694	1.00	48.23	C
ATOM	3810	OD1	ASN	A	497	2.660	89.675	-33.510	1.00	50.70	O
ATOM	3811	ND2	ASN	A	497	2.046	89.622	-35.674	1.00	42.34	N
ATOM	3812	O	PHE	A	498	6.842	88.019	-34.489	1.00	51.98	O
ATOM	3813	N	PHE	A	498	6.634	90.438	-33.296	1.00	53.33	N
ATOM	3814	CA	PHE	A	498	7.975	89.915	-33.499	1.00	57.27	C
ATOM	3815	C	PHE	A	498	7.885	88.692	-34.428	1.00	56.25	C
ATOM	3816	CB	PHE	A	498	8.630	89.528	-32.161	1.00	59.96	C
ATOM	3817	CG	PHE	A	498	9.273	90.673	-31.435	1.00	57.57	C
ATOM	3818	CD1	PHE	A	498	10.541	91.097	-31.776	1.00	56.00	C
ATOM	3819	CD2	PHE	A	498	8.610	91.323	-30.398	1.00	65.21	C
ATOM	3820	CE1	PHE	A	498	11.140	92.155	-31.112	1.00	53.97	C
ATOM	3821	CE2	PHE	A	498	9.203	92.377	-29.725	1.00	61.09	C
ATOM	3822	CE	PHE	A	498	10.469	92.793	-30.087	1.00	60.32	C
ATOM	3823	O	ASP	A	499	9.885	85.747	-34.284	1.00	54.20	O
ATOM	3824	N	ASP	A	499	8.982	88.428	-35.144	1.00	61.44	N
ATOM	3825	CA	ASP	A	499	9.167	87.236	-35.991	1.00	53.58	C
ATOM	3826	C	ASP	A	499	9.075	85.957	-35.168	1.00	49.43	C
ATOM	3827	CB	ASP	A	499	10.536	87.328	-36.677	1.00	59.17	C
ATOM	3828	CG	ASP	A	499	10.692	86.390	-37.878	1.00	59.67	C
ATOM	3829	OD1	ASP	A	499	10.029	85.327	-37.961	1.00	59.77	O
ATOM	3830	OD2	ASP	A	499	11.516	86.742	-38.747	1.00	57.91	O
ATOM	3831	O	LYS	A	500	9.477	82.051	-34.132	1.00	62.36	O
ATOM	3832	N	LYS	A	500	8.086	85.116	-35.442	1.00	51.09	N
ATOM	3833	CA	LYS	A	500	7.956	83.826	-34.754	1.00	55.78	C
ATOM	3834	C	LYS	A	500	9.169	82.894	-34.978	1.00	58.74	C
ATOM	3835	CB	LYS	A	500	6.674	83.097	-35.197	1.00	57.88	C
ATOM	3836	CG	LYS	A	500	5.380	83.688	-34.663	1.00	65.42	C
ATOM	3837	CD	LYS	A	500	4.141	82.928	-35.150	1.00	63.97	C
ATOM	3838	CE	LYS	A	500	2.858	83.742	-34.891	1.00	67.40	C
ATOM	3839	NZ	LYS	A	500	1.614	83.017	-35.291	1.00	63.99	N
ATOM	3840	O	ASN	A	501	13.134	82.008	-35.182	1.00	61.90	O
ATOM	3841	N	ASN	A	501	9.851	83.030	-36.111	1.00	58.37	N
ATOM	3842	CA	ASN	A	501	11.056	82.235	-36.354	1.00	58.92	C
ATOM	3843	C	ASN	A	501	12.255	82.774	-35.578	1.00	61.64	C
ATOM	3844	CB	ASN	A	501	11.396	82.188	-37.848	1.00	59.93	C

ATOM	3845	CG	ASN	A	501	10.273	81.595	-38.695	1.00	62.25	C
ATOM	3846	OD1	ASN	A	501	9.539	82.322	-39.379	1.00	65.51	O
ATOM	3847	ND2	ASN	A	501	10.138	80.272	-38.656	1.00	57.46	N
ATOM	3848	O	LEU	A	502	12.756	86.912	-33.808	1.00	63.09	O
ATOM	3849	N	LEU	A	502	12.291	84.094	-35.381	1.00	59.94	N
ATOM	3850	CA	LEU	A	502	13.351	84.750	-34.622	1.00	53.18	C
ATOM	3851	C	LEU	A	502	12.758	85.700	-33.597	1.00	60.33	C
ATOM	3852	CB	LEU	A	502	14.282	85.509	-35.551	1.00	54.02	C
ATOM	3853	CG	LEU	A	502	15.256	84.623	-36.322	1.00	58.21	C
ATOM	3854	CD1	LEU	A	502	15.740	85.325	-37.571	1.00	56.93	C
ATOM	3855	CD2	LEU	A	502	16.431	84.262	-35.438	1.00	59.13	C
ATOM	3856	O	PRO	A	503	11.284	87.794	-30.104	1.00	59.90	O
ATOM	3857	N	PRO	A	503	12.250	85.150	-32.481	1.00	61.09	N
ATOM	3858	CA	PRO	A	503	11.415	85.869	-31.507	1.00	56.78	C
ATOM	3859	C	PRO	A	503	12.004	87.137	-30.858	1.00	62.91	C
ATOM	3860	CB	PRO	A	503	11.142	84.805	-30.430	1.00	59.54	C
ATOM	3861	CG	PRO	A	503	12.062	83.646	-30.735	1.00	65.34	C
ATOM	3862	CD	PRO	A	503	12.293	83.706	-32.199	1.00	61.54	C
ATOM	3863	O	ASN	A	504	14.388	90.879	-31.477	1.00	64.90	O
ATOM	3864	N	ASN	A	504	13.259	87.481	-31.129	1.00	65.34	N
ATOM	3865	CA	ASN	A	504	13.824	88.719	-30.601	1.00	61.57	C
ATOM	3866	C	ASN	A	504	13.938	89.752	-31.692	1.00	63.71	C
ATOM	3867	CB	ASN	A	504	15.185	88.473	-29.964	1.00	64.30	C
ATOM	3868	CG	ASN	A	504	15.064	87.904	-28.557	1.00	76.80	C
ATOM	3869	OD1	ASN	A	504	14.084	88.168	-27.849	1.00	75.75	O
ATOM	3870	ND2	ASN	A	504	16.060	87.123	-28.143	1.00	77.42	N
ATOM	3871	O	GLU	A	505	11.313	90.068	-34.695	1.00	56.52	O
ATOM	3872	N	GLU	A	505	13.505	89.358	-32.875	1.00	61.47	N
ATOM	3873	CA	GLU	A	505	13.604	90.223	-34.027	1.00	61.35	C
ATOM	3874	C	GLU	A	505	12.255	90.797	-34.409	1.00	53.38	C
ATOM	3875	CB	GLU	A	505	14.211	89.454	-35.194	1.00	60.18	C
ATOM	3876	CG	GLU	A	505	15.545	88.879	-34.853	1.00	61.76	C
ATOM	3877	CD	GLU	A	505	16.581	89.964	-34.653	1.00	63.78	C
ATOM	3878	OE1	GLU	A	505	16.511	90.987	-35.358	1.00	67.18	O
ATOM	3879	OE2	GLU	A	505	17.469	89.792	-33.795	1.00	72.08	O
ATOM	3880	O	LYS	A	506	11.575	92.122	-37.081	1.00	62.69	O
ATOM	3881	N	LYS	A	506	12.175	92.117	-34.396	1.00	57.87	N
ATOM	3882	CA	LYS	A	506	10.980	92.823	-34.843	1.00	55.35	C
ATOM	3883	C	LYS	A	506	10.690	92.499	-36.296	1.00	60.15	C
ATOM	3884	CB	LYS	A	506	11.144	94.329	-34.664	1.00	53.93	C
ATOM	3885	CG	LYS	A	506	9.849	95.065	-34.587	1.00	66.14	C
ATOM	3886	CD	LYS	A	506	9.026	94.566	-33.416	1.00	64.50	C
ATOM	3887	CE	LYS	A	506	9.350	95.331	-32.157	1.00	62.67	C
ATOM	3888	NZ	LYS	A	506	8.264	95.136	-31.170	1.00	63.01	N
ATOM	3889	O	VAL	A	507	9.335	94.674	-38.377	1.00	61.39	O
ATOM	3890	N	VAL	A	507	9.425	92.631	-36.642	1.00	54.45	N
ATOM	3891	CA	VAL	A	507	8.943	92.348	-37.970	1.00	45.21	C
ATOM	3892	C	VAL	A	507	9.231	93.545	-38.870	1.00	48.41	C
ATOM	3893	CB	VAL	A	507	7.451	92.001	-37.899	1.00	48.11	C
ATOM	3894	CG1	VAL	A	507	6.639	92.870	-38.812	1.00	56.11	C
ATOM	3895	CG2	VAL	A	507	7.244	90.522	-38.171	1.00	54.62	C
ATOM	3896	O	LEU	A	508	7.247	94.553	-41.379	1.00	54.78	O
ATOM	3897	N	LEU	A	508	9.410	93.299	-40.169	1.00	49.63	N
ATOM	3898	CA	LEU	A	508	9.628	94.363	-41.155	1.00	55.30	C
ATOM	3899	C	LEU	A	508	8.328	95.118	-41.500	1.00	55.23	C
ATOM	3900	CB	LEU	A	508	10.247	93.772	-42.427	1.00	46.27	C
ATOM	3901	CG	LEU	A	508	11.784	93.707	-42.441	1.00	56.04	C
ATOM	3902	CD1	LEU	A	508	12.329	92.718	-43.473	1.00	47.87	C
ATOM	3903	CD2	LEU	A	508	12.363	95.100	-42.690	1.00	54.54	C
ATOM	3904	O	PRO	A	509	7.500	95.711	-44.435	1.00	61.75	O
ATOM	3905	N	PRO	A	509	8.428	96.400	-41.912	1.00	52.83	N
ATOM	3906	CA	PRO	A	509	7.230	97.047	-42.476	1.00	55.08	C
ATOM	3907	C	PRO	A	509	6.702	96.273	-43.680	1.00	56.39	C

ATOM	3908	CB	PRO	A	509	7.730	98.437	-42.888	1.00	50.64	C
ATOM	3909	CG	PRO	A	509	8.825	98.726	-41.935	1.00	52.65	C
ATOM	3910	CD	PRO	A	509	9.507	97.373	-41.669	1.00	52.42	C
ATOM	3911	O	LYS	A	510	5.253	95.301	-47.281	1.00	60.45	O
ATOM	3912	N	LYS	A	510	5.386	96.229	-43.846	1.00	52.47	N
ATOM	3913	CA	LYS	A	510	4.766	95.509	-44.946	1.00	52.31	C
ATOM	3914	C	LYS	A	510	5.228	96.031	-46.293	1.00	54.73	C
ATOM	3915	CB	LYS	A	510	3.247	95.599	-44.851	1.00	50.91	C
ATOM	3916	CG	LYS	A	510	2.509	94.715	-45.842	1.00	48.16	C
ATOM	3917	CD	LYS	A	510	2.975	93.268	-45.765	1.00	56.71	C
ATOM	3918	CE	LYS	A	510	1.886	92.285	-46.178	1.00	56.48	C
ATOM	3919	NZ	LYS	A	510	1.739	91.233	-45.109	1.00	59.70	N
ATOM	3920	N	HIS	A	511	5.619	97.293	-46.328	1.00	57.36	N
ATOM	3921	CA	HIS	A	511	5.991	97.934	-47.582	1.00	59.92	C
ATOM	3922	C	HIS	A	511	7.499	98.128	-47.718	1.00	57.13	C
ATOM	3923	O	HIS	A	511	7.964	98.874	-48.569	1.00	60.08	O
ATOM	3924	CB	HIS	A	511	5.260	99.272	-47.699	1.00	61.39	C
ATOM	3925	CG	HIS	A	511	3.773	99.128	-47.732	1.00	60.31	C
ATOM	3926	ND1	HIS	A	511	3.066	98.980	-48.906	1.00	54.83	N
ATOM	3927	CD2	HIS	A	511	2.862	99.073	-46.733	1.00	58.53	C
ATOM	3928	CE1	HIS	A	511	1.783	98.845	-48.631	1.00	54.28	C
ATOM	3929	NE2	HIS	A	511	1.631	98.903	-47.320	1.00	59.67	N
ATOM	3930	N	SER	A	512	8.251	97.463	-46.853	1.00	59.32	N
ATOM	3931	CA	SER	A	512	9.703	97.357	-46.987	1.00	61.19	C
ATOM	3932	C	SER	A	512	10.146	96.847	-48.369	1.00	60.57	C
ATOM	3933	O	SER	A	512	9.620	95.848	-48.857	1.00	59.82	O
ATOM	3934	CB	SER	A	512	10.239	96.421	-45.911	1.00	59.81	C
ATOM	3935	OG	SER	A	512	11.300	95.644	-46.426	1.00	57.34	O
ATOM	3936	O	LEU	A	513	11.885	94.881	-51.131	1.00	64.01	O
ATOM	3937	N	LEU	A	513	11.103	97.539	-48.987	1.00	64.39	N
ATOM	3938	CA	LEU	A	513	11.701	97.111	-50.257	1.00	64.26	C
ATOM	3939	C	LEU	A	513	12.149	95.656	-50.209	1.00	64.22	C
ATOM	3940	CB	LEU	A	513	12.911	97.974	-50.609	1.00	67.34	C
ATOM	3941	CG	LEU	A	513	12.745	99.422	-51.065	1.00	72.16	C
ATOM	3942	CD2	LEU	A	513	12.341	100.331	-49.888	1.00	76.51	C
ATOM	3943	CD1	LEU	A	513	11.760	99.508	-52.225	1.00	70.96	C
ATOM	3944	N	LEU	A	514	12.834	95.306	-49.123	1.00	62.15	N
ATOM	3945	CA	LEU	A	514	13.320	93.951	-48.914	1.00	64.61	C
ATOM	3946	C	LEU	A	514	12.189	92.941	-48.848	1.00	63.47	C
ATOM	3947	O	LEU	A	514	12.315	91.827	-49.347	1.00	63.36	O
ATOM	3948	CB	LEU	A	514	14.138	93.866	-47.629	1.00	63.23	C
ATOM	3949	CG	LEU	A	514	15.658	93.909	-47.784	1.00	73.76	C
ATOM	3950	CD1	LEU	A	514	16.331	93.261	-46.570	1.00	67.58	C
ATOM	3951	CD2	LEU	A	514	16.094	93.243	-49.084	1.00	65.07	C
ATOM	3952	N	TYR	A	515	11.094	93.339	-48.210	1.00	65.26	N
ATOM	3953	CA	TYR	A	515	9.953	92.460	-48.018	1.00	60.05	C
ATOM	3954	C	TYR	A	515	9.329	92.107	-49.368	1.00	53.35	C
ATOM	3955	O	TYR	A	515	9.018	90.956	-49.619	1.00	56.27	O
ATOM	3956	CB	TYR	A	515	8.911	93.109	-47.072	1.00	55.84	C
ATOM	3957	CG	TYR	A	515	7.988	92.093	-46.418	1.00	50.58	C
ATOM	3958	CD2	TYR	A	515	6.697	91.872	-46.893	1.00	49.40	C
ATOM	3959	CD1	TYR	A	515	8.432	91.319	-45.357	1.00	52.77	C
ATOM	3960	CE2	TYR	A	515	5.869	90.924	-46.304	1.00	46.68	C
ATOM	3961	CE1	TYR	A	515	7.622	90.372	-44.768	1.00	50.48	C
ATOM	3962	CZ	TYR	A	515	6.341	90.180	-45.240	1.00	52.04	C
ATOM	3963	OH	TYR	A	515	5.545	89.233	-44.632	1.00	52.82	O
ATOM	3964	N	GLU	A	516	9.169	93.090	-50.245	1.00	55.86	N
ATOM	3965	CA	GLU	A	516	8.541	92.844	-51.543	1.00	58.96	C
ATOM	3966	C	GLU	A	516	9.436	91.956	-52.423	1.00	59.33	C
ATOM	3967	O	GLU	A	516	8.952	91.005	-53.060	1.00	56.33	O
ATOM	3968	CB	GLU	A	516	8.217	94.173	-52.239	1.00	60.31	C
ATOM	3969	CG	GLU	A	516	7.725	95.255	-51.276	1.00	62.31	C
ATOM	3970	CD	GLU	A	516	6.444	95.963	-51.733	1.00	71.11	C

ATOM	3971	OE1	GLU	A	516	6.533	97.106	-52.227	1.00	66.92	O
ATOM	3972	OE2	GLU	A	516	5.344	95.387	-51.576	1.00	74.76	O
ATOM	3973	N	TYR	A	517	10.734	92.262	-52.437	1.00	53.40	N
ATOM	3974	CA	TYR	A	517	11.728	91.402	-53.081	1.00	57.16	C
ATOM	3975	C	TYR	A	517	11.578	89.942	-52.634	1.00	58.68	C
ATOM	3976	O	TYR	A	517	11.584	89.018	-53.465	1.00	56.67	O
ATOM	3977	CB	TYR	A	517	13.146	91.903	-52.784	1.00	56.84	C
ATOM	3978	CG	TYR	A	517	13.593	93.031	-53.679	1.00	51.89	C
ATOM	3979	CD1	TYR	A	517	13.327	93.000	-55.045	1.00	56.06	C
ATOM	3980	CD2	TYR	A	517	14.263	94.135	-53.160	1.00	52.87	C
ATOM	3981	CE1	TYR	A	517	13.723	94.031	-55.876	1.00	60.10	C
ATOM	3982	CE2	TYR	A	517	14.671	95.173	-53.977	1.00	54.42	C
ATOM	3983	CZ	TYR	A	517	14.391	95.117	-55.339	1.00	66.42	C
ATOM	3984	OH	TYR	A	517	14.777	96.144	-56.169	1.00	72.22	O
ATOM	3985	N	PHE	A	518	11.423	89.746	-51.325	1.00	55.00	N
ATOM	3986	CA	PHE	A	518	11.213	88.412	-50.752	1.00	58.96	C
ATOM	3987	C	PHE	A	518	9.980	87.733	-51.349	1.00	62.56	C
ATOM	3988	O	PHE	A	518	10.077	86.640	-51.944	1.00	60.63	O
ATOM	3989	CB	PHE	A	518	11.075	88.494	-49.219	1.00	53.82	C
ATOM	3990	CG	PHE	A	518	10.724	87.190	-48.572	1.00	57.91	C
ATOM	3991	CD1	PHE	A	518	9.423	86.915	-48.195	1.00	60.64	C
ATOM	3992	CD2	PHE	A	518	11.696	86.220	-48.361	1.00	62.54	C
ATOM	3993	CE1	PHE	A	518	9.090	85.689	-47.604	1.00	61.10	C
ATOM	3994	CE2	PHE	A	518	11.379	84.990	-47.763	1.00	62.32	C
ATOM	3995	CZ	PHE	A	518	10.071	84.728	-47.388	1.00	63.03	C
ATOM	3996	N	THR	A	519	8.826	88.387	-51.187	1.00	56.91	N
ATOM	3997	CA	THR	A	519	7.554	87.835	-51.651	1.00	55.41	C
ATOM	3998	C	THR	A	519	7.571	87.585	-53.155	1.00	52.31	C
ATOM	3999	O	THR	A	519	6.966	86.629	-53.621	1.00	55.62	O
ATOM	4000	CB	THR	A	519	6.332	88.764	-51.315	1.00	55.44	C
ATOM	4001	OG1	THR	A	519	6.449	90.005	-52.022	1.00	53.30	O
ATOM	4002	CG2	THR	A	519	6.223	89.042	-49.816	1.00	46.11	C
ATOM	4003	N	VAL	A	520	8.244	88.438	-53.921	1.00	53.48	N
ATOM	4004	CA	VAL	A	520	8.264	88.231	-55.369	1.00	56.34	C
ATOM	4005	C	VAL	A	520	9.129	87.012	-55.745	1.00	57.98	C
ATOM	4006	O	VAL	A	520	8.665	86.118	-56.469	1.00	51.97	O
ATOM	4007	CB	VAL	A	520	8.746	89.480	-56.133	1.00	59.55	C
ATOM	4008	CG1	VAL	A	520	9.268	89.093	-57.509	1.00	56.23	C
ATOM	4009	CG2	VAL	A	520	7.601	90.503	-56.278	1.00	54.25	C
ATOM	4010	N	TYR	A	521	10.357	86.946	-55.230	1.00	56.76	N
ATOM	4011	CA	TYR	A	521	11.219	85.803	-55.561	1.00	61.30	C
ATOM	4012	C	TYR	A	521	10.642	84.509	-55.024	1.00	55.57	C
ATOM	4013	O	TYR	A	521	10.853	83.441	-55.606	1.00	60.67	O
ATOM	4014	CB	TYR	A	521	12.651	85.987	-55.041	1.00	52.44	C
ATOM	4015	CG	TYR	A	521	13.472	86.909	-55.906	1.00	54.71	C
ATOM	4016	CD1	TYR	A	521	13.947	86.497	-57.170	1.00	52.88	C
ATOM	4017	CD2	TYR	A	521	13.767	88.195	-55.477	1.00	53.64	C
ATOM	4018	CE1	TYR	A	521	14.701	87.352	-57.967	1.00	45.91	C
ATOM	4019	CE2	TYR	A	521	14.520	89.052	-56.261	1.00	55.35	C
ATOM	4020	CZ	TYR	A	521	14.986	88.631	-57.493	1.00	52.37	C
ATOM	4021	OH	TYR	A	521	15.717	89.526	-58.234	1.00	55.75	O
ATOM	4022	N	ASN	A	522	9.897	84.595	-53.930	1.00	52.18	N
ATOM	4023	CA	ASN	A	522	9.363	83.376	-53.339	1.00	58.40	C
ATOM	4024	C	ASN	A	522	8.311	82.738	-54.237	1.00	59.71	C
ATOM	4025	O	ASN	A	522	8.162	81.507	-54.278	1.00	52.86	O
ATOM	4026	CB	ASN	A	522	8.770	83.648	-51.965	1.00	57.16	C
ATOM	4027	CG	ASN	A	522	8.707	82.403	-51.140	1.00	59.15	C
ATOM	4028	OD1	ASN	A	522	9.346	81.392	-51.484	1.00	54.10	O
ATOM	4029	ND2	ASN	A	522	7.949	82.447	-50.046	1.00	56.25	N
ATOM	4030	N	GLU	A	523	7.585	83.603	-54.947	1.00	59.70	N
ATOM	4031	CA	GLU	A	523	6.584	83.178	-55.910	1.00	59.50	C
ATOM	4032	C	GLU	A	523	7.276	82.815	-57.227	1.00	52.27	C
ATOM	4033	O	GLU	A	523	6.942	81.820	-57.860	1.00	48.29	O

ATOM	4034	CB	GLU	A	523	5.526	84.285	-56.121	1.00	58.47	C
ATOM	4035	CG	GLU	A	523	4.197	83.784	-56.712	1.00	59.48	C
ATOM	4036	CD	GLU	A	523	3.182	84.898	-56.960	1.00	64.53	C
ATOM	4037	OE1	GLU	A	523	3.481	86.070	-56.646	1.00	65.89	O
ATOM	4038	OE2	GLU	A	523	2.086	84.595	-57.479	1.00	65.80	O
ATOM	4039	N	LEU	A	524	8.241	83.643	-57.619	1.00	55.50	N
ATOM	4040	CA	LEU	A	524	9.014	83.434	-58.838	1.00	58.01	C
ATOM	4041	C	LEU	A	524	9.771	82.101	-58.865	1.00	55.01	C
ATOM	4042	O	LEU	A	524	9.800	81.448	-59.893	1.00	54.59	O
ATOM	4043	CB	LEU	A	524	10.006	84.573	-59.043	1.00	56.99	C
ATOM	4044	CG	LEU	A	524	10.220	84.958	-60.504	1.00	57.14	C
ATOM	4045	CD1	LEU	A	524	8.882	85.230	-61.175	1.00	53.87	C
ATOM	4046	CD2	LEU	A	524	11.136	86.157	-60.619	1.00	60.84	C
ATOM	4047	N	THR	A	525	10.350	81.683	-57.742	1.00	57.98	N
ATOM	4048	CA	THR	A	525	11.168	80.466	-57.738	1.00	54.22	C
ATOM	4049	C	THR	A	525	10.318	79.209	-57.859	1.00	56.55	C
ATOM	4050	O	THR	A	525	10.847	78.099	-57.949	1.00	60.84	O
ATOM	4051	CB	THR	A	525	12.050	80.359	-56.466	1.00	58.10	C
ATOM	4052	OG1	THR	A	525	13.303	79.746	-56.800	1.00	66.15	O
ATOM	4053	CG2	THR	A	525	11.364	79.538	-55.367	1.00	57.18	C
ATOM	4054	N	LYS	A	526	8.998	79.360	-57.885	1.00	55.03	N
ATOM	4055	CA	LYS	A	526	8.166	78.175	-58.017	1.00	55.89	C
ATOM	4056	C	LYS	A	526	7.310	78.159	-59.288	1.00	56.65	C
ATOM	4057	O	LYS	A	526	6.469	77.269	-59.461	1.00	61.79	O
ATOM	4058	CB	LYS	A	526	7.288	78.003	-56.780	1.00	55.41	C
ATOM	4059	CG	LYS	A	526	8.010	77.361	-55.612	1.00	56.19	C
ATOM	4060	CD	LYS	A	526	8.653	76.016	-55.995	1.00	59.07	C
ATOM	4061	CE	LYS	A	526	9.396	75.381	-54.806	1.00	61.05	C
ATOM	4062	NZ	LYS	A	526	10.209	74.157	-55.124	1.00	58.67	N
ATOM	4063	N	VAL	A	527	7.548	79.093	-60.205	1.00	51.55	N
ATOM	4064	CA	VAL	A	527	6.850	79.006	-61.487	1.00	61.84	C
ATOM	4065	C	VAL	A	527	7.585	78.068	-62.465	1.00	65.99	C
ATOM	4066	O	VAL	A	527	8.782	77.766	-62.310	1.00	64.37	O
ATOM	4067	CB	VAL	A	527	6.612	80.420	-62.128	1.00	64.85	C
ATOM	4068	CG2	VAL	A	527	7.376	80.601	-63.426	1.00	64.63	C
ATOM	4069	CG1	VAL	A	527	6.911	81.543	-61.132	1.00	57.94	C
ATOM	4070	O	LYS	A	528	6.034	77.940	-65.992	1.00	72.32	O
ATOM	4071	N	LYS	A	528	6.833	77.561	-63.435	1.00	64.29	N
ATOM	4072	CA	LYS	A	528	7.375	76.676	-64.449	1.00	70.50	C
ATOM	4073	C	LYS	A	528	6.968	77.156	-65.836	1.00	71.04	C
ATOM	4074	CB	LYS	A	528	6.911	75.232	-64.217	1.00	69.38	C
ATOM	4075	CG	LYS	A	528	7.140	74.749	-62.794	1.00	68.83	C
ATOM	4076	CD	LYS	A	528	7.026	73.244	-62.656	1.00	75.66	C
ATOM	4077	CE	LYS	A	528	7.245	72.806	-61.206	1.00	79.66	C
ATOM	4078	NZ	LYS	A	528	6.265	73.443	-60.247	1.00	83.17	N
ATOM	4079	O	TYR	A	529	8.564	75.035	-68.864	1.00	72.69	O
ATOM	4080	N	TYR	A	529	7.692	76.695	-66.842	1.00	68.16	N
ATOM	4081	CA	TYR	A	529	7.387	77.036	-68.214	1.00	68.40	C
ATOM	4082	C	TYR	A	529	7.707	75.877	-69.148	1.00	74.74	C
ATOM	4083	CB	TYR	A	529	8.157	78.277	-68.645	1.00	69.15	C
ATOM	4084	CG	TYR	A	529	9.644	78.075	-68.655	1.00	74.86	C
ATOM	4085	CD2	TYR	A	529	10.317	77.790	-69.829	1.00	77.46	C
ATOM	4086	CD1	TYR	A	529	10.379	78.156	-67.481	1.00	74.52	C
ATOM	4087	CE2	TYR	A	529	11.695	77.605	-69.833	1.00	78.55	C
ATOM	4088	CE1	TYR	A	529	11.748	77.973	-67.469	1.00	73.64	C
ATOM	4089	CZ	TYR	A	529	12.403	77.697	-68.649	1.00	78.54	C
ATOM	4090	OH	TYR	A	529	13.767	77.519	-68.645	1.00	74.82	O
ATOM	4091	O	VAL	A	530	6.285	76.354	-72.943	1.00	83.98	O
ATOM	4092	N	VAL	A	530	6.977	75.827	-70.252	1.00	75.68	N
ATOM	4093	CA	VAL	A	530	7.264	74.899	-71.325	1.00	79.50	C
ATOM	4094	C	VAL	A	530	7.278	75.704	-72.611	1.00	82.26	C
ATOM	4095	CB	VAL	A	530	6.223	73.763	-71.412	1.00	80.28	C
ATOM	4096	CG1	VAL	A	530	6.415	72.975	-72.679	1.00	83.27	C

ATOM	4097	CG2	VAL	A	530	6.313	72.847	-70.199	1.00	76.16	C
ATOM	4098	O	THR	A	531	8.417	73.959	-75.248	1.00	88.41	O
ATOM	4099	N	THR	A	531	8.415	75.705	-73.303	1.00	80.28	N
ATOM	4100	CA	THR	A	531	8.496	76.269	-74.648	1.00	83.62	C
ATOM	4101	C	THR	A	531	8.455	75.119	-75.651	1.00	82.45	C
ATOM	4102	CB	THR	A	531	9.767	77.119	-74.862	1.00	88.00	C
ATOM	4103	OG1	THR	A	531	10.897	76.261	-75.071	1.00	90.06	O
ATOM	4104	CG2	THR	A	531	10.015	78.049	-73.669	1.00	81.90	C
ATOM	4105	O	GLU	A	532	8.474	72.072	-78.107	1.00	88.07	O
ATOM	4106	N	GLU	A	532	8.474	75.440	-76.944	1.00	88.04	N
ATOM	4107	CA	GLU	A	532	8.220	74.461	-78.009	1.00	84.77	C
ATOM	4108	C	GLU	A	532	9.017	73.163	-77.892	1.00	87.09	C
ATOM	4109	CB	GLU	A	532	8.496	75.090	-79.376	1.00	80.41	C
ATOM	4110	O	GLY	A	533	12.889	71.601	-75.964	1.00	86.50	O
ATOM	4111	N	GLY	A	533	10.296	73.271	-77.543	1.00	84.61	N
ATOM	4112	CA	GLY	A	533	11.165	72.106	-77.545	1.00	90.79	C
ATOM	4113	C	GLY	A	533	11.679	71.683	-76.184	1.00	90.65	C
ATOM	4114	O	MET	A	534	11.474	68.818	-73.083	1.00	96.72	O
ATOM	4115	N	MET	A	534	10.760	71.406	-75.266	1.00	91.79	N
ATOM	4116	CA	MET	A	534	11.149	71.037	-73.915	1.00	89.28	C
ATOM	4117	C	MET	A	534	10.683	69.628	-73.577	1.00	91.48	C
ATOM	4118	CB	MET	A	534	10.603	72.053	-72.903	1.00	87.85	C
ATOM	4119	CG	MET	A	534	11.054	73.488	-73.192	1.00	85.55	C
ATOM	4120	SD	MET	A	534	11.484	74.489	-71.738	1.00	83.87	S
ATOM	4121	CE	MET	A	534	12.504	75.741	-72.523	1.00	77.15	C
ATOM	4122	O	ARG	A	535	8.076	66.711	-71.708	1.00	97.17	O
ATOM	4123	N	ARG	A	535	9.407	69.349	-73.848	1.00	90.92	N
ATOM	4124	CA	ARG	A	535	8.774	68.047	-73.581	1.00	92.61	C
ATOM	4125	C	ARG	A	535	8.577	67.768	-72.088	1.00	91.69	C
ATOM	4126	CB	ARG	A	535	9.578	66.905	-74.217	1.00	86.90	C
ATOM	4127	O	LYS	A	536	9.632	70.883	-69.757	1.00	85.35	O
ATOM	4128	N	LYS	A	536	8.958	68.728	-71.253	1.00	92.29	N
ATOM	4129	CA	LYS	A	536	8.853	68.609	-69.802	1.00	89.81	C
ATOM	4130	C	LYS	A	536	8.962	70.011	-69.194	1.00	88.03	C
ATOM	4131	CB	LYS	A	536	9.938	67.677	-69.251	1.00	84.56	C
ATOM	4132	O	PRO	A	537	9.980	71.122	-65.882	1.00	78.54	O
ATOM	4133	N	PRO	A	537	8.286	70.243	-68.056	1.00	87.33	N
ATOM	4134	CA	PRO	A	537	8.233	71.592	-67.463	1.00	83.67	C
ATOM	4135	C	PRO	A	537	9.477	71.953	-66.638	1.00	77.38	C
ATOM	4136	CB	PRO	A	537	6.985	71.525	-66.579	1.00	83.79	C
ATOM	4137	CG	PRO	A	537	6.912	70.079	-66.163	1.00	88.55	C
ATOM	4138	CD	PRO	A	537	7.459	69.270	-67.316	1.00	83.56	C
ATOM	4139	O	ALA	A	538	10.275	75.729	-65.507	1.00	69.16	O
ATOM	4140	N	ALA	A	538	9.954	73.188	-66.781	1.00	72.17	N
ATOM	4141	CA	ALA	A	538	11.208	73.615	-66.159	1.00	71.31	C
ATOM	4142	C	ALA	A	538	11.050	74.814	-65.222	1.00	72.32	C
ATOM	4143	CB	ALA	A	538	12.237	73.945	-67.242	1.00	72.91	C
ATOM	4144	O	PHE	A	539	13.702	76.799	-64.513	1.00	70.99	O
ATOM	4145	N	PHE	A	539	11.798	74.806	-64.116	1.00	63.62	N
ATOM	4146	CA	PHE	A	539	11.881	75.963	-63.233	1.00	60.26	C
ATOM	4147	C	PHE	A	539	12.686	77.067	-63.885	1.00	63.53	C
ATOM	4148	CB	PHE	A	539	12.536	75.617	-61.897	1.00	56.44	C
ATOM	4149	CG	PHE	A	539	11.647	74.880	-60.936	1.00	60.16	C
ATOM	4150	CD2	PHE	A	539	12.045	73.656	-60.404	1.00	64.58	C
ATOM	4151	CD1	PHE	A	539	10.441	75.419	-60.522	1.00	61.82	C
ATOM	4152	CE2	PHE	A	539	11.237	72.974	-59.507	1.00	64.60	C
ATOM	4153	CE1	PHE	A	539	9.631	74.744	-59.632	1.00	59.36	C
ATOM	4154	CZ	PHE	A	539	10.029	73.523	-59.121	1.00	67.30	C
ATOM	4155	O	LEU	A	540	14.517	78.867	-62.296	1.00	63.99	O
ATOM	4156	N	LEU	A	540	12.233	78.304	-63.725	1.00	57.90	N
ATOM	4157	CA	LEU	A	540	13.031	79.464	-64.086	1.00	59.60	C
ATOM	4158	C	LEU	A	540	14.378	79.430	-63.386	1.00	62.97	C
ATOM	4159	CB	LEU	A	540	12.319	80.764	-63.719	1.00	57.20	C

ATOM	4160	CG	LEU	A	540	10.856	80.986	-64.075	1.00	62.11	C
ATOM	4161	CD1	LEU	A	540	10.413	82.379	-63.603	1.00	53.79	C
ATOM	4162	CD2	LEU	A	540	10.653	80.840	-65.557	1.00	60.08	C
ATOM	4163	O	SER	A	541	16.507	82.407	-63.308	1.00	63.82	O
ATOM	4164	N	SER	A	541	15.364	80.064	-64.001	1.00	65.40	N
ATOM	4165	CA	SER	A	541	16.730	80.032	-63.489	1.00	67.52	C
ATOM	4166	C	SER	A	541	17.175	81.412	-63.030	1.00	68.02	C
ATOM	4167	CB	SER	A	541	17.670	79.513	-64.562	1.00	61.30	C
ATOM	4168	OG	SER	A	541	17.574	80.329	-65.716	1.00	62.95	O
ATOM	4169	N	GLY	A	542	18.318	81.463	-62.352	1.00	65.56	N
ATOM	4170	CA	GLY	A	542	18.825	82.691	-61.760	1.00	61.76	C
ATOM	4171	C	GLY	A	542	18.887	83.867	-62.716	1.00	64.32	C
ATOM	4172	O	GLY	A	542	18.513	84.986	-62.368	1.00	63.39	O
ATOM	4173	N	GLU	A	543	19.369	83.616	-63.927	1.00	66.83	N
ATOM	4174	CA	GLU	A	543	19.390	84.652	-64.944	1.00	67.74	C
ATOM	4175	C	GLU	A	543	17.941	85.009	-65.298	1.00	68.58	C
ATOM	4176	O	GLU	A	543	17.595	86.188	-65.426	1.00	58.96	O
ATOM	4177	CB	GLU	A	543	20.165	84.196	-66.188	1.00	63.54	C
ATOM	4178	N	GLN	A	544	17.103	83.978	-65.426	1.00	65.36	N
ATOM	4179	CA	GLN	A	544	15.710	84.168	-65.825	1.00	69.12	C
ATOM	4180	C	GLN	A	544	14.938	84.965	-64.765	1.00	67.02	C
ATOM	4181	O	GLN	A	544	14.240	85.930	-65.098	1.00	67.86	O
ATOM	4182	CB	GLN	A	544	15.041	82.817	-66.100	1.00	66.71	C
ATOM	4183	CG	GLN	A	544	15.481	82.183	-67.422	1.00	65.66	C
ATOM	4184	CD	GLN	A	544	14.893	80.795	-67.654	1.00	65.18	C
ATOM	4185	OE1	GLN	A	544	14.775	79.988	-66.730	1.00	68.32	O
ATOM	4186	NE2	GLN	A	544	14.524	80.514	-68.894	1.00	68.50	N
ATOM	4187	N	LYS	A	545	15.090	84.573	-63.502	1.00	60.63	N
ATOM	4188	CA	LYS	A	545	14.529	85.312	-62.385	1.00	61.54	C
ATOM	4189	C	LYS	A	545	15.004	86.760	-62.391	1.00	64.21	C
ATOM	4190	O	LYS	A	545	14.182	87.682	-62.381	1.00	64.26	O
ATOM	4191	CB	LYS	A	545	14.882	84.644	-61.054	1.00	58.04	C
ATOM	4192	N	LYS	A	546	16.318	86.964	-62.449	1.00	60.22	N
ATOM	4193	CA	LYS	A	546	16.891	88.317	-62.349	1.00	62.74	C
ATOM	4194	C	LYS	A	546	16.458	89.237	-63.476	1.00	66.65	C
ATOM	4195	O	LYS	A	546	16.455	90.445	-63.309	1.00	69.63	O
ATOM	4196	CB	LYS	A	546	18.416	88.264	-62.323	1.00	67.73	C
ATOM	4197	N	ALA	A	547	16.109	88.657	-64.622	1.00	66.15	N
ATOM	4198	CA	ALA	A	547	15.704	89.433	-65.783	1.00	67.02	C
ATOM	4199	C	ALA	A	547	14.253	89.828	-65.655	1.00	70.78	C
ATOM	4200	O	ALA	A	547	13.892	90.989	-65.850	1.00	70.30	O
ATOM	4201	CB	ALA	A	547	15.916	88.653	-67.055	1.00	61.67	C
ATOM	4202	N	ILE	A	548	13.423	88.841	-65.339	1.00	70.17	N
ATOM	4203	CA	ILE	A	548	12.002	89.069	-65.178	1.00	67.24	C
ATOM	4204	C	ILE	A	548	11.777	90.199	-64.190	1.00	66.42	C
ATOM	4205	O	ILE	A	548	11.052	91.138	-64.472	1.00	70.64	O
ATOM	4206	CB	ILE	A	548	11.285	87.802	-64.712	1.00	67.32	C
ATOM	4207	CG1	ILE	A	548	11.065	86.865	-65.903	1.00	62.93	C
ATOM	4208	CG2	ILE	A	548	9.955	88.155	-64.086	1.00	63.23	C
ATOM	4209	CD1	ILE	A	548	10.976	85.424	-65.519	1.00	63.87	C
ATOM	4210	N	VAL	A	549	12.446	90.123	-63.052	1.00	65.51	N
ATOM	4211	CA	VAL	A	549	12.374	91.171	-62.049	1.00	67.59	C
ATOM	4212	C	VAL	A	549	12.900	92.516	-62.579	1.00	72.46	C
ATOM	4213	O	VAL	A	549	12.270	93.559	-62.379	1.00	71.86	O
ATOM	4214	CB	VAL	A	549	13.161	90.770	-60.776	1.00	61.14	C
ATOM	4215	CG1	VAL	A	549	13.371	91.971	-59.875	1.00	58.14	C
ATOM	4216	CG2	VAL	A	549	12.450	89.630	-60.040	1.00	54.06	C
ATOM	4217	N	ASP	A	550	14.046	92.485	-63.257	1.00	74.72	N
ATOM	4218	CA	ASP	A	550	14.667	93.694	-63.807	1.00	71.90	C
ATOM	4219	C	ASP	A	550	13.828	94.334	-64.899	1.00	71.19	C
ATOM	4220	O	ASP	A	550	13.865	95.553	-65.081	1.00	74.87	O
ATOM	4221	CB	ASP	A	550	16.060	93.383	-64.362	1.00	69.53	C
ATOM	4222	CG	ASP	A	550	17.132	93.413	-63.291	1.00	72.83	C

ATOM	4223	OD1	ASP	A	550	16.769	93.547	-62.104	1.00	76.08	O
ATOM	4224	OD2	ASP	A	550	18.329	93.304	-63.630	1.00	69.40	O
ATOM	4225	N	LEU	A	551	13.074	93.507	-65.620	1.00	73.73	N
ATOM	4226	CA	LEU	A	551	12.359	93.947	-66.824	1.00	77.34	C
ATOM	4227	C	LEU	A	551	10.828	94.064	-66.640	1.00	76.01	C
ATOM	4228	O	LEU	A	551	10.200	94.926	-67.250	1.00	80.14	O
ATOM	4229	CB	LEU	A	551	12.687	92.998	-67.996	1.00	70.73	C
ATOM	4230	CG	LEU	A	551	14.193	92.919	-68.293	1.00	76.66	C
ATOM	4231	CD1	LEU	A	551	14.550	91.863	-69.355	1.00	66.45	C
ATOM	4232	CD2	LEU	A	551	14.740	94.298	-68.670	1.00	74.24	C
ATOM	4233	N	LEU	A	552	10.234	93.217	-65.801	1.00	71.30	N
ATOM	4234	CA	LEU	A	552	8.790	93.249	-65.600	1.00	67.91	C
ATOM	4235	C	LEU	A	552	8.385	93.872	-64.254	1.00	73.36	C
ATOM	4236	O	LEU	A	552	7.690	94.882	-64.227	1.00	75.74	O
ATOM	4237	CB	LEU	A	552	8.203	91.841	-65.729	1.00	69.35	C
ATOM	4238	CG	LEU	A	552	8.365	91.212	-67.119	1.00	70.69	C
ATOM	4239	CD1	LEU	A	552	7.471	89.995	-67.311	1.00	69.51	C
ATOM	4240	CD2	LEU	A	552	8.089	92.250	-68.182	1.00	69.43	C
ATOM	4241	N	PHE	A	553	8.814	93.300	-63.137	1.00	66.99	N
ATOM	4242	CA	PHE	A	553	8.331	93.797	-61.851	1.00	69.47	C
ATOM	4243	C	PHE	A	553	8.861	95.185	-61.458	1.00	77.12	C
ATOM	4244	O	PHE	A	553	8.371	95.779	-60.492	1.00	76.81	O
ATOM	4245	CB	PHE	A	553	8.658	92.806	-60.743	1.00	63.13	C
ATOM	4246	CG	PHE	A	553	7.881	91.531	-60.825	1.00	68.20	C
ATOM	4247	CD1	PHE	A	553	8.331	90.475	-61.612	1.00	62.33	C
ATOM	4248	CD2	PHE	A	553	6.709	91.376	-60.110	1.00	61.29	C
ATOM	4249	CE1	PHE	A	553	7.621	89.303	-61.694	1.00	56.32	C
ATOM	4250	CE2	PHE	A	553	5.997	90.188	-60.179	1.00	63.33	C
ATOM	4251	CZ	PHE	A	553	6.457	89.152	-60.977	1.00	60.72	C
ATOM	4252	N	LYS	A	554	9.842	95.699	-62.198	1.00	77.56	N
ATOM	4253	CA	LYS	A	554	10.434	97.005	-61.887	1.00	81.45	C
ATOM	4254	C	LYS	A	554	10.030	98.083	-62.893	1.00	82.35	C
ATOM	4255	O	LYS	A	554	10.492	99.229	-62.814	1.00	80.95	O
ATOM	4256	CB	LYS	A	554	11.965	96.917	-61.829	1.00	78.18	C
ATOM	4257	CG	LYS	A	554	12.540	96.631	-60.457	1.00	76.75	C
ATOM	4258	CD	LYS	A	554	14.044	96.849	-60.459	1.00	79.34	C
ATOM	4259	CE	LYS	A	554	14.734	96.003	-59.400	1.00	75.14	C
ATOM	4260	NZ	LYS	A	554	16.175	96.333	-59.292	1.00	76.30	N
ATOM	4261	N	THR	A	555	9.177	97.704	-63.839	1.00	82.35	N
ATOM	4262	CA	THR	A	555	8.639	98.647	-64.815	1.00	81.12	C
ATOM	4263	C	THR	A	555	7.105	98.572	-64.905	1.00	84.91	C
ATOM	4264	O	THR	A	555	6.498	99.291	-65.699	1.00	91.98	O
ATOM	4265	CB	THR	A	555	9.251	98.429	-66.227	1.00	84.05	C
ATOM	4266	OG1	THR	A	555	9.101	97.059	-66.627	1.00	82.03	O
ATOM	4267	CG2	THR	A	555	10.730	98.810	-66.245	1.00	79.14	C
ATOM	4268	N	ASN	A	556	6.480	97.701	-64.109	1.00	85.04	N
ATOM	4269	CA	ASN	A	556	5.054	97.850	-63.820	1.00	83.24	C
ATOM	4270	C	ASN	A	556	4.643	97.262	-62.474	1.00	80.28	C
ATOM	4271	O	ASN	A	556	5.095	96.184	-62.081	1.00	78.06	O
ATOM	4272	CB	ASN	A	556	4.188	97.251	-64.932	1.00	82.92	C
ATOM	4273	CG	ASN	A	556	2.977	98.142	-65.258	1.00	87.41	C
ATOM	4274	OD1	ASN	A	556	3.116	99.178	-65.919	1.00	86.77	O
ATOM	4275	ND2	ASN	A	556	1.798	97.757	-64.768	1.00	77.77	N
ATOM	4276	O	ARG	A	557	2.690	95.750	-59.194	1.00	78.29	O
ATOM	4277	N	ARG	A	557	3.763	97.996	-61.792	1.00	80.24	N
ATOM	4278	CA	ARG	A	557	3.328	97.693	-60.435	1.00	76.72	C
ATOM	4279	C	ARG	A	557	2.695	96.327	-60.281	1.00	78.01	C
ATOM	4280	CB	ARG	A	557	2.340	98.745	-59.966	1.00	77.49	C
ATOM	4281	CG	ARG	A	557	2.964	100.079	-59.742	1.00	73.91	C
ATOM	4282	CD	ARG	A	557	1.917	101.078	-59.302	1.00	67.94	C
ATOM	4283	NE	ARG	A	557	2.563	102.350	-59.040	1.00	68.62	N
ATOM	4284	CZ	ARG	A	557	3.079	102.682	-57.867	1.00	69.26	C
ATOM	4285	NH1	ARG	A	557	2.978	101.836	-56.849	1.00	69.19	N

ATOM	4286	NH2	ARG	A	557	3.681	103.858	-57.712	1.00	70.68	N
ATOM	4287	O	LYS	A	558	2.786	94.508	-63.506	1.00	67.10	O
ATOM	4288	N	LYS	A	558	2.122	95.821	-61.360	1.00	77.31	N
ATOM	4289	CA	LYS	A	558	1.709	94.437	-61.373	1.00	70.87	C
ATOM	4290	C	LYS	A	558	2.241	93.816	-62.648	1.00	72.55	C
ATOM	4291	CB	LYS	A	558	0.194	94.304	-61.260	1.00	74.12	C
ATOM	4292	CG	LYS	A	558	-0.361	94.751	-59.904	1.00	78.94	C
ATOM	4293	O	VAL	A	559	1.640	89.648	-63.264	1.00	68.55	O
ATOM	4294	N	VAL	A	559	2.117	92.498	-62.739	1.00	74.02	N
ATOM	4295	CA	VAL	A	559	2.669	91.736	-63.843	1.00	65.95	C
ATOM	4296	C	VAL	A	559	1.757	90.547	-64.104	1.00	70.48	C
ATOM	4297	CB	VAL	A	559	4.115	91.245	-63.535	1.00	71.24	C
ATOM	4298	CG1	VAL	A	559	4.537	90.108	-64.480	1.00	68.38	C
ATOM	4299	CG2	VAL	A	559	5.112	92.395	-63.598	1.00	64.83	C
ATOM	4300	O	THR	A	560	2.289	88.478	-66.554	1.00	74.84	O
ATOM	4301	N	THR	A	560	1.088	90.547	-65.252	1.00	69.41	N
ATOM	4302	CA	THR	A	560	0.274	89.394	-65.630	1.00	71.46	C
ATOM	4303	C	THR	A	560	1.117	88.274	-66.225	1.00	73.52	C
ATOM	4304	CB	THR	A	560	-0.791	89.768	-66.654	1.00	72.20	C
ATOM	4305	CG1	THR	A	560	-1.271	88.577	-67.302	1.00	72.59	O
ATOM	4306	CG2	THR	A	560	-0.196	90.680	-67.694	1.00	66.73	C
ATOM	4307	N	VAL	A	561	0.508	87.102	-66.380	1.00	69.69	N
ATOM	4308	CA	VAL	A	561	1.120	86.006	-67.126	1.00	73.33	C
ATOM	4309	C	VAL	A	561	1.263	86.366	-68.608	1.00	78.07	C
ATOM	4310	O	VAL	A	561	2.220	85.964	-69.276	1.00	78.68	O
ATOM	4311	CB	VAL	A	561	0.296	84.719	-66.991	1.00	72.12	C
ATOM	4312	CG1	VAL	A	561	0.981	83.567	-67.685	1.00	75.71	C
ATOM	4313	CG2	VAL	A	561	0.082	84.393	-65.530	1.00	73.69	C
ATOM	4314	N	LYS	A	562	0.303	87.133	-69.117	1.00	81.69	N
ATOM	4315	CA	LYS	A	562	0.355	87.607	-70.492	1.00	78.73	C
ATOM	4316	C	LYS	A	562	1.586	88.487	-70.691	1.00	83.98	C
ATOM	4317	O	LYS	A	562	2.247	88.418	-71.726	1.00	90.79	O
ATOM	4318	CB	LYS	A	562	-0.919	88.369	-70.855	1.00	71.73	C
ATOM	4319	N	GLN	A	563	1.899	89.304	-69.693	1.00	79.57	N
ATOM	4320	CA	GLN	A	563	3.078	90.147	-69.761	1.00	79.82	C
ATOM	4321	C	GLN	A	563	4.306	89.267	-69.798	1.00	84.76	C
ATOM	4322	O	GLN	A	563	5.266	89.549	-70.506	1.00	87.16	O
ATOM	4323	CB	GLN	A	563	3.147	91.087	-68.571	1.00	81.16	C
ATOM	4324	CG	GLN	A	563	3.690	92.455	-68.899	1.00	81.52	C
ATOM	4325	CD	GLN	A	563	3.004	93.536	-68.088	1.00	81.54	C
ATOM	4326	OE1	GLN	A	563	2.347	94.410	-68.647	1.00	80.75	O
ATOM	4327	NE2	GLN	A	563	3.147	93.477	-66.759	1.00	75.14	N
ATOM	4328	N	LEU	A	564	4.258	88.184	-69.032	1.00	83.20	N
ATOM	4329	CA	LEU	A	564	5.372	87.248	-68.962	1.00	86.15	C
ATOM	4330	C	LEU	A	564	5.567	86.537	-70.298	1.00	85.17	C
ATOM	4331	O	LEU	A	564	6.691	86.356	-70.771	1.00	81.74	O
ATOM	4332	CB	LEU	A	564	5.145	86.217	-67.851	1.00	80.63	C
ATOM	4333	CG	LEU	A	564	6.218	85.132	-67.832	1.00	78.65	C
ATOM	4334	CD1	LEU	A	564	7.557	85.800	-67.572	1.00	78.81	C
ATOM	4335	CD2	LEU	A	564	5.920	84.064	-66.794	1.00	77.83	C
ATOM	4336	N	LYS	A	565	4.459	86.135	-70.901	1.00	83.09	N
ATOM	4337	CA	LYS	A	565	4.539	85.373	-72.122	1.00	83.61	C
ATOM	4338	C	LYS	A	565	5.062	86.253	-73.242	1.00	84.47	C
ATOM	4339	O	LYS	A	565	6.131	86.005	-73.787	1.00	83.19	O
ATOM	4340	CB	LYS	A	565	3.177	84.782	-72.460	1.00	81.04	C
ATOM	4341	CG	LYS	A	565	2.712	83.779	-71.418	1.00	77.89	C
ATOM	4342	CD	LYS	A	565	1.551	82.945	-71.934	1.00	78.18	C
ATOM	4343	CE	LYS	A	565	1.190	81.846	-70.963	1.00	72.42	C
ATOM	4344	NZ	LYS	A	565	-0.019	81.126	-71.398	1.00	72.69	N
ATOM	4345	N	GLU	A	566	4.328	87.313	-73.546	1.00	85.81	N
ATOM	4346	CA	GLU	A	566	4.637	88.136	-74.702	1.00	87.22	C
ATOM	4347	C	GLU	A	566	5.827	89.054	-74.477	1.00	88.75	C
ATOM	4348	O	GLU	A	566	6.721	89.130	-75.320	1.00	88.93	O

ATOM	4349	CB	GLU	A	566	3.418	88.972	-75.091	1.00	92.36	C
ATOM	4350	CG	GLU	A	566	2.186	88.150	-75.417	1.00	97.52	C
ATOM	4351	CD	GLU	A	566	0.939	89.008	-75.537	1.00	108.75	C
ATOM	4352	OE1	GLU	A	566	-0.046	88.548	-76.158	1.00	113.75	O
ATOM	4353	OE2	GLU	A	566	0.947	90.141	-75.003	1.00	104.76	O
ATOM	4354	N	ASP	A	567	5.833	89.761	-73.349	1.00	85.14	N
ATOM	4355	CA	ASP	A	567	6.795	90.841	-73.154	1.00	85.91	C
ATOM	4356	C	ASP	A	567	8.188	90.336	-72.758	1.00	88.86	C
ATOM	4357	O	ASP	A	567	9.180	91.022	-72.990	1.00	89.93	O
ATOM	4358	CB	ASP	A	567	6.276	91.837	-72.110	1.00	88.30	C
ATOM	4359	CG	ASP	A	567	6.320	93.271	-72.605	1.00	94.00	C
ATOM	4360	OD2	ASP	A	567	5.266	93.949	-72.575	1.00	85.33	O
ATOM	4361	OD1	ASP	A	567	7.410	93.707	-73.047	1.00	96.98	O
ATOM	4362	N	TYR	A	568	8.272	89.146	-72.171	1.00	83.05	N
ATOM	4363	CA	TYR	A	568	9.575	88.563	-71.867	1.00	82.68	C
ATOM	4364	C	TYR	A	568	9.864	87.357	-72.741	1.00	81.96	C
ATOM	4365	O	TYR	A	568	10.752	87.394	-73.594	1.00	80.86	O
ATOM	4366	CB	TYR	A	568	9.677	88.147	-70.394	1.00	81.71	C
ATOM	4367	CG	TYR	A	568	10.970	87.415	-70.053	1.00	79.86	C
ATOM	4368	CD2	TYR	A	568	10.980	86.048	-69.811	1.00	75.32	C
ATOM	4369	CD1	TYR	A	568	12.179	88.100	-69.971	1.00	79.67	C
ATOM	4370	CE2	TYR	A	568	12.151	85.390	-69.503	1.00	77.30	C
ATOM	4371	CE1	TYR	A	568	13.355	87.450	-69.666	1.00	70.95	C
ATOM	4372	CZ	TYR	A	568	13.339	86.095	-69.431	1.00	77.06	C
ATOM	4373	OH	TYR	A	568	14.518	85.438	-69.123	1.00	74.87	O
ATOM	4374	O	PHE	A	569	10.184	84.473	-75.361	1.00	78.54	O
ATOM	4375	N	PHE	A	569	9.114	86.284	-72.515	1.00	77.70	N
ATOM	4376	CA	PHE	A	569	9.410	85.020	-73.159	1.00	77.50	C
ATOM	4377	C	PHE	A	569	9.372	85.106	-74.689	1.00	82.35	C
ATOM	4378	CB	PHE	A	569	8.460	83.940	-72.647	1.00	79.19	C
ATOM	4379	CG	PHE	A	569	9.083	83.050	-71.615	1.00	81.93	C
ATOM	4380	CD1	PHE	A	569	9.859	81.965	-71.996	1.00	83.90	C
ATOM	4381	CD2	PHE	A	569	8.933	83.315	-70.264	1.00	83.19	C
ATOM	4382	CE1	PHE	A	569	10.454	81.141	-71.046	1.00	83.12	C
ATOM	4383	CE2	PHE	A	569	9.528	82.498	-69.307	1.00	82.54	C
ATOM	4384	CZ	PHE	A	569	10.290	81.408	-69.702	1.00	81.90	C
ATOM	4385	O	LYS	A	570	10.243	87.083	-77.866	1.00	84.01	O
ATOM	4386	N	LYS	A	570	8.458	85.906	-75.239	1.00	84.54	N
ATOM	4387	CA	LYS	A	570	8.413	86.109	-76.683	1.00	77.10	C
ATOM	4388	C	LYS	A	570	9.313	87.262	-77.086	1.00	80.83	C
ATOM	4389	CB	LYS	A	570	6.985	86.361	-77.162	1.00	76.15	C
ATOM	4390	O	LYS	A	571	12.062	89.791	-77.621	1.00	87.77	O
ATOM	4391	N	LYS	A	571	9.040	88.444	-76.547	1.00	82.36	N
ATOM	4392	CA	LYS	A	571	9.774	89.643	-76.930	1.00	82.14	C
ATOM	4393	C	LYS	A	571	11.278	89.476	-76.729	1.00	84.95	C
ATOM	4394	CB	LYS	A	571	9.266	90.855	-76.138	1.00	85.20	C
ATOM	4395	CG	LYS	A	571	9.666	92.212	-76.714	1.00	78.23	C
ATOM	4396	O	ILE	A	572	14.960	87.507	-75.658	1.00	85.12	O
ATOM	4397	N	ILE	A	572	11.682	88.951	-75.575	1.00	85.89	N
ATOM	4398	CA	ILE	A	572	13.100	88.935	-75.214	1.00	83.52	C
ATOM	4399	C	ILE	A	572	13.784	87.569	-75.331	1.00	82.00	C
ATOM	4400	CB	ILE	A	572	13.308	89.455	-73.773	1.00	86.49	C
ATOM	4401	O	GLU	A	573	13.493	83.261	-76.673	1.00	80.71	O
ATOM	4402	N	GLU	A	573	13.072	86.480	-75.058	1.00	80.80	N
ATOM	4403	CA	GLU	A	573	13.664	85.144	-75.191	1.00	78.57	C
ATOM	4404	C	GLU	A	573	13.288	84.466	-76.506	1.00	80.90	C
ATOM	4405	CB	GLU	A	573	13.244	84.250	-74.023	1.00	82.43	C
ATOM	4406	CG	GLU	A	573	13.939	84.552	-72.716	1.00	82.79	C
ATOM	4407	CD	GLU	A	573	15.204	83.747	-72.523	1.00	77.91	C
ATOM	4408	OE1	GLU	A	573	16.293	84.369	-72.524	1.00	84.51	O
ATOM	4409	OE2	GLU	A	573	15.106	82.505	-72.351	1.00	73.35	O
ATOM	4410	O	GLU	A	574	11.820	82.739	-79.859	1.00	84.41	O
ATOM	4411	N	GLU	A	574	12.709	85.247	-77.412	1.00	80.35	N

ATOM	4412	CA	GLU	A	574	12.326	84.812	-78.758	1.00	78.85	C
ATOM	4413	C	GLU	A	574	11.655	83.440	-78.862	1.00	80.70	C
ATOM	4414	CB	GLU	A	574	13.551	84.845	-79.671	1.00	84.85	C
ATOM	4415	CG	GLU	A	574	14.020	86.262	-80.003	1.00	90.17	C
ATOM	4416	CD	GLU	A	574	15.485	86.323	-80.407	1.00	93.74	C
ATOM	4417	OE1	GLU	A	574	16.152	85.263	-80.406	1.00	91.69	O
ATOM	4418	OE2	GLU	A	574	15.969	87.436	-80.712	1.00	96.17	O
ATOM	4419	O	PHE	A	575	8.060	83.168	-77.636	1.00	81.49	O
ATOM	4420	N	PHE	A	575	10.889	83.065	-77.845	1.00	79.15	N
ATOM	4421	CA	PHE	A	575	10.057	81.873	-77.931	1.00	84.44	C
ATOM	4422	C	PHE	A	575	8.608	82.255	-78.235	1.00	84.31	C
ATOM	4423	CB	PHE	A	575	10.141	81.064	-76.639	1.00	85.31	C
ATOM	4424	CG	PHE	A	575	11.461	80.390	-76.439	1.00	85.38	C
ATOM	4425	CD1	PHE	A	575	12.087	79.747	-77.497	1.00	84.34	C
ATOM	4426	CD2	PHE	A	575	12.086	80.414	-75.203	1.00	86.41	C
ATOM	4427	CE1	PHE	A	575	13.311	79.128	-77.330	1.00	83.93	C
ATOM	4428	CE2	PHE	A	575	13.308	79.793	-75.023	1.00	91.57	C
ATOM	4429	CZ	PHE	A	575	13.928	79.147	-76.093	1.00	86.10	C
ATOM	4430	O	ASP	A	576	4.958	82.043	-77.855	1.00	94.12	O
ATOM	4431	N	ASP	A	576	7.992	81.553	-79.174	1.00	88.24	N
ATOM	4432	CA	ASP	A	576	6.635	81.877	-79.575	1.00	89.55	C
ATOM	4433	C	ASP	A	576	5.636	81.300	-78.571	1.00	93.57	C
ATOM	4434	CB	ASP	A	576	6.353	81.359	-80.993	1.00	90.19	C
ATOM	4435	CG	ASP	A	576	7.188	82.069	-82.058	1.00	92.18	C
ATOM	4436	OD1	ASP	A	576	7.361	83.306	-81.972	1.00	99.69	O
ATOM	4437	OD2	ASP	A	576	7.678	81.388	-82.985	1.00	94.97	O
ATOM	4438	O	SER	A	577	5.921	78.020	-76.113	1.00	92.12	O
ATOM	4439	N	SER	A	577	5.563	79.975	-78.509	1.00	92.89	N
ATOM	4440	CA	SER	A	577	4.605	79.310	-77.638	1.00	92.88	C
ATOM	4441	C	SER	A	577	5.189	79.005	-76.267	1.00	95.07	C
ATOM	4442	CB	SER	A	577	4.134	78.005	-78.263	1.00	94.54	C
ATOM	4443	OG	SER	A	577	5.087	76.982	-78.006	1.00	97.37	O
ATOM	4444	O	VAL	A	578	2.975	80.111	-73.184	1.00	83.05	O
ATOM	4445	N	VAL	A	578	4.862	79.836	-75.277	1.00	92.01	N
ATOM	4446	CA	VAL	A	578	5.208	79.541	-73.889	1.00	83.89	C
ATOM	4447	C	VAL	A	578	3.939	79.356	-73.055	1.00	80.56	C
ATOM	4448	CB	VAL	A	578	6.107	80.645	-73.268	1.00	86.40	C
ATOM	4449	CG1	VAL	A	578	7.311	80.886	-74.153	1.00	85.18	C
ATOM	4450	CG2	VAL	A	578	5.344	81.943	-73.066	1.00	81.91	C
ATOM	4451	O	GLU	A	579	4.152	77.210	-69.542	1.00	76.21	O
ATOM	4452	N	GLU	A	579	3.929	78.317	-72.229	1.00	81.74	N
ATOM	4453	CA	GLU	A	579	2.804	78.072	-71.333	1.00	84.00	C
ATOM	4454	C	GLU	A	579	3.286	78.014	-69.880	1.00	80.22	C
ATOM	4455	CB	GLU	A	579	2.075	76.778	-71.712	1.00	83.50	C
ATOM	4456	CG	GLU	A	579	0.569	76.785	-71.368	1.00	91.33	C
ATOM	4457	CD	GLU	A	579	-0.314	77.246	-72.524	1.00	88.67	C
ATOM	4458	OE1	GLU	A	579	-1.127	76.425	-72.998	1.00	92.35	O
ATOM	4459	OE2	GLU	A	579	-0.201	78.415	-72.959	1.00	83.16	O
ATOM	4460	O	ILE	A	580	1.145	78.359	-66.580	1.00	69.35	O
ATOM	4461	N	ILE	A	580	2.702	78.867	-69.034	1.00	79.00	N
ATOM	4462	CA	ILE	A	580	3.170	79.100	-67.660	1.00	71.31	C
ATOM	4463	C	ILE	A	580	2.368	78.364	-66.570	1.00	69.32	C
ATOM	4464	CB	ILE	A	580	3.162	80.620	-67.359	1.00	75.80	C
ATOM	4465	CG1	ILE	A	580	4.167	81.342	-68.268	1.00	79.41	C
ATOM	4466	CG2	ILE	A	580	3.435	80.914	-65.882	1.00	69.86	C
ATOM	4467	CD1	ILE	A	580	5.578	80.770	-68.218	1.00	75.64	C
ATOM	4468	O	SER	A	581	3.756	78.618	-63.159	1.00	69.59	O
ATOM	4469	N	SER	A	581	3.085	77.742	-65.635	1.00	71.99	N
ATOM	4470	CA	SER	A	581	2.498	77.051	-64.488	1.00	67.69	C
ATOM	4471	C	SER	A	581	2.901	77.730	-63.167	1.00	72.04	C
ATOM	4472	CB	SER	A	581	2.927	75.585	-64.488	1.00	65.84	C
ATOM	4473	OG	SER	A	581	2.649	74.973	-63.249	1.00	69.03	O
ATOM	4474	O	GLY	A	582	2.477	79.829	-59.374	1.00	73.10	O

ATOM	4475	N	GLY	A	582	2.278	77.332	-62.058	1.00	75.24	N
ATOM	4476	CA	GLY	A	582	2.625	77.878	-60.752	1.00	69.87	C
ATOM	4477	C	GLY	A	582	2.171	79.299	-60.446	1.00	72.20	C
ATOM	4478	O	VAL	A	583	-0.347	81.151	-63.221	1.00	78.77	O
ATOM	4479	N	VAL	A	583	1.461	79.925	-61.384	1.00	72.79	N
ATOM	4480	CA	VAL	A	583	0.858	81.236	-61.142	1.00	69.09	C
ATOM	4481	C	VAL	A	583	-0.375	81.437	-62.027	1.00	75.42	C
ATOM	4482	CB	VAL	A	583	1.863	82.377	-61.377	1.00	64.52	C
ATOM	4483	CG1	VAL	A	583	1.216	83.728	-61.117	1.00	75.42	C
ATOM	4484	CG2	VAL	A	583	2.400	82.338	-62.774	1.00	66.82	C
ATOM	4485	O	GLU	A	584	-1.639	84.266	-62.628	1.00	80.99	O
ATOM	4486	N	GLU	A	584	-1.465	81.902	-61.423	1.00	80.77	N
ATOM	4487	CA	GLU	A	584	-2.701	82.183	-62.154	1.00	77.29	C
ATOM	4488	C	GLU	A	584	-2.597	83.528	-62.851	1.00	76.89	C
ATOM	4489	CB	GLU	A	584	-3.906	82.168	-61.212	1.00	75.17	C
ATOM	4490	O	ASP	A	585	-2.404	86.994	-65.143	1.00	71.68	O
ATOM	4491	N	ASP	A	585	-3.599	83.844	-63.665	1.00	71.51	N
ATOM	4492	CA	ASP	A	585	-3.648	85.029	-64.541	1.00	73.31	C
ATOM	4493	C	ASP	A	585	-2.747	86.238	-64.230	1.00	73.54	C
ATOM	4494	CB	ASP	A	585	-5.100	85.525	-64.597	1.00	83.05	C
ATOM	4495	CG	ASP	A	585	-6.090	84.397	-64.851	1.00	87.80	C
ATOM	4496	OD1	ASP	A	585	-5.828	83.557	-65.743	1.00	90.38	O
ATOM	4497	OD2	ASP	A	585	-7.120	84.336	-64.148	1.00	88.62	O
ATOM	4498	O	ARG	A	586	-1.071	86.342	-60.552	1.00	74.49	O
ATOM	4499	N	ARG	A	586	-2.384	86.434	-62.962	1.00	69.35	N
ATOM	4500	CA	ARG	A	586	-1.539	87.566	-62.569	1.00	69.03	C
ATOM	4501	C	ARG	A	586	-0.714	87.231	-61.331	1.00	73.69	C
ATOM	4502	CB	ARG	A	586	-2.386	88.820	-62.307	1.00	70.98	C
ATOM	4503	O	PHE	A	587	0.489	89.587	-58.708	1.00	66.65	O
ATOM	4504	N	PHE	A	587	0.392	87.944	-61.146	1.00	71.78	N
ATOM	4505	CA	PHE	A	587	1.259	87.713	-59.991	1.00	66.27	C
ATOM	4506	C	PHE	A	587	0.706	88.374	-58.735	1.00	66.05	C
ATOM	4507	CB	PHE	A	587	2.680	88.225	-60.264	1.00	65.78	C
ATOM	4508	CG	PHE	A	587	3.617	87.166	-60.781	1.00	66.44	C
ATOM	4509	CD1	PHE	A	587	4.132	86.207	-59.930	1.00	67.82	C
ATOM	4510	CD2	PHE	A	587	3.984	87.133	-62.109	1.00	67.23	C
ATOM	4511	CE1	PHE	A	587	5.000	85.222	-60.397	1.00	66.52	C
ATOM	4512	CE2	PHE	A	587	4.843	86.162	-62.578	1.00	68.58	C
ATOM	4513	CZ	PHE	A	587	5.352	85.205	-61.721	1.00	65.13	C
ATOM	4514	O	ASN	A	588	0.612	90.187	-55.432	1.00	60.52	O
ATOM	4515	N	ASN	A	588	0.484	87.568	-57.702	1.00	65.34	N
ATOM	4516	CA	ASN	A	588	0.019	88.056	-56.409	1.00	62.60	C
ATOM	4517	C	ASN	A	588	0.999	89.063	-55.787	1.00	64.21	C
ATOM	4518	CB	ASN	A	588	-0.231	86.875	-55.461	1.00	58.85	C
ATOM	4519	CG	ASN	A	588	-1.427	86.026	-55.893	1.00	67.24	C
ATOM	4520	OD1	ASN	A	588	-2.290	86.492	-56.642	1.00	67.86	O
ATOM	4521	ND2	ASN	A	588	-1.482	84.783	-55.425	1.00	70.28	N
ATOM	4522	O	ALA	A	589	3.304	90.503	-57.341	1.00	59.35	O
ATOM	4523	N	ALA	A	589	2.267	88.679	-55.674	1.00	61.75	N
ATOM	4524	CA	ALA	A	589	3.268	89.586	-55.135	1.00	55.01	C
ATOM	4525	C	ALA	A	589	3.589	90.667	-56.155	1.00	55.37	C
ATOM	4526	CB	ALA	A	589	4.513	88.828	-54.737	1.00	54.86	C
ATOM	4527	O	SER	A	590	5.698	93.779	-54.734	1.00	61.50	O
ATOM	4528	N	SER	A	590	4.163	91.778	-55.695	1.00	48.84	N
ATOM	4529	CA	SER	A	590	4.460	92.898	-56.579	1.00	47.86	C
ATOM	4530	C	SER	A	590	5.448	93.850	-55.929	1.00	55.72	C
ATOM	4531	CB	SER	A	590	3.164	93.643	-56.978	1.00	65.96	C
ATOM	4532	OG	SER	A	590	2.334	93.989	-55.869	1.00	63.28	O
ATOM	4533	N	LEU	A	591	6.020	94.743	-56.718	1.00	61.34	N
ATOM	4534	CA	LEU	A	591	7.006	95.675	-56.196	1.00	63.64	C
ATOM	4535	C	LEU	A	591	6.460	97.101	-56.149	1.00	65.38	C
ATOM	4536	O	LEU	A	591	6.989	97.998	-56.795	1.00	68.74	O
ATOM	4537	CB	LEU	A	591	8.277	95.624	-57.047	1.00	71.24	C

ATOM	4538	CG	LEU	A	591	9.538	94.971	-56.471	1.00	66.61	C
ATOM	4539	CD1	LEU	A	591	9.262	93.567	-55.979	1.00	60.97	C
ATOM	4540	CD2	LEU	A	591	10.646	94.968	-57.500	1.00	66.07	C
ATOM	4541	N	GLY	A	592	5.410	97.304	-55.363	1.00	67.96	N
ATOM	4542	CA	GLY	A	592	4.716	98.578	-55.321	1.00	64.45	C
ATOM	4543	C	GLY	A	592	5.506	99.721	-54.718	1.00	68.09	C
ATOM	4544	O	GLY	A	592	5.444	100.844	-55.205	1.00	65.02	O
ATOM	4545	N	THR	A	593	6.239	99.445	-53.646	1.00	65.62	N
ATOM	4546	CA	THR	A	593	7.043	100.472	-52.998	1.00	66.14	C
ATOM	4547	C	THR	A	593	8.155	100.941	-53.930	1.00	74.59	C
ATOM	4548	O	THR	A	593	8.475	102.141	-53.962	1.00	70.78	O
ATOM	4549	CB	THR	A	593	7.653	99.964	-51.661	1.00	66.41	C
ATOM	4550	OG1	THR	A	593	6.596	99.707	-50.730	1.00	68.69	O
ATOM	4551	CG2	THR	A	593	8.627	100.979	-51.057	1.00	61.50	C
ATOM	4552	N	TYR	A	594	8.733	100.001	-54.688	1.00	68.38	N
ATOM	4553	CA	TYR	A	594	9.798	100.338	-55.618	1.00	67.73	C
ATOM	4554	C	TYR	A	594	9.362	101.423	-56.575	1.00	73.22	C
ATOM	4555	O	TYR	A	594	10.113	102.350	-56.855	1.00	75.34	O
ATOM	4556	CB	TYR	A	594	10.249	99.120	-56.417	1.00	75.08	C
ATOM	4557	CG	TYR	A	594	11.234	99.469	-57.518	1.00	77.61	C
ATOM	4558	CD1	TYR	A	594	12.588	99.636	-57.240	1.00	74.61	C
ATOM	4559	CD2	TYR	A	594	10.809	99.644	-58.838	1.00	80.72	C
ATOM	4560	CE1	TYR	A	594	13.495	99.962	-58.242	1.00	78.12	C
ATOM	4561	CE2	TYR	A	594	11.710	99.968	-59.848	1.00	81.02	C
ATOM	4562	CZ	TYR	A	594	13.050	100.123	-59.541	1.00	80.33	C
ATOM	4563	OH	TYR	A	594	13.943	100.440	-60.536	1.00	82.50	O
ATOM	4564	N	HIS	A	595	8.135	101.300	-57.070	1.00	76.33	N
ATOM	4565	CA	HIS	A	595	7.579	102.253	-58.029	1.00	72.97	C
ATOM	4566	C	HIS	A	595	7.163	103.587	-57.384	1.00	75.05	C
ATOM	4567	O	HIS	A	595	7.301	104.637	-58.005	1.00	74.76	O
ATOM	4568	CB	HIS	A	595	6.393	101.619	-58.753	1.00	72.18	C
ATOM	4569	CG	HIS	A	595	6.774	100.469	-59.630	1.00	78.77	C
ATOM	4570	ND1	HIS	A	595	6.588	100.480	-60.995	1.00	83.33	N
ATOM	4571	CD2	HIS	A	595	7.348	99.277	-59.338	1.00	75.70	C
ATOM	4572	CE1	HIS	A	595	7.025	99.342	-61.506	1.00	81.99	C
ATOM	4573	NE2	HIS	A	595	7.488	98.594	-60.521	1.00	83.02	N
ATOM	4574	N	ASP	A	596	6.658	103.540	-56.150	1.00	71.23	N
ATOM	4575	CA	ASP	A	596	6.370	104.751	-55.381	1.00	72.41	C
ATOM	4576	C	ASP	A	596	7.625	105.606	-55.277	1.00	74.71	C
ATOM	4577	O	ASP	A	596	7.658	106.742	-55.751	1.00	81.22	O
ATOM	4578	CB	ASP	A	596	5.852	104.419	-53.970	1.00	74.37	C
ATOM	4579	CG	ASP	A	596	4.541	103.633	-53.983	1.00	74.36	C
ATOM	4580	OD2	ASP	A	596	4.210	102.996	-52.959	1.00	68.33	O
ATOM	4581	OD1	ASP	A	596	3.836	103.655	-55.011	1.00	75.52	O
ATOM	4582	N	LEU	A	597	8.654	105.043	-54.655	1.00	74.62	N
ATOM	4583	CA	LEU	A	597	9.956	105.688	-54.541	1.00	78.47	C
ATOM	4584	C	LEU	A	597	10.543	106.108	-55.887	1.00	80.70	C
ATOM	4585	O	LEU	A	597	11.310	107.064	-55.959	1.00	82.46	O
ATOM	4586	CB	LEU	A	597	10.932	104.757	-53.837	1.00	75.39	C
ATOM	4587	CG	LEU	A	597	10.520	104.437	-52.412	1.00	72.22	C
ATOM	4588	CD1	LEU	A	597	11.319	103.279	-51.896	1.00	74.02	C
ATOM	4589	CD2	LEU	A	597	10.748	105.653	-51.570	1.00	77.12	C
ATOM	4590	N	LEU	A	598	10.189	105.401	-56.953	1.00	77.28	N
ATOM	4591	CA	LEU	A	598	10.724	105.739	-58.266	1.00	81.57	C
ATOM	4592	C	LEU	A	598	10.150	107.063	-58.767	1.00	83.73	C
ATOM	4593	O	LEU	A	598	10.905	107.953	-59.175	1.00	83.76	O
ATOM	4594	CB	LEU	A	598	10.451	104.624	-59.280	1.00	81.45	C
ATOM	4595	CG	LEU	A	598	11.284	104.746	-60.559	1.00	81.79	C
ATOM	4596	CD1	LEU	A	598	12.732	105.119	-60.217	1.00	78.40	C
ATOM	4597	CD2	LEU	A	598	11.224	103.459	-61.394	1.00	78.13	C
ATOM	4598	N	LYS	A	599	8.822	107.186	-58.734	1.00	83.93	N
ATOM	4599	CA	LYS	A	599	8.154	108.443	-59.067	1.00	80.05	C
ATOM	4600	C	LYS	A	599	8.695	109.592	-58.228	1.00	80.29	C

ATOM	4601	O	LYS	A	599	9.228	110.562	-58.760	1.00	83.61	O
ATOM	4602	CB	LYS	A	599	6.645	108.331	-58.865	1.00	81.94	C
ATOM	4603	CG	LYS	A	599	5.866	107.941	-60.111	1.00	86.57	C
ATOM	4604	CD	LYS	A	599	4.402	108.373	-60.001	1.00	89.60	C
ATOM	4605	CE	LYS	A	599	4.279	109.882	-59.805	1.00	86.51	C
ATOM	4606	NZ	LYS	A	599	2.867	110.312	-59.574	1.00	87.54	N
ATOM	4607	N	ILE	A	600	8.559	109.465	-56.915	1.00	82.32	N
ATOM	4608	CA	ILE	A	600	9.000	110.492	-55.979	1.00	85.51	C
ATOM	4609	C	ILE	A	600	10.400	111.037	-56.296	1.00	88.83	C
ATOM	4610	O	ILE	A	600	10.586	112.248	-56.431	1.00	90.11	O
ATOM	4611	CB	ILE	A	600	9.002	109.954	-54.527	1.00	88.15	C
ATOM	4612	CG1	ILE	A	600	7.633	109.378	-54.151	1.00	84.23	C
ATOM	4613	CG2	ILE	A	600	9.441	111.031	-53.552	1.00	90.73	C
ATOM	4614	CD1	ILE	A	600	6.483	110.316	-54.394	1.00	92.10	C
ATOM	4615	N	ILE	A	601	11.373	110.141	-56.452	1.00	89.11	N
ATOM	4616	CA	ILE	A	601	12.773	110.561	-56.431	1.00	88.31	C
ATOM	4617	C	ILE	A	601	13.502	110.533	-57.782	1.00	86.88	C
ATOM	4618	O	ILE	A	601	14.560	111.154	-57.923	1.00	86.26	O
ATOM	4619	CB	ILE	A	601	13.564	109.718	-55.421	1.00	84.12	C
ATOM	4620	CG1	ILE	A	601	14.102	108.444	-56.059	1.00	85.35	C
ATOM	4621	CG2	ILE	A	601	12.699	109.387	-54.221	1.00	86.45	C
ATOM	4622	CD1	ILE	A	601	15.017	107.677	-55.142	1.00	87.17	C
ATOM	4623	N	LYS	A	602	12.941	109.824	-58.760	1.00	83.97	N
ATOM	4624	CA	LYS	A	602	13.402	109.914	-60.146	1.00	87.92	C
ATOM	4625	C	LYS	A	602	14.890	109.601	-60.339	1.00	89.74	C
ATOM	4626	O	LYS	A	602	15.560	110.253	-61.138	1.00	90.43	O
ATOM	4627	CB	LYS	A	602	13.103	111.318	-60.698	1.00	85.24	C
ATOM	4628	O	ASP	A	603	17.443	106.137	-58.673	1.00	87.60	O
ATOM	4629	N	ASP	A	603	15.395	108.599	-59.622	1.00	88.59	N
ATOM	4630	CA	ASP	A	603	16.817	108.249	-59.654	1.00	89.49	C
ATOM	4631	C	ASP	A	603	17.014	106.726	-59.666	1.00	88.26	C
ATOM	4632	CB	ASP	A	603	17.530	108.877	-58.453	1.00	90.56	C
ATOM	4633	CG	ASP	A	603	19.048	108.786	-58.545	1.00	93.64	C
ATOM	4634	OD1	ASP	A	603	19.569	107.860	-59.204	1.00	85.33	O
ATOM	4635	OD2	ASP	A	603	19.718	109.647	-57.932	1.00	100.55	O
ATOM	4636	O	LYS	A	604	17.912	102.847	-59.939	1.00	83.26	O
ATOM	4637	N	LYS	A	604	16.714	106.106	-60.804	1.00	85.81	N
ATOM	4638	CA	LYS	A	604	16.648	104.649	-60.927	1.00	84.40	C
ATOM	4639	C	LYS	A	604	17.947	103.917	-60.555	1.00	86.90	C
ATOM	4640	CB	LYS	A	604	16.237	104.280	-62.359	1.00	81.85	C
ATOM	4641	CG	LYS	A	604	15.946	102.814	-62.573	1.00	76.78	C
ATOM	4642	CD	LYS	A	604	14.940	102.616	-63.680	1.00	78.19	C
ATOM	4643	CE	LYS	A	604	14.429	101.186	-63.718	1.00	77.02	C
ATOM	4644	NZ	LYS	A	604	15.491	100.230	-64.143	1.00	75.79	N
ATOM	4645	O	ASP	A	605	21.332	102.975	-58.623	1.00	79.94	O
ATOM	4646	N	ASP	A	605	19.090	104.485	-60.925	1.00	86.14	N
ATOM	4647	CA	ASP	A	605	20.360	103.821	-60.655	1.00	85.75	C
ATOM	4648	C	ASP	A	605	20.627	103.836	-59.153	1.00	87.29	C
ATOM	4649	CB	ASP	A	605	21.506	104.485	-61.427	1.00	86.61	C
ATOM	4650	O	PHE	A	606	19.763	103.079	-55.468	1.00	83.95	O
ATOM	4651	N	PHE	A	606	20.051	104.818	-58.468	1.00	88.38	N
ATOM	4652	CA	PHE	A	606	20.146	104.880	-57.015	1.00	86.31	C
ATOM	4653	C	PHE	A	606	19.317	103.756	-56.396	1.00	85.62	C
ATOM	4654	CB	PHE	A	606	19.686	106.244	-56.505	1.00	83.72	C
ATOM	4655	CG	PHE	A	606	19.695	106.371	-55.017	1.00	82.60	C
ATOM	4656	CD2	PHE	A	606	18.552	106.125	-54.285	1.00	81.45	C
ATOM	4657	CD1	PHE	A	606	20.843	106.748	-54.350	1.00	83.96	C
ATOM	4658	CE2	PHE	A	606	18.555	106.241	-52.917	1.00	78.26	C
ATOM	4659	CE1	PHE	A	606	20.852	106.867	-52.975	1.00	83.31	C
ATOM	4660	CZ	PHE	A	606	19.707	106.611	-52.259	1.00	80.87	C
ATOM	4661	O	LEU	A	607	17.855	100.324	-55.744	1.00	87.75	O
ATOM	4662	N	LEU	A	607	18.114	103.562	-56.930	1.00	87.68	N
ATOM	4663	CA	LEU	A	607	17.211	102.509	-56.467	1.00	87.82	C

ATOM	4664	C	LEU	A	607	17.808	101.125	-56.673	1.00	86.49	C
ATOM	4665	CB	LEU	A	607	15.853	102.591	-57.183	1.00	86.41	C
ATOM	4666	CG	LEU	A	607	14.671	103.222	-56.430	1.00	85.80	C
ATOM	4667	CD1	LEU	A	607	14.900	103.148	-54.935	1.00	90.08	C
ATOM	4668	CD2	LEU	A	607	14.385	104.658	-56.858	1.00	82.03	C
ATOM	4669	O	ASP	A	608	20.440	98.047	-57.351	1.00	90.14	O
ATOM	4670	N	ASP	A	608	18.262	100.854	-57.894	1.00	88.96	N
ATOM	4671	CA	ASP	A	608	18.785	99.534	-58.258	1.00	85.24	C
ATOM	4672	C	ASP	A	608	20.114	99.210	-57.569	1.00	84.29	C
ATOM	4673	CB	ASP	A	608	18.941	99.437	-59.775	1.00	80.98	C
ATOM	4674	CG	ASP	A	608	17.615	99.587	-60.506	1.00	86.37	C
ATOM	4675	OD2	ASP	A	608	17.539	100.435	-61.422	1.00	88.11	O
ATOM	4676	OD1	ASP	A	608	16.647	98.865	-60.163	1.00	78.38	O
ATOM	4677	O	ASN	A	609	21.475	100.175	-54.224	1.00	87.93	O
ATOM	4678	N	ASN	A	609	20.869	100.239	-57.215	1.00	84.76	N
ATOM	4679	CA	ASN	A	609	22.128	100.048	-56.518	1.00	86.26	C
ATOM	4680	C	ASN	A	609	21.926	99.473	-55.122	1.00	87.52	C
ATOM	4681	CB	ASN	A	609	22.881	101.372	-56.432	1.00	87.55	C
ATOM	4682	CG	ASN	A	609	24.272	101.213	-55.866	1.00	86.63	C
ATOM	4683	OD1	ASN	A	609	24.759	100.095	-55.696	1.00	91.91	O
ATOM	4684	ND2	ASN	A	609	24.926	102.333	-55.573	1.00	83.04	N
ATOM	4685	O	GLU	A	610	23.210	97.373	-51.526	1.00	90.22	O
ATOM	4686	N	GLU	A	610	22.298	98.207	-54.932	1.00	90.71	N
ATOM	4687	CA	GLU	A	610	22.108	97.522	-53.650	1.00	86.20	C
ATOM	4688	C	GLU	A	610	23.049	98.023	-52.556	1.00	88.62	C
ATOM	4689	CB	GLU	A	610	22.286	96.011	-53.812	1.00	84.23	C
ATOM	4690	CG	GLU	A	610	21.198	95.303	-54.627	1.00	88.01	C
ATOM	4691	CD	GLU	A	610	21.451	93.795	-54.762	1.00	86.54	C
ATOM	4692	OE1	GLU	A	610	22.530	93.335	-54.330	1.00	88.90	O
ATOM	4693	OE2	GLU	A	610	20.578	93.073	-55.298	1.00	79.96	O
ATOM	4694	O	GLU	A	611	24.111	100.646	-49.584	1.00	79.89	O
ATOM	4695	N	GLU	A	611	23.658	99.181	-52.779	1.00	91.68	N
ATOM	4696	CA	GLU	A	611	24.545	99.798	-51.803	1.00	91.12	C
ATOM	4697	C	GLU	A	611	23.733	100.551	-50.756	1.00	83.68	C
ATOM	4698	CB	GLU	A	611	25.517	100.745	-52.510	1.00	90.85	C
ATOM	4699	CG	GLU	A	611	26.797	101.036	-51.754	1.00	97.22	C
ATOM	4700	CD	GLU	A	611	27.751	101.905	-52.558	1.00	100.95	C
ATOM	4701	OE1	GLU	A	611	27.950	101.617	-53.761	1.00	103.65	O
ATOM	4702	OE2	GLU	A	611	28.290	102.883	-51.991	1.00	104.96	O
ATOM	4703	O	ASN	A	612	19.510	101.662	-49.539	1.00	83.49	O
ATOM	4704	N	ASN	A	612	22.600	101.076	-51.198	1.00	86.01	N
ATOM	4705	CA	ASN	A	612	21.751	101.895	-50.344	1.00	86.37	C
ATOM	4706	C	ASN	A	612	20.579	101.108	-49.777	1.00	81.34	C
ATOM	4707	CB	ASN	A	612	21.231	103.100	-51.126	1.00	86.35	C
ATOM	4708	CG	ASN	A	612	22.236	103.613	-52.133	1.00	87.82	C
ATOM	4709	OD1	ASN	A	612	23.258	104.194	-51.766	1.00	89.39	O
ATOM	4710	ND2	ASN	A	612	21.950	103.404	-53.414	1.00	89.08	N
ATOM	4711	O	GLU	A	613	18.151	99.417	-47.319	1.00	81.19	O
ATOM	4712	N	GLU	A	613	20.775	99.812	-49.574	1.00	82.79	N
ATOM	4713	CA	GLU	A	613	19.693	98.975	-49.080	1.00	84.16	C
ATOM	4714	C	GLU	A	613	19.329	99.365	-47.649	1.00	80.91	C
ATOM	4715	CB	GLU	A	613	20.051	97.478	-49.165	1.00	77.25	C
ATOM	4716	CG	GLU	A	613	19.566	96.798	-50.452	1.00	80.38	C
ATOM	4717	CD	GLU	A	613	19.967	95.329	-50.555	1.00	88.79	C
ATOM	4718	OE1	GLU	A	613	19.078	94.453	-50.446	1.00	81.15	O
ATOM	4719	OE2	GLU	A	613	21.170	95.046	-50.758	1.00	93.92	O
ATOM	4720	N	ASP	A	614	20.325	99.645	-46.810	1.00	75.94	N
ATOM	4721	CA	ASP	A	614	20.056	100.092	-45.442	1.00	80.52	C
ATOM	4722	C	ASP	A	614	19.303	101.443	-45.435	1.00	78.31	C
ATOM	4723	O	ASP	A	614	18.353	101.639	-44.672	1.00	72.14	O
ATOM	4724	CB	ASP	A	614	21.359	100.207	-44.634	1.00	74.60	C
ATOM	4725	CG	ASP	A	614	22.161	98.895	-44.593	1.00	88.28	C
ATOM	4726	OD1	ASP	A	614	21.563	97.797	-44.523	1.00	84.55	O

ATOM	4727	OD2	ASP	A	614	23.408	98.961	-44.626	1.00	91.34	O
ATOM	4728	N	ILE	A	615	19.722	102.356	-46.304	1.00	78.52	N
ATOM	4729	CA	ILE	A	615	19.163	103.700	-46.348	1.00	76.28	C
ATOM	4730	C	ILE	A	615	17.661	103.688	-46.664	1.00	77.56	C
ATOM	4731	O	ILE	A	615	16.855	104.206	-45.891	1.00	74.77	O
ATOM	4732	CB	ILE	A	615	19.904	104.570	-47.389	1.00	76.26	C
ATOM	4733	CG1	ILE	A	615	21.414	104.530	-47.148	1.00	82.10	C
ATOM	4734	CG2	ILE	A	615	19.409	106.004	-47.344	1.00	83.05	C
ATOM	4735	CD1	ILE	A	615	22.225	105.157	-48.265	1.00	82.00	C
ATOM	4736	N	LEU	A	616	17.292	103.091	-47.796	1.00	77.93	N
ATOM	4737	CA	LEU	A	616	15.897	103.032	-48.222	1.00	75.24	C
ATOM	4738	C	LEU	A	616	15.050	102.137	-47.319	1.00	75.35	C
ATOM	4739	O	LEU	A	616	13.825	102.206	-47.343	1.00	72.93	O
ATOM	4740	CB	LEU	A	616	15.798	102.536	-49.662	1.00	72.71	C
ATOM	4741	CG	LEU	A	616	16.238	103.464	-50.795	1.00	75.60	C
ATOM	4742	CD1	LEU	A	616	16.784	102.669	-51.962	1.00	84.57	C
ATOM	4743	CD2	LEU	A	616	15.084	104.300	-51.269	1.00	79.46	C
ATOM	4744	N	GLU	A	617	15.698	101.281	-46.540	1.00	72.47	N
ATOM	4745	CA	GLU	A	617	14.980	100.453	-45.583	1.00	71.91	C
ATOM	4746	C	GLU	A	617	14.638	101.305	-44.379	1.00	74.71	C
ATOM	4747	O	GLU	A	617	13.585	101.140	-43.766	1.00	75.00	O
ATOM	4748	CB	GLU	A	617	15.813	99.243	-45.167	1.00	72.71	C
ATOM	4749	CG	GLU	A	617	15.031	97.957	-45.046	1.00	73.59	C
ATOM	4750	CD	GLU	A	617	14.131	97.707	-46.242	1.00	70.87	C
ATOM	4751	OE1	GLU	A	617	14.586	97.857	-47.393	1.00	73.16	O
ATOM	4752	OE2	GLU	A	617	12.957	97.366	-46.029	1.00	66.62	O
ATOM	4753	N	ASP	A	618	15.549	102.218	-44.059	1.00	74.14	N
ATOM	4754	CA	ASP	A	618	15.383	103.183	-42.985	1.00	72.66	C
ATOM	4755	C	ASP	A	618	14.269	104.192	-43.289	1.00	71.59	C
ATOM	4756	O	ASP	A	618	13.540	104.628	-42.391	1.00	69.40	O
ATOM	4757	CB	ASP	A	618	16.707	103.905	-42.748	1.00	75.43	C
ATOM	4758	CG	ASP	A	618	16.585	105.035	-41.762	1.00	69.27	C
ATOM	4759	OD2	ASP	A	618	16.761	106.199	-42.164	1.00	71.58	O
ATOM	4760	OD1	ASP	A	618	16.336	104.753	-40.581	1.00	75.84	O
ATOM	4761	N	ILE	A	619	14.131	104.552	-44.557	1.00	70.42	N
ATOM	4762	CA	ILE	A	619	13.112	105.515	-44.956	1.00	72.71	C
ATOM	4763	C	ILE	A	619	11.720	104.914	-44.870	1.00	70.79	C
ATOM	4764	O	ILE	A	619	10.827	105.514	-44.283	1.00	72.01	O
ATOM	4765	CB	ILE	A	619	13.337	106.027	-46.382	1.00	71.92	C
ATOM	4766	CG1	ILE	A	619	14.666	106.768	-46.469	1.00	76.66	C
ATOM	4767	CG2	ILE	A	619	12.213	106.942	-46.805	1.00	65.92	C
ATOM	4768	CD1	ILE	A	619	14.903	107.437	-47.797	1.00	74.25	C
ATOM	4769	N	VAL	A	620	11.534	103.735	-45.459	1.00	64.52	N
ATOM	4770	CA	VAL	A	620	10.250	103.059	-45.390	1.00	64.77	C
ATOM	4771	C	VAL	A	620	9.840	102.801	-43.936	1.00	64.30	C
ATOM	4772	O	VAL	A	620	8.661	102.855	-43.594	1.00	67.10	O
ATOM	4773	CB	VAL	A	620	10.270	101.747	-46.179	1.00	55.43	C
ATOM	4774	CG1	VAL	A	620	9.109	100.855	-45.787	1.00	58.95	C
ATOM	4775	CG2	VAL	A	620	10.198	102.036	-47.643	1.00	56.52	C
ATOM	4776	N	LEU	A	621	10.821	102.570	-43.077	1.00	66.86	N
ATOM	4777	CA	LEU	A	621	10.559	102.306	-41.663	1.00	65.34	C
ATOM	4778	C	LEU	A	621	9.971	103.515	-40.938	1.00	73.97	C
ATOM	4779	O	LEU	A	621	8.965	103.385	-40.239	1.00	75.46	O
ATOM	4780	CB	LEU	A	621	11.833	101.866	-40.950	1.00	63.68	C
ATOM	4781	CG	LEU	A	621	11.584	101.596	-39.474	1.00	61.50	C
ATOM	4782	CD1	LEU	A	621	10.465	100.588	-39.316	1.00	55.83	C
ATOM	4783	CD2	LEU	A	621	12.851	101.103	-38.844	1.00	60.58	C
ATOM	4784	N	THR	A	622	10.593	104.684	-41.099	1.00	73.94	N
ATOM	4785	CA	THR	A	622	10.088	105.901	-40.467	1.00	71.43	C
ATOM	4786	C	THR	A	622	8.803	106.404	-41.146	1.00	73.50	C
ATOM	4787	O	THR	A	622	8.055	107.174	-40.553	1.00	79.67	O
ATOM	4788	CB	THR	A	622	11.154	107.031	-40.455	1.00	66.49	C
ATOM	4789	OG1	THR	A	622	11.615	107.272	-41.783	1.00	62.97	O

ATOM	4790	CG2	THR	A	622	12.337	106.671	-39.556	1.00	64.99	C
ATOM	4791	N	LEU	A	623	8.543	105.962	-42.376	1.00	71.19	N
ATOM	4792	CA	LEU	A	623	7.309	106.317	-43.092	1.00	74.33	C
ATOM	4793	C	LEU	A	623	6.147	105.357	-42.764	1.00	76.44	C
ATOM	4794	O	LEU	A	623	4.979	105.657	-43.047	1.00	73.64	O
ATOM	4795	CB	LEU	A	623	7.531	106.334	-44.616	1.00	73.05	C
ATOM	4796	CG	LEU	A	623	8.388	107.383	-45.344	1.00	73.56	C
ATOM	4797	CD1	LEU	A	623	8.535	107.017	-46.813	1.00	73.14	C
ATOM	4798	CD2	LEU	A	623	7.814	108.782	-45.218	1.00	76.13	C
ATOM	4799	N	THR	A	624	6.480	104.196	-42.197	1.00	73.34	N
ATOM	4800	CA	THR	A	624	5.490	103.237	-41.705	1.00	72.31	C
ATOM	4801	C	THR	A	624	5.233	103.488	-40.209	1.00	76.19	C
ATOM	4802	O	THR	A	624	4.239	103.031	-39.637	1.00	75.11	O
ATOM	4803	CB	THR	A	624	5.962	101.772	-41.938	1.00	66.85	C
ATOM	4804	OG1	THR	A	624	6.031	101.507	-43.346	1.00	65.76	O
ATOM	4805	CG2	THR	A	624	5.009	100.765	-41.297	1.00	63.35	C
ATOM	4806	N	LEU	A	625	6.126	104.254	-39.591	1.00	74.53	N
ATOM	4807	CA	LEU	A	625	6.113	104.442	-38.150	1.00	76.19	C
ATOM	4808	C	LEU	A	625	5.445	105.754	-37.745	1.00	77.20	C
ATOM	4809	O	LEU	A	625	4.585	105.786	-36.864	1.00	79.65	O
ATOM	4810	CB	LEU	A	625	7.543	104.392	-37.615	1.00	79.13	C
ATOM	4811	CG	LEU	A	625	7.757	103.774	-36.235	1.00	76.15	C
ATOM	4812	CD2	LEU	A	625	9.228	103.779	-35.884	1.00	76.25	C
ATOM	4813	CD1	LEU	A	625	7.202	102.372	-36.205	1.00	66.58	C
ATOM	4814	N	PHE	A	626	5.843	106.836	-38.402	1.00	81.57	N
ATOM	4815	CA	PHE	A	626	5.346	108.168	-38.070	1.00	76.50	C
ATOM	4816	C	PHE	A	626	4.393	108.690	-39.145	1.00	79.82	C
ATOM	4817	O	PHE	A	626	4.664	108.575	-40.339	1.00	77.06	O
ATOM	4818	CB	PHE	A	626	6.523	109.132	-37.878	1.00	73.41	C
ATOM	4819	CG	PHE	A	626	7.567	108.615	-36.935	1.00	73.71	C
ATOM	4820	CD1	PHE	A	626	7.370	108.673	-35.570	1.00	70.46	C
ATOM	4821	CD2	PHE	A	626	8.733	108.042	-37.416	1.00	74.13	C
ATOM	4822	CE1	PHE	A	626	8.322	108.188	-34.694	1.00	73.83	C
ATOM	4823	CE2	PHE	A	626	9.690	107.551	-36.551	1.00	72.85	C
ATOM	4824	CZ	PHE	A	626	9.487	107.619	-35.189	1.00	76.38	C
ATOM	4825	O	GLU	A	627	2.202	111.989	-40.709	1.00	76.05	O
ATOM	4826	N	GLU	A	627	3.271	109.257	-38.712	1.00	84.39	N
ATOM	4827	CA	GLU	A	627	2.297	109.834	-39.633	1.00	85.89	C
ATOM	4828	C	GLU	A	627	2.486	111.345	-39.694	1.00	81.20	C
ATOM	4829	CB	GLU	A	627	0.873	109.493	-39.191	1.00	85.24	C
ATOM	4830	CG	GLU	A	627	0.598	109.923	-37.759	1.00	85.69	C
ATOM	4831	CD	GLU	A	627	-0.818	109.648	-37.300	1.00	84.62	C
ATOM	4832	OE1	GLU	A	627	-1.674	109.259	-38.127	1.00	80.60	O
ATOM	4833	OE2	GLU	A	627	-1.081	109.820	-36.091	1.00	84.80	O
ATOM	4834	O	ASP	A	628	5.407	113.472	-39.265	1.00	83.73	O
ATOM	4835	N	ASP	A	628	2.982	111.894	-38.591	1.00	81.07	N
ATOM	4836	CA	ASP	A	628	3.158	113.332	-38.450	1.00	81.85	C
ATOM	4837	C	ASP	A	628	4.254	113.880	-39.370	1.00	84.62	C
ATOM	4838	CB	ASP	A	628	3.474	113.665	-36.998	1.00	79.78	C
ATOM	4839	CG	ASP	A	628	3.528	115.153	-36.744	1.00	88.28	C
ATOM	4840	OD1	ASP	A	628	2.770	115.895	-37.415	1.00	90.71	O
ATOM	4841	OD2	ASP	A	628	4.325	115.578	-35.879	1.00	82.08	O
ATOM	4842	O	ARG	A	629	7.070	116.211	-41.239	1.00	90.62	O
ATOM	4843	N	ARG	A	629	3.890	114.807	-40.259	1.00	88.64	N
ATOM	4844	CA	ARG	A	629	4.825	115.357	-41.246	1.00	86.61	C
ATOM	4845	C	ARG	A	629	6.014	116.088	-40.616	1.00	89.20	C
ATOM	4846	CB	ARG	A	629	4.102	116.303	-42.202	1.00	87.15	C
ATOM	4847	O	GLU	A	630	9.088	116.161	-38.046	1.00	87.04	O
ATOM	4848	N	GLU	A	630	5.851	116.574	-39.390	1.00	85.53	N
ATOM	4849	CA	GLU	A	630	6.979	117.150	-38.668	1.00	84.27	C
ATOM	4850	C	GLU	A	630	7.860	116.041	-38.084	1.00	87.28	C
ATOM	4851	CB	GLU	A	630	6.499	118.090	-37.561	1.00	88.89	C
ATOM	4852	O	MET	A	631	9.773	112.473	-37.883	1.00	87.18	O

ATOM	4853	N	MET	A	631	7.231	114.958	-37.634	1.00	90.06	N
ATOM	4854	CA	MET	A	631	7.964	113.824	-37.072	1.00	85.25	C
ATOM	4855	C	MET	A	631	8.752	113.113	-38.157	1.00	85.95	C
ATOM	4856	CB	MET	A	631	7.014	112.839	-36.375	1.00	83.29	C
ATOM	4857	CG	MET	A	631	6.369	113.386	-35.099	1.00	87.45	C
ATOM	4858	SD	MET	A	631	5.752	112.124	-33.969	1.00	76.17	S
ATOM	4859	CE	MET	A	631	7.295	111.359	-33.510	1.00	73.08	C
ATOM	4860	O	ILE	A	632	11.355	112.885	-40.754	1.00	83.48	O
ATOM	4861	N	ILE	A	632	8.259	113.218	-39.389	1.00	87.08	N
ATOM	4862	CA	ILE	A	632	8.964	112.699	-40.553	1.00	84.42	C
ATOM	4863	C	ILE	A	632	10.268	113.474	-40.745	1.00	87.21	C
ATOM	4864	CB	ILE	A	632	8.107	112.800	-41.824	1.00	80.85	C
ATOM	4865	CG1	ILE	A	632	6.800	112.023	-41.653	1.00	83.87	C
ATOM	4866	CG2	ILE	A	632	8.872	112.308	-43.024	1.00	81.72	C
ATOM	4867	CD1	ILE	A	632	6.968	110.641	-41.078	1.00	79.54	C
ATOM	4868	O	GLU	A	633	13.596	115.252	-40.651	1.00	76.67	O
ATOM	4869	N	GLU	A	633	10.138	114.797	-40.869	1.00	86.64	N
ATOM	4870	CA	GLU	A	633	11.266	115.714	-41.025	1.00	83.07	C
ATOM	4871	C	GLU	A	633	12.487	115.396	-40.142	1.00	81.50	C
ATOM	4872	CB	GLU	A	633	10.799	117.142	-40.747	1.00	81.43	C
ATOM	4873	O	GLU	A	634	15.259	113.562	-37.741	1.00	86.89	O
ATOM	4874	N	GLU	A	634	12.280	115.285	-38.832	1.00	81.50	N
ATOM	4875	CA	GLU	A	634	13.382	115.080	-37.886	1.00	82.45	C
ATOM	4876	C	GLU	A	634	14.051	113.701	-37.992	1.00	87.74	C
ATOM	4877	CB	GLU	A	634	12.887	115.291	-36.453	1.00	82.17	C
ATOM	4878	O	ARG	A	635	14.668	109.952	-40.273	1.00	91.17	O
ATOM	4879	N	ARG	A	635	13.274	112.681	-38.350	1.00	85.34	N
ATOM	4880	CA	ARG	A	635	13.820	111.331	-38.478	1.00	84.34	C
ATOM	4881	C	ARG	A	635	14.283	111.070	-39.922	1.00	85.47	C
ATOM	4882	CB	ARG	A	635	12.788	110.289	-38.027	1.00	75.76	C
ATOM	4883	O	LEU	A	636	16.156	113.292	-43.585	1.00	80.02	O
ATOM	4884	N	LEU	A	636	14.259	112.115	-40.747	1.00	81.80	N
ATOM	4885	CA	LEU	A	636	14.702	112.022	-42.137	1.00	81.99	C
ATOM	4886	C	LEU	A	636	15.808	113.045	-42.425	1.00	85.30	C
ATOM	4887	CB	LEU	A	636	13.517	112.237	-43.087	1.00	83.66	C
ATOM	4888	CG	LEU	A	636	13.387	111.331	-44.317	1.00	83.11	C
ATOM	4889	CD1	LEU	A	636	13.440	109.862	-43.913	1.00	83.52	C
ATOM	4890	CD2	LEU	A	636	12.104	111.628	-45.081	1.00	78.10	C
ATOM	4891	O	LYS	A	637	19.114	115.368	-42.832	1.00	87.70	O
ATOM	4892	N	LYS	A	637	16.359	113.614	-41.349	1.00	89.64	N
ATOM	4893	CA	LYS	A	637	17.290	114.745	-41.404	1.00	87.75	C
ATOM	4894	C	LYS	A	637	18.573	114.472	-42.184	1.00	85.23	C
ATOM	4895	CB	LYS	A	637	17.656	115.188	-39.982	1.00	86.07	C
ATOM	4896	O	THR	A	638	21.227	113.214	-44.973	1.00	97.96	O
ATOM	4897	N	THR	A	638	19.068	113.243	-42.124	1.00	88.70	N
ATOM	4898	CA	THR	A	638	20.344	112.923	-42.763	1.00	86.56	C
ATOM	4899	C	THR	A	638	20.249	112.926	-44.283	1.00	88.00	C
ATOM	4900	CB	THR	A	638	20.877	111.555	-42.303	1.00	85.61	C
ATOM	4901	OG1	THR	A	638	19.817	110.590	-42.330	1.00	84.45	O
ATOM	4902	CG2	THR	A	638	21.430	111.654	-40.893	1.00	88.64	C
ATOM	4903	O	TYR	A	639	19.457	114.305	-47.512	1.00	86.36	O
ATOM	4904	N	TYR	A	639	19.067	112.626	-44.801	1.00	83.78	N
ATOM	4905	CA	TYR	A	639	18.917	112.345	-46.217	1.00	81.23	C
ATOM	4906	C	TYR	A	639	18.573	113.596	-47.028	1.00	86.04	C
ATOM	4907	CB	TYR	A	639	17.850	111.266	-46.411	1.00	77.07	C
ATOM	4908	CG	TYR	A	639	18.129	109.956	-45.690	1.00	81.28	C
ATOM	4909	CD1	TYR	A	639	17.118	109.032	-45.479	1.00	79.45	C
ATOM	4910	CD2	TYR	A	639	19.401	109.640	-45.232	1.00	81.63	C
ATOM	4911	CE1	TYR	A	639	17.364	107.836	-44.830	1.00	78.97	C
ATOM	4912	CE2	TYR	A	639	19.650	108.449	-44.581	1.00	80.14	C
ATOM	4913	CZ	TYR	A	639	18.628	107.551	-44.383	1.00	77.14	C
ATOM	4914	OH	TYR	A	639	18.871	106.361	-43.743	1.00	75.43	O
ATOM	4915	N	ASP	A	644	16.848	116.513	-53.541	1.00	96.73	N

ATOM	4916	CA	ASP	A	644	16.681	117.790	-52.867	1.00	97.16	C
ATOM	4917	C	ASP	A	644	15.194	118.129	-52.664	1.00	100.71	C
ATOM	4918	O	ASP	A	644	14.334	117.249	-52.731	1.00	98.59	O
ATOM	4919	CB	ASP	A	644	17.391	118.896	-53.652	1.00	98.58	C
ATOM	4920	CG	ASP	A	644	17.795	120.079	-52.775	1.00	102.84	C
ATOM	4921	OD2	ASP	A	644	16.896	120.754	-52.225	1.00	104.56	O
ATOM	4922	OD1	ASP	A	644	19.012	120.343	-52.646	1.00	96.61	O
ATOM	4923	N	ASP	A	645	14.909	119.414	-52.450	1.00	99.08	N
ATOM	4924	CA	ASP	A	645	13.656	119.882	-51.842	1.00	97.28	C
ATOM	4925	C	ASP	A	645	12.341	119.521	-52.551	1.00	97.74	C
ATOM	4926	O	ASP	A	645	11.316	119.396	-51.888	1.00	98.46	O
ATOM	4927	CB	ASP	A	645	13.716	121.406	-51.673	1.00	98.82	C
ATOM	4928	N	LYS	A	646	12.347	119.376	-53.875	1.00	99.85	N
ATOM	4929	CA	LYS	A	646	11.116	119.018	-54.593	1.00	97.58	C
ATOM	4930	C	LYS	A	646	10.763	117.567	-54.323	1.00	97.88	C
ATOM	4931	O	LYS	A	646	9.589	117.180	-54.302	1.00	93.95	O
ATOM	4932	CB	LYS	A	646	11.265	119.241	-56.102	1.00	92.87	C
ATOM	4933	CG	LYS	A	646	10.081	118.744	-56.914	1.00	88.36	C
ATOM	4934	CD	LYS	A	646	10.518	118.326	-58.310	1.00	94.47	C
ATOM	4935	CE	LYS	A	646	9.346	117.840	-59.150	1.00	85.24	C
ATOM	4936	NZ	LYS	A	646	9.656	117.930	-60.600	1.00	74.93	N
ATOM	4937	O	VAL	A	647	10.334	114.216	-52.269	1.00	91.70	O
ATOM	4938	N	VAL	A	647	11.808	116.772	-54.116	1.00	99.75	N
ATOM	4939	CA	VAL	A	647	11.676	115.343	-53.894	1.00	95.36	C
ATOM	4940	C	VAL	A	647	11.194	115.067	-52.476	1.00	92.52	C
ATOM	4941	CB	VAL	A	647	13.010	114.621	-54.140	1.00	97.07	C
ATOM	4942	CG1	VAL	A	647	12.826	113.120	-54.028	1.00	96.89	C
ATOM	4943	CG2	VAL	A	647	13.563	114.989	-55.514	1.00	96.98	C
ATOM	4944	O	MET	A	648	9.281	115.546	-48.891	1.00	92.18	O
ATOM	4945	N	MET	A	648	11.736	115.803	-51.510	1.00	93.10	N
ATOM	4946	CA	MET	A	648	11.360	115.646	-50.102	1.00	94.37	C
ATOM	4947	C	MET	A	648	9.901	116.028	-49.839	1.00	94.16	C
ATOM	4948	CB	MET	A	648	12.275	116.486	-49.207	1.00	92.64	C
ATOM	4949	CG	MET	A	648	12.239	116.101	-47.737	1.00	89.78	C
ATOM	4950	SD	MET	A	648	13.239	114.637	-47.378	1.00	107.06	S
ATOM	4951	CE	MET	A	648	14.905	115.231	-47.684	1.00	81.82	C
ATOM	4952	N	LYS	A	649	9.363	116.910	-50.674	1.00	96.62	N
ATOM	4953	CA	LYS	A	649	7.982	117.353	-50.528	1.00	100.63	C
ATOM	4954	C	LYS	A	649	7.048	116.222	-50.932	1.00	96.88	C
ATOM	4955	O	LYS	A	649	5.979	116.040	-50.340	1.00	95.89	O
ATOM	4956	CB	LYS	A	649	7.710	118.610	-51.369	1.00	96.35	C
ATOM	4957	N	GLN	A	650	7.461	115.460	-51.940	1.00	90.16	N
ATOM	4958	CA	GLN	A	650	6.681	114.321	-52.396	1.00	92.84	C
ATOM	4959	C	GLN	A	650	6.890	113.135	-51.453	1.00	91.62	C
ATOM	4960	O	GLN	A	650	6.188	112.126	-51.551	1.00	92.81	O
ATOM	4961	CB	GLN	A	650	7.061	113.946	-53.832	1.00	89.53	C
ATOM	4962	N	LEU	A	651	7.833	113.279	-50.521	1.00	87.27	N
ATOM	4963	CA	LEU	A	651	8.243	112.170	-49.664	1.00	88.79	C
ATOM	4964	C	LEU	A	651	7.666	112.219	-48.246	1.00	89.95	C
ATOM	4965	O	LEU	A	651	7.231	111.194	-47.720	1.00	90.46	O
ATOM	4966	CB	LEU	A	651	9.770	112.105	-49.585	1.00	91.64	C
ATOM	4967	CG	LEU	A	651	10.400	110.770	-49.158	1.00	91.68	C
ATOM	4968	CD1	LEU	A	651	10.359	109.723	-50.276	1.00	92.45	C
ATOM	4969	CD2	LEU	A	651	11.818	110.983	-48.682	1.00	83.01	C
ATOM	4970	O	LYS	A	652	5.024	112.831	-45.302	1.00	91.89	O
ATOM	4971	N	LYS	A	652	7.663	113.394	-47.621	1.00	93.75	N
ATOM	4972	CA	LYS	A	652	7.093	113.529	-46.282	1.00	87.57	C
ATOM	4973	C	LYS	A	652	5.612	113.183	-46.321	1.00	86.93	C
ATOM	4974	CB	LYS	A	652	7.296	114.940	-45.733	1.00	86.61	C
ATOM	4975	CG	LYS	A	652	8.744	115.379	-45.658	1.00	87.86	C
ATOM	4976	CD	LYS	A	652	9.127	115.805	-44.247	1.00	89.70	C
ATOM	4977	CE	LYS	A	652	10.011	117.046	-44.256	1.00	86.20	C
ATOM	4978	NZ	LYS	A	652	9.266	118.261	-44.717	1.00	93.99	N

ATOM	4979	O	ARG	A	653	2.338	110.883	-47.549	1.00	92.01	O
ATOM	4980	N	ARG	A	653	5.025	113.269	-47.510	1.00	83.65	N
ATOM	4981	CA	ARG	A	653	3.630	112.907	-47.728	1.00	86.07	C
ATOM	4982	C	ARG	A	653	3.405	111.389	-47.901	1.00	91.45	C
ATOM	4983	CB	ARG	A	653	3.083	113.654	-48.949	1.00	83.31	C
ATOM	4984	O	ARG	A	654	5.405	107.854	-47.046	1.00	84.09	O
ATOM	4985	N	ARG	A	654	4.386	110.656	-48.433	1.00	84.86	N
ATOM	4986	CA	ARG	A	654	4.197	109.215	-48.619	1.00	84.47	C
ATOM	4987	C	ARG	A	654	4.358	108.457	-47.305	1.00	87.11	C
ATOM	4988	CB	ARG	A	654	5.170	108.651	-49.659	1.00	86.87	C
ATOM	4989	CG	ARG	A	654	5.083	107.121	-49.855	1.00	83.63	C
ATOM	4990	CD	ARG	A	654	3.923	106.716	-50.736	1.00	82.74	C
ATOM	4991	NE	ARG	A	654	4.023	107.389	-52.027	1.00	90.96	N
ATOM	4992	CZ	ARG	A	654	3.309	107.077	-53.104	1.00	88.12	C
ATOM	4993	NH1	ARG	A	654	2.432	106.081	-53.061	1.00	88.35	N
ATOM	4994	NH2	ARG	A	654	3.481	107.761	-54.227	1.00	87.96	N
ATOM	4995	O	ARG	A	655	1.521	106.321	-46.056	1.00	80.09	O
ATOM	4996	N	ARG	A	655	3.321	108.489	-46.472	1.00	85.84	N
ATOM	4997	CA	ARG	A	655	3.316	107.708	-45.240	1.00	78.00	C
ATOM	4998	C	ARG	A	655	2.614	106.364	-45.480	1.00	77.71	C
ATOM	4999	CB	ARG	A	655	2.644	108.490	-44.110	1.00	79.73	C
ATOM	5000	O	TYR	A	656	2.382	103.861	-42.858	1.00	69.54	O
ATOM	5001	N	TYR	A	656	3.263	105.277	-45.053	1.00	65.34	N
ATOM	5002	CA	TYR	A	656	2.754	103.912	-45.231	1.00	68.50	C
ATOM	5003	C	TYR	A	656	2.149	103.346	-43.954	1.00	67.26	C
ATOM	5004	CB	TYR	A	656	3.870	102.943	-45.676	1.00	66.37	C
ATOM	5005	CG	TYR	A	656	4.369	103.107	-47.083	1.00	62.93	C
ATOM	5006	CD1	TYR	A	656	3.566	102.785	-48.165	1.00	69.18	C
ATOM	5007	CD2	TYR	A	656	5.657	103.555	-47.333	1.00	67.77	C
ATOM	5008	CE1	TYR	A	656	4.026	102.923	-49.468	1.00	70.40	C
ATOM	5009	CE2	TYR	A	656	6.129	103.692	-48.624	1.00	71.62	C
ATOM	5010	CZ	TYR	A	656	5.311	103.376	-49.691	1.00	70.83	C
ATOM	5011	OH	TYR	A	656	5.775	103.507	-50.980	1.00	72.33	O
ATOM	5012	O	THR	A	657	0.893	99.549	-44.243	1.00	56.59	O
ATOM	5013	N	THR	A	657	1.425	102.240	-44.098	1.00	60.84	N
ATOM	5014	CA	THR	A	657	0.825	101.568	-42.952	1.00	61.76	C
ATOM	5015	C	THR	A	657	0.959	100.040	-43.126	1.00	55.95	C
ATOM	5016	CB	THR	A	657	-0.681	102.008	-42.764	1.00	58.00	C
ATOM	5017	OG1	THR	A	657	-1.307	101.227	-41.741	1.00	61.05	O
ATOM	5018	CG2	THR	A	657	-1.479	101.849	-44.054	1.00	49.90	O
ATOM	5019	O	GLY	A	658	3.616	97.765	-42.151	1.00	60.03	O
ATOM	5020	N	GLY	A	658	1.168	99.310	-42.029	1.00	51.22	N
ATOM	5021	CA	GLY	A	658	1.208	97.860	-42.067	1.00	53.33	C
ATOM	5022	C	GLY	A	658	2.573	97.224	-41.781	1.00	58.27	C
ATOM	5023	O	TRP	A	659	2.530	93.294	-41.205	1.00	53.16	O
ATOM	5024	N	TRP	A	659	2.551	96.072	-41.116	1.00	47.84	N
ATOM	5025	CA	TRP	A	659	3.748	95.320	-40.782	1.00	50.45	C
ATOM	5026	C	TRP	A	659	3.617	93.870	-41.269	1.00	56.16	C
ATOM	5027	CB	TRP	A	659	3.986	95.359	-39.279	1.00	54.13	C
ATOM	5028	CG	TRP	A	659	4.104	96.744	-38.793	1.00	57.26	C
ATOM	5029	CD1	TRP	A	659	3.086	97.569	-38.401	1.00	51.95	C
ATOM	5030	CD2	TRP	A	659	5.310	97.498	-38.660	1.00	54.67	C
ATOM	5031	NE1	TRP	A	659	3.589	98.781	-38.028	1.00	57.72	N
ATOM	5032	CE2	TRP	A	659	4.952	98.769	-38.181	1.00	58.57	C
ATOM	5033	CE3	TRP	A	659	6.662	97.220	-38.900	1.00	56.48	C
ATOM	5034	CZ2	TRP	A	659	5.896	99.765	-37.935	1.00	60.82	C
ATOM	5035	CZ3	TRP	A	659	7.599	98.204	-38.655	1.00	51.89	C
ATOM	5036	CH2	TRP	A	659	7.215	99.462	-38.180	1.00	58.39	C
ATOM	5037	O	GLY	A	660	4.702	91.079	-40.168	1.00	53.74	O
ATOM	5038	N	GLY	A	660	4.726	93.291	-41.739	1.00	53.91	N
ATOM	5039	CA	GLY	A	660	4.742	91.977	-42.366	1.00	48.09	C
ATOM	5040	C	GLY	A	660	4.860	90.856	-41.353	1.00	49.80	C
ATOM	5041	O	ARG	A	661	6.865	87.268	-39.679	1.00	54.13	O

ATOM	5042	N	ARG	A	661	5.138	89.644	-41.805	1.00	44.59	N
ATOM	5043	CA	ARG	A	661	5.202	88.521	-40.883	1.00	50.58	C
ATOM	5044	C	ARG	A	661	6.640	88.101	-40.559	1.00	52.43	C
ATOM	5045	CB	ARG	A	661	4.421	87.329	-41.446	1.00	51.17	C
ATOM	5046	CG	ARG	A	661	2.984	87.673	-41.913	1.00	50.86	C
ATOM	5047	CD	ARG	A	661	1.998	87.783	-40.739	1.00	49.77	C
ATOM	5048	NE	ARG	A	661	1.993	86.571	-39.928	1.00	57.55	N
ATOM	5049	CZ	ARG	A	661	1.423	86.455	-38.733	1.00	58.48	C
ATOM	5050	NH1	ARG	A	661	0.804	87.494	-38.175	1.00	51.56	N
ATOM	5051	NH2	ARG	A	661	1.482	85.293	-38.089	1.00	51.15	N
ATOM	5052	O	LEU	A	662	9.875	90.413	-41.396	1.00	53.20	O
ATOM	5053	N	LEU	A	662	7.618	88.695	-41.236	1.00	52.30	N
ATOM	5054	CA	LEU	A	662	8.997	88.201	-41.134	1.00	57.50	C
ATOM	5055	C	LEU	A	662	10.016	89.308	-40.886	1.00	52.18	C
ATOM	5056	CB	LEU	A	662	9.381	87.418	-42.409	1.00	50.96	C
ATOM	5057	CG	LEU	A	662	8.505	86.223	-42.794	1.00	49.41	C
ATOM	5058	CD1	LEU	A	662	8.989	85.566	-44.054	1.00	58.15	C
ATOM	5059	CD2	LEU	A	662	8.453	85.215	-41.681	1.00	53.62	C
ATOM	5060	N	SER	A	663	11.050	89.002	-40.106	1.00	56.50	N
ATOM	5061	CA	SER	A	663	12.119	89.970	-39.851	1.00	57.48	C
ATOM	5062	C	SER	A	663	13.090	90.075	-41.003	1.00	52.35	C
ATOM	5063	O	SER	A	663	13.045	89.288	-41.933	1.00	53.10	O
ATOM	5064	CB	SER	A	663	12.900	89.613	-38.588	1.00	55.51	C
ATOM	5065	OG	SER	A	663	13.326	88.281	-38.634	1.00	53.79	O
ATOM	5066	N	ARG	A	664	13.948	91.081	-40.920	1.00	55.71	N
ATOM	5067	CA	ARG	A	664	15.067	91.296	-41.837	1.00	54.49	C
ATOM	5068	C	ARG	A	664	16.196	90.263	-41.630	1.00	59.48	C
ATOM	5069	O	ARG	A	664	16.737	89.711	-42.581	1.00	59.68	O
ATOM	5070	CB	ARG	A	664	15.599	92.707	-41.638	1.00	54.68	C
ATOM	5071	CG	ARG	A	664	16.667	93.129	-42.594	1.00	61.74	C
ATOM	5072	CD	ARG	A	664	17.202	94.450	-42.135	1.00	66.33	C
ATOM	5073	NE	ARG	A	664	18.031	95.097	-43.134	1.00	69.96	N
ATOM	5074	CZ	ARG	A	664	18.421	96.361	-43.037	1.00	75.69	C
ATOM	5075	NH1	ARG	A	664	18.044	97.082	-41.992	1.00	70.34	N
ATOM	5076	NH2	ARG	A	664	19.175	96.905	-43.981	1.00	77.44	N
ATOM	5077	N	LYS	A	665	16.524	90.019	-40.366	1.00	51.35	N
ATOM	5078	CA	LYS	A	665	17.514	89.045	-39.978	1.00	56.07	C
ATOM	5079	C	LYS	A	665	17.170	87.713	-40.608	1.00	63.82	C
ATOM	5080	O	LYS	A	665	18.047	86.974	-41.053	1.00	58.18	O
ATOM	5081	CB	LYS	A	665	17.575	88.892	-38.453	1.00	57.71	C
ATOM	5082	CG	LYS	A	665	18.971	88.756	-37.919	1.00	62.62	C
ATOM	5083	CD	LYS	A	665	19.026	87.861	-36.707	1.00	63.17	C
ATOM	5084	CE	LYS	A	665	20.456	87.788	-36.192	1.00	72.29	C
ATOM	5085	NZ	LYS	A	665	20.588	86.976	-34.955	1.00	82.97	N
ATOM	5086	N	LEU	A	666	15.879	87.413	-40.642	1.00	56.18	N
ATOM	5087	CA	LEU	A	666	15.444	86.126	-41.124	1.00	54.12	C
ATOM	5088	C	LEU	A	666	15.474	86.079	-42.640	1.00	56.97	C
ATOM	5089	O	LEU	A	666	15.954	85.111	-43.216	1.00	59.27	O
ATOM	5090	CB	LEU	A	666	14.043	85.807	-40.608	1.00	58.24	C
ATOM	5091	CG	LEU	A	666	13.424	84.558	-41.234	1.00	53.99	C
ATOM	5092	CD1	LEU	A	666	14.286	83.352	-40.912	1.00	50.35	C
ATOM	5093	CD2	LEU	A	666	11.993	84.367	-40.765	1.00	52.55	C
ATOM	5094	N	ILE	A	667	14.975	87.125	-43.290	1.00	56.36	N
ATOM	5095	CA	ILE	A	667	14.837	87.105	-44.745	1.00	58.16	C
ATOM	5096	C	ILE	A	667	16.193	87.252	-45.457	1.00	59.74	C
ATOM	5097	O	ILE	A	667	16.414	86.661	-46.524	1.00	59.25	O
ATOM	5098	CB	ILE	A	667	13.861	88.213	-45.228	1.00	57.90	C
ATOM	5099	CG1	ILE	A	667	13.802	88.278	-46.745	1.00	62.50	C
ATOM	5100	CG2	ILE	A	667	14.284	89.591	-44.727	1.00	58.33	C
ATOM	5101	CD1	ILE	A	667	13.577	89.707	-47.287	1.00	63.08	C
ATOM	5102	N	ASN	A	668	17.106	88.011	-44.848	1.00	61.63	N
ATOM	5103	CA	ASN	A	668	18.375	88.365	-45.496	1.00	60.24	C
ATOM	5104	C	ASN	A	668	19.508	88.708	-44.522	1.00	56.41	C

ATOM	5105	O	ASN	A	668	20.264	89.635	-44.758	1.00	57.56	O
ATOM	5106	CB	ASN	A	668	18.143	89.547	-46.441	1.00	63.17	C
ATOM	5107	CG	ASN	A	668	19.058	89.533	-47.641	1.00	63.60	C
ATOM	5108	OD1	ASN	A	668	19.622	90.563	-48.016	1.00	70.92	O
ATOM	5109	ND2	ASN	A	668	19.194	88.375	-48.270	1.00	58.98	N
ATOM	5110	N	GLY	A	669	19.621	87.965	-43.432	1.00	56.59	N
ATOM	5111	CA	GLY	A	669	20.701	88.178	-42.496	1.00	58.47	C
ATOM	5112	C	GLY	A	669	21.421	86.891	-42.160	1.00	59.64	C
ATOM	5113	O	GLY	A	669	22.628	86.757	-42.377	1.00	66.57	O
ATOM	5114	O	ILE	A	670	21.241	84.085	-43.716	1.00	61.18	O
ATOM	5115	N	ILE	A	670	20.681	85.936	-41.624	1.00	54.94	N
ATOM	5116	CA	ILE	A	670	21.237	84.626	-41.349	1.00	63.71	C
ATOM	5117	C	ILE	A	670	21.796	83.964	-42.624	1.00	63.52	C
ATOM	5118	CB	ILE	A	670	20.182	83.724	-40.688	1.00	63.92	C
ATOM	5119	CG1	ILE	A	670	19.874	84.259	-39.303	1.00	63.31	C
ATOM	5120	CG2	ILE	A	670	20.675	82.277	-40.565	1.00	70.35	C
ATOM	5121	CD1	ILE	A	670	21.114	84.574	-38.486	1.00	63.95	C
ATOM	5122	O	ARG	A	671	23.593	80.708	-42.164	1.00	62.15	O
ATOM	5123	N	ARG	A	671	22.926	83.284	-42.493	1.00	70.34	N
ATOM	5124	CA	ARG	A	671	23.476	82.584	-43.638	1.00	59.96	C
ATOM	5125	C	ARG	A	671	23.512	81.108	-43.328	1.00	59.49	C
ATOM	5126	CB	ARG	A	671	24.854	83.138	-43.995	1.00	63.47	C
ATOM	5127	CG	ARG	A	671	24.799	84.616	-44.351	1.00	63.66	C
ATOM	5128	CD	ARG	A	671	26.127	85.258	-44.761	1.00	61.65	C
ATOM	5129	NE	ARG	A	671	25.889	86.679	-45.010	1.00	67.53	N
ATOM	5130	CZ	ARG	A	671	25.523	87.185	-46.186	1.00	70.83	C
ATOM	5131	NH1	ARG	A	671	25.295	88.494	-46.311	1.00	59.74	N
ATOM	5132	NH2	ARG	A	671	25.390	86.387	-47.242	1.00	64.78	N
ATOM	5133	O	ASP	A	672	25.873	79.378	-44.830	1.00	60.19	O
ATOM	5134	N	ASP	A	672	23.371	80.301	-44.374	1.00	63.64	N
ATOM	5135	CA	ASP	A	672	23.629	78.873	-44.283	1.00	61.32	C
ATOM	5136	C	ASP	A	672	25.126	78.696	-44.143	1.00	60.23	C
ATOM	5137	CB	ASP	A	672	23.107	78.159	-45.511	1.00	59.01	C
ATOM	5138	CG	ASP	A	672	23.623	76.749	-45.620	1.00	64.14	C
ATOM	5139	OD2	ASP	A	672	24.487	76.522	-46.489	1.00	63.40	O
ATOM	5140	OD1	ASP	A	672	23.162	75.870	-44.850	1.00	60.67	O
ATOM	5141	O	LYS	A	673	28.640	78.275	-44.538	1.00	66.83	O
ATOM	5142	N	LYS	A	673	25.563	77.812	-43.244	1.00	63.43	N
ATOM	5143	CA	LYS	A	673	26.992	77.692	-42.900	1.00	63.60	C
ATOM	5144	C	LYS	A	673	27.856	77.416	-44.122	1.00	65.77	C
ATOM	5145	CB	LYS	A	673	27.224	76.600	-41.851	1.00	56.44	C
ATOM	5146	O	GLN	A	674	29.396	77.388	-47.475	1.00	70.14	O
ATOM	5147	N	GLN	A	674	27.693	76.231	-44.705	1.00	66.76	N
ATOM	5148	CA	GLN	A	674	28.455	75.847	-45.894	1.00	68.33	C
ATOM	5149	C	GLN	A	674	28.373	76.852	-47.039	1.00	68.21	C
ATOM	5150	CB	GLN	A	674	27.992	74.485	-46.400	1.00	70.40	C
ATOM	5151	CG	GLN	A	674	28.503	73.319	-45.589	1.00	71.30	C
ATOM	5152	CD	GLN	A	674	27.983	72.004	-46.112	1.00	78.40	C
ATOM	5153	OE1	GLN	A	674	27.743	71.856	-47.318	1.00	79.95	O
ATOM	5154	NE2	GLN	A	674	27.789	71.038	-45.209	1.00	74.75	N
ATOM	5155	O	SER	A	675	27.489	80.230	-49.305	1.00	62.34	O
ATOM	5156	N	SER	A	675	27.161	77.100	-47.527	1.00	65.02	N
ATOM	5157	CA	SER	A	675	26.976	77.977	-48.679	1.00	60.32	C
ATOM	5158	C	SER	A	675	27.230	79.457	-48.388	1.00	59.69	C
ATOM	5159	CB	SER	A	675	25.564	77.814	-49.229	1.00	61.50	C
ATOM	5160	OG	SER	A	675	24.604	78.288	-48.299	1.00	67.40	O
ATOM	5161	O	GLY	A	676	26.090	83.337	-47.220	1.00	63.24	O
ATOM	5162	N	GLY	A	676	27.132	79.860	-47.126	1.00	62.50	N
ATOM	5163	CA	GLY	A	676	27.228	81.271	-46.774	1.00	61.23	C
ATOM	5164	C	GLY	A	676	26.057	82.106	-47.275	1.00	63.66	C
ATOM	5165	O	LYS	A	677	22.410	81.743	-46.493	1.00	58.48	O
ATOM	5166	N	LYS	A	677	25.011	81.452	-47.767	1.00	61.77	N
ATOM	5167	CA	LYS	A	677	23.887	82.192	-48.358	1.00	64.50	C

ATOM	5168	C	LYS	A	677	22.730	82.520	-47.398	1.00	58.61	C
ATOM	5169	CB	LYS	A	677	23.337	81.425	-49.556	1.00	61.95	C
ATOM	5170	CG	LYS	A	677	24.227	81.492	-50.771	1.00	57.32	C
ATOM	5171	CD	LYS	A	677	23.417	81.336	-52.041	1.00	61.47	C
ATOM	5172	CE	LYS	A	677	22.767	79.975	-52.121	1.00	56.16	C
ATOM	5173	NZ	LYS	A	677	22.024	79.807	-53.410	1.00	57.98	N
ATOM	5174	N	THR	A	678	22.123	83.691	-47.600	1.00	61.45	N
ATOM	5175	CA	THR	A	678	20.859	84.041	-46.941	1.00	54.79	C
ATOM	5176	C	THR	A	678	19.667	83.451	-47.698	1.00	54.43	C
ATOM	5177	O	THR	A	678	19.758	83.140	-48.887	1.00	51.98	O
ATOM	5178	CB	THR	A	678	20.642	85.570	-46.845	1.00	60.33	C
ATOM	5179	OG1	THR	A	678	20.442	86.112	-48.163	1.00	54.44	O
ATOM	5180	CG2	THR	A	678	21.811	86.255	-46.152	1.00	54.51	C
ATOM	5181	N	ILE	A	679	18.540	83.337	-47.002	1.00	60.47	N
ATOM	5182	CA	ILE	A	679	17.293	82.857	-47.587	1.00	48.27	C
ATOM	5183	C	ILE	A	679	16.976	83.538	-48.910	1.00	52.22	C
ATOM	5184	O	ILE	A	679	16.621	82.860	-49.876	1.00	54.20	O
ATOM	5185	CB	ILE	A	679	16.115	83.049	-46.609	1.00	48.69	C
ATOM	5186	CG1	ILE	A	679	16.393	82.305	-45.295	1.00	50.29	C
ATOM	5187	CG2	ILE	A	679	14.807	82.570	-47.222	1.00	50.50	C
ATOM	5188	CD1	ILE	A	679	15.171	82.020	-44.487	1.00	50.96	C
ATOM	5189	N	LEU	A	680	17.138	84.862	-48.970	1.00	56.03	N
ATOM	5190	CA	LEU	A	680	16.793	85.613	-50.177	1.00	53.76	C
ATOM	5191	C	LEU	A	680	17.777	85.338	-51.316	1.00	56.08	C
ATOM	5192	O	LEU	A	680	17.366	85.281	-52.478	1.00	57.51	O
ATOM	5193	CB	LEU	A	680	16.707	87.116	-49.877	1.00	55.24	C
ATOM	5194	CG	LEU	A	680	16.552	88.029	-51.099	1.00	51.57	C
ATOM	5195	CD1	LEU	A	680	15.254	87.752	-51.807	1.00	52.42	C
ATOM	5196	CD2	LEU	A	680	16.643	89.467	-50.698	1.00	51.05	C
ATOM	5197	N	ASP	A	681	19.058	85.147	-50.987	1.00	59.21	N
ATOM	5198	CA	ASP	A	681	20.035	84.598	-51.949	1.00	54.21	C
ATOM	5199	C	ASP	A	681	19.538	83.304	-52.595	1.00	55.37	C
ATOM	5200	O	ASP	A	681	19.536	83.171	-53.818	1.00	59.24	O
ATOM	5201	CB	ASP	A	681	21.379	84.331	-51.278	1.00	54.33	C
ATOM	5202	CG	ASP	A	681	22.157	85.613	-50.970	1.00	61.78	C
ATOM	5203	OD1	ASP	A	681	21.903	86.665	-51.607	1.00	58.25	O
ATOM	5204	OD2	ASP	A	681	23.042	85.550	-50.087	1.00	67.82	O
ATOM	5205	N	PHE	A	682	19.119	82.345	-51.777	1.00	53.19	N
ATOM	5206	CA	PHE	A	682	18.574	81.095	-52.305	1.00	48.09	C
ATOM	5207	C	PHE	A	682	17.391	81.311	-53.237	1.00	52.63	C
ATOM	5208	O	PHE	A	682	17.327	80.713	-54.297	1.00	49.30	O
ATOM	5209	CB	PHE	A	682	18.160	80.171	-51.170	1.00	48.78	C
ATOM	5210	CG	PHE	A	682	19.287	79.328	-50.625	1.00	53.06	C
ATOM	5211	CD1	PHE	A	682	19.757	78.224	-51.341	1.00	57.41	C
ATOM	5212	CD2	PHE	A	682	19.882	79.629	-49.406	1.00	52.31	C
ATOM	5213	CE1	PHE	A	682	20.794	77.423	-50.850	1.00	53.40	C
ATOM	5214	CE2	PHE	A	682	20.930	78.834	-48.912	1.00	57.91	C
ATOM	5215	CZ	PHE	A	682	21.381	77.727	-49.646	1.00	54.85	C
ATOM	5216	N	LEU	A	683	16.461	82.183	-52.834	1.00	56.76	N
ATOM	5217	CA	LEU	A	683	15.253	82.443	-53.598	1.00	46.31	C
ATOM	5218	C	LEU	A	683	15.592	83.076	-54.932	1.00	53.02	C
ATOM	5219	O	LEU	A	683	14.937	82.819	-55.934	1.00	56.16	O
ATOM	5220	CB	LEU	A	683	14.296	83.351	-52.815	1.00	52.86	C
ATOM	5221	CG	LEU	A	683	13.711	82.828	-51.501	1.00	54.16	C
ATOM	5222	CD1	LEU	A	683	12.791	83.881	-50.881	1.00	53.85	C
ATOM	5223	CD2	LEU	A	683	12.980	81.494	-51.683	1.00	49.33	C
ATOM	5224	N	LYS	A	684	16.619	83.913	-54.939	1.00	54.11	N
ATOM	5225	CA	LYS	A	684	17.161	84.433	-56.185	1.00	54.86	C
ATOM	5226	C	LYS	A	684	17.731	83.322	-57.105	1.00	59.09	C
ATOM	5227	O	LYS	A	684	17.395	83.266	-58.292	1.00	60.28	O
ATOM	5228	CB	LYS	A	684	18.243	85.468	-55.883	1.00	54.28	C
ATOM	5229	CG	LYS	A	684	17.700	86.801	-55.398	1.00	53.22	C
ATOM	5230	CD	LYS	A	684	18.848	87.670	-54.938	1.00	53.17	C

ATOM	5231	CE	LYS	A	684	18.462	89.112	-54.864	1.00	54.69	C
ATOM	5232	NZ	LYS	A	684	18.748	89.636	-53.495	1.00	58.96	N
ATOM	5233	N	SER	A	685	18.583	82.452	-56.563	1.00	54.58	N
ATOM	5234	CA	SER	A	685	19.200	81.388	-57.362	1.00	57.63	C
ATOM	5235	C	SER	A	685	19.537	80.143	-56.559	1.00	55.61	C
ATOM	5236	O	SER	A	685	20.323	80.191	-55.604	1.00	53.10	O
ATOM	5237	CB	SER	A	685	20.471	81.879	-58.038	1.00	60.94	C
ATOM	5238	OG	SER	A	685	21.073	80.798	-58.741	1.00	68.18	O
ATOM	5239	O	ASP	A	686	18.672	75.571	-56.985	1.00	56.77	O
ATOM	5240	N	ASP	A	686	18.954	79.020	-56.950	1.00	53.93	N
ATOM	5241	CA	ASP	A	686	19.177	77.782	-56.204	1.00	53.30	C
ATOM	5242	C	ASP	A	686	19.292	76.609	-57.175	1.00	52.10	C
ATOM	5243	CB	ASP	A	686	18.048	77.571	-55.188	1.00	52.93	C
ATOM	5244	CG	ASP	A	686	18.251	76.354	-54.293	1.00	57.83	C
ATOM	5245	OD1	ASP	A	686	19.397	76.062	-53.868	1.00	61.58	O
ATOM	5246	OD2	ASP	A	686	17.238	75.681	-54.004	1.00	58.49	O
ATOM	5247	O	GLY	A	687	18.298	75.835	-60.209	1.00	58.45	O
ATOM	5248	N	GLY	A	687	20.086	76.798	-58.224	1.00	54.77	N
ATOM	5249	CA	GLY	A	687	20.417	75.727	-59.149	1.00	56.22	C
ATOM	5250	C	GLY	A	687	19.170	75.111	-59.742	1.00	60.71	C
ATOM	5251	O	PHE	A	688	15.675	72.548	-59.524	1.00	67.48	O
ATOM	5252	N	PHE	A	688	19.087	73.781	-59.715	1.00	59.81	N
ATOM	5253	CA	PHE	A	688	17.917	73.050	-60.220	1.00	63.73	C
ATOM	5254	C	PHE	A	688	16.810	72.884	-59.179	1.00	65.39	C
ATOM	5255	CB	PHE	A	688	18.320	71.654	-60.716	1.00	64.56	C
ATOM	5256	CG	PHE	A	688	19.145	71.665	-61.966	1.00	62.87	C
ATOM	5257	CD1	PHE	A	688	19.074	72.725	-62.848	1.00	58.02	C
ATOM	5258	CD2	PHE	A	688	19.999	70.616	-62.253	1.00	60.05	C
ATOM	5259	CE1	PHE	A	688	19.834	72.742	-63.987	1.00	59.15	C
ATOM	5260	CE2	PHE	A	688	20.762	70.627	-63.396	1.00	61.31	C
ATOM	5261	CE	PHE	A	688	20.684	71.689	-64.261	1.00	61.25	C
ATOM	5262	O	ALA	A	689	14.032	73.596	-56.272	1.00	59.47	O
ATOM	5263	N	ALA	A	689	17.157	73.093	-57.910	1.00	66.88	N
ATOM	5264	CA	ALA	A	689	16.246	72.844	-56.793	1.00	63.20	C
ATOM	5265	C	ALA	A	689	15.166	73.927	-56.616	1.00	56.75	C
ATOM	5266	CB	ALA	A	689	17.038	72.690	-55.498	1.00	59.18	C
ATOM	5267	O	ASN	A	690	12.511	76.165	-55.493	1.00	59.99	O
ATOM	5268	N	ASN	A	690	15.521	75.194	-56.852	1.00	58.24	N
ATOM	5269	CA	ASN	A	690	14.608	76.345	-56.647	1.00	64.33	C
ATOM	5270	C	ASN	A	690	13.736	76.197	-55.403	1.00	60.18	C
ATOM	5271	CB	ASN	A	690	13.709	76.559	-57.871	1.00	55.80	C
ATOM	5272	CG	ASN	A	690	14.409	77.309	-58.986	1.00	64.15	C
ATOM	5273	OD1	ASN	A	690	15.641	77.444	-58.991	1.00	66.24	O
ATOM	5274	ND2	ASN	A	690	13.628	77.811	-59.939	1.00	58.56	N
ATOM	5275	O	ARG	A	691	13.196	78.078	-52.726	1.00	51.11	O
ATOM	5276	N	ARG	A	691	14.381	76.069	-54.251	1.00	54.71	N
ATOM	5277	CA	ARG	A	691	13.679	75.748	-53.024	1.00	55.95	C
ATOM	5278	C	ARG	A	691	12.851	76.914	-52.517	1.00	57.13	C
ATOM	5279	CB	ARG	A	691	14.662	75.315	-51.953	1.00	57.99	C
ATOM	5280	CG	ARG	A	691	14.971	73.823	-51.971	1.00	56.38	C
ATOM	5281	CD	ARG	A	691	16.102	73.501	-51.026	1.00	45.42	C
ATOM	5282	NE	ARG	A	691	17.368	74.035	-51.514	1.00	56.94	N
ATOM	5283	CZ	ARG	A	691	18.564	73.653	-51.069	1.00	52.96	C
ATOM	5284	NH1	ARG	A	691	18.652	72.735	-50.124	1.00	53.12	N
ATOM	5285	NH2	ARG	A	691	19.666	74.185	-51.571	1.00	54.73	N
ATOM	5286	O	ASN	A	692	12.169	77.456	-49.323	1.00	56.82	O
ATOM	5287	N	ASN	A	692	11.749	76.571	-51.860	1.00	61.06	N
ATOM	5288	CA	ASN	A	692	10.838	77.547	-51.270	1.00	58.03	C
ATOM	5289	C	ASN	A	692	11.329	78.076	-49.945	1.00	50.55	C
ATOM	5290	CB	ASN	A	692	9.464	76.921	-51.058	1.00	52.33	C
ATOM	5291	CG	ASN	A	692	8.422	77.676	-51.752	1.00	54.08	C
ATOM	5292	OD1	ASN	A	692	7.270	77.253	-51.846	1.00	58.39	O
ATOM	5293	ND2	ASN	A	692	8.812	78.834	-52.272	1.00	58.75	N

ATOM	5294	O	PHE	A	693	11.435	78.344	-46.193	1.00	54.55	O
ATOM	5295	N	PHE	A	693	10.766	79.189	-49.491	1.00	56.29	N
ATOM	5296	CA	PHE	A	693	11.025	79.675	-48.141	1.00	50.71	C
ATOM	5297	C	PHE	A	693	10.675	78.586	-47.133	1.00	50.63	C
ATOM	5298	CB	PHE	A	693	10.232	80.967	-47.864	1.00	56.95	C
ATOM	5299	CG	PHE	A	693	10.159	81.344	-46.402	1.00	54.73	C
ATOM	5300	CD1	PHE	A	693	11.222	81.988	-45.777	1.00	58.28	C
ATOM	5301	CD2	PHE	A	693	9.029	81.067	-45.657	1.00	58.12	C
ATOM	5302	CE1	PHE	A	693	11.161	82.335	-44.428	1.00	61.09	C
ATOM	5303	CE2	PHE	A	693	8.959	81.424	-44.304	1.00	62.56	C
ATOM	5304	CZ	PHE	A	693	10.029	82.053	-43.696	1.00	60.15	C
ATOM	5305	O	MET	A	694	10.232	74.847	-45.705	1.00	58.27	O
ATOM	5306	N	MET	A	694	9.536	77.924	-47.344	1.00	47.21	N
ATOM	5307	CA	MET	A	694	9.121	76.817	-46.485	1.00	53.86	C
ATOM	5308	C	MET	A	694	10.055	75.623	-46.638	1.00	56.92	C
ATOM	5309	CB	MET	A	694	7.682	76.374	-46.790	1.00	59.70	C
ATOM	5310	CG	MET	A	694	6.572	77.133	-46.051	1.00	51.16	C
ATOM	5311	SD	MET	A	694	6.554	76.796	-44.285	1.00	52.87	S
ATOM	5312	CE	MET	A	694	7.288	78.329	-43.681	1.00	54.21	C
ATOM	5313	O	GLN	A	695	13.560	73.789	-46.852	1.00	57.13	O
ATOM	5314	N	GLN	A	695	10.647	75.484	-47.822	1.00	58.38	N
ATOM	5315	CA	GLN	A	695	11.598	74.400	-48.088	1.00	60.50	C
ATOM	5316	C	GLN	A	695	12.967	74.673	-47.463	1.00	55.56	C
ATOM	5317	CB	GLN	A	695	11.732	74.171	-49.600	1.00	57.77	C
ATOM	5318	CG	GLN	A	695	10.733	73.163	-50.158	1.00	54.15	C
ATOM	5319	CD	GLN	A	695	10.603	73.277	-51.655	1.00	59.70	C
ATOM	5320	OE1	GLN	A	695	11.029	74.271	-52.250	1.00	57.55	O
ATOM	5321	NE2	GLN	A	695	10.009	72.266	-52.277	1.00	53.64	N
ATOM	5322	O	LEU	A	696	15.512	75.615	-44.823	1.00	58.18	O
ATOM	5323	N	LEU	A	696	13.455	75.902	-47.620	1.00	52.16	N
ATOM	5324	CA	LEU	A	696	14.686	76.334	-46.976	1.00	52.32	C
ATOM	5325	C	LEU	A	696	14.618	76.192	-45.447	1.00	55.89	C
ATOM	5326	CB	LEU	A	696	14.987	77.776	-47.355	1.00	49.20	C
ATOM	5327	CG	LEU	A	696	15.100	78.103	-48.840	1.00	47.71	C
ATOM	5328	CD1	LEU	A	696	15.400	79.562	-49.026	1.00	46.65	C
ATOM	5329	CD2	LEU	A	696	16.203	77.282	-49.453	1.00	55.79	C
ATOM	5330	O	ILE	A	697	13.548	75.089	-41.635	1.00	57.95	O
ATOM	5331	N	ILE	A	697	13.532	76.703	-44.867	1.00	60.57	N
ATOM	5332	CA	ILE	A	697	13.285	76.689	-43.419	1.00	58.54	C
ATOM	5333	C	ILE	A	697	13.190	75.278	-42.792	1.00	56.18	C
ATOM	5334	CB	ILE	A	697	11.982	77.511	-43.113	1.00	62.63	C
ATOM	5335	CG1	ILE	A	697	12.284	79.001	-43.178	1.00	57.74	C
ATOM	5336	CG2	ILE	A	697	11.392	77.185	-41.766	1.00	65.13	C
ATOM	5337	CD1	ILE	A	697	13.709	79.311	-42.819	1.00	57.73	C
ATOM	5338	O	HIS	A	698	13.795	70.785	-43.221	1.00	66.48	O
ATOM	5339	N	HIS	A	698	12.731	74.286	-43.551	1.00	57.59	N
ATOM	5340	CA	HIS	A	698	12.682	72.909	-43.040	1.00	60.53	C
ATOM	5341	C	HIS	A	698	13.784	71.964	-43.566	1.00	60.15	C
ATOM	5342	CB	HIS	A	698	11.324	72.294	-43.351	1.00	55.87	C
ATOM	5343	CG	HIS	A	698	10.182	73.069	-42.784	1.00	65.67	C
ATOM	5344	ND1	HIS	A	698	9.607	74.137	-43.441	1.00	62.83	N
ATOM	5345	CD2	HIS	A	698	9.527	72.954	-41.605	1.00	62.28	C
ATOM	5346	CE1	HIS	A	698	8.642	74.640	-42.695	1.00	63.42	C
ATOM	5347	NE2	HIS	A	698	8.571	73.938	-41.578	1.00	67.92	N
ATOM	5348	O	ASP	A	699	17.597	72.099	-43.588	1.00	59.70	O
ATOM	5349	N	ASP	A	699	14.700	72.464	-44.389	1.00	57.08	N
ATOM	5350	CA	ASP	A	699	15.705	71.589	-44.989	1.00	61.46	C
ATOM	5351	C	ASP	A	699	16.830	71.245	-44.026	1.00	61.56	C
ATOM	5352	CB	ASP	A	699	16.302	72.198	-46.258	1.00	58.65	C
ATOM	5353	CG	ASP	A	699	17.038	71.162	-47.111	1.00	65.28	C
ATOM	5354	OD2	ASP	A	699	17.098	71.340	-48.348	1.00	64.40	O
ATOM	5355	OD1	ASP	A	699	17.550	70.164	-46.555	1.00	65.85	O
ATOM	5356	O	ASP	A	700	20.370	69.382	-42.792	1.00	68.81	O

ATOM	5357	N	ASP	A	700	16.944	69.957	-43.739	1.00	66.08	N
ATOM	5358	CA	ASP	A	700	17.985	69.475	-42.850	1.00	68.90	C
ATOM	5359	C	ASP	A	700	19.373	69.565	-43.481	1.00	65.55	C
ATOM	5360	CE	ASP	A	700	17.676	68.045	-42.430	1.00	63.04	C
ATOM	5361	CG	ASP	A	700	16.257	67.896	-41.916	1.00	67.37	C
ATOM	5362	OD1	ASP	A	700	15.350	67.667	-42.750	1.00	70.39	O
ATOM	5363	OD2	ASP	A	700	16.051	68.033	-40.688	1.00	66.60	O
ATOM	5364	N	SER	A	701	19.439	69.856	-44.778	1.00	63.32	N
ATOM	5365	CA	SER	A	701	20.733	70.058	-45.428	1.00	68.33	C
ATOM	5366	C	SER	A	701	21.281	71.420	-45.066	1.00	68.66	C
ATOM	5367	O	SER	A	701	22.491	71.615	-44.975	1.00	71.91	O
ATOM	5368	CB	SER	A	701	20.627	69.935	-46.948	1.00	71.13	C
ATOM	5369	OG	SER	A	701	20.548	68.576	-47.340	1.00	76.48	O
ATOM	5370	N	LEU	A	702	20.372	72.364	-44.858	1.00	67.48	N
ATOM	5371	CA	LEU	A	702	20.744	73.733	-44.563	1.00	59.70	C
ATOM	5372	C	LEU	A	702	20.784	73.949	-43.065	1.00	60.81	C
ATOM	5373	O	LEU	A	702	20.284	73.126	-42.300	1.00	64.90	O
ATOM	5374	CB	LEU	A	702	19.766	74.699	-45.223	1.00	56.89	C
ATOM	5375	CG	LEU	A	702	19.604	74.442	-46.717	1.00	60.91	C
ATOM	5376	CD2	LEU	A	702	20.949	74.575	-47.428	1.00	61.68	C
ATOM	5377	CD1	LEU	A	702	18.573	75.380	-47.313	1.00	55.01	C
ATOM	5378	N	THR	A	703	21.377	75.058	-42.644	1.00	61.13	N
ATOM	5379	CA	THR	A	703	21.456	75.363	-41.230	1.00	64.26	C
ATOM	5380	C	THR	A	703	20.351	76.307	-40.742	1.00	66.34	C
ATOM	5381	O	THR	A	703	20.279	76.563	-39.538	1.00	69.43	O
ATOM	5382	CB	THR	A	703	22.825	75.990	-40.856	1.00	65.93	C
ATOM	5383	OG1	THR	A	703	23.045	77.183	-41.621	1.00	66.28	O
ATOM	5384	CG2	THR	A	703	23.959	74.995	-41.096	1.00	60.36	C
ATOM	5385	N	PHE	A	704	19.504	76.817	-41.644	1.00	59.35	N
ATOM	5386	CA	PHE	A	704	18.439	77.758	-41.237	1.00	59.60	C
ATOM	5387	C	PHE	A	704	17.530	77.142	-40.182	1.00	59.58	C
ATOM	5388	O	PHE	A	704	17.276	77.746	-39.147	1.00	66.27	O
ATOM	5389	CE	PHE	A	704	17.570	78.201	-42.418	1.00	57.76	C
ATOM	5390	CG	PHE	A	704	18.327	78.880	-43.527	1.00	60.02	C
ATOM	5391	CD1	PHE	A	704	19.107	80.000	-43.272	1.00	56.98	C
ATOM	5392	CD2	PHE	A	704	18.235	78.408	-44.835	1.00	55.18	C
ATOM	5393	CE1	PHE	A	704	19.793	80.627	-44.295	1.00	57.04	C
ATOM	5394	CE2	PHE	A	704	18.903	79.038	-45.853	1.00	50.38	C
ATOM	5395	CZ	PHE	A	704	19.689	80.142	-45.584	1.00	52.68	C
ATOM	5396	N	LYS	A	705	17.059	75.931	-40.453	1.00	59.70	N
ATOM	5397	CA	LYS	A	705	16.199	75.186	-39.539	1.00	60.67	C
ATOM	5398	C	LYS	A	705	16.750	75.125	-38.113	1.00	66.44	C
ATOM	5399	O	LYS	A	705	15.990	75.237	-37.144	1.00	66.88	O
ATOM	5400	CB	LYS	A	705	15.983	73.765	-40.077	1.00	59.01	C
ATOM	5401	CG	LYS	A	705	15.155	72.878	-39.179	1.00	63.31	C
ATOM	5402	CD	LYS	A	705	14.913	71.503	-39.789	1.00	65.60	C
ATOM	5403	CE	LYS	A	705	14.163	70.613	-38.809	1.00	64.73	C
ATOM	5404	NZ	LYS	A	705	13.514	69.464	-39.468	1.00	64.29	N
ATOM	5405	N	GLU	A	706	18.073	74.961	-38.000	1.00	67.92	N
ATOM	5406	CA	GLU	A	706	18.765	74.848	-36.714	1.00	64.47	C
ATOM	5407	C	GLU	A	706	18.935	76.209	-36.059	1.00	66.66	C
ATOM	5408	O	GLU	A	706	18.663	76.365	-34.867	1.00	70.27	O
ATOM	5409	CB	GLU	A	706	20.137	74.182	-36.883	1.00	63.80	C
ATOM	5410	N	ASP	A	707	19.397	77.188	-36.838	1.00	65.37	N
ATOM	5411	CA	ASP	A	707	19.499	78.568	-36.368	1.00	70.33	C
ATOM	5412	C	ASP	A	707	18.149	79.069	-35.823	1.00	68.60	C
ATOM	5413	O	ASP	A	707	18.113	79.802	-34.833	1.00	69.97	O
ATOM	5414	CB	ASP	A	707	19.988	79.494	-37.491	1.00	68.37	C
ATOM	5415	CG	ASP	A	707	21.505	79.605	-37.555	1.00	71.40	C
ATOM	5416	OD1	ASP	A	707	22.168	79.568	-36.492	1.00	73.62	O
ATOM	5417	OD2	ASP	A	707	22.035	79.746	-38.680	1.00	72.06	O
ATOM	5418	N	ILE	A	708	17.055	78.658	-36.473	1.00	67.93	N
ATOM	5419	CA	ILE	A	708	15.698	79.031	-36.066	1.00	65.22	C

ATOM	5420	C	ILE	A	708	15.289	78.398	-34.736	1.00	66.51	C
ATOM	5421	O	ILE	A	708	14.918	79.105	-33.800	1.00	67.14	O
ATOM	5422	CB	ILE	A	708	14.660	78.652	-37.138	1.00	62.45	C
ATOM	5423	CG1	ILE	A	708	14.737	79.624	-38.318	1.00	63.05	C
ATOM	5424	CG2	ILE	A	708	13.254	78.671	-36.556	1.00	59.01	C
ATOM	5425	CD1	ILE	A	708	13.582	79.515	-39.278	1.00	55.15	C
ATOM	5426	N	GLN	A	709	15.375	77.073	-34.647	1.00	68.81	N
ATOM	5427	CA	GLN	A	709	15.021	76.365	-33.414	1.00	71.01	C
ATOM	5428	C	GLN	A	709	15.938	76.685	-32.225	1.00	67.88	C
ATOM	5429	O	GLN	A	709	15.547	76.494	-31.072	1.00	69.06	O
ATOM	5430	CB	GLN	A	709	15.003	74.861	-33.664	1.00	72.46	C
ATOM	5431	CG	GLN	A	709	13.763	74.417	-34.409	1.00	76.15	C
ATOM	5432	CD	GLN	A	709	14.029	73.264	-35.363	1.00	81.29	C
ATOM	5433	OE1	GLN	A	709	14.740	72.303	-35.031	1.00	72.86	O
ATOM	5434	NE2	GLN	A	709	13.462	73.359	-36.564	1.00	80.36	N
ATOM	5435	N	LYS	A	710	17.143	77.176	-32.499	1.00	66.69	N
ATOM	5436	CA	LYS	A	710	17.990	77.713	-31.442	1.00	67.12	C
ATOM	5437	C	LYS	A	710	17.469	79.075	-30.960	1.00	73.16	C
ATOM	5438	O	LYS	A	710	17.729	79.469	-29.831	1.00	74.31	O
ATOM	5439	CB	LYS	A	710	19.436	77.849	-31.915	1.00	68.82	C
ATOM	5440	N	ALA	A	711	16.731	79.780	-31.814	1.00	68.21	N
ATOM	5441	CA	ALA	A	711	16.298	81.141	-31.517	1.00	69.87	C
ATOM	5442	C	ALA	A	711	15.059	81.167	-30.649	1.00	70.50	C
ATOM	5443	O	ALA	A	711	14.794	82.151	-29.965	1.00	75.34	O
ATOM	5444	CB	ALA	A	711	16.033	81.904	-32.800	1.00	66.09	C
ATOM	5445	N	GLN	A	712	14.291	80.091	-30.696	1.00	67.51	N
ATOM	5446	CA	GLN	A	712	13.050	80.028	-29.951	1.00	74.01	C
ATOM	5447	C	GLN	A	712	13.335	79.569	-28.520	1.00	82.38	C
ATOM	5448	O	GLN	A	712	13.904	78.493	-28.302	1.00	83.88	O
ATOM	5449	CB	GLN	A	712	12.055	79.113	-30.677	1.00	73.50	C
ATOM	5450	CG	GLN	A	712	11.648	79.674	-32.070	1.00	69.27	C
ATOM	5451	CD	GLN	A	712	10.587	78.847	-32.786	1.00	73.81	C
ATOM	5452	OE1	GLN	A	712	9.798	78.143	-32.157	1.00	78.37	O
ATOM	5453	NE2	GLN	A	712	10.564	78.933	-34.112	1.00	74.86	N
ATOM	5454	O	VAL	A	713	12.389	78.711	-24.455	1.00	70.65	O
ATOM	5455	N	VAL	A	713	12.963	80.402	-27.550	1.00	80.18	N
ATOM	5456	CA	VAL	A	713	13.313	80.168	-26.145	1.00	82.07	C
ATOM	5457	C	VAL	A	713	12.164	79.488	-25.387	1.00	77.29	C
ATOM	5458	CB	VAL	A	713	13.706	81.506	-25.436	1.00	76.50	C
ATOM	5459	CG1	VAL	A	713	15.140	81.459	-24.927	1.00	79.91	C
ATOM	5460	CG2	VAL	A	713	12.741	81.842	-24.302	1.00	75.98	C
ATOM	5461	O	ASP	A	718	3.324	78.974	-19.458	1.00	77.40	O
ATOM	5462	N	ASP	A	718	5.962	80.580	-19.021	1.00	90.22	N
ATOM	5463	CA	ASP	A	718	4.708	80.901	-19.697	1.00	90.25	C
ATOM	5464	C	ASP	A	718	3.554	80.122	-19.095	1.00	83.53	C
ATOM	5465	CB	ASP	A	718	4.803	80.596	-21.190	1.00	92.22	C
ATOM	5466	CG	ASP	A	718	6.009	81.241	-21.841	1.00	103.00	C
ATOM	5467	OD2	ASP	A	718	5.958	81.484	-23.067	1.00	104.15	O
ATOM	5468	OD1	ASP	A	718	7.007	81.498	-21.130	1.00	103.76	O
ATOM	5469	N	SER	A	719	2.831	80.749	-18.172	1.00	85.06	N
ATOM	5470	CA	SER	A	719	1.714	80.095	-17.496	1.00	79.89	C
ATOM	5471	C	SER	A	719	0.636	79.680	-18.484	1.00	73.51	C
ATOM	5472	O	SER	A	719	0.514	80.246	-19.572	1.00	69.49	O
ATOM	5473	CB	SER	A	719	1.110	81.017	-16.445	1.00	86.52	C
ATOM	5474	OG	SER	A	719	0.547	82.166	-17.051	1.00	77.63	O
ATOM	5475	N	LEU	A	720	-0.148	78.684	-18.104	1.00	71.21	N
ATOM	5476	CA	LEU	A	720	-1.202	78.211	-18.979	1.00	69.10	C
ATOM	5477	C	LEU	A	720	-2.311	79.265	-19.031	1.00	69.41	C
ATOM	5478	O	LEU	A	720	-2.908	79.516	-20.088	1.00	67.96	O
ATOM	5479	CB	LEU	A	720	-1.736	76.856	-18.506	1.00	68.11	C
ATOM	5480	CG	LEU	A	720	-2.975	76.347	-19.252	1.00	68.46	C
ATOM	5481	CD1	LEU	A	720	-2.631	75.931	-20.663	1.00	67.96	C
ATOM	5482	CD2	LEU	A	720	-3.659	75.220	-18.505	1.00	65.81	C

ATOM	5483	N	HIS	A	721	-2.568	79.898	-17.893	1.00	67.83	N
ATOM	5484	CA	HIS	A	721	-3.524	80.989	-17.867	1.00	67.99	C
ATOM	5485	C	HIS	A	721	-3.147	82.028	-18.909	1.00	65.30	C
ATOM	5486	O	HIS	A	721	-3.974	82.410	-19.737	1.00	67.80	O
ATOM	5487	CB	HIS	A	721	-3.605	81.635	-16.484	1.00	66.22	C
ATOM	5488	CG	HIS	A	721	-4.518	82.822	-16.436	1.00	66.51	C
ATOM	5489	ND1	HIS	A	721	-4.399	83.817	-15.491	1.00	63.88	N
ATOM	5490	CD2	HIS	A	721	-5.553	83.182	-17.234	1.00	62.32	C
ATOM	5491	CE1	HIS	A	721	-5.325	84.737	-15.705	1.00	67.02	C
ATOM	5492	NE2	HIS	A	721	-6.036	84.376	-16.758	1.00	63.64	N
ATOM	5493	N	GLU	A	722	-1.896	82.467	-18.885	1.00	62.37	N
ATOM	5494	CA	GLU	A	722	-1.466	83.517	-19.794	1.00	66.37	C
ATOM	5495	C	GLU	A	722	-1.593	83.098	-21.252	1.00	69.51	C
ATOM	5496	O	GLU	A	722	-2.015	83.899	-22.087	1.00	70.54	O
ATOM	5497	CB	GLU	A	722	-0.032	83.941	-19.486	1.00	72.02	C
ATOM	5498	CG	GLU	A	722	0.057	84.913	-18.320	1.00	78.95	C
ATOM	5499	CD	GLU	A	722	1.479	85.311	-17.980	1.00	81.77	C
ATOM	5500	OE1	GLU	A	722	2.340	85.313	-18.889	1.00	74.31	O
ATOM	5501	OE2	GLU	A	722	1.729	85.629	-16.794	1.00	85.57	O
ATOM	5502	N	HIS	A	723	-1.251	81.849	-21.558	1.00	67.25	N
ATOM	5503	CA	HIS	A	723	-1.329	81.373	-22.933	1.00	67.51	C
ATOM	5504	C	HIS	A	723	-2.758	81.427	-23.441	1.00	66.19	C
ATOM	5505	O	HIS	A	723	-3.005	81.903	-24.549	1.00	67.45	O
ATOM	5506	CB	HIS	A	723	-0.787	79.948	-23.071	1.00	72.96	C
ATOM	5507	CG	HIS	A	723	-0.949	79.381	-24.448	1.00	71.84	C
ATOM	5508	ND1	HIS	A	723	-0.121	79.723	-25.496	1.00	76.73	N
ATOM	5509	CD2	HIS	A	723	-1.864	78.523	-24.957	1.00	68.64	C
ATOM	5510	CE1	HIS	A	723	-0.508	79.085	-26.586	1.00	79.65	C
ATOM	5511	NE2	HIS	A	723	-1.568	78.356	-26.288	1.00	73.56	N
ATOM	5512	N	ILE	A	724	-3.689	80.927	-22.630	1.00	66.93	N
ATOM	5513	CA	ILE	A	724	-5.119	81.003	-22.943	1.00	66.13	C
ATOM	5514	C	ILE	A	724	-5.593	82.459	-22.987	1.00	67.16	C
ATOM	5515	O	ILE	A	724	-6.418	82.821	-23.824	1.00	66.71	O
ATOM	5516	CB	ILE	A	724	-5.980	80.241	-21.915	1.00	63.23	C
ATOM	5517	CG1	ILE	A	724	-5.549	78.776	-21.826	1.00	61.13	C
ATOM	5518	CG2	ILE	A	724	-7.479	80.359	-22.244	1.00	48.03	C
ATOM	5519	CD1	ILE	A	724	-6.086	78.059	-20.588	1.00	54.24	C
ATOM	5520	N	ALA	A	725	-5.072	83.296	-22.097	1.00	60.81	N
ATOM	5521	CA	ALA	A	725	-5.514	84.689	-22.075	1.00	65.83	C
ATOM	5522	C	ALA	A	725	-5.199	85.356	-23.393	1.00	66.33	C
ATOM	5523	O	ALA	A	725	-5.891	86.285	-23.799	1.00	68.55	O
ATOM	5524	CB	ALA	A	725	-4.865	85.458	-20.925	1.00	66.76	C
ATOM	5525	N	ASN	A	726	-4.168	84.854	-24.071	1.00	68.02	N
ATOM	5526	CA	ASN	A	726	-3.589	85.542	-25.222	1.00	65.59	C
ATOM	5527	C	ASN	A	726	-4.122	85.071	-26.560	1.00	69.74	C
ATOM	5528	O	ASN	A	726	-3.982	85.764	-27.564	1.00	75.24	O
ATOM	5529	CB	ASN	A	726	-2.072	85.406	-25.196	1.00	69.05	C
ATOM	5530	CG	ASN	A	726	-1.434	86.278	-24.122	1.00	82.83	C
ATOM	5531	OD1	ASN	A	726	-2.103	86.729	-23.179	1.00	81.47	O
ATOM	5532	ND2	ASN	A	726	-0.136	86.530	-24.263	1.00	90.15	N
ATOM	5533	O	LEU	A	727	-7.112	85.083	-27.388	1.00	66.41	O
ATOM	5534	N	LEU	A	727	-4.732	83.892	-26.578	1.00	68.67	N
ATOM	5535	CA	LEU	A	727	-5.439	83.426	-27.764	1.00	64.96	C
ATOM	5536	C	LEU	A	727	-6.482	84.431	-28.213	1.00	60.23	C
ATOM	5537	CB	LEU	A	727	-6.119	82.093	-27.481	1.00	64.87	C
ATOM	5538	CG	LEU	A	727	-5.176	80.965	-27.081	1.00	68.34	C
ATOM	5539	CD1	LEU	A	727	-5.974	79.783	-26.555	1.00	62.47	C
ATOM	5540	CD2	LEU	A	727	-4.311	80.578	-28.276	1.00	68.39	C
ATOM	5541	O	ALA	A	728	-8.991	83.304	-29.235	1.00	62.15	O
ATOM	5542	N	ALA	A	728	-6.676	84.559	-29.515	1.00	57.69	N
ATOM	5543	CA	ALA	A	728	-7.849	85.265	-30.004	1.00	64.32	C
ATOM	5544	C	ALA	A	728	-9.094	84.471	-29.595	1.00	63.03	C
ATOM	5545	CB	ALA	A	728	-7.781	85.441	-31.510	1.00	59.16	C

ATOM	5546	O	GLY	A	729	-11.641	85.834	-27.381	1.00	59.53	O
ATOM	5547	N	GLY	A	729	-10.260	85.103	-29.643	1.00	61.13	N
ATOM	5548	CA	GLY	A	729	-11.505	84.430	-29.323	1.00	60.46	C
ATOM	5549	C	GLY	A	729	-12.231	85.069	-28.152	1.00	62.97	C
ATOM	5550	O	SER	A	730	-13.561	83.728	-25.406	1.00	61.10	O
ATOM	5551	N	SER	A	730	-13.514	84.749	-28.014	1.00	61.30	N
ATOM	5552	CA	SER	A	730	-14.332	85.340	-26.969	1.00	60.80	C
ATOM	5553	C	SER	A	730	-13.851	84.905	-25.607	1.00	58.62	C
ATOM	5554	CB	SER	A	730	-15.798	84.946	-27.135	1.00	69.73	C
ATOM	5555	OG	SER	A	730	-16.039	83.666	-26.573	1.00	69.25	O
ATOM	5556	O	PRO	A	731	-14.059	83.846	-21.748	1.00	56.89	O
ATOM	5557	N	PRO	A	731	-13.777	85.855	-24.661	1.00	58.25	N
ATOM	5558	CA	PRO	A	731	-13.401	85.544	-23.279	1.00	58.88	C
ATOM	5559	C	PRO	A	731	-14.401	84.569	-22.680	1.00	55.22	C
ATOM	5560	CB	PRO	A	731	-13.456	86.916	-22.563	1.00	58.02	C
ATOM	5561	CG	PRO	A	731	-13.476	87.924	-23.648	1.00	59.54	C
ATOM	5562	CD	PRO	A	731	-14.158	87.269	-24.817	1.00	61.41	C
ATOM	5563	O	ALA	A	732	-16.177	81.250	-22.315	1.00	55.45	O
ATOM	5564	N	ALA	A	732	-15.622	84.563	-23.210	1.00	48.26	N
ATOM	5565	CA	ALA	A	732	-16.602	83.580	-22.790	1.00	55.61	C
ATOM	5566	C	ALA	A	732	-16.111	82.162	-23.141	1.00	58.40	C
ATOM	5567	CB	ALA	A	732	-17.941	83.856	-23.424	1.00	49.02	C
ATOM	5568	O	ILE	A	733	-13.517	79.280	-23.598	1.00	52.50	O
ATOM	5569	N	ILE	A	733	-15.608	81.986	-24.359	1.00	58.66	N
ATOM	5570	CA	ILE	A	733	-15.051	80.697	-24.744	1.00	58.73	C
ATOM	5571	C	ILE	A	733	-13.737	80.410	-24.037	1.00	56.24	C
ATOM	5572	CB	ILE	A	733	-14.848	80.595	-26.253	1.00	62.18	C
ATOM	5573	CG1	ILE	A	733	-16.208	80.396	-26.910	1.00	76.89	C
ATOM	5574	CG2	ILE	A	733	-14.034	79.350	-26.612	1.00	64.38	C
ATOM	5575	CD1	ILE	A	733	-16.896	79.076	-26.484	1.00	68.22	C
ATOM	5576	O	LYS	A	734	-11.066	79.868	-21.339	1.00	48.70	O
ATOM	5577	N	LYS	A	734	-12.874	81.416	-23.903	1.00	54.85	N
ATOM	5578	CA	LYS	A	734	-11.581	81.163	-23.279	1.00	51.52	C
ATOM	5579	C	LYS	A	734	-11.805	80.720	-21.851	1.00	55.15	C
ATOM	5580	CB	LYS	A	734	-10.691	82.385	-23.317	1.00	51.95	C
ATOM	5581	CG	LYS	A	734	-10.085	82.667	-24.672	1.00	60.76	C
ATOM	5582	CD	LYS	A	734	-10.121	84.164	-24.957	1.00	60.31	C
ATOM	5583	CE	LYS	A	734	-8.773	84.825	-24.756	1.00	57.62	C
ATOM	5584	NZ	LYS	A	734	-8.953	86.300	-24.747	1.00	71.99	N
ATOM	5585	N	LYS	A	735	-12.833	81.282	-21.211	1.00	50.06	N
ATOM	5586	CA	LYS	A	735	-13.150	80.849	-19.864	1.00	46.70	C
ATOM	5587	C	LYS	A	735	-13.379	79.340	-19.880	1.00	48.74	C
ATOM	5588	O	LYS	A	735	-12.699	78.607	-19.161	1.00	48.82	O
ATOM	5589	CB	LYS	A	735	-14.361	81.562	-19.300	1.00	43.01	C
ATOM	5590	CG	LYS	A	735	-14.681	81.124	-17.879	1.00	44.51	C
ATOM	5591	CD	LYS	A	735	-15.419	82.225	-17.097	1.00	41.00	C
ATOM	5592	CE	LYS	A	735	-15.674	81.790	-15.681	1.00	42.58	C
ATOM	5593	NZ	LYS	A	735	-16.479	82.802	-14.943	1.00	39.29	N
ATOM	5594	N	GLY	A	736	-14.310	78.879	-20.714	1.00	47.52	N
ATOM	5595	CA	GLY	A	736	-14.593	77.453	-20.818	1.00	49.91	C
ATOM	5596	C	GLY	A	736	-13.359	76.585	-21.039	1.00	45.10	C
ATOM	5597	O	GLY	A	736	-13.276	75.457	-20.561	1.00	49.31	O
ATOM	5598	N	ILE	A	737	-12.374	77.136	-21.730	1.00	46.25	N
ATOM	5599	CA	ILE	A	737	-11.209	76.375	-22.151	1.00	47.19	C
ATOM	5600	C	ILE	A	737	-10.288	76.102	-20.977	1.00	52.46	C
ATOM	5601	O	ILE	A	737	-9.738	75.013	-20.839	1.00	54.27	O
ATOM	5602	CB	ILE	A	737	-10.456	77.119	-23.255	1.00	48.68	C
ATOM	5603	CG1	ILE	A	737	-11.223	76.967	-24.566	1.00	49.04	C
ATOM	5604	CG2	ILE	A	737	-9.030	76.624	-23.377	1.00	47.79	C
ATOM	5605	CD1	ILE	A	737	-10.676	77.786	-25.705	1.00	56.67	C
ATOM	5606	N	LEU	A	738	-10.138	77.098	-20.114	1.00	51.83	N
ATOM	5607	CA	LEU	A	738	-9.335	76.922	-18.920	1.00	52.73	C
ATOM	5608	C	LEU	A	738	-9.961	75.870	-18.013	1.00	51.94	C

ATOM	5609	O	LEU	A	738	-9.275	74.966	-17.518	1.00	55.27	O
ATOM	5610	CB	LEU	A	738	-9.172	78.239	-18.179	1.00	51.12	C
ATOM	5611	CG	LEU	A	738	-8.408	78.203	-16.856	1.00	51.97	C
ATOM	5612	CD1	LEU	A	738	-7.116	77.391	-16.984	1.00	51.41	C
ATOM	5613	CD2	LEU	A	738	-8.107	79.628	-16.428	1.00	46.70	C
ATOM	5614	N	GLN	A	739	-11.267	75.959	-17.817	1.00	49.85	N
ATOM	5615	CA	GLN	A	739	-11.911	75.037	-16.903	1.00	48.50	C
ATOM	5616	C	GLN	A	739	-11.852	73.605	-17.452	1.00	49.32	C
ATOM	5617	O	GLN	A	739	-11.898	72.656	-16.686	1.00	47.57	O
ATOM	5618	CB	GLN	A	739	-13.349	75.474	-16.629	1.00	43.25	C
ATOM	5619	CG	GLN	A	739	-13.442	76.921	-16.131	1.00	44.04	C
ATOM	5620	CD	GLN	A	739	-12.622	77.151	-14.879	1.00	41.93	C
ATOM	5621	OE1	GLN	A	739	-12.841	76.509	-13.862	1.00	43.91	O
ATOM	5622	NE2	GLN	A	739	-11.662	78.055	-14.954	1.00	44.86	N
ATOM	5623	N	THR	A	740	-11.724	73.469	-18.772	1.00	52.28	N
ATOM	5624	CA	THR	A	740	-11.662	72.161	-19.419	1.00	49.52	C
ATOM	5625	C	THR	A	740	-10.348	71.511	-19.047	1.00	49.48	C
ATOM	5626	O	THR	A	740	-10.325	70.385	-18.546	1.00	49.94	O
ATOM	5627	CB	THR	A	740	-11.783	72.246	-20.962	1.00	49.13	C
ATOM	5628	OG1	THR	A	740	-13.057	72.798	-21.314	1.00	54.29	O
ATOM	5629	CG2	THR	A	740	-11.680	70.871	-21.589	1.00	45.53	C
ATOM	5630	N	VAL	A	741	-9.262	72.236	-19.261	1.00	47.38	N
ATOM	5631	CA	VAL	A	741	-7.946	71.749	-18.864	1.00	46.74	C
ATOM	5632	C	VAL	A	741	-7.869	71.408	-17.375	1.00	48.35	C
ATOM	5633	O	VAL	A	741	-7.286	70.402	-16.993	1.00	50.48	O
ATOM	5634	CB	VAL	A	741	-6.847	72.770	-19.187	1.00	51.38	C
ATOM	5635	CG1	VAL	A	741	-5.481	72.257	-18.744	1.00	48.17	C
ATOM	5636	CG2	VAL	A	741	-6.869	73.107	-20.666	1.00	50.08	C
ATOM	5637	N	LYS	A	742	-8.455	72.225	-16.511	1.00	52.26	N
ATOM	5638	CA	LYS	A	742	-8.419	71.851	-15.103	1.00	50.04	C
ATOM	5639	C	LYS	A	742	-9.217	70.565	-14.861	1.00	52.31	C
ATOM	5640	O	LYS	A	742	-8.845	69.754	-14.018	1.00	50.34	O
ATOM	5641	CB	LYS	A	742	-8.940	72.969	-14.223	1.00	46.17	C
ATOM	5642	CG	LYS	A	742	-7.993	74.129	-14.082	1.00	48.49	C
ATOM	5643	CD	LYS	A	742	-8.639	75.241	-13.249	1.00	50.66	C
ATOM	5644	CE	LYS	A	742	-7.752	76.491	-13.185	1.00	44.34	C
ATOM	5645	NZ	LYS	A	742	-7.809	77.153	-11.843	1.00	49.07	N
ATOM	5646	N	VAL	A	743	-10.303	70.380	-15.611	1.00	51.62	N
ATOM	5647	CA	VAL	A	743	-11.186	69.249	-15.374	1.00	47.59	C
ATOM	5648	C	VAL	A	743	-10.480	67.980	-15.780	1.00	49.59	C
ATOM	5649	O	VAL	A	743	-10.521	66.979	-15.079	1.00	49.02	O
ATOM	5650	CB	VAL	A	743	-12.512	69.374	-16.140	1.00	45.42	C
ATOM	5651	CG1	VAL	A	743	-13.180	68.020	-16.278	1.00	41.97	C
ATOM	5652	CG2	VAL	A	743	-13.449	70.324	-15.421	1.00	43.88	C
ATOM	5653	N	VAL	A	744	-9.812	68.041	-16.918	1.00	53.76	N
ATOM	5654	CA	VAL	A	744	-9.099	66.890	-17.433	1.00	50.06	C
ATOM	5655	C	VAL	A	744	-7.945	66.504	-16.497	1.00	53.97	C
ATOM	5656	O	VAL	A	744	-7.743	65.321	-16.216	1.00	62.47	O
ATOM	5657	CB	VAL	A	744	-8.558	67.161	-18.844	1.00	53.22	C
ATOM	5658	CG1	VAL	A	744	-7.602	66.033	-19.266	1.00	53.77	C
ATOM	5659	CG2	VAL	A	744	-9.711	67.323	-19.837	1.00	42.59	C
ATOM	5660	N	ASP	A	745	-7.211	67.498	-16.001	1.00	48.31	N
ATOM	5661	CA	ASP	A	745	-6.068	67.260	-15.137	1.00	45.36	C
ATOM	5662	C	ASP	A	745	-6.467	66.612	-13.826	1.00	54.65	C
ATOM	5663	O	ASP	A	745	-5.731	65.770	-13.299	1.00	63.37	O
ATOM	5664	CB	ASP	A	745	-5.307	68.552	-14.849	1.00	52.54	C
ATOM	5665	CG	ASP	A	745	-4.194	68.837	-15.872	1.00	66.44	C
ATOM	5666	OD1	ASP	A	745	-4.343	68.514	-17.081	1.00	62.77	O
ATOM	5667	OD2	ASP	A	745	-3.156	69.400	-15.451	1.00	69.28	O
ATOM	5668	N	GLU	A	746	-7.618	66.978	-13.289	1.00	51.25	N
ATOM	5669	CA	GLU	A	746	-8.036	66.391	-12.021	1.00	53.17	C
ATOM	5670	C	GLU	A	746	-8.587	64.982	-12.244	1.00	55.43	C
ATOM	5671	O	GLU	A	746	-8.468	64.120	-11.374	1.00	56.23	O

ATOM	5672	CB	GLU	A	746	-9.055	67.301	-11.310	1.00	52.30	C
ATOM	5673	CG	GLU	A	746	-10.141	66.593	-10.485	1.00	50.35	C
ATOM	5674	CD	GLU	A	746	-10.651	67.446	-9.306	1.00	55.97	C
ATOM	5675	OE1	GLU	A	746	-11.752	67.155	-8.761	1.00	49.81	O
ATOM	5676	OE2	GLU	A	746	-9.930	68.389	-8.917	1.00	49.53	O
ATOM	5677	N	LEU	A	747	-9.177	64.741	-13.410	1.00	53.17	N
ATOM	5678	CA	LEU	A	747	-9.679	63.411	-13.747	1.00	56.53	C
ATOM	5679	C	LEU	A	747	-8.519	62.418	-13.914	1.00	59.70	C
ATOM	5680	O	LEU	A	747	-8.668	61.238	-13.613	1.00	50.32	O
ATOM	5681	CB	LEU	A	747	-10.518	63.429	-15.025	1.00	52.80	C
ATOM	5682	CG	LEU	A	747	-11.960	63.915	-14.979	1.00	59.66	C
ATOM	5683	CD1	LEU	A	747	-12.598	63.805	-16.364	1.00	55.30	C
ATOM	5684	CD2	LEU	A	747	-12.764	63.141	-13.935	1.00	58.76	C
ATOM	5685	N	VAL	A	748	-7.383	62.911	-14.401	1.00	55.18	N
ATOM	5686	CA	VAL	A	748	-6.187	62.102	-14.503	1.00	54.48	C
ATOM	5687	C	VAL	A	748	-5.750	61.653	-13.110	1.00	61.73	C
ATOM	5688	O	VAL	A	748	-5.537	60.455	-12.873	1.00	63.11	O
ATOM	5689	CB	VAL	A	748	-5.053	62.860	-15.212	1.00	57.32	C
ATOM	5690	CG1	VAL	A	748	-3.699	62.444	-14.689	1.00	62.26	C
ATOM	5691	CG2	VAL	A	748	-5.128	62.613	-16.689	1.00	58.39	C
ATOM	5692	N	LYS	A	749	-5.652	62.598	-12.180	1.00	62.83	N
ATOM	5693	CA	LYS	A	749	-5.356	62.249	-10.799	1.00	62.07	C
ATOM	5694	C	LYS	A	749	-6.390	61.262	-10.273	1.00	62.28	C
ATOM	5695	O	LYS	A	749	-6.033	60.265	-9.661	1.00	69.32	O
ATOM	5696	CB	LYS	A	749	-5.312	63.483	-9.917	1.00	59.65	C
ATOM	5697	CG	LYS	A	749	-4.185	64.459	-10.230	1.00	64.58	C
ATOM	5698	CD	LYS	A	749	-4.059	65.499	-9.102	1.00	66.39	C
ATOM	5699	CE	LYS	A	749	-3.649	66.879	-9.604	1.00	70.47	C
ATOM	5700	NZ	LYS	A	749	-4.751	67.904	-9.482	1.00	74.76	N
ATOM	5701	N	VAL	A	750	-7.665	61.515	-10.544	1.00	61.82	N
ATOM	5702	CA	VAL	A	750	-8.722	60.566	-10.180	1.00	64.60	C
ATOM	5703	C	VAL	A	750	-8.438	59.169	-10.752	1.00	60.19	C
ATOM	5704	O	VAL	A	750	-8.790	58.152	-10.153	1.00	57.09	O
ATOM	5705	CB	VAL	A	750	-10.120	61.051	-10.661	1.00	57.06	C
ATOM	5706	CG1	VAL	A	750	-11.100	59.889	-10.792	1.00	59.17	C
ATOM	5707	CG2	VAL	A	750	-10.668	62.076	-9.718	1.00	58.93	C
ATOM	5708	O	MET	A	751	-5.479	56.772	-13.218	1.00	69.54	O
ATOM	5709	N	MET	A	751	-7.772	59.133	-11.900	1.00	63.53	N
ATOM	5710	CA	MET	A	751	-7.516	57.877	-12.590	1.00	62.44	C
ATOM	5711	C	MET	A	751	-6.099	57.355	-12.339	1.00	64.75	C
ATOM	5712	CB	MET	A	751	-7.758	58.047	-14.083	1.00	57.47	C
ATOM	5713	CG	MET	A	751	-9.218	58.146	-14.439	1.00	55.56	C
ATOM	5714	SD	MET	A	751	-10.280	57.008	-13.524	1.00	69.10	S
ATOM	5715	CE	MET	A	751	-10.556	55.699	-14.712	1.00	51.84	C
ATOM	5716	O	GLY	A	752	-2.010	57.161	-11.471	1.00	80.57	O
ATOM	5717	N	GLY	A	752	-5.592	57.588	-11.138	1.00	64.47	N
ATOM	5718	CA	GLY	A	752	-4.272	57.129	-10.764	1.00	70.26	C
ATOM	5719	C	GLY	A	752	-3.085	57.749	-11.482	1.00	71.90	C
ATOM	5720	O	ARG	A	753	-1.074	59.131	-14.990	1.00	72.51	O
ATOM	5721	N	ARG	A	753	-3.263	58.925	-12.078	1.00	68.72	N
ATOM	5722	CA	ARG	A	753	-2.236	59.573	-12.917	1.00	70.80	C
ATOM	5723	C	ARG	A	753	-2.007	58.821	-14.249	1.00	72.83	C
ATOM	5724	CB	ARG	A	753	-0.901	59.722	-12.163	1.00	74.89	C
ATOM	5725	CG	ARG	A	753	-0.787	60.897	-11.182	1.00	75.67	C
ATOM	5726	CD	ARG	A	753	0.233	60.583	-10.071	1.00	86.96	C
ATOM	5727	NE	ARG	A	753	1.041	61.737	-9.646	1.00	106.08	N
ATOM	5728	CZ	ARG	A	753	1.973	61.703	-8.683	1.00	103.46	C
ATOM	5729	NH1	ARG	A	753	2.218	60.574	-8.025	1.00	103.43	N
ATOM	5730	NH2	ARG	A	753	2.661	62.798	-8.367	1.00	96.57	N
ATOM	5731	O	HIS	A	754	-4.815	58.149	-16.809	1.00	68.60	O
ATOM	5732	N	HIS	A	754	-2.867	57.849	-14.556	1.00	69.14	N
ATOM	5733	CA	HIS	A	754	-2.831	57.158	-15.842	1.00	68.62	C
ATOM	5734	C	HIS	A	754	-3.607	57.913	-16.934	1.00	74.12	C

ATOM	5735	CB	HIS	A	754	-3.404	55.745	-15.703	1.00	75.33	C
ATOM	5736	CG	HIS	A	754	-2.409	54.723	-15.240	1.00	85.69	C
ATOM	5737	ND1	HIS	A	754	-2.592	53.369	-15.431	1.00	85.03	N
ATOM	5738	CD2	HIS	A	754	-1.224	54.855	-14.595	1.00	85.29	C
ATOM	5739	CE1	HIS	A	754	-1.565	52.713	-14.922	1.00	88.92	C
ATOM	5740	NE2	HIS	A	754	-0.720	53.591	-14.408	1.00	89.60	N
ATOM	5741	O	LYS	A	755	-4.745	56.981	-19.510	1.00	72.76	O
ATOM	5742	N	LYS	A	755	-2.909	58.267	-18.011	1.00	71.62	N
ATOM	5743	CA	LYS	A	755	-3.511	58.976	-19.134	1.00	65.92	C
ATOM	5744	C	LYS	A	755	-4.654	58.178	-19.733	1.00	67.02	C
ATOM	5745	CB	LYS	A	755	-2.472	59.268	-20.213	1.00	66.33	C
ATOM	5746	CG	LYS	A	755	-1.123	59.684	-19.689	1.00	66.67	C
ATOM	5747	CD	LYS	A	755	-1.110	61.097	-19.194	1.00	71.83	C
ATOM	5748	CE	LYS	A	755	0.332	61.563	-19.082	1.00	78.53	C
ATOM	5749	NZ	LYS	A	755	1.120	61.070	-20.255	1.00	70.21	N
ATOM	5750	O	PRO	A	756	-5.270	58.176	-23.143	1.00	65.34	O
ATOM	5751	N	PRO	A	756	-5.557	58.851	-20.468	1.00	71.82	N
ATOM	5752	CA	PRO	A	756	-6.640	58.151	-21.167	1.00	66.96	C
ATOM	5753	C	PRO	A	756	-6.241	57.678	-22.575	1.00	68.04	C
ATOM	5754	CB	PRO	A	756	-7.739	59.217	-21.231	1.00	62.31	C
ATOM	5755	CG	PRO	A	756	-6.996	60.472	-21.329	1.00	59.65	C
ATOM	5756	CD	PRO	A	756	-5.774	60.309	-20.464	1.00	57.98	C
ATOM	5757	O	GLU	A	757	-6.241	58.013	-26.153	1.00	65.64	O
ATOM	5758	N	GLU	A	757	-6.981	56.712	-23.118	1.00	72.33	N
ATOM	5759	CA	GLU	A	757	-6.838	56.332	-24.526	1.00	67.87	C
ATOM	5760	C	GLU	A	757	-7.104	57.561	-25.390	1.00	68.15	C
ATOM	5761	CB	GLU	A	757	-7.817	55.206	-24.910	1.00	65.90	C
ATOM	5762	CG	GLU	A	757	-7.286	53.774	-24.860	1.00	74.45	C
ATOM	5763	CD	GLU	A	757	-8.177	52.800	-25.639	1.00	76.82	C
ATOM	5764	OE1	GLU	A	757	-9.094	52.198	-25.028	1.00	74.97	O
ATOM	5765	OE2	GLU	A	757	-7.965	52.645	-26.866	1.00	75.46	O
ATOM	5766	N	ASN	A	758	-8.314	58.100	-25.236	1.00	67.37	N
ATOM	5767	CA	ASN	A	758	-8.807	59.191	-26.068	1.00	68.51	C
ATOM	5768	C	ASN	A	758	-9.359	60.387	-25.297	1.00	68.72	C
ATOM	5769	O	ASN	A	758	-9.759	60.278	-24.129	1.00	67.39	O
ATOM	5770	CB	ASN	A	758	-9.918	58.683	-26.990	1.00	69.28	C
ATOM	5771	CG	ASN	A	758	-9.473	57.547	-27.863	1.00	70.56	C
ATOM	5772	OD1	ASN	A	758	-8.277	57.266	-27.974	1.00	69.89	O
ATOM	5773	ND2	ASN	A	758	-10.432	56.893	-28.513	1.00	68.53	N
ATOM	5774	N	ILE	A	759	-9.410	61.528	-25.978	1.00	65.84	N
ATOM	5775	CA	ILE	A	759	-10.166	62.665	-25.487	1.00	55.17	C
ATOM	5776	C	ILE	A	759	-11.023	63.230	-26.612	1.00	56.14	C
ATOM	5777	O	ILE	A	759	-10.526	63.830	-27.562	1.00	58.31	O
ATOM	5778	CB	ILE	A	759	-9.264	63.752	-24.912	1.00	60.52	C
ATOM	5779	CG1	ILE	A	759	-8.539	63.225	-23.664	1.00	52.02	C
ATOM	5780	CG2	ILE	A	759	-10.116	64.984	-24.561	1.00	52.86	C
ATOM	5781	CD1	ILE	A	759	-7.352	64.070	-23.212	1.00	50.80	C
ATOM	5782	N	VAL	A	760	-12.323	63.008	-26.506	1.00	54.71	N
ATOM	5783	CA	VAL	A	760	-13.253	63.444	-27.530	1.00	56.36	C
ATOM	5784	C	VAL	A	760	-13.937	64.768	-27.146	1.00	60.73	C
ATOM	5785	O	VAL	A	760	-14.782	64.815	-26.247	1.00	59.55	O
ATOM	5786	CB	VAL	A	760	-14.323	62.372	-27.791	1.00	58.43	C
ATOM	5787	CG1	VAL	A	760	-15.225	62.800	-28.912	1.00	53.55	C
ATOM	5788	CG2	VAL	A	760	-13.662	61.034	-28.109	1.00	63.30	C
ATOM	5789	N	ILE	A	761	-13.584	65.836	-27.856	1.00	61.16	N
ATOM	5790	CA	ILE	A	761	-14.123	67.166	-27.582	1.00	59.74	C
ATOM	5791	C	ILE	A	761	-15.213	67.632	-28.544	1.00	58.20	C
ATOM	5792	O	ILE	A	761	-15.065	67.556	-29.755	1.00	62.79	O
ATOM	5793	CB	ILE	A	761	-13.027	68.224	-27.622	1.00	54.83	C
ATOM	5794	CG1	ILE	A	761	-11.762	67.713	-26.954	1.00	53.81	C
ATOM	5795	CG2	ILE	A	761	-13.507	69.477	-26.944	1.00	61.73	C
ATOM	5796	CD1	ILE	A	761	-10.598	68.641	-27.149	1.00	55.54	C
ATOM	5797	N	GLU	A	762	-16.305	68.126	-27.980	1.00	53.47	N

ATOM	5798	CA	GLU	A	762	-17.306	68.854	-28.731	1.00	55.92	C
ATOM	5799	C	GLU	A	762	-17.374	70.279	-28.164	1.00	59.23	C
ATOM	5800	O	GLU	A	762	-17.566	70.485	-26.965	1.00	57.67	O
ATOM	5801	CB	GLU	A	762	-18.661	68.150	-28.650	1.00	55.84	C
ATOM	5802	CG	GLU	A	762	-19.830	68.909	-29.280	1.00	66.29	C
ATOM	5803	CD	GLU	A	762	-21.154	68.718	-28.502	1.00	76.53	C
ATOM	5804	OE1	GLU	A	762	-21.215	69.131	-27.322	1.00	72.25	O
ATOM	5805	OE2	GLU	A	762	-22.129	68.145	-29.054	1.00	73.74	O
ATOM	5806	O	MET	A	763	-18.753	73.163	-30.432	1.00	61.52	O
ATOM	5807	N	MET	A	763	-17.162	71.269	-29.012	1.00	55.96	N
ATOM	5808	CA	MET	A	763	-17.321	72.636	-28.574	1.00	53.69	C
ATOM	5809	C	MET	A	763	-18.556	73.256	-29.221	1.00	60.78	C
ATOM	5810	CB	MET	A	763	-16.088	73.450	-28.903	1.00	53.69	C
ATOM	5811	CG	MET	A	763	-16.253	74.912	-28.568	1.00	55.44	C
ATOM	5812	SD	MET	A	763	-14.732	75.816	-28.825	1.00	63.82	S
ATOM	5813	CE	MET	A	763	-13.727	75.131	-27.534	1.00	46.30	C
ATOM	5814	O	ALA	A	764	-19.317	76.570	-29.308	1.00	70.38	O
ATOM	5815	N	ALA	A	764	-19.394	73.874	-28.401	1.00	55.59	N
ATOM	5816	CA	ALA	A	764	-20.578	74.564	-28.904	1.00	68.60	C
ATOM	5817	C	ALA	A	764	-20.189	75.796	-29.714	1.00	67.70	C
ATOM	5818	CB	ALA	A	764	-21.510	74.961	-27.744	1.00	68.12	C
ATOM	5819	O	ARG	A	765	-22.761	77.989	-30.742	1.00	80.16	O
ATOM	5820	N	ARG	A	765	-20.834	75.965	-30.865	1.00	73.23	N
ATOM	5821	CA	ARG	A	765	-20.688	77.184	-31.655	1.00	76.31	C
ATOM	5822	C	ARG	A	765	-21.601	78.267	-31.065	1.00	79.72	C
ATOM	5823	CB	ARG	A	765	-21.017	76.911	-33.123	1.00	74.71	C
ATOM	5824	O	GLU	A	766	-23.475	80.627	-31.852	1.00	86.11	O
ATOM	5825	N	GLU	A	766	-21.077	79.487	-30.916	1.00	82.39	N
ATOM	5826	CA	GLU	A	766	-21.752	80.553	-30.152	1.00	83.40	C
ATOM	5827	C	GLU	A	766	-22.972	81.177	-30.870	1.00	85.45	C
ATOM	5828	CB	GLU	A	766	-20.731	81.641	-29.784	1.00	81.86	C
ATOM	5829	CG	GLU	A	766	-19.428	81.078	-29.169	1.00	82.99	C
ATOM	5830	CD	GLU	A	766	-18.460	82.152	-28.663	1.00	82.46	C
ATOM	5831	OE1	GLU	A	766	-17.514	82.516	-29.399	1.00	84.73	O
ATOM	5832	OE2	GLU	A	766	-18.628	82.616	-27.517	1.00	74.85	O
ATOM	5833	O	ASN	A	767	-25.240	84.830	-32.264	1.00	95.83	O
ATOM	5834	N	ASN	A	767	-23.459	82.311	-30.365	1.00	91.85	N
ATOM	5835	CA	ASN	A	767	-24.669	82.933	-30.918	1.00	91.03	C
ATOM	5836	C	ASN	A	767	-24.380	84.002	-31.963	1.00	92.11	C
ATOM	5837	CB	ASN	A	767	-25.516	83.542	-29.805	1.00	83.76	C
ATOM	5838	O	LYS	A	775	-24.799	100.659	-38.758	1.00	102.58	O
ATOM	5839	N	LYS	A	775	-27.244	101.878	-36.532	1.00	95.88	N
ATOM	5840	CA	LYS	A	775	-25.832	101.658	-36.834	1.00	100.42	C
ATOM	5841	C	LYS	A	775	-25.638	100.548	-37.860	1.00	103.22	C
ATOM	5842	CB	LYS	A	775	-25.053	101.325	-35.560	1.00	99.52	C
ATOM	5843	CG	LYS	A	775	-23.710	100.647	-35.812	1.00	90.50	C
ATOM	5844	CD	LYS	A	775	-22.652	101.186	-34.871	1.00	90.28	C
ATOM	5845	CE	LYS	A	775	-22.612	102.713	-34.928	1.00	84.74	C
ATOM	5846	NZ	LYS	A	775	-21.508	103.288	-34.101	1.00	77.48	N
ATOM	5847	O	ASN	A	776	-26.521	98.502	-41.060	1.00	104.34	O
ATOM	5848	N	ASN	A	776	-26.406	99.473	-37.709	1.00	104.28	N
ATOM	5849	CA	ASN	A	776	-26.382	98.374	-38.666	1.00	105.63	C
ATOM	5850	C	ASN	A	776	-27.035	98.782	-39.977	1.00	104.72	C
ATOM	5851	CB	ASN	A	776	-27.089	97.143	-38.095	1.00	108.91	C
ATOM	5852	CG	ASN	A	776	-27.302	96.057	-39.136	1.00	108.19	C
ATOM	5853	OD1	ASN	A	776	-28.315	96.040	-39.845	1.00	104.92	O
ATOM	5854	ND2	ASN	A	776	-26.343	95.144	-39.234	1.00	108.11	N
ATOM	5855	N	SER	A	777	-28.175	99.451	-39.870	1.00	100.81	N
ATOM	5856	CA	SER	A	777	-28.909	99.873	-41.049	1.00	103.69	C
ATOM	5857	C	SER	A	777	-28.198	101.020	-41.775	1.00	105.17	C
ATOM	5858	O	SER	A	777	-28.351	101.178	-42.988	1.00	103.57	O
ATOM	5859	CB	SER	A	777	-30.334	100.282	-40.667	1.00	105.84	C
ATOM	5860	OG	SER	A	777	-31.060	99.180	-40.147	1.00	105.21	O

ATOM	5861	N	ARG	A	778	-27.423	101.811	-41.031	1.00105.45	N
ATOM	5862	CA	ARG	A	778	-26.653	102.914	-41.609	1.00101.53	C
ATOM	5863	C	ARG	A	778	-25.371	102.390	-42.257	1.00103.54	C
ATOM	5864	O	ARG	A	778	-24.783	103.042	-43.119	1.00102.46	O
ATOM	5865	CB	ARG	A	778	-26.322	103.965	-40.546	1.00 96.27	C
ATOM	5866	N	GLU	A	779	-24.942	101.208	-41.826	1.00105.88	N
ATOM	5867	CA	GLU	A	779	-23.834	100.505	-42.459	1.00104.51	C
ATOM	5868	C	GLU	A	779	-24.291	99.952	-43.806	1.00103.78	C
ATOM	5869	O	GLU	A	779	-23.615	100.117	-44.825	1.00 99.58	O
ATOM	5870	CB	GLU	A	779	-23.327	99.372	-41.559	1.00102.87	C
ATOM	5871	CG	GLU	A	779	-22.066	99.693	-40.776	1.00103.58	C
ATOM	5872	CD	GLU	A	779	-20.793	99.361	-41.549	1.00109.94	C
ATOM	5873	OE1	GLU	A	779	-19.848	98.812	-40.940	1.00110.21	O
ATOM	5874	OE2	GLU	A	779	-20.730	99.648	-42.763	1.00111.31	O
ATOM	5875	N	ARG	A	780	-25.454	99.304	-43.792	1.00103.77	N
ATOM	5876	CA	ARG	A	780	-26.031	98.702	-44.988	1.00103.30	C
ATOM	5877	C	ARG	A	780	-26.404	99.779	-45.997	1.00100.01	C
ATOM	5878	O	ARG	A	780	-26.425	99.540	-47.202	1.00 96.06	O
ATOM	5879	CB	ARG	A	780	-27.260	97.858	-44.627	1.00 98.76	C
ATOM	5880	N	MET	A	781	-26.686	100.972	-45.486	1.00102.86	N
ATOM	5881	CA	MET	A	781	-27.089	102.107	-46.309	1.00101.30	C
ATOM	5882	C	MET	A	781	-25.890	102.776	-46.981	1.00 95.33	C
ATOM	5883	O	MET	A	781	-26.046	103.490	-47.971	1.00 92.52	O
ATOM	5884	CB	MET	A	781	-27.853	103.129	-45.460	1.00100.20	C
ATOM	5885	CG	MET	A	781	-28.653	104.124	-46.265	1.00 97.84	C
ATOM	5886	SD	MET	A	781	-29.845	103.309	-47.338	1.00105.09	S
ATOM	5887	CE	MET	A	781	-30.412	104.712	-48.287	1.00103.85	C
ATOM	5888	N	LYS	A	782	-24.697	102.540	-46.436	1.00 98.61	N
ATOM	5889	CA	LYS	A	782	-23.469	103.100	-47.003	1.00100.05	C
ATOM	5890	C	LYS	A	782	-22.830	102.138	-48.010	1.00 97.69	C
ATOM	5891	O	LYS	A	782	-22.008	102.543	-48.834	1.00 95.73	O
ATOM	5892	CB	LYS	A	782	-22.469	103.454	-45.895	1.00 94.41	C
ATOM	5893	N	ARG	A	783	-23.212	100.866	-47.951	1.00 98.23	N
ATOM	5894	CA	ARG	A	783	-22.759	99.912	-48.952	1.00 93.67	C
ATOM	5895	C	ARG	A	783	-23.680	99.951	-50.175	1.00 94.15	C
ATOM	5896	O	ARG	A	783	-23.308	99.482	-51.247	1.00 96.88	O
ATOM	5897	CB	ARG	A	783	-22.689	98.502	-48.370	1.00 91.41	C
ATOM	5898	CG	ARG	A	783	-21.874	97.540	-49.219	1.00 92.53	C
ATOM	5899	CD	ARG	A	783	-21.042	96.616	-48.362	1.00 90.40	C
ATOM	5900	NE	ARG	A	783	-19.903	96.072	-49.101	1.00101.54	N
ATOM	5901	CE	ARG	A	783	-18.672	96.580	-49.072	1.00 96.80	C
ATOM	5902	NH1	ARG	A	783	-18.409	97.653	-48.336	1.00 96.35	N
ATOM	5903	NH2	ARG	A	783	-17.702	96.013	-49.780	1.00 91.29	N
ATOM	5904	N	ILE	A	784	-24.874	100.521	-50.010	1.00 91.65	N
ATOM	5905	CA	ILE	A	784	-25.823	100.699	-51.115	1.00 89.93	C
ATOM	5906	C	ILE	A	784	-25.557	101.981	-51.911	1.00 93.13	C
ATOM	5907	O	ILE	A	784	-25.448	101.958	-53.140	1.00 90.82	O
ATOM	5908	CB	ILE	A	784	-27.280	100.747	-50.607	1.00 90.88	C
ATOM	5909	CG1	ILE	A	784	-27.680	99.417	-49.972	1.00 89.27	C
ATOM	5910	CG2	ILE	A	784	-28.226	101.123	-51.728	1.00 82.85	C
ATOM	5911	CD1	ILE	A	784	-27.271	98.220	-50.762	1.00 88.41	C
ATOM	5912	N	GLU	A	785	-25.468	103.098	-51.197	1.00 91.87	N
ATOM	5913	CA	GLU	A	785	-25.248	104.393	-51.819	1.00 94.98	C
ATOM	5914	C	GLU	A	785	-23.899	104.443	-52.549	1.00 95.54	C
ATOM	5915	O	GLU	A	785	-23.806	104.988	-53.651	1.00 97.49	O
ATOM	5916	CB	GLU	A	785	-25.342	105.513	-50.769	1.00 88.95	C
ATOM	5917	N	GLU	A	786	-22.862	103.865	-51.951	1.00 89.48	N
ATOM	5918	CA	GLU	A	786	-21.527	103.896	-52.551	1.00 92.81	C
ATOM	5919	C	GLU	A	786	-21.403	102.932	-53.737	1.00 98.36	C
ATOM	5920	O	GLU	A	786	-20.455	103.016	-54.523	1.00 98.29	O
ATOM	5921	CB	GLU	A	786	-20.460	103.571	-51.500	1.00 86.83	C
ATOM	5922	N	GLY	A	787	-22.361	102.018	-53.860	1.00 99.18	N
ATOM	5923	CA	GLY	A	787	-22.362	101.045	-54.938	1.00 93.96	C

ATOM	5924	C	GLY	A	787	-23.191	101.535	-56.111	1.00	94.89	C
ATOM	5925	O	GLY	A	787	-22.794	101.395	-57.267	1.00	95.30	O
ATOM	5926	N	ILE	A	788	-24.354	102.103	-55.813	1.00	92.18	N
ATOM	5927	CA	ILE	A	788	-25.164	102.753	-56.837	1.00	94.04	C
ATOM	5928	C	ILE	A	788	-24.377	103.862	-57.527	1.00	94.21	C
ATOM	5929	O	ILE	A	788	-24.320	103.915	-58.756	1.00	92.56	O
ATOM	5930	CB	ILE	A	788	-26.452	103.338	-56.245	1.00	92.70	C
ATOM	5931	CG1	ILE	A	788	-27.383	102.211	-55.800	1.00	90.64	C
ATOM	5932	CG2	ILE	A	788	-27.132	104.245	-57.241	1.00	87.55	C
ATOM	5933	CD1	ILE	A	788	-27.547	101.116	-56.825	1.00	95.94	C
ATOM	5934	O	LYS	A	789	-21.041	106.197	-58.677	1.00	99.52	O
ATOM	5935	N	LYS	A	789	-23.751	104.722	-56.720	1.00	95.82	N
ATOM	5936	CA	LYS	A	789	-22.918	105.835	-57.195	1.00	97.05	C
ATOM	5937	C	LYS	A	789	-21.758	105.374	-58.100	1.00	97.92	C
ATOM	5938	CB	LYS	A	789	-22.366	106.627	-55.995	1.00	91.48	C
ATOM	5939	CG	LYS	A	789	-21.885	108.049	-56.309	1.00	87.67	C
ATOM	5940	CD	LYS	A	789	-20.528	108.338	-55.650	1.00	86.60	C
ATOM	5941	CE	LYS	A	789	-20.554	109.574	-54.740	1.00	81.06	C
ATOM	5942	NZ	LYS	A	789	-20.078	110.847	-55.396	1.00	78.21	N
ATOM	5943	O	GLU	A	790	-20.602	102.311	-61.200	1.00	101.55	O
ATOM	5944	N	GLU	A	790	-21.570	104.065	-58.222	1.00	94.76	N
ATOM	5945	CA	GLU	A	790	-20.583	103.538	-59.152	1.00	96.98	C
ATOM	5946	C	GLU	A	790	-21.265	102.794	-60.289	1.00	96.69	C
ATOM	5947	CB	GLU	A	790	-19.595	102.615	-58.438	1.00	97.76	C
ATOM	5948	CG	GLU	A	790	-18.203	102.602	-59.058	1.00	99.33	C
ATOM	5949	CD	GLU	A	790	-17.411	103.874	-58.762	1.00	105.53	C
ATOM	5950	OE1	GLU	A	790	-16.384	104.101	-59.438	1.00	106.93	O
ATOM	5951	OE2	GLU	A	790	-17.813	104.645	-57.856	1.00	107.71	O
ATOM	5952	O	LEU	A	791	-24.320	102.859	-63.306	1.00	99.25	O
ATOM	5953	N	LEU	A	791	-22.591	102.703	-60.227	1.00	96.83	N
ATOM	5954	CA	LEU	A	791	-23.372	102.028	-61.262	1.00	96.68	C
ATOM	5955	C	LEU	A	791	-24.186	103.019	-62.093	1.00	98.06	C
ATOM	5956	CB	LEU	A	791	-24.311	100.986	-60.644	1.00	96.44	C
ATOM	5957	CG	LEU	A	791	-23.711	99.693	-60.088	1.00	93.74	C
ATOM	5958	CD1	LEU	A	791	-24.797	98.873	-59.406	1.00	92.82	C
ATOM	5959	CD2	LEU	A	791	-23.031	98.893	-61.189	1.00	91.70	C
ATOM	5960	O	GLY	A	792	-27.495	104.683	-63.390	1.00	97.72	O
ATOM	5961	N	GLY	A	792	-24.743	104.031	-61.435	1.00	96.81	N
ATOM	5962	CA	GLY	A	792	-25.501	105.057	-62.127	1.00	93.43	C
ATOM	5963	C	GLY	A	792	-26.980	104.749	-62.269	1.00	95.96	C
ATOM	5964	O	SER	A	793	-31.119	105.425	-61.638	1.00	96.52	O
ATOM	5965	N	SER	A	793	-27.660	104.579	-61.134	1.00	96.46	N
ATOM	5966	CA	SER	A	793	-29.093	104.269	-61.097	1.00	97.45	C
ATOM	5967	C	SER	A	793	-29.953	105.185	-61.958	1.00	94.93	C
ATOM	5968	CB	SER	A	793	-29.608	104.342	-59.668	1.00	96.75	C
ATOM	5969	OG	SER	A	793	-29.457	105.658	-59.162	1.00	92.45	O
ATOM	5970	O	LYS	A	797	-37.066	105.881	-58.232	1.00	97.65	O
ATOM	5971	N	LYS	A	797	-35.325	107.244	-59.788	1.00	106.58	N
ATOM	5972	CA	LYS	A	797	-34.807	106.603	-58.587	1.00	102.97	C
ATOM	5973	C	LYS	A	797	-35.874	105.715	-57.966	1.00	102.82	C
ATOM	5974	CB	LYS	A	797	-34.332	107.651	-57.571	1.00	94.33	C
ATOM	5975	O	GLU	A	798	-35.520	104.747	-54.160	1.00	107.01	O
ATOM	5976	N	GLU	A	798	-35.449	104.758	-57.149	1.00	108.09	N
ATOM	5977	CA	GLU	A	798	-36.409	104.078	-56.298	1.00	105.85	C
ATOM	5978	C	GLU	A	798	-36.458	104.785	-54.957	1.00	106.22	C
ATOM	5979	CB	GLU	A	798	-36.090	102.593	-56.133	1.00	102.80	C
ATOM	5980	CG	GLU	A	798	-36.493	101.733	-57.340	1.00	98.74	C
ATOM	5981	CD	GLU	A	798	-38.002	101.711	-57.637	1.00	97.89	C
ATOM	5982	OE1	GLU	A	798	-38.775	102.528	-57.089	1.00	99.50	O
ATOM	5983	OE2	GLU	A	798	-38.421	100.861	-58.445	1.00	95.81	O
ATOM	5984	O	HIS	A	799	-37.262	106.492	-51.290	1.00	114.17	O
ATOM	5985	N	HIS	A	799	-37.594	105.427	-54.730	1.00	109.66	N
ATOM	5986	CA	HIS	A	799	-37.806	106.298	-53.585	1.00	109.59	C

ATOM	5987	C	HIS	A	799	-37.613	105.720	-52.173	1.00111.85	C
ATOM	5988	CB	HIS	A	799	-39.219	106.890	-53.666	1.00107.85	C
ATOM	5989	O	PRO	A	800	-36.473	105.348	-49.192	1.00109.21	O
ATOM	5990	N	PRO	A	800	-37.878	104.406	-51.935	1.00112.65	N
ATOM	5991	CA	PRO	A	800	-37.862	103.947	-50.534	1.00110.64	C
ATOM	5992	C	PRO	A	800	-36.592	104.261	-49.754	1.00110.40	C
ATOM	5993	CB	PRO	A	800	-38.024	102.430	-50.664	1.00109.45	C
ATOM	5994	CG	PRO	A	800	-38.817	102.254	-51.876	1.00107.81	C
ATOM	5995	CD	PRO	A	800	-38.348	103.326	-52.827	1.00111.22	C
ATOM	5996	O	VAL	A	801	-33.499	105.209	-47.668	1.00109.59	O
ATOM	5997	N	VAL	A	801	-35.686	103.291	-49.691	1.00112.61	N
ATOM	5998	CA	VAL	A	801	-34.379	103.460	-49.060	1.00112.62	C
ATOM	5999	C	VAL	A	801	-34.365	104.345	-47.802	1.00110.51	C
ATOM	6000	CB	VAL	A	801	-33.374	104.047	-50.067	1.00110.18	C
ATOM	6001	O	GLU	A	802	-34.206	104.802	-43.518	1.00116.63	O
ATOM	6002	N	GLU	A	802	-35.324	104.143	-46.896	1.00110.77	N
ATOM	6003	CA	GLU	A	802	-35.351	104.887	-45.632	1.00112.05	C
ATOM	6004	C	GLU	A	802	-34.406	104.255	-44.608	1.00111.23	C
ATOM	6005	CB	GLU	A	802	-36.774	104.962	-45.067	1.00110.48	C
ATOM	6006	O	ASN	A	803	-32.482	100.459	-42.940	1.00110.35	O
ATOM	6007	N	ASN	A	803	-33.868	103.090	-44.976	1.00109.39	N
ATOM	6008	CA	ASN	A	803	-32.754	102.404	-44.301	1.00109.66	C
ATOM	6009	C	ASN	A	803	-33.159	101.462	-43.167	1.00110.06	C
ATOM	6010	CB	ASN	A	803	-31.719	103.411	-43.778	1.00109.27	C
ATOM	6011	O	THR	A	804	-34.960	98.440	-41.786	1.00107.00	O
ATOM	6012	N	THR	A	804	-34.243	101.766	-42.459	1.00108.10	N
ATOM	6013	CA	THR	A	804	-34.768	100.817	-41.482	1.00106.15	C
ATOM	6014	C	THR	A	804	-35.191	99.565	-42.238	1.00106.74	C
ATOM	6015	CB	THR	A	804	-35.969	101.379	-40.690	1.00107.11	C
ATOM	6016	OG1	THR	A	804	-37.195	101.042	-41.356	1.00107.11	O
ATOM	6017	CG2	THR	A	804	-35.862	102.896	-40.544	1.00110.10	C
ATOM	6018	O	GLN	A	805	-35.590	96.548	-44.917	1.00103.40	O
ATOM	6019	N	GLN	A	805	-35.784	99.794	-43.409	1.00105.45	N
ATOM	6020	CA	GLN	A	805	-36.310	98.748	-44.282	1.00107.03	C
ATOM	6021	C	GLN	A	805	-35.259	97.714	-44.695	1.00104.56	C
ATOM	6022	CB	GLN	A	805	-36.921	99.390	-45.532	1.00102.68	C
ATOM	6023	CG	GLN	A	805	-37.784	100.606	-45.243	1.00103.78	C
ATOM	6024	CD	GLN	A	805	-37.806	101.596	-46.393	1.00106.05	C
ATOM	6025	OE1	GLN	A	805	-36.808	102.252	-46.673	1.00106.03	O
ATOM	6026	NE2	GLN	A	805	-38.948	101.709	-47.062	1.00105.23	N
ATOM	6027	O	LEU	A	806	-31.673	95.324	-44.638	1.00 96.76	O
ATOM	6028	N	LEU	A	806	-34.000	98.149	-44.786	1.00105.28	N
ATOM	6029	CA	LEU	A	806	-32.888	97.303	-45.243	1.00102.07	C
ATOM	6030	C	LEU	A	806	-32.588	96.101	-44.345	1.00102.16	C
ATOM	6031	CB	LEU	A	806	-31.600	98.129	-45.377	1.00102.96	C
ATOM	6032	CG	LEU	A	806	-31.436	99.175	-46.484	1.00104.26	C
ATOM	6033	CD1	LEU	A	806	-29.945	99.453	-46.722	1.00 99.91	C
ATOM	6034	CD2	LEU	A	806	-32.139	98.751	-47.773	1.00100.16	C
ATOM	6035	O	GLN	A	807	-33.180	92.485	-42.999	1.00 98.56	O
ATOM	6036	N	GLN	A	807	-33.325	95.962	-43.245	1.00104.67	N
ATOM	6037	CA	GLN	A	807	-33.181	94.797	-42.384	1.00102.43	C
ATOM	6038	C	GLN	A	807	-33.750	93.571	-43.092	1.00 97.77	C
ATOM	6039	CB	GLN	A	807	-33.869	95.020	-41.034	1.00101.36	C
ATOM	6040	N	ASN	A	808	-34.863	93.755	-43.807	1.00 97.25	N
ATOM	6041	CA	ASN	A	808	-35.466	92.675	-44.593	1.00100.04	C
ATOM	6042	C	ASN	A	808	-34.483	92.131	-45.612	1.00101.25	C
ATOM	6043	O	ASN	A	808	-33.798	92.899	-46.290	1.00 98.55	O
ATOM	6044	CB	ASN	A	808	-36.736	93.141	-45.316	1.00101.20	C
ATOM	6045	CG	ASN	A	808	-37.234	92.121	-46.346	1.00101.35	C
ATOM	6046	OD1	ASN	A	808	-37.096	90.904	-46.162	1.00102.52	O
ATOM	6047	ND2	ASN	A	808	-37.807	92.618	-47.441	1.00 98.96	N
ATOM	6048	N	GLU	A	809	-34.425	90.806	-45.723	1.00101.73	N
ATOM	6049	CA	GLU	A	809	-33.434	90.158	-46.568	1.00 95.57	C

ATOM	6050	C	GLU	A	809	-33.667	90.406	-48.063	1.00	97.43	C
ATOM	6051	O	GLU	A	809	-32.750	90.823	-48.773	1.00	96.37	O
ATOM	6052	CB	GLU	A	809	-33.404	88.660	-46.278	1.00	96.88	C
ATOM	6053	CG	GLU	A	809	-34.756	87.978	-46.341	1.00	101.49	C
ATOM	6054	CD	GLU	A	809	-34.626	86.500	-46.648	1.00	104.75	C
ATOM	6055	OE1	GLU	A	809	-35.634	85.876	-47.054	1.00	105.09	O
ATOM	6056	OE2	GLU	A	809	-33.506	85.966	-46.487	1.00	103.40	O
ATOM	6057	N	LYS	A	810	-34.887	90.167	-48.537	1.00	99.54	N
ATOM	6058	CA	LYS	A	810	-35.182	90.276	-49.962	1.00	97.33	C
ATOM	6059	C	LYS	A	810	-34.958	91.695	-50.476	1.00	97.12	C
ATOM	6060	O	LYS	A	810	-34.291	91.900	-51.492	1.00	96.39	O
ATOM	6061	CB	LYS	A	810	-36.615	89.833	-50.242	1.00	91.76	C
ATOM	6062	CG	LYS	A	810	-36.986	88.560	-49.525	1.00	95.26	C
ATOM	6063	CD	LYS	A	810	-37.507	87.518	-50.486	1.00	95.25	C
ATOM	6064	CE	LYS	A	810	-37.749	86.207	-49.766	1.00	96.12	C
ATOM	6065	NZ	LYS	A	810	-38.451	85.223	-50.628	1.00	98.09	N
ATOM	6066	N	LEU	A	811	-35.504	92.675	-49.768	1.00	95.88	N
ATOM	6067	CA	LEU	A	811	-35.340	94.060	-50.174	1.00	96.57	C
ATOM	6068	C	LEU	A	811	-33.869	94.465	-50.238	1.00	96.95	C
ATOM	6069	O	LEU	A	811	-33.466	95.204	-51.135	1.00	95.50	O
ATOM	6070	CB	LEU	A	811	-36.086	94.994	-49.225	1.00	101.17	C
ATOM	6071	CG	LEU	A	811	-35.987	96.477	-49.588	1.00	97.56	C
ATOM	6072	CD1	LEU	A	811	-36.536	96.700	-50.982	1.00	96.29	C
ATOM	6073	CD2	LEU	A	811	-36.726	97.329	-48.573	1.00	98.78	C
ATOM	6074	N	TYR	A	812	-33.067	93.980	-49.293	1.00	93.19	N
ATOM	6075	CA	TYR	A	812	-31.676	94.403	-49.212	1.00	89.38	C
ATOM	6076	C	TYR	A	812	-30.895	93.838	-50.383	1.00	92.35	C
ATOM	6077	O	TYR	A	812	-30.048	94.522	-50.961	1.00	90.71	O
ATOM	6078	CB	TYR	A	812	-31.048	93.976	-47.884	1.00	92.27	C
ATOM	6079	CG	TYR	A	812	-29.606	94.407	-47.722	1.00	90.15	C
ATOM	6080	CD1	TYR	A	812	-29.225	95.726	-47.937	1.00	94.38	C
ATOM	6081	CD2	TYR	A	812	-28.629	93.500	-47.346	1.00	87.87	C
ATOM	6082	CE1	TYR	A	812	-27.904	96.127	-47.789	1.00	90.66	C
ATOM	6083	CE2	TYR	A	812	-27.308	93.891	-47.193	1.00	89.91	C
ATOM	6084	CZ	TYR	A	812	-26.952	95.204	-47.419	1.00	89.69	C
ATOM	6085	OH	TYR	A	812	-25.638	95.591	-47.272	1.00	93.80	O
ATOM	6086	N	LEU	A	813	-31.198	92.588	-50.731	1.00	94.12	N
ATOM	6087	CA	LEU	A	813	-30.599	91.925	-51.887	1.00	88.33	C
ATOM	6088	C	LEU	A	813	-30.958	92.658	-53.174	1.00	86.52	C
ATOM	6089	O	LEU	A	813	-30.092	92.930	-54.000	1.00	86.56	O
ATOM	6090	CB	LEU	A	813	-31.054	90.463	-51.968	1.00	87.83	C
ATOM	6091	CG	LEU	A	813	-30.318	89.446	-51.096	1.00	83.55	C
ATOM	6092	CD1	LEU	A	813	-30.993	88.093	-51.160	1.00	84.01	C
ATOM	6093	CD2	LEU	A	813	-28.881	89.326	-51.543	1.00	84.39	C
ATOM	6094	N	TYR	A	814	-32.242	92.970	-53.326	1.00	87.72	N
ATOM	6095	CA	TYR	A	814	-32.756	93.727	-54.470	1.00	92.96	C
ATOM	6096	C	TYR	A	814	-31.862	94.927	-54.810	1.00	92.99	C
ATOM	6097	O	TYR	A	814	-31.351	95.033	-55.929	1.00	90.76	O
ATOM	6098	CB	TYR	A	814	-34.195	94.175	-54.183	1.00	87.67	C
ATOM	6099	CG	TYR	A	814	-34.845	95.037	-55.245	1.00	92.83	C
ATOM	6100	CD2	TYR	A	814	-35.004	96.406	-55.053	1.00	95.33	C
ATOM	6101	CD1	TYR	A	814	-35.338	94.482	-56.418	1.00	92.78	C
ATOM	6102	CE2	TYR	A	814	-35.609	97.199	-56.011	1.00	92.98	C
ATOM	6103	CE1	TYR	A	814	-35.947	95.272	-57.385	1.00	91.56	C
ATOM	6104	CZ	TYR	A	814	-36.077	96.628	-57.176	1.00	94.15	C
ATOM	6105	OH	TYR	A	814	-36.680	97.422	-58.129	1.00	100.46	O
ATOM	6106	N	TYR	A	815	-31.646	95.803	-53.831	1.00	96.37	N
ATOM	6107	CA	TYR	A	815	-30.777	96.964	-54.007	1.00	93.36	C
ATOM	6108	C	TYR	A	815	-29.327	96.529	-54.235	1.00	90.39	C
ATOM	6109	O	TYR	A	815	-28.631	97.093	-55.076	1.00	91.80	O
ATOM	6110	CB	TYR	A	815	-30.876	97.908	-52.799	1.00	93.99	C
ATOM	6111	CG	TYR	A	815	-32.133	98.770	-52.761	1.00	94.69	C
ATOM	6112	CD2	TYR	A	815	-33.182	98.485	-51.890	1.00	96.56	C

ATOM	6113	CD1	TYR	A	815	-32.256	99.888	-53.580	1.00	98.77	C
ATOM	6114	CE2	TYR	A	815	-34.330	99.288	-51.851	1.00	99.41	C
ATOM	6115	CE1	TYR	A	815	-33.399	100.695	-53.550	1.00	98.31	C
ATOM	6116	CZ	TYR	A	815	-34.432	100.393	-52.686	1.00	100.05	C
ATOM	6117	OH	TYR	A	815	-35.559	101.200	-52.668	1.00	102.75	O
ATOM	6118	N	LEU	A	816	-28.879	95.511	-53.506	1.00	92.03	N
ATOM	6119	CA	LEU	A	816	-27.542	94.949	-53.706	1.00	88.90	C
ATOM	6120	C	LEU	A	816	-27.335	94.409	-55.123	1.00	89.47	C
ATOM	6121	O	LEU	A	816	-26.203	94.177	-55.549	1.00	91.63	O
ATOM	6122	CB	LEU	A	816	-27.281	93.830	-52.700	1.00	88.47	C
ATOM	6123	CG	LEU	A	816	-26.925	94.219	-51.267	1.00	86.55	C
ATOM	6124	CD1	LEU	A	816	-26.842	92.965	-50.435	1.00	89.86	C
ATOM	6125	CD2	LEU	A	816	-25.607	94.973	-51.205	1.00	86.65	C
ATOM	6126	N	GLN	A	817	-28.431	94.206	-55.844	1.00	87.22	N
ATOM	6127	CA	GLN	A	817	-28.373	93.638	-57.179	1.00	88.60	C
ATOM	6128	C	GLN	A	817	-28.938	94.606	-58.206	1.00	90.09	C
ATOM	6129	O	GLN	A	817	-29.301	94.208	-59.311	1.00	93.38	O
ATOM	6130	CB	GLN	A	817	-29.128	92.311	-57.219	1.00	87.57	C
ATOM	6131	CG	GLN	A	817	-28.613	91.302	-56.209	1.00	88.27	C
ATOM	6132	CD	GLN	A	817	-29.544	90.128	-56.034	1.00	84.31	C
ATOM	6133	OE1	GLN	A	817	-29.280	89.225	-55.245	1.00	82.38	O
ATOM	6134	NE2	GLN	A	817	-30.634	90.123	-56.790	1.00	85.44	N
ATOM	6135	N	ASN	A	818	-29.007	95.877	-57.827	1.00	91.81	N
ATOM	6136	CA	ASN	A	818	-29.452	96.956	-58.712	1.00	92.70	C
ATOM	6137	C	ASN	A	818	-30.799	96.688	-59.392	1.00	93.97	C
ATOM	6138	O	ASN	A	818	-30.995	97.014	-60.560	1.00	96.86	O
ATOM	6139	CB	ASN	A	818	-28.384	97.238	-59.774	1.00	92.69	C
ATOM	6140	CG	ASN	A	818	-28.633	98.537	-60.520	1.00	97.56	C
ATOM	6141	OD1	ASN	A	818	-29.269	99.452	-59.997	1.00	101.59	O
ATOM	6142	ND2	ASN	A	818	-28.157	98.613	-61.755	1.00	97.69	N
ATOM	6143	O	GLY	A	819	-33.920	94.792	-61.155	1.00	96.81	O
ATOM	6144	N	GLY	A	819	-31.729	96.100	-58.652	1.00	93.12	N
ATOM	6145	CA	GLY	A	819	-33.042	95.804	-59.188	1.00	90.86	C
ATOM	6146	C	GLY	A	819	-33.022	94.790	-60.315	1.00	91.09	C
ATOM	6147	O	ARG	A	820	-31.083	91.302	-59.740	1.00	85.30	O
ATOM	6148	N	ARG	A	820	-32.004	93.927	-60.336	1.00	90.25	N
ATOM	6149	CA	ARG	A	820	-31.876	92.889	-61.371	1.00	91.52	C
ATOM	6150	C	ARG	A	820	-31.683	91.479	-60.804	1.00	85.28	C
ATOM	6151	CB	ARG	A	820	-30.702	93.194	-62.308	1.00	91.46	C
ATOM	6152	CG	ARG	A	820	-30.513	94.656	-62.670	1.00	93.85	C
ATOM	6153	CD	ARG	A	820	-29.447	94.803	-63.747	1.00	95.58	C
ATOM	6154	NE	ARG	A	820	-29.760	93.989	-64.918	1.00	93.53	N
ATOM	6155	CZ	ARG	A	820	-30.688	94.308	-65.812	1.00	96.75	C
ATOM	6156	NH1	ARG	A	820	-31.392	95.424	-65.670	1.00	87.39	N
ATOM	6157	NH2	ARG	A	820	-30.916	93.513	-66.845	1.00	96.05	N
ATOM	6158	O	ASP	A	821	-29.662	89.492	-61.936	1.00	83.17	O
ATOM	6159	N	ASP	A	821	-32.175	90.481	-61.534	1.00	84.84	N
ATOM	6160	CA	ASP	A	821	-31.919	89.078	-61.213	1.00	83.07	C
ATOM	6161	C	ASP	A	821	-30.414	88.804	-61.247	1.00	80.84	C
ATOM	6162	CB	ASP	A	821	-32.665	88.165	-62.195	1.00	82.72	C
ATOM	6163	CG	ASP	A	821	-32.673	86.705	-61.772	1.00	81.61	C
ATOM	6164	OD2	ASP	A	821	-33.755	86.083	-61.820	1.00	83.63	O
ATOM	6165	OD1	ASP	A	821	-31.609	86.166	-61.408	1.00	82.91	O
ATOM	6166	O	MET	A	822	-27.031	85.967	-61.566	1.00	78.21	O
ATOM	6167	N	MET	A	822	-29.977	87.800	-60.499	1.00	81.62	N
ATOM	6168	CA	MET	A	822	-28.561	87.450	-60.454	1.00	83.92	C
ATOM	6169	C	MET	A	822	-28.209	86.251	-61.333	1.00	80.47	C
ATOM	6170	CB	MET	A	822	-28.144	87.168	-59.015	1.00	83.34	C
ATOM	6171	CG	MET	A	822	-27.903	88.409	-58.208	1.00	79.38	C
ATOM	6172	SD	MET	A	822	-26.253	89.046	-58.497	1.00	85.13	S
ATOM	6173	CE	MET	A	822	-25.288	87.620	-57.994	1.00	79.65	C
ATOM	6174	O	TYR	A	823	-29.088	83.748	-64.949	1.00	81.02	O
ATOM	6175	N	TYR	A	823	-29.231	85.552	-61.813	1.00	80.45	N

ATOM	6176	CA	TYR	A	823	-29.031	84.352	-62.624	1.00	81.01	C
ATOM	6177	C	TYR	A	823	-29.393	84.570	-64.087	1.00	81.31	C
ATOM	6178	CB	TYR	A	823	-29.856	83.204	-62.063	1.00	78.96	C
ATOM	6179	CG	TYR	A	823	-29.291	82.641	-60.797	1.00	76.61	C
ATOM	6180	CD2	TYR	A	823	-30.118	82.113	-59.819	1.00	78.81	C
ATOM	6181	CD1	TYR	A	823	-27.928	82.642	-60.573	1.00	75.37	C
ATOM	6182	CE2	TYR	A	823	-29.597	81.592	-58.652	1.00	80.38	C
ATOM	6183	CE1	TYR	A	823	-27.398	82.129	-59.413	1.00	75.77	C
ATOM	6184	CZ	TYR	A	823	-28.231	81.602	-58.456	1.00	77.51	C
ATOM	6185	OH	TYR	A	823	-27.695	81.091	-57.293	1.00	78.37	O
ATOM	6186	O	VAL	A	824	-30.932	88.196	-64.837	1.00	84.63	O
ATOM	6187	N	VAL	A	824	-30.075	85.676	-64.352	1.00	81.96	N
ATOM	6188	CA	VAL	A	824	-30.540	85.992	-65.690	1.00	81.57	C
ATOM	6189	C	VAL	A	824	-30.657	87.509	-65.815	1.00	85.06	C
ATOM	6190	CB	VAL	A	824	-31.883	85.284	-65.989	1.00	81.79	C
ATOM	6191	CG2	VAL	A	824	-32.782	86.132	-66.866	1.00	87.67	C
ATOM	6192	CG1	VAL	A	824	-32.585	84.890	-64.697	1.00	80.89	C
ATOM	6193	O	ASP	A	825	-32.446	89.798	-68.541	1.00	91.82	O
ATOM	6194	N	ASP	A	825	-30.396	88.036	-67.006	1.00	90.28	N
ATOM	6195	CA	ASP	A	825	-30.459	89.475	-67.221	1.00	92.05	C
ATOM	6196	C	ASP	A	825	-31.888	89.948	-67.453	1.00	92.91	C
ATOM	6197	CB	ASP	A	825	-29.572	89.880	-68.396	1.00	94.52	C
ATOM	6198	CG	ASP	A	825	-29.754	91.330	-68.790	1.00	100.63	C
ATOM	6199	OD2	ASP	A	825	-29.386	92.226	-67.995	1.00	101.26	O
ATOM	6200	OD1	ASP	A	825	-30.275	91.574	-69.897	1.00	107.81	O
ATOM	6201	O	GLN	A	826	-33.112	92.067	-64.386	1.00	99.30	O
ATOM	6202	N	GLN	A	826	-32.467	90.521	-66.405	1.00	92.93	N
ATOM	6203	CA	GLN	A	826	-33.822	91.053	-66.436	1.00	95.64	C
ATOM	6204	C	GLN	A	826	-33.984	91.995	-65.251	1.00	96.54	C
ATOM	6205	CB	GLN	A	826	-34.848	89.927	-66.377	1.00	90.28	C
ATOM	6206	CG	GLN	A	826	-34.585	88.976	-65.231	1.00	93.32	C
ATOM	6207	CD	GLN	A	826	-35.455	87.738	-65.262	1.00	94.14	C
ATOM	6208	OE1	GLN	A	826	-36.313	87.583	-66.133	1.00	95.68	O
ATOM	6209	OE2	GLN	A	826	-35.236	86.843	-64.303	1.00	89.84	O
ATOM	6210	O	GLU	A	827	-37.417	92.448	-63.622	1.00	99.25	O
ATOM	6211	N	GLU	A	827	-35.085	92.725	-65.203	1.00	90.83	N
ATOM	6212	CA	GLU	A	827	-35.326	93.554	-64.041	1.00	95.16	C
ATOM	6213	C	GLU	A	827	-36.382	92.923	-63.149	1.00	99.64	C
ATOM	6214	CB	GLU	A	827	-35.734	94.967	-64.452	1.00	95.99	C
ATOM	6215	CG	GLU	A	827	-34.552	95.842	-64.821	1.00	95.66	C
ATOM	6216	CD	GLU	A	827	-34.708	97.272	-64.349	1.00	95.48	C
ATOM	6217	OE1	GLU	A	827	-35.791	97.854	-64.582	1.00	98.32	O
ATOM	6218	OE2	GLU	A	827	-33.747	97.808	-63.746	1.00	92.89	O
ATOM	6219	O	LEU	A	828	-37.548	94.608	-60.085	1.00	95.04	O
ATOM	6220	N	LEU	A	828	-36.098	92.906	-61.852	1.00	97.39	N
ATOM	6221	CA	LEU	A	828	-37.038	92.393	-60.871	1.00	97.75	C
ATOM	6222	C	LEU	A	828	-37.984	93.503	-60.413	1.00	98.56	C
ATOM	6223	CB	LEU	A	828	-36.289	91.789	-59.683	1.00	95.85	C
ATOM	6224	CG	LEU	A	828	-35.298	90.679	-60.045	1.00	90.46	C
ATOM	6225	CD1	LEU	A	828	-34.702	90.038	-58.800	1.00	86.37	C
ATOM	6226	CD2	LEU	A	828	-35.963	89.638	-60.927	1.00	91.32	C
ATOM	6227	O	ASP	A	829	-40.349	93.419	-57.697	1.00	103.09	O
ATOM	6228	N	ASP	A	829	-39.280	93.197	-60.421	1.00	102.22	N
ATOM	6229	CA	ASP	A	829	-40.320	94.131	-59.992	1.00	103.13	C
ATOM	6230	C	ASP	A	829	-40.236	94.361	-58.485	1.00	105.74	C
ATOM	6231	CB	ASP	A	829	-41.708	93.601	-60.389	1.00	105.02	C
ATOM	6232	CG	ASP	A	829	-42.857	94.386	-59.755	1.00	108.77	C
ATOM	6233	OD2	ASP	A	829	-43.421	93.906	-58.747	1.00	111.68	O
ATOM	6234	OD1	ASP	A	829	-43.215	95.467	-60.272	1.00	108.45	O
ATOM	6235	O	ILE	A	830	-41.016	95.128	-54.744	1.00	108.35	O
ATOM	6236	N	ILE	A	830	-40.031	95.620	-58.099	1.00	106.79	N
ATOM	6237	CA	ILE	A	830	-39.916	95.999	-56.692	1.00	105.68	C
ATOM	6238	C	ILE	A	830	-41.145	95.588	-55.877	1.00	107.47	C

ATOM	6239	CB	ILE	A	830	-39.700	97.521	-56.536	1.00104.48	C
ATOM	6240	O	ASN	A	831	-43.818	93.560	-54.279	1.00109.83	O
ATOM	6241	N	ASN	A	831	-42.333	95.746	-56.455	1.00108.38	N
ATOM	6242	CA	ASN	A	831	-43.577	95.447	-55.745	1.00108.10	C
ATOM	6243	C	ASN	A	831	-43.756	93.956	-55.445	1.00106.93	C
ATOM	6244	CB	ASN	A	831	-44.776	95.968	-56.540	1.00110.47	C
ATOM	6245	O	ARG	A	832	-42.269	89.991	-56.223	1.00101.24	O
ATOM	6246	N	ARG	A	832	-43.824	93.129	-56.486	1.00107.63	N
ATOM	6247	CA	ARG	A	832	-43.974	91.682	-56.312	1.00105.11	C
ATOM	6248	C	ARG	A	832	-42.691	91.053	-55.762	1.00104.65	C
ATOM	6249	CB	ARG	A	832	-44.364	91.024	-57.640	1.00 98.94	C
ATOM	6250	O	LEU	A	833	-39.405	89.471	-54.050	1.00103.15	O
ATOM	6251	N	LEU	A	833	-42.114	91.700	-54.747	1.00106.94	N
ATOM	6252	CA	LEU	A	833	-40.759	91.420	-54.263	1.00102.93	C
ATOM	6253	C	LEU	A	833	-40.506	89.973	-53.861	1.00100.02	C
ATOM	6254	CB	LEU	A	833	-40.424	92.326	-53.072	1.00100.77	C
ATOM	6255	CG	LEU	A	833	-39.150	93.175	-53.168	1.00 98.97	C
ATOM	6256	CD1	LEU	A	833	-38.703	93.688	-51.798	1.00 98.11	C
ATOM	6257	CD2	LEU	A	833	-38.030	92.411	-53.844	1.00 97.83	C
ATOM	6258	O	SER	A	834	-42.698	85.983	-53.111	1.00 95.89	O
ATOM	6259	N	SER	A	834	-41.496	89.301	-53.289	1.00 98.07	N
ATOM	6260	CA	SER	A	834	-41.274	87.908	-52.938	1.00101.18	C
ATOM	6261	C	SER	A	834	-42.251	86.997	-53.648	1.00 98.43	C
ATOM	6262	CB	SER	A	834	-41.347	87.698	-51.431	1.00107.56	C
ATOM	6263	OG	SER	A	834	-40.587	86.547	-51.078	1.00108.55	O
ATOM	6264	O	ASP	A	835	-42.198	84.541	-56.922	1.00 91.09	O
ATOM	6265	N	ASP	A	835	-42.576	87.382	-54.872	1.00 99.43	N
ATOM	6266	CA	ASP	A	835	-43.144	86.445	-55.814	1.00101.76	C
ATOM	6267	C	ASP	A	835	-41.989	85.570	-56.293	1.00 96.50	C
ATOM	6268	CB	ASP	A	835	-43.832	87.170	-56.975	1.00100.30	C
ATOM	6269	O	TYR	A	836	-39.152	84.801	-54.016	1.00100.18	O
ATOM	6270	N	TYR	A	836	-40.767	85.997	-55.966	1.00 98.90	N
ATOM	6271	CA	TYR	A	836	-39.546	85.288	-56.353	1.00 97.75	C
ATOM	6272	C	TYR	A	836	-38.856	84.566	-55.190	1.00 97.75	C
ATOM	6273	CB	TYR	A	836	-38.527	86.245	-56.987	1.00 94.89	C
ATOM	6274	CG	TYR	A	836	-39.104	87.441	-57.705	1.00 96.53	C
ATOM	6275	CD1	TYR	A	836	-39.865	87.291	-58.858	1.00 96.78	C
ATOM	6276	CD2	TYR	A	836	-38.853	88.728	-57.245	1.00 98.00	C
ATOM	6277	CE1	TYR	A	836	-40.383	88.394	-59.517	1.00100.10	C
ATOM	6278	CE2	TYR	A	836	-39.359	89.833	-57.897	1.00 98.09	C
ATOM	6279	CH	TYR	A	836	-40.123	89.662	-59.030	1.00100.85	C
ATOM	6280	OH	TYR	A	836	-40.625	90.764	-59.675	1.00104.63	O
ATOM	6281	O	ASP	A	837	-35.313	84.490	-54.858	1.00 89.82	O
ATOM	6282	N	ASP	A	837	-37.909	83.706	-55.548	1.00 91.48	N
ATOM	6283	CA	ASP	A	837	-37.130	82.940	-54.591	1.00 94.09	C
ATOM	6284	C	ASP	A	837	-35.894	83.698	-54.119	1.00 91.12	C
ATOM	6285	CB	ASP	A	837	-36.689	81.604	-55.212	1.00 90.74	C
ATOM	6286	CG	ASP	A	837	-37.861	80.701	-55.575	1.00 93.84	C
ATOM	6287	OD1	ASP	A	837	-38.706	80.429	-54.694	1.00 93.32	O
ATOM	6288	OD2	ASP	A	837	-37.932	80.256	-56.743	1.00 90.98	O
ATOM	6289	N	VAL	A	838	-35.495	83.449	-52.880	1.00 90.35	N
ATOM	6290	CA	VAL	A	838	-34.142	83.764	-52.451	1.00 86.41	C
ATOM	6291	C	VAL	A	838	-33.365	82.458	-52.457	1.00 84.92	C
ATOM	6292	O	VAL	A	838	-33.866	81.433	-51.998	1.00 86.52	O
ATOM	6293	CB	VAL	A	838	-34.101	84.420	-51.060	1.00 88.61	C
ATOM	6294	CG1	VAL	A	838	-32.834	84.044	-50.325	1.00 84.33	C
ATOM	6295	CG2	VAL	A	838	-34.215	85.934	-51.186	1.00 92.74	C
ATOM	6296	O	ASP	A	839	-29.318	82.302	-52.766	1.00 82.83	O
ATOM	6297	N	ASP	A	839	-32.153	82.485	-52.998	1.00 82.96	N
ATOM	6298	CA	ASP	A	839	-31.428	81.246	-53.240	1.00 87.54	C
ATOM	6299	C	ASP	A	839	-29.993	81.270	-52.726	1.00 83.90	C
ATOM	6300	CB	ASP	A	839	-31.433	80.926	-54.737	1.00 86.08	C
ATOM	6301	CG	ASP	A	839	-30.621	79.694	-55.072	1.00 82.59	C

ATOM	6302	OD2	ASP	A	839	-30.053	79.648	-56.178	1.00	81.72	O
ATOM	6303	OD1	ASP	A	839	-30.545	78.775	-54.229	1.00	87.30	O
ATOM	6304	O	ALA	A	840	-27.571	78.447	-53.508	1.00	83.03	O
ATOM	6305	N	ALA	A	840	-29.544	80.110	-52.253	1.00	81.75	N
ATOM	6306	CA	ALA	A	840	-28.198	79.947	-51.739	1.00	81.54	C
ATOM	6307	C	ALA	A	840	-27.280	79.446	-52.848	1.00	83.22	C
ATOM	6308	CB	ALA	A	840	-28.194	78.997	-50.559	1.00	80.84	C
ATOM	6309	O	ILE	A	841	-24.623	77.682	-54.842	1.00	79.48	O
ATOM	6310	N	ILE	A	841	-26.176	80.160	-53.044	1.00	80.77	N
ATOM	6311	CA	ILE	A	841	-25.233	79.887	-54.122	1.00	80.18	C
ATOM	6312	C	ILE	A	841	-24.550	78.537	-53.953	1.00	81.16	C
ATOM	6313	CB	ILE	A	841	-24.175	80.993	-54.203	1.00	82.36	C
ATOM	6314	CG1	ILE	A	841	-24.859	82.337	-54.458	1.00	77.37	C
ATOM	6315	CG2	ILE	A	841	-23.146	80.682	-55.282	1.00	78.93	C
ATOM	6316	CD1	ILE	A	841	-24.448	83.421	-53.508	1.00	76.41	C
ATOM	6317	O	VAL	A	842	-25.076	76.930	-50.724	1.00	81.61	O
ATOM	6318	N	VAL	A	842	-23.871	78.353	-52.823	1.00	81.89	N
ATOM	6319	CA	VAL	A	842	-23.426	77.024	-52.427	1.00	78.82	C
ATOM	6320	C	VAL	A	842	-24.584	76.380	-51.705	1.00	80.18	C
ATOM	6321	CB	VAL	A	842	-22.200	77.053	-51.524	1.00	79.48	C
ATOM	6322	CG2	VAL	A	842	-21.053	77.721	-52.235	1.00	78.38	C
ATOM	6323	CG1	VAL	A	842	-21.816	75.635	-51.103	1.00	81.29	C
ATOM	6324	O	PRO	A	843	-25.281	74.096	-49.548	1.00	84.91	O
ATOM	6325	N	PRO	A	843	-25.047	75.229	-52.214	1.00	80.25	N
ATOM	6326	CA	PRO	A	843	-26.245	74.553	-51.711	1.00	83.73	C
ATOM	6327	C	PRO	A	843	-26.291	74.413	-50.188	1.00	85.86	C
ATOM	6328	CB	PRO	A	843	-26.166	73.192	-52.389	1.00	84.31	C
ATOM	6329	CG	PRO	A	843	-25.540	73.503	-53.703	1.00	81.42	C
ATOM	6330	CD	PRO	A	843	-24.523	74.575	-53.423	1.00	78.76	C
ATOM	6331	O	GLN	A	844	-27.254	72.863	-46.523	1.00	93.75	O
ATOM	6332	N	GLN	A	844	-27.469	74.666	-49.623	1.00	84.77	N
ATOM	6333	CA	GLN	A	844	-27.685	74.550	-48.187	1.00	85.99	C
ATOM	6334	C	GLN	A	844	-27.404	73.119	-47.721	1.00	92.14	C
ATOM	6335	CB	GLN	A	844	-29.113	74.971	-47.823	1.00	85.16	C
ATOM	6336	O	SER	A	845	-25.165	69.845	-47.169	1.00	87.17	O
ATOM	6337	N	SER	A	845	-27.328	72.199	-48.681	1.00	89.18	N
ATOM	6338	CA	SER	A	845	-26.963	70.812	-48.433	1.00	82.50	C
ATOM	6339	C	SER	A	845	-25.503	70.669	-48.027	1.00	84.85	C
ATOM	6340	CB	SER	A	845	-27.219	69.967	-49.683	1.00	86.33	C
ATOM	6341	OG	SER	A	845	-28.197	70.573	-50.511	1.00	95.67	O
ATOM	6342	O	PHE	A	846	-21.539	71.861	-46.862	1.00	81.96	O
ATOM	6343	N	PHE	A	846	-24.639	71.465	-48.652	1.00	84.83	N
ATOM	6344	CA	PHE	A	846	-23.192	71.301	-48.509	1.00	84.10	C
ATOM	6345	C	PHE	A	846	-22.578	72.192	-47.432	1.00	84.88	C
ATOM	6346	CB	PHE	A	846	-22.495	71.572	-49.842	1.00	82.87	C
ATOM	6347	CG	PHE	A	846	-22.818	70.569	-50.911	1.00	86.75	C
ATOM	6348	CD1	PHE	A	846	-22.288	69.289	-50.860	1.00	82.66	C
ATOM	6349	CD2	PHE	A	846	-23.644	70.908	-51.977	1.00	87.38	C
ATOM	6350	CE1	PHE	A	846	-22.584	68.359	-51.852	1.00	89.43	C
ATOM	6351	CE2	PHE	A	846	-23.943	69.984	-52.975	1.00	86.76	C
ATOM	6352	CE	PHE	A	846	-23.414	68.710	-52.912	1.00	87.93	C
ATOM	6353	O	LEU	A	847	-24.768	75.429	-46.127	1.00	90.86	O
ATOM	6354	N	LEU	A	847	-23.220	73.320	-47.153	1.00	85.11	N
ATOM	6355	CA	LEU	A	847	-22.674	74.287	-46.207	1.00	81.28	C
ATOM	6356	C	LEU	A	847	-23.779	75.046	-45.500	1.00	84.85	C
ATOM	6357	CB	LEU	A	847	-21.751	75.265	-46.934	1.00	84.40	C
ATOM	6358	CG	LEU	A	847	-21.240	76.491	-46.178	1.00	87.49	C
ATOM	6359	CD1	LEU	A	847	-21.108	77.666	-47.135	1.00	83.48	C
ATOM	6360	CD2	LEU	A	847	-19.908	76.193	-45.491	1.00	78.20	C
ATOM	6361	O	LYS	A	848	-23.654	78.069	-42.485	1.00	89.14	O
ATOM	6362	N	LYS	A	848	-23.621	75.272	-44.201	1.00	87.39	N
ATOM	6363	CA	LYS	A	848	-24.594	76.073	-43.458	1.00	92.59	C
ATOM	6364	C	LYS	A	848	-24.230	77.568	-43.453	1.00	90.95	C

ATOM	6365	CB	LYS	A	848	-24.719	75.559	-42.023	1.00	95.13	C
ATOM	6366	O	ASP	A	849	-25.748	80.504	-46.385	1.00	91.64	O
ATOM	6367	N	ASP	A	849	-24.556	78.270	-44.540	1.00	91.23	N
ATOM	6368	CA	ASP	A	849	-24.341	79.719	-44.613	1.00	90.73	C
ATOM	6369	C	ASP	A	849	-25.573	80.413	-45.173	1.00	87.25	C
ATOM	6370	CB	ASP	A	849	-23.114	80.056	-45.464	1.00	84.67	C
ATOM	6371	O	ASP	A	850	-28.166	83.884	-45.233	1.00	92.16	O
ATOM	6372	N	ASP	A	850	-26.440	80.885	-44.284	1.00	85.39	N
ATOM	6373	CA	ASP	A	850	-27.644	81.597	-44.704	1.00	90.61	C
ATOM	6374	C	ASP	A	850	-27.305	83.072	-44.903	1.00	88.13	C
ATOM	6375	CB	ASP	A	850	-28.769	81.422	-43.679	1.00	89.52	C
ATOM	6376	O	SER	A	851	-25.084	84.468	-47.221	1.00	86.97	O
ATOM	6377	N	SER	A	851	-26.025	83.385	-44.712	1.00	87.71	N
ATOM	6378	CA	SER	A	851	-25.474	84.724	-44.872	1.00	83.56	C
ATOM	6379	C	SER	A	851	-25.478	85.213	-46.320	1.00	89.45	C
ATOM	6380	CB	SER	A	851	-24.051	84.742	-44.334	1.00	86.94	C
ATOM	6381	OG	SER	A	851	-23.292	85.756	-44.954	1.00	89.36	O
ATOM	6382	O	ILE	A	852	-25.057	86.879	-50.034	1.00	88.52	O
ATOM	6383	N	ILE	A	852	-25.887	86.473	-46.527	1.00	90.88	N
ATOM	6384	CA	ILE	A	852	-26.069	87.054	-47.870	1.00	88.86	C
ATOM	6385	C	ILE	A	852	-24.880	86.887	-48.815	1.00	86.80	C
ATOM	6386	CB	ILE	A	852	-26.396	88.577	-47.823	1.00	86.04	C
ATOM	6387	CG1	ILE	A	852	-25.505	89.316	-46.824	1.00	85.80	C
ATOM	6388	CG2	ILE	A	852	-27.848	88.801	-47.488	1.00	86.12	C
ATOM	6389	CD1	ILE	A	852	-25.704	90.812	-46.856	1.00	78.71	C
ATOM	6390	O	ASP	A	853	-21.827	84.542	-50.454	1.00	86.03	O
ATOM	6391	N	ASP	A	853	-23.674	86.735	-48.281	1.00	85.22	N
ATOM	6392	CA	ASP	A	853	-22.547	86.439	-49.153	1.00	85.85	C
ATOM	6393	C	ASP	A	853	-22.688	85.012	-49.712	1.00	87.92	C
ATOM	6394	CB	ASP	A	853	-21.218	86.615	-48.424	1.00	85.14	C
ATOM	6395	CG	ASP	A	853	-21.045	85.630	-47.290	1.00	93.46	C
ATOM	6396	OD1	ASP	A	853	-22.067	85.278	-46.661	1.00	94.95	O
ATOM	6397	OD2	ASP	A	853	-19.894	85.205	-47.029	1.00	90.48	O
ATOM	6398	O	ASN	A	854	-26.352	82.052	-50.177	1.00	83.79	O
ATOM	6399	N	ASN	A	854	-23.777	84.334	-49.343	1.00	86.46	N
ATOM	6400	CA	ASN	A	854	-24.192	83.098	-49.994	1.00	84.74	C
ATOM	6401	C	ASN	A	854	-25.697	83.089	-50.256	1.00	84.58	C
ATOM	6402	CB	ASN	A	854	-23.803	81.890	-49.159	1.00	83.03	C
ATOM	6403	CG	ASN	A	854	-23.897	80.601	-49.938	1.00	86.12	C
ATOM	6404	OD1	ASN	A	854	-22.928	80.165	-50.565	1.00	84.27	O
ATOM	6405	ND2	ASN	A	854	-25.074	79.988	-49.918	1.00	85.72	N
ATOM	6406	N	LYS	A	855	-26.245	84.255	-50.569	1.00	80.34	N
ATOM	6407	CA	LYS	A	855	-27.671	84.355	-50.844	1.00	82.99	C
ATOM	6408	C	LYS	A	855	-27.928	85.210	-52.084	1.00	80.70	C
ATOM	6409	O	LYS	A	855	-27.328	86.271	-52.262	1.00	77.16	O
ATOM	6410	CB	LYS	A	855	-28.412	84.926	-49.634	1.00	83.37	C
ATOM	6411	N	VAL	A	856	-28.820	84.737	-52.943	1.00	79.64	N
ATOM	6412	CA	VAL	A	856	-29.095	85.413	-54.204	1.00	83.06	C
ATOM	6413	C	VAL	A	856	-30.596	85.633	-54.359	1.00	84.41	C
ATOM	6414	O	VAL	A	856	-31.381	84.715	-54.115	1.00	87.11	O
ATOM	6415	CB	VAL	A	856	-28.542	84.592	-55.404	1.00	77.52	C
ATOM	6416	CG1	VAL	A	856	-29.364	84.821	-56.643	1.00	77.18	C
ATOM	6417	CG2	VAL	A	856	-27.070	84.916	-55.654	1.00	71.64	C
ATOM	6418	N	LEU	A	857	-30.996	86.845	-54.739	1.00	79.24	N
ATOM	6419	CA	LEU	A	857	-32.401	87.118	-55.034	1.00	83.67	C
ATOM	6420	C	LEU	A	857	-32.687	86.927	-56.522	1.00	82.38	C
ATOM	6421	O	LEU	A	857	-32.210	87.690	-57.362	1.00	81.44	O
ATOM	6422	CB	LEU	A	857	-32.783	88.532	-54.597	1.00	85.53	C
ATOM	6423	CG	LEU	A	857	-34.230	88.943	-54.879	1.00	86.79	C
ATOM	6424	CD1	LEU	A	857	-35.214	87.992	-54.210	1.00	86.82	C
ATOM	6425	CD2	LEU	A	857	-34.463	90.370	-54.421	1.00	87.61	C
ATOM	6426	N	THR	A	858	-33.463	85.899	-56.846	1.00	82.00	N
ATOM	6427	CA	THR	A	858	-33.682	85.531	-58.239	1.00	83.08	C

ATOM	6428	C	THR	A	858	-35.123	85.116	-58.449	1.00	87.15	C
ATOM	6429	O	THR	A	858	-35.791	84.671	-57.517	1.00	86.69	O
ATOM	6430	CB	THR	A	858	-32.738	84.381	-58.693	1.00	81.67	C
ATOM	6431	OG1	THR	A	858	-33.019	84.019	-60.052	1.00	82.83	O
ATOM	6432	CG2	THR	A	858	-32.913	83.166	-57.815	1.00	83.75	C
ATOM	6433	N	ARG	A	859	-35.584	85.260	-59.689	1.00	88.15	N
ATOM	6434	CA	ARG	A	859	-36.974	85.013	-60.059	1.00	87.69	C
ATOM	6435	C	ARG	A	859	-37.381	83.550	-59.884	1.00	91.18	C
ATOM	6436	O	ARG	A	859	-38.564	83.238	-59.767	1.00	96.43	O
ATOM	6437	CB	ARG	A	859	-37.204	85.458	-61.504	1.00	90.03	C
ATOM	6438	CG	ARG	A	859	-38.609	85.252	-62.017	1.00	91.93	C
ATOM	6439	CD	ARG	A	859	-38.879	86.053	-63.280	1.00	93.15	C
ATOM	6440	NE	ARG	A	859	-38.684	87.482	-63.053	1.00	98.79	N
ATOM	6441	CZ	ARG	A	859	-38.946	88.425	-63.950	1.00	97.22	C
ATOM	6442	NH1	ARG	A	859	-38.734	89.701	-63.656	1.00	93.57	N
ATOM	6443	NH2	ARG	A	859	-39.423	88.087	-65.140	1.00	98.17	N
ATOM	6444	O	SER	A	860	-34.422	80.614	-59.492	1.00	89.34	O
ATOM	6445	N	SER	A	860	-36.404	82.652	-59.844	1.00	90.18	N
ATOM	6446	CA	SER	A	860	-36.714	81.236	-59.715	1.00	91.26	C
ATOM	6447	C	SER	A	860	-35.580	80.419	-59.132	1.00	89.63	C
ATOM	6448	CB	SER	A	860	-37.054	80.655	-61.074	1.00	92.98	C
ATOM	6449	OG	SER	A	860	-35.841	80.352	-61.737	1.00	90.23	O
ATOM	6450	O	ASP	A	861	-33.283	77.361	-59.141	1.00	85.34	O
ATOM	6451	N	ASP	A	861	-35.927	79.488	-58.249	1.00	94.06	N
ATOM	6452	CA	ASP	A	861	-35.020	78.411	-57.861	1.00	90.86	C
ATOM	6453	C	ASP	A	861	-34.439	77.768	-59.109	1.00	86.36	C
ATOM	6454	CB	ASP	A	861	-35.747	77.341	-57.036	1.00	88.18	C
ATOM	6455	CG	ASP	A	861	-35.933	77.736	-55.589	1.00	90.87	C
ATOM	6456	OD1	ASP	A	861	-35.194	78.627	-55.120	1.00	88.85	O
ATOM	6457	OD2	ASP	A	861	-36.810	77.139	-54.920	1.00	95.25	O
ATOM	6458	O	LYS	A	862	-32.771	76.674	-62.367	1.00	82.26	O
ATOM	6459	N	LYS	A	862	-35.263	77.684	-60.142	1.00	83.14	N
ATOM	6460	CA	LYS	A	862	-34.928	76.924	-61.331	1.00	84.24	C
ATOM	6461	C	LYS	A	862	-33.698	77.437	-62.090	1.00	84.69	C
ATOM	6462	CB	LYS	A	862	-36.134	76.901	-62.259	1.00	85.19	C
ATOM	6463	O	ASN	A	863	-30.382	79.568	-63.771	1.00	82.67	O
ATOM	6464	N	ASN	A	863	-33.687	78.730	-62.397	1.00	84.06	N
ATOM	6465	CA	ASN	A	863	-32.708	79.335	-63.305	1.00	81.02	C
ATOM	6466	C	ASN	A	863	-31.230	79.105	-63.016	1.00	80.01	C
ATOM	6467	CB	ASN	A	863	-32.940	80.842	-63.359	1.00	80.70	C
ATOM	6468	CG	ASN	A	863	-34.114	81.215	-64.237	1.00	80.21	C
ATOM	6469	OD1	ASN	A	863	-34.245	80.718	-65.350	1.00	79.29	O
ATOM	6470	ND2	ASN	A	863	-34.977	82.091	-63.740	1.00	82.36	N
ATOM	6471	O	ARG	A	864	-27.735	76.681	-61.958	1.00	85.85	O
ATOM	6472	N	ARG	A	864	-30.916	78.401	-61.937	1.00	79.38	N
ATOM	6473	CA	ARG	A	864	-29.530	78.204	-61.544	1.00	77.16	C
ATOM	6474	C	ARG	A	864	-28.924	76.934	-62.126	1.00	80.93	C
ATOM	6475	CB	ARG	A	864	-29.422	78.158	-60.028	1.00	76.56	C
ATOM	6476	CG	ARG	A	864	-30.236	77.044	-59.426	1.00	83.40	C
ATOM	6477	CD	ARG	A	864	-29.402	76.188	-58.507	1.00	84.38	C
ATOM	6478	NE	ARG	A	864	-28.789	76.995	-57.466	1.00	78.25	N
ATOM	6479	CZ	ARG	A	864	-27.680	76.650	-56.835	1.00	80.56	C
ATOM	6480	NH1	ARG	A	864	-27.170	77.441	-55.900	1.00	80.46	N
ATOM	6481	NH2	ARG	A	864	-27.085	75.507	-57.149	1.00	81.42	N
ATOM	6482	O	GLY	A	865	-30.634	73.625	-61.729	1.00	89.49	O
ATOM	6483	N	GLY	A	865	-29.737	76.134	-62.808	1.00	82.51	N
ATOM	6484	CA	GLY	A	865	-29.289	74.839	-63.289	1.00	88.79	C
ATOM	6485	C	GLY	A	865	-29.542	73.726	-62.283	1.00	86.65	C
ATOM	6486	O	LYS	A	866	-28.482	73.356	-59.326	1.00	91.52	O
ATOM	6487	N	LYS	A	866	-28.531	72.896	-62.043	1.00	85.11	N
ATOM	6488	CA	LYS	A	866	-28.659	71.770	-61.119	1.00	90.06	C
ATOM	6489	C	LYS	A	866	-28.915	72.265	-59.694	1.00	90.93	C
ATOM	6490	CB	LYS	A	866	-27.400	70.886	-61.156	1.00	92.31	C

ATOM	6491	CG	LYS	A	866	-26.961	70.453	-62.560	1.00	92.41	C
ATOM	6492	CD	LYS	A	866	-27.238	68.979	-62.829	1.00	93.87	C
ATOM	6493	CE	LYS	A	866	-27.251	68.688	-64.328	1.00	94.46	C
ATOM	6494	NZ	LYS	A	866	-27.453	67.237	-64.629	1.00	100.35	N
ATOM	6495	O	SER	A	867	-28.684	72.063	-55.494	1.00	91.03	O
ATOM	6496	N	SER	A	867	-29.620	71.463	-58.900	1.00	89.20	N
ATOM	6497	CA	SER	A	867	-29.950	71.836	-57.526	1.00	90.73	C
ATOM	6498	C	SER	A	867	-28.819	71.479	-56.566	1.00	89.67	C
ATOM	6499	CB	SER	A	867	-31.242	71.151	-57.087	1.00	91.17	C
ATOM	6500	OG	SER	A	867	-32.195	71.178	-58.136	1.00	97.88	O
ATOM	6501	O	ASP	A	868	-24.545	69.940	-56.241	1.00	82.23	O
ATOM	6502	N	ASP	A	868	-27.999	70.523	-56.973	1.00	86.42	N
ATOM	6503	CA	ASP	A	868	-26.942	69.993	-56.120	1.00	90.00	C
ATOM	6504	C	ASP	A	868	-25.573	70.612	-56.402	1.00	91.61	C
ATOM	6505	CB	ASP	A	868	-26.849	68.474	-56.299	1.00	92.05	C
ATOM	6506	CG	ASP	A	868	-26.767	68.066	-57.770	1.00	93.16	C
ATOM	6507	OD1	ASP	A	868	-27.829	67.751	-58.361	1.00	93.07	O
ATOM	6508	OD2	ASP	A	868	-25.646	68.088	-58.335	1.00	89.65	O
ATOM	6509	O	ASN	A	869	-25.120	74.648	-56.765	1.00	78.65	O
ATOM	6510	N	ASN	A	869	-25.542	71.877	-56.823	1.00	90.27	N
ATOM	6511	CA	ASN	A	869	-24.269	72.465	-57.229	1.00	86.71	C
ATOM	6512	C	ASN	A	869	-24.161	73.971	-57.120	1.00	82.13	C
ATOM	6513	CB	ASN	A	869	-23.958	72.068	-58.673	1.00	85.39	C
ATOM	6514	CG	ASN	A	869	-22.723	71.209	-58.778	1.00	85.91	C
ATOM	6515	OD1	ASN	A	869	-22.805	69.980	-58.742	1.00	88.77	O
ATOM	6516	ND2	ASN	A	869	-21.562	71.851	-58.889	1.00	84.49	N
ATOM	6517	O	VAL	A	870	-23.497	75.265	-59.897	1.00	91.88	O
ATOM	6518	N	VAL	A	870	-22.951	74.455	-57.400	1.00	79.26	N
ATOM	6519	CA	VAL	A	870	-22.670	75.846	-57.739	1.00	80.67	C
ATOM	6520	C	VAL	A	870	-23.388	76.160	-59.055	1.00	86.36	C
ATOM	6521	CB	VAL	A	870	-21.144	76.066	-57.874	1.00	79.70	C
ATOM	6522	CG1	VAL	A	870	-20.517	74.898	-58.601	1.00	86.53	C
ATOM	6523	CG2	VAL	A	870	-20.810	77.362	-58.605	1.00	87.19	C
ATOM	6524	O	PRO	A	871	-22.664	77.235	-61.782	1.00	85.47	O
ATOM	6525	N	PRO	A	871	-23.903	77.402	-59.231	1.00	81.59	N
ATOM	6526	CA	PRO	A	871	-24.544	77.844	-60.480	1.00	83.67	C
ATOM	6527	C	PRO	A	871	-23.889	77.292	-61.741	1.00	84.88	C
ATOM	6528	CB	PRO	A	871	-24.388	79.364	-60.419	1.00	85.00	C
ATOM	6529	CG	PRO	A	871	-24.516	79.664	-58.962	1.00	82.75	C
ATOM	6530	CD	PRO	A	871	-23.975	78.458	-58.202	1.00	83.21	C
ATOM	6531	O	SER	A	872	-23.543	78.306	-64.928	1.00	85.82	O
ATOM	6532	N	SER	A	872	-24.691	76.900	-62.733	1.00	86.20	N
ATOM	6533	CA	SER	A	872	-24.195	76.221	-63.940	1.00	87.04	C
ATOM	6534	C	SER	A	872	-23.318	77.106	-64.828	1.00	86.38	C
ATOM	6535	CB	SER	A	872	-25.367	75.702	-64.767	1.00	82.79	C
ATOM	6536	OG	SER	A	872	-25.941	76.745	-65.538	1.00	83.52	O
ATOM	6537	O	GLU	A	873	-21.643	79.054	-67.941	1.00	86.15	O
ATOM	6538	N	GLU	A	873	-22.336	76.503	-65.495	1.00	88.55	N
ATOM	6539	CA	GLU	A	873	-21.429	77.252	-66.364	1.00	86.83	C
ATOM	6540	C	GLU	A	873	-22.172	78.061	-67.436	1.00	85.18	C
ATOM	6541	CB	GLU	A	873	-20.424	76.302	-67.022	1.00	89.41	C
ATOM	6542	O	GLU	A	874	-24.313	80.780	-68.800	1.00	89.00	O
ATOM	6543	N	GLU	A	874	-23.396	77.647	-67.765	1.00	82.75	N
ATOM	6544	CA	GLU	A	874	-24.232	78.382	-68.714	1.00	84.67	C
ATOM	6545	C	GLU	A	874	-24.600	79.760	-68.166	1.00	86.86	C
ATOM	6546	CB	GLU	A	874	-25.500	77.592	-69.053	1.00	83.33	C
ATOM	6547	O	VAL	A	875	-24.238	83.056	-65.967	1.00	79.05	O
ATOM	6548	N	VAL	A	875	-25.229	79.800	-66.991	1.00	84.45	N
ATOM	6549	CA	VAL	A	875	-25.551	81.081	-66.364	1.00	83.34	C
ATOM	6550	C	VAL	A	875	-24.279	81.828	-65.936	1.00	83.00	C
ATOM	6551	CB	VAL	A	875	-26.500	80.915	-65.144	1.00	85.16	C
ATOM	6552	CG1	VAL	A	875	-27.958	80.870	-65.593	1.00	87.38	C
ATOM	6553	CG2	VAL	A	875	-26.159	79.680	-64.355	1.00	84.29	C

ATOM	6554	O	VAL	A	876	-20.960	83.585	-66.388	1.00	83.76	O
ATOM	6555	N	VAL	A	876	-23.237	81.091	-65.553	1.00	84.46	N
ATOM	6556	CA	VAL	A	876	-21.947	81.714	-65.259	1.00	80.63	C
ATOM	6557	C	VAL	A	876	-21.413	82.445	-66.489	1.00	82.55	C
ATOM	6558	CB	VAL	A	876	-20.905	80.695	-64.785	1.00	82.65	C
ATOM	6559	CG2	VAL	A	876	-21.299	80.124	-63.437	1.00	86.37	C
ATOM	6560	CG1	VAL	A	876	-19.535	81.346	-64.690	1.00	85.25	C
ATOM	6561	O	LYS	A	877	-21.381	84.696	-69.667	1.00	79.15	O
ATOM	6562	N	LYS	A	877	-21.491	81.800	-67.649	1.00	82.98	N
ATOM	6563	CA	LYS	A	877	-21.085	82.436	-68.902	1.00	82.45	C
ATOM	6564	C	LYS	A	877	-21.919	83.682	-69.220	1.00	77.58	C
ATOM	6565	CB	LYS	A	877	-21.173	81.440	-70.069	1.00	79.30	C
ATOM	6566	N	LYS	A	878	-23.223	83.627	-68.990	1.00	71.37	N
ATOM	6567	CA	LYS	A	878	-24.055	84.767	-69.366	1.00	80.34	C
ATOM	6568	C	LYS	A	878	-24.009	85.911	-68.350	1.00	78.42	C
ATOM	6569	O	LYS	A	878	-24.285	87.056	-68.698	1.00	81.22	O
ATOM	6570	CB	LYS	A	878	-25.508	84.327	-69.580	1.00	79.92	C
ATOM	6571	N	MET	A	879	-23.655	85.615	-67.102	1.00	81.05	N
ATOM	6572	CA	MET	A	879	-23.803	86.605	-66.030	1.00	81.46	C
ATOM	6573	C	MET	A	879	-22.497	87.208	-65.497	1.00	82.72	C
ATOM	6574	O	MET	A	879	-22.520	88.302	-64.926	1.00	83.77	O
ATOM	6575	CB	MET	A	879	-24.566	85.990	-64.854	1.00	81.03	C
ATOM	6576	CG	MET	A	879	-25.979	85.531	-65.169	1.00	78.89	C
ATOM	6577	SD	MET	A	879	-26.987	86.790	-65.968	1.00	79.53	S
ATOM	6578	CE	MET	A	879	-26.975	88.102	-64.745	1.00	84.68	C
ATOM	6579	N	LYS	A	880	-21.381	86.496	-65.680	1.00	82.44	N
ATOM	6580	CA	LYS	A	880	-20.081	86.843	-65.084	1.00	81.05	C
ATOM	6581	C	LYS	A	880	-19.751	88.333	-65.151	1.00	85.13	C
ATOM	6582	O	LYS	A	880	-19.214	88.919	-64.204	1.00	84.26	O
ATOM	6583	CB	LYS	A	880	-18.967	86.049	-65.766	1.00	75.03	C
ATOM	6584	N	ASN	A	881	-20.092	88.938	-66.280	1.00	87.78	N
ATOM	6585	CA	ASN	A	881	-19.862	90.356	-66.504	1.00	87.80	C
ATOM	6586	C	ASN	A	881	-20.667	91.223	-65.539	1.00	86.93	C
ATOM	6587	O	ASN	A	881	-20.108	92.057	-64.828	1.00	86.22	O
ATOM	6588	CB	ASN	A	881	-20.204	90.704	-67.953	1.00	88.37	C
ATOM	6589	CG	ASN	A	881	-19.280	91.743	-68.529	1.00	95.70	C
ATOM	6590	OD1	ASN	A	881	-19.530	92.946	-68.413	1.00	100.49	O
ATOM	6591	ND2	ASN	A	881	-18.195	91.289	-69.150	1.00	101.53	N
ATOM	6592	N	TYR	A	882	-21.981	91.005	-65.521	1.00	84.42	N
ATOM	6593	CA	TYR	A	882	-22.889	91.730	-64.640	1.00	85.03	C
ATOM	6594	C	TYR	A	882	-22.465	91.636	-63.178	1.00	85.46	C
ATOM	6595	O	TYR	A	882	-22.551	92.616	-62.439	1.00	85.92	O
ATOM	6596	CB	TYR	A	882	-24.319	91.207	-64.812	1.00	86.47	C
ATOM	6597	CG	TYR	A	882	-25.274	91.629	-63.710	1.00	91.46	C
ATOM	6598	CD1	TYR	A	882	-25.650	92.961	-63.549	1.00	86.45	C
ATOM	6599	CD2	TYR	A	882	-25.807	90.690	-62.834	1.00	90.87	C
ATOM	6600	CE1	TYR	A	882	-26.521	93.340	-62.538	1.00	88.01	C
ATOM	6601	CE2	TYR	A	882	-26.682	91.060	-61.827	1.00	89.30	C
ATOM	6602	CZ	TYR	A	882	-27.036	92.381	-61.684	1.00	89.33	C
ATOM	6603	OH	TYR	A	882	-27.904	92.729	-60.677	1.00	88.16	O
ATOM	6604	N	TRP	A	883	-22.003	90.455	-62.770	1.00	86.34	N
ATOM	6605	CA	TRP	A	883	-21.518	90.242	-61.407	1.00	85.25	C
ATOM	6606	C	TRP	A	883	-20.289	91.098	-61.117	1.00	85.84	C
ATOM	6607	O	TRP	A	883	-20.152	91.658	-60.028	1.00	85.85	O
ATOM	6608	CB	TRP	A	883	-21.168	88.770	-61.168	1.00	83.68	C
ATOM	6609	CG	TRP	A	883	-22.314	87.802	-61.230	1.00	79.98	C
ATOM	6610	CD1	TRP	A	883	-23.640	88.081	-61.085	1.00	81.36	C
ATOM	6611	CD2	TRP	A	883	-22.221	86.387	-61.453	1.00	78.52	C
ATOM	6612	NE1	TRP	A	883	-24.378	86.926	-61.208	1.00	82.40	N
ATOM	6613	CE2	TRP	A	883	-23.530	85.875	-61.435	1.00	72.35	C
ATOM	6614	CE3	TRP	A	883	-21.154	85.505	-61.667	1.00	81.13	C
ATOM	6615	CZ2	TRP	A	883	-23.803	84.522	-61.624	1.00	80.66	C
ATOM	6616	CZ3	TRP	A	883	-21.427	84.160	-61.858	1.00	79.82	C

ATOM	6617	CH2	TRP	A	883	-22.740	83.681	-61.833	1.00	80.09	C
ATOM	6618	N	ARG	A	884	-19.395	91.185	-62.098	1.00	85.29	N
ATOM	6619	CA	ARG	A	884	-18.145	91.910	-61.925	1.00	87.95	C
ATOM	6620	C	ARG	A	884	-18.421	93.381	-61.674	1.00	86.32	C
ATOM	6621	O	ARG	A	884	-17.764	94.012	-60.854	1.00	87.58	O
ATOM	6622	CB	ARG	A	884	-17.236	91.739	-63.145	1.00	89.91	C
ATOM	6623	CG	ARG	A	884	-15.967	92.579	-63.070	1.00	95.72	C
ATOM	6624	CD	ARG	A	884	-14.914	92.184	-64.102	1.00	97.82	C
ATOM	6625	NE	ARG	A	884	-14.338	90.862	-63.851	1.00	100.50	N
ATOM	6626	CZ	ARG	A	884	-13.417	90.598	-62.925	1.00	99.07	C
ATOM	6627	NH1	ARG	A	884	-12.954	89.360	-62.782	1.00	94.05	N
ATOM	6628	NH2	ARG	A	884	-12.963	91.565	-62.135	1.00	95.89	N
ATOM	6629	N	GLN	A	885	-19.407	93.917	-62.382	1.00	88.58	N
ATOM	6630	CA	GLN	A	885	-19.833	95.297	-62.184	1.00	89.75	C
ATOM	6631	C	GLN	A	885	-20.356	95.491	-60.776	1.00	89.12	C
ATOM	6632	O	GLN	A	885	-20.149	96.536	-60.163	1.00	90.31	O
ATOM	6633	CB	GLN	A	885	-20.917	95.682	-63.181	1.00	86.93	C
ATOM	6634	CG	GLN	A	885	-20.522	95.554	-64.628	1.00	89.35	C
ATOM	6635	CD	GLN	A	885	-21.630	96.019	-65.553	1.00	95.96	C
ATOM	6636	OE1	GLN	A	885	-22.799	96.091	-65.160	1.00	91.13	O
ATOM	6637	NE2	GLN	A	885	-21.267	96.351	-66.789	1.00	98.83	N
ATOM	6638	N	LEU	A	886	-21.065	94.482	-60.280	1.00	89.51	N
ATOM	6639	CA	LEU	A	886	-21.563	94.511	-58.917	1.00	88.60	C
ATOM	6640	C	LEU	A	886	-20.385	94.389	-57.967	1.00	89.04	C
ATOM	6641	O	LEU	A	886	-20.356	95.042	-56.923	1.00	88.29	O
ATOM	6642	CB	LEU	A	886	-22.573	93.392	-58.676	1.00	87.48	C
ATOM	6643	CG	LEU	A	886	-23.950	93.553	-59.313	1.00	88.26	C
ATOM	6644	CD2	LEU	A	886	-24.601	94.840	-58.861	1.00	87.13	C
ATOM	6645	CD1	LEU	A	886	-24.821	92.358	-58.965	1.00	89.32	C
ATOM	6646	N	LEU	A	887	-19.411	93.561	-58.343	1.00	85.34	N
ATOM	6647	CA	LEU	A	887	-18.190	93.398	-57.553	1.00	88.66	C
ATOM	6648	C	LEU	A	887	-17.388	94.694	-57.500	1.00	91.43	C
ATOM	6649	O	LEU	A	887	-16.950	95.123	-56.430	1.00	89.43	O
ATOM	6650	CB	LEU	A	887	-17.315	92.275	-58.122	1.00	86.48	C
ATOM	6651	CG	LEU	A	887	-15.970	92.079	-57.423	1.00	80.52	C
ATOM	6652	CD2	LEU	A	887	-15.131	91.044	-58.145	1.00	83.22	C
ATOM	6653	CD1	LEU	A	887	-16.176	91.675	-55.979	1.00	80.60	C
ATOM	6654	N	ASN	A	888	-17.204	95.313	-58.666	1.00	93.10	N
ATOM	6655	CA	ASN	A	888	-16.437	96.550	-58.778	1.00	93.04	C
ATOM	6656	C	ASN	A	888	-17.188	97.733	-58.173	1.00	91.05	C
ATOM	6657	O	ASN	A	888	-16.638	98.818	-58.011	1.00	89.73	O
ATOM	6658	CB	ASN	A	888	-16.081	96.829	-60.243	1.00	94.02	C
ATOM	6659	CG	ASN	A	888	-14.859	96.037	-60.710	1.00	99.40	C
ATOM	6660	OD1	ASN	A	888	-14.969	95.100	-61.508	1.00	98.55	O
ATOM	6661	ND2	ASN	A	888	-13.685	96.417	-60.214	1.00	101.22	N
ATOM	6662	N	ALA	A	889	-18.451	97.516	-57.840	1.00	88.02	N
ATOM	6663	CA	ALA	A	889	-19.198	98.493	-57.081	1.00	90.48	C
ATOM	6664	C	ALA	A	889	-19.148	98.107	-55.603	1.00	91.60	C
ATOM	6665	O	ALA	A	889	-19.818	98.718	-54.767	1.00	91.25	O
ATOM	6666	CB	ALA	A	889	-20.631	98.576	-57.581	1.00	91.43	C
ATOM	6667	N	LYS	A	890	-18.339	97.089	-55.299	1.00	87.10	N
ATOM	6668	CA	LYS	A	890	-18.262	96.488	-53.965	1.00	89.27	C
ATOM	6669	C	LYS	A	890	-19.650	96.165	-53.403	1.00	92.10	C
ATOM	6670	O	LYS	A	890	-19.877	96.263	-52.197	1.00	94.02	O
ATOM	6671	CB	LYS	A	890	-17.496	97.399	-52.999	1.00	86.41	C
ATOM	6672	O	LEU	A	891	-23.002	93.399	-53.081	1.00	89.08	O
ATOM	6673	N	LEU	A	891	-20.568	95.783	-54.292	1.00	90.88	N
ATOM	6674	CA	LEU	A	891	-21.928	95.382	-53.917	1.00	91.85	C
ATOM	6675	C	LEU	A	891	-22.004	93.890	-53.612	1.00	88.52	C
ATOM	6676	CB	LEU	A	891	-22.931	95.719	-55.028	1.00	91.01	C
ATOM	6677	CG	LEU	A	891	-23.415	97.165	-55.182	1.00	93.52	C
ATOM	6678	CD1	LEU	A	891	-24.673	97.231	-56.063	1.00	90.45	C
ATOM	6679	CD2	LEU	A	891	-23.660	97.810	-53.825	1.00	90.99	C

ATOM	6680	O	ILE	A	892	-18.472	92.199	-53.600	1.00	84.42	O
ATOM	6681	N	ILE	A	892	-20.959	93.167	-53.987	1.00	86.07	N
ATOM	6682	CA	ILE	A	892	-20.828	91.775	-53.607	1.00	84.51	C
ATOM	6683	C	ILE	A	892	-19.410	91.524	-53.158	1.00	88.39	C
ATOM	6684	CB	ILE	A	892	-21.170	90.798	-54.750	1.00	82.66	C
ATOM	6685	CG1	ILE	A	892	-20.239	91.014	-55.944	1.00	82.84	C
ATOM	6686	CG2	ILE	A	892	-22.630	90.921	-55.150	1.00	89.04	C
ATOM	6687	CD1	ILE	A	892	-20.341	89.934	-57.001	1.00	86.70	C
ATOM	6688	O	THR	A	893	-17.636	89.147	-53.919	1.00	81.86	O
ATOM	6689	N	THR	A	893	-19.263	90.545	-52.277	1.00	86.68	N
ATOM	6690	CA	THR	A	893	-17.962	90.164	-51.785	1.00	85.63	C
ATOM	6691	C	THR	A	893	-17.113	89.622	-52.910	1.00	86.82	C
ATOM	6692	CB	THR	A	893	-18.064	89.099	-50.693	1.00	84.73	C
ATOM	6693	CG1	THR	A	893	-19.221	89.351	-49.886	1.00	86.68	C
ATOM	6694	CG2	THR	A	893	-16.811	89.112	-49.822	1.00	89.25	O
ATOM	6695	N	GLN	A	894	-15.800	89.723	-52.729	1.00	86.77	N
ATOM	6696	CA	GLN	A	894	-14.856	88.946	-53.504	1.00	90.21	C
ATOM	6697	C	GLN	A	894	-15.256	87.482	-53.439	1.00	93.18	C
ATOM	6698	O	GLN	A	894	-15.353	86.808	-54.470	1.00	94.88	O
ATOM	6699	CB	GLN	A	894	-13.434	89.113	-52.974	1.00	90.27	C
ATOM	6700	CG	GLN	A	894	-12.469	88.119	-53.573	1.00	88.63	C
ATOM	6701	CD	GLN	A	894	-12.257	88.371	-55.045	1.00	94.11	C
ATOM	6702	OE1	GLN	A	894	-11.692	89.395	-55.423	1.00	97.96	O
ATOM	6703	NE2	GLN	A	894	-12.721	87.452	-55.890	1.00	90.42	N
ATOM	6704	N	ARG	A	895	-15.492	87.000	-52.218	1.00	91.73	N
ATOM	6705	CA	ARG	A	895	-15.829	85.597	-52.007	1.00	93.64	C
ATOM	6706	C	ARG	A	895	-17.137	85.241	-52.700	1.00	89.12	C
ATOM	6707	O	ARG	A	895	-17.221	84.212	-53.376	1.00	86.61	O
ATOM	6708	CB	ARG	A	895	-15.924	85.260	-50.518	1.00	92.78	C
ATOM	6709	CG	ARG	A	895	-16.205	83.784	-50.271	1.00	88.61	C
ATOM	6710	CD	ARG	A	895	-16.309	83.460	-48.792	1.00	90.65	C
ATOM	6711	NE	ARG	A	895	-17.690	83.366	-48.315	1.00	89.16	N
ATOM	6712	CZ	ARG	A	895	-18.380	82.229	-48.232	1.00	90.53	C
ATOM	6713	NH1	ARG	A	895	-17.822	81.085	-48.611	1.00	91.97	N
ATOM	6714	NH2	ARG	A	895	-19.630	82.234	-47.777	1.00	91.22	N
ATOM	6715	N	LYS	A	896	-18.148	86.093	-52.539	1.00	89.46	N
ATOM	6716	CA	LYS	A	896	-19.433	85.854	-53.184	1.00	84.48	C
ATOM	6717	C	LYS	A	896	-19.240	85.720	-54.683	1.00	83.00	C
ATOM	6718	O	LYS	A	896	-19.782	84.814	-55.295	1.00	82.09	O
ATOM	6719	CB	LYS	A	896	-20.433	86.967	-52.888	1.00	82.70	C
ATOM	6720	CG	LYS	A	896	-21.856	86.552	-53.235	1.00	84.61	C
ATOM	6721	CD	LYS	A	896	-22.840	87.701	-53.249	1.00	74.50	C
ATOM	6722	CE	LYS	A	896	-24.258	87.176	-53.343	1.00	71.84	C
ATOM	6723	NZ	LYS	A	896	-25.265	88.235	-53.072	1.00	74.85	N
ATOM	6724	N	PHE	A	897	-18.437	86.610	-55.258	1.00	85.71	N
ATOM	6725	CA	PHE	A	897	-18.116	86.552	-56.677	1.00	82.37	C
ATOM	6726	C	PHE	A	897	-17.510	85.216	-57.050	1.00	87.71	C
ATOM	6727	O	PHE	A	897	-17.837	84.641	-58.086	1.00	89.72	O
ATOM	6728	CB	PHE	A	897	-17.146	87.661	-57.067	1.00	83.36	C
ATOM	6729	CG	PHE	A	897	-16.733	87.616	-58.507	1.00	85.86	C
ATOM	6730	CD1	PHE	A	897	-17.458	88.303	-59.468	1.00	89.68	C
ATOM	6731	CD2	PHE	A	897	-15.630	86.879	-58.910	1.00	87.66	C
ATOM	6732	CE1	PHE	A	897	-17.088	88.258	-60.801	1.00	84.45	C
ATOM	6733	CE2	PHE	A	897	-15.260	86.832	-60.238	1.00	85.16	C
ATOM	6734	CZ	PHE	A	897	-15.987	87.527	-61.183	1.00	82.37	C
ATOM	6735	N	ASP	A	898	-16.602	84.731	-56.217	1.00	88.11	N
ATOM	6736	CA	ASP	A	898	-15.897	83.504	-56.539	1.00	86.41	C
ATOM	6737	C	ASP	A	898	-16.803	82.288	-56.446	1.00	85.87	C
ATOM	6738	O	ASP	A	898	-16.572	81.306	-57.140	1.00	88.55	O
ATOM	6739	CB	ASP	A	898	-14.683	83.331	-55.634	1.00	87.13	C
ATOM	6740	CG	ASP	A	898	-13.472	84.067	-56.154	1.00	94.37	C
ATOM	6741	OD2	ASP	A	898	-13.280	85.244	-55.771	1.00	95.59	O
ATOM	6742	OD1	ASP	A	898	-12.719	83.470	-56.956	1.00	98.13	O

ATOM	6743	N	ASN	A	899	-17.830	82.349	-55.597	1.00	86.19	N
ATOM	6744	CA	ASN	A	899	-18.782	81.241	-55.473	1.00	82.08	C
ATOM	6745	C	ASN	A	899	-19.771	81.240	-56.641	1.00	83.16	C
ATOM	6746	O	ASN	A	899	-19.997	80.204	-57.268	1.00	80.35	O
ATOM	6747	CB	ASN	A	899	-19.542	81.297	-54.139	1.00	80.61	C
ATOM	6748	CG	ASN	A	899	-18.684	80.881	-52.936	1.00	84.32	C
ATOM	6749	OD1	ASN	A	899	-19.010	81.200	-51.788	1.00	81.38	O
ATOM	6750	ND2	ASN	A	899	-17.593	80.164	-53.196	1.00	83.75	N
ATOM	6751	N	LEU	A	900	-20.352	82.406	-56.927	1.00	82.99	N
ATOM	6752	CA	LEU	A	900	-21.224	82.579	-58.083	1.00	80.65	C
ATOM	6753	C	LEU	A	900	-20.591	81.999	-59.341	1.00	79.82	C
ATOM	6754	O	LEU	A	900	-21.253	81.373	-60.160	1.00	79.98	O
ATOM	6755	CB	LEU	A	900	-21.531	84.063	-58.312	1.00	80.07	C
ATOM	6756	CG	LEU	A	900	-22.732	84.744	-57.647	1.00	78.95	C
ATOM	6757	CD1	LEU	A	900	-24.047	84.136	-58.095	1.00	77.96	C
ATOM	6758	CD2	LEU	A	900	-22.623	84.666	-56.161	1.00	83.37	C
ATOM	6759	N	THR	A	901	-19.286	82.195	-59.458	1.00	81.89	N
ATOM	6760	CA	THR	A	901	-18.572	81.953	-60.697	1.00	84.48	C
ATOM	6761	C	THR	A	901	-17.860	80.604	-60.801	1.00	86.63	C
ATOM	6762	O	THR	A	901	-17.468	80.194	-61.888	1.00	90.46	O
ATOM	6763	CB	THR	A	901	-17.509	83.046	-60.921	1.00	86.58	C
ATOM	6764	OG1	THR	A	901	-17.111	83.047	-62.293	1.00	91.90	O
ATOM	6765	CG2	THR	A	901	-16.280	82.796	-60.056	1.00	85.65	C
ATOM	6766	N	LYS	A	902	-17.683	79.908	-59.691	1.00	85.17	N
ATOM	6767	CA	LYS	A	902	-16.676	78.859	-59.677	1.00	90.38	C
ATOM	6768	C	LYS	A	902	-17.045	77.582	-60.426	1.00	91.42	C
ATOM	6769	O	LYS	A	902	-16.307	76.600	-60.366	1.00	92.83	O
ATOM	6770	CB	LYS	A	902	-16.303	78.508	-58.239	1.00	92.67	C
ATOM	6771	CG	LYS	A	902	-14.802	78.600	-57.981	1.00	95.32	C
ATOM	6772	CD	LYS	A	902	-14.189	79.841	-58.626	1.00	85.56	C
ATOM	6773	CE	LYS	A	902	-12.679	79.787	-58.496	1.00	95.49	C
ATOM	6774	NZ	LYS	A	902	-12.252	79.510	-57.089	1.00	97.36	N
ATOM	6775	N	ALA	A	903	-18.159	77.585	-61.144	1.00	86.31	N
ATOM	6776	CA	ALA	A	903	-18.452	76.460	-62.018	1.00	88.18	C
ATOM	6777	C	ALA	A	903	-17.550	76.526	-63.243	1.00	89.60	C
ATOM	6778	O	ALA	A	903	-17.308	75.530	-63.930	1.00	88.19	O
ATOM	6779	CB	ALA	A	903	-19.891	76.465	-62.424	1.00	90.63	C
ATOM	6780	N	GLU	A	904	-17.063	77.729	-63.504	1.00	91.08	N
ATOM	6781	CA	GLU	A	904	-16.208	77.996	-64.643	1.00	91.16	C
ATOM	6782	C	GLU	A	904	-14.817	77.434	-64.391	1.00	90.67	C
ATOM	6783	O	GLU	A	904	-14.121	77.034	-65.326	1.00	93.34	O
ATOM	6784	CB	GLU	A	904	-16.165	79.505	-64.914	1.00	91.89	C
ATOM	6785	CG	GLU	A	904	-14.793	80.056	-65.209	1.00	96.69	C
ATOM	6786	CD	GLU	A	904	-14.508	81.330	-64.443	1.00	100.09	C
ATOM	6787	OE1	GLU	A	904	-13.772	81.268	-63.426	1.00	99.35	O
ATOM	6788	OE2	GLU	A	904	-15.018	82.391	-64.863	1.00	97.26	O
ATOM	6789	N	ARG	A	905	-14.431	77.383	-63.118	1.00	92.52	N
ATOM	6790	CA	ARG	A	905	-13.114	76.893	-62.717	1.00	90.61	C
ATOM	6791	C	ARG	A	905	-13.093	75.380	-62.518	1.00	89.14	C
ATOM	6792	O	ARG	A	905	-12.051	74.809	-62.212	1.00	94.44	O
ATOM	6793	CB	ARG	A	905	-12.660	77.589	-61.433	1.00	89.55	C
ATOM	6794	N	GLY	A	906	-14.243	74.737	-62.691	1.00	85.89	N
ATOM	6795	CA	GLY	A	906	-14.351	73.304	-62.507	1.00	83.13	C
ATOM	6796	C	GLY	A	906	-15.511	72.889	-61.621	1.00	87.78	C
ATOM	6797	O	GLY	A	906	-15.867	71.712	-61.558	1.00	89.56	O
ATOM	6798	O	GLY	A	907	-15.900	72.135	-58.720	1.00	86.74	O
ATOM	6799	N	GLY	A	907	-16.096	73.855	-60.920	1.00	88.88	N
ATOM	6800	CA	GLY	A	907	-17.251	73.604	-60.073	1.00	86.92	C
ATOM	6801	C	GLY	A	907	-17.013	72.636	-58.925	1.00	87.66	C
ATOM	6802	O	LEU	A	908	-18.522	69.277	-57.907	1.00	87.70	O
ATOM	6803	N	LEU	A	908	-18.077	72.363	-58.177	1.00	86.78	N
ATOM	6804	CA	LEU	A	908	-17.993	71.455	-57.037	1.00	89.95	C
ATOM	6805	C	LEU	A	908	-17.659	70.022	-57.442	1.00	86.99	C

ATOM	6806	CB	LEU	A	908	-19.304	71.468	-56.248	1.00	89.64	C
ATOM	6807	CG	LEU	A	908	-19.633	72.743	-55.469	1.00	87.47	C
ATOM	6808	CD1	LEU	A	908	-20.783	72.506	-54.488	1.00	84.98	C
ATOM	6809	CD2	LEU	A	908	-18.400	73.261	-54.754	1.00	78.72	C
ATOM	6810	O	SER	A	909	-17.633	67.582	-55.903	1.00	87.49	O
ATOM	6811	N	SER	A	909	-16.401	69.644	-57.243	1.00	87.72	N
ATOM	6812	CA	SER	A	909	-15.940	68.279	-57.478	1.00	85.23	C
ATOM	6813	C	SER	A	909	-16.684	67.250	-56.622	1.00	88.49	C
ATOM	6814	CB	SER	A	909	-14.446	68.182	-57.192	1.00	77.47	C
ATOM	6815	OG	SER	A	909	-14.203	67.144	-56.269	1.00	81.58	O
ATOM	6816	O	GLU	A	910	-16.513	64.382	-53.534	1.00	83.17	O
ATOM	6817	N	GLU	A	910	-16.244	65.998	-56.682	1.00	82.98	N
ATOM	6818	CA	GLU	A	910	-16.844	64.977	-55.837	1.00	83.47	C
ATOM	6819	C	GLU	A	910	-16.019	64.835	-54.566	1.00	84.10	C
ATOM	6820	CB	GLU	A	910	-16.943	63.641	-56.573	1.00	92.50	C
ATOM	6821	CG	GLU	A	910	-18.096	62.755	-56.117	1.00	91.15	C
ATOM	6822	CD	GLU	A	910	-19.378	63.062	-56.855	1.00	88.34	C
ATOM	6823	OE1	GLU	A	910	-20.385	62.342	-56.660	1.00	87.99	O
ATOM	6824	OE2	GLU	A	910	-19.375	64.028	-57.641	1.00	90.02	O
ATOM	6825	N	LEU	A	911	-14.749	65.217	-54.657	1.00	84.07	N
ATOM	6826	CA	LEU	A	911	-13.889	65.300	-53.486	1.00	83.34	C
ATOM	6827	C	LEU	A	911	-14.242	66.569	-52.690	1.00	85.73	C
ATOM	6828	O	LEU	A	911	-14.010	66.662	-51.480	1.00	81.94	O
ATOM	6829	CB	LEU	A	911	-12.420	65.299	-53.901	1.00	81.11	C
ATOM	6830	N	ASP	A	912	-14.813	67.542	-53.391	1.00	85.16	N
ATOM	6831	CA	ASP	A	912	-15.341	68.739	-52.765	1.00	83.13	C
ATOM	6832	C	ASP	A	912	-16.669	68.464	-52.069	1.00	85.25	C
ATOM	6833	O	ASP	A	912	-16.933	68.987	-50.989	1.00	80.32	O
ATOM	6834	CB	ASP	A	912	-15.526	69.845	-53.798	1.00	86.04	C
ATOM	6835	CG	ASP	A	912	-14.222	70.430	-54.252	1.00	87.94	C
ATOM	6836	OD2	ASP	A	912	-14.255	71.336	-55.118	1.00	85.29	O
ATOM	6837	OD1	ASP	A	912	-13.172	69.990	-53.730	1.00	84.63	O
ATOM	6838	N	LYS	A	913	-17.521	67.663	-52.699	1.00	87.40	N
ATOM	6839	CA	LYS	A	913	-18.777	67.290	-52.065	1.00	87.11	C
ATOM	6840	C	LYS	A	913	-18.473	66.536	-50.768	1.00	83.45	C
ATOM	6841	O	LYS	A	913	-19.094	66.785	-49.743	1.00	83.15	O
ATOM	6842	CB	LYS	A	913	-19.642	66.449	-53.007	1.00	86.48	C
ATOM	6843	N	ALA	A	914	-17.483	65.650	-50.819	1.00	83.79	N
ATOM	6844	CA	ALA	A	914	-17.049	64.875	-49.653	1.00	84.22	C
ATOM	6845	C	ALA	A	914	-16.532	65.769	-48.528	1.00	81.81	C
ATOM	6846	O	ALA	A	914	-16.970	65.652	-47.379	1.00	78.04	O
ATOM	6847	CB	ALA	A	914	-15.976	63.873	-50.056	1.00	75.26	C
ATOM	6848	N	GLY	A	915	-15.595	66.651	-48.873	1.00	80.84	N
ATOM	6849	CA	GLY	A	915	-15.008	67.584	-47.928	1.00	78.62	C
ATOM	6850	C	GLY	A	915	-16.033	68.427	-47.193	1.00	76.51	C
ATOM	6851	O	GLY	A	915	-15.932	68.611	-45.989	1.00	76.98	O
ATOM	6852	N	PHE	A	916	-17.024	68.938	-47.918	1.00	80.46	N
ATOM	6853	CA	PHE	A	916	-18.084	69.729	-47.313	1.00	76.14	C
ATOM	6854	C	PHE	A	916	-18.857	68.897	-46.313	1.00	78.25	C
ATOM	6855	O	PHE	A	916	-19.407	69.442	-45.354	1.00	79.43	O
ATOM	6856	CB	PHE	A	916	-19.041	70.287	-48.373	1.00	79.00	C
ATOM	6857	CG	PHE	A	916	-18.627	71.623	-48.923	1.00	83.48	C
ATOM	6858	CD2	PHE	A	916	-18.103	71.734	-50.201	1.00	82.81	C
ATOM	6859	CD1	PHE	A	916	-18.764	72.774	-48.161	1.00	82.92	C
ATOM	6860	CE2	PHE	A	916	-17.713	72.964	-50.702	1.00	81.21	C
ATOM	6861	CE1	PHE	A	916	-18.375	74.006	-48.658	1.00	82.75	C
ATOM	6862	CZ	PHE	A	916	-17.851	74.101	-49.931	1.00	78.69	C
ATOM	6863	N	ILE	A	917	-18.896	67.582	-46.533	1.00	78.77	N
ATOM	6864	CA	ILE	A	917	-19.590	66.667	-45.619	1.00	79.85	C
ATOM	6865	C	ILE	A	917	-18.671	66.216	-44.463	1.00	75.94	C
ATOM	6866	O	ILE	A	917	-19.128	66.061	-43.334	1.00	76.61	O
ATOM	6867	CB	ILE	A	917	-20.157	65.419	-46.363	1.00	83.22	C
ATOM	6868	CG1	ILE	A	917	-21.015	65.828	-47.567	1.00	84.04	C

ATOM	6869	CG2	ILE	A	917	-21.008	64.568	-45.428	1.00	82.83	C
ATOM	6870	CD1	ILE	A	917	-22.325	66.536	-47.222	1.00	81.82	C
ATOM	6871	N	LYS	A	918	-17.383	66.025	-44.736	1.00	72.34	N
ATOM	6872	CA	LYS	A	918	-16.396	65.825	-43.671	1.00	72.20	C
ATOM	6873	C	LYS	A	918	-16.316	67.018	-42.709	1.00	72.94	C
ATOM	6874	O	LYS	A	918	-16.245	66.860	-41.487	1.00	70.97	O
ATOM	6875	CB	LYS	A	918	-15.018	65.582	-44.267	1.00	71.75	C
ATOM	6876	CG	LYS	A	918	-13.903	65.690	-43.261	1.00	71.20	C
ATOM	6877	CD	LYS	A	918	-12.692	66.391	-43.843	1.00	73.82	C
ATOM	6878	CE	LYS	A	918	-12.095	65.622	-45.014	1.00	78.55	C
ATOM	6879	NZ	LYS	A	918	-10.854	66.272	-45.546	1.00	71.60	N
ATOM	6880	O	ARG	A	919	-17.501	70.618	-40.872	1.00	79.70	O
ATOM	6881	N	ARG	A	919	-16.319	68.216	-43.275	1.00	73.15	N
ATOM	6882	CA	ARG	A	919	-16.211	69.432	-42.486	1.00	70.81	C
ATOM	6883	C	ARG	A	919	-17.484	69.721	-41.709	1.00	73.54	C
ATOM	6884	CB	ARG	A	919	-15.859	70.617	-43.380	1.00	70.12	C
ATOM	6885	CG	ARG	A	919	-14.370	70.881	-43.473	1.00	70.19	C
ATOM	6886	CD	ARG	A	919	-14.055	72.016	-44.430	1.00	70.59	C
ATOM	6887	NE	ARG	A	919	-14.201	71.590	-45.817	1.00	80.29	N
ATOM	6888	CZ	ARG	A	919	-15.219	71.926	-46.600	1.00	82.08	C
ATOM	6889	NH1	ARG	A	919	-16.179	72.715	-46.133	1.00	88.04	C
ATOM	6890	NH2	ARG	A	919	-15.270	71.485	-47.850	1.00	79.42	N
ATOM	6891	O	GLN	A	920	-20.515	68.256	-39.030	1.00	71.68	O
ATOM	6892	N	GLN	A	920	-18.551	68.972	-41.982	1.00	72.55	N
ATOM	6893	CA	GLN	A	920	-19.761	69.047	-41.166	1.00	69.68	C
ATOM	6894	C	GLN	A	920	-19.676	68.157	-39.932	1.00	72.17	C
ATOM	6895	CB	GLN	A	920	-20.992	68.645	-41.962	1.00	73.45	C
ATOM	6896	CG	GLN	A	920	-21.490	69.663	-42.942	1.00	73.21	C
ATOM	6897	CD	GLN	A	920	-22.568	69.077	-43.810	1.00	74.55	C
ATOM	6898	OE1	GLN	A	920	-23.528	68.505	-43.306	1.00	76.20	O
ATOM	6899	NE2	GLN	A	920	-22.401	69.179	-45.120	1.00	77.99	N
ATOM	6900	O	LEU	A	921	-17.411	66.480	-36.725	1.00	66.99	O
ATOM	6901	N	LEU	A	921	-18.670	67.284	-39.896	1.00	76.57	N
ATOM	6902	CA	LEU	A	921	-18.551	66.303	-38.819	1.00	73.25	C
ATOM	6903	C	LEU	A	921	-17.333	66.570	-37.945	1.00	68.45	C
ATOM	6904	CB	LEU	A	921	-18.508	64.890	-39.398	1.00	69.53	C
ATOM	6905	CG	LEU	A	921	-19.696	64.524	-40.294	1.00	72.59	C
ATOM	6906	CD1	LEU	A	921	-19.648	63.062	-40.700	1.00	77.34	C
ATOM	6907	CD2	LEU	A	921	-21.034	64.847	-39.635	1.00	72.58	C
ATOM	6908	O	VAL	A	922	-15.668	69.630	-38.493	1.00	71.01	O
ATOM	6909	N	VAL	A	922	-16.211	66.895	-38.573	1.00	68.03	N
ATOM	6910	CA	VAL	A	922	-15.058	67.393	-37.839	1.00	64.10	C
ATOM	6911	C	VAL	A	922	-15.149	68.913	-37.638	1.00	71.54	C
ATOM	6912	CB	VAL	A	922	-13.770	67.093	-38.555	1.00	62.93	C
ATOM	6913	CG1	VAL	A	922	-12.615	67.177	-37.579	1.00	67.39	C
ATOM	6914	CG2	VAL	A	922	-13.842	65.731	-39.209	1.00	70.35	C
ATOM	6915	O	GLU	A	923	-12.438	70.954	-37.310	1.00	71.46	O
ATOM	6916	N	GLU	A	923	-14.629	69.392	-36.510	1.00	73.63	N
ATOM	6917	CA	GLU	A	923	-14.576	70.820	-36.204	1.00	70.02	C
ATOM	6918	C	GLU	A	923	-13.491	71.531	-37.028	1.00	70.57	C
ATOM	6919	CB	GLU	A	923	-14.331	71.021	-34.706	1.00	66.36	C
ATOM	6920	CG	GLU	A	923	-14.310	72.478	-34.256	1.00	67.74	C
ATOM	6921	CD	GLU	A	923	-15.677	73.107	-34.247	1.00	66.58	C
ATOM	6922	OE1	GLU	A	923	-16.527	72.645	-33.454	1.00	71.33	O
ATOM	6923	OE2	GLU	A	923	-15.903	74.054	-35.033	1.00	66.28	O
ATOM	6924	O	THR	A	924	-11.148	75.300	-37.936	1.00	70.28	O
ATOM	6925	N	THR	A	924	-13.742	72.783	-37.413	1.00	68.61	N
ATOM	6926	CA	THR	A	924	-12.773	73.523	-38.230	1.00	75.86	C
ATOM	6927	C	THR	A	924	-12.227	74.810	-37.569	1.00	70.93	C
ATOM	6928	CB	THR	A	924	-13.385	73.887	-39.607	1.00	73.38	C
ATOM	6929	OG1	THR	A	924	-14.148	72.781	-40.101	1.00	69.47	O
ATOM	6930	CG2	THR	A	924	-12.288	74.222	-40.615	1.00	77.94	C
ATOM	6931	N	ARG	A	925	-12.965	75.340	-36.596	1.00	70.00	N

ATOM	6932	CA	ARG	A	925	-12.608	76.588	-35.911	1.00	62.60	C
ATOM	6933	C	ARG	A	925	-11.180	76.593	-35.353	1.00	61.00	C
ATOM	6934	O	ARG	A	925	-10.697	75.567	-34.878	1.00	62.86	O
ATOM	6935	CB	ARG	A	925	-13.611	76.851	-34.781	1.00	61.11	C
ATOM	6936	CG	ARG	A	925	-15.031	77.130	-35.264	1.00	66.69	C
ATOM	6937	CD	ARG	A	925	-15.973	77.444	-34.120	1.00	61.27	C
ATOM	6938	NE	ARG	A	925	-16.663	76.262	-33.612	1.00	65.52	N
ATOM	6939	CZ	ARG	A	925	-17.231	76.177	-32.410	1.00	67.55	C
ATOM	6940	NH1	ARG	A	925	-17.848	75.058	-32.040	1.00	61.92	N
ATOM	6941	NH2	ARG	A	925	-17.174	77.206	-31.565	1.00	65.62	N
ATOM	6942	N	GLN	A	926	-10.509	77.744	-35.441	1.00	62.95	N
ATOM	6943	CA	GLN	A	926	-9.191	77.965	-34.825	1.00	64.12	C
ATOM	6944	C	GLN	A	926	-9.184	77.721	-33.318	1.00	65.80	C
ATOM	6945	O	GLN	A	926	-8.330	76.995	-32.787	1.00	61.07	O
ATOM	6946	CB	GLN	A	926	-8.719	79.398	-35.064	1.00	67.46	C
ATOM	6947	CG	GLN	A	926	-7.482	79.574	-35.945	1.00	75.91	C
ATOM	6948	CD	GLN	A	926	-6.554	78.366	-35.992	1.00	73.14	C
ATOM	6949	OE1	GLN	A	926	-5.992	77.944	-34.969	1.00	73.69	O
ATOM	6950	NE2	GLN	A	926	-6.369	77.816	-37.199	1.00	68.87	N
ATOM	6951	N	ILE	A	927	-10.137	78.357	-32.637	1.00	58.47	N
ATOM	6952	CA	ILE	A	927	-10.186	78.326	-31.185	1.00	60.25	C
ATOM	6953	C	ILE	A	927	-10.272	76.875	-30.684	1.00	58.86	C
ATOM	6954	O	ILE	A	927	-9.601	76.522	-29.715	1.00	60.93	O
ATOM	6955	CB	ILE	A	927	-11.377	79.225	-30.629	1.00	54.45	C
ATOM	6956	CG1	ILE	A	927	-11.234	79.469	-29.135	1.00	54.90	C
ATOM	6957	CG2	ILE	A	927	-12.739	78.640	-30.933	1.00	48.69	C
ATOM	6958	CD1	ILE	A	927	-9.829	79.840	-28.687	1.00	55.01	C
ATOM	6959	N	THR	A	928	-11.049	76.028	-31.362	1.00	54.16	N
ATOM	6960	CA	THR	A	928	-11.132	74.609	-31.001	1.00	58.40	C
ATOM	6961	C	THR	A	928	-9.798	73.879	-31.218	1.00	62.29	C
ATOM	6962	O	THR	A	928	-9.403	73.036	-30.410	1.00	62.68	O
ATOM	6963	CB	THR	A	928	-12.229	73.869	-31.796	1.00	61.41	C
ATOM	6964	OG1	THR	A	928	-13.525	74.245	-31.319	1.00	60.33	O
ATOM	6965	CG2	THR	A	928	-12.086	72.382	-31.620	1.00	62.08	C
ATOM	6966	N	LYS	A	929	-9.093	74.211	-32.296	1.00	61.65	N
ATOM	6967	CA	LYS	A	929	-7.769	73.639	-32.520	1.00	57.45	C
ATOM	6968	C	LYS	A	929	-6.814	74.026	-31.407	1.00	60.91	C
ATOM	6969	O	LYS	A	929	-5.894	73.269	-31.099	1.00	64.27	O
ATOM	6970	CB	LYS	A	929	-7.204	74.070	-33.873	1.00	58.71	C
ATOM	6971	CG	LYS	A	929	-7.580	73.113	-34.999	1.00	67.09	C
ATOM	6972	CD	LYS	A	929	-7.621	73.795	-36.373	1.00	78.11	C
ATOM	6973	CE	LYS	A	929	-8.600	73.085	-37.324	1.00	79.21	C
ATOM	6974	NZ	LYS	A	929	-8.458	73.503	-38.753	1.00	78.53	N
ATOM	6975	N	HIS	A	930	-7.032	75.183	-30.782	1.00	55.33	N
ATOM	6976	CA	HIS	A	930	-6.169	75.580	-29.678	1.00	59.90	C
ATOM	6977	C	HIS	A	930	-6.393	74.708	-28.448	1.00	61.14	C
ATOM	6978	O	HIS	A	930	-5.428	74.240	-27.833	1.00	56.95	O
ATOM	6979	CB	HIS	A	930	-6.365	77.056	-29.338	1.00	59.55	C
ATOM	6980	CG	HIS	A	930	-5.684	77.973	-30.300	1.00	59.89	C
ATOM	6981	ND1	HIS	A	930	-6.332	79.021	-30.918	1.00	64.56	N
ATOM	6982	CD2	HIS	A	930	-4.416	77.984	-30.768	1.00	56.95	C
ATOM	6983	CE1	HIS	A	930	-5.488	79.640	-31.724	1.00	65.37	C
ATOM	6984	NE2	HIS	A	930	-4.320	79.026	-31.656	1.00	62.14	N
ATOM	6985	N	VAL	A	931	-7.662	74.508	-28.100	1.00	55.86	N
ATOM	6986	CA	VAL	A	931	-8.048	73.550	-27.076	1.00	57.72	C
ATOM	6987	C	VAL	A	931	-7.340	72.221	-27.287	1.00	59.86	C
ATOM	6988	O	VAL	A	931	-6.636	71.740	-26.403	1.00	57.91	O
ATOM	6989	CB	VAL	A	931	-9.559	73.270	-27.088	1.00	59.53	C
ATOM	6990	CG1	VAL	A	931	-10.000	72.656	-25.775	1.00	53.05	C
ATOM	6991	CG2	VAL	A	931	-10.322	74.531	-27.381	1.00	61.13	C
ATOM	6992	N	ALA	A	932	-7.544	71.643	-28.469	1.00	58.46	N
ATOM	6993	CA	ALA	A	932	-6.977	70.336	-28.831	1.00	63.71	C
ATOM	6994	C	ALA	A	932	-5.456	70.340	-28.742	1.00	59.16	C

ATOM	6995	O	ALA	A	932	-4.868	69.455	-28.121	1.00	55.55	O
ATOM	6996	CB	ALA	A	932	-7.428	69.936	-30.227	1.00	59.79	C
ATOM	6997	N	GLN	A	933	-4.835	71.365	-29.324	1.00	57.51	N
ATOM	6998	CA	GLN	A	933	-3.393	71.545	-29.216	1.00	59.67	C
ATOM	6999	C	GLN	A	933	-2.917	71.585	-27.770	1.00	62.63	C
ATOM	7000	O	GLN	A	933	-1.808	71.166	-27.477	1.00	67.08	O
ATOM	7001	CB	GLN	A	933	-2.957	72.830	-29.925	1.00	64.76	C
ATOM	7002	CG	GLN	A	933	-1.452	73.112	-29.893	1.00	65.12	C
ATOM	7003	CD	GLN	A	933	-1.013	73.945	-28.686	1.00	71.66	C
ATOM	7004	OE1	GLN	A	933	-1.059	75.184	-28.709	1.00	73.44	O
ATOM	7005	NE2	GLN	A	933	-0.568	73.266	-27.632	1.00	72.52	N
ATOM	7006	N	ILE	A	934	-3.726	72.126	-26.868	1.00	62.73	N
ATOM	7007	CA	ILE	A	934	-3.264	72.351	-25.500	1.00	61.79	C
ATOM	7008	C	ILE	A	934	-3.292	71.067	-24.732	1.00	55.17	C
ATOM	7009	O	ILE	A	934	-2.386	70.768	-23.968	1.00	60.62	O
ATOM	7010	CB	ILE	A	934	-4.130	73.407	-24.756	1.00	60.68	C
ATOM	7011	CG1	ILE	A	934	-3.801	74.813	-25.250	1.00	57.66	C
ATOM	7012	CG2	ILE	A	934	-3.958	73.306	-23.237	1.00	47.08	C
ATOM	7013	CD1	ILE	A	934	-4.957	75.822	-25.005	1.00	65.85	C
ATOM	7014	N	LEU	A	935	-4.358	70.308	-24.940	1.00	54.82	N
ATOM	7015	CA	LEU	A	935	-4.508	69.022	-24.296	1.00	56.10	C
ATOM	7016	C	LEU	A	935	-3.508	68.018	-24.885	1.00	66.36	C
ATOM	7017	O	LEU	A	935	-3.098	67.061	-24.227	1.00	65.91	O
ATOM	7018	CB	LEU	A	935	-5.942	68.533	-24.449	1.00	54.83	C
ATOM	7019	CG	LEU	A	935	-6.962	69.449	-23.749	1.00	45.75	C
ATOM	7020	CD2	LEU	A	935	-6.868	69.300	-22.245	1.00	45.56	C
ATOM	7021	CD1	LEU	A	935	-8.361	69.132	-24.205	1.00	42.59	C
ATOM	7022	O	ASP	A	936	-0.022	66.564	-26.066	1.00	73.20	O
ATOM	7023	N	ASP	A	936	-3.098	68.251	-26.125	1.00	68.92	N
ATOM	7024	CA	ASP	A	936	-2.175	67.342	-26.781	1.00	68.77	C
ATOM	7025	C	ASP	A	936	-0.769	67.528	-26.229	1.00	70.75	C
ATOM	7026	CB	ASP	A	936	-2.186	67.551	-28.296	1.00	67.97	C
ATOM	7027	CG	ASP	A	936	-1.197	66.650	-29.005	1.00	74.34	C
ATOM	7028	OD1	ASP	A	936	-1.534	65.470	-29.245	1.00	70.30	O
ATOM	7029	OD2	ASP	A	936	-0.079	67.118	-29.306	1.00	77.87	O
ATOM	7030	N	SER	A	937	-0.427	68.775	-25.926	1.00	66.73	N
ATOM	7031	CA	SER	A	937	0.892	69.099	-25.404	1.00	69.46	C
ATOM	7032	C	SER	A	937	1.056	68.649	-23.959	1.00	72.22	C
ATOM	7033	O	SER	A	937	2.171	68.420	-23.495	1.00	74.30	O
ATOM	7034	CB	SER	A	937	1.149	70.601	-25.494	1.00	65.49	C
ATOM	7035	OG	SER	A	937	0.692	71.132	-26.725	1.00	72.44	O
ATOM	7036	N	ARG	A	938	-0.058	68.543	-23.244	1.00	70.14	N
ATOM	7037	CA	ARG	A	938	-0.025	68.244	-21.817	1.00	69.95	C
ATOM	7038	C	ARG	A	938	-0.213	66.751	-21.573	1.00	65.60	C
ATOM	7039	O	ARG	A	938	0.119	66.244	-20.510	1.00	64.44	O
ATOM	7040	CB	ARG	A	938	-1.096	69.059	-21.058	1.00	63.48	C
ATOM	7041	CG	ARG	A	938	-0.751	70.538	-20.919	1.00	69.19	C
ATOM	7042	CD	ARG	A	938	-1.891	71.373	-20.344	1.00	64.91	C
ATOM	7043	NE	ARG	A	938	-2.303	70.919	-19.015	1.00	63.27	N
ATOM	7044	CZ	ARG	A	938	-1.834	71.418	-17.877	1.00	62.60	C
ATOM	7045	NH1	ARG	A	938	-0.933	72.394	-17.886	1.00	65.94	N
ATOM	7046	NH2	ARG	A	938	-2.264	70.938	-16.725	1.00	59.53	N
ATOM	7047	N	MET	A	939	-0.734	66.039	-22.558	1.00	70.17	N
ATOM	7048	CA	MET	A	939	-0.910	64.605	-22.383	1.00	71.48	C
ATOM	7049	C	MET	A	939	0.239	63.818	-22.996	1.00	73.11	C
ATOM	7050	O	MET	A	939	0.644	62.790	-22.460	1.00	74.56	O
ATOM	7051	CB	MET	A	939	-2.238	64.142	-22.985	1.00	63.04	C
ATOM	7052	CG	MET	A	939	-3.478	64.574	-22.202	1.00	66.59	C
ATOM	7053	SD	MET	A	939	-3.767	63.766	-20.610	1.00	67.70	S
ATOM	7054	CE	MET	A	939	-2.810	64.787	-19.484	1.00	61.30	C
ATOM	7055	O	ASN	A	940	3.615	64.925	-25.151	1.00	75.70	O
ATOM	7056	N	ASN	A	940	0.760	64.299	-24.119	1.00	75.99	N
ATOM	7057	CA	ASN	A	940	1.704	63.511	-24.904	1.00	71.67	C

ATOM	7058	C	ASN	A	940	3.154	63.895	-24.661	1.00	78.13	C
ATOM	7059	CB	ASN	A	940	1.368	63.633	-26.388	1.00	62.38	C
ATOM	7060	CG	ASN	A	940	0.154	62.803	-26.774	1.00	71.15	C
ATOM	7061	OD1	ASN	A	940	-0.160	61.802	-26.119	1.00	68.70	O
ATOM	7062	ND2	ASN	A	940	-0.539	63.211	-27.838	1.00	70.97	N
ATOM	7063	O	THR	A	941	7.202	61.821	-23.767	1.00	87.51	O
ATOM	7064	N	THR	A	941	3.864	63.060	-23.897	1.00	82.94	N
ATOM	7065	CA	THR	A	941	5.289	63.274	-23.611	1.00	87.57	C
ATOM	7066	C	THR	A	941	6.038	61.957	-23.394	1.00	85.07	C
ATOM	7067	CB	THR	A	941	5.497	64.154	-22.369	1.00	85.65	C
ATOM	7068	OG1	THR	A	941	4.577	65.254	-22.391	1.00	82.28	O
ATOM	7069	CG2	THR	A	941	6.920	64.681	-22.340	1.00	89.50	C
ATOM	7070	O	ARG	A	951	2.184	59.565	-24.147	1.00	78.82	O
ATOM	7071	N	ARG	A	951	2.687	58.652	-21.631	1.00	74.08	N
ATOM	7072	CA	ARG	A	951	2.024	57.753	-22.573	1.00	78.96	C
ATOM	7073	C	ARG	A	951	1.612	58.509	-23.844	1.00	79.75	C
ATOM	7074	CB	ARG	A	951	0.808	57.092	-21.913	1.00	79.55	C
ATOM	7075	N	GLU	A	952	0.637	57.971	-24.586	1.00	76.62	N
ATOM	7076	CA	GLU	A	952	0.142	58.628	-25.800	1.00	69.75	C
ATOM	7077	C	GLU	A	952	-1.375	58.703	-25.810	1.00	73.83	C
ATOM	7078	O	GLU	A	952	-2.048	57.672	-25.714	1.00	66.04	O
ATOM	7079	CB	GLU	A	952	0.609	57.906	-27.059	1.00	63.30	C
ATOM	7080	CG	GLU	A	952	0.590	58.772	-28.313	1.00	68.81	C
ATOM	7081	CD	GLU	A	952	1.922	59.475	-28.559	1.00	75.33	C
ATOM	7082	OE1	GLU	A	952	2.132	60.008	-29.677	1.00	69.73	O
ATOM	7083	OE2	GLU	A	952	2.762	59.495	-27.631	1.00	76.71	O
ATOM	7084	N	VAL	A	953	-1.899	59.928	-25.938	1.00	71.17	N
ATOM	7085	CA	VAL	A	953	-3.343	60.188	-25.959	1.00	60.11	C
ATOM	7086	C	VAL	A	953	-3.743	60.753	-27.327	1.00	62.30	C
ATOM	7087	O	VAL	A	953	-2.989	61.525	-27.938	1.00	58.62	O
ATOM	7088	CB	VAL	A	953	-3.760	61.185	-24.816	1.00	65.60	C
ATOM	7089	CG2	VAL	A	953	-3.326	60.667	-23.452	1.00	63.84	C
ATOM	7090	CG1	VAL	A	953	-5.269	61.482	-24.833	1.00	62.47	C
ATOM	7091	N	LYS	A	954	-4.916	60.358	-27.816	1.00	65.16	N
ATOM	7092	CA	LYS	A	954	-5.462	60.922	-29.049	1.00	62.35	C
ATOM	7093	C	LYS	A	954	-6.549	61.952	-28.745	1.00	69.11	C
ATOM	7094	O	LYS	A	954	-7.498	61.666	-27.998	1.00	70.64	O
ATOM	7095	CB	LYS	A	954	-6.032	59.824	-29.949	1.00	60.57	C
ATOM	7096	N	VAL	A	955	-6.423	63.136	-29.344	1.00	62.54	N
ATOM	7097	CA	VAL	A	955	-7.397	64.195	-29.143	1.00	63.81	C
ATOM	7098	C	VAL	A	955	-8.294	64.380	-30.375	1.00	62.90	C
ATOM	7099	O	VAL	A	955	-7.822	64.670	-31.477	1.00	58.57	O
ATOM	7100	CB	VAL	A	955	-6.677	65.508	-28.780	1.00	63.28	C
ATOM	7101	CG1	VAL	A	955	-7.671	66.613	-28.429	1.00	58.64	C
ATOM	7102	CG2	VAL	A	955	-5.725	65.248	-27.626	1.00	61.50	C
ATOM	7103	N	ILE	A	956	-9.598	64.225	-30.151	1.00	61.21	N
ATOM	7104	CA	ILE	A	956	-10.597	64.187	-31.211	1.00	53.29	C
ATOM	7105	C	ILE	A	956	-11.623	65.309	-31.081	1.00	61.45	C
ATOM	7106	O	ILE	A	956	-12.341	65.378	-30.094	1.00	61.87	O
ATOM	7107	CB	ILE	A	956	-11.341	62.839	-31.209	1.00	57.48	C
ATOM	7108	CG1	ILE	A	956	-10.352	61.673	-31.288	1.00	66.47	C
ATOM	7109	CG2	ILE	A	956	-12.281	62.748	-32.365	1.00	59.85	C
ATOM	7110	CD1	ILE	A	956	-10.963	60.330	-30.885	1.00	64.06	C
ATOM	7111	N	THR	A	957	-11.712	66.176	-32.084	1.00	61.61	N
ATOM	7112	CA	THR	A	957	-12.650	67.284	-32.015	1.00	64.39	C
ATOM	7113	C	THR	A	957	-13.821	67.140	-32.999	1.00	70.19	C
ATOM	7114	O	THR	A	957	-13.709	67.433	-34.197	1.00	69.11	O
ATOM	7115	CB	THR	A	957	-11.940	68.625	-32.253	1.00	65.64	C
ATOM	7116	OG1	THR	A	957	-11.767	68.843	-33.657	1.00	71.45	O
ATOM	7117	CG2	THR	A	957	-10.590	68.643	-31.550	1.00	62.03	C
ATOM	7118	N	LEU	A	958	-14.953	66.692	-32.470	1.00	65.38	N
ATOM	7119	CA	LEU	A	958	-16.136	66.498	-33.274	1.00	64.37	C
ATOM	7120	C	LEU	A	958	-16.957	67.751	-33.299	1.00	63.33	C

ATOM	7121	O	LEU	A	958	-16.790	68.631	-32.459	1.00	70.67	O
ATOM	7122	CB	LEU	A	958	-16.994	65.367	-32.726	1.00	67.43	C
ATOM	7123	CG	LEU	A	958	-16.321	64.070	-32.328	1.00	64.16	C
ATOM	7124	CD1	LEU	A	958	-17.396	63.083	-31.895	1.00	57.55	C
ATOM	7125	CD2	LEU	A	958	-15.516	63.543	-33.490	1.00	64.15	C
ATOM	7126	N	LYS	A	959	-17.864	67.828	-34.258	1.00	62.84	N
ATOM	7127	CA	LYS	A	959	-18.890	68.840	-34.211	1.00	64.78	C
ATOM	7128	C	LYS	A	959	-20.099	68.211	-33.547	1.00	64.65	C
ATOM	7129	O	LYS	A	959	-20.181	66.997	-33.432	1.00	65.07	O
ATOM	7130	CB	LYS	A	959	-19.225	69.373	-35.601	1.00	69.14	C
ATOM	7131	CG	LYS	A	959	-18.126	70.238	-36.187	1.00	68.78	C
ATOM	7132	CD	LYS	A	959	-18.654	71.195	-37.235	1.00	64.23	C
ATOM	7133	CE	LYS	A	959	-17.532	72.061	-37.781	1.00	67.24	C
ATOM	7134	NZ	LYS	A	959	-17.905	72.781	-39.028	1.00	71.32	N
ATOM	7135	N	SER	A	960	-21.030	69.035	-33.089	1.00	66.08	N
ATOM	7136	CA	SER	A	960	-22.164	68.512	-32.358	1.00	65.52	C
ATOM	7137	C	SER	A	960	-23.172	67.810	-33.267	1.00	70.00	C
ATOM	7138	O	SER	A	960	-24.222	67.398	-32.795	1.00	70.46	O
ATOM	7139	CB	SER	A	960	-22.854	69.631	-31.584	1.00	69.15	C
ATOM	7140	OG	SER	A	960	-23.647	70.427	-32.437	1.00	69.01	O
ATOM	7141	N	LYS	A	961	-22.856	67.663	-34.556	1.00	72.15	N
ATOM	7142	CA	LYS	A	961	-23.769	66.997	-35.494	1.00	71.51	C
ATOM	7143	C	LYS	A	961	-23.833	65.491	-35.293	1.00	69.32	C
ATOM	7144	O	LYS	A	961	-24.921	64.925	-35.185	1.00	67.25	O
ATOM	7145	CB	LYS	A	961	-23.382	67.266	-36.955	1.00	77.07	C
ATOM	7146	CG	LYS	A	961	-24.436	66.735	-37.939	1.00	76.06	C
ATOM	7147	CD	LYS	A	961	-23.979	66.746	-39.383	1.00	78.05	C
ATOM	7148	CE	LYS	A	961	-24.962	65.965	-40.240	1.00	77.42	C
ATOM	7149	NZ	LYS	A	961	-26.311	66.606	-40.208	1.00	85.66	N
ATOM	7150	N	LEU	A	962	-22.670	64.851	-35.287	1.00	63.18	N
ATOM	7151	CA	LEU	A	962	-22.598	63.424	-35.049	1.00	70.33	C
ATOM	7152	C	LEU	A	962	-23.487	63.065	-33.891	1.00	70.54	C
ATOM	7153	O	LEU	A	962	-24.507	62.400	-34.040	1.00	74.78	O
ATOM	7154	CB	LEU	A	962	-21.169	62.992	-34.744	1.00	68.88	C
ATOM	7155	CG	LEU	A	962	-20.320	62.630	-35.943	1.00	73.82	C
ATOM	7156	CD1	LEU	A	962	-18.921	62.249	-35.478	1.00	69.83	C
ATOM	7157	CD2	LEU	A	962	-20.984	61.492	-36.700	1.00	76.91	C
ATOM	7158	N	VAL	A	963	-23.094	63.574	-32.741	1.00	68.66	N
ATOM	7159	CA	VAL	A	963	-23.727	63.266	-31.483	1.00	66.75	C
ATOM	7160	C	VAL	A	963	-25.221	63.548	-31.523	1.00	67.58	C
ATOM	7161	O	VAL	A	963	-26.019	62.742	-31.056	1.00	66.72	O
ATOM	7162	CB	VAL	A	963	-23.064	64.075	-30.367	1.00	71.75	C
ATOM	7163	CG1	VAL	A	963	-22.952	63.255	-29.105	1.00	58.61	C
ATOM	7164	CG2	VAL	A	963	-21.668	64.559	-30.835	1.00	71.16	C
ATOM	7165	N	SER	A	964	-25.598	64.683	-32.103	1.00	68.19	N
ATOM	7166	CA	SER	A	964	-26.997	65.103	-32.127	1.00	64.44	C
ATOM	7167	C	SER	A	964	-27.853	64.180	-32.991	1.00	73.22	C
ATOM	7168	O	SER	A	964	-29.046	64.005	-32.725	1.00	73.63	O
ATOM	7169	CB	SER	A	964	-27.108	66.538	-32.633	1.00	65.31	C
ATOM	7170	OG	SER	A	964	-28.380	67.085	-32.358	1.00	68.27	O
ATOM	7171	N	ASP	A	965	-27.237	63.601	-34.026	1.00	73.69	N
ATOM	7172	CA	ASP	A	965	-27.917	62.670	-34.932	1.00	75.38	C
ATOM	7173	C	ASP	A	965	-28.164	61.335	-34.247	1.00	76.43	C
ATOM	7174	O	ASP	A	965	-29.262	60.782	-34.312	1.00	77.67	O
ATOM	7175	CB	ASP	A	965	-27.102	62.443	-36.213	1.00	76.95	C
ATOM	7176	CG	ASP	A	965	-27.189	63.613	-37.181	1.00	76.93	C
ATOM	7177	OD1	ASP	A	965	-28.028	64.513	-36.950	1.00	77.19	O
ATOM	7178	OD2	ASP	A	965	-26.422	63.625	-38.175	1.00	77.53	O
ATOM	7179	N	PHE	A	966	-27.119	60.818	-33.617	1.00	72.76	N
ATOM	7180	CA	PHE	A	966	-27.212	59.653	-32.755	1.00	69.18	C
ATOM	7181	C	PHE	A	966	-28.424	59.761	-31.793	1.00	72.26	C
ATOM	7182	O	PHE	A	966	-29.178	58.815	-31.637	1.00	75.29	O
ATOM	7183	CB	PHE	A	966	-25.894	59.511	-31.999	1.00	64.58	C

ATOM	7184	CG	PHE	A	966	-25.708	58.203	-31.305	1.00	73.05	C
ATOM	7185	CD2	PHE	A	966	-24.733	57.313	-31.734	1.00	77.18	C
ATOM	7186	CD1	PHE	A	966	-26.456	57.879	-30.185	1.00	72.66	C
ATOM	7187	CE2	PHE	A	966	-24.533	56.110	-31.084	1.00	75.32	C
ATOM	7188	CE1	PHE	A	966	-26.263	56.677	-29.533	1.00	77.36	C
ATOM	7189	CZ	PHE	A	966	-25.295	55.791	-29.981	1.00	77.23	C
ATOM	7190	N	ARG	A	967	-28.637	60.921	-31.178	1.00	74.79	N
ATOM	7191	CA	ARG	A	967	-29.756	61.087	-30.242	1.00	75.10	C
ATOM	7192	C	ARG	A	967	-31.130	61.017	-30.927	1.00	77.41	C
ATOM	7193	O	ARG	A	967	-32.086	60.497	-30.348	1.00	77.73	O
ATOM	7194	CB	ARG	A	967	-29.642	62.417	-29.478	1.00	73.60	C
ATOM	7195	CG	ARG	A	967	-28.560	62.477	-28.406	1.00	69.59	C
ATOM	7196	CD	ARG	A	967	-28.594	63.803	-27.653	1.00	66.37	C
ATOM	7197	NE	ARG	A	967	-29.070	63.638	-26.282	1.00	70.67	N
ATOM	7198	CZ	ARG	A	967	-28.357	63.970	-25.217	1.00	64.50	C
ATOM	7199	NH1	ARG	A	967	-27.162	64.496	-25.381	1.00	60.21	N
ATOM	7200	NH2	ARG	A	967	-28.835	63.787	-23.998	1.00	66.89	N
ATOM	7201	N	LYS	A	968	-31.233	61.555	-32.143	1.00	76.05	N
ATOM	7202	CA	LYS	A	968	-32.496	61.548	-32.891	1.00	76.69	C
ATOM	7203	C	LYS	A	968	-32.744	60.178	-33.514	1.00	76.83	C
ATOM	7204	O	LYS	A	968	-33.869	59.667	-33.480	1.00	75.53	O
ATOM	7205	CB	LYS	A	968	-32.496	62.629	-33.977	1.00	74.19	C
ATOM	7206	N	ASP	A	969	-31.682	59.603	-34.083	1.00	75.21	N
ATOM	7207	CA	ASP	A	969	-31.695	58.237	-34.603	1.00	78.65	C
ATOM	7208	C	ASP	A	969	-32.234	57.252	-33.573	1.00	82.85	C
ATOM	7209	O	ASP	A	969	-33.252	56.603	-33.805	1.00	86.67	O
ATOM	7210	CB	ASP	A	969	-30.287	57.791	-35.032	1.00	76.35	C
ATOM	7211	CG	ASP	A	969	-29.863	58.365	-36.380	1.00	78.52	C
ATOM	7212	OD1	ASP	A	969	-30.718	58.913	-37.108	1.00	75.74	O
ATOM	7213	OD2	ASP	A	969	-28.664	58.250	-36.720	1.00	81.36	O
ATOM	7214	N	PHE	A	970	-31.559	57.159	-32.430	1.00	78.55	N
ATOM	7215	CA	PHE	A	970	-31.854	56.119	-31.461	1.00	75.40	C
ATOM	7216	C	PHE	A	970	-32.745	56.570	-30.319	1.00	75.42	C
ATOM	7217	O	PHE	A	970	-32.819	55.905	-29.295	1.00	80.99	O
ATOM	7218	CB	PHE	A	970	-30.554	55.571	-30.914	1.00	76.67	C
ATOM	7219	CG	PHE	A	970	-29.644	55.032	-31.969	1.00	81.20	C
ATOM	7220	CD1	PHE	A	970	-30.160	54.452	-33.111	1.00	84.64	C
ATOM	7221	CD2	PHE	A	970	-28.273	55.093	-31.819	1.00	82.41	C
ATOM	7222	CE1	PHE	A	970	-29.325	53.944	-34.080	1.00	82.37	C
ATOM	7223	CE2	PHE	A	970	-27.429	54.577	-32.785	1.00	84.96	C
ATOM	7224	CE	PHE	A	970	-27.955	54.006	-33.916	1.00	85.80	C
ATOM	7225	N	GLN	A	971	-33.429	57.692	-30.506	1.00	79.90	N
ATOM	7226	CA	GLN	A	971	-34.351	58.254	-29.505	1.00	83.40	C
ATOM	7227	C	GLN	A	971	-33.752	58.451	-28.102	1.00	84.95	C
ATOM	7228	O	GLN	A	971	-34.430	58.210	-27.099	1.00	85.47	O
ATOM	7229	CB	GLN	A	971	-35.604	57.382	-29.385	1.00	81.24	C
ATOM	7230	CG	GLN	A	971	-36.536	57.441	-30.583	1.00	84.57	C
ATOM	7231	CD	GLN	A	971	-37.557	56.315	-30.570	1.00	87.82	C
ATOM	7232	OE1	GLN	A	971	-38.392	56.228	-29.671	1.00	89.88	O
ATOM	7233	NE2	GLN	A	971	-37.477	55.433	-31.559	1.00	90.19	N
ATOM	7234	O	PHE	A	972	-31.196	61.656	-26.722	1.00	77.20	O
ATOM	7235	N	PHE	A	972	-32.489	58.880	-28.035	1.00	85.73	N
ATOM	7236	CA	PHE	A	972	-31.890	59.378	-26.791	1.00	76.21	C
ATOM	7237	C	PHE	A	972	-32.134	60.868	-26.708	1.00	74.60	C
ATOM	7238	CB	PHE	A	972	-30.398	59.093	-26.742	1.00	71.44	C
ATOM	7239	CG	PHE	A	972	-30.067	57.636	-26.731	1.00	75.31	C
ATOM	7240	CD1	PHE	A	972	-30.859	56.743	-26.043	1.00	76.74	C
ATOM	7241	CD2	PHE	A	972	-28.961	57.158	-27.411	1.00	76.54	C
ATOM	7242	CE1	PHE	A	972	-30.552	55.397	-26.024	1.00	77.90	C
ATOM	7243	CE2	PHE	A	972	-28.652	55.815	-27.402	1.00	79.77	C
ATOM	7244	CZ	PHE	A	972	-29.447	54.933	-26.708	1.00	80.90	C
ATOM	7245	O	TYR	A	973	-33.251	63.160	-24.514	1.00	77.64	O
ATOM	7246	N	TYR	A	973	-33.403	61.248	-26.648	1.00	73.69	N

ATOM	7247	CA	TYR	A	973	-33.781	62.642	-26.790	1.00	77.00	C
ATOM	7248	C	TYR	A	973	-33.231	63.519	-25.688	1.00	76.62	C
ATOM	7249	CB	TYR	A	973	-35.303	62.789	-26.826	1.00	78.41	C
ATOM	7250	CG	TYR	A	973	-35.932	62.191	-28.049	1.00	81.96	C
ATOM	7251	CD1	TYR	A	973	-35.380	62.392	-29.309	1.00	81.17	C
ATOM	7252	CD2	TYR	A	973	-37.064	61.404	-27.943	1.00	86.77	C
ATOM	7253	CE1	TYR	A	973	-35.954	61.837	-30.436	1.00	81.49	C
ATOM	7254	CE2	TYR	A	973	-37.645	60.840	-29.061	1.00	87.64	C
ATOM	7255	CZ	TYR	A	973	-37.094	61.060	-30.307	1.00	85.11	C
ATOM	7256	OH	TYR	A	973	-37.694	60.491	-31.410	1.00	81.54	O
ATOM	7257	O	LYS	A	974	-33.943	67.321	-25.873	1.00	71.12	O
ATOM	7258	N	LYS	A	974	-32.753	64.688	-26.090	1.00	75.90	N
ATOM	7259	CA	LYS	A	974	-32.340	65.711	-25.157	1.00	67.68	C
ATOM	7260	C	LYS	A	974	-33.458	66.703	-24.933	1.00	69.92	C
ATOM	7261	CB	LYS	A	974	-31.097	66.430	-25.666	1.00	70.63	C
ATOM	7262	CG	LYS	A	974	-30.944	67.823	-25.103	1.00	70.89	C
ATOM	7263	CD	LYS	A	974	-29.502	68.250	-25.123	1.00	68.86	C
ATOM	7264	CE	LYS	A	974	-29.031	68.564	-26.516	1.00	63.78	C
ATOM	7265	NZ	LYS	A	974	-27.553	68.555	-26.562	1.00	62.06	N
ATOM	7266	O	VAL	A	975	-33.948	68.342	-21.073	1.00	79.75	O
ATOM	7267	N	VAL	A	975	-33.875	66.836	-23.681	1.00	73.52	N
ATOM	7268	CA	VAL	A	975	-34.799	67.886	-23.281	1.00	71.81	C
ATOM	7269	C	VAL	A	975	-34.116	68.757	-22.226	1.00	80.51	C
ATOM	7270	CB	VAL	A	975	-36.099	67.313	-22.737	1.00	73.87	C
ATOM	7271	CG1	VAL	A	975	-37.121	68.412	-22.555	1.00	70.88	C
ATOM	7272	CG2	VAL	A	975	-36.628	66.256	-23.683	1.00	77.72	C
ATOM	7273	O	ARG	A	976	-32.627	71.769	-19.697	1.00	70.40	O
ATOM	7274	N	ARG	A	976	-33.725	69.964	-22.632	1.00	76.50	N
ATOM	7275	CA	ARG	A	976	-32.767	70.769	-21.876	1.00	72.83	C
ATOM	7276	C	ARG	A	976	-33.348	71.486	-20.655	1.00	73.45	C
ATOM	7277	CB	ARG	A	976	-32.112	71.796	-22.808	1.00	73.22	C
ATOM	7278	CG	ARG	A	976	-31.069	71.207	-23.777	1.00	76.16	C
ATOM	7279	CD	ARG	A	976	-30.421	72.302	-24.642	1.00	83.85	C
ATOM	7280	NE	ARG	A	976	-31.424	73.207	-25.215	1.00	93.48	N
ATOM	7281	CZ	ARG	A	976	-31.350	74.538	-25.192	1.00	97.93	C
ATOM	7282	NH1	ARG	A	976	-32.321	75.271	-25.736	1.00	101.05	N
ATOM	7283	NH2	ARG	A	976	-30.307	75.141	-24.629	1.00	98.15	N
ATOM	7284	O	GLU	A	977	-36.118	72.204	-17.411	1.00	78.44	O
ATOM	7285	N	GLU	A	977	-34.646	71.773	-20.685	1.00	77.75	N
ATOM	7286	CA	GLU	A	977	-35.295	72.533	-19.617	1.00	72.66	C
ATOM	7287	C	GLU	A	977	-35.559	71.703	-18.370	1.00	70.17	C
ATOM	7288	CB	GLU	A	977	-36.614	73.120	-20.112	1.00	73.30	C
ATOM	7289	CG	GLU	A	977	-36.471	74.128	-21.237	1.00	76.13	C
ATOM	7290	CD	GLU	A	977	-36.294	73.474	-22.586	1.00	71.74	C
ATOM	7291	OE1	GLU	A	977	-36.176	74.195	-23.595	1.00	86.17	O
ATOM	7292	OE2	GLU	A	977	-36.282	72.236	-22.642	1.00	72.74	O
ATOM	7293	O	ILE	A	978	-34.855	70.014	-15.046	1.00	72.56	O
ATOM	7294	N	ILE	A	978	-35.147	70.446	-18.387	1.00	67.94	N
ATOM	7295	CA	ILE	A	978	-35.457	69.507	-17.318	1.00	71.72	C
ATOM	7296	C	ILE	A	978	-34.485	69.612	-16.148	1.00	71.12	C
ATOM	7297	CB	ILE	A	978	-35.437	68.061	-17.847	1.00	76.07	C
ATOM	7298	CG1	ILE	A	978	-36.442	67.888	-19.003	1.00	80.47	C
ATOM	7299	CG2	ILE	A	978	-35.652	67.061	-16.705	1.00	77.02	C
ATOM	7300	CD1	ILE	A	978	-37.836	68.483	-18.750	1.00	74.24	C
ATOM	7301	O	ASN	A	979	-30.950	69.925	-17.459	1.00	63.22	O
ATOM	7302	N	ASN	A	979	-33.245	69.209	-16.398	1.00	70.23	N
ATOM	7303	CA	ASN	A	979	-32.152	69.398	-15.462	1.00	64.73	C
ATOM	7304	C	ASN	A	979	-30.897	69.743	-16.247	1.00	61.98	C
ATOM	7305	CB	ASN	A	979	-31.945	68.154	-14.602	1.00	64.47	C
ATOM	7306	CG	ASN	A	979	-31.689	66.902	-15.426	1.00	66.03	C
ATOM	7307	OD1	ASN	A	979	-30.921	66.913	-16.388	1.00	62.91	O
ATOM	7308	ND2	ASN	A	979	-32.334	65.810	-15.040	1.00	68.02	N
ATOM	7309	O	ASN	A	980	-26.671	69.188	-17.288	1.00	54.29	O

ATOM	7310	N	ASN	A	980	-29.764	69.831	-15.572	1.00	59.94	N
ATOM	7311	CA	ASN	A	980	-28.551	70.218	-16.260	1.00	54.80	C
ATOM	7312	C	ASN	A	980	-27.772	69.026	-16.764	1.00	52.23	C
ATOM	7313	CB	ASN	A	980	-27.673	71.061	-15.349	1.00	53.67	C
ATOM	7314	CG	ASN	A	980	-28.251	72.429	-15.101	1.00	55.74	C
ATOM	7315	OD1	ASN	A	980	-28.082	73.338	-15.913	1.00	52.32	O
ATOM	7316	ND2	ASN	A	980	-28.945	72.587	-13.981	1.00	60.28	N
ATOM	7317	N	TYR	A	981	-28.345	67.833	-16.631	1.00	54.75	N
ATOM	7318	C	TYR	A	981	-27.092	66.409	-18.274	1.00	50.32	C
ATOM	7319	CA	TYR	A	981	-27.577	66.597	-16.840	1.00	52.86	C
ATOM	7320	O	TYR	A	981	-26.113	65.722	-18.501	1.00	57.61	O
ATOM	7321	CB	TYR	A	981	-28.395	65.359	-16.462	1.00	58.55	C
ATOM	7322	CG	TYR	A	981	-28.560	65.091	-14.989	1.00	60.17	C
ATOM	7323	CD2	TYR	A	981	-29.232	63.963	-14.548	1.00	63.46	C
ATOM	7324	CD1	TYR	A	981	-28.043	65.953	-14.037	1.00	59.89	C
ATOM	7325	CE2	TYR	A	981	-29.399	63.709	-13.198	1.00	63.92	C
ATOM	7326	CE1	TYR	A	981	-28.198	65.707	-12.679	1.00	57.60	C
ATOM	7327	CZ	TYR	A	981	-28.876	64.584	-12.267	1.00	63.03	C
ATOM	7328	OH	TYR	A	981	-29.032	64.325	-10.921	1.00	62.57	O
ATOM	7329	N	HIS	A	982	-27.806	66.993	-19.229	1.00	52.05	N
ATOM	7330	C	HIS	A	982	-26.154	67.318	-21.053	1.00	50.83	C
ATOM	7331	CA	HIS	A	982	-27.526	66.814	-20.649	1.00	50.27	C
ATOM	7332	O	HIS	A	982	-25.637	66.946	-22.092	1.00	52.04	O
ATOM	7333	CB	HIS	A	982	-28.591	67.522	-21.485	1.00	51.41	C
ATOM	7334	CG	HIS	A	982	-28.537	69.013	-21.396	1.00	54.78	C
ATOM	7335	ND1	HIS	A	982	-29.269	69.732	-20.471	1.00	62.33	N
ATOM	7336	CD2	HIS	A	982	-27.839	69.924	-22.114	1.00	52.72	C
ATOM	7337	CE1	HIS	A	982	-29.032	71.022	-20.630	1.00	54.11	C
ATOM	7338	NE2	HIS	A	982	-28.163	71.165	-21.617	1.00	56.17	N
ATOM	7339	N	HIS	A	983	-25.570	68.186	-20.243	1.00	51.99	N
ATOM	7340	C	HIS	A	983	-23.301	67.533	-20.376	1.00	48.19	C
ATOM	7341	CA	HIS	A	983	-24.248	68.686	-20.544	1.00	49.22	C
ATOM	7342	O	HIS	A	983	-22.309	67.430	-21.078	1.00	49.24	O
ATOM	7343	CB	HIS	A	983	-23.838	69.834	-19.620	1.00	45.64	C
ATOM	7344	CG	HIS	A	983	-24.666	71.069	-19.752	1.00	48.38	C
ATOM	7345	ND1	HIS	A	983	-24.447	72.014	-20.733	1.00	50.39	N
ATOM	7346	CD2	HIS	A	983	-25.690	71.539	-19.000	1.00	54.24	C
ATOM	7347	CE1	HIS	A	983	-25.311	73.003	-20.587	1.00	54.71	C
ATOM	7348	NE2	HIS	A	983	-26.074	72.742	-19.540	1.00	49.43	N
ATOM	7349	N	ALA	A	984	-23.629	66.666	-19.423	1.00	47.80	N
ATOM	7350	C	ALA	A	984	-23.104	64.356	-20.051	1.00	55.83	C
ATOM	7351	CA	ALA	A	984	-22.816	65.503	-19.092	1.00	50.96	C
ATOM	7352	O	ALA	A	984	-22.191	63.614	-20.442	1.00	59.19	O
ATOM	7353	CB	ALA	A	984	-23.066	65.060	-17.656	1.00	46.96	C
ATOM	7354	N	HIS	A	985	-24.381	64.196	-20.389	1.00	48.23	N
ATOM	7355	C	HIS	A	985	-24.027	63.521	-22.700	1.00	52.53	C
ATOM	7356	CA	HIS	A	985	-24.782	63.244	-21.406	1.00	54.55	C
ATOM	7357	O	HIS	A	985	-23.399	62.634	-23.263	1.00	57.44	O
ATOM	7358	CB	HIS	A	985	-26.288	63.322	-21.640	1.00	56.32	C
ATOM	7359	CG	HIS	A	985	-27.100	62.914	-20.453	1.00	54.71	C
ATOM	7360	ND1	HIS	A	985	-26.599	62.109	-19.452	1.00	50.18	N
ATOM	7361	CD2	HIS	A	985	-28.380	63.192	-20.111	1.00	53.28	C
ATOM	7362	CE1	HIS	A	985	-27.535	61.912	-18.541	1.00	52.07	C
ATOM	7363	NE2	HIS	A	985	-28.623	62.561	-18.915	1.00	56.29	N
ATOM	7364	N	ASP	A	986	-24.089	64.768	-23.148	1.00	54.93	N
ATOM	7365	C	ASP	A	986	-21.992	64.772	-24.400	1.00	54.73	C
ATOM	7366	CA	ASP	A	986	-23.448	65.178	-24.390	1.00	57.80	C
ATOM	7367	O	ASP	A	986	-21.485	64.315	-25.415	1.00	59.38	O
ATOM	7368	CB	ASP	A	986	-23.569	66.687	-24.596	1.00	56.37	C
ATOM	7369	CG	ASP	A	986	-24.924	67.093	-25.119	1.00	60.58	C
ATOM	7370	OD1	ASP	A	986	-25.771	66.203	-25.311	1.00	58.16	O
ATOM	7371	OD2	ASP	A	986	-25.137	68.301	-25.349	1.00	65.96	O
ATOM	7372	N	ALA	A	987	-21.333	64.932	-23.257	1.00	56.09	N

ATOM	7373	C	ALA	A	987	-19.766	63.037	-23.206	1.00	56.51	C
ATOM	7374	CA	ALA	A	987	-19.938	64.537	-23.106	1.00	54.78	C
ATOM	7375	O	ALA	A	987	-18.768	62.540	-23.738	1.00	57.64	O
ATOM	7376	CB	ALA	A	987	-19.404	65.020	-21.782	1.00	55.46	C
ATOM	7377	N	TYR	A	988	-20.731	62.318	-22.648	1.00	55.78	N
ATOM	7378	CA	TYR	A	988	-20.644	60.868	-22.590	1.00	63.29	C
ATOM	7379	C	TYR	A	988	-20.759	60.298	-23.998	1.00	61.50	O
ATOM	7380	O	TYR	A	988	-19.874	59.567	-24.461	1.00	56.95	C
ATOM	7381	CB	TYR	A	988	-21.733	60.292	-21.674	1.00	60.75	C
ATOM	7382	CG	TYR	A	988	-21.961	58.799	-21.854	1.00	59.82	C
ATOM	7383	CD1	TYR	A	988	-21.033	57.880	-21.404	1.00	61.76	C
ATOM	7384	CD2	TYR	A	988	-23.110	58.320	-22.476	1.00	61.10	C
ATOM	7385	CE1	TYR	A	988	-21.229	56.538	-21.569	1.00	64.56	C
ATOM	7386	CE2	TYR	A	988	-23.314	56.974	-22.646	1.00	61.96	C
ATOM	7387	CZ	TYR	A	988	-22.371	56.089	-22.191	1.00	64.10	C
ATOM	7388	OH	TYR	A	988	-22.561	54.741	-22.352	1.00	65.77	O
ATOM	7389	N	LEU	A	989	-21.858	60.662	-24.662	1.00	56.03	N
ATOM	7390	CA	LEU	A	989	-22.134	60.263	-26.039	1.00	58.08	C
ATOM	7391	C	LEU	A	989	-21.001	60.641	-26.982	1.00	61.84	C
ATOM	7392	O	LEU	A	989	-20.760	59.972	-27.977	1.00	66.80	O
ATOM	7393	CB	LEU	A	989	-23.431	60.896	-26.518	1.00	52.61	C
ATOM	7394	CG	LEU	A	989	-24.633	60.659	-25.615	1.00	59.59	C
ATOM	7395	CD1	LEU	A	989	-25.845	61.453	-26.100	1.00	50.97	C
ATOM	7396	CD2	LEU	A	989	-24.937	59.173	-25.534	1.00	54.55	C
ATOM	7397	N	ASN	A	990	-20.305	61.720	-26.669	1.00	59.58	N
ATOM	7398	CA	ASN	A	990	-19.218	62.149	-27.513	1.00	58.13	C
ATOM	7399	C	ASN	A	990	-18.078	61.158	-27.447	1.00	61.76	O
ATOM	7400	O	ASN	A	990	-17.522	60.792	-28.469	1.00	62.49	C
ATOM	7401	CB	ASN	A	990	-18.748	63.541	-27.110	1.00	54.66	C
ATOM	7402	CG	ASN	A	990	-19.181	64.580	-28.080	1.00	62.92	C
ATOM	7403	OD1	ASN	A	990	-18.461	64.882	-29.027	1.00	65.84	O
ATOM	7404	ND2	ASN	A	990	-20.386	65.127	-27.882	1.00	65.25	N
ATOM	7405	N	ALA	A	991	-17.738	60.723	-26.239	1.00	60.09	N
ATOM	7406	CA	ALA	A	991	-16.654	59.772	-26.061	1.00	60.85	C
ATOM	7407	C	ALA	A	991	-17.023	58.412	-26.682	1.00	65.24	C
ATOM	7408	O	ALA	A	991	-16.210	57.786	-27.364	1.00	59.42	O
ATOM	7409	CB	ALA	A	991	-16.326	59.623	-24.602	1.00	53.03	C
ATOM	7410	N	VAL	A	992	-18.262	57.983	-26.439	1.00	70.03	N
ATOM	7411	CA	VAL	A	992	-18.824	56.770	-27.035	1.00	68.48	C
ATOM	7412	C	VAL	A	992	-18.686	56.807	-28.552	1.00	70.14	O
ATOM	7413	O	VAL	A	992	-18.029	55.946	-29.134	1.00	68.40	C
ATOM	7414	CB	VAL	A	992	-20.325	56.579	-26.659	1.00	70.12	C
ATOM	7415	CG1	VAL	A	992	-21.008	55.579	-27.597	1.00	63.75	C
ATOM	7416	CG2	VAL	A	992	-20.459	56.119	-25.212	1.00	69.20	C
ATOM	7417	N	VAL	A	993	-19.283	57.814	-29.191	1.00	65.45	N
ATOM	7418	CA	VAL	A	993	-19.199	57.926	-30.641	1.00	66.91	C
ATOM	7419	C	VAL	A	993	-17.754	58.163	-31.121	1.00	69.36	O
ATOM	7420	O	VAL	A	993	-17.336	57.628	-32.136	1.00	67.24	C
ATOM	7421	CB	VAL	A	993	-20.135	59.038	-31.153	1.00	67.83	C
ATOM	7422	CG1	VAL	A	993	-19.957	59.273	-32.640	1.00	66.06	C
ATOM	7423	CG2	VAL	A	993	-21.588	58.662	-30.863	1.00	68.16	C
ATOM	7424	N	GLY	A	994	-16.975	58.927	-30.374	1.00	67.95	N
ATOM	7425	CA	GLY	A	994	-15.633	59.249	-30.817	1.00	66.29	C
ATOM	7426	C	GLY	A	994	-14.748	58.023	-30.921	1.00	72.35	C
ATOM	7427	O	GLY	A	994	-13.967	57.860	-31.859	1.00	71.35	O
ATOM	7428	N	THR	A	995	-14.884	57.152	-29.936	1.00	71.51	N
ATOM	7429	CA	THR	A	995	-14.009	56.008	-29.783	1.00	69.32	C
ATOM	7430	C	THR	A	995	-14.395	54.853	-30.712	1.00	71.67	C
ATOM	7431	O	THR	A	995	-13.541	54.225	-31.346	1.00	68.59	O
ATOM	7432	CB	THR	A	995	-14.061	55.534	-28.355	1.00	72.06	C
ATOM	7433	OG1	THR	A	995	-15.441	55.402	-27.984	1.00	69.10	O
ATOM	7434	CG2	THR	A	995	-13.405	56.558	-27.445	1.00	68.91	C
ATOM	7435	N	ALA	A	996	-15.696	54.584	-30.758	1.00	67.40	N

ATOM	7436	CA	ALA	A	996	-16.285	53.599	-31.654	1.00	71.56	C
ATOM	7437	C	ALA	A	996	-15.998	53.901	-33.126	1.00	75.58	C
ATOM	7438	O	ALA	A	996	-15.780	52.997	-33.932	1.00	79.08	O
ATOM	7439	CB	ALA	A	996	-17.792	53.528	-31.429	1.00	70.29	C
ATOM	7440	N	LEU	A	997	-16.015	55.175	-33.485	1.00	73.18	N
ATOM	7441	CA	LEU	A	997	-15.825	55.543	-34.876	1.00	72.77	C
ATOM	7442	C	LEU	A	997	-14.359	55.494	-35.269	1.00	74.11	C
ATOM	7443	O	LEU	A	997	-14.039	55.310	-36.436	1.00	78.38	O
ATOM	7444	CB	LEU	A	997	-16.405	56.927	-35.153	1.00	68.58	C
ATOM	7445	CG	LEU	A	997	-17.615	56.891	-36.083	1.00	75.40	C
ATOM	7446	CD1	LEU	A	997	-18.647	57.937	-35.698	1.00	73.16	C
ATOM	7447	CD2	LEU	A	997	-17.164	57.078	-37.530	1.00	77.88	C
ATOM	7448	N	ILE	A	998	-13.460	55.654	-34.311	1.00	70.26	N
ATOM	7449	CA	ILE	A	998	-12.058	55.602	-34.655	1.00	70.08	C
ATOM	7450	C	ILE	A	998	-11.563	54.176	-34.452	1.00	76.65	C
ATOM	7451	O	ILE	A	998	-10.404	53.868	-34.734	1.00	76.85	O
ATOM	7452	CB	ILE	A	998	-11.228	56.591	-33.827	1.00	72.91	C
ATOM	7453	CG1	ILE	A	998	-9.994	57.047	-34.618	1.00	79.12	C
ATOM	7454	CG2	ILE	A	998	-10.883	56.000	-32.451	1.00	77.05	C
ATOM	7455	CD1	ILE	A	998	-8.670	56.573	-34.060	1.00	80.67	C
ATOM	7456	N	LYS	A	999	-12.450	53.306	-33.965	1.00	74.53	N
ATOM	7457	CA	LYS	A	999	-12.113	51.891	-33.776	1.00	79.23	C
ATOM	7458	C	LYS	A	999	-12.629	51.041	-34.947	1.00	77.32	C
ATOM	7459	O	LYS	A	999	-11.874	50.259	-35.522	1.00	77.25	O
ATOM	7460	CB	LYS	A	999	-12.670	51.373	-32.445	1.00	78.90	C
ATOM	7461	CG	LYS	A	999	-11.708	50.486	-31.647	1.00	83.78	C
ATOM	7462	CD	LYS	A	999	-12.187	50.339	-30.196	1.00	91.65	C
ATOM	7463	CE	LYS	A	999	-11.945	48.936	-29.623	1.00	92.38	C
ATOM	7464	NZ	LYS	A	999	-12.840	48.649	-28.447	1.00	77.16	N
ATOM	7465	N	LYS	A1000		-13.907	51.204	-35.297	1.00	76.80	N
ATOM	7466	CA	LYS	A1000		-14.452	50.599	-36.512	1.00	77.87	C
ATOM	7467	C	LYS	A1000		-13.586	50.978	-37.709	1.00	78.96	C
ATOM	7468	O	LYS	A1000		-12.983	50.119	-38.350	1.00	81.00	O
ATOM	7469	CB	LYS	A1000		-15.903	51.037	-36.747	1.00	75.50	C
ATOM	7470	N	TYR	A1001		-13.513	52.277	-37.985	1.00	79.86	N
ATOM	7471	CA	TYR	A1001		-12.693	52.802	-39.071	1.00	78.25	C
ATOM	7472	C	TYR	A1001		-11.483	53.585	-38.564	1.00	76.89	C
ATOM	7473	O	TYR	A1001		-11.608	54.749	-38.229	1.00	79.92	O
ATOM	7474	CB	TYR	A1001		-13.513	53.723	-39.969	1.00	74.78	C
ATOM	7475	CG	TYR	A1001		-14.937	53.292	-40.236	1.00	79.14	C
ATOM	7476	CD1	TYR	A1001		-15.216	52.133	-40.960	1.00	77.45	C
ATOM	7477	CD2	TYR	A1001		-16.004	54.074	-39.812	1.00	73.97	C
ATOM	7478	CE1	TYR	A1001		-16.526	51.750	-41.229	1.00	76.04	C
ATOM	7479	CE2	TYR	A1001		-17.314	53.703	-40.076	1.00	81.12	C
ATOM	7480	CZ	TYR	A1001		-17.571	52.538	-40.783	1.00	81.39	C
ATOM	7481	OH	TYR	A1001		-18.873	52.168	-41.042	1.00	79.26	O
ATOM	7482	O	PRO	A1002		-8.668	54.488	-40.403	1.00	76.90	O
ATOM	7483	N	PRO	A1002		-10.308	52.954	-38.499	1.00	78.53	N
ATOM	7484	CA	PRO	A1002		-9.133	53.767	-38.173	1.00	71.12	C
ATOM	7485	C	PRO	A1002		-8.838	54.830	-39.235	1.00	75.54	C
ATOM	7486	CB	PRO	A1002		-8.018	52.731	-38.096	1.00	77.13	C
ATOM	7487	CG	PRO	A1002		-8.731	51.473	-37.669	1.00	73.26	C
ATOM	7488	CD	PRO	A1002		-10.045	51.509	-38.374	1.00	74.04	C
ATOM	7489	O	LYS	A1003		-9.112	58.969	-38.096	1.00	78.26	O
ATOM	7490	N	LYS	A1003		-8.815	56.104	-38.824	1.00	87.98	N
ATOM	7491	CA	LYS	A1003		-8.537	57.246	-39.716	1.00	82.46	C
ATOM	7492	C	LYS	A1003		-8.336	58.585	-38.971	1.00	82.90	C
ATOM	7493	CB	LYS	A1003		-9.652	57.406	-40.758	1.00	76.42	C
ATOM	7494	CG	LYS	A1003		-10.868	58.220	-40.326	1.00	78.72	C
ATOM	7495	CD	LYS	A1003		-11.568	57.604	-39.133	1.00	74.95	C
ATOM	7496	CE	LYS	A1003		-12.890	58.271	-38.851	1.00	70.60	C
ATOM	7497	NZ	LYS	A1003		-13.908	57.907	-39.864	1.00	72.37	N
ATOM	7498	O	LEU	A1004		-5.586	60.732	-40.771	1.00	82.78	O

ATOM	7499	N	LEU	A1004	-7.250	59.271	-39.305	1.00	82.42	N
ATOM	7500	CA	LEU	A1004	-7.027	60.642	-38.876	1.00	77.53	C
ATOM	7501	C	LEU	A1004	-6.422	61.331	-40.095	1.00	81.46	C
ATOM	7502	CB	LEU	A1004	-6.123	60.717	-37.644	1.00	74.30	C
ATOM	7503	CG	LEU	A1004	-5.504	59.447	-37.037	1.00	81.49	C
ATOM	7504	CD1	LEU	A1004	-6.506	58.529	-36.331	1.00	80.84	C
ATOM	7505	CD2	LEU	A1004	-4.386	59.827	-36.073	1.00	78.45	C
ATOM	7506	O	GLU	A1005	-9.713	63.761	-39.707	1.00	77.13	O
ATOM	7507	N	GLU	A1005	-6.783	62.581	-40.387	1.00	76.65	N
ATOM	7508	CA	GLU	A1005	-7.304	63.555	-39.436	1.00	80.24	C
ATOM	7509	C	GLU	A1005	-8.764	63.445	-38.981	1.00	84.88	C
ATOM	7510	CB	GLU	A1005	-7.093	64.959	-40.009	1.00	85.55	C
ATOM	7511	O	SER	A1006	-9.931	64.059	-34.625	1.00	70.87	O
ATOM	7512	N	SER	A1006	-8.894	62.974	-37.747	1.00	81.21	N
ATOM	7513	CA	SER	A1006	-10.015	63.250	-36.880	1.00	69.88	C
ATOM	7514	C	SER	A1006	-9.363	63.425	-35.510	1.00	69.48	C
ATOM	7515	CB	SER	A1006	-11.053	62.132	-36.895	1.00	72.04	C
ATOM	7516	OG	SER	A1006	-12.354	62.652	-36.666	1.00	76.46	O
ATOM	7517	O	GLU	A1007	-6.389	64.724	-35.670	1.00	73.79	O
ATOM	7518	N	GLU	A1007	-8.159	62.864	-35.357	1.00	66.42	N
ATOM	7519	CA	GLU	A1007	-7.303	63.114	-34.197	1.00	66.14	C
ATOM	7520	C	GLU	A1007	-6.487	64.356	-34.510	1.00	66.52	C
ATOM	7521	CB	GLU	A1007	-6.395	61.914	-33.889	1.00	61.66	C
ATOM	7522	O	PHE	A1008	-2.866	66.080	-33.715	1.00	61.28	O
ATOM	7523	N	PHE	A1008	-5.913	65.014	-33.503	1.00	68.18	N
ATOM	7524	CA	PHE	A1008	-5.290	66.329	-33.722	1.00	66.70	C
ATOM	7525	C	PHE	A1008	-3.892	66.230	-34.374	1.00	61.21	C
ATOM	7526	CB	PHE	A1008	-5.225	67.122	-32.400	1.00	62.02	C
ATOM	7527	CG	PHE	A1008	-4.503	68.447	-32.515	1.00	61.48	C
ATOM	7528	CD1	PHE	A1008	-3.181	68.575	-32.106	1.00	61.73	C
ATOM	7529	CD2	PHE	A1008	-5.139	69.556	-33.045	1.00	61.58	C
ATOM	7530	CE1	PHE	A1008	-2.508	69.780	-32.223	1.00	60.03	C
ATOM	7531	CE2	PHE	A1008	-4.470	70.773	-33.165	1.00	63.69	C
ATOM	7532	CZ	PHE	A1008	-3.154	70.884	-32.754	1.00	62.73	C
ATOM	7533	O	GLY	A1030	-12.657	57.536	-57.259	1.00	87.52	O
ATOM	7534	N	GLY	A1030	-10.361	59.616	-57.240	1.00	90.29	N
ATOM	7535	CA	GLY	A1030	-10.351	58.165	-57.171	1.00	92.18	C
ATOM	7536	C	GLY	A1030	-11.633	57.595	-56.588	1.00	92.98	C
ATOM	7537	O	LYS	A1031	-14.094	57.683	-52.902	1.00	97.60	O
ATOM	7538	N	LYS	A1031	-11.575	57.169	-55.330	1.00	96.43	N
ATOM	7539	CA	LYS	A1031	-12.762	56.694	-54.628	1.00	93.17	C
ATOM	7540	C	LYS	A1031	-13.425	57.861	-53.919	1.00	99.79	C
ATOM	7541	CB	LYS	A1031	-12.414	55.599	-53.622	1.00	95.25	C
ATOM	7542	O	ALA	A1032	-16.051	60.527	-53.070	1.00	99.71	O
ATOM	7543	N	ALA	A1032	-13.216	59.058	-54.459	1.00	98.13	N
ATOM	7544	CA	ALA	A1032	-13.837	60.260	-53.938	1.00	94.53	C
ATOM	7545	C	ALA	A1032	-15.348	60.120	-53.993	1.00	98.04	C
ATOM	7546	CB	ALA	A1032	-13.382	61.479	-54.721	1.00	97.40	C
ATOM	7547	O	THR	A1033	-18.764	58.713	-53.399	1.00	98.03	O
ATOM	7548	N	THR	A1033	-15.845	59.537	-55.077	1.00	98.15	N
ATOM	7549	CA	THR	A1033	-17.272	59.272	-55.196	1.00	98.55	C
ATOM	7550	C	THR	A1033	-17.732	58.430	-54.013	1.00	98.63	C
ATOM	7551	CB	THR	A1033	-17.619	58.546	-56.515	1.00	100.04	C
ATOM	7552	OG1	THR	A1033	-17.181	59.334	-57.631	1.00	104.11	O
ATOM	7553	CG2	THR	A1033	-19.123	58.322	-56.621	1.00	93.00	C
ATOM	7554	O	ALA	A1034	-17.720	57.052	-50.295	1.00	97.27	O
ATOM	7555	N	ALA	A1034	-16.942	57.407	-53.694	1.00	98.60	N
ATOM	7556	CA	ALA	A1034	-17.224	56.512	-52.574	1.00	96.08	C
ATOM	7557	C	ALA	A1034	-16.937	57.184	-51.236	1.00	97.89	C
ATOM	7558	CB	ALA	A1034	-16.416	55.229	-52.701	1.00	96.61	C
ATOM	7559	O	LYS	A1035	-16.227	60.453	-48.596	1.00	93.02	O
ATOM	7560	N	LYS	A1035	-15.824	57.918	-51.161	1.00	98.96	N
ATOM	7561	CA	LYS	A1035	-15.435	58.636	-49.942	1.00	96.54	C

ATOM	7562	C	LYS	A1035	-16.407	59.753	-49.587	1.00	95.20	C
ATOM	7563	CB	LYS	A1035	-14.022	59.204	-50.076	1.00	96.03	C
ATOM	7564	CG	LYS	A1035	-12.918	58.179	-49.823	1.00	99.22	C
ATOM	7565	CD	LYS	A1035	-12.267	58.374	-48.453	1.00	99.42	C
ATOM	7566	CE	LYS	A1035	-13.211	58.006	-47.315	1.00	92.80	C
ATOM	7567	NZ	LYS	A1035	-12.711	58.480	-45.995	1.00	86.31	N
ATOM	7568	O	TYR	A1036	-20.741	60.109	-49.116	1.00	94.68	O
ATOM	7569	N	TYR	A1036	-17.437	59.898	-50.413	1.00	95.19	N
ATOM	7570	CA	TYR	A1036	-18.617	60.692	-50.118	1.00	93.52	C
ATOM	7571	C	TYR	A1036	-19.535	59.871	-49.190	1.00	94.20	C
ATOM	7572	CB	TYR	A1036	-19.294	61.086	-51.446	1.00	94.61	C
ATOM	7573	CG	TYR	A1036	-20.533	61.963	-51.391	1.00	94.97	C
ATOM	7574	CD1	TYR	A1036	-20.456	63.297	-51.023	1.00	89.72	C
ATOM	7575	CD2	TYR	A1036	-21.777	61.461	-51.766	1.00	97.60	C
ATOM	7576	CE1	TYR	A1036	-21.585	64.092	-50.993	1.00	85.31	C
ATOM	7577	CE2	TYR	A1036	-22.909	62.250	-51.740	1.00	92.54	C
ATOM	7578	CZ	TYR	A1036	-22.806	63.563	-51.354	1.00	91.19	C
ATOM	7579	OH	TYR	A1036	-23.935	64.348	-51.333	1.00	97.92	O
ATOM	7580	O	PHE	A1037	-20.594	58.129	-45.305	1.00	94.00	O
ATOM	7581	N	PHE	A1037	-18.935	58.917	-48.466	1.00	95.50	N
ATOM	7582	CA	PHE	A1037	-19.651	58.034	-47.531	1.00	95.03	C
ATOM	7583	C	PHE	A1037	-19.866	58.667	-46.150	1.00	98.88	C
ATOM	7584	CB	PHE	A1037	-18.908	56.705	-47.377	1.00	92.95	C
ATOM	7585	CG	PHE	A1037	-17.854	56.693	-46.287	1.00	98.69	C
ATOM	7586	CD1	PHE	A1037	-17.735	55.593	-45.446	1.00	99.48	C
ATOM	7587	CD2	PHE	A1037	-16.959	57.742	-46.126	1.00	97.85	C
ATOM	7588	CE1	PHE	A1037	-16.768	55.551	-44.452	1.00	93.70	C
ATOM	7589	CE2	PHE	A1037	-15.997	57.705	-45.122	1.00	97.68	C
ATOM	7590	CZ	PHE	A1037	-15.902	56.603	-44.292	1.00	95.91	C
ATOM	7591	N	PHE	A1038	-19.216	59.809	-45.933	1.00	96.94	N
ATOM	7592	CA	PHE	A1038	-19.496	60.652	-44.781	1.00	91.91	C
ATOM	7593	C	PHE	A1038	-20.991	60.958	-44.781	1.00	95.30	C
ATOM	7594	O	PHE	A1038	-21.576	61.261	-43.737	1.00	97.94	O
ATOM	7595	CB	PHE	A1038	-18.684	61.962	-44.823	1.00	86.30	C
ATOM	7596	CG	PHE	A1038	-17.190	61.791	-44.648	1.00	82.33	C
ATOM	7597	CD2	PHE	A1038	-16.641	61.578	-43.397	1.00	81.62	C
ATOM	7598	CD1	PHE	A1038	-16.335	61.887	-45.729	1.00	81.27	C
ATOM	7599	CE2	PHE	A1038	-15.269	61.442	-43.238	1.00	74.52	C
ATOM	7600	CE1	PHE	A1038	-14.965	61.748	-45.569	1.00	82.04	C
ATOM	7601	CZ	PHE	A1038	-14.434	61.529	-44.322	1.00	73.28	C
ATOM	7602	O	TYR	A1039	-25.046	60.701	-45.010	1.00	98.32	O
ATOM	7603	N	TYR	A1039	-21.596	60.873	-45.966	1.00	93.19	N
ATOM	7604	CA	TYR	A1039	-23.000	61.215	-46.165	1.00	98.12	C
ATOM	7605	C	TYR	A1039	-23.936	60.305	-45.375	1.00	95.65	C
ATOM	7606	CB	TYR	A1039	-23.349	61.161	-47.656	1.00	93.90	C
ATOM	7607	N	SER	A1040	-23.491	59.086	-45.106	1.00	95.15	N
ATOM	7608	CA	SER	A1040	-24.313	58.165	-44.340	1.00	99.39	C
ATOM	7609	C	SER	A1040	-23.448	57.206	-43.547	1.00	98.15	C
ATOM	7610	O	SER	A1040	-23.385	57.284	-42.318	1.00	98.64	O
ATOM	7611	CB	SER	A1040	-25.266	57.379	-45.261	1.00	97.70	C
ATOM	7612	OG	SER	A1040	-24.566	56.422	-46.048	1.00	97.41	O
ATOM	7613	N	ASN	A1041	-22.748	56.346	-44.282	1.00	96.36	N
ATOM	7614	CA	ASN	A1041	-22.200	55.090	-43.768	1.00	98.07	C
ATOM	7615	C	ASN	A1041	-21.459	55.152	-42.432	1.00	98.49	C
ATOM	7616	O	ASN	A1041	-21.417	54.147	-41.701	1.00	96.25	O
ATOM	7617	CB	ASN	A1041	-21.271	54.473	-44.823	1.00	98.89	C
ATOM	7618	CG	ASN	A1041	-21.308	52.954	-44.820	1.00	95.33	C
ATOM	7619	OD1	ASN	A1041	-20.272	52.299	-44.931	1.00	97.43	O
ATOM	7620	ND2	ASN	A1041	-22.507	52.387	-44.691	1.00	93.05	N
ATOM	7621	N	ILE	A1042	-20.881	56.311	-42.107	1.00	97.58	N
ATOM	7622	CA	ILE	A1042	-20.112	56.438	-40.869	1.00	90.58	C
ATOM	7623	C	ILE	A1042	-21.042	56.325	-39.667	1.00	89.52	C
ATOM	7624	O	ILE	A1042	-20.620	55.942	-38.580	1.00	93.96	O

ATOM	7625	CB	ILE	A1042	-19.305	57.762	-40.811	1.00	94.48	C
ATOM	7626	CG1	ILE	A1042	-20.038	58.894	-41.540	1.00	95.90	C
ATOM	7627	CG2	ILE	A1042	-17.913	57.564	-41.416	1.00	91.84	C
ATOM	7628	CD1	ILE	A1042	-21.194	59.509	-40.776	1.00	90.77	C
ATOM	7629	N	MET	A1043	-22.316	56.636	-39.872	1.00	89.26	N
ATOM	7630	CA	MET	A1043	-23.312	56.449	-38.829	1.00	94.02	C
ATOM	7631	C	MET	A1043	-24.213	55.263	-39.159	1.00	95.35	C
ATOM	7632	O	MET	A1043	-25.246	55.058	-38.521	1.00	97.79	O
ATOM	7633	CB	MET	A1043	-24.148	57.718	-38.640	1.00	96.38	C
ATOM	7634	CG	MET	A1043	-24.324	58.124	-37.181	1.00	93.83	C
ATOM	7635	SD	MET	A1043	-22.756	58.360	-36.295	1.00	93.07	S
ATOM	7636	CE	MET	A1043	-23.380	58.873	-34.698	1.00	85.58	C
ATOM	7637	N	ASN	A1044	-23.816	54.485	-40.162	1.00	96.42	N
ATOM	7638	CA	ASN	A1044	-24.562	53.291	-40.540	1.00	94.60	C
ATOM	7639	C	ASN	A1044	-24.087	52.059	-39.760	1.00	85.58	C
ATOM	7640	O	ASN	A1044	-24.903	51.250	-39.323	1.00	80.21	O
ATOM	7641	CB	ASN	A1044	-24.466	53.049	-42.055	1.00	95.21	C
ATOM	7642	CG	ASN	A1044	-25.354	54.006	-42.865	1.00	95.22	C
ATOM	7643	OD1	ASN	A1044	-25.954	54.933	-42.314	1.00	98.01	O
ATOM	7644	ND2	ASN	A1044	-25.437	53.778	-44.175	1.00	91.81	N
ATOM	7645	O	PHE	A1045	-22.524	49.740	-36.662	1.00	82.16	O
ATOM	7646	N	PHE	A1045	-22.781	51.939	-39.536	1.00	82.09	N
ATOM	7647	CA	PHE	A1045	-22.242	50.791	-38.801	1.00	80.52	C
ATOM	7648	C	PHE	A1045	-22.806	50.691	-37.384	1.00	82.95	C
ATOM	7649	CB	PHE	A1045	-20.724	50.868	-38.721	1.00	79.63	C
ATOM	7650	CG	PHE	A1045	-20.237	51.591	-37.509	1.00	87.29	C
ATOM	7651	CD2	PHE	A1045	-20.363	52.969	-37.412	1.00	88.30	C
ATOM	7652	CD1	PHE	A1045	-19.693	50.900	-36.447	1.00	88.72	C
ATOM	7653	CE2	PHE	A1045	-19.930	53.641	-36.290	1.00	83.88	C
ATOM	7654	CE1	PHE	A1045	-19.259	51.571	-35.322	1.00	86.80	C
ATOM	7655	CZ	PHE	A1045	-19.378	52.941	-35.247	1.00	83.15	C
ATOM	7656	O	PHE	A1046	-26.114	50.307	-35.037	1.00	83.30	O
ATOM	7657	N	PHE	A1046	-23.556	51.714	-36.983	1.00	88.54	N
ATOM	7658	CA	PHE	A1046	-24.306	51.732	-35.731	1.00	87.93	C
ATOM	7659	C	PHE	A1046	-25.656	51.047	-35.915	1.00	88.25	C
ATOM	7660	CB	PHE	A1046	-24.536	53.178	-35.251	1.00	90.38	C
ATOM	7661	CG	PHE	A1046	-23.544	53.664	-34.219	1.00	87.40	C
ATOM	7662	CD1	PHE	A1046	-23.061	52.816	-33.234	1.00	81.78	C
ATOM	7663	CD2	PHE	A1046	-23.117	54.987	-34.227	1.00	85.23	C
ATOM	7664	CE1	PHE	A1046	-22.160	53.274	-32.287	1.00	80.80	C
ATOM	7665	CE2	PHE	A1046	-22.212	55.452	-33.282	1.00	83.58	C
ATOM	7666	CZ	PHE	A1046	-21.737	54.596	-32.311	1.00	82.24	C
ATOM	7667	O	LYS	A1047	-26.867	48.681	-37.694	1.00	80.25	O
ATOM	7668	N	LYS	A1047	-26.282	51.321	-37.065	1.00	90.16	N
ATOM	7669	CA	LYS	A1047	-27.670	50.933	-37.351	1.00	89.03	C
ATOM	7670	C	LYS	A1047	-27.840	49.437	-37.592	1.00	86.83	C
ATOM	7671	CB	LYS	A1047	-28.207	51.709	-38.563	1.00	85.22	C
ATOM	7672	CG	LYS	A1047	-29.104	52.882	-38.213	1.00	88.18	C
ATOM	7673	CD	LYS	A1047	-29.283	53.824	-39.397	1.00	90.77	C
ATOM	7674	CE	LYS	A1047	-29.867	55.158	-38.949	1.00	81.30	C
ATOM	7675	NE	LYS	A1047	-29.687	56.218	-39.989	1.00	88.41	N
ATOM	7676	O	THR	A1048	-30.388	46.975	-39.789	1.00	82.66	O
ATOM	7677	N	THR	A1048	-29.096	49.019	-37.694	1.00	86.97	N
ATOM	7678	CA	THR	A1048	-29.407	47.603	-37.686	1.00	88.38	C
ATOM	7679	C	THR	A1048	-30.578	47.261	-38.605	1.00	85.59	C
ATOM	7680	CB	THR	A1048	-29.721	47.151	-36.260	1.00	91.82	C
ATOM	7681	OG1	THR	A1048	-29.681	45.721	-36.185	1.00	96.97	O
ATOM	7682	CG2	THR	A1048	-31.089	47.680	-35.829	1.00	93.14	C
ATOM	7683	O	ILE	A1063	-24.281	44.325	-33.894	1.00	90.37	O
ATOM	7684	N	ILE	A1063	-24.590	42.523	-36.902	1.00	87.47	N
ATOM	7685	CA	ILE	A1063	-25.227	43.010	-35.675	1.00	78.70	C
ATOM	7686	C	ILE	A1063	-24.190	43.311	-34.589	1.00	85.86	C
ATOM	7687	CB	ILE	A1063	-26.258	42.007	-35.151	1.00	77.61	C

ATOM	7688	CG1	ILE	A1063	-27.366	41.805	-36.193	1.00	83.81	C
ATOM	7689	CG2	ILE	A1063	-26.829	42.461	-33.826	1.00	84.71	C
ATOM	7690	CD1	ILE	A1063	-27.776	43.066	-36.943	1.00	85.58	C
ATOM	7691	O	GLU	A1064	-19.964	42.562	-34.888	1.00	84.62	O
ATOM	7692	N	GLU	A1064	-23.200	42.440	-34.453	1.00	80.49	N
ATOM	7693	CA	GLU	A1064	-22.018	42.760	-33.673	1.00	78.26	C
ATOM	7694	C	GLU	A1064	-20.928	43.280	-34.611	1.00	86.72	C
ATOM	7695	CB	GLU	A1064	-21.518	41.535	-32.905	1.00	73.10	C
ATOM	7696	O	THR	A1065	-18.483	45.126	-34.383	1.00	76.67	O
ATOM	7697	N	THR	A1065	-21.080	44.520	-35.093	1.00	88.96	N
ATOM	7698	CA	THR	A1065	-20.164	45.106	-36.089	1.00	85.95	C
ATOM	7699	C	THR	A1065	-18.727	45.085	-35.583	1.00	81.68	C
ATOM	7700	CB	THR	A1065	-20.554	46.566	-36.479	1.00	86.66	C
ATOM	7701	OG1	THR	A1065	-21.914	46.825	-36.108	1.00	86.83	C
ATOM	7702	CG2	THR	A1065	-20.381	46.799	-38.000	1.00	79.79	O
ATOM	7703	O	ASN	A1066	-15.602	46.286	-37.725	1.00	77.34	O
ATOM	7704	N	ASN	A1066	-17.778	45.008	-36.509	1.00	82.69	N
ATOM	7705	CA	ASN	A1066	-16.415	44.669	-36.147	1.00	82.26	C
ATOM	7706	C	ASN	A1066	-15.362	45.593	-36.731	1.00	84.07	C
ATOM	7707	CB	ASN	A1066	-16.108	43.228	-36.578	1.00	94.74	C
ATOM	7708	O	GLY	A1067	-12.834	44.842	-38.350	1.00	99.59	O
ATOM	7709	N	GLY	A1067	-14.184	45.572	-36.111	1.00	81.66	N
ATOM	7710	CA	GLY	A1067	-13.071	46.396	-36.537	1.00	85.28	C
ATOM	7711	C	GLY	A1067	-12.423	45.870	-37.798	1.00	97.28	C
ATOM	7712	O	GLU	A1068	-9.958	44.029	-40.222	1.00	98.00	O
ATOM	7713	N	GLU	A1068	-11.399	46.578	-38.259	1.00	98.37	N
ATOM	7714	CA	GLU	A1068	-10.701	46.186	-39.474	1.00	100.23	C
ATOM	7715	C	GLU	A1068	-10.020	44.831	-39.294	1.00	99.43	C
ATOM	7716	CB	GLU	A1068	-9.680	47.258	-39.867	1.00	98.35	C
ATOM	7717	O	THR	A1069	-8.693	42.356	-35.611	1.00	93.83	O
ATOM	7718	N	THR	A1069	-9.526	44.576	-38.086	1.00	101.56	N
ATOM	7719	CA	THR	A1069	-8.786	43.350	-37.803	1.00	101.04	C
ATOM	7720	C	THR	A1069	-9.365	42.570	-36.622	1.00	99.07	C
ATOM	7721	CB	THR	A1069	-7.302	43.642	-37.512	1.00	101.15	C
ATOM	7722	OG1	THR	A1069	-7.174	44.242	-36.215	1.00	101.85	O
ATOM	7723	CG2	THR	A1069	-6.707	44.562	-38.585	1.00	100.58	C
ATOM	7724	O	GLY	A1070	-11.389	41.160	-33.426	1.00	97.91	O
ATOM	7725	N	GLY	A1070	-10.617	42.147	-36.764	1.00	100.47	N
ATOM	7726	CA	GLY	A1070	-11.245	41.257	-35.805	1.00	95.37	C
ATOM	7727	C	GLY	A1070	-11.493	41.856	-34.436	1.00	96.84	C
ATOM	7728	O	GLU	A1071	-14.265	44.555	-33.813	1.00	85.32	O
ATOM	7729	N	GLU	A1071	-11.828	43.142	-34.402	1.00	95.93	N
ATOM	7730	CA	GLU	A1071	-12.067	43.837	-33.144	1.00	92.50	C
ATOM	7731	C	GLU	A1071	-13.558	44.081	-32.918	1.00	92.66	C
ATOM	7732	CB	GLU	A1071	-11.309	45.162	-33.120	1.00	94.91	C
ATOM	7733	CG	GLU	A1071	-11.393	45.908	-31.796	1.00	98.24	C
ATOM	7734	CD	GLU	A1071	-10.388	45.406	-30.777	1.00	100.32	C
ATOM	7735	OE1	GLU	A1071	-9.661	44.430	-31.081	1.00	92.31	O
ATOM	7736	OE2	GLU	A1071	-10.324	45.995	-29.674	1.00	99.36	O
ATOM	7737	O	ILE	A1072	-14.743	46.068	-30.281	1.00	91.58	O
ATOM	7738	N	ILE	A1072	-14.036	43.742	-31.724	1.00	90.58	N
ATOM	7739	CA	ILE	A1072	-15.418	44.026	-31.355	1.00	91.38	C
ATOM	7740	C	ILE	A1072	-15.559	45.510	-31.021	1.00	93.08	C
ATOM	7741	CB	ILE	A1072	-15.885	43.156	-30.167	1.00	93.18	C
ATOM	7742	CG1	ILE	A1072	-14.771	43.004	-29.121	1.00	94.64	C
ATOM	7743	CG2	ILE	A1072	-16.327	41.785	-30.664	1.00	94.59	C
ATOM	7744	CD1	ILE	A1072	-14.859	43.983	-27.953	1.00	101.93	C
ATOM	7745	O	VAL	A1073	-18.250	48.991	-30.326	1.00	85.29	O
ATOM	7746	N	VAL	A1073	-16.585	46.150	-31.580	1.00	86.27	N
ATOM	7747	CA	VAL	A1073	-16.685	47.599	-31.517	1.00	85.22	C
ATOM	7748	C	VAL	A1073	-18.089	48.075	-31.138	1.00	86.06	C
ATOM	7749	CB	VAL	A1073	-16.267	48.229	-32.863	1.00	84.72	C
ATOM	7750	CG1	VAL	A1073	-16.694	49.689	-32.930	1.00	81.53	C

ATOM	7751	CG2	VAL	A1073	-14.756	48.096	-33.070	1.00	83.88	C
ATOM	7752	N	TRP	A1074	-19.111	47.458	-31.715	1.00	83.00	N
ATOM	7753	CA	TRP	A1074	-20.467	47.802	-31.326	1.00	80.73	C
ATOM	7754	C	TRP	A1074	-21.368	46.576	-31.270	1.00	86.07	C
ATOM	7755	O	TRP	A1074	-21.857	46.095	-32.296	1.00	87.17	O
ATOM	7756	CB	TRP	A1074	-21.059	48.841	-32.276	1.00	82.55	C
ATOM	7757	CG	TRP	A1074	-22.292	49.495	-31.718	1.00	79.86	C
ATOM	7758	CD1	TRP	A1074	-23.568	49.387	-32.185	1.00	83.18	C
ATOM	7759	CD2	TRP	A1074	-22.357	50.338	-30.568	1.00	78.98	C
ATOM	7760	NE1	TRP	A1074	-24.427	50.122	-31.400	1.00	83.83	N
ATOM	7761	CE2	TRP	A1074	-23.703	50.712	-30.397	1.00	83.24	C
ATOM	7762	CE3	TRP	A1074	-21.404	50.819	-29.669	1.00	75.58	C
ATOM	7763	CZ2	TRP	A1074	-24.117	51.544	-29.364	1.00	84.64	C
ATOM	7764	CZ3	TRP	A1074	-21.812	51.637	-28.653	1.00	76.64	C
ATOM	7765	CH2	TRP	A1074	-23.157	51.996	-28.503	1.00	81.40	C
ATOM	7766	O	ASP	A1075	-24.380	46.165	-28.847	1.00	88.45	O
ATOM	7767	N	ASP	A1075	-21.583	46.077	-30.059	1.00	84.34	N
ATOM	7768	CA	ASP	A1075	-22.551	45.019	-29.828	1.00	84.36	C
ATOM	7769	C	ASP	A1075	-23.949	45.603	-29.844	1.00	83.58	C
ATOM	7770	CB	ASP	A1075	-22.281	44.336	-28.494	1.00	87.33	C
ATOM	7771	CG	ASP	A1075	-23.093	43.079	-28.313	1.00	92.45	C
ATOM	7772	OD2	ASP	A1075	-22.538	42.101	-27.765	1.00	93.17	O
ATOM	7773	OD1	ASP	A1075	-24.279	43.067	-28.721	1.00	92.41	O
ATOM	7774	O	LYS	A1076	-27.831	46.694	-29.759	1.00	89.90	O
ATOM	7775	N	LYS	A1076	-24.664	45.455	-30.955	1.00	80.86	N
ATOM	7776	CA	LYS	A1076	-25.935	46.159	-31.132	1.00	85.31	C
ATOM	7777	C	LYS	A1076	-26.971	45.861	-30.043	1.00	89.78	C
ATOM	7778	CB	LYS	A1076	-26.528	45.841	-32.499	1.00	87.75	C
ATOM	7779	O	GLY	A1077	-27.855	46.156	-26.668	1.00	87.92	O
ATOM	7780	N	GLY	A1077	-26.893	44.686	-29.425	1.00	91.92	N
ATOM	7781	CA	GLY	A1077	-27.768	44.390	-28.300	1.00	96.43	C
ATOM	7782	C	GLY	A1077	-27.305	45.113	-27.044	1.00	92.54	C
ATOM	7783	N	ARG	A1078	-26.277	44.539	-26.422	1.00	87.17	N
ATOM	7784	CA	ARG	A1078	-25.569	45.072	-25.252	1.00	88.76	C
ATOM	7785	C	ARG	A1078	-25.470	46.604	-25.082	1.00	91.27	C
ATOM	7786	O	ARG	A1078	-26.009	47.178	-24.126	1.00	86.93	O
ATOM	7787	CB	ARG	A1078	-24.140	44.517	-25.252	1.00	89.87	C
ATOM	7788	CG	ARG	A1078	-24.009	43.072	-24.812	1.00	91.02	C
ATOM	7789	CD	ARG	A1078	-22.580	42.806	-24.364	1.00	92.87	C
ATOM	7790	NE	ARG	A1078	-22.000	43.993	-23.732	1.00	94.63	C
ATOM	7791	CZ	ARG	A1078	-20.864	44.002	-23.040	1.00	103.51	N
ATOM	7792	NH1	ARG	A1078	-20.169	42.877	-22.879	1.00	100.68	N
ATOM	7793	NH2	ARG	A1078	-20.421	45.138	-22.506	1.00	92.45	N
ATOM	7794	N	ASP	A1079	-24.766	47.256	-26.002	1.00	87.71	N
ATOM	7795	CA	ASP	A1079	-24.294	48.616	-25.778	1.00	81.27	C
ATOM	7796	C	ASP	A1079	-25.376	49.695	-25.915	1.00	82.29	C
ATOM	7797	O	ASP	A1079	-25.201	50.799	-25.414	1.00	78.94	O
ATOM	7798	CB	ASP	A1079	-23.125	48.902	-26.719	1.00	82.48	C
ATOM	7799	CG	ASP	A1079	-21.990	47.891	-26.562	1.00	77.67	C
ATOM	7800	OD1	ASP	A1079	-21.928	47.220	-25.510	1.00	83.86	O
ATOM	7801	OD2	ASP	A1079	-21.158	47.775	-27.481	1.00	73.23	O
ATOM	7802	N	PHE	A1080	-26.489	49.385	-26.575	1.00	83.57	N
ATOM	7803	CA	PHE	A1080	-27.643	50.296	-26.586	1.00	81.19	C
ATOM	7804	C	PHE	A1080	-28.239	50.436	-25.186	1.00	80.24	C
ATOM	7805	O	PHE	A1080	-28.618	51.528	-24.765	1.00	81.54	O
ATOM	7806	CB	PHE	A1080	-28.735	49.810	-27.544	1.00	82.66	C
ATOM	7807	CG	PHE	A1080	-28.793	50.558	-28.849	1.00	88.54	C
ATOM	7808	CD1	PHE	A1080	-29.708	51.584	-29.035	1.00	85.76	C
ATOM	7809	CD2	PHE	A1080	-27.950	50.211	-29.904	1.00	92.75	C
ATOM	7810	CE1	PHE	A1080	-29.775	52.257	-30.240	1.00	88.11	C
ATOM	7811	CE2	PHE	A1080	-28.005	50.884	-31.110	1.00	89.89	C
ATOM	7812	CZ	PHE	A1080	-28.920	51.906	-31.279	1.00	92.06	C
ATOM	7813	N	ALA	A1081	-28.341	49.314	-24.479	1.00	80.67	N

ATOM	7814	CA	ALA	A1081	-28.834	49.314	-23.111	1.00	77.80	C
ATOM	7815	C	ALA	A1081	-27.771	49.884	-22.172	1.00	78.20	C
ATOM	7816	O	ALA	A1081	-28.100	50.563	-21.205	1.00	70.79	O
ATOM	7817	CB	ALA	A1081	-29.232	47.914	-22.688	1.00	74.95	C
ATOM	7818	N	THR	A1082	-26.500	49.594	-22.459	1.00	77.22	N
ATOM	7819	CA	THR	A1082	-25.395	50.183	-21.720	1.00	74.83	C
ATOM	7820	C	THR	A1082	-25.546	51.709	-21.737	1.00	79.13	C
ATOM	7821	O	THR	A1082	-25.478	52.370	-20.700	1.00	78.75	O
ATOM	7822	CB	THR	A1082	-24.021	49.781	-22.308	1.00	77.92	C
ATOM	7823	OG1	THR	A1082	-23.702	48.436	-21.935	1.00	83.90	O
ATOM	7824	CG2	THR	A1082	-22.933	50.699	-21.793	1.00	74.39	C
ATOM	7825	N	VAL	A1083	-25.789	52.251	-22.924	1.00	74.03	N
ATOM	7826	CA	VAL	A1083	-25.909	53.684	-23.107	1.00	73.17	C
ATOM	7827	C	VAL	A1083	-27.231	54.219	-22.542	1.00	74.08	C
ATOM	7828	O	VAL	A1083	-27.263	55.293	-21.952	1.00	71.63	O
ATOM	7829	CB	VAL	A1083	-25.763	54.052	-24.601	1.00	73.67	C
ATOM	7830	CG1	VAL	A1083	-26.110	55.513	-24.850	1.00	66.71	C
ATOM	7831	CG2	VAL	A1083	-24.347	53.751	-25.073	1.00	68.33	C
ATOM	7832	N	ARG	A1084	-28.321	53.474	-22.699	1.00	78.50	N
ATOM	7833	CA	ARG	A1084	-29.596	53.890	-22.105	1.00	75.07	C
ATOM	7834	C	ARG	A1084	-29.511	53.804	-20.580	1.00	74.23	C
ATOM	7835	O	ARG	A1084	-30.271	54.461	-19.874	1.00	73.03	O
ATOM	7836	CB	ARG	A1084	-30.760	53.033	-22.619	1.00	75.75	C
ATOM	7837	N	LYS	A1085	-28.585	52.984	-20.079	1.00	72.59	N
ATOM	7838	CA	LYS	A1085	-28.407	52.830	-18.639	1.00	72.80	C
ATOM	7839	C	LYS	A1085	-27.756	54.087	-18.079	1.00	73.61	C
ATOM	7840	O	LYS	A1085	-28.323	54.766	-17.212	1.00	69.88	O
ATOM	7841	CB	LYS	A1085	-27.560	51.597	-18.312	1.00	70.73	C
ATOM	7842	N	VAL	A1086	-26.564	54.381	-18.594	1.00	67.96	N
ATOM	7843	CA	VAL	A1086	-25.864	55.619	-18.307	1.00	64.39	C
ATOM	7844	C	VAL	A1086	-26.761	56.865	-18.268	1.00	65.74	C
ATOM	7845	O	VAL	A1086	-26.731	57.619	-17.300	1.00	68.22	O
ATOM	7846	CB	VAL	A1086	-24.766	55.845	-19.327	1.00	62.25	C
ATOM	7847	CG1	VAL	A1086	-24.229	57.252	-19.204	1.00	59.40	C
ATOM	7848	CG2	VAL	A1086	-23.673	54.829	-19.114	1.00	59.14	C
ATOM	7849	O	LEU	A1087	-30.338	59.096	-18.148	1.00	68.75	O
ATOM	7850	N	LEU	A1087	-27.578	57.084	-19.291	1.00	63.25	N
ATOM	7851	CA	LEU	A1087	-28.404	58.284	-19.297	1.00	61.57	C
ATOM	7852	C	LEU	A1087	-29.543	58.165	-18.294	1.00	66.00	C
ATOM	7853	CB	LEU	A1087	-28.981	58.578	-20.689	1.00	65.61	C
ATOM	7854	CG	LEU	A1087	-28.081	58.692	-21.923	1.00	61.50	C
ATOM	7855	CD1	LEU	A1087	-28.763	59.544	-22.987	1.00	63.15	C
ATOM	7856	CD2	LEU	A1087	-26.710	59.232	-21.593	1.00	60.36	C
ATOM	7857	N	SER	A1088	-29.633	57.029	-17.607	1.00	63.97	N
ATOM	7858	CA	SER	A1088	-30.661	56.867	-16.583	1.00	67.44	C
ATOM	7859	C	SER	A1088	-30.126	57.042	-15.158	1.00	64.25	C
ATOM	7860	O	SER	A1088	-30.915	57.170	-14.227	1.00	66.99	O
ATOM	7861	CB	SER	A1088	-31.341	55.502	-16.717	1.00	70.12	C
ATOM	7862	OG	SER	A1088	-32.372	55.535	-17.690	1.00	72.49	O
ATOM	7863	N	MET	A1089	-28.801	57.044	-15.000	1.00	64.97	N
ATOM	7864	CA	MET	A1089	-28.150	57.298	-13.710	1.00	65.89	C
ATOM	7865	C	MET	A1089	-28.736	58.529	-13.016	1.00	66.18	C
ATOM	7866	O	MET	A1089	-28.838	59.601	-13.619	1.00	64.18	O
ATOM	7867	CB	MET	A1089	-26.640	57.487	-13.889	1.00	60.67	C
ATOM	7868	CG	MET	A1089	-25.954	56.346	-14.566	1.00	63.17	C
ATOM	7869	SD	MET	A1089	-24.202	56.218	-14.165	1.00	70.86	S
ATOM	7870	CE	MET	A1089	-23.459	57.438	-15.231	1.00	68.08	C
ATOM	7871	O	PRO	A1090	-29.019	61.563	-10.068	1.00	71.94	O
ATOM	7872	N	PRO	A1090	-29.135	58.376	-11.746	1.00	66.31	N
ATOM	7873	CA	PRO	A1090	-29.758	59.481	-11.014	1.00	70.45	C
ATOM	7874	C	PRO	A1090	-28.707	60.440	-10.455	1.00	67.44	C
ATOM	7875	CB	PRO	A1090	-30.527	58.765	-9.897	1.00	70.30	C
ATOM	7876	CG	PRO	A1090	-29.731	57.524	-9.640	1.00	67.18	C

ATOM	7877	CD	PRO	A1090	-29.126	57.127	-10.968	1.00	67.17	C
ATOM	7878	O	GLN	A1091	-24.505	60.438	-11.319	1.00	59.29	O
ATOM	7879	N	GLN	A1091	-27.461	59.997	-10.441	1.00	60.34	N
ATOM	7880	CA	GLN	A1091	-26.390	60.777	-9.847	1.00	66.63	C
ATOM	7881	C	GLN	A1091	-25.333	61.237	-10.851	1.00	65.69	C
ATOM	7882	CB	GLN	A1091	-25.714	59.975	-8.733	1.00	61.52	C
ATOM	7883	CG	GLN	A1091	-24.838	60.810	-7.843	1.00	60.78	C
ATOM	7884	CD	GLN	A1091	-23.434	60.962	-8.374	1.00	59.41	C
ATOM	7885	OE1	GLN	A1091	-22.777	59.979	-8.705	1.00	57.64	O
ATOM	7886	NE2	GLN	A1091	-22.963	62.205	-8.462	1.00	56.49	N
ATOM	7887	O	VAL	A1092	-24.355	65.123	-10.517	1.00	52.96	O
ATOM	7888	N	VAL	A1092	-25.356	62.539	-11.144	1.00	60.80	N
ATOM	7889	CA	VAL	A1092	-24.318	63.191	-11.937	1.00	54.88	C
ATOM	7890	C	VAL	A1092	-23.659	64.334	-11.159	1.00	56.18	C
ATOM	7891	CB	VAL	A1092	-24.896	63.767	-13.229	1.00	58.39	C
ATOM	7892	CG1	VAL	A1092	-23.803	63.890	-14.270	1.00	58.02	C
ATOM	7893	CG2	VAL	A1092	-26.044	62.909	-13.718	1.00	62.34	C
ATOM	7894	O	ASN	A1093	-21.055	67.343	-12.095	1.00	49.06	O
ATOM	7895	N	ASN	A1093	-22.338	64.450	-11.238	1.00	53.28	N
ATOM	7896	CA	ASN	A1093	-21.630	65.555	-10.578	1.00	53.79	C
ATOM	7897	C	ASN	A1093	-21.824	66.929	-11.223	1.00	48.48	C
ATOM	7898	CB	ASN	A1093	-20.130	65.270	-10.526	1.00	50.22	C
ATOM	7899	CG	ASN	A1093	-19.818	63.966	-9.878	1.00	56.21	C
ATOM	7900	OD1	ASN	A1093	-20.345	63.645	-8.803	1.00	54.19	O
ATOM	7901	ND2	ASN	A1093	-18.958	63.183	-10.528	1.00	52.21	N
ATOM	7902	O	ILE	A1094	-22.948	70.241	-9.268	1.00	56.07	O
ATOM	7903	N	ILE	A1094	-22.817	67.663	-10.768	1.00	47.30	N
ATOM	7904	CA	ILE	A1094	-23.021	69.005	-11.303	1.00	49.88	C
ATOM	7905	C	ILE	A1094	-22.455	70.066	-10.374	1.00	49.69	C
ATOM	7906	CB	ILE	A1094	-24.498	69.258	-11.548	1.00	50.13	C
ATOM	7907	CG1	ILE	A1094	-24.939	68.462	-12.775	1.00	52.19	C
ATOM	7908	CG2	ILE	A1094	-24.768	70.711	-11.752	1.00	41.31	C
ATOM	7909	CD1	ILE	A1094	-26.377	68.657	-13.069	1.00	60.27	C
ATOM	7910	O	VAL	A1095	-20.680	73.477	-11.688	1.00	45.39	O
ATOM	7911	N	VAL	A1095	-21.414	70.762	-10.818	1.00	46.32	N
ATOM	7912	CA	VAL	A1095	-20.791	71.797	-10.000	1.00	45.17	C
ATOM	7913	C	VAL	A1095	-21.025	73.203	-10.546	1.00	44.25	C
ATOM	7914	CB	VAL	A1095	-19.264	71.615	-9.898	1.00	47.62	C
ATOM	7915	CG1	VAL	A1095	-18.647	72.799	-9.136	1.00	41.12	C
ATOM	7916	CG2	VAL	A1095	-18.893	70.272	-9.267	1.00	44.61	C
ATOM	7917	O	LYS	A1096	-20.069	76.164	-8.383	1.00	43.21	O
ATOM	7918	N	LYS	A1096	-21.577	74.097	-9.724	1.00	41.81	N
ATOM	7919	CA	LYS	A1096	-21.616	75.520	-10.047	1.00	36.17	C
ATOM	7920	C	LYS	A1096	-20.331	76.158	-9.562	1.00	36.81	C
ATOM	7921	CB	LYS	A1096	-22.818	76.207	-9.392	1.00	39.87	C
ATOM	7922	CG	LYS	A1096	-23.612	77.176	-10.276	1.00	41.98	C
ATOM	7923	CD	LYS	A1096	-22.755	78.237	-10.946	1.00	44.28	C
ATOM	7924	CE	LYS	A1096	-23.589	79.440	-11.427	1.00	44.28	C
ATOM	7925	NZ	LYS	A1096	-24.549	79.086	-12.503	1.00	47.68	N
ATOM	7926	O	LYS	A1097	-19.206	79.559	-9.524	1.00	38.09	O
ATOM	7927	N	LYS	A1097	-19.537	76.716	-10.457	1.00	34.09	N
ATOM	7928	CA	LYS	A1097	-18.295	77.363	-10.064	1.00	37.50	C
ATOM	7929	C	LYS	A1097	-18.542	78.581	-9.132	1.00	42.09	C
ATOM	7930	CB	LYS	A1097	-17.533	77.792	-11.319	1.00	37.70	C
ATOM	7931	CG	LYS	A1097	-16.103	78.243	-11.120	1.00	37.59	C
ATOM	7932	CD	LYS	A1097	-15.592	78.759	-12.431	1.00	38.00	C
ATOM	7933	CE	LYS	A1097	-14.202	79.321	-12.368	1.00	39.74	C
ATOM	7934	NZ	LYS	A1097	-14.049	80.484	-11.500	1.00	39.99	N
ATOM	7935	O	THR	A1098	-16.031	80.479	-7.586	1.00	41.83	O
ATOM	7936	N	THR	A1098	-18.030	78.496	-7.899	1.00	40.33	N
ATOM	7937	CA	THR	A1098	-18.148	79.575	-6.920	1.00	39.53	C
ATOM	7938	C	THR	A1098	-17.210	80.708	-7.278	1.00	45.50	C
ATOM	7939	CB	THR	A1098	-17.847	79.120	-5.501	1.00	41.93	C

ATOM	7940	OG1	THR	A1098	-16.463	78.789	-5.400	1.00	59.41	O
ATOM	7941	CG2	THR	A1098	-18.712	77.916	-5.117	1.00	32.77	C
ATOM	7942	O	GLU	A1099	-18.427	84.538	-6.389	1.00	38.92	O
ATOM	7943	N	GLU	A1099	-17.752	81.928	-7.268	1.00	36.57	N
ATOM	7944	CA	GLU	A1099	-17.028	83.090	-7.742	1.00	44.64	C
ATOM	7945	C	GLU	A1099	-17.296	84.302	-6.834	1.00	48.07	C
ATOM	7946	CB	GLU	A1099	-17.411	83.413	-9.203	1.00	42.84	C
ATOM	7947	CG	GLU	A1099	-16.981	82.334	-10.219	1.00	47.48	C
ATOM	7948	CD	GLU	A1099	-17.120	82.746	-11.693	1.00	49.59	C
ATOM	7949	OE1	GLU	A1099	-17.987	83.582	-12.025	1.00	48.04	O
ATOM	7950	OE2	GLU	A1099	-16.347	82.216	-12.530	1.00	51.25	O
ATOM	7951	O	VAL	A1100	-16.199	87.446	-8.001	1.00	37.06	O
ATOM	7952	N	VAL	A1100	-16.225	85.032	-6.544	1.00	41.36	N
ATOM	7953	CA	VAL	A1100	-16.319	86.322	-5.899	1.00	43.86	C
ATOM	7954	C	VAL	A1100	-16.796	87.327	-6.930	1.00	41.86	C
ATOM	7955	CB	VAL	A1100	-14.958	86.785	-5.301	1.00	44.09	C
ATOM	7956	CG2	VAL	A1100	-14.536	85.873	-4.187	1.00	42.64	C
ATOM	7957	CG1	VAL	A1100	-15.053	88.201	-4.794	1.00	42.38	C
ATOM	7958	O	GLN	A1101	-17.057	90.694	-6.574	1.00	45.71	O
ATOM	7959	N	GLN	A1101	-17.889	88.022	-6.617	1.00	40.81	N
ATOM	7960	CA	GLN	A1101	-18.438	89.021	-7.535	1.00	38.50	C
ATOM	7961	C	GLN	A1101	-17.504	90.207	-7.602	1.00	42.73	C
ATOM	7962	CB	GLN	A1101	-19.844	89.443	-7.105	1.00	35.82	C
ATOM	7963	CG	GLN	A1101	-20.817	88.252	-7.038	1.00	37.00	C
ATOM	7964	CD	GLN	A1101	-20.789	87.448	-8.315	1.00	45.09	C
ATOM	7965	OE1	GLN	A1101	-21.340	87.872	-9.326	1.00	48.52	O
ATOM	7966	NE2	GLN	A1101	-20.095	86.310	-8.297	1.00	39.64	N
ATOM	7967	O	THR	A1102	-18.122	92.705	-10.428	1.00	47.00	O
ATOM	7968	N	THR	A1102	-17.168	90.648	-8.812	1.00	40.26	N
ATOM	7969	CA	THR	A1102	-16.357	91.852	-8.963	1.00	43.91	C
ATOM	7970	C	THR	A1102	-17.029	92.916	-9.892	1.00	43.58	C
ATOM	7971	CB	THR	A1102	-14.940	91.507	-9.484	1.00	41.26	C
ATOM	7972	OG1	THR	A1102	-14.967	91.302	-10.904	1.00	41.76	O
ATOM	7973	CG2	THR	A1102	-14.391	90.265	-8.766	1.00	41.07	C
ATOM	7974	O	GLY	A1103	-16.959	96.890	-9.204	1.00	41.40	O
ATOM	7975	N	GLY	A1103	-16.397	94.069	-10.047	1.00	39.63	N
ATOM	7976	CA	GLY	A1103	-17.005	95.125	-10.851	1.00	49.19	C
ATOM	7977	C	GLY	A1103	-17.576	96.351	-10.129	1.00	44.26	C
ATOM	7978	O	GLY	A1104	-20.476	96.967	-8.388	1.00	40.48	O
ATOM	7979	N	GLY	A1104	-18.756	96.788	-10.575	1.00	49.33	N
ATOM	7980	CA	GLY	A1104	-19.353	98.053	-10.173	1.00	32.25	C
ATOM	7981	C	GLY	A1104	-19.928	97.990	-8.777	1.00	41.39	C
ATOM	7982	O	PHE	A1105	-22.228	98.187	-5.605	1.00	46.19	O
ATOM	7983	N	PHE	A1105	-19.817	99.088	-8.029	1.00	41.23	N
ATOM	7984	CA	PHE	A1105	-20.283	99.140	-6.640	1.00	40.19	C
ATOM	7985	C	PHE	A1105	-21.779	98.876	-6.516	1.00	41.13	C
ATOM	7986	CB	PHE	A1105	-19.932	100.494	-6.012	1.00	41.31	C
ATOM	7987	CG	PHE	A1105	-18.460	100.718	-5.850	1.00	40.58	C
ATOM	7988	CD1	PHE	A1105	-17.593	99.638	-5.805	1.00	42.47	C
ATOM	7989	CD2	PHE	A1105	-17.943	101.989	-5.763	1.00	37.72	C
ATOM	7990	CE1	PHE	A1105	-16.244	99.818	-5.671	1.00	41.14	C
ATOM	7991	CE2	PHE	A1105	-16.589	102.193	-5.636	1.00	38.64	C
ATOM	7992	CZ	PHE	A1105	-15.739	101.107	-5.584	1.00	51.82	C
ATOM	7993	O	SER	A1106	-23.860	99.958	-9.653	1.00	47.44	O
ATOM	7994	N	SER	A1106	-22.548	99.381	-7.464	1.00	43.71	N
ATOM	7995	CA	SER	A1106	-23.993	99.278	-7.388	1.00	42.69	C
ATOM	7996	C	SER	A1106	-24.595	99.649	-8.720	1.00	46.77	C
ATOM	7997	CB	SER	A1106	-24.532	100.214	-6.327	1.00	47.35	C
ATOM	7998	OG	SER	A1106	-24.558	101.510	-6.878	1.00	45.00	O
ATOM	7999	O	LYS	A1107	-25.793	102.271	-9.241	1.00	51.24	O
ATOM	8000	N	LYS	A1107	-25.927	99.656	-8.794	1.00	48.90	N
ATOM	8001	CA	LYS	A1107	-26.632	100.151	-9.960	1.00	46.07	C
ATOM	8002	C	LYS	A1107	-26.170	101.567	-10.197	1.00	56.61	C

ATOM	8003	CB	LYS	A1107	-28.142	100.102	-9.759	1.00	50.25	C
ATOM	8004	CG	LYS	A1107	-28.774	98.782	-10.033	1.00	52.95	C
ATOM	8005	CD	LYS	A1107	-30.295	98.862	-10.012	1.00	61.40	C
ATOM	8006	CE	LYS	A1107	-30.853	99.824	-11.077	1.00	72.93	C
ATOM	8007	NZ	LYS	A1107	-31.452	101.067	-10.476	1.00	72.62	N
ATOM	8008	O	GLU	A1108	-26.275	105.634	-11.719	1.00	48.74	O
ATOM	8009	N	GLU	A1108	-26.190	101.999	-11.452	1.00	57.89	N
ATOM	8010	CA	GLU	A1108	-25.645	103.311	-11.786	1.00	51.33	C
ATOM	8011	C	GLU	A1108	-26.655	104.465	-11.686	1.00	52.20	C
ATOM	8012	CB	GLU	A1108	-25.041	103.269	-13.182	1.00	54.96	C
ATOM	8013	CG	GLU	A1108	-23.784	102.460	-13.259	1.00	50.96	C
ATOM	8014	CD	GLU	A1108	-22.711	103.120	-14.095	1.00	57.35	C
ATOM	8015	OE1	GLU	A1108	-22.899	104.288	-14.496	1.00	67.64	O
ATOM	8016	OE2	GLU	A1108	-21.667	102.476	-14.347	1.00	66.53	O
ATOM	8017	O	SER	A1109	-28.834	105.458	-9.045	1.00	57.43	O
ATOM	8018	N	SER	A1109	-27.928	104.134	-11.553	1.00	52.18	N
ATOM	8019	CA	SER	A1109	-28.955	105.156	-11.432	1.00	53.62	C
ATOM	8020	C	SER	A1109	-28.788	105.983	-10.154	1.00	52.13	C
ATOM	8021	CB	SER	A1109	-30.341	104.515	-11.476	1.00	57.24	C
ATOM	8022	OG	SER	A1109	-30.389	103.354	-10.657	1.00	64.06	O
ATOM	8023	O	ILE	A1110	-30.626	109.256	-9.521	1.00	48.48	O
ATOM	8024	N	ILE	A1110	-28.561	107.277	-10.315	1.00	48.71	N
ATOM	8025	CA	ILE	A1110	-28.501	108.165	-9.169	1.00	53.16	C
ATOM	8026	C	ILE	A1110	-29.938	108.547	-8.779	1.00	56.58	C
ATOM	8027	CB	ILE	A1110	-27.659	109.393	-9.479	1.00	54.11	C
ATOM	8028	CG1	ILE	A1110	-26.188	108.988	-9.541	1.00	54.98	C
ATOM	8029	CG2	ILE	A1110	-27.826	110.410	-8.409	1.00	57.43	C
ATOM	8030	CD1	ILE	A1110	-25.291	109.865	-10.401	1.00	60.05	C
ATOM	8031	O	LEU	A1111	-31.050	110.050	-5.946	1.00	57.62	O
ATOM	8032	N	LEU	A1111	-30.398	108.033	-7.637	1.00	54.25	N
ATOM	8033	CA	LEU	A1111	-31.798	108.177	-7.245	1.00	54.46	C
ATOM	8034	C	LEU	A1111	-32.008	109.492	-6.481	1.00	57.56	C
ATOM	8035	CB	LEU	A1111	-32.239	106.972	-6.402	1.00	54.60	C
ATOM	8036	CG	LEU	A1111	-31.906	105.561	-6.919	1.00	61.46	C
ATOM	8037	CD1	LEU	A1111	-32.000	104.542	-5.799	1.00	66.98	C
ATOM	8038	CD2	LEU	A1111	-32.783	105.121	-8.081	1.00	57.08	C
ATOM	8039	O	PRO	A1112	-33.522	109.996	-3.634	1.00	60.89	O
ATOM	8040	N	PRO	A1112	-33.263	109.993	-6.438	1.00	55.38	N
ATOM	8041	CA	PRO	A1112	-33.599	111.232	-5.710	1.00	57.87	C
ATOM	8042	C	PRO	A1112	-33.518	111.105	-4.182	1.00	65.24	C
ATOM	8043	CB	PRO	A1112	-35.043	111.517	-6.132	1.00	52.30	C
ATOM	8044	CG	PRO	A1112	-35.288	110.644	-7.340	1.00	53.66	C
ATOM	8045	CD	PRO	A1112	-34.425	109.447	-7.157	1.00	48.36	C
ATOM	8046	O	LYS	A1113	-35.723	111.604	-2.045	1.00	74.43	O
ATOM	8047	N	LYS	A1113	-33.462	112.254	-3.508	1.00	66.95	N
ATOM	8048	CA	LYS	A1113	-33.411	112.301	-2.052	1.00	69.13	C
ATOM	8049	C	LYS	A1113	-34.624	111.582	-1.474	1.00	74.48	C
ATOM	8050	CB	LYS	A1113	-33.338	113.747	-1.544	1.00	70.52	C
ATOM	8051	CG	LYS	A1113	-34.642	114.532	-1.648	1.00	71.95	C
ATOM	8052	CD	LYS	A1113	-34.472	115.955	-1.160	1.00	72.17	C
ATOM	8053	CE	LYS	A1113	-35.779	116.720	-1.277	1.00	66.86	C
ATOM	8054	NZ	LYS	A1113	-35.658	118.077	-0.694	1.00	74.96	N
ATOM	8055	O	ARG	A1114	-34.457	110.793	2.304	1.00	88.88	O
ATOM	8056	N	ARG	A1114	-34.404	110.921	-0.347	1.00	78.86	N
ATOM	8057	CA	ARG	A1114	-35.403	110.037	0.225	1.00	87.40	C
ATOM	8058	C	ARG	A1114	-35.295	110.071	1.750	1.00	91.62	C
ATOM	8059	CB	ARG	A1114	-35.206	108.618	-0.311	1.00	89.01	C
ATOM	8060	CG	ARG	A1114	-36.435	107.743	-0.302	1.00	93.38	C
ATOM	8061	CD	ARG	A1114	-36.015	106.301	-0.119	1.00	99.17	C
ATOM	8062	NE	ARG	A1114	-36.274	105.483	-1.296	1.00	97.66	N
ATOM	8063	CZ	ARG	A1114	-35.680	104.319	-1.532	1.00	104.74	C
ATOM	8064	NH1	ARG	A1114	-35.978	103.631	-2.628	1.00	115.51	N
ATOM	8065	NH2	ARG	A1114	-34.778	103.848	-0.676	1.00	97.03	N

ATOM	8066	O	ASN	A1115	-34.688	108.000	5.422	1.00	95.81	O
ATOM	8067	N	ASN	A1115	-36.139	109.298	2.426	1.00	95.31	N
ATOM	8068	CA	ASN	A1115	-36.079	109.211	3.878	1.00	96.63	C
ATOM	8069	C	ASN	A1115	-35.323	107.958	4.368	1.00	96.83	C
ATOM	8070	CB	ASN	A1115	-37.493	109.247	4.464	1.00	94.65	C
ATOM	8071	CG	ASN	A1115	-37.522	109.796	5.881	1.00	98.01	C
ATOM	8072	OD1	ASN	A1115	-36.808	110.745	6.203	1.00	100.26	O
ATOM	8073	ND2	ASN	A1115	-38.342	109.193	6.737	1.00	95.99	N
ATOM	8074	O	SER	A1116	-32.577	106.619	3.906	1.00	101.78	O
ATOM	8075	N	SER	A1116	-35.376	106.867	3.595	1.00	100.26	N
ATOM	8076	CA	SER	A1116	-34.751	105.581	3.966	1.00	101.14	C
ATOM	8077	C	SER	A1116	-33.258	105.669	4.289	1.00	99.89	C
ATOM	8078	CB	SER	A1116	-34.932	104.545	2.847	1.00	95.30	C
ATOM	8079	OG	SER	A1116	-36.294	104.360	2.510	1.00	105.71	O
ATOM	8080	O	ASP	A1117	-29.484	103.382	4.270	1.00	97.54	O
ATOM	8081	N	ASP	A1117	-32.755	104.662	4.995	1.00	96.65	N
ATOM	8082	CA	ASP	A1117	-31.329	104.566	5.269	1.00	97.11	C
ATOM	8083	C	ASP	A1117	-30.689	103.646	4.231	1.00	98.93	C
ATOM	8084	CB	ASP	A1117	-31.080	104.054	6.691	1.00	96.96	C
ATOM	8085	O	LYS	A1118	-29.003	102.195	1.077	1.00	90.62	O
ATOM	8086	N	LYS	A1118	-31.519	103.177	3.299	1.00	99.80	N
ATOM	8087	CA	LYS	A1118	-31.114	102.259	2.234	1.00	90.67	C
ATOM	8088	C	LYS	A1118	-30.036	102.826	1.301	1.00	88.11	C
ATOM	8089	CB	LYS	A1118	-32.339	101.856	1.404	1.00	83.56	C
ATOM	8090	O	LEU	A1119	-27.708	105.324	1.134	1.00	77.86	O
ATOM	8091	N	LEU	A1119	-30.280	104.020	0.771	1.00	80.34	N
ATOM	8092	CA	LEU	A1119	-29.472	104.575	-0.308	1.00	75.95	C
ATOM	8093	C	LEU	A1119	-28.013	104.849	0.051	1.00	73.23	C
ATOM	8094	CB	LEU	A1119	-30.114	105.870	-0.818	1.00	74.50	C
ATOM	8095	CG	LEU	A1119	-31.605	105.796	-1.180	1.00	83.59	C
ATOM	8096	CD1	LEU	A1119	-32.131	107.161	-1.620	1.00	78.02	C
ATOM	8097	CD2	LEU	A1119	-31.900	104.729	-2.240	1.00	79.66	C
ATOM	8098	O	ILE	A1120	-26.081	106.879	-1.848	1.00	71.33	O
ATOM	8099	N	ILE	A1120	-27.123	104.559	-0.893	1.00	71.12	N
ATOM	8100	CA	ILE	A1120	-25.697	104.815	-0.737	1.00	72.54	C
ATOM	8101	C	ILE	A1120	-25.403	106.271	-1.033	1.00	68.41	C
ATOM	8102	CB	ILE	A1120	-24.832	103.948	-1.690	1.00	69.56	C
ATOM	8103	CG1	ILE	A1120	-25.410	102.544	-1.843	1.00	68.33	C
ATOM	8104	CG2	ILE	A1120	-23.381	103.903	-1.207	1.00	65.42	C
ATOM	8105	CD1	ILE	A1120	-25.409	101.775	-0.566	1.00	73.25	C
ATOM	8106	O	ALA	A1121	-21.956	107.768	-1.733	1.00	70.50	O
ATOM	8107	N	ALA	A1121	-24.373	106.817	-0.398	1.00	69.30	N
ATOM	8108	CA	ALA	A1121	-24.002	108.217	-0.583	1.00	71.51	C
ATOM	8109	C	ALA	A1121	-23.015	108.385	-1.733	1.00	69.34	C
ATOM	8110	CB	ALA	A1121	-23.407	108.778	0.706	1.00	66.45	C
ATOM	8111	O	ARG	A1122	-20.123	109.988	-4.021	1.00	63.32	O
ATOM	8112	N	ARG	A1122	-23.354	109.226	-2.705	1.00	65.15	N
ATOM	8113	CA	ARG	A1122	-22.442	109.504	-3.811	1.00	61.15	C
ATOM	8114	C	ARG	A1122	-21.130	110.130	-3.360	1.00	63.20	C
ATOM	8115	CB	ARG	A1122	-23.094	110.427	-4.820	1.00	54.77	C
ATOM	8116	CG	ARG	A1122	-24.330	109.876	-5.430	1.00	56.21	C
ATOM	8117	CD	ARG	A1122	-25.050	110.973	-6.170	1.00	57.18	C
ATOM	8118	NE	ARG	A1122	-24.248	111.513	-7.253	1.00	54.10	N
ATOM	8119	CE	ARG	A1122	-24.464	112.694	-7.823	1.00	57.31	C
ATOM	8120	NH1	ARG	A1122	-25.457	113.477	-7.393	1.00	47.56	N
ATOM	8121	NH2	ARG	A1122	-23.677	113.094	-8.816	1.00	56.30	N
ATOM	8122	O	LYS	A1123	-21.024	110.750	0.329	1.00	65.87	O
ATOM	8123	N	LYS	A1123	-21.146	110.877	-2.266	1.00	63.77	N
ATOM	8124	CA	LYS	A1123	-19.899	111.342	-1.688	1.00	60.08	C
ATOM	8125	C	LYS	A1123	-19.958	111.088	-0.197	1.00	68.39	C
ATOM	8126	CB	LYS	A1123	-19.662	112.812	-1.993	1.00	67.12	C
ATOM	8127	CG	LYS	A1123	-19.441	113.110	-3.465	1.00	62.85	C
ATOM	8128	CD	LYS	A1123	-18.126	112.570	-3.959	1.00	56.40	C

ATOM	8129	CE	LYS	A1123	-17.846	113.080	-5.361	1.00	49.06	C
ATOM	8130	NZ	LYS	A1123	-16.474	112.763	-5.813	1.00	54.86	N
ATOM	8131	O	LYS	A1124	-20.571	111.523	3.422	1.00	77.47	O
ATOM	8132	N	LYS	A1124	-18.811	111.210	0.474	1.00	71.65	N
ATOM	8133	CA	LYS	A1124	-18.743	110.997	1.922	1.00	75.75	C
ATOM	8134	C	LYS	A1124	-19.699	111.944	2.647	1.00	75.98	C
ATOM	8135	CB	LYS	A1124	-17.309	111.198	2.432	1.00	69.49	C
ATOM	8136	O	ASP	A1125	-22.018	115.749	2.356	1.00	81.10	O
ATOM	8137	N	ASP	A1125	-19.544	113.228	2.352	1.00	73.33	N
ATOM	8138	CA	ASP	A1125	-20.289	114.266	3.034	1.00	71.12	C
ATOM	8139	C	ASP	A1125	-21.586	114.601	2.321	1.00	75.14	C
ATOM	8140	CB	ASP	A1125	-19.425	115.521	3.166	1.00	72.27	C
ATOM	8141	O	TRP	A1126	-24.816	111.903	0.810	1.00	68.99	O
ATOM	8142	N	TRP	A1126	-22.208	113.614	1.679	1.00	71.28	N
ATOM	8143	CA	TRP	A1126	-23.478	113.851	0.999	1.00	68.37	C
ATOM	8144	C	TRP	A1126	-24.553	112.906	1.459	1.00	69.91	C
ATOM	8145	CB	TRP	A1126	-23.352	113.712	-0.512	1.00	62.43	C
ATOM	8146	CG	TRP	A1126	-22.600	114.790	-1.186	1.00	65.00	C
ATOM	8147	CD1	TRP	A1126	-22.015	115.872	-0.609	1.00	67.98	C
ATOM	8148	CD2	TRP	A1126	-22.344	114.896	-2.594	1.00	67.45	C
ATOM	8149	NE1	TRP	A1126	-21.409	116.655	-1.568	1.00	70.58	N
ATOM	8150	CE2	TRP	A1126	-21.593	116.071	-2.795	1.00	69.63	C
ATOM	8151	CE3	TRP	A1126	-22.677	114.106	-3.704	1.00	59.47	C
ATOM	8152	CZ2	TRP	A1126	-21.165	116.476	-4.066	1.00	64.33	C
ATOM	8153	CZ3	TRP	A1126	-22.255	114.508	-4.954	1.00	60.12	C
ATOM	8154	CH2	TRP	A1126	-21.502	115.679	-5.128	1.00	59.32	C
ATOM	8155	O	ASP	A1127	-27.868	113.408	1.457	1.00	73.66	O
ATOM	8156	N	ASP	A1127	-25.204	113.239	2.561	1.00	74.72	N
ATOM	8157	CA	ASP	A1127	-26.321	112.432	3.023	1.00	71.06	C
ATOM	8158	C	ASP	A1127	-27.460	112.383	1.999	1.00	71.45	C
ATOM	8159	CB	ASP	A1127	-26.846	112.953	4.355	1.00	66.66	C
ATOM	8160	CG	ASP	A1127	-27.759	111.964	5.020	1.00	74.75	C
ATOM	8161	OD1	ASP	A1127	-28.851	111.718	4.463	1.00	75.45	O
ATOM	8162	OD2	ASP	A1127	-27.381	111.411	6.079	1.00	78.60	O
ATOM	8163	O	PRO	A1128	-31.405	111.202	0.501	1.00	74.82	O
ATOM	8164	N	PRO	A1128	-27.966	111.175	1.727	1.00	75.63	N
ATOM	8165	CA	PRO	A1128	-29.046	110.944	0.758	1.00	70.73	C
ATOM	8166	C	PRO	A1128	-30.427	111.364	1.238	1.00	74.04	C
ATOM	8167	CB	PRO	A1128	-28.998	109.422	0.540	1.00	71.26	C
ATOM	8168	CG	PRO	A1128	-27.592	109.031	0.907	1.00	72.40	C
ATOM	8169	CD	PRO	A1128	-27.251	109.929	2.062	1.00	72.38	C
ATOM	8170	O	LYS	A1129	-33.163	114.073	1.789	1.00	68.00	O
ATOM	8171	N	LYS	A1129	-30.530	111.871	2.459	1.00	74.88	N
ATOM	8172	CA	LYS	A1129	-31.813	112.409	2.903	1.00	80.55	C
ATOM	8173	C	LYS	A1129	-32.039	113.724	2.162	1.00	73.37	C
ATOM	8174	CE	LYS	A1129	-31.844	112.612	4.423	1.00	80.30	C
ATOM	8175	O	LYS	A1130	-31.147	116.291	-1.053	1.00	72.03	O
ATOM	8176	N	LYS	A1130	-30.930	114.418	1.931	1.00	70.39	N
ATOM	8177	CA	LYS	A1130	-30.925	115.706	1.267	1.00	73.72	C
ATOM	8178	C	LYS	A1130	-30.554	115.607	-0.218	1.00	72.47	C
ATOM	8179	CB	LYS	A1130	-29.954	116.647	1.991	1.00	73.35	C
ATOM	8180	CG	LYS	A1130	-30.317	116.872	3.457	1.00	69.67	C
ATOM	8181	CD	LYS	A1130	-29.457	117.928	4.120	1.00	69.79	C
ATOM	8182	CE	LYS	A1130	-28.050	117.423	4.401	1.00	71.79	C
ATOM	8183	NZ	LYS	A1130	-27.295	118.340	5.302	1.00	66.43	N
ATOM	8184	O	TYR	A1131	-28.634	113.515	-3.864	1.00	65.12	O
ATOM	8185	N	TYR	A1131	-29.603	114.733	-0.540	1.00	69.68	N
ATOM	8186	CA	TYR	A1131	-28.945	114.753	-1.843	1.00	69.39	C
ATOM	8187	C	TYR	A1131	-29.152	113.529	-2.757	1.00	68.91	C
ATOM	8188	CB	TYR	A1131	-27.443	114.956	-1.627	1.00	65.10	C
ATOM	8189	CG	TYR	A1131	-27.097	116.270	-0.949	1.00	70.18	C
ATOM	8190	CD2	TYR	A1131	-27.131	117.466	-1.657	1.00	67.92	C
ATOM	8191	CD1	TYR	A1131	-26.747	116.319	0.394	1.00	73.69	C

ATOM	8192	CE2	TYR	A1131	-26.821	118.676	-1.057	1.00	67.88	C
ATOM	8193	CE1	TYR	A1131	-26.435	117.535	1.010	1.00	72.22	C
ATOM	8194	CZ	TYR	A1131	-26.472	118.704	0.277	1.00	72.83	C
ATOM	8195	OH	TYR	A1131	-26.161	119.911	0.864	1.00	76.72	O
ATOM	8196	O	GLY	A1132	-27.845	110.666	-2.649	1.00	67.86	O
ATOM	8197	N	GLY	A1132	-29.895	112.515	-2.317	1.00	69.93	N
ATOM	8198	CA	GLY	A1132	-30.114	111.323	-3.131	1.00	62.93	C
ATOM	8199	O	GLY	A1132	-28.916	110.374	-3.196	1.00	70.68	C
ATOM	8200	C	GLY	A1133	-29.275	106.797	-5.407	1.00	63.00	O
ATOM	8201	N	GLY	A1133	-29.085	109.233	-3.871	1.00	65.30	N
ATOM	8202	CA	GLY	A1133	-27.994	108.285	-4.014	1.00	57.38	C
ATOM	8203	C	GLY	A1133	-28.274	106.963	-4.715	1.00	58.03	C
ATOM	8204	O	PHE	A1134	-27.996	103.738	-3.052	1.00	63.83	O
ATOM	8205	N	PHE	A1134	-27.365	106.011	-4.542	1.00	58.32	N
ATOM	8206	CA	PHE	A1134	-27.498	104.703	-5.184	1.00	60.23	C
ATOM	8207	C	PHE	A1134	-28.157	103.681	-4.266	1.00	59.94	C
ATOM	8208	CB	PHE	A1134	-26.132	104.164	-5.608	1.00	54.26	C
ATOM	8209	CG	PHE	A1134	-25.281	105.144	-6.363	1.00	53.44	C
ATOM	8210	CD1	PHE	A1134	-25.543	105.431	-7.694	1.00	52.07	C
ATOM	8211	CD2	PHE	A1134	-24.195	105.748	-5.754	1.00	50.68	C
ATOM	8212	CE1	PHE	A1134	-24.733	106.306	-8.391	1.00	46.31	C
ATOM	8213	CE2	PHE	A1134	-23.391	106.623	-6.442	1.00	44.11	C
ATOM	8214	CZ	PHE	A1134	-23.658	106.906	-7.754	1.00	45.39	C
ATOM	8215	O	ASP	A1135	-27.765	100.353	-5.522	1.00	54.60	O
ATOM	8216	N	ASP	A1135	-28.883	102.736	-4.842	1.00	55.27	N
ATOM	8217	CA	ASP	A1135	-29.285	101.570	-4.074	1.00	61.24	C
ATOM	8218	C	ASP	A1135	-28.628	100.291	-4.642	1.00	58.31	C
ATOM	8219	CB	ASP	A1135	-30.822	101.460	-4.009	1.00	67.15	C
ATOM	8220	CG	ASP	A1135	-31.469	101.004	-5.325	1.00	78.68	C
ATOM	8221	OD2	ASP	A1135	-30.791	100.899	-6.374	1.00	75.65	O
ATOM	8222	OD1	ASP	A1135	-32.694	100.742	-5.297	1.00	93.29	O
ATOM	8223	O	SER	A1136	-26.420	97.579	-5.646	1.00	62.14	O
ATOM	8224	N	SER	A1136	-29.026	99.146	-4.105	1.00	58.28	N
ATOM	8225	CA	SER	A1136	-28.547	97.848	-4.576	1.00	62.83	C
ATOM	8226	C	SER	A1136	-27.019	97.717	-4.577	1.00	56.22	C
ATOM	8227	CB	SER	A1136	-29.080	97.572	-5.993	1.00	64.10	C
ATOM	8228	OG	SER	A1136	-30.380	98.117	-6.180	1.00	72.60	O
ATOM	8229	O	PRO	A1137	-25.407	95.151	-3.523	1.00	49.13	O
ATOM	8230	N	PRO	A1137	-26.383	97.770	-3.395	1.00	50.03	N
ATOM	8231	CA	PRO	A1137	-24.939	97.510	-3.378	1.00	54.25	C
ATOM	8232	C	PRO	A1137	-24.648	96.073	-3.823	1.00	51.09	C
ATOM	8233	CB	PRO	A1137	-24.546	97.739	-1.910	1.00	47.16	C
ATOM	8234	CG	PRO	A1137	-25.703	98.477	-1.324	1.00	50.20	C
ATOM	8235	CD	PRO	A1137	-26.906	98.042	-2.050	1.00	48.94	C
ATOM	8236	O	THR	A1138	-21.334	94.376	-3.509	1.00	43.45	O
ATOM	8237	N	THR	A1138	-23.579	95.897	-4.583	1.00	49.52	N
ATOM	8238	CA	THR	A1138	-23.202	94.553	-5.011	1.00	45.00	C
ATOM	8239	C	THR	A1138	-22.374	93.860	-3.928	1.00	44.79	C
ATOM	8240	CB	THR	A1138	-22.410	94.574	-6.341	1.00	48.81	C
ATOM	8241	OG1	THR	A1138	-23.172	95.256	-7.352	1.00	52.23	O
ATOM	8242	CG2	THR	A1138	-22.114	93.142	-6.809	1.00	49.46	C
ATOM	8243	O	VAL	A1139	-21.171	90.362	-4.107	1.00	46.93	O
ATOM	8244	N	VAL	A1139	-22.841	92.696	-3.474	1.00	42.94	N
ATOM	8245	CA	VAL	A1139	-22.079	91.897	-2.515	1.00	43.96	C
ATOM	8246	C	VAL	A1139	-20.937	91.110	-3.177	1.00	40.04	C
ATOM	8247	CB	VAL	A1139	-22.994	90.939	-1.768	1.00	45.70	C
ATOM	8248	CG1	VAL	A1139	-22.188	89.955	-0.967	1.00	44.44	C
ATOM	8249	CG2	VAL	A1139	-23.915	91.737	-0.839	1.00	47.92	C
ATOM	8250	O	ALA	A1140	-18.419	88.223	-3.691	1.00	42.84	O
ATOM	8251	N	ALA	A1140	-19.702	91.302	-2.709	1.00	43.03	N
ATOM	8252	CA	ALA	A1140	-18.548	90.596	-3.280	1.00	46.99	C
ATOM	8253	C	ALA	A1140	-18.535	89.116	-2.859	1.00	43.83	C
ATOM	8254	CB	ALA	A1140	-17.256	91.282	-2.885	1.00	49.75	C

ATOM	8255	O	TYR	A1141	-19.307	88.826	0.977	1.00	47.50	O
ATOM	8256	N	TYR	A1141	-18.680	88.882	-1.560	1.00	48.21	N
ATOM	8257	CA	TYR	A1141	-18.842	87.545	-0.976	1.00	46.53	C
ATOM	8258	C	TYR	A1141	-19.371	87.734	0.431	1.00	47.47	C
ATOM	8259	CB	TYR	A1141	-17.526	86.730	-0.943	1.00	38.83	C
ATOM	8260	CG	TYR	A1141	-16.337	87.472	-0.379	1.00	44.47	C
ATOM	8261	CD1	TYR	A1141	-16.132	87.586	0.999	1.00	51.15	C
ATOM	8262	CD2	TYR	A1141	-15.421	88.070	-1.221	1.00	45.78	C
ATOM	8263	CE1	TYR	A1141	-15.042	88.286	1.511	1.00	45.34	C
ATOM	8264	CE2	TYR	A1141	-14.331	88.750	-0.724	1.00	48.66	C
ATOM	8265	CZ	TYR	A1141	-14.145	88.856	0.638	1.00	50.41	C
ATOM	8266	OH	TYR	A1141	-13.049	89.546	1.094	1.00	50.94	O
ATOM	8267	O	SER	A1142	-18.413	85.450	2.937	1.00	49.80	O
ATOM	8268	N	SER	A1142	-19.874	86.663	1.019	1.00	44.16	N
ATOM	8269	CA	SER	A1142	-20.359	86.723	2.374	1.00	42.39	C
ATOM	8270	C	SER	A1142	-19.353	86.122	3.337	1.00	46.78	C
ATOM	8271	CB	SER	A1142	-21.682	86.010	2.495	1.00	42.98	C
ATOM	8272	OG	SER	A1142	-22.651	86.701	1.771	1.00	43.25	O
ATOM	8273	O	VAL	A1143	-20.370	86.036	7.173	1.00	56.67	O
ATOM	8274	N	VAL	A1143	-19.532	86.385	4.617	1.00	45.83	N
ATOM	8275	CA	VAL	A1143	-18.603	85.853	5.583	1.00	45.10	C
ATOM	8276	C	VAL	A1143	-19.411	85.388	6.768	1.00	46.70	C
ATOM	8277	CB	VAL	A1143	-17.524	86.873	5.997	1.00	53.16	C
ATOM	8278	CG2	VAL	A1143	-16.459	87.052	4.900	1.00	40.46	C
ATOM	8279	CG1	VAL	A1143	-16.860	86.413	7.228	1.00	61.25	C
ATOM	8280	O	LEU	A1144	-17.810	84.539	9.671	1.00	52.03	O
ATOM	8281	N	LEU	A1144	-19.066	84.203	7.260	1.00	60.06	N
ATOM	8282	CA	LEU	A1144	-19.659	83.667	8.467	1.00	58.22	C
ATOM	8283	C	LEU	A1144	-19.033	84.392	9.625	1.00	55.37	C
ATOM	8284	CB	LEU	A1144	-19.411	82.167	8.591	1.00	55.09	C
ATOM	8285	CG	LEU	A1144	-19.909	81.536	9.894	1.00	55.24	C
ATOM	8286	CD1	LEU	A1144	-21.431	81.546	9.927	1.00	56.17	C
ATOM	8287	CD2	LEU	A1144	-19.367	80.124	10.058	1.00	60.50	C
ATOM	8288	O	VAL	A1145	-21.224	84.970	13.114	1.00	56.89	O
ATOM	8289	N	VAL	A1145	-19.863	84.857	10.549	1.00	53.39	N
ATOM	8290	CA	VAL	A1145	-19.334	85.522	11.722	1.00	58.29	C
ATOM	8291	C	VAL	A1145	-19.999	84.988	12.978	1.00	58.56	C
ATOM	8292	CB	VAL	A1145	-19.479	87.063	11.631	1.00	59.93	C
ATOM	8293	CG1	VAL	A1145	-20.542	87.444	10.632	1.00	56.44	C
ATOM	8294	CG2	VAL	A1145	-19.737	87.676	13.011	1.00	58.61	C
ATOM	8295	O	VAL	A1146	-17.674	84.945	16.276	1.00	68.89	O
ATOM	8296	N	VAL	A1146	-19.145	84.494	13.866	1.00	66.35	N
ATOM	8297	CA	VAL	A1146	-19.557	83.962	15.150	1.00	68.18	C
ATOM	8298	C	VAL	A1146	-18.907	84.851	16.191	1.00	68.64	C
ATOM	8299	CB	VAL	A1146	-19.145	82.481	15.328	1.00	71.29	C
ATOM	8300	CG1	VAL	A1146	-19.616	81.941	16.671	1.00	67.93	C
ATOM	8301	CG2	VAL	A1146	-19.717	81.645	14.201	1.00	66.20	C
ATOM	8302	O	ALA	A1147	-21.487	86.386	18.862	1.00	71.67	O
ATOM	8303	N	ALA	A1147	-19.751	85.541	16.945	1.00	67.18	N
ATOM	8304	CA	ALA	A1147	-19.281	86.544	17.880	1.00	73.19	C
ATOM	8305	C	ALA	A1147	-20.386	86.964	18.837	1.00	74.49	C
ATOM	8306	CB	ALA	A1147	-18.750	87.745	17.133	1.00	73.32	C
ATOM	8307	O	LYS	A1148	-20.646	90.641	19.473	1.00	74.63	O
ATOM	8308	N	LYS	A1148	-20.077	87.971	19.639	1.00	77.29	N
ATOM	8309	CA	LYS	A1148	-21.067	88.518	20.539	1.00	78.56	C
ATOM	8310	C	LYS	A1148	-21.464	89.893	20.026	1.00	75.47	C
ATOM	8311	CB	LYS	A1148	-20.524	88.580	21.964	1.00	76.58	C
ATOM	8312	O	VAL	A1149	-24.518	91.600	21.836	1.00	74.92	O
ATOM	8313	N	VAL	A1149	-22.732	90.218	20.181	1.00	76.02	N
ATOM	8314	CA	VAL	A1149	-23.169	91.557	19.843	1.00	79.22	C
ATOM	8315	C	VAL	A1149	-23.778	92.232	21.073	1.00	75.09	C
ATOM	8316	CB	VAL	A1149	-24.173	91.540	18.666	1.00	75.99	C
ATOM	8317	CG1	VAL	A1149	-25.545	90.991	19.098	1.00	74.23	C

ATOM	8318	CG2	VAL	A1149	-24.301	92.930	18.076	1.00	83.98	C
ATOM	8319	O	GLU	A1150	-25.886	94.598	20.726	1.00	76.75	O
ATOM	8320	N	GLU	A1150	-23.426	93.499	21.292	1.00	77.38	N
ATOM	8321	CA	GLU	A1150	-24.130	94.299	22.288	1.00	76.39	C
ATOM	8322	C	GLU	A1150	-25.571	94.242	21.860	1.00	74.20	C
ATOM	8323	CB	GLU	A1150	-23.612	95.737	22.354	1.00	73.63	C
ATOM	8324	O	LYS	A1151	-29.009	93.012	24.374	1.00	81.61	O
ATOM	8325	N	LYS	A1151	-26.433	93.735	22.735	1.00	73.80	N
ATOM	8326	CA	LYS	A1151	-27.822	93.490	22.365	1.00	76.49	C
ATOM	8327	C	LYS	A1151	-28.792	93.826	23.482	1.00	81.79	C
ATOM	8328	CB	LYS	A1151	-28.013	92.031	21.955	1.00	80.38	C
ATOM	8329	O	GLY	A1152	-29.361	97.583	24.074	1.00	79.33	O
ATOM	8330	N	GLY	A1152	-29.387	95.015	23.414	1.00	76.40	N
ATOM	8331	CA	GLY	A1152	-30.342	95.446	24.413	1.00	74.31	C
ATOM	8332	C	GLY	A1152	-30.204	96.925	24.687	1.00	81.60	C
ATOM	8333	O	LYS	A1153	-28.995	100.200	26.117	1.00	93.32	O
ATOM	8334	N	LYS	A1153	-31.035	97.449	25.590	1.00	82.64	N
ATOM	8335	CA	LYS	A1153	-30.964	98.860	25.961	1.00	85.22	C
ATOM	8336	C	LYS	A1153	-29.560	99.160	26.451	1.00	85.24	C
ATOM	8337	CB	LYS	A1153	-32.002	99.228	27.033	1.00	77.28	C
ATOM	8338	O	SER	A1154	-28.230	96.534	29.214	1.00	87.20	O
ATOM	8339	N	SER	A1154	-29.003	98.230	27.225	1.00	85.81	N
ATOM	8340	CA	SER	A1154	-27.608	98.277	27.691	1.00	91.68	C
ATOM	8341	C	SER	A1154	-27.319	97.080	28.591	1.00	86.10	C
ATOM	8342	CB	SER	A1154	-27.303	99.577	28.466	1.00	96.09	C
ATOM	8343	OG	SER	A1154	-27.339	100.730	27.632	1.00	90.12	O
ATOM	8344	O	LYS	A1155	-23.367	95.334	26.895	1.00	75.38	O
ATOM	8345	N	LYS	A1155	-26.074	96.628	28.636	1.00	83.57	N
ATOM	8346	CA	LYS	A1155	-25.064	96.891	27.632	1.00	78.74	C
ATOM	8347	C	LYS	A1155	-24.447	95.507	27.462	1.00	76.84	C
ATOM	8348	CB	LYS	A1155	-24.059	97.950	28.082	1.00	73.15	C
ATOM	8349	O	LYS	A1156	-24.757	93.281	25.580	1.00	76.89	O
ATOM	8350	N	LYS	A1156	-25.191	94.525	27.972	1.00	78.06	N
ATOM	8351	CA	LYS	A1156	-24.836	93.107	27.957	1.00	71.85	C
ATOM	8352	C	LYS	A1156	-24.623	92.564	26.558	1.00	72.35	C
ATOM	8353	CB	LYS	A1156	-25.923	92.288	28.660	1.00	73.48	C
ATOM	8354	O	LEU	A1157	-25.171	88.719	25.813	1.00	72.62	O
ATOM	8355	N	LEU	A1157	-24.297	91.281	26.466	1.00	80.62	N
ATOM	8356	CA	LEU	A1157	-23.945	90.681	25.185	1.00	73.41	C
ATOM	8357	C	LEU	A1157	-24.751	89.420	24.904	1.00	73.00	C
ATOM	8358	CB	LEU	A1157	-22.451	90.365	25.136	1.00	68.63	C
ATOM	8359	CG	LEU	A1157	-21.500	91.535	25.407	1.00	68.53	C
ATOM	8360	CD1	LEU	A1157	-20.069	91.172	25.099	1.00	64.79	C
ATOM	8361	CD2	LEU	A1157	-21.889	92.754	24.610	1.00	69.84	C
ATOM	8362	O	LYS	A1158	-24.310	88.147	21.202	1.00	77.34	O
ATOM	8363	N	LYS	A1158	-24.992	89.159	23.630	1.00	76.07	N
ATOM	8364	CA	LYS	A1158	-25.578	87.901	23.201	1.00	76.09	C
ATOM	8365	C	LYS	A1158	-24.687	87.390	22.101	1.00	75.11	C
ATOM	8366	CB	LYS	A1158	-27.017	88.070	22.708	1.00	80.07	C
ATOM	8367	N	SER	A1159	-24.314	86.120	22.192	1.00	80.07	N
ATOM	8368	CA	SER	A1159	-23.411	85.529	21.220	1.00	78.21	C
ATOM	8369	C	SER	A1159	-24.225	85.283	19.969	1.00	72.15	C
ATOM	8370	O	SER	A1159	-25.416	84.959	20.055	1.00	66.47	O
ATOM	8371	CB	SER	A1159	-22.788	84.239	21.758	1.00	78.90	C
ATOM	8372	OG	SER	A1159	-21.440	84.098	21.331	1.00	78.22	O
ATOM	8373	N	VAL	A1160	-23.619	85.471	18.803	1.00	69.78	N
ATOM	8374	CA	VAL	A1160	-24.409	85.344	17.578	1.00	69.47	C
ATOM	8375	C	VAL	A1160	-23.674	84.621	16.488	1.00	64.36	C
ATOM	8376	O	VAL	A1160	-22.450	84.706	16.369	1.00	67.28	O
ATOM	8377	CB	VAL	A1160	-24.872	86.726	17.005	1.00	67.48	C
ATOM	8378	CG1	VAL	A1160	-26.089	87.263	17.758	1.00	63.19	C
ATOM	8379	CG2	VAL	A1160	-23.736	87.729	16.990	1.00	63.73	C
ATOM	8380	O	LYS	A1161	-25.913	83.873	13.235	1.00	60.40	O

ATOM	8381	N	LYS	A1161	-24.450	83.898	15.695	1.00	64.03	N
ATOM	8382	CA	LYS	A1161	-23.961	83.285	14.480	1.00	65.03	C
ATOM	8383	C	LYS	A1161	-24.689	83.954	13.331	1.00	62.77	C
ATOM	8384	CB	LYS	A1161	-24.208	81.771	14.480	1.00	68.27	C
ATOM	8385	CG	LYS	A1161	-23.565	81.031	13.329	1.00	61.73	C
ATOM	8386	CD	LYS	A1161	-24.291	79.722	13.062	1.00	68.35	C
ATOM	8387	CE	LYS	A1161	-24.118	78.727	14.182	1.00	68.39	C
ATOM	8388	NZ	LYS	A1161	-24.862	77.461	13.923	1.00	65.92	N
ATOM	8389	O	GLU	A1162	-22.654	85.233	10.037	1.00	55.60	O
ATOM	8390	N	GLU	A1162	-23.951	84.637	12.467	1.00	58.78	N
ATOM	8391	CA	GLU	A1162	-24.613	85.404	11.427	1.00	62.60	C
ATOM	8392	C	GLU	A1162	-23.869	85.416	10.091	1.00	58.02	C
ATOM	8393	CB	GLU	A1162	-24.839	86.840	11.924	1.00	60.62	C
ATOM	8394	CG	GLU	A1162	-25.988	86.955	12.912	1.00	65.33	C
ATOM	8395	CD	GLU	A1162	-26.234	88.365	13.403	1.00	70.39	C
ATOM	8396	OE1	GLU	A1162	-25.457	89.280	13.039	1.00	64.73	O
ATOM	8397	OE2	GLU	A1162	-27.215	88.546	14.158	1.00	72.45	O
ATOM	8398	O	LEU	A1163	-25.041	87.941	7.213	1.00	52.12	O
ATOM	8399	N	LEU	A1163	-24.640	85.630	9.026	1.00	59.23	N
ATOM	8400	CA	LEU	A1163	-24.141	85.774	7.667	1.00	54.99	C
ATOM	8401	C	LEU	A1163	-24.040	87.247	7.242	1.00	54.09	C
ATOM	8402	CB	LEU	A1163	-25.061	85.033	6.708	1.00	50.92	C
ATOM	8403	CG	LEU	A1163	-24.405	84.712	5.373	1.00	54.21	C
ATOM	8404	CD1	LEU	A1163	-23.193	83.857	5.652	1.00	50.31	C
ATOM	8405	CD2	LEU	A1163	-25.382	83.993	4.461	1.00	51.65	C
ATOM	8406	O	LEU	A1164	-21.202	88.666	4.647	1.00	49.44	O
ATOM	8407	N	LEU	A1164	-22.842	87.706	6.886	1.00	57.16	N
ATOM	8408	CA	LEU	A1164	-22.634	89.106	6.538	1.00	54.24	C
ATOM	8409	C	LEU	A1164	-22.154	89.328	5.100	1.00	57.55	C
ATOM	8410	CB	LEU	A1164	-21.621	89.742	7.503	1.00	57.54	C
ATOM	8411	CG	LEU	A1164	-21.314	91.237	7.287	1.00	61.37	C
ATOM	8412	CD1	LEU	A1164	-22.471	92.110	7.744	1.00	53.13	C
ATOM	8413	CD2	LEU	A1164	-19.996	91.674	7.945	1.00	58.92	C
ATOM	8414	O	GLY	A1165	-21.327	92.790	3.492	1.00	59.26	O
ATOM	8415	N	GLY	A1165	-22.780	90.302	4.421	1.00	50.02	N
ATOM	8416	CA	GLY	A1165	-22.392	90.689	3.075	1.00	43.50	C
ATOM	8417	C	GLY	A1165	-21.239	91.668	3.014	1.00	47.03	C
ATOM	8418	O	ILE	A1166	-18.861	91.903	-0.176	1.00	45.65	O
ATOM	8419	N	ILE	A1166	-20.142	91.243	2.421	1.00	40.25	N
ATOM	8420	CA	ILE	A1166	-19.016	92.112	2.211	1.00	37.27	C
ATOM	8421	C	ILE	A1166	-19.124	92.634	0.787	1.00	47.64	C
ATOM	8422	CB	ILE	A1166	-17.683	91.383	2.429	1.00	46.88	C
ATOM	8423	CG1	ILE	A1166	-17.661	90.710	3.807	1.00	45.79	C
ATOM	8424	CG2	ILE	A1166	-16.495	92.330	2.251	1.00	47.23	C
ATOM	8425	CD1	ILE	A1166	-17.790	91.668	4.972	1.00	50.79	C
ATOM	8426	O	THR	A1167	-17.464	94.833	-0.790	1.00	42.95	O
ATOM	8427	N	THR	A1167	-19.538	93.899	0.667	1.00	47.05	N
ATOM	8428	CA	THR	A1167	-19.827	94.546	-0.602	1.00	38.98	C
ATOM	8429	C	THR	A1167	-18.558	94.819	-1.356	1.00	40.39	C
ATOM	8430	CB	THR	A1167	-20.596	95.924	-0.411	1.00	44.41	C
ATOM	8431	OG1	THR	A1167	-19.725	96.915	0.171	1.00	44.52	O
ATOM	8432	CG2	THR	A1167	-21.807	95.738	0.446	1.00	41.09	C
ATOM	8433	O	ILE	A1168	-15.621	96.634	-3.053	1.00	50.36	O
ATOM	8434	N	ILE	A1168	-18.710	95.081	-2.642	1.00	37.94	N
ATOM	8435	CA	ILE	A1168	-17.564	95.319	-3.487	1.00	41.73	C
ATOM	8436	C	ILE	A1168	-16.834	96.563	-3.008	1.00	40.65	C
ATOM	8437	CB	ILE	A1168	-18.000	95.423	-4.967	1.00	37.41	C
ATOM	8438	CG1	ILE	A1168	-18.463	94.047	-5.445	1.00	44.60	C
ATOM	8439	CG2	ILE	A1168	-16.883	95.963	-5.834	1.00	36.47	C
ATOM	8440	CD1	ILE	A1168	-18.766	93.922	-6.940	1.00	43.10	C
ATOM	8441	O	MET	A1169	-15.142	99.121	-0.590	1.00	58.86	O
ATOM	8442	N	MET	A1169	-17.582	97.540	-2.526	1.00	45.87	N
ATOM	8443	CA	MET	A1169	-17.001	98.795	-2.069	1.00	45.65	C

ATOM	8444	C	MET	A1169	-16.237	98.589	-0.750	1.00	54.66	C
ATOM	8445	CB	MET	A1169	-18.104	99.837	-1.912	1.00	48.10	C
ATOM	8446	CG	MET	A1169	-17.688	101.269	-2.020	1.00	51.36	C
ATOM	8447	SD	MET	A1169	-19.190	102.310	-2.032	1.00	66.31	S
ATOM	8448	CE	MET	A1169	-19.509	102.621	-0.291	1.00	57.16	C
ATOM	8449	O	GLU	A1170	-14.131	96.477	2.323	1.00	60.29	O
ATOM	8450	N	GLU	A1170	-16.797	97.801	0.175	1.00	51.71	N
ATOM	8451	CA	GLU	A1170	-16.140	97.495	1.461	1.00	52.95	C
ATOM	8452	C	GLU	A1170	-14.941	96.531	1.392	1.00	57.56	C
ATOM	8453	CB	GLU	A1170	-17.147	96.892	2.449	1.00	53.48	C
ATOM	8454	CG	GLU	A1170	-18.219	97.841	2.965	1.00	51.50	C
ATOM	8455	CD	GLU	A1170	-19.408	97.099	3.568	1.00	61.72	C
ATOM	8456	OE1	GLU	A1170	-19.486	95.857	3.415	1.00	57.48	O
ATOM	8457	OE2	GLU	A1170	-20.276	97.757	4.189	1.00	67.08	O
ATOM	8458	O	ARG	A1171	-11.866	94.108	1.348	1.00	57.40	O
ATOM	8459	N	ARG	A1171	-14.825	95.768	0.306	1.00	58.62	N
ATOM	8460	CA	ARG	A1171	-13.974	94.575	0.311	1.00	53.17	C
ATOM	8461	C	ARG	A1171	-12.504	94.853	0.617	1.00	53.64	C
ATOM	8462	CB	ARG	A1171	-14.091	93.854	-1.028	1.00	49.57	C
ATOM	8463	CG	ARG	A1171	-13.274	92.588	-1.150	1.00	46.49	C
ATOM	8464	CD	ARG	A1171	-13.223	92.157	-2.596	1.00	54.81	C
ATOM	8465	NE	ARG	A1171	-12.379	90.986	-2.802	1.00	59.51	N
ATOM	8466	CZ	ARG	A1171	-11.934	90.592	-3.987	1.00	62.02	C
ATOM	8467	NH1	ARG	A1171	-12.237	91.293	-5.073	1.00	56.46	N
ATOM	8468	NH2	ARG	A1171	-11.173	89.510	-4.081	1.00	57.65	N
ATOM	8469	O	SER	A1172	-9.203	95.999	2.211	1.00	62.84	O
ATOM	8470	N	SER	A1172	-11.966	95.916	0.051	1.00	53.83	N
ATOM	8471	CA	SER	A1172	-10.554	96.221	0.226	1.00	53.34	C
ATOM	8472	C	SER	A1172	-10.214	96.471	1.694	1.00	57.55	C
ATOM	8473	CB	SER	A1172	-10.171	97.439	-0.611	1.00	53.75	C
ATOM	8474	OG	SER	A1172	-8.900	97.280	-1.214	1.00	63.98	O
ATOM	8475	O	SER	A1173	-9.998	96.009	5.403	1.00	69.60	O
ATOM	8476	N	SER	A1173	-11.069	97.208	2.374	1.00	60.60	N
ATOM	8477	CA	SER	A1173	-10.783	97.537	3.750	1.00	63.09	C
ATOM	8478	C	SER	A1173	-10.865	96.271	4.577	1.00	63.08	C
ATOM	8479	CB	SER	A1173	-11.745	98.600	4.280	1.00	60.10	C
ATOM	8480	OG	SER	A1173	-12.699	98.020	5.136	1.00	60.27	O
ATOM	8481	O	PHE	A1174	-10.280	92.960	5.938	1.00	64.22	O
ATOM	8482	N	PHE	A1174	-11.898	95.476	4.326	1.00	64.54	N
ATOM	8483	CA	PHE	A1174	-12.091	94.226	5.045	1.00	61.58	C
ATOM	8484	C	PHE	A1174	-10.869	93.322	4.935	1.00	60.51	C
ATOM	8485	CB	PHE	A1174	-13.338	93.510	4.542	1.00	55.51	C
ATOM	8486	CG	PHE	A1174	-13.562	92.175	5.182	1.00	54.40	C
ATOM	8487	CD2	PHE	A1174	-13.179	91.003	4.534	1.00	57.21	C
ATOM	8488	CD1	PHE	A1174	-14.164	92.083	6.419	1.00	55.92	C
ATOM	8489	CE2	PHE	A1174	-13.380	89.752	5.126	1.00	53.13	C
ATOM	8490	CE1	PHE	A1174	-14.369	90.854	7.016	1.00	59.55	C
ATOM	8491	CZ	PHE	A1174	-13.975	89.679	6.362	1.00	54.00	C
ATOM	8492	O	GLU	A1175	-7.144	91.805	4.433	1.00	68.90	O
ATOM	8493	N	GLU	A1175	-10.456	92.997	3.723	1.00	61.25	N
ATOM	8494	CA	GLU	A1175	-9.354	92.056	3.553	1.00	62.55	C
ATOM	8495	C	GLU	A1175	-8.042	92.582	4.132	1.00	65.45	C
ATOM	8496	CB	GLU	A1175	-9.168	91.708	2.072	1.00	54.24	C
ATOM	8497	CG	GLU	A1175	-10.386	91.047	1.482	1.00	53.03	C
ATOM	8498	CD	GLU	A1175	-10.220	90.723	0.019	1.00	60.47	C
ATOM	8499	OE1	GLU	A1175	-9.261	91.238	-0.606	1.00	58.28	O
ATOM	8500	OE2	GLU	A1175	-11.048	89.943	-0.505	1.00	63.60	O
ATOM	8501	O	LYS	A1176	-5.452	93.943	6.819	1.00	73.87	O
ATOM	8502	N	LYS	A1176	-7.928	93.896	4.292	1.00	68.35	N
ATOM	8503	CA	LYS	A1176	-6.687	94.464	4.817	1.00	75.04	C
ATOM	8504	C	LYS	A1176	-6.565	94.119	6.295	1.00	77.29	C
ATOM	8505	CB	LYS	A1176	-6.637	95.983	4.628	1.00	67.75	C
ATOM	8506	N	ASN	A1177	-7.724	93.986	6.945	1.00	70.10	N

ATOM	8507	CA	ASN	A1177	-7.791	93.858	8.391	1.00	60.07	C
ATOM	8508	C	ASN	A1177	-9.197	93.491	8.858	1.00	60.79	C
ATOM	8509	O	ASN	A1177	-9.930	94.351	9.314	1.00	68.52	O
ATOM	8510	CB	ASN	A1177	-7.335	95.173	9.004	1.00	60.41	C
ATOM	8511	CG	ASN	A1177	-7.078	95.092	10.494	1.00	69.89	C
ATOM	8512	OD1	ASN	A1177	-7.714	94.318	11.230	1.00	68.13	O
ATOM	8513	ND2	ASN	A1177	-6.155	95.937	10.962	1.00	67.10	N
ATOM	8514	N	PRO	A1178	-9.588	92.207	8.738	1.00	61.08	N
ATOM	8515	CA	PRO	A1178	-10.996	91.869	8.996	1.00	58.83	C
ATOM	8516	C	PRO	A1178	-11.496	92.089	10.414	1.00	66.73	C
ATOM	8517	O	PRO	A1178	-12.615	92.576	10.585	1.00	68.92	O
ATOM	8518	CB	PRO	A1178	-11.077	90.381	8.639	1.00	56.35	C
ATOM	8519	CG	PRO	A1178	-9.688	89.951	8.315	1.00	56.88	C
ATOM	8520	CD	PRO	A1178	-8.891	91.140	8.002	1.00	55.77	C
ATOM	8521	N	ILE	A1179	-10.698	91.749	11.418	1.00	72.03	N
ATOM	8522	CA	ILE	A1179	-11.178	91.819	12.794	1.00	71.32	C
ATOM	8523	C	ILE	A1179	-11.490	93.272	13.195	1.00	71.33	C
ATOM	8524	O	ILE	A1179	-12.518	93.548	13.824	1.00	67.53	O
ATOM	8525	CB	ILE	A1179	-10.164	91.185	13.770	1.00	75.31	C
ATOM	8526	CG1	ILE	A1179	-10.671	91.302	15.207	1.00	75.27	C
ATOM	8527	CG2	ILE	A1179	-8.777	91.792	13.586	1.00	77.93	C
ATOM	8528	CD1	ILE	A1179	-11.997	90.588	15.426	1.00	81.03	C
ATOM	8529	N	ASP	A1180	-10.617	94.197	12.807	1.00	69.85	N
ATOM	8530	CA	ASP	A1180	-10.875	95.606	13.053	1.00	69.49	C
ATOM	8531	C	ASP	A1180	-12.146	96.016	12.302	1.00	70.49	C
ATOM	8532	O	ASP	A1180	-13.068	96.551	12.918	1.00	68.91	O
ATOM	8533	CB	ASP	A1180	-9.670	96.467	12.651	1.00	70.83	C
ATOM	8534	CG	ASP	A1180	-8.587	96.505	13.738	1.00	73.61	C
ATOM	8535	OD1	ASP	A1180	-8.932	96.258	14.915	1.00	74.86	O
ATOM	8536	OD2	ASP	A1180	-7.405	96.792	13.432	1.00	66.88	O
ATOM	8537	N	PHE	A1181	-12.210	95.699	11.000	1.00	71.62	N
ATOM	8538	CA	PHE	A1181	-13.400	95.929	10.159	1.00	66.29	C
ATOM	8539	C	PHE	A1181	-14.683	95.526	10.872	1.00	64.43	C
ATOM	8540	O	PHE	A1181	-15.706	96.206	10.784	1.00	64.84	O
ATOM	8541	CB	PHE	A1181	-13.289	95.154	8.820	1.00	63.39	C
ATOM	8542	CG	PHE	A1181	-14.437	95.422	7.845	1.00	62.83	C
ATOM	8543	CD1	PHE	A1181	-15.705	94.896	8.051	1.00	59.89	C
ATOM	8544	CD2	PHE	A1181	-14.235	96.196	6.726	1.00	63.94	C
ATOM	8545	CE1	PHE	A1181	-16.730	95.157	7.181	1.00	62.63	C
ATOM	8546	CE2	PHE	A1181	-15.270	96.456	5.838	1.00	62.30	C
ATOM	8547	CE	PHE	A1181	-16.516	95.937	6.070	1.00	60.51	C
ATOM	8548	N	LEU	A1182	-14.614	94.405	11.574	1.00	69.20	N
ATOM	8549	CA	LEU	A1182	-15.795	93.745	12.106	1.00	69.67	C
ATOM	8550	C	LEU	A1182	-16.252	94.277	13.460	1.00	65.24	C
ATOM	8551	O	LEU	A1182	-17.444	94.247	13.774	1.00	61.90	O
ATOM	8552	CB	LEU	A1182	-15.518	92.245	12.204	1.00	69.95	C
ATOM	8553	CG	LEU	A1182	-15.631	91.446	10.909	1.00	69.11	C
ATOM	8554	CD1	LEU	A1182	-14.711	90.219	10.943	1.00	65.32	C
ATOM	8555	CD2	LEU	A1182	-17.092	91.051	10.707	1.00	60.22	C
ATOM	8556	N	GLU	A1183	-15.308	94.729	14.279	1.00	67.85	N
ATOM	8557	CA	GLU	A1183	-15.691	95.378	15.531	1.00	73.34	C
ATOM	8558	C	GLU	A1183	-16.452	96.657	15.169	1.00	67.06	C
ATOM	8559	O	GLU	A1183	-17.472	96.991	15.784	1.00	67.01	O
ATOM	8560	CB	GLU	A1183	-14.468	95.671	16.412	1.00	73.56	C
ATOM	8561	N	ALA	A1184	-15.981	97.317	14.110	1.00	63.29	N
ATOM	8562	CA	ALA	A1184	-16.571	98.559	13.617	1.00	68.71	C
ATOM	8563	C	ALA	A1184	-18.047	98.460	13.219	1.00	63.38	C
ATOM	8564	O	ALA	A1184	-18.675	99.479	12.997	1.00	63.82	O
ATOM	8565	CB	ALA	A1184	-15.761	99.079	12.445	1.00	65.74	C
ATOM	8566	N	LYS	A1185	-18.610	97.259	13.131	1.00	62.51	N
ATOM	8567	CA	LYS	A1185	-20.016	97.137	12.740	1.00	65.10	C
ATOM	8568	C	LYS	A1185	-20.878	96.533	13.847	1.00	71.92	C
ATOM	8569	O	LYS	A1185	-22.022	96.134	13.603	1.00	69.98	O

ATOM	8570	CB	LYS	A1185	-20.148	96.312	11.459	1.00	72.43	C
ATOM	8571	CG	LYS	A1185	-19.349	96.870	10.274	1.00	75.49	C
ATOM	8572	CD	LYS	A1185	-19.709	96.195	8.955	1.00	66.31	C
ATOM	8573	CE	LYS	A1185	-21.161	96.445	8.584	1.00	73.98	C
ATOM	8574	NZ	LYS	A1185	-21.368	96.400	7.098	1.00	76.87	N
ATOM	8575	O	GLY	A1186	-21.348	93.978	17.528	1.00	75.13	O
ATOM	8576	N	GLY	A1186	-20.329	96.480	15.062	1.00	70.66	N
ATOM	8577	CA	GLY	A1186	-21.057	95.958	16.209	1.00	73.64	C
ATOM	8578	C	GLY	A1186	-20.683	94.544	16.654	1.00	76.21	C
ATOM	8579	O	TYR	A1187	-16.917	92.955	16.811	1.00	75.26	O
ATOM	8580	N	TYR	A1187	-19.634	93.971	16.060	1.00	72.32	N
ATOM	8581	CA	TYR	A1187	-19.245	92.587	16.349	1.00	74.40	C
ATOM	8582	C	TYR	A1187	-17.993	92.494	17.210	1.00	77.92	C
ATOM	8583	CB	TYR	A1187	-18.989	91.800	15.056	1.00	69.82	C
ATOM	8584	CG	TYR	A1187	-20.220	91.407	14.286	1.00	65.61	C
ATOM	8585	CD1	TYR	A1187	-21.260	90.723	14.899	1.00	64.02	C
ATOM	8586	CD2	TYR	A1187	-20.340	91.717	12.938	1.00	65.01	C
ATOM	8587	CE1	TYR	A1187	-22.399	90.359	14.185	1.00	65.61	C
ATOM	8588	CE2	TYR	A1187	-21.474	91.370	12.215	1.00	64.79	C
ATOM	8589	CZ	TYR	A1187	-22.500	90.692	12.838	1.00	67.13	C
ATOM	8590	OH	TYR	A1187	-23.623	90.345	12.112	1.00	58.29	O
ATOM	8591	O	LYS	A1188	-18.111	89.516	19.683	1.00	78.63	O
ATOM	8592	N	LYS	A1188	-18.116	91.879	18.381	1.00	75.35	N
ATOM	8593	CA	LYS	A1188	-16.914	91.538	19.135	1.00	83.65	C
ATOM	8594	C	LYS	A1188	-17.037	90.139	19.726	1.00	82.66	C
ATOM	8595	CB	LYS	A1188	-16.628	92.576	20.229	1.00	83.68	C
ATOM	8596	CG	LYS	A1188	-15.162	93.026	20.293	1.00	82.20	C
ATOM	8597	CD	LYS	A1188	-15.059	94.496	20.709	1.00	88.46	C
ATOM	8598	CE	LYS	A1188	-13.618	95.010	20.660	1.00	92.13	C
ATOM	8599	NZ	LYS	A1188	-13.517	96.486	20.894	1.00	67.40	N
ATOM	8600	O	GLU	A1189	-16.078	86.245	19.520	1.00	75.44	O
ATOM	8601	N	GLU	A1189	-15.919	89.673	20.276	1.00	81.12	N
ATOM	8602	CA	GLU	A1189	-15.743	88.295	20.723	1.00	86.22	C
ATOM	8603	C	GLU	A1189	-15.690	87.413	19.483	1.00	81.66	C
ATOM	8604	CB	GLU	A1189	-16.860	87.854	21.683	1.00	87.08	C
ATOM	8605	CG	GLU	A1189	-17.085	88.779	22.892	1.00	87.79	C
ATOM	8606	CD	GLU	A1189	-16.039	88.604	24.004	1.00	91.44	C
ATOM	8607	OE1	GLU	A1189	-14.829	88.446	23.695	1.00	82.73	O
ATOM	8608	OE2	GLU	A1189	-16.441	88.633	25.194	1.00	84.46	O
ATOM	8609	N	VAL	A1190	-15.185	88.007	18.399	1.00	82.87	N
ATOM	8610	CA	VAL	A1190	-15.109	87.391	17.078	1.00	77.05	C
ATOM	8611	C	VAL	A1190	-14.054	86.312	17.015	1.00	70.57	C
ATOM	8612	O	VAL	A1190	-12.861	86.601	17.131	1.00	71.30	O
ATOM	8613	CB	VAL	A1190	-14.792	88.443	15.985	1.00	75.94	C
ATOM	8614	CG1	VAL	A1190	-14.304	87.772	14.701	1.00	74.36	C
ATOM	8615	CG2	VAL	A1190	-16.004	89.307	15.710	1.00	74.89	C
ATOM	8616	N	LYS	A1191	-14.483	85.070	16.828	1.00	71.95	N
ATOM	8617	CA	LYS	A1191	-13.526	83.986	16.632	1.00	68.00	C
ATOM	8618	C	LYS	A1191	-12.938	84.115	15.238	1.00	67.28	C
ATOM	8619	O	LYS	A1191	-13.629	83.893	14.244	1.00	71.26	O
ATOM	8620	CB	LYS	A1191	-14.188	82.624	16.829	1.00	66.69	C
ATOM	8621	N	LYS	A1192	-11.672	84.513	15.173	1.00	65.93	N
ATOM	8622	CA	LYS	A1192	-10.981	84.690	13.907	1.00	67.55	C
ATOM	8623	C	LYS	A1192	-11.075	83.404	13.101	1.00	72.45	C
ATOM	8624	O	LYS	A1192	-11.380	83.422	11.912	1.00	70.81	O
ATOM	8625	CB	LYS	A1192	-9.510	85.074	14.136	1.00	66.11	C
ATOM	8626	N	ASP	A1193	-10.846	82.283	13.787	1.00	80.52	N
ATOM	8627	CA	ASP	A1193	-10.753	80.963	13.170	1.00	77.62	C
ATOM	8628	C	ASP	A1193	-12.098	80.478	12.656	1.00	71.03	C
ATOM	8629	O	ASP	A1193	-12.208	79.374	12.148	1.00	73.86	O
ATOM	8630	CB	ASP	A1193	-10.186	79.939	14.168	1.00	78.25	C
ATOM	8631	CG	ASP	A1193	-8.670	80.028	14.318	1.00	85.68	C
ATOM	8632	OD1	ASP	A1193	-7.966	80.234	13.302	1.00	86.76	O

ATOM	8633	OD2	ASP	A1193	-8.180	79.874	15.460	1.00	86.57	O
ATOM	8634	N	LEU	A1194	-13.130	81.291	12.794	1.00	68.60	N
ATOM	8635	CA	LEU	A1194	-14.426	80.882	12.287	1.00	68.94	C
ATOM	8636	C	LEU	A1194	-14.908	81.778	11.158	1.00	68.48	C
ATOM	8637	O	LEU	A1194	-16.084	81.749	10.792	1.00	64.93	O
ATOM	8638	CB	LEU	A1194	-15.448	80.856	13.410	1.00	63.89	C
ATOM	8639	CG	LEU	A1194	-15.339	79.654	14.339	1.00	68.37	C
ATOM	8640	CD1	LEU	A1194	-16.640	79.473	15.107	1.00	68.36	C
ATOM	8641	CD2	LEU	A1194	-15.005	78.414	13.530	1.00	69.47	C
ATOM	8642	N	ILE	A1195	-13.996	82.565	10.597	1.00	65.73	N
ATOM	8643	CA	ILE	A1195	-14.366	83.478	9.525	1.00	66.28	C
ATOM	8644	C	ILE	A1195	-14.245	82.769	8.180	1.00	65.03	C
ATOM	8645	O	ILE	A1195	-13.180	82.727	7.558	1.00	72.25	O
ATOM	8646	CB	ILE	A1195	-13.510	84.756	9.564	1.00	68.80	C
ATOM	8647	CG1	ILE	A1195	-13.910	85.603	10.779	1.00	68.56	C
ATOM	8648	CG2	ILE	A1195	-13.700	85.574	8.315	1.00	65.50	C
ATOM	8649	CD1	ILE	A1195	-12.940	86.709	11.093	1.00	62.22	C
ATOM	8650	N	ILE	A1196	-15.353	82.176	7.763	1.00	58.00	N
ATOM	8651	CA	ILE	A1196	-15.451	81.460	6.498	1.00	57.99	C
ATOM	8652	C	ILE	A1196	-15.901	82.357	5.323	1.00	53.83	C
ATOM	8653	O	ILE	A1196	-16.949	83.012	5.392	1.00	48.15	O
ATOM	8654	CB	ILE	A1196	-16.431	80.301	6.646	1.00	55.59	C
ATOM	8655	CG1	ILE	A1196	-16.014	79.439	7.837	1.00	61.67	C
ATOM	8656	CG2	ILE	A1196	-16.515	79.508	5.361	1.00	58.04	C
ATOM	8657	CD1	ILE	A1196	-16.823	78.191	8.006	1.00	60.68	C
ATOM	8658	N	LYS	A1197	-15.075	82.397	4.278	1.00	52.08	N
ATOM	8659	CA	LYS	A1197	-15.396	83.032	3.000	1.00	49.03	C
ATOM	8660	C	LYS	A1197	-16.469	82.244	2.267	1.00	51.06	C
ATOM	8661	O	LYS	A1197	-16.277	81.083	1.932	1.00	55.14	O
ATOM	8662	CB	LYS	A1197	-14.164	83.126	2.109	1.00	47.87	C
ATOM	8663	CG	LYS	A1197	-13.902	84.500	1.506	1.00	59.45	C
ATOM	8664	CD	LYS	A1197	-13.197	84.400	0.143	1.00	57.78	C
ATOM	8665	CE	LYS	A1197	-11.988	85.334	0.027	1.00	65.21	C
ATOM	8666	NZ	LYS	A1197	-11.628	85.581	-1.403	1.00	64.07	N
ATOM	8667	O	LEU	A1198	-19.770	84.018	0.021	1.00	43.91	O
ATOM	8668	N	LEU	A1198	-17.594	82.887	2.004	1.00	45.96	N
ATOM	8669	CA	LEU	A1198	-18.671	82.257	1.282	1.00	44.07	C
ATOM	8670	C	LEU	A1198	-18.973	83.075	0.020	1.00	44.85	C
ATOM	8671	CB	LEU	A1198	-19.898	82.135	2.174	1.00	47.11	C
ATOM	8672	CG	LEU	A1198	-19.764	81.205	3.381	1.00	47.41	C
ATOM	8673	CD1	LEU	A1198	-20.859	81.491	4.402	1.00	40.15	C
ATOM	8674	CD2	LEU	A1198	-19.806	79.719	2.938	1.00	50.85	C
ATOM	8675	O	PRO	A1199	-20.605	82.214	-2.286	1.00	43.11	O
ATOM	8676	N	PRO	A1199	-18.304	82.742	-1.074	1.00	44.57	N
ATOM	8677	CA	PRO	A1199	-18.582	83.499	-2.299	1.00	41.52	C
ATOM	8678	C	PRO	A1199	-19.932	83.066	-2.868	1.00	43.59	C
ATOM	8679	CB	PRO	A1199	-17.411	83.109	-3.220	1.00	44.99	C
ATOM	8680	CG	PRO	A1199	-17.021	81.725	-2.755	1.00	43.72	C
ATOM	8681	CD	PRO	A1199	-17.301	81.678	-1.271	1.00	42.24	C
ATOM	8682	O	LYS	A1200	-20.626	81.404	-5.573	1.00	47.30	O
ATOM	8683	N	LYS	A1200	-20.330	83.637	-3.990	1.00	45.25	N
ATOM	8684	CA	LYS	A1200	-21.630	83.301	-4.533	1.00	47.06	C
ATOM	8685	C	LYS	A1200	-21.631	81.861	-5.028	1.00	43.23	C
ATOM	8686	CB	LYS	A1200	-22.004	84.268	-5.660	1.00	41.70	C
ATOM	8687	CG	LYS	A1200	-23.453	84.179	-6.083	1.00	43.48	C
ATOM	8688	CD	LYS	A1200	-23.774	85.291	-7.066	1.00	44.83	C
ATOM	8689	CE	LYS	A1200	-25.134	85.113	-7.676	1.00	42.98	C
ATOM	8690	NZ	LYS	A1200	-25.266	86.062	-8.813	1.00	46.25	N
ATOM	8691	N	TYR	A1201	-22.760	81.180	-4.824	1.00	42.85	N
ATOM	8692	CA	TYR	A1201	-23.037	79.795	-5.250	1.00	45.27	C
ATOM	8693	C	TYR	A1201	-22.430	78.760	-4.279	1.00	49.75	C
ATOM	8694	O	TYR	A1201	-22.220	77.609	-4.645	1.00	50.94	O
ATOM	8695	CB	TYR	A1201	-22.553	79.525	-6.685	1.00	39.44	C

ATOM	8696	CG	TYR	A1201	-22.990	80.552	-7.715	1.00	42.10	C
ATOM	8697	CD1	TYR	A1201	-24.330	80.785	-7.977	1.00	44.16	C
ATOM	8698	CD2	TYR	A1201	-22.051	81.283	-8.433	1.00	42.16	C
ATOM	8699	CE1	TYR	A1201	-24.723	81.728	-8.905	1.00	44.49	C
ATOM	8700	CE2	TYR	A1201	-22.426	82.216	-9.367	1.00	40.19	C
ATOM	8701	CZ	TYR	A1201	-23.776	82.444	-9.593	1.00	47.89	C
ATOM	8702	OH	TYR	A1201	-24.164	83.376	-10.528	1.00	44.13	O
ATOM	8703	N	SER	A1202	-22.158	79.178	-3.041	1.00	54.72	N
ATOM	8704	CA	SER	A1202	-21.686	78.263	-2.003	1.00	48.83	C
ATOM	8705	C	SER	A1202	-22.795	77.302	-1.664	1.00	51.22	C
ATOM	8706	O	SER	A1202	-23.925	77.718	-1.415	1.00	52.28	O
ATOM	8707	CB	SER	A1202	-21.248	79.011	-0.749	1.00	51.15	C
ATOM	8708	OG	SER	A1202	-20.209	79.925	-1.026	1.00	54.36	O
ATOM	8709	N	LEU	A1203	-22.448	76.021	-1.638	1.00	46.67	N
ATOM	8710	CA	LEU	A1203	-23.413	74.934	-1.522	1.00	51.47	C
ATOM	8711	C	LEU	A1203	-23.776	74.582	-0.082	1.00	54.18	C
ATOM	8712	O	LEU	A1203	-22.919	74.577	0.787	1.00	52.14	O
ATOM	8713	CB	LEU	A1203	-22.848	73.691	-2.217	1.00	55.69	C
ATOM	8714	CG	LEU	A1203	-23.826	72.547	-2.434	1.00	49.42	C
ATOM	8715	CD1	LEU	A1203	-25.105	73.153	-2.971	1.00	51.80	C
ATOM	8716	CD2	LEU	A1203	-23.242	71.536	-3.392	1.00	49.81	C
ATOM	8717	N	PHE	A1204	-25.041	74.254	0.160	1.00	55.58	N
ATOM	8718	CA	PHE	A1204	-25.485	73.828	1.493	1.00	54.64	C
ATOM	8719	C	PHE	A1204	-26.491	72.705	1.387	1.00	58.25	C
ATOM	8720	O	PHE	A1204	-27.474	72.827	0.652	1.00	59.52	O
ATOM	8721	CB	PHE	A1204	-26.121	74.993	2.278	1.00	54.54	C
ATOM	8722	CG	PHE	A1204	-25.171	76.101	2.577	1.00	56.84	C
ATOM	8723	CD1	PHE	A1204	-24.405	76.077	3.728	1.00	58.76	C
ATOM	8724	CD2	PHE	A1204	-25.011	77.146	1.692	1.00	58.05	C
ATOM	8725	CE1	PHE	A1204	-23.506	77.082	4.003	1.00	56.19	C
ATOM	8726	CE2	PHE	A1204	-24.115	78.155	1.959	1.00	58.75	C
ATOM	8727	CZ	PHE	A1204	-23.360	78.120	3.116	1.00	58.06	C
ATOM	8728	O	GLU	A1205	-27.450	71.131	4.549	1.00	60.81	O
ATOM	8729	N	GLU	A1205	-26.262	71.614	2.116	1.00	57.36	N
ATOM	8730	CA	GLU	A1205	-27.282	70.579	2.224	1.00	57.96	C
ATOM	8731	C	GLU	A1205	-28.038	70.759	3.535	1.00	61.42	C
ATOM	8732	CB	GLU	A1205	-26.678	69.176	2.138	1.00	57.89	C
ATOM	8733	CG	GLU	A1205	-27.728	68.066	2.117	1.00	59.33	C
ATOM	8734	CD	GLU	A1205	-27.150	66.705	1.735	1.00	68.29	C
ATOM	8735	OE1	GLU	A1205	-27.827	65.683	1.983	1.00	66.29	O
ATOM	8736	OE2	GLU	A1205	-26.028	66.661	1.181	1.00	68.85	O
ATOM	8737	O	LEU	A1206	-30.255	68.255	4.737	1.00	65.70	O
ATOM	8738	N	LEU	A1206	-29.342	70.510	3.501	1.00	61.52	N
ATOM	8739	CA	LEU	A1206	-30.183	70.638	4.674	1.00	60.45	C
ATOM	8740	C	LEU	A1206	-30.872	69.299	4.920	1.00	65.10	C
ATOM	8741	CB	LEU	A1206	-31.179	71.786	4.489	1.00	64.15	C
ATOM	8742	CG	LEU	A1206	-30.459	73.145	4.423	1.00	62.96	C
ATOM	8743	CD1	LEU	A1206	-30.010	73.534	3.016	1.00	56.49	C
ATOM	8744	CD2	LEU	A1206	-31.274	74.261	5.053	1.00	65.60	C
ATOM	8745	O	GLU	A1207	-33.575	68.023	3.381	1.00	74.40	O
ATOM	8746	N	GLU	A1207	-32.137	69.309	5.323	1.00	65.10	N
ATOM	8747	CA	GLU	A1207	-32.815	68.050	5.635	1.00	70.73	C
ATOM	8748	C	GLU	A1207	-33.306	67.368	4.377	1.00	72.35	C
ATOM	8749	CB	GLU	A1207	-33.993	68.281	6.583	1.00	70.81	C
ATOM	8750	CG	GLU	A1207	-35.274	68.711	5.884	1.00	74.26	C
ATOM	8751	CD	GLU	A1207	-35.214	70.122	5.314	1.00	72.70	C
ATOM	8752	OE1	GLU	A1207	-34.192	70.815	5.494	1.00	75.32	O
ATOM	8753	OE2	GLU	A1207	-36.204	70.547	4.684	1.00	72.96	O
ATOM	8754	O	ASN	A1208	-33.766	65.171	0.925	1.00	77.05	O
ATOM	8755	N	ASN	A1208	-33.416	66.046	4.430	1.00	77.22	N
ATOM	8756	CA	ASN	A1208	-33.920	65.245	3.313	1.00	75.81	C
ATOM	8757	C	ASN	A1208	-33.223	65.501	1.984	1.00	73.18	C
ATOM	8758	CB	ASN	A1208	-35.420	65.465	3.143	1.00	80.29	C

ATOM	8759	CG	ASN	A1208	-36.226	64.728	4.185	1.00	84.47	C
ATOM	8760	OD1	ASN	A1208	-35.812	63.666	4.666	1.00	77.88	O
ATOM	8761	ND2	ASN	A1208	-37.379	65.285	4.548	1.00	80.51	N
ATOM	8762	O	GLY	A1209	-30.680	67.680	-0.946	1.00	66.92	O
ATOM	8763	N	GLY	A1209	-32.034	66.094	2.046	1.00	71.19	N
ATOM	8764	CA	GLY	A1209	-31.177	66.231	0.879	1.00	70.54	C
ATOM	8765	C	GLY	A1209	-31.342	67.507	0.078	1.00	68.39	C
ATOM	8766	O	ARG	A1210	-30.618	70.637	0.980	1.00	63.41	O
ATOM	8767	N	ARG	A1210	-32.221	68.402	0.521	1.00	64.21	N
ATOM	8768	CA	ARG	A1210	-32.422	69.627	-0.231	1.00	65.89	C
ATOM	8769	C	ARG	A1210	-31.217	70.529	-0.087	1.00	65.49	C
ATOM	8770	CB	ARG	A1210	-33.697	70.359	0.193	1.00	64.60	C
ATOM	8771	CG	ARG	A1210	-33.867	70.545	1.659	1.00	67.43	C
ATOM	8772	CD	ARG	A1210	-35.049	71.436	1.930	1.00	71.40	C
ATOM	8773	NE	ARG	A1210	-34.732	72.834	1.675	1.00	74.09	N
ATOM	8774	CZ	ARG	A1210	-34.547	73.739	2.630	1.00	74.72	C
ATOM	8775	NH1	ARG	A1210	-34.257	74.988	2.311	1.00	68.38	N
ATOM	8776	NH2	ARG	A1210	-34.658	73.392	3.906	1.00	78.01	N
ATOM	8777	N	LYS	A1211	-30.861	71.166	-1.192	1.00	66.13	N
ATOM	8778	CA	LYS	A1211	-29.681	71.997	-1.236	1.00	60.74	C
ATOM	8779	C	LYS	A1211	-30.047	73.422	-1.581	1.00	60.03	C
ATOM	8780	O	LYS	A1211	-31.015	73.678	-2.293	1.00	64.56	O
ATOM	8781	CB	LYS	A1211	-28.678	71.435	-2.239	1.00	59.71	C
ATOM	8782	CG	LYS	A1211	-28.237	70.027	-1.894	1.00	57.21	C
ATOM	8783	CD	LYS	A1211	-27.291	69.448	-2.936	1.00	54.32	C
ATOM	8784	CE	LYS	A1211	-26.786	68.081	-2.490	1.00	61.11	C
ATOM	8785	NZ	LYS	A1211	-26.036	67.353	-3.567	1.00	70.37	N
ATOM	8786	N	ARG	A1212	-29.278	74.352	-1.041	1.00	59.27	N
ATOM	8787	CA	ARG	A1212	-29.415	75.747	-1.395	1.00	55.40	C
ATOM	8788	C	ARG	A1212	-28.032	76.253	-1.788	1.00	52.58	C
ATOM	8789	O	ARG	A1212	-27.042	75.798	-1.236	1.00	53.12	O
ATOM	8790	CB	ARG	A1212	-29.989	76.560	-0.230	1.00	54.46	C
ATOM	8791	CG	ARG	A1212	-31.350	76.097	0.259	1.00	56.15	C
ATOM	8792	CD	ARG	A1212	-32.480	76.647	-0.580	1.00	55.65	C
ATOM	8793	NE	ARG	A1212	-33.412	75.580	-0.936	1.00	66.95	N
ATOM	8794	CZ	ARG	A1212	-34.718	75.619	-0.714	1.00	69.23	C
ATOM	8795	NH1	ARG	A1212	-35.261	76.679	-0.144	1.00	79.12	N
ATOM	8796	NH2	ARG	A1212	-35.483	74.600	-1.059	1.00	69.77	N
ATOM	8797	N	MET	A1213	-27.968	77.179	-2.746	1.00	58.91	N
ATOM	8798	CA	MET	A1213	-26.732	77.898	-3.047	1.00	53.86	C
ATOM	8799	C	MET	A1213	-26.871	79.354	-2.625	1.00	54.95	C
ATOM	8800	O	MET	A1213	-27.957	79.907	-2.691	1.00	56.14	O
ATOM	8801	CB	MET	A1213	-26.397	77.825	-4.531	1.00	52.40	C
ATOM	8802	CG	MET	A1213	-26.078	76.429	-5.037	1.00	56.83	C
ATOM	8803	SD	MET	A1213	-25.477	76.464	-6.739	1.00	52.60	S
ATOM	8804	CE	MET	A1213	-26.856	77.318	-7.495	1.00	45.46	C
ATOM	8805	N	LEU	A1214	-25.782	79.980	-2.187	1.00	58.75	N
ATOM	8806	CA	LEU	A1214	-25.826	81.401	-1.841	1.00	49.14	C
ATOM	8807	C	LEU	A1214	-25.953	82.246	-3.082	1.00	53.62	C
ATOM	8808	O	LEU	A1214	-25.199	82.061	-4.029	1.00	53.49	O
ATOM	8809	CB	LEU	A1214	-24.566	81.850	-1.092	1.00	53.45	C
ATOM	8810	CG	LEU	A1214	-24.432	81.886	0.438	1.00	60.96	C
ATOM	8811	CD1	LEU	A1214	-25.651	82.483	1.086	1.00	60.65	C
ATOM	8812	CD2	LEU	A1214	-23.183	82.688	0.847	1.00	51.90	C
ATOM	8813	N	ALA	A1215	-26.885	83.190	-3.075	1.00	55.19	N
ATOM	8814	CA	ALA	A1215	-26.905	84.223	-4.101	1.00	49.05	C
ATOM	8815	C	ALA	A1215	-26.278	85.499	-3.565	1.00	52.51	C
ATOM	8816	O	ALA	A1215	-25.749	86.310	-4.318	1.00	53.51	O
ATOM	8817	CB	ALA	A1215	-28.306	84.477	-4.565	1.00	52.06	C
ATOM	8818	O	SER	A1216	-26.778	85.600	0.284	1.00	65.05	O
ATOM	8819	N	SER	A1216	-26.332	85.650	-2.248	1.00	50.51	N
ATOM	8820	CA	SER	A1216	-25.829	86.824	-1.538	1.00	48.17	C
ATOM	8821	C	SER	A1216	-26.109	86.581	-0.070	1.00	60.07	C

ATOM	8822	CB	SER	A1216	-26.510	88.110	-1.983	1.00	52.60	C
ATOM	8823	OG	SER	A1216	-27.865	88.074	-1.596	1.00	55.53	O
ATOM	8824	O	ALA	A1217	-27.453	86.999	3.892	1.00	62.23	O
ATOM	8825	N	ALA	A1217	-25.640	87.482	0.784	1.00	58.82	N
ATOM	8826	CA	ALA	A1217	-25.778	87.301	2.224	1.00	57.53	C
ATOM	8827	C	ALA	A1217	-27.224	87.233	2.707	1.00	55.90	C
ATOM	8828	CB	ALA	A1217	-25.049	88.409	2.954	1.00	56.88	C
ATOM	8829	O	GLY	A1218	-31.743	86.567	1.588	1.00	67.65	O
ATOM	8830	N	GLY	A1218	-28.185	87.421	1.799	1.00	56.62	N
ATOM	8831	CA	GLY	A1218	-29.596	87.447	2.154	1.00	53.78	C
ATOM	8832	C	GLY	A1218	-30.567	86.673	1.264	1.00	60.76	C
ATOM	8833	N	GLU	A1219	-30.099	86.130	0.148	1.00	59.35	N
ATOM	8834	CA	GLU	A1219	-30.948	85.279	-0.684	1.00	57.29	C
ATOM	8835	C	GLU	A1219	-30.249	83.951	-1.086	1.00	60.47	C
ATOM	8836	O	GLU	A1219	-29.012	83.874	-1.129	1.00	55.05	O
ATOM	8837	CB	GLU	A1219	-31.383	86.052	-1.921	1.00	56.40	C
ATOM	8838	CG	GLU	A1219	-32.348	85.285	-2.776	1.00	62.73	C
ATOM	8839	CD	GLU	A1219	-32.745	86.027	-4.028	1.00	73.38	C
ATOM	8840	OE1	GLU	A1219	-33.205	85.351	-4.983	1.00	74.64	O
ATOM	8841	OE2	GLU	A1219	-32.609	87.277	-4.051	1.00	74.10	O
ATOM	8842	N	LEU	A1220	-31.043	82.909	-1.347	1.00	56.97	N
ATOM	8843	CA	LEU	A1220	-30.511	81.615	-1.769	1.00	51.75	C
ATOM	8844	C	LEU	A1220	-31.134	81.185	-3.087	1.00	57.84	C
ATOM	8845	O	LEU	A1220	-32.011	81.865	-3.628	1.00	57.70	O
ATOM	8846	CB	LEU	A1220	-30.767	80.529	-0.716	1.00	50.37	C
ATOM	8847	CG	LEU	A1220	-30.240	80.677	0.716	1.00	54.98	C
ATOM	8848	CD1	LEU	A1220	-30.980	79.740	1.653	1.00	47.21	C
ATOM	8849	CD2	LEU	A1220	-28.735	80.441	0.792	1.00	51.82	C
ATOM	8850	N	GLN	A1221	-30.668	80.049	-3.591	1.00	50.36	N
ATOM	8851	CA	GLN	A1221	-31.170	79.460	-4.815	1.00	51.72	C
ATOM	8852	C	GLN	A1221	-31.349	77.958	-4.650	1.00	58.85	C
ATOM	8853	O	GLN	A1221	-30.776	77.355	-3.730	1.00	56.59	O
ATOM	8854	CB	GLN	A1221	-30.213	79.717	-5.970	1.00	56.49	C
ATOM	8855	CG	GLN	A1221	-29.649	81.112	-6.062	1.00	52.46	C
ATOM	8856	CD	GLN	A1221	-28.849	81.303	-7.339	1.00	52.70	C
ATOM	8857	OE1	GLN	A1221	-28.336	80.346	-7.918	1.00	47.67	O
ATOM	8858	NE2	GLN	A1221	-28.756	82.534	-7.791	1.00	49.28	N
ATOM	8859	N	LYS	A1222	-32.110	77.348	-5.559	1.00	59.24	N
ATOM	8860	CA	LYS	A1222	-32.301	75.899	-5.548	1.00	58.35	C
ATOM	8861	C	LYS	A1222	-30.984	75.191	-5.814	1.00	56.96	C
ATOM	8862	O	LYS	A1222	-30.207	75.628	-6.655	1.00	57.41	O
ATOM	8863	CB	LYS	A1222	-33.353	75.483	-6.576	1.00	61.61	C
ATOM	8864	CG	LYS	A1222	-34.771	75.923	-6.191	1.00	64.90	C
ATOM	8865	CD	LYS	A1222	-35.257	77.090	-7.017	1.00	66.58	C
ATOM	8866	CE	LYS	A1222	-35.978	76.624	-8.271	1.00	68.35	C
ATOM	8867	NZ	LYS	A1222	-35.871	77.612	-9.372	1.00	66.74	N
ATOM	8868	O	GLY	A1223	-28.609	71.210	-5.666	1.00	58.52	O
ATOM	8869	N	GLY	A1223	-30.727	74.109	-5.088	1.00	56.30	N
ATOM	8870	CA	GLY	A1223	-29.469	73.398	-5.226	1.00	57.95	C
ATOM	8871	C	GLY	A1223	-29.590	71.955	-5.683	1.00	61.98	C
ATOM	8872	O	ASN	A1224	-32.045	71.110	-8.518	1.00	66.50	O
ATOM	8873	N	ASN	A1224	-30.795	71.560	-6.087	1.00	60.80	N
ATOM	8874	CA	ASN	A1224	-31.052	70.195	-6.529	1.00	59.77	C
ATOM	8875	C	ASN	A1224	-31.509	70.139	-7.977	1.00	63.46	C
ATOM	8876	CB	ASN	A1224	-32.115	69.517	-5.656	1.00	63.41	C
ATOM	8877	CG	ASN	A1224	-31.913	69.767	-4.178	1.00	61.91	C
ATOM	8878	OD1	ASN	A1224	-32.034	70.900	-3.713	1.00	65.79	O
ATOM	8879	ND2	ASN	A1224	-31.641	68.713	-3.424	1.00	57.54	N
ATOM	8880	O	GLU	A1225	-32.717	66.686	-9.071	1.00	67.57	O
ATOM	8881	N	GLU	A1225	-31.296	68.978	-8.578	1.00	64.88	N
ATOM	8882	CA	GLU	A1225	-31.734	68.661	-9.927	1.00	65.08	C
ATOM	8883	C	GLU	A1225	-32.827	67.636	-9.841	1.00	67.57	C
ATOM	8884	CB	GLU	A1225	-30.594	68.077	-10.762	1.00	68.09	C

ATOM	8885	CG	GLU	A1225	-29.340	68.920	-10.825	1.00	65.19	C
ATOM	8886	CD	GLU	A1225	-29.451	70.047	-11.827	1.00	65.44	C
ATOM	8887	OE1	GLU	A1225	-28.447	70.754	-12.031	1.00	67.96	O
ATOM	8888	OE2	GLU	A1225	-30.536	70.224	-12.425	1.00	71.55	O
ATOM	8889	O	LEU	A1226	-34.468	66.124	-13.061	1.00	69.14	O
ATOM	8890	N	LEU	A1226	-33.870	67.803	-10.640	1.00	67.59	N
ATOM	8891	CA	LEU	A1226	-34.862	66.751	-10.772	1.00	70.94	C
ATOM	8892	C	LEU	A1226	-34.463	65.779	-11.883	1.00	73.06	C
ATOM	8893	CB	LEU	A1226	-36.234	67.347	-11.032	1.00	73.97	C
ATOM	8894	CG	LEU	A1226	-37.340	66.398	-11.484	1.00	75.91	C
ATOM	8895	CD1	LEU	A1226	-37.467	65.194	-10.577	1.00	75.35	C
ATOM	8896	CD2	LEU	A1226	-38.643	67.180	-11.523	1.00	80.60	C
ATOM	8897	O	ALA	A1227	-34.901	61.509	-12.653	1.00	81.13	O
ATOM	8898	N	ALA	A1227	-34.121	64.560	-11.483	1.00	72.49	N
ATOM	8899	CA	ALA	A1227	-33.627	63.541	-12.398	1.00	73.82	C
ATOM	8900	C	ALA	A1227	-34.742	62.682	-13.018	1.00	82.36	C
ATOM	8901	CB	ALA	A1227	-32.633	62.650	-11.670	1.00	70.35	C
ATOM	8902	O	LEU	A1228	-35.023	61.498	-16.197	1.00	87.41	O
ATOM	8903	N	LEU	A1228	-35.495	63.259	-13.962	1.00	84.98	N
ATOM	8904	CA	LEU	A1228	-36.548	62.536	-14.687	1.00	82.59	C
ATOM	8905	C	LEU	A1228	-36.005	61.354	-15.459	1.00	86.76	C
ATOM	8906	CB	LEU	A1228	-37.275	63.452	-15.666	1.00	80.43	C
ATOM	8907	CG	LEU	A1228	-38.603	64.034	-15.195	1.00	87.82	C
ATOM	8908	CD1	LEU	A1228	-39.441	64.492	-16.382	1.00	87.83	C
ATOM	8909	CD2	LEU	A1228	-39.362	63.031	-14.341	1.00	87.81	C
ATOM	8910	N	PRO	A1229	-36.651	60.182	-15.309	1.00	92.56	N
ATOM	8911	CA	PRO	A1229	-36.219	58.972	-16.027	1.00	87.41	C
ATOM	8912	C	PRO	A1229	-36.384	59.150	-17.530	1.00	82.41	C
ATOM	8913	O	PRO	A1229	-37.190	59.978	-17.946	1.00	84.84	O
ATOM	8914	CB	PRO	A1229	-37.152	57.882	-15.482	1.00	87.90	C
ATOM	8915	CG	PRO	A1229	-37.709	58.456	-14.187	1.00	84.94	C
ATOM	8916	CD	PRO	A1229	-37.813	59.922	-14.439	1.00	84.81	C
ATOM	8917	N	SER	A1230	-35.633	58.391	-18.321	1.00	87.01	N
ATOM	8918	CA	SER	A1230	-35.599	58.555	-19.776	1.00	85.50	C
ATOM	8919	C	SER	A1230	-36.974	58.491	-20.439	1.00	88.25	C
ATOM	8920	O	SER	A1230	-37.222	59.186	-21.426	1.00	90.32	O
ATOM	8921	CB	SER	A1230	-34.696	57.495	-20.402	1.00	85.83	C
ATOM	8922	OG	SER	A1230	-33.384	57.544	-19.865	1.00	87.97	O
ATOM	8923	N	LYS	A1231	-37.862	57.661	-19.895	1.00	89.02	N
ATOM	8924	CA	LYS	A1231	-39.189	57.444	-20.479	1.00	83.46	C
ATOM	8925	C	LYS	A1231	-39.981	58.733	-20.578	1.00	83.98	C
ATOM	8926	O	LYS	A1231	-40.526	59.057	-21.637	1.00	87.53	O
ATOM	8927	CB	LYS	A1231	-39.978	56.417	-19.661	1.00	84.81	C
ATOM	8928	N	TYR	A1232	-40.044	59.468	-19.473	1.00	81.51	N
ATOM	8929	CA	TYR	A1232	-40.776	60.729	-19.433	1.00	87.60	C
ATOM	8930	C	TYR	A1232	-40.114	61.805	-20.283	1.00	86.22	C
ATOM	8931	O	TYR	A1232	-40.766	62.753	-20.726	1.00	87.59	O
ATOM	8932	CB	TYR	A1232	-40.908	61.208	-17.992	1.00	93.70	C
ATOM	8933	CG	TYR	A1232	-41.774	60.314	-17.127	1.00	95.11	C
ATOM	8934	CD1	TYR	A1232	-42.611	59.366	-17.692	1.00	91.61	C
ATOM	8935	CD2	TYR	A1232	-41.759	60.433	-15.750	1.00	93.00	C
ATOM	8936	CE1	TYR	A1232	-43.401	58.555	-16.913	1.00	93.09	C
ATOM	8937	CE2	TYR	A1232	-42.549	59.635	-14.954	1.00	93.99	C
ATOM	8938	CE	TYR	A1232	-43.369	58.696	-15.540	1.00	95.44	C
ATOM	8939	OH	TYR	A1232	-44.147	57.891	-14.755	1.00	96.83	O
ATOM	8940	N	VAL	A1233	-38.813	61.636	-20.506	1.00	89.01	N
ATOM	8941	CA	VAL	A1233	-38.015	62.546	-21.322	1.00	86.58	C
ATOM	8942	C	VAL	A1233	-38.360	62.393	-22.803	1.00	81.43	C
ATOM	8943	O	VAL	A1233	-38.665	63.375	-23.473	1.00	81.90	O
ATOM	8944	CB	VAL	A1233	-36.504	62.301	-21.107	1.00	84.56	C
ATOM	8945	CG1	VAL	A1233	-35.673	63.191	-22.002	1.00	81.05	C
ATOM	8946	CG2	VAL	A1233	-36.145	62.537	-19.660	1.00	86.19	C
ATOM	8947	N	ASN	A1234	-38.313	61.161	-23.303	1.00	82.66	N

ATOM	8948	CA	ASN	A1234	-38.682	60.870	-24.690	1.00	83.45	C
ATOM	8949	C	ASN	A1234	-40.089	61.317	-25.008	1.00	81.14	C
ATOM	8950	O	ASN	A1234	-40.342	61.918	-26.048	1.00	80.19	O
ATOM	8951	CB	ASN	A1234	-38.565	59.380	-24.981	1.00	79.83	C
ATOM	8952	CG	ASN	A1234	-37.148	58.886	-24.908	1.00	80.49	C
ATOM	8953	OD1	ASN	A1234	-36.209	59.606	-25.242	1.00	81.74	O
ATOM	8954	ND2	ASN	A1234	-36.981	57.647	-24.468	1.00	82.27	N
ATOM	8955	N	PHE	A1235	-41.000	61.007	-24.094	1.00	81.57	N
ATOM	8956	CA	PHE	A1235	-42.404	61.352	-24.254	1.00	81.53	C
ATOM	8957	C	PHE	A1235	-42.597	62.843	-24.363	1.00	86.11	C
ATOM	8958	O	PHE	A1235	-43.331	63.324	-25.227	1.00	89.62	O
ATOM	8959	CB	PHE	A1235	-43.234	60.833	-23.084	1.00	85.80	C
ATOM	8960	CG	PHE	A1235	-44.666	61.254	-23.138	1.00	85.02	C
ATOM	8961	CD2	PHE	A1235	-45.595	60.495	-23.820	1.00	88.43	C
ATOM	8962	CD1	PHE	A1235	-45.088	62.417	-22.521	1.00	91.00	C
ATOM	8963	CE2	PHE	A1235	-46.913	60.882	-23.878	1.00	91.77	C
ATOM	8964	CE1	PHE	A1235	-46.400	62.813	-22.580	1.00	90.92	C
ATOM	8965	CZ	PHE	A1235	-47.318	62.046	-23.257	1.00	96.21	C
ATOM	8966	N	LEU	A1236	-41.970	63.571	-23.449	1.00	87.92	N
ATOM	8967	CA	LEU	A1236	-42.039	65.021	-23.462	1.00	85.81	C
ATOM	8968	C	LEU	A1236	-41.517	65.583	-24.782	1.00	84.91	C
ATOM	8969	O	LEU	A1236	-42.074	66.536	-25.329	1.00	84.00	O
ATOM	8970	CB	LEU	A1236	-41.251	65.597	-22.289	1.00	84.96	C
ATOM	8971	CG	LEU	A1236	-42.097	65.973	-21.077	1.00	89.04	C
ATOM	8972	CD1	LEU	A1236	-41.279	66.781	-20.085	1.00	89.73	C
ATOM	8973	CD2	LEU	A1236	-43.329	66.754	-21.510	1.00	86.67	C
ATOM	8974	N	TYR	A1237	-40.452	64.984	-25.299	1.00	80.64	N
ATOM	8975	CA	TYR	A1237	-39.864	65.476	-26.531	1.00	83.47	C
ATOM	8976	C	TYR	A1237	-40.807	65.306	-27.707	1.00	83.12	C
ATOM	8977	O	TYR	A1237	-41.096	66.260	-28.423	1.00	81.46	O
ATOM	8978	CB	TYR	A1237	-38.550	64.764	-26.842	1.00	80.97	C
ATOM	8979	CG	TYR	A1237	-38.037	65.145	-28.205	1.00	84.24	C
ATOM	8980	CD2	TYR	A1237	-38.157	64.283	-29.285	1.00	83.61	C
ATOM	8981	CD1	TYR	A1237	-37.470	66.391	-28.422	1.00	82.14	C
ATOM	8982	CE2	TYR	A1237	-37.705	64.645	-30.536	1.00	85.46	C
ATOM	8983	CE1	TYR	A1237	-37.018	66.759	-29.665	1.00	85.24	C
ATOM	8984	CZ	TYR	A1237	-37.137	65.883	-30.718	1.00	86.78	C
ATOM	8985	OH	TYR	A1237	-36.683	66.252	-31.959	1.00	88.10	O
ATOM	8986	N	LEU	A1238	-41.252	64.070	-27.911	1.00	83.43	N
ATOM	8987	CA	LEU	A1238	-42.109	63.734	-29.034	1.00	81.45	C
ATOM	8988	C	LEU	A1238	-43.409	64.512	-28.965	1.00	82.53	C
ATOM	8989	O	LEU	A1238	-43.718	65.266	-29.879	1.00	85.38	O
ATOM	8990	CB	LEU	A1238	-42.380	62.235	-29.071	1.00	73.46	C
ATOM	8991	CG	LEU	A1238	-41.094	61.429	-29.267	1.00	79.91	C
ATOM	8992	CD1	LEU	A1238	-41.278	60.002	-28.840	1.00	77.45	C
ATOM	8993	CD2	LEU	A1238	-40.623	61.490	-30.708	1.00	79.14	C
ATOM	8994	N	ALA	A1239	-44.145	64.352	-27.870	1.00	80.56	N
ATOM	8995	CA	ALA	A1239	-45.443	65.005	-27.696	1.00	86.33	C
ATOM	8996	C	ALA	A1239	-45.412	66.499	-28.035	1.00	90.18	C
ATOM	8997	O	ALA	A1239	-46.386	67.059	-28.546	1.00	93.22	O
ATOM	8998	CB	ALA	A1239	-45.933	64.803	-26.275	1.00	88.08	C
ATOM	8999	N	SER	A1240	-44.272	67.124	-27.761	1.00	90.39	N
ATOM	9000	CA	SER	A1240	-44.077	68.547	-27.990	1.00	91.17	C
ATOM	9001	C	SER	A1240	-43.769	68.828	-29.456	1.00	88.60	C
ATOM	9002	O	SER	A1240	-43.860	69.966	-29.914	1.00	86.83	O
ATOM	9003	CB	SER	A1240	-42.945	69.066	-27.096	1.00	92.44	C
ATOM	9004	OG	SER	A1240	-43.236	70.359	-26.591	1.00	97.53	O
ATOM	9005	O	HIS	A1241	-43.729	66.204	-33.202	1.00	94.29	O
ATOM	9006	N	HIS	A1241	-43.392	67.777	-30.179	1.00	90.64	N
ATOM	9007	CA	HIS	A1241	-43.036	67.878	-31.592	1.00	94.46	C
ATOM	9008	C	HIS	A1241	-44.066	67.147	-32.477	1.00	95.22	C
ATOM	9009	CB	HIS	A1241	-41.620	67.320	-31.814	1.00	89.36	C
ATOM	9010	CG	HIS	A1241	-40.525	68.257	-31.398	1.00	89.66	C

ATOM	9011	ND1	HIS	A1241	-40.673	69.173	-30.377	1.00	91.79	N
ATOM	9012	CD2	HIS	A1241	-39.266	68.424	-31.869	1.00	87.12	C
ATOM	9013	CE1	HIS	A1241	-39.555	69.861	-30.237	1.00	85.78	C
ATOM	9014	NE2	HIS	A1241	-38.686	69.428	-31.131	1.00	88.94	N
ATOM	9015	O	TYR	A1242	-46.350	65.939	-35.275	1.00	92.24	O
ATOM	9016	N	TYR	A1242	-45.318	67.600	-32.411	1.00	96.87	N
ATOM	9017	CA	TYR	A1242	-46.433	66.948	-33.102	1.00	98.73	C
ATOM	9018	C	TYR	A1242	-46.286	66.979	-34.621	1.00	93.95	C
ATOM	9019	CB	TYR	A1242	-47.759	67.600	-32.698	1.00	93.49	C
ATOM	9020	O	PRO	A1249	-41.743	58.556	-40.958	1.00	109.13	O
ATOM	9021	N	PRO	A1249	-39.285	59.028	-42.241	1.00	108.61	N
ATOM	9022	CA	PRO	A1249	-40.407	58.354	-42.907	1.00	108.52	C
ATOM	9023	C	PRO	A1249	-41.720	58.620	-42.189	1.00	107.41	C
ATOM	9024	CB	PRO	A1249	-40.042	56.863	-42.813	1.00	106.80	C
ATOM	9025	CG	PRO	A1249	-38.584	56.831	-42.461	1.00	108.51	C
ATOM	9026	CD	PRO	A1249	-38.336	58.068	-41.656	1.00	110.30	C
ATOM	9027	O	GLU	A1250	-45.405	57.605	-40.881	1.00	102.81	O
ATOM	9028	N	GLU	A1250	-42.790	58.900	-42.932	1.00	106.22	N
ATOM	9029	CA	GLU	A1250	-44.115	59.025	-42.327	1.00	102.38	C
ATOM	9030	C	GLU	A1250	-44.519	57.680	-41.732	1.00	102.59	C
ATOM	9031	CB	GLU	A1250	-45.147	59.499	-43.348	1.00	96.89	C
ATOM	9032	N	ASP	A1251	-43.850	56.623	-42.196	1.00	107.94	N
ATOM	9033	CA	ASP	A1251	-43.960	55.285	-41.615	1.00	108.92	C
ATOM	9034	C	ASP	A1251	-43.510	55.294	-40.162	1.00	109.09	C
ATOM	9035	O	ASP	A1251	-44.279	54.964	-39.259	1.00	110.72	O
ATOM	9036	CB	ASP	A1251	-43.124	54.280	-42.408	1.00	104.74	C
ATOM	9037	N	ASN	A1252	-42.260	55.680	-39.938	1.00	106.68	N
ATOM	9038	CA	ASN	A1252	-41.764	55.807	-38.580	1.00	104.61	C
ATOM	9039	C	ASN	A1252	-42.407	56.969	-37.827	1.00	105.23	C
ATOM	9040	O	ASN	A1252	-42.672	56.856	-36.630	1.00	107.68	O
ATOM	9041	CB	ASN	A1252	-40.253	55.970	-38.579	1.00	105.30	C
ATOM	9042	CG	ASN	A1252	-39.594	55.138	-37.513	1.00	101.54	C
ATOM	9043	OD1	ASN	A1252	-38.631	54.427	-37.781	1.00	104.17	O
ATOM	9044	ND2	ASN	A1252	-40.128	55.199	-36.294	1.00	100.14	N
ATOM	9045	N	GLU	A1253	-42.668	58.074	-38.525	1.00	101.90	N
ATOM	9046	CA	GLU	A1253	-43.267	59.255	-37.903	1.00	98.88	C
ATOM	9047	C	GLU	A1253	-44.693	58.986	-37.433	1.00	102.60	C
ATOM	9048	O	GLU	A1253	-45.257	59.753	-36.651	1.00	101.18	O
ATOM	9049	CB	GLU	A1253	-43.253	60.437	-38.868	1.00	99.37	C
ATOM	9050	N	GLN	A1254	-45.277	57.898	-37.921	1.00	105.62	N
ATOM	9051	CA	GLN	A1254	-46.570	57.447	-37.426	1.00	104.34	C
ATOM	9052	C	GLN	A1254	-46.368	56.485	-36.264	1.00	104.36	C
ATOM	9053	O	GLN	A1254	-47.078	56.559	-35.261	1.00	103.15	O
ATOM	9054	CB	GLN	A1254	-47.380	56.779	-38.538	1.00	102.59	C
ATOM	9055	N	LYS	A1255	-45.380	55.598	-36.401	1.00	103.63	N
ATOM	9056	CA	LYS	A1255	-45.051	54.606	-35.379	1.00	99.78	C
ATOM	9057	C	LYS	A1255	-44.657	55.275	-34.070	1.00	106.60	C
ATOM	9058	O	LYS	A1255	-44.574	54.621	-33.030	1.00	107.34	O
ATOM	9059	CB	LYS	A1255	-43.915	53.696	-35.854	1.00	101.68	C
ATOM	9060	N	GLN	A1256	-44.415	56.582	-34.132	1.00	106.53	N
ATOM	9061	CA	GLN	A1256	-44.000	57.350	-32.966	1.00	104.92	C
ATOM	9062	C	GLN	A1256	-45.126	58.236	-32.451	1.00	105.25	C
ATOM	9063	O	GLN	A1256	-45.284	58.397	-31.244	1.00	105.06	O
ATOM	9064	CB	GLN	A1256	-42.766	58.189	-33.294	1.00	100.65	C
ATOM	9065	CG	GLN	A1256	-41.474	57.384	-33.318	1.00	98.22	C
ATOM	9066	CD	GLN	A1256	-40.336	58.153	-33.944	1.00	97.14	C
ATOM	9067	OE1	GLN	A1256	-40.516	59.294	-34.378	1.00	92.91	O
ATOM	9068	NE2	GLN	A1256	-39.156	57.534	-34.001	1.00	92.48	N
ATOM	9069	N	LEU	A1257	-45.929	58.792	-33.353	1.00	104.69	N
ATOM	9070	CA	LEU	A1257	-47.142	59.482	-32.923	1.00	104.06	C
ATOM	9071	C	LEU	A1257	-48.054	58.449	-32.245	1.00	106.58	C
ATOM	9072	O	LEU	A1257	-49.009	58.802	-31.556	1.00	104.72	O
ATOM	9073	CB	LEU	A1257	-47.846	60.164	-34.102	1.00	99.80	C

ATOM	9074	CG	LEU	A1257	-48.338	61.610	-33.920	1.00	99.55	C
ATOM	9075	CD2	LEU	A1257	-47.180	62.582	-33.697	1.00	95.67	C
ATOM	9076	CD1	LEU	A1257	-49.355	61.723	-32.793	1.00	97.57	C
ATOM	9077	N	PHE	A1258	-47.722	57.171	-32.438	1.00105.73		N
ATOM	9078	CA	PHE	A1258	-48.439	56.045	-31.845	1.00106.46		C
ATOM	9079	C	PHE	A1258	-48.194	55.918	-30.346	1.00103.17		C
ATOM	9080	O	PHE	A1258	-49.110	56.122	-29.549	1.00102.72		O
ATOM	9081	CB	PHE	A1258	-48.039	54.740	-32.536	1.00106.54		C
ATOM	9082	N	VAL	A1259	-46.964	55.563	-29.973	1.00102.28		N
ATOM	9083	CA	VAL	A1259	-46.567	55.470	-28.563	1.00	99.80	C
ATOM	9084	C	VAL	A1259	-46.971	56.733	-27.799	1.00100.02		C
ATOM	9085	O	VAL	A1259	-47.367	56.679	-26.632	1.00	95.27	O
ATOM	9086	CB	VAL	A1259	-45.044	55.225	-28.425	1.00	97.84	C
ATOM	9087	CG1	VAL	A1259	-44.278	55.962	-29.511	1.00	98.83	C
ATOM	9088	CG2	VAL	A1259	-44.544	55.607	-27.042	1.00	97.28	C
ATOM	9089	N	GLU	A1260	-46.908	57.866	-28.489	1.00	99.95	N
ATOM	9090	CA	GLU	A1260	-47.366	59.129	-27.939	1.00	96.91	C
ATOM	9091	C	GLU	A1260	-48.791	59.013	-27.403	1.00100.73		C
ATOM	9092	O	GLU	A1260	-49.013	59.120	-26.197	1.00101.17		O
ATOM	9093	CB	GLU	A1260	-47.285	60.222	-29.003	1.00	99.27	C
ATOM	9094	CG	GLU	A1260	-47.002	61.609	-28.451	1.00	95.91	C
ATOM	9095	CD	GLU	A1260	-48.260	62.407	-28.170	1.00	98.83	C
ATOM	9096	OE1	GLU	A1260	-48.358	63.553	-28.657	1.00	99.21	O
ATOM	9097	OE2	GLU	A1260	-49.149	61.897	-27.460	1.00103.52		O
ATOM	9098	N	GLN	A1261	-49.751	58.785	-28.296	1.00101.41		N
ATOM	9099	CA	GLN	A1261	-51.152	58.677	-27.898	1.00100.23		C
ATOM	9100	C	GLN	A1261	-51.383	57.486	-26.981	1.00102.08		C
ATOM	9101	O	GLN	A1261	-52.281	57.508	-26.141	1.00106.09		O
ATOM	9102	CB	GLN	A1261	-52.049	58.564	-29.123	1.00100.40		C
ATOM	9103	CG	GLN	A1261	-51.673	59.519	-30.225	1.00103.69		C
ATOM	9104	CD	GLN	A1261	-52.857	60.286	-30.756	1.00110.42		C
ATOM	9105	OE1	GLN	A1261	-53.103	60.313	-31.965	1.00113.23		O
ATOM	9106	NE2	GLN	A1261	-53.601	60.925	-29.855	1.00108.93		N
ATOM	9107	N	HIS	A1262	-50.558	56.456	-27.146	1.00	99.52	N
ATOM	9108	CA	HIS	A1262	-50.654	55.236	-26.355	1.00100.57		C
ATOM	9109	C	HIS	A1262	-50.324	55.463	-24.876	1.00100.92		C
ATOM	9110	O	HIS	A1262	-50.575	54.596	-24.035	1.00	97.20	O
ATOM	9111	CB	HIS	A1262	-49.720	54.169	-26.929	1.00100.32		C
ATOM	9112	CG	HIS	A1262	-50.391	52.860	-27.211	1.00105.41		C
ATOM	9113	ND1	HIS	A1262	-49.728	51.654	-27.139	1.00111.60		N
ATOM	9114	CD2	HIS	A1262	-51.663	52.569	-27.574	1.00106.66		C
ATOM	9115	CE1	HIS	A1262	-50.563	50.675	-27.440	1.00114.73		C
ATOM	9116	NE2	HIS	A1262	-51.744	51.204	-27.709	1.00115.66		N
ATOM	9117	O	LYS	A1263	-50.354	59.029	-23.112	1.00	92.47	O
ATOM	9118	N	LYS	A1263	-49.756	56.622	-24.557	1.00102.44		N
ATOM	9119	CA	LYS	A1263	-49.282	56.863	-23.200	1.00	97.51	C
ATOM	9120	C	LYS	A1263	-49.975	58.031	-22.500	1.00	95.08	C
ATOM	9121	CB	LYS	A1263	-47.768	57.081	-23.199	1.00	92.53	C
ATOM	9122	CG	LYS	A1263	-46.956	55.803	-23.082	1.00	92.34	C
ATOM	9123	CD	LYS	A1263	-47.147	54.894	-24.283	1.00	89.54	C
ATOM	9124	CE	LYS	A1263	-46.056	53.873	-24.379	1.00	84.25	C
ATOM	9125	NZ	LYS	A1263	-45.945	53.131	-23.099	1.00	87.44	N
ATOM	9126	O	HIS	A1264	-50.529	60.609	-18.897	1.00	97.06	O
ATOM	9127	N	HIS	A1264	-50.102	57.870	-21.190	1.00	95.68	N
ATOM	9128	CA	HIS	A1264	-50.893	58.719	-20.312	1.00	94.06	C
ATOM	9129	C	HIS	A1264	-50.025	59.712	-19.572	1.00	97.26	C
ATOM	9130	CB	HIS	A1264	-51.617	57.840	-19.306	1.00	91.43	C
ATOM	9131	CG	HIS	A1264	-50.758	56.737	-18.771	1.00	93.75	C
ATOM	9132	ND1	HIS	A1264	-50.529	55.569	-19.468	1.00	90.24	N
ATOM	9133	CD2	HIS	A1264	-50.039	56.637	-17.627	1.00	96.10	C
ATOM	9134	CE1	HIS	A1264	-49.725	54.789	-18.768	1.00	90.32	C
ATOM	9135	NE2	HIS	A1264	-49.413	55.414	-17.646	1.00	93.16	N
ATOM	9136	O	TYR	A1265	-47.182	61.896	-17.362	1.00	95.16	O

ATOM	9137	N	TYR	A1265	-48.716	59.534	-19.734	1.00	97.90	N
ATOM	9138	CA	TYR	A1265	-47.662	60.112	-18.891	1.00	95.93	C
ATOM	9139	C	TYR	A1265	-47.862	61.525	-18.318	1.00	95.11	C
ATOM	9140	CB	TYR	A1265	-46.347	60.075	-19.679	1.00	90.54	C
ATOM	9141	CG	TYR	A1265	-45.796	58.674	-19.849	1.00	89.40	C
ATOM	9142	CD1	TYR	A1265	-46.242	57.633	-19.047	1.00	90.45	C
ATOM	9143	CD2	TYR	A1265	-44.829	58.392	-20.802	1.00	88.33	C
ATOM	9144	CE1	TYR	A1265	-45.743	56.352	-19.190	1.00	90.51	C
ATOM	9145	CE2	TYR	A1265	-44.323	57.110	-20.949	1.00	82.19	C
ATOM	9146	CZ	TYR	A1265	-44.786	56.096	-20.143	1.00	84.89	C
ATOM	9147	OH	TYR	A1265	-44.290	54.820	-20.277	1.00	83.04	O
ATOM	9148	N	LEU	A1266	-48.788	62.299	-18.880	1.00	95.41	N
ATOM	9149	CA	LEU	A1266	-49.051	63.660	-18.400	1.00	100.92	C
ATOM	9150	C	LEU	A1266	-49.312	63.733	-16.891	1.00	101.92	C
ATOM	9151	O	LEU	A1266	-48.916	64.688	-16.224	1.00	100.76	O
ATOM	9152	CB	LEU	A1266	-50.250	64.277	-19.126	1.00	95.50	C
ATOM	9153	CG	LEU	A1266	-50.352	64.206	-20.646	1.00	95.77	C
ATOM	9154	CD1	LEU	A1266	-51.315	65.278	-21.148	1.00	95.88	C
ATOM	9155	CD2	LEU	A1266	-49.000	64.363	-21.289	1.00	92.44	C
ATOM	9156	N	ASP	A1267	-49.996	62.727	-16.364	1.00	103.54	N
ATOM	9157	CA	ASP	A1267	-50.330	62.702	-14.950	1.00	105.25	C
ATOM	9158	C	ASP	A1267	-49.106	62.301	-14.116	1.00	104.07	C
ATOM	9159	O	ASP	A1267	-48.935	62.771	-12.990	1.00	106.08	O
ATOM	9160	CB	ASP	A1267	-51.506	61.744	-14.694	1.00	105.37	C
ATOM	9161	CG	ASP	A1267	-52.690	62.426	-14.017	1.00	107.64	C
ATOM	9162	OD2	ASP	A1267	-52.868	62.227	-12.793	1.00	114.11	O
ATOM	9163	OD1	ASP	A1267	-53.450	63.145	-14.706	1.00	102.29	O
ATOM	9164	N	GLU	A1268	-48.246	61.453	-14.674	1.00	98.99	N
ATOM	9165	CA	GLU	A1268	-47.131	60.907	-13.905	1.00	98.54	C
ATOM	9166	C	GLU	A1268	-45.965	61.899	-13.750	1.00	100.11	C
ATOM	9167	O	GLU	A1268	-45.266	61.891	-12.735	1.00	97.62	O
ATOM	9168	CB	GLU	A1268	-46.649	59.599	-14.546	1.00	96.87	C
ATOM	9169	CG	GLU	A1268	-47.623	58.426	-14.388	1.00	96.43	C
ATOM	9170	CD	GLU	A1268	-47.193	57.162	-15.135	1.00	98.31	C
ATOM	9171	OE1	GLU	A1268	-46.066	57.121	-15.673	1.00	96.95	O
ATOM	9172	OE2	GLU	A1268	-47.991	56.200	-15.187	1.00	100.27	O
ATOM	9173	N	ILE	A1269	-45.763	62.751	-14.751	1.00	98.02	N
ATOM	9174	CA	ILE	A1269	-44.708	63.759	-14.693	1.00	96.69	C
ATOM	9175	C	ILE	A1269	-45.089	64.853	-13.709	1.00	93.55	C
ATOM	9176	O	ILE	A1269	-44.259	65.343	-12.948	1.00	93.16	O
ATOM	9177	CB	ILE	A1269	-44.432	64.382	-16.086	1.00	97.18	C
ATOM	9178	CG1	ILE	A1269	-43.411	63.543	-16.841	1.00	93.95	C
ATOM	9179	CG2	ILE	A1269	-43.949	65.819	-15.971	1.00	95.28	C
ATOM	9180	CD1	ILE	A1269	-44.045	62.575	-17.792	1.00	96.38	C
ATOM	9181	N	ILE	A1270	-46.360	65.228	-13.730	1.00	97.39	N
ATOM	9182	CA	ILE	A1270	-46.899	66.163	-12.754	1.00	96.71	C
ATOM	9183	C	ILE	A1270	-46.632	65.635	-11.346	1.00	94.96	C
ATOM	9184	O	ILE	A1270	-46.248	66.383	-10.452	1.00	90.77	O
ATOM	9185	CB	ILE	A1270	-48.398	66.377	-12.973	1.00	96.13	C
ATOM	9186	CG1	ILE	A1270	-48.636	67.148	-14.276	1.00	99.47	C
ATOM	9187	CG2	ILE	A1270	-49.011	67.115	-11.798	1.00	99.13	C
ATOM	9188	CD1	ILE	A1270	-48.557	68.666	-14.134	1.00	94.91	C
ATOM	9189	N	GLU	A1271	-46.808	64.328	-11.171	1.00	98.04	N
ATOM	9190	CA	GLU	A1271	-46.511	63.671	-9.904	1.00	99.61	C
ATOM	9191	C	GLU	A1271	-45.017	63.793	-9.583	1.00	99.45	C
ATOM	9192	O	GLU	A1271	-44.640	64.139	-8.460	1.00	99.79	O
ATOM	9193	CB	GLU	A1271	-46.936	62.195	-9.945	1.00	99.39	C
ATOM	9194	CG	GLU	A1271	-47.492	61.657	-8.628	1.00	101.42	C
ATOM	9195	CD	GLU	A1271	-48.947	62.051	-8.389	1.00	106.95	C
ATOM	9196	OE1	GLU	A1271	-49.842	61.262	-8.766	1.00	108.02	O
ATOM	9197	OE2	GLU	A1271	-49.197	63.138	-7.818	1.00	100.15	O
ATOM	9198	N	GLN	A1272	-44.180	63.510	-10.578	1.00	97.41	N
ATOM	9199	CA	GLN	A1272	-42.733	63.663	-10.458	1.00	93.90	C

ATOM	9200	C	GLN	A1272	-42.358	65.051	-9.952	1.00	92.75	C
ATOM	9201	O	GLN	A1272	-41.704	65.201	-8.922	1.00	93.57	O
ATOM	9202	CB	GLN	A1272	-42.071	63.404	-11.808	1.00	89.41	C
ATOM	9203	CG	GLN	A1272	-42.088	61.962	-12.214	1.00	85.31	C
ATOM	9204	CD	GLN	A1272	-40.965	61.217	-11.581	1.00	85.01	C
ATOM	9205	OE1	GLN	A1272	-39.901	61.783	-11.342	1.00	89.35	O
ATOM	9206	NE2	GLN	A1272	-41.182	59.945	-11.286	1.00	86.66	N
ATOM	9207	N	ILE	A1273	-42.794	66.064	-10.684	1.00	87.64	N
ATOM	9208	CA	ILE	A1273	-42.493	67.442	-10.346	1.00	90.89	C
ATOM	9209	C	ILE	A1273	-42.969	67.831	-8.934	1.00	94.99	C
ATOM	9210	O	ILE	A1273	-42.268	68.544	-8.211	1.00	92.98	O
ATOM	9211	CB	ILE	A1273	-43.115	68.391	-11.387	1.00	87.18	C
ATOM	9212	CG1	ILE	A1273	-42.420	68.212	-12.740	1.00	87.11	C
ATOM	9213	CG2	ILE	A1273	-43.023	69.825	-10.928	1.00	80.93	C
ATOM	9214	CD1	ILE	A1273	-42.909	69.160	-13.820	1.00	83.34	C
ATOM	9215	N	SER	A1274	-44.143	67.347	-8.533	1.00	95.82	N
ATOM	9216	CA	SER	A1274	-44.682	67.679	-7.214	1.00	92.77	C
ATOM	9217	C	SER	A1274	-43.972	66.911	-6.091	1.00	93.32	C
ATOM	9218	O	SER	A1274	-43.790	67.442	-4.995	1.00	92.64	O
ATOM	9219	CB	SER	A1274	-46.188	67.419	-7.174	1.00	95.47	C
ATOM	9220	OG	SER	A1274	-46.489	66.102	-7.591	1.00	94.63	O
ATOM	9221	N	GLU	A1275	-43.563	65.673	-6.365	1.00	92.11	N
ATOM	9222	CA	GLU	A1275	-42.721	64.923	-5.431	1.00	92.64	C
ATOM	9223	C	GLU	A1275	-41.439	65.698	-5.121	1.00	92.56	C
ATOM	9224	O	GLU	A1275	-40.926	65.670	-4.003	1.00	92.05	O
ATOM	9225	CB	GLU	A1275	-42.371	63.540	-6.005	1.00	100.19	C
ATOM	9226	CG	GLU	A1275	-41.421	62.689	-5.140	1.00	98.52	C
ATOM	9227	CD	GLU	A1275	-40.784	61.524	-5.911	1.00	102.39	C
ATOM	9228	OE1	GLU	A1275	-40.852	61.528	-7.161	1.00	100.58	O
ATOM	9229	OE2	GLU	A1275	-40.212	60.609	-5.270	1.00	98.88	O
ATOM	9230	N	PHE	A1276	-40.930	66.389	-6.132	1.00	92.28	N
ATOM	9231	CA	PHE	A1276	-39.687	67.133	-6.027	1.00	87.66	C
ATOM	9232	C	PHE	A1276	-39.915	68.417	-5.243	1.00	83.42	C
ATOM	9233	O	PHE	A1276	-39.205	68.706	-4.281	1.00	80.54	O
ATOM	9234	CB	PHE	A1276	-39.154	67.434	-7.428	1.00	83.35	C
ATOM	9235	CG	PHE	A1276	-37.718	67.872	-7.471	1.00	76.62	C
ATOM	9236	CD2	PHE	A1276	-37.397	69.205	-7.654	1.00	74.61	C
ATOM	9237	CD1	PHE	A1276	-36.692	66.952	-7.377	1.00	74.30	C
ATOM	9238	CE2	PHE	A1276	-36.082	69.615	-7.732	1.00	73.07	C
ATOM	9239	CE1	PHE	A1276	-35.366	67.359	-7.441	1.00	72.12	C
ATOM	9240	CZ	PHE	A1276	-35.065	68.694	-7.621	1.00	71.06	C
ATOM	9241	N	SER	A1277	-40.924	69.175	-5.655	1.00	83.47	N
ATOM	9242	CA	SER	A1277	-41.215	70.457	-5.030	1.00	86.55	C
ATOM	9243	C	SER	A1277	-41.470	70.333	-3.536	1.00	84.24	C
ATOM	9244	O	SER	A1277	-40.836	71.027	-2.739	1.00	85.19	O
ATOM	9245	CB	SER	A1277	-42.416	71.126	-5.699	1.00	89.39	C
ATOM	9246	OG	SER	A1277	-42.762	72.323	-5.017	1.00	88.50	O
ATOM	9247	N	LYS	A1278	-42.385	69.443	-3.162	1.00	85.94	N
ATOM	9248	CA	LYS	A1278	-42.764	69.280	-1.760	1.00	87.46	C
ATOM	9249	C	LYS	A1278	-41.563	68.888	-0.890	1.00	86.80	C
ATOM	9250	O	LYS	A1278	-41.480	69.272	0.279	1.00	86.54	O
ATOM	9251	CB	LYS	A1278	-43.888	68.246	-1.627	1.00	86.38	C
ATOM	9252	N	ARG	A1279	-40.622	68.147	-1.465	1.00	82.30	N
ATOM	9253	CA	ARG	A1279	-39.431	67.749	-0.721	1.00	79.29	C
ATOM	9254	C	ARG	A1279	-38.392	68.866	-0.676	1.00	80.04	C
ATOM	9255	O	ARG	A1279	-37.736	69.088	0.339	1.00	79.56	O
ATOM	9256	CB	ARG	A1279	-38.801	66.492	-1.333	1.00	77.47	C
ATOM	9257	CG	ARG	A1279	-37.777	65.815	-0.428	1.00	78.21	C
ATOM	9258	CD	ARG	A1279	-37.226	64.531	-1.027	1.00	76.65	C
ATOM	9259	NE	ARG	A1279	-36.295	64.817	-2.117	1.00	85.72	N
ATOM	9260	CZ	ARG	A1279	-35.364	63.976	-2.561	1.00	84.10	C
ATOM	9261	NH1	ARG	A1279	-35.227	62.775	-2.005	1.00	79.35	N
ATOM	9262	NH2	ARG	A1279	-34.572	64.343	-3.567	1.00	80.10	N

ATOM	9263	N	VAL	A1280	-38.252	69.576	-1.784	1.00	78.72	N
ATOM	9264	CA	VAL	A1280	-37.056	70.359	-1.999	1.00	72.49	C
ATOM	9265	C	VAL	A1280	-37.323	71.819	-2.320	1.00	78.71	C
ATOM	9266	O	VAL	A1280	-36.697	72.701	-1.739	1.00	82.24	O
ATOM	9267	CB	VAL	A1280	-36.236	69.749	-3.126	1.00	71.02	C
ATOM	9268	CG1	VAL	A1280	-35.066	70.614	-3.417	1.00	73.53	C
ATOM	9269	CG2	VAL	A1280	-35.790	68.368	-2.733	1.00	68.21	C
ATOM	9270	N	ILE	A1281	-38.242	72.087	-3.238	1.00	75.63	N
ATOM	9271	CA	ILE	A1281	-38.456	73.464	-3.656	1.00	76.25	C
ATOM	9272	C	ILE	A1281	-39.154	74.232	-2.548	1.00	81.78	C
ATOM	9273	O	ILE	A1281	-38.855	75.407	-2.311	1.00	80.47	O
ATOM	9274	CB	ILE	A1281	-39.268	73.553	-4.959	1.00	76.86	C
ATOM	9275	CG1	ILE	A1281	-38.569	72.762	-6.071	1.00	77.91	C
ATOM	9276	CG2	ILE	A1281	-39.457	74.990	-5.370	1.00	75.66	C
ATOM	9277	CD1	ILE	A1281	-37.056	72.956	-6.128	1.00	73.22	C
ATOM	9278	O	LEU	A1282	-41.447	76.409	-0.362	1.00	87.07	O
ATOM	9279	N	LEU	A1282	-40.059	73.548	-1.852	1.00	81.80	N
ATOM	9280	CA	LEU	A1282	-40.793	74.128	-0.721	1.00	84.07	C
ATOM	9281	C	LEU	A1282	-41.490	75.424	-1.108	1.00	86.29	C
ATOM	9282	CB	LEU	A1282	-39.866	74.379	0.473	1.00	80.47	C
ATOM	9283	CG	LEU	A1282	-39.489	73.204	1.381	1.00	82.15	C
ATOM	9284	CD2	LEU	A1282	-38.073	73.409	1.887	1.00	79.62	C
ATOM	9285	CD1	LEU	A1282	-39.616	71.854	0.681	1.00	75.27	C
ATOM	9286	O	ALA	A1283	-45.039	75.987	-3.696	1.00	95.87	O
ATOM	9287	N	ALA	A1283	-42.121	75.416	-2.280	1.00	86.38	N
ATOM	9288	CA	ALA	A1283	-42.902	76.555	-2.750	1.00	90.94	C
ATOM	9289	C	ALA	A1283	-44.394	76.236	-2.675	1.00	93.82	C
ATOM	9290	CB	ALA	A1283	-42.501	76.930	-4.167	1.00	90.63	C
ATOM	9291	O	ASP	A1284	-47.997	75.782	-2.829	1.00	93.55	O
ATOM	9292	N	ASP	A1284	-44.920	76.252	-1.451	1.00	90.68	N
ATOM	9293	CA	ASP	A1284	-46.296	75.870	-1.148	1.00	91.21	C
ATOM	9294	C	ASP	A1284	-47.327	76.492	-2.077	1.00	95.44	C
ATOM	9295	CB	ASP	A1284	-46.628	76.249	0.292	1.00	95.55	C
ATOM	9296	CG	ASP	A1284	-45.579	75.771	1.273	1.00	100.69	C
ATOM	9297	OD1	ASP	A1284	-45.364	74.536	1.347	1.00	88.46	O
ATOM	9298	OD2	ASP	A1284	-44.980	76.628	1.969	1.00	99.73	O
ATOM	9299	O	ALA	A1285	-49.220	77.715	-4.921	1.00	99.53	O
ATOM	9300	N	ALA	A1285	-47.443	77.816	-2.015	1.00	96.59	N
ATOM	9301	CA	ALA	A1285	-48.390	78.567	-2.842	1.00	96.75	C
ATOM	9302	C	ALA	A1285	-48.273	78.221	-4.326	1.00	98.37	C
ATOM	9303	CB	ALA	A1285	-48.191	80.068	-2.639	1.00	96.17	C
ATOM	9304	N	ASN	A1286	-47.101	78.484	-4.903	1.00	99.14	N
ATOM	9305	CA	ASN	A1286	-46.842	78.270	-6.327	1.00	95.35	C
ATOM	9306	C	ASN	A1286	-47.224	76.895	-6.858	1.00	98.46	C
ATOM	9307	O	ASN	A1286	-47.812	76.792	-7.934	1.00	101.07	O
ATOM	9308	CB	ASN	A1286	-45.368	78.512	-6.628	1.00	92.64	C
ATOM	9309	CG	ASN	A1286	-45.096	79.918	-7.088	1.00	95.27	C
ATOM	9310	OD1	ASN	A1286	-45.839	80.845	-6.765	1.00	93.75	O
ATOM	9311	ND2	ASN	A1286	-44.032	80.089	-7.862	1.00	97.70	N
ATOM	9312	N	LEU	A1287	-46.881	75.844	-6.119	1.00	94.59	N
ATOM	9313	CA	LEU	A1287	-47.191	74.485	-6.552	1.00	94.21	C
ATOM	9314	C	LEU	A1287	-48.693	74.270	-6.638	1.00	98.78	C
ATOM	9315	O	LEU	A1287	-49.188	73.579	-7.526	1.00	97.78	O
ATOM	9316	CB	LEU	A1287	-46.578	73.462	-5.602	1.00	93.20	C
ATOM	9317	CG	LEU	A1287	-46.780	71.996	-5.987	1.00	93.25	C
ATOM	9318	CD1	LEU	A1287	-46.392	71.760	-7.432	1.00	90.66	C
ATOM	9319	CD2	LEU	A1287	-45.972	71.090	-5.074	1.00	90.26	C
ATOM	9320	N	ASP	A1288	-49.415	74.872	-5.701	1.00	102.27	N
ATOM	9321	CA	ASP	A1288	-50.865	74.741	-5.663	1.00	102.68	C
ATOM	9322	C	ASP	A1288	-51.498	75.471	-6.849	1.00	100.21	C
ATOM	9323	O	ASP	A1288	-52.384	74.937	-7.507	1.00	102.18	O
ATOM	9324	CB	ASP	A1288	-51.414	75.270	-4.336	1.00	101.28	C
ATOM	9325	CG	ASP	A1288	-50.701	74.672	-3.120	1.00	106.19	C

ATOM	9326	OD1	ASP	A1288	-50.089	73.583	-3.238	1.00107.39	O
ATOM	9327	OD2	ASP	A1288	-50.753	75.300	-2.038	1.00106.70	O
ATOM	9328	N	LYS	A1289	-51.023	76.683	-7.127	1.00 99.47	N
ATOM	9329	CA	LYS	A1289	-51.468	77.440	-8.296	1.00 98.56	C
ATOM	9330	C	LYS	A1289	-51.059	76.742	-9.594	1.00100.40	C
ATOM	9331	O	LYS	A1289	-51.686	76.937	-10.636	1.00 99.85	O
ATOM	9332	CB	LYS	A1289	-50.908	78.864	-8.262	1.00 94.61	C
ATOM	9333	CG	LYS	A1289	-51.291	79.700	-9.461	1.00 91.73	C
ATOM	9334	CD	LYS	A1289	-51.011	81.163	-9.230	1.00 89.19	C
ATOM	9335	CE	LYS	A1289	-51.383	81.982	-10.457	1.00 96.64	C
ATOM	9336	NZ	LYS	A1289	-51.489	83.441	-10.169	1.00 90.46	N
ATOM	9337	N	VAL	A1290	-50.009	75.925	-9.515	1.00 97.88	N
ATOM	9338	CA	VAL	A1290	-49.566	75.108	-10.641	1.00 97.76	C
ATOM	9339	C	VAL	A1290	-50.550	73.984	-10.924	1.00 99.50	O
ATOM	9340	O	VAL	A1290	-50.969	73.782	-12.063	1.00 99.68	C
ATOM	9341	CB	VAL	A1290	-48.168	74.485	-10.388	1.00 97.75	C
ATOM	9342	CG1	VAL	A1290	-47.970	73.229	-11.221	1.00 93.69	C
ATOM	9343	CG2	VAL	A1290	-47.084	75.472	-10.686	1.00 95.31	C
ATOM	9344	N	LEU	A1291	-50.919	73.252	-9.879	1.00101.26	N
ATOM	9345	CA	LEU	A1291	-51.712	72.042	-10.047	1.00101.94	C
ATOM	9346	C	LEU	A1291	-53.164	72.355	-10.401	1.00105.26	C
ATOM	9347	O	LEU	A1291	-53.834	71.554	-11.061	1.00101.99	O
ATOM	9348	CB	LEU	A1291	-51.628	71.186	-8.783	1.00101.51	C
ATOM	9349	CG	LEU	A1291	-50.224	70.596	-8.582	1.00 95.72	C
ATOM	9350	CD1	LEU	A1291	-50.149	69.656	-7.385	1.00 84.37	C
ATOM	9351	CD2	LEU	A1291	-49.788	69.888	-9.851	1.00 96.07	C
ATOM	9352	N	SER	A1292	-53.632	73.531	-9.976	1.00107.00	N
ATOM	9353	CA	SER	A1292	-54.971	74.017	-10.314	1.00104.00	C
ATOM	9354	C	SER	A1292	-55.073	74.348	-11.802	1.00106.29	C
ATOM	9355	O	SER	A1292	-55.894	73.772	-12.524	1.00107.86	O
ATOM	9356	CB	SER	A1292	-55.329	75.253	-9.480	1.00105.59	C
ATOM	9357	OG	SER	A1292	-54.658	76.410	-9.950	1.00103.30	O
ATOM	9358	O	ALA	A1293	-53.824	74.631	-15.791	1.00105.60	O
ATOM	9359	N	ALA	A1293	-54.226	75.271	-12.255	1.00105.36	N
ATOM	9360	CA	ALA	A1293	-54.196	75.666	-13.661	1.00103.27	C
ATOM	9361	C	ALA	A1293	-53.725	74.532	-14.569	1.00103.26	C
ATOM	9362	CB	ALA	A1293	-53.316	76.876	-13.846	1.00 99.80	C
ATOM	9363	O	TYR	A1294	-54.289	71.720	-16.574	1.00100.71	O
ATOM	9364	N	TYR	A1294	-53.203	73.463	-13.978	1.00100.73	N
ATOM	9365	CA	TYR	A1294	-52.838	72.293	-14.758	1.00100.32	C
ATOM	9366	C	TYR	A1294	-54.078	71.659	-15.359	1.00102.17	C
ATOM	9367	CB	TYR	A1294	-52.092	71.262	-13.912	1.00 98.61	C
ATOM	9368	CG	TYR	A1294	-52.064	69.899	-14.557	1.00 95.61	C
ATOM	9369	CD2	TYR	A1294	-52.559	68.789	-13.897	1.00 97.22	C
ATOM	9370	CD1	TYR	A1294	-51.550	69.725	-15.833	1.00 95.00	C
ATOM	9371	CE2	TYR	A1294	-52.537	67.544	-14.485	1.00 96.56	C
ATOM	9372	CE1	TYR	A1294	-51.531	68.489	-16.428	1.00 95.40	C
ATOM	9373	CZ	TYR	A1294	-52.023	67.401	-15.751	1.00 93.93	C
ATOM	9374	OH	TYR	A1294	-52.000	66.165	-16.344	1.00 97.16	O
ATOM	9375	O	ASN	A1295	-57.633	70.790	-16.686	1.00 97.28	O
ATOM	9376	N	ASN	A1295	-54.888	71.048	-14.494	1.00103.84	N
ATOM	9377	CA	ASN	A1295	-56.094	70.342	-14.912	1.00102.71	C
ATOM	9378	C	ASN	A1295	-57.057	71.227	-15.694	1.00100.57	C
ATOM	9379	CB	ASN	A1295	-56.798	69.744	-13.697	1.00 99.94	C
ATOM	9380	CG	ASN	A1295	-56.334	68.341	-13.402	1.00 98.97	C
ATOM	9381	OD1	ASN	A1295	-55.926	67.613	-14.305	1.00102.55	O
ATOM	9382	ND2	ASN	A1295	-56.398	67.947	-12.139	1.00 99.42	N
ATOM	9383	O	LYS	A1296	-58.740	73.680	-18.233	1.00106.19	O
ATOM	9384	N	LYS	A1296	-57.204	72.475	-15.252	1.00102.18	N
ATOM	9385	CA	LYS	A1296	-58.017	73.481	-15.944	1.00101.49	C
ATOM	9386	C	LYS	A1296	-57.813	73.439	-17.456	1.00104.29	C
ATOM	9387	CB	LYS	A1296	-57.694	74.877	-15.405	1.00102.43	C
ATOM	9388	CG	LYS	A1296	-58.176	76.031	-16.270	1.00104.89	C

ATOM	9389	CD	LYS	A1296	-58.344	77.303	-15.445	1.00106.00	C
ATOM	9390	CE	LYS	A1296	-57.121	77.581	-14.581	1.00105.99	C
ATOM	9391	NZ	LYS	A1296	-57.420	78.518	-13.459	1.00111.48	N
ATOM	9392	O	HIS	A1297	-54.964	71.225	-20.316	1.00 99.09	O
ATOM	9393	N	HIS	A1297	-56.596	73.103	-17.866	1.00102.96	N
ATOM	9394	CA	HIS	A1297	-56.309	72.900	-19.269	1.00101.81	C
ATOM	9395	C	HIS	A1297	-55.853	71.468	-19.499	1.00 99.16	C
ATOM	9396	CB	HIS	A1297	-55.247	73.885	-19.758	1.00100.74	C
ATOM	9397	CG	HIS	A1297	-55.430	75.279	-19.242	1.00102.90	C
ATOM	9398	ND1	HIS	A1297	-54.976	75.680	-18.004	1.00102.44	N
ATOM	9399	CD2	HIS	A1297	-56.013	76.369	-19.798	1.00105.02	C
ATOM	9400	CE1	HIS	A1297	-55.268	76.954	-17.819	1.00104.80	C
ATOM	9401	NE2	HIS	A1297	-55.898	77.396	-18.893	1.00105.70	N
ATOM	9402	O	ARG	A1298	-56.917	67.547	-20.731	1.00102.58	O
ATOM	9403	N	ARG	A1298	-56.460	70.528	-18.773	1.00 96.26	N
ATOM	9404	CA	ARG	A1298	-56.238	69.105	-19.038	1.00101.42	C
ATOM	9405	C	ARG	A1298	-57.091	68.654	-20.220	1.00102.45	C
ATOM	9406	CB	ARG	A1298	-56.550	68.247	-17.807	1.00 98.81	C
ATOM	9407	O	ASP	A1299	-58.343	68.937	-24.116	1.00 99.59	O
ATOM	9408	N	ASP	A1299	-58.012	69.523	-20.644	1.00101.15	N
ATOM	9409	CA	ASP	A1299	-58.873	69.272	-21.803	1.00 99.32	C
ATOM	9410	C	ASP	A1299	-58.182	69.637	-23.118	1.00100.59	C
ATOM	9411	CB	ASP	A1299	-60.189	70.048	-21.676	1.00101.72	C
ATOM	9412	O	LYS	A1300	-55.150	69.258	-23.693	1.00103.49	O
ATOM	9413	N	LYS	A1300	-57.428	70.738	-23.116	1.00100.96	N
ATOM	9414	CA	LYS	A1300	-56.588	71.117	-24.254	1.00 98.27	C
ATOM	9415	C	LYS	A1300	-55.603	69.970	-24.595	1.00102.58	C
ATOM	9416	CB	LYS	A1300	-55.850	72.425	-23.944	1.00 93.22	C
ATOM	9417	O	PRO	A1301	-52.709	69.051	-25.054	1.00103.41	O
ATOM	9418	N	PRO	A1301	-55.267	69.791	-25.896	1.00102.74	N
ATOM	9419	CA	PRO	A1301	-54.623	68.565	-26.410	1.00101.40	C
ATOM	9420	C	PRO	A1301	-53.226	68.278	-25.860	1.00102.57	C
ATOM	9421	CB	PRO	A1301	-54.541	68.824	-27.915	1.00 98.06	C
ATOM	9422	CG	PRO	A1301	-54.428	70.296	-28.019	1.00 95.92	C
ATOM	9423	CD	PRO	A1301	-55.323	70.839	-26.934	1.00100.67	C
ATOM	9424	O	ILE	A1302	-49.442	68.089	-25.256	1.00100.59	O
ATOM	9425	N	ILE	A1302	-52.620	67.182	-26.319	1.00104.50	N
ATOM	9426	CA	ILE	A1302	-51.337	66.720	-25.782	1.00102.68	C
ATOM	9427	C	ILE	A1302	-50.178	67.653	-26.139	1.00102.32	C
ATOM	9428	CB	ILE	A1302	-51.006	65.287	-26.267	1.00102.07	C
ATOM	9429	CG1	ILE	A1302	-51.948	64.274	-25.612	1.00101.64	C
ATOM	9430	CG2	ILE	A1302	-49.571	64.928	-25.937	1.00 99.87	C
ATOM	9431	CD1	ILE	A1302	-51.601	62.821	-25.887	1.00 91.99	C
ATOM	9432	O	ARG	A1303	-48.024	70.768	-26.775	1.00101.11	O
ATOM	9433	N	ARG	A1303	-50.025	67.960	-27.425	1.00102.66	N
ATOM	9434	CA	ARG	A1303	-48.977	68.868	-27.882	1.00 99.95	C
ATOM	9435	C	ARG	A1303	-49.051	70.190	-27.128	1.00101.86	C
ATOM	9436	CB	ARG	A1303	-49.083	69.113	-29.392	1.00 92.75	C
ATOM	9437	N	GLU	A1304	-50.271	70.654	-26.870	1.00104.44	N
ATOM	9438	CA	GLU	A1304	-50.481	71.907	-26.147	1.00104.95	C
ATOM	9439	C	GLU	A1304	-50.323	71.715	-24.641	1.00102.92	C
ATOM	9440	O	GLU	A1304	-50.059	72.673	-23.913	1.00103.41	O
ATOM	9441	CB	GLU	A1304	-51.863	72.486	-26.459	1.00102.78	C
ATOM	9442	N	GLN	A1305	-50.485	70.477	-24.182	1.00102.47	N
ATOM	9443	CA	GLN	A1305	-50.295	70.159	-22.773	1.00100.28	C
ATOM	9444	C	GLN	A1305	-48.842	69.777	-22.509	1.00100.28	C
ATOM	9445	O	GLN	A1305	-48.371	69.857	-21.374	1.00 95.16	O
ATOM	9446	CB	GLN	A1305	-51.230	69.028	-22.332	1.00 99.89	C
ATOM	9447	N	ALA	A1306	-48.135	69.367	-23.563	1.00102.25	N
ATOM	9448	CA	ALA	A1306	-46.733	68.957	-23.443	1.00 99.18	C
ATOM	9449	C	ALA	A1306	-45.789	70.152	-23.498	1.00 97.31	C
ATOM	9450	O	ALA	A1306	-44.805	70.204	-22.763	1.00 94.99	O
ATOM	9451	CB	ALA	A1306	-46.373	67.954	-24.530	1.00 95.99	C

ATOM	9452	O	GLU	A1307	-44.226	73.657	-22.802	1.00	95.79	O
ATOM	9453	N	GLU	A1307	-46.090	71.107	-24.373	1.00	97.84	N
ATOM	9454	CA	GLU	A1307	-45.302	72.328	-24.478	1.00	97.20	C
ATOM	9455	C	GLU	A1307	-45.251	73.073	-23.153	1.00	96.10	C
ATOM	9456	CB	GLU	A1307	-45.872	73.247	-25.565	1.00	100.24	C
ATOM	9457	CG	GLU	A1307	-45.276	73.055	-26.954	1.00	104.61	C
ATOM	9458	CD	GLU	A1307	-44.687	74.343	-27.518	1.00	109.58	C
ATOM	9459	OE1	GLU	A1307	-44.933	74.637	-28.710	1.00	110.29	O
ATOM	9460	OE2	GLU	A1307	-43.974	75.055	-26.770	1.00	109.77	O
ATOM	9461	N	ASN	A1308	-46.360	73.044	-22.423	1.00	94.87	N
ATOM	9462	CA	ASN	A1308	-46.488	73.821	-21.197	1.00	94.52	C
ATOM	9463	C	ASN	A1308	-46.009	73.101	-19.926	1.00	90.50	C
ATOM	9464	O	ASN	A1308	-45.665	73.750	-18.939	1.00	88.81	O
ATOM	9465	CB	ASN	A1308	-47.941	74.268	-21.033	1.00	94.37	C
ATOM	9466	CG	ASN	A1308	-48.228	75.569	-21.738	1.00	94.09	C
ATOM	9467	OD1	ASN	A1308	-49.230	76.215	-21.471	1.00	100.10	O
ATOM	9468	ND2	ASN	A1308	-47.343	75.967	-22.633	1.00	94.66	N
ATOM	9469	N	ILE	A1309	-45.987	71.772	-19.946	1.00	89.98	N
ATOM	9470	CA	ILE	A1309	-45.349	71.009	-18.875	1.00	90.61	C
ATOM	9471	C	ILE	A1309	-43.888	71.427	-18.759	1.00	88.73	C
ATOM	9472	O	ILE	A1309	-43.361	71.631	-17.669	1.00	83.76	O
ATOM	9473	CB	ILE	A1309	-45.423	69.485	-19.123	1.00	86.23	C
ATOM	9474	CG1	ILE	A1309	-46.828	68.962	-18.838	1.00	88.51	C
ATOM	9475	CG2	ILE	A1309	-44.419	68.746	-18.251	1.00	83.49	C
ATOM	9476	CD1	ILE	A1309	-47.182	68.957	-17.378	1.00	90.79	C
ATOM	9477	N	ILE	A1310	-43.245	71.563	-19.910	1.00	88.80	N
ATOM	9478	CA	ILE	A1310	-41.846	71.927	-19.972	1.00	86.99	C
ATOM	9479	C	ILE	A1310	-41.627	73.320	-19.385	1.00	80.97	C
ATOM	9480	O	ILE	A1310	-40.604	73.577	-18.754	1.00	82.32	O
ATOM	9481	CB	ILE	A1310	-41.348	71.826	-21.420	1.00	83.46	C
ATOM	9482	CG1	ILE	A1310	-41.238	70.350	-21.808	1.00	78.62	C
ATOM	9483	CG2	ILE	A1310	-40.016	72.517	-21.602	1.00	76.02	C
ATOM	9484	CD1	ILE	A1310	-41.189	70.121	-23.292	1.00	85.76	C
ATOM	9485	N	HIS	A1311	-42.602	74.205	-19.544	1.00	84.05	N
ATOM	9486	CA	HIS	A1311	-42.527	75.510	-18.894	1.00	83.65	C
ATOM	9487	C	HIS	A1311	-42.418	75.351	-17.371	1.00	81.87	C
ATOM	9488	O	HIS	A1311	-41.892	76.225	-16.690	1.00	82.06	O
ATOM	9489	CB	HIS	A1311	-43.749	76.372	-19.230	1.00	87.46	C
ATOM	9490	CG	HIS	A1311	-43.728	76.975	-20.601	1.00	90.02	C
ATOM	9491	ND1	HIS	A1311	-42.864	76.566	-21.592	1.00	88.42	N
ATOM	9492	CD2	HIS	A1311	-44.482	77.962	-21.144	1.00	91.72	C
ATOM	9493	CE1	HIS	A1311	-43.084	77.276	-22.687	1.00	89.54	C
ATOM	9494	NE2	HIS	A1311	-44.060	78.130	-22.440	1.00	87.38	N
ATOM	9495	N	LEU	A1312	-42.913	74.231	-16.848	1.00	84.78	N
ATOM	9496	CA	LEU	A1312	-43.049	74.032	-15.401	1.00	83.68	C
ATOM	9497	C	LEU	A1312	-41.747	73.683	-14.685	1.00	80.92	C
ATOM	9498	O	LEU	A1312	-41.628	73.894	-13.478	1.00	81.15	O
ATOM	9499	CB	LEU	A1312	-44.069	72.924	-15.100	1.00	86.97	C
ATOM	9500	CG	LEU	A1312	-45.546	73.048	-15.467	1.00	82.41	C
ATOM	9501	CD1	LEU	A1312	-46.243	71.724	-15.217	1.00	86.61	C
ATOM	9502	CD2	LEU	A1312	-46.191	74.139	-14.644	1.00	86.20	C
ATOM	9503	N	PHE	A1313	-40.780	73.130	-15.407	1.00	77.80	N
ATOM	9504	CA	PHE	A1313	-39.514	72.762	-14.777	1.00	78.04	C
ATOM	9505	C	PHE	A1313	-38.746	73.995	-14.322	1.00	73.87	C
ATOM	9506	O	PHE	A1313	-37.849	73.902	-13.491	1.00	67.55	O
ATOM	9507	CB	PHE	A1313	-38.676	71.918	-15.719	1.00	71.39	C
ATOM	9508	CG	PHE	A1313	-39.196	70.532	-15.879	1.00	76.34	C
ATOM	9509	CD2	PHE	A1313	-38.572	69.472	-15.248	1.00	74.68	C
ATOM	9510	CD1	PHE	A1313	-40.332	70.287	-16.641	1.00	81.39	C
ATOM	9511	CE2	PHE	A1313	-39.056	68.187	-15.379	1.00	80.88	C
ATOM	9512	CE1	PHE	A1313	-40.825	69.002	-16.778	1.00	83.56	C
ATOM	9513	CZ	PHE	A1313	-40.184	67.948	-16.146	1.00	83.85	C
ATOM	9514	N	THR	A1314	-39.131	75.152	-14.850	1.00	67.79	N

ATOM	9515	CA	THR	A1314	-38.688	76.430	-14.314	1.00	72.78	C
ATOM	9516	C	THR	A1314	-38.905	76.501	-12.796	1.00	73.73	C
ATOM	9517	O	THR	A1314	-38.207	77.218	-12.084	1.00	74.79	O
ATOM	9518	CB	THR	A1314	-39.422	77.586	-15.002	1.00	75.82	C
ATOM	9519	OG1	THR	A1314	-39.177	77.528	-16.415	1.00	76.48	O
ATOM	9520	CG2	THR	A1314	-38.963	78.930	-14.465	1.00	69.52	C
ATOM	9521	N	LEU	A1315	-39.867	75.737	-12.297	1.00	76.68	N
ATOM	9522	CA	LEU	A1315	-40.066	75.620	-10.861	1.00	75.95	C
ATOM	9523	C	LEU	A1315	-38.988	74.752	-10.235	1.00	73.48	C
ATOM	9524	O	LEU	A1315	-38.515	75.036	-9.141	1.00	71.62	O
ATOM	9525	CB	LEU	A1315	-41.444	75.036	-10.560	1.00	79.41	C
ATOM	9526	CG	LEU	A1315	-41.729	74.637	-9.116	1.00	77.28	C
ATOM	9527	CD1	LEU	A1315	-42.887	75.457	-8.566	1.00	81.12	C
ATOM	9528	CD2	LEU	A1315	-42.013	73.142	-9.019	1.00	75.84	C
ATOM	9529	N	THR	A1316	-38.598	73.712	-10.965	1.00	73.95	N
ATOM	9530	CA	THR	A1316	-37.748	72.635	-10.469	1.00	70.99	C
ATOM	9531	C	THR	A1316	-36.254	72.891	-10.672	1.00	73.25	C
ATOM	9532	O	THR	A1316	-35.398	72.123	-10.215	1.00	76.26	O
ATOM	9533	CB	THR	A1316	-38.103	71.311	-11.178	1.00	72.72	C
ATOM	9534	OG1	THR	A1316	-37.949	70.229	-10.266	1.00	76.47	O
ATOM	9535	CG2	THR	A1316	-37.200	71.061	-12.400	1.00	71.93	C
ATOM	9536	N	ASN	A1317	-35.946	73.972	-11.371	1.00	71.35	N
ATOM	9537	CA	ASN	A1317	-34.611	74.152	-11.920	1.00	69.91	C
ATOM	9538	C	ASN	A1317	-33.597	74.662	-10.918	1.00	67.43	C
ATOM	9539	O	ASN	A1317	-33.833	75.676	-10.235	1.00	59.46	O
ATOM	9540	CB	ASN	A1317	-34.659	75.110	-13.119	1.00	66.31	C
ATOM	9541	CG	ASN	A1317	-34.742	74.381	-14.453	1.00	69.05	C
ATOM	9542	OD1	ASN	A1317	-34.428	73.190	-14.554	1.00	69.08	O
ATOM	9543	ND2	ASN	A1317	-35.154	75.100	-15.487	1.00	72.11	N
ATOM	9544	O	LEU	A1318	-31.255	76.364	-11.622	1.00	67.29	O
ATOM	9545	N	LEU	A1318	-32.473	73.945	-10.842	1.00	59.69	N
ATOM	9546	CA	LEU	A1318	-31.275	74.447	-10.175	1.00	60.72	C
ATOM	9547	C	LEU	A1318	-31.058	75.928	-10.493	1.00	62.01	C
ATOM	9548	CB	LEU	A1318	-30.057	73.635	-10.603	1.00	63.47	C
ATOM	9549	CG	LEU	A1318	-28.666	73.962	-10.051	1.00	63.31	C
ATOM	9550	CD2	LEU	A1318	-27.710	74.197	-11.189	1.00	60.71	C
ATOM	9551	CD1	LEU	A1318	-28.168	72.825	-9.208	1.00	62.85	C
ATOM	9552	O	GLY	A1319	-32.328	78.842	-8.732	1.00	62.70	O
ATOM	9553	N	GLY	A1319	-30.689	76.720	-9.502	1.00	55.90	N
ATOM	9554	CA	GLY	A1319	-30.332	78.088	-9.793	1.00	51.01	C
ATOM	9555	C	GLY	A1319	-31.385	79.115	-9.458	1.00	60.82	C
ATOM	9556	O	ALA	A1320	-33.898	80.703	-11.144	1.00	70.45	O
ATOM	9557	N	ALA	A1320	-31.192	80.316	-9.985	1.00	60.98	N
ATOM	9558	CA	ALA	A1320	-32.088	81.434	-9.754	1.00	61.67	C
ATOM	9559	C	ALA	A1320	-33.548	81.093	-10.028	1.00	70.21	C
ATOM	9560	CB	ALA	A1320	-31.667	82.611	-10.618	1.00	62.48	C
ATOM	9561	O	PRO	A1321	-35.701	83.356	-10.300	1.00	66.27	O
ATOM	9562	N	PRO	A1321	-34.400	81.221	-8.997	1.00	73.47	N
ATOM	9563	CA	PRO	A1321	-35.852	81.249	-9.191	1.00	71.27	C
ATOM	9564	C	PRO	A1321	-36.250	82.261	-10.256	1.00	66.55	C
ATOM	9565	CB	PRO	A1321	-36.375	81.662	-7.818	1.00	68.58	C
ATOM	9566	CG	PRO	A1321	-35.382	81.072	-6.881	1.00	67.96	C
ATOM	9567	CD	PRO	A1321	-34.043	81.198	-7.567	1.00	66.89	C
ATOM	9568	O	ALA	A1322	-39.520	81.250	-12.315	1.00	81.84	O
ATOM	9569	N	ALA	A1322	-37.170	81.875	-11.129	1.00	71.99	N
ATOM	9570	CA	ALA	A1322	-37.685	82.781	-12.149	1.00	78.47	C
ATOM	9571	C	ALA	A1322	-39.120	82.401	-12.503	1.00	82.53	C
ATOM	9572	CB	ALA	A1322	-36.805	82.758	-13.379	1.00	75.13	C
ATOM	9573	O	ALA	A1323	-40.717	82.333	-15.524	1.00	85.18	O
ATOM	9574	N	ALA	A1323	-39.886	83.364	-13.012	1.00	79.97	N
ATOM	9575	CA	ALA	A1323	-41.300	83.156	-13.336	1.00	82.94	C
ATOM	9576	C	ALA	A1323	-41.529	82.310	-14.602	1.00	81.01	C
ATOM	9577	CB	ALA	A1323	-41.983	84.502	-13.484	1.00	86.23	C

ATOM	9578	O	PHE	A1324	-45.309	80.895	-15.111	1.00	90.23	O
ATOM	9579	N	PHE	A1324	-42.649	81.587	-14.644	1.00	80.91	N
ATOM	9580	CA	PHE	A1324	-43.003	80.731	-15.782	1.00	83.99	C
ATOM	9581	C	PHE	A1324	-44.514	80.665	-16.026	1.00	92.00	C
ATOM	9582	CB	PHE	A1324	-42.462	79.318	-15.580	1.00	81.52	C
ATOM	9583	CG	PHE	A1324	-42.962	78.637	-14.331	1.00	84.02	C
ATOM	9584	CD1	PHE	A1324	-42.645	79.126	-13.070	1.00	82.58	C
ATOM	9585	CD2	PHE	A1324	-43.716	77.482	-14.415	1.00	85.77	C
ATOM	9586	CE1	PHE	A1324	-43.095	78.499	-11.924	1.00	82.13	C
ATOM	9587	CE2	PHE	A1324	-44.160	76.844	-13.266	1.00	88.09	C
ATOM	9588	CZ	PHE	A1324	-43.847	77.358	-12.019	1.00	83.96	C
ATOM	9589	O	LYS	A1325	-46.257	78.213	-18.711	1.00	96.62	O
ATOM	9590	N	LYS	A1325	-44.905	80.337	-17.259	1.00	94.64	N
ATOM	9591	CA	LYS	A1325	-46.317	80.368	-17.648	1.00	93.84	C
ATOM	9592	C	LYS	A1325	-46.891	78.998	-18.005	1.00	98.15	C
ATOM	9593	CB	LYS	A1325	-46.515	81.317	-18.832	1.00	95.93	C
ATOM	9594	O	TYR	A1326	-51.107	78.497	-18.044	1.00	103.37	O
ATOM	9595	N	TYR	A1326	-48.093	78.720	-17.499	1.00	99.75	N
ATOM	9596	CA	TYR	A1326	-48.889	77.578	-17.946	1.00	98.81	C
ATOM	9597	C	TYR	A1326	-50.120	78.101	-18.677	1.00	103.43	C
ATOM	9598	CB	TYR	A1326	-49.311	76.691	-16.780	1.00	95.93	C
ATOM	9599	CG	TYR	A1326	-49.672	75.278	-17.193	1.00	98.33	C
ATOM	9600	CD1	TYR	A1326	-48.694	74.395	-17.615	1.00	93.50	C
ATOM	9601	CD2	TYR	A1326	-50.985	74.826	-17.154	1.00	100.03	C
ATOM	9602	CE1	TYR	A1326	-49.006	73.102	-17.990	1.00	95.00	C
ATOM	9603	CE2	TYR	A1326	-51.307	73.526	-17.533	1.00	96.67	C
ATOM	9604	CZ	TYR	A1326	-50.310	72.671	-17.949	1.00	96.46	C
ATOM	9605	OH	TYR	A1326	-50.600	71.376	-18.326	1.00	96.14	O
ATOM	9606	O	PHE	A1327	-50.177	80.982	-20.711	1.00	109.01	O
ATOM	9607	N	PHE	A1327	-50.041	78.095	-20.009	1.00	105.69	N
ATOM	9608	CA	PHE	A1327	-51.025	78.735	-20.887	1.00	104.54	C
ATOM	9609	C	PHE	A1327	-51.142	80.228	-20.535	1.00	108.85	C
ATOM	9610	CB	PHE	A1327	-52.379	78.014	-20.811	1.00	102.81	C
ATOM	9611	CG	PHE	A1327	-52.322	76.554	-21.241	1.00	102.63	C
ATOM	9612	CD1	PHE	A1327	-52.523	76.192	-22.567	1.00	103.07	C
ATOM	9613	CD2	PHE	A1327	-52.072	75.547	-20.317	1.00	96.59	C
ATOM	9614	CE1	PHE	A1327	-52.472	74.858	-22.958	1.00	103.47	C
ATOM	9615	CE2	PHE	A1327	-52.020	74.217	-20.707	1.00	97.38	C
ATOM	9616	CZ	PHE	A1327	-52.222	73.873	-22.024	1.00	97.97	C
ATOM	9617	O	ASP	A1328	-51.757	83.422	-17.819	1.00	106.09	O
ATOM	9618	N	ASP	A1328	-52.303	80.662	-20.048	1.00	111.60	N
ATOM	9619	CA	ASP	A1328	-52.489	82.070	-19.678	1.00	110.52	C
ATOM	9620	C	ASP	A1328	-52.134	82.308	-18.210	1.00	109.39	C
ATOM	9621	CB	ASP	A1328	-53.928	82.526	-19.963	1.00	109.07	C
ATOM	9622	CG	ASP	A1328	-54.947	81.404	-19.800	1.00	109.32	C
ATOM	9623	OD1	ASP	A1328	-55.916	81.366	-20.589	1.00	110.65	O
ATOM	9624	OD2	ASP	A1328	-54.787	80.565	-18.883	1.00	107.66	O
ATOM	9625	O	THR	A1329	-49.630	80.648	-16.111	1.00	103.62	O
ATOM	9626	N	THR	A1329	-52.249	81.250	-17.409	1.00	105.81	N
ATOM	9627	CA	THR	A1329	-51.937	81.325	-15.988	1.00	105.49	C
ATOM	9628	C	THR	A1329	-50.439	81.513	-15.778	1.00	105.80	C
ATOM	9629	CB	THR	A1329	-52.411	80.073	-15.228	1.00	107.70	C
ATOM	9630	OG1	THR	A1329	-53.838	80.113	-15.082	1.00	103.53	O
ATOM	9631	CG2	THR	A1329	-51.764	80.018	-13.845	1.00	103.89	C
ATOM	9632	N	THR	A1330	-50.087	82.658	-15.210	1.00	108.15	N
ATOM	9633	CA	THR	A1330	-48.701	83.056	-15.060	1.00	99.97	C
ATOM	9634	C	THR	A1330	-48.330	83.124	-13.570	1.00	99.09	C
ATOM	9635	O	THR	A1330	-49.123	83.585	-12.744	1.00	96.96	O
ATOM	9636	CB	THR	A1330	-48.465	84.407	-15.772	1.00	102.30	C
ATOM	9637	OG1	THR	A1330	-47.105	84.818	-15.615	1.00	102.97	O
ATOM	9638	CG2	THR	A1330	-49.406	85.485	-15.232	1.00	103.50	C
ATOM	9639	N	ILE	A1331	-47.135	82.642	-13.228	1.00	97.81	N
ATOM	9640	CA	ILE	A1331	-46.731	82.492	-11.825	1.00	91.73	C

ATOM	9641	C	ILE	A1331	-45.540	83.347	-11.420	1.00	87.80	C
ATOM	9642	O	ILE	A1331	-44.433	83.124	-11.894	1.00	87.15	O
ATOM	9643	CB	ILE	A1331	-46.361	81.041	-11.507	1.00	88.98	C
ATOM	9644	CG1	ILE	A1331	-47.306	80.085	-12.220	1.00	92.30	C
ATOM	9645	CG2	ILE	A1331	-46.389	80.810	-10.017	1.00	86.76	C
ATOM	9646	CD1	ILE	A1331	-46.999	78.663	-11.940	1.00	89.84	C
ATOM	9647	N	ASP	A1332	-45.763	84.307	-10.530	1.00	90.24	N
ATOM	9648	CA	ASP	A1332	-44.673	85.129	-10.031	1.00	85.13	C
ATOM	9649	C	ASP	A1332	-43.617	84.230	-9.405	1.00	91.63	C
ATOM	9650	O	ASP	A1332	-43.945	83.212	-8.789	1.00	92.52	O
ATOM	9651	CB	ASP	A1332	-45.183	86.152	-9.020	1.00	88.07	C
ATOM	9652	N	ARG	A1333	-42.348	84.579	-9.588	1.00	90.57	N
ATOM	9653	CA	ARG	A1333	-41.275	83.803	-8.984	1.00	87.05	C
ATOM	9654	C	ARG	A1333	-41.269	84.036	-7.482	1.00	87.27	C
ATOM	9655	O	ARG	A1333	-41.507	85.151	-7.010	1.00	91.84	O
ATOM	9656	CB	ARG	A1333	-39.917	84.170	-9.589	1.00	84.58	C
ATOM	9657	CG	ARG	A1333	-39.458	85.576	-9.269	1.00	86.20	C
ATOM	9658	CD	ARG	A1333	-38.163	85.925	-9.964	1.00	82.00	C
ATOM	9659	NE	ARG	A1333	-37.782	87.304	-9.694	1.00	82.46	N
ATOM	9660	CZ	ARG	A1333	-36.837	87.955	-10.358	1.00	90.58	C
ATOM	9661	NH1	ARG	A1333	-36.181	87.346	-11.340	1.00	94.11	N
ATOM	9662	NH2	ARG	A1333	-36.552	89.214	-10.051	1.00	90.55	N
ATOM	9663	N	LYS	A1334	-41.024	82.978	-6.725	1.00	85.47	N
ATOM	9664	CA	LYS	A1334	-40.894	83.122	-5.285	1.00	88.89	C
ATOM	9665	C	LYS	A1334	-39.436	82.897	-4.902	1.00	85.95	C
ATOM	9666	O	LYS	A1334	-38.885	81.819	-5.118	1.00	80.02	O
ATOM	9667	CB	LYS	A1334	-41.817	82.144	-4.555	1.00	92.96	C
ATOM	9668	N	ARG	A1335	-38.799	83.920	-4.352	1.00	83.18	N
ATOM	9669	CA	ARG	A1335	-37.385	83.799	-4.062	1.00	79.51	C
ATOM	9670	C	ARG	A1335	-37.109	83.506	-2.593	1.00	78.83	C
ATOM	9671	O	ARG	A1335	-37.875	83.878	-1.701	1.00	78.51	O
ATOM	9672	CB	ARG	A1335	-36.645	85.061	-4.504	1.00	80.01	C
ATOM	9673	CG	ARG	A1335	-37.263	86.339	-4.044	1.00	83.75	C
ATOM	9674	CD	ARG	A1335	-37.057	87.425	-5.076	1.00	87.81	C
ATOM	9675	NE	ARG	A1335	-35.837	88.194	-4.850	1.00	87.30	N
ATOM	9676	CZ	ARG	A1335	-35.240	88.924	-5.787	1.00	86.65	C
ATOM	9677	NH1	ARG	A1335	-34.136	89.609	-5.506	1.00	82.48	N
ATOM	9678	NH2	ARG	A1335	-35.746	88.961	-7.014	1.00	86.99	N
ATOM	9679	N	TYR	A1336	-35.999	82.820	-2.350	1.00	76.44	N
ATOM	9680	CA	TYR	A1336	-35.626	82.452	-1.003	1.00	66.21	C
ATOM	9681	C	TYR	A1336	-34.956	83.619	-0.312	1.00	66.13	C
ATOM	9682	O	TYR	A1336	-33.735	83.761	-0.353	1.00	67.85	O
ATOM	9683	CB	TYR	A1336	-34.724	81.236	-1.035	1.00	67.42	C
ATOM	9684	CG	TYR	A1336	-35.356	80.064	-1.744	1.00	65.61	C
ATOM	9685	CD1	TYR	A1336	-36.460	79.422	-1.209	1.00	68.11	C
ATOM	9686	CD2	TYR	A1336	-34.844	79.591	-2.937	1.00	62.72	C
ATOM	9687	CE1	TYR	A1336	-37.033	78.347	-1.842	1.00	69.86	C
ATOM	9688	CE2	TYR	A1336	-35.410	78.514	-3.574	1.00	63.72	C
ATOM	9689	CZ	TYR	A1336	-36.500	77.892	-3.019	1.00	67.93	C
ATOM	9690	OH	TYR	A1336	-37.074	76.820	-3.651	1.00	72.51	O
ATOM	9691	O	THR	A1337	-34.307	86.469	2.945	1.00	75.05	O
ATOM	9692	N	THR	A1337	-35.779	84.449	0.321	1.00	69.71	N
ATOM	9693	CA	THR	A1337	-35.343	85.698	0.940	1.00	69.80	C
ATOM	9694	C	THR	A1337	-34.690	85.508	2.299	1.00	67.19	C
ATOM	9695	CB	THR	A1337	-36.528	86.656	1.120	1.00	71.77	C
ATOM	9696	OG1	THR	A1337	-37.408	86.131	2.123	1.00	74.44	O
ATOM	9697	CG2	THR	A1337	-37.289	86.794	-0.181	1.00	69.15	C
ATOM	9698	O	SER	A1338	-32.862	82.046	3.229	1.00	67.30	O
ATOM	9699	N	SER	A1338	-34.571	84.267	2.743	1.00	72.17	N
ATOM	9700	CA	SER	A1338	-34.010	83.997	4.058	1.00	66.97	C
ATOM	9701	C	SER	A1338	-32.813	83.043	3.947	1.00	69.73	C
ATOM	9702	CB	SER	A1338	-35.089	83.417	4.978	1.00	64.79	C
ATOM	9703	OG	SER	A1338	-34.633	83.276	6.309	1.00	70.51	O

ATOM	9704	N	THR	A1339	-31.740	83.367	4.660	1.00	65.42	N
ATOM	9705	CA	THR	A1339	-30.549	82.538	4.688	1.00	65.30	C
ATOM	9706	C	THR	A1339	-30.286	82.036	6.097	1.00	71.07	C
ATOM	9707	O	THR	A1339	-29.221	81.478	6.364	1.00	66.63	O
ATOM	9708	CB	THR	A1339	-29.305	83.294	4.190	1.00	65.32	C
ATOM	9709	OG1	THR	A1339	-29.197	84.557	4.864	1.00	61.48	O
ATOM	9710	CG2	THR	A1339	-29.384	83.529	2.681	1.00	65.20	C
ATOM	9711	N	LYS	A1340	-31.253	82.259	6.991	1.00	67.25	N
ATOM	9712	CA	LYS	A1340	-31.198	81.724	8.347	1.00	68.72	C
ATOM	9713	C	LYS	A1340	-30.869	80.230	8.286	1.00	72.53	C
ATOM	9714	O	LYS	A1340	-29.913	79.760	8.915	1.00	75.45	O
ATOM	9715	CB	LYS	A1340	-32.529	81.950	9.062	1.00	73.84	C
ATOM	9716	CG	LYS	A1340	-32.456	82.301	10.551	1.00	79.02	C
ATOM	9717	CD	LYS	A1340	-33.858	82.724	11.049	1.00	81.92	C
ATOM	9718	CE	LYS	A1340	-33.927	82.937	12.557	1.00	83.74	C
ATOM	9719	NZ	LYS	A1340	-35.316	83.282	12.999	1.00	90.87	N
ATOM	9720	N	GLU	A1341	-31.649	79.509	7.487	1.00	67.52	N
ATOM	9721	CA	GLU	A1341	-31.527	78.064	7.329	1.00	65.83	C
ATOM	9722	C	GLU	A1341	-30.107	77.536	7.283	1.00	65.00	C
ATOM	9723	O	GLU	A1341	-29.793	76.491	7.846	1.00	69.34	O
ATOM	9724	CB	GLU	A1341	-32.223	77.641	6.047	1.00	69.10	C
ATOM	9725	CG	GLU	A1341	-33.595	77.070	6.256	1.00	78.43	C
ATOM	9726	CD	GLU	A1341	-34.137	76.479	4.981	1.00	83.12	C
ATOM	9727	OE1	GLU	A1341	-33.360	76.426	3.999	1.00	74.79	O
ATOM	9728	OE2	GLU	A1341	-35.323	76.073	4.960	1.00	88.00	O
ATOM	9729	N	VAL	A1342	-29.260	78.290	6.605	1.00	66.84	N
ATOM	9730	CA	VAL	A1342	-27.982	77.810	6.119	1.00	64.77	C
ATOM	9731	C	VAL	A1342	-26.946	77.741	7.240	1.00	68.75	C
ATOM	9732	O	VAL	A1342	-26.000	76.948	7.200	1.00	63.93	O
ATOM	9733	CB	VAL	A1342	-27.527	78.719	4.968	1.00	62.60	C
ATOM	9734	CG1	VAL	A1342	-26.059	78.982	5.005	1.00	68.68	C
ATOM	9735	CG2	VAL	A1342	-27.962	78.131	3.644	1.00	61.79	C
ATOM	9736	N	LEU	A1343	-27.165	78.554	8.264	1.00	70.73	N
ATOM	9737	CA	LEU	A1343	-26.251	78.643	9.390	1.00	68.29	C
ATOM	9738	C	LEU	A1343	-26.142	77.349	10.209	1.00	68.50	C
ATOM	9739	O	LEU	A1343	-25.097	77.077	10.795	1.00	67.98	O
ATOM	9740	CB	LEU	A1343	-26.682	79.794	10.290	1.00	67.52	C
ATOM	9741	CG	LEU	A1343	-26.521	81.131	9.588	1.00	65.64	C
ATOM	9742	CD1	LEU	A1343	-27.118	82.229	10.414	1.00	64.25	C
ATOM	9743	CD2	LEU	A1343	-25.051	81.385	9.344	1.00	66.59	C
ATOM	9744	N	ASP	A1344	-27.210	76.561	10.264	1.00	65.01	N
ATOM	9745	CA	ASP	A1344	-27.160	75.292	10.998	1.00	72.44	C
ATOM	9746	C	ASP	A1344	-27.178	74.091	10.064	1.00	68.32	C
ATOM	9747	O	ASP	A1344	-27.808	73.086	10.364	1.00	68.98	O
ATOM	9748	CB	ASP	A1344	-28.327	75.193	11.985	1.00	70.54	C
ATOM	9749	CG	ASP	A1344	-28.232	76.218	13.103	1.00	77.61	C
ATOM	9750	OD1	ASP	A1344	-27.107	76.423	13.622	1.00	71.39	O
ATOM	9751	OD2	ASP	A1344	-29.280	76.823	13.456	1.00	81.04	O
ATOM	9752	N	ALA	A1345	-26.477	74.208	8.940	1.00	67.11	N
ATOM	9753	CA	ALA	A1345	-26.558	73.242	7.851	1.00	58.27	C
ATOM	9754	C	ALA	A1345	-25.155	72.790	7.437	1.00	60.17	C
ATOM	9755	O	ALA	A1345	-24.171	73.202	8.046	1.00	60.30	O
ATOM	9756	CB	ALA	A1345	-27.303	73.849	6.671	1.00	55.88	C
ATOM	9757	N	THR	A1346	-25.048	71.951	6.410	1.00	52.25	N
ATOM	9758	CA	THR	A1346	-23.735	71.457	6.003	1.00	56.48	C
ATOM	9759	C	THR	A1346	-23.178	72.173	4.781	1.00	56.82	C
ATOM	9760	O	THR	A1346	-23.652	71.963	3.666	1.00	60.60	O
ATOM	9761	CB	THR	A1346	-23.769	69.947	5.691	1.00	57.45	C
ATOM	9762	OG1	THR	A1346	-24.320	69.252	6.805	1.00	64.67	O
ATOM	9763	CG2	THR	A1346	-22.364	69.414	5.418	1.00	57.07	C
ATOM	9764	N	LEU	A1347	-22.169	73.010	4.992	1.00	53.42	N
ATOM	9765	CA	LEU	A1347	-21.452	73.642	3.890	1.00	53.51	C
ATOM	9766	C	LEU	A1347	-20.602	72.605	3.136	1.00	57.74	C

ATOM	9767	O	LEU	A1347	-19.866	71.820	3.750	1.00	54.41	O
ATOM	9768	CB	LEU	A1347	-20.572	74.786	4.405	1.00	50.92	C
ATOM	9769	CG	LEU	A1347	-19.522	75.320	3.429	1.00	54.16	C
ATOM	9770	CD2	LEU	A1347	-18.477	76.176	4.121	1.00	49.16	C
ATOM	9771	CD1	LEU	A1347	-20.171	76.072	2.253	1.00	51.55	C
ATOM	9772	N	ILE	A1348	-20.701	72.610	1.807	1.00	55.91	N
ATOM	9773	CA	ILE	A1348	-19.973	71.648	0.988	1.00	52.51	C
ATOM	9774	C	ILE	A1348	-19.008	72.319	0.027	1.00	49.10	C
ATOM	9775	O	ILE	A1348	-19.438	72.911	-0.952	1.00	52.75	O
ATOM	9776	CB	ILE	A1348	-20.938	70.783	0.183	1.00	50.14	C
ATOM	9777	CG1	ILE	A1348	-21.903	70.072	1.115	1.00	53.11	C
ATOM	9778	CG2	ILE	A1348	-20.196	69.755	-0.636	1.00	49.25	C
ATOM	9779	CD1	ILE	A1348	-22.890	69.196	0.380	1.00	53.69	C
ATOM	9780	N	HIS	A1349	-17.711	72.232	0.317	1.00	49.53	N
ATOM	9781	CA	HIS	A1349	-16.662	72.656	-0.613	1.00	49.34	C
ATOM	9782	C	HIS	A1349	-16.378	71.580	-1.659	1.00	55.72	C
ATOM	9783	O	HIS	A1349	-16.078	70.435	-1.311	1.00	54.92	O
ATOM	9784	CB	HIS	A1349	-15.355	72.976	0.123	1.00	49.40	C
ATOM	9785	CG	HIS	A1349	-15.476	74.078	1.123	1.00	59.01	C
ATOM	9786	ND1	HIS	A1349	-15.742	75.382	0.762	1.00	56.78	N
ATOM	9787	CD2	HIS	A1349	-15.372	74.072	2.474	1.00	56.16	C
ATOM	9788	CE1	HIS	A1349	-15.795	76.131	1.848	1.00	56.13	C
ATOM	9789	NE2	HIS	A1349	-15.580	75.360	2.900	1.00	59.53	N
ATOM	9790	N	GLN	A1350	-16.438	71.952	-2.933	1.00	49.43	N
ATOM	9791	CA	GLN	A1350	-16.276	70.992	-4.008	1.00	45.08	C
ATOM	9792	C	GLN	A1350	-15.098	71.336	-4.860	1.00	49.26	C
ATOM	9793	O	GLN	A1350	-14.908	72.499	-5.177	1.00	48.30	O
ATOM	9794	CB	GLN	A1350	-17.503	70.953	-4.900	1.00	50.94	C
ATOM	9795	CG	GLN	A1350	-18.840	70.703	-4.223	1.00	46.71	C
ATOM	9796	CD	GLN	A1350	-19.966	70.777	-5.236	1.00	48.43	C
ATOM	9797	OE1	GLN	A1350	-20.427	71.862	-5.571	1.00	55.92	O
ATOM	9798	NE2	GLN	A1350	-20.386	69.627	-5.757	1.00	50.99	N
ATOM	9799	N	SER	A1351	-14.295	70.333	-5.226	1.00	46.57	N
ATOM	9800	CA	SER	A1351	-13.333	70.494	-6.311	1.00	47.34	C
ATOM	9801	C	SER	A1351	-14.073	70.668	-7.646	1.00	48.04	C
ATOM	9802	O	SER	A1351	-15.298	70.542	-7.717	1.00	44.44	O
ATOM	9803	CB	SER	A1351	-12.401	69.300	-6.399	1.00	47.42	C
ATOM	9804	OG	SER	A1351	-13.142	68.153	-6.754	1.00	53.98	O
ATOM	9805	O	ILE	A1352	-15.882	70.635	-11.150	1.00	52.83	O
ATOM	9806	N	ILE	A1352	-13.317	70.940	-8.700	1.00	45.44	N
ATOM	9807	CA	ILE	A1352	-13.889	71.347	-9.975	1.00	43.65	C
ATOM	9808	C	ILE	A1352	-14.839	70.285	-10.561	1.00	53.47	C
ATOM	9809	CB	ILE	A1352	-12.763	71.694	-10.990	1.00	42.30	C
ATOM	9810	CG1	ILE	A1352	-13.311	72.482	-12.163	1.00	40.31	C
ATOM	9811	CG2	ILE	A1352	-12.060	70.461	-11.479	1.00	47.77	C
ATOM	9812	CD1	ILE	A1352	-12.246	72.960	-13.074	1.00	43.78	C
ATOM	9813	O	THR	A1353	-17.398	66.863	-10.276	1.00	54.38	O
ATOM	9814	N	THR	A1353	-14.517	69.006	-10.345	1.00	45.52	N
ATOM	9815	CA	THR	A1353	-15.331	67.884	-10.819	1.00	44.74	C
ATOM	9816	C	THR	A1353	-16.456	67.521	-9.875	1.00	44.77	C
ATOM	9817	CB	THR	A1353	-14.486	66.576	-11.001	1.00	48.11	C
ATOM	9818	OG1	THR	A1353	-13.995	66.133	-9.719	1.00	47.72	O
ATOM	9819	CG2	THR	A1353	-13.328	66.806	-11.946	1.00	49.55	C
ATOM	9820	O	GLY	A1354	-17.671	65.758	-5.963	1.00	52.77	O
ATOM	9821	N	GLY	A1354	-16.322	67.877	-8.605	1.00	45.64	N
ATOM	9822	CA	GLY	A1354	-17.290	67.465	-7.602	1.00	46.68	C
ATOM	9823	C	GLY	A1354	-16.973	66.157	-6.892	1.00	47.90	C
ATOM	9824	O	LEU	A1355	-15.383	63.531	-4.480	1.00	50.16	O
ATOM	9825	N	LEU	A1355	-15.929	65.473	-7.327	1.00	44.32	N
ATOM	9826	CA	LEU	A1355	-15.653	64.150	-6.792	1.00	52.55	C
ATOM	9827	C	LEU	A1355	-15.044	64.281	-5.384	1.00	51.75	C
ATOM	9828	CB	LEU	A1355	-14.728	63.363	-7.757	1.00	51.18	C
ATOM	9829	CG	LEU	A1355	-15.334	63.111	-9.150	1.00	49.45	C

ATOM	9830	CD2	LEU	A1355	-16.389	62.048	-9.094	1.00	47.73	C
ATOM	9831	CD1	LEU	A1355	-14.306	62.774	-10.210	1.00	45.22	C
ATOM	9832	O	TYR	A1356	-14.169	67.799	-3.595	1.00	53.35	O
ATOM	9833	N	TYR	A1356	-14.174	65.271	-5.216	1.00	52.74	N
ATOM	9834	CA	TYR	A1356	-13.525	65.550	-3.948	1.00	49.63	C
ATOM	9835	C	TYR	A1356	-14.227	66.648	-3.194	1.00	52.30	C
ATOM	9836	CB	TYR	A1356	-12.087	65.982	-4.170	1.00	51.10	C
ATOM	9837	CG	TYR	A1356	-11.261	64.958	-4.863	1.00	51.09	C
ATOM	9838	CD1	TYR	A1356	-11.270	63.636	-4.437	1.00	52.45	C
ATOM	9839	CD2	TYR	A1356	-10.480	65.309	-5.959	1.00	52.61	C
ATOM	9840	CE1	TYR	A1356	-10.496	62.674	-5.081	1.00	60.77	C
ATOM	9841	CE2	TYR	A1356	-9.712	64.371	-6.615	1.00	62.88	C
ATOM	9842	CZ	TYR	A1356	-9.719	63.047	-6.173	1.00	64.89	C
ATOM	9843	OH	TYR	A1356	-8.962	62.112	-6.835	1.00	63.15	O
ATOM	9844	N	GLU	A1357	-14.867	66.319	-2.088	1.00	54.17	N
ATOM	9845	CA	GLU	A1357	-15.489	67.374	-1.332	1.00	48.34	C
ATOM	9846	C	GLU	A1357	-15.022	67.399	0.123	1.00	56.36	C
ATOM	9847	O	GLU	A1357	-14.576	66.382	0.666	1.00	56.99	O
ATOM	9848	CB	GLU	A1357	-17.022	67.281	-1.441	1.00	50.95	C
ATOM	9849	CG	GLU	A1357	-17.687	65.965	-1.151	1.00	49.22	C
ATOM	9850	CD	GLU	A1357	-19.157	65.976	-1.580	1.00	60.45	C
ATOM	9851	OE1	GLU	A1357	-20.053	65.682	-0.745	1.00	63.81	O
ATOM	9852	OE2	GLU	A1357	-19.427	66.290	-2.764	1.00	58.19	O
ATOM	9853	N	THR	A1358	-15.057	68.597	0.708	1.00	55.47	N
ATOM	9854	CA	THR	A1358	-14.855	68.815	2.133	1.00	50.61	C
ATOM	9855	C	THR	A1358	-16.148	69.388	2.646	1.00	54.05	C
ATOM	9856	O	THR	A1358	-16.520	70.484	2.224	1.00	54.18	O
ATOM	9857	CB	THR	A1358	-13.712	69.814	2.441	1.00	52.10	C
ATOM	9858	OG1	THR	A1358	-12.464	69.319	1.957	1.00	55.79	O
ATOM	9859	CG2	THR	A1358	-13.598	70.054	3.939	1.00	54.21	C
ATOM	9860	N	ARG	A1359	-16.840	68.686	3.541	1.00	53.02	N
ATOM	9861	CA	ARG	A1359	-18.068	69.246	4.093	1.00	55.73	C
ATOM	9862	C	ARG	A1359	-17.957	69.638	5.580	1.00	60.54	C
ATOM	9863	O	ARG	A1359	-17.420	68.900	6.413	1.00	56.03	O
ATOM	9864	CB	ARG	A1359	-19.260	68.297	3.893	1.00	52.34	C
ATOM	9865	CG	ARG	A1359	-18.926	66.896	3.484	1.00	63.22	C
ATOM	9866	CD	ARG	A1359	-20.193	66.029	3.371	1.00	66.67	C
ATOM	9867	NE	ARG	A1359	-20.869	66.182	2.090	1.00	61.70	N
ATOM	9868	CZ	ARG	A1359	-22.124	65.817	1.854	1.00	61.22	C
ATOM	9869	NH1	ARG	A1359	-22.842	65.278	2.819	1.00	65.71	N
ATOM	9870	NH2	ARG	A1359	-22.667	65.997	0.650	1.00	62.83	N
ATOM	9871	N	ILE	A1360	-18.487	70.820	5.888	1.00	54.68	N
ATOM	9872	CA	ILE	A1360	-18.436	71.381	7.227	1.00	55.23	C
ATOM	9873	C	ILE	A1360	-19.816	71.490	7.843	1.00	57.79	C
ATOM	9874	O	ILE	A1360	-20.629	72.264	7.369	1.00	62.49	O
ATOM	9875	CB	ILE	A1360	-17.821	72.769	7.210	1.00	55.72	C
ATOM	9876	CG1	ILE	A1360	-16.481	72.734	6.478	1.00	47.38	C
ATOM	9877	CG2	ILE	A1360	-17.738	73.329	8.635	1.00	52.67	C
ATOM	9878	CD1	ILE	A1360	-15.409	72.060	7.248	1.00	54.45	C
ATOM	9879	N	ASP	A1361	-20.092	70.727	8.892	1.00	58.70	N
ATOM	9880	CA	ASP	A1361	-21.361	70.867	9.592	1.00	59.16	C
ATOM	9881	C	ASP	A1361	-21.318	72.168	10.370	1.00	62.19	C
ATOM	9882	O	ASP	A1361	-20.441	72.361	11.205	1.00	67.14	O
ATOM	9883	CB	ASP	A1361	-21.600	69.682	10.519	1.00	61.83	C
ATOM	9884	CG	ASP	A1361	-22.960	69.725	11.210	1.00	73.19	C
ATOM	9885	OD1	ASP	A1361	-23.848	70.527	10.820	1.00	74.36	O
ATOM	9886	OD2	ASP	A1361	-23.145	68.924	12.154	1.00	74.83	O
ATOM	9887	O	LEU	A1362	-22.711	75.365	12.875	1.00	67.36	O
ATOM	9888	N	LEU	A1362	-22.248	73.076	10.102	1.00	67.74	N
ATOM	9889	CA	LEU	A1362	-22.197	74.384	10.757	1.00	66.62	C
ATOM	9890	C	LEU	A1362	-22.928	74.440	12.104	1.00	64.35	C
ATOM	9891	CB	LEU	A1362	-22.748	75.468	9.830	1.00	63.63	C
ATOM	9892	CG	LEU	A1362	-21.891	75.908	8.645	1.00	65.54	C

ATOM	9893	CD1	LEU	A1362	-22.353	77.288	8.195	1.00	64.90	C
ATOM	9894	CD2	LEU	A1362	-20.388	75.883	8.955	1.00	59.07	C
ATOM	9895	O	SER	A1363	-23.763	73.209	16.007	1.00	77.59	O
ATOM	9896	N	SER	A1363	-23.775	73.458	12.399	1.00	70.10	N
ATOM	9897	CA	SER	A1363	-24.427	73.407	13.707	1.00	68.13	C
ATOM	9898	C	SER	A1363	-23.418	73.162	14.837	1.00	67.76	C
ATOM	9899	CB	SER	A1363	-25.529	72.335	13.736	1.00	66.35	C
ATOM	9900	OG	SER	A1363	-25.149	71.141	13.070	1.00	68.57	O
ATOM	9901	O	GLN	A1364	-19.232	73.902	16.323	1.00	81.65	O
ATOM	9902	N	GLN	A1364	-22.164	72.922	14.499	1.00	66.01	N
ATOM	9903	CA	GLN	A1364	-21.156	72.726	15.528	1.00	75.35	C
ATOM	9904	C	GLN	A1364	-20.283	73.950	15.680	1.00	78.81	C
ATOM	9905	CB	GLN	A1364	-20.292	71.511	15.212	1.00	73.08	C
ATOM	9906	CG	GLN	A1364	-21.057	70.217	15.320	1.00	76.45	C
ATOM	9907	CD	GLN	A1364	-20.510	69.165	14.400	1.00	80.50	C
ATOM	9908	OE1	GLN	A1364	-19.298	68.918	14.370	1.00	83.20	O
ATOM	9909	NE2	GLN	A1364	-21.397	68.541	13.623	1.00	75.80	N
ATOM	9910	O	LEU	A1365	-20.353	78.354	16.260	1.00	77.77	O
ATOM	9911	N	LEU	A1365	-20.704	75.043	15.064	1.00	75.17	N
ATOM	9912	CA	LEU	A1365	-19.950	76.272	15.166	1.00	72.49	C
ATOM	9913	C	LEU	A1365	-20.795	77.251	15.961	1.00	74.82	C
ATOM	9914	CB	LEU	A1365	-19.583	76.825	13.786	1.00	69.25	C
ATOM	9915	CG	LEU	A1365	-18.859	75.898	12.799	1.00	72.61	C
ATOM	9916	CD1	LEU	A1365	-18.123	76.704	11.743	1.00	69.38	C
ATOM	9917	CD2	LEU	A1365	-17.896	74.920	13.479	1.00	71.28	C
ATOM	9918	O	GLY	A1366	-21.412	78.868	18.651	1.00	79.67	O
ATOM	9919	N	GLY	A1366	-22.007	76.826	16.318	1.00	71.74	N
ATOM	9920	CA	GLY	A1366	-22.855	77.601	17.205	1.00	80.22	C
ATOM	9921	C	GLY	A1366	-22.195	77.917	18.537	1.00	82.53	C
TER										
ATOM	9922	P	G B	1	-6.966	70.152	-39.923	1.00	87.23	P
ATOM	9923	OP1	G B	1	-6.786	68.677	-40.111	1.00	89.82	O
ATOM	9924	OP2	G B	1	-7.265	71.006	-41.109	1.00	81.10	O
ATOM	9925	OP3	G B	1	-8.076	70.351	-38.959	1.00	91.73	O
ATOM	9926	O5'	G B	1	-5.644	70.710	-39.226	1.00	74.25	O
ATOM	9927	C5'	G B	1	-5.393	70.470	-37.847	1.00	74.53	C
ATOM	9928	C4'	G B	1	-3.924	70.575	-37.505	1.00	77.47	C
ATOM	9929	O4'	G B	1	-3.179	69.518	-38.186	1.00	76.51	O
ATOM	9930	C3'	G B	1	-3.209	71.861	-37.920	1.00	71.81	C
ATOM	9931	O3'	G B	1	-3.419	72.957	-37.037	1.00	74.46	O
ATOM	9932	C2'	G B	1	-1.761	71.396	-38.007	1.00	74.79	C
ATOM	9933	O2'	G B	1	-1.216	71.185	-36.712	1.00	79.33	O
ATOM	9934	C1'	G B	1	-1.949	70.029	-38.659	1.00	72.84	C
ATOM	9935	N9	G B	1	-2.051	70.173	-40.129	1.00	70.42	N
ATOM	9936	C8	G B	1	-3.169	69.991	-40.920	1.00	68.97	C
ATOM	9937	N7	G B	1	-2.951	70.231	-42.187	1.00	67.96	N
ATOM	9938	C5	G B	1	-1.608	70.596	-42.244	1.00	63.09	C
ATOM	9939	C4	G B	1	-1.043	70.578	-40.981	1.00	64.95	C
ATOM	9940	N1	G B	1	0.509	71.269	-42.963	1.00	55.74	N
ATOM	9941	C2	G B	1	0.977	71.220	-41.664	1.00	61.17	C
ATOM	9942	N3	G B	1	0.233	70.871	-40.621	1.00	61.05	N
ATOM	9943	C6	G B	1	-0.792	70.963	-43.353	1.00	57.84	C
ATOM	9944	O6	G B	1	-1.123	71.047	-44.546	1.00	60.74	O
ATOM	9945	N2	G B	1	2.263	71.539	-41.457	1.00	58.48	N
ATOM	9946	O5'	G B	2	-2.231	74.895	-38.169	1.00	67.99	O
ATOM	9947	C4'	G B	2	0.166	75.121	-38.120	1.00	64.65	C
ATOM	9948	C3'	G B	2	0.267	76.370	-38.975	1.00	61.96	C
ATOM	9949	C2'	G B	2	1.409	75.999	-39.917	1.00	63.39	C
ATOM	9950	P	G B	2	-3.657	74.452	-37.612	1.00	76.47	P
ATOM	9951	OP1	G B	2	-3.971	75.327	-36.452	1.00	74.52	O
ATOM	9952	OP2	G B	2	-4.570	74.403	-38.789	1.00	72.60	O
ATOM	9953	C5'	G B	2	-1.096	74.935	-37.325	1.00	60.47	C
ATOM	9954	O4'	G B	2	0.331	74.047	-39.093	1.00	65.22	O

ATOM	9955	O3'	G B	2	0.497	77.555	-38.234	1.00	62.01	O
ATOM	9956	O2'	G B	2	2.656	76.076	-39.246	1.00	61.62	O
ATOM	9957	C1'	G B	2	1.101	74.524	-40.189	1.00	60.68	C
ATOM	9958	N9	G B	2	0.366	74.376	-41.465	1.00	56.24	N
ATOM	9959	C8	G B	2	-0.961	74.100	-41.683	1.00	57.83	C
ATOM	9960	N7	G B	2	-1.281	74.093	-42.954	1.00	58.89	N
ATOM	9961	C5	G B	2	-0.094	74.384	-43.626	1.00	62.13	C
ATOM	9962	C4	G B	2	0.926	74.565	-42.714	1.00	60.29	C
ATOM	9963	N1	G B	2	1.543	74.810	-45.250	1.00	62.14	N
ATOM	9964	C2	G B	2	2.485	74.975	-44.269	1.00	64.30	C
ATOM	9965	N3	G B	2	2.224	74.862	-42.970	1.00	65.35	N
ATOM	9966	C6	G B	2	0.205	74.499	-45.022	1.00	63.16	C
ATOM	9967	O6	G B	2	-0.544	74.371	-45.997	1.00	65.30	O
ATOM	9968	N2	G B	2	3.726	75.278	-44.679	1.00	63.75	N
ATOM	9969	O5'	A B	3	1.381	79.079	-40.052	1.00	66.00	O
ATOM	9970	C4'	A B	3	3.579	79.499	-40.972	1.00	64.40	C
ATOM	9971	C3'	A B	3	3.127	80.693	-41.795	1.00	60.65	C
ATOM	9972	C2'	A B	3	3.689	80.388	-43.181	1.00	65.30	C
ATOM	9973	P	A B	3	0.277	79.001	-38.908	1.00	62.19	P
ATOM	9974	OF1	A B	3	0.653	80.010	-37.881	1.00	71.43	O
ATOM	9975	OF2	A B	3	-1.057	79.107	-39.555	1.00	64.13	O
ATOM	9976	C5'	A B	3	2.763	79.203	-39.740	1.00	62.34	C
ATOM	9977	O4'	A B	3	3.508	78.382	-41.901	1.00	66.06	O
ATOM	9978	O3'	A B	3	3.577	81.921	-41.265	1.00	60.25	O
ATOM	9979	O2'	A B	3	5.063	80.763	-43.270	1.00	64.19	O
ATOM	9980	C1'	A B	3	3.582	78.858	-43.230	1.00	60.94	C
ATOM	9981	N9	A B	3	2.401	78.372	-43.980	1.00	61.91	N
ATOM	9982	C8	A B	3	1.245	77.800	-43.497	1.00	56.84	C
ATOM	9983	N7	A B	3	0.404	77.436	-44.436	1.00	57.87	N
ATOM	9984	C5	A B	3	1.039	77.780	-45.622	1.00	61.93	C
ATOM	9985	C4	A B	3	2.274	78.351	-45.353	1.00	62.05	C
ATOM	9986	N1	A B	3	1.544	78.109	-47.900	1.00	62.52	N
ATOM	9987	C2	A B	3	2.706	78.628	-47.491	1.00	63.20	C
ATOM	9988	N3	A B	3	3.170	78.792	-46.254	1.00	62.84	N
ATOM	9989	C6	A B	3	0.677	77.657	-46.976	1.00	61.75	C
ATOM	9990	N6	A B	3	-0.467	77.135	-47.404	1.00	61.15	N
ATOM	9991	O5'	A B	4	3.238	83.565	-43.145	1.00	60.97	O
ATOM	9992	C4'	A B	4	4.722	84.181	-44.934	1.00	58.20	C
ATOM	9993	C3'	A B	4	3.677	85.049	-45.600	1.00	59.03	C
ATOM	9994	C2'	A B	4	3.760	84.597	-47.047	1.00	57.11	C
ATOM	9995	P	A B	4	2.804	83.275	-41.645	1.00	65.99	P
ATOM	9996	OF1	A B	4	3.334	84.365	-40.786	1.00	67.47	O
ATOM	9997	OF2	A B	4	1.344	82.995	-41.647	1.00	63.31	O
ATOM	9998	C5'	A B	4	4.555	83.991	-43.452	1.00	61.80	C
ATOM	9999	O4'	A B	4	4.574	82.907	-45.605	1.00	64.56	O
ATOM	10000	N6	A B	4	3.899	86.437	-45.419	1.00	59.84	N
ATOM	10001	O2'	A B	4	4.908	85.151	-47.663	1.00	59.21	O
ATOM	10002	C1'	A B	4	3.986	83.103	-46.873	1.00	59.88	C
ATOM	10003	N9	A B	4	2.727	82.337	-46.955	1.00	60.67	N
ATOM	10004	C8	A B	4	1.923	81.852	-45.954	1.00	59.47	C
ATOM	10005	N7	A B	4	0.874	81.197	-46.398	1.00	61.04	N
ATOM	10006	C5	A B	4	0.993	81.260	-47.778	1.00	60.73	C
ATOM	10007	C4	A B	4	2.133	81.953	-48.133	1.00	62.80	C
ATOM	10008	N1	A B	4	0.634	81.010	-50.091	1.00	69.45	N
ATOM	10009	C2	A B	4	1.763	81.701	-50.286	1.00	63.24	C
ATOM	10010	N3	A B	4	2.581	82.212	-49.378	1.00	66.47	N
ATOM	10011	C6	A B	4	0.211	80.763	-48.832	1.00	65.87	C
ATOM	10012	N6	A B	4	-0.917	80.067	-48.672	1.00	68.07	N
ATOM	10013	O5'	A B	5	2.429	87.360	-47.269	1.00	56.05	O
ATOM	10014	C4'	A B	5	2.900	87.646	-49.612	1.00	54.28	C
ATOM	10015	C3'	A B	5	1.593	88.294	-49.977	1.00	55.43	C
ATOM	10016	C2'	A B	5	1.090	87.424	-51.109	1.00	57.71	C
ATOM	10017	P	A B	5	2.705	87.473	-45.706	1.00	54.24	P

ATOM	10018	OP1	A B	5	3.194	88.866	-45.472	1.00	52.69	O
ATOM	10019	OP2	A B	5	1.528	86.907	-45.002	1.00	63.86	O
ATOM	10020	C5'	A B	5	3.344	87.909	-48.204	1.00	57.18	C
ATOM	10021	O4'	A B	5	2.643	86.233	-49.790	1.00	61.22	O
ATOM	10022	O3'	A B	5	1.745	89.652	-50.329	1.00	64.76	O
ATOM	10023	O2'	A B	5	1.786	87.740	-52.298	1.00	55.38	O
ATOM	10024	C1'	A B	5	1.528	86.052	-50.637	1.00	56.95	C
ATOM	10025	N9	A B	5	0.487	85.362	-49.858	1.00	59.67	N
ATOM	10026	C8	A B	5	0.394	85.317	-48.492	1.00	62.93	C
ATOM	10027	N7	A B	5	-0.608	84.597	-48.045	1.00	63.39	N
ATOM	10028	C5	A B	5	-1.206	84.129	-49.197	1.00	59.75	C
ATOM	10029	C4	A B	5	-0.545	84.584	-50.324	1.00	62.69	C
ATOM	10030	N1	A B	5	-2.667	83.022	-50.646	1.00	65.66	N
ATOM	10031	C2	A B	5	-1.932	83.532	-51.646	1.00	68.74	C
ATOM	10032	N3	A B	5	-0.861	84.319	-51.602	1.00	68.15	N
ATOM	10033	C6	A B	5	-2.322	83.311	-49.381	1.00	62.00	C
ATOM	10034	N6	A B	5	-3.037	82.813	-48.371	1.00	64.63	N
ATOM	10035	O5'	U B	6	-0.589	90.234	-50.993	1.00	59.35	O
ATOM	10036	C4'	U B	6	-1.595	89.718	-53.102	1.00	64.98	C
ATOM	10037	C3'	U B	6	-2.839	90.431	-52.610	1.00	60.23	C
ATOM	10038	C2'	U B	6	-3.954	89.450	-52.928	1.00	66.24	C
ATOM	10039	P	U B	6	0.556	90.663	-49.984	1.00	55.38	P
ATOM	10040	OP1	U B	6	0.938	92.068	-50.306	1.00	54.32	O
ATOM	10041	OP2	U B	6	0.131	90.258	-48.617	1.00	49.83	O
ATOM	10042	C5'	U B	6	-0.347	90.158	-52.391	1.00	62.16	C
ATOM	10043	O4'	U B	6	-1.861	88.310	-52.848	1.00	55.15	O
ATOM	10044	O3'	U B	6	-2.979	91.695	-53.214	1.00	67.22	O
ATOM	10045	O2'	U B	6	-4.323	89.559	-54.294	1.00	62.60	O
ATOM	10046	C1'	U B	6	-3.253	88.102	-52.703	1.00	61.61	C
ATOM	10047	N1	U B	6	-3.505	87.506	-51.362	1.00	65.73	N
ATOM	10048	C2	U B	6	-4.504	86.561	-51.292	1.00	66.85	C
ATOM	10049	N3	U B	6	-4.708	85.979	-50.064	1.00	63.20	N
ATOM	10050	C4	U B	6	-4.015	86.238	-48.901	1.00	61.09	C
ATOM	10051	C5	U B	6	-2.985	87.226	-49.045	1.00	59.65	C
ATOM	10052	C6	U B	6	-2.764	87.806	-50.236	1.00	61.95	C
ATOM	10053	O2	U B	6	-5.161	86.263	-52.268	1.00	68.11	O
ATOM	10054	O4	U B	6	-4.316	85.623	-47.874	1.00	54.84	O
ATOM	10055	O5'	U B	7	-5.360	92.373	-53.480	1.00	76.29	O
ATOM	10056	C4'	U B	7	-7.698	91.879	-53.059	1.00	79.80	C
ATOM	10057	C3'	U B	7	-8.723	92.092	-51.965	1.00	79.95	C
ATOM	10058	C2'	U B	7	-9.365	90.713	-51.861	1.00	79.33	C
ATOM	10059	P	U B	7	-4.052	92.740	-52.656	1.00	72.84	P
ATOM	10060	OP1	U B	7	-3.577	94.101	-53.003	1.00	62.69	O
ATOM	10061	OP2	U B	7	-4.370	92.373	-51.255	1.00	77.09	O
ATOM	10062	C5'	U B	7	-6.606	92.915	-53.103	1.00	79.25	C
ATOM	10063	O4'	U B	7	-7.168	90.553	-52.769	1.00	77.09	O
ATOM	10064	O3'	U B	7	-9.602	93.176	-52.219	1.00	77.67	O
ATOM	10065	O2'	U B	7	-10.238	90.477	-52.956	1.00	75.95	O
ATOM	10066	C1'	U B	7	-8.130	89.815	-52.027	1.00	79.17	C
ATOM	10067	N1	U B	7	-7.554	89.401	-50.716	1.00	75.54	N
ATOM	10068	C2	U B	7	-8.085	88.263	-50.131	1.00	75.26	C
ATOM	10069	N3	U B	7	-7.550	87.889	-48.911	1.00	72.02	N
ATOM	10070	C4	U B	7	-6.547	88.528	-48.199	1.00	68.13	C
ATOM	10071	C5	U B	7	-6.051	89.702	-48.860	1.00	64.68	C
ATOM	10072	C6	U B	7	-6.554	90.089	-50.051	1.00	72.54	C
ATOM	10073	O2	U B	7	-8.967	87.619	-50.666	1.00	79.56	O
ATOM	10074	O4	U B	7	-6.169	88.063	-47.106	1.00	58.82	O
ATOM	10075	P	G B	8	-9.328	94.592	-51.506	1.00	79.44	P
ATOM	10076	OP1	G B	8	-9.824	95.664	-52.394	1.00	81.66	O
ATOM	10077	OP2	G B	8	-7.930	94.678	-51.026	1.00	89.34	O
ATOM	10078	O5'	G B	8	-10.189	94.506	-50.170	1.00	88.57	O
ATOM	10079	C5'	G B	8	-11.602	94.603	-50.209	1.00	85.66	C
ATOM	10080	C4'	G B	8	-12.267	93.317	-49.792	1.00	81.14	C

ATOM	10081	O4'	G B	8	-11.322	92.219	-49.793	1.00	82.73	O
ATOM	10082	C3'	G B	8	-12.839	93.285	-48.392	1.00	83.07	C
ATOM	10083	O3'	G B	8	-14.067	93.973	-48.299	1.00	85.34	O
ATOM	10084	C2'	G B	8	-12.964	91.793	-48.136	1.00	80.72	C
ATOM	10085	O2'	G B	8	-14.082	91.268	-48.839	1.00	80.03	O
ATOM	10086	C1'	G B	8	-11.693	91.276	-48.805	1.00	78.69	C
ATOM	10087	N9	G B	8	-10.583	91.113	-47.841	1.00	77.46	N
ATOM	10088	C8	G B	8	-9.401	91.815	-47.753	1.00	78.66	C
ATOM	10089	N7	G B	8	-8.620	91.409	-46.782	1.00	73.05	N
ATOM	10090	C5	G B	8	-9.325	90.368	-46.188	1.00	70.61	C
ATOM	10091	C4	G B	8	-10.530	90.180	-46.838	1.00	72.78	C
ATOM	10092	N1	G B	8	-10.016	88.616	-44.843	1.00	70.30	N
ATOM	10093	C2	G B	8	-11.187	88.515	-45.557	1.00	73.18	C
ATOM	10094	N3	G B	8	-11.498	89.287	-46.582	1.00	72.00	N
ATOM	10095	C6	G B	8	-9.003	89.524	-45.085	1.00	68.48	C
ATOM	10096	O6	G B	8	-8.000	89.484	-44.357	1.00	67.50	O
ATOM	10097	N2	G B	8	-12.041	87.555	-45.156	1.00	73.46	N
ATOM	10098	O5'	G B	9	-15.192	95.159	-46.433	1.00	85.84	O
ATOM	10099	C4'	G B	9	-15.664	93.088	-45.257	1.00	80.62	C
ATOM	10100	C3'	G B	9	-16.029	92.720	-43.829	1.00	78.37	C
ATOM	10101	C2'	G B	9	-15.938	91.200	-43.796	1.00	74.53	C
ATOM	10102	F	G B	9	-14.142	95.408	-47.590	1.00	81.91	F
ATOM	10103	OF1	G B	9	-14.744	96.324	-48.592	1.00	93.73	O
ATOM	10104	OF2	G B	9	-12.863	95.761	-46.919	1.00	82.41	O
ATOM	10105	C5'	G B	9	-14.839	94.348	-45.334	1.00	83.60	C
ATOM	10106	O4'	G B	9	-14.875	91.971	-45.746	1.00	78.66	O
ATOM	10107	O3'	G B	9	-17.273	93.273	-43.443	1.00	76.97	O
ATOM	10108	O2'	G B	9	-17.108	90.602	-44.326	1.00	76.43	O
ATOM	10109	C1'	G B	9	-14.800	90.960	-44.774	1.00	74.42	C
ATOM	10110	N9	G B	9	-13.465	91.085	-44.145	1.00	69.35	N
ATOM	10111	C8	G B	9	-12.539	92.045	-44.499	1.00	69.15	C
ATOM	10112	N7	G B	9	-11.422	91.982	-43.834	1.00	69.86	N
ATOM	10113	C5	G B	9	-11.604	90.894	-42.991	1.00	62.65	C
ATOM	10114	C4	G B	9	-12.853	90.326	-43.164	1.00	63.93	C
ATOM	10115	N1	G B	9	-11.262	89.252	-41.384	1.00	57.95	N
ATOM	10116	C2	G B	9	-12.521	88.754	-41.625	1.00	59.14	C
ATOM	10117	N3	G B	9	-13.369	89.261	-42.513	1.00	63.32	N
ATOM	10118	C6	G B	9	-10.710	90.342	-42.042	1.00	58.22	C
ATOM	10119	O6	G B	9	-9.571	90.719	-41.765	1.00	57.81	O
ATOM	10120	N2	G B	9	-12.870	87.692	-40.888	1.00	54.99	N
ATOM	10121	O5'	G B	10	-17.080	93.767	-41.015	1.00	73.95	O
ATOM	10122	C4'	G B	10	-17.159	91.628	-39.875	1.00	69.29	C
ATOM	10123	C3'	G B	10	-16.752	92.073	-38.484	1.00	70.01	C
ATOM	10124	C2'	G B	10	-15.736	90.998	-38.106	1.00	62.21	C
ATOM	10125	F	G B	10	-17.266	94.499	-42.416	1.00	83.96	F
ATOM	10126	OF1	G B	10	-18.613	95.119	-42.461	1.00	93.18	O
ATOM	10127	OF2	G B	10	-16.048	95.323	-42.635	1.00	83.38	O
ATOM	10128	C5'	G B	10	-17.872	92.630	-40.735	1.00	66.10	C
ATOM	10129	O4'	G B	10	-15.904	91.214	-40.471	1.00	67.47	O
ATOM	10130	O3'	G B	10	-17.853	92.171	-37.585	1.00	70.02	O
ATOM	10131	O2'	G B	10	-16.396	89.802	-37.729	1.00	66.80	O
ATOM	10132	C1'	G B	10	-15.044	90.743	-39.450	1.00	63.03	C
ATOM	10133	N9	G B	10	-13.733	91.417	-39.530	1.00	59.06	N
ATOM	10134	C8	G B	10	-13.381	92.497	-40.289	1.00	56.40	C
ATOM	10135	N7	G B	10	-12.142	92.853	-40.115	1.00	54.34	N
ATOM	10136	C5	G B	10	-11.642	91.955	-39.173	1.00	55.95	C
ATOM	10137	C4	G B	10	-12.615	91.058	-38.802	1.00	55.01	C
ATOM	10138	N1	G B	10	-10.248	90.790	-37.694	1.00	51.54	N
ATOM	10139	C2	G B	10	-11.282	89.951	-37.390	1.00	55.86	C
ATOM	10140	N3	G B	10	-12.511	90.040	-37.920	1.00	50.91	N
ATOM	10141	C6	G B	10	-10.346	91.831	-38.593	1.00	47.58	C
ATOM	10142	O6	G B	10	-9.352	92.513	-38.788	1.00	47.78	O
ATOM	10143	N2	G B	10	-10.964	89.013	-36.487	1.00	50.24	N

ATOM	10144	O5'	U B	11	-16.774	92.475	-35.309	1.00	62.88	O
ATOM	10145	C4'	U B	11	-15.921	90.642	-33.921	1.00	62.84	C
ATOM	10146	C3'	U B	11	-15.360	91.505	-32.807	1.00	62.64	C
ATOM	10147	C2'	U B	11	-13.974	90.912	-32.605	1.00	57.60	C
ATOM	10148	P	U B	11	-17.808	93.161	-36.313	1.00	66.00	P
ATOM	10149	OP1	U B	11	-19.148	93.099	-35.680	1.00	71.84	O
ATOM	10150	OP2	U B	11	-17.264	94.474	-36.734	1.00	59.83	O
ATOM	10151	C5'	U B	11	-17.074	91.217	-34.717	1.00	65.19	O
ATOM	10152	O4'	U B	11	-14.775	90.417	-34.777	1.00	57.33	O
ATOM	10153	O3'	U B	11	-16.143	91.504	-31.633	1.00	68.21	O
ATOM	10154	O2'	U B	11	-14.061	89.675	-31.913	1.00	62.96	O
ATOM	10155	C1'	U B	11	-13.580	90.609	-34.040	1.00	56.69	C
ATOM	10156	N1	U B	11	-12.803	91.699	-34.671	1.00	52.71	N
ATOM	10157	C2	U B	11	-11.452	91.850	-34.382	1.00	50.38	C
ATOM	10158	N3	U B	11	-10.825	92.879	-35.058	1.00	46.06	N
ATOM	10159	C4	U B	11	-11.390	93.733	-35.991	1.00	48.93	C
ATOM	10160	C5	U B	11	-12.781	93.497	-36.235	1.00	55.41	C
ATOM	10161	C6	U B	11	-13.419	92.519	-35.590	1.00	57.62	C
ATOM	10162	O2	U B	11	-10.860	91.147	-33.577	1.00	51.69	O
ATOM	10163	O4	U B	11	-10.722	94.618	-36.542	1.00	47.46	O
ATOM	10164	O5'	G B	12	-14.483	92.656	-30.100	1.00	56.50	O
ATOM	10165	C4'	G B	12	-12.626	91.769	-28.881	1.00	50.88	C
ATOM	10166	C3'	G B	12	-11.859	92.813	-28.099	1.00	48.01	C
ATOM	10167	C2'	G B	12	-10.451	92.683	-28.666	1.00	44.43	C
ATOM	10168	P	G B	12	-15.992	92.730	-30.609	1.00	71.91	P
ATOM	10169	OP1	G B	12	-16.890	92.430	-29.463	1.00	74.94	O
ATOM	10170	OP2	G B	12	-16.046	93.985	-31.408	1.00	56.20	O
ATOM	10171	C5'	G B	12	-14.118	91.934	-28.944	1.00	45.20	O
ATOM	10172	O4'	G B	12	-12.057	91.858	-30.205	1.00	53.37	O
ATOM	10173	O3'	G B	12	-11.917	92.565	-26.709	1.00	50.58	O
ATOM	10174	O2'	G B	12	-9.824	91.531	-28.119	1.00	49.78	O
ATOM	10175	C1'	G B	12	-10.742	92.365	-30.121	1.00	45.02	C
ATOM	10176	N9	G B	12	-10.577	93.480	-31.067	1.00	42.31	N
ATOM	10177	C8	G B	12	-11.557	94.018	-31.870	1.00	46.68	C
ATOM	10178	N7	G B	12	-11.134	94.959	-32.661	1.00	47.61	N
ATOM	10179	C5	G B	12	-9.766	95.016	-32.397	1.00	45.36	C
ATOM	10180	C4	G B	12	-9.413	94.113	-31.419	1.00	40.83	C
ATOM	10181	N1	G B	12	-7.524	95.600	-32.396	1.00	45.80	N
ATOM	10182	C2	G B	12	-7.286	94.668	-31.423	1.00	43.73	C
ATOM	10183	N3	G B	12	-8.210	93.888	-30.886	1.00	43.05	N
ATOM	10184	C6	G B	12	-8.766	95.844	-32.955	1.00	44.94	C
ATOM	10185	O6	G B	12	-8.881	96.698	-33.831	1.00	47.16	O
ATOM	10186	N2	G B	12	-6.010	94.580	-31.011	1.00	43.52	N
ATOM	10187	O5'	C B	13	-10.371	94.266	-25.733	1.00	46.66	O
ATOM	10188	C4'	C B	13	-8.005	94.089	-25.364	1.00	44.26	C
ATOM	10189	C3'	C B	13	-7.895	95.551	-24.971	1.00	42.02	C
ATOM	10190	C2'	C B	13	-6.695	96.012	-25.788	1.00	45.49	C
ATOM	10191	P	C B	13	-11.879	93.782	-25.672	1.00	51.89	P
ATOM	10192	OP1	C B	13	-12.151	93.113	-24.365	1.00	49.35	O
ATOM	10193	OP2	C B	13	-12.730	94.893	-26.158	1.00	41.90	O
ATOM	10194	C5'	C B	13	-9.352	93.463	-25.159	1.00	39.87	C
ATOM	10195	O4'	C B	13	-7.682	94.097	-26.777	1.00	44.32	O
ATOM	10196	O3'	C B	13	-7.758	95.743	-23.580	1.00	50.00	O
ATOM	10197	O2'	C B	13	-5.491	95.514	-25.220	1.00	46.79	O
ATOM	10198	C1'	C B	13	-6.931	95.261	-27.089	1.00	41.74	C
ATOM	10199	N1	C B	13	-7.695	96.044	-28.077	1.00	38.96	N
ATOM	10200	C2	C B	13	-6.995	96.870	-28.929	1.00	43.07	C
ATOM	10201	N3	C B	13	-7.666	97.581	-29.865	1.00	45.16	N
ATOM	10202	C4	C B	13	-8.987	97.461	-29.980	1.00	43.88	C
ATOM	10203	C5	C B	13	-9.744	96.620	-29.133	1.00	38.86	C
ATOM	10204	C6	C B	13	-9.058	95.932	-28.211	1.00	43.96	C
ATOM	10205	O2	C B	13	-5.771	96.940	-28.783	1.00	49.41	O
ATOM	10206	N4	C B	13	-9.582	98.166	-30.934	1.00	45.65	N

ATOM	10207	O5'	G B	14	-7.350	98.201	-23.591	1.00	41.68	O
ATOM	10208	C4'	G B	14	-5.310	99.349	-24.056	1.00	43.43	C
ATOM	10209	C3'	G B	14	-5.823	100.773	-24.012	1.00	39.78	C
ATOM	10210	C2'	G B	14	-5.234	101.354	-25.282	1.00	45.86	C
ATOM	10211	P	G B	14	-8.275	97.113	-22.916	1.00	46.27	P
ATOM	10212	OP1	G B	14	-7.978	97.112	-21.465	1.00	47.67	O
ATOM	10213	OP2	G B	14	-9.660	97.332	-23.413	1.00	45.67	O
ATOM	10214	C5'	G B	14	-6.017	98.358	-23.173	1.00	37.10	O
ATOM	10215	O4'	G B	14	-5.460	98.994	-25.462	1.00	40.67	O
ATOM	10216	O3'	G B	14	-5.479	101.479	-22.835	1.00	45.94	O
ATOM	10217	O2'	G B	14	-3.850	101.607	-25.101	1.00	48.12	O
ATOM	10218	C1'	G B	14	-5.391	100.170	-26.248	1.00	45.00	C
ATOM	10219	N9	G B	14	-6.611	100.315	-27.065	1.00	43.11	N
ATOM	10220	C8	G B	14	-7.839	99.730	-26.892	1.00	42.50	C
ATOM	10221	N7	G B	14	-8.697	100.088	-27.801	1.00	41.24	N
ATOM	10222	C5	G B	14	-8.023	100.977	-28.613	1.00	38.78	C
ATOM	10223	C4	G B	14	-6.728	101.111	-28.165	1.00	40.43	C
ATOM	10224	N1	G B	14	-7.419	102.474	-30.305	1.00	42.57	N
ATOM	10225	C2	G B	14	-6.142	102.523	-29.762	1.00	48.09	C
ATOM	10226	N3	G B	14	-5.754	101.864	-28.685	1.00	45.32	N
ATOM	10227	C6	G B	14	-8.448	101.704	-29.760	1.00	39.30	C
ATOM	10228	O6	G B	14	-9.547	101.686	-30.310	1.00	42.73	O
ATOM	10229	N2	G B	14	-5.242	103.302	-30.362	1.00	47.42	N
ATOM	10230	O5'	C B	15	-6.088	103.886	-23.248	1.00	44.27	O
ATOM	10231	C4'	C B	15	-4.570	105.329	-24.448	1.00	47.17	C
ATOM	10232	C3'	C B	15	-5.489	106.544	-24.486	1.00	42.70	C
ATOM	10233	C2'	C B	15	-5.413	106.943	-25.943	1.00	44.90	C
ATOM	10234	P	C B	15	-6.455	102.660	-22.318	1.00	43.30	P
ATOM	10235	OP1	C B	15	-6.165	102.970	-20.901	1.00	39.60	O
ATOM	10236	OP2	C B	15	-7.787	102.200	-22.721	1.00	40.36	O
ATOM	10237	C5'	C B	15	-4.763	104.377	-23.296	1.00	46.71	C
ATOM	10238	O4'	C B	15	-4.814	104.661	-25.719	1.00	44.94	O
ATOM	10239	O3'	C B	15	-5.034	107.565	-23.637	1.00	43.90	O
ATOM	10240	O2'	C B	15	-4.169	107.582	-26.166	1.00	42.30	O
ATOM	10241	C1'	C B	15	-5.389	105.572	-26.627	1.00	46.22	C
ATOM	10242	N1	C B	15	-6.752	105.104	-26.979	1.00	45.18	N
ATOM	10243	C2	C B	15	-7.285	105.533	-28.195	1.00	46.17	C
ATOM	10244	N3	C B	15	-8.524	105.138	-28.562	1.00	42.45	N
ATOM	10245	C4	C B	15	-9.232	104.346	-27.768	1.00	41.90	C
ATOM	10246	C5	C B	15	-8.725	103.870	-26.522	1.00	37.55	C
ATOM	10247	C6	C B	15	-7.488	104.272	-26.171	1.00	40.88	C
ATOM	10248	O2	C B	15	-6.596	106.283	-28.902	1.00	47.00	O
ATOM	10249	N4	C B	15	-10.455	103.999	-28.186	1.00	36.91	N
ATOM	10250	O5'	U B	16	-6.570	109.461	-24.045	1.00	46.28	O
ATOM	10251	C4'	U B	16	-6.217	110.885	-25.976	1.00	43.61	C
ATOM	10252	C3'	U B	16	-7.514	111.654	-25.782	1.00	48.85	C
ATOM	10253	C2'	U B	16	-8.029	111.730	-27.195	1.00	43.44	C
ATOM	10254	P	U B	16	-6.055	108.524	-22.867	1.00	47.87	P
ATOM	10255	OP1	U B	16	-5.246	109.329	-21.909	1.00	44.55	O
ATOM	10256	OP2	U B	16	-7.145	107.709	-22.304	1.00	47.66	O
ATOM	10257	C5'	U B	16	-5.628	110.228	-24.767	1.00	45.17	C
ATOM	10258	O4'	U B	16	-6.551	109.898	-26.972	1.00	45.22	O
ATOM	10259	O3'	U B	16	-7.312	112.933	-25.218	1.00	50.60	O
ATOM	10260	O2'	U B	16	-7.229	112.672	-27.880	1.00	46.59	O
ATOM	10261	C1'	U B	16	-7.665	110.336	-27.714	1.00	47.11	C
ATOM	10262	N1	U B	16	-8.759	109.349	-27.523	1.00	43.99	N
ATOM	10263	C2	U B	16	-9.770	109.275	-28.457	1.00	45.64	C
ATOM	10264	N3	U B	16	-10.724	108.322	-28.172	1.00	43.90	N
ATOM	10265	C4	U B	16	-10.766	107.462	-27.095	1.00	44.87	C
ATOM	10266	C5	U B	16	-9.672	107.591	-26.203	1.00	40.01	C
ATOM	10267	C6	U B	16	-8.744	108.505	-26.444	1.00	42.45	C
ATOM	10268	O2	U B	16	-9.836	110.006	-29.443	1.00	49.51	O
ATOM	10269	O4	U B	16	-11.696	106.654	-26.982	1.00	44.52	O

ATOM	10270	O5'	U B	17	-9.706	113.677	-25.142	1.00	37.80	O
ATOM	10271	C4'	U B	17	-10.972	114.598	-26.979	1.00	43.98	C
ATOM	10272	C3'	U B	17	-12.361	114.708	-26.360	1.00	40.48	C
ATOM	10273	C2'	U B	17	-13.198	114.283	-27.549	1.00	41.36	C
ATOM	10274	P	U B	17	-8.407	113.559	-24.232	1.00	46.63	P
ATOM	10275	OP1	U B	17	-7.851	114.880	-23.900	1.00	47.33	O
ATOM	10276	OP2	U B	17	-8.804	112.632	-23.151	1.00	43.80	O
ATOM	10277	C5'	U B	17	-9.757	114.682	-26.107	1.00	43.24	C
ATOM	10278	O4'	U B	17	-11.026	113.342	-27.705	1.00	47.42	O
ATOM	10279	O3'	U B	17	-12.670	116.025	-25.900	1.00	41.72	O
ATOM	10280	O2'	U B	17	-13.134	115.310	-28.520	1.00	44.97	O
ATOM	10281	C1'	U B	17	-12.369	113.107	-28.088	1.00	41.16	C
ATOM	10282	N1	U B	17	-12.846	111.830	-27.518	1.00	44.02	N
ATOM	10283	C2	U B	17	-14.079	111.413	-27.997	1.00	44.11	C
ATOM	10284	N3	U B	17	-14.560	110.262	-27.463	1.00	39.28	N
ATOM	10285	C4	U B	17	-13.972	109.536	-26.479	1.00	37.62	C
ATOM	10286	C5	U B	17	-12.707	110.025	-26.002	1.00	38.65	C
ATOM	10287	C6	U B	17	-12.195	111.135	-26.527	1.00	38.74	C
ATOM	10288	O2	U B	17	-14.714	112.002	-28.845	1.00	42.26	O
ATOM	10289	O4	U B	17	-14.570	108.540	-26.118	1.00	41.81	O
ATOM	10290	O5'	G B	18	-15.210	116.317	-25.856	1.00	38.06	O
ATOM	10291	C4'	G B	18	-16.473	116.963	-27.848	1.00	43.01	C
ATOM	10292	C3'	G B	18	-17.877	117.039	-27.231	1.00	35.62	C
ATOM	10293	C2'	G B	18	-18.687	116.195	-28.191	1.00	39.68	C
ATOM	10294	P	G B	18	-13.925	116.360	-24.909	1.00	39.20	P
ATOM	10295	OP1	G B	18	-13.696	117.757	-24.570	1.00	48.09	O
ATOM	10296	OP2	G B	18	-14.169	115.424	-23.802	1.00	44.04	O
ATOM	10297	C5'	G B	18	-15.303	117.234	-26.941	1.00	43.77	C
ATOM	10298	O4'	G B	18	-16.384	115.611	-28.365	1.00	42.88	O
ATOM	10299	O3'	G B	18	-18.367	118.360	-27.108	1.00	43.83	O
ATOM	10300	O2'	G B	18	-18.941	116.911	-29.391	1.00	44.16	O
ATOM	10301	C1'	G B	18	-17.688	115.081	-28.509	1.00	42.54	C
ATOM	10302	N9	G B	18	-17.838	113.974	-27.568	1.00	40.73	N
ATOM	10303	C8	G B	18	-17.018	113.609	-26.532	1.00	42.61	C
ATOM	10304	N7	G B	18	-17.468	112.561	-25.884	1.00	43.91	N
ATOM	10305	C5	G B	18	-18.666	112.264	-26.525	1.00	42.06	C
ATOM	10306	C4	G B	18	-18.917	113.141	-27.559	1.00	41.11	C
ATOM	10307	N1	G B	18	-20.673	111.327	-27.165	1.00	38.66	N
ATOM	10308	C2	G B	18	-20.816	112.259	-28.164	1.00	36.59	C
ATOM	10309	N3	G B	18	-19.958	113.214	-28.413	1.00	36.57	N
ATOM	10310	C6	G B	18	-19.601	111.249	-26.285	1.00	39.85	C
ATOM	10311	O6	G B	18	-19.560	110.375	-25.431	1.00	40.58	O
ATOM	10312	N2	G B	18	-21.905	112.158	-28.910	1.00	37.51	N
ATOM	10313	O5'	G B	19	-20.673	118.075	-26.096	1.00	41.91	O
ATOM	10314	C4'	G B	19	-22.606	117.414	-27.372	1.00	38.90	C
ATOM	10315	C3'	G B	19	-23.553	117.346	-26.181	1.00	33.34	C
ATOM	10316	C2'	G B	19	-24.253	116.022	-26.419	1.00	39.07	C
ATOM	10317	P	G B	19	-19.276	118.795	-25.848	1.00	43.96	P
ATOM	10318	OP1	G B	19	-19.464	120.245	-25.895	1.00	42.48	O
ATOM	10319	OP2	G B	19	-18.717	118.213	-24.619	1.00	45.13	O
ATOM	10320	C5'	G B	19	-21.415	118.326	-27.262	1.00	38.83	C
ATOM	10321	O4'	G B	19	-22.157	116.046	-27.546	1.00	40.69	O
ATOM	10322	O3'	G B	19	-24.431	118.466	-26.097	1.00	42.61	O
ATOM	10323	O2'	G B	19	-25.217	116.146	-27.453	1.00	39.48	O
ATOM	10324	C1'	G B	19	-23.088	115.169	-26.957	1.00	39.22	C
ATOM	10325	N1	G B	19	-23.446	111.112	-24.200	1.00	40.32	N
ATOM	10326	N9	G B	19	-22.405	114.458	-25.870	1.00	36.58	N
ATOM	10327	C8	G B	19	-21.287	114.792	-25.152	1.00	34.76	C
ATOM	10328	N7	G B	19	-21.035	113.913	-24.248	1.00	37.01	N
ATOM	10329	C5	G B	19	-22.027	112.940	-24.387	1.00	38.19	C
ATOM	10330	C6	G B	19	-22.304	111.715	-23.712	1.00	41.28	C
ATOM	10331	O6	G B	19	-21.704	111.163	-22.785	1.00	44.61	O
ATOM	10332	C2	G B	19	-24.221	111.594	-25.229	1.00	40.29	C

ATOM	10333	N2	G B	19	-25.302	110.897	-25.608	1.00	40.10	N
ATOM	10334	N3	G B	19	-23.972	112.700	-25.854	1.00	42.39	N
ATOM	10335	C4	G B	19	-22.884	113.301	-25.366	1.00	37.86	C
ATOM	10336	O5'	C B	20	-26.430	117.666	-24.845	1.00	33.29	O
ATOM	10337	C4'	C B	20	-27.560	115.774	-23.959	1.00	39.00	C
ATOM	10338	C3'	C B	20	-28.305	115.189	-22.793	1.00	42.73	C
ATOM	10339	C2'	C B	20	-28.362	113.712	-23.149	1.00	41.78	C
ATOM	10340	P	C B	20	-25.305	118.770	-24.773	1.00	36.32	P
ATOM	10341	OP1	C B	20	-25.908	120.110	-24.906	1.00	41.82	O
ATOM	10342	OP2	C B	20	-24.577	118.537	-23.517	1.00	35.32	O
ATOM	10343	C5'	C B	20	-26.919	117.092	-23.666	1.00	33.65	C
ATOM	10344	O4'	C B	20	-26.558	114.754	-24.287	1.00	37.05	O
ATOM	10345	O3'	C B	20	-29.560	115.797	-22.603	1.00	45.95	O
ATOM	10346	O2'	C B	20	-29.369	113.474	-24.111	1.00	42.60	O
ATOM	10347	C1'	C B	20	-26.975	113.504	-23.781	1.00	37.36	C
ATOM	10348	N1	C B	20	-26.004	113.076	-22.749	1.00	38.45	N
ATOM	10349	C2	C B	20	-26.146	111.824	-22.134	1.00	39.28	C
ATOM	10350	N3	C B	20	-25.286	111.489	-21.167	1.00	40.34	N
ATOM	10351	C4	C B	20	-24.315	112.312	-20.793	1.00	39.55	C
ATOM	10352	C5	C B	20	-24.130	113.589	-21.371	1.00	36.34	C
ATOM	10353	C6	C B	20	-25.008	113.926	-22.334	1.00	43.11	C
ATOM	10354	O2	C B	20	-27.038	111.021	-22.461	1.00	40.72	O
ATOM	10355	N4	C B	20	-23.517	111.870	-19.831	1.00	43.10	N
ATOM	10356	O5'	G B	21	-30.181	114.796	-20.389	1.00	40.37	O
ATOM	10357	C4'	G B	21	-30.794	112.497	-20.132	1.00	45.93	C
ATOM	10358	C3'	G B	21	-30.912	112.616	-18.625	1.00	45.42	C
ATOM	10359	C2'	G B	21	-30.054	111.470	-18.140	1.00	43.18	C
ATOM	10360	P	G B	21	-30.048	116.195	-21.129	1.00	46.13	P
ATOM	10361	OP1	G B	21	-31.404	116.779	-21.265	1.00	52.92	O
ATOM	10362	OP2	G B	21	-28.975	116.968	-20.498	1.00	41.23	O
ATOM	10363	C5'	G B	21	-31.012	113.772	-20.894	1.00	40.12	C
ATOM	10364	O4'	G B	21	-29.439	112.020	-20.346	1.00	44.04	O
ATOM	10365	O3'	G B	21	-32.246	112.483	-18.196	1.00	48.64	O
ATOM	10366	O2'	G B	21	-30.768	110.270	-18.323	1.00	45.83	O
ATOM	10367	C1'	G B	21	-28.925	111.491	-19.153	1.00	39.58	C
ATOM	10368	N9	G B	21	-27.800	112.351	-18.735	1.00	45.24	N
ATOM	10369	C8	G B	21	-27.487	113.609	-19.207	1.00	36.33	C
ATOM	10370	N7	G B	21	-26.400	114.072	-18.664	1.00	38.37	N
ATOM	10371	C5	G B	21	-25.965	113.078	-17.788	1.00	39.24	C
ATOM	10372	C4	G B	21	-26.823	112.012	-17.826	1.00	39.55	C
ATOM	10373	N1	G B	21	-24.798	111.818	-16.214	1.00	40.40	N
ATOM	10374	C2	G B	21	-25.721	110.814	-16.329	1.00	45.49	C
ATOM	10375	N3	G B	21	-26.766	110.860	-17.142	1.00	44.76	N
ATOM	10376	C6	G B	21	-24.845	113.015	-16.921	1.00	39.99	C
ATOM	10377	O6	G B	21	-23.962	113.858	-16.737	1.00	41.94	O
ATOM	10378	N2	G B	21	-25.528	109.724	-15.577	1.00	43.82	N
ATOM	10379	O5'	U B	22	-32.259	112.840	-15.698	1.00	46.30	O
ATOM	10380	C4'	U B	22	-31.422	111.082	-14.264	1.00	46.05	C
ATOM	10381	C3'	U B	22	-31.438	112.029	-13.068	1.00	49.47	C
ATOM	10382	C2'	U B	22	-30.057	111.841	-12.461	1.00	50.75	C
ATOM	10383	P	U B	22	-32.841	113.429	-17.058	1.00	40.51	P
ATOM	10384	OP1	U B	22	-34.318	113.216	-17.086	1.00	56.75	O
ATOM	10385	OP2	U B	22	-32.267	114.762	-17.284	1.00	42.94	O
ATOM	10386	C5'	U B	22	-32.349	111.454	-15.395	1.00	44.07	C
ATOM	10387	O4'	U B	22	-30.036	111.084	-14.719	1.00	40.03	O
ATOM	10388	O3'	U B	22	-32.472	111.704	-12.155	1.00	54.90	O
ATOM	10389	O2'	U B	22	-30.053	110.678	-11.645	1.00	50.96	O
ATOM	10390	C1'	U B	22	-29.196	111.581	-13.703	1.00	46.49	C
ATOM	10391	N1	U B	22	-28.541	112.800	-14.227	1.00	48.41	N
ATOM	10392	C2	U B	22	-27.351	113.147	-13.648	1.00	43.20	C
ATOM	10393	N3	U B	22	-26.742	114.236	-14.192	1.00	38.43	N
ATOM	10394	C4	U B	22	-27.200	115.019	-15.236	1.00	36.20	C
ATOM	10395	C5	U B	22	-28.445	114.617	-15.792	1.00	37.07	C

ATOM	10396	C6	U B	22	-29.063	113.537	-15.278	1.00	46.06	C
ATOM	10397	O2	U B	22	-26.882	112.511	-12.723	1.00	48.09	O
ATOM	10398	O4	U B	22	-26.518	115.980	-15.593	1.00	37.49	O
ATOM	10399	O5'	U B	23	-32.233	113.201	-10.175	1.00	48.66	O
ATOM	10400	C4'	U B	23	-30.732	112.712	-8.399	1.00	49.57	C
ATOM	10401	C3'	U B	23	-30.846	114.084	-7.773	1.00	48.24	C
ATOM	10402	C2'	U B	23	-29.392	114.512	-7.635	1.00	51.47	C
ATOM	10403	P	U B	23	-33.239	112.837	-11.331	1.00	50.23	P
ATOM	10404	OP1	U B	23	-34.414	112.208	-10.697	1.00	59.95	O
ATOM	10405	OP2	U B	23	-33.413	114.019	-12.193	1.00	52.04	O
ATOM	10406	C5'	U B	23	-31.931	112.261	-9.173	1.00	45.15	C
ATOM	10407	O4'	U B	23	-29.597	112.824	-9.292	1.00	50.80	O
ATOM	10408	O3'	U B	23	-31.559	114.053	-6.541	1.00	56.87	O
ATOM	10409	O2'	U B	23	-28.826	113.915	-6.486	1.00	56.88	O
ATOM	10410	C1'	U B	23	-28.749	113.860	-8.865	1.00	49.31	C
ATOM	10411	N1	U B	23	-28.546	114.788	-9.997	1.00	43.66	N
ATOM	10412	C2	U B	23	-27.362	115.486	-10.091	1.00	43.00	C
ATOM	10413	N3	U B	23	-27.238	116.331	-11.160	1.00	38.05	N
ATOM	10414	C4	U B	23	-28.185	116.537	-12.145	1.00	40.27	C
ATOM	10415	C5	U B	23	-29.397	115.803	-11.990	1.00	39.85	C
ATOM	10416	C6	U B	23	-29.525	114.968	-10.948	1.00	45.82	C
ATOM	10417	O2	U B	23	-26.467	115.382	-9.290	1.00	50.38	O
ATOM	10418	O4	U B	23	-27.927	117.304	-13.066	1.00	41.05	O
ATOM	10419	O5'	U B	24	-31.713	116.369	-5.657	1.00	60.45	O
ATOM	10420	C4'	U B	24	-30.375	117.521	-4.049	1.00	55.81	C
ATOM	10421	C3'	U B	24	-30.955	118.909	-4.279	1.00	49.01	C
ATOM	10422	C2'	U B	24	-29.703	119.729	-4.530	1.00	53.32	C
ATOM	10423	P	U B	24	-32.638	115.203	-6.176	1.00	53.98	P
ATOM	10424	OP1	U B	24	-33.444	114.866	-4.988	1.00	59.65	O
ATOM	10425	OP2	U B	24	-33.382	115.564	-7.391	1.00	48.46	O
ATOM	10426	C5'	U B	24	-31.294	116.370	-4.309	1.00	56.83	C
ATOM	10427	O4'	U B	24	-29.270	117.448	-4.975	1.00	49.15	O
ATOM	10428	O3'	U B	24	-31.715	119.359	-3.172	1.00	61.18	O
ATOM	10429	O2'	U B	24	-29.000	119.922	-3.314	1.00	54.84	O
ATOM	10430	C1'	U B	24	-28.874	118.745	-5.345	1.00	56.24	C
ATOM	10431	N1	U B	24	-29.048	118.878	-6.810	1.00	51.19	N
ATOM	10432	C2	U B	24	-28.379	119.897	-7.440	1.00	49.69	C
ATOM	10433	N3	U B	24	-28.529	119.941	-8.799	1.00	50.89	N
ATOM	10434	C4	U B	24	-29.251	119.062	-9.583	1.00	46.92	C
ATOM	10435	C5	U B	24	-29.909	118.032	-8.857	1.00	43.91	C
ATOM	10436	C6	U B	24	-29.778	117.969	-7.529	1.00	46.56	C
ATOM	10437	O2	U B	24	-27.706	120.705	-6.838	1.00	54.38	O
ATOM	10438	O4	U B	24	-29.283	119.228	-10.800	1.00	46.17	O
ATOM	10439	O5'	U B	25	-31.784	121.870	-3.668	1.00	55.40	O
ATOM	10440	C4'	U B	25	-29.987	123.485	-3.438	1.00	58.15	C
ATOM	10441	C3'	U B	25	-30.736	124.629	-4.117	1.00	54.37	C
ATOM	10442	C2'	U B	25	-29.702	125.145	-5.109	1.00	57.03	C
ATOM	10443	P	U B	25	-32.702	120.634	-3.251	1.00	57.22	P
ATOM	10444	OP1	U B	25	-33.077	120.818	-1.843	1.00	64.10	O
ATOM	10445	OP2	U B	25	-33.740	120.456	-4.293	1.00	45.26	O
ATOM	10446	C5'	U B	25	-30.840	122.428	-2.769	1.00	55.12	C
ATOM	10447	O4'	U B	25	-29.185	122.908	-4.505	1.00	56.13	O
ATOM	10448	O3'	U B	25	-31.181	125.603	-3.196	1.00	56.34	O
ATOM	10449	O2'	U B	25	-28.688	125.880	-4.439	1.00	55.39	O
ATOM	10450	C1'	U B	25	-29.072	123.835	-5.576	1.00	56.10	C
ATOM	10451	N1	U B	25	-29.738	123.274	-6.785	1.00	47.32	N
ATOM	10452	C2	U B	25	-29.323	123.706	-8.027	1.00	47.52	C
ATOM	10453	N3	U B	25	-29.969	123.147	-9.088	1.00	44.01	N
ATOM	10454	C4	U B	25	-30.953	122.169	-9.048	1.00	50.41	C
ATOM	10455	C5	U B	25	-31.331	121.770	-7.730	1.00	46.61	C
ATOM	10456	C6	U B	25	-30.727	122.332	-6.685	1.00	49.16	C
ATOM	10457	O2	U B	25	-28.447	124.535	-8.183	1.00	48.91	O
ATOM	10458	O4	U B	25	-31.445	121.707	-10.093	1.00	49.71	O

ATOM	10459	O5'	A B	26	-31.774	127.596	-4.603	1.00	56.19	O
ATOM	10460	C4'	A B	26	-30.270	129.252	-5.445	1.00	58.89	C
ATOM	10461	C3'	A B	26	-31.418	129.817	-6.262	1.00	54.22	C
ATOM	10462	C2'	A B	26	-30.752	130.067	-7.612	1.00	54.86	C
ATOM	10463	P	A B	26	-32.394	126.607	-3.537	1.00	60.51	P
ATOM	10464	OP1	A B	26	-32.573	127.343	-2.276	1.00	64.51	O
ATOM	10465	OP2	A B	26	-33.576	125.950	-4.152	1.00	55.02	O
ATOM	10466	C5'	A B	26	-30.663	128.404	-4.269	1.00	58.77	C
ATOM	10467	O4'	A B	26	-29.526	128.446	-6.397	1.00	55.85	O
ATOM	10468	O3'	A B	26	-32.017	130.958	-5.666	1.00	61.17	O
ATOM	10469	O2'	A B	26	-29.942	131.231	-7.586	1.00	59.88	O
ATOM	10470	C1'	A B	26	-29.835	128.842	-7.711	1.00	54.69	C
ATOM	10471	N9	A B	26	-30.563	127.746	-8.358	1.00	47.71	N
ATOM	10472	C8	A B	26	-31.386	126.807	-7.794	1.00	48.29	C
ATOM	10473	N7	A B	26	-31.947	126.014	-8.669	1.00	47.14	N
ATOM	10474	C5	A B	26	-31.476	126.479	-9.895	1.00	47.56	C
ATOM	10475	C4	A B	26	-30.633	127.558	-9.701	1.00	46.62	C
ATOM	10476	N1	A B	26	-31.042	126.773	-12.190	1.00	50.38	N
ATOM	10477	C2	A B	26	-30.259	127.799	-11.834	1.00	51.66	C
ATOM	10478	N3	A B	26	-29.980	128.271	-10.623	1.00	46.77	N
ATOM	10479	C6	A B	26	-31.682	126.077	-11.232	1.00	49.51	C
ATOM	10480	N6	A B	26	-32.462	125.068	-11.630	1.00	52.11	N
ATOM	10481	O5'	G B	27	-33.902	131.470	-7.252	1.00	48.96	O
ATOM	10482	C4'	G B	27	-33.498	132.559	-9.365	1.00	54.33	C
ATOM	10483	C3'	G B	27	-34.948	132.441	-9.813	1.00	56.48	C
ATOM	10484	C2'	G B	27	-34.781	131.977	-11.249	1.00	59.49	C
ATOM	10485	P	G B	27	-33.618	131.196	-5.715	1.00	65.71	P
ATOM	10486	OP1	G B	27	-33.817	132.490	-5.001	1.00	70.68	O
ATOM	10487	OP2	G B	27	-34.419	130.042	-5.242	1.00	55.14	O
ATOM	10488	C5'	G B	27	-33.241	132.546	-7.891	1.00	55.08	C
ATOM	10489	O4'	G B	27	-32.864	131.404	-9.966	1.00	63.59	O
ATOM	10490	O3'	G B	27	-35.676	133.660	-9.691	1.00	70.30	O
ATOM	10491	O2'	G B	27	-34.397	133.064	-12.057	1.00	63.48	O
ATOM	10492	C1'	G B	27	-33.575	131.030	-11.128	1.00	61.12	C
ATOM	10493	N9	G B	27	-34.046	129.635	-11.033	1.00	53.63	N
ATOM	10494	C8	G B	27	-34.429	128.946	-9.910	1.00	52.33	C
ATOM	10495	N7	G B	27	-34.897	127.761	-10.187	1.00	57.72	N
ATOM	10496	C5	G B	27	-34.827	127.679	-11.579	1.00	52.17	C
ATOM	10497	C4	G B	27	-34.326	128.834	-12.122	1.00	51.98	C
ATOM	10498	N1	G B	27	-34.981	126.954	-13.798	1.00	51.58	N
ATOM	10499	C2	G B	27	-34.452	128.139	-14.248	1.00	49.57	C
ATOM	10500	N3	G B	27	-34.111	129.130	-13.433	1.00	51.82	N
ATOM	10501	C6	G B	27	-35.198	126.634	-12.456	1.00	50.78	C
ATOM	10502	O6	G B	27	-35.662	125.527	-12.152	1.00	59.57	O
ATOM	10503	N2	G B	27	-34.316	128.255	-15.584	1.00	47.68	N
ATOM	10504	P	A B	28	-37.285	133.708	-9.470	1.00	65.10	P
ATOM	10505	OP1	A B	28	-37.956	132.404	-9.625	1.00	66.63	O
ATOM	10506	OP2	A B	28	-37.770	134.801	-10.349	1.00	58.89	O
ATOM	10507	O5'	A B	28	-37.436	134.103	-7.941	1.00	63.97	O
ATOM	10508	C5'	A B	28	-36.934	133.269	-6.897	1.00	64.82	C
ATOM	10509	C4'	A B	28	-37.674	133.501	-5.597	1.00	75.43	C
ATOM	10510	O4'	A B	28	-37.317	134.808	-5.057	1.00	68.06	O
ATOM	10511	C3'	A B	28	-39.197	133.499	-5.716	1.00	73.24	C
ATOM	10512	O3'	A B	28	-39.762	133.050	-4.490	1.00	71.09	O
ATOM	10513	C2'	A B	28	-39.512	134.978	-5.894	1.00	77.51	C
ATOM	10514	O2'	A B	28	-40.837	135.347	-5.560	1.00	85.63	O
ATOM	10515	C1'	A B	28	-38.478	135.619	-4.966	1.00	80.59	C
ATOM	10516	N9	A B	28	-38.105	136.988	-5.338	1.00	79.87	N
ATOM	10517	C8	A B	28	-38.153	137.571	-6.583	1.00	77.10	C
ATOM	10518	N7	A B	28	-37.733	138.813	-6.584	1.00	81.82	N
ATOM	10519	C5	A B	28	-37.381	139.061	-5.259	1.00	80.23	C
ATOM	10520	C4	A B	28	-37.607	137.942	-4.486	1.00	73.29	C
ATOM	10521	N1	A B	28	-36.635	140.102	-3.265	1.00	76.10	N

ATOM	10522	C2	A B	28	-36.908	138.947	-2.655	1.00	75.75	C
ATOM	10523	N3	A B	28	-37.396	137.819	-3.168	1.00	74.29	N
ATOM	10524	C6	A B	28	-36.871	140.197	-4.592	1.00	80.92	C
ATOM	10525	N6	A B	28	-36.601	141.361	-5.192	1.00	81.76	N
ATOM	10526	P	G B	29	-40.143	131.507	-4.290	1.00	75.54	P
ATOM	10527	OP1	G B	29	-40.780	131.324	-2.966	1.00	78.46	O
ATOM	10528	OP2	G B	29	-38.893	130.749	-4.558	1.00	83.34	O
ATOM	10529	O5'	G B	29	-41.232	131.219	-5.423	1.00	74.95	O
ATOM	10530	C5'	G B	29	-42.623	131.452	-5.204	1.00	77.00	C
ATOM	10531	C4'	G B	29	-43.171	132.498	-6.147	1.00	77.75	C
ATOM	10532	O4'	G B	29	-43.678	131.891	-7.366	1.00	69.50	O
ATOM	10533	C3'	G B	29	-44.352	133.323	-5.656	1.00	77.68	C
ATOM	10534	O3'	G B	29	-43.991	134.321	-4.716	1.00	80.54	O
ATOM	10535	C2'	G B	29	-44.905	133.898	-6.956	1.00	78.24	C
ATOM	10536	O2'	G B	29	-44.140	135.020	-7.371	1.00	81.98	O
ATOM	10537	C1'	G B	29	-44.652	132.749	-7.940	1.00	80.60	C
ATOM	10538	N9	G B	29	-45.890	132.011	-8.286	1.00	83.08	N
ATOM	10539	C8	G B	29	-46.900	132.453	-9.127	1.00	80.96	C
ATOM	10540	N7	G B	29	-47.899	131.617	-9.258	1.00	77.82	N
ATOM	10541	C5	G B	29	-47.523	130.557	-8.448	1.00	77.63	C
ATOM	10542	C4	G B	29	-46.299	130.786	-7.841	1.00	80.06	C
ATOM	10543	N1	G B	29	-47.461	128.556	-7.305	1.00	82.52	N
ATOM	10544	C2	G B	29	-46.247	128.889	-6.754	1.00	82.69	C
ATOM	10545	N3	G B	29	-45.604	130.012	-6.992	1.00	76.71	N
ATOM	10546	C6	G B	29	-48.193	129.342	-8.184	1.00	79.14	C
ATOM	10547	O6	G B	29	-49.281	128.941	-8.618	1.00	80.97	O
ATOM	10548	N2	G B	29	-45.702	127.989	-5.923	1.00	94.34	N
ATOM	10549	P	C B	30	-45.040	134.820	-3.596	1.00	86.47	P
ATOM	10550	OP1	C B	30	-44.428	136.002	-2.936	1.00	84.04	O
ATOM	10551	OP2	C B	30	-45.468	133.679	-2.750	1.00	77.69	O
ATOM	10552	O5'	C B	30	-46.318	135.285	-4.428	1.00	75.47	O
ATOM	10553	C5'	C B	30	-46.340	136.531	-5.107	1.00	77.66	C
ATOM	10554	C4'	C B	30	-47.625	136.714	-5.876	1.00	79.78	C
ATOM	10555	O4'	C B	30	-47.796	135.620	-6.812	1.00	72.66	O
ATOM	10556	C3'	C B	30	-48.911	136.704	-5.062	1.00	80.94	C
ATOM	10557	O3'	C B	30	-49.170	137.941	-4.416	1.00	82.52	O
ATOM	10558	C2'	C B	30	-49.955	136.316	-6.104	1.00	80.85	C
ATOM	10559	O2'	C B	30	-50.310	137.433	-6.905	1.00	81.73	O
ATOM	10560	C1'	C B	30	-49.168	135.336	-6.975	1.00	75.03	C
ATOM	10561	N1	C B	30	-49.417	133.938	-6.580	1.00	71.66	N
ATOM	10562	C2	C B	30	-50.463	133.279	-7.214	1.00	80.38	C
ATOM	10563	N3	C B	30	-50.723	132.000	-6.882	1.00	81.13	N
ATOM	10564	C4	C B	30	-49.994	131.402	-5.952	1.00	78.88	C
ATOM	10565	C5	C B	30	-48.927	132.057	-5.277	1.00	74.92	C
ATOM	10566	C6	C B	30	-48.675	133.319	-5.621	1.00	73.88	C
ATOM	10567	O2	C B	30	-51.124	133.876	-8.080	1.00	82.39	O
ATOM	10568	N4	C B	30	-50.310	130.141	-5.675	1.00	82.70	N
ATOM	10569	P	U B	31	-50.058	138.003	-3.071	1.00	90.29	P
ATOM	10570	OP1	U B	31	-50.024	139.401	-2.571	1.00	84.29	O
ATOM	10571	OP2	U B	31	-49.633	136.923	-2.146	1.00	86.60	O
ATOM	10572	O5'	U B	31	-51.536	137.687	-3.577	1.00	82.61	O
ATOM	10573	C5'	U B	31	-52.155	138.480	-4.583	1.00	84.57	C
ATOM	10574	C4'	U B	31	-53.561	138.014	-4.847	1.00	84.56	C
ATOM	10575	O4'	U B	31	-53.545	136.828	-5.682	1.00	87.72	O
ATOM	10576	C3'	U B	31	-54.323	137.584	-3.610	1.00	86.88	C
ATOM	10577	O3'	U B	31	-54.863	138.677	-2.905	1.00	92.63	O
ATOM	10578	C2'	U B	31	-55.358	136.613	-4.163	1.00	92.48	C
ATOM	10579	O2'	U B	31	-56.457	137.298	-4.749	1.00	94.00	O
ATOM	10580	C1'	U B	31	-54.557	135.930	-5.271	1.00	89.00	C
ATOM	10581	N1	U B	31	-53.919	134.686	-4.781	1.00	88.47	N
ATOM	10582	C2	U B	31	-54.608	133.509	-4.987	1.00	91.78	C
ATOM	10583	N3	U B	31	-53.977	132.382	-4.510	1.00	90.28	N
ATOM	10584	C4	U B	31	-52.761	132.322	-3.854	1.00	88.47	C

ATOM	10585	C5	U B	31	-52.109	133.581	-3.670	1.00	84.65	C
ATOM	10586	C6	U B	31	-52.700	134.686	-4.130	1.00	87.96	C
ATOM	10587	O2	U B	31	-55.686	133.473	-5.560	1.00	91.84	O
ATOM	10588	O4	U B	31	-52.331	131.233	-3.482	1.00	88.58	O
ATOM	10589	P	A B	32	-55.186	138.536	-1.346	1.00	89.96	P
ATOM	10590	OP1	A B	32	-54.981	139.871	-0.735	1.00	93.57	O
ATOM	10591	OP2	A B	32	-54.452	137.365	-0.801	1.00	95.61	O
ATOM	10592	O5'	A B	32	-56.726	138.167	-1.354	1.00	92.45	O
ATOM	10593	C5'	A B	32	-57.241	137.226	-0.441	1.00	95.24	C
ATOM	10594	C4'	A B	32	-58.228	136.300	-1.098	1.00	96.76	C
ATOM	10595	O4'	A B	32	-57.553	135.532	-2.128	1.00	95.55	O
ATOM	10596	C1'	A B	32	-57.973	134.187	-2.090	1.00	97.33	C
ATOM	10597	C2'	A B	32	-59.139	134.095	-1.113	1.00	98.87	C
ATOM	10598	O2'	A B	32	-60.336	134.327	-1.837	1.00	101.09	O
ATOM	10599	C3'	A B	32	-58.830	135.256	-0.170	1.00	103.22	C
ATOM	10600	O3'	A B	32	-59.959	135.748	0.538	1.00	101.89	O
ATOM	10601	N9	A B	32	-56.829	133.375	-1.647	1.00	96.63	N
ATOM	10602	C8	A B	32	-55.659	133.826	-1.092	1.00	97.08	C
ATOM	10603	N7	A B	32	-54.813	132.874	-0.792	1.00	98.00	N
ATOM	10604	C5	A B	32	-55.480	131.720	-1.182	1.00	101.10	C
ATOM	10605	C4	A B	32	-56.723	132.016	-1.709	1.00	97.38	C
ATOM	10606	N1	A B	32	-56.010	129.456	-1.603	1.00	99.69	N
ATOM	10607	C2	A B	32	-57.180	129.898	-2.084	1.00	99.67	C
ATOM	10608	N3	A B	32	-57.631	131.147	-2.183	1.00	97.70	N
ATOM	10609	C6	A B	32	-55.122	130.362	-1.136	1.00	102.25	C
ATOM	10610	N6	A B	32	-53.956	129.935	-0.653	1.00	101.08	N
ATOM	10611	P	G B	33	-59.806	136.438	1.985	1.00	97.65	P
ATOM	10612	OP1	G B	33	-60.902	137.435	2.132	1.00	103.94	O
ATOM	10613	OP2	G B	33	-58.390	136.800	2.261	1.00	83.50	O
ATOM	10614	O5'	G B	33	-60.134	135.263	2.990	1.00	103.19	O
ATOM	10615	C5'	G B	33	-59.125	134.339	3.317	1.00	107.91	C
ATOM	10616	C4'	G B	33	-59.602	132.933	3.143	1.00	111.70	C
ATOM	10617	O4'	G B	33	-58.945	132.353	1.985	1.00	114.73	O
ATOM	10618	C1'	G B	33	-58.515	131.043	2.279	1.00	113.85	C
ATOM	10619	N9	G B	33	-57.043	131.076	2.390	1.00	113.31	N
ATOM	10620	C8	G B	33	-56.269	132.200	2.597	1.00	112.56	C
ATOM	10621	N7	G B	33	-54.991	131.948	2.673	1.00	110.49	N
ATOM	10622	C5	G B	33	-54.915	130.569	2.508	1.00	113.46	C
ATOM	10623	C4	G B	33	-56.167	130.010	2.335	1.00	114.12	C
ATOM	10624	N3	G B	33	-56.487	128.706	2.143	1.00	114.92	N
ATOM	10625	C2	G B	33	-55.417	127.919	2.135	1.00	116.06	C
ATOM	10626	N2	G B	33	-55.549	126.593	1.959	1.00	116.75	N
ATOM	10627	N1	G B	33	-54.134	128.383	2.300	1.00	113.60	N
ATOM	10628	C6	G B	33	-53.785	129.716	2.497	1.00	111.20	C
ATOM	10629	O6	G B	33	-52.601	130.030	2.637	1.00	108.42	O
ATOM	10630	C2'	G B	33	-59.160	130.651	3.605	1.00	118.71	C
ATOM	10631	O2'	G B	33	-60.464	130.158	3.336	1.00	121.36	O
ATOM	10632	C3'	G B	33	-59.236	132.006	4.289	1.00	119.25	C
ATOM	10633	O3'	G B	33	-60.156	132.078	5.366	1.00	125.37	O
ATOM	10634	P	A B	34	-59.839	132.989	6.658	1.00	128.76	P
ATOM	10635	OP1	A B	34	-61.081	133.016	7.472	1.00	127.85	O
ATOM	10636	OP2	A B	34	-59.210	134.274	6.267	1.00	114.47	O
ATOM	10637	O5'	A B	34	-58.733	132.167	7.455	1.00	126.61	O
ATOM	10638	C5'	A B	34	-57.661	132.843	8.098	1.00	126.62	C
ATOM	10639	C4'	A B	34	-56.737	131.891	8.817	1.00	130.62	C
ATOM	10640	O4'	A B	34	-57.399	131.376	10.008	1.00	133.94	O
ATOM	10641	C1'	A B	34	-57.245	129.974	10.064	1.00	133.69	C
ATOM	10642	N9	A B	34	-58.376	129.373	10.805	1.00	136.92	N
ATOM	10643	C8	A B	34	-58.650	129.612	12.136	1.00	132.04	C
ATOM	10644	N7	A B	34	-59.692	128.976	12.618	1.00	132.06	N
ATOM	10645	C5	A B	34	-60.161	128.247	11.535	1.00	135.56	C
ATOM	10646	C4	A B	34	-59.371	128.473	10.405	1.00	137.36	C
ATOM	10647	N3	A B	34	-59.573	127.900	9.194	1.00	130.72	N

ATOM	10648	C2	A B	34	-60.631	127.092	9.198	1.00132.26	C
ATOM	10649	N1	A B	34	-61.467	126.793	10.204	1.00135.62	N
ATOM	10650	C6	A B	34	-61.257	127.364	11.411	1.00133.04	C
ATOM	10651	N6	A B	34	-62.095	127.062	12.408	1.00127.45	N
ATOM	10652	C2'	A B	34	-57.087	129.522	8.616	1.00133.42	C
ATOM	10653	O2'	A B	34	-56.453	128.265	8.542	1.00133.84	O
ATOM	10654	C3'	A B	34	-56.278	130.671	8.010	1.00133.18	C
ATOM	10655	O3'	A B	34	-54.883	130.434	8.214	1.00134.86	O
ATOM	10656	F	A B	35	-53.929	130.079	6.964	1.00133.54	F
ATOM	10657	OP1	A B	35	-54.396	130.858	5.785	1.00125.01	O
ATOM	10658	OP2	A B	35	-52.525	130.232	7.428	1.00130.10	O
ATOM	10659	O5'	A B	35	-54.220	128.533	6.669	1.00131.41	O
ATOM	10660	C5'	A B	35	-53.494	127.499	7.330	1.00132.74	C
ATOM	10661	C4'	A B	35	-54.173	126.146	7.215	1.00133.35	C
ATOM	10662	O4'	A B	35	-55.545	126.234	7.675	1.00132.70	O
ATOM	10663	C1'	A B	35	-56.352	125.310	6.975	1.00130.09	C
ATOM	10664	C2'	A B	35	-55.472	124.587	5.953	1.00131.44	C
ATOM	10665	O2'	A B	35	-55.063	123.346	6.506	1.00132.85	O
ATOM	10666	C3'	A B	35	-54.287	125.542	5.819	1.00132.32	C
ATOM	10667	O3'	A B	35	-53.096	124.893	5.397	1.00132.28	O
ATOM	10668	N9	A B	35	-57.489	126.019	6.352	1.00131.23	N
ATOM	10669	C8	A B	35	-57.644	127.363	6.112	1.00129.32	C
ATOM	10670	N7	A B	35	-58.787	127.681	5.556	1.00128.27	N
ATOM	10671	C5	A B	35	-59.433	126.460	5.413	1.00130.65	C
ATOM	10672	C4	A B	35	-58.645	125.431	5.899	1.00131.41	C
ATOM	10673	N1	A B	35	-61.025	124.795	4.891	1.00127.54	N
ATOM	10674	C2	A B	35	-60.158	123.914	5.399	1.00128.89	C
ATOM	10675	N3	A B	35	-58.952	124.124	5.920	1.00130.19	N
ATOM	10676	C6	A B	35	-60.686	126.102	4.883	1.00129.55	C
ATOM	10677	N6	A B	35	-61.553	126.980	4.375	1.00128.37	N
ATOM	10678	F	A B	36	-52.920	124.416	3.868	1.00134.84	F
ATOM	10679	OP1	A B	36	-53.563	125.424	2.977	1.00127.45	O
ATOM	10680	OP2	A B	36	-51.502	124.021	3.664	1.00134.52	O
ATOM	10681	O5'	A B	36	-53.788	123.088	3.766	1.00131.04	O
ATOM	10682	C5'	A B	36	-53.219	121.806	3.974	1.00129.77	C
ATOM	10683	C4'	A B	36	-54.249	120.745	3.711	1.00129.22	C
ATOM	10684	O4'	A B	36	-55.490	121.141	4.355	1.00129.46	O
ATOM	10685	C1'	A B	36	-56.585	120.861	3.512	1.00129.03	C
ATOM	10686	N9	A B	36	-57.135	122.149	3.047	1.00129.22	N
ATOM	10687	C8	A B	36	-56.450	123.310	2.778	1.00126.85	C
ATOM	10688	N7	A B	36	-57.201	124.301	2.373	1.00127.02	N
ATOM	10689	C5	A B	36	-58.478	123.753	2.372	1.00128.42	C
ATOM	10690	C4	A B	36	-58.453	122.430	2.780	1.00130.95	C
ATOM	10691	N3	A B	36	-59.508	121.601	2.896	1.00131.11	N
ATOM	10692	C2	A B	36	-60.636	122.219	2.555	1.00127.22	C
ATOM	10693	N1	A B	36	-60.814	123.481	2.145	1.00128.31	N
ATOM	10694	C6	A B	36	-59.734	124.288	2.039	1.00127.60	C
ATOM	10695	N6	A B	36	-59.910	125.545	1.627	1.00127.44	N
ATOM	10696	C2'	A B	36	-56.056	120.032	2.348	1.00128.92	C
ATOM	10697	O2'	A B	36	-56.058	118.664	2.728	1.00128.12	O
ATOM	10698	C3'	A B	36	-54.634	120.562	2.251	1.00128.69	C
ATOM	10699	O3'	A B	36	-53.744	119.724	1.538	1.00128.15	O
ATOM	10700	F	U B	37	-54.023	119.361	-0.004	1.00134.51	F
ATOM	10701	OP1	U B	37	-54.674	118.026	-0.048	1.00135.23	O
ATOM	10702	OP2	U B	37	-52.768	119.609	-0.760	1.00130.64	O
ATOM	10703	O5'	U B	37	-55.115	120.416	-0.489	1.00128.00	O
ATOM	10704	C5'	U B	37	-56.077	120.051	-1.468	1.00124.91	C
ATOM	10705	C4'	U B	37	-57.221	121.031	-1.537	1.00122.41	C
ATOM	10706	O4'	U B	37	-57.030	122.099	-0.576	1.00125.03	O
ATOM	10707	C1'	U B	37	-57.561	123.305	-1.082	1.00121.02	C
ATOM	10708	C2'	U B	37	-58.145	123.017	-2.468	1.00116.56	C
ATOM	10709	O2'	U B	37	-59.536	122.770	-2.334	1.00114.55	O
ATOM	10710	C3'	U B	37	-57.396	121.749	-2.864	1.00116.44	C

ATOM	10711	O3'	U B	37	-58.085	120.955	-3.811	1.00121.79	O
ATOM	10712	N1	U B	37	-56.476	124.309	-1.126	1.00118.46	N
ATOM	10713	C2	U B	37	-56.815	125.623	-1.391	1.00113.71	C
ATOM	10714	N3	U B	37	-55.753	126.489	-1.418	1.00109.36	N
ATOM	10715	C4	U B	37	-54.428	126.182	-1.202	1.00110.50	C
ATOM	10716	C5	U B	37	-54.162	124.804	-0.929	1.00116.70	C
ATOM	10717	C6	U B	37	-55.174	123.935	-0.898	1.00118.44	C
ATOM	10718	O2	U B	37	-57.960	125.996	-1.599	1.00111.61	O
ATOM	10719	O4	U B	37	-53.590	127.077	-1.260	1.00109.25	O
ATOM	10720	P	A B	38	-57.860	121.178	-5.387	1.00122.68	P
ATOM	10721	OP1	A B	38	-59.189	121.104	-6.050	1.00117.09	O
ATOM	10722	OP2	A B	38	-56.737	120.328	-5.857	1.00123.38	O
ATOM	10723	O5'	A B	38	-57.360	122.677	-5.491	1.00116.42	O
ATOM	10724	C5'	A B	38	-57.486	123.376	-6.711	1.00114.24	C
ATOM	10725	C4'	A B	38	-58.658	124.316	-6.675	1.00111.65	C
ATOM	10726	O4'	A B	38	-58.875	124.781	-5.308	1.00111.68	O
ATOM	10727	C1'	A B	38	-59.006	126.187	-5.304	1.00106.43	C
ATOM	10728	C2'	A B	38	-59.331	126.588	-6.729	1.00103.49	C
ATOM	10729	O2'	A B	38	-60.703	126.324	-6.969	1.00101.79	O
ATOM	10730	C3'	A B	38	-58.448	125.596	-7.465	1.00108.16	C
ATOM	10731	O3'	A B	38	-58.652	125.488	-8.861	1.00107.86	O
ATOM	10732	N9	A B	38	-57.669	126.696	-4.966	1.00101.98	N
ATOM	10733	C8	A B	38	-56.627	125.933	-4.509	1.00102.37	C
ATOM	10734	N7	A B	38	-55.527	126.606	-4.309	1.00103.57	N
ATOM	10735	C5	A B	38	-55.859	127.895	-4.686	1.00101.48	C
ATOM	10736	C4	A B	38	-57.177	127.971	-5.106	1.00100.58	C
ATOM	10737	N1	A B	38	-55.721	130.206	-5.132	1.00 92.71	N
ATOM	10738	C2	A B	38	-57.003	130.128	-5.510	1.00 94.32	C
ATOM	10739	N3	A B	38	-57.816	129.074	-5.534	1.00 97.55	N
ATOM	10740	C6	A B	38	-55.105	129.078	-4.705	1.00 97.88	C
ATOM	10741	N6	A B	38	-53.828	129.123	-4.323	1.00 93.32	N
ATOM	10742	P	G B	39	-59.946	124.777	-9.482	1.00110.70	P
ATOM	10743	OP1	G B	39	-60.996	124.579	-8.445	1.00112.90	O
ATOM	10744	OP2	G B	39	-59.444	123.619	-10.261	1.00105.37	O
ATOM	10745	O5'	G B	39	-60.482	125.879	-10.501	1.00106.20	O
ATOM	10746	C5'	G B	39	-59.569	126.610	-11.304	1.00103.36	C
ATOM	10747	C4'	G B	39	-59.487	128.065	-10.908	1.00 99.06	C
ATOM	10748	O4'	G B	39	-59.059	128.201	-9.528	1.00 99.04	O
ATOM	10749	C3'	G B	39	-58.460	128.870	-11.676	1.00 95.56	C
ATOM	10750	O3'	G B	39	-58.902	129.238	-12.958	1.00 94.81	O
ATOM	10751	C2'	G B	39	-58.181	130.035	-10.748	1.00 92.15	C
ATOM	10752	O2'	G B	39	-59.240	130.970	-10.800	1.00 97.40	O
ATOM	10753	C1'	G B	39	-58.225	129.339	-9.394	1.00 97.05	C
ATOM	10754	N9	G B	39	-56.881	128.905	-8.957	1.00 94.51	N
ATOM	10755	C8	G B	39	-56.418	127.616	-8.862	1.00 93.56	C
ATOM	10756	N7	G B	39	-55.192	127.527	-8.435	1.00 91.91	N
ATOM	10757	C5	G B	39	-54.806	128.847	-8.245	1.00 91.48	C
ATOM	10758	C4	G B	39	-55.837	129.710	-8.565	1.00 88.64	C
ATOM	10759	N1	G B	39	-53.608	130.774	-7.750	1.00 86.70	N
ATOM	10760	C2	G B	39	-54.688	131.544	-8.093	1.00 87.08	C
ATOM	10761	N3	G B	39	-55.845	131.056	-8.512	1.00 88.37	N
ATOM	10762	C6	G B	39	-53.573	129.387	-7.792	1.00 88.76	C
ATOM	10763	O6	G B	39	-52.540	128.794	-7.465	1.00 88.49	O
ATOM	10764	N2	G B	39	-54.514	132.867	-7.980	1.00 86.53	N
ATOM	10765	P	C B	40	-58.137	128.614	-14.216	1.00101.64	P
ATOM	10766	OP1	C B	40	-58.928	128.997	-15.415	1.00 94.51	O
ATOM	10767	OP2	C B	40	-57.838	127.180	-13.919	1.00 89.16	O
ATOM	10768	O5'	C B	40	-56.735	129.381	-14.204	1.00 95.05	O
ATOM	10769	C5'	C B	40	-56.650	130.724	-14.648	1.00 90.15	C
ATOM	10770	C4'	C B	40	-55.559	131.512	-13.961	1.00 87.10	C
ATOM	10771	O4'	C B	40	-55.437	131.167	-12.557	1.00 86.57	O
ATOM	10772	C3'	C B	40	-54.141	131.345	-14.464	1.00 84.03	C
ATOM	10773	O3'	C B	40	-53.903	131.906	-15.746	1.00 86.42	O

ATOM	10774	C2'	C B	40	-53.353	131.996	-13.333	1.00	83.85	C
ATOM	10775	O2'	C B	40	-53.497	133.409	-13.361	1.00	82.12	O
ATOM	10776	C1'	C B	40	-54.127	131.488	-12.117	1.00	83.67	C
ATOM	10777	N1	C B	40	-53.479	130.297	-11.521	1.00	85.51	N
ATOM	10778	C2	C B	40	-52.318	130.483	-10.752	1.00	78.37	C
ATOM	10779	N3	C B	40	-51.707	129.417	-10.205	1.00	79.47	N
ATOM	10780	C4	C B	40	-52.198	128.190	-10.397	1.00	86.12	C
ATOM	10781	C5	C B	40	-53.378	127.966	-11.168	1.00	84.44	C
ATOM	10782	C6	C B	40	-53.979	129.036	-11.711	1.00	87.48	C
ATOM	10783	O2	C B	40	-51.862	131.623	-10.584	1.00	79.09	O
ATOM	10784	N4	C B	40	-51.556	127.160	-9.828	1.00	86.86	N
ATOM	10785	P	A B	41	-52.730	131.307	-16.677	1.00	87.02	P
ATOM	10786	OP1	A B	41	-52.781	131.938	-18.018	1.00	81.23	O
ATOM	10787	OP2	A B	41	-52.754	129.826	-16.569	1.00	80.47	O
ATOM	10788	O5'	A B	41	-51.403	131.854	-15.996	1.00	73.66	O
ATOM	10789	C5'	A B	41	-51.119	133.243	-15.988	1.00	71.55	C
ATOM	10790	C4'	A B	41	-49.902	133.538	-15.157	1.00	71.88	C
ATOM	10791	O4'	A B	41	-50.041	132.909	-13.861	1.00	71.65	O
ATOM	10792	C3'	A B	41	-48.593	132.995	-15.701	1.00	65.23	C
ATOM	10793	O3'	A B	41	-48.038	133.864	-16.671	1.00	68.74	O
ATOM	10794	C2'	A B	41	-47.739	132.830	-14.448	1.00	67.55	C
ATOM	10795	O2'	A B	41	-47.134	134.054	-14.067	1.00	67.44	O
ATOM	10796	C1'	A B	41	-48.787	132.471	-13.395	1.00	73.00	C
ATOM	10797	N9	A B	41	-48.868	131.024	-13.138	1.00	69.92	N
ATOM	10798	C8	A B	41	-49.850	130.141	-13.519	1.00	75.34	C
ATOM	10799	N7	A B	41	-49.650	128.912	-13.115	1.00	73.89	N
ATOM	10800	C5	A B	41	-48.456	129.001	-12.421	1.00	73.07	C
ATOM	10801	C4	A B	41	-47.973	130.299	-12.418	1.00	70.44	C
ATOM	10802	N1	A B	41	-46.552	128.468	-11.158	1.00	72.45	N
ATOM	10803	C2	A B	41	-46.207	129.761	-11.244	1.00	72.94	C
ATOM	10804	N3	A B	41	-46.848	130.760	-11.850	1.00	72.70	N
ATOM	10805	C6	A B	41	-47.690	128.042	-11.748	1.00	71.49	C
ATOM	10806	N6	A B	41	-48.031	126.754	-11.658	1.00	74.52	N
ATOM	10807	P	A B	42	-47.427	133.295	-18.044	1.00	69.77	P
ATOM	10808	OP1	A B	42	-47.321	134.381	-19.044	1.00	68.02	O
ATOM	10809	OP2	A B	42	-48.063	131.995	-18.410	1.00	66.50	O
ATOM	10810	O5'	A B	42	-45.948	132.954	-17.617	1.00	68.20	O
ATOM	10811	C5'	A B	42	-45.591	131.612	-17.423	1.00	65.82	C
ATOM	10812	C4'	A B	42	-44.550	131.472	-16.358	1.00	68.78	C
ATOM	10813	O4'	A B	42	-45.184	130.999	-15.146	1.00	62.35	O
ATOM	10814	C3'	A B	42	-43.474	130.449	-16.711	1.00	57.50	C
ATOM	10815	O3'	A B	42	-42.328	131.113	-17.205	1.00	56.75	O
ATOM	10816	C2'	A B	42	-43.222	129.694	-15.414	1.00	58.30	C
ATOM	10817	O2'	A B	42	-42.206	130.328	-14.658	1.00	60.63	O
ATOM	10818	C1'	A B	42	-44.561	129.837	-14.684	1.00	66.45	C
ATOM	10819	N9	A B	42	-45.494	128.738	-14.972	1.00	64.60	N
ATOM	10820	C8	A B	42	-46.567	128.835	-15.815	1.00	63.16	C
ATOM	10821	N7	A B	42	-47.256	127.736	-15.915	1.00	66.34	N
ATOM	10822	C5	A B	42	-46.586	126.860	-15.076	1.00	66.12	C
ATOM	10823	C4	A B	42	-45.491	127.456	-14.482	1.00	66.30	C
ATOM	10824	N1	A B	42	-45.987	124.916	-13.884	1.00	66.55	N
ATOM	10825	C2	A B	42	-44.962	125.620	-13.381	1.00	64.13	C
ATOM	10826	N3	A B	42	-44.623	126.886	-13.619	1.00	67.59	N
ATOM	10827	C6	A B	42	-46.833	125.525	-14.751	1.00	66.82	C
ATOM	10828	N6	A B	42	-47.867	124.853	-15.265	1.00	67.82	N
ATOM	10829	P	G B	43	-41.751	130.834	-18.674	1.00	54.11	P
ATOM	10830	OP1	G B	43	-42.802	130.622	-19.693	1.00	56.94	O
ATOM	10831	OP2	G B	43	-40.778	131.900	-18.936	1.00	57.42	O
ATOM	10832	O5'	G B	43	-40.927	129.494	-18.431	1.00	60.28	O
ATOM	10833	C5'	G B	43	-40.077	129.374	-17.287	1.00	54.15	C
ATOM	10834	C4'	G B	43	-39.871	127.938	-16.883	1.00	53.38	C
ATOM	10835	O4'	G B	43	-41.147	127.343	-16.531	1.00	58.00	O
ATOM	10836	C3'	G B	43	-39.272	127.033	-17.953	1.00	53.20	C

ATOM	10837	O3'	G B	43	-38.530	126.005	-17.298	1.00	60.85	O
ATOM	10838	C2'	G B	43	-40.511	126.420	-18.582	1.00	55.65	C
ATOM	10839	O2'	G B	43	-40.309	125.214	-19.287	1.00	56.11	O
ATOM	10840	C1'	G B	43	-41.392	126.223	-17.357	1.00	55.97	C
ATOM	10841	N9	G B	43	-42.812	126.194	-17.694	1.00	64.93	N
ATOM	10842	C8	G B	43	-43.486	127.138	-18.433	1.00	58.32	C
ATOM	10843	N7	G B	43	-44.736	126.832	-18.595	1.00	61.44	N
ATOM	10844	C5	G B	43	-44.893	125.625	-17.929	1.00	62.13	C
ATOM	10845	C4	G B	43	-43.707	125.208	-17.368	1.00	65.99	C
ATOM	10846	N1	G B	43	-45.764	123.657	-17.030	1.00	66.93	N
ATOM	10847	C2	G B	43	-44.532	123.343	-16.506	1.00	67.00	C
ATOM	10848	N3	G B	43	-43.448	124.096	-16.648	1.00	61.60	N
ATOM	10849	C6	G B	43	-46.038	124.805	-17.776	1.00	64.96	C
ATOM	10850	O6	G B	43	-47.176	125.012	-18.206	1.00	67.60	O
ATOM	10851	N2	G B	43	-44.469	122.196	-15.813	1.00	69.61	N
ATOM	10852	P	U B	44	-36.930	126.007	-17.338	1.00	51.86	P
ATOM	10853	OP1	U B	44	-36.349	127.309	-16.965	1.00	51.01	O
ATOM	10854	OP2	U B	44	-36.516	124.828	-16.568	1.00	55.46	O
ATOM	10855	O5'	U B	44	-36.620	125.802	-18.886	1.00	51.68	O
ATOM	10856	C5'	U B	44	-36.605	124.511	-19.473	1.00	46.83	C
ATOM	10857	C4'	U B	44	-35.955	124.547	-20.825	1.00	48.54	C
ATOM	10858	O4'	U B	44	-36.890	125.125	-21.782	1.00	53.06	O
ATOM	10859	C3'	U B	44	-34.692	125.398	-20.898	1.00	50.83	C
ATOM	10860	O3'	U B	44	-33.789	124.817	-21.839	1.00	48.13	O
ATOM	10861	C2'	U B	44	-35.233	126.729	-21.432	1.00	50.62	C
ATOM	10862	O2'	U B	44	-34.298	127.609	-22.031	1.00	52.23	O
ATOM	10863	C1'	U B	44	-36.299	126.247	-22.405	1.00	51.69	C
ATOM	10864	N1	U B	44	-37.334	127.260	-22.657	1.00	56.29	N
ATOM	10865	C2	U B	44	-37.268	127.952	-23.853	1.00	59.00	C
ATOM	10866	N3	U B	44	-38.243	128.913	-24.017	1.00	61.37	N
ATOM	10867	C4	U B	44	-39.241	129.240	-23.111	1.00	61.71	C
ATOM	10868	C5	U B	44	-39.235	128.480	-21.895	1.00	54.11	C
ATOM	10869	C6	U B	44	-38.295	127.548	-21.717	1.00	55.65	C
ATOM	10870	O2	U B	44	-36.417	127.735	-24.706	1.00	55.74	O
ATOM	10871	O4	U B	44	-40.045	130.135	-23.392	1.00	63.85	O
ATOM	10872	O5'	U B	45	-31.594	125.164	-20.651	1.00	43.32	O
ATOM	10873	C4'	U B	45	-30.466	127.280	-20.414	1.00	43.85	C
ATOM	10874	C3'	U B	45	-29.387	126.697	-19.507	1.00	43.52	C
ATOM	10875	C2'	U B	45	-29.362	127.703	-18.365	1.00	43.14	C
ATOM	10876	P	U B	45	-32.457	124.041	-21.365	1.00	49.45	P
ATOM	10877	OP1	U B	45	-31.783	123.608	-22.623	1.00	47.61	O
ATOM	10878	OP2	U B	45	-32.760	122.991	-20.357	1.00	43.77	O
ATOM	10879	C5'	U B	45	-31.146	126.306	-21.353	1.00	44.52	C
ATOM	10880	O4'	U B	45	-31.449	127.816	-19.484	1.00	43.14	O
ATOM	10881	O3'	U B	45	-28.123	126.501	-20.142	1.00	47.98	O
ATOM	10882	O2'	U B	45	-28.696	128.892	-18.759	1.00	49.65	O
ATOM	10883	C1'	U B	45	-30.860	128.007	-18.217	1.00	43.95	C
ATOM	10884	N1	U B	45	-31.485	127.056	-17.274	1.00	41.06	N
ATOM	10885	C2	U B	45	-31.165	127.201	-15.941	1.00	41.23	C
ATOM	10886	N3	U B	45	-31.734	126.273	-15.129	1.00	41.71	N
ATOM	10887	C4	U B	45	-32.563	125.242	-15.497	1.00	46.86	C
ATOM	10888	C5	U B	45	-32.855	125.143	-16.896	1.00	41.24	C
ATOM	10889	C6	U B	45	-32.295	126.033	-17.719	1.00	44.48	C
ATOM	10890	O2	U B	45	-30.444	128.087	-15.502	1.00	43.06	O
ATOM	10891	O4	U B	45	-32.992	124.506	-14.610	1.00	50.82	O
ATOM	10892	O5'	A B	46	-26.391	125.820	-18.404	1.00	32.46	O
ATOM	10893	C4'	A B	46	-25.533	127.570	-17.018	1.00	42.65	C
ATOM	10894	C3'	A B	46	-24.715	126.641	-16.158	1.00	44.65	C
ATOM	10895	C2'	A B	46	-25.177	126.993	-14.753	1.00	43.85	C
ATOM	10896	P	A B	46	-27.116	125.299	-19.700	1.00	38.75	P
ATOM	10897	OP1	A B	46	-26.057	125.231	-20.740	1.00	41.34	O
ATOM	10898	OP2	A B	46	-27.917	124.124	-19.314	1.00	36.72	O
ATOM	10899	C5'	A B	46	-25.734	127.069	-18.418	1.00	40.62	C

ATOM	10900	O4'	A B	46	-26.805	127.678	-16.324	1.00	41.64	O
ATOM	10901	O3'	A B	46	-23.340	126.866	-16.375	1.00	43.89	O
ATOM	10902	O2'	A B	46	-24.548	128.193	-14.351	1.00	47.57	O
ATOM	10903	C1'	A B	46	-26.657	127.280	-14.986	1.00	38.44	C
ATOM	10904	N9	A B	46	-27.542	126.111	-14.762	1.00	50.49	N
ATOM	10905	C8	A B	46	-28.249	125.345	-15.680	1.00	41.35	C
ATOM	10906	N7	A B	46	-28.992	124.396	-15.136	1.00	35.65	N
ATOM	10907	C5	A B	46	-28.749	124.529	-13.774	1.00	38.47	C
ATOM	10908	C4	A B	46	-27.872	125.585	-13.535	1.00	46.04	C
ATOM	10909	N1	A B	46	-28.793	124.266	-11.419	1.00	47.19	N
ATOM	10910	C2	A B	46	-27.934	125.288	-11.368	1.00	45.35	C
ATOM	10911	N3	A B	46	-27.416	126.014	-12.349	1.00	42.92	N
ATOM	10912	C6	A B	46	-29.232	123.858	-12.633	1.00	40.74	C
ATOM	10913	N6	A B	46	-30.088	122.849	-12.646	1.00	38.07	N
ATOM	10914	O5'	A B	47	-22.049	125.587	-14.696	1.00	43.51	O
ATOM	10915	C4'	A B	47	-21.723	126.487	-12.479	1.00	43.04	C
ATOM	10916	C3'	A B	47	-21.025	125.233	-12.005	1.00	41.65	C
ATOM	10917	C2'	A B	47	-21.797	124.844	-10.758	1.00	48.46	C
ATOM	10918	P	A B	47	-22.289	125.671	-16.258	1.00	44.46	P
ATOM	10919	OF1	A B	47	-21.086	126.102	-17.030	1.00	42.34	O
ATOM	10920	OF2	A B	47	-22.922	124.402	-16.677	1.00	44.03	O
ATOM	10921	C5'	A B	47	-21.628	126.734	-13.961	1.00	45.32	C
ATOM	10922	O4'	A B	47	-23.104	126.273	-12.127	1.00	40.16	O
ATOM	10923	O3'	A B	47	-19.659	125.434	-11.774	1.00	47.51	O
ATOM	10924	O2'	A B	47	-21.335	125.597	-9.654	1.00	47.53	O
ATOM	10925	C1'	A B	47	-23.203	125.305	-11.110	1.00	41.86	C
ATOM	10926	N9	A B	47	-24.104	124.253	-11.608	1.00	42.50	N
ATOM	10927	C8	A B	47	-24.375	123.943	-12.913	1.00	38.11	C
ATOM	10928	N7	A B	47	-25.302	123.026	-13.047	1.00	37.63	N
ATOM	10929	C5	A B	47	-25.661	122.728	-11.758	1.00	35.93	C
ATOM	10930	C4	A B	47	-24.945	123.481	-10.857	1.00	42.72	C
ATOM	10931	N1	A B	47	-26.726	121.784	-9.899	1.00	42.49	N
ATOM	10932	C2	A B	47	-25.963	122.576	-9.138	1.00	42.61	C
ATOM	10933	N3	A B	47	-25.044	123.457	-9.517	1.00	45.54	N
ATOM	10934	C6	A B	47	-26.587	121.847	-11.240	1.00	38.83	C
ATOM	10935	N6	A B	47	-27.329	121.066	-11.995	1.00	41.65	N
ATOM	10936	O5'	A B	48	-18.967	123.095	-11.342	1.00	43.93	O
ATOM	10937	C4'	A B	48	-19.337	122.058	-9.192	1.00	41.15	C
ATOM	10938	C3'	A B	48	-19.017	120.667	-9.711	1.00	37.30	C
ATOM	10939	C2'	A B	48	-20.130	119.834	-9.104	1.00	36.85	C
ATOM	10940	P	A B	48	-18.637	124.316	-12.305	1.00	47.55	P
ATOM	10941	OF1	A B	48	-17.237	124.799	-12.137	1.00	43.92	O
ATOM	10942	OF2	A B	48	-19.056	124.011	-13.684	1.00	47.20	O
ATOM	10943	C5'	A B	48	-18.772	123.224	-9.949	1.00	43.27	C
ATOM	10944	O4'	A B	48	-20.774	122.109	-9.232	1.00	42.32	O
ATOM	10945	O3'	A B	48	-17.738	120.224	-9.324	1.00	43.41	O
ATOM	10946	O2'	A B	48	-19.867	119.599	-7.731	1.00	36.91	O
ATOM	10947	C1'	A B	48	-21.298	120.798	-9.188	1.00	44.26	C
ATOM	10948	N9	A B	48	-22.131	120.588	-10.384	1.00	47.02	N
ATOM	10949	C8	A B	48	-22.061	121.305	-11.542	1.00	39.65	C
ATOM	10950	N7	A B	48	-22.937	120.904	-12.413	1.00	42.74	N
ATOM	10951	C5	A B	48	-23.633	119.878	-11.770	1.00	39.93	C
ATOM	10952	C4	A B	48	-23.150	119.660	-10.516	1.00	42.13	C
ATOM	10953	N1	A B	48	-25.162	118.118	-11.301	1.00	48.07	N
ATOM	10954	C2	A B	48	-24.588	118.015	-10.091	1.00	42.37	C
ATOM	10955	N3	A B	48	-23.581	118.741	-9.615	1.00	43.98	N
ATOM	10956	C6	A B	48	-24.708	119.069	-12.168	1.00	43.08	C
ATOM	10957	N6	A B	48	-25.264	119.196	-13.375	1.00	35.10	N
ATOM	10958	O5'	A B	49	-17.949	117.713	-9.592	1.00	42.56	O
ATOM	10959	C4'	A B	49	-18.838	116.040	-8.130	1.00	43.13	C
ATOM	10960	C3'	A B	49	-18.636	114.912	-9.140	1.00	41.62	C
ATOM	10961	C2'	A B	49	-19.986	114.226	-9.109	1.00	41.17	C
ATOM	10962	P	A B	49	-17.062	118.948	-10.043	1.00	45.32	P

ATOM	10963	OP1	A B	49	-15.708	118.856	-9.485	1.00	50.60	O
ATOM	10964	OP2	A B	49	-17.222	119.027	-11.513	1.00	44.26	O
ATOM	10965	C5'	A B	49	-17.921	117.221	-8.269	1.00	39.52	C
ATOM	10966	O4'	A B	49	-20.205	116.455	-8.341	1.00	38.20	O
ATOM	10967	O3'	A B	49	-17.576	114.060	-8.779	1.00	44.25	O
ATOM	10968	O2'	A B	49	-20.094	113.475	-7.906	1.00	48.81	O
ATOM	10969	C1'	A B	49	-20.921	115.436	-9.002	1.00	43.85	C
ATOM	10970	N9	A B	49	-21.317	115.947	-10.334	1.00	39.98	N
ATOM	10971	C8	A B	49	-20.687	116.906	-11.078	1.00	41.32	C
ATOM	10972	N7	A B	49	-21.245	117.154	-12.242	1.00	40.13	N
ATOM	10973	C5	A B	49	-22.298	116.271	-12.267	1.00	36.11	C
ATOM	10974	C4	A B	49	-22.360	115.527	-11.122	1.00	37.97	C
ATOM	10975	N1	A B	49	-24.215	115.111	-12.996	1.00	43.52	N
ATOM	10976	C2	A B	49	-24.148	114.450	-11.835	1.00	43.73	C
ATOM	10977	N3	A B	49	-23.267	114.575	-10.843	1.00	45.10	N
ATOM	10978	C6	A B	49	-23.281	116.055	-13.231	1.00	44.72	C
ATOM	10979	N6	A B	49	-23.319	116.758	-14.368	1.00	46.25	N
ATOM	10980	O5'	U B	50	-17.391	112.380	-10.675	1.00	41.39	O
ATOM	10981	C4'	U B	50	-19.078	110.691	-10.836	1.00	42.73	C
ATOM	10982	C3'	U B	50	-18.592	110.251	-12.214	1.00	40.12	C
ATOM	10983	C2'	U B	50	-19.879	110.258	-13.031	1.00	36.47	C
ATOM	10984	F	U B	50	-16.537	113.456	-9.873	1.00	47.48	F
ATOM	10985	OP1	U B	50	-15.539	112.753	-9.038	1.00	39.54	O
ATOM	10986	OP2	U B	50	-16.048	114.475	-10.818	1.00	47.01	O
ATOM	10987	C5'	U B	50	-18.069	111.365	-9.964	1.00	41.76	C
ATOM	10988	O4'	U B	50	-20.130	111.625	-11.106	1.00	39.12	O
ATOM	10989	O3'	U B	50	-18.022	108.966	-12.161	1.00	43.22	O
ATOM	10990	O2'	U B	50	-20.636	109.095	-12.757	1.00	39.04	O
ATOM	10991	C1'	U B	50	-20.646	111.417	-12.394	1.00	41.52	C
ATOM	10992	N1	U B	50	-20.564	112.668	-13.180	1.00	38.65	N
ATOM	10993	C2	U B	50	-21.598	112.790	-14.061	1.00	38.35	C
ATOM	10994	N3	U B	50	-21.557	113.926	-14.827	1.00	37.61	N
ATOM	10995	C4	U B	50	-20.601	114.903	-14.784	1.00	43.31	C
ATOM	10996	C5	U B	50	-19.541	114.687	-13.826	1.00	41.18	C
ATOM	10997	C6	U B	50	-19.556	113.585	-13.074	1.00	37.95	C
ATOM	10998	O2	U B	50	-22.463	111.923	-14.119	1.00	35.47	O
ATOM	10999	O4	U B	50	-20.702	115.857	-15.550	1.00	40.27	O
ATOM	11000	F	A B	51	-16.550	108.629	-12.719	1.00	43.43	F
ATOM	11001	OP1	A B	51	-16.735	107.933	-13.995	1.00	38.78	O
ATOM	11002	OP2	A B	51	-15.679	109.804	-12.777	1.00	43.78	O
ATOM	11003	O5'	A B	51	-15.947	107.814	-11.491	1.00	41.50	O
ATOM	11004	C5'	A B	51	-16.432	106.537	-11.119	1.00	42.46	C
ATOM	11005	C4'	A B	51	-17.576	106.518	-10.129	1.00	40.90	C
ATOM	11006	O4'	A B	51	-18.153	105.191	-10.228	1.00	41.67	O
ATOM	11007	C3'	A B	51	-17.228	106.711	-8.641	1.00	43.88	C
ATOM	11008	O3'	A B	51	-17.501	108.020	-8.153	1.00	46.24	O
ATOM	11009	C2'	A B	51	-18.051	105.643	-7.924	1.00	44.24	C
ATOM	11010	O2'	A B	51	-19.348	106.103	-7.643	1.00	48.93	O
ATOM	11011	C1'	A B	51	-18.148	104.555	-8.983	1.00	46.52	C
ATOM	11012	N9	A B	51	-16.954	103.675	-8.926	1.00	45.33	N
ATOM	11013	C8	A B	51	-15.640	104.062	-8.725	1.00	47.39	C
ATOM	11014	N7	A B	51	-14.734	103.136	-8.670	1.00	46.18	N
ATOM	11015	C5	A B	51	-15.535	102.041	-8.851	1.00	45.88	C
ATOM	11016	C4	A B	51	-16.883	102.342	-9.009	1.00	40.20	C
ATOM	11017	N1	A B	51	-16.068	99.815	-9.062	1.00	45.76	N
ATOM	11018	C2	A B	51	-17.334	100.292	-9.186	1.00	49.32	C
ATOM	11019	N3	A B	51	-17.885	101.512	-9.188	1.00	40.80	N
ATOM	11020	C6	A B	51	-15.128	100.734	-8.892	1.00	41.89	C
ATOM	11021	N6	A B	51	-13.852	100.440	-8.765	1.00	53.36	N
ATOM	11022	F	A B	52	-16.678	108.680	-6.921	1.00	45.09	F
ATOM	11023	OP1	A B	52	-17.349	109.995	-6.658	1.00	52.51	O
ATOM	11024	OP2	A B	52	-15.219	108.709	-7.151	1.00	41.57	O
ATOM	11025	O5'	A B	52	-17.004	107.775	-5.663	1.00	48.76	O

ATOM	11026	C5'	A B	52	-17.958	108.201	-4.708	1.00	53.11	C
ATOM	11027	C4'	A B	52	-17.823	107.513	-3.372	1.00	55.17	C
ATOM	11028	O4'	A B	52	-17.754	106.082	-3.577	1.00	58.62	O
ATOM	11029	C3'	A B	52	-16.591	107.826	-2.523	1.00	60.80	C
ATOM	11030	O3'	A B	52	-16.710	109.024	-1.756	1.00	56.75	O
ATOM	11031	C2'	A B	52	-16.507	106.590	-1.639	1.00	56.53	C
ATOM	11032	O2'	A B	52	-17.527	106.639	-0.650	1.00	64.33	O
ATOM	11033	C1'	A B	52	-16.887	105.499	-2.627	1.00	59.28	C
ATOM	11034	N9	A B	52	-15.703	104.939	-3.324	1.00	57.23	N
ATOM	11035	C8	A B	52	-15.150	105.345	-4.515	1.00	51.47	C
ATOM	11036	N7	A B	52	-14.076	104.673	-4.876	1.00	49.87	N
ATOM	11037	C5	A B	52	-13.904	103.753	-3.859	1.00	49.73	C
ATOM	11038	C4	A B	52	-14.887	103.908	-2.887	1.00	54.53	C
ATOM	11039	N1	A B	52	-13.033	101.989	-2.558	1.00	48.72	N
ATOM	11040	C2	A B	52	-14.037	102.256	-1.697	1.00	54.25	C
ATOM	11041	N3	A B	52	-15.014	103.177	-1.757	1.00	57.25	N
ATOM	11042	C6	A B	52	-12.934	102.730	-3.682	1.00	53.69	C
ATOM	11043	N6	A B	52	-11.936	102.489	-4.554	1.00	45.60	N
ATOM	11044	O5'	G B	53	-14.210	109.650	-1.342	1.00	56.62	O
ATOM	11045	C4'	G B	53	-13.162	107.547	-0.919	1.00	58.66	C
ATOM	11046	C3'	G B	53	-11.668	107.828	-0.957	1.00	56.97	C
ATOM	11047	C2'	G B	53	-11.186	106.797	-1.967	1.00	56.54	C
ATOM	11048	P	G B	53	-15.622	110.222	-1.796	1.00	57.72	P
ATOM	11049	OP1	G B	53	-16.182	111.172	-0.792	1.00	66.05	O
ATOM	11050	OP2	G B	53	-15.241	110.711	-3.140	1.00	53.62	O
ATOM	11051	C5'	G B	53	-14.054	108.634	-0.376	1.00	58.65	C
ATOM	11052	O4'	G B	53	-13.486	107.284	-2.313	1.00	52.62	O
ATOM	11053	O3'	G B	53	-11.035	107.698	0.309	1.00	61.60	O
ATOM	11054	O2'	G B	53	-11.132	105.509	-1.376	1.00	56.90	O
ATOM	11055	C1'	G B	53	-12.330	106.808	-2.981	1.00	52.90	C
ATOM	11056	N9	G B	53	-11.992	107.685	-4.111	1.00	46.29	N
ATOM	11057	C8	G B	53	-12.553	108.872	-4.482	1.00	48.27	C
ATOM	11058	N7	G B	53	-11.958	109.405	-5.520	1.00	51.03	N
ATOM	11059	C5	G B	53	-10.952	108.516	-5.855	1.00	40.68	C
ATOM	11060	C4	G B	53	-10.953	107.443	-4.991	1.00	46.27	C
ATOM	11061	N1	G B	53	-9.167	107.437	-6.891	1.00	48.04	N
ATOM	11062	C2	G B	53	-9.244	106.425	-5.970	1.00	44.90	C
ATOM	11063	N3	G B	53	-10.129	106.360	-4.985	1.00	44.44	N
ATOM	11064	C6	G B	53	-10.005	108.553	-6.906	1.00	47.99	C
ATOM	11065	O6	G B	53	-9.848	109.404	-7.784	1.00	49.46	O
ATOM	11066	N2	G B	53	-8.348	105.456	-6.149	1.00	47.31	N
ATOM	11067	O5'	G B	54	-8.539	107.678	-0.225	1.00	57.14	O
ATOM	11068	C4'	G B	54	-7.270	105.759	-1.004	1.00	57.68	C
ATOM	11069	C3'	G B	54	-5.917	106.435	-0.916	1.00	57.96	C
ATOM	11070	C2'	G B	54	-5.301	106.141	-2.281	1.00	59.38	C
ATOM	11071	P	G B	54	-9.641	108.448	0.628	1.00	64.31	P
ATOM	11072	OP1	G B	54	-9.404	108.213	2.079	1.00	69.71	O
ATOM	11073	OP2	G B	54	-9.686	109.838	0.113	1.00	66.54	O
ATOM	11074	C5'	G B	54	-8.329	106.279	-0.061	1.00	58.42	C
ATOM	11075	O4'	G B	54	-7.672	105.961	-2.380	1.00	59.39	O
ATOM	11076	O3'	G B	54	-5.154	105.959	0.178	1.00	69.97	O
ATOM	11077	O2'	G B	54	-4.738	104.840	-2.317	1.00	67.35	O
ATOM	11078	C1'	G B	54	-6.531	106.160	-3.193	1.00	55.12	C
ATOM	11079	N1	G B	54	-5.156	108.900	-7.294	1.00	49.54	N
ATOM	11080	N9	G B	54	-6.688	107.426	-3.946	1.00	52.44	N
ATOM	11081	C8	G B	54	-7.520	108.481	-3.631	1.00	50.50	C
ATOM	11082	N7	G B	54	-7.460	109.465	-4.501	1.00	50.80	N
ATOM	11083	C5	G B	54	-6.545	109.047	-5.440	1.00	45.64	C
ATOM	11084	C6	G B	54	-6.081	109.701	-6.610	1.00	50.12	C
ATOM	11085	O6	G B	54	-6.401	110.813	-7.056	1.00	48.85	O
ATOM	11086	C2	G B	54	-4.745	107.649	-6.879	1.00	48.41	C
ATOM	11087	N2	G B	54	-3.858	107.046	-7.670	1.00	47.71	N
ATOM	11088	N3	G B	54	-5.165	107.033	-5.790	1.00	48.04	N

ATOM	11089	C4	G B	54	-6.060	107.783	-5.120	1.00	47.36	C
ATOM	11090	O5'	C B	55	-3.150	107.474	0.316	1.00	67.16	O
ATOM	11091	C4'	C B	55	-0.996	106.789	-0.373	1.00	72.96	C
ATOM	11092	C3'	C B	55	-0.007	107.795	-0.952	1.00	82.27	C
ATOM	11093	C2'	C B	55	0.140	107.288	-2.375	1.00	80.47	C
ATOM	11094	P	C B	55	-4.393	106.978	1.168	1.00	73.70	P
ATOM	11095	OP1	C B	55	-3.850	106.176	2.276	1.00	72.18	O
ATOM	11096	OP2	C B	55	-5.250	108.146	1.493	1.00	63.74	O
ATOM	11097	C5'	C B	55	-1.832	107.251	0.772	1.00	70.22	C
ATOM	11098	O4'	C B	55	-1.910	106.553	-1.476	1.00	75.60	O
ATOM	11099	O3'	C B	55	1.208	108.013	-0.200	1.00	92.57	O
ATOM	11100	O2'	C B	55	0.814	106.046	-2.366	1.00	87.85	O
ATOM	11101	C1'	C B	55	-1.307	106.953	-2.693	1.00	74.34	C
ATOM	11102	N1	C B	55	-2.052	108.109	-3.256	1.00	66.41	N
ATOM	11103	C2	C B	55	-1.720	108.583	-4.532	1.00	62.67	C
ATOM	11104	N3	C B	55	-2.385	109.633	-5.058	1.00	54.48	N
ATOM	11105	C4	C B	55	-3.370	110.202	-4.369	1.00	56.73	C
ATOM	11106	C5	C B	55	-3.741	109.738	-3.070	1.00	56.98	C
ATOM	11107	C6	C B	55	-3.066	108.707	-2.556	1.00	59.13	C
ATOM	11108	O2	C B	55	-0.805	108.043	-5.165	1.00	66.56	O
ATOM	11109	N4	C B	55	-4.016	111.234	-4.943	1.00	55.08	N
ATOM	11110	O5'	U B	56	3.612	107.983	-1.118	1.00	88.51	O
ATOM	11111	C4'	U B	56	3.979	108.605	-3.453	1.00	87.22	C
ATOM	11112	C3'	U B	56	3.414	109.374	-4.635	1.00	84.66	C
ATOM	11113	C2'	U B	56	2.462	108.365	-5.252	1.00	81.09	C
ATOM	11114	P	U B	56	2.555	107.108	-0.304	1.00	95.07	P
ATOM	11115	OP1	U B	56	2.406	105.816	-1.018	1.00	87.31	O
ATOM	11116	OP2	U B	56	3.061	107.078	1.091	1.00	100.78	O
ATOM	11117	C5'	U B	56	3.209	108.842	-2.173	1.00	87.40	C
ATOM	11118	O4'	U B	56	3.924	107.197	-3.836	1.00	89.36	O
ATOM	11119	O3'	U B	56	4.462	109.659	-5.553	1.00	82.04	O
ATOM	11120	O2'	U B	56	2.129	108.635	-6.595	1.00	83.72	O
ATOM	11121	C1'	U B	56	3.263	107.073	-5.095	1.00	88.46	C
ATOM	11122	N1	U B	56	2.457	105.826	-5.090	1.00	92.38	N
ATOM	11123	C2	U B	56	1.496	105.547	-6.070	1.00	83.70	C
ATOM	11124	N3	U B	56	0.826	104.353	-5.930	1.00	86.79	N
ATOM	11125	C4	U B	56	1.007	103.397	-4.951	1.00	94.86	C
ATOM	11126	C5	U B	56	2.016	103.730	-3.989	1.00	99.56	C
ATOM	11127	C6	U B	56	2.690	104.886	-4.103	1.00	95.71	C
ATOM	11128	O2	U B	56	1.218	106.272	-7.009	1.00	78.62	O
ATOM	11129	O4	U B	56	0.325	102.368	-4.966	1.00	98.34	O
ATOM	11130	P	A B	57	4.726	111.184	-5.967	1.00	82.89	P
ATOM	11131	OP1	A B	57	4.885	111.948	-4.704	1.00	74.22	O
ATOM	11132	OP2	A B	57	5.753	111.228	-7.047	1.00	75.70	O
ATOM	11133	O5'	A B	57	3.338	111.652	-6.591	1.00	78.39	O
ATOM	11134	C5'	A B	57	3.283	112.845	-7.349	1.00	71.94	C
ATOM	11135	C4'	A B	57	1.890	113.403	-7.463	1.00	73.39	C
ATOM	11136	O4'	A B	57	0.932	112.655	-6.648	1.00	65.97	O
ATOM	11137	C3'	A B	57	1.763	114.865	-7.048	1.00	66.73	C
ATOM	11138	O3'	A B	57	0.894	115.524	-7.959	1.00	64.00	O
ATOM	11139	C2'	A B	57	1.112	114.772	-5.671	1.00	64.49	C
ATOM	11140	O2'	A B	57	0.396	115.924	-5.282	1.00	70.86	O
ATOM	11141	C1'	A B	57	0.201	113.564	-5.850	1.00	59.04	C
ATOM	11142	N9	A B	57	-0.174	112.902	-4.608	1.00	57.07	N
ATOM	11143	C8	A B	57	0.410	111.823	-4.010	1.00	60.52	C
ATOM	11144	N7	A B	57	-0.195	111.460	-2.903	1.00	61.18	N
ATOM	11145	C5	A B	57	-1.242	112.349	-2.771	1.00	49.57	C
ATOM	11146	C4	A B	57	-1.241	113.240	-3.823	1.00	52.75	C
ATOM	11147	N1	A B	57	-3.146	113.488	-1.998	1.00	52.05	N
ATOM	11148	C2	A B	57	-3.014	114.278	-3.068	1.00	51.09	C
ATOM	11149	N3	A B	57	-2.103	114.239	-4.034	1.00	50.90	N
ATOM	11150	C6	A B	57	-2.253	112.494	-1.819	1.00	52.23	C
ATOM	11151	N6	A B	57	-2.384	111.720	-0.747	1.00	58.22	N

ATOM	11152	P	G B	58	1.466	116.005	-9.379	1.00	75.95	P
ATOM	11153	OP1	G B	58	2.887	116.397	-9.204	1.00	79.84	O
ATOM	11154	OP2	G B	58	0.470	116.958	-9.957	1.00	76.14	O
ATOM	11155	O5'	G B	58	1.532	114.675	-10.255	1.00	68.92	O
ATOM	11156	C5'	G B	58	2.758	114.200	-10.809	1.00	71.85	C
ATOM	11157	C4'	G B	58	2.478	113.160	-11.863	1.00	67.87	C
ATOM	11158	O4'	G B	58	1.841	112.020	-11.215	1.00	66.30	O
ATOM	11159	C3'	G B	58	1.489	113.632	-12.928	1.00	65.07	C
ATOM	11160	O3'	G B	58	2.132	114.165	-14.081	1.00	67.08	O
ATOM	11161	C2'	G B	58	0.630	112.405	-13.209	1.00	59.54	C
ATOM	11162	O2'	G B	58	1.265	111.570	-14.159	1.00	59.78	O
ATOM	11163	C1'	G B	58	0.630	111.701	-11.852	1.00	57.01	C
ATOM	11164	N9	G B	58	-0.464	112.156	-10.958	1.00	52.72	N
ATOM	11165	C8	G B	58	-1.234	113.276	-11.047	1.00	49.46	C
ATOM	11166	N7	G B	58	-2.097	113.396	-10.070	1.00	52.99	N
ATOM	11167	C5	G B	58	-1.894	112.293	-9.277	1.00	43.38	C
ATOM	11168	C4	G B	58	-0.887	111.525	-9.806	1.00	50.65	C
ATOM	11169	N1	G B	58	-1.989	110.688	-7.605	1.00	52.02	N
ATOM	11170	C2	G B	58	-0.988	109.990	-8.205	1.00	52.40	C
ATOM	11171	N3	G B	58	-0.394	110.371	-9.326	1.00	50.47	N
ATOM	11172	C6	G B	58	-2.523	111.877	-8.078	1.00	50.97	C
ATOM	11173	O6	G B	58	-3.442	112.396	-7.423	1.00	53.97	O
ATOM	11174	N2	G B	58	-0.625	108.861	-7.571	1.00	55.13	N
ATOM	11175	P	U B	59	1.955	115.720	-14.467	1.00	63.66	P
ATOM	11176	OP1	U B	59	2.617	116.027	-15.758	1.00	55.90	O
ATOM	11177	OP2	U B	59	2.334	116.468	-13.239	1.00	69.29	O
ATOM	11178	O5'	U B	59	0.376	115.901	-14.661	1.00	69.39	O
ATOM	11179	C5'	U B	59	-0.367	115.086	-15.567	1.00	60.60	C
ATOM	11180	C4'	U B	59	-1.852	115.151	-15.285	1.00	56.08	C
ATOM	11181	O4'	U B	59	-2.314	116.509	-15.473	1.00	57.97	O
ATOM	11182	C3'	U B	59	-2.742	114.312	-16.198	1.00	54.19	C
ATOM	11183	O3'	U B	59	-2.845	112.973	-15.759	1.00	49.67	O
ATOM	11184	C2'	U B	59	-4.074	115.055	-16.175	1.00	56.83	C
ATOM	11185	O2'	U B	59	-4.864	114.667	-15.054	1.00	52.52	O
ATOM	11186	C1'	U B	59	-3.620	116.511	-15.995	1.00	54.88	C
ATOM	11187	N1	U B	59	-3.610	117.282	-17.255	1.00	59.08	N
ATOM	11188	C2	U B	59	-4.845	117.707	-17.737	1.00	51.56	C
ATOM	11189	N3	U B	59	-4.824	118.424	-18.890	1.00	45.19	N
ATOM	11190	C4	U B	59	-3.720	118.793	-19.609	1.00	58.80	C
ATOM	11191	C5	U B	59	-2.469	118.324	-19.049	1.00	56.73	C
ATOM	11192	C6	U B	59	-2.445	117.608	-17.907	1.00	52.82	C
ATOM	11193	O2	U B	59	-5.887	117.443	-17.186	1.00	49.97	O
ATOM	11194	O4	U B	59	-3.890	119.466	-20.641	1.00	59.39	O
ATOM	11195	O5'	C B	60	-3.220	110.519	-16.027	1.00	53.93	O
ATOM	11196	C4'	C B	60	-1.648	109.325	-14.678	1.00	52.91	C
ATOM	11197	C3'	C B	60	-2.751	108.305	-14.484	1.00	52.89	C
ATOM	11198	C2'	C B	60	-2.509	107.853	-13.043	1.00	55.43	C
ATOM	11199	P	C B	60	-3.752	111.915	-16.553	1.00	46.43	P
ATOM	11200	OP1	C B	60	-5.124	111.880	-16.007	1.00	50.80	O
ATOM	11201	OP2	C B	60	-3.505	112.066	-17.995	1.00	44.96	O
ATOM	11202	C5'	C B	60	-1.842	110.285	-15.815	1.00	52.57	C
ATOM	11203	O4'	C B	60	-1.618	110.027	-13.412	1.00	52.31	O
ATOM	11204	O3'	C B	60	-2.729	107.264	-15.456	1.00	55.20	O
ATOM	11205	O2'	C B	60	-1.400	106.962	-12.980	1.00	53.55	O
ATOM	11206	C1'	C B	60	-2.084	109.171	-12.385	1.00	46.94	C
ATOM	11207	N1	C B	60	-3.160	109.854	-11.626	1.00	43.93	N
ATOM	11208	C2	C B	60	-3.588	109.315	-10.416	1.00	46.57	C
ATOM	11209	N3	C B	60	-4.557	109.945	-9.701	1.00	48.64	N
ATOM	11210	C4	C B	60	-5.092	111.101	-10.152	1.00	45.38	C
ATOM	11211	C5	C B	60	-4.679	111.695	-11.377	1.00	36.63	C
ATOM	11212	C6	C B	60	-3.726	111.042	-12.064	1.00	50.01	C
ATOM	11213	O2	C B	60	-3.084	108.260	-10.027	1.00	52.87	O
ATOM	11214	N4	C B	60	-6.038	111.665	-9.397	1.00	38.99	N

ATOM	11215	O5'	C B	61	-4.284	105.638	-14.312	1.00	45.85	O
ATOM	11216	C4'	C B	61	-3.957	103.998	-12.570	1.00	38.01	C
ATOM	11217	C3'	C B	61	-5.413	103.580	-12.546	1.00	42.23	C
ATOM	11218	C2'	C B	61	-5.755	103.639	-11.065	1.00	46.20	C
ATOM	11219	P	C B	61	-4.032	106.355	-15.707	1.00	48.13	P
ATOM	11220	OP1	C B	61	-3.690	105.297	-16.666	1.00	44.89	O
ATOM	11221	OP2	C B	61	-5.184	107.252	-15.998	1.00	48.03	O
ATOM	11222	C5'	C B	61	-3.466	104.556	-13.878	1.00	45.84	C
ATOM	11223	O4'	C B	61	-3.885	105.026	-11.549	1.00	42.70	O
ATOM	11224	O3'	C B	61	-5.624	102.319	-13.125	1.00	47.95	O
ATOM	11225	O2'	C B	61	-5.279	102.490	-10.390	1.00	52.07	O
ATOM	11226	C1'	C B	61	-4.926	104.839	-10.607	1.00	41.52	C
ATOM	11227	N1	C B	61	-5.748	106.058	-10.513	1.00	41.64	N
ATOM	11228	C2	C B	61	-6.588	106.170	-9.401	1.00	47.74	C
ATOM	11229	N3	C B	61	-7.373	107.253	-9.244	1.00	44.86	N
ATOM	11230	C4	C B	61	-7.347	108.213	-10.164	1.00	46.50	C
ATOM	11231	C5	C B	61	-6.500	108.124	-11.322	1.00	44.68	C
ATOM	11232	C6	C B	61	-5.725	107.035	-11.468	1.00	44.46	C
ATOM	11233	O2	C B	61	-6.604	105.282	-8.545	1.00	47.79	O
ATOM	11234	N4	C B	61	-8.168	109.260	-9.952	1.00	41.02	N
ATOM	11235	O5'	G B	62	-8.014	101.970	-12.460	1.00	34.30	O
ATOM	11236	C4'	G B	62	-9.139	101.139	-10.509	1.00	43.69	C
ATOM	11237	C3'	G B	62	-10.574	101.365	-10.993	1.00	40.49	C
ATOM	11238	C2'	G B	62	-11.167	102.186	-9.856	1.00	40.83	C
ATOM	11239	P	G B	62	-7.055	101.901	-13.711	1.00	40.42	P
ATOM	11240	OP1	G B	62	-7.008	100.456	-14.118	1.00	50.53	O
ATOM	11241	OP2	G B	62	-7.366	102.821	-14.798	1.00	45.66	O
ATOM	11242	C5'	G B	62	-8.104	100.878	-11.562	1.00	37.79	C
ATOM	11243	O4'	G B	62	-8.800	102.389	-9.852	1.00	44.69	O
ATOM	11244	O3'	G B	62	-11.324	100.174	-11.237	1.00	40.47	O
ATOM	11245	O2'	G B	62	-11.566	101.366	-8.786	1.00	38.08	O
ATOM	11246	C1'	G B	62	-9.973	103.018	-9.395	1.00	42.60	C
ATOM	11247	N1	G B	62	-12.405	107.407	-8.934	1.00	34.53	N
ATOM	11248	N9	G B	62	-10.078	104.372	-9.956	1.00	45.27	N
ATOM	11249	C8	G B	62	-9.442	104.931	-11.035	1.00	42.17	C
ATOM	11250	N7	G B	62	-9.826	106.161	-11.243	1.00	38.50	N
ATOM	11251	C5	G B	62	-10.768	106.398	-10.258	1.00	39.07	C
ATOM	11252	C6	G B	62	-11.554	107.560	-10.018	1.00	41.26	C
ATOM	11253	O6	G B	62	-11.525	108.612	-10.667	1.00	41.19	O
ATOM	11254	C2	G B	62	-12.500	106.267	-8.169	1.00	45.02	C
ATOM	11255	N2	G B	62	-13.397	106.341	-7.159	1.00	44.32	N
ATOM	11256	N3	G B	62	-11.778	105.140	-8.392	1.00	38.47	N
ATOM	11257	C4	G B	62	-10.948	105.302	-9.455	1.00	38.96	C
ATOM	11258	P	U B	63	-11.019	99.208	-12.495	1.00	47.23	P
ATOM	11259	OP1	U B	63	-9.874	98.331	-12.120	1.00	48.28	O
ATOM	11260	OP2	U B	63	-10.850	99.953	-13.757	1.00	42.09	O
ATOM	11261	O5'	U B	63	-12.327	98.308	-12.598	1.00	40.54	O
ATOM	11262	C5'	U B	63	-12.515	97.150	-11.795	1.00	35.70	C
ATOM	11263	C4'	U B	63	-13.828	96.473	-12.101	1.00	38.97	C
ATOM	11264	O4'	U B	63	-14.926	97.344	-11.723	1.00	49.28	O
ATOM	11265	C3'	U B	63	-14.060	96.129	-13.566	1.00	42.02	C
ATOM	11266	O3'	U B	63	-14.928	95.004	-13.626	1.00	42.93	O
ATOM	11267	C2'	U B	63	-14.831	97.347	-14.075	1.00	43.07	C
ATOM	11268	O2'	U B	63	-15.616	97.097	-15.223	1.00	46.61	O
ATOM	11269	C1'	U B	63	-15.709	97.660	-12.871	1.00	45.08	C
ATOM	11270	N1	U B	63	-16.157	99.057	-12.755	1.00	39.84	N
ATOM	11271	C2	U B	63	-17.499	99.327	-12.932	1.00	44.03	C
ATOM	11272	N3	U B	63	-17.883	100.661	-12.773	1.00	44.16	N
ATOM	11273	C4	U B	63	-17.018	101.693	-12.435	1.00	43.26	C
ATOM	11274	C5	U B	63	-15.646	101.294	-12.269	1.00	44.13	C
ATOM	11275	C6	U B	63	-15.274	100.034	-12.425	1.00	42.01	C
ATOM	11276	O2	U B	63	-18.264	98.424	-13.222	1.00	42.24	O
ATOM	11277	O4	U B	63	-17.386	102.852	-12.324	1.00	41.44	O

ATOM	11278	O5'	U B	64	-13.764	93.171	-14.864	1.00	46.03	O
ATOM	11279	C4'	U B	64	-13.812	92.511	-17.160	1.00	45.84	C
ATOM	11280	C3'	U B	64	-13.146	91.134	-17.007	1.00	41.70	C
ATOM	11281	C2'	U B	64	-11.989	91.225	-17.974	1.00	40.08	C
ATOM	11282	P	U B	64	-14.360	93.516	-13.434	1.00	42.47	P
ATOM	11283	OP1	U B	64	-15.519	92.649	-13.126	1.00	39.79	O
ATOM	11284	OP2	U B	64	-13.212	93.557	-12.506	1.00	46.68	O
ATOM	11285	C5'	U B	64	-14.612	92.981	-15.986	1.00	39.93	C
ATOM	11286	O4'	U B	64	-12.693	93.416	-17.360	1.00	41.95	O
ATOM	11287	O3'	U B	64	-14.002	90.042	-17.266	1.00	40.17	O
ATOM	11288	O2'	U B	64	-12.434	91.065	-19.311	1.00	42.18	O
ATOM	11289	C1'	U B	64	-11.552	92.673	-17.767	1.00	45.99	C
ATOM	11290	N1	U B	64	-10.511	92.760	-16.713	1.00	48.98	N
ATOM	11291	C2	U B	64	-9.239	92.359	-17.061	1.00	45.16	C
ATOM	11292	N3	U B	64	-8.300	92.461	-16.081	1.00	47.10	N
ATOM	11293	C4	U B	64	-8.507	92.915	-14.792	1.00	53.00	C
ATOM	11294	C5	U B	64	-9.844	93.313	-14.499	1.00	48.83	C
ATOM	11295	C6	U B	64	-10.781	93.222	-15.445	1.00	49.13	C
ATOM	11296	O2	U B	64	-8.964	91.969	-18.171	1.00	48.73	O
ATOM	11297	O4	U B	64	-7.566	92.946	-14.004	1.00	58.33	O
ATOM	11298	O5'	A B	65	-12.645	88.068	-16.505	1.00	53.50	O
ATOM	11299	C4'	A B	65	-10.757	87.363	-17.862	1.00	42.07	C
ATOM	11300	C3'	A B	65	-10.309	86.298	-16.871	1.00	47.62	C
ATOM	11301	C2'	A B	65	-8.834	86.625	-16.668	1.00	48.09	C
ATOM	11302	P	A B	65	-14.043	88.802	-16.255	1.00	39.80	P
ATOM	11303	OP1	A B	65	-15.136	87.905	-16.686	1.00	47.19	O
ATOM	11304	OP2	A B	65	-14.057	89.308	-14.877	1.00	44.24	O
ATOM	11305	C5'	A B	65	-12.226	87.696	-17.819	1.00	43.98	C
ATOM	11306	O4'	A B	65	-9.956	88.532	-17.530	1.00	51.11	O
ATOM	11307	O3'	A B	65	-10.536	84.992	-17.379	1.00	48.60	O
ATOM	11308	O2'	A B	65	-8.057	86.122	-17.745	1.00	53.59	O
ATOM	11309	C1'	A B	65	-8.834	88.150	-16.759	1.00	50.02	C
ATOM	11310	N9	A B	65	-8.957	88.757	-15.427	1.00	50.32	N
ATOM	11311	C8	A B	65	-10.074	89.374	-14.937	1.00	48.16	C
ATOM	11312	N7	A B	65	-9.932	89.799	-13.715	1.00	52.05	N
ATOM	11313	C5	A B	65	-8.649	89.442	-13.364	1.00	53.21	C
ATOM	11314	C4	A B	65	-8.033	88.787	-14.412	1.00	53.03	C
ATOM	11315	N1	A B	65	-6.647	89.115	-12.141	1.00	57.74	N
ATOM	11316	C2	A B	65	-6.183	88.506	-13.240	1.00	54.25	C
ATOM	11317	N3	A B	65	-6.785	88.296	-14.408	1.00	57.13	N
ATOM	11318	C6	A B	65	-7.908	89.610	-12.179	1.00	57.73	C
ATOM	11319	N6	A B	65	-8.381	90.221	-11.096	1.00	56.86	N
ATOM	11320	P	U B	66	-11.345	83.884	-16.557	1.00	46.57	P
ATOM	11321	OP1	U B	66	-11.407	82.663	-17.400	1.00	48.70	O
ATOM	11322	OP2	U B	66	-12.601	84.397	-15.998	1.00	55.18	O
ATOM	11323	O5'	U B	66	-10.380	83.579	-15.331	1.00	55.81	O
ATOM	11324	C5'	U B	66	-9.026	83.220	-15.562	1.00	52.66	C
ATOM	11325	C4'	U B	66	-8.211	83.260	-14.294	1.00	51.23	C
ATOM	11326	O4'	U B	66	-7.904	84.635	-13.946	1.00	51.46	O
ATOM	11327	C3'	U B	66	-8.877	82.705	-13.051	1.00	46.21	C
ATOM	11328	O3'	U B	66	-8.840	81.297	-12.976	1.00	46.35	O
ATOM	11329	C2'	U B	66	-8.104	83.400	-11.947	1.00	50.56	C
ATOM	11330	O2'	U B	66	-6.820	82.832	-11.818	1.00	49.08	O
ATOM	11331	C1'	U B	66	-7.931	84.791	-12.548	1.00	54.19	C
ATOM	11332	N1	U B	66	-9.059	85.681	-12.180	1.00	47.59	N
ATOM	11333	C2	U B	66	-8.929	86.390	-11.016	1.00	52.85	C
ATOM	11334	N3	U B	66	-9.977	87.197	-10.671	1.00	59.06	N
ATOM	11335	C4	U B	66	-11.153	87.347	-11.359	1.00	53.10	C
ATOM	11336	C5	U B	66	-11.237	86.551	-12.547	1.00	51.07	C
ATOM	11337	C6	U B	66	-10.217	85.767	-12.904	1.00	49.89	C
ATOM	11338	O2	U B	66	-7.932	86.348	-10.344	1.00	63.62	O
ATOM	11339	O4	U B	66	-11.996	88.106	-10.918	1.00	47.36	O
ATOM	11340	O5'	C B	67	-9.948	80.758	-10.762	1.00	49.69	O

ATOM	11341	C4'	C B	67	-9.129	80.659	-8.518	1.00	45.18	C
ATOM	11342	C3'	C B	67	-10.398	79.982	-8.034	1.00	48.68	C
ATOM	11343	C2'	C B	67	-10.895	80.904	-6.926	1.00	46.73	C
ATOM	11344	P	C B	67	-10.035	80.454	-12.310	1.00	46.06	P
ATOM	11345	OP1	C B	67	-9.735	79.038	-12.583	1.00	47.51	O
ATOM	11346	OP2	C B	67	-11.362	80.949	-12.714	1.00	49.58	O
ATOM	11347	C5'	C B	67	-8.817	80.416	-9.972	1.00	47.70	C
ATOM	11348	O4'	C B	67	-9.390	82.075	-8.331	1.00	49.10	O
ATOM	11349	O3'	C B	67	-10.184	78.645	-7.624	1.00	47.07	O
ATOM	11350	O2'	C B	67	-10.240	80.658	-5.701	1.00	57.85	O
ATOM	11351	C1'	C B	67	-10.440	82.265	-7.418	1.00	44.90	C
ATOM	11352	N1	C B	67	-11.516	83.021	-8.091	1.00	47.51	N
ATOM	11353	C2	C B	67	-12.532	83.520	-7.295	1.00	40.01	C
ATOM	11354	N3	C B	67	-13.510	84.227	-7.875	1.00	48.74	N
ATOM	11355	C4	C B	67	-13.507	84.446	-9.172	1.00	44.97	C
ATOM	11356	C5	C B	67	-12.484	83.929	-10.025	1.00	41.90	C
ATOM	11357	C6	C B	67	-11.499	83.235	-9.445	1.00	46.97	C
ATOM	11358	O2	C B	67	-12.543	83.314	-6.070	1.00	43.82	O
ATOM	11359	N4	C B	67	-14.542	85.154	-9.618	1.00	45.85	N
ATOM	11360	O5'	A B	68	-12.165	78.205	-6.160	1.00	51.08	O
ATOM	11361	C4'	A B	68	-12.777	77.192	-4.066	1.00	52.43	C
ATOM	11362	C3'	A B	68	-12.380	76.771	-2.665	1.00	56.07	C
ATOM	11363	C2'	A B	68	-13.322	75.612	-2.376	1.00	52.41	C
ATOM	11364	P	A B	68	-11.434	77.665	-7.462	1.00	53.05	P
ATOM	11365	OP1	A B	68	-10.947	76.282	-7.245	1.00	54.53	O
ATOM	11366	OP2	A B	68	-12.376	77.954	-8.563	1.00	52.85	O
ATOM	11367	C5'	A B	68	-11.700	77.876	-4.865	1.00	52.19	C
ATOM	11368	O4'	A B	68	-13.158	75.953	-4.715	1.00	45.89	O
ATOM	11369	O3'	A B	68	-12.480	77.827	-1.729	1.00	60.33	O
ATOM	11370	O2'	A B	68	-14.595	76.058	-1.965	1.00	52.49	O
ATOM	11371	C1'	A B	68	-13.447	74.969	-3.748	1.00	49.94	C
ATOM	11372	N1	A B	68	-11.722	70.359	-2.112	1.00	55.43	N
ATOM	11373	N9	A B	68	-12.464	73.883	-3.897	1.00	55.21	N
ATOM	11374	C8	A B	68	-11.441	73.844	-4.804	1.00	52.97	C
ATOM	11375	N7	A B	68	-10.716	72.763	-4.730	1.00	51.64	N
ATOM	11376	C5	A B	68	-11.295	72.049	-3.697	1.00	50.56	C
ATOM	11377	C6	A B	68	-10.959	70.810	-3.133	1.00	53.87	C
ATOM	11378	N6	A B	68	-9.933	70.080	-3.581	1.00	48.07	N
ATOM	11379	C2	A B	68	-12.754	71.118	-1.694	1.00	50.83	C
ATOM	11380	N3	A B	68	-13.154	72.312	-2.150	1.00	51.45	N
ATOM	11381	C4	A B	68	-12.369	72.724	-3.162	1.00	51.03	C
ATOM	11382	P	A B	69	-11.238	78.188	-0.781	1.00	57.11	P
ATOM	11383	OP1	A B	69	-11.673	79.384	-0.015	1.00	55.73	O
ATOM	11384	OP2	A B	69	-9.980	78.227	-1.587	1.00	46.81	O
ATOM	11385	O5'	A B	69	-11.136	76.940	0.202	1.00	52.25	O
ATOM	11386	C5'	A B	69	-12.242	76.514	0.980	1.00	52.90	C
ATOM	11387	C4'	A B	69	-11.953	75.192	1.639	1.00	58.61	C
ATOM	11388	O4'	A B	69	-12.020	74.131	0.646	1.00	57.54	O
ATOM	11389	C3'	A B	69	-10.561	75.064	2.239	1.00	58.55	C
ATOM	11390	O3'	A B	69	-10.498	75.579	3.551	1.00	58.17	O
ATOM	11391	C2'	A B	69	-10.287	73.563	2.170	1.00	60.14	C
ATOM	11392	O2'	A B	69	-10.884	72.873	3.259	1.00	59.31	O
ATOM	11393	C1'	A B	69	-11.017	73.174	0.887	1.00	56.34	C
ATOM	11394	N9	A B	69	-10.107	73.162	-0.261	1.00	53.94	N
ATOM	11395	C8	A B	69	-9.939	74.113	-1.226	1.00	57.64	C
ATOM	11396	N7	A B	69	-9.030	73.783	-2.119	1.00	57.52	N
ATOM	11397	C5	A B	69	-8.577	72.534	-1.697	1.00	58.06	C
ATOM	11398	C4	A B	69	-9.240	72.155	-0.547	1.00	54.44	C
ATOM	11399	N1	A B	69	-7.416	70.490	-1.512	1.00	55.32	N
ATOM	11400	C2	A B	69	-8.131	70.269	-0.412	1.00	56.19	C
ATOM	11401	N3	A B	69	-9.063	71.030	0.156	1.00	60.89	N
ATOM	11402	C6	A B	69	-7.608	71.631	-2.197	1.00	57.28	C
ATOM	11403	N6	A B	69	-6.876	71.829	-3.291	1.00	55.16	N

ATOM	11404	P	C B	70	-9.167	76.287	4.079	1.00	58.49	P
ATOM	11405	OP1	C B	70	-9.544	76.793	5.416	1.00	62.42	O
ATOM	11406	OP2	C B	70	-8.609	77.154	3.007	1.00	56.53	O
ATOM	11407	O5'	C B	70	-8.095	75.119	4.262	1.00	68.23	O
ATOM	11408	C5'	C B	70	-8.312	74.035	5.158	1.00	71.16	C
ATOM	11409	C4'	C B	70	-7.299	72.932	4.950	1.00	73.80	C
ATOM	11410	O4'	C B	70	-7.453	72.358	3.628	1.00	69.38	O
ATOM	11411	C3'	C B	70	-5.844	73.361	4.990	1.00	84.21	C
ATOM	11412	O3'	C B	70	-5.348	73.499	6.305	1.00	89.40	O
ATOM	11413	C2'	C B	70	-5.146	72.270	4.190	1.00	80.90	C
ATOM	11414	O2'	C B	70	-4.959	71.115	4.995	1.00	84.86	O
ATOM	11415	C1'	C B	70	-6.195	71.961	3.122	1.00	74.08	C
ATOM	11416	N1	C B	70	-5.933	72.676	1.848	1.00	72.86	N
ATOM	11417	C2	C B	70	-5.054	72.101	0.922	1.00	72.07	C
ATOM	11418	N3	C B	70	-4.799	72.727	-0.239	1.00	73.33	N
ATOM	11419	C4	C B	70	-5.373	73.888	-0.515	1.00	67.30	C
ATOM	11420	C5	C B	70	-6.274	74.511	0.399	1.00	64.65	C
ATOM	11421	C6	C B	70	-6.526	73.877	1.555	1.00	68.41	C
ATOM	11422	O2	C B	70	-4.516	71.024	1.166	1.00	75.08	O
ATOM	11423	N4	C B	70	-5.063	74.441	-1.685	1.00	68.01	N
ATOM	11424	P	U B	71	-3.970	74.276	6.546	1.00	94.97	P
ATOM	11425	OP1	U B	71	-3.781	75.343	5.524	1.00	88.54	O
ATOM	11426	OP2	U B	71	-3.924	74.615	7.990	1.00	105.74	O
ATOM	11427	O5'	U B	71	-2.872	73.176	6.237	1.00	95.29	O
ATOM	11428	C5'	U B	71	-1.554	73.582	5.930	1.00	102.48	C
ATOM	11429	C4'	U B	71	-0.767	72.486	5.270	1.00	103.31	C
ATOM	11430	O4'	U B	71	-1.472	72.008	4.094	1.00	96.02	O
ATOM	11431	C1'	U B	71	-0.549	71.737	3.060	1.00	101.17	C
ATOM	11432	C2'	U B	71	0.851	71.905	3.644	1.00	106.44	C
ATOM	11433	O2'	U B	71	1.240	70.663	4.211	1.00	110.70	O
ATOM	11434	C3'	U B	71	0.584	72.923	4.736	1.00	106.53	C
ATOM	11435	O3'	U B	71	1.584	72.993	5.735	1.00	111.50	O
ATOM	11436	N1	U B	71	-0.819	72.674	1.942	1.00	100.52	N
ATOM	11437	C2	U B	71	-0.121	72.543	0.744	1.00	102.42	C
ATOM	11438	N3	U B	71	-0.467	73.451	-0.231	1.00	99.68	N
ATOM	11439	C4	U B	71	-1.420	74.445	-0.137	1.00	98.47	C
ATOM	11440	C5	U B	71	-2.095	74.514	1.123	1.00	92.30	C
ATOM	11441	C6	U B	71	-1.784	73.645	2.088	1.00	94.40	C
ATOM	11442	O2	U B	71	0.740	71.700	0.544	1.00	104.68	O
ATOM	11443	O4	U B	71	-1.616	75.187	-1.100	1.00	102.77	O
ATOM	11444	P	U B	72	2.480	74.318	5.855	1.00	116.11	P
ATOM	11445	OP1	U B	72	3.840	73.907	6.304	1.00	114.15	O
ATOM	11446	OP2	U B	72	1.699	75.331	6.619	1.00	109.16	O
ATOM	11447	O5'	U B	72	2.589	74.822	4.347	1.00	111.13	O
ATOM	11448	C5'	U B	72	3.796	75.371	3.845	1.00	116.67	C
ATOM	11449	C4'	U B	72	4.384	74.519	2.747	1.00	118.61	C
ATOM	11450	O4'	U B	72	3.317	73.936	1.948	1.00	118.57	O
ATOM	11451	C1'	U B	72	3.670	73.958	0.579	1.00	118.60	C
ATOM	11452	C2'	U B	72	5.129	74.397	0.493	1.00	121.99	C
ATOM	11453	O2'	U B	72	5.950	73.245	0.609	1.00	121.03	O
ATOM	11454	C3'	U B	72	5.241	75.266	1.734	1.00	122.39	C
ATOM	11455	O3'	U B	72	6.570	75.482	2.166	1.00	120.67	O
ATOM	11456	N1	U B	72	2.765	74.913	-0.107	1.00	118.68	N
ATOM	11457	C2	U B	72	2.865	75.094	-1.480	1.00	117.15	C
ATOM	11458	N3	U B	72	1.973	76.000	-2.009	1.00	115.78	N
ATOM	11459	C4	U B	72	1.014	76.727	-1.326	1.00	114.90	C
ATOM	11460	C5	U B	72	0.977	76.491	0.085	1.00	114.28	C
ATOM	11461	C6	U B	72	1.827	75.612	0.625	1.00	115.88	C
ATOM	11462	O2	U B	72	3.671	74.508	-2.185	1.00	119.13	O
ATOM	11463	O4	U B	72	0.280	77.502	-1.941	1.00	115.36	O
ATOM	11464	P	G B	73	7.145	76.979	2.238	1.00	125.80	P
ATOM	11465	OP1	G B	73	8.529	76.888	2.779	1.00	129.55	O
ATOM	11466	OP2	G B	73	6.132	77.823	2.933	1.00	123.82	O

ATOM	11467	O5'	G B	73	7.197	77.459	0.713	1.00127.51	O
ATOM	11468	C5'	G B	73	8.185	76.964	-0.184	1.00126.25	C
ATOM	11469	C4'	G B	73	8.043	77.542	-1.576	1.00125.60	C
ATOM	11470	O4'	G B	73	6.810	77.077	-2.188	1.00126.17	O
ATOM	11471	C1'	G B	73	6.279	78.087	-3.022	1.00123.46	C
ATOM	11472	N9	G B	73	4.993	78.534	-2.461	1.00122.72	N
ATOM	11473	C8	G B	73	4.592	78.565	-1.146	1.00122.59	C
ATOM	11474	N7	G B	73	3.387	79.050	-0.989	1.00123.08	N
ATOM	11475	C5	G B	73	2.970	79.365	-2.278	1.00121.76	C
ATOM	11476	C4	G B	73	3.961	79.055	-3.191	1.00122.44	C
ATOM	11477	N3	G B	73	3.968	79.204	-4.529	1.00121.82	N
ATOM	11478	C2	G B	73	2.832	79.724	-4.961	1.00122.58	C
ATOM	11479	N2	G B	73	2.674	79.938	-6.276	1.00121.00	N
ATOM	11480	N1	G B	73	1.775	80.069	-4.142	1.00121.66	N
ATOM	11481	C6	G B	73	1.750	79.928	-2.755	1.00120.30	C
ATOM	11482	O6	G B	73	0.742	80.272	-2.117	1.00115.31	O
ATOM	11483	C2'	G B	73	7.282	79.237	-3.043	1.00122.78	C
ATOM	11484	O2'	G B	73	8.207	79.011	-4.098	1.00120.67	O
ATOM	11485	C3'	G B	73	7.951	79.058	-1.689	1.00124.16	C
ATOM	11486	O3'	G B	73	9.198	79.720	-1.577	1.00125.65	O
ATOM	11487	P	A B	74	9.308	81.092	-0.743	1.00120.12	P
ATOM	11488	OP1	A B	74	10.547	81.783	-1.185	1.00119.16	O
ATOM	11489	OP2	A B	74	9.102	80.777	0.694	1.00121.19	O
ATOM	11490	O5'	A B	74	8.061	81.949	-1.237	1.00118.17	O
ATOM	11491	C5'	A B	74	7.593	83.056	-0.484	1.00119.69	C
ATOM	11492	C4'	A B	74	7.429	84.276	-1.354	1.00121.94	C
ATOM	11493	O4'	A B	74	8.717	84.646	-1.909	1.00120.82	O
ATOM	11494	C1'	A B	74	8.556	85.124	-3.229	1.00120.61	C
ATOM	11495	N9	A B	74	9.262	84.208	-4.146	1.00122.01	N
ATOM	11496	C8	A B	74	9.744	82.950	-3.870	1.00122.76	C
ATOM	11497	N7	A B	74	10.334	82.375	-4.887	1.00121.92	N
ATOM	11498	C5	A B	74	10.233	83.320	-5.902	1.00124.54	C
ATOM	11499	C4	A B	74	9.576	84.453	-5.462	1.00122.72	C
ATOM	11500	N3	A B	74	9.306	85.559	-6.182	1.00126.45	N
ATOM	11501	C2	A B	74	9.757	85.449	-7.430	1.00125.12	C
ATOM	11502	N1	A B	74	10.404	84.423	-7.995	1.00126.79	N
ATOM	11503	C6	A B	74	10.662	83.325	-7.243	1.00128.55	C
ATOM	11504	N6	A B	74	11.309	82.301	-7.808	1.00130.91	N
ATOM	11505	C2'	A B	74	7.057	85.182	-3.517	1.00121.29	C
ATOM	11506	O2'	A B	74	6.572	86.462	-3.133	1.00113.18	O
ATOM	11507	C3'	A B	74	6.537	84.107	-2.576	1.00123.03	C
ATOM	11508	O3'	A B	74	5.156	84.225	-2.286	1.00122.04	O
ATOM	11509	P	G B	75	4.145	83.081	-2.780	1.00118.55	P
ATOM	11510	OP1	G B	75	4.757	81.780	-2.411	1.00124.29	O
ATOM	11511	OP2	G B	75	2.777	83.418	-2.312	1.00124.70	O
ATOM	11512	O5'	G B	75	4.174	83.199	-4.366	1.00119.41	O
ATOM	11513	C5'	G B	75	3.807	84.407	-5.014	1.00124.20	C
ATOM	11514	C4'	G B	75	4.397	84.483	-6.399	1.00126.08	C
ATOM	11515	O4'	G B	75	5.800	84.123	-6.349	1.00124.85	O
ATOM	11516	C1'	G B	75	6.186	83.505	-7.556	1.00124.35	C
ATOM	11517	N9	G B	75	6.863	82.220	-7.260	1.00125.28	N
ATOM	11518	C8	G B	75	6.755	81.435	-6.132	1.00123.67	C
ATOM	11519	N7	G B	75	7.510	80.368	-6.169	1.00121.44	N
ATOM	11520	C5	G B	75	8.171	80.451	-7.391	1.00124.86	C
ATOM	11521	C4	G B	75	7.786	81.590	-8.070	1.00124.15	C
ATOM	11522	N3	G B	75	8.200	82.027	-9.279	1.00124.43	N
ATOM	11523	C2	G B	75	9.084	81.215	-9.834	1.00125.56	C
ATOM	11524	N2	G B	75	9.598	81.501	-11.041	1.00125.99	N
ATOM	11525	N1	G B	75	9.530	80.059	-9.246	1.00127.83	N
ATOM	11526	C6	G B	75	9.126	79.581	-8.001	1.00129.99	C
ATOM	11527	O6	G B	75	9.607	78.514	-7.578	1.00131.84	O
ATOM	11528	C2'	G B	75	4.941	83.369	-8.442	1.00124.03	C
ATOM	11529	O2'	G B	75	4.942	84.434	-9.381	1.00123.23	O

ATOM	11530	C3'	G B	75	3.802	83.536	-7.433	1.00126.95	C
ATOM	11531	O3'	G B	75	2.604	84.056	-8.004	1.00128.52	O
ATOM	11532	P	A B	76	1.315	83.122	-8.280	1.00125.59	P
ATOM	11533	OP1	A B	76	1.226	82.085	-7.220	1.00121.78	O
ATOM	11534	OP2	A B	76	0.143	84.003	-8.516	1.00129.28	O
ATOM	11535	O5'	A B	76	1.635	82.427	-9.679	1.00123.71	O
ATOM	11536	C5'	A B	76	1.842	83.196	-10.860	1.00122.14	C
ATOM	11537	C4'	A B	76	2.691	82.451	-11.865	1.00120.40	C
ATOM	11538	O4'	A B	76	4.015	82.221	-11.303	1.00121.62	O
ATOM	11539	C1'	A B	76	4.501	80.951	-11.691	1.00122.34	C
ATOM	11540	N9	A B	76	4.720	80.130	-10.471	1.00122.52	N
ATOM	11541	C8	A B	76	4.079	80.260	-9.260	1.00121.76	C
ATOM	11542	N7	A B	76	4.455	79.398	-8.344	1.00122.85	N
ATOM	11543	C5	A B	76	5.417	78.628	-8.982	1.00124.42	C
ATOM	11544	C4	A B	76	5.592	79.066	-10.292	1.00123.40	C
ATOM	11545	N3	A B	76	6.452	78.541	-11.187	1.00123.46	N
ATOM	11546	C2	A B	76	7.134	77.521	-10.658	1.00127.66	C
ATOM	11547	N1	A B	76	7.070	76.993	-9.425	1.00128.20	N
ATOM	11548	C6	A B	76	6.201	77.535	-8.540	1.00125.76	C
ATOM	11549	N6	A B	76	6.139	77.005	-7.311	1.00124.02	N
ATOM	11550	C2'	A B	76	3.472	80.329	-12.645	1.00119.33	C
ATOM	11551	O2'	A B	76	3.841	80.628	-13.985	1.00111.53	O
ATOM	11552	C3'	A B	76	2.190	81.062	-12.245	1.00120.23	C
ATOM	11553	O3'	A B	76	1.183	81.075	-13.255	1.00114.99	O
ATOM	11554	P	A B	77	-0.352	80.702	-12.908	1.00113.09	P
ATOM	11555	OP1	A B	77	-1.111	80.468	-14.172	1.00100.61	O
ATOM	11556	OP2	A B	77	-0.856	81.697	-11.929	1.00115.43	O
ATOM	11557	O5'	A B	77	-0.252	79.316	-12.124	1.00120.67	O
ATOM	11558	C5'	A B	77	0.273	78.144	-12.735	1.00114.95	C
ATOM	11559	C4'	A B	77	1.352	77.520	-11.883	1.00117.43	C
ATOM	11560	O4'	A B	77	1.610	78.355	-10.723	1.00116.19	O
ATOM	11561	C1'	A B	77	2.006	77.551	-9.631	1.00118.10	C
ATOM	11562	C2'	A B	77	2.025	76.099	-10.110	1.00117.88	C
ATOM	11563	O2'	A B	77	3.341	75.802	-10.562	1.00116.99	O
ATOM	11564	C3'	A B	77	1.052	76.156	-11.284	1.00119.01	C
ATOM	11565	O3'	A B	77	1.200	75.090	-12.212	1.00116.45	O
ATOM	11566	N9	A B	77	1.080	77.766	-8.496	1.00118.79	N
ATOM	11567	C8	A B	77	-0.141	78.402	-8.481	1.00119.91	C
ATOM	11568	N7	A B	77	-0.721	78.430	-7.303	1.00118.67	N
ATOM	11569	C5	A B	77	0.179	77.770	-6.481	1.00116.20	C
ATOM	11570	C4	A B	77	1.291	77.356	-7.198	1.00118.36	C
ATOM	11571	N1	A B	77	1.214	76.794	-4.600	1.00118.63	N
ATOM	11572	C2	A B	77	2.225	76.457	-5.415	1.00118.64	C
ATOM	11573	N3	A B	77	2.360	76.690	-6.720	1.00118.50	N
ATOM	11574	C6	A B	77	0.156	77.464	-5.111	1.00114.79	C
ATOM	11575	N6	A B	77	-0.845	77.797	-4.296	1.00113.88	N
ATOM	11576	P	A B	78	0.362	73.726	-12.034	1.00107.67	P
ATOM	11577	OP1	A B	78	0.376	73.008	-13.333	1.00107.15	O
ATOM	11578	OP2	A B	78	-0.956	74.041	-11.434	1.00111.43	O
ATOM	11579	O5'	A B	78	1.198	72.904	-10.942	1.00120.29	O
ATOM	11580	C5'	A B	78	2.621	72.829	-10.999	1.00116.73	C
ATOM	11581	C4'	A B	78	3.245	72.446	-9.672	1.00112.83	C
ATOM	11582	O4'	A B	78	3.096	73.502	-8.686	1.00114.18	O
ATOM	11583	C1'	A B	78	3.014	72.937	-7.389	1.00112.76	C
ATOM	11584	C2'	A B	78	3.124	71.419	-7.536	1.00109.70	C
ATOM	11585	O2'	A B	78	4.487	71.053	-7.366	1.00107.82	O
ATOM	11586	C3'	A B	78	2.669	71.226	-8.983	1.00111.25	C
ATOM	11587	O3'	A B	78	3.102	70.016	-9.576	1.00116.24	O
ATOM	11588	N9	A B	78	1.743	73.348	-6.752	1.00114.67	N
ATOM	11589	C8	A B	78	0.640	73.922	-7.341	1.00113.06	C
ATOM	11590	N7	A B	78	-0.340	74.175	-6.504	1.00109.93	N
ATOM	11591	C5	A B	78	0.141	73.747	-5.274	1.00110.06	C
ATOM	11592	C4	A B	78	1.423	73.234	-5.413	1.00112.09	C

ATOM	11593	N1	A B	78	0.330	73.242	-2.968	1.00106.38	N
ATOM	11594	C2	A B	78	1.549	72.775	-3.260	1.00107.25	C
ATOM	11595	N3	A B	78	2.191	72.733	-4.428	1.00110.24	N
ATOM	11596	C6	A B	78	-0.415	73.746	-3.975	1.00108.22	C
ATOM	11597	N6	A B	78	-1.633	74.200	-3.674	1.00106.62	N
ATOM	11598	P	G B	79	2.273	68.661	-9.344	1.00107.23	P
ATOM	11599	OP1	G B	79	2.772	67.659	-10.320	1.00114.55	O
ATOM	11600	OP2	G B	79	0.819	68.964	-9.309	1.00110.60	O
ATOM	11601	O5'	G B	79	2.710	68.233	-7.876	1.00104.29	O
ATOM	11602	C5'	G B	79	1.850	67.455	-7.071	1.00100.35	C
ATOM	11603	C4'	G B	79	2.154	67.618	-5.607	1.00 97.72	C
ATOM	11604	O4'	G B	79	2.075	69.014	-5.225	1.00101.07	O
ATOM	11605	C1'	G B	79	1.420	69.144	-3.983	1.00 99.60	C
ATOM	11606	C2'	G B	79	1.193	67.741	-3.430	1.00 90.23	C
ATOM	11607	O2'	G B	79	2.311	67.388	-2.638	1.00 92.89	O
ATOM	11608	C3'	G B	79	1.163	66.917	-4.706	1.00 87.88	C
ATOM	11609	O3'	G B	79	1.519	65.571	-4.530	1.00 83.15	O
ATOM	11610	N9	G B	79	0.161	69.884	-4.218	1.00103.04	N
ATOM	11611	C8	G B	79	-0.241	70.363	-5.448	1.00103.07	C
ATOM	11612	N7	G B	79	-1.374	71.007	-5.412	1.00102.30	N
ATOM	11613	C5	G B	79	-1.755	70.961	-4.075	1.00 98.65	C
ATOM	11614	C4	G B	79	-0.816	70.280	-3.316	1.00 98.12	C
ATOM	11615	N1	G B	79	-2.910	71.240	-2.080	1.00 86.86	N
ATOM	11616	C2	G B	79	-1.929	70.548	-1.411	1.00 92.68	C
ATOM	11617	N3	G B	79	-0.846	70.038	-1.985	1.00 94.93	N
ATOM	11618	C6	G B	79	-2.908	71.501	-3.442	1.00 88.42	C
ATOM	11619	O6	G B	79	-3.838	72.136	-3.954	1.00 86.75	O
ATOM	11620	N2	G B	79	-2.123	70.402	-0.095	1.00 88.85	N
ATOM	11621	P	U B	80	0.529	64.422	-5.032	1.00 90.70	P
ATOM	11622	OP1	U B	80	-0.224	64.933	-6.203	1.00 92.05	O
ATOM	11623	OP2	U B	80	1.303	63.166	-5.185	1.00 95.14	O
ATOM	11624	O5'	U B	80	-0.435	64.251	-3.782	1.00 82.56	O
ATOM	11625	C5'	U B	80	0.084	64.452	-2.481	1.00 79.08	C
ATOM	11626	C4'	U B	80	-1.006	64.620	-1.470	1.00 74.61	C
ATOM	11627	O4'	U B	80	-1.376	66.013	-1.344	1.00 79.52	O
ATOM	11628	C3'	U B	80	-2.303	63.924	-1.802	1.00 73.78	C
ATOM	11629	O3'	U B	80	-2.245	62.543	-1.521	1.00 69.56	O
ATOM	11630	C2'	U B	80	-3.314	64.688	-0.954	1.00 76.46	C
ATOM	11631	O2'	U B	80	-3.279	64.233	0.388	1.00 79.00	O
ATOM	11632	C1'	U B	80	-2.744	66.112	-1.003	1.00 79.65	C
ATOM	11633	N1	U B	80	-3.444	66.985	-1.986	1.00 79.51	N
ATOM	11634	C2	U B	80	-4.617	67.612	-1.584	1.00 75.38	C
ATOM	11635	N3	U B	80	-5.215	68.403	-2.538	1.00 78.24	N
ATOM	11636	C4	U B	80	-4.780	68.635	-3.828	1.00 83.57	C
ATOM	11637	C5	U B	80	-3.559	67.955	-4.173	1.00 82.57	C
ATOM	11638	C6	U B	80	-2.957	67.181	-3.264	1.00 82.64	C
ATOM	11639	O2	U B	80	-5.109	67.489	-0.475	1.00 68.40	O
ATOM	11640	O4	U B	80	-5.445	69.378	-4.563	1.00 78.87	O
ATOM	11641	P	G B	81	-2.950	61.492	-2.494	1.00 76.06	P
ATOM	11642	OP1	G B	81	-3.002	62.143	-3.821	1.00 80.96	O
ATOM	11643	OP2	G B	81	-2.267	60.167	-2.376	1.00 78.54	O
ATOM	11644	O5'	G B	81	-4.417	61.359	-1.898	1.00 64.56	O
ATOM	11645	C5'	G B	81	-4.627	60.936	-0.558	1.00 67.83	C
ATOM	11646	C4'	G B	81	-6.038	60.454	-0.339	1.00 67.35	C
ATOM	11647	O4'	G B	81	-6.922	61.600	-0.234	1.00 71.16	O
ATOM	11648	C3'	G B	81	-6.603	59.609	-1.460	1.00 68.29	C
ATOM	11649	O3'	G B	81	-7.660	58.812	-0.922	1.00 76.34	O
ATOM	11650	C2'	G B	81	-7.205	60.665	-2.384	1.00 69.74	C
ATOM	11651	O2'	G B	81	-8.184	60.153	-3.254	1.00 67.00	O
ATOM	11652	C1'	G B	81	-7.778	61.665	-1.370	1.00 62.84	C
ATOM	11653	N9	G B	81	-7.749	63.074	-1.781	1.00 59.19	N
ATOM	11654	C8	G B	81	-6.725	63.721	-2.419	1.00 63.97	C
ATOM	11655	N7	G B	81	-6.947	64.998	-2.587	1.00 57.59	N

ATOM	11656	C5	G B	81	-8.183	65.225	-2.004	1.00	55.34	C
ATOM	11657	C4	G B	81	-8.677	64.059	-1.486	1.00	52.89	C
ATOM	11658	N1	G B	81	-10.147	66.237	-1.199	1.00	40.95	N
ATOM	11659	C2	G B	81	-10.548	65.021	-0.728	1.00	51.24	C
ATOM	11660	N3	G B	81	-9.852	63.900	-0.847	1.00	56.50	N
ATOM	11661	C6	G B	81	-8.959	66.434	-1.875	1.00	54.06	C
ATOM	11662	O6	G B	81	-8.689	67.569	-2.273	1.00	51.32	O
ATOM	11663	N2	G B	81	-11.728	64.989	-0.108	1.00	52.29	N
ATOM	11664	F	G B	82	-7.373	57.339	-0.332	1.00	82.13	F
ATOM	11665	OP1	G B	82	-8.689	56.641	-0.185	1.00	67.39	O
ATOM	11666	OP2	G B	82	-6.481	57.505	0.842	1.00	72.31	O
ATOM	11667	O5'	G B	82	-6.553	56.605	-1.488	1.00	73.92	O
ATOM	11668	C5'	G B	82	-7.215	56.159	-2.665	1.00	77.26	C
ATOM	11669	C4'	G B	82	-6.840	54.740	-3.033	1.00	81.92	C
ATOM	11670	O4'	G B	82	-6.739	53.922	-1.834	1.00	80.43	O
ATOM	11671	C3'	G B	82	-7.836	53.986	-3.910	1.00	79.90	C
ATOM	11672	O3'	G B	82	-7.732	54.316	-5.290	1.00	76.56	O
ATOM	11673	C2'	G B	82	-7.505	52.530	-3.601	1.00	85.63	C
ATOM	11674	O2'	G B	82	-6.338	52.118	-4.304	1.00	85.66	O
ATOM	11675	C1'	G B	82	-7.166	52.606	-2.111	1.00	79.70	C
ATOM	11676	N9	G B	82	-8.328	52.284	-1.259	1.00	81.64	N
ATOM	11677	C8	G B	82	-9.047	53.118	-0.430	1.00	79.36	C
ATOM	11678	N7	G B	82	-10.029	52.513	0.194	1.00	77.49	N
ATOM	11679	C5	G B	82	-9.950	51.196	-0.248	1.00	87.33	C
ATOM	11680	C4	G B	82	-8.909	51.040	-1.140	1.00	87.11	C
ATOM	11681	N1	G B	82	-10.313	48.922	-0.609	1.00	91.26	N
ATOM	11682	C2	G B	82	-9.257	48.876	-1.480	1.00	91.62	C
ATOM	11683	N3	G B	82	-8.512	49.921	-1.781	1.00	90.12	N
ATOM	11684	C6	G B	82	-10.741	50.060	0.066	1.00	90.56	C
ATOM	11685	O6	G B	82	-11.709	49.984	0.830	1.00	92.67	O
ATOM	11686	N2	G B	82	-8.988	47.690	-2.042	1.00	95.42	N
ATOM	11687	O5'	C B	83	-9.094	52.521	-6.481	1.00	90.21	O
ATOM	11688	C4'	C B	83	-8.482	50.318	-7.252	1.00	90.46	C
ATOM	11689	C3'	C B	83	-9.860	49.985	-7.802	1.00	93.16	C
ATOM	11690	C2'	C B	83	-10.157	48.640	-7.159	1.00	95.17	C
ATOM	11691	P	C B	83	-8.964	54.098	-6.307	1.00	84.78	P
ATOM	11692	OP1	C B	83	-8.500	54.647	-7.613	1.00	80.03	O
ATOM	11693	OP2	C B	83	-10.251	54.513	-5.680	1.00	80.39	O
ATOM	11694	C5'	C B	83	-8.132	51.782	-7.222	1.00	91.39	C
ATOM	11695	O4'	C B	83	-8.516	49.806	-5.894	1.00	88.97	O
ATOM	11696	O3'	C B	83	-9.918	49.961	-9.217	1.00	91.21	O
ATOM	11697	O2'	C B	83	-9.482	47.594	-7.844	1.00	99.51	O
ATOM	11698	C1'	C B	83	-9.517	48.813	-5.782	1.00	93.95	C
ATOM	11699	N1	C B	83	-10.507	49.208	-4.751	1.00	90.78	N
ATOM	11700	C2	C B	83	-11.327	48.205	-4.235	1.00	92.75	C
ATOM	11701	N3	C B	83	-12.249	48.501	-3.300	1.00	94.90	N
ATOM	11702	C4	C B	83	-12.370	49.748	-2.868	1.00	90.28	C
ATOM	11703	C5	C B	83	-11.548	50.798	-3.374	1.00	86.28	C
ATOM	11704	C6	C B	83	-10.636	50.494	-4.307	1.00	87.58	C
ATOM	11705	O2	C B	83	-11.197	47.047	-4.646	1.00	100.25	O
ATOM	11706	N4	C B	83	-13.296	49.975	-1.938	1.00	89.21	N
ATOM	11707	O5'	A B	84	-11.984	48.600	-9.778	1.00	97.93	O
ATOM	11708	C4'	A B	84	-11.912	46.166	-9.766	1.00	98.17	C
ATOM	11709	C3'	A B	84	-13.398	45.946	-9.988	1.00	99.73	C
ATOM	11710	C2'	A B	84	-13.779	45.015	-8.843	1.00	98.15	C
ATOM	11711	P	A B	84	-11.341	50.051	-9.959	1.00	95.76	P
ATOM	11712	OP1	A B	84	-11.071	50.272	-11.402	1.00	110.11	O
ATOM	11713	OP2	A B	84	-12.181	51.030	-9.233	1.00	97.22	O
ATOM	11714	C5'	A B	84	-11.354	47.449	-10.333	1.00	101.79	C
ATOM	11715	O4'	A B	84	-11.754	46.142	-8.322	1.00	94.88	O
ATOM	11716	O3'	A B	84	-13.666	45.411	-11.270	1.00	99.88	O
ATOM	11717	O2'	A B	84	-13.428	43.672	-9.149	1.00	101.77	O
ATOM	11718	C1'	A B	84	-12.870	45.518	-7.722	1.00	97.89	C

ATOM	11719	N9	A B	84	-13.543	46.505	-6.851	1.00101.49	N
ATOM	11720	C8	A B	84	-13.272	47.847	-6.769	1.00 98.07	C
ATOM	11721	N7	A B	84	-14.016	48.497	-5.911	1.00100.26	N
ATOM	11722	C5	A B	84	-14.849	47.525	-5.386	1.00100.22	C
ATOM	11723	C4	A B	84	-14.567	46.292	-5.955	1.00 99.70	C
ATOM	11724	N1	A B	84	-16.512	46.425	-4.130	1.00106.28	N
ATOM	11725	C2	A B	84	-16.131	45.306	-4.764	1.00100.98	C
ATOM	11726	N3	A B	84	-15.184	45.136	-5.684	1.00 98.32	N
ATOM	11727	C6	A B	84	-15.875	47.583	-4.422	1.00102.63	C
ATOM	11728	N6	A B	84	-16.257	48.697	-3.787	1.00 98.57	N
ATOM	11729	O5'	C B	85	-16.124	44.869	-11.122	1.00 97.80	O
ATOM	11730	C4'	C B	85	-16.980	42.993	-9.909	1.00 96.64	C
ATOM	11731	C3'	C B	85	-18.428	43.401	-10.113	1.00 97.23	C
ATOM	11732	C2'	C B	85	-18.986	43.429	-8.697	1.00 97.97	C
ATOM	11733	P	C B	85	-15.071	45.683	-11.993	1.00 99.35	P
ATOM	11734	OP1	C B	85	-15.025	45.062	-13.341	1.00103.11	O
ATOM	11735	OP2	C B	85	-15.387	47.124	-11.859	1.00102.01	O
ATOM	11736	C5'	C B	85	-16.043	43.460	-10.986	1.00 97.85	C
ATOM	11737	O4'	C B	85	-16.611	43.612	-8.649	1.00 95.23	O
ATOM	11738	O3'	C B	85	-19.130	42.534	-10.976	1.00 93.52	O
ATOM	11739	O2'	C B	85	-19.373	42.132	-8.272	1.00 96.22	O
ATOM	11740	C1'	C B	85	-17.771	43.899	-7.890	1.00 98.29	C
ATOM	11741	N1	C B	85	-17.825	45.357	-7.609	1.00 98.07	N
ATOM	11742	C2	C B	85	-18.718	45.839	-6.639	1.00100.02	C
ATOM	11743	N3	C B	85	-18.781	47.167	-6.386	1.00100.81	N
ATOM	11744	C4	C B	85	-17.996	48.012	-7.054	1.00103.47	C
ATOM	11745	C5	C B	85	-17.075	47.557	-8.047	1.00 98.66	C
ATOM	11746	C6	C B	85	-17.030	46.240	-8.289	1.00 98.45	C
ATOM	11747	O2	C B	85	-19.444	45.047	-6.023	1.00 99.82	O
ATOM	11748	N4	C B	85	-18.096	49.313	-6.763	1.00102.52	N
ATOM	11749	O5'	C B	86	-21.567	43.180	-10.860	1.00 93.93	O
ATOM	11750	C4'	C B	86	-23.261	42.341	-9.354	1.00100.55	C
ATOM	11751	C3'	C B	86	-24.319	43.318	-9.832	1.00103.17	C
ATOM	11752	C2'	C B	86	-24.808	43.966	-8.540	1.00100.23	C
ATOM	11753	P	C B	86	-20.334	43.104	-11.866	1.00 94.09	P
ATOM	11754	OP1	C B	86	-20.677	42.112	-12.911	1.00111.45	O
ATOM	11755	OP2	C B	86	-19.945	44.470	-12.288	1.00104.25	O
ATOM	11756	C5'	C B	86	-22.192	42.006	-10.364	1.00 98.40	C
ATOM	11757	O4'	C B	86	-22.659	43.002	-8.210	1.00104.10	O
ATOM	11758	O3'	C B	86	-25.341	42.699	-10.582	1.00104.24	O
ATOM	11759	O2'	C B	86	-25.750	43.135	-7.874	1.00 96.61	O
ATOM	11760	C1'	C B	86	-23.520	44.013	-7.719	1.00102.51	C
ATOM	11761	N1	C B	86	-22.823	45.321	-7.826	1.00 98.08	N
ATOM	11762	C2	C B	86	-23.301	46.436	-7.131	1.00 95.69	C
ATOM	11763	N3	C B	86	-22.642	47.619	-7.242	1.00 94.09	N
ATOM	11764	C4	C B	86	-21.543	47.712	-7.993	1.00 95.25	C
ATOM	11765	C5	C B	86	-21.034	46.592	-8.703	1.00 96.86	C
ATOM	11766	C6	C B	86	-21.697	45.439	-8.588	1.00 97.60	C
ATOM	11767	O2	C B	86	-24.329	46.322	-6.441	1.00 93.79	O
ATOM	11768	N4	C B	86	-20.914	48.886	-8.076	1.00 93.16	N
ATOM	11769	O5'	G B	87	-26.657	44.814	-10.893	1.00 97.77	O
ATOM	11770	C4'	G B	87	-28.463	45.796	-9.651	1.00 93.21	C
ATOM	11771	C3'	G B	87	-29.036	47.192	-9.783	1.00 89.28	C
ATOM	11772	C2'	G B	87	-28.796	47.775	-8.396	1.00 92.07	C
ATOM	11773	P	G B	87	-26.115	43.556	-11.693	1.00108.98	P
ATOM	11774	OP1	G B	87	-27.325	42.804	-12.127	1.00116.23	O
ATOM	11775	OP2	G B	87	-25.100	44.030	-12.673	1.00 99.39	O
ATOM	11776	C5'	G B	87	-28.031	45.149	-10.936	1.00 98.40	C
ATOM	11777	O4'	G B	87	-27.311	45.967	-8.783	1.00 91.90	O
ATOM	11778	O3'	G B	87	-30.395	47.188	-10.185	1.00 92.52	O
ATOM	11779	O2'	G B	87	-29.770	47.305	-7.473	1.00 89.40	O
ATOM	11780	C1'	G B	87	-27.443	47.157	-8.040	1.00 86.72	C
ATOM	11781	N9	G B	87	-26.313	48.046	-8.379	1.00 86.88	N

ATOM	11782	C8	G B	87	-25.220	47.739	-9.154	1.00	88.18	C
ATOM	11783	N7	G B	87	-24.369	48.723	-9.281	1.00	83.17	N
ATOM	11784	C5	G B	87	-24.934	49.759	-8.548	1.00	85.40	C
ATOM	11785	C4	G B	87	-26.133	49.356	-7.982	1.00	85.93	C
ATOM	11786	N1	G B	87	-25.359	51.795	-7.507	1.00	78.21	N
ATOM	11787	C2	G B	87	-26.539	51.302	-6.998	1.00	80.76	C
ATOM	11788	N3	G B	87	-26.979	50.074	-7.207	1.00	83.88	N
ATOM	11789	C6	G B	87	-24.472	51.088	-8.315	1.00	79.62	C
ATOM	11790	O6	G B	87	-23.438	51.634	-8.728	1.00	75.38	O
ATOM	11791	N2	G B	87	-27.268	52.126	-6.238	1.00	72.43	N
ATOM	11792	O5'	A B	88	-30.852	49.651	-10.110	1.00	86.63	O
ATOM	11793	C4'	A B	88	-31.486	51.057	-8.237	1.00	80.16	C
ATOM	11794	C3'	A B	88	-32.199	52.169	-8.977	1.00	78.36	C
ATOM	11795	C2'	A B	88	-31.089	52.756	-9.833	1.00	78.26	C
ATOM	11796	P	A B	88	-30.984	48.395	-11.071	1.00	95.11	P
ATOM	11797	OP1	A B	88	-32.456	48.237	-11.272	1.00	80.48	O
ATOM	11798	OP2	A B	88	-30.060	48.546	-12.229	1.00	94.90	O
ATOM	11799	C5'	A B	88	-31.582	49.704	-8.889	1.00	87.81	C
ATOM	11800	O4'	A B	88	-30.094	51.467	-8.155	1.00	81.28	O
ATOM	11801	O3'	A B	88	-32.572	53.126	-8.010	1.00	81.47	O
ATOM	11802	O2'	A B	88	-31.332	54.072	-10.275	1.00	79.52	O
ATOM	11803	C1'	A B	88	-29.912	52.673	-8.871	1.00	73.90	C
ATOM	11804	N9	A B	88	-28.601	52.605	-9.511	1.00	76.65	N
ATOM	11805	C8	A B	88	-28.032	51.516	-10.114	1.00	75.62	C
ATOM	11806	N7	A B	88	-26.834	51.744	-10.582	1.00	75.52	N
ATOM	11807	C5	A B	88	-26.589	53.066	-10.247	1.00	74.94	C
ATOM	11808	C4	A B	88	-27.667	53.609	-9.572	1.00	77.84	C
ATOM	11809	N1	A B	88	-25.560	55.180	-9.991	1.00	72.33	N
ATOM	11810	C2	A B	88	-26.669	55.567	-9.354	1.00	70.19	C
ATOM	11811	N3	A B	88	-27.772	54.866	-9.097	1.00	71.60	N
ATOM	11812	C6	A B	88	-25.483	53.911	-10.457	1.00	72.48	C
ATOM	11813	N6	A B	88	-24.365	53.525	-11.088	1.00	74.85	N
ATOM	11814	P	G B	89	-33.936	53.941	-8.156	1.00	95.88	P
ATOM	11815	OP1	G B	89	-35.017	53.068	-7.629	1.00	94.36	O
ATOM	11816	OP2	G B	89	-34.027	54.498	-9.538	1.00	90.88	O
ATOM	11817	O5'	G B	89	-33.722	55.147	-7.138	1.00	92.92	O
ATOM	11818	C5'	G B	89	-32.425	55.706	-6.921	1.00	88.26	C
ATOM	11819	C4'	G B	89	-32.517	57.168	-6.567	1.00	83.67	C
ATOM	11820	O4'	G B	89	-33.371	57.809	-7.551	1.00	81.37	O
ATOM	11821	C3'	G B	89	-33.146	57.460	-5.205	1.00	83.75	C
ATOM	11822	O3'	G B	89	-32.629	58.685	-4.679	1.00	88.54	O
ATOM	11823	C2'	G B	89	-34.615	57.660	-5.561	1.00	84.69	C
ATOM	11824	O2'	G B	89	-35.338	58.433	-4.629	1.00	92.64	O
ATOM	11825	C1'	G B	89	-34.510	58.361	-6.915	1.00	87.38	C
ATOM	11826	N9	G B	89	-35.666	58.159	-7.802	1.00	89.64	N
ATOM	11827	C8	G B	89	-36.127	56.943	-8.247	1.00	92.59	C
ATOM	11828	N7	G B	89	-37.158	57.030	-9.040	1.00	93.72	N
ATOM	11829	C5	G B	89	-37.404	58.390	-9.133	1.00	91.23	C
ATOM	11830	C4	G B	89	-36.492	59.106	-8.383	1.00	89.64	C
ATOM	11831	N1	G B	89	-38.312	60.455	-9.686	1.00	89.03	N
ATOM	11832	C2	G B	89	-37.368	61.082	-8.918	1.00	87.69	C
ATOM	11833	N3	G B	89	-36.423	60.449	-8.235	1.00	90.17	N
ATOM	11834	C6	G B	89	-38.410	59.083	-9.856	1.00	92.38	C
ATOM	11835	O6	G B	89	-39.304	58.622	-10.577	1.00	92.84	O
ATOM	11836	N2	G B	89	-37.450	62.419	-8.888	1.00	85.47	N
ATOM	11837	P	U B	90	-31.246	58.748	-3.854	1.00	83.23	P
ATOM	11838	OP1	U B	90	-31.462	59.806	-2.835	1.00	73.70	O
ATOM	11839	OP2	U B	90	-30.761	57.397	-3.485	1.00	81.85	O
ATOM	11840	O5'	U B	90	-30.218	59.321	-4.918	1.00	79.52	O
ATOM	11841	C5'	U B	90	-28.826	59.360	-4.663	1.00	74.23	C
ATOM	11842	C4'	U B	90	-28.192	60.466	-5.463	1.00	75.93	C
ATOM	11843	O4'	U B	90	-29.073	60.791	-6.576	1.00	72.03	O
ATOM	11844	C3'	U B	90	-27.977	61.774	-4.702	1.00	67.48	C

ATOM	11845	O3'	U B	90	-26.858	62.448	-5.277	1.00	71.37	O
ATOM	11846	C2'	U B	90	-29.249	62.543	-5.042	1.00	69.61	C
ATOM	11847	O2'	U B	90	-29.174	63.947	-4.878	1.00	71.80	O
ATOM	11848	C1'	U B	90	-29.431	62.155	-6.501	1.00	71.95	C
ATOM	11849	N1	U B	90	-30.791	62.339	-7.019	1.00	71.53	N
ATOM	11850	C2	U B	90	-30.971	63.504	-7.711	1.00	64.79	C
ATOM	11851	N3	U B	90	-32.222	63.719	-8.212	1.00	70.92	N
ATOM	11852	C4	U B	90	-33.309	62.876	-8.084	1.00	75.17	C
ATOM	11853	C5	U B	90	-33.040	61.678	-7.345	1.00	74.28	C
ATOM	11854	C6	U B	90	-31.816	61.445	-6.851	1.00	74.56	C
ATOM	11855	O2	U B	90	-30.064	64.284	-7.860	1.00	65.64	O
ATOM	11856	O4	U B	90	-34.390	63.201	-8.590	1.00	76.55	O
ATOM	11857	P	C B	91	-25.490	62.703	-4.471	1.00	74.09	P
ATOM	11858	OP1	C B	91	-24.319	62.425	-5.330	1.00	72.34	O
ATOM	11859	OP2	C B	91	-25.608	63.941	-3.679	1.00	77.35	O
ATOM	11860	O5'	C B	91	-25.331	61.493	-3.482	1.00	76.96	O
ATOM	11861	C5'	C B	91	-24.524	60.393	-3.839	1.00	68.40	C
ATOM	11862	C4'	C B	91	-25.353	59.153	-3.720	1.00	72.16	C
ATOM	11863	O4'	C B	91	-25.758	58.673	-5.023	1.00	73.59	O
ATOM	11864	C3'	C B	91	-24.723	57.945	-3.074	1.00	72.26	C
ATOM	11865	O3'	C B	91	-24.620	58.093	-1.669	1.00	71.43	O
ATOM	11866	C2'	C B	91	-25.680	56.856	-3.527	1.00	72.18	C
ATOM	11867	O2'	C B	91	-26.922	57.001	-2.857	1.00	72.22	O
ATOM	11868	C1'	C B	91	-25.920	57.277	-4.973	1.00	72.23	C
ATOM	11869	N1	C B	91	-24.952	56.652	-5.897	1.00	69.17	N
ATOM	11870	C2	C B	91	-25.164	55.313	-6.204	1.00	70.82	C
ATOM	11871	N3	C B	91	-24.310	54.667	-7.031	1.00	70.77	N
ATOM	11872	C4	C B	91	-23.273	55.317	-7.551	1.00	68.94	C
ATOM	11873	C5	C B	91	-23.033	56.697	-7.253	1.00	71.55	C
ATOM	11874	C6	C B	91	-23.890	57.326	-6.427	1.00	66.53	C
ATOM	11875	O2	C B	91	-26.149	54.764	-5.695	1.00	71.88	O
ATOM	11876	N4	C B	91	-22.465	54.642	-8.366	1.00	56.94	N
ATOM	11877	O5'	G B	92	-24.443	55.784	-0.748	1.00	75.67	O
ATOM	11878	C4'	G B	92	-26.440	54.436	-0.419	1.00	81.34	C
ATOM	11879	C3'	G B	92	-25.674	53.220	0.061	1.00	87.06	C
ATOM	11880	C2'	G B	92	-26.388	52.107	-0.685	1.00	89.06	C
ATOM	11881	P	G B	92	-23.653	57.163	-0.786	1.00	70.44	P
ATOM	11882	OP1	G B	92	-23.732	57.729	0.580	1.00	67.36	O
ATOM	11883	OP2	G B	92	-22.303	56.951	-1.387	1.00	69.07	O
ATOM	11884	C5'	G B	92	-25.767	55.769	-0.238	1.00	78.14	C
ATOM	11885	O4'	G B	92	-26.658	54.156	-1.829	1.00	81.14	O
ATOM	11886	O3'	G B	92	-25.642	53.072	1.466	1.00	88.91	O
ATOM	11887	O2'	G B	92	-27.696	51.911	-0.157	1.00	86.56	O
ATOM	11888	C1'	G B	92	-26.525	52.766	-2.056	1.00	87.16	C
ATOM	11889	N9	G B	92	-25.301	52.528	-2.842	1.00	81.20	N
ATOM	11890	C8	G B	92	-24.167	53.298	-2.956	1.00	80.98	C
ATOM	11891	N7	G B	92	-23.244	52.751	-3.707	1.00	83.30	N
ATOM	11892	C5	G B	92	-23.808	51.546	-4.094	1.00	87.51	C
ATOM	11893	C4	G B	92	-25.066	51.395	-3.562	1.00	87.66	C
ATOM	11894	N1	G B	92	-24.210	49.465	-5.037	1.00	87.39	N
ATOM	11895	C2	G B	92	-25.455	49.411	-4.455	1.00	89.49	C
ATOM	11896	N3	G B	92	-25.936	50.375	-3.693	1.00	90.85	N
ATOM	11897	C6	G B	92	-23.303	50.515	-4.914	1.00	89.52	C
ATOM	11898	O6	G B	92	-22.205	50.468	-5.481	1.00	94.04	O
ATOM	11899	N2	G B	92	-26.208	48.321	-4.689	1.00	87.59	N
ATOM	11900	O5'	G B	93	-25.266	50.711	2.170	1.00	99.08	O
ATOM	11901	C4'	G B	93	-25.035	48.479	1.253	1.00	102.13	C
ATOM	11902	C3'	G B	93	-24.130	47.270	1.078	1.00	106.11	C
ATOM	11903	C2'	G B	93	-24.458	46.794	-0.333	1.00	103.62	C
ATOM	11904	P	G B	93	-24.537	52.125	2.144	1.00	93.99	P
ATOM	11905	OP1	G B	93	-24.338	52.597	3.538	1.00	97.54	O
ATOM	11906	OP2	G B	93	-23.345	51.994	1.263	1.00	92.60	O
ATOM	11907	C5'	G B	93	-24.514	49.512	2.218	1.00	102.55	C

ATOM	11908	O4'	G B	93	-25.143	49.050	-0.081	1.00	98.98	O
ATOM	11909	O3'	G B	93	-24.326	46.300	2.092	1.00	110.71	O
ATOM	11910	O2'	G B	93	-25.666	46.046	-0.366	1.00	99.86	O
ATOM	11911	C1'	G B	93	-24.688	48.126	-1.045	1.00	99.71	C
ATOM	11912	N9	G B	93	-23.435	48.661	-1.601	1.00	98.39	N
ATOM	11913	C8	G B	93	-22.886	49.882	-1.296	1.00	97.07	C
ATOM	11914	N7	G B	93	-21.767	50.107	-1.923	1.00	101.15	N
ATOM	11915	C5	G B	93	-21.566	48.961	-2.685	1.00	99.86	C
ATOM	11916	C4	G B	93	-22.588	48.055	-2.498	1.00	100.31	C
ATOM	11917	N1	G B	93	-20.702	47.369	-4.131	1.00	101.51	N
ATOM	11918	C2	G B	93	-21.763	46.539	-3.875	1.00	98.37	C
ATOM	11919	N3	G B	93	-22.751	46.836	-3.054	1.00	98.32	N
ATOM	11920	C6	G B	93	-20.514	48.629	-3.574	1.00	99.74	C
ATOM	11921	O6	G B	93	-19.516	49.296	-3.874	1.00	100.72	O
ATOM	11922	N2	G B	93	-21.761	45.364	-4.519	1.00	100.26	N
ATOM	11923	O5'	U B	94	-22.377	44.780	2.512	1.00	111.21	O
ATOM	11924	C4'	U B	94	-22.243	43.043	0.835	1.00	106.87	C
ATOM	11925	C3'	U B	94	-20.775	42.860	1.180	1.00	109.95	C
ATOM	11926	C2'	U B	94	-20.121	42.767	-0.191	1.00	111.58	C
ATOM	11927	P	U B	94	-23.167	45.999	3.165	1.00	110.22	P
ATOM	11928	OP1	U B	94	-22.246	47.161	3.253	1.00	103.92	O
ATOM	11929	OP2	U B	94	-23.837	45.514	4.394	1.00	104.61	O
ATOM	11930	C5'	U B	94	-23.080	43.711	1.893	1.00	107.86	C
ATOM	11931	O4'	U B	94	-22.220	43.860	-0.366	1.00	105.49	O
ATOM	11932	O3'	U B	94	-20.531	41.739	2.007	1.00	115.96	O
ATOM	11933	O2'	U B	94	-20.328	41.484	-0.767	1.00	108.86	O
ATOM	11934	C1'	U B	94	-20.942	43.792	-0.971	1.00	106.63	C
ATOM	11935	N1	U B	94	-20.323	45.136	-0.902	1.00	109.96	N
ATOM	11936	C2	U B	94	-19.149	45.375	-1.607	1.00	108.74	C
ATOM	11937	N3	U B	94	-18.642	46.646	-1.467	1.00	106.71	N
ATOM	11938	C4	U B	94	-19.186	47.675	-0.720	1.00	107.11	C
ATOM	11939	C5	U B	94	-20.398	47.353	-0.028	1.00	105.80	C
ATOM	11940	C6	U B	94	-20.909	46.127	-0.142	1.00	107.53	C
ATOM	11941	O2	U B	94	-18.578	44.540	-2.291	1.00	107.90	O
ATOM	11942	O4	U B	94	-18.621	48.768	-0.694	1.00	109.72	O
ATOM	11943	O5'	G B	95	-18.040	41.613	2.416	1.00	105.25	O
ATOM	11944	C4'	G B	95	-16.605	40.467	0.850	1.00	104.11	C
ATOM	11945	C3'	G B	95	-15.255	40.984	1.317	1.00	103.14	C
ATOM	11946	C2'	G B	95	-14.646	41.531	0.034	1.00	105.44	C
ATOM	11947	P	G B	95	-19.430	41.832	3.171	1.00	112.13	P
ATOM	11948	OP1	G B	95	-19.674	40.703	4.099	1.00	114.16	O
ATOM	11949	OP2	G B	95	-19.450	43.214	3.705	1.00	107.31	O
ATOM	11950	C5'	G B	95	-17.676	40.344	1.901	1.00	103.56	C
ATOM	11951	O4'	G B	95	-17.016	41.434	-0.146	1.00	110.96	O
ATOM	11952	O3'	G B	95	-14.458	39.987	1.926	1.00	103.34	O
ATOM	11953	O2'	G B	95	-14.106	40.486	-0.758	1.00	103.27	O
ATOM	11954	C1'	G B	95	-15.878	42.083	-0.679	1.00	111.81	C
ATOM	11955	N9	G B	95	-16.004	43.547	-0.517	1.00	110.18	N
ATOM	11956	C8	G B	95	-16.912	44.263	0.226	1.00	107.36	C
ATOM	11957	N7	G B	95	-16.731	45.555	0.132	1.00	106.46	N
ATOM	11958	C5	G B	95	-15.640	45.702	-0.719	1.00	107.40	C
ATOM	11959	C4	G B	95	-15.183	44.469	-1.128	1.00	106.67	C
ATOM	11960	N1	G B	95	-13.909	46.537	-2.043	1.00	104.37	N
ATOM	11961	C2	G B	95	-13.533	45.259	-2.391	1.00	103.03	C
ATOM	11962	N3	G B	95	-14.150	44.179	-1.951	1.00	106.47	N
ATOM	11963	C6	G B	95	-14.975	46.867	-1.198	1.00	106.09	C
ATOM	11964	O6	G B	95	-15.233	48.059	-0.956	1.00	99.57	O
ATOM	11965	N2	G B	95	-12.485	45.125	-3.219	1.00	100.46	N
ATOM	11966	O5'	C B	96	-12.091	40.841	1.642	1.00	106.17	O
ATOM	11967	C4'	C B	96	-10.388	40.528	-0.040	1.00	105.41	C
ATOM	11968	C3'	C B	96	-9.381	41.349	0.746	1.00	105.95	C
ATOM	11969	C2'	C B	96	-8.832	42.298	-0.306	1.00	107.44	C
ATOM	11970	P	C B	96	-13.147	40.400	2.752	1.00	103.48	P

ATOM	11971	OP1	C B	96	-12.612	39.206	3.450	1.00110.64	O
ATOM	11972	OP2	C B	96	-13.509	41.599	3.545	1.00109.88	O
ATOM	11973	C5'	C B	96	-11.484	39.894	0.777	1.00103.34	C
ATOM	11974	O4'	C B	96	-10.956	41.482	-0.978	1.00104.90	O
ATOM	11975	O3'	C B	96	-8.394	40.572	1.384	1.00107.77	O
ATOM	11976	O2'	C B	96	-7.906	41.634	-1.154	1.00111.68	O
ATOM	11977	C1'	C B	96	-10.098	42.601	-1.105	1.00107.54	C
ATOM	11978	N1	C B	96	-10.796	43.795	-0.567	1.00108.13	N
ATOM	11979	C2	C B	96	-10.276	45.075	-0.814	1.00106.16	C
ATOM	11980	N3	C B	96	-10.917	46.161	-0.313	1.00104.74	N
ATOM	11981	C4	C B	96	-12.027	46.012	0.416	1.00104.15	C
ATOM	11982	C5	C B	96	-12.570	44.725	0.692	1.00106.56	C
ATOM	11983	C6	C B	96	-11.931	43.661	0.186	1.00107.38	C
ATOM	11984	O2	C B	96	-9.242	45.195	-1.489	1.00106.35	O
ATOM	11985	N4	C B	96	-12.625	47.107	0.892	1.00102.09	N
ATOM	11986	P	U B	97	-8.069	40.850	2.926	1.00113.85	P
ATOM	11987	OP1	U B	97	-7.294	39.691	3.439	1.00124.18	O
ATOM	11988	OP2	U B	97	-9.358	41.218	3.575	1.00107.97	O
ATOM	11989	O5'	U B	97	-7.101	42.121	2.899	1.00111.65	O
ATOM	11990	C5'	U B	97	-5.814	42.050	2.297	1.00110.91	C
ATOM	11991	C4'	U B	97	-5.235	43.419	2.018	1.00110.33	C
ATOM	11992	O4'	U B	97	-6.162	44.195	1.211	1.00106.78	O
ATOM	11993	C3'	U B	97	-4.959	44.310	3.225	1.00108.74	C
ATOM	11994	O3'	U B	97	-3.742	44.003	3.892	1.00100.18	O
ATOM	11995	C2'	U B	97	-4.982	45.706	2.615	1.00107.24	C
ATOM	11996	O2'	U B	97	-3.761	45.981	1.943	1.00108.85	O
ATOM	11997	C1'	U B	97	-6.088	45.560	1.568	1.00105.58	C
ATOM	11998	N1	U B	97	-7.406	45.973	2.100	1.00107.04	N
ATOM	11999	C2	U B	97	-7.657	47.325	2.275	1.00105.19	C
ATOM	12000	N3	U B	97	-8.901	47.622	2.782	1.00 99.50	N
ATOM	12001	C4	U B	97	-9.897	46.731	3.128	1.00100.25	C
ATOM	12002	C5	U B	97	-9.562	45.357	2.919	1.00105.71	C
ATOM	12003	C6	U B	97	-8.360	45.035	2.424	1.00107.83	C
ATOM	12004	O2	U B	97	-6.848	48.198	2.008	1.00103.39	O
ATOM	12005	O4	U B	97	-10.963	47.153	3.576	1.00 99.89	O
TER									
ATOM	12006	O6	DG C	1	-23.729	109.460	-18.317	1.00 44.35	O
ATOM	12007	C6	DG C	1	-24.617	108.681	-18.661	1.00 43.85	C
ATOM	12008	N1	DG C	1	-25.526	109.043	-19.665	1.00 44.12	N
ATOM	12009	C2	DG C	1	-26.573	108.257	-20.096	1.00 39.95	C
ATOM	12010	N2	DG C	1	-27.364	108.764	-21.054	1.00 42.69	N
ATOM	12011	N3	DG C	1	-26.820	107.058	-19.633	1.00 43.03	N
ATOM	12012	C4	DG C	1	-25.938	106.690	-18.684	1.00 45.32	C
ATOM	12013	C5	DG C	1	-24.882	107.390	-18.167	1.00 46.28	C
ATOM	12014	N7	DG C	1	-24.230	106.640	-17.200	1.00 50.06	N
ATOM	12015	C8	DG C	1	-24.898	105.532	-17.156	1.00 48.39	C
ATOM	12016	N9	DG C	1	-25.966	105.519	-18.011	1.00 48.71	N
ATOM	12017	C1'	DG C	1	-26.875	104.442	-18.270	1.00 53.26	C
ATOM	12018	O4'	DG C	1	-26.882	103.551	-17.187	1.00 56.91	O
ATOM	12019	C2'	DG C	1	-26.423	103.654	-19.490	1.00 56.35	C
ATOM	12020	C3'	DG C	1	-25.825	102.397	-18.890	1.00 55.21	C
ATOM	12021	O3'	DG C	1	-25.943	101.315	-19.832	1.00 56.22	O
ATOM	12022	C4'	DG C	1	-26.772	102.222	-17.708	1.00 63.92	C
ATOM	12023	C5'	DG C	1	-26.373	101.298	-16.570	1.00 67.39	C
ATOM	12024	O5'	DG C	1	-27.277	101.544	-15.450	1.00 76.41	O
ATOM	12025	P	DG C	1	-27.806	100.348	-14.527	1.00105.45	P
ATOM	12026	OP1	DG C	1	-26.583	99.797	-13.897	1.00 75.08	O
ATOM	12027	OP2	DG C	1	-28.698	99.490	-15.349	1.00 86.30	O
ATOM	12028	OP3	DG C	1	-28.655	100.902	-13.442	1.00 70.28	O
ATOM	12029	O5'	DC C	2	-25.888	102.514	-22.097	1.00 55.48	O
ATOM	12030	C4'	DC C	2	-27.573	103.607	-23.322	1.00 47.78	C
ATOM	12031	C3'	DC C	2	-26.755	103.903	-24.558	1.00 43.76	C
ATOM	12032	C2'	DC C	2	-27.030	105.382	-24.724	1.00 55.80	C

ATOM	12033	P	DC	C	2	-25.188	101.367	-21.258	1.00	57.19	P
ATOM	12034	OP1	DC	C	2	-25.590	100.129	-21.958	1.00	59.14	O
ATOM	12035	OP2	DC	C	2	-23.789	101.817	-21.092	1.00	53.41	O
ATOM	12036	C5'	DC	C	2	-27.187	102.358	-22.588	1.00	48.22	C
ATOM	12037	O4'	DC	C	2	-27.299	104.739	-22.463	1.00	53.50	O
ATOM	12038	O3'	DC	C	2	-27.253	103.176	-25.664	1.00	57.50	O
ATOM	12039	C1'	DC	C	2	-27.066	105.872	-23.268	1.00	52.27	C
ATOM	12040	N1	DC	C	2	-25.805	106.512	-22.847	1.00	46.39	N
ATOM	12041	C2	DC	C	2	-25.486	107.771	-23.367	1.00	43.48	C
ATOM	12042	N3	DC	C	2	-24.321	108.361	-22.999	1.00	43.72	N
ATOM	12043	C4	DC	C	2	-23.495	107.739	-22.143	1.00	45.23	C
ATOM	12044	C5	DC	C	2	-23.806	106.441	-21.601	1.00	45.19	C
ATOM	12045	C6	DC	C	2	-24.959	105.868	-21.987	1.00	42.90	C
ATOM	12046	O2	DC	C	2	-26.272	108.309	-24.161	1.00	43.90	O
ATOM	12047	N4	DC	C	2	-22.358	108.377	-21.800	1.00	38.83	N
ATOM	12048	P	DC	C	3	-26.279	102.722	-26.870	1.00	63.08	P
ATOM	12049	OP1	DC	C	3	-27.031	101.694	-27.616	1.00	60.75	O
ATOM	12050	OP2	DC	C	3	-24.945	102.332	-26.366	1.00	48.15	O
ATOM	12051	O5'	DC	C	3	-26.066	104.067	-27.726	1.00	56.26	O
ATOM	12052	C5'	DC	C	3	-27.138	104.660	-28.438	1.00	45.79	C
ATOM	12053	C4'	DC	C	3	-26.743	106.014	-28.995	1.00	42.76	C
ATOM	12054	O4'	DC	C	3	-26.489	106.926	-27.904	1.00	48.50	O
ATOM	12055	C3'	DC	C	3	-25.454	106.044	-29.784	1.00	47.12	C
ATOM	12056	O3'	DC	C	3	-25.636	105.577	-31.117	1.00	52.57	O
ATOM	12057	C2'	DC	C	3	-25.141	107.526	-29.755	1.00	41.21	C
ATOM	12058	C1'	DC	C	3	-25.510	107.879	-28.317	1.00	43.87	C
ATOM	12059	N1	DC	C	3	-24.328	107.845	-27.383	1.00	40.67	N
ATOM	12060	C2	DC	C	3	-23.475	108.936	-27.357	1.00	40.44	C
ATOM	12061	N3	DC	C	3	-22.402	108.909	-26.541	1.00	38.67	N
ATOM	12062	C4	DC	C	3	-22.163	107.847	-25.772	1.00	40.73	C
ATOM	12063	C5	DC	C	3	-23.010	106.693	-25.783	1.00	34.06	C
ATOM	12064	C6	DC	C	3	-24.069	106.729	-26.610	1.00	41.16	C
ATOM	12065	O2	DC	C	3	-23.720	109.911	-28.084	1.00	41.62	O
ATOM	12066	N4	DC	C	3	-21.088	107.900	-24.983	1.00	42.56	N
ATOM	12067	O5'	DA	C	4	-23.430	106.138	-32.233	1.00	52.48	O
ATOM	12068	C4'	DA	C	4	-22.916	108.433	-32.797	1.00	54.65	C
ATOM	12069	C3'	DA	C	4	-21.511	108.108	-33.237	1.00	51.83	C
ATOM	12070	C2'	DA	C	4	-20.786	109.322	-32.691	1.00	49.26	C
ATOM	12071	P	DA	C	4	-24.398	104.924	-31.908	1.00	56.29	P
ATOM	12072	OP1	DA	C	4	-24.923	104.335	-33.156	1.00	73.82	O
ATOM	12073	OP2	DA	C	4	-23.648	104.072	-30.957	1.00	62.81	O
ATOM	12074	C5'	DA	C	4	-23.920	107.291	-32.884	1.00	57.61	C
ATOM	12075	O4'	DA	C	4	-22.722	108.836	-31.426	1.00	49.72	O
ATOM	12076	O3'	DA	C	4	-21.421	108.030	-34.664	1.00	63.30	O
ATOM	12077	C1'	DA	C	4	-21.458	109.477	-31.327	1.00	46.08	C
ATOM	12078	N9	DA	C	4	-20.699	108.856	-30.254	1.00	45.11	N
ATOM	12079	C8	DA	C	4	-21.016	107.716	-29.588	1.00	44.37	C
ATOM	12080	N7	DA	C	4	-20.136	107.377	-28.665	1.00	43.46	N
ATOM	12081	C5	DA	C	4	-19.180	108.371	-28.740	1.00	41.31	C
ATOM	12082	C4	DA	C	4	-19.505	109.291	-29.714	1.00	38.57	C
ATOM	12083	N1	DA	C	4	-17.265	109.691	-28.340	1.00	42.83	N
ATOM	12084	C2	DA	C	4	-17.710	110.489	-29.319	1.00	41.58	C
ATOM	12085	N3	DA	C	4	-18.802	110.369	-30.062	1.00	38.24	N
ATOM	12086	C6	DA	C	4	-17.987	108.590	-28.023	1.00	42.28	C
ATOM	12087	N6	DA	C	4	-17.548	107.769	-27.051	1.00	42.02	N
ATOM	12088	O5'	DA	C	5	-18.939	108.177	-35.211	1.00	51.78	O
ATOM	12089	C4'	DA	C	5	-17.678	110.205	-35.447	1.00	53.18	C
ATOM	12090	C3'	DA	C	5	-16.411	109.459	-35.841	1.00	51.30	C
ATOM	12091	C2'	DA	C	5	-15.375	110.136	-34.946	1.00	46.93	C
ATOM	12092	P	DA	C	5	-20.215	107.218	-35.367	1.00	60.70	P
ATOM	12093	OP1	DA	C	5	-20.584	107.156	-36.788	1.00	57.52	O
ATOM	12094	OP2	DA	C	5	-19.908	105.995	-34.597	1.00	56.31	O
ATOM	12095	C5'	DA	C	5	-18.969	109.483	-35.747	1.00	47.38	C

ATOM	12096	O4'	DA	C	5	-17.553	110.385	-34.017	1.00	43.98	O
ATOM	12097	O3'	DA	C	5	-16.115	109.648	-37.246	1.00	57.26	O
ATOM	12098	C1'	DA	C	5	-16.177	110.411	-33.663	1.00	44.67	C
ATOM	12099	N9	DA	C	5	-15.941	109.428	-32.596	1.00	42.91	N
ATOM	12100	C8	DA	C	5	-16.757	108.399	-32.224	1.00	45.49	C
ATOM	12101	N7	DA	C	5	-16.291	107.674	-31.230	1.00	41.42	N
ATOM	12102	C5	DA	C	5	-15.065	108.265	-30.945	1.00	42.64	C
ATOM	12103	C4	DA	C	5	-14.840	109.340	-31.775	1.00	44.53	C
ATOM	12104	N1	DA	C	5	-12.972	108.767	-29.973	1.00	44.71	N
ATOM	12105	C2	DA	C	5	-12.893	109.761	-30.838	1.00	43.82	C
ATOM	12106	N3	DA	C	5	-13.766	110.133	-31.774	1.00	47.38	N
ATOM	12107	C6	DA	C	5	-14.058	107.974	-29.995	1.00	46.14	C
ATOM	12108	N6	DA	C	5	-14.127	106.952	-29.124	1.00	46.70	N
ATOM	12109	O5'	DG	C	6	-13.777	108.651	-37.454	1.00	56.20	O
ATOM	12110	C4'	DG	C	6	-11.666	109.705	-36.905	1.00	57.33	C
ATOM	12111	C3'	DG	C	6	-10.764	108.510	-37.040	1.00	56.64	C
ATOM	12112	C2'	DG	C	6	-9.937	108.655	-35.773	1.00	59.18	C
ATOM	12113	P	DG	C	6	-15.250	108.548	-38.073	1.00	61.57	P
ATOM	12114	OP1	DG	C	6	-15.283	108.986	-39.480	1.00	61.43	O
ATOM	12115	OP2	DG	C	6	-15.670	107.182	-37.723	1.00	49.96	O
ATOM	12116	C5'	DG	C	6	-12.900	109.719	-37.797	1.00	57.95	C
ATOM	12117	O4'	DG	C	6	-12.072	109.609	-35.530	1.00	55.70	O
ATOM	12118	O3'	DG	C	6	-9.954	108.617	-38.177	1.00	69.13	O
ATOM	12119	C1'	DG	C	6	-10.993	109.113	-34.777	1.00	54.93	C
ATOM	12120	N9	DG	C	6	-11.454	108.039	-33.899	1.00	52.16	N
ATOM	12121	C8	DG	C	6	-12.616	107.305	-33.994	1.00	46.37	C
ATOM	12122	N7	DG	C	6	-12.732	106.405	-33.052	1.00	48.69	N
ATOM	12123	C5	DG	C	6	-11.565	106.555	-32.293	1.00	45.68	C
ATOM	12124	C4	DG	C	6	-10.776	107.550	-32.812	1.00	46.15	C
ATOM	12125	N1	DG	C	6	-9.889	106.352	-30.688	1.00	48.06	N
ATOM	12126	C2	DG	C	6	-9.182	107.361	-31.292	1.00	48.24	C
ATOM	12127	N3	DG	C	6	-9.579	107.996	-32.372	1.00	47.18	N
ATOM	12128	C6	DG	C	6	-11.120	105.868	-31.133	1.00	45.95	C
ATOM	12129	O6	DG	C	6	-11.675	104.948	-30.519	1.00	43.32	O
ATOM	12130	N2	DG	C	6	-8.022	107.688	-30.741	1.00	48.26	N
ATOM	12131	O5'	DC	C	7	-7.967	107.064	-37.809	1.00	65.24	O
ATOM	12132	C4'	DC	C	7	-5.905	107.473	-36.716	1.00	55.43	C
ATOM	12133	C3'	DC	C	7	-5.447	106.051	-36.962	1.00	56.85	C
ATOM	12134	C2'	DC	C	7	-5.003	105.614	-35.569	1.00	55.00	C
ATOM	12135	P	DC	C	7	-9.220	107.309	-38.777	1.00	67.30	P
ATOM	12136	OP1	DC	C	7	-8.814	107.741	-40.133	1.00	70.76	O
ATOM	12137	OP2	DC	C	7	-9.996	106.064	-38.561	1.00	62.07	O
ATOM	12138	C5'	DC	C	7	-6.906	107.994	-37.718	1.00	55.71	C
ATOM	12139	O4'	DC	C	7	-6.545	107.405	-35.425	1.00	56.99	O
ATOM	12140	O3'	DC	C	7	-4.377	106.012	-37.908	1.00	59.06	O
ATOM	12141	C1'	DC	C	7	-6.008	106.341	-34.668	1.00	52.92	C
ATOM	12142	N1	DC	C	7	-7.140	105.474	-34.192	1.00	49.21	N
ATOM	12143	C2	DC	C	7	-7.009	104.752	-33.004	1.00	49.59	C
ATOM	12144	N3	DC	C	7	-8.030	103.983	-32.586	1.00	49.72	N
ATOM	12145	C4	DC	C	7	-9.147	103.912	-33.292	1.00	47.52	C
ATOM	12146	C5	DC	C	7	-9.315	104.635	-34.506	1.00	49.46	C
ATOM	12147	C6	DC	C	7	-8.294	105.406	-34.911	1.00	52.23	C
ATOM	12148	O2	DC	C	7	-5.963	104.834	-32.360	1.00	50.59	O
ATOM	12149	N4	DC	C	7	-10.118	103.121	-32.828	1.00	47.59	N
ATOM	12150	O5'	DG	C	8	-3.385	103.708	-37.668	1.00	54.77	O
ATOM	12151	C4'	DG	C	8	-1.881	103.225	-35.874	1.00	51.22	C
ATOM	12152	C3'	DG	C	8	-1.826	101.751	-36.216	1.00	56.57	C
ATOM	12153	C2'	DG	C	8	-1.949	101.128	-34.819	1.00	54.54	C
ATOM	12154	P	DG	C	8	-4.077	104.650	-38.734	1.00	64.79	P
ATOM	12155	OP1	DG	C	8	-3.122	105.012	-39.798	1.00	69.25	O
ATOM	12156	OP2	DG	C	8	-5.327	103.970	-39.123	1.00	61.45	O
ATOM	12157	C5'	DG	C	8	-2.226	104.143	-37.022	1.00	53.71	C
ATOM	12158	O4'	DG	C	8	-2.874	103.328	-34.827	1.00	59.16	O

ATOM	12159	O3'	DG	C	8	-0.554	101.479	-36.813	1.00	59.38	O
ATOM	12160	C1'	DG	C	8	-2.894	102.119	-34.087	1.00	56.90	C
ATOM	12161	N9	DG	C	8	-4.280	101.641	-33.986	1.00	52.04	N
ATOM	12162	C8	DG	C	8	-5.298	101.848	-34.886	1.00	50.34	C
ATOM	12163	N7	DG	C	8	-6.422	101.267	-34.547	1.00	48.75	N
ATOM	12164	C5	DG	C	8	-6.123	100.623	-33.355	1.00	49.66	C
ATOM	12165	C4	DG	C	8	-4.809	100.836	-32.999	1.00	48.98	C
ATOM	12166	N1	DG	C	8	-6.245	99.367	-31.400	1.00	47.12	N
ATOM	12167	C2	DG	C	8	-4.915	99.629	-31.144	1.00	46.34	C
ATOM	12168	N3	DG	C	8	-4.152	100.382	-31.912	1.00	46.70	N
ATOM	12169	C6	DG	C	8	-6.944	99.837	-32.512	1.00	49.17	C
ATOM	12170	O6	DG	C	8	-8.134	99.544	-32.665	1.00	53.66	O
ATOM	12171	N2	DG	C	8	-4.398	99.093	-30.025	1.00	44.24	N
ATOM	12172	O5'	DC	C	9	-0.316	98.953	-36.554	1.00	55.66	O
ATOM	12173	C4'	DC	C	9	0.234	97.732	-34.521	1.00	46.82	C
ATOM	12174	C3'	DC	C	9	-0.171	96.370	-35.104	1.00	52.92	C
ATOM	12175	C2'	DC	C	9	-1.157	95.848	-34.054	1.00	49.75	C
ATOM	12176	P	DC	C	9	-0.236	100.137	-37.644	1.00	59.25	P
ATOM	12177	OP1	DC	C	9	1.154	100.413	-38.094	1.00	65.81	O
ATOM	12178	OP2	DC	C	9	-1.241	99.768	-38.675	1.00	50.20	O
ATOM	12179	O5'	DC	C	9	0.686	98.778	-35.537	1.00	53.30	O
ATOM	12180	O4'	DC	C	9	-0.962	98.213	-33.845	1.00	59.14	O
ATOM	12181	O3'	DC	C	9	1.003	95.457	-35.245	1.00	50.09	O
ATOM	12182	C1'	DC	C	9	-1.813	97.130	-33.515	1.00	52.84	C
ATOM	12183	N1	DC	C	9	-3.155	97.361	-34.092	1.00	49.22	N
ATOM	12184	C2	DC	C	9	-4.273	96.795	-33.479	1.00	50.85	C
ATOM	12185	N3	DC	C	9	-5.505	96.991	-34.037	1.00	47.82	N
ATOM	12186	C4	DC	C	9	-5.605	97.697	-35.170	1.00	50.78	C
ATOM	12187	C5	DC	C	9	-4.469	98.264	-35.809	1.00	50.03	C
ATOM	12188	C6	DC	C	9	-3.281	98.067	-35.243	1.00	52.84	C
ATOM	12189	O2	DC	C	9	-4.117	96.152	-32.433	1.00	48.46	O
ATOM	12190	N4	DC	C	9	-6.812	97.878	-35.695	1.00	51.68	N
ATOM	12191	O5'	DA	C	10	-0.052	93.117	-35.261	1.00	45.05	O
ATOM	12192	C4'	DA	C	10	-0.836	91.877	-33.309	1.00	43.80	C
ATOM	12193	C3'	DA	C	10	-1.462	90.754	-34.136	1.00	49.34	C
ATOM	12194	C2'	DA	C	10	-2.877	90.674	-33.577	1.00	47.67	C
ATOM	12195	P	DA	C	10	0.899	94.082	-36.104	1.00	51.21	P
ATOM	12196	OP1	DA	C	10	2.257	93.520	-36.107	1.00	52.71	O
ATOM	12197	OP2	DA	C	10	0.231	94.333	-37.417	1.00	44.91	O
ATOM	12198	C5'	DA	C	10	0.331	92.618	-33.966	1.00	43.72	C
ATOM	12199	O4'	DA	C	10	-1.919	92.797	-33.048	1.00	48.86	O
ATOM	12200	O3'	DA	C	10	-0.763	89.538	-33.890	1.00	53.33	O
ATOM	12201	C1'	DA	C	10	-3.162	92.119	-33.125	1.00	49.09	C
ATOM	12202	N9	DA	C	10	-4.039	92.829	-34.046	1.00	41.22	N
ATOM	12203	C8	DA	C	10	-3.671	93.660	-35.060	1.00	43.88	C
ATOM	12204	N7	DA	C	10	-4.683	94.121	-35.760	1.00	49.17	N
ATOM	12205	C5	DA	C	10	-5.791	93.541	-35.160	1.00	49.15	C
ATOM	12206	C4	DA	C	10	-5.402	92.725	-34.113	1.00	48.52	C
ATOM	12207	N1	DA	C	10	-8.014	92.918	-34.629	1.00	42.58	N
ATOM	12208	C2	DA	C	10	-7.495	92.171	-33.649	1.00	47.56	C
ATOM	12209	N3	DA	C	10	-6.206	92.007	-33.308	1.00	52.45	N
ATOM	12210	C6	DA	C	10	-7.181	93.631	-35.416	1.00	45.31	C
ATOM	12211	N6	DA	C	10	-7.702	94.357	-36.406	1.00	46.51	N
ATOM	12212	O5'	DC	C	11	-2.482	87.793	-34.639	1.00	57.34	O
ATOM	12213	C4'	DC	C	11	-4.398	86.886	-33.614	1.00	57.70	C
ATOM	12214	C3'	DC	C	11	-4.925	85.942	-34.688	1.00	53.86	C
ATOM	12215	C2'	DC	C	11	-6.228	86.600	-35.153	1.00	54.76	C
ATOM	12216	P	DC	C	11	-0.982	88.257	-34.835	1.00	56.18	P
ATOM	12217	OP1	DC	C	11	-0.095	87.201	-34.312	1.00	61.83	O
ATOM	12218	OP2	DC	C	11	-0.987	88.783	-36.224	1.00	52.86	O
ATOM	12219	C5'	DC	C	11	-2.883	87.011	-33.564	1.00	49.85	C
ATOM	12220	O4'	DC	C	11	-4.955	88.173	-33.943	1.00	50.15	O
ATOM	12221	O3'	DC	C	11	-5.192	84.718	-34.091	1.00	59.34	O

ATOM	12222	C1'	DC	C	11	-6.195	88.003	-34.575	1.00	48.78	C
ATOM	12223	N1	DC	C	11	-6.328	89.036	-35.601	1.00	50.37	N
ATOM	12224	C2	DC	C	11	-7.600	89.533	-35.923	1.00	52.31	C
ATOM	12225	N3	DC	C	11	-7.712	90.471	-36.881	1.00	48.32	N
ATOM	12226	C4	DC	C	11	-6.622	90.929	-37.490	1.00	50.79	C
ATOM	12227	C5	DC	C	11	-5.315	90.436	-37.176	1.00	48.15	C
ATOM	12228	C6	DC	C	11	-5.216	89.499	-36.234	1.00	48.21	C
ATOM	12229	O2	DC	C	11	-8.591	89.082	-35.341	1.00	56.89	O
ATOM	12230	N4	DC	C	11	-6.785	91.873	-38.427	1.00	50.68	N
ATOM	12231	O5'	DC	C	12	-7.071	83.810	-35.555	1.00	67.11	O
ATOM	12232	C4'	DC	C	12	-9.493	83.891	-35.516	1.00	63.52	C
ATOM	12233	C3'	DC	C	12	-9.561	82.905	-36.688	1.00	65.30	C
ATOM	12234	C2'	DC	C	12	-9.481	83.794	-37.928	1.00	62.60	C
ATOM	12235	P	DC	C	12	-5.641	83.431	-34.934	1.00	73.82	P
ATOM	12236	OP1	DC	C	12	-5.902	82.431	-33.854	1.00	62.91	O
ATOM	12237	OP2	DC	C	12	-4.689	83.206	-36.048	1.00	62.77	O
ATOM	12238	C5'	DC	C	12	-8.224	83.804	-34.705	1.00	63.24	C
ATOM	12239	O4'	DC	C	12	-9.606	85.221	-36.077	1.00	58.94	O
ATOM	12240	O3'	DC	C	12	-10.783	82.164	-36.643	1.00	73.75	O
ATOM	12241	C1'	DC	C	12	-9.996	85.136	-37.418	1.00	59.10	C
ATOM	12242	N1	DC	C	12	-9.405	86.271	-38.133	1.00	52.17	N
ATOM	12243	C2	DC	C	12	-10.198	87.018	-38.989	1.00	53.23	C
ATOM	12244	N3	DC	C	12	-9.652	88.050	-39.657	1.00	54.54	N
ATOM	12245	C4	DC	C	12	-8.368	88.341	-39.491	1.00	55.98	C
ATOM	12246	C5	DC	C	12	-7.530	87.577	-38.619	1.00	54.12	C
ATOM	12247	C6	DC	C	12	-8.092	86.563	-37.965	1.00	50.77	C
ATOM	12248	O2	DC	C	12	-11.388	86.727	-39.101	1.00	57.76	O
ATOM	12249	N4	DC	C	12	-7.874	89.377	-40.173	1.00	53.41	N
ATOM	12250	O5'	DC	C	13	-11.793	81.390	-38.815	1.00	67.38	O
ATOM	12251	C4'	DC	C	13	-13.436	82.631	-39.953	1.00	66.94	C
ATOM	12252	C3'	DC	C	13	-13.295	81.641	-41.111	1.00	62.98	C
ATOM	12253	C2'	DC	C	13	-12.228	82.266	-42.016	1.00	66.99	C
ATOM	12254	P	DC	C	13	-10.978	80.851	-37.560	1.00	75.86	P
ATOM	12255	OP1	DC	C	13	-11.855	79.918	-36.810	1.00	66.48	O
ATOM	12256	OP2	DC	C	13	-9.652	80.433	-38.090	1.00	67.95	O
ATOM	12257	C5'	DC	C	13	-12.980	82.091	-38.629	1.00	63.50	C
ATOM	12258	O4'	DC	C	13	-12.634	83.790	-40.300	1.00	70.50	O
ATOM	12259	O3'	DC	C	13	-14.536	81.507	-41.780	1.00	73.68	O
ATOM	12260	C1'	DC	C	13	-12.329	83.747	-41.671	1.00	64.17	C
ATOM	12261	N1	DC	C	13	-11.067	84.488	-41.889	1.00	53.97	N
ATOM	12262	C2	DC	C	13	-11.035	85.546	-42.792	1.00	57.44	C
ATOM	12263	O2	DC	C	13	-12.070	85.852	-43.398	1.00	60.29	O
ATOM	12264	N3	DC	C	13	-9.867	86.210	-42.982	1.00	56.72	N
ATOM	12265	C4	DC	C	13	-8.774	85.842	-42.310	1.00	58.46	C
ATOM	12266	N4	DC	C	13	-7.646	86.527	-42.524	1.00	61.41	N
ATOM	12267	C5	DC	C	13	-8.789	84.759	-41.381	1.00	55.54	C
ATOM	12268	C6	DC	C	13	-9.947	84.120	-41.205	1.00	56.93	C
ATOM	12269	O5'	DA	C	14	-14.407	80.701	-44.164	1.00	75.98	O
ATOM	12270	C4'	DA	C	14	-14.362	82.104	-46.079	1.00	77.19	C
ATOM	12271	C3'	DA	C	14	-13.736	80.861	-46.728	1.00	84.51	C
ATOM	12272	C2'	DA	C	14	-12.235	81.155	-46.710	1.00	78.49	C
ATOM	12273	P	DA	C	14	-14.836	80.226	-42.707	1.00	83.46	P
ATOM	12274	OP1	DA	C	14	-16.304	80.020	-42.696	1.00	75.58	O
ATOM	12275	OP2	DA	C	14	-13.896	79.136	-42.358	1.00	75.30	O
ATOM	12276	C5'	DA	C	14	-14.996	81.836	-44.741	1.00	74.03	C
ATOM	12277	O4'	DA	C	14	-13.284	83.063	-45.921	1.00	71.91	O
ATOM	12278	O3'	DA	C	14	-14.222	80.693	-48.052	1.00	90.01	O
ATOM	12279	C1'	DA	C	14	-12.223	82.673	-46.751	1.00	74.33	C
ATOM	12280	N9	DA	C	14	-10.994	83.242	-46.237	1.00	65.22	N
ATOM	12281	C8	DA	C	14	-10.230	82.750	-45.226	1.00	59.46	C
ATOM	12282	N7	DA	C	14	-9.162	83.466	-44.983	1.00	62.78	N
ATOM	12283	C5	DA	C	14	-9.236	84.499	-45.903	1.00	59.62	C
ATOM	12284	C4	DA	C	14	-10.353	84.365	-46.689	1.00	61.46	C

ATOM	12285	N1	DA	C	14	-8.758	86.438	-47.159	1.00	65.27	N
ATOM	12286	C2	DA	C	14	-9.882	86.184	-47.831	1.00	69.26	C
ATOM	12287	N3	DA	C	14	-10.739	85.173	-47.678	1.00	71.05	N
ATOM	12288	C6	DA	C	14	-8.398	85.599	-46.166	1.00	64.18	C
ATOM	12289	N6	DA	C	14	-7.265	85.840	-45.490	1.00	66.61	N
ATOM	12290	O5'	DA	C	15	-12.794	78.810	-48.985	1.00	90.63	O
ATOM	12291	C4'	DA	C	15	-12.347	79.556	-51.285	1.00	89.20	C
ATOM	12292	O3'	DA	C	15	-11.159	79.569	-52.237	1.00	89.88	O
ATOM	12293	C2'	DA	C	15	-10.905	81.059	-52.466	1.00	88.31	C
ATOM	12294	P	DA	C	15	-14.335	79.219	-48.692	1.00	94.40	P
ATOM	12295	OP1	DA	C	15	-15.119	79.435	-49.932	1.00	92.99	O
ATOM	12296	OP2	DA	C	15	-14.880	78.293	-47.662	1.00	79.21	O
ATOM	12297	C5'	DA	C	15	-12.364	78.394	-50.294	1.00	87.27	C
ATOM	12298	O4'	DA	C	15	-12.316	80.826	-50.581	1.00	90.53	O
ATOM	12299	O3'	DA	C	15	-11.516	78.925	-53.441	1.00	90.78	O
ATOM	12300	C1'	DA	C	15	-11.318	81.670	-51.132	1.00	85.83	C
ATOM	12301	N9	DA	C	15	-10.228	81.782	-50.162	1.00	79.86	N
ATOM	12302	C8	DA	C	15	-10.040	81.004	-49.053	1.00	78.32	C
ATOM	12303	N7	DA	C	15	-8.991	81.338	-48.341	1.00	75.11	N
ATOM	12304	C5	DA	C	15	-8.443	82.405	-49.036	1.00	71.41	C
ATOM	12305	C4	DA	C	15	-9.194	82.697	-50.159	1.00	70.43	C
ATOM	12306	N1	DA	C	15	-7.038	84.189	-49.687	1.00	65.52	N
ATOM	12307	C2	DA	C	15	-7.864	84.359	-50.727	1.00	71.68	C
ATOM	12308	N3	DA	C	15	-8.960	83.668	-51.051	1.00	73.35	N
ATOM	12309	C6	DA	C	15	-7.305	83.209	-48.798	1.00	68.05	C
ATOM	12310	N6	DA	C	15	-6.489	83.042	-47.741	1.00	60.50	N
ATOM	12311	O5'	DT	C	16	-9.268	78.405	-54.473	1.00	90.13	O
ATOM	12312	C4'	DT	C	16	-7.961	79.779	-55.996	1.00	93.11	C
ATOM	12313	C3'	DT	C	16	-6.583	79.148	-55.888	1.00	89.24	C
ATOM	12314	C2'	DT	C	16	-5.730	80.389	-55.659	1.00	89.86	C
ATOM	12315	P	DT	C	16	-10.632	77.709	-53.997	1.00	98.91	P
ATOM	12316	OP1	DT	C	16	-11.384	77.197	-55.170	1.00	95.27	O
ATOM	12317	OP2	DT	C	16	-10.283	76.815	-52.864	1.00	97.14	O
ATOM	12318	C5'	DT	C	16	-9.144	78.842	-55.816	1.00	93.25	C
ATOM	12319	O4'	DT	C	16	-7.962	80.786	-54.953	1.00	91.01	O
ATOM	12320	O3'	DT	C	16	-6.229	78.495	-57.103	1.00	90.42	O
ATOM	12321	C1'	DT	C	16	-6.629	81.213	-54.729	1.00	84.87	C
ATOM	12322	N1	DT	C	16	-6.300	81.012	-53.317	1.00	78.59	N
ATOM	12323	C2	DT	C	16	-5.337	81.800	-52.757	1.00	76.53	C
ATOM	12324	N3	DT	C	16	-5.080	81.542	-51.434	1.00	70.12	N
ATOM	12325	C4	DT	C	16	-5.680	80.580	-50.641	1.00	74.94	C
ATOM	12326	C5	DT	C	16	-6.684	79.772	-51.304	1.00	79.03	C
ATOM	12327	C6	DT	C	16	-6.940	80.024	-52.596	1.00	80.62	C
ATOM	12328	O2	DT	C	16	-4.756	82.674	-53.380	1.00	75.99	O
ATOM	12329	O4	DT	C	16	-5.375	80.417	-49.459	1.00	73.83	O
ATOM	12330	C7	DT	C	16	-7.406	78.691	-50.549	1.00	82.08	C
ATOM	12331	P	DT	C	17	-5.147	77.298	-57.109	1.00	96.67	P
ATOM	12332	OP1	DT	C	17	-5.316	76.419	-55.923	1.00	86.35	O
ATOM	12333	OP2	DT	C	17	-5.223	76.732	-58.473	1.00	97.42	O
ATOM	12334	O5'	DT	C	17	-3.736	78.037	-56.977	1.00	87.15	O
ATOM	12335	O3'	DT	C	17	-0.292	77.652	-58.133	1.00	75.39	O
ATOM	12336	C1'	DT	C	17	-0.923	80.392	-55.804	1.00	79.36	C
ATOM	12337	C2'	DT	C	17	0.024	79.329	-56.364	1.00	77.18	C
ATOM	12338	C3'	DT	C	17	-0.946	78.412	-57.097	1.00	80.55	C
ATOM	12339	C4'	DT	C	17	-1.907	79.436	-57.706	1.00	84.38	C
ATOM	12340	C5'	DT	C	17	-3.291	78.903	-58.016	1.00	87.16	C
ATOM	12341	O4'	DT	C	17	-2.009	80.492	-56.712	1.00	78.68	O
ATOM	12342	N1	DT	C	17	-1.424	80.053	-54.405	1.00	79.36	N
ATOM	12343	C2	DT	C	17	-0.753	80.576	-53.327	1.00	70.59	C
ATOM	12344	N3	DT	C	17	-1.235	80.203	-52.108	1.00	69.07	N
ATOM	12345	C4	DT	C	17	-2.300	79.364	-51.850	1.00	76.19	C
ATOM	12346	C5	DT	C	17	-2.959	78.827	-53.017	1.00	77.98	C
ATOM	12347	C6	DT	C	17	-2.493	79.188	-54.230	1.00	79.15	C

ATOM	12348	O2	DT	C	17	0.189	81.329	-53.440	1.00	71.96	O
ATOM	12349	O4	DT	C	17	-2.662	79.092	-50.704	1.00	76.12	O
ATOM	12350	C7	DT	C	17	-4.128	77.900	-52.856	1.00	81.32	C
ATOM	12351	P	DT	C	18	0.273	76.169	-57.858	1.00	73.29	P
ATOM	12352	OP1	DT	C	18	0.847	75.763	-59.161	1.00	80.02	O
ATOM	12353	OP2	DT	C	18	-0.694	75.298	-57.148	1.00	65.06	O
ATOM	12354	O5'	DT	C	18	1.463	76.377	-56.816	1.00	71.30	O
ATOM	12355	C5'	DT	C	18	2.611	77.118	-57.193	1.00	69.60	C
ATOM	12356	C4'	DT	C	18	3.492	77.381	-55.988	1.00	67.48	C
ATOM	12357	O4'	DT	C	18	2.767	78.170	-55.012	1.00	69.22	O
ATOM	12358	C3'	DT	C	18	3.905	76.146	-55.211	1.00	64.97	C
ATOM	12359	O3'	DT	C	18	5.001	75.474	-55.864	1.00	60.15	O
ATOM	12360	C2'	DT	C	18	4.319	76.763	-53.878	1.00	59.47	C
ATOM	12361	C1'	DT	C	18	3.297	77.905	-53.724	1.00	68.57	C
ATOM	12362	N1	DT	C	18	2.192	77.549	-52.795	1.00	71.83	N
ATOM	12363	C2	DT	C	18	2.304	77.892	-51.468	1.00	65.58	C
ATOM	12364	N3	DT	C	18	1.268	77.479	-50.683	1.00	71.02	N
ATOM	12365	C4	DT	C	18	0.148	76.768	-51.077	1.00	74.66	C
ATOM	12366	C5	DT	C	18	0.101	76.414	-52.482	1.00	76.04	C
ATOM	12367	C6	DT	C	18	1.117	76.815	-53.263	1.00	73.29	C
ATOM	12368	O2	DT	C	18	3.242	78.520	-51.019	1.00	62.51	O
ATOM	12369	O4	DT	C	18	-0.731	76.438	-50.284	1.00	74.99	O
ATOM	12370	C7	DT	C	18	-1.061	75.627	-53.031	1.00	74.04	C
ATOM	12371	P	DC	C	19	5.372	73.966	-55.468	1.00	61.86	P
ATOM	12372	OP1	DC	C	19	6.289	73.463	-56.515	1.00	73.37	O
ATOM	12373	OP2	DC	C	19	4.154	73.187	-55.176	1.00	62.95	O
ATOM	12374	O5'	DC	C	19	6.177	74.127	-54.104	1.00	59.13	O
ATOM	12375	C5'	DC	C	19	5.940	73.242	-53.033	1.00	56.20	C
ATOM	12376	C4'	DC	C	19	6.469	73.826	-51.742	1.00	57.19	C
ATOM	12377	O4'	DC	C	19	5.652	74.974	-51.355	1.00	66.25	O
ATOM	12378	C3'	DC	C	19	6.413	72.888	-50.562	1.00	59.36	C
ATOM	12379	O3'	DC	C	19	7.591	72.111	-50.500	1.00	63.29	O
ATOM	12380	C2'	DC	C	19	6.303	73.845	-49.381	1.00	62.35	C
ATOM	12381	C1'	DC	C	19	5.404	74.937	-49.960	1.00	62.10	C
ATOM	12382	N1	DC	C	19	3.949	74.700	-49.754	1.00	62.69	N
ATOM	12383	C2	DC	C	19	3.405	74.821	-48.475	1.00	61.30	C
ATOM	12384	N3	DC	C	19	2.077	74.612	-48.300	1.00	66.25	N
ATOM	12385	C4	DC	C	19	1.304	74.307	-49.350	1.00	72.23	C
ATOM	12386	C5	DC	C	19	1.845	74.178	-50.670	1.00	66.55	C
ATOM	12387	C6	DC	C	19	3.154	74.387	-50.825	1.00	62.41	C
ATOM	12388	O2	DC	C	19	4.143	75.110	-47.540	1.00	62.35	O
ATOM	12389	N4	DC	C	19	-0.008	74.119	-49.133	1.00	69.57	N
ATOM	12390	O5'	DC	C	20	7.475	71.138	-48.179	1.00	71.10	O
ATOM	12391	C4'	DC	C	20	8.314	71.796	-46.016	1.00	65.58	C
ATOM	12392	C3'	DC	C	20	7.955	70.553	-45.222	1.00	63.03	C
ATOM	12393	C2'	DC	C	20	7.088	71.122	-44.107	1.00	57.58	C
ATOM	12394	P	DC	C	20	7.541	70.713	-49.726	1.00	62.96	P
ATOM	12395	OP1	DC	C	20	8.779	69.936	-49.979	1.00	69.30	O
ATOM	12396	OP2	DC	C	20	6.210	70.165	-50.036	1.00	65.86	O
ATOM	12397	C5'	DC	C	20	8.643	71.552	-47.480	1.00	63.00	C
ATOM	12398	O4'	DC	C	20	7.133	72.640	-45.932	1.00	65.35	O
ATOM	12399	O3'	DC	C	20	9.127	69.943	-44.704	1.00	66.38	O
ATOM	12400	C1'	DC	C	20	6.351	72.258	-44.818	1.00	65.38	C
ATOM	12401	N1	DC	C	20	4.983	71.892	-45.298	1.00	63.58	N
ATOM	12402	C2	DC	C	20	3.942	71.750	-44.371	1.00	65.23	C
ATOM	12403	N3	DC	C	20	2.704	71.422	-44.820	1.00	65.31	N
ATOM	12404	C4	DC	C	20	2.491	71.251	-46.124	1.00	63.56	C
ATOM	12405	C5	DC	C	20	3.537	71.402	-47.086	1.00	62.19	C
ATOM	12406	C6	DC	C	20	4.755	71.723	-46.631	1.00	63.80	C
ATOM	12407	O2	DC	C	20	4.179	71.915	-43.165	1.00	68.05	O
ATOM	12408	N4	DC	C	20	1.258	70.928	-46.513	1.00	59.23	N
TER											
ATOM	12409	O	LYS	D	3	26.996	70.297	39.675	1.00	84.46	O

ATOM	12410	N	LYS	D	3	27.400	73.484	38.276	1.00	89.12	N
ATOM	12411	CA	LYS	D	3	27.508	72.633	39.452	1.00	86.99	C
ATOM	12412	C	LYS	D	3	26.582	71.415	39.348	1.00	87.92	C
ATOM	12413	CB	LYS	D	3	27.201	73.433	40.723	1.00	85.45	C
ATOM	12414	O	LYS	D	4	24.295	70.371	36.419	1.00	73.23	O
ATOM	12415	N	LYS	D	4	25.346	71.618	38.884	1.00	77.37	N
ATOM	12416	CA	LYS	D	4	24.350	70.529	38.857	1.00	80.26	C
ATOM	12417	C	LYS	D	4	24.232	69.771	37.505	1.00	80.19	C
ATOM	12418	CB	LYS	D	4	22.972	71.074	39.255	1.00	66.31	C
ATOM	12419	O	TYR	D	5	22.957	65.936	37.810	1.00	60.10	O
ATOM	12420	N	TYR	D	5	24.053	68.449	37.585	1.00	71.86	N
ATOM	12421	CA	TYR	D	5	23.944	67.601	36.388	1.00	64.06	C
ATOM	12422	C	TYR	D	5	23.169	66.329	36.660	1.00	61.25	C
ATOM	12423	CB	TYR	D	5	25.324	67.221	35.839	1.00	55.67	C
ATOM	12424	CG	TYR	D	5	26.036	66.194	36.686	1.00	61.45	C
ATOM	12425	CD1	TYR	D	5	26.656	66.565	37.869	1.00	59.48	C
ATOM	12426	CD2	TYR	D	5	26.080	64.850	36.309	1.00	60.01	C
ATOM	12427	CE1	TYR	D	5	27.285	65.659	38.656	1.00	63.85	C
ATOM	12428	CE2	TYR	D	5	26.727	63.918	37.100	1.00	61.51	C
ATOM	12429	CZ	TYR	D	5	27.329	64.331	38.271	1.00	65.05	C
ATOM	12430	OH	TYR	D	5	27.986	63.430	39.071	1.00	60.13	O
ATOM	12431	N	SER	D	6	22.773	65.673	35.578	1.00	53.95	N
ATOM	12432	CA	SER	D	6	22.052	64.417	35.671	1.00	57.51	C
ATOM	12433	C	SER	D	6	22.724	63.313	34.844	1.00	52.45	C
ATOM	12434	O	SER	D	6	23.411	63.594	33.850	1.00	54.02	O
ATOM	12435	CB	SER	D	6	20.603	64.614	35.217	1.00	52.76	C
ATOM	12436	OG	SER	D	6	19.703	64.294	36.264	1.00	61.19	O
ATOM	12437	N	ILE	D	7	22.497	62.066	35.232	1.00	46.32	N
ATOM	12438	CA	ILE	D	7	23.034	60.923	34.474	1.00	42.14	C
ATOM	12439	C	ILE	D	7	21.929	59.987	33.977	1.00	42.53	C
ATOM	12440	O	ILE	D	7	21.105	59.510	34.766	1.00	40.60	O
ATOM	12441	CB	ILE	D	7	24.041	60.132	35.320	1.00	46.84	C
ATOM	12442	CG1	ILE	D	7	25.345	60.919	35.461	1.00	50.64	C
ATOM	12443	CG2	ILE	D	7	24.383	58.789	34.662	1.00	48.80	C
ATOM	12444	CD1	ILE	D	7	26.172	60.509	36.668	1.00	55.49	C
ATOM	12445	N	GLY	D	8	21.886	59.764	32.661	1.00	42.85	N
ATOM	12446	CA	GLY	D	8	21.041	58.719	32.087	1.00	44.12	C
ATOM	12447	C	GLY	D	8	21.771	57.404	31.721	1.00	52.36	C
ATOM	12448	O	GLY	D	8	22.876	57.390	31.137	1.00	47.43	O
ATOM	12449	N	LEU	D	9	21.126	56.286	32.031	1.00	47.15	N
ATOM	12450	CA	LEU	D	9	21.734	54.961	31.871	1.00	42.60	C
ATOM	12451	C	LEU	D	9	20.863	54.039	31.043	1.00	47.59	C
ATOM	12452	O	LEU	D	9	19.701	53.854	31.373	1.00	50.41	O
ATOM	12453	CB	LEU	D	9	21.972	54.300	33.243	1.00	43.92	C
ATOM	12454	CG	LEU	D	9	23.026	54.849	34.218	1.00	39.71	C
ATOM	12455	CD1	LEU	D	9	22.984	54.105	35.539	1.00	32.79	C
ATOM	12456	CD2	LEU	D	9	24.408	54.866	33.618	1.00	38.19	C
ATOM	12457	N	ALA	D	10	21.427	53.438	29.993	1.00	46.25	N
ATOM	12458	CA	ALA	D	10	20.693	52.462	29.191	1.00	47.44	C
ATOM	12459	C	ALA	D	10	21.419	51.105	29.176	1.00	43.68	C
ATOM	12460	O	ALA	D	10	22.393	50.898	28.463	1.00	44.49	O
ATOM	12461	CB	ALA	D	10	20.484	52.986	27.764	1.00	43.53	C
ATOM	12462	N	ILE	D	11	20.935	50.180	29.980	1.00	48.74	N
ATOM	12463	CA	ILE	D	11	21.664	48.939	30.192	1.00	52.66	C
ATOM	12464	C	ILE	D	11	21.079	47.777	29.395	1.00	52.04	C
ATOM	12465	O	ILE	D	11	19.892	47.463	29.501	1.00	49.68	O
ATOM	12466	CB	ILE	D	11	21.681	48.567	31.683	1.00	50.01	C
ATOM	12467	CG1	ILE	D	11	22.359	49.656	32.505	1.00	41.36	C
ATOM	12468	CG2	ILE	D	11	22.385	47.247	31.896	1.00	49.13	C
ATOM	12469	CD1	ILE	D	11	22.004	49.575	33.970	1.00	46.65	C
ATOM	12470	N	GLY	D	12	21.923	47.153	28.582	1.00	50.28	N
ATOM	12471	CA	GLY	D	12	21.558	45.924	27.883	1.00	55.74	C
ATOM	12472	C	GLY	D	12	22.480	44.780	28.278	1.00	53.71	C

ATOM	12473	O	GLY	D	12	23.334	44.933	29.166	1.00	55.91	O
ATOM	12474	O	THR	D	13	25.526	42.084	28.099	1.00	56.49	O
ATOM	12475	N	THR	D	13	22.336	43.637	27.616	1.00	61.55	N
ATOM	12476	CA	THR	D	13	23.154	42.457	27.955	1.00	61.17	C
ATOM	12477	C	THR	D	13	24.599	42.648	27.513	1.00	56.85	C
ATOM	12478	CB	THR	D	13	22.596	41.182	27.320	1.00	57.20	C
ATOM	12479	OG1	THR	D	13	22.177	41.464	25.975	1.00	60.05	O
ATOM	12480	CG2	THR	D	13	21.402	40.702	28.117	1.00	63.00	C
ATOM	12481	O	ASN	D	14	27.403	45.504	25.076	1.00	41.75	O
ATOM	12482	N	ASN	D	14	24.787	43.491	26.505	1.00	53.73	N
ATOM	12483	CA	ASN	D	14	26.104	43.705	25.962	1.00	43.96	C
ATOM	12484	C	ASN	D	14	26.502	45.166	25.835	1.00	41.92	C
ATOM	12485	CB	ASN	D	14	26.183	42.993	24.621	1.00	43.85	C
ATOM	12486	CG	ASN	D	14	26.140	41.491	24.788	1.00	49.94	C
ATOM	12487	OD1	ASN	D	14	25.073	40.871	24.771	1.00	51.37	O
ATOM	12488	ND2	ASN	D	14	27.309	40.899	25.021	1.00	46.48	N
ATOM	12489	O	SER	D	15	24.742	47.941	28.421	1.00	49.52	O
ATOM	12490	N	SER	D	15	25.838	46.038	26.591	1.00	50.01	N
ATOM	12491	CA	SER	D	15	26.168	47.465	26.542	1.00	46.56	C
ATOM	12492	C	SER	D	15	25.718	48.270	27.745	1.00	46.42	C
ATOM	12493	CB	SER	D	15	25.591	48.109	25.286	1.00	41.97	C
ATOM	12494	OG	SER	D	15	24.299	47.642	25.047	1.00	43.38	O
ATOM	12495	O	VAL	D	16	27.202	52.223	27.977	1.00	43.03	O
ATOM	12496	N	VAL	D	16	26.478	49.320	28.014	1.00	44.48	N
ATOM	12497	CA	VAL	D	16	26.080	50.348	28.955	1.00	44.61	C
ATOM	12498	C	VAL	D	16	26.119	51.677	28.217	1.00	41.95	C
ATOM	12499	CB	VAL	D	16	27.002	50.415	30.187	1.00	45.39	C
ATOM	12500	CG1	VAL	D	16	26.625	51.598	31.051	1.00	48.75	C
ATOM	12501	CG2	VAL	D	16	26.938	49.121	30.993	1.00	40.13	C
ATOM	12502	N	GLY	D	17	24.943	52.169	27.824	1.00	44.45	N
ATOM	12503	CA	GLY	D	17	24.818	53.494	27.215	1.00	42.07	C
ATOM	12504	C	GLY	D	17	24.672	54.513	28.335	1.00	42.90	C
ATOM	12505	O	GLY	D	17	23.926	54.265	29.296	1.00	44.34	O
ATOM	12506	N	TRP	D	18	25.390	55.630	28.250	1.00	39.47	N
ATOM	12507	CA	TRP	D	18	25.332	56.632	29.326	1.00	43.64	C
ATOM	12508	C	TRP	D	18	25.317	58.063	28.795	1.00	45.15	C
ATOM	12509	O	TRP	D	18	25.828	58.349	27.703	1.00	42.13	O
ATOM	12510	CB	TRP	D	18	26.512	56.472	30.304	1.00	42.54	C
ATOM	12511	CG	TRP	D	18	27.816	56.442	29.609	1.00	41.96	C
ATOM	12512	CD1	TRP	D	18	28.457	55.336	29.134	1.00	46.53	C
ATOM	12513	CD2	TRP	D	18	28.629	57.567	29.245	1.00	47.89	C
ATOM	12514	NE1	TRP	D	18	29.624	55.694	28.509	1.00	49.35	N
ATOM	12515	CE2	TRP	D	18	29.765	57.056	28.566	1.00	45.95	C
ATOM	12516	CE3	TRP	D	18	28.514	58.959	29.429	1.00	47.89	C
ATOM	12517	CZ2	TRP	D	18	30.783	57.879	28.074	1.00	45.18	C
ATOM	12518	CZ3	TRP	D	18	29.528	59.787	28.944	1.00	45.23	C
ATOM	12519	CH2	TRP	D	18	30.648	59.240	28.270	1.00	55.05	C
ATOM	12520	N	ALA	D	19	24.741	58.969	29.579	1.00	48.08	N
ATOM	12521	CA	ALA	D	19	24.829	60.397	29.227	1.00	51.98	C
ATOM	12522	C	ALA	D	19	24.821	61.320	30.445	1.00	46.18	C
ATOM	12523	O	ALA	D	19	24.192	61.028	31.477	1.00	49.64	O
ATOM	12524	CB	ALA	D	19	23.718	60.776	28.269	1.00	43.13	C
ATOM	12525	N	VAL	D	20	25.575	62.409	30.328	1.00	44.44	N
ATOM	12526	CA	VAL	D	20	25.465	63.505	31.293	1.00	56.37	C
ATOM	12527	C	VAL	D	20	24.529	64.610	30.745	1.00	52.01	C
ATOM	12528	O	VAL	D	20	24.749	65.103	29.638	1.00	53.46	O
ATOM	12529	CB	VAL	D	20	26.843	64.125	31.613	1.00	56.60	C
ATOM	12530	CG1	VAL	D	20	26.732	65.084	32.800	1.00	57.90	C
ATOM	12531	CG2	VAL	D	20	27.870	63.042	31.889	1.00	53.10	C
ATOM	12532	N	ILE	D	21	23.480	64.976	31.472	1.00	50.63	N
ATOM	12533	CA	ILE	D	21	22.728	66.182	31.065	1.00	56.59	C
ATOM	12534	C	ILE	D	21	22.695	67.279	32.131	1.00	57.53	C
ATOM	12535	O	ILE	D	21	22.615	67.004	33.331	1.00	56.80	O

ATOM	12536	CB	ILE	D	21	21.253	65.894	30.676	1.00	53.71	C
ATOM	12537	CG1	ILE	D	21	20.484	65.316	31.854	1.00	55.02	C
ATOM	12538	CG2	ILE	D	21	21.167	65.004	29.457	1.00	52.77	C
ATOM	12539	CD1	ILE	D	21	18.996	65.550	31.782	1.00	60.04	C
ATOM	12540	N	THR	D	22	22.763	68.524	31.658	1.00	64.72	N
ATOM	12541	CA	THR	D	22	22.436	69.731	32.438	1.00	63.82	C
ATOM	12542	C	THR	D	22	20.930	69.823	32.733	1.00	69.19	C
ATOM	12543	O	THR	D	22	20.177	68.911	32.413	1.00	69.08	O
ATOM	12544	CB	THR	D	22	22.853	70.977	31.677	1.00	57.97	C
ATOM	12545	OG1	THR	D	22	21.901	71.205	30.635	1.00	67.71	O
ATOM	12546	CG2	THR	D	22	24.221	70.775	31.032	1.00	56.07	C
ATOM	12547	N	ASP	D	23	20.470	70.928	33.319	1.00	79.39	N
ATOM	12548	CA	ASP	D	23	19.020	71.097	33.529	1.00	78.39	C
ATOM	12549	C	ASP	D	23	18.374	71.883	32.368	1.00	74.08	C
ATOM	12550	O	ASP	D	23	17.145	72.067	32.320	1.00	66.82	O
ATOM	12551	CB	ASP	D	23	18.727	71.763	34.885	1.00	78.35	C
ATOM	12552	CG	ASP	D	23	19.486	73.075	35.085	1.00	87.28	C
ATOM	12553	OD1	ASP	D	23	20.061	73.601	34.098	1.00	81.11	O
ATOM	12554	OD2	ASP	D	23	19.492	73.584	36.236	1.00	83.37	O
ATOM	12555	N	GLU	D	24	19.219	72.327	31.439	1.00	64.85	N
ATOM	12556	CA	GLU	D	24	18.764	72.748	30.124	1.00	64.67	C
ATOM	12557	C	GLU	D	24	18.538	71.558	29.195	1.00	71.64	C
ATOM	12558	O	GLU	D	24	18.094	71.737	28.067	1.00	72.87	O
ATOM	12559	CB	GLU	D	24	19.775	73.689	29.487	1.00	69.29	C
ATOM	12560	N	TYR	D	25	18.861	70.356	29.684	1.00	73.44	N
ATOM	12561	CA	TYR	D	25	18.843	69.098	28.922	1.00	63.40	C
ATOM	12562	C	TYR	D	25	19.867	69.092	27.802	1.00	67.86	C
ATOM	12563	O	TYR	D	25	19.646	68.485	26.752	1.00	65.09	O
ATOM	12564	CB	TYR	D	25	17.465	68.800	28.327	1.00	56.59	C
ATOM	12565	CG	TYR	D	25	16.330	68.908	29.303	1.00	66.93	C
ATOM	12566	CD1	TYR	D	25	16.161	67.956	30.289	1.00	59.42	C
ATOM	12567	CD2	TYR	D	25	15.413	69.973	29.237	1.00	65.54	C
ATOM	12568	CE1	TYR	D	25	15.123	68.037	31.192	1.00	58.70	C
ATOM	12569	CE2	TYR	D	25	14.364	70.059	30.135	1.00	59.73	C
ATOM	12570	CZ	TYR	D	25	14.230	69.087	31.112	1.00	63.97	C
ATOM	12571	OH	TYR	D	25	13.205	69.140	32.020	1.00	67.68	O
ATOM	12572	O	LYS	D	26	23.482	68.562	28.676	1.00	58.16	O
ATOM	12573	N	LYS	D	26	20.997	69.750	28.012	1.00	66.46	N
ATOM	12574	CA	LYS	D	26	22.060	69.659	27.016	1.00	66.21	C
ATOM	12575	C	LYS	D	26	23.274	68.815	27.484	1.00	61.28	C
ATOM	12576	CB	LYS	D	26	22.492	71.067	26.602	1.00	67.10	C
ATOM	12577	CG	LYS	D	26	22.295	72.115	27.681	1.00	72.09	C
ATOM	12578	CD	LYS	D	26	22.596	73.520	27.167	1.00	70.24	C
ATOM	12579	CE	LYS	D	26	21.753	73.840	25.944	1.00	70.30	C
ATOM	12580	NZ	LYS	D	26	22.221	75.064	25.262	1.00	62.08	N
ATOM	12581	N	VAL	D	27	24.062	68.366	26.517	1.00	61.00	N
ATOM	12582	CA	VAL	D	27	25.210	67.526	26.798	1.00	52.06	C
ATOM	12583	C	VAL	D	27	26.498	68.343	26.760	1.00	47.50	C
ATOM	12584	O	VAL	D	27	26.922	68.808	25.711	1.00	46.00	O
ATOM	12585	CB	VAL	D	27	25.304	66.328	25.795	1.00	54.90	C
ATOM	12586	CG1	VAL	D	27	26.642	65.548	25.953	1.00	48.85	C
ATOM	12587	CG2	VAL	D	27	24.130	65.394	25.971	1.00	51.54	C
ATOM	12588	N	PRO	D	28	27.150	68.481	27.912	1.00	44.72	N
ATOM	12589	CA	PRO	D	28	28.421	69.203	27.994	1.00	37.58	C
ATOM	12590	C	PRO	D	28	29.530	68.540	27.235	1.00	55.22	C
ATOM	12591	O	PRO	D	28	29.589	67.312	27.143	1.00	65.32	O
ATOM	12592	CB	PRO	D	28	28.747	69.199	29.480	1.00	44.40	C
ATOM	12593	CG	PRO	D	28	27.851	68.205	30.105	1.00	46.81	C
ATOM	12594	CD	PRO	D	28	26.685	67.978	29.214	1.00	47.32	C
ATOM	12595	N	SER	D	29	30.410	69.362	26.687	1.00	59.36	N
ATOM	12596	CA	SER	D	29	31.683	68.906	26.174	1.00	54.05	C
ATOM	12597	C	SER	D	29	32.724	69.331	27.183	1.00	60.59	C
ATOM	12598	O	SER	D	29	32.439	70.172	28.029	1.00	67.28	O

ATOM	12599	CB	SER	D	29	31.977	69.512	24.815	1.00	60.44	C
ATOM	12600	OG	SER	D	29	32.273	70.888	24.965	1.00	63.40	O
ATOM	12601	N	LYS	D	30	33.918	68.750	27.118	1.00	62.00	N
ATOM	12602	CA	LYS	D	30	35.015	69.208	27.955	1.00	60.45	C
ATOM	12603	C	LYS	D	30	36.311	69.022	27.212	1.00	62.65	C
ATOM	12604	O	LYS	D	30	36.317	68.525	26.089	1.00	68.76	O
ATOM	12605	CB	LYS	D	30	35.035	68.479	29.287	1.00	57.98	C
ATOM	12606	CG	LYS	D	30	34.108	69.123	30.293	1.00	60.74	C
ATOM	12607	CD	LYS	D	30	33.587	68.167	31.346	1.00	58.98	C
ATOM	12608	CE	LYS	D	30	34.334	68.311	32.651	1.00	64.48	C
ATOM	12609	NZ	LYS	D	30	33.718	69.326	33.561	1.00	61.60	N
ATOM	12610	N	LYS	D	31	37.407	69.473	27.803	1.00	65.68	N
ATOM	12611	CA	LYS	D	31	38.712	69.217	27.214	1.00	68.25	C
ATOM	12612	C	LYS	D	31	39.489	68.261	28.105	1.00	65.51	C
ATOM	12613	O	LYS	D	31	39.661	68.493	29.303	1.00	67.47	O
ATOM	12614	CB	LYS	D	31	39.483	70.513	26.988	1.00	76.66	C
ATOM	12615	CG	LYS	D	31	39.491	70.959	25.537	1.00	74.40	C
ATOM	12616	CD	LYS	D	31	40.206	72.289	25.379	1.00	80.61	C
ATOM	12617	CE	LYS	D	31	39.595	73.102	24.255	1.00	82.51	C
ATOM	12618	NZ	LYS	D	31	40.484	74.225	23.856	1.00	87.68	N
ATOM	12619	N	PHE	D	32	39.927	67.160	27.516	1.00	66.60	N
ATOM	12620	CA	PHE	D	32	40.479	66.067	28.299	1.00	64.69	C
ATOM	12621	C	PHE	D	32	41.936	65.867	27.962	1.00	66.96	C
ATOM	12622	O	PHE	D	32	42.308	65.851	26.791	1.00	64.61	O
ATOM	12623	CB	PHE	D	32	39.691	64.781	28.041	1.00	60.42	C
ATOM	12624	CG	PHE	D	32	38.284	64.807	28.592	1.00	57.59	C
ATOM	12625	CD1	PHE	D	32	38.036	64.450	29.905	1.00	56.92	C
ATOM	12626	CD2	PHE	D	32	37.216	65.175	27.790	1.00	55.46	C
ATOM	12627	CE1	PHE	D	32	36.759	64.467	30.410	1.00	53.29	C
ATOM	12628	CE2	PHE	D	32	35.931	65.193	28.290	1.00	55.95	C
ATOM	12629	CE	PHE	D	32	35.702	64.845	29.603	1.00	56.37	C
ATOM	12630	N	LYS	D	33	42.762	65.738	28.994	1.00	68.91	N
ATOM	12631	CA	LYS	D	33	44.175	65.454	28.793	1.00	64.56	C
ATOM	12632	C	LYS	D	33	44.354	64.175	27.969	1.00	70.38	C
ATOM	12633	O	LYS	D	33	43.608	63.202	28.122	1.00	70.14	O
ATOM	12634	CB	LYS	D	33	44.900	65.328	30.140	1.00	61.42	C
ATOM	12635	CG	LYS	D	33	46.397	65.068	30.020	1.00	64.25	C
ATOM	12636	CD	LYS	D	33	47.264	66.278	30.382	1.00	70.79	C
ATOM	12637	CE	LYS	D	33	48.521	66.345	29.498	1.00	78.25	C
ATOM	12638	NZ	LYS	D	33	49.815	66.375	30.252	1.00	81.32	N
ATOM	12639	N	VAL	D	34	45.331	64.197	27.072	1.00	66.20	N
ATOM	12640	CA	VAL	D	34	45.727	63.004	26.349	1.00	64.83	C
ATOM	12641	C	VAL	D	34	47.174	62.649	26.679	1.00	64.23	C
ATOM	12642	O	VAL	D	34	48.086	63.433	26.429	1.00	63.89	O
ATOM	12643	CB	VAL	D	34	45.587	63.184	24.837	1.00	64.32	C
ATOM	12644	CG1	VAL	D	34	46.131	61.965	24.117	1.00	65.67	C
ATOM	12645	CG2	VAL	D	34	44.139	63.429	24.474	1.00	61.48	C
ATOM	12646	N	LEU	D	35	47.376	61.460	27.230	1.00	63.72	N
ATOM	12647	CA	LEU	D	35	48.706	61.002	27.599	1.00	56.83	C
ATOM	12648	C	LEU	D	35	49.436	60.353	26.445	1.00	58.12	C
ATOM	12649	O	LEU	D	35	49.046	60.491	25.286	1.00	61.61	O
ATOM	12650	CB	LEU	D	35	48.618	60.033	28.765	1.00	53.37	C
ATOM	12651	CG	LEU	D	35	48.018	60.772	29.949	1.00	55.68	C
ATOM	12652	CD1	LEU	D	35	48.209	59.979	31.203	1.00	52.95	C
ATOM	12653	CD2	LEU	D	35	48.671	62.134	30.073	1.00	59.28	C
ATOM	12654	O	GLY	D	36	52.909	60.663	25.882	1.00	61.27	O
ATOM	12655	N	GLY	D	36	50.522	59.660	26.765	1.00	62.39	N
ATOM	12656	CA	GLY	D	36	51.262	58.936	25.752	1.00	56.25	C
ATOM	12657	C	GLY	D	36	52.431	59.734	25.221	1.00	65.24	C
ATOM	12658	O	ASN	D	37	54.923	60.664	21.356	1.00	70.19	O
ATOM	12659	N	ASN	D	37	52.865	59.383	24.011	1.00	66.26	N
ATOM	12660	CA	ASN	D	37	54.114	59.866	23.452	1.00	61.12	C
ATOM	12661	C	ASN	D	37	53.988	60.648	22.152	1.00	67.25	C

ATOM	12662	CB	ASN	D	37	55.056	58.677	23.225	1.00	68.73	C
ATOM	12663	CG	ASN	D	37	54.714	57.876	21.975	1.00	63.13	C
ATOM	12664	OD1	ASN	D	37	53.555	57.624	21.671	1.00	62.50	O
ATOM	12665	ND2	ASN	D	37	55.739	57.481	21.240	1.00	70.49	N
ATOM	12666	O	THR	D	38	52.677	64.009	22.140	1.00	78.48	O
ATOM	12667	N	THR	D	38	52.845	61.289	21.923	1.00	67.43	N
ATOM	12668	CA	THR	D	38	52.657	62.079	20.703	1.00	70.61	C
ATOM	12669	C	THR	D	38	52.485	63.571	21.006	1.00	74.67	C
ATOM	12670	CB	THR	D	38	51.437	61.595	19.904	1.00	74.38	C
ATOM	12671	OG1	THR	D	38	50.366	61.320	20.811	1.00	77.37	O
ATOM	12672	CG2	THR	D	38	51.761	60.331	19.155	1.00	70.23	C
ATOM	12673	O	ASP	D	39	50.357	67.038	21.508	1.00	76.69	O
ATOM	12674	N	ASP	D	39	52.113	64.342	19.988	1.00	76.60	N
ATOM	12675	CA	ASP	D	39	51.867	65.781	20.134	1.00	79.76	C
ATOM	12676	C	ASP	D	39	50.490	66.120	20.705	1.00	79.15	C
ATOM	12677	CB	ASP	D	39	52.010	66.476	18.784	1.00	83.99	C
ATOM	12678	CG	ASP	D	39	53.318	66.169	18.117	1.00	86.86	C
ATOM	12679	OD2	ASP	D	39	53.316	66.012	16.877	1.00	88.57	O
ATOM	12680	OD1	ASP	D	39	54.342	66.081	18.835	1.00	85.00	O
ATOM	12681	O	ARG	D	40	48.242	64.307	22.735	1.00	71.77	O
ATOM	12682	N	ARG	D	40	49.468	65.404	20.240	1.00	79.48	N
ATOM	12683	CA	ARG	D	40	48.108	65.580	20.723	1.00	72.69	C
ATOM	12684	C	ARG	D	40	48.101	65.420	22.224	1.00	72.50	C
ATOM	12685	CB	ARG	D	40	47.170	64.572	20.068	1.00	71.25	C
ATOM	12686	CG	ARG	D	40	45.696	64.900	20.182	1.00	73.01	C
ATOM	12687	CD	ARG	D	40	44.876	63.904	19.361	1.00	75.64	C
ATOM	12688	NE	ARG	D	40	43.662	64.491	18.795	1.00	76.72	N
ATOM	12689	CZ	ARG	D	40	42.865	63.872	17.925	1.00	73.73	C
ATOM	12690	NH1	ARG	D	40	43.132	62.640	17.504	1.00	67.45	N
ATOM	12691	NH2	ARG	D	40	41.792	64.492	17.468	1.00	77.55	N
ATOM	12692	O	HIS	D	41	46.562	66.584	26.252	1.00	64.20	O
ATOM	12693	N	HIS	D	41	47.963	66.543	22.924	1.00	68.49	N
ATOM	12694	CA	HIS	D	41	48.044	66.573	24.383	1.00	69.48	C
ATOM	12695	C	HIS	D	41	46.692	66.775	25.040	1.00	67.56	C
ATOM	12696	CB	HIS	D	41	48.995	67.675	24.850	1.00	75.64	C
ATOM	12697	CG	HIS	D	41	50.436	67.293	24.777	1.00	77.07	C
ATOM	12698	ND1	HIS	D	41	51.134	67.247	23.589	1.00	77.68	N
ATOM	12699	CD2	HIS	D	41	51.309	66.928	25.743	1.00	80.19	C
ATOM	12700	CE1	HIS	D	41	52.379	66.875	23.827	1.00	80.87	C
ATOM	12701	NE2	HIS	D	41	52.511	66.676	25.126	1.00	84.97	N
ATOM	12702	O	SER	D	42	43.739	67.128	22.394	1.00	63.31	O
ATOM	12703	N	SER	D	42	45.702	67.184	24.244	1.00	65.72	N
ATOM	12704	CA	SER	D	42	44.325	67.279	24.713	1.00	66.54	C
ATOM	12705	C	SER	D	42	43.365	67.038	23.560	1.00	61.94	C
ATOM	12706	CB	SER	D	42	44.049	68.645	25.363	1.00	71.60	C
ATOM	12707	OG	SER	D	42	43.286	69.479	24.504	1.00	73.78	O
ATOM	12708	O	ILE	D	43	39.554	66.842	24.662	1.00	60.90	O
ATOM	12709	N	ILE	D	43	42.120	66.745	23.894	1.00	62.66	N
ATOM	12710	CA	ILE	D	43	41.118	66.449	22.888	1.00	61.40	C
ATOM	12711	C	ILE	D	43	39.750	66.851	23.446	1.00	57.70	C
ATOM	12712	CB	ILE	D	43	41.163	64.946	22.506	1.00	62.43	C
ATOM	12713	CG1	ILE	D	43	40.745	64.715	21.056	1.00	63.87	C
ATOM	12714	CG2	ILE	D	43	40.338	64.112	23.468	1.00	59.46	C
ATOM	12715	CD1	ILE	D	43	40.784	63.258	20.657	1.00	65.89	C
ATOM	12716	O	LYS	D	44	36.535	65.757	21.782	1.00	56.24	O
ATOM	12717	N	LYS	D	44	38.812	67.235	22.585	1.00	57.65	N
ATOM	12718	CA	LYS	D	44	37.471	67.549	23.084	1.00	60.97	C
ATOM	12719	C	LYS	D	44	36.518	66.391	22.839	1.00	56.50	C
ATOM	12720	CB	LYS	D	44	36.912	68.828	22.446	1.00	61.92	C
ATOM	12721	CG	LYS	D	44	35.648	69.347	23.130	1.00	59.13	C
ATOM	12722	CD	LYS	D	44	35.322	70.782	22.710	1.00	67.51	C
ATOM	12723	CE	LYS	D	44	36.389	71.776	23.141	1.00	65.40	C
ATOM	12724	NZ	LYS	D	44	36.340	72.000	24.613	1.00	69.48	N

ATOM	12725	O	LYS	D	45	33.422	66.109	25.368	1.00	55.59	O
ATOM	12726	N	LYS	D	45	35.680	66.110	23.822	1.00	53.61	N
ATOM	12727	CA	LYS	D	45	34.727	65.033	23.675	1.00	54.35	C
ATOM	12728	C	LYS	D	45	33.417	65.416	24.354	1.00	58.16	C
ATOM	12729	CB	LYS	D	45	35.301	63.728	24.261	1.00	58.60	C
ATOM	12730	CG	LYS	D	45	36.570	63.242	23.549	1.00	52.31	C
ATOM	12731	CD	LYS	D	45	37.010	61.860	23.949	1.00	63.20	C
ATOM	12732	CE	LYS	D	45	38.139	61.360	23.029	1.00	60.30	C
ATOM	12733	NZ	LYS	D	45	39.281	60.805	23.813	1.00	61.21	N
ATOM	12734	O	ASN	D	46	31.419	62.960	25.432	1.00	60.31	O
ATOM	12735	N	ASN	D	46	32.296	64.972	23.792	1.00	53.27	N
ATOM	12736	CA	ASN	D	46	31.032	65.121	24.476	1.00	46.44	C
ATOM	12737	C	ASN	D	46	30.890	64.065	25.546	1.00	50.80	C
ATOM	12738	CB	ASN	D	46	29.863	65.042	23.499	1.00	53.64	C
ATOM	12739	CG	ASN	D	46	29.950	66.080	22.409	1.00	56.15	C
ATOM	12740	OD1	ASN	D	46	30.209	67.259	22.677	1.00	65.82	O
ATOM	12741	ND2	ASN	D	46	29.766	65.650	21.164	1.00	57.66	N
ATOM	12742	O	LEU	D	47	27.816	62.495	28.249	1.00	46.37	O
ATOM	12743	N	LEU	D	47	30.177	64.415	26.597	1.00	51.84	N
ATOM	12744	CA	LEU	D	47	29.938	63.527	27.709	1.00	50.14	C
ATOM	12745	C	LEU	D	47	28.737	62.645	27.427	1.00	49.74	C
ATOM	12746	CB	LEU	D	47	29.737	64.332	28.983	1.00	58.35	C
ATOM	12747	CG	LEU	D	47	31.014	64.769	29.702	1.00	62.88	C
ATOM	12748	CD1	LEU	D	47	32.194	65.065	28.771	1.00	59.47	C
ATOM	12749	CD2	LEU	D	47	30.662	65.981	30.494	1.00	57.83	C
ATOM	12750	O	ILE	D	48	29.484	59.950	24.537	1.00	48.88	O
ATOM	12751	N	ILE	D	48	28.755	62.075	26.234	1.00	48.32	N
ATOM	12752	CA	ILE	D	48	27.785	61.067	25.860	1.00	53.35	C
ATOM	12753	C	ILE	D	48	28.504	59.823	25.286	1.00	50.09	C
ATOM	12754	CB	ILE	D	48	26.781	61.633	24.845	1.00	46.99	C
ATOM	12755	CG1	ILE	D	48	25.709	60.601	24.530	1.00	51.19	C
ATOM	12756	CG2	ILE	D	48	27.488	62.088	23.576	1.00	47.03	C
ATOM	12757	CD1	ILE	D	48	24.304	61.172	24.553	1.00	48.79	C
ATOM	12758	O	GLY	D	49	26.919	55.974	25.943	1.00	42.75	O
ATOM	12759	N	GLY	D	49	28.035	58.626	25.638	1.00	47.28	N
ATOM	12760	CA	GLY	D	49	28.595	57.433	25.015	1.00	49.22	C
ATOM	12761	C	GLY	D	49	28.000	56.081	25.352	1.00	43.09	C
ATOM	12762	O	ALA	D	50	30.389	52.617	24.448	1.00	44.58	O
ATOM	12763	N	ALA	D	50	28.735	55.034	24.979	1.00	46.17	N
ATOM	12764	CA	ALA	D	50	28.338	53.653	25.280	1.00	48.45	C
ATOM	12765	C	ALA	D	50	29.524	52.661	25.338	1.00	45.63	C
ATOM	12766	CB	ALA	D	50	27.306	53.178	24.259	1.00	45.79	C
ATOM	12767	O	LEU	D	51	28.781	49.083	26.366	1.00	41.79	O
ATOM	12768	N	LEU	D	51	29.550	51.869	26.399	1.00	40.70	N
ATOM	12769	CA	LEU	D	51	30.489	50.763	26.497	1.00	45.03	C
ATOM	12770	C	LEU	D	51	29.845	49.496	25.911	1.00	42.02	C
ATOM	12771	CB	LEU	D	51	30.906	50.565	27.958	1.00	38.76	C
ATOM	12772	CG	LEU	D	51	31.853	49.463	28.394	1.00	43.77	C
ATOM	12773	CD1	LEU	D	51	33.312	49.769	28.004	1.00	43.97	C
ATOM	12774	CD2	LEU	D	51	31.697	49.233	29.896	1.00	40.54	C
ATOM	12775	O	LEU	D	52	32.208	46.491	24.608	1.00	49.19	O
ATOM	12776	N	LEU	D	52	30.471	48.919	24.886	1.00	42.04	N
ATOM	12777	CA	LEU	D	52	30.055	47.613	24.330	1.00	44.00	C
ATOM	12778	C	LEU	D	52	30.977	46.440	24.766	1.00	48.27	C
ATOM	12779	CB	LEU	D	52	30.014	47.684	22.802	1.00	42.42	C
ATOM	12780	CG	LEU	D	52	29.292	48.895	22.175	1.00	38.86	C
ATOM	12781	CD1	LEU	D	52	29.312	48.808	20.669	1.00	37.95	C
ATOM	12782	CD2	LEU	D	52	27.887	48.899	22.623	1.00	39.43	C
ATOM	12783	O	PHE	D	53	29.412	42.733	25.342	1.00	38.65	O
ATOM	12784	N	PHE	D	53	30.395	45.381	25.316	1.00	44.63	N
ATOM	12785	CA	PHE	D	53	31.213	44.284	25.819	1.00	44.19	C
ATOM	12786	C	PHE	D	53	30.640	42.905	25.498	1.00	46.52	C
ATOM	12787	CB	PHE	D	53	31.391	44.399	27.329	1.00	44.52	C

ATOM	12788	CG	PHE	D	53	30.094	44.424	28.080	1.00	45.62	C
ATOM	12789	CD1	PHE	D	53	29.481	45.629	28.387	1.00	49.12	C
ATOM	12790	CD2	PHE	D	53	29.475	43.250	28.457	1.00	45.14	C
ATOM	12791	CE1	PHE	D	53	28.263	45.655	29.081	1.00	49.48	C
ATOM	12792	CE2	PHE	D	53	28.265	43.269	29.145	1.00	49.58	C
ATOM	12793	CZ	PHE	D	53	27.667	44.469	29.460	1.00	45.93	C
ATOM	12794	O	ASP	D	54	31.051	40.253	27.564	1.00	43.76	O
ATOM	12795	N	ASP	D	54	31.546	41.929	25.413	1.00	44.85	N
ATOM	12796	CA	ASP	D	54	31.180	40.519	25.188	1.00	41.89	C
ATOM	12797	C	ASP	D	54	30.585	39.940	26.463	1.00	46.07	C
ATOM	12798	CB	ASP	D	54	32.387	39.710	24.753	1.00	39.05	C
ATOM	12799	CG	ASP	D	54	32.900	40.098	23.389	1.00	47.82	C
ATOM	12800	OD1	ASP	D	54	32.145	40.660	22.554	1.00	51.50	O
ATOM	12801	OD2	ASP	D	54	34.087	39.845	23.147	1.00	50.65	O
ATOM	12802	O	SER	D	55	30.664	37.148	28.116	1.00	48.48	O
ATOM	12803	N	SER	D	55	29.545	39.126	26.295	1.00	43.71	N
ATOM	12804	CA	SER	D	55	28.805	38.496	27.393	1.00	45.85	C
ATOM	12805	C	SER	D	55	29.633	37.741	28.433	1.00	49.62	C
ATOM	12806	CB	SER	D	55	27.790	37.515	26.815	1.00	42.86	C
ATOM	12807	OG	SER	D	55	27.022	38.138	25.789	1.00	50.57	O
ATOM	12808	O	GLY	D	56	28.313	35.200	29.825	1.00	50.68	O
ATOM	12809	N	GLY	D	56	29.168	37.758	29.681	1.00	50.02	N
ATOM	12810	CA	GLY	D	56	29.745	36.910	30.705	1.00	50.32	C
ATOM	12811	C	GLY	D	56	29.315	35.462	30.492	1.00	53.09	C
ATOM	12812	O	GLU	D	57	29.701	33.071	33.416	1.00	36.75	O
ATOM	12813	N	GLU	D	57	30.057	34.510	31.057	1.00	49.33	N
ATOM	12814	CA	GLU	D	57	29.597	33.125	31.037	1.00	42.37	C
ATOM	12815	C	GLU	D	57	29.216	32.615	32.413	1.00	37.19	C
ATOM	12816	CB	GLU	D	57	30.664	32.233	30.423	1.00	41.93	C
ATOM	12817	CG	GLU	D	57	31.192	32.822	29.179	1.00	47.32	C
ATOM	12818	CD	GLU	D	57	32.290	32.016	28.582	1.00	56.26	C
ATOM	12819	OE1	GLU	D	57	31.967	31.035	27.884	1.00	64.74	O
ATOM	12820	OE2	GLU	D	57	33.469	32.367	28.804	1.00	59.82	O
ATOM	12821	O	THR	D	58	30.242	29.939	33.394	1.00	37.94	O
ATOM	12822	N	THR	D	58	28.349	31.626	32.433	1.00	41.55	N
ATOM	12823	CA	THR	D	58	28.042	30.902	33.646	1.00	41.49	C
ATOM	12824	C	THR	D	58	29.234	30.034	34.101	1.00	42.87	C
ATOM	12825	CB	THR	D	58	26.794	30.037	33.436	1.00	50.51	C
ATOM	12826	OG1	THR	D	58	27.067	29.030	32.455	1.00	41.67	O
ATOM	12827	CG2	THR	D	58	25.605	30.931	32.965	1.00	33.17	O
ATOM	12828	O	ALA	D	59	30.983	26.465	36.068	1.00	41.83	O
ATOM	12829	N	ALA	D	59	29.102	29.451	35.295	1.00	40.01	N
ATOM	12830	CA	ALA	D	59	30.165	28.722	35.973	1.00	34.60	C
ATOM	12831	C	ALA	D	59	30.069	27.213	35.721	1.00	43.94	C
ATOM	12832	CB	ALA	D	59	30.124	28.994	37.456	1.00	34.71	C
ATOM	12833	O	GLU	D	60	30.026	23.503	34.746	1.00	45.13	O
ATOM	12834	N	GLU	D	60	28.957	26.804	35.105	1.00	44.88	N
ATOM	12835	CA	GLU	D	60	28.588	25.419	34.892	1.00	40.58	C
ATOM	12836	C	GLU	D	60	29.664	24.565	34.229	1.00	43.23	C
ATOM	12837	CB	GLU	D	60	27.319	25.339	34.054	1.00	40.99	C
ATOM	12838	CG	GLU	D	60	27.035	23.929	33.597	1.00	45.07	C
ATOM	12839	CD	GLU	D	60	25.588	23.660	33.284	1.00	57.51	C
ATOM	12840	OE1	GLU	D	60	25.334	22.712	32.509	1.00	67.87	O
ATOM	12841	OE2	GLU	D	60	24.702	24.368	33.814	1.00	68.15	O
ATOM	12842	N	ALA	D	61	30.150	25.024	33.081	1.00	41.46	N
ATOM	12843	CA	ALA	D	61	31.171	24.326	32.332	1.00	38.07	C
ATOM	12844	C	ALA	D	61	32.439	24.161	33.187	1.00	41.43	C
ATOM	12845	O	ALA	D	61	33.067	23.104	33.196	1.00	46.25	O
ATOM	12846	CB	ALA	D	61	31.481	25.064	31.042	1.00	28.44	C
ATOM	12847	N	THR	D	62	32.790	25.208	33.925	1.00	48.39	N
ATOM	12848	CA	THR	D	62	33.954	25.186	34.781	1.00	39.59	C
ATOM	12849	C	THR	D	62	33.748	24.102	35.832	1.00	40.96	C
ATOM	12850	O	THR	D	62	34.688	23.364	36.156	1.00	43.87	O

ATOM	12851	CB	THR	D	62	34.199	26.587	35.391	1.00	41.46	C
ATOM	12852	OG1	THR	D	62	34.582	27.473	34.342	1.00	37.74	O
ATOM	12853	CG2	THR	D	62	35.302	26.598	36.444	1.00	34.22	C
ATOM	12854	N	ARG	D	63	32.496	23.933	36.261	1.00	39.53	N
ATOM	12855	CA	ARG	D	63	32.105	22.990	37.314	1.00	39.73	C
ATOM	12856	C	ARG	D	63	32.167	21.504	36.866	1.00	45.30	C
ATOM	12857	O	ARG	D	63	32.654	20.643	37.610	1.00	45.60	O
ATOM	12858	CB	ARG	D	63	30.678	23.281	37.831	1.00	35.94	C
ATOM	12859	CG	ARG	D	63	30.313	22.505	39.101	1.00	38.96	C
ATOM	12860	CD	ARG	D	63	28.904	22.745	39.672	1.00	41.56	C
ATOM	12861	NE	ARG	D	63	27.826	22.437	38.733	1.00	41.03	N
ATOM	12862	CZ	ARG	D	63	27.069	23.367	38.135	1.00	47.70	C
ATOM	12863	NH1	ARG	D	63	26.127	22.995	37.279	1.00	49.29	N
ATOM	12864	NH2	ARG	D	63	27.249	24.666	38.383	1.00	34.95	N
ATOM	12865	N	LEU	D	64	31.615	21.210	35.692	1.00	40.47	N
ATOM	12866	CA	LEU	D	64	31.530	19.846	35.228	1.00	38.25	C
ATOM	12867	C	LEU	D	64	32.946	19.351	34.977	1.00	40.32	C
ATOM	12868	O	LEU	D	64	33.256	18.220	35.302	1.00	44.41	O
ATOM	12869	CB	LEU	D	64	30.684	19.732	33.959	1.00	40.90	C
ATOM	12870	CG	LEU	D	64	29.191	20.020	34.074	1.00	49.60	C
ATOM	12871	CD1	LEU	D	64	28.542	19.931	32.707	1.00	48.62	C
ATOM	12872	CD2	LEU	D	64	28.506	19.087	35.070	1.00	36.18	C
ATOM	12873	N	LYS	D	65	33.801	20.213	34.433	1.00	38.10	N
ATOM	12874	CA	LYS	D	65	35.214	19.878	34.308	1.00	38.64	C
ATOM	12875	C	LYS	D	65	35.893	19.753	35.650	1.00	41.01	C
ATOM	12876	O	LYS	D	65	36.729	18.875	35.824	1.00	53.02	O
ATOM	12877	CB	LYS	D	65	35.958	20.889	33.444	1.00	32.94	C
ATOM	12878	CG	LYS	D	65	35.460	20.801	32.038	1.00	38.82	C
ATOM	12879	CD	LYS	D	65	35.935	21.896	31.151	1.00	48.34	C
ATOM	12880	CE	LYS	D	65	35.213	21.792	29.807	1.00	46.80	C
ATOM	12881	NE	LYS	D	65	35.745	22.798	28.869	1.00	55.82	N
ATOM	12882	N	ARG	D	66	35.509	20.561	36.625	1.00	42.22	N
ATOM	12883	CA	ARG	D	66	36.201	20.495	37.905	1.00	41.55	C
ATOM	12884	C	ARG	D	66	35.944	19.160	38.556	1.00	40.82	C
ATOM	12885	O	ARG	D	66	36.856	18.564	39.128	1.00	46.13	O
ATOM	12886	CB	ARG	D	66	35.778	21.631	38.841	1.00	36.06	C
ATOM	12887	CG	ARG	D	66	36.087	21.454	40.341	1.00	33.23	C
ATOM	12888	CD	ARG	D	66	35.176	22.431	41.196	1.00	43.84	C
ATOM	12889	NE	ARG	D	66	35.059	23.728	40.541	1.00	44.44	N
ATOM	12890	CZ	ARG	D	66	33.932	24.383	40.313	1.00	41.28	C
ATOM	12891	NH1	ARG	D	66	34.004	25.527	39.680	1.00	52.65	N
ATOM	12892	NH2	ARG	D	66	32.752	23.931	40.735	1.00	45.67	N
ATOM	12893	N	THR	D	67	34.707	18.697	38.477	1.00	38.33	N
ATOM	12894	CA	THR	D	67	34.345	17.482	39.170	1.00	41.57	C
ATOM	12895	C	THR	D	67	34.857	16.277	38.363	1.00	43.79	C
ATOM	12896	O	THR	D	67	35.186	15.249	38.933	1.00	39.76	O
ATOM	12897	CB	THR	D	67	32.826	17.333	39.387	1.00	38.35	C
ATOM	12898	OG1	THR	D	67	32.182	17.350	38.127	1.00	42.68	O
ATOM	12899	CG2	THR	D	67	32.263	18.431	40.315	1.00	35.95	C
ATOM	12900	N	ALA	D	68	34.928	16.420	37.046	1.00	40.45	N
ATOM	12901	CA	ALA	D	68	35.493	15.358	36.210	1.00	43.29	C
ATOM	12902	C	ALA	D	68	36.984	15.206	36.522	1.00	41.61	C
ATOM	12903	O	ALA	D	68	37.483	14.103	36.616	1.00	48.81	O
ATOM	12904	CB	ALA	D	68	35.268	15.652	34.704	1.00	39.51	C
ATOM	12905	N	ARG	D	69	37.684	16.319	36.726	1.00	47.02	N
ATOM	12906	CA	ARG	D	69	39.074	16.267	37.160	1.00	39.78	C
ATOM	12907	C	ARG	D	69	39.202	15.486	38.424	1.00	42.39	C
ATOM	12908	O	ARG	D	69	40.088	14.620	38.551	1.00	44.90	O
ATOM	12909	CB	ARG	D	69	39.623	17.630	37.420	1.00	38.21	C
ATOM	12910	CG	ARG	D	69	40.235	18.261	36.281	1.00	37.85	C
ATOM	12911	CD	ARG	D	69	40.930	19.453	36.818	1.00	40.98	C
ATOM	12912	NE	ARG	D	69	40.554	20.564	35.987	1.00	58.52	N
ATOM	12913	CZ	ARG	D	69	39.824	21.604	36.369	1.00	42.23	C

ATOM	12914	NH1	ARG	D	69	39.427	21.744	37.625	1.00	47.75	N
ATOM	12915	NH2	ARG	D	69	39.554	22.514	35.473	1.00	40.34	N
ATOM	12916	N	ARG	D	70	38.299	15.768	39.360	1.00	37.78	N
ATOM	12917	CA	ARG	D	70	38.384	15.073	40.626	1.00	41.42	C
ATOM	12918	C	ARG	D	70	38.267	13.576	40.401	1.00	44.22	C
ATOM	12919	O	ARG	D	70	38.902	12.768	41.086	1.00	38.40	O
ATOM	12920	CB	ARG	D	70	37.322	15.530	41.613	1.00	34.40	C
ATOM	12921	CG	ARG	D	70	37.693	16.856	42.222	1.00	40.20	C
ATOM	12922	CD	ARG	D	70	36.752	17.275	43.347	1.00	42.67	C
ATOM	12923	NE	ARG	D	70	36.961	18.686	43.659	1.00	39.51	N
ATOM	12924	CZ	ARG	D	70	36.003	19.618	43.642	1.00	38.15	C
ATOM	12925	NH1	ARG	D	70	34.746	19.307	43.357	1.00	36.22	N
ATOM	12926	NH2	ARG	D	70	36.321	20.870	43.915	1.00	42.35	N
ATOM	12927	N	ARG	D	71	37.436	13.216	39.440	1.00	42.28	N
ATOM	12928	CA	ARG	D	71	37.030	11.847	39.361	1.00	43.26	C
ATOM	12929	C	ARG	D	71	38.054	10.993	38.586	1.00	43.58	C
ATOM	12930	O	ARG	D	71	38.238	9.850	38.921	1.00	48.91	O
ATOM	12931	CB	ARG	D	71	35.631	11.776	38.785	1.00	41.78	C
ATOM	12932	CG	ARG	D	71	34.607	11.945	39.874	1.00	38.08	C
ATOM	12933	CD	ARG	D	71	33.249	11.517	39.406	1.00	40.42	C
ATOM	12934	NE	ARG	D	71	32.842	12.318	38.264	1.00	44.16	N
ATOM	12935	CZ	ARG	D	71	32.221	11.822	37.201	1.00	54.38	C
ATOM	12936	NH1	ARG	D	71	31.885	12.631	36.197	1.00	49.01	N
ATOM	12937	NH2	ARG	D	71	31.941	10.513	37.144	1.00	49.02	N
ATOM	12938	N	TYR	D	72	38.744	11.562	37.603	1.00	44.09	N
ATOM	12939	CA	TYR	D	72	39.906	10.907	37.031	1.00	40.50	C
ATOM	12940	C	TYR	D	72	40.992	10.709	38.089	1.00	48.20	C
ATOM	12941	O	TYR	D	72	41.729	9.718	38.070	1.00	55.99	O
ATOM	12942	CB	TYR	D	72	40.466	11.698	35.863	1.00	37.94	C
ATOM	12943	CG	TYR	D	72	39.645	11.549	34.611	1.00	44.67	C
ATOM	12944	CD1	TYR	D	72	39.188	10.304	34.202	1.00	41.77	C
ATOM	12945	CD2	TYR	D	72	39.306	12.660	33.839	1.00	44.51	C
ATOM	12946	CE1	TYR	D	72	38.413	10.174	33.071	1.00	37.92	C
ATOM	12947	CE2	TYR	D	72	38.555	12.529	32.700	1.00	43.72	C
ATOM	12948	CZ	TYR	D	72	38.117	11.283	32.318	1.00	38.96	C
ATOM	12949	OH	TYR	D	72	37.361	11.177	31.188	1.00	42.06	O
ATOM	12950	N	THR	D	73	41.091	11.642	39.023	1.00	49.57	N
ATOM	12951	CA	THR	D	73	42.121	11.552	40.035	1.00	44.24	C
ATOM	12952	C	THR	D	73	41.821	10.378	40.971	1.00	45.96	C
ATOM	12953	O	THR	D	73	42.715	9.618	41.359	1.00	46.51	O
ATOM	12954	CB	THR	D	73	42.240	12.879	40.819	1.00	44.70	C
ATOM	12955	OG1	THR	D	73	43.290	13.664	40.252	1.00	41.85	O
ATOM	12956	CG2	THR	D	73	42.570	12.637	42.307	1.00	47.95	C
ATOM	12957	N	ARG	D	74	40.552	10.227	41.313	1.00	39.82	N
ATOM	12958	C	ARG	D	74	40.096	7.811	41.612	1.00	45.53	C
ATOM	12959	CA	ARG	D	74	40.144	9.215	42.256	1.00	41.66	C
ATOM	12960	O	ARG	D	74	40.358	6.829	42.289	1.00	49.25	O
ATOM	12961	CB	ARG	D	74	38.783	9.594	42.878	1.00	36.61	C
ATOM	12962	CG	ARG	D	74	38.881	10.821	43.854	1.00	45.99	C
ATOM	12963	CD	ARG	D	74	37.510	11.524	44.177	1.00	43.49	C
ATOM	12964	NE	ARG	D	74	37.625	12.743	44.995	1.00	38.74	N
ATOM	12965	CZ	ARG	D	74	36.636	13.633	45.148	1.00	44.12	C
ATOM	12966	NH1	ARG	D	74	35.457	13.440	44.574	1.00	38.10	N
ATOM	12967	NH2	ARG	D	74	36.813	14.720	45.883	1.00	41.17	N
ATOM	12968	N	ARG	D	75	39.745	7.716	40.332	1.00	40.27	N
ATOM	12969	C	ARG	D	75	41.148	5.888	39.614	1.00	49.20	C
ATOM	12970	CA	ARG	D	75	39.708	6.433	39.659	1.00	45.23	C
ATOM	12971	O	ARG	D	75	41.403	4.740	39.965	1.00	46.69	O
ATOM	12972	CB	ARG	D	75	39.125	6.552	38.249	1.00	41.55	C
ATOM	12973	CG	ARG	D	75	38.952	5.222	37.562	1.00	37.06	C
ATOM	12974	CD	ARG	D	75	38.546	5.344	36.102	1.00	37.57	C
ATOM	12975	NE	ARG	D	75	39.609	5.862	35.253	1.00	31.75	N
ATOM	12976	CZ	ARG	D	75	39.456	6.097	33.958	1.00	39.38	C

ATOM	12977	NH1	ARG	D	75	38.266	5.874	33.389	1.00	32.17	N
ATOM	12978	NH2	ARG	D	75	40.481	6.567	33.245	1.00	28.95	N
ATOM	12979	N	LYS	D	76	42.071	6.756	39.213	1.00	46.52	N
ATOM	12980	C	LYS	D	76	43.933	6.011	40.603	1.00	49.62	C
ATOM	12981	CA	LYS	D	76	43.492	6.472	39.218	1.00	47.21	C
ATOM	12982	O	LYS	D	76	44.737	5.110	40.718	1.00	56.56	O
ATOM	12983	CB	LYS	D	76	44.281	7.709	38.756	1.00	45.09	C
ATOM	12984	CG	LYS	D	76	45.775	7.648	38.980	1.00	46.29	C
ATOM	12985	CD	LYS	D	76	46.571	8.208	37.787	1.00	46.70	C
ATOM	12986	CE	LYS	D	76	46.137	9.631	37.361	1.00	54.55	C
ATOM	12987	NZ	LYS	D	76	46.962	10.245	36.218	1.00	48.81	N
ATOM	12988	N	ASN	D	77	43.371	6.582	41.657	1.00	51.34	N
ATOM	12989	C	ASN	D	77	43.255	4.845	43.467	1.00	50.64	C
ATOM	12990	CA	ASN	D	77	43.777	6.216	43.017	1.00	50.27	C
ATOM	12991	O	ASN	D	77	43.897	4.163	44.263	1.00	50.90	O
ATOM	12992	CB	ASN	D	77	43.330	7.282	44.026	1.00	39.75	C
ATOM	12993	CG	ASN	D	77	44.215	8.522	44.002	1.00	49.42	C
ATOM	12994	OD1	ASN	D	77	45.354	8.475	43.522	1.00	53.72	O
ATOM	12995	ND2	ASN	D	77	43.693	9.648	44.517	1.00	43.77	N
ATOM	12996	N	ARG	D	78	42.075	4.473	42.995	1.00	48.35	N
ATOM	12997	C	ARG	D	78	42.524	2.063	42.740	1.00	47.63	C
ATOM	12998	CA	ARG	D	78	41.542	3.137	43.224	1.00	50.85	C
ATOM	12999	O	ARG	D	78	42.745	1.041	43.389	1.00	50.20	O
ATOM	13000	CB	ARG	D	78	40.218	2.963	42.489	1.00	48.49	C
ATOM	13001	CG	ARG	D	78	38.996	3.581	43.137	1.00	42.68	C
ATOM	13002	CD	ARG	D	78	37.725	2.953	42.529	1.00	44.10	C
ATOM	13003	NE	ARG	D	78	36.744	3.978	42.233	1.00	58.52	N
ATOM	13004	CZ	ARG	D	78	36.342	4.336	41.017	1.00	55.48	C
ATOM	13005	NH1	ARG	D	78	36.800	3.726	39.935	1.00	48.60	N
ATOM	13006	NH2	ARG	D	78	35.441	5.308	40.897	1.00	57.45	N
ATOM	13007	N	ILE	D	79	43.102	2.332	41.583	1.00	43.71	N
ATOM	13008	C	ILE	D	79	45.311	1.345	41.646	1.00	57.33	C
ATOM	13009	CA	ILE	D	79	43.980	1.414	40.892	1.00	51.35	C
ATOM	13010	O	ILE	D	79	45.914	0.266	41.795	1.00	53.08	O
ATOM	13011	CB	ILE	D	79	44.166	1.861	39.418	1.00	51.59	C
ATOM	13012	CG1	ILE	D	79	42.899	1.547	38.630	1.00	51.10	C
ATOM	13013	CG2	ILE	D	79	45.362	1.210	38.755	1.00	46.93	C
ATOM	13014	CD1	ILE	D	79	42.437	0.105	38.789	1.00	55.91	C
ATOM	13015	N	LEU	D	80	45.740	2.498	42.147	1.00	51.17	N
ATOM	13016	C	LEU	D	80	46.693	1.807	44.268	1.00	55.54	C
ATOM	13017	CA	LEU	D	80	46.926	2.566	42.961	1.00	49.16	C
ATOM	13018	O	LEU	D	80	47.590	1.128	44.759	1.00	52.61	O
ATOM	13019	CB	LEU	D	80	47.313	4.011	43.238	1.00	47.75	C
ATOM	13020	CG	LEU	D	80	47.856	4.847	42.075	1.00	51.22	C
ATOM	13021	CD1	LEU	D	80	48.091	6.315	42.511	1.00	50.92	C
ATOM	13022	CD2	LEU	D	80	49.122	4.254	41.503	1.00	48.52	C
ATOM	13023	N	TYR	D	81	45.495	1.902	44.836	1.00	53.84	N
ATOM	13024	C	TYR	D	81	45.373	-0.326	45.862	1.00	58.62	C
ATOM	13025	CA	TYR	D	81	45.252	1.190	46.083	1.00	55.78	C
ATOM	13026	O	TYR	D	81	45.967	-1.034	46.664	1.00	59.40	O
ATOM	13027	CB	TYR	D	81	43.887	1.501	46.645	1.00	56.85	C
ATOM	13028	CG	TYR	D	81	43.673	2.905	47.167	1.00	61.72	C
ATOM	13029	CD1	TYR	D	81	44.678	3.600	47.835	1.00	64.68	C
ATOM	13030	CD2	TYR	D	81	42.443	3.528	47.003	1.00	55.02	C
ATOM	13031	CE1	TYR	D	81	44.455	4.897	48.314	1.00	60.75	C
ATOM	13032	CE2	TYR	D	81	42.216	4.801	47.463	1.00	57.97	C
ATOM	13033	CZ	TYR	D	81	43.206	5.486	48.113	1.00	60.45	C
ATOM	13034	OH	TYR	D	81	42.913	6.754	48.563	1.00	58.50	O
ATOM	13035	N	LEU	D	82	44.796	-0.803	44.767	1.00	54.05	N
ATOM	13036	C	LEU	D	82	46.358	-2.611	44.069	1.00	56.89	C
ATOM	13037	CA	LEU	D	82	44.905	-2.193	44.367	1.00	56.17	C
ATOM	13038	O	LEU	D	82	46.812	-3.642	44.538	1.00	58.35	O
ATOM	13039	CB	LEU	D	82	44.039	-2.447	43.149	1.00	50.58	C

ATOM	13040	CG	LEU	D	82	43.890	-3.896	42.728	1.00	53.60	C
ATOM	13041	CD1	LEU	D	82	43.147	-4.651	43.821	1.00	48.41	C
ATOM	13042	CD2	LEU	D	82	43.169	-3.976	41.380	1.00	49.69	C
ATOM	13043	N	GLN	D	83	47.082	-1.805	43.300	1.00	57.39	N
ATOM	13044	C	GLN	D	83	49.321	-2.088	44.291	1.00	61.56	C
ATOM	13045	CA	GLN	D	83	48.475	-2.089	43.016	1.00	51.96	C
ATOM	13046	O	GLN	D	83	50.380	-2.717	44.343	1.00	62.34	O
ATOM	13047	CB	GLN	D	83	49.035	-1.088	42.015	1.00	48.08	C
ATOM	13048	CG	GLN	D	83	48.457	-1.263	40.623	1.00	50.58	C
ATOM	13049	CD	GLN	D	83	49.193	-0.458	39.586	1.00	52.48	C
ATOM	13050	OE1	GLN	D	83	50.220	0.144	39.885	1.00	57.79	O
ATOM	13051	NE2	GLN	D	83	48.682	-0.444	38.354	1.00	50.32	N
ATOM	13052	N	GLU	D	84	48.851	-1.392	45.323	1.00	62.86	N
ATOM	13053	C	GLU	D	84	49.428	-2.690	47.330	1.00	63.21	C
ATOM	13054	CA	GLU	D	84	49.569	-1.354	46.598	1.00	63.80	C
ATOM	13055	O	GLU	D	84	50.400	-3.230	47.866	1.00	57.02	O
ATOM	13056	CB	GLU	D	84	49.065	-0.212	47.489	1.00	58.09	C
ATOM	13057	CG	GLU	D	84	49.984	0.101	48.671	1.00	68.93	C
ATOM	13058	CD	GLU	D	84	49.300	0.893	49.791	1.00	84.61	C
ATOM	13059	OE1	GLU	D	84	48.157	1.377	49.584	1.00	86.87	O
ATOM	13060	OE2	GLU	D	84	49.912	1.027	50.882	1.00	80.22	O
ATOM	13061	N	ILE	D	85	48.196	-3.188	47.355	1.00	58.31	N
ATOM	13062	C	ILE	D	85	48.578	-5.612	47.093	1.00	60.13	C
ATOM	13063	CA	ILE	D	85	47.879	-4.493	47.894	1.00	58.87	C
ATOM	13064	O	ILE	D	85	48.831	-6.681	47.618	1.00	64.28	O
ATOM	13065	CB	ILE	D	85	46.349	-4.699	47.908	1.00	58.25	C
ATOM	13066	CG1	ILE	D	85	45.716	-3.771	48.940	1.00	54.86	C
ATOM	13067	CG2	ILE	D	85	45.962	-6.147	48.184	1.00	53.01	C
ATOM	13068	CD1	ILE	D	85	44.252	-4.062	49.227	1.00	59.29	C
ATOM	13069	O	PHE	D	86	51.672	-7.436	44.754	1.00	66.98	O
ATOM	13070	N	PHE	D	86	48.937	-5.351	45.841	1.00	62.45	N
ATOM	13071	CA	PHE	D	86	49.543	-6.402	45.017	1.00	64.33	C
ATOM	13072	C	PHE	D	86	51.072	-6.391	44.961	1.00	58.05	C
ATOM	13073	CB	PHE	D	86	48.987	-6.339	43.581	1.00	54.45	C
ATOM	13074	CG	PHE	D	86	47.850	-7.284	43.349	1.00	59.50	C
ATOM	13075	CD2	PHE	D	86	47.975	-8.339	42.451	1.00	55.67	C
ATOM	13076	CD1	PHE	D	86	46.654	-7.137	44.044	1.00	54.85	C
ATOM	13077	CE2	PHE	D	86	46.919	-9.223	42.249	1.00	52.34	C
ATOM	13078	CE1	PHE	D	86	45.606	-8.025	43.843	1.00	54.31	C
ATOM	13079	CZ	PHE	D	86	45.742	-9.067	42.950	1.00	51.50	O
ATOM	13080	O	SER	D	87	55.109	-6.307	44.656	1.00	65.20	O
ATOM	13081	N	SER	D	87	51.691	-5.232	45.168	1.00	53.89	N
ATOM	13082	CA	SER	D	87	53.095	-4.998	44.799	1.00	58.51	C
ATOM	13083	C	SER	D	87	54.150	-5.981	45.356	1.00	68.31	C
ATOM	13084	CB	SER	D	87	53.511	-3.587	45.209	1.00	59.59	C
ATOM	13085	OG	SER	D	87	53.293	-3.390	46.594	1.00	67.63	O
ATOM	13086	O	ASN	D	88	55.751	-9.039	45.635	1.00	66.13	O
ATOM	13087	N	ASN	D	88	53.997	-6.421	46.602	1.00	61.20	N
ATOM	13088	CA	ASN	D	88	54.951	-7.353	47.176	1.00	69.69	C
ATOM	13089	C	ASN	D	88	54.869	-8.704	46.456	1.00	70.08	C
ATOM	13090	CB	ASN	D	88	54.711	-7.521	48.678	1.00	74.70	C
ATOM	13091	O	GLU	D	89	54.359	-11.590	44.023	1.00	72.63	O
ATOM	13092	N	GLU	D	89	53.798	-9.449	46.741	1.00	66.07	N
ATOM	13093	CA	GLU	D	89	53.545	-10.730	46.094	1.00	64.33	C
ATOM	13094	C	GLU	D	89	53.791	-10.665	44.595	1.00	67.05	C
ATOM	13095	CB	GLU	D	89	52.123	-11.206	46.379	1.00	59.49	C
ATOM	13096	CG	GLU	D	89	51.958	-11.897	47.731	1.00	69.36	C
ATOM	13097	CD	GLU	D	89	52.474	-13.357	47.743	1.00	75.89	C
ATOM	13098	OE1	GLU	D	89	53.663	-13.574	47.408	1.00	67.93	O
ATOM	13099	OE2	GLU	D	89	51.684	-14.285	48.079	1.00	69.21	O
ATOM	13100	O	MET	D	90	55.341	-10.174	41.139	1.00	66.32	O
ATOM	13101	N	MET	D	90	53.418	-9.551	43.970	1.00	73.74	N
ATOM	13102	CA	MET	D	90	53.582	-9.406	42.521	1.00	71.10	C

ATOM	13103	C	MET	D	90	55.026	-9.472	42.091	1.00	63.39	C
ATOM	13104	CB	MET	D	90	52.986	-8.090	42.013	1.00	66.27	C
ATOM	13105	CG	MET	D	90	53.004	-7.971	40.486	1.00	60.26	C
ATOM	13106	SD	MET	D	90	51.855	-9.143	39.717	1.00	70.43	S
ATOM	13107	CE	MET	D	90	52.938	-9.833	38.512	1.00	64.04	C
ATOM	13108	O	ALA	D	91	58.921	-10.299	41.664	1.00	64.24	O
ATOM	13109	N	ALA	D	91	55.886	-8.739	42.793	1.00	58.61	N
ATOM	13110	CA	ALA	D	91	57.315	-8.668	42.474	1.00	66.75	C
ATOM	13111	C	ALA	D	91	57.994	-10.063	42.443	1.00	67.73	C
ATOM	13112	CB	ALA	D	91	58.015	-7.763	43.469	1.00	59.32	C
ATOM	13113	O	LYS	D	92	58.640	-13.612	41.391	1.00	66.20	O
ATOM	13114	N	LYS	D	92	57.513	-10.967	43.293	1.00	63.57	N
ATOM	13115	CA	LYS	D	92	57.969	-12.353	43.320	1.00	68.74	C
ATOM	13116	C	LYS	D	92	57.723	-13.029	41.974	1.00	69.66	C
ATOM	13117	CB	LYS	D	92	57.261	-13.121	44.443	1.00	67.25	C
ATOM	13118	CG	LYS	D	92	57.531	-12.569	45.851	1.00	68.97	C
ATOM	13119	CD	LYS	D	92	56.758	-13.357	46.919	1.00	68.81	C
ATOM	13120	CE	LYS	D	92	57.244	-13.044	48.339	1.00	60.89	C
ATOM	13121	NZ	LYS	D	92	56.444	-13.761	49.382	1.00	62.75	N
ATOM	13122	O	VAL	D	93	57.416	-13.187	38.236	1.00	66.27	O
ATOM	13123	N	VAL	D	93	56.480	-12.922	41.495	1.00	70.88	N
ATOM	13124	CA	VAL	D	93	56.043	-13.445	40.193	1.00	62.27	C
ATOM	13125	C	VAL	D	93	56.634	-12.664	39.017	1.00	63.39	C
ATOM	13126	CB	VAL	D	93	54.514	-13.406	40.080	1.00	61.14	C
ATOM	13127	CG1	VAL	D	93	54.053	-14.051	38.778	1.00	59.90	C
ATOM	13128	CG2	VAL	D	93	53.868	-14.057	41.294	1.00	60.03	C
ATOM	13129	O	ASP	D	94	56.500	-8.725	39.484	1.00	60.82	O
ATOM	13130	N	ASP	D	94	56.238	-11.402	38.882	1.00	70.96	N
ATOM	13131	CA	ASP	D	94	56.869	-10.505	37.926	1.00	62.93	C
ATOM	13132	C	ASP	D	94	57.250	-9.223	38.658	1.00	68.07	C
ATOM	13133	CB	ASP	D	94	55.943	-10.219	36.752	1.00	58.64	C
ATOM	13134	CG	ASP	D	94	56.665	-9.602	35.566	1.00	62.89	C
ATOM	13135	OD1	ASP	D	94	57.605	-8.799	35.764	1.00	60.40	O
ATOM	13136	OD2	ASP	D	94	56.284	-9.927	34.419	1.00	63.66	O
ATOM	13137	O	ASP	D	95	58.876	-5.198	38.907	1.00	65.67	O
ATOM	13138	N	ASP	D	95	58.432	-8.698	38.369	1.00	69.12	N
ATOM	13139	CA	ASP	D	95	58.929	-7.573	39.141	1.00	70.73	C
ATOM	13140	C	ASP	D	95	58.832	-6.279	38.340	1.00	65.32	C
ATOM	13141	CB	ASP	D	95	60.372	-7.834	39.582	1.00	69.28	C
ATOM	13142	CG	ASP	D	95	61.351	-7.746	38.436	1.00	73.86	C
ATOM	13143	OD1	ASP	D	95	61.039	-8.245	37.331	1.00	73.24	O
ATOM	13144	OD2	ASP	D	95	62.433	-7.159	38.638	1.00	84.76	O
ATOM	13145	O	SER	D	96	57.132	-4.783	34.255	1.00	60.83	O
ATOM	13146	N	SER	D	96	58.718	-6.407	37.022	1.00	64.57	N
ATOM	13147	CA	SER	D	96	58.569	-5.265	36.139	1.00	58.97	C
ATOM	13148	C	SER	D	96	57.229	-5.294	35.368	1.00	58.79	C
ATOM	13149	CB	SER	D	96	59.745	-5.200	35.162	1.00	61.44	C
ATOM	13150	OG	SER	D	96	59.582	-6.086	34.064	1.00	58.25	O
ATOM	13151	O	PHE	D	97	53.830	-4.108	34.224	1.00	50.98	O
ATOM	13152	N	PHE	D	97	56.205	-5.885	35.973	1.00	54.33	N
ATOM	13153	CA	PHE	D	97	54.875	-5.990	35.367	1.00	56.28	C
ATOM	13154	C	PHE	D	97	54.169	-4.626	35.304	1.00	56.39	C
ATOM	13155	CB	PHE	D	97	54.047	-6.989	36.174	1.00	56.92	C
ATOM	13156	CG	PHE	D	97	52.597	-7.054	35.795	1.00	58.44	C
ATOM	13157	CD1	PHE	D	97	52.215	-7.268	34.482	1.00	54.34	C
ATOM	13158	CD2	PHE	D	97	51.612	-6.948	36.772	1.00	59.27	C
ATOM	13159	CE1	PHE	D	97	50.887	-7.355	34.142	1.00	54.98	C
ATOM	13160	CE2	PHE	D	97	50.281	-7.026	36.437	1.00	57.88	C
ATOM	13161	CZ	PHE	D	97	49.918	-7.230	35.115	1.00	56.03	C
ATOM	13162	N	PHE	D	98	53.977	-4.059	36.487	1.00	55.68	N
ATOM	13163	CA	PHE	D	98	53.444	-2.717	36.658	1.00	52.07	C
ATOM	13164	C	PHE	D	98	54.216	-1.684	35.872	1.00	57.81	C
ATOM	13165	O	PHE	D	98	53.627	-0.738	35.355	1.00	61.09	O

ATOM	13166	CB	PHE	D	98	53.429	-2.367	38.127	1.00	41.37	C
ATOM	13167	CG	PHE	D	98	52.445	-3.165	38.899	1.00	45.59	C
ATOM	13168	CD1	PHE	D	98	51.236	-3.516	38.330	1.00	49.29	C
ATOM	13169	CD2	PHE	D	98	52.719	-3.582	40.175	1.00	44.52	C
ATOM	13170	CE1	PHE	D	98	50.304	-4.252	39.039	1.00	48.61	C
ATOM	13171	CE2	PHE	D	98	51.794	-4.330	40.883	1.00	49.88	C
ATOM	13172	CZ	PHE	D	98	50.586	-4.663	40.314	1.00	48.95	C
ATOM	13173	N	HIS	D	99	55.522	-1.881	35.744	1.00	60.17	N
ATOM	13174	CA	HIS	D	99	56.341	-1.003	34.909	1.00	64.76	C
ATOM	13175	C	HIS	D	99	55.902	-1.067	33.458	1.00	62.55	C
ATOM	13176	O	HIS	D	99	55.923	-0.060	32.751	1.00	62.02	O
ATOM	13177	CB	HIS	D	99	57.823	-1.374	35.007	1.00	69.04	C
ATOM	13178	CG	HIS	D	99	58.452	-0.992	36.307	1.00	75.42	C
ATOM	13179	ND1	HIS	D	99	58.742	0.315	36.635	1.00	76.58	N
ATOM	13180	CD2	HIS	D	99	58.834	-1.743	37.368	1.00	77.18	C
ATOM	13181	CE1	HIS	D	99	59.279	0.353	37.842	1.00	81.87	C
ATOM	13182	NE2	HIS	D	99	59.348	-0.882	38.309	1.00	83.27	N
ATOM	13183	N	ARG	D	100	55.517	-2.265	33.017	1.00	62.04	N
ATOM	13184	CA	ARG	D	100	55.088	-2.460	31.641	1.00	62.66	C
ATOM	13185	C	ARG	D	100	53.681	-1.899	31.462	1.00	57.11	C
ATOM	13186	O	ARG	D	100	53.314	-1.412	30.392	1.00	51.62	O
ATOM	13187	CB	ARG	D	100	55.151	-3.941	31.260	1.00	58.97	C
ATOM	13188	CG	ARG	D	100	56.548	-4.389	30.814	1.00	63.38	C
ATOM	13189	CD	ARG	D	100	56.596	-5.868	30.420	1.00	56.49	C
ATOM	13190	NE	ARG	D	100	56.608	-6.736	31.595	1.00	62.35	N
ATOM	13191	CZ	ARG	D	100	55.721	-7.698	31.823	1.00	62.69	C
ATOM	13192	NH1	ARG	D	100	54.762	-7.924	30.952	1.00	66.30	N
ATOM	13193	NH2	ARG	D	100	55.787	-8.441	32.911	1.00	58.57	N
ATOM	13194	N	LEU	D	101	52.902	-1.981	32.529	1.00	55.62	N
ATOM	13195	CA	LEU	D	101	51.582	-1.408	32.546	1.00	53.06	C
ATOM	13196	C	LEU	D	101	51.668	0.107	32.352	1.00	58.77	C
ATOM	13197	O	LEU	D	101	51.090	0.666	31.407	1.00	57.05	O
ATOM	13198	CB	LEU	D	101	50.869	-1.738	33.855	1.00	49.22	C
ATOM	13199	CG	LEU	D	101	50.056	-3.021	33.787	1.00	50.73	C
ATOM	13200	CD1	LEU	D	101	48.895	-2.996	34.760	1.00	47.32	C
ATOM	13201	CD2	LEU	D	101	49.585	-3.292	32.383	1.00	47.14	C
ATOM	13202	N	GLU	D	102	52.435	0.762	33.218	1.00	55.29	N
ATOM	13203	CA	GLU	D	102	52.455	2.210	33.245	1.00	58.40	C
ATOM	13204	C	GLU	D	102	53.283	2.742	32.075	1.00	62.44	C
ATOM	13205	O	GLU	D	102	53.547	3.934	31.967	1.00	66.31	O
ATOM	13206	CB	GLU	D	102	52.974	2.711	34.599	1.00	58.82	C
ATOM	13207	CG	GLU	D	102	52.305	2.014	35.838	1.00	63.84	C
ATOM	13208	CD	GLU	D	102	50.769	2.224	35.969	1.00	67.10	C
ATOM	13209	OE1	GLU	D	102	50.363	3.338	36.406	1.00	67.53	O
ATOM	13210	OE2	GLU	D	102	49.970	1.281	35.664	1.00	52.95	O
ATOM	13211	N	GLU	D	103	53.621	1.855	31.149	1.00	52.23	N
ATOM	13212	CA	GLU	D	103	54.444	2.231	30.014	1.00	51.27	C
ATOM	13213	C	GLU	D	103	53.779	1.878	28.707	1.00	47.02	C
ATOM	13214	O	GLU	D	103	54.293	2.198	27.632	1.00	55.73	O
ATOM	13215	CB	GLU	D	103	55.798	1.520	30.123	1.00	64.52	C
ATOM	13216	CG	GLU	D	103	56.922	2.140	29.347	1.00	67.42	C
ATOM	13217	CD	GLU	D	103	58.211	1.348	29.514	1.00	70.10	C
ATOM	13218	OE1	GLU	D	103	58.150	0.239	30.086	1.00	72.64	O
ATOM	13219	OE2	GLU	D	103	59.269	1.823	29.046	1.00	69.84	O
ATOM	13220	N	SER	D	104	52.637	1.204	28.808	1.00	48.59	N
ATOM	13221	CA	SER	D	104	51.957	0.620	27.638	1.00	40.91	C
ATOM	13222	C	SER	D	104	51.820	1.587	26.495	1.00	47.15	C
ATOM	13223	O	SER	D	104	51.862	1.181	25.344	1.00	44.76	O
ATOM	13224	CB	SER	D	104	50.585	0.100	28.037	1.00	45.99	C
ATOM	13225	OG	SER	D	104	49.783	1.108	28.673	1.00	51.51	O
ATOM	13226	O	PHE	D	105	52.324	4.756	23.814	1.00	41.99	O
ATOM	13227	N	PHE	D	105	51.672	2.879	26.821	1.00	48.49	N
ATOM	13228	CA	PHE	D	105	51.311	3.927	25.851	1.00	43.46	C

ATOM	13229	C	PHE	D	105	52.488	4.325	24.973	1.00	47.90	C
ATOM	13230	CB	PHE	D	105	50.778	5.150	26.622	1.00	48.95	C
ATOM	13231	CG	PHE	D	105	50.373	6.301	25.761	1.00	49.27	C
ATOM	13232	CD2	PHE	D	105	51.293	7.262	25.392	1.00	48.47	C
ATOM	13233	CD1	PHE	D	105	49.038	6.448	25.354	1.00	50.71	C
ATOM	13234	CE2	PHE	D	105	50.888	8.345	24.601	1.00	53.16	C
ATOM	13235	CE1	PHE	D	105	48.636	7.515	24.565	1.00	50.63	C
ATOM	13236	CZ	PHE	D	105	49.560	8.464	24.183	1.00	49.30	C
ATOM	13237	O	LEU	D	106	54.938	2.513	23.627	1.00	52.62	O
ATOM	13238	N	LEU	D	106	53.681	4.196	25.559	1.00	47.60	N
ATOM	13239	CA	LEU	D	106	54.926	4.559	24.892	1.00	50.30	C
ATOM	13240	C	LEU	D	106	55.199	3.727	23.643	1.00	55.57	C
ATOM	13241	CB	LEU	D	106	56.098	4.391	25.845	1.00	57.39	C
ATOM	13242	CG	LEU	D	106	56.157	5.376	26.995	1.00	60.35	C
ATOM	13243	CD1	LEU	D	106	57.518	5.278	27.662	1.00	61.49	C
ATOM	13244	CD2	LEU	D	106	55.904	6.762	26.473	1.00	50.37	C
ATOM	13245	O	VAL	D	107	57.942	2.770	22.932	1.00	55.90	O
ATOM	13246	N	VAL	D	107	55.730	4.399	22.620	1.00	53.98	N
ATOM	13247	CA	VAL	D	107	56.298	3.780	21.433	1.00	55.72	C
ATOM	13248	C	VAL	D	107	57.411	2.762	21.810	1.00	59.60	C
ATOM	13249	CB	VAL	D	107	56.826	4.892	20.483	1.00	60.05	C
ATOM	13250	CG1	VAL	D	107	57.748	4.364	19.378	1.00	69.12	C
ATOM	13251	CG2	VAL	D	107	55.662	5.620	19.859	1.00	54.92	C
ATOM	13252	O	GLU	D	108	60.633	1.145	22.578	1.00	55.16	O
ATOM	13253	N	GLU	D	108	57.723	1.849	20.894	1.00	62.95	N
ATOM	13254	CA	GLU	D	108	58.753	0.832	21.144	1.00	66.42	C
ATOM	13255	C	GLU	D	108	60.087	1.463	21.527	1.00	56.45	C
ATOM	13256	CB	GLU	D	108	58.922	-0.061	19.920	1.00	63.78	C
ATOM	13257	CG	GLU	D	108	59.609	-1.367	20.196	1.00	72.61	C
ATOM	13258	CD	GLU	D	108	59.513	-2.323	19.015	1.00	80.49	C
ATOM	13259	OE1	GLU	D	108	59.033	-1.901	17.930	1.00	65.73	O
ATOM	13260	OE2	GLU	D	108	59.921	-3.498	19.178	1.00	85.31	O
ATOM	13261	O	GLU	D	109	62.533	3.101	23.290	1.00	73.94	O
ATOM	13262	N	GLU	D	109	60.593	2.359	20.686	1.00	53.23	N
ATOM	13263	CA	GLU	D	109	61.797	3.106	21.023	1.00	56.91	C
ATOM	13264	C	GLU	D	109	61.770	3.584	22.454	1.00	65.23	C
ATOM	13265	CB	GLU	D	109	61.972	4.316	20.128	1.00	66.36	C
ATOM	13266	CG	GLU	D	109	61.414	4.176	18.743	1.00	71.72	C
ATOM	13267	CD	GLU	D	109	61.353	5.522	18.050	1.00	83.21	C
ATOM	13268	OE1	GLU	D	109	60.522	5.688	17.123	1.00	90.76	O
ATOM	13269	OE2	GLU	D	109	62.136	6.417	18.450	1.00	79.63	O
ATOM	13270	O	ASP	D	110	60.638	4.603	26.348	1.00	70.68	O
ATOM	13271	N	ASP	D	110	60.854	4.503	22.742	1.00	60.63	N
ATOM	13272	CA	ASP	D	110	60.811	5.170	24.035	1.00	61.83	C
ATOM	13273	C	ASP	D	110	60.498	4.227	25.182	1.00	64.61	C
ATOM	13274	CB	ASP	D	110	59.783	6.306	24.016	1.00	60.81	C
ATOM	13275	CG	ASP	D	110	59.946	7.215	22.820	1.00	64.51	C
ATOM	13276	OD1	ASP	D	110	60.612	6.815	21.837	1.00	66.95	O
ATOM	13277	OD2	ASP	D	110	59.394	8.334	22.853	1.00	74.37	O
ATOM	13278	O	LYS	D	111	62.183	1.531	25.825	1.00	64.85	O
ATOM	13279	N	LYS	D	111	60.078	3.007	24.875	1.00	60.46	N
ATOM	13280	CA	LYS	D	111	59.821	2.046	25.940	1.00	63.04	C
ATOM	13281	C	LYS	D	111	61.152	1.526	26.501	1.00	68.46	C
ATOM	13282	CB	LYS	D	111	58.935	0.894	25.446	1.00	62.10	C
ATOM	13283	CG	LYS	D	111	58.179	0.192	26.574	1.00	60.91	C
ATOM	13284	CD	LYS	D	111	57.091	-0.796	26.098	1.00	57.57	C
ATOM	13285	CE	LYS	D	111	56.190	-0.244	24.999	1.00	54.50	C
ATOM	13286	NZ	LYS	D	111	54.744	-0.621	25.210	1.00	56.00	N
ATOM	13287	O	LYS	D	112	63.124	-1.411	29.378	1.00	72.62	O
ATOM	13288	N	LYS	D	112	61.116	1.097	27.753	1.00	67.23	N
ATOM	13289	CA	LYS	D	112	62.299	0.652	28.458	1.00	65.56	C
ATOM	13290	C	LYS	D	112	62.178	-0.819	28.856	1.00	71.58	C
ATOM	13291	CB	LYS	D	112	62.533	1.506	29.701	1.00	64.05	C

ATOM	13292	O	HIS	D	113	59.966	-2.836	26.627	1.00	59.85	O
ATOM	13293	N	HIS	D	113	61.004	-1.395	28.624	1.00	68.61	N
ATOM	13294	CA	HIS	D	113	60.772	-2.808	28.877	1.00	61.38	C
ATOM	13295	C	HIS	D	113	60.229	-3.491	27.645	1.00	60.55	C
ATOM	13296	CB	HIS	D	113	59.808	-3.014	30.037	1.00	64.60	C
ATOM	13297	CG	HIS	D	113	60.332	-2.537	31.350	1.00	65.60	C
ATOM	13298	ND1	HIS	D	113	60.828	-1.265	31.534	1.00	70.48	N
ATOM	13299	CD2	HIS	D	113	60.432	-3.160	32.547	1.00	68.07	C
ATOM	13300	CE1	HIS	D	113	61.208	-1.123	32.792	1.00	72.82	C
ATOM	13301	NE2	HIS	D	113	60.982	-2.260	33.428	1.00	74.06	N
ATOM	13302	O	GLU	D	114	57.349	-4.862	27.145	1.00	56.38	O
ATOM	13303	N	GLU	D	114	60.094	-4.815	27.745	1.00	67.99	N
ATOM	13304	CA	GLU	D	114	59.555	-5.637	26.664	1.00	63.50	C
ATOM	13305	C	GLU	D	114	58.187	-5.100	26.277	1.00	57.50	C
ATOM	13306	CB	GLU	D	114	59.460	-7.108	27.084	1.00	60.11	C
ATOM	13307	O	ARG	D	115	54.414	-4.262	24.567	1.00	54.62	O
ATOM	13308	N	ARG	D	115	57.967	-4.924	24.980	1.00	55.07	N
ATOM	13309	CA	ARG	D	115	56.828	-4.153	24.509	1.00	57.67	C
ATOM	13310	C	ARG	D	115	55.482	-4.868	24.728	1.00	63.16	C
ATOM	13311	CB	ARG	D	115	57.016	-3.795	23.035	1.00	51.73	C
ATOM	13312	CG	ARG	D	115	56.629	-4.880	22.043	1.00	54.52	C
ATOM	13313	CD	ARG	D	115	57.003	-4.418	20.634	1.00	61.62	C
ATOM	13314	NE	ARG	D	115	56.576	-5.326	19.572	1.00	61.78	N
ATOM	13315	CZ	ARG	D	115	57.159	-6.496	19.320	1.00	69.98	C
ATOM	13316	NH1	ARG	D	115	58.175	-6.907	20.073	1.00	65.61	N
ATOM	13317	NH2	ARG	D	115	56.716	-7.264	18.328	1.00	64.68	N
ATOM	13318	O	HIS	D	116	54.793	-6.983	27.731	1.00	61.15	O
ATOM	13319	N	HIS	D	116	55.533	-6.140	25.116	1.00	55.67	N
ATOM	13320	CA	HIS	D	116	54.324	-6.905	25.402	1.00	54.69	C
ATOM	13321	C	HIS	D	116	53.994	-6.688	26.864	1.00	60.24	C
ATOM	13322	CB	HIS	D	116	54.517	-8.392	25.013	1.00	58.85	C
ATOM	13323	CG	HIS	D	116	54.798	-8.569	23.552	1.00	52.18	C
ATOM	13324	ND1	HIS	D	116	56.066	-8.481	23.022	1.00	53.92	N
ATOM	13325	CD2	HIS	D	116	53.961	-8.700	22.496	1.00	55.86	C
ATOM	13326	CE1	HIS	D	116	56.002	-8.577	21.705	1.00	54.80	C
ATOM	13327	NE2	HIS	D	116	54.734	-8.710	21.359	1.00	49.21	N
ATOM	13328	O	PRO	D	117	52.815	-6.722	30.650	1.00	64.82	O
ATOM	13329	N	PRO	D	117	52.833	-6.081	27.143	1.00	62.73	N
ATOM	13330	CA	PRO	D	117	52.681	-5.642	28.532	1.00	60.93	C
ATOM	13331	C	PRO	D	117	52.353	-6.758	29.505	1.00	60.83	C
ATOM	13332	CB	PRO	D	117	51.529	-4.616	28.458	1.00	58.00	C
ATOM	13333	CG	PRO	D	117	50.818	-4.908	27.201	1.00	55.19	C
ATOM	13334	CD	PRO	D	117	51.862	-5.435	26.244	1.00	59.21	C
ATOM	13335	O	ILE	D	118	52.385	-9.852	31.715	1.00	66.53	O
ATOM	13336	N	ILE	D	118	51.554	-7.727	29.093	1.00	57.46	N
ATOM	13337	CA	ILE	D	118	51.073	-8.694	30.073	1.00	59.69	C
ATOM	13338	C	ILE	D	118	52.159	-9.647	30.514	1.00	64.06	C
ATOM	13339	CB	ILE	D	118	49.926	-9.507	29.533	1.00	62.16	C
ATOM	13340	CG1	ILE	D	118	48.829	-8.562	29.035	1.00	53.95	C
ATOM	13341	CG2	ILE	D	118	49.432	-10.482	30.610	1.00	57.36	C
ATOM	13342	CD1	ILE	D	118	47.527	-9.250	28.753	1.00	49.75	C
ATOM	13343	O	PHE	D	119	55.121	-9.408	28.498	1.00	71.26	O
ATOM	13344	N	PHE	D	119	52.814	-10.247	29.525	1.00	63.48	N
ATOM	13345	CA	PHE	D	119	53.974	-11.095	29.767	1.00	64.74	C
ATOM	13346	C	PHE	D	119	55.203	-10.464	29.113	1.00	67.88	C
ATOM	13347	CB	PHE	D	119	53.733	-12.496	29.222	1.00	62.49	C
ATOM	13348	CG	PHE	D	119	52.456	-13.120	29.700	1.00	56.31	C
ATOM	13349	CD1	PHE	D	119	52.355	-13.621	30.982	1.00	56.52	C
ATOM	13350	CD2	PHE	D	119	51.358	-13.210	28.862	1.00	58.79	C
ATOM	13351	CE1	PHE	D	119	51.188	-14.197	31.418	1.00	56.87	C
ATOM	13352	CE2	PHE	D	119	50.185	-13.786	29.295	1.00	51.26	C
ATOM	13353	CZ	PHE	D	119	50.100	-14.280	30.574	1.00	50.29	C
ATOM	13354	O	GLY	D	120	57.902	-9.971	26.306	1.00	73.19	O

ATOM	13355	N	GLY	D	120	56.346	-11.101	29.219	1.00	60.78	N
ATOM	13356	CA	GLY	D	120	57.517	-10.518	28.604	1.00	68.22	C
ATOM	13357	C	GLY	D	120	57.554	-10.823	27.130	1.00	64.73	C
ATOM	13358	O	ASN	D	121	55.022	-12.574	25.041	1.00	58.74	O
ATOM	13359	N	ASN	D	121	57.174	-12.049	26.797	1.00	70.01	N
ATOM	13360	CA	ASN	D	121	57.384	-12.561	25.454	1.00	67.60	C
ATOM	13361	C	ASN	D	121	56.154	-12.447	24.577	1.00	56.10	C
ATOM	13362	CB	ASN	D	121	57.835	-14.022	25.513	1.00	55.15	C
ATOM	13363	N	ILE	D	122	56.406	-12.233	23.299	1.00	52.98	N
ATOM	13364	CA	ILE	D	122	55.375	-12.273	22.292	1.00	52.07	C
ATOM	13365	C	ILE	D	122	54.626	-13.604	22.225	1.00	58.47	C
ATOM	13366	O	ILE	D	122	53.486	-13.638	21.780	1.00	59.30	O
ATOM	13367	CB	ILE	D	122	55.960	-11.984	20.918	1.00	52.86	C
ATOM	13368	CG1	ILE	D	122	54.833	-11.704	19.924	1.00	50.86	C
ATOM	13369	CG2	ILE	D	122	56.845	-13.159	20.469	1.00	57.60	C
ATOM	13370	CD1	ILE	D	122	55.291	-11.144	18.604	1.00	56.35	C
ATOM	13371	N	VAL	D	123	55.239	-14.704	22.655	1.00	59.70	N
ATOM	13372	CA	VAL	D	123	54.576	-16.006	22.518	1.00	56.40	C
ATOM	13373	C	VAL	D	123	53.460	-16.153	23.546	1.00	56.83	C
ATOM	13374	O	VAL	D	123	52.369	-16.641	23.247	1.00	57.55	O
ATOM	13375	CB	VAL	D	123	55.571	-17.217	22.674	1.00	62.62	C
ATOM	13376	CG1	VAL	D	123	54.799	-18.521	22.896	1.00	53.88	C
ATOM	13377	CG2	VAL	D	123	56.486	-17.337	21.458	1.00	55.90	C
ATOM	13378	N	ASP	D	124	53.755	-15.769	24.774	1.00	56.32	N
ATOM	13379	CA	ASP	D	124	52.760	-15.797	25.828	1.00	63.04	C
ATOM	13380	C	ASP	D	124	51.622	-14.784	25.538	1.00	63.67	C
ATOM	13381	O	ASP	D	124	50.445	-15.084	25.745	1.00	62.15	O
ATOM	13382	CB	ASP	D	124	53.427	-15.503	27.171	1.00	64.15	C
ATOM	13383	CG	ASP	D	124	54.802	-16.156	27.296	1.00	70.04	C
ATOM	13384	OD1	ASP	D	124	54.825	-17.350	27.644	1.00	77.65	O
ATOM	13385	OD2	ASP	D	124	55.847	-15.487	27.054	1.00	61.08	O
ATOM	13386	N	GLU	D	125	51.995	-13.606	25.035	1.00	60.03	N
ATOM	13387	CA	GLU	D	125	51.059	-12.528	24.729	1.00	60.97	C
ATOM	13388	C	GLU	D	125	49.985	-12.983	23.747	1.00	61.73	C
ATOM	13389	O	GLU	D	125	48.783	-12.919	24.033	1.00	59.43	O
ATOM	13390	CB	GLU	D	125	51.808	-11.318	24.148	1.00	59.57	C
ATOM	13391	CG	GLU	D	125	51.210	-9.950	24.521	1.00	52.85	C
ATOM	13392	CD	GLU	D	125	51.496	-9.558	25.961	1.00	60.60	C
ATOM	13393	OE1	GLU	D	125	52.381	-10.186	26.585	1.00	67.47	O
ATOM	13394	OE2	GLU	D	125	50.848	-8.619	26.481	1.00	64.78	O
ATOM	13395	N	VAL	D	126	50.444	-13.445	22.590	1.00	63.56	N
ATOM	13396	CA	VAL	D	126	49.577	-13.947	21.535	1.00	58.18	C
ATOM	13397	C	VAL	D	126	48.707	-15.106	22.031	1.00	58.11	C
ATOM	13398	O	VAL	D	126	47.555	-15.238	21.626	1.00	59.79	O
ATOM	13399	CB	VAL	D	126	50.405	-14.380	20.320	1.00	54.03	C
ATOM	13400	CG1	VAL	D	126	49.546	-15.085	19.301	1.00	51.44	C
ATOM	13401	CG2	VAL	D	126	51.093	-13.165	19.691	1.00	52.58	C
ATOM	13402	N	ALA	D	127	49.225	-15.906	22.955	1.00	54.06	N
ATOM	13403	CA	ALA	D	127	48.458	-17.049	23.436	1.00	56.46	C
ATOM	13404	C	ALA	D	127	47.385	-16.599	24.412	1.00	56.63	C
ATOM	13405	O	ALA	D	127	46.324	-17.221	24.518	1.00	57.06	O
ATOM	13406	CB	ALA	D	127	49.375	-18.098	24.088	1.00	52.22	C
ATOM	13407	N	TYR	D	128	47.661	-15.523	25.138	1.00	53.73	N
ATOM	13408	CA	TYR	D	128	46.640	-14.909	25.976	1.00	54.56	C
ATOM	13409	C	TYR	D	128	45.446	-14.397	25.156	1.00	49.77	C
ATOM	13410	O	TYR	D	128	44.286	-14.664	25.461	1.00	49.10	O
ATOM	13411	CB	TYR	D	128	47.237	-13.752	26.778	1.00	59.28	C
ATOM	13412	CG	TYR	D	128	46.190	-12.982	27.564	1.00	55.47	C
ATOM	13413	CD1	TYR	D	128	45.689	-13.481	28.764	1.00	55.61	C
ATOM	13414	CD2	TYR	D	128	45.691	-11.775	27.096	1.00	53.98	C
ATOM	13415	CE1	TYR	D	128	44.715	-12.784	29.478	1.00	55.91	C
ATOM	13416	CE2	TYR	D	128	44.722	-11.075	27.806	1.00	53.21	C
ATOM	13417	CZ	TYR	D	128	44.252	-11.583	28.997	1.00	54.45	C

ATOM	13418	OH	TYR	D	128	43.291	-10.894	29.705	1.00	65.71	O
ATOM	13419	N	HIS	D	129	45.752	-13.661	24.105	1.00	48.75	N
ATOM	13420	CA	HIS	D	129	44.721	-13.002	23.338	1.00	51.55	C
ATOM	13421	C	HIS	D	129	43.857	-13.977	22.583	1.00	54.74	C
ATOM	13422	O	HIS	D	129	42.745	-13.625	22.163	1.00	49.24	O
ATOM	13423	CB	HIS	D	129	45.340	-11.999	22.374	1.00	46.66	C
ATOM	13424	CG	HIS	D	129	45.560	-10.654	22.987	1.00	59.31	C
ATOM	13425	ND1	HIS	D	129	46.792	-10.033	23.008	1.00	61.99	N
ATOM	13426	CD2	HIS	D	129	44.703	-9.810	23.612	1.00	55.87	C
ATOM	13427	CE1	HIS	D	129	46.683	-8.865	23.617	1.00	53.11	C
ATOM	13428	NE2	HIS	D	129	45.423	-8.703	23.984	1.00	55.74	N
ATOM	13429	N	GLU	D	130	44.365	-15.202	22.420	1.00	54.13	N
ATOM	13430	CA	GLU	D	130	43.679	-16.216	21.634	1.00	48.86	C
ATOM	13431	C	GLU	D	130	42.774	-17.042	22.526	1.00	47.71	C
ATOM	13432	O	GLU	D	130	41.649	-17.355	22.157	1.00	48.97	O
ATOM	13433	CB	GLU	D	130	44.679	-17.101	20.908	1.00	57.96	C
ATOM	13434	CG	GLU	D	130	44.222	-17.571	19.538	1.00	61.05	C
ATOM	13435	CD	GLU	D	130	44.821	-16.743	18.427	1.00	71.18	C
ATOM	13436	OE1	GLU	D	130	45.966	-17.032	17.996	1.00	72.45	O
ATOM	13437	OE2	GLU	D	130	44.143	-15.795	17.975	1.00	79.39	O
ATOM	13438	N	LYS	D	131	43.246	-17.395	23.711	1.00	49.98	N
ATOM	13439	CA	LYS	D	131	42.358	-18.050	24.669	1.00	48.46	C
ATOM	13440	C	LYS	D	131	41.340	-17.031	25.193	1.00	49.75	C
ATOM	13441	O	LYS	D	131	40.193	-17.392	25.449	1.00	51.32	O
ATOM	13442	CB	LYS	D	131	43.146	-18.666	25.839	1.00	43.26	C
ATOM	13443	N	TYR	D	132	41.779	-15.772	25.367	1.00	45.81	N
ATOM	13444	CA	TYR	D	132	40.942	-14.705	25.975	1.00	53.58	C
ATOM	13445	C	TYR	D	132	40.809	-13.459	25.117	1.00	50.13	C
ATOM	13446	O	TYR	D	132	41.414	-12.432	25.429	1.00	52.17	O
ATOM	13447	CB	TYR	D	132	41.508	-14.261	27.327	1.00	51.71	C
ATOM	13448	CG	TYR	D	132	41.731	-15.375	28.326	1.00	52.03	C
ATOM	13449	CD1	TYR	D	132	40.670	-15.894	29.045	1.00	49.05	C
ATOM	13450	CD2	TYR	D	132	43.015	-15.893	28.560	1.00	53.83	C
ATOM	13451	CE1	TYR	D	132	40.864	-16.893	29.969	1.00	56.11	C
ATOM	13452	CE2	TYR	D	132	43.221	-16.892	29.484	1.00	47.65	C
ATOM	13453	CZ	TYR	D	132	42.142	-17.397	30.183	1.00	55.99	C
ATOM	13454	OH	TYR	D	132	42.309	-18.401	31.108	1.00	56.90	O
ATOM	13455	O	PRO	D	133	39.686	-9.987	23.464	1.00	47.88	O
ATOM	13456	N	PRO	D	133	40.031	-13.535	24.032	1.00	49.15	N
ATOM	13457	CA	PRO	D	133	39.917	-12.360	23.149	1.00	45.20	C
ATOM	13458	C	PRO	D	133	39.330	-11.105	23.849	1.00	47.05	C
ATOM	13459	CB	PRO	D	133	38.993	-12.849	22.018	1.00	47.48	C
ATOM	13460	CG	PRO	D	133	38.946	-14.357	22.161	1.00	46.01	C
ATOM	13461	CD	PRO	D	133	39.154	-14.644	23.619	1.00	45.13	C
ATOM	13462	O	THR	D	134	38.534	-11.479	27.502	1.00	45.61	O
ATOM	13463	N	THR	D	134	38.482	-11.264	24.859	1.00	38.47	N
ATOM	13464	CA	THR	D	134	38.095	-10.097	25.642	1.00	45.68	C
ATOM	13465	C	THR	D	134	38.385	-10.342	27.103	1.00	48.15	C
ATOM	13466	CB	THR	D	134	36.591	-9.719	25.495	1.00	45.37	C
ATOM	13467	OG1	THR	D	134	35.784	-10.570	26.325	1.00	47.57	O
ATOM	13468	CG2	THR	D	134	36.133	-9.760	24.022	1.00	38.41	C
ATOM	13469	O	ILE	D	135	37.747	-10.562	31.090	1.00	44.04	O
ATOM	13470	N	ILE	D	135	38.439	-9.268	27.895	1.00	41.84	N
ATOM	13471	CA	ILE	D	135	38.740	-9.357	29.321	1.00	37.03	C
ATOM	13472	C	ILE	D	135	37.611	-10.085	29.996	1.00	39.25	C
ATOM	13473	CB	ILE	D	135	38.936	-7.922	29.941	1.00	46.86	C
ATOM	13474	CG1	ILE	D	135	39.395	-7.965	31.409	1.00	46.13	C
ATOM	13475	CG2	ILE	D	135	37.663	-7.080	29.797	1.00	41.62	C
ATOM	13476	CD1	ILE	D	135	40.837	-8.362	31.598	1.00	42.58	C
ATOM	13477	N	TYR	D	136	36.468	-10.158	29.330	1.00	43.76	N
ATOM	13478	CA	TYR	D	136	35.298	-10.793	29.916	1.00	48.22	C
ATOM	13479	C	TYR	D	136	35.437	-12.337	29.878	1.00	44.46	C
ATOM	13480	O	TYR	D	136	34.963	-13.051	30.788	1.00	42.21	O

ATOM	13481	CB	TYR	D	136	34.018	-10.304	29.196	1.00	44.19	C
ATOM	13482	CG	TYR	D	136	33.793	-8.806	29.389	1.00	47.14	C
ATOM	13483	CD1	TYR	D	136	33.370	-8.309	30.614	1.00	42.69	C
ATOM	13484	CD2	TYR	D	136	34.040	-7.897	28.361	1.00	43.07	C
ATOM	13485	CE1	TYR	D	136	33.200	-6.974	30.819	1.00	42.88	C
ATOM	13486	CE2	TYR	D	136	33.856	-6.541	28.552	1.00	43.55	C
ATOM	13487	CZ	TYR	D	136	33.439	-6.085	29.796	1.00	46.32	C
ATOM	13488	OH	TYR	D	136	33.253	-4.739	30.036	1.00	45.40	O
ATOM	13489	N	HIS	D	137	36.095	-12.832	28.834	1.00	44.68	N
ATOM	13490	CA	HIS	D	137	36.498	-14.255	28.791	1.00	48.25	C
ATOM	13491	C	HIS	D	137	37.339	-14.559	30.025	1.00	43.48	C
ATOM	13492	O	HIS	D	137	36.990	-15.425	30.791	1.00	46.15	O
ATOM	13493	CB	HIS	D	137	37.262	-14.583	27.514	1.00	40.91	C
ATOM	13494	CG	HIS	D	137	36.415	-14.571	26.283	1.00	43.70	C
ATOM	13495	ND1	HIS	D	137	36.199	-13.430	25.535	1.00	44.84	N
ATOM	13496	CD2	HIS	D	137	35.736	-15.562	25.663	1.00	40.74	C
ATOM	13497	CE1	HIS	D	137	35.417	-13.719	24.513	1.00	42.91	C
ATOM	13498	NE2	HIS	D	137	35.120	-15.005	24.570	1.00	52.42	N
ATOM	13499	N	LEU	D	138	38.399	-13.785	30.250	1.00	46.04	N
ATOM	13500	CA	LEU	D	138	39.242	-13.961	31.437	1.00	48.66	C
ATOM	13501	C	LEU	D	138	38.443	-13.929	32.716	1.00	47.79	C
ATOM	13502	O	LEU	D	138	38.606	-14.777	33.592	1.00	53.02	O
ATOM	13503	CB	LEU	D	138	40.328	-12.896	31.501	1.00	43.77	C
ATOM	13504	CG	LEU	D	138	41.284	-13.002	32.686	1.00	51.41	C
ATOM	13505	CD1	LEU	D	138	41.743	-14.453	32.877	1.00	50.45	C
ATOM	13506	CD2	LEU	D	138	42.504	-12.072	32.501	1.00	45.72	C
ATOM	13507	N	ARG	D	139	37.558	-12.955	32.804	1.00	50.00	N
ATOM	13508	CA	ARG	D	139	36.825	-12.714	34.025	1.00	50.68	C
ATOM	13509	C	ARG	D	139	35.922	-13.882	34.370	1.00	46.43	C
ATOM	13510	O	ARG	D	139	35.951	-14.363	35.500	1.00	51.44	O
ATOM	13511	CB	ARG	D	139	36.010	-11.413	33.918	1.00	45.16	C
ATOM	13512	CG	ARG	D	139	36.852	-10.140	34.004	1.00	48.78	C
ATOM	13513	CD	ARG	D	139	36.060	-8.850	33.636	1.00	39.41	C
ATOM	13514	NE	ARG	D	139	34.798	-8.725	34.358	1.00	43.57	N
ATOM	13515	CZ	ARG	D	139	34.201	-7.556	34.642	1.00	53.52	C
ATOM	13516	NH1	ARG	D	139	34.762	-6.410	34.261	1.00	40.25	N
ATOM	13517	NH2	ARG	D	139	33.044	-7.527	35.311	1.00	45.96	N
ATOM	13518	N	LYS	D	140	35.100	-14.327	33.431	1.00	46.44	N
ATOM	13519	CA	LYS	D	140	34.251	-15.478	33.736	1.00	52.01	C
ATOM	13520	C	LYS	D	140	35.090	-16.716	34.096	1.00	51.10	C
ATOM	13521	O	LYS	D	140	34.742	-17.456	35.015	1.00	50.88	O
ATOM	13522	CB	LYS	D	140	33.330	-15.801	32.570	1.00	49.66	C
ATOM	13523	CG	LYS	D	140	32.257	-16.779	32.924	1.00	47.31	C
ATOM	13524	CD	LYS	D	140	31.911	-17.636	31.725	1.00	52.33	C
ATOM	13525	CE	LYS	D	140	30.462	-18.107	31.794	1.00	55.46	C
ATOM	13526	NZ	LYS	D	140	30.119	-18.708	33.119	1.00	60.76	N
ATOM	13527	N	LYS	D	141	36.206	-16.916	33.387	1.00	52.57	N
ATOM	13528	CA	LYS	D	141	37.110	-18.034	33.671	1.00	52.98	C
ATOM	13529	C	LYS	D	141	37.593	-17.996	35.117	1.00	57.68	C
ATOM	13530	O	LYS	D	141	37.631	-19.025	35.783	1.00	56.81	O
ATOM	13531	CB	LYS	D	141	38.306	-18.035	32.722	1.00	52.49	C
ATOM	13532	N	LEU	D	142	37.937	-16.809	35.617	1.00	53.15	N
ATOM	13533	CA	LEU	D	142	38.436	-16.709	36.986	1.00	51.70	C
ATOM	13534	C	LEU	D	142	37.311	-16.795	37.999	1.00	53.54	C
ATOM	13535	O	LEU	D	142	37.554	-16.849	39.193	1.00	52.05	O
ATOM	13536	CB	LEU	D	142	39.221	-15.421	37.189	1.00	47.74	C
ATOM	13537	CG	LEU	D	142	40.381	-15.257	36.210	1.00	50.77	C
ATOM	13538	CD1	LEU	D	142	41.025	-13.885	36.350	1.00	44.39	C
ATOM	13539	CD2	LEU	D	142	41.427	-16.397	36.383	1.00	46.58	C
ATOM	13540	N	VAL	D	143	36.075	-16.822	37.527	1.00	51.41	N
ATOM	13541	CA	VAL	D	143	34.957	-17.026	38.439	1.00	54.78	C
ATOM	13542	C	VAL	D	143	34.602	-18.506	38.468	1.00	60.14	C
ATOM	13543	O	VAL	D	143	34.089	-19.024	39.464	1.00	59.31	O

ATOM	13544	CB	VAL	D	143	33.706	-16.182	38.028	1.00	59.68	C
ATOM	13545	CG1	VAL	D	143	32.551	-16.355	39.037	1.00	51.22	C
ATOM	13546	CG2	VAL	D	143	34.074	-14.706	37.899	1.00	57.14	C
ATOM	13547	N	ASP	D	144	34.901	-19.183	37.365	1.00	59.12	N
ATOM	13548	CA	ASP	D	144	34.515	-20.576	37.172	1.00	58.11	C
ATOM	13549	C	ASP	D	144	35.542	-21.578	37.707	1.00	59.82	C
ATOM	13550	O	ASP	D	144	35.242	-22.332	38.619	1.00	57.27	O
ATOM	13551	CB	ASP	D	144	34.263	-20.826	35.695	1.00	57.23	C
ATOM	13552	CG	ASP	D	144	32.924	-20.298	35.256	1.00	59.76	C
ATOM	13553	OD1	ASP	D	144	32.084	-20.083	36.147	1.00	59.74	O
ATOM	13554	OD2	ASP	D	144	32.707	-20.111	34.037	1.00	63.47	O
ATOM	13555	N	SER	D	145	36.744	-21.557	37.134	1.00	58.64	N
ATOM	13556	CA	SER	D	145	37.852	-22.404	37.542	1.00	55.55	C
ATOM	13557	C	SER	D	145	38.051	-22.517	39.048	1.00	60.83	C
ATOM	13558	O	SER	D	145	37.775	-21.576	39.791	1.00	63.28	O
ATOM	13559	CB	SER	D	145	39.150	-21.897	36.922	1.00	59.24	C
ATOM	13560	OG	SER	D	145	38.934	-21.505	35.585	1.00	60.09	O
ATOM	13561	O	THR	D	146	41.230	-23.938	41.780	1.00	57.64	O
ATOM	13562	N	THR	D	146	38.517	-23.695	39.474	1.00	66.82	N
ATOM	13563	CA	THR	D	146	39.030	-23.916	40.822	1.00	62.79	C
ATOM	13564	C	THR	D	146	40.550	-23.960	40.755	1.00	58.54	C
ATOM	13565	CB	THR	D	146	38.499	-25.209	41.449	1.00	56.89	C
ATOM	13566	OG1	THR	D	146	38.557	-26.259	40.480	1.00	70.16	O
ATOM	13567	CG2	THR	D	146	37.062	-25.041	41.884	1.00	60.32	C
ATOM	13568	O	ASP	D	147	42.537	-21.866	40.469	1.00	71.61	O
ATOM	13569	N	ASP	D	147	41.071	-23.986	39.533	1.00	51.39	N
ATOM	13570	CA	ASP	D	147	42.513	-23.958	39.305	1.00	54.09	C
ATOM	13571	C	ASP	D	147	43.197	-22.732	39.915	1.00	61.42	C
ATOM	13572	CB	ASP	D	147	42.796	-24.018	37.802	1.00	59.73	C
ATOM	13573	CG	ASP	D	147	42.585	-25.419	37.215	1.00	68.68	C
ATOM	13574	OD2	ASP	D	147	42.934	-25.620	36.027	1.00	66.80	O
ATOM	13575	OD1	ASP	D	147	42.064	-26.312	37.935	1.00	65.97	O
ATOM	13576	O	LYS	D	148	46.278	-21.148	38.174	1.00	52.73	O
ATOM	13577	N	LYS	D	148	44.518	-22.652	39.802	1.00	60.72	N
ATOM	13578	CA	LYS	D	148	45.272	-21.507	40.303	1.00	58.92	C
ATOM	13579	C	LYS	D	148	45.704	-20.635	39.137	1.00	58.98	C
ATOM	13580	CB	LYS	D	148	46.496	-21.969	41.105	1.00	61.19	C
ATOM	13581	CG	LYS	D	148	47.572	-20.913	41.333	1.00	62.28	C
ATOM	13582	CD	LYS	D	148	48.652	-21.407	42.307	1.00	67.81	C
ATOM	13583	CE	LYS	D	148	49.777	-20.386	42.501	1.00	64.38	C
ATOM	13584	NZ	LYS	D	148	50.728	-20.775	43.595	1.00	63.24	N
ATOM	13585	O	ALA	D	149	47.507	-17.590	39.261	1.00	44.41	O
ATOM	13586	N	ALA	D	149	45.447	-19.320	39.210	1.00	56.65	N
ATOM	13587	CA	ALA	D	149	45.697	-18.477	38.039	1.00	48.25	C
ATOM	13588	C	ALA	D	149	47.011	-17.792	38.161	1.00	42.08	C
ATOM	13589	CB	ALA	D	149	44.590	-17.452	37.854	1.00	53.98	C
ATOM	13590	N	ASP	D	150	47.577	-17.420	37.027	1.00	36.71	N
ATOM	13591	CA	ASP	D	150	48.695	-16.503	37.064	1.00	41.85	C
ATOM	13592	C	ASP	D	150	48.204	-15.227	37.744	1.00	51.56	C
ATOM	13593	O	ASP	D	150	47.037	-14.838	37.610	1.00	50.82	O
ATOM	13594	CB	ASP	D	150	49.239	-16.217	35.672	1.00	41.14	C
ATOM	13595	CG	ASP	D	150	50.474	-15.331	35.704	1.00	59.66	C
ATOM	13596	OD2	ASP	D	150	51.472	-15.691	35.036	1.00	71.32	O
ATOM	13597	OD1	ASP	D	150	50.470	-14.294	36.417	1.00	57.76	O
ATOM	13598	N	LEU	D	151	49.094	-14.599	38.499	1.00	51.69	N
ATOM	13599	CA	LEU	D	151	48.692	-13.559	39.413	1.00	49.56	C
ATOM	13600	C	LEU	D	151	48.460	-12.289	38.601	1.00	57.83	C
ATOM	13601	O	LEU	D	151	47.569	-11.504	38.904	1.00	52.24	O
ATOM	13602	CB	LEU	D	151	49.738	-13.342	40.494	1.00	47.74	C
ATOM	13603	CG	LEU	D	151	49.324	-12.409	41.632	1.00	53.59	C
ATOM	13604	CD1	LEU	D	151	48.197	-13.007	42.447	1.00	55.51	C
ATOM	13605	CD2	LEU	D	151	50.507	-12.124	42.520	1.00	60.74	C
ATOM	13606	N	ARG	D	152	49.259	-12.128	37.553	1.00	54.36	N

ATOM	13607	CA	ARG	D	152	49.095	-11.045	36.611	1.00	51.25	C
ATOM	13608	C	ARG	D	152	47.667	-10.965	36.069	1.00	59.40	C
ATOM	13609	O	ARG	D	152	47.107	-9.878	35.933	1.00	59.57	O
ATOM	13610	CB	ARG	D	152	50.067	-11.202	35.460	1.00	52.42	C
ATOM	13611	CG	ARG	D	152	51.349	-10.468	35.697	1.00	61.01	C
ATOM	13612	CD	ARG	D	152	52.459	-10.931	34.799	1.00	61.04	C
ATOM	13613	NE	ARG	D	152	52.757	-12.338	35.074	1.00	71.59	N
ATOM	13614	CZ	ARG	D	152	53.714	-13.042	34.475	1.00	60.10	C
ATOM	13615	NH1	ARG	D	152	54.489	-12.486	33.545	1.00	57.40	N
ATOM	13616	NH2	ARG	D	152	53.877	-14.310	34.807	1.00	65.82	N
ATOM	13617	N	LEU	D	153	47.079	-12.114	35.764	1.00	56.68	N
ATOM	13618	CA	LEU	D	153	45.727	-12.128	35.248	1.00	49.26	C
ATOM	13619	C	LEU	D	153	44.755	-11.987	36.388	1.00	53.90	C
ATOM	13620	O	LEU	D	153	43.621	-11.536	36.181	1.00	58.63	O
ATOM	13621	CB	LEU	D	153	45.436	-13.408	34.466	1.00	46.15	C
ATOM	13622	CG	LEU	D	153	46.524	-13.729	33.443	1.00	50.99	C
ATOM	13623	CD1	LEU	D	153	46.232	-15.032	32.672	1.00	42.47	C
ATOM	13624	CD2	LEU	D	153	46.760	-12.564	32.494	1.00	43.89	C
ATOM	13625	N	ILE	D	154	45.159	-12.371	37.590	1.00	40.22	N
ATOM	13626	CA	ILE	D	154	44.263	-12.124	38.699	1.00	47.72	C
ATOM	13627	C	ILE	D	154	44.178	-10.579	38.883	1.00	55.70	C
ATOM	13628	O	ILE	D	154	43.122	-10.021	39.132	1.00	51.10	O
ATOM	13629	CB	ILE	D	154	44.720	-12.813	39.970	1.00	49.08	C
ATOM	13630	CG1	ILE	D	154	44.467	-14.319	39.853	1.00	58.62	C
ATOM	13631	CG2	ILE	D	154	43.977	-12.264	41.183	1.00	50.40	C
ATOM	13632	CD1	ILE	D	154	44.994	-15.135	41.021	1.00	56.43	C
ATOM	13633	N	TYR	D	155	45.306	-9.909	38.697	1.00	53.06	N
ATOM	13634	CA	TYR	D	155	45.366	-8.491	38.850	1.00	53.59	C
ATOM	13635	C	TYR	D	155	44.436	-7.821	37.829	1.00	54.94	C
ATOM	13636	O	TYR	D	155	43.507	-7.098	38.208	1.00	55.37	O
ATOM	13637	CB	TYR	D	155	46.795	-7.971	38.682	1.00	50.04	C
ATOM	13638	CG	TYR	D	155	46.775	-6.466	38.588	1.00	56.31	C
ATOM	13639	CD1	TYR	D	155	46.331	-5.693	39.660	1.00	53.66	C
ATOM	13640	CD2	TYR	D	155	47.127	-5.812	37.406	1.00	58.29	C
ATOM	13641	CE1	TYR	D	155	46.262	-4.323	39.565	1.00	49.05	C
ATOM	13642	CE2	TYR	D	155	47.068	-4.430	37.313	1.00	48.69	C
ATOM	13643	CZ	TYR	D	155	46.633	-3.703	38.406	1.00	46.58	C
ATOM	13644	OH	TYR	D	155	46.577	-2.343	38.338	1.00	57.57	O
ATOM	13645	N	LEU	D	156	44.684	-8.078	36.548	1.00	46.29	N
ATOM	13646	CA	LEU	D	156	43.936	-7.447	35.488	1.00	46.50	C
ATOM	13647	C	LEU	D	156	42.412	-7.561	35.652	1.00	51.23	C
ATOM	13648	O	LEU	D	156	41.693	-6.557	35.529	1.00	52.07	O
ATOM	13649	CB	LEU	D	156	44.373	-8.012	34.158	1.00	41.79	C
ATOM	13650	CG	LEU	D	156	45.777	-7.477	33.875	1.00	44.21	C
ATOM	13651	CD1	LEU	D	156	46.337	-8.010	32.547	1.00	49.00	C
ATOM	13652	CD2	LEU	D	156	45.789	-5.967	33.879	1.00	45.11	C
ATOM	13653	N	ALA	D	157	41.924	-8.753	35.967	1.00	49.19	N
ATOM	13654	CA	ALA	D	157	40.496	-8.941	36.156	1.00	50.69	C
ATOM	13655	C	ALA	D	157	39.969	-8.084	37.302	1.00	54.09	C
ATOM	13656	O	ALA	D	157	38.841	-7.564	37.242	1.00	53.88	O
ATOM	13657	CB	ALA	D	157	40.163	-10.388	36.408	1.00	38.14	C
ATOM	13658	N	LEU	D	158	40.761	-7.956	38.356	1.00	48.85	N
ATOM	13659	CA	LEU	D	158	40.317	-7.180	39.502	1.00	52.85	C
ATOM	13660	C	LEU	D	158	40.413	-5.652	39.235	1.00	51.98	C
ATOM	13661	O	LEU	D	158	39.645	-4.880	39.770	1.00	49.52	O
ATOM	13662	CB	LEU	D	158	41.121	-7.570	40.747	1.00	54.62	C
ATOM	13663	CG	LEU	D	158	40.948	-9.016	41.240	1.00	57.62	C
ATOM	13664	CD1	LEU	D	158	41.944	-9.330	42.339	1.00	61.05	C
ATOM	13665	CD2	LEU	D	158	39.536	-9.325	41.714	1.00	54.36	C
ATOM	13666	N	ALA	D	159	41.360	-5.250	38.397	1.00	47.26	N
ATOM	13667	CA	ALA	D	159	41.617	-3.864	38.105	1.00	45.57	C
ATOM	13668	C	ALA	D	159	40.505	-3.333	37.211	1.00	53.04	C
ATOM	13669	O	ALA	D	159	40.004	-2.222	37.380	1.00	48.44	O

ATOM	13670	CB	ALA	D	159	42.960	-3.703	37.425	1.00	46.21	C
ATOM	13671	N	HIS	D	160	40.127	-4.163	36.259	1.00	48.21	N
ATOM	13672	CA	HIS	D	160	39.125	-3.823	35.295	1.00	43.62	C
ATOM	13673	C	HIS	D	160	37.816	-3.568	36.008	1.00	44.93	C
ATOM	13674	O	HIS	D	160	37.085	-2.645	35.658	1.00	45.36	O
ATOM	13675	CB	HIS	D	160	38.978	-4.941	34.296	1.00	37.50	C
ATOM	13676	CG	HIS	D	160	38.154	-4.593	33.106	1.00	37.20	C
ATOM	13677	ND1	HIS	D	160	36.842	-4.981	32.980	1.00	31.88	N
ATOM	13678	CD2	HIS	D	160	38.464	-3.924	31.970	1.00	39.64	C
ATOM	13679	CE1	HIS	D	160	36.382	-4.580	31.811	1.00	38.52	C
ATOM	13680	NE2	HIS	D	160	37.345	-3.934	31.180	1.00	39.30	N
ATOM	13681	N	MET	D	161	37.534	-4.392	37.010	1.00	45.35	N
ATOM	13682	CA	MET	D	161	36.322	-4.254	37.803	1.00	41.79	C
ATOM	13683	C	MET	D	161	36.373	-3.001	38.688	1.00	46.70	C
ATOM	13684	O	MET	D	161	35.353	-2.343	38.894	1.00	45.27	O
ATOM	13685	CB	MET	D	161	36.099	-5.487	38.668	1.00	43.19	C
ATOM	13686	CG	MET	D	161	35.797	-6.745	37.887	1.00	50.88	C
ATOM	13687	SD	MET	D	161	36.016	-8.244	38.887	1.00	52.21	S
ATOM	13688	CE	MET	D	161	35.563	-9.503	37.697	1.00	49.83	C
ATOM	13689	N	ILE	D	162	37.558	-2.676	39.199	1.00	42.02	N
ATOM	13690	CA	ILE	D	162	37.721	-1.487	40.018	1.00	46.61	C
ATOM	13691	C	ILE	D	162	37.740	-0.194	39.185	1.00	39.24	C
ATOM	13692	O	ILE	D	162	37.231	0.809	39.608	1.00	48.50	O
ATOM	13693	CB	ILE	D	162	39.024	-1.569	40.856	1.00	45.51	C
ATOM	13694	CG1	ILE	D	162	38.941	-2.696	41.876	1.00	49.16	C
ATOM	13695	CG2	ILE	D	162	39.269	-0.289	41.584	1.00	47.86	C
ATOM	13696	CD1	ILE	D	162	37.654	-2.745	42.595	1.00	54.08	C
ATOM	13697	N	LYS	D	163	38.347	-0.231	38.008	1.00	46.16	N
ATOM	13698	CA	LYS	D	163	38.512	0.946	37.184	1.00	42.32	C
ATOM	13699	C	LYS	D	163	37.178	1.349	36.528	1.00	45.47	C
ATOM	13700	O	LYS	D	163	36.943	2.525	36.246	1.00	47.05	O
ATOM	13701	CB	LYS	D	163	39.589	0.722	36.107	1.00	37.41	C
ATOM	13702	CG	LYS	D	163	40.303	2.031	35.682	1.00	41.24	C
ATOM	13703	CD	LYS	D	163	40.980	1.957	34.312	1.00	37.31	C
ATOM	13704	CE	LYS	D	163	41.892	3.150	34.086	1.00	33.95	C
ATOM	13705	NZ	LYS	D	163	42.623	3.216	32.778	1.00	39.46	N
ATOM	13706	N	PHE	D	164	36.318	0.363	36.309	1.00	42.17	N
ATOM	13707	CA	PHE	D	164	35.055	0.541	35.626	1.00	40.65	C
ATOM	13708	C	PHE	D	164	33.990	-0.125	36.457	1.00	42.21	C
ATOM	13709	O	PHE	D	164	33.481	-1.186	36.111	1.00	45.21	O
ATOM	13710	CB	PHE	D	164	35.108	-0.044	34.214	1.00	38.56	C
ATOM	13711	CG	PHE	D	164	36.257	0.492	33.384	1.00	42.77	C
ATOM	13712	CD1	PHE	D	164	36.260	1.814	32.958	1.00	33.21	C
ATOM	13713	CD2	PHE	D	164	37.339	-0.330	33.041	1.00	33.22	C
ATOM	13714	CE1	PHE	D	164	37.324	2.311	32.218	1.00	34.16	C
ATOM	13715	CE2	PHE	D	164	38.394	0.149	32.315	1.00	29.57	C
ATOM	13716	CZ	PHE	D	164	38.397	1.451	31.878	1.00	38.90	C
ATOM	13717	O	ARG	D	165	30.833	-0.897	39.409	1.00	45.43	O
ATOM	13718	N	ARG	D	165	33.630	0.516	37.558	1.00	37.44	N
ATOM	13719	CA	ARG	D	165	32.961	-0.210	38.608	1.00	37.71	C
ATOM	13720	C	ARG	D	165	31.433	-0.248	38.563	1.00	44.94	C
ATOM	13721	CB	ARG	D	165	33.419	0.342	39.943	1.00	39.10	C
ATOM	13722	CG	ARG	D	165	33.158	1.802	40.165	1.00	46.89	C
ATOM	13723	CD	ARG	D	165	33.459	2.152	41.604	1.00	45.78	C
ATOM	13724	NE	ARG	D	165	33.447	3.591	41.814	1.00	51.52	N
ATOM	13725	CZ	ARG	D	165	33.562	4.173	42.999	1.00	49.38	C
ATOM	13726	NH1	ARG	D	165	33.696	3.441	44.096	1.00	50.86	N
ATOM	13727	NH2	ARG	D	165	33.523	5.485	43.081	1.00	46.16	N
ATOM	13728	O	GLY	D	166	29.405	1.962	39.396	1.00	46.42	O
ATOM	13729	N	GLY	D	166	30.800	0.401	37.586	1.00	39.21	N
ATOM	13730	CA	GLY	D	166	29.344	0.424	37.545	1.00	45.98	C
ATOM	13731	C	GLY	D	166	28.712	1.387	38.557	1.00	46.08	C
ATOM	13732	O	HIS	D	167	26.100	1.248	41.053	1.00	55.75	O

ATOM	13733	N	HIS	D	167	27.390	1.536	38.517	1.00	50.39	N
ATOM	13734	CA	HIS	D	167	26.744	2.663	39.223	1.00	46.10	C
ATOM	13735	C	HIS	D	167	26.200	2.390	40.617	1.00	47.56	C
ATOM	13736	CB	HIS	D	167	25.619	3.226	38.373	1.00	42.67	C
ATOM	13737	CG	HIS	D	167	24.460	2.302	38.204	1.00	44.61	C
ATOM	13738	ND1	HIS	D	167	23.671	1.900	39.255	1.00	48.35	N
ATOM	13739	CD2	HIS	D	167	23.936	1.725	37.099	1.00	46.86	C
ATOM	13740	CE1	HIS	D	167	22.718	1.104	38.809	1.00	47.45	C
ATOM	13741	NE2	HIS	D	167	22.861	0.973	37.505	1.00	45.53	N
ATOM	13742	O	PHE	D	168	23.613	4.620	43.773	1.00	52.02	O
ATOM	13743	N	PHE	D	168	25.847	3.470	41.306	1.00	48.36	N
ATOM	13744	CA	PHE	D	168	25.385	3.427	42.684	1.00	44.73	C
ATOM	13745	C	PHE	D	168	23.948	3.914	42.819	1.00	50.08	C
ATOM	13746	CB	PHE	D	168	26.303	4.268	43.559	1.00	46.05	C
ATOM	13747	CG	PHE	D	168	27.666	3.721	43.664	1.00	47.71	C
ATOM	13748	CD2	PHE	D	168	28.011	2.917	44.735	1.00	46.73	C
ATOM	13749	CD1	PHE	D	168	28.600	3.953	42.662	1.00	50.23	C
ATOM	13750	CE2	PHE	D	168	29.268	2.371	44.818	1.00	47.57	C
ATOM	13751	CE1	PHE	D	168	29.875	3.403	42.732	1.00	49.49	C
ATOM	13752	CZ	PHE	D	168	30.210	2.616	43.820	1.00	50.99	C
ATOM	13753	O	LEU	D	169	19.676	3.102	42.874	1.00	59.33	O
ATOM	13754	N	LEU	D	169	23.111	3.550	41.855	1.00	49.25	N
ATOM	13755	CA	LEU	D	169	21.702	3.922	41.881	1.00	53.85	C
ATOM	13756	C	LEU	D	169	20.877	2.905	42.662	1.00	58.98	C
ATOM	13757	CB	LEU	D	169	21.147	4.060	40.461	1.00	47.96	C
ATOM	13758	CG	LEU	D	169	21.915	5.028	39.559	1.00	49.52	C
ATOM	13759	CD1	LEU	D	169	21.357	5.032	38.148	1.00	46.24	C
ATOM	13760	CD2	LEU	D	169	21.902	6.437	40.148	1.00	46.15	C
ATOM	13761	O	ILE	D	170	22.791	0.361	45.231	1.00	55.75	O
ATOM	13762	N	ILE	D	170	21.519	1.819	43.088	1.00	55.34	N
ATOM	13763	CA	ILE	D	170	20.851	0.798	43.888	1.00	54.55	C
ATOM	13764	C	ILE	D	170	21.587	0.632	45.207	1.00	56.47	C
ATOM	13765	CB	ILE	D	170	20.772	-0.570	43.165	1.00	59.20	C
ATOM	13766	CG1	ILE	D	170	19.826	-0.510	41.981	1.00	53.67	C
ATOM	13767	CG2	ILE	D	170	20.233	-1.650	44.089	1.00	60.09	C
ATOM	13768	CD1	ILE	D	170	19.916	-1.738	41.116	1.00	43.75	C
ATOM	13769	O	GLU	D	171	19.839	-1.246	47.831	1.00	75.70	O
ATOM	13770	N	GLU	D	171	20.858	0.833	46.300	1.00	62.33	N
ATOM	13771	CA	GLU	D	171	21.373	0.573	47.638	1.00	64.94	C
ATOM	13772	C	GLU	D	171	20.982	-0.840	48.026	1.00	65.90	C
ATOM	13773	CB	GLU	D	171	20.824	1.576	48.657	1.00	59.96	C
ATOM	13774	O	GLY	D	172	23.220	-3.779	47.556	1.00	73.01	O
ATOM	13775	N	GLY	D	172	21.917	-1.599	48.566	1.00	58.81	N
ATOM	13776	CA	GLY	D	172	21.567	-2.917	49.053	1.00	67.68	C
ATOM	13777	C	GLY	D	172	22.350	-4.030	48.390	1.00	72.04	C
ATOM	13778	O	ASP	D	173	20.714	-7.394	47.544	1.00	78.40	O
ATOM	13779	N	ASP	D	173	22.041	-5.265	48.765	1.00	73.15	N
ATOM	13780	CA	ASP	D	173	22.785	-6.415	48.278	1.00	70.93	C
ATOM	13781	C	ASP	D	173	21.933	-7.288	47.375	1.00	76.93	C
ATOM	13782	CB	ASP	D	173	23.318	-7.229	49.450	1.00	74.09	C
ATOM	13783	CG	ASP	D	173	24.435	-6.515	50.185	1.00	80.02	C
ATOM	13784	OD2	ASP	D	173	24.675	-6.820	51.375	1.00	75.98	O
ATOM	13785	OD1	ASP	D	173	25.079	-5.646	49.558	1.00	80.41	O
ATOM	13786	O	LEU	D	174	23.605	-10.543	45.613	1.00	77.58	O
ATOM	13787	N	LEU	D	174	22.587	-7.905	46.403	1.00	77.95	N
ATOM	13788	CA	LEU	D	174	21.918	-8.833	45.510	1.00	79.51	C
ATOM	13789	C	LEU	D	174	22.411	-10.257	45.753	1.00	78.66	C
ATOM	13790	CB	LEU	D	174	22.152	-8.433	44.055	1.00	75.15	C
ATOM	13791	CG	LEU	D	174	21.618	-9.457	43.060	1.00	77.62	C
ATOM	13792	CD1	LEU	D	174	20.416	-8.894	42.343	1.00	77.74	C
ATOM	13793	CD2	LEU	D	174	22.708	-9.867	42.083	1.00	76.45	C
ATOM	13794	O	ASN	D	175	21.083	-13.067	44.005	1.00	72.15	O
ATOM	13795	N	ASN	D	175	21.496	-11.145	46.129	1.00	78.51	N

ATOM	13796	CA	ASN	D	175	21.826	-12.559	46.203	1.00	77.72	C
ATOM	13797	C	ASN	D	175	22.002	-13.134	44.814	1.00	74.58	C
ATOM	13798	CB	ASN	D	175	20.745	-13.358	46.934	1.00	80.97	C
ATOM	13799	CG	ASN	D	175	20.431	-12.808	48.298	1.00	87.41	C
ATOM	13800	OD1	ASN	D	175	21.187	-12.001	48.850	1.00	92.12	O
ATOM	13801	ND2	ASN	D	175	19.304	-13.247	48.864	1.00	83.49	N
ATOM	13802	O	PRO	D	176	22.268	-16.378	42.333	1.00	85.14	O
ATOM	13803	N	PRO	D	176	23.178	-13.725	44.538	1.00	79.57	N
ATOM	13804	CA	PRO	D	176	23.337	-14.474	43.291	1.00	74.31	C
ATOM	13805	C	PRO	D	176	22.505	-15.744	43.358	1.00	76.79	C
ATOM	13806	CB	PRO	D	176	24.823	-14.784	43.255	1.00	77.23	C
ATOM	13807	CG	PRO	D	176	25.193	-14.872	44.696	1.00	77.36	C
ATOM	13808	CD	PRO	D	176	24.359	-13.859	45.409	1.00	77.86	C
ATOM	13809	O	ASP	D	177	19.608	-17.676	42.949	1.00	83.23	O
ATOM	13810	N	ASP	D	177	22.079	-16.105	44.566	1.00	73.18	N
ATOM	13811	CA	ASP	D	177	21.067	-17.134	44.782	1.00	80.67	C
ATOM	13812	C	ASP	D	177	19.860	-16.907	43.881	1.00	81.00	C
ATOM	13813	CB	ASP	D	177	20.599	-17.139	46.242	1.00	88.38	C
ATOM	13814	CG	ASP	D	177	21.384	-18.101	47.123	1.00	93.69	C
ATOM	13815	OD1	ASP	D	177	22.515	-18.481	46.747	1.00	92.69	O
ATOM	13816	OD2	ASP	D	177	20.861	-18.459	48.206	1.00	94.31	O
ATOM	13817	O	ASN	D	178	18.270	-14.057	41.616	1.00	76.53	O
ATOM	13818	N	ASN	D	178	19.119	-15.843	44.183	1.00	78.87	N
ATOM	13819	CA	ASN	D	178	17.894	-15.498	43.477	1.00	75.77	C
ATOM	13820	C	ASN	D	178	18.154	-15.215	42.016	1.00	72.72	C
ATOM	13821	CB	ASN	D	178	17.232	-14.282	44.123	1.00	76.33	C
ATOM	13822	CG	ASN	D	178	17.150	-14.400	45.624	1.00	78.23	C
ATOM	13823	OD1	ASN	D	178	17.049	-15.502	46.160	1.00	79.40	O
ATOM	13824	ND2	ASN	D	178	17.190	-13.261	46.317	1.00	77.58	N
ATOM	13825	O	SER	D	179	18.051	-17.017	37.693	1.00	69.87	O
ATOM	13826	N	SER	D	179	18.227	-16.276	41.223	1.00	74.81	N
ATOM	13827	CA	SER	D	179	18.667	-16.172	39.837	1.00	74.88	C
ATOM	13828	C	SER	D	179	17.742	-16.893	38.873	1.00	72.21	C
ATOM	13829	CB	SER	D	179	20.079	-16.734	39.702	1.00	72.32	C
ATOM	13830	OG	SER	D	179	20.105	-18.092	40.101	1.00	75.65	O
ATOM	13831	N	ASP	D	180	16.619	-17.381	39.380	1.00	75.30	N
ATOM	13832	CA	ASP	D	180	15.715	-18.179	38.563	1.00	78.25	C
ATOM	13833	C	ASP	D	180	14.323	-17.571	38.606	1.00	74.51	C
ATOM	13834	O	ASP	D	180	13.559	-17.861	39.518	1.00	73.54	O
ATOM	13835	CB	ASP	D	180	15.700	-19.633	39.056	1.00	74.71	C
ATOM	13836	CG	ASP	D	180	14.987	-20.574	38.104	1.00	77.39	C
ATOM	13837	OD1	ASP	D	180	13.861	-20.259	37.670	1.00	78.18	O
ATOM	13838	OD2	ASP	D	180	15.557	-21.639	37.788	1.00	84.71	O
ATOM	13839	N	VAL	D	181	14.002	-16.745	37.610	1.00	72.66	N
ATOM	13840	CA	VAL	D	181	12.769	-15.966	37.627	1.00	68.61	C
ATOM	13841	C	VAL	D	181	11.526	-16.836	37.712	1.00	71.58	C
ATOM	13842	O	VAL	D	181	10.616	-16.516	38.460	1.00	69.52	O
ATOM	13843	CB	VAL	D	181	12.647	-15.060	36.380	1.00	71.94	C
ATOM	13844	CG1	VAL	D	181	11.340	-14.257	36.424	1.00	70.83	C
ATOM	13845	CG2	VAL	D	181	13.832	-14.117	36.294	1.00	67.89	C
ATOM	13846	N	ASP	D	182	11.490	-17.932	36.952	1.00	76.70	N
ATOM	13847	CA	ASP	D	182	10.328	-18.836	36.941	1.00	74.74	C
ATOM	13848	C	ASP	D	182	9.961	-19.382	38.337	1.00	77.57	C
ATOM	13849	O	ASP	D	182	8.800	-19.313	38.754	1.00	75.89	O
ATOM	13850	CB	ASP	D	182	10.564	-20.013	35.985	1.00	71.84	C
ATOM	13851	CG	ASP	D	182	10.179	-19.697	34.534	1.00	79.52	C
ATOM	13852	OD1	ASP	D	182	9.461	-18.702	34.297	1.00	80.33	O
ATOM	13853	OD2	ASP	D	182	10.578	-20.462	33.622	1.00	84.11	O
ATOM	13854	N	LYS	D	183	10.947	-19.915	39.058	1.00	74.29	N
ATOM	13855	CA	LYS	D	183	10.707	-20.473	40.392	1.00	74.22	C
ATOM	13856	C	LYS	D	183	10.334	-19.371	41.383	1.00	76.33	C
ATOM	13857	O	LYS	D	183	9.357	-19.481	42.135	1.00	75.52	O
ATOM	13858	CB	LYS	D	183	11.939	-21.248	40.883	1.00	79.08	C

ATOM	13859	N	LEU	D	184	11.107	-18.292	41.351	1.00	75.58	N
ATOM	13860	CA	LEU	D	184	10.864	-17.134	42.200	1.00	72.78	C
ATOM	13861	C	LEU	D	184	9.569	-16.375	41.854	1.00	71.71	C
ATOM	13862	O	LEU	D	184	9.107	-15.559	42.642	1.00	75.00	O
ATOM	13863	CB	LEU	D	184	12.067	-16.191	42.131	1.00	66.14	C
ATOM	13864	CG	LEU	D	184	13.340	-16.761	42.765	1.00	70.88	C
ATOM	13865	CD1	LEU	D	184	14.547	-15.936	42.407	1.00	68.97	C
ATOM	13866	CD2	LEU	D	184	13.189	-16.836	44.271	1.00	70.32	C
ATOM	13867	N	PHE	D	185	8.976	-16.641	40.695	1.00	69.35	N
ATOM	13868	CA	PHE	D	185	7.703	-16.002	40.363	1.00	73.75	C
ATOM	13869	C	PHE	D	185	6.574	-16.854	40.912	1.00	75.47	C
ATOM	13870	O	PHE	D	185	5.527	-16.342	41.312	1.00	75.96	O
ATOM	13871	CB	PHE	D	185	7.545	-15.804	38.848	1.00	72.01	C
ATOM	13872	CG	PHE	D	185	6.147	-15.439	38.419	1.00	68.52	C
ATOM	13873	CD1	PHE	D	185	5.701	-14.132	38.498	1.00	68.69	C
ATOM	13874	CD2	PHE	D	185	5.285	-16.399	37.920	1.00	68.27	C
ATOM	13875	CE1	PHE	D	185	4.415	-13.788	38.094	1.00	66.71	C
ATOM	13876	CE2	PHE	D	185	4.006	-16.064	37.516	1.00	69.99	C
ATOM	13877	CZ	PHE	D	185	3.570	-14.752	37.608	1.00	63.84	C
ATOM	13878	N	ILE	D	186	6.805	-18.161	40.920	1.00	74.86	N
ATOM	13879	CA	ILE	D	186	5.864	-19.114	41.489	1.00	78.18	C
ATOM	13880	C	ILE	D	186	5.766	-18.892	42.987	1.00	78.22	C
ATOM	13881	O	ILE	D	186	4.680	-18.946	43.560	1.00	82.89	O
ATOM	13882	CB	ILE	D	186	6.291	-20.578	41.219	1.00	81.90	C
ATOM	13883	CG1	ILE	D	186	6.267	-20.889	39.724	1.00	80.54	C
ATOM	13884	CG2	ILE	D	186	5.387	-21.555	41.945	1.00	83.97	C
ATOM	13885	CD1	ILE	D	186	6.631	-22.331	39.412	1.00	80.23	C
ATOM	13886	N	GLN	D	187	6.908	-18.638	43.617	1.00	74.89	N
ATOM	13887	CA	GLN	D	187	6.945	-18.420	45.054	1.00	75.70	C
ATOM	13888	C	GLN	D	187	6.149	-17.180	45.444	1.00	79.77	C
ATOM	13889	O	GLN	D	187	5.530	-17.155	46.504	1.00	83.73	O
ATOM	13890	CB	GLN	D	187	8.388	-18.301	45.551	1.00	80.35	C
ATOM	13891	N	LEU	D	188	6.150	-16.156	44.593	1.00	79.02	N
ATOM	13892	CA	LEU	D	188	5.362	-14.954	44.862	1.00	74.50	C
ATOM	13893	C	LEU	D	188	3.905	-15.223	44.566	1.00	80.06	C
ATOM	13894	O	LEU	D	188	3.020	-14.541	45.081	1.00	81.75	O
ATOM	13895	CB	LEU	D	188	5.848	-13.772	44.028	1.00	75.92	C
ATOM	13896	CG	LEU	D	188	4.955	-12.521	43.968	1.00	69.29	C
ATOM	13897	CD1	LEU	D	188	4.861	-11.816	45.312	1.00	67.28	C
ATOM	13898	CD2	LEU	D	188	5.456	-11.568	42.907	1.00	66.61	C
ATOM	13899	N	VAL	D	189	3.659	-16.213	43.714	1.00	80.89	N
ATOM	13900	CA	VAL	D	189	2.290	-16.569	43.355	1.00	86.40	C
ATOM	13901	C	VAL	D	189	1.657	-17.302	44.532	1.00	83.45	C
ATOM	13902	O	VAL	D	189	0.654	-16.855	45.097	1.00	79.51	O
ATOM	13903	CB	VAL	D	189	2.235	-17.435	42.055	1.00	85.12	C
ATOM	13904	CG1	VAL	D	189	0.924	-18.227	41.953	1.00	81.81	C
ATOM	13905	CG2	VAL	D	189	2.421	-16.553	40.821	1.00	80.08	C
ATOM	13906	N	GLN	D	190	2.279	-18.411	44.913	1.00	81.10	N
ATOM	13907	CA	GLN	D	190	1.806	-19.224	46.018	1.00	81.54	C
ATOM	13908	C	GLN	D	190	1.725	-18.410	47.324	1.00	84.72	C
ATOM	13909	O	GLN	D	190	0.773	-18.560	48.091	1.00	86.62	O
ATOM	13910	CB	GLN	D	190	2.708	-20.459	46.159	1.00	77.92	C
ATOM	13911	CG	GLN	D	190	2.512	-21.471	45.002	1.00	78.64	C
ATOM	13912	CD	GLN	D	190	3.626	-22.506	44.872	1.00	83.17	C
ATOM	13913	OE1	GLN	D	190	4.633	-22.457	45.582	1.00	84.41	O
ATOM	13914	NE2	GLN	D	190	3.449	-23.448	43.947	1.00	84.14	N
ATOM	13915	N	THR	D	191	2.691	-17.522	47.551	1.00	82.12	N
ATOM	13916	CA	THR	D	191	2.638	-16.601	48.693	1.00	79.84	C
ATOM	13917	C	THR	D	191	1.394	-15.720	48.666	1.00	81.98	C
ATOM	13918	O	THR	D	191	0.711	-15.578	49.676	1.00	90.41	O
ATOM	13919	CB	THR	D	191	3.879	-15.686	48.750	1.00	79.42	C
ATOM	13920	OG1	THR	D	191	5.027	-16.456	49.120	1.00	73.04	O
ATOM	13921	CG2	THR	D	191	3.686	-14.571	49.763	1.00	77.89	C

ATOM	13922	N	TYR	D	192	1.103	-15.127	47.514	1.00	80.34	N
ATOM	13923	CA	TYR	D	192	-0.064	-14.267	47.370	1.00	79.17	C
ATOM	13924	C	TYR	D	192	-1.379	-15.028	47.524	1.00	82.29	C
ATOM	13925	O	TYR	D	192	-2.380	-14.474	48.002	1.00	79.10	O
ATOM	13926	CB	TYR	D	192	-0.049	-13.572	46.008	1.00	79.85	C
ATOM	13927	CG	TYR	D	192	-1.279	-12.718	45.727	1.00	71.85	C
ATOM	13928	CD2	TYR	D	192	-2.448	-13.282	45.220	1.00	73.45	C
ATOM	13929	CD1	TYR	D	192	-1.262	-11.356	45.960	1.00	63.66	C
ATOM	13930	CE2	TYR	D	192	-3.559	-12.516	44.972	1.00	72.10	C
ATOM	13931	CE1	TYR	D	192	-2.369	-10.577	45.702	1.00	70.57	C
ATOM	13932	CZ	TYR	D	192	-3.511	-11.163	45.210	1.00	70.20	C
ATOM	13933	OH	TYR	D	192	-4.611	-10.389	44.951	1.00	75.70	O
ATOM	13934	N	ASN	D	193	-1.388	-16.284	47.089	1.00	81.07	N
ATOM	13935	CA	ASN	D	193	-2.628	-17.053	47.045	1.00	84.45	C
ATOM	13936	C	ASN	D	193	-3.134	-17.413	48.443	1.00	87.31	C
ATOM	13937	O	ASN	D	193	-4.334	-17.357	48.712	1.00	87.52	O
ATOM	13938	CB	ASN	D	193	-2.445	-18.324	46.203	1.00	82.40	C
ATOM	13939	CG	ASN	D	193	-2.508	-18.051	44.699	1.00	80.00	C
ATOM	13940	OD1	ASN	D	193	-3.032	-17.033	44.258	1.00	76.28	O
ATOM	13941	ND2	ASN	D	193	-1.980	-18.977	43.912	1.00	83.59	N
ATOM	13942	N	GLN	D	194	-2.218	-17.767	49.337	1.00	88.02	N
ATOM	13943	CA	GLN	D	194	-2.602	-18.123	50.693	1.00	86.42	C
ATOM	13944	C	GLN	D	194	-3.285	-16.933	51.376	1.00	88.04	C
ATOM	13945	O	GLN	D	194	-4.341	-17.087	51.991	1.00	91.44	O
ATOM	13946	CB	GLN	D	194	-1.385	-18.594	51.495	1.00	89.57	C
ATOM	13947	CG	GLN	D	194	-0.519	-19.649	50.784	1.00	93.39	C
ATOM	13948	CD	GLN	D	194	-1.329	-20.801	50.182	1.00	98.41	C
ATOM	13949	OE1	GLN	D	194	-2.199	-21.376	50.840	1.00	98.52	O
ATOM	13950	NE2	GLN	D	194	-1.040	-21.139	48.924	1.00	91.35	N
ATOM	13951	N	LEU	D	195	-2.699	-15.747	51.241	1.00	83.05	N
ATOM	13952	CA	LEU	D	195	-3.256	-14.543	51.856	1.00	85.18	C
ATOM	13953	C	LEU	D	195	-4.683	-14.274	51.392	1.00	84.39	C
ATOM	13954	O	LEU	D	195	-5.547	-13.897	52.188	1.00	81.66	O
ATOM	13955	CB	LEU	D	195	-2.382	-13.323	51.552	1.00	84.32	C
ATOM	13956	CG	LEU	D	195	-1.126	-13.056	52.385	1.00	84.53	C
ATOM	13957	CD1	LEU	D	195	-0.285	-11.982	51.710	1.00	82.63	C
ATOM	13958	CD2	LEU	D	195	-1.481	-12.629	53.806	1.00	77.00	C
ATOM	13959	N	PHE	D	196	-4.917	-14.469	50.098	1.00	85.79	N
ATOM	13960	CA	PHE	D	196	-6.225	-14.235	49.499	1.00	81.09	C
ATOM	13961	C	PHE	D	196	-6.773	-15.531	48.901	1.00	86.48	C
ATOM	13962	O	PHE	D	196	-6.941	-15.635	47.689	1.00	87.90	O
ATOM	13963	CB	PHE	D	196	-6.136	-13.160	48.421	1.00	77.71	C
ATOM	13964	CG	PHE	D	196	-5.512	-11.877	48.882	1.00	71.69	C
ATOM	13965	CD1	PHE	D	196	-6.292	-10.858	49.400	1.00	77.12	C
ATOM	13966	CD2	PHE	D	196	-4.149	-11.678	48.776	1.00	75.02	C
ATOM	13967	CE1	PHE	D	196	-5.721	-9.656	49.820	1.00	78.78	C
ATOM	13968	CE2	PHE	D	196	-3.564	-10.485	49.198	1.00	76.50	C
ATOM	13969	CZ	PHE	D	196	-4.354	-9.472	49.718	1.00	75.24	C
ATOM	13970	O	GLU	D	197	-9.257	-18.545	47.808	1.00	89.42	O
ATOM	13971	N	GLU	D	197	-7.043	-16.520	49.750	1.00	89.53	N
ATOM	13972	CA	GLU	D	197	-7.521	-17.819	49.290	1.00	85.42	C
ATOM	13973	C	GLU	D	197	-8.857	-17.674	48.575	1.00	86.55	C
ATOM	13974	CB	GLU	D	197	-7.641	-18.797	50.462	1.00	85.00	C
ATOM	13975	O	GLU	D	198	-11.242	-16.778	45.886	1.00	94.48	O
ATOM	13976	N	GLU	D	198	-9.537	-16.560	48.827	1.00	88.46	N
ATOM	13977	CA	GLU	D	198	-10.814	-16.271	48.185	1.00	88.07	C
ATOM	13978	C	GLU	D	198	-10.633	-16.067	46.689	1.00	92.43	C
ATOM	13979	CB	GLU	D	198	-11.468	-15.042	48.812	1.00	82.96	C
ATOM	13980	O	ASN	D	199	-7.300	-14.125	44.283	1.00	93.80	O
ATOM	13981	N	ASN	D	199	-9.786	-15.105	46.320	1.00	94.27	N
ATOM	13982	CA	ASN	D	199	-9.494	-14.820	44.913	1.00	91.32	C
ATOM	13983	C	ASN	D	199	-8.041	-15.072	44.520	1.00	89.76	C
ATOM	13984	CB	ASN	D	199	-9.828	-13.363	44.575	1.00	91.13	C

ATOM	13985	CG	ASN	D	199	-11.233	-12.973	44.970	1.00	92.38	C
ATOM	13986	OD1	ASN	D	199	-11.434	-12.319	45.988	1.00	99.29	O
ATOM	13987	ND2	ASN	D	199	-12.213	-13.358	44.159	1.00	91.48	N
ATOM	13988	O	PRO	D	200	-6.874	-15.691	41.837	1.00	94.29	O
ATOM	13989	N	PRO	D	200	-7.625	-16.344	44.432	1.00	87.72	N
ATOM	13990	CA	PRO	D	200	-6.255	-16.619	43.976	1.00	88.77	C
ATOM	13991	C	PRO	D	200	-5.993	-16.222	42.515	1.00	91.95	C
ATOM	13992	CB	PRO	D	200	-6.136	-18.138	44.140	1.00	86.24	C
ATOM	13993	CG	PRO	D	200	-7.542	-18.632	44.028	1.00	90.00	C
ATOM	13994	CD	PRO	D	200	-8.368	-17.583	44.713	1.00	89.09	C
ATOM	13995	N	ILE	D	201	-4.771	-16.458	42.049	1.00	89.91	N
ATOM	13996	CA	ILE	D	201	-4.468	-16.382	40.623	1.00	87.95	C
ATOM	13997	C	ILE	D	201	-3.613	-17.583	40.250	1.00	86.06	C
ATOM	13998	O	ILE	D	201	-2.958	-18.180	41.106	1.00	80.20	O
ATOM	13999	CB	ILE	D	201	-3.734	-15.084	40.226	1.00	87.54	C
ATOM	14000	CG1	ILE	D	201	-3.644	-14.117	41.408	1.00	84.36	C
ATOM	14001	CG2	ILE	D	201	-4.423	-14.440	39.017	1.00	86.64	C
ATOM	14002	CD1	ILE	D	201	-2.788	-12.906	41.133	1.00	79.17	C
ATOM	14003	N	ASN	D	202	-3.624	-17.946	38.976	1.00	85.75	N
ATOM	14004	CA	ASN	D	202	-2.891	-19.130	38.566	1.00	91.85	C
ATOM	14005	C	ASN	D	202	-1.954	-18.908	37.380	1.00	92.15	C
ATOM	14006	O	ASN	D	202	-2.226	-18.116	36.471	1.00	92.20	O
ATOM	14007	CB	ASN	D	202	-3.869	-20.266	38.256	1.00	89.16	C
ATOM	14008	CG	ASN	D	202	-4.855	-19.906	37.168	1.00	88.68	C
ATOM	14009	OD1	ASN	D	202	-5.044	-18.731	36.840	1.00	88.80	O
ATOM	14010	ND2	ASN	D	202	-5.501	-20.919	36.606	1.00	82.20	N
ATOM	14011	N	ALA	D	203	-0.835	-19.617	37.424	1.00	90.05	N
ATOM	14012	CA	ALA	D	203	0.131	-19.630	36.339	1.00	95.66	C
ATOM	14013	C	ALA	D	203	0.201	-21.030	35.741	1.00	95.01	C
ATOM	14014	O	ALA	D	203	0.870	-21.913	36.277	1.00	94.35	O
ATOM	14015	CB	ALA	D	203	1.502	-19.186	36.831	1.00	91.05	C
ATOM	14016	O	SER	D	204	1.581	-22.868	32.778	1.00	92.37	O
ATOM	14017	N	SER	D	204	-0.517	-21.234	34.642	1.00	97.38	N
ATOM	14018	CA	SER	D	204	-0.485	-22.507	33.936	1.00	96.71	C
ATOM	14019	C	SER	D	204	0.447	-22.391	32.743	1.00	92.79	C
ATOM	14020	CB	SER	D	204	-1.890	-22.927	33.485	1.00	100.97	C
ATOM	14021	OG	SER	D	204	-2.441	-22.008	32.554	1.00	104.92	O
ATOM	14022	O	GLY	D	205	3.007	-20.804	30.213	1.00	94.21	O
ATOM	14023	N	GLY	D	205	-0.029	-21.740	31.693	1.00	88.38	N
ATOM	14024	CA	GLY	D	205	0.774	-21.565	30.506	1.00	85.82	C
ATOM	14025	C	GLY	D	205	1.900	-20.572	30.704	1.00	89.65	C
ATOM	14026	O	VAL	D	206	4.345	-19.369	32.591	1.00	82.47	O
ATOM	14027	N	VAL	D	206	1.629	-19.495	31.446	1.00	87.76	N
ATOM	14028	CA	VAL	D	206	2.483	-18.305	31.441	1.00	82.61	C
ATOM	14029	C	VAL	D	206	3.969	-18.626	31.683	1.00	81.08	C
ATOM	14030	CB	VAL	D	206	1.969	-17.242	32.461	1.00	77.10	C
ATOM	14031	CG1	VAL	D	206	0.465	-17.320	32.571	1.00	83.40	C
ATOM	14032	CG2	VAL	D	206	2.563	-17.422	33.830	1.00	78.67	C
ATOM	14033	N	ASP	D	207	4.796	-18.096	30.790	1.00	79.52	N
ATOM	14034	CA	ASP	D	207	6.237	-18.261	30.838	1.00	76.45	C
ATOM	14035	C	ASP	D	207	6.818	-16.951	31.323	1.00	76.83	C
ATOM	14036	O	ASP	D	207	7.165	-16.075	30.524	1.00	74.09	O
ATOM	14037	CB	ASP	D	207	6.791	-18.644	29.460	1.00	77.52	C
ATOM	14038	CG	ASP	D	207	8.313	-18.741	29.426	1.00	76.06	C
ATOM	14039	OD2	ASP	D	207	8.875	-18.625	28.320	1.00	75.29	O
ATOM	14040	OD1	ASP	D	207	8.949	-18.958	30.480	1.00	78.65	O
ATOM	14041	N	ALA	D	208	6.902	-16.831	32.645	1.00	73.39	N
ATOM	14042	CA	ALA	D	208	7.289	-15.596	33.298	1.00	72.61	C
ATOM	14043	C	ALA	D	208	8.723	-15.238	32.989	1.00	69.80	C
ATOM	14044	O	ALA	D	208	9.066	-14.063	32.889	1.00	70.76	O
ATOM	14045	CB	ALA	D	208	7.088	-15.712	34.801	1.00	76.52	C
ATOM	14046	N	LYS	D	209	9.560	-16.259	32.851	1.00	74.18	N
ATOM	14047	CA	LYS	D	209	10.952	-16.048	32.483	1.00	72.75	C

ATOM	14048	C	LYS	D	209	11.025	-15.219	31.206	1.00	76.07	C
ATOM	14049	O	LYS	D	209	11.694	-14.194	31.174	1.00	73.59	O
ATOM	14050	CB	LYS	D	209	11.682	-17.380	32.301	1.00	70.06	C
ATOM	14051	CG	LYS	D	209	13.161	-17.208	32.014	1.00	68.59	C
ATOM	14052	CD	LYS	D	209	13.807	-16.224	32.988	1.00	70.64	C
ATOM	14053	CE	LYS	D	209	15.142	-15.730	32.463	1.00	70.39	C
ATOM	14054	NZ	LYS	D	209	15.876	-16.836	31.785	1.00	63.29	N
ATOM	14055	N	ALA	D	210	10.308	-15.656	30.171	1.00	74.91	N
ATOM	14056	CA	ALA	D	210	10.243	-14.920	28.914	1.00	73.06	C
ATOM	14057	C	ALA	D	210	9.651	-13.524	29.081	1.00	74.16	C
ATOM	14058	O	ALA	D	210	10.306	-12.540	28.752	1.00	78.98	O
ATOM	14059	CB	ALA	D	210	9.449	-15.695	27.896	1.00	75.01	C
ATOM	14060	N	ILE	D	211	8.423	-13.436	29.590	1.00	73.57	N
ATOM	14061	CA	ILE	D	211	7.713	-12.151	29.683	1.00	67.61	C
ATOM	14062	C	ILE	D	211	8.477	-11.093	30.459	1.00	67.16	C
ATOM	14063	O	ILE	D	211	8.622	-9.967	30.023	1.00	68.35	O
ATOM	14064	CB	ILE	D	211	6.349	-12.308	30.361	1.00	68.54	C
ATOM	14065	CG1	ILE	D	211	5.513	-13.380	29.666	1.00	62.54	C
ATOM	14066	CG2	ILE	D	211	5.616	-10.986	30.354	1.00	69.77	C
ATOM	14067	CD1	ILE	D	211	4.629	-14.151	30.607	1.00	69.89	C
ATOM	14068	N	LEU	D	212	8.973	-11.487	31.622	1.00	74.98	N
ATOM	14069	CA	LEU	D	212	9.578	-10.555	32.561	1.00	75.31	C
ATOM	14070	C	LEU	D	212	11.029	-10.204	32.239	1.00	73.68	C
ATOM	14071	O	LEU	D	212	11.542	-9.190	32.714	1.00	71.62	O
ATOM	14072	CB	LEU	D	212	9.487	-11.122	33.979	1.00	72.17	C
ATOM	14073	CG	LEU	D	212	8.145	-10.887	34.685	1.00	72.53	C
ATOM	14074	CD1	LEU	D	212	8.196	-11.457	36.090	1.00	74.02	C
ATOM	14075	CD2	LEU	D	212	7.798	-9.407	34.715	1.00	61.04	C
ATOM	14076	N	SER	D	213	11.688	-11.029	31.431	1.00	72.81	N
ATOM	14077	CA	SER	D	213	13.084	-10.788	31.096	1.00	64.86	C
ATOM	14078	C	SER	D	213	13.278	-10.199	29.710	1.00	73.82	C
ATOM	14079	O	SER	D	213	14.417	-10.031	29.274	1.00	77.15	O
ATOM	14080	CB	SER	D	213	13.884	-12.080	31.187	1.00	77.35	C
ATOM	14081	OG	SER	D	213	13.604	-12.922	30.078	1.00	78.56	O
ATOM	14082	N	ALA	D	214	12.184	-9.898	29.012	1.00	76.81	N
ATOM	14083	CA	ALA	D	214	12.288	-9.381	27.651	1.00	78.24	C
ATOM	14084	C	ALA	D	214	13.198	-8.156	27.626	1.00	80.88	C
ATOM	14085	O	ALA	D	214	13.306	-7.432	28.621	1.00	77.50	O
ATOM	14086	CB	ALA	D	214	10.924	-9.041	27.098	1.00	71.79	C
ATOM	14087	O	ARG	D	215	14.169	-4.715	25.194	1.00	82.07	O
ATOM	14088	N	ARG	D	215	13.877	-7.944	26.499	1.00	83.87	N
ATOM	14089	CA	ARG	D	215	14.714	-6.761	26.324	1.00	81.98	C
ATOM	14090	C	ARG	D	215	13.835	-5.538	26.040	1.00	82.49	C
ATOM	14091	CB	ARG	D	215	15.725	-6.975	25.194	1.00	74.26	C
ATOM	14092	O	LEU	D	216	12.329	-3.851	28.849	1.00	79.45	O
ATOM	14093	N	LEU	D	216	12.716	-5.443	26.759	1.00	76.39	N
ATOM	14094	CA	LEU	D	216	11.732	-4.381	26.593	1.00	76.45	C
ATOM	14095	C	LEU	D	216	11.626	-3.561	27.878	1.00	78.58	C
ATOM	14096	CB	LEU	D	216	10.370	-4.973	26.219	1.00	77.42	C
ATOM	14097	CG	LEU	D	216	9.988	-5.015	24.736	1.00	79.63	C
ATOM	14098	CD1	LEU	D	216	9.616	-3.613	24.226	1.00	86.03	C
ATOM	14099	CD2	LEU	D	216	11.107	-5.624	23.895	1.00	82.84	C
ATOM	14100	N	SER	D	217	10.746	-2.556	27.894	1.00	71.36	N
ATOM	14101	CA	SER	D	217	10.625	-1.649	29.049	1.00	73.99	C
ATOM	14102	C	SER	D	217	9.937	-2.299	30.249	1.00	73.27	C
ATOM	14103	O	SER	D	217	9.367	-3.382	30.146	1.00	73.02	O
ATOM	14104	CB	SER	D	217	9.864	-0.368	28.670	1.00	70.42	C
ATOM	14105	OG	SER	D	217	8.455	-0.539	28.755	1.00	64.68	O
ATOM	14106	N	LYS	D	218	9.983	-1.618	31.389	1.00	72.44	N
ATOM	14107	CA	LYS	D	218	9.373	-2.140	32.601	1.00	71.39	C
ATOM	14108	C	LYS	D	218	7.850	-2.211	32.468	1.00	69.44	C
ATOM	14109	O	LYS	D	218	7.233	-3.257	32.691	1.00	67.07	O
ATOM	14110	CB	LYS	D	218	9.779	-1.283	33.798	1.00	71.16	C

ATOM	141111	CG	LYS	D	218	11.279	-1.105	33.899	1.00	70.93	C
ATOM	141112	CD	LYS	D	218	11.719	-0.533	35.226	1.00	64.16	C
ATOM	141113	CE	LYS	D	218	13.231	-0.586	35.353	1.00	66.48	C
ATOM	141114	NZ	LYS	D	218	13.707	-2.007	35.420	1.00	69.69	N
ATOM	141115	N	SER	D	219	7.247	-1.103	32.072	1.00	68.98	N
ATOM	141116	CA	SER	D	219	5.802	-1.045	31.966	1.00	68.96	C
ATOM	141117	C	SER	D	219	5.251	-2.006	30.914	1.00	69.54	C
ATOM	141118	O	SER	D	219	4.235	-2.668	31.133	1.00	67.10	O
ATOM	141119	CB	SER	D	219	5.391	0.379	31.663	1.00	62.14	C
ATOM	14120	OG	SER	D	219	6.151	1.249	32.481	1.00	69.44	O
ATOM	14121	N	ARG	D	220	5.927	-2.085	29.774	1.00	69.37	N
ATOM	14122	CA	ARG	D	220	5.512	-2.999	28.716	1.00	71.76	C
ATOM	14123	C	ARG	D	220	5.616	-4.446	29.191	1.00	71.81	C
ATOM	14124	O	ARG	D	220	4.716	-5.251	28.935	1.00	71.49	O
ATOM	14125	CB	ARG	D	220	6.356	-2.788	27.454	1.00	76.81	C
ATOM	14126	N	ARG	D	221	6.707	-4.767	29.890	1.00	70.35	N
ATOM	14127	CA	ARG	D	221	6.872	-6.093	30.493	1.00	74.56	C
ATOM	14128	C	ARG	D	221	5.765	-6.334	31.515	1.00	71.67	C
ATOM	14129	O	ARG	D	221	5.283	-7.460	31.671	1.00	68.98	O
ATOM	14130	CB	ARG	D	221	8.248	-6.238	31.152	1.00	69.28	C
ATOM	14131	CG	ARG	D	221	9.299	-6.892	30.275	1.00	72.49	C
ATOM	14132	CD	ARG	D	221	10.616	-6.120	30.304	1.00	70.32	C
ATOM	14133	NE	ARG	D	221	11.349	-6.271	31.556	1.00	71.51	N
ATOM	14134	CZ	ARG	D	221	12.343	-5.473	31.937	1.00	75.38	C
ATOM	14135	NH1	ARG	D	221	12.705	-4.452	31.178	1.00	78.91	N
ATOM	14136	NH2	ARG	D	221	12.967	-5.682	33.085	1.00	74.52	N
ATOM	14137	N	LEU	D	222	5.365	-5.265	32.199	1.00	66.42	N
ATOM	14138	CA	LEU	D	222	4.324	-5.353	33.214	1.00	69.15	C
ATOM	14139	C	LEU	D	222	3.000	-5.795	32.616	1.00	72.61	C
ATOM	14140	O	LEU	D	222	2.491	-6.871	32.959	1.00	71.70	O
ATOM	14141	CB	LEU	D	222	4.146	-4.014	33.932	1.00	69.44	C
ATOM	14142	CG	LEU	D	222	3.121	-4.001	35.068	1.00	65.38	C
ATOM	14143	CD2	LEU	D	222	3.273	-2.733	35.881	1.00	60.06	C
ATOM	14144	CD1	LEU	D	222	3.272	-5.226	35.972	1.00	64.77	C
ATOM	14145	N	GLU	D	223	2.449	-4.969	31.723	1.00	76.19	N
ATOM	14146	CA	GLU	D	223	1.169	-5.276	31.089	1.00	71.32	C
ATOM	14147	C	GLU	D	223	1.247	-6.608	30.357	1.00	70.60	C
ATOM	14148	O	GLU	D	223	0.279	-7.369	30.347	1.00	70.81	O
ATOM	14149	CB	GLU	D	223	0.737	-4.159	30.139	1.00	74.66	C
ATOM	14150	CG	GLU	D	223	-0.785	-4.120	29.925	1.00	86.29	C
ATOM	14151	CD	GLU	D	223	-1.374	-2.705	29.946	1.00	89.64	C
ATOM	14152	OE1	GLU	D	223	-0.719	-1.770	29.431	1.00	86.82	O
ATOM	14153	OE2	GLU	D	223	-2.494	-2.537	30.484	1.00	91.25	O
ATOM	14154	N	ASN	D	224	2.408	-6.910	29.779	1.00	69.00	N
ATOM	14155	CA	ASN	D	224	2.626	-8.233	29.181	1.00	73.79	C
ATOM	14156	C	ASN	D	224	2.409	-9.370	30.173	1.00	70.40	C
ATOM	14157	O	ASN	D	224	2.009	-10.468	29.788	1.00	70.92	O
ATOM	14158	CB	ASN	D	224	4.029	-8.349	28.589	1.00	73.21	C
ATOM	14159	CG	ASN	D	224	4.119	-7.808	27.174	1.00	75.72	C
ATOM	14160	OD1	ASN	D	224	3.101	-7.570	26.506	1.00	70.44	O
ATOM	14161	ND2	ASN	D	224	5.350	-7.624	26.701	1.00	70.19	N
ATOM	14162	N	LEU	D	225	2.660	-9.113	31.452	1.00	71.46	N
ATOM	14163	CA	LEU	D	225	2.404	-10.141	32.446	1.00	70.29	C
ATOM	14164	C	LEU	D	225	0.953	-10.141	32.932	1.00	70.44	C
ATOM	14165	O	LEU	D	225	0.388	-11.214	33.110	1.00	68.37	O
ATOM	14166	CB	LEU	D	225	3.350	-10.006	33.636	1.00	69.29	C
ATOM	14167	CG	LEU	D	225	3.278	-11.281	34.475	1.00	72.65	C
ATOM	14168	CD1	LEU	D	225	4.658	-11.856	34.760	1.00	71.10	C
ATOM	14169	CD2	LEU	D	225	2.503	-11.031	35.761	1.00	68.49	C
ATOM	14170	N	ILE	D	226	0.345	-8.968	33.143	1.00	69.69	N
ATOM	14171	CA	ILE	D	226	-1.053	-8.940	33.582	1.00	71.60	C
ATOM	14172	C	ILE	D	226	-1.956	-9.542	32.517	1.00	72.33	C
ATOM	14173	O	ILE	D	226	-2.946	-10.195	32.834	1.00	77.34	O

ATOM	14174	CB	ILE	D	226	-1.553	-7.496	33.940	1.00	76.77	C
ATOM	14175	CG1	ILE	D	226	-1.764	-6.601	32.700	1.00	79.03	C
ATOM	14176	CG2	ILE	D	226	-0.586	-6.854	34.911	1.00	77.39	C
ATOM	14177	CD1	ILE	D	226	-3.161	-6.671	32.003	1.00	76.13	C
ATOM	14178	N	ALA	D	227	-1.611	-9.303	31.254	1.00	70.84	N
ATOM	14179	CA	ALA	D	227	-2.361	-9.822	30.120	1.00	70.69	C
ATOM	14180	O	ALA	D	227	-2.542	-11.328	30.239	1.00	71.37	C
ATOM	14181	O	ALA	D	227	-3.566	-11.881	29.824	1.00	68.70	O
ATOM	14182	CB	ALA	D	227	-1.656	-9.481	28.830	1.00	70.87	C
ATOM	14183	N	GLN	D	228	-1.546	-11.994	30.812	1.00	69.11	N
ATOM	14184	CA	GLN	D	228	-1.641	-13.432	31.008	1.00	72.03	C
ATOM	14185	C	GLN	D	228	-2.336	-13.731	32.315	1.00	74.63	C
ATOM	14186	O	GLN	D	228	-2.393	-14.882	32.738	1.00	78.34	O
ATOM	14187	CB	GLN	D	228	-0.266	-14.087	30.986	1.00	72.94	C
ATOM	14188	CG	GLN	D	228	-0.123	-15.157	29.925	1.00	75.97	C
ATOM	14189	CD	GLN	D	228	0.769	-14.721	28.787	1.00	73.29	C
ATOM	14190	OE1	GLN	D	228	1.568	-15.497	28.270	1.00	74.69	O
ATOM	14191	NE2	GLN	D	228	0.648	-13.466	28.400	1.00	75.75	N
ATOM	14192	N	LEU	D	229	-2.859	-12.688	32.954	1.00	76.21	N
ATOM	14193	CA	LEU	D	229	-3.548	-12.846	34.231	1.00	81.55	C
ATOM	14194	C	LEU	D	229	-5.023	-12.437	34.135	1.00	84.10	C
ATOM	14195	O	LEU	D	229	-5.373	-11.240	34.112	1.00	79.67	O
ATOM	14196	CB	LEU	D	229	-2.832	-12.050	35.324	1.00	81.03	C
ATOM	14197	CG	LEU	D	229	-1.440	-12.597	35.647	1.00	76.35	C
ATOM	14198	CD1	LEU	D	229	-0.823	-11.857	36.815	1.00	65.95	C
ATOM	14199	CD2	LEU	D	229	-1.516	-14.099	35.909	1.00	79.77	C
ATOM	14200	O	PRO	D	230	-7.762	-12.722	36.213	1.00	86.67	O
ATOM	14201	N	PRO	D	230	-5.893	-13.458	34.095	1.00	85.86	N
ATOM	14202	CA	PRO	D	230	-7.338	-13.312	33.935	1.00	89.39	C
ATOM	14203	C	PRO	D	230	-7.934	-12.431	35.031	1.00	87.36	C
ATOM	14204	CB	PRO	D	230	-7.856	-14.758	34.046	1.00	84.84	C
ATOM	14205	CG	PRO	D	230	-6.663	-15.634	33.924	1.00	77.37	C
ATOM	14206	CD	PRO	D	230	-5.512	-14.845	34.420	1.00	80.92	C
ATOM	14207	O	GLY	D	231	-8.898	-8.540	36.875	1.00	96.81	O
ATOM	14208	N	GLY	D	231	-8.609	-11.357	34.643	1.00	90.64	N
ATOM	14209	CA	GLY	D	231	-9.318	-10.527	35.601	1.00	89.77	C
ATOM	14210	C	GLY	D	231	-8.452	-9.618	36.459	1.00	92.77	C
ATOM	14211	O	GLU	D	232	-5.448	-7.787	35.927	1.00	84.19	O
ATOM	14212	N	GLU	D	232	-7.219	-10.039	36.731	1.00	89.13	N
ATOM	14213	CA	GLU	D	232	-6.339	-9.248	37.581	1.00	88.34	C
ATOM	14214	C	GLU	D	232	-6.079	-7.886	36.975	1.00	83.64	C
ATOM	14215	CB	GLU	D	232	-5.007	-9.954	37.813	1.00	83.72	C
ATOM	14216	CG	GLU	D	232	-4.166	-9.272	38.873	1.00	81.64	C
ATOM	14217	CD	GLU	D	232	-4.524	-9.731	40.269	1.00	84.88	C
ATOM	14218	OE1	GLU	D	232	-5.044	-10.863	40.397	1.00	81.91	O
ATOM	14219	OE2	GLU	D	232	-4.287	-8.966	41.233	1.00	84.16	O
ATOM	14220	O	LYS	D	233	-3.998	-6.142	37.847	1.00	81.91	O
ATOM	14221	N	LYS	D	233	-6.570	-6.840	37.631	1.00	81.55	N
ATOM	14222	CA	LYS	D	233	-6.227	-5.490	37.228	1.00	85.96	C
ATOM	14223	C	LYS	D	233	-4.704	-5.365	37.202	1.00	86.23	C
ATOM	14224	CB	LYS	D	233	-6.845	-4.454	38.174	1.00	83.17	C
ATOM	14225	O	LYS	D	234	-1.273	-3.359	38.152	1.00	83.69	O
ATOM	14226	N	LYS	D	234	-4.195	-4.406	36.435	1.00	89.86	N
ATOM	14227	CA	LYS	D	234	-2.762	-4.139	36.426	1.00	88.13	C
ATOM	14228	C	LYS	D	234	-2.394	-3.273	37.635	1.00	86.09	C
ATOM	14229	CB	LYS	D	234	-2.338	-3.465	35.117	1.00	85.26	C
ATOM	14230	O	ASN	D	235	-3.348	-1.937	41.691	1.00	75.16	O
ATOM	14231	N	ASN	D	235	-3.352	-2.453	38.076	1.00	81.09	N
ATOM	14232	CA	ASN	D	235	-3.223	-1.652	39.296	1.00	81.00	C
ATOM	14233	C	ASN	D	235	-3.465	-2.461	40.577	1.00	79.04	C
ATOM	14234	CB	ASN	D	235	-4.197	-0.473	39.257	1.00	76.18	C
ATOM	14235	CG	ASN	D	235	-3.593	0.762	38.633	1.00	82.29	C
ATOM	14236	OD1	ASN	D	235	-3.180	1.687	39.335	1.00	88.13	O

ATOM	14237	ND2	ASN	D	235	-3.538	0.791	37.306	1.00	90.62	N
ATOM	14238	O	GLY	D	236	-1.822	-4.254	42.213	1.00	69.55	O
ATOM	14239	N	GLY	D	236	-3.818	-3.733	40.409	1.00	76.74	N
ATOM	14240	CA	GLY	D	236	-4.088	-4.620	41.526	1.00	74.90	C
ATOM	14241	C	GLY	D	236	-2.905	-4.779	42.461	1.00	71.91	C
ATOM	14242	N	LEU	D	237	-3.113	-5.495	43.554	1.00	70.48	N
ATOM	14243	CA	LEU	D	237	-2.030	-5.719	44.493	1.00	69.09	C
ATOM	14244	C	LEU	D	237	-0.913	-6.484	43.789	1.00	70.04	C
ATOM	14245	O	LEU	D	237	0.262	-6.100	43.838	1.00	67.32	O
ATOM	14246	CB	LEU	D	237	-2.522	-6.485	45.717	1.00	63.80	C
ATOM	14247	CG	LEU	D	237	-1.499	-6.559	46.842	1.00	63.79	C
ATOM	14248	CD1	LEU	D	237	-1.050	-5.165	47.255	1.00	65.67	C
ATOM	14249	CD2	LEU	D	237	-2.067	-7.323	48.011	1.00	72.04	C
ATOM	14250	N	PHE	D	238	-1.303	-7.551	43.106	1.00	66.36	N
ATOM	14251	CA	PHE	D	238	-0.355	-8.394	42.425	1.00	64.20	C
ATOM	14252	C	PHE	D	238	0.401	-7.622	41.346	1.00	68.25	C
ATOM	14253	O	PHE	D	238	1.576	-7.881	41.110	1.00	71.31	O
ATOM	14254	CB	PHE	D	238	-1.055	-9.597	41.825	1.00	62.56	C
ATOM	14255	CG	PHE	D	238	-0.137	-10.736	41.541	1.00	69.38	C
ATOM	14256	CD1	PHE	D	238	0.152	-11.675	42.525	1.00	70.98	C
ATOM	14257	CD2	PHE	D	238	0.450	-10.873	40.303	1.00	65.82	C
ATOM	14258	CE1	PHE	D	238	1.003	-12.741	42.273	1.00	71.54	C
ATOM	14259	CE2	PHE	D	238	1.306	-11.942	40.044	1.00	72.06	C
ATOM	14260	CZ	PHE	D	238	1.579	-12.876	41.033	1.00	70.18	C
ATOM	14261	N	GLY	D	239	-0.261	-6.670	40.701	1.00	65.79	N
ATOM	14262	CA	GLY	D	239	0.388	-5.881	39.675	1.00	62.33	C
ATOM	14263	C	GLY	D	239	1.451	-4.977	40.262	1.00	68.28	C
ATOM	14264	O	GLY	D	239	2.564	-4.890	39.740	1.00	68.71	O
ATOM	14265	N	ASN	D	240	1.105	-4.306	41.357	1.00	70.41	N
ATOM	14266	CA	ASN	D	240	2.034	-3.416	42.051	1.00	70.18	C
ATOM	14267	C	ASN	D	240	3.246	-4.164	42.581	1.00	64.39	C
ATOM	14268	O	ASN	D	240	4.356	-3.634	42.611	1.00	65.49	O
ATOM	14269	CB	ASN	D	240	1.338	-2.696	43.205	1.00	71.42	C
ATOM	14270	CG	ASN	D	240	0.324	-1.676	42.732	1.00	73.16	C
ATOM	14271	OD1	ASN	D	240	0.452	-0.481	43.002	1.00	74.39	O
ATOM	14272	ND2	ASN	D	240	-0.698	-2.143	42.029	1.00	74.73	N
ATOM	14273	N	LEU	D	241	3.031	-5.397	43.011	1.00	65.10	N
ATOM	14274	CA	LEU	D	241	4.145	-6.226	43.435	1.00	65.34	C
ATOM	14275	C	LEU	D	241	5.041	-6.547	42.241	1.00	65.48	C
ATOM	14276	O	LEU	D	241	6.259	-6.475	42.344	1.00	65.34	O
ATOM	14277	CB	LEU	D	241	3.652	-7.511	44.096	1.00	64.96	C
ATOM	14278	CG	LEU	D	241	3.037	-7.396	45.494	1.00	66.01	C
ATOM	14279	CD1	LEU	D	241	2.375	-8.719	45.834	1.00	64.23	C
ATOM	14280	CD2	LEU	D	241	4.065	-7.014	46.554	1.00	59.79	C
ATOM	14281	N	ILE	D	242	4.439	-6.882	41.104	1.00	64.20	N
ATOM	14282	CA	ILE	D	242	5.220	-7.183	39.910	1.00	64.82	C
ATOM	14283	C	ILE	D	242	5.952	-5.922	39.450	1.00	65.58	C
ATOM	14284	O	ILE	D	242	7.121	-5.983	39.048	1.00	63.51	O
ATOM	14285	CB	ILE	D	242	4.343	-7.740	38.768	1.00	63.77	C
ATOM	14286	CG1	ILE	D	242	3.671	-9.038	39.191	1.00	57.39	C
ATOM	14287	CG2	ILE	D	242	5.181	-8.020	37.536	1.00	60.48	C
ATOM	14288	CD1	ILE	D	242	4.608	-10.239	39.180	1.00	68.57	C
ATOM	14289	N	ALA	D	243	5.264	-4.785	39.521	1.00	59.80	N
ATOM	14290	CA	ALA	D	243	5.884	-3.493	39.257	1.00	62.29	C
ATOM	14291	C	ALA	D	243	7.118	-3.305	40.139	1.00	67.11	C
ATOM	14292	O	ALA	D	243	8.194	-2.918	39.664	1.00	64.54	O
ATOM	14293	CB	ALA	D	243	4.885	-2.358	39.489	1.00	52.97	C
ATOM	14294	N	LEU	D	244	6.953	-3.586	41.429	1.00	68.82	N
ATOM	14295	CA	LEU	D	244	8.040	-3.438	42.388	1.00	66.23	C
ATOM	14296	C	LEU	D	244	9.216	-4.318	41.996	1.00	58.76	C
ATOM	14297	O	LEU	D	244	10.346	-3.859	41.973	1.00	59.22	O
ATOM	14298	CB	LEU	D	244	7.564	-3.778	43.801	1.00	63.16	C
ATOM	14299	CG	LEU	D	244	8.508	-3.329	44.916	1.00	61.26	C

ATOM	14300	CD1	LEU	D	244	8.617	-1.810	44.964	1.00	63.46	C
ATOM	14301	CD2	LEU	D	244	8.049	-3.877	46.248	1.00	65.60	C
ATOM	14302	N	SER	D	245	8.921	-5.573	41.663	1.00	61.02	N
ATOM	14303	CA	SER	D	245	9.914	-6.548	41.228	1.00	64.12	C
ATOM	14304	C	SER	D	245	10.684	-6.095	39.992	1.00	67.28	C
ATOM	14305	O	SER	D	245	11.870	-6.393	39.863	1.00	64.27	O
ATOM	14306	CB	SER	D	245	9.254	-7.900	40.929	1.00	64.67	C
ATOM	14307	OG	SER	D	245	8.472	-8.363	42.014	1.00	66.69	O
ATOM	14308	N	LEU	D	246	10.006	-5.395	39.081	1.00	65.87	N
ATOM	14309	CA	LEU	D	246	10.628	-4.956	37.828	1.00	66.05	C
ATOM	14310	C	LEU	D	246	11.555	-3.772	38.072	1.00	69.00	C
ATOM	14311	O	LEU	D	246	12.494	-3.529	37.301	1.00	71.49	O
ATOM	14312	CB	LEU	D	246	9.564	-4.598	36.777	1.00	64.55	C
ATOM	14313	CG	LEU	D	246	8.910	-5.817	36.124	1.00	61.02	C
ATOM	14314	CD2	LEU	D	246	9.922	-6.536	35.271	1.00	69.08	C
ATOM	14315	CD1	LEU	D	246	7.724	-5.451	35.301	1.00	59.09	C
ATOM	14316	O	GLY	D	247	12.113	0.429	39.655	1.00	59.43	O
ATOM	14317	N	GLY	D	247	11.301	-3.046	39.154	1.00	62.50	N
ATOM	14318	CA	GLY	D	247	12.174	-1.956	39.542	1.00	61.08	C
ATOM	14319	C	GLY	D	247	11.478	-0.614	39.518	1.00	63.14	C
ATOM	14320	O	LEU	D	248	9.765	0.610	41.673	1.00	71.08	O
ATOM	14321	N	LEU	D	248	10.162	-0.650	39.356	1.00	66.17	N
ATOM	14322	CA	LEU	D	248	9.366	0.562	39.309	1.00	65.32	C
ATOM	14323	C	LEU	D	248	9.139	1.080	40.719	1.00	68.30	C
ATOM	14324	CB	LEU	D	248	8.041	0.297	38.596	1.00	69.22	C
ATOM	14325	CG	LEU	D	248	8.214	-0.159	37.141	1.00	63.33	C
ATOM	14326	CD1	LEU	D	248	6.941	-0.742	36.583	1.00	60.36	C
ATOM	14327	CD2	LEU	D	248	8.661	1.015	36.310	1.00	65.26	C
ATOM	14328	O	THR	D	249	5.960	3.835	42.644	1.00	70.92	O
ATOM	14329	N	THR	D	249	8.238	2.045	40.848	1.00	69.74	N
ATOM	14330	CA	THR	D	249	8.007	2.714	42.120	1.00	68.71	C
ATOM	14331	C	THR	D	249	6.526	2.754	42.454	1.00	68.88	C
ATOM	14332	CB	THR	D	249	8.560	4.156	42.097	1.00	71.93	C
ATOM	14333	OG1	THR	D	249	9.780	4.189	41.354	1.00	79.23	O
ATOM	14334	CG2	THR	D	249	8.837	4.666	43.506	1.00	70.94	C
ATOM	14335	O	PRO	D	250	4.766	2.439	44.937	1.00	71.13	O
ATOM	14336	N	PRO	D	250	5.894	1.576	42.551	1.00	65.42	N
ATOM	14337	CA	PRO	D	250	4.439	1.549	42.734	1.00	67.18	C
ATOM	14338	C	PRO	D	250	3.982	2.271	44.004	1.00	72.53	C
ATOM	14339	CB	PRO	D	250	4.118	0.052	42.810	1.00	68.58	C
ATOM	14340	CG	PRO	D	250	5.395	-0.596	43.262	1.00	68.10	C
ATOM	14341	CD	PRO	D	250	6.497	0.235	42.667	1.00	69.68	C
ATOM	14342	O	ASN	D	251	0.213	1.817	44.946	1.00	70.76	O
ATOM	14343	N	ASN	D	251	2.730	2.720	44.006	1.00	76.73	N
ATOM	14344	CA	ASN	D	251	2.091	3.310	45.176	1.00	71.80	C
ATOM	14345	C	ASN	D	251	1.039	2.337	45.706	1.00	71.77	C
ATOM	14346	CB	ASN	D	251	1.464	4.663	44.821	1.00	73.67	C
ATOM	14347	CG	ASN	D	251	0.905	5.402	46.034	1.00	76.66	C
ATOM	14348	OD1	ASN	D	251	0.280	4.810	46.906	1.00	78.26	O
ATOM	14349	ND2	ASN	D	251	1.131	6.708	46.084	1.00	74.12	N
ATOM	14350	O	PHE	D	252	-1.669	1.115	49.196	1.00	83.29	O
ATOM	14351	N	PHE	D	252	1.071	2.090	47.011	1.00	73.37	N
ATOM	14352	CA	PHE	D	252	0.159	1.129	47.617	1.00	74.77	C
ATOM	14353	C	PHE	D	252	-1.004	1.784	48.408	1.00	81.52	C
ATOM	14354	CB	PHE	D	252	0.953	0.174	48.522	1.00	76.95	C
ATOM	14355	CG	PHE	D	252	1.794	-0.845	47.765	1.00	73.92	C
ATOM	14356	CD1	PHE	D	252	1.240	-2.039	47.336	1.00	71.73	C
ATOM	14357	CD2	PHE	D	252	3.140	-0.609	47.502	1.00	71.45	C
ATOM	14358	CE1	PHE	D	252	2.009	-2.980	46.641	1.00	73.28	C
ATOM	14359	CE2	PHE	D	252	3.911	-1.543	46.817	1.00	69.66	C
ATOM	14360	CZ	PHE	D	252	3.342	-2.730	46.379	1.00	68.49	C
ATOM	14361	O	LYS	D	253	-4.616	3.285	49.432	1.00	88.66	O
ATOM	14362	N	LYS	D	253	-1.276	3.070	48.176	1.00	78.58	N

ATOM	14363	CA	LYS	D	253	-2.335	3.774	48.917	1.00	82.61	C
ATOM	14364	C	LYS	D	253	-3.745	3.294	48.572	1.00	85.71	C
ATOM	14365	CB	LYS	D	253	-2.259	5.289	48.691	1.00	78.80	C
ATOM	14366	O	SER	D	254	-6.547	0.537	47.687	1.00	92.28	O
ATOM	14367	N	SER	D	254	-3.979	2.911	47.322	1.00	84.97	N
ATOM	14368	CA	SER	D	254	-5.300	2.430	46.934	1.00	84.48	C
ATOM	14369	C	SER	D	254	-5.470	0.962	47.275	1.00	88.64	C
ATOM	14370	CB	SER	D	254	-5.547	2.643	45.441	1.00	80.30	C
ATOM	14371	OG	SER	D	254	-5.787	4.008	45.172	1.00	96.06	O
ATOM	14372	O	ASN	D	255	-5.582	-2.679	48.854	1.00	84.68	O
ATOM	14373	N	ASN	D	255	-4.400	0.194	47.095	1.00	83.28	N
ATOM	14374	CA	ASN	D	255	-4.426	-1.249	47.296	1.00	80.66	C
ATOM	14375	C	ASN	D	255	-4.917	-1.651	48.687	1.00	84.72	C
ATOM	14376	CB	ASN	D	255	-3.031	-1.828	47.051	1.00	81.19	C
ATOM	14377	CG	ASN	D	255	-2.576	-1.671	45.611	1.00	82.04	C
ATOM	14378	OD1	ASN	D	255	-2.388	-2.659	44.904	1.00	81.86	O
ATOM	14379	ND2	ASN	D	255	-2.407	-0.423	45.164	1.00	83.79	N
ATOM	14380	O	PHE	D	256	-5.799	0.292	52.828	1.00	86.73	O
ATOM	14381	N	PHE	D	256	-4.581	-0.835	49.682	1.00	84.81	N
ATOM	14382	CA	PHE	D	256	-4.999	-1.087	51.053	1.00	84.61	C
ATOM	14383	C	PHE	D	256	-5.738	0.118	51.615	1.00	86.48	C
ATOM	14384	CB	PHE	D	256	-3.807	-1.401	51.958	1.00	81.89	C
ATOM	14385	CG	PHE	D	256	-2.998	-2.593	51.541	1.00	77.61	C
ATOM	14386	CD1	PHE	D	256	-3.400	-3.874	51.881	1.00	73.13	C
ATOM	14387	CD2	PHE	D	256	-1.809	-2.427	50.852	1.00	75.52	C
ATOM	14388	CE1	PHE	D	256	-2.648	-4.971	51.512	1.00	76.29	C
ATOM	14389	CE2	PHE	D	256	-1.048	-3.519	50.480	1.00	75.78	C
ATOM	14390	CZ	PHE	D	256	-1.465	-4.793	50.811	1.00	75.76	C
ATOM	14391	O	ASP	D	257	-7.242	2.908	53.342	1.00	85.28	O
ATOM	14392	N	ASP	D	257	-6.265	0.954	50.727	1.00	87.59	N
ATOM	14393	CA	ASP	D	257	-7.126	2.079	51.101	1.00	90.57	C
ATOM	14394	C	ASP	D	257	-6.609	2.879	52.295	1.00	85.37	C
ATOM	14395	CB	ASP	D	257	-8.548	1.579	51.397	1.00	97.97	C
ATOM	14396	CG	ASP	D	257	-9.428	1.510	50.141	1.00	104.49	C
ATOM	14397	OD2	ASP	D	257	-9.535	0.413	49.536	1.00	104.37	O
ATOM	14398	OD1	ASP	D	257	-10.022	2.556	49.769	1.00	102.03	O
ATOM	14399	O	LEU	D	258	-5.983	6.219	52.395	1.00	77.47	O
ATOM	14400	N	LEU	D	258	-5.464	3.529	52.125	1.00	84.82	N
ATOM	14401	CA	LEU	D	258	-4.825	4.274	53.208	1.00	80.89	C
ATOM	14402	C	LEU	D	258	-5.151	5.766	53.172	1.00	79.52	C
ATOM	14403	CB	LEU	D	258	-3.306	4.079	53.161	1.00	81.32	C
ATOM	14404	CG	LEU	D	258	-2.772	2.662	53.420	1.00	83.86	C
ATOM	14405	CD1	LEU	D	258	-2.775	1.839	52.155	1.00	86.52	C
ATOM	14406	CD2	LEU	D	258	-1.374	2.688	54.016	1.00	84.31	C
ATOM	14407	O	ALA	D	259	-4.025	9.555	52.518	1.00	81.52	O
ATOM	14408	N	ALA	D	259	-4.487	6.527	54.030	1.00	79.97	N
ATOM	14409	CA	ALA	D	259	-4.751	7.952	54.141	1.00	78.30	C
ATOM	14410	C	ALA	D	259	-3.702	8.739	53.383	1.00	82.62	C
ATOM	14411	CB	ALA	D	259	-4.779	8.375	55.597	1.00	79.36	C
ATOM	14412	O	GLU	D	260	-1.227	7.041	51.886	1.00	79.12	O
ATOM	14413	N	GLU	D	260	-2.440	8.489	53.726	1.00	82.10	N
ATOM	14414	CA	GLU	D	260	-1.317	9.125	53.057	1.00	76.64	C
ATOM	14415	C	GLU	D	260	-0.752	8.165	52.016	1.00	74.95	C
ATOM	14416	CB	GLU	D	260	-0.252	9.540	54.073	1.00	70.84	C
ATOM	14417	O	ASP	D	261	2.127	6.700	51.956	1.00	76.19	O
ATOM	14418	N	ASP	D	261	0.247	8.606	51.259	1.00	77.10	N
ATOM	14419	CA	ASP	D	261	0.827	7.758	50.221	1.00	76.24	C
ATOM	14420	C	ASP	D	261	1.661	6.623	50.821	1.00	78.20	C
ATOM	14421	CB	ASP	D	261	1.684	8.590	49.261	1.00	74.38	C
ATOM	14422	CG	ASP	D	261	0.867	9.240	48.149	1.00	82.31	C
ATOM	14423	OD1	ASP	D	261	0.132	8.516	47.439	1.00	79.61	O
ATOM	14424	OD2	ASP	D	261	0.956	10.480	47.986	1.00	88.03	O
ATOM	14425	O	ALA	D	262	3.320	2.907	48.719	1.00	72.55	O

ATOM	14426	N	ALA	D	262	1.837	5.562	50.047	1.00	78.02	N
ATOM	14427	CA	ALA	D	262	2.710	4.469	50.441	1.00	72.53	C
ATOM	14428	C	ALA	D	262	3.520	4.009	49.240	1.00	75.55	C
ATOM	14429	CB	ALA	D	262	1.912	3.331	51.016	1.00	75.98	C
ATOM	14430	O	LYS	D	263	7.270	4.246	48.864	1.00	71.52	O
ATOM	14431	N	LYS	D	263	4.433	4.870	48.801	1.00	79.54	N
ATOM	14432	CA	LYS	D	263	5.245	4.597	47.620	1.00	75.16	C
ATOM	14433	C	LYS	D	263	6.524	3.849	47.972	1.00	72.76	C
ATOM	14434	CB	LYS	D	263	5.576	5.901	46.889	1.00	75.26	C
ATOM	14435	CG	LYS	D	263	4.444	6.412	46.000	1.00	75.73	C
ATOM	14436	CD	LYS	D	263	4.883	7.582	45.141	1.00	66.96	C
ATOM	14437	CE	LYS	D	263	4.731	8.888	45.890	1.00	82.37	C
ATOM	14438	NZ	LYS	D	263	5.082	10.062	45.033	1.00	82.83	N
ATOM	14439	O	LEU	D	264	8.399	1.741	45.158	1.00	69.32	O
ATOM	14440	N	LEU	D	264	6.769	2.764	47.249	1.00	72.24	N
ATOM	14441	CA	LEU	D	264	7.901	1.886	47.529	1.00	75.77	C
ATOM	14442	C	LEU	D	264	8.835	1.706	46.313	1.00	73.61	C
ATOM	14443	CB	LEU	D	264	7.394	0.523	48.015	1.00	72.28	C
ATOM	14444	CG	LEU	D	264	6.574	0.526	49.307	1.00	75.10	C
ATOM	14445	CD1	LEU	D	264	6.493	-0.862	49.906	1.00	70.61	C
ATOM	14446	CD2	LEU	D	264	7.169	1.488	50.315	1.00	79.09	C
ATOM	14447	O	GLN	D	265	13.157	1.297	46.680	1.00	67.05	O
ATOM	14448	N	GLN	D	265	10.125	1.533	46.580	1.00	66.42	N
ATOM	14449	CA	GLN	D	265	11.079	1.347	45.500	1.00	71.93	C
ATOM	14450	C	GLN	D	265	12.332	0.672	46.013	1.00	67.06	C
ATOM	14451	CB	GLN	D	265	11.435	2.681	44.846	1.00	70.54	C
ATOM	14452	CG	GLN	D	265	12.077	2.524	43.476	1.00	72.87	C
ATOM	14453	CD	GLN	D	265	12.913	3.723	43.069	1.00	78.15	C
ATOM	14454	OE1	GLN	D	265	13.073	4.682	43.832	1.00	78.98	O
ATOM	14455	NE2	GLN	D	265	13.461	3.669	41.860	1.00	77.75	N
ATOM	14456	O	LEU	D	266	15.719	-0.987	47.050	1.00	71.48	O
ATOM	14457	N	LEU	D	266	12.467	-0.602	45.674	1.00	63.68	N
ATOM	14458	CA	LEU	D	266	13.556	-1.444	46.159	1.00	63.24	C
ATOM	14459	C	LEU	D	266	14.945	-0.806	46.127	1.00	64.40	C
ATOM	14460	CB	LEU	D	266	13.565	-2.739	45.365	1.00	59.52	C
ATOM	14461	CG	LEU	D	266	12.291	-3.544	45.636	1.00	64.98	C
ATOM	14462	CD1	LEU	D	266	12.125	-4.707	44.664	1.00	67.20	C
ATOM	14463	CD2	LEU	D	266	12.311	-4.043	47.070	1.00	62.52	C
ATOM	14464	O	SER	D	267	18.049	1.939	46.261	1.00	68.63	O
ATOM	14465	N	SER	D	267	15.249	-0.042	45.087	1.00	70.11	N
ATOM	14466	CA	SER	D	267	16.572	0.578	44.946	1.00	66.60	C
ATOM	14467	C	SER	D	267	16.879	1.708	45.941	1.00	68.75	C
ATOM	14468	CB	SER	D	267	16.736	1.119	43.522	1.00	65.97	C
ATOM	14469	OG	SER	D	267	15.597	1.873	43.130	1.00	70.12	O
ATOM	14470	O	LYS	D	268	16.142	2.103	49.139	1.00	68.60	O
ATOM	14471	N	LYS	D	268	15.847	2.422	46.404	1.00	69.52	N
ATOM	14472	CA	LYS	D	268	16.046	3.588	47.272	1.00	68.52	C
ATOM	14473	C	LYS	D	268	16.531	3.152	48.646	1.00	72.05	C
ATOM	14474	CB	LYS	D	268	14.765	4.416	47.399	1.00	73.09	C
ATOM	14475	O	ASP	D	269	17.571	3.169	52.792	1.00	82.60	O
ATOM	14476	N	ASP	D	269	17.389	3.970	49.253	1.00	80.61	N
ATOM	14477	CA	ASP	D	269	18.095	3.607	50.485	1.00	82.64	C
ATOM	14478	C	ASP	D	269	17.188	3.612	51.707	1.00	81.83	C
ATOM	14479	CB	ASP	D	269	19.281	4.556	50.719	1.00	81.64	C
ATOM	14480	CG	ASP	D	269	18.946	6.008	50.414	1.00	85.40	C
ATOM	14481	OD2	ASP	D	269	19.455	6.897	51.131	1.00	90.19	O
ATOM	14482	OD1	ASP	D	269	18.182	6.262	49.457	1.00	82.42	O
ATOM	14483	O	THR	D	270	13.044	3.197	53.369	1.00	84.14	O
ATOM	14484	N	THR	D	270	15.979	4.113	51.518	1.00	83.44	N
ATOM	14485	CA	THR	D	270	15.047	4.284	52.615	1.00	82.58	C
ATOM	14486	C	THR	D	270	13.997	3.176	52.594	1.00	81.48	C
ATOM	14487	CB	THR	D	270	14.380	5.669	52.538	1.00	79.45	C
ATOM	14488	OG1	THR	D	270	13.551	5.741	51.375	1.00	80.35	O

ATOM	14489	CG2	THR	D	270	15.440	6.750	52.429	1.00	81.81	C
ATOM	14490	N	TYR	D	271	14.196	2.196	51.717	1.00	75.47	N
ATOM	14491	CA	TYR	D	271	13.168	1.199	51.436	1.00	74.07	C
ATOM	14492	C	TYR	D	271	12.816	0.325	52.632	1.00	75.52	C
ATOM	14493	O	TYR	D	271	11.645	0.054	52.886	1.00	76.96	O
ATOM	14494	CB	TYR	D	271	13.591	0.291	50.280	1.00	71.04	C
ATOM	14495	CG	TYR	D	271	12.667	-0.890	50.120	1.00	67.24	C
ATOM	14496	CD1	TYR	D	271	11.448	-0.754	49.475	1.00	67.36	C
ATOM	14497	CD2	TYR	D	271	12.998	-2.133	50.634	1.00	64.50	C
ATOM	14498	CE1	TYR	D	271	10.599	-1.819	49.339	1.00	65.71	C
ATOM	14499	CE2	TYR	D	271	12.146	-3.203	50.504	1.00	60.92	C
ATOM	14500	CZ	TYR	D	271	10.951	-3.039	49.858	1.00	60.98	C
ATOM	14501	OH	TYR	D	271	10.105	-4.108	49.716	1.00	64.09	O
ATOM	14502	N	ASP	D	272	13.825	-0.157	53.341	1.00	77.17	N
ATOM	14503	CA	ASP	D	272	13.567	-1.022	54.477	1.00	77.89	C
ATOM	14504	C	ASP	D	272	12.740	-0.290	55.526	1.00	79.59	C
ATOM	14505	O	ASP	D	272	11.889	-0.887	56.167	1.00	81.87	O
ATOM	14506	CB	ASP	D	272	14.874	-1.531	55.066	1.00	74.34	C
ATOM	14507	CG	ASP	D	272	15.480	-2.635	54.234	1.00	83.44	C
ATOM	14508	OD2	ASP	D	272	16.726	-2.773	54.210	1.00	84.97	O
ATOM	14509	OD1	ASP	D	272	14.693	-3.365	53.594	1.00	81.34	O
ATOM	14510	N	ASP	D	273	12.985	1.005	55.684	1.00	73.26	N
ATOM	14511	CA	ASP	D	273	12.171	1.827	56.574	1.00	85.18	C
ATOM	14512	C	ASP	D	273	10.791	2.055	55.973	1.00	83.62	C
ATOM	14513	O	ASP	D	273	9.782	1.935	56.658	1.00	84.24	O
ATOM	14514	CB	ASP	D	273	12.851	3.176	56.853	1.00	88.46	C
ATOM	14515	CG	ASP	D	273	14.034	3.050	57.801	1.00	95.69	C
ATOM	14516	OD1	ASP	D	273	13.863	2.424	58.871	1.00	97.40	O
ATOM	14517	OD2	ASP	D	273	15.133	3.563	57.476	1.00	98.92	O
ATOM	14518	N	ASP	D	274	10.765	2.381	54.684	1.00	81.22	N
ATOM	14519	CA	ASP	D	274	9.534	2.691	53.972	1.00	79.01	C
ATOM	14520	C	ASP	D	274	8.547	1.535	53.988	1.00	79.14	C
ATOM	14521	O	ASP	D	274	7.332	1.733	54.047	1.00	83.57	O
ATOM	14522	CB	ASP	D	274	9.856	3.076	52.533	1.00	77.83	C
ATOM	14523	CG	ASP	D	274	10.558	4.412	52.437	1.00	82.53	C
ATOM	14524	OD2	ASP	D	274	11.406	4.575	51.539	1.00	85.13	O
ATOM	14525	OD1	ASP	D	274	10.267	5.295	53.269	1.00	83.41	O
ATOM	14526	N	LEU	D	275	9.082	0.326	53.920	1.00	77.59	N
ATOM	14527	CA	LEU	D	275	8.278	-0.874	53.966	1.00	73.36	C
ATOM	14528	C	LEU	D	275	7.703	-1.053	55.360	1.00	77.73	C
ATOM	14529	O	LEU	D	275	6.560	-1.469	55.516	1.00	78.00	O
ATOM	14530	CB	LEU	D	275	9.114	-2.088	53.577	1.00	71.05	C
ATOM	14531	CG	LEU	D	275	8.353	-3.409	53.651	1.00	73.18	C
ATOM	14532	CD1	LEU	D	275	7.118	-3.365	52.753	1.00	73.23	C
ATOM	14533	CD2	LEU	D	275	9.235	-4.575	53.288	1.00	60.00	C
ATOM	14534	N	ASP	D	276	8.503	-0.723	56.372	1.00	80.11	N
ATOM	14535	CA	ASP	D	276	8.104	-0.904	57.767	1.00	78.52	C
ATOM	14536	C	ASP	D	276	7.010	0.064	58.163	1.00	80.58	C
ATOM	14537	O	ASP	D	276	6.079	-0.311	58.869	1.00	79.52	O
ATOM	14538	CB	ASP	D	276	9.300	-0.749	58.698	1.00	79.77	C
ATOM	14539	CG	ASP	D	276	10.182	-1.985	58.710	1.00	89.26	C
ATOM	14540	OD1	ASP	D	276	9.871	-2.944	57.964	1.00	86.40	O
ATOM	14541	OD2	ASP	D	276	11.190	-1.994	59.453	1.00	95.11	O
ATOM	14542	N	ASN	D	277	7.118	1.308	57.706	1.00	81.81	N
ATOM	14543	CA	ASN	D	277	6.049	2.262	57.915	1.00	81.97	C
ATOM	14544	C	ASN	D	277	4.769	1.765	57.279	1.00	81.45	C
ATOM	14545	O	ASN	D	277	3.680	2.049	57.764	1.00	85.08	O
ATOM	14546	CB	ASN	D	277	6.396	3.630	57.348	1.00	87.28	C
ATOM	14547	CG	ASN	D	277	5.221	4.591	57.417	1.00	91.76	C
ATOM	14548	OD1	ASN	D	277	4.628	4.947	56.396	1.00	101.10	O
ATOM	14549	ND2	ASN	D	277	4.860	4.996	58.633	1.00	94.09	N
ATOM	14550	N	LEU	D	278	4.905	1.022	56.189	1.00	79.24	N
ATOM	14551	CA	LEU	D	278	3.745	0.454	55.532	1.00	77.80	C

ATOM	14552	C	LEU	D	278	3.233	-0.756	56.292	1.00	73.48	C
ATOM	14553	O	LEU	D	278	2.055	-0.840	56.607	1.00	72.71	O
ATOM	14554	CB	LEU	D	278	4.059	0.058	54.089	1.00	79.21	C
ATOM	14555	CG	LEU	D	278	2.816	-0.508	53.388	1.00	76.49	C
ATOM	14556	CD1	LEU	D	278	1.719	0.537	53.358	1.00	71.77	C
ATOM	14557	CD2	LEU	D	278	3.101	-1.021	51.988	1.00	74.53	C
ATOM	14558	N	LEU	D	279	4.119	-1.699	56.573	1.00	76.22	N
ATOM	14559	CA	LEU	D	279	3.730	-2.930	57.257	1.00	76.86	C
ATOM	14560	C	LEU	D	279	3.146	-2.670	58.651	1.00	73.46	C
ATOM	14561	O	LEU	D	279	2.397	-3.484	59.177	1.00	74.61	O
ATOM	14562	CB	LEU	D	279	4.929	-3.873	57.360	1.00	75.67	C
ATOM	14563	CG	LEU	D	279	5.441	-4.409	56.021	1.00	77.39	C
ATOM	14564	CD1	LEU	D	279	6.727	-5.221	56.204	1.00	73.88	C
ATOM	14565	CD2	LEU	D	279	4.356	-5.236	55.332	1.00	74.76	C
ATOM	14566	N	ALA	D	280	3.491	-1.530	59.238	1.00	71.69	N
ATOM	14567	CA	ALA	D	280	2.946	-1.133	60.529	1.00	71.56	C
ATOM	14568	C	ALA	D	280	1.471	-0.829	60.376	1.00	74.16	C
ATOM	14569	O	ALA	D	280	0.625	-1.461	60.997	1.00	73.33	O
ATOM	14570	CB	ALA	D	280	3.685	0.076	61.075	1.00	71.65	C
ATOM	14571	N	GLN	D	281	1.192	0.148	59.519	1.00	73.86	N
ATOM	14572	CA	GLN	D	281	-0.150	0.534	59.129	1.00	65.41	C
ATOM	14573	C	GLN	D	281	-0.979	-0.591	58.517	1.00	68.34	C
ATOM	14574	O	GLN	D	281	-2.193	-0.542	58.558	1.00	71.02	O
ATOM	14575	CB	GLN	D	281	-0.069	1.692	58.136	1.00	65.94	C
ATOM	14576	N	ILE	D	282	-0.340	-1.609	57.954	1.00	76.65	N
ATOM	14577	CA	ILE	D	282	-1.067	-2.532	57.075	1.00	77.39	C
ATOM	14578	C	ILE	D	282	-1.112	-3.983	57.539	1.00	74.80	C
ATOM	14579	O	ILE	D	282	-2.059	-4.699	57.225	1.00	73.89	O
ATOM	14580	CB	ILE	D	282	-0.485	-2.479	55.629	1.00	74.97	C
ATOM	14581	CG1	ILE	D	282	-1.601	-2.160	54.646	1.00	69.43	C
ATOM	14582	CG2	ILE	D	282	0.304	-3.730	55.249	1.00	73.03	C
ATOM	14583	CD1	ILE	D	282	-2.011	-0.741	54.767	1.00	79.72	C
ATOM	14584	N	GLY	D	283	-0.099	-4.422	58.280	1.00	72.86	N
ATOM	14585	C	GLY	D	283	1.165	-6.550	58.566	1.00	77.54	C
ATOM	14586	CA	GLY	D	283	-0.108	-5.767	58.809	1.00	69.98	C
ATOM	14587	O	GLY	D	283	1.693	-6.587	57.460	1.00	81.51	O
ATOM	14588	N	ASP	D	284	1.648	-7.183	59.625	1.00	73.93	N
ATOM	14589	CA	ASP	D	284	2.725	-8.162	59.564	1.00	77.02	C
ATOM	14590	C	ASP	D	284	2.404	-9.299	58.596	1.00	77.00	C
ATOM	14591	O	ASP	D	284	3.302	-9.955	58.072	1.00	82.96	O
ATOM	14592	CB	ASP	D	284	2.980	-8.703	60.977	1.00	79.98	C
ATOM	14593	CG	ASP	D	284	3.884	-9.894	61.003	1.00	87.89	C
ATOM	14594	OD2	ASP	D	284	3.366	-11.033	61.118	1.00	89.81	O
ATOM	14595	OD1	ASP	D	284	5.114	-9.684	60.935	1.00	96.99	O
ATOM	14596	N	GLN	D	285	1.118	-9.529	58.359	1.00	76.26	N
ATOM	14597	CA	GLN	D	285	0.667	-10.603	57.479	1.00	74.78	C
ATOM	14598	C	GLN	D	285	1.228	-10.465	56.064	1.00	79.19	C
ATOM	14599	O	GLN	D	285	1.472	-11.458	55.376	1.00	78.01	O
ATOM	14600	CB	GLN	D	285	-0.853	-10.615	57.437	1.00	71.67	C
ATOM	14601	CG	GLN	D	285	-1.448	-9.221	57.315	1.00	70.30	C
ATOM	14602	CD	GLN	D	285	-2.949	-9.242	57.431	1.00	73.30	C
ATOM	14603	OE1	GLN	D	285	-3.552	-10.314	57.510	1.00	72.49	O
ATOM	14604	NE2	GLN	D	285	-3.569	-8.063	57.446	1.00	72.51	N
ATOM	14605	N	TYR	D	286	1.429	-9.216	55.652	1.00	80.56	N
ATOM	14606	CA	TYR	D	286	1.901	-8.880	54.314	1.00	80.17	C
ATOM	14607	C	TYR	D	286	3.421	-8.737	54.219	1.00	79.21	C
ATOM	14608	O	TYR	D	286	3.913	-7.935	53.427	1.00	77.96	O
ATOM	14609	CB	TYR	D	286	1.256	-7.567	53.845	1.00	71.59	C
ATOM	14610	CG	TYR	D	286	-0.241	-7.619	53.754	1.00	75.29	C
ATOM	14611	CD1	TYR	D	286	-0.868	-8.544	52.936	1.00	76.74	C
ATOM	14612	CD2	TYR	D	286	-1.030	-6.738	54.477	1.00	72.15	C
ATOM	14613	CE1	TYR	D	286	-2.237	-8.597	52.847	1.00	77.52	C
ATOM	14614	CE2	TYR	D	286	-2.396	-6.777	54.393	1.00	71.71	C

ATOM	14615	CZ	TYR	D	286	-2.999	-7.709	53.574	1.00	76.39	C
ATOM	14616	OH	TYR	D	286	-4.368	-7.758	53.479	1.00	78.49	O
ATOM	14617	N	ALA	D	287	4.170	-9.492	55.016	1.00	77.81	N
ATOM	14618	CA	ALA	D	287	5.625	-9.321	55.024	1.00	78.97	C
ATOM	14619	C	ALA	D	287	6.329	-10.393	54.201	1.00	79.43	C
ATOM	14620	O	ALA	D	287	7.400	-10.148	53.658	1.00	79.30	O
ATOM	14621	CB	ALA	D	287	6.155	-9.319	56.443	1.00	78.67	C
ATOM	14622	N	ASP	D	288	5.739	-11.583	54.125	1.00	78.96	N
ATOM	14623	CA	ASP	D	288	6.277	-12.628	53.267	1.00	77.20	C
ATOM	14624	C	ASP	D	288	6.039	-12.257	51.803	1.00	79.13	C
ATOM	14625	O	ASP	D	288	6.827	-12.606	50.912	1.00	79.15	O
ATOM	14626	CB	ASP	D	288	5.644	-13.978	53.589	1.00	73.82	C
ATOM	14627	CG	ASP	D	288	6.280	-14.647	54.784	1.00	81.24	C
ATOM	14628	OD1	ASP	D	288	7.420	-14.273	55.135	1.00	77.71	C
ATOM	14629	OD2	ASP	D	288	5.646	-15.554	55.366	1.00	83.66	O
ATOM	14630	N	LEU	D	289	4.943	-11.538	51.580	1.00	77.42	N
ATOM	14631	CA	LEU	D	289	4.558	-11.070	50.265	1.00	72.75	C
ATOM	14632	C	LEU	D	289	5.651	-10.183	49.710	1.00	70.40	C
ATOM	14633	O	LEU	D	289	6.317	-10.540	48.741	1.00	71.94	O
ATOM	14634	CB	LEU	D	289	3.230	-10.316	50.335	1.00	72.99	C
ATOM	14635	CG	LEU	D	289	2.472	-10.172	49.019	1.00	70.44	C
ATOM	14636	CD2	LEU	D	289	1.174	-9.428	49.227	1.00	64.12	C
ATOM	14637	CD1	LEU	D	289	2.228	-11.532	48.363	1.00	71.10	C
ATOM	14638	N	PHE	D	290	5.860	-9.040	50.347	1.00	69.82	N
ATOM	14639	CA	PHE	D	290	6.897	-8.119	49.904	1.00	71.68	C
ATOM	14640	C	PHE	D	290	8.288	-8.751	49.911	1.00	68.60	C
ATOM	14641	O	PHE	D	290	9.184	-8.287	49.216	1.00	70.70	O
ATOM	14642	CB	PHE	D	290	6.890	-6.854	50.760	1.00	70.13	C
ATOM	14643	CG	PHE	D	290	5.735	-5.934	50.471	1.00	69.53	C
ATOM	14644	CD2	PHE	D	290	5.893	-4.842	49.633	1.00	69.59	C
ATOM	14645	CD1	PHE	D	290	4.490	-6.164	51.033	1.00	68.32	C
ATOM	14646	CE2	PHE	D	290	4.829	-3.988	49.367	1.00	72.48	C
ATOM	14647	CE1	PHE	D	290	3.425	-5.320	50.773	1.00	68.21	C
ATOM	14648	CZ	PHE	D	290	3.592	-4.227	49.941	1.00	70.13	C
ATOM	14649	N	LEU	D	291	8.469	-9.816	50.680	1.00	71.46	N
ATOM	14650	CA	LEU	D	291	9.749	-10.502	50.696	1.00	70.03	C
ATOM	14651	C	LEU	D	291	9.904	-11.277	49.393	1.00	71.48	C
ATOM	14652	O	LEU	D	291	10.953	-11.226	48.742	1.00	69.53	O
ATOM	14653	CB	LEU	D	291	9.859	-11.432	51.902	1.00	67.33	C
ATOM	14654	CG	LEU	D	291	11.040	-12.404	51.872	1.00	67.81	C
ATOM	14655	CD2	LEU	D	291	10.896	-13.455	52.958	1.00	73.85	C
ATOM	14656	CD1	LEU	D	291	12.373	-11.684	51.988	1.00	64.71	C
ATOM	14657	N	ALA	D	292	8.839	-11.978	49.018	1.00	68.45	N
ATOM	14658	CA	ALA	D	292	8.792	-12.708	47.766	1.00	66.70	C
ATOM	14659	C	ALA	D	292	9.144	-11.810	46.580	1.00	69.51	C
ATOM	14660	O	ALA	D	292	9.936	-12.190	45.714	1.00	73.31	O
ATOM	14661	CB	ALA	D	292	7.425	-13.318	47.576	1.00	69.96	C
ATOM	14662	N	ALA	D	293	8.568	-10.614	46.558	1.00	68.57	N
ATOM	14663	CA	ALA	D	293	8.776	-9.664	45.465	1.00	69.72	C
ATOM	14664	C	ALA	D	293	10.233	-9.232	45.344	1.00	70.26	C
ATOM	14665	O	ALA	D	293	10.799	-9.230	44.250	1.00	71.10	O
ATOM	14666	CB	ALA	D	293	7.881	-8.446	45.648	1.00	62.29	C
ATOM	14667	N	LYS	D	294	10.836	-8.861	46.468	1.00	71.57	N
ATOM	14668	CA	LYS	D	294	12.215	-8.389	46.467	1.00	71.41	C
ATOM	14669	C	LYS	D	294	13.123	-9.458	45.881	1.00	70.44	C
ATOM	14670	O	LYS	D	294	14.044	-9.170	45.112	1.00	67.12	O
ATOM	14671	CB	LYS	D	294	12.650	-8.009	47.883	1.00	72.88	C
ATOM	14672	CG	LYS	D	294	14.144	-8.024	48.116	1.00	73.79	C
ATOM	14673	CD	LYS	D	294	14.449	-7.769	49.575	1.00	75.50	C
ATOM	14674	CE	LYS	D	294	15.824	-8.293	49.958	1.00	86.32	C
ATOM	14675	NZ	LYS	D	294	16.161	-7.937	51.368	1.00	84.92	N
ATOM	14676	N	ASN	D	295	12.829	-10.704	46.220	1.00	71.30	N
ATOM	14677	CA	ASN	D	295	13.566	-11.816	45.665	1.00	66.96	C

ATOM	14678	C	ASN	D	295	13.374	-11.939	44.162	1.00	68.38	C
ATOM	14679	O	ASN	D	295	14.335	-12.164	43.430	1.00	69.88	O
ATOM	14680	CB	ASN	D	295	13.162	-13.097	46.376	1.00	75.43	C
ATOM	14681	CG	ASN	D	295	13.820	-13.224	47.740	1.00	80.01	C
ATOM	14682	OD1	ASN	D	295	15.048	-13.120	47.865	1.00	81.33	O
ATOM	14683	ND2	ASN	D	295	13.010	-13.423	48.771	1.00	71.90	N
ATOM	14684	N	LEU	D	296	12.136	-11.783	43.705	1.00	70.18	N
ATOM	14685	CA	LEU	D	296	11.851	-11.727	42.276	1.00	68.63	C
ATOM	14686	C	LEU	D	296	12.727	-10.680	41.623	1.00	67.37	C
ATOM	14687	O	LEU	D	296	13.452	-10.960	40.672	1.00	65.67	O
ATOM	14688	CB	LEU	D	296	10.384	-11.400	42.032	1.00	66.99	C
ATOM	14689	CG	LEU	D	296	9.878	-11.506	40.596	1.00	70.13	C
ATOM	14690	CD1	LEU	D	296	10.279	-12.832	39.984	1.00	70.45	C
ATOM	14691	CD2	LEU	D	296	8.366	-11.343	40.573	1.00	69.37	C
ATOM	14692	N	SER	D	297	12.686	-9.479	42.182	1.00	66.91	N
ATOM	14693	CA	SER	D	297	13.475	-8.371	41.676	1.00	65.16	C
ATOM	14694	C	SER	D	297	14.951	-8.707	41.471	1.00	65.92	C
ATOM	14695	O	SER	D	297	15.596	-8.118	40.615	1.00	68.89	O
ATOM	14696	CB	SER	D	297	13.360	-7.185	42.611	1.00	67.80	C
ATOM	14697	OG	SER	D	297	14.227	-7.355	43.716	1.00	74.48	O
ATOM	14698	N	ASP	D	298	15.485	-9.640	42.253	1.00	67.92	N
ATOM	14699	CA	ASP	D	298	16.884	-10.049	42.105	1.00	71.45	C
ATOM	14700	C	ASP	D	298	17.126	-10.904	40.853	1.00	70.36	C
ATOM	14701	O	ASP	D	298	18.091	-10.690	40.118	1.00	67.50	O
ATOM	14702	CB	ASP	D	298	17.357	-10.822	43.339	1.00	70.16	C
ATOM	14703	CG	ASP	D	298	17.625	-9.923	44.519	1.00	71.13	C
ATOM	14704	OD1	ASP	D	298	17.923	-8.731	44.297	1.00	70.80	O
ATOM	14705	OD2	ASP	D	298	17.539	-10.409	45.668	1.00	74.97	O
ATOM	14706	N	ALA	D	299	16.264	-11.887	40.626	1.00	70.99	N
ATOM	14707	CA	ALA	D	299	16.370	-12.712	39.433	1.00	67.08	C
ATOM	14708	C	ALA	D	299	16.050	-11.890	38.189	1.00	62.78	C
ATOM	14709	O	ALA	D	299	16.614	-12.112	37.135	1.00	63.48	O
ATOM	14710	CB	ALA	D	299	15.449	-13.907	39.536	1.00	69.23	C
ATOM	14711	N	ILE	D	300	15.146	-10.931	38.327	1.00	62.67	N
ATOM	14712	CA	ILE	D	300	14.772	-10.067	37.215	1.00	64.22	C
ATOM	14713	C	ILE	D	300	15.953	-9.209	36.766	1.00	68.61	C
ATOM	14714	O	ILE	D	300	16.260	-9.134	35.573	1.00	68.44	O
ATOM	14715	CB	ILE	D	300	13.572	-9.168	37.588	1.00	65.07	C
ATOM	14716	CG1	ILE	D	300	12.267	-9.955	37.445	1.00	66.01	C
ATOM	14717	CG2	ILE	D	300	13.533	-7.919	36.726	1.00	63.98	C
ATOM	14718	CD1	ILE	D	300	11.034	-9.162	37.777	1.00	65.40	C
ATOM	14719	N	LEU	D	301	16.625	-8.578	37.722	1.00	64.64	N
ATOM	14720	CA	LEU	D	301	17.817	-7.799	37.425	1.00	59.79	C
ATOM	14721	C	LEU	D	301	18.898	-8.660	36.733	1.00	68.13	C
ATOM	14722	O	LEU	D	301	19.469	-8.241	35.728	1.00	67.98	O
ATOM	14723	CB	LEU	D	301	18.357	-7.177	38.707	1.00	62.48	C
ATOM	14724	CG	LEU	D	301	19.323	-5.993	38.633	1.00	70.56	C
ATOM	14725	CD1	LEU	D	301	18.713	-4.809	37.871	1.00	69.09	C
ATOM	14726	CD2	LEU	D	301	19.707	-5.567	40.041	1.00	60.73	C
ATOM	14727	N	LEU	D	302	19.162	-9.857	37.265	1.00	62.80	N
ATOM	14728	CA	LEU	D	302	20.152	-10.779	36.703	1.00	64.27	C
ATOM	14729	C	LEU	D	302	19.860	-11.163	35.233	1.00	64.97	C
ATOM	14730	O	LEU	D	302	20.770	-11.267	34.413	1.00	64.03	O
ATOM	14731	CB	LEU	D	302	20.222	-12.045	37.568	1.00	66.55	C
ATOM	14732	CG	LEU	D	302	21.474	-12.531	38.324	1.00	68.26	C
ATOM	14733	CD1	LEU	D	302	22.471	-11.441	38.722	1.00	64.64	C
ATOM	14734	CD2	LEU	D	302	21.041	-13.302	39.571	1.00	70.37	C
ATOM	14735	N	SER	D	303	18.590	-11.370	34.904	1.00	62.66	N
ATOM	14736	CA	SER	D	303	18.207	-11.780	33.563	1.00	59.85	C
ATOM	14737	C	SER	D	303	18.069	-10.590	32.615	1.00	67.67	C
ATOM	14738	O	SER	D	303	17.870	-10.777	31.415	1.00	69.56	O
ATOM	14739	CB	SER	D	303	16.898	-12.559	33.593	1.00	67.63	C
ATOM	14740	OG	SER	D	303	15.794	-11.671	33.588	1.00	72.34	O

ATOM	14741	N	ASP	D	304	18.139	-9.378	33.164	1.00	63.20	N
ATOM	14742	C	ASP	D	304	19.773	-8.115	31.870	1.00	69.47	C
ATOM	14743	CA	ASP	D	304	18.336	-8.172	32.368	1.00	60.40	C
ATOM	14744	O	ASP	D	304	20.054	-7.602	30.784	1.00	69.03	O
ATOM	14745	CB	ASP	D	304	18.031	-6.921	33.183	1.00	65.01	C
ATOM	14746	CG	ASP	D	304	16.541	-6.621	33.259	1.00	73.15	C
ATOM	14747	OD1	ASP	D	304	15.743	-7.412	32.695	1.00	72.65	O
ATOM	14748	OD2	ASP	D	304	16.177	-5.594	33.882	1.00	74.76	O
ATOM	14749	N	ILE	D	305	20.688	-8.632	32.685	1.00	64.68	N
ATOM	14750	C	ILE	D	305	22.229	-9.830	31.295	1.00	62.28	C
ATOM	14751	CA	ILE	D	305	22.083	-8.698	32.301	1.00	61.61	C
ATOM	14752	O	ILE	D	305	22.685	-9.612	30.177	1.00	63.27	O
ATOM	14753	CB	ILE	D	305	23.020	-8.921	33.518	1.00	60.00	C
ATOM	14754	CG1	ILE	D	305	23.434	-7.584	34.149	1.00	65.63	C
ATOM	14755	CG2	ILE	D	305	24.273	-9.609	33.078	1.00	54.96	C
ATOM	14756	CD1	ILE	D	305	22.534	-7.081	35.255	1.00	56.78	C
ATOM	14757	O	LEU	D	306	20.190	-13.595	31.816	1.00	64.11	O
ATOM	14758	N	LEU	D	306	21.801	-11.026	31.694	1.00	61.92	N
ATOM	14759	CA	LEU	D	306	21.897	-12.219	30.851	1.00	65.62	C
ATOM	14760	C	LEU	D	306	20.576	-12.973	30.826	1.00	65.67	C
ATOM	14761	CB	LEU	D	306	23.011	-13.156	31.336	1.00	61.71	C
ATOM	14762	CG	LEU	D	306	23.148	-14.479	30.576	1.00	59.78	C
ATOM	14763	CD2	LEU	D	306	24.026	-15.462	31.332	1.00	55.37	C
ATOM	14764	CD1	LEU	D	306	23.702	-14.222	29.180	1.00	59.42	C
ATOM	14765	O	ARG	D	307	17.451	-15.424	30.205	1.00	73.15	O
ATOM	14766	N	ARG	D	307	19.915	-12.934	29.672	1.00	65.45	N
ATOM	14767	CA	ARG	D	307	18.544	-13.403	29.516	1.00	64.95	C
ATOM	14768	C	ARG	D	307	18.369	-14.921	29.551	1.00	71.37	C
ATOM	14769	CB	ARG	D	307	17.974	-12.863	28.207	1.00	68.65	C
ATOM	14770	CG	ARG	D	307	16.536	-13.220	28.001	1.00	72.04	C
ATOM	14771	CD	ARG	D	307	15.909	-12.419	26.888	1.00	79.83	C
ATOM	14772	NE	ARG	D	307	14.497	-12.760	26.757	1.00	84.20	N
ATOM	14773	CZ	ARG	D	307	14.017	-13.614	25.860	1.00	86.66	C
ATOM	14774	NH1	ARG	D	307	12.715	-13.872	25.824	1.00	88.44	N
ATOM	14775	NH2	ARG	D	307	14.836	-14.202	24.995	1.00	84.70	N
ATOM	14776	O	VAL	D	308	21.412	-17.477	29.306	1.00	58.31	O
ATOM	14777	N	VAL	D	308	19.229	-15.649	28.841	1.00	66.02	N
ATOM	14778	CA	VAL	D	308	19.116	-17.103	28.772	1.00	68.25	C
ATOM	14779	C	VAL	D	308	20.252	-17.815	29.504	1.00	63.66	C
ATOM	14780	CB	VAL	D	308	19.098	-17.596	27.317	1.00	68.71	C
ATOM	14781	CG2	VAL	D	308	18.193	-16.713	26.462	1.00	67.59	C
ATOM	14782	CG1	VAL	D	308	18.638	-19.045	27.268	1.00	66.89	C
ATOM	14783	O	ASN	D	309	22.415	-19.142	32.815	1.00	66.76	O
ATOM	14784	N	ASN	D	309	19.880	-18.802	30.329	1.00	68.40	N
ATOM	14785	CA	ASN	D	309	20.779	-19.629	31.153	1.00	66.00	C
ATOM	14786	C	ASN	D	309	21.302	-18.888	32.351	1.00	67.54	C
ATOM	14787	CB	ASN	D	309	21.960	-20.165	30.349	1.00	65.06	C
ATOM	14788	CG	ASN	D	309	21.547	-21.214	29.357	1.00	69.97	C
ATOM	14789	OD1	ASN	D	309	20.453	-21.778	29.449	1.00	72.52	O
ATOM	14790	ND2	ASN	D	309	22.419	-21.491	28.399	1.00	75.31	N
ATOM	14791	O	THR	D	310	21.445	-17.283	36.212	1.00	70.32	O
ATOM	14792	N	THR	D	310	20.468	-17.981	32.847	1.00	69.70	N
ATOM	14793	CA	THR	D	310	20.818	-17.067	33.916	1.00	60.60	C
ATOM	14794	C	THR	D	310	20.789	-17.739	35.277	1.00	69.58	C
ATOM	14795	CB	THR	D	310	19.868	-15.860	33.906	1.00	67.54	C
ATOM	14796	OG1	THR	D	310	19.464	-15.540	35.238	1.00	68.31	O
ATOM	14797	CG2	THR	D	310	18.648	-16.171	33.078	1.00	63.02	C
ATOM	14798	O	GLU	D	311	21.246	-21.100	37.911	1.00	74.34	O
ATOM	14799	N	GLU	D	311	20.049	-18.838	35.382	1.00	72.70	N
ATOM	14800	CA	GLU	D	311	19.922	-19.548	36.648	1.00	71.45	C
ATOM	14801	C	GLU	D	311	21.065	-20.539	36.828	1.00	73.84	C
ATOM	14802	CB	GLU	D	311	18.571	-20.266	36.735	1.00	71.99	C
ATOM	14803	CG	GLU	D	311	18.416	-21.452	35.786	1.00	78.76	C

ATOM	14804	CD	GLU	D	311	18.043	-21.050	34.365	1.00	83.56	C
ATOM	14805	OE1	GLU	D	311	17.483	-19.928	34.177	1.00	75.95	O
ATOM	14806	OE2	GLU	D	311	18.315	-21.872	33.446	1.00	78.09	O
ATOM	14807	O	ILE	D	312	25.339	-21.783	35.497	1.00	63.01	O
ATOM	14808	N	ILE	D	312	21.849	-20.738	35.772	1.00	70.97	N
ATOM	14809	CA	ILE	D	312	22.956	-21.695	35.824	1.00	68.09	C
ATOM	14810	C	ILE	D	312	24.325	-21.088	35.493	1.00	67.70	C
ATOM	14811	CB	ILE	D	312	22.715	-22.888	34.859	1.00	71.91	C
ATOM	14812	CG1	ILE	D	312	22.771	-22.434	33.398	1.00	68.88	C
ATOM	14813	CG2	ILE	D	312	21.400	-23.588	35.178	1.00	72.69	C
ATOM	14814	CD1	ILE	D	312	22.117	-23.408	32.447	1.00	70.20	C
ATOM	14815	O	THR	D	313	25.451	-17.298	36.299	1.00	66.49	O
ATOM	14816	N	THR	D	313	24.376	-19.792	35.221	1.00	67.65	N
ATOM	14817	CA	THR	D	313	25.656	-19.209	34.861	1.00	62.14	C
ATOM	14818	C	THR	D	313	26.165	-18.210	35.898	1.00	61.51	C
ATOM	14819	CB	THR	D	313	25.572	-18.525	33.505	1.00	64.51	C
ATOM	14820	OG1	THR	D	313	24.904	-19.390	32.575	1.00	60.99	O
ATOM	14821	CG2	THR	D	313	26.961	-18.172	33.003	1.00	53.93	C
ATOM	14822	O	LYS	D	314	29.290	-16.763	35.291	1.00	64.34	O
ATOM	14823	N	LYS	D	314	27.403	-18.415	36.333	1.00	64.74	N
ATOM	14824	CA	LYS	D	314	28.101	-17.507	37.236	1.00	60.56	C
ATOM	14825	C	LYS	D	314	28.833	-16.467	36.405	1.00	65.06	C
ATOM	14826	CB	LYS	D	314	29.086	-18.269	38.115	1.00	64.44	C
ATOM	14827	CG	LYS	D	314	28.486	-19.471	38.814	1.00	66.93	C
ATOM	14828	CD	LYS	D	314	29.556	-20.286	39.525	1.00	70.38	C
ATOM	14829	CE	LYS	D	314	28.933	-21.390	40.370	1.00	74.82	C
ATOM	14830	NZ	LYS	D	314	29.964	-22.372	40.818	1.00	79.00	N
ATOM	14831	O	ALA	D	315	28.953	-13.875	33.803	1.00	48.02	O
ATOM	14832	N	ALA	D	315	28.964	-15.264	36.953	1.00	57.50	N
ATOM	14833	CA	ALA	D	315	29.391	-14.118	36.171	1.00	48.15	C
ATOM	14834	C	ALA	D	315	28.483	-13.906	34.946	1.00	48.67	C
ATOM	14835	CB	ALA	D	315	30.852	-14.283	35.754	1.00	44.20	C
ATOM	14836	N	PRO	D	316	27.169	-13.751	35.182	1.00	49.36	N
ATOM	14837	CA	PRO	D	316	26.236	-13.467	34.080	1.00	49.86	C
ATOM	14838	C	PRO	D	316	26.656	-12.266	33.210	1.00	53.07	C
ATOM	14839	O	PRO	D	316	26.412	-12.274	31.994	1.00	50.13	O
ATOM	14840	CB	PRO	D	316	24.923	-13.148	34.808	1.00	50.43	C
ATOM	14841	CG	PRO	D	316	25.348	-12.635	36.134	1.00	53.36	C
ATOM	14842	CD	PRO	D	316	26.522	-13.542	36.488	1.00	53.17	C
ATOM	14843	N	LEU	D	317	27.285	-11.256	33.813	1.00	47.89	N
ATOM	14844	CA	LEU	D	317	27.704	-10.108	33.034	1.00	44.09	C
ATOM	14845	C	LEU	D	317	28.759	-10.481	32.026	1.00	43.81	C
ATOM	14846	O	LEU	D	317	28.591	-10.231	30.824	1.00	52.12	O
ATOM	14847	CB	LEU	D	317	28.236	-8.967	33.914	1.00	43.93	C
ATOM	14848	CG	LEU	D	317	28.724	-7.887	32.935	1.00	44.19	C
ATOM	14849	CD1	LEU	D	317	27.537	-7.109	32.342	1.00	41.05	C
ATOM	14850	CD2	LEU	D	317	29.797	-6.987	33.494	1.00	45.47	C
ATOM	14851	N	SER	D	318	29.858	-11.057	32.499	1.00	46.33	N
ATOM	14852	CA	SER	D	318	30.917	-11.467	31.577	1.00	41.65	C
ATOM	14853	C	SER	D	318	30.363	-12.446	30.557	1.00	44.39	C
ATOM	14854	O	SER	D	318	30.662	-12.321	29.366	1.00	46.07	O
ATOM	14855	CB	SER	D	318	32.096	-12.059	32.324	1.00	47.99	C
ATOM	14856	OG	SER	D	318	32.942	-11.036	32.842	1.00	49.08	O
ATOM	14857	N	ALA	D	319	29.505	-13.367	30.992	1.00	41.16	N
ATOM	14858	CA	ALA	D	319	28.907	-14.301	30.033	1.00	46.05	C
ATOM	14859	C	ALA	D	319	28.144	-13.574	28.909	1.00	50.56	C
ATOM	14860	O	ALA	D	319	28.289	-13.933	27.729	1.00	50.40	O
ATOM	14861	CB	ALA	D	319	27.999	-15.289	30.735	1.00	43.78	C
ATOM	14862	N	SER	D	320	27.353	-12.552	29.250	1.00	44.55	N
ATOM	14863	CA	SER	D	320	26.605	-11.839	28.211	1.00	47.77	C
ATOM	14864	C	SER	D	320	27.565	-11.029	27.332	1.00	44.55	C
ATOM	14865	O	SER	D	320	27.326	-10.871	26.142	1.00	49.53	O
ATOM	14866	CB	SER	D	320	25.512	-10.933	28.816	1.00	47.26	C

ATOM	14867	OG	SER	D	320	26.081	-9.883	29.571	1.00	47.56	O
ATOM	14868	N	MET	D	321	28.664	-10.533	27.886	1.00	45.53	N
ATOM	14869	CA	MET	D	321	29.679	-9.931	27.025	1.00	43.51	C
ATOM	14870	C	MET	D	321	30.254	-10.991	26.115	1.00	45.34	C
ATOM	14871	O	MET	D	321	30.409	-10.765	24.915	1.00	49.75	O
ATOM	14872	CB	MET	D	321	30.790	-9.268	27.837	1.00	39.36	C
ATOM	14873	CG	MET	D	321	30.313	-8.099	28.697	1.00	46.23	C
ATOM	14874	SD	MET	D	321	29.471	-6.818	27.704	1.00	45.75	S
ATOM	14875	CE	MET	D	321	27.736	-7.290	27.952	1.00	53.22	C
ATOM	14876	N	ILE	D	322	30.530	-12.168	26.677	1.00	50.77	N
ATOM	14877	CA	ILE	D	322	31.084	-13.278	25.894	1.00	46.88	C
ATOM	14878	C	ILE	D	322	30.105	-13.660	24.799	1.00	46.24	C
ATOM	14879	O	ILE	D	322	30.491	-13.852	23.651	1.00	49.16	O
ATOM	14880	CB	ILE	D	322	31.403	-14.491	26.770	1.00	46.28	C
ATOM	14881	CG1	ILE	D	322	32.642	-14.203	27.602	1.00	43.50	C
ATOM	14882	CG2	ILE	D	322	31.626	-15.741	25.911	1.00	44.13	C
ATOM	14883	CD1	ILE	D	322	32.904	-15.239	28.648	1.00	42.34	C
ATOM	14884	N	LYS	D	323	28.828	-13.718	25.147	1.00	45.09	N
ATOM	14885	CA	LYS	D	323	27.793	-14.001	24.156	1.00	43.96	C
ATOM	14886	C	LYS	D	323	27.719	-12.941	23.045	1.00	50.51	C
ATOM	14887	O	LYS	D	323	27.453	-13.297	21.901	1.00	53.85	O
ATOM	14888	CB	LYS	D	323	26.435	-14.135	24.847	1.00	49.19	C
ATOM	14889	CG	LYS	D	323	25.292	-14.550	23.929	1.00	54.79	C
ATOM	14890	CD	LYS	D	323	24.059	-14.945	24.733	1.00	55.46	C
ATOM	14891	CE	LYS	D	323	22.873	-15.330	23.842	1.00	61.32	C
ATOM	14892	NZ	LYS	D	323	22.193	-14.142	23.238	1.00	67.05	N
ATOM	14893	N	ARG	D	324	27.957	-11.659	23.369	1.00	42.93	N
ATOM	14894	CA	ARG	D	324	27.978	-10.610	22.344	1.00	44.13	C
ATOM	14895	C	ARG	D	324	29.122	-10.900	21.417	1.00	48.73	C
ATOM	14896	O	ARG	D	324	28.973	-10.886	20.194	1.00	51.39	O
ATOM	14897	CB	ARG	D	324	28.162	-9.181	22.918	1.00	46.42	C
ATOM	14898	CG	ARG	D	324	26.966	-8.541	23.640	1.00	42.27	C
ATOM	14899	CD	ARG	D	324	27.007	-6.964	23.578	1.00	43.55	C
ATOM	14900	NE	ARG	D	324	26.517	-6.356	24.821	1.00	50.95	N
ATOM	14901	CZ	ARG	D	324	26.805	-5.125	25.254	1.00	47.84	C
ATOM	14902	NH1	ARG	D	324	27.589	-4.315	24.555	1.00	41.00	N
ATOM	14903	NH2	ARG	D	324	26.305	-4.709	26.413	1.00	48.53	N
ATOM	14904	N	TYR	D	325	30.281	-11.138	22.023	1.00	47.44	N
ATOM	14905	CA	TYR	D	325	31.480	-11.454	21.283	1.00	44.36	C
ATOM	14906	C	TYR	D	325	31.250	-12.611	20.286	1.00	50.57	C
ATOM	14907	O	TYR	D	325	31.553	-12.475	19.091	1.00	46.51	O
ATOM	14908	CB	TYR	D	325	32.618	-11.810	22.244	1.00	48.33	C
ATOM	14909	CG	TYR	D	325	33.843	-12.200	21.475	1.00	50.53	C
ATOM	14910	CD1	TYR	D	325	34.717	-11.220	21.016	1.00	44.04	C
ATOM	14911	CD2	TYR	D	325	34.097	-13.544	21.136	1.00	45.97	C
ATOM	14912	CE1	TYR	D	325	35.829	-11.546	20.272	1.00	42.84	C
ATOM	14913	CE2	TYR	D	325	35.215	-13.883	20.382	1.00	45.21	C
ATOM	14914	CZ	TYR	D	325	36.084	-12.881	19.956	1.00	50.63	C
ATOM	14915	OH	TYR	D	325	37.210	-13.169	19.204	1.00	53.14	O
ATOM	14916	N	ASP	D	326	30.732	-13.739	20.786	1.00	49.05	N
ATOM	14917	CA	ASP	D	326	30.440	-14.911	19.947	1.00	48.30	C
ATOM	14918	C	ASP	D	326	29.434	-14.617	18.823	1.00	52.62	C
ATOM	14919	O	ASP	D	326	29.617	-15.043	17.676	1.00	52.67	O
ATOM	14920	CB	ASP	D	326	29.917	-16.071	20.799	1.00	42.57	C
ATOM	14921	CG	ASP	D	326	30.997	-16.694	21.670	1.00	49.23	C
ATOM	14922	OD1	ASP	D	326	32.180	-16.546	21.328	1.00	51.47	O
ATOM	14923	OD2	ASP	D	326	30.662	-17.324	22.698	1.00	49.09	O
ATOM	14924	N	GLU	D	327	28.370	-13.887	19.142	1.00	53.03	N
ATOM	14925	CA	GLU	D	327	27.353	-13.607	18.133	1.00	51.44	C
ATOM	14926	C	GLU	D	327	27.865	-12.609	17.110	1.00	49.50	C
ATOM	14927	O	GLU	D	327	27.502	-12.683	15.953	1.00	51.01	O
ATOM	14928	CB	GLU	D	327	26.075	-13.110	18.790	1.00	54.63	C
ATOM	14929	CG	GLU	D	327	25.287	-14.217	19.445	1.00	55.14	C

ATOM	14930	CD	GLU	D	327	23.918	-13.760	19.859	1.00	64.72	C
ATOM	14931	OE1	GLU	D	327	23.665	-12.542	19.768	1.00	71.21	O
ATOM	14932	OE2	GLU	D	327	23.100	-14.607	20.273	1.00	68.87	O
ATOM	14933	N	HIS	D	328	28.737	-11.703	17.542	1.00	49.08	N
ATOM	14934	CA	HIS	D	328	29.352	-10.730	16.648	1.00	46.69	C
ATOM	14935	C	HIS	D	328	30.148	-11.514	15.601	1.00	47.61	C
ATOM	14936	O	HIS	D	328	30.069	-11.233	14.408	1.00	49.27	O
ATOM	14937	CB	HIS	D	328	30.211	-9.731	17.473	1.00	45.05	C
ATOM	14938	CG	HIS	D	328	30.894	-8.644	16.677	1.00	45.62	C
ATOM	14939	ND1	HIS	D	328	31.091	-7.375	17.183	1.00	43.52	N
ATOM	14940	CD2	HIS	D	328	31.488	-8.651	15.456	1.00	44.68	C
ATOM	14941	CE1	HIS	D	328	31.742	-6.640	16.297	1.00	43.95	C
ATOM	14942	NE2	HIS	D	328	31.991	-7.388	15.237	1.00	44.34	N
ATOM	14943	N	HIS	D	329	30.869	-12.538	16.048	1.00	51.63	N
ATOM	14944	CA	HIS	D	329	31.681	-13.353	15.142	1.00	49.92	C
ATOM	14945	C	HIS	D	329	30.845	-14.116	14.127	1.00	53.30	C
ATOM	14946	O	HIS	D	329	31.131	-14.069	12.925	1.00	52.30	O
ATOM	14947	CB	HIS	D	329	32.543	-14.354	15.907	1.00	45.82	C
ATOM	14948	CG	HIS	D	329	33.293	-15.289	15.007	1.00	53.75	C
ATOM	14949	ND1	HIS	D	329	32.919	-16.603	14.815	1.00	47.46	N
ATOM	14950	CD2	HIS	D	329	34.376	-15.088	14.221	1.00	54.66	C
ATOM	14951	CE1	HIS	D	329	33.754	-17.175	13.966	1.00	51.92	C
ATOM	14952	NE2	HIS	D	329	34.646	-16.277	13.589	1.00	54.30	N
ATOM	14953	N	GLN	D	330	29.819	-14.815	14.610	1.00	51.71	N
ATOM	14954	CA	GLN	D	330	28.895	-15.508	13.718	1.00	48.44	C
ATOM	14955	C	GLN	D	330	28.241	-14.543	12.730	1.00	55.31	C
ATOM	14956	O	GLN	D	330	28.246	-14.823	11.529	1.00	55.90	O
ATOM	14957	CB	GLN	D	330	27.845	-16.266	14.525	1.00	50.63	C
ATOM	14958	CG	GLN	D	330	28.384	-17.558	15.143	1.00	55.11	C
ATOM	14959	CD	GLN	D	330	27.947	-17.767	16.591	1.00	63.43	C
ATOM	14960	OE1	GLN	D	330	26.888	-17.288	17.010	1.00	63.63	O
ATOM	14961	NE2	GLN	D	330	28.772	-18.483	17.369	1.00	62.16	N
ATOM	14962	N	ASP	D	331	27.716	-13.400	13.206	1.00	54.32	N
ATOM	14963	CA	ASP	D	331	27.075	-12.450	12.296	1.00	47.73	C
ATOM	14964	C	ASP	D	331	28.108	-11.939	11.311	1.00	52.66	C
ATOM	14965	O	ASP	D	331	27.796	-11.671	10.158	1.00	55.56	O
ATOM	14966	CB	ASP	D	331	26.454	-11.233	13.014	1.00	54.67	C
ATOM	14967	CG	ASP	D	331	25.588	-11.601	14.228	1.00	61.53	C
ATOM	14968	OD1	ASP	D	331	25.062	-12.745	14.287	1.00	55.47	O
ATOM	14969	OD2	ASP	D	331	25.450	-10.717	15.133	1.00	61.90	O
ATOM	14970	N	LEU	D	332	29.343	-11.781	11.768	1.00	48.29	N
ATOM	14971	CA	LEU	D	332	30.369	-11.241	10.887	1.00	47.51	C
ATOM	14972	C	LEU	D	332	30.766	-12.257	9.836	1.00	56.13	C
ATOM	14973	O	LEU	D	332	30.948	-11.895	8.676	1.00	57.51	O
ATOM	14974	CB	LEU	D	332	31.594	-10.801	11.669	1.00	47.75	C
ATOM	14975	CG	LEU	D	332	32.686	-10.141	10.830	1.00	47.52	C
ATOM	14976	CD1	LEU	D	332	32.193	-8.840	10.196	1.00	50.76	C
ATOM	14977	CD2	LEU	D	332	33.886	-9.886	11.701	1.00	45.13	C
ATOM	14978	N	THR	D	333	30.889	-13.523	10.243	1.00	51.19	N
ATOM	14979	CA	THR	D	333	31.202	-14.602	9.313	1.00	50.72	C
ATOM	14980	C	THR	D	333	30.131	-14.648	8.213	1.00	57.94	C
ATOM	14981	O	THR	D	333	30.438	-14.578	7.017	1.00	59.98	O
ATOM	14982	CB	THR	D	333	31.307	-15.975	10.047	1.00	50.23	C
ATOM	14983	OG1	THR	D	333	32.437	-15.964	10.934	1.00	49.14	O
ATOM	14984	CG2	THR	D	333	31.480	-17.122	9.048	1.00	49.44	C
ATOM	14985	N	LEU	D	334	28.871	-14.732	8.625	1.00	55.01	N
ATOM	14986	CA	LEU	D	334	27.766	-14.765	7.676	1.00	57.12	C
ATOM	14987	C	LEU	D	334	27.747	-13.538	6.782	1.00	57.56	C
ATOM	14988	O	LEU	D	334	27.688	-13.658	5.567	1.00	62.29	O
ATOM	14989	CB	LEU	D	334	26.423	-14.887	8.403	1.00	58.32	C
ATOM	14990	CG	LEU	D	334	25.192	-14.746	7.500	1.00	60.79	C
ATOM	14991	CD1	LEU	D	334	25.217	-15.805	6.398	1.00	62.07	C
ATOM	14992	CD2	LEU	D	334	23.895	-14.827	8.297	1.00	60.76	C

ATOM	14993	N	LEU	D	335	27.790	-12.359	7.383	1.00	58.90	N
ATOM	14994	CA	LEU	D	335	27.706	-11.118	6.615	1.00	59.42	C
ATOM	14995	C	LEU	D	335	28.792	-11.057	5.535	1.00	60.26	C
ATOM	14996	O	LEU	D	335	28.512	-10.699	4.396	1.00	63.64	O
ATOM	14997	CB	LEU	D	335	27.806	-9.897	7.538	1.00	52.41	C
ATOM	14998	CG	LEU	D	335	27.980	-8.581	6.788	1.00	58.44	C
ATOM	14999	CD1	LEU	D	335	26.714	-8.254	6.003	1.00	60.64	C
ATOM	15000	CD2	LEU	D	335	28.333	-7.452	7.731	1.00	61.39	C
ATOM	15001	O	LYS	D	336	30.959	-12.134	2.602	1.00	67.85	O
ATOM	15002	N	LYS	D	336	30.022	-11.421	5.892	1.00	59.05	N
ATOM	15003	CA	LYS	D	336	31.116	-11.489	4.911	1.00	64.23	C
ATOM	15004	C	LYS	D	336	30.796	-12.465	3.774	1.00	66.21	C
ATOM	15005	CB	LYS	D	336	32.429	-11.893	5.585	1.00	57.92	C
ATOM	15006	CG	LYS	D	336	33.289	-10.716	6.025	1.00	60.09	C
ATOM	15007	CD	LYS	D	336	34.326	-11.123	7.073	1.00	52.91	C
ATOM	15008	CE	LYS	D	336	35.358	-10.019	7.280	1.00	54.00	C
ATOM	15009	NZ	LYS	D	336	36.379	-10.386	8.299	1.00	54.40	N
ATOM	15010	O	ALA	D	337	29.147	-14.003	0.938	1.00	67.01	O
ATOM	15011	N	ALA	D	337	30.339	-13.663	4.119	1.00	62.98	N
ATOM	15012	CA	ALA	D	337	29.965	-14.642	3.102	1.00	61.94	C
ATOM	15013	C	ALA	D	337	28.921	-14.060	2.147	1.00	65.00	C
ATOM	15014	CB	ALA	D	337	29.445	-15.923	3.759	1.00	56.24	C
ATOM	15015	O	LEU	D	338	26.942	-11.991	-0.253	1.00	72.11	O
ATOM	15016	N	LEU	D	338	27.797	-13.605	2.699	1.00	66.10	N
ATOM	15017	CA	LEU	D	338	26.727	-13.007	1.900	1.00	63.60	C
ATOM	15018	C	LEU	D	338	27.230	-11.935	0.940	1.00	66.86	C
ATOM	15019	CB	LEU	D	338	25.655	-12.382	2.791	1.00	66.65	C
ATOM	15020	CG	LEU	D	338	24.879	-13.168	3.842	1.00	62.83	C
ATOM	15021	CD1	LEU	D	338	23.879	-12.213	4.452	1.00	62.29	C
ATOM	15022	CD2	LEU	D	338	24.193	-14.400	3.280	1.00	55.77	C
ATOM	15023	O	VAL	D	339	29.379	-9.655	-1.554	1.00	71.27	O
ATOM	15024	N	VAL	D	339	27.970	-10.957	1.458	1.00	65.11	N
ATOM	15025	CA	VAL	D	339	28.413	-9.821	0.642	1.00	66.90	C
ATOM	15026	C	VAL	D	339	29.361	-10.259	-0.475	1.00	69.01	C
ATOM	15027	CB	VAL	D	339	29.103	-8.736	1.511	1.00	62.70	C
ATOM	15028	CG1	VAL	D	339	29.636	-7.601	0.663	1.00	55.14	C
ATOM	15029	CG2	VAL	D	339	28.146	-8.216	2.562	1.00	61.66	C
ATOM	15030	O	ARG	D	340	30.643	-12.412	-3.519	1.00	73.64	O
ATOM	15031	N	ARG	D	340	30.136	-11.312	-0.217	1.00	64.62	N
ATOM	15032	CA	ARG	D	340	31.044	-11.869	-1.229	1.00	70.76	C
ATOM	15033	C	ARG	D	340	30.259	-12.511	-2.357	1.00	71.63	C
ATOM	15034	CB	ARG	D	340	31.999	-12.919	-0.630	1.00	66.01	C
ATOM	15035	CG	ARG	D	340	33.090	-12.380	0.277	1.00	68.08	C
ATOM	15036	CD	ARG	D	340	34.263	-11.763	-0.493	1.00	71.85	C
ATOM	15037	NE	ARG	D	340	35.440	-11.640	0.371	1.00	78.47	N
ATOM	15038	CZ	ARG	D	340	36.575	-11.028	0.042	1.00	76.77	C
ATOM	15039	NH1	ARG	D	340	36.723	-10.451	-1.144	1.00	74.29	N
ATOM	15040	NH2	ARG	D	340	37.567	-10.984	0.918	1.00	74.66	N
ATOM	15041	O	GLN	D	341	26.818	-13.516	-4.734	1.00	68.27	O
ATOM	15042	N	GLN	D	341	29.163	-13.178	-2.001	1.00	72.05	N
ATOM	15043	CA	GLN	D	341	28.361	-13.935	-2.962	1.00	71.11	C
ATOM	15044	C	GLN	D	341	27.288	-13.110	-3.681	1.00	68.99	C
ATOM	15045	CB	GLN	D	341	27.693	-15.125	-2.263	1.00	73.57	C
ATOM	15046	O	GLN	D	342	25.608	-9.297	-5.137	1.00	82.15	O
ATOM	15047	N	GLN	D	342	26.895	-11.961	-3.136	1.00	69.07	N
ATOM	15048	CA	GLN	D	342	25.779	-11.214	-3.730	1.00	68.87	C
ATOM	15049	C	GLN	D	342	26.124	-9.799	-4.143	1.00	73.90	C
ATOM	15050	CB	GLN	D	342	24.595	-11.144	-2.770	1.00	70.24	C
ATOM	15051	CG	GLN	D	342	24.036	-12.477	-2.337	1.00	70.99	C
ATOM	15052	CD	GLN	D	342	22.770	-12.315	-1.517	1.00	77.92	C
ATOM	15053	OE1	GLN	D	342	22.512	-13.091	-0.591	1.00	75.30	O
ATOM	15054	NE2	GLN	D	342	21.964	-11.305	-1.861	1.00	75.54	N
ATOM	15055	O	LEU	D	343	29.291	-6.654	-2.856	1.00	73.27	O

ATOM	15056	N	LEU	D	343	26.955	-9.129	-3.357	1.00	73.48	N
ATOM	15057	CA	LEU	D	343	27.355	-7.768	-3.688	1.00	72.85	C
ATOM	15058	C	LEU	D	343	28.857	-7.549	-3.583	1.00	73.62	C
ATOM	15059	CB	LEU	D	343	26.633	-6.769	-2.782	1.00	75.41	C
ATOM	15060	CG	LEU	D	343	25.224	-6.354	-3.215	1.00	76.45	C
ATOM	15061	CD2	LEU	D	343	24.850	-4.999	-2.626	1.00	77.12	C
ATOM	15062	CD1	LEU	D	343	24.173	-7.416	-2.884	1.00	78.07	C
ATOM	15063	O	PRO	D	344	32.920	-6.855	-4.207	1.00	77.89	O
ATOM	15064	N	PRO	D	344	29.649	-8.336	-4.339	1.00	75.35	N
ATOM	15065	CA	PRO	D	344	31.112	-8.390	-4.205	1.00	74.31	C
ATOM	15066	C	PRO	D	344	31.773	-7.082	-4.572	1.00	72.85	C
ATOM	15067	CB	PRO	D	344	31.527	-9.487	-5.200	1.00	73.54	C
ATOM	15068	CG	PRO	D	344	30.259	-10.159	-5.610	1.00	73.81	C
ATOM	15069	CD	PRO	D	344	29.192	-9.131	-5.490	1.00	72.92	C
ATOM	15070	N	GLU	D	345	31.051	-6.234	-5.292	1.00	73.02	N
ATOM	15071	CA	GLU	D	345	31.583	-4.950	-5.715	1.00	74.67	C
ATOM	15072	C	GLU	D	345	31.456	-3.924	-4.581	1.00	77.81	C
ATOM	15073	O	GLU	D	345	31.897	-2.776	-4.696	1.00	72.97	O
ATOM	15074	CB	GLU	D	345	30.862	-4.469	-6.982	1.00	71.64	C
ATOM	15075	N	LYS	D	346	30.852	-4.353	-3.479	1.00	78.02	N
ATOM	15076	CA	LYS	D	346	30.656	-3.478	-2.333	1.00	74.58	C
ATOM	15077	C	LYS	D	346	31.537	-3.902	-1.157	1.00	72.93	C
ATOM	15078	O	LYS	D	346	31.543	-3.250	-0.115	1.00	75.11	O
ATOM	15079	CB	LYS	D	346	29.181	-3.466	-1.919	1.00	70.71	C
ATOM	15080	N	TYR	D	347	32.291	-4.983	-1.333	1.00	70.00	N
ATOM	15081	CA	TYR	D	347	33.063	-5.556	-0.240	1.00	66.08	C
ATOM	15082	C	TYR	D	347	34.181	-4.632	0.257	1.00	65.82	C
ATOM	15083	O	TYR	D	347	34.428	-4.551	1.458	1.00	66.52	O
ATOM	15084	CB	TYR	D	347	33.661	-6.906	-0.657	1.00	60.52	C
ATOM	15085	CG	TYR	D	347	34.211	-7.698	0.508	1.00	62.22	C
ATOM	15086	CD1	TYR	D	347	35.470	-7.426	1.031	1.00	64.85	C
ATOM	15087	CD2	TYR	D	347	33.464	-8.702	1.099	1.00	62.99	C
ATOM	15088	CE1	TYR	D	347	35.966	-8.133	2.104	1.00	63.95	C
ATOM	15089	CE2	TYR	D	347	33.952	-9.412	2.169	1.00	64.54	C
ATOM	15090	CZ	TYR	D	347	35.201	-9.127	2.666	1.00	65.70	C
ATOM	15091	OH	TYR	D	347	35.688	-9.840	3.736	1.00	68.79	O
ATOM	15092	N	LYS	D	348	34.866	-3.955	-0.656	1.00	66.14	N
ATOM	15093	CA	LYS	D	348	35.990	-3.104	-0.272	1.00	70.02	C
ATOM	15094	C	LYS	D	348	35.514	-1.906	0.553	1.00	70.60	C
ATOM	15095	O	LYS	D	348	36.133	-1.534	1.553	1.00	67.37	O
ATOM	15096	CB	LYS	D	348	36.756	-2.622	-1.510	1.00	70.01	C
ATOM	15097	N	GLU	D	349	34.410	-1.306	0.124	1.00	71.53	N
ATOM	15098	CA	GLU	D	349	33.814	-0.212	0.868	1.00	69.81	C
ATOM	15099	C	GLU	D	349	33.427	-0.650	2.272	1.00	66.53	C
ATOM	15100	O	GLU	D	349	33.702	0.052	3.248	1.00	67.96	O
ATOM	15101	CB	GLU	D	349	32.589	0.326	0.133	1.00	76.23	C
ATOM	15102	CG	GLU	D	349	31.934	1.511	0.811	1.00	78.30	C
ATOM	15103	CD	GLU	D	349	30.873	2.137	-0.050	1.00	87.46	C
ATOM	15104	OE1	GLU	D	349	29.971	1.403	-0.515	1.00	90.94	O
ATOM	15105	OE2	GLU	D	349	30.947	3.363	-0.276	1.00	92.56	O
ATOM	15106	N	ILE	D	350	32.807	-1.823	2.372	1.00	64.10	N
ATOM	15107	CA	ILE	D	350	32.256	-2.290	3.639	1.00	63.67	C
ATOM	15108	C	ILE	D	350	33.317	-2.672	4.665	1.00	61.61	C
ATOM	15109	O	ILE	D	350	33.192	-2.327	5.844	1.00	63.76	O
ATOM	15110	CB	ILE	D	350	31.321	-3.491	3.436	1.00	57.65	C
ATOM	15111	CG1	ILE	D	350	30.058	-3.055	2.694	1.00	57.13	C
ATOM	15112	CG2	ILE	D	350	30.923	-4.085	4.773	1.00	55.00	C
ATOM	15113	CD1	ILE	D	350	29.152	-4.208	2.289	1.00	56.65	C
ATOM	15114	N	PHE	D	351	34.374	-3.345	4.225	1.00	64.31	N
ATOM	15115	CA	PHE	D	351	35.324	-3.934	5.172	1.00	59.16	C
ATOM	15116	C	PHE	D	351	36.722	-3.328	5.192	1.00	60.07	C
ATOM	15117	O	PHE	D	351	37.442	-3.502	6.175	1.00	63.15	O
ATOM	15118	CB	PHE	D	351	35.432	-5.433	4.910	1.00	57.87	C

ATOM	15119	CG	PHE	D	351	34.148	-6.153	5.106	1.00	55.10	C
ATOM	15120	CD1	PHE	D	351	33.646	-6.349	6.373	1.00	57.17	C
ATOM	15121	CD2	PHE	D	351	33.427	-6.603	4.031	1.00	53.35	C
ATOM	15122	CE1	PHE	D	351	32.444	-6.993	6.559	1.00	59.74	C
ATOM	15123	CE2	PHE	D	351	32.236	-7.245	4.214	1.00	54.89	C
ATOM	15124	CZ	PHE	D	351	31.739	-7.438	5.480	1.00	52.40	C
ATOM	15125	N	PHE	D	352	37.123	-2.624	4.139	1.00	62.09	N
ATOM	15126	CA	PHE	D	352	38.471	-2.052	4.123	1.00	64.67	C
ATOM	15127	C	PHE	D	352	38.487	-0.539	4.301	1.00	69.74	C
ATOM	15128	O	PHE	D	352	39.485	0.022	4.771	1.00	71.38	O
ATOM	15129	CB	PHE	D	352	39.196	-2.397	2.826	1.00	64.31	C
ATOM	15130	CG	PHE	D	352	39.706	-3.801	2.768	1.00	63.73	C
ATOM	15131	CD1	PHE	D	352	40.953	-4.120	3.277	1.00	71.40	C
ATOM	15132	CD2	PHE	D	352	38.952	-4.800	2.194	1.00	66.62	C
ATOM	15133	CE1	PHE	D	352	41.435	-5.418	3.221	1.00	70.77	C
ATOM	15134	CE2	PHE	D	352	39.425	-6.098	2.136	1.00	70.42	C
ATOM	15135	CZ	PHE	D	352	40.669	-6.407	2.649	1.00	71.02	C
ATOM	15136	N	ASP	D	353	37.386	0.112	3.928	1.00	65.20	N
ATOM	15137	CA	ASP	D	353	37.325	1.575	3.840	1.00	68.40	C
ATOM	15138	C	ASP	D	353	36.841	2.253	5.140	1.00	70.39	C
ATOM	15139	O	ASP	D	353	35.638	2.331	5.422	1.00	70.85	O
ATOM	15140	CB	ASP	D	353	36.425	1.974	2.665	1.00	67.75	C
ATOM	15141	CG	ASP	D	353	36.480	3.458	2.358	1.00	73.25	C
ATOM	15142	OD1	ASP	D	353	37.410	4.138	2.848	1.00	74.31	O
ATOM	15143	OD2	ASP	D	353	35.590	3.941	1.618	1.00	76.55	O
ATOM	15144	O	GLN	D	354	36.023	5.074	7.963	1.00	68.93	O
ATOM	15145	N	GLN	D	354	37.798	2.751	5.915	1.00	68.99	N
ATOM	15146	CA	GLN	D	354	37.516	3.387	7.196	1.00	68.77	C
ATOM	15147	C	GLN	D	354	36.765	4.703	7.067	1.00	67.47	C
ATOM	15148	CB	GLN	D	354	38.810	3.642	7.959	1.00	64.21	C
ATOM	15149	CG	GLN	D	354	39.660	2.423	8.193	1.00	71.45	C
ATOM	15150	CD	GLN	D	354	40.734	2.706	9.218	1.00	77.32	C
ATOM	15151	OE1	GLN	D	354	40.677	3.723	9.919	1.00	73.83	O
ATOM	15152	NE2	GLN	D	354	41.727	1.823	9.309	1.00	71.81	N
ATOM	15153	O	SER	D	355	34.037	7.128	6.363	1.00	72.82	O
ATOM	15154	N	SER	D	355	36.985	5.419	5.969	1.00	71.00	N
ATOM	15155	CA	SER	D	355	36.286	6.680	5.722	1.00	66.31	C
ATOM	15156	C	SER	D	355	34.781	6.458	5.663	1.00	65.91	C
ATOM	15157	CB	SER	D	355	36.768	7.320	4.427	1.00	67.63	C
ATOM	15158	OG	SER	D	355	36.566	6.434	3.339	1.00	71.78	O
ATOM	15159	O	LYS	D	356	33.307	4.244	6.950	1.00	65.44	O
ATOM	15160	N	LYS	D	356	34.342	5.512	4.838	1.00	64.23	N
ATOM	15161	CA	LYS	D	356	32.929	5.154	4.762	1.00	61.25	C
ATOM	15162	C	LYS	D	356	32.478	4.541	6.083	1.00	62.42	C
ATOM	15163	CB	LYS	D	356	32.669	4.189	3.603	1.00	67.41	C
ATOM	15164	O	ASN	D	357	29.234	2.135	8.174	1.00	60.91	O
ATOM	15165	N	ASN	D	357	31.171	4.362	6.241	1.00	57.84	N
ATOM	15166	CA	ASN	D	357	30.601	3.988	7.532	1.00	57.12	C
ATOM	15167	C	ASN	D	357	30.229	2.516	7.562	1.00	59.11	C
ATOM	15168	CB	ASN	D	357	29.349	4.838	7.877	1.00	60.28	C
ATOM	15169	CG	ASN	D	357	29.685	6.266	8.377	1.00	63.24	C
ATOM	15170	OD1	ASN	D	357	30.828	6.594	8.714	1.00	64.61	O
ATOM	15171	ND2	ASN	D	357	28.662	7.112	8.434	1.00	63.39	N
ATOM	15172	O	GLY	D	358	31.248	0.103	9.147	1.00	53.18	O
ATOM	15173	N	GLY	D	358	31.038	1.687	6.909	1.00	62.97	N
ATOM	15174	CA	GLY	D	358	30.792	0.259	6.838	1.00	56.89	C
ATOM	15175	C	GLY	D	358	31.275	-0.461	8.071	1.00	54.30	C
ATOM	15176	O	TYR	D	359	33.870	-1.763	10.716	1.00	56.59	O
ATOM	15177	N	TYR	D	359	31.726	-1.705	7.927	1.00	56.47	N
ATOM	15178	CA	TYR	D	359	32.255	-2.409	9.084	1.00	53.34	C
ATOM	15179	C	TYR	D	359	33.587	-1.825	9.515	1.00	54.14	C
ATOM	15180	CB	TYR	D	359	32.418	-3.894	8.812	1.00	56.64	C
ATOM	15181	CG	TYR	D	359	32.868	-4.652	10.029	1.00	52.35	C

ATOM	15182	CD1	TYR	D	359	31.978	-4.928	11.057	1.00	51.88	C
ATOM	15183	CD2	TYR	D	359	34.182	-5.082	10.159	1.00	49.68	C
ATOM	15184	CE1	TYR	D	359	32.385	-5.620	12.174	1.00	54.84	C
ATOM	15185	CE2	TYR	D	359	34.599	-5.780	11.266	1.00	46.91	C
ATOM	15186	CZ	TYR	D	359	33.705	-6.049	12.273	1.00	52.18	C
ATOM	15187	OH	TYR	D	359	34.109	-6.749	13.391	1.00	48.07	O
ATOM	15188	O	ALA	D	360	36.393	0.976	10.331	1.00	61.93	O
ATOM	15189	N	ALA	D	360	34.392	-1.385	8.549	1.00	54.82	N
ATOM	15190	CA	ALA	D	360	35.707	-0.801	8.848	1.00	60.06	C
ATOM	15191	C	ALA	D	360	35.571	0.583	9.497	1.00	61.13	C
ATOM	15192	CB	ALA	D	360	36.567	-0.716	7.582	1.00	56.88	C
ATOM	15193	O	GLY	D	361	34.257	3.230	12.039	1.00	58.28	O
ATOM	15194	N	GLY	D	361	34.533	1.319	9.125	1.00	58.62	N
ATOM	15195	CA	GLY	D	361	34.301	2.621	9.727	1.00	60.97	C
ATOM	15196	C	GLY	D	361	33.885	2.454	11.172	1.00	56.97	C
ATOM	15197	O	TYR	D	362	33.765	0.941	14.850	1.00	50.06	O
ATOM	15198	N	TYR	D	362	33.107	1.411	11.408	1.00	54.56	N
ATOM	15199	CA	TYR	D	362	32.612	1.030	12.720	1.00	51.86	C
ATOM	15200	C	TYR	D	362	33.738	0.595	13.666	1.00	54.17	C
ATOM	15201	CB	TYR	D	362	31.613	-0.098	12.521	1.00	45.90	C
ATOM	15202	CG	TYR	D	362	30.933	-0.647	13.737	1.00	50.05	C
ATOM	15203	CD1	TYR	D	362	30.349	0.196	14.693	1.00	48.53	C
ATOM	15204	CD2	TYR	D	362	30.800	-2.022	13.900	1.00	48.90	C
ATOM	15205	CE1	TYR	D	362	29.675	-0.343	15.794	1.00	49.81	C
ATOM	15206	CE2	TYR	D	362	30.148	-2.558	14.988	1.00	48.66	C
ATOM	15207	CZ	TYR	D	362	29.584	-1.730	15.927	1.00	43.50	C
ATOM	15208	OH	TYR	D	362	28.933	-2.296	16.997	1.00	44.48	O
ATOM	15209	O	ILE	D	363	37.477	0.585	14.994	1.00	54.11	O
ATOM	15210	N	ILE	D	363	34.673	-0.178	13.136	1.00	53.63	N
ATOM	15211	CA	ILE	D	363	35.733	-0.692	13.970	1.00	54.77	C
ATOM	15212	C	ILE	D	363	36.937	0.228	13.949	1.00	51.83	C
ATOM	15213	CB	ILE	D	363	36.154	-2.101	13.544	1.00	53.22	C
ATOM	15214	CG1	ILE	D	363	34.965	-3.065	13.635	1.00	51.77	C
ATOM	15215	CG2	ILE	D	363	37.273	-2.575	14.423	1.00	51.18	C
ATOM	15216	CD1	ILE	D	363	34.429	-3.254	15.036	1.00	43.05	C
ATOM	15217	O	ASP	D	364	39.426	3.559	12.503	1.00	69.04	O
ATOM	15218	N	ASP	D	364	37.350	0.636	12.766	1.00	53.41	N
ATOM	15219	CA	ASP	D	364	38.628	1.320	12.676	1.00	60.41	C
ATOM	15220	C	ASP	D	364	38.489	2.791	12.326	1.00	61.52	C
ATOM	15221	CB	ASP	D	364	39.526	0.587	11.676	1.00	56.54	C
ATOM	15222	CG	ASP	D	364	39.998	-0.763	12.219	1.00	59.30	C
ATOM	15223	OD1	ASP	D	364	40.415	-0.797	13.403	1.00	54.09	O
ATOM	15224	OD2	ASP	D	364	39.932	-1.778	11.486	1.00	60.53	O
ATOM	15225	O	GLY	D	365	36.858	4.791	13.973	1.00	69.21	O
ATOM	15226	N	GLY	D	365	37.316	3.191	11.856	1.00	60.49	N
ATOM	15227	CA	GLY	D	365	37.058	4.595	11.606	1.00	65.01	C
ATOM	15228	C	GLY	D	365	36.480	5.186	12.870	1.00	66.79	C
ATOM	15229	O	GLY	D	366	32.778	6.996	14.890	1.00	70.78	O
ATOM	15230	N	GLY	D	366	35.550	6.120	12.723	1.00	64.13	N
ATOM	15231	CA	GLY	D	366	34.929	6.720	13.887	1.00	64.73	C
ATOM	15232	C	GLY	D	366	33.434	6.468	13.989	1.00	68.80	C
ATOM	15233	O	ALA	D	367	31.486	3.745	14.767	1.00	59.40	O
ATOM	15234	N	ALA	D	367	32.897	5.663	13.075	1.00	59.61	N
ATOM	15235	CA	ALA	D	367	31.466	5.408	13.028	1.00	55.04	C
ATOM	15236	C	ALA	D	367	30.932	4.725	14.282	1.00	55.24	C
ATOM	15237	CB	ALA	D	367	31.123	4.579	11.810	1.00	52.95	C
ATOM	15238	N	SER	D	368	29.835	5.259	14.792	1.00	56.25	N
ATOM	15239	CA	SER	D	368	29.127	4.685	15.921	1.00	52.61	C
ATOM	15240	C	SER	D	368	28.246	3.532	15.495	1.00	49.16	C
ATOM	15241	O	SER	D	368	28.030	3.311	14.307	1.00	51.44	O
ATOM	15242	CB	SER	D	368	28.244	5.738	16.577	1.00	49.82	C
ATOM	15243	OG	SER	D	368	27.192	6.046	15.687	1.00	51.76	O
ATOM	15244	N	GLN	D	369	27.695	2.838	16.479	1.00	47.30	N

ATOM	15245	CA	GLN	D	369	26.760	1.765	16.217	1.00	49.94	C
ATOM	15246	C	GLN	D	369	25.663	2.265	15.308	1.00	53.35	C
ATOM	15247	O	GLN	D	369	25.421	1.681	14.253	1.00	55.41	O
ATOM	15248	CB	GLN	D	369	26.168	1.244	17.514	1.00	48.60	C
ATOM	15249	CG	GLN	D	369	25.157	0.143	17.343	1.00	48.02	C
ATOM	15250	CD	GLN	D	369	24.863	-0.520	18.661	1.00	53.29	C
ATOM	15251	OE1	GLN	D	369	25.765	-1.074	19.299	1.00	58.14	O
ATOM	15252	NE2	GLN	D	369	23.619	-0.446	19.103	1.00	51.76	N
ATOM	15253	N	GLU	D	370	25.041	3.374	15.715	1.00	54.95	N
ATOM	15254	CA	GLU	D	370	23.916	3.989	15.007	1.00	52.31	C
ATOM	15255	C	GLU	D	370	24.245	4.335	13.554	1.00	55.12	C
ATOM	15256	O	GLU	D	370	23.516	3.942	12.636	1.00	60.43	O
ATOM	15257	CB	GLU	D	370	23.473	5.246	15.764	1.00	59.04	C
ATOM	15258	CG	GLU	D	370	22.158	5.837	15.323	1.00	69.18	C
ATOM	15259	CD	GLU	D	370	21.631	6.896	16.294	1.00	75.48	C
ATOM	15260	OE1	GLU	D	370	21.020	7.875	15.822	1.00	79.80	O
ATOM	15261	OE2	GLU	D	370	21.818	6.743	17.523	1.00	80.03	O
ATOM	15262	N	GLU	D	371	25.341	5.063	13.347	1.00	52.36	N
ATOM	15263	CA	GLU	D	371	25.808	5.368	11.999	1.00	50.34	C
ATOM	15264	C	GLU	D	371	26.072	4.090	11.204	1.00	54.72	C
ATOM	15265	O	GLU	D	371	25.795	4.045	10.011	1.00	60.62	O
ATOM	15266	CB	GLU	D	371	27.067	6.253	12.046	1.00	55.30	C
ATOM	15267	CG	GLU	D	371	26.792	7.730	12.419	1.00	59.52	C
ATOM	15268	CD	GLU	D	371	28.025	8.519	12.934	1.00	70.18	C
ATOM	15269	OE1	GLU	D	371	27.861	9.713	13.277	1.00	75.16	O
ATOM	15270	OE2	GLU	D	371	29.144	7.966	13.019	1.00	67.86	O
ATOM	15271	N	PHE	D	372	26.577	3.044	11.867	1.00	56.97	N
ATOM	15272	CA	PHE	D	372	26.896	1.773	11.189	1.00	57.65	C
ATOM	15273	C	PHE	D	372	25.638	1.089	10.688	1.00	56.85	C
ATOM	15274	O	PHE	D	372	25.607	0.532	9.593	1.00	60.97	O
ATOM	15275	CB	PHE	D	372	27.668	0.815	12.114	1.00	53.07	C
ATOM	15276	CG	PHE	D	372	27.761	-0.602	11.588	1.00	53.59	C
ATOM	15277	CD1	PHE	D	372	28.313	-0.865	10.346	1.00	51.54	C
ATOM	15278	CD2	PHE	D	372	27.308	-1.665	12.343	1.00	54.99	C
ATOM	15279	CE1	PHE	D	372	28.407	-2.154	9.868	1.00	55.50	C
ATOM	15280	CE2	PHE	D	372	27.409	-2.966	11.876	1.00	51.52	C
ATOM	15281	CZ	PHE	D	372	27.955	-3.210	10.632	1.00	54.81	C
ATOM	15282	N	TYR	D	373	24.610	1.123	11.519	1.00	55.75	N
ATOM	15283	CA	TYR	D	373	23.324	0.568	11.166	1.00	57.26	C
ATOM	15284	C	TYR	D	373	22.666	1.337	10.005	1.00	65.03	C
ATOM	15285	O	TYR	D	373	22.122	0.714	9.090	1.00	68.09	O
ATOM	15286	CB	TYR	D	373	22.422	0.562	12.392	1.00	50.53	C
ATOM	15287	CG	TYR	D	373	22.769	-0.491	13.406	1.00	52.82	C
ATOM	15288	CD1	TYR	D	373	23.671	-1.520	13.106	1.00	54.67	C
ATOM	15289	CD2	TYR	D	373	22.185	-0.479	14.664	1.00	49.26	C
ATOM	15290	CE1	TYR	D	373	23.973	-2.496	14.042	1.00	45.22	C
ATOM	15291	CE2	TYR	D	373	22.472	-1.446	15.598	1.00	49.32	C
ATOM	15292	CZ	TYR	D	373	23.368	-2.454	15.283	1.00	52.42	C
ATOM	15293	OH	TYR	D	373	23.647	-3.405	16.235	1.00	59.26	O
ATOM	15294	N	LYS	D	374	22.713	2.673	10.036	1.00	62.39	N
ATOM	15295	CA	LYS	D	374	22.145	3.475	8.950	1.00	62.94	C
ATOM	15296	C	LYS	D	374	22.754	3.046	7.630	1.00	67.54	C
ATOM	15297	O	LYS	D	374	22.047	2.892	6.637	1.00	71.30	O
ATOM	15298	CB	LYS	D	374	22.374	4.978	9.166	1.00	57.51	C
ATOM	15299	N	PHE	D	375	24.065	2.827	7.638	1.00	63.85	N
ATOM	15300	CA	PHE	D	375	24.805	2.454	6.432	1.00	66.29	C
ATOM	15301	C	PHE	D	375	24.464	1.050	5.945	1.00	66.76	C
ATOM	15302	O	PHE	D	375	24.402	0.814	4.745	1.00	69.50	O
ATOM	15303	CB	PHE	D	375	26.320	2.559	6.699	1.00	67.06	C
ATOM	15304	CG	PHE	D	375	27.205	2.021	5.583	1.00	68.03	C
ATOM	15305	CD1	PHE	D	375	27.816	2.888	4.686	1.00	64.60	C
ATOM	15306	CD2	PHE	D	375	27.471	0.658	5.466	1.00	69.87	C
ATOM	15307	CE1	PHE	D	375	28.639	2.408	3.683	1.00	67.35	C

ATOM	15308	CE2	PHE	D	375	28.290	0.171	4.453	1.00	64.06	C
ATOM	15309	CZ	PHE	D	375	28.876	1.043	3.566	1.00	64.21	C
ATOM	15310	N	ILE	D	376	24.266	0.118	6.874	1.00	66.36	N
ATOM	15311	CA	ILE	D	376	24.262	-1.302	6.528	1.00	64.24	C
ATOM	15312	C	ILE	D	376	22.865	-1.892	6.423	1.00	64.56	C
ATOM	15313	O	ILE	D	376	22.699	-2.986	5.900	1.00	69.35	O
ATOM	15314	CB	ILE	D	376	25.083	-2.149	7.558	1.00	62.34	C
ATOM	15315	CG1	ILE	D	376	25.643	-3.420	6.905	1.00	60.94	C
ATOM	15316	CG2	ILE	D	376	24.240	-2.522	8.757	1.00	59.38	C
ATOM	15317	CD1	ILE	D	376	26.684	-3.153	5.842	1.00	62.37	C
ATOM	15318	N	LYS	D	377	21.858	-1.179	6.915	1.00	70.43	N
ATOM	15319	CA	LYS	D	377	20.474	-1.654	6.792	1.00	72.81	C
ATOM	15320	C	LYS	D	377	20.040	-1.861	5.330	1.00	71.66	C
ATOM	15321	O	LYS	D	377	19.515	-2.925	5.012	1.00	73.08	O
ATOM	15322	CB	LYS	D	377	19.491	-0.703	7.496	1.00	66.25	C
ATOM	15323	CG	LYS	D	377	18.110	-1.306	7.664	1.00	70.89	C
ATOM	15324	CD	LYS	D	377	17.161	-0.362	8.383	1.00	75.39	C
ATOM	15325	CE	LYS	D	377	15.747	-0.907	8.381	1.00	71.43	C
ATOM	15326	NZ	LYS	D	377	14.775	0.088	8.905	1.00	88.17	N
ATOM	15327	N	PRO	D	378	20.260	-0.867	4.441	1.00	65.96	N
ATOM	15328	CA	PRO	D	378	19.879	-1.092	3.041	1.00	66.54	C
ATOM	15329	C	PRO	D	378	20.520	-2.320	2.392	1.00	69.06	C
ATOM	15330	O	PRO	D	378	19.813	-3.112	1.758	1.00	68.23	O
ATOM	15331	CB	PRO	D	378	20.350	0.187	2.338	1.00	70.29	C
ATOM	15332	CG	PRO	D	378	21.241	0.881	3.298	1.00	72.31	C
ATOM	15333	CD	PRO	D	378	20.728	0.515	4.643	1.00	68.24	C
ATOM	15334	N	ILE	D	379	21.829	-2.484	2.557	1.00	75.36	N
ATOM	15335	CA	ILE	D	379	22.554	-3.621	1.969	1.00	67.66	C
ATOM	15336	C	ILE	D	379	21.965	-4.957	2.443	1.00	69.12	C
ATOM	15337	O	ILE	D	379	21.815	-5.900	1.664	1.00	70.89	O
ATOM	15338	CB	ILE	D	379	24.051	-3.536	2.309	1.00	65.02	C
ATOM	15339	CG1	ILE	D	379	24.702	-2.424	1.497	1.00	68.28	C
ATOM	15340	CG2	ILE	D	379	24.747	-4.822	1.995	1.00	72.17	C
ATOM	15341	CD1	ILE	D	379	26.071	-2.053	1.979	1.00	68.00	C
ATOM	15342	N	LEU	D	380	21.602	-5.018	3.721	1.00	70.15	N
ATOM	15343	CA	LEU	D	380	20.948	-6.194	4.283	1.00	68.74	C
ATOM	15344	C	LEU	D	380	19.632	-6.505	3.589	1.00	71.40	C
ATOM	15345	O	LEU	D	380	19.178	-7.644	3.574	1.00	66.86	O
ATOM	15346	CB	LEU	D	380	20.686	-6.001	5.769	1.00	63.36	C
ATOM	15347	CG	LEU	D	380	21.896	-5.974	6.676	1.00	62.45	C
ATOM	15348	CD1	LEU	D	380	21.402	-5.939	8.101	1.00	55.78	C
ATOM	15349	CD2	LEU	D	380	22.767	-7.211	6.429	1.00	61.85	C
ATOM	15350	O	GLU	D	381	17.092	-6.880	0.464	1.00	72.22	O
ATOM	15351	N	GLU	D	381	19.011	-5.475	3.026	1.00	72.48	N
ATOM	15352	CA	GLU	D	381	17.706	-5.631	2.400	1.00	69.58	C
ATOM	15353	C	GLU	D	381	17.838	-6.031	0.940	1.00	69.94	C
ATOM	15354	CB	GLU	D	381	16.904	-4.345	2.568	1.00	74.81	C
ATOM	15355	CG	GLU	D	381	16.600	-4.088	4.040	1.00	73.95	C
ATOM	15356	CD	GLU	D	381	15.813	-2.833	4.295	1.00	72.76	C
ATOM	15357	OE1	GLU	D	381	16.150	-1.784	3.697	1.00	76.67	O
ATOM	15358	OE2	GLU	D	381	14.860	-2.903	5.110	1.00	72.17	O
ATOM	15359	O	LYS	D	382	19.492	-7.931	-2.305	1.00	84.01	O
ATOM	15360	N	LYS	D	382	18.823	-5.468	0.249	1.00	70.05	N
ATOM	15361	CA	LYS	D	382	19.130	-5.883	-1.115	1.00	69.39	C
ATOM	15362	C	LYS	D	382	19.491	-7.370	-1.209	1.00	76.73	C
ATOM	15363	CB	LYS	D	382	20.277	-5.042	-1.683	1.00	66.59	C
ATOM	15364	O	MET	D	383	18.266	-10.121	1.001	1.00	76.94	O
ATOM	15365	N	MET	D	383	19.783	-8.002	-0.068	1.00	71.70	N
ATOM	15366	CA	MET	D	383	20.302	-9.375	-0.044	1.00	72.73	C
ATOM	15367	C	MET	D	383	19.362	-10.431	0.537	1.00	75.38	C
ATOM	15368	CB	MET	D	383	21.602	-9.433	0.748	1.00	74.15	C
ATOM	15369	CG	MET	D	383	22.747	-8.638	0.175	1.00	77.37	C
ATOM	15370	SD	MET	D	383	24.270	-9.077	1.036	1.00	77.93	S

ATOM	15371	CE	MET	D	383	25.398	-7.911	0.311	1.00	75.24	C
ATOM	15372	O	ASP	D	384	17.821	-13.310	2.884	1.00	78.22	O
ATOM	15373	N	ASP	D	384	19.830	-11.679	0.561	1.00	74.30	N
ATOM	15374	CA	ASP	D	384	18.944	-12.812	0.813	1.00	71.90	C
ATOM	15375	C	ASP	D	384	18.880	-13.372	2.238	1.00	75.67	C
ATOM	15376	CB	ASP	D	384	19.297	-13.944	-0.139	1.00	74.19	C
ATOM	15377	CG	ASP	D	384	18.478	-13.900	-1.408	1.00	82.20	O
ATOM	15378	OD1	ASP	D	384	18.081	-12.784	-1.804	1.00	88.93	C
ATOM	15379	OD2	ASP	D	384	18.214	-14.968	-2.002	1.00	86.65	O
ATOM	15380	N	GLY	D	385	19.972	-13.944	2.733	1.00	72.86	N
ATOM	15381	CA	GLY	D	385	19.918	-14.620	4.025	1.00	67.03	C
ATOM	15382	C	GLY	D	385	19.899	-13.686	5.220	1.00	63.64	C
ATOM	15383	O	GLY	D	385	20.213	-14.071	6.343	1.00	63.17	O
ATOM	15384	N	THR	D	386	19.500	-12.447	4.984	1.00	67.93	N
ATOM	15385	CA	THR	D	386	19.666	-11.399	5.973	1.00	65.15	C
ATOM	15386	C	THR	D	386	18.543	-11.285	7.006	1.00	65.05	C
ATOM	15387	O	THR	D	386	18.615	-10.441	7.895	1.00	67.71	O
ATOM	15388	CB	THR	D	386	19.811	-10.081	5.272	1.00	64.06	C
ATOM	15389	OG1	THR	D	386	18.883	-10.050	4.184	1.00	72.99	O
ATOM	15390	CG2	THR	D	386	21.204	-9.953	4.704	1.00	67.81	C
ATOM	15391	N	GLU	D	387	17.525	-12.134	6.904	1.00	61.15	N
ATOM	15392	CA	GLU	D	387	16.378	-12.064	7.806	1.00	61.45	C
ATOM	15393	C	GLU	D	387	16.767	-12.007	9.273	1.00	64.71	C
ATOM	15394	O	GLU	D	387	16.345	-11.097	9.999	1.00	70.45	O
ATOM	15395	CB	GLU	D	387	15.439	-13.252	7.582	1.00	61.80	C
ATOM	15396	N	GLU	D	388	17.570	-12.967	9.719	1.00	63.87	N
ATOM	15397	CA	GLU	D	388	17.925	-13.032	11.129	1.00	62.63	C
ATOM	15398	C	GLU	D	388	18.802	-11.845	11.516	1.00	65.11	C
ATOM	15399	O	GLU	D	388	18.840	-11.447	12.681	1.00	70.81	O
ATOM	15400	CB	GLU	D	388	18.621	-14.353	11.452	1.00	64.95	C
ATOM	15401	N	LEU	D	389	19.491	-11.268	10.538	1.00	60.50	N
ATOM	15402	CA	LEU	D	389	20.350	-10.131	10.801	1.00	56.19	C
ATOM	15403	C	LEU	D	389	19.506	-8.885	11.077	1.00	63.42	C
ATOM	15404	O	LEU	D	389	19.854	-8.045	11.914	1.00	62.59	O
ATOM	15405	CB	LEU	D	389	21.300	-9.884	9.620	1.00	62.65	C
ATOM	15406	CG	LEU	D	389	22.307	-10.953	9.162	1.00	61.12	C
ATOM	15407	CD1	LEU	D	389	23.248	-10.431	8.064	1.00	55.77	C
ATOM	15408	CD2	LEU	D	389	23.111	-11.544	10.323	1.00	53.24	C
ATOM	15409	N	LEU	D	390	18.394	-8.770	10.358	1.00	67.09	N
ATOM	15410	CA	LEU	D	390	17.538	-7.593	10.436	1.00	56.93	C
ATOM	15411	C	LEU	D	390	16.712	-7.589	11.722	1.00	57.51	C
ATOM	15412	O	LEU	D	390	16.489	-6.537	12.327	1.00	61.46	O
ATOM	15413	CB	LEU	D	390	16.645	-7.514	9.199	1.00	60.46	C
ATOM	15414	CG	LEU	D	390	17.399	-6.992	7.969	1.00	61.51	C
ATOM	15415	CD1	LEU	D	390	16.589	-7.117	6.715	1.00	61.68	C
ATOM	15416	CD2	LEU	D	390	17.772	-5.557	8.188	1.00	62.58	C
ATOM	15417	N	VAL	D	391	16.280	-8.757	12.172	1.00	57.12	N
ATOM	15418	CA	VAL	D	391	15.687	-8.835	13.506	1.00	60.82	C
ATOM	15419	C	VAL	D	391	16.651	-8.285	14.581	1.00	60.81	C
ATOM	15420	O	VAL	D	391	16.234	-7.577	15.505	1.00	63.01	O
ATOM	15421	CB	VAL	D	391	15.274	-10.269	13.848	1.00	59.34	C
ATOM	15422	CG1	VAL	D	391	15.180	-10.468	15.359	1.00	52.15	C
ATOM	15423	CG2	VAL	D	391	13.956	-10.600	13.179	1.00	53.51	C
ATOM	15424	N	LYS	D	392	17.942	-8.574	14.428	1.00	62.54	N
ATOM	15425	CA	LYS	D	392	18.961	-8.103	15.368	1.00	55.77	C
ATOM	15426	C	LYS	D	392	19.207	-6.610	15.213	1.00	58.69	C
ATOM	15427	O	LYS	D	392	19.283	-5.890	16.203	1.00	56.94	O
ATOM	15428	CB	LYS	D	392	20.265	-8.870	15.182	1.00	57.74	C
ATOM	15429	CG	LYS	D	392	20.151	-10.335	15.522	1.00	56.18	C
ATOM	15430	CD	LYS	D	392	21.491	-10.994	15.543	1.00	53.51	C
ATOM	15431	CE	LYS	D	392	21.366	-12.399	16.075	1.00	58.26	C
ATOM	15432	NZ	LYS	D	392	22.715	-13.005	16.286	1.00	69.61	N
ATOM	15433	N	LEU	D	393	19.312	-6.147	13.973	1.00	53.61	N

ATOM	15434	CA	LEU	D	393	19.445	-4.720	13.706	1.00	54.75	C
ATOM	15435	C	LEU	D	393	18.257	-3.914	14.311	1.00	58.09	C
ATOM	15436	O	LEU	D	393	18.435	-2.834	14.859	1.00	57.82	O
ATOM	15437	CB	LEU	D	393	19.571	-4.487	12.189	1.00	52.38	C
ATOM	15438	CG	LEU	D	393	20.233	-3.195	11.706	1.00	56.05	C
ATOM	15439	CD1	LEU	D	393	20.841	-3.370	10.339	1.00	54.76	C
ATOM	15440	CD2	LEU	D	393	19.242	-2.055	11.664	1.00	54.39	C
ATOM	15441	N	ASN	D	394	17.054	-4.463	14.245	1.00	60.02	N
ATOM	15442	CA	ASN	D	394	15.906	-3.792	14.829	1.00	59.87	C
ATOM	15443	C	ASN	D	394	15.903	-3.850	16.340	1.00	64.01	C
ATOM	15444	O	ASN	D	394	15.481	-2.898	17.002	1.00	70.23	O
ATOM	15445	CB	ASN	D	394	14.605	-4.386	14.291	1.00	63.74	C
ATOM	15446	CG	ASN	D	394	14.207	-3.772	12.991	1.00	65.01	C
ATOM	15447	OD1	ASN	D	394	13.547	-2.736	12.966	1.00	73.34	O
ATOM	15448	ND2	ASN	D	394	14.641	-4.375	11.892	1.00	65.57	N
ATOM	15449	N	ARG	D	395	16.371	-4.959	16.896	1.00	61.39	N
ATOM	15450	CA	ARG	D	395	16.478	-5.050	18.339	1.00	60.20	C
ATOM	15451	C	ARG	D	395	17.741	-4.331	18.850	1.00	59.95	C
ATOM	15452	O	ARG	D	395	18.052	-4.412	20.030	1.00	59.12	O
ATOM	15453	CB	ARG	D	395	16.475	-6.515	18.769	1.00	60.87	C
ATOM	15454	N	GLU	D	396	18.449	-3.627	17.960	1.00	60.29	N
ATOM	15455	CA	GLU	D	396	19.742	-2.989	18.270	1.00	62.05	C
ATOM	15456	C	GLU	D	396	20.739	-3.974	18.896	1.00	60.27	C
ATOM	15457	O	GLU	D	396	21.359	-3.699	19.921	1.00	61.64	O
ATOM	15458	CB	GLU	D	396	19.552	-1.778	19.199	1.00	61.91	C
ATOM	15459	CG	GLU	D	396	19.148	-0.488	18.466	1.00	65.69	C
ATOM	15460	CD	GLU	D	396	18.648	0.626	19.386	1.00	74.01	C
ATOM	15461	OE1	GLU	D	396	19.177	0.787	20.514	1.00	68.41	O
ATOM	15462	OE2	GLU	D	396	17.721	1.358	18.964	1.00	80.46	O
ATOM	15463	O	ASP	D	397	22.323	-8.188	17.699	1.00	59.16	O
ATOM	15464	N	ASP	D	397	20.899	-5.119	18.257	1.00	56.63	N
ATOM	15465	CA	ASP	D	397	21.646	-6.216	18.838	1.00	56.68	C
ATOM	15466	C	ASP	D	397	22.406	-6.983	17.765	1.00	53.02	C
ATOM	15467	CB	ASP	D	397	20.694	-7.142	19.573	1.00	58.65	C
ATOM	15468	CG	ASP	D	397	21.408	-8.111	20.452	1.00	65.99	C
ATOM	15469	OD2	ASP	D	397	21.390	-9.316	20.128	1.00	74.83	O
ATOM	15470	OD1	ASP	D	397	21.993	-7.664	21.463	1.00	69.81	O
ATOM	15471	O	LEU	D	398	25.537	-5.213	16.030	1.00	50.46	O
ATOM	15472	N	LEU	D	398	23.138	-6.259	16.930	1.00	54.51	N
ATOM	15473	CA	LEU	D	398	23.798	-6.795	15.747	1.00	50.91	C
ATOM	15474	C	LEU	D	398	25.257	-6.388	15.803	1.00	53.97	C
ATOM	15475	CB	LEU	D	398	23.148	-6.239	14.477	1.00	51.47	C
ATOM	15476	CG	LEU	D	398	23.400	-6.735	13.049	1.00	50.98	C
ATOM	15477	CD2	LEU	D	398	23.859	-5.619	12.114	1.00	52.36	C
ATOM	15478	CD1	LEU	D	398	24.354	-7.900	12.997	1.00	52.56	C
ATOM	15479	O	LEU	D	399	28.760	-5.131	16.500	1.00	46.89	O
ATOM	15480	N	LEU	D	399	26.178	-7.336	15.591	1.00	52.61	N
ATOM	15481	CA	LEU	D	399	27.616	-7.041	15.616	1.00	47.88	C
ATOM	15482	C	LEU	D	399	27.996	-6.061	16.734	1.00	47.75	C
ATOM	15483	CB	LEU	D	399	28.071	-6.458	14.275	1.00	46.33	C
ATOM	15484	CG	LEU	D	399	27.997	-7.290	12.998	1.00	51.16	C
ATOM	15485	CD1	LEU	D	399	27.652	-6.412	11.816	1.00	50.61	C
ATOM	15486	CD2	LEU	D	399	29.309	-8.007	12.738	1.00	49.62	C
ATOM	15487	O	ARG	D	400	29.805	-6.570	19.582	1.00	39.45	O
ATOM	15488	N	ARG	D	400	27.435	-6.244	17.928	1.00	45.63	N
ATOM	15489	CA	ARG	D	400	27.736	-5.352	19.055	1.00	44.55	C
ATOM	15490	C	ARG	D	400	29.191	-5.477	19.590	1.00	45.18	C
ATOM	15491	CB	ARG	D	400	26.741	-5.604	20.201	1.00	41.89	C
ATOM	15492	CG	ARG	D	400	25.272	-5.258	19.865	1.00	50.55	C
ATOM	15493	CD	ARG	D	400	24.866	-3.834	20.348	1.00	51.74	C
ATOM	15494	NE	ARG	D	400	24.635	-3.812	21.789	1.00	44.33	N
ATOM	15495	CZ	ARG	D	400	24.890	-2.789	22.591	1.00	46.27	C
ATOM	15496	NH1	ARG	D	400	25.355	-1.642	22.115	1.00	49.02	N

ATOM	15497	NH2	ARG	D	400	24.659	-2.918	23.884	1.00	49.80	N
ATOM	15498	O	LYS	D	401	29.424	-4.900	22.487	1.00	40.49	O
ATOM	15499	N	LYS	D	401	29.721	-4.339	20.045	1.00	39.22	N
ATOM	15500	CA	LYS	D	401	30.954	-4.282	20.814	1.00	37.54	C
ATOM	15501	C	LYS	D	401	30.576	-4.598	22.239	1.00	38.12	C
ATOM	15502	CB	LYS	D	401	31.637	-2.934	20.682	1.00	37.23	C
ATOM	15503	CG	LYS	D	401	32.112	-2.636	19.262	1.00	41.95	C
ATOM	15504	CD	LYS	D	401	32.141	-1.127	18.981	1.00	39.97	C
ATOM	15505	CE	LYS	D	401	32.496	-0.823	17.522	1.00	44.74	C
ATOM	15506	NZ	LYS	D	401	33.186	0.489	17.324	1.00	46.53	N
ATOM	15507	O	GLN	D	402	30.774	-3.531	26.529	1.00	41.11	O
ATOM	15508	N	GLN	D	402	31.528	-4.611	23.169	1.00	38.15	N
ATOM	15509	CA	GLN	D	402	31.157	-4.882	24.560	1.00	37.88	C
ATOM	15510	C	GLN	D	402	31.356	-3.635	25.443	1.00	39.35	C
ATOM	15511	CB	GLN	D	402	31.941	-6.077	25.134	1.00	37.81	C
ATOM	15512	CG	GLN	D	402	31.708	-7.445	24.414	1.00	40.89	C
ATOM	15513	CD	GLN	D	402	32.441	-7.552	23.089	1.00	38.56	C
ATOM	15514	OE1	GLN	D	402	33.635	-7.303	23.017	1.00	40.93	O
ATOM	15515	NE2	GLN	D	402	31.722	-7.873	22.032	1.00	40.94	N
ATOM	15516	O	ARG	D	403	31.724	0.033	23.663	1.00	43.34	O
ATOM	15517	N	ARG	D	403	32.205	-2.724	24.988	1.00	33.38	N
ATOM	15518	CA	ARG	D	403	32.255	-1.385	25.539	1.00	41.60	C
ATOM	15519	C	ARG	D	403	31.370	-0.427	24.737	1.00	42.15	C
ATOM	15520	CB	ARG	D	403	33.673	-0.891	25.571	1.00	41.36	C
ATOM	15521	CG	ARG	D	403	34.514	-1.718	26.513	1.00	41.73	C
ATOM	15522	CD	ARG	D	403	34.093	-1.481	27.950	1.00	42.00	C
ATOM	15523	NE	ARG	D	403	35.307	-1.441	28.730	1.00	44.72	N
ATOM	15524	CZ	ARG	D	403	35.832	-0.356	29.260	1.00	43.64	C
ATOM	15525	NH1	ARG	D	403	36.967	-0.470	29.909	1.00	48.97	N
ATOM	15526	NH2	ARG	D	403	35.238	0.826	29.149	1.00	42.69	N
ATOM	15527	N	THR	D	404	30.190	-0.166	25.263	1.00	36.86	N
ATOM	15528	CA	THR	D	404	29.175	0.509	24.486	1.00	41.07	C
ATOM	15529	C	THR	D	404	28.483	1.537	25.351	1.00	42.11	C
ATOM	15530	O	THR	D	404	28.544	1.447	26.586	1.00	41.30	O
ATOM	15531	CB	THR	D	404	28.126	-0.476	23.925	1.00	43.44	C
ATOM	15532	OG1	THR	D	404	27.544	-1.214	25.015	1.00	49.32	O
ATOM	15533	CG2	THR	D	404	28.752	-1.442	22.933	1.00	38.78	C
ATOM	15534	N	PHE	D	405	27.824	2.492	24.687	1.00	45.50	N
ATOM	15535	CA	PHE	D	405	27.129	3.609	25.340	1.00	42.20	C
ATOM	15536	C	PHE	D	405	26.132	3.145	26.411	1.00	47.56	C
ATOM	15537	O	PHE	D	405	25.910	3.860	27.382	1.00	53.85	O
ATOM	15538	CB	PHE	D	405	26.406	4.477	24.285	1.00	45.91	C
ATOM	15539	CG	PHE	D	405	25.360	3.722	23.483	1.00	52.91	C
ATOM	15540	CD2	PHE	D	405	24.054	3.612	23.944	1.00	48.07	C
ATOM	15541	CD1	PHE	D	405	25.694	3.103	22.286	1.00	46.94	C
ATOM	15542	CE2	PHE	D	405	23.111	2.904	23.240	1.00	44.52	C
ATOM	15543	CE1	PHE	D	405	24.746	2.394	21.564	1.00	48.61	C
ATOM	15544	CZ	PHE	D	405	23.456	2.296	22.043	1.00	51.42	C
ATOM	15545	N	ASP	D	406	25.550	1.951	26.257	1.00	47.55	N
ATOM	15546	CA	ASP	D	406	24.505	1.500	27.184	1.00	47.17	C
ATOM	15547	C	ASP	D	406	24.962	0.661	28.375	1.00	46.50	C
ATOM	15548	O	ASP	D	406	24.125	0.141	29.108	1.00	48.70	O
ATOM	15549	CB	ASP	D	406	23.425	0.709	26.444	1.00	41.21	C
ATOM	15550	CG	ASP	D	406	23.993	-0.403	25.602	1.00	49.42	C
ATOM	15551	OD1	ASP	D	406	25.047	-0.184	24.983	1.00	56.50	O
ATOM	15552	OD2	ASP	D	406	23.385	-1.490	25.534	1.00	51.64	O
ATOM	15553	N	ASN	D	407	26.258	0.555	28.620	1.00	41.18	N
ATOM	15554	CA	ASN	D	407	26.690	-0.169	29.807	1.00	40.92	C
ATOM	15555	C	ASN	D	407	26.447	0.602	31.077	1.00	42.42	C
ATOM	15556	O	ASN	D	407	26.713	0.106	32.165	1.00	44.77	O
ATOM	15557	CB	ASN	D	407	28.168	-0.521	29.712	1.00	43.16	C
ATOM	15558	CG	ASN	D	407	28.427	-1.601	28.710	1.00	38.14	C
ATOM	15559	OD1	ASN	D	407	27.525	-2.348	28.369	1.00	35.70	O

ATOM	15560	ND2	ASN	D	407	29.654	-1.665	28.202	1.00	40.11	N
ATOM	15561	N	GLY	D	408	25.929	1.820	30.929	1.00	47.23	N
ATOM	15562	CA	GLY	D	408	25.646	2.698	32.052	1.00	42.00	C
ATOM	15563	C	GLY	D	408	24.650	2.114	33.004	1.00	39.86	C
ATOM	15564	O	GLY	D	408	24.626	2.484	34.170	1.00	44.46	O
ATOM	15565	N	SER	D	409	23.840	1.180	32.527	1.00	40.52	N
ATOM	15566	CA	SER	D	409	22.781	0.634	33.378	1.00	45.51	C
ATOM	15567	C	SER	D	409	23.276	-0.405	34.362	1.00	47.89	C
ATOM	15568	O	SER	D	409	22.520	-0.847	35.217	1.00	55.79	O
ATOM	15569	CB	SER	D	409	21.676	0.035	32.532	1.00	38.15	C
ATOM	15570	OG	SER	D	409	22.248	-0.679	31.461	1.00	57.68	O
ATOM	15571	O	ILE	D	410	26.366	-0.328	36.519	1.00	52.54	O
ATOM	15572	N	ILE	D	410	24.541	-0.802	34.254	1.00	49.94	N
ATOM	15573	CA	ILE	D	410	25.077	-1.820	35.152	1.00	46.22	C
ATOM	15574	C	ILE	D	410	25.516	-1.231	36.482	1.00	48.60	C
ATOM	15575	CB	ILE	D	410	26.286	-2.556	34.543	1.00	48.83	C
ATOM	15576	CG1	ILE	D	410	25.886	-3.343	33.297	1.00	47.99	C
ATOM	15577	CG2	ILE	D	410	26.909	-3.448	35.568	1.00	41.59	C
ATOM	15578	CD1	ILE	D	410	27.031	-3.532	32.342	1.00	51.19	C
ATOM	15579	N	PRO	D	411	24.940	-1.750	37.578	1.00	52.72	N
ATOM	15580	CA	PRO	D	411	25.261	-1.386	38.962	1.00	47.68	C
ATOM	15581	C	PRO	D	411	26.529	-2.075	39.457	1.00	49.60	C
ATOM	15582	O	PRO	D	411	26.846	-3.193	39.028	1.00	46.33	O
ATOM	15583	CB	PRO	D	411	24.044	-1.886	39.763	1.00	49.80	C
ATOM	15584	CG	PRO	D	411	23.069	-2.436	38.759	1.00	52.23	C
ATOM	15585	CD	PRO	D	411	23.884	-2.771	37.525	1.00	53.95	C
ATOM	15586	N	HIS	D	412	27.214	-1.412	40.380	1.00	51.79	N
ATOM	15587	CA	HIS	D	412	28.470	-1.897	40.915	1.00	49.02	C
ATOM	15588	C	HIS	D	412	28.340	-3.304	41.500	1.00	51.96	C
ATOM	15589	O	HIS	D	412	29.282	-4.087	41.386	1.00	54.70	O
ATOM	15590	CB	HIS	D	412	29.039	-0.906	41.962	1.00	44.82	C
ATOM	15591	CG	HIS	D	412	28.348	-0.933	43.294	1.00	50.54	C
ATOM	15592	ND1	HIS	D	412	27.100	-0.381	43.502	1.00	58.79	N
ATOM	15593	CD2	HIS	D	412	28.751	-1.410	44.499	1.00	54.41	C
ATOM	15594	CE1	HIS	D	412	26.750	-0.546	44.767	1.00	53.18	C
ATOM	15595	NE2	HIS	D	412	27.734	-1.164	45.395	1.00	53.79	N
ATOM	15596	N	GLN	D	413	27.181	-3.623	42.089	1.00	53.50	N
ATOM	15597	CA	GLN	D	413	26.938	-4.927	42.720	1.00	50.92	C
ATOM	15598	C	GLN	D	413	27.162	-6.104	41.766	1.00	51.44	C
ATOM	15599	O	GLN	D	413	27.491	-7.205	42.199	1.00	58.93	O
ATOM	15600	CB	GLN	D	413	25.519	-5.012	43.288	1.00	49.10	C
ATOM	15601	CG	GLN	D	413	25.259	-4.125	44.493	1.00	57.25	C
ATOM	15602	CD	GLN	D	413	24.552	-2.812	44.117	1.00	59.15	C
ATOM	15603	OE1	GLN	D	413	24.387	-2.498	42.936	1.00	54.62	O
ATOM	15604	NE2	GLN	D	413	24.127	-2.056	45.124	1.00	55.07	N
ATOM	15605	N	ILE	D	414	26.999	-5.877	40.470	1.00	51.70	N
ATOM	15606	CA	ILE	D	414	27.309	-6.915	39.487	1.00	47.05	C
ATOM	15607	C	ILE	D	414	28.835	-7.125	39.352	1.00	48.98	C
ATOM	15608	O	ILE	D	414	29.304	-8.246	39.490	1.00	54.19	O
ATOM	15609	CB	ILE	D	414	26.670	-6.576	38.137	1.00	45.15	C
ATOM	15610	CG1	ILE	D	414	25.153	-6.751	38.236	1.00	48.01	C
ATOM	15611	CG2	ILE	D	414	27.192	-7.446	37.035	1.00	43.64	C
ATOM	15612	CD1	ILE	D	414	24.694	-8.173	38.147	1.00	45.27	C
ATOM	15613	N	HIS	D	415	29.617	-6.069	39.117	1.00	49.95	N
ATOM	15614	CA	HIS	D	415	31.078	-6.218	39.071	1.00	52.52	C
ATOM	15615	C	HIS	D	415	31.637	-6.728	40.396	1.00	54.55	C
ATOM	15616	O	HIS	D	415	32.661	-7.419	40.432	1.00	50.57	O
ATOM	15617	CB	HIS	D	415	31.772	-4.906	38.725	1.00	44.27	C
ATOM	15618	CG	HIS	D	415	31.401	-4.353	37.387	1.00	47.91	C
ATOM	15619	ND1	HIS	D	415	31.678	-5.002	36.205	1.00	47.43	N
ATOM	15620	CD2	HIS	D	415	30.803	-3.187	37.044	1.00	45.32	C
ATOM	15621	CE1	HIS	D	415	31.252	-4.269	35.191	1.00	49.50	C
ATOM	15622	NE2	HIS	D	415	30.728	-3.157	35.675	1.00	46.48	N

ATOM	15623	N	LEU	D	416	30.967	-6.350	41.483	1.00	56.81	N
ATOM	15624	CA	LEU	D	416	31.423	-6.695	42.821	1.00	57.46	C
ATOM	15625	C	LEU	D	416	31.267	-8.192	43.023	1.00	53.69	C
ATOM	15626	O	LEU	D	416	32.127	-8.837	43.617	1.00	51.77	O
ATOM	15627	CB	LEU	D	416	30.636	-5.922	43.894	1.00	50.14	C
ATOM	15628	CG	LEU	D	416	30.834	-6.336	45.361	1.00	51.08	C
ATOM	15629	CD1	LEU	D	416	32.242	-6.043	45.801	1.00	50.27	C
ATOM	15630	CD2	LEU	D	416	29.837	-5.661	46.303	1.00	46.00	C
ATOM	15631	N	GLY	D	417	30.136	-8.707	42.542	1.00	55.39	N
ATOM	15632	CA	GLY	D	417	29.780	-10.107	42.669	1.00	55.58	C
ATOM	15633	C	GLY	D	417	30.884	-10.939	42.088	1.00	49.00	C
ATOM	15634	O	GLY	D	417	31.439	-11.786	42.771	1.00	60.16	O
ATOM	15635	N	GLU	D	418	31.222	-10.653	40.837	1.00	49.83	N
ATOM	15636	CA	GLU	D	418	32.313	-11.301	40.142	1.00	48.88	C
ATOM	15637	C	GLU	D	418	33.673	-11.140	40.867	1.00	53.85	C
ATOM	15638	O	GLU	D	418	34.470	-12.073	40.919	1.00	58.33	O
ATOM	15639	CB	GLU	D	418	32.407	-10.765	38.702	1.00	45.07	C
ATOM	15640	CG	GLU	D	418	31.217	-11.120	37.805	1.00	40.95	C
ATOM	15641	CD	GLU	D	418	31.484	-10.849	36.320	1.00	42.83	C
ATOM	15642	OE1	GLU	D	418	32.621	-10.456	35.960	1.00	43.64	O
ATOM	15643	OE2	GLU	D	418	30.565	-11.046	35.495	1.00	38.22	O
ATOM	15644	N	LEU	D	419	33.945	-9.963	41.416	1.00	52.47	N
ATOM	15645	CA	LEU	D	419	35.220	-9.722	42.095	1.00	53.78	C
ATOM	15646	C	LEU	D	419	35.342	-10.546	43.370	1.00	57.24	C
ATOM	15647	O	LEU	D	419	36.348	-11.207	43.594	1.00	58.18	O
ATOM	15648	CB	LEU	D	419	35.388	-8.242	42.424	1.00	49.12	C
ATOM	15649	CG	LEU	D	419	36.489	-7.860	43.419	1.00	53.84	C
ATOM	15650	CD1	LEU	D	419	37.242	-6.643	42.930	1.00	47.71	C
ATOM	15651	CD2	LEU	D	419	35.886	-7.594	44.804	1.00	56.67	C
ATOM	15652	N	HIS	D	420	34.322	-10.451	44.211	1.00	51.11	N
ATOM	15653	CA	HIS	D	420	34.155	-11.282	45.385	1.00	52.18	C
ATOM	15654	C	HIS	D	420	34.354	-12.768	45.008	1.00	64.64	C
ATOM	15655	O	HIS	D	420	35.176	-13.480	45.615	1.00	64.74	O
ATOM	15656	CB	HIS	D	420	32.769	-11.003	45.977	1.00	49.09	C
ATOM	15657	CG	HIS	D	420	32.377	-11.884	47.124	1.00	58.34	C
ATOM	15658	ND1	HIS	D	420	33.062	-11.911	48.319	1.00	61.81	N
ATOM	15659	CD2	HIS	D	420	31.333	-12.735	47.272	1.00	58.07	C
ATOM	15660	CE1	HIS	D	420	32.472	-12.757	49.147	1.00	56.11	C
ATOM	15661	NE2	HIS	D	420	31.422	-13.274	48.534	1.00	59.09	N
ATOM	15662	N	ALA	D	421	33.643	-13.216	43.972	1.00	60.28	N
ATOM	15663	CA	ALA	D	421	33.722	-14.609	43.553	1.00	59.64	C
ATOM	15664	C	ALA	D	421	35.149	-14.971	43.180	1.00	60.70	C
ATOM	15665	O	ALA	D	421	35.647	-16.022	43.582	1.00	68.07	O
ATOM	15666	CB	ALA	D	421	32.779	-14.881	42.396	1.00	56.97	C
ATOM	15667	N	ILE	D	422	35.821	-14.099	42.436	1.00	60.12	N
ATOM	15668	CA	ILE	D	422	37.195	-14.390	42.022	1.00	59.68	C
ATOM	15669	C	ILE	D	422	38.070	-14.504	43.260	1.00	60.77	C
ATOM	15670	O	ILE	D	422	38.902	-15.402	43.364	1.00	70.30	O
ATOM	15671	CB	ILE	D	422	37.766	-13.320	41.074	1.00	55.01	C
ATOM	15672	CG1	ILE	D	422	37.210	-13.485	39.661	1.00	60.53	C
ATOM	15673	CG2	ILE	D	422	39.265	-13.402	40.982	1.00	50.43	C
ATOM	15674	CD1	ILE	D	422	37.839	-12.517	38.651	1.00	55.59	C
ATOM	15675	N	LEU	D	423	37.851	-13.621	44.220	1.00	60.04	N
ATOM	15676	CA	LEU	D	423	38.678	-13.613	45.414	1.00	65.64	C
ATOM	15677	C	LEU	D	423	38.477	-14.899	46.218	1.00	66.98	C
ATOM	15678	O	LEU	D	423	39.439	-15.485	46.700	1.00	59.78	O
ATOM	15679	CB	LEU	D	423	38.379	-12.385	46.292	1.00	57.47	C
ATOM	15680	CG	LEU	D	423	38.832	-11.023	45.758	1.00	59.93	C
ATOM	15681	CD1	LEU	D	423	38.204	-9.882	46.565	1.00	53.31	C
ATOM	15682	CD2	LEU	D	423	40.347	-10.908	45.735	1.00	57.54	C
ATOM	15683	N	ARG	D	424	37.223	-15.330	46.355	1.00	70.49	N
ATOM	15684	CA	ARG	D	424	36.914	-16.513	47.149	1.00	63.45	C
ATOM	15685	C	ARG	D	424	37.455	-17.767	46.476	1.00	67.76	C

ATOM	15686	O	ARG	D	424	37.561	-18.810	47.110	1.00	71.25	O
ATOM	15687	CB	ARG	D	424	35.410	-16.643	47.379	1.00	57.65	C
ATOM	15688	N	ARG	D	425	37.818	-17.664	45.201	1.00	67.43	N
ATOM	15689	CA	ARG	D	425	38.358	-18.814	44.482	1.00	63.05	C
ATOM	15690	C	ARG	D	425	39.845	-18.950	44.657	1.00	66.51	C
ATOM	15691	O	ARG	D	425	40.361	-20.057	44.754	1.00	74.36	O
ATOM	15692	CB	ARG	D	425	38.051	-18.731	42.989	1.00	67.45	C
ATOM	15693	CG	ARG	D	425	36.570	-18.863	42.649	1.00	67.00	C
ATOM	15694	CD	ARG	D	425	36.049	-20.243	42.952	1.00	62.23	C
ATOM	15695	NE	ARG	D	425	35.528	-20.873	41.749	1.00	61.22	N
ATOM	15696	CZ	ARG	D	425	34.534	-21.753	41.735	1.00	60.41	C
ATOM	15697	NH1	ARG	D	425	33.947	-22.116	42.866	1.00	64.63	N
ATOM	15698	NH2	ARG	D	425	34.117	-22.264	40.584	1.00	60.79	N
ATOM	15699	N	GLN	D	426	40.545	-17.832	44.700	1.00	61.44	N
ATOM	15700	C	GLN	D	426	42.742	-17.433	45.818	1.00	67.75	C
ATOM	15701	CA	GLN	D	426	41.985	-17.901	44.587	1.00	63.08	C
ATOM	15702	O	GLN	D	426	43.983	-17.329	45.813	1.00	59.42	O
ATOM	15703	CB	GLN	D	426	42.402	-17.112	43.373	1.00	61.76	C
ATOM	15704	CG	GLN	D	426	42.117	-17.888	42.120	1.00	61.95	C
ATOM	15705	CD	GLN	D	426	43.376	-18.265	41.419	1.00	60.72	C
ATOM	15706	OE1	GLN	D	426	43.352	-18.666	40.266	1.00	60.23	O
ATOM	15707	NE2	GLN	D	426	44.503	-18.127	42.108	1.00	61.07	N
ATOM	15708	O	GLU	D	427	44.497	-17.674	49.246	1.00	78.66	O
ATOM	15709	N	GLU	D	427	41.989	-17.172	46.878	1.00	67.13	N
ATOM	15710	CA	GLU	D	427	42.586	-16.762	48.132	1.00	70.64	C
ATOM	15711	C	GLU	D	427	43.429	-17.898	48.676	1.00	76.20	C
ATOM	15712	CB	GLU	D	427	41.514	-16.365	49.130	1.00	70.19	C
ATOM	15713	CG	GLU	D	427	40.365	-17.334	49.186	1.00	72.08	C
ATOM	15714	CD	GLU	D	427	39.279	-16.858	50.118	1.00	76.40	C
ATOM	15715	OE1	GLU	D	427	39.382	-15.709	50.605	1.00	73.06	O
ATOM	15716	OE2	GLU	D	427	38.325	-17.631	50.361	1.00	82.64	O
ATOM	15717	O	ASP	D	428	46.061	-20.361	48.944	1.00	79.40	O
ATOM	15718	N	ASP	D	428	42.940	-19.118	48.481	1.00	76.01	N
ATOM	15719	CA	ASP	D	428	43.672	-20.311	48.871	1.00	78.67	C
ATOM	15720	C	ASP	D	428	45.064	-20.306	48.236	1.00	73.27	C
ATOM	15721	CB	ASP	D	428	42.885	-21.577	48.491	1.00	80.17	C
ATOM	15722	CG	ASP	D	428	41.638	-21.781	49.362	1.00	88.02	C
ATOM	15723	OD1	ASP	D	428	41.163	-20.802	49.987	1.00	86.64	O
ATOM	15724	OD2	ASP	D	428	41.131	-22.922	49.427	1.00	87.13	O
ATOM	15725	N	PHE	D	429	45.141	-20.192	46.915	1.00	69.33	N
ATOM	15726	CA	PHE	D	429	46.435	-20.243	46.238	1.00	67.29	C
ATOM	15727	C	PHE	D	429	47.314	-19.045	46.540	1.00	69.70	C
ATOM	15728	O	PHE	D	429	48.508	-19.045	46.236	1.00	72.24	O
ATOM	15729	CB	PHE	D	429	46.246	-20.360	44.729	1.00	65.11	C
ATOM	15730	CG	PHE	D	429	45.364	-21.490	44.334	1.00	71.37	C
ATOM	15731	CD1	PHE	D	429	45.873	-22.775	44.235	1.00	68.93	C
ATOM	15732	CD2	PHE	D	429	44.016	-21.281	44.103	1.00	66.12	C
ATOM	15733	CE1	PHE	D	429	45.060	-23.823	43.880	1.00	65.31	C
ATOM	15734	CE2	PHE	D	429	43.196	-22.329	43.755	1.00	68.42	C
ATOM	15735	CZ	PHE	D	429	43.714	-23.603	43.640	1.00	65.26	C
ATOM	15736	N	TYR	D	430	46.731	-18.017	47.137	1.00	74.87	N
ATOM	15737	CA	TYR	D	430	47.460	-16.776	47.312	1.00	70.08	C
ATOM	15738	C	TYR	D	430	47.103	-16.136	48.631	1.00	74.23	C
ATOM	15739	O	TYR	D	430	46.018	-15.583	48.791	1.00	75.77	O
ATOM	15740	CB	TYR	D	430	47.175	-15.823	46.165	1.00	62.05	C
ATOM	15741	CG	TYR	D	430	47.875	-16.147	44.870	1.00	54.61	C
ATOM	15742	CD1	TYR	D	430	49.181	-15.763	44.664	1.00	50.77	C
ATOM	15743	CD2	TYR	D	430	47.207	-16.787	43.830	1.00	53.44	C
ATOM	15744	CE1	TYR	D	430	49.832	-16.027	43.464	1.00	55.89	C
ATOM	15745	CE2	TYR	D	430	47.842	-17.048	42.613	1.00	52.35	C
ATOM	15746	CZ	TYR	D	430	49.160	-16.669	42.437	1.00	58.13	C
ATOM	15747	OH	TYR	D	430	49.817	-16.917	41.237	1.00	56.66	O
ATOM	15748	N	PRO	D	431	48.030	-16.223	49.588	1.00	81.41	N

ATOM	15749	CA	PRO	D	431	47.919	-15.726	50.959	1.00	81.25	C
ATOM	15750	C	PRO	D	431	47.160	-14.404	51.093	1.00	78.88	C
ATOM	15751	O	PRO	D	431	46.046	-14.375	51.634	1.00	76.44	O
ATOM	15752	CB	PRO	D	431	49.377	-15.552	51.358	1.00	78.17	C
ATOM	15753	CG	PRO	D	431	50.049	-16.713	50.661	1.00	77.12	C
ATOM	15754	CD	PRO	D	431	49.340	-16.857	49.342	1.00	78.79	C
ATOM	15755	O	PHE	D	432	45.095	-10.999	50.970	1.00	76.38	O
ATOM	15756	N	PHE	D	432	47.762	-13.334	50.585	1.00	76.32	N
ATOM	15757	CA	PHE	D	432	47.270	-11.975	50.809	1.00	78.68	C
ATOM	15758	C	PHE	D	432	45.836	-11.736	50.328	1.00	76.72	C
ATOM	15759	CB	PHE	D	432	48.213	-10.961	50.153	1.00	77.53	C
ATOM	15760	CG	PHE	D	432	48.193	-10.981	48.651	1.00	75.19	C
ATOM	15761	CD2	PHE	D	432	47.813	-9.857	47.942	1.00	71.57	C
ATOM	15762	CD1	PHE	D	432	48.589	-12.101	47.951	1.00	70.78	C
ATOM	15763	CE2	PHE	D	432	47.811	-9.859	46.564	1.00	67.72	C
ATOM	15764	CE1	PHE	D	432	48.589	-12.111	46.578	1.00	70.10	C
ATOM	15765	CZ	PHE	D	432	48.197	-10.990	45.882	1.00	67.23	C
ATOM	15766	N	LEU	D	433	45.431	-12.375	49.234	1.00	71.83	N
ATOM	15767	CA	LEU	D	433	44.073	-12.195	48.738	1.00	69.85	C
ATOM	15768	C	LEU	D	433	43.018	-12.612	49.755	1.00	72.48	C
ATOM	15769	O	LEU	D	433	41.883	-12.153	49.689	1.00	79.38	O
ATOM	15770	CB	LEU	D	433	43.872	-12.965	47.440	1.00	67.98	C
ATOM	15771	CG	LEU	D	433	44.855	-12.534	46.362	1.00	65.40	C
ATOM	15772	CD1	LEU	D	433	44.683	-13.356	45.091	1.00	56.50	C
ATOM	15773	CD2	LEU	D	433	44.657	-11.060	46.096	1.00	63.87	C
ATOM	15774	N	LYS	D	434	43.378	-13.471	50.699	1.00	73.54	N
ATOM	15775	CA	LYS	D	434	42.441	-13.851	51.761	1.00	75.80	C
ATOM	15776	C	LYS	D	434	42.403	-12.756	52.814	1.00	77.01	C
ATOM	15777	O	LYS	D	434	41.342	-12.394	53.338	1.00	76.69	O
ATOM	15778	CB	LYS	D	434	42.837	-15.183	52.405	1.00	68.75	C
ATOM	15779	N	ASP	D	435	43.587	-12.230	53.106	1.00	73.69	N
ATOM	15780	CA	ASP	D	435	43.767	-11.232	54.144	1.00	78.51	C
ATOM	15781	C	ASP	D	435	43.064	-9.923	53.772	1.00	79.33	C
ATOM	15782	O	ASP	D	435	42.309	-9.370	54.571	1.00	82.08	O
ATOM	15783	CB	ASP	D	435	45.264	-11.003	54.393	1.00	78.80	C
ATOM	15784	N	ASN	D	436	43.293	-9.455	52.548	1.00	76.52	N
ATOM	15785	CA	ASN	D	436	42.719	-8.200	52.069	1.00	75.36	C
ATOM	15786	C	ASN	D	436	41.393	-8.303	51.295	1.00	73.11	C
ATOM	15787	O	ASN	D	436	41.074	-7.399	50.535	1.00	69.60	O
ATOM	15788	CB	ASN	D	436	43.733	-7.482	51.169	1.00	71.67	C
ATOM	15789	CG	ASN	D	436	45.070	-7.250	51.850	1.00	72.04	C
ATOM	15790	OD1	ASN	D	436	45.326	-6.173	52.396	1.00	68.90	O
ATOM	15791	ND2	ASN	D	436	45.937	-8.257	51.808	1.00	70.14	N
ATOM	15792	N	ARG	D	437	40.615	-9.365	51.470	1.00	71.12	N
ATOM	15793	CA	ARG	D	437	39.394	-9.486	50.667	1.00	72.10	C
ATOM	15794	C	ARG	D	437	38.447	-8.316	50.932	1.00	71.11	C
ATOM	15795	O	ARG	D	437	37.900	-7.724	50.003	1.00	69.03	O
ATOM	15796	CB	ARG	D	437	38.665	-10.811	50.932	1.00	64.08	C
ATOM	15797	N	GLU	D	438	38.266	-7.983	52.203	1.00	72.23	N
ATOM	15798	CA	GLU	D	438	37.278	-6.991	52.587	1.00	66.46	C
ATOM	15799	C	GLU	D	438	37.719	-5.588	52.166	1.00	65.12	C
ATOM	15800	O	GLU	D	438	36.881	-4.729	51.914	1.00	68.01	O
ATOM	15801	CB	GLU	D	438	37.017	-7.056	54.096	1.00	63.77	C
ATOM	15802	N	LYS	D	439	39.030	-5.375	52.072	1.00	67.41	N
ATOM	15803	CA	LYS	D	439	39.595	-4.076	51.712	1.00	62.32	C
ATOM	15804	C	LYS	D	439	39.544	-3.825	50.202	1.00	65.37	C
ATOM	15805	O	LYS	D	439	39.241	-2.702	49.771	1.00	68.33	O
ATOM	15806	CB	LYS	D	439	41.043	-3.951	52.209	1.00	53.77	C
ATOM	15807	N	ILE	D	440	39.852	-4.856	49.412	1.00	59.90	N
ATOM	15808	CA	ILE	D	440	39.722	-4.829	47.949	1.00	54.56	C
ATOM	15809	C	ILE	D	440	38.286	-4.544	47.536	1.00	59.44	C
ATOM	15810	O	ILE	D	440	38.034	-3.821	46.571	1.00	56.18	O
ATOM	15811	CB	ILE	D	440	40.163	-6.178	47.301	1.00	57.56	C

ATOM	15812	CG1	ILE	D	440	41.598	-6.518	47.687	1.00	59.38	C
ATOM	15813	CG2	ILE	D	440	40.047	-6.139	45.769	1.00	44.43	C
ATOM	15814	CD1	ILE	D	440	41.947	-7.993	47.504	1.00	59.64	C
ATOM	15815	N	GLU	D	441	37.339	-5.128	48.261	1.00	59.72	N
ATOM	15816	CA	GLU	D	441	35.937	-4.873	47.981	1.00	60.26	C
ATOM	15817	C	GLU	D	441	35.556	-3.440	48.293	1.00	59.78	C
ATOM	15818	O	GLU	D	441	34.684	-2.887	47.638	1.00	58.30	O
ATOM	15819	CB	GLU	D	441	35.053	-5.818	48.770	1.00	59.35	C
ATOM	15820	CG	GLU	D	441	35.126	-7.225	48.246	1.00	72.05	C
ATOM	15821	CD	GLU	D	441	34.381	-8.178	49.126	1.00	75.04	C
ATOM	15822	OE1	GLU	D	441	33.546	-7.695	49.940	1.00	75.55	O
ATOM	15823	OE2	GLU	D	441	34.650	-9.392	49.006	1.00	70.11	O
ATOM	15824	N	LYS	D	442	36.208	-2.857	49.297	1.00	56.00	N
ATOM	15825	CA	LYS	D	442	35.979	-1.463	49.655	1.00	62.80	C
ATOM	15826	C	LYS	D	442	36.493	-0.513	48.575	1.00	57.08	C
ATOM	15827	O	LYS	D	442	35.888	0.517	48.329	1.00	57.96	O
ATOM	15828	CB	LYS	D	442	36.642	-1.126	50.989	1.00	61.20	C
ATOM	15829	CG	LYS	D	442	35.711	-1.180	52.175	1.00	65.49	C
ATOM	15830	CD	LYS	D	442	34.905	0.106	52.354	1.00	55.69	C
ATOM	15831	CE	LYS	D	442	33.525	-0.224	52.880	1.00	50.20	C
ATOM	15832	NZ	LYS	D	442	32.663	0.994	52.938	1.00	64.21	N
ATOM	15833	N	ILE	D	443	37.606	-0.855	47.935	1.00	55.78	N
ATOM	15834	CA	ILE	D	443	38.090	-0.028	46.845	1.00	56.05	C
ATOM	15835	C	ILE	D	443	37.018	0.060	45.759	1.00	57.02	C
ATOM	15836	O	ILE	D	443	36.824	1.117	45.176	1.00	55.28	O
ATOM	15837	CB	ILE	D	443	39.403	-0.557	46.242	1.00	54.97	C
ATOM	15838	CG1	ILE	D	443	40.450	-0.796	47.335	1.00	62.04	C
ATOM	15839	CG2	ILE	D	443	39.960	0.437	45.207	1.00	52.14	C
ATOM	15840	CD1	ILE	D	443	41.806	-1.371	46.813	1.00	57.49	C
ATOM	15841	N	LEU	D	444	36.308	-1.040	45.507	1.00	54.32	N
ATOM	15842	CA	LEU	D	444	35.187	-1.012	44.569	1.00	55.26	C
ATOM	15843	C	LEU	D	444	33.980	-0.218	45.084	1.00	53.37	C
ATOM	15844	O	LEU	D	444	33.372	0.543	44.339	1.00	54.48	O
ATOM	15845	CB	LEU	D	444	34.716	-2.433	44.229	1.00	48.41	C
ATOM	15846	CG	LEU	D	444	33.979	-2.625	42.889	1.00	44.70	C
ATOM	15847	CD1	LEU	D	444	34.075	-4.078	42.444	1.00	49.85	C
ATOM	15848	CD2	LEU	D	444	32.526	-2.268	42.960	1.00	47.28	C
ATOM	15849	N	THR	D	445	33.618	-0.429	46.341	1.00	47.43	N
ATOM	15850	CA	THR	D	445	32.286	-0.084	46.796	1.00	51.59	C
ATOM	15851	C	THR	D	445	32.181	1.239	47.535	1.00	54.81	C
ATOM	15852	O	THR	D	445	31.083	1.721	47.757	1.00	49.45	O
ATOM	15853	CB	THR	D	445	31.734	-1.140	47.737	1.00	52.66	C
ATOM	15854	OG1	THR	D	445	32.511	-1.130	48.937	1.00	55.35	O
ATOM	15855	CG2	THR	D	445	31.770	-2.521	47.087	1.00	53.08	C
ATOM	15856	N	PHE	D	446	33.314	1.790	47.954	1.00	55.82	N
ATOM	15857	CA	PHE	D	446	33.296	3.001	48.746	1.00	52.45	C
ATOM	15858	C	PHE	D	446	33.078	4.207	47.865	1.00	52.00	C
ATOM	15859	O	PHE	D	446	33.707	4.336	46.817	1.00	54.11	O
ATOM	15860	CB	PHE	D	446	34.598	3.190	49.522	1.00	54.44	C
ATOM	15861	CG	PHE	D	446	34.762	4.580	50.068	1.00	54.59	C
ATOM	15862	CD1	PHE	D	446	33.811	5.112	50.942	1.00	55.61	C
ATOM	15863	CD2	PHE	D	446	35.839	5.369	49.688	1.00	58.14	C
ATOM	15864	CE1	PHE	D	446	33.945	6.403	51.437	1.00	56.53	C
ATOM	15865	CE2	PHE	D	446	35.981	6.659	50.177	1.00	54.89	C
ATOM	15866	CZ	PHE	D	446	35.034	7.174	51.051	1.00	54.88	C
ATOM	15867	O	ARG	D	447	31.011	7.476	49.417	1.00	49.37	O
ATOM	15868	N	ARG	D	447	32.224	5.111	48.323	1.00	52.78	N
ATOM	15869	CA	ARG	D	447	31.911	6.308	47.560	1.00	52.55	C
ATOM	15870	C	ARG	D	447	31.801	7.507	48.486	1.00	49.21	C
ATOM	15871	CB	ARG	D	447	30.608	6.088	46.797	1.00	50.68	C
ATOM	15872	CG	ARG	D	447	30.037	7.296	46.150	1.00	49.57	C
ATOM	15873	CD	ARG	D	447	28.563	7.083	45.854	1.00	46.97	C
ATOM	15874	NE	ARG	D	447	28.089	8.093	44.927	1.00	53.47	N

ATOM	15875	CZ	ARG	D	447	26.818	8.261	44.593	1.00	55.30	C
ATOM	15876	NH1	ARG	D	447	25.888	7.481	45.124	1.00	56.25	N
ATOM	15877	NH2	ARG	D	447	26.489	9.200	43.721	1.00	47.33	N
ATOM	15878	O	ILE	D	448	30.605	10.689	47.986	1.00	47.41	O
ATOM	15879	N	ILE	D	448	32.601	8.543	48.242	1.00	46.64	N
ATOM	15880	CA	ILE	D	448	32.545	9.756	49.049	1.00	46.41	C
ATOM	15881	C	ILE	D	448	31.126	10.338	49.046	1.00	47.35	C
ATOM	15882	CB	ILE	D	448	33.514	10.827	48.534	1.00	46.67	C
ATOM	15883	CG1	ILE	D	448	34.844	10.205	48.136	1.00	48.50	C
ATOM	15884	CG2	ILE	D	448	33.721	11.910	49.575	1.00	49.37	C
ATOM	15885	CD1	ILE	D	448	35.927	11.265	47.836	1.00	51.47	C
ATOM	15886	O	PRO	D	449	29.975	13.173	50.178	1.00	49.21	O
ATOM	15887	N	PRO	D	449	30.479	10.398	50.222	1.00	51.68	N
ATOM	15888	CA	PRO	D	449	29.115	10.944	50.285	1.00	47.97	C
ATOM	15889	C	PRO	D	449	29.073	12.398	49.851	1.00	43.02	C
ATOM	15890	CB	PRO	D	449	28.748	10.795	51.760	1.00	54.38	C
ATOM	15891	CG	PRO	D	449	29.650	9.683	52.261	1.00	46.94	C
ATOM	15892	CD	PRO	D	449	30.936	9.936	51.545	1.00	49.93	C
ATOM	15893	O	TYR	D	450	28.385	16.313	49.298	1.00	48.67	O
ATOM	15894	N	TYR	D	450	28.059	12.748	49.075	1.00	44.62	N
ATOM	15895	CA	TYR	D	450	27.958	14.099	48.510	1.00	45.25	C
ATOM	15896	C	TYR	D	450	27.943	15.201	49.574	1.00	51.23	C
ATOM	15897	CB	TYR	D	450	26.701	14.212	47.654	1.00	47.20	C
ATOM	15898	CG	TYR	D	450	25.450	14.163	48.484	1.00	45.61	C
ATOM	15899	CD2	TYR	D	450	24.822	15.333	48.897	1.00	53.24	C
ATOM	15900	CD1	TYR	D	450	24.901	12.953	48.863	1.00	49.48	C
ATOM	15901	CE2	TYR	D	450	23.696	15.295	49.671	1.00	52.34	C
ATOM	15902	CE1	TYR	D	450	23.779	12.896	49.627	1.00	53.76	C
ATOM	15903	CZ	TYR	D	450	23.173	14.077	50.034	1.00	60.34	C
ATOM	15904	OH	TYR	D	450	22.037	14.034	50.803	1.00	65.38	O
ATOM	15905	O	TYR	D	451	28.790	16.779	53.565	1.00	55.18	O
ATOM	15906	N	TYR	D	451	27.426	14.898	50.773	1.00	47.33	N
ATOM	15907	CA	TYR	D	451	27.349	15.879	51.862	1.00	46.09	C
ATOM	15908	C	TYR	D	451	28.686	16.042	52.575	1.00	53.58	C
ATOM	15909	CB	TYR	D	451	26.279	15.491	52.875	1.00	44.93	C
ATOM	15910	CG	TYR	D	451	26.485	14.138	53.496	1.00	49.75	C
ATOM	15911	CD2	TYR	D	451	25.742	13.046	53.088	1.00	48.46	C
ATOM	15912	CD1	TYR	D	451	27.416	13.952	54.505	1.00	55.33	C
ATOM	15913	CE2	TYR	D	451	25.940	11.805	53.664	1.00	51.60	C
ATOM	15914	CE1	TYR	D	451	27.619	12.721	55.078	1.00	51.79	C
ATOM	15915	CE	TYR	D	451	26.884	11.656	54.654	1.00	53.26	C
ATOM	15916	OH	TYR	D	451	27.103	10.432	55.237	1.00	66.25	O
ATOM	15917	O	VAL	D	452	31.650	16.002	50.279	1.00	41.09	O
ATOM	15918	N	VAL	D	452	29.697	15.334	52.082	1.00	43.94	N
ATOM	15919	CA	VAL	D	452	31.058	15.509	52.549	1.00	44.87	C
ATOM	15920	C	VAL	D	452	31.806	16.269	51.475	1.00	47.13	C
ATOM	15921	CB	VAL	D	452	31.758	14.137	52.822	1.00	50.39	C
ATOM	15922	CG1	VAL	D	452	33.234	14.337	53.203	1.00	48.93	C
ATOM	15923	CG2	VAL	D	452	31.018	13.338	53.893	1.00	44.45	C
ATOM	15924	O	GLY	D	453	34.317	15.764	50.121	1.00	43.55	O
ATOM	15925	N	GLY	D	453	32.613	17.243	51.854	1.00	48.26	N
ATOM	15926	CA	GLY	D	453	33.379	17.908	50.810	1.00	53.19	C
ATOM	15927	C	GLY	D	453	34.252	16.982	49.933	1.00	50.82	C
ATOM	15928	O	PRO	D	454	36.990	17.666	50.812	1.00	51.18	O
ATOM	15929	N	PRO	D	454	34.931	17.567	48.949	1.00	47.89	N
ATOM	15930	CA	PRO	D	454	36.242	17.003	48.622	1.00	44.44	C
ATOM	15931	C	PRO	D	454	37.107	16.866	49.881	1.00	49.65	C
ATOM	15932	CB	PRO	D	454	36.840	18.029	47.662	1.00	42.22	C
ATOM	15933	CG	PRO	D	454	35.851	19.228	47.686	1.00	42.48	C
ATOM	15934	CD	PRO	D	454	34.538	18.641	48.029	1.00	38.52	C
ATOM	15935	O	LEU	D	455	41.110	16.010	51.409	1.00	52.71	O
ATOM	15936	N	LEU	D	455	37.982	15.867	49.918	1.00	50.90	N
ATOM	15937	CA	LEU	D	455	38.729	15.583	51.150	1.00	51.86	C

ATOM	15938	C	LEU	D	455	39.963	16.487	51.316	1.00	55.35	C
ATOM	15939	CB	LEU	D	455	39.122	14.114	51.176	1.00	43.42	C
ATOM	15940	CG	LEU	D	455	37.936	13.227	50.792	1.00	50.38	C
ATOM	15941	CD1	LEU	D	455	38.368	11.753	50.768	1.00	49.05	C
ATOM	15942	CD2	LEU	D	455	36.705	13.429	51.694	1.00	40.83	C
ATOM	15943	O	ALA	D	456	41.007	18.453	53.775	1.00	50.25	O
ATOM	15944	N	ALA	D	456	39.705	17.793	51.393	1.00	47.76	N
ATOM	15945	CA	ALA	D	456	40.760	18.792	51.390	1.00	49.31	C
ATOM	15946	C	ALA	D	456	41.438	18.984	52.743	1.00	52.67	C
ATOM	15947	CB	ALA	D	456	40.204	20.133	50.899	1.00	46.55	C
ATOM	15948	O	ARG	D	457	44.634	22.100	53.835	1.00	57.22	O
ATOM	15949	N	ARG	D	457	42.523	19.750	52.711	1.00	51.34	N
ATOM	15950	CA	ARG	D	457	43.226	20.156	53.918	1.00	57.31	C
ATOM	15951	C	ARG	D	457	43.482	21.648	53.835	1.00	61.41	C
ATOM	15952	CB	ARG	D	457	44.549	19.399	54.099	1.00	62.67	C
ATOM	15953	CG	ARG	D	457	45.089	19.514	55.510	1.00	64.69	C
ATOM	15954	CD	ARG	D	457	46.554	19.190	55.580	1.00	66.12	C
ATOM	15955	NE	ARG	D	457	46.744	17.779	55.859	1.00	70.54	N
ATOM	15956	CZ	ARG	D	457	47.890	17.141	55.689	1.00	71.80	C
ATOM	15957	NH1	ARG	D	457	47.967	15.841	55.958	1.00	72.13	N
ATOM	15958	NH2	ARG	D	457	48.948	17.804	55.228	1.00	69.71	N
ATOM	15959	O	GLY	D	458	43.365	25.753	52.754	1.00	61.48	O
ATOM	15960	N	GLY	D	458	42.392	22.403	53.713	1.00	56.90	N
ATOM	15961	CA	GLY	D	458	42.443	23.842	53.813	1.00	54.09	C
ATOM	15962	C	GLY	D	458	43.006	24.582	52.624	1.00	57.38	C
ATOM	15963	O	ASN	D	459	42.833	24.758	47.975	1.00	43.77	O
ATOM	15964	N	ASN	D	459	43.087	23.935	51.469	1.00	52.31	N
ATOM	15965	CA	ASN	D	459	43.470	24.676	50.273	1.00	47.15	C
ATOM	15966	C	ASN	D	459	42.483	24.549	49.147	1.00	49.70	C
ATOM	15967	CB	ASN	D	459	44.831	24.253	49.800	1.00	56.87	C
ATOM	15968	CG	ASN	D	459	45.904	24.804	50.655	1.00	66.31	C
ATOM	15969	OD1	ASN	D	459	46.237	24.231	51.693	1.00	70.96	O
ATOM	15970	ND2	ASN	D	459	46.441	25.948	50.257	1.00	69.59	N
ATOM	15971	O	SER	D	460	38.425	25.158	49.969	1.00	49.72	O
ATOM	15972	N	SER	D	460	41.242	24.237	49.514	1.00	47.11	N
ATOM	15973	CA	SER	D	460	40.143	24.223	48.561	1.00	44.58	C
ATOM	15974	C	SER	D	460	39.074	25.264	48.921	1.00	45.78	C
ATOM	15975	CB	SER	D	460	39.509	22.837	48.501	1.00	42.67	C
ATOM	15976	OG	SER	D	460	38.473	22.804	47.539	1.00	43.01	O
ATOM	15977	O	ARG	D	461	35.450	27.266	48.516	1.00	47.71	O
ATOM	15978	N	ARG	D	461	38.853	26.238	48.046	1.00	42.46	N
ATOM	15979	CA	ARG	D	461	37.803	27.213	48.310	1.00	40.01	C
ATOM	15980	C	ARG	D	461	36.416	26.578	48.250	1.00	46.47	C
ATOM	15981	CB	ARG	D	461	37.884	28.379	47.334	1.00	43.54	C
ATOM	15982	CG	ARG	D	461	37.183	28.151	45.994	1.00	46.44	C
ATOM	15983	CD	ARG	D	461	37.548	29.273	45.049	1.00	39.16	C
ATOM	15984	NE	ARG	D	461	37.022	29.114	43.699	1.00	40.32	N
ATOM	15985	CZ	ARG	D	461	35.742	29.229	43.354	1.00	45.51	C
ATOM	15986	NH1	ARG	D	461	34.799	29.470	44.255	1.00	50.45	N
ATOM	15987	NH2	ARG	D	461	35.399	29.084	42.090	1.00	48.15	N
ATOM	15988	O	PHE	D	462	33.640	23.018	48.910	1.00	47.85	O
ATOM	15989	N	PHE	D	462	36.340	25.271	47.939	1.00	42.44	N
ATOM	15990	CA	PHE	D	462	35.082	24.526	47.738	1.00	41.68	C
ATOM	15991	C	PHE	D	462	34.734	23.579	48.874	1.00	46.99	C
ATOM	15992	CB	PHE	D	462	35.135	23.655	46.462	1.00	39.97	C
ATOM	15993	CG	PHE	D	462	35.506	24.405	45.211	1.00	47.76	C
ATOM	15994	CD1	PHE	D	462	34.560	25.206	44.542	1.00	43.06	C
ATOM	15995	CD2	PHE	D	462	36.799	24.333	44.708	1.00	38.07	C
ATOM	15996	CE1	PHE	D	462	34.914	25.908	43.394	1.00	41.75	C
ATOM	15997	CE2	PHE	D	462	37.162	25.032	43.555	1.00	36.14	C
ATOM	15998	CZ	PHE	D	462	36.216	25.807	42.893	1.00	43.93	C
ATOM	15999	O	ALA	D	463	35.036	23.892	52.331	1.00	56.60	O
ATOM	16000	N	ALA	D	463	35.682	23.331	49.768	1.00	46.51	N

ATOM	16001	CA	ALA	D	463	35.511	22.229	50.700	1.00	43.65	C
ATOM	16002	C	ALA	D	463	34.946	22.716	52.017	1.00	46.58	C
ATOM	16003	CB	ALA	D	463	36.824	21.513	50.908	1.00	45.91	C
ATOM	16004	O	TRP	D	464	33.591	21.078	56.203	1.00	60.97	O
ATOM	16005	N	TRP	D	464	34.344	21.815	52.776	1.00	50.71	N
ATOM	16006	CA	TRP	D	464	33.772	22.150	54.074	1.00	52.93	C
ATOM	16007	C	TRP	D	464	34.002	21.014	55.049	1.00	48.32	C
ATOM	16008	CB	TRP	D	464	32.277	22.416	53.950	1.00	51.04	C
ATOM	16009	CG	TRP	D	464	31.522	21.221	53.465	1.00	48.93	C
ATOM	16010	CD1	TRP	D	464	31.018	20.209	54.218	1.00	48.78	C
ATOM	16011	CD2	TRP	D	464	31.188	20.923	52.116	1.00	45.10	C
ATOM	16012	NE1	TRP	D	464	30.382	19.296	53.423	1.00	46.51	N
ATOM	16013	CE2	TRP	D	464	30.479	19.708	52.121	1.00	49.67	C
ATOM	16014	CE3	TRP	D	464	31.413	21.574	50.896	1.00	48.58	C
ATOM	16015	CZ2	TRP	D	464	29.991	19.119	50.953	1.00	47.01	C
ATOM	16016	CZ3	TRP	D	464	30.926	20.994	49.743	1.00	46.79	C
ATOM	16017	CH2	TRP	D	464	30.226	19.770	49.781	1.00	43.69	C
ATOM	16018	O	MET	D	465	36.507	19.578	56.775	1.00	55.80	O
ATOM	16019	N	MET	D	465	34.652	19.971	54.563	1.00	50.07	N
ATOM	16020	CA	MET	D	465	34.808	18.716	55.307	1.00	54.07	C
ATOM	16021	C	MET	D	465	35.520	18.860	56.654	1.00	53.55	C
ATOM	16022	CB	MET	D	465	35.555	17.704	54.445	1.00	45.37	C
ATOM	16023	CG	MET	D	465	35.521	16.314	54.999	1.00	48.10	C
ATOM	16024	SD	MET	D	465	36.990	15.919	55.947	1.00	64.16	S
ATOM	16025	CE	MET	D	465	38.298	16.319	54.795	1.00	49.72	C
ATOM	16026	O	THR	D	466	35.551	15.784	59.401	1.00	63.01	O
ATOM	16027	N	THR	D	466	35.012	18.152	57.655	1.00	56.04	N
ATOM	16028	CA	THR	D	466	35.581	18.163	59.004	1.00	62.59	C
ATOM	16029	C	THR	D	466	36.225	16.821	59.397	1.00	59.58	C
ATOM	16030	CB	THR	D	466	34.491	18.505	60.041	1.00	60.11	C
ATOM	16031	OG1	THR	D	466	33.825	19.710	59.647	1.00	76.27	O
ATOM	16032	CG2	THR	D	466	35.085	18.664	61.421	1.00	60.74	C
ATOM	16033	O	ARG	D	467	38.054	16.215	62.501	1.00	69.53	O
ATOM	16034	N	ARG	D	467	37.508	16.838	59.751	1.00	59.38	N
ATOM	16035	CA	ARG	D	467	38.194	15.610	60.171	1.00	61.77	C
ATOM	16036	C	ARG	D	467	38.077	15.305	61.671	1.00	66.62	C
ATOM	16037	CB	ARG	D	467	39.673	15.679	59.798	1.00	64.82	C
ATOM	16038	CG	ARG	D	467	39.964	15.259	58.385	1.00	61.14	C
ATOM	16039	CD	ARG	D	467	41.439	15.296	58.086	1.00	63.64	C
ATOM	16040	NE	ARG	D	467	41.684	14.973	56.683	1.00	64.92	N
ATOM	16041	CE	ARG	D	467	42.151	15.836	55.789	1.00	61.87	C
ATOM	16042	NH1	ARG	D	467	42.328	15.456	54.533	1.00	58.07	N
ATOM	16043	NH2	ARG	D	467	42.448	17.080	56.155	1.00	68.42	N
ATOM	16044	O	LYS	D	468	40.097	13.799	64.797	1.00	71.33	O
ATOM	16045	N	LYS	D	468	38.008	14.019	62.005	1.00	67.29	N
ATOM	16046	CA	LYS	D	468	38.165	13.551	63.385	1.00	65.86	C
ATOM	16047	C	LYS	D	468	39.643	13.374	63.735	1.00	70.00	C
ATOM	16048	CB	LYS	D	468	37.424	12.234	63.603	1.00	64.60	C
ATOM	16049	CG	LYS	D	468	36.052	12.397	64.181	1.00	64.63	C
ATOM	16050	CD	LYS	D	468	35.435	11.058	64.512	1.00	65.12	C
ATOM	16051	CE	LYS	D	468	35.180	10.263	63.267	1.00	64.41	C
ATOM	16052	NZ	LYS	D	468	34.424	9.016	63.566	1.00	65.34	N
ATOM	16053	O	SER	D	469	42.075	13.797	60.948	1.00	73.38	O
ATOM	16054	N	SER	D	469	40.397	12.737	62.846	1.00	71.04	N
ATOM	16055	CA	SER	D	469	41.840	12.647	63.035	1.00	70.28	C
ATOM	16056	C	SER	D	469	42.605	13.447	61.998	1.00	70.66	C
ATOM	16057	CB	SER	D	469	42.312	11.207	62.988	1.00	71.17	C
ATOM	16058	OG	SER	D	469	43.698	11.185	62.713	1.00	75.39	O
ATOM	16059	O	GLU	D	470	46.857	13.653	60.772	1.00	80.87	O
ATOM	16060	N	GLU	D	470	43.864	13.727	62.295	1.00	72.81	N
ATOM	16061	CA	GLU	D	470	44.683	14.496	61.376	1.00	75.06	C
ATOM	16062	C	GLU	D	470	45.636	13.571	60.618	1.00	77.93	C
ATOM	16063	CB	GLU	D	470	45.450	15.585	62.132	1.00	75.68	C

ATOM	16064	CG	GLU	D	470	45.413	16.958	61.459	1.00	76.66	C
ATOM	16065	CD	GLU	D	470	44.000	17.455	61.160	1.00	73.31	C
ATOM	16066	OE1	GLU	D	470	43.845	18.215	60.183	1.00	75.01	O
ATOM	16067	OE2	GLU	D	470	43.050	17.098	61.895	1.00	70.82	O
ATOM	16068	O	GLU	D	471	44.118	12.185	57.290	1.00	67.03	O
ATOM	16069	N	GLU	D	471	45.056	12.688	59.807	1.00	69.51	N
ATOM	16070	CA	GLU	D	471	45.813	11.776	58.957	1.00	74.76	C
ATOM	16071	C	GLU	D	471	45.188	11.636	57.559	1.00	71.83	C
ATOM	16072	CB	GLU	D	471	45.909	10.398	59.621	1.00	70.15	C
ATOM	16073	CG	GLU	D	471	44.561	9.846	60.042	1.00	72.57	C
ATOM	16074	CD	GLU	D	471	44.617	8.381	60.436	1.00	78.85	C
ATOM	16075	OE1	GLU	D	471	43.955	7.993	61.427	1.00	78.18	O
ATOM	16076	OE2	GLU	D	471	45.314	7.610	59.742	1.00	80.67	O
ATOM	16077	O	THR	D	472	43.935	8.818	56.040	1.00	66.85	O
ATOM	16078	N	THR	D	472	45.852	10.874	56.689	1.00	72.97	N
ATOM	16079	CA	THR	D	472	45.367	10.599	55.335	1.00	62.82	C
ATOM	16080	C	THR	D	472	44.071	9.801	55.321	1.00	60.94	C
ATOM	16081	CB	THR	D	472	46.420	9.836	54.525	1.00	60.70	C
ATOM	16082	OG1	THR	D	472	47.442	10.748	54.108	1.00	64.33	O
ATOM	16083	CG2	THR	D	472	45.802	9.199	53.292	1.00	58.66	C
ATOM	16084	O	ILE	D	473	42.674	8.590	52.250	1.00	62.32	O
ATOM	16085	N	ILE	D	473	43.113	10.234	54.504	1.00	60.05	N
ATOM	16086	CA	ILE	D	473	41.864	9.501	54.336	1.00	57.33	C
ATOM	16087	C	ILE	D	473	41.993	8.418	53.267	1.00	62.51	C
ATOM	16088	CB	ILE	D	473	40.716	10.440	53.977	1.00	59.63	C
ATOM	16089	CG1	ILE	D	473	40.576	11.517	55.055	1.00	61.03	C
ATOM	16090	CG2	ILE	D	473	39.413	9.670	53.832	1.00	55.69	C
ATOM	16091	CD1	ILE	D	473	39.853	12.761	54.598	1.00	53.05	C
ATOM	16092	O	THR	D	474	39.182	5.906	53.384	1.00	55.91	O
ATOM	16093	N	THR	D	474	41.363	7.279	53.527	1.00	57.97	N
ATOM	16094	CA	THR	D	474	41.419	6.141	52.627	1.00	55.82	C
ATOM	16095	C	THR	D	474	40.031	5.559	52.560	1.00	57.79	C
ATOM	16096	CB	THR	D	474	42.418	5.032	53.107	1.00	57.51	C
ATOM	16097	OG1	THR	D	474	41.800	4.225	54.124	1.00	58.51	O
ATOM	16098	CG2	THR	D	474	43.706	5.632	53.631	1.00	50.82	C
ATOM	16099	O	PRO	D	475	37.157	2.994	53.279	1.00	58.72	O
ATOM	16100	N	PRO	D	475	39.792	4.661	51.592	1.00	56.05	N
ATOM	16101	CA	PRO	D	475	38.527	3.930	51.576	1.00	53.51	C
ATOM	16102	C	PRO	D	475	38.310	3.165	52.865	1.00	57.06	C
ATOM	16103	CB	PRO	D	475	38.689	2.980	50.396	1.00	52.69	C
ATOM	16104	CG	PRO	D	475	39.607	3.699	49.485	1.00	55.39	C
ATOM	16105	CD	PRO	D	475	40.569	4.441	50.361	1.00	53.73	C
ATOM	16106	O	TRP	D	476	38.259	2.360	56.748	1.00	59.50	O
ATOM	16107	N	TRP	D	476	39.405	2.752	53.507	1.00	57.55	N
ATOM	16108	CA	TRP	D	476	39.337	1.894	54.692	1.00	57.42	C
ATOM	16109	C	TRP	D	476	39.150	2.682	55.970	1.00	54.10	C
ATOM	16110	CB	TRP	D	476	40.592	1.018	54.777	1.00	57.05	C
ATOM	16111	CG	TRP	D	476	40.880	0.488	53.451	1.00	56.48	C
ATOM	16112	CD1	TRP	D	476	40.091	-0.350	52.719	1.00	55.06	C
ATOM	16113	CD2	TRP	D	476	41.995	0.811	52.631	1.00	58.11	C
ATOM	16114	NE1	TRP	D	476	40.662	-0.585	51.499	1.00	58.34	N
ATOM	16115	CE2	TRP	D	476	41.833	0.118	51.418	1.00	55.24	C
ATOM	16116	CE3	TRP	D	476	43.124	1.610	52.805	1.00	60.99	C
ATOM	16117	CE2	TRP	D	476	42.762	0.191	50.390	1.00	60.01	C
ATOM	16118	CZ3	TRP	D	476	44.045	1.688	51.773	1.00	57.06	C
ATOM	16119	CH2	TRP	D	476	43.856	0.987	50.582	1.00	57.93	C
ATOM	16120	O	ASN	D	477	38.655	6.446	58.310	1.00	65.51	O
ATOM	16121	N	ASN	D	477	39.953	3.719	56.185	1.00	52.69	N
ATOM	16122	CA	ASN	D	477	39.804	4.533	57.406	1.00	57.39	C
ATOM	16123	C	ASN	D	477	38.744	5.661	57.368	1.00	61.65	C
ATOM	16124	CB	ASN	D	477	41.161	5.144	57.796	1.00	49.75	C
ATOM	16125	CG	ASN	D	477	41.658	6.207	56.812	1.00	59.79	C
ATOM	16126	OD1	ASN	D	477	40.935	6.646	55.920	1.00	61.83	O

ATOM	16127	ND2	ASN	D	477	42.902	6.634	56.992	1.00	57.12	N
ATOM	16128	O	PHE	D	478	36.197	8.365	57.781	1.00	67.04	O
ATOM	16129	N	PHE	D	478	37.944	5.743	56.305	1.00	60.45	N
ATOM	16130	CA	PHE	D	478	37.072	6.916	56.092	1.00	62.49	C
ATOM	16131	C	PHE	D	478	36.156	7.248	57.264	1.00	64.70	C
ATOM	16132	CB	PHE	D	478	36.206	6.740	54.842	1.00	59.69	C
ATOM	16133	CG	PHE	D	478	35.372	7.965	54.482	1.00	62.74	C
ATOM	16134	CD1	PHE	D	478	35.885	8.952	53.659	1.00	57.09	C
ATOM	16135	CD2	PHE	D	478	34.064	8.107	54.946	1.00	61.79	C
ATOM	16136	CE1	PHE	D	478	35.117	10.049	53.312	1.00	59.45	C
ATOM	16137	CE2	PHE	D	478	33.302	9.202	54.607	1.00	63.34	C
ATOM	16138	CZ	PHE	D	478	33.828	10.179	53.788	1.00	59.04	C
ATOM	16139	O	GLU	D	479	34.215	7.387	60.961	1.00	68.14	O
ATOM	16140	N	GLU	D	479	35.323	6.300	57.685	1.00	66.64	N
ATOM	16141	CA	GLU	D	479	34.308	6.616	58.689	1.00	67.70	C
ATOM	16142	C	GLU	D	479	34.907	6.906	60.066	1.00	69.45	C
ATOM	16143	CB	GLU	D	479	33.288	5.489	58.791	1.00	70.81	C
ATOM	16144	CG	GLU	D	479	31.906	5.981	59.179	1.00	81.58	C
ATOM	16145	CD	GLU	D	479	30.786	5.095	58.638	1.00	92.76	C
ATOM	16146	OE1	GLU	D	479	31.091	4.037	58.037	1.00	87.38	O
ATOM	16147	OE2	GLU	D	479	29.599	5.465	58.815	1.00	95.20	O
ATOM	16148	O	GLU	D	480	37.843	8.987	62.360	1.00	67.13	O
ATOM	16149	N	GLU	D	480	36.200	6.632	60.223	1.00	68.69	N
ATOM	16150	CA	GLU	D	480	36.915	6.946	61.459	1.00	68.07	C
ATOM	16151	C	GLU	D	480	37.709	8.267	61.370	1.00	67.21	C
ATOM	16152	CB	GLU	D	480	37.854	5.784	61.835	1.00	71.40	C
ATOM	16153	CG	GLU	D	480	37.138	4.502	62.330	1.00	68.54	C
ATOM	16154	CD	GLU	D	480	36.809	3.502	61.224	1.00	73.85	C
ATOM	16155	OE1	GLU	D	480	37.639	3.326	60.302	1.00	76.48	O
ATOM	16156	OE2	GLU	D	480	35.723	2.877	61.285	1.00	75.39	O
ATOM	16157	O	VAL	D	481	38.377	12.141	60.064	1.00	64.59	O
ATOM	16158	N	VAL	D	481	38.234	8.583	60.188	1.00	68.37	N
ATOM	16159	CA	VAL	D	481	38.998	9.814	59.996	1.00	64.27	C
ATOM	16160	C	VAL	D	481	38.083	11.008	59.698	1.00	66.26	C
ATOM	16161	CB	VAL	D	481	40.011	9.661	58.865	1.00	61.72	C
ATOM	16162	CG1	VAL	D	481	40.795	10.944	58.670	1.00	66.13	C
ATOM	16163	CG2	VAL	D	481	40.952	8.532	59.170	1.00	68.88	C
ATOM	16164	O	VAL	D	482	34.192	11.033	59.919	1.00	66.07	O
ATOM	16165	N	VAL	D	482	36.958	10.750	59.050	1.00	65.26	N
ATOM	16166	CA	VAL	D	482	36.069	11.834	58.653	1.00	64.52	C
ATOM	16167	C	VAL	D	482	34.923	11.988	59.641	1.00	65.40	C
ATOM	16168	CB	VAL	D	482	35.505	11.605	57.222	1.00	64.25	C
ATOM	16169	CG1	VAL	D	482	34.287	12.481	56.963	1.00	60.36	C
ATOM	16170	CG2	VAL	D	482	36.594	11.832	56.162	1.00	60.50	C
ATOM	16171	N	ASP	D	483	34.758	13.193	60.174	1.00	63.87	N
ATOM	16172	CA	ASP	D	483	33.601	13.456	61.012	1.00	62.69	C
ATOM	16173	C	ASP	D	483	32.412	13.756	60.107	1.00	66.05	C
ATOM	16174	O	ASP	D	483	32.179	14.905	59.744	1.00	66.03	O
ATOM	16175	CB	ASP	D	483	33.855	14.614	61.977	1.00	58.53	C
ATOM	16176	CG	ASP	D	483	32.740	14.774	62.999	1.00	61.68	C
ATOM	16177	OD1	ASP	D	483	31.600	14.312	62.753	1.00	60.27	O
ATOM	16178	OD2	ASP	D	483	33.000	15.375	64.061	1.00	70.00	O
ATOM	16179	N	LYS	D	484	31.669	12.714	59.750	1.00	62.67	N
ATOM	16180	CA	LYS	D	484	30.545	12.844	58.844	1.00	57.10	C
ATOM	16181	C	LYS	D	484	29.526	13.829	59.394	1.00	63.55	C
ATOM	16182	O	LYS	D	484	29.134	14.785	58.713	1.00	65.10	O
ATOM	16183	CB	LYS	D	484	29.889	11.487	58.612	1.00	65.21	C
ATOM	16184	CG	LYS	D	484	30.825	10.414	58.081	1.00	69.08	C
ATOM	16185	CD	LYS	D	484	30.271	9.812	56.801	1.00	68.42	C
ATOM	16186	CE	LYS	D	484	30.387	8.301	56.779	1.00	68.43	C
ATOM	16187	NZ	LYS	D	484	29.373	7.688	57.677	1.00	74.69	N
ATOM	16188	N	GLY	D	485	29.119	13.592	60.637	1.00	64.11	N
ATOM	16189	CA	GLY	D	485	28.149	14.428	61.315	1.00	61.94	C

ATOM	16190	C	GLY	D	485	28.462	15.894	61.128	1.00	55.42	C
ATOM	16191	O	GLY	D	485	27.672	16.620	60.531	1.00	61.64	O
ATOM	16192	N	ALA	D	486	29.633	16.306	61.597	1.00	52.19	N
ATOM	16193	CA	ALA	D	486	30.074	17.682	61.481	1.00	57.24	C
ATOM	16194	C	ALA	D	486	30.116	18.148	60.028	1.00	62.20	C
ATOM	16195	O	ALA	D	486	30.003	19.343	59.743	1.00	65.30	O
ATOM	16196	CB	ALA	D	486	31.431	17.852	62.121	1.00	60.45	C
ATOM	16197	N	SER	D	487	30.266	17.210	59.105	1.00	58.17	N
ATOM	16198	CA	SER	D	487	30.347	17.577	57.707	1.00	58.79	C
ATOM	16199	C	SER	D	487	28.951	17.728	57.115	1.00	58.72	C
ATOM	16200	O	SER	D	487	28.700	18.663	56.361	1.00	59.66	O
ATOM	16201	CB	SER	D	487	31.178	16.558	56.931	1.00	54.73	C
ATOM	16202	OG	SER	D	487	32.562	16.762	57.179	1.00	57.00	O
ATOM	16203	N	ALA	D	488	28.039	16.833	57.474	1.00	56.10	N
ATOM	16204	CA	ALA	D	488	26.660	16.969	57.043	1.00	51.79	C
ATOM	16205	C	ALA	D	488	26.075	18.294	57.531	1.00	62.24	C
ATOM	16206	O	ALA	D	488	25.394	19.001	56.786	1.00	63.89	O
ATOM	16207	CB	ALA	D	488	25.831	15.822	57.542	1.00	55.91	C
ATOM	16208	N	GLN	D	489	26.345	18.637	58.780	1.00	58.93	N
ATOM	16209	CA	GLN	D	489	25.803	19.863	59.321	1.00	56.64	C
ATOM	16210	C	GLN	D	489	26.365	21.074	58.581	1.00	58.55	C
ATOM	16211	O	GLN	D	489	25.608	21.956	58.154	1.00	59.85	O
ATOM	16212	CB	GLN	D	489	26.091	19.964	60.812	1.00	58.97	C
ATOM	16213	CG	GLN	D	489	25.528	21.219	61.441	1.00	66.43	C
ATOM	16214	CD	GLN	D	489	25.083	21.014	62.884	1.00	69.57	C
ATOM	16215	OE1	GLN	D	489	25.426	20.019	63.526	1.00	64.78	O
ATOM	16216	NE2	GLN	D	489	24.312	21.959	63.397	1.00	67.51	N
ATOM	16217	N	SER	D	490	27.684	21.112	58.423	1.00	56.12	N
ATOM	16218	CA	SER	D	490	28.339	22.203	57.711	1.00	53.86	C
ATOM	16219	C	SER	D	490	27.815	22.325	56.294	1.00	58.81	C
ATOM	16220	O	SER	D	490	27.581	23.429	55.806	1.00	61.44	O
ATOM	16221	CB	SER	D	490	29.842	21.995	57.671	1.00	57.27	C
ATOM	16222	OG	SER	D	490	30.456	22.713	58.703	1.00	62.16	O
ATOM	16223	N	PHE	D	491	27.636	21.175	55.646	1.00	52.26	N
ATOM	16224	CA	PHE	D	491	27.066	21.103	54.308	1.00	52.61	C
ATOM	16225	C	PHE	D	491	25.812	21.978	54.163	1.00	54.64	C
ATOM	16226	O	PHE	D	491	25.735	22.827	53.274	1.00	53.13	O
ATOM	16227	CB	PHE	D	491	26.743	19.640	53.961	1.00	48.45	C
ATOM	16228	CG	PHE	D	491	26.099	19.448	52.613	1.00	46.65	C
ATOM	16229	CD2	PHE	D	491	24.843	18.874	52.510	1.00	46.46	C
ATOM	16230	CD1	PHE	D	491	26.765	19.788	51.452	1.00	45.42	C
ATOM	16231	CE2	PHE	D	491	24.245	18.671	51.275	1.00	46.72	C
ATOM	16232	CE1	PHE	D	491	26.175	19.577	50.211	1.00	44.31	C
ATOM	16233	CZ	PHE	D	491	24.920	19.018	50.126	1.00	45.51	C
ATOM	16234	N	ILE	D	492	24.830	21.765	55.028	1.00	54.89	N
ATOM	16235	CA	ILE	D	492	23.601	22.547	54.948	1.00	59.24	C
ATOM	16236	C	ILE	D	492	23.774	23.964	55.486	1.00	52.44	C
ATOM	16237	O	ILE	D	492	23.329	24.917	54.859	1.00	59.05	O
ATOM	16238	CB	ILE	D	492	22.457	21.869	55.697	1.00	57.00	C
ATOM	16239	CG1	ILE	D	492	22.197	20.500	55.071	1.00	60.11	C
ATOM	16240	CG2	ILE	D	492	21.214	22.720	55.613	1.00	54.15	C
ATOM	16241	CD1	ILE	D	492	21.842	20.595	53.598	1.00	54.51	C
ATOM	16242	N	GLU	D	493	24.453	24.119	56.614	1.00	55.26	N
ATOM	16243	CA	GLU	D	493	24.493	25.430	57.260	1.00	56.90	C
ATOM	16244	C	GLU	D	493	25.247	26.482	56.473	1.00	56.19	C
ATOM	16245	O	GLU	D	493	24.956	27.662	56.618	1.00	56.20	O
ATOM	16246	CB	GLU	D	493	25.082	25.327	58.662	1.00	56.31	C
ATOM	16247	CG	GLU	D	493	24.110	24.698	59.624	1.00	62.85	C
ATOM	16248	CD	GLU	D	493	24.573	24.763	61.059	1.00	72.22	C
ATOM	16249	OE1	GLU	D	493	25.807	24.805	61.278	1.00	67.38	O
ATOM	16250	OE2	GLU	D	493	23.694	24.770	61.958	1.00	73.91	O
ATOM	16251	N	ARG	D	494	26.198	26.065	55.636	1.00	57.12	N
ATOM	16252	CA	ARG	D	494	26.971	27.009	54.823	1.00	53.72	C

ATOM	16253	C	ARG	D	494	26.111	27.639	53.730	1.00	53.09	C
ATOM	16254	O	ARG	D	494	26.499	28.626	53.095	1.00	49.10	O
ATOM	16255	CB	ARG	D	494	28.195	26.315	54.192	1.00	55.36	C
ATOM	16256	CG	ARG	D	494	27.894	25.057	53.352	1.00	55.75	C
ATOM	16257	CD	ARG	D	494	29.177	24.229	52.977	1.00	51.88	C
ATOM	16258	NE	ARG	D	494	29.698	24.662	51.683	1.00	50.38	N
ATOM	16259	CZ	ARG	D	494	30.827	25.338	51.532	1.00	50.05	C
ATOM	16260	NH1	ARG	D	494	31.194	25.726	50.326	1.00	49.01	N
ATOM	16261	NH2	ARG	D	494	31.591	25.618	52.581	1.00	49.77	N
ATOM	16262	N	MET	D	495	24.933	27.066	53.513	1.00	55.98	N
ATOM	16263	CA	MET	D	495	24.097	27.482	52.400	1.00	52.57	C
ATOM	16264	C	MET	D	495	22.795	28.160	52.801	1.00	47.30	C
ATOM	16265	O	MET	D	495	22.247	28.907	52.005	1.00	46.91	O
ATOM	16266	CB	MET	D	495	23.758	26.284	51.512	1.00	50.42	C
ATOM	16267	CG	MET	D	495	24.955	25.631	50.829	1.00	49.49	C
ATOM	16268	SD	MET	D	495	24.419	24.308	49.742	1.00	54.13	S
ATOM	16269	CE	MET	D	495	23.716	23.175	50.916	1.00	52.73	C
ATOM	16270	O	THR	D	496	21.869	30.517	55.023	1.00	50.71	O
ATOM	16271	N	THR	D	496	22.287	27.872	53.996	1.00	47.19	N
ATOM	16272	CA	THR	D	496	20.954	28.364	54.405	1.00	49.32	C
ATOM	16273	C	THR	D	496	20.880	29.883	54.683	1.00	46.86	C
ATOM	16274	CB	THR	D	496	20.444	27.630	55.659	1.00	51.83	C
ATOM	16275	OG1	THR	D	496	21.549	27.304	56.512	1.00	55.87	O
ATOM	16276	CG2	THR	D	496	19.724	26.355	55.274	1.00	49.90	C
ATOM	16277	O	ASN	D	497	19.466	31.581	57.077	1.00	52.32	O
ATOM	16278	N	ASN	D	497	19.694	30.462	54.532	1.00	51.48	N
ATOM	16279	CA	ASN	D	497	19.542	31.905	54.700	1.00	49.45	C
ATOM	16280	C	ASN	D	497	19.708	32.344	56.141	1.00	51.97	C
ATOM	16281	CB	ASN	D	497	18.188	32.374	54.181	1.00	46.08	C
ATOM	16282	CG	ASN	D	497	18.203	32.680	52.702	1.00	48.20	C
ATOM	16283	OD1	ASN	D	497	19.156	33.254	52.197	1.00	51.15	O
ATOM	16284	ND2	ASN	D	497	17.142	32.299	52.000	1.00	46.40	N
ATOM	16285	O	PHE	D	498	18.379	35.523	56.250	1.00	55.30	O
ATOM	16286	N	PHE	D	498	20.174	33.575	56.298	1.00	54.05	N
ATOM	16287	CA	PHE	D	498	20.006	34.321	57.535	1.00	55.40	C
ATOM	16288	C	PHE	D	498	18.757	35.186	57.377	1.00	55.72	C
ATOM	16289	CB	PHE	D	498	21.244	35.165	57.821	1.00	54.94	C
ATOM	16290	CG	PHE	D	498	22.413	34.366	58.305	1.00	55.90	C
ATOM	16291	CD2	PHE	D	498	22.592	34.130	59.655	1.00	55.31	C
ATOM	16292	CD1	PHE	D	498	23.325	33.825	57.403	1.00	63.69	C
ATOM	16293	CE2	PHE	D	498	23.668	33.381	60.101	1.00	61.93	C
ATOM	16294	CE1	PHE	D	498	24.405	33.069	57.840	1.00	55.51	C
ATOM	16295	CZ	PHE	D	498	24.576	32.847	59.189	1.00	58.74	C
ATOM	16296	O	ASP	D	499	18.394	38.307	58.384	1.00	58.46	O
ATOM	16297	N	ASP	D	499	18.088	35.516	58.479	1.00	63.98	N
ATOM	16298	CA	ASP	D	499	16.926	36.421	58.415	1.00	56.42	C
ATOM	16299	C	ASP	D	499	17.406	37.765	57.888	1.00	57.00	C
ATOM	16300	CB	ASP	D	499	16.267	36.580	59.791	1.00	57.42	C
ATOM	16301	CG	ASP	D	499	14.852	37.196	59.722	1.00	62.92	C
ATOM	16302	OD1	ASP	D	499	14.568	38.059	58.845	1.00	61.52	O
ATOM	16303	OD2	ASP	D	499	14.013	36.811	60.567	1.00	58.46	O
ATOM	16304	O	LYS	D	500	17.607	41.494	57.823	1.00	59.85	O
ATOM	16305	N	LYS	D	500	16.746	38.284	56.858	1.00	51.31	N
ATOM	16306	CA	LYS	D	500	17.060	39.627	56.422	1.00	56.66	C
ATOM	16307	C	LYS	D	500	16.795	40.609	57.568	1.00	60.19	C
ATOM	16308	CB	LYS	D	500	16.253	40.020	55.191	1.00	59.16	C
ATOM	16309	CG	LYS	D	500	16.654	39.286	53.941	1.00	61.02	C
ATOM	16310	CD	LYS	D	500	15.939	39.837	52.731	1.00	57.28	C
ATOM	16311	CE	LYS	D	500	16.115	38.947	51.529	1.00	60.10	C
ATOM	16312	NZ	LYS	D	500	16.077	39.743	50.261	1.00	73.16	N
ATOM	16313	O	ASN	D	501	16.838	42.408	60.853	1.00	67.04	O
ATOM	16314	N	ASN	D	501	15.672	40.427	58.264	1.00	59.60	N
ATOM	16315	CA	ASN	D	501	15.305	41.302	59.382	1.00	61.40	C

ATOM	16316	C	ASN	D	501	16.392	41.339	60.452	1.00	60.43	C
ATOM	16317	CB	ASN	D	501	13.972	40.863	60.012	1.00	57.52	C
ATOM	16318	CG	ASN	D	501	12.796	40.925	59.030	1.00	61.65	C
ATOM	16319	OD1	ASN	D	501	12.127	39.920	58.782	1.00	67.49	O
ATOM	16320	ND2	ASN	D	501	12.544	42.104	58.474	1.00	48.55	N
ATOM	16321	O	LEU	D	502	18.883	37.944	61.046	1.00	61.46	O
ATOM	16322	N	LEU	D	502	16.801	40.165	60.915	1.00	58.85	N
ATOM	16323	CA	LEU	D	502	17.924	40.028	61.837	1.00	62.44	C
ATOM	16324	C	LEU	D	502	19.007	39.176	61.157	1.00	66.51	C
ATOM	16325	CB	LEU	D	502	17.466	39.404	63.153	1.00	64.31	C
ATOM	16326	CG	LEU	D	502	16.230	40.079	63.765	1.00	64.97	C
ATOM	16327	CD1	LEU	D	502	15.614	39.233	64.859	1.00	67.12	C
ATOM	16328	CD2	LEU	D	502	16.598	41.452	64.306	1.00	62.15	C
ATOM	16329	O	PRO	D	503	22.340	37.257	59.796	1.00	65.71	O
ATOM	16330	N	PRO	D	503	20.054	39.845	60.656	1.00	67.47	N
ATOM	16331	CA	PRO	D	503	21.081	39.258	59.787	1.00	65.74	C
ATOM	16332	C	PRO	D	503	21.924	38.188	60.467	1.00	66.02	C
ATOM	16333	CB	PRO	D	503	21.950	40.461	59.414	1.00	66.40	C
ATOM	16334	CG	PRO	D	503	21.069	41.647	59.627	1.00	64.86	C
ATOM	16335	CD	PRO	D	503	20.230	41.295	60.805	1.00	64.33	C
ATOM	16336	O	ASN	D	504	22.815	35.247	63.501	1.00	63.39	O
ATOM	16337	N	ASN	D	504	22.174	38.319	61.763	1.00	63.85	N
ATOM	16338	CA	ASN	D	504	23.019	37.372	62.459	1.00	60.66	C
ATOM	16339	C	ASN	D	504	22.261	36.138	62.877	1.00	65.08	C
ATOM	16340	CB	ASN	D	504	23.641	38.016	63.685	1.00	65.96	C
ATOM	16341	CG	ASN	D	504	25.140	37.857	63.713	1.00	80.98	C
ATOM	16342	OD1	ASN	D	504	25.867	38.613	63.058	1.00	85.38	C
ATOM	16343	ND2	ASN	D	504	25.619	36.864	64.461	1.00	74.67	N
ATOM	16344	O	GLU	D	505	19.423	34.359	60.751	1.00	62.00	O
ATOM	16345	N	GLU	D	505	20.983	36.092	62.537	1.00	66.08	N
ATOM	16346	CA	GLU	D	505	20.126	34.996	62.971	1.00	64.84	C
ATOM	16347	C	GLU	D	505	19.843	33.994	61.853	1.00	60.46	C
ATOM	16348	CB	GLU	D	505	18.809	35.556	63.523	1.00	68.75	C
ATOM	16349	CG	GLU	D	505	18.975	36.382	64.794	1.00	67.38	C
ATOM	16350	CD	GLU	D	505	19.557	35.560	65.939	1.00	71.00	C
ATOM	16351	OE1	GLU	D	505	19.161	34.379	66.088	1.00	70.74	O
ATOM	16352	OE2	GLU	D	505	20.417	36.092	66.676	1.00	72.97	O
ATOM	16353	O	LYS	D	506	17.543	31.565	61.977	1.00	62.73	O
ATOM	16354	N	LYS	D	506	20.071	32.723	62.151	1.00	60.85	N
ATOM	16355	CA	LYS	D	506	19.813	31.674	61.189	1.00	56.61	C
ATOM	16356	C	LYS	D	506	18.318	31.517	61.022	1.00	56.81	C
ATOM	16357	CB	LYS	D	506	20.470	30.352	61.623	1.00	60.46	C
ATOM	16358	CG	LYS	D	506	21.128	29.566	60.478	1.00	57.96	C
ATOM	16359	CD	LYS	D	506	21.948	30.461	59.547	1.00	55.84	C
ATOM	16360	CE	LYS	D	506	23.072	29.704	58.840	1.00	57.59	C
ATOM	16361	NZ	LYS	D	506	22.773	29.383	57.411	1.00	55.60	N
ATOM	16362	O	VAL	D	507	16.699	29.021	60.385	1.00	62.24	O
ATOM	16363	N	VAL	D	507	17.917	31.348	59.780	1.00	55.72	N
ATOM	16364	CA	VAL	D	507	16.524	31.211	59.426	1.00	48.62	C
ATOM	16365	C	VAL	D	507	15.944	29.916	59.995	1.00	55.57	C
ATOM	16366	CB	VAL	D	507	16.405	31.255	57.910	1.00	54.07	C
ATOM	16367	CG1	VAL	D	507	16.312	29.837	57.314	1.00	54.31	C
ATOM	16368	CG2	VAL	D	507	15.288	32.162	57.499	1.00	50.46	C
ATOM	16369	O	LEU	D	508	13.680	27.743	58.386	1.00	55.03	O
ATOM	16370	N	LEU	D	508	14.620	29.801	60.059	1.00	52.78	N
ATOM	16371	CA	LEU	D	508	14.015	28.589	60.616	1.00	57.45	C
ATOM	16372	C	LEU	D	508	13.745	27.488	59.589	1.00	55.40	C
ATOM	16373	CB	LEU	D	508	12.696	28.924	61.313	1.00	54.38	C
ATOM	16374	CG	LEU	D	508	12.656	29.243	62.807	1.00	59.86	C
ATOM	16375	CD1	LEU	D	508	11.327	29.940	63.136	1.00	61.29	C
ATOM	16376	CD2	LEU	D	508	12.833	28.022	63.684	1.00	48.20	C
ATOM	16377	O	PRO	D	509	10.869	26.232	59.488	1.00	66.55	O
ATOM	16378	N	PRO	D	509	13.563	26.253	60.069	1.00	51.82	N

ATOM	16379	CA	PRO	D	509	12.984	25.200	59.219	1.00	57.39	C
ATOM	16380	C	PRO	D	509	11.599	25.603	58.729	1.00	62.80	C
ATOM	16381	CB	PRO	D	509	12.904	23.995	60.150	1.00	53.92	C
ATOM	16382	CG	PRO	D	509	14.011	24.220	61.118	1.00	57.55	C
ATOM	16383	CD	PRO	D	509	14.097	25.716	61.328	1.00	52.19	C
ATOM	16384	O	LYS	D	510	7.655	25.155	57.309	1.00	68.42	O
ATOM	16385	N	LYS	D	510	11.244	25.258	57.493	1.00	63.47	N
ATOM	16386	CA	LYS	D	510	9.967	25.679	56.908	1.00	61.90	C
ATOM	16387	C	LYS	D	510	8.832	24.860	57.502	1.00	63.77	C
ATOM	16388	CB	LYS	D	510	10.009	25.544	55.385	1.00	61.86	C
ATOM	16389	CG	LYS	D	510	8.754	25.992	54.635	1.00	66.74	C
ATOM	16390	CD	LYS	D	510	8.562	27.510	54.587	1.00	60.85	C
ATOM	16391	CE	LYS	D	510	7.545	27.874	53.487	1.00	65.86	C
ATOM	16392	NZ	LYS	D	510	7.897	29.088	52.659	1.00	62.75	N
ATOM	16393	N	HIS	D	511	9.198	23.840	58.264	1.00	66.35	N
ATOM	16394	CA	HIS	D	511	8.213	22.926	58.810	1.00	67.40	C
ATOM	16395	C	HIS	D	511	8.184	23.018	60.326	1.00	68.04	C
ATOM	16396	O	HIS	D	511	7.461	22.273	60.982	1.00	69.77	O
ATOM	16397	CB	HIS	D	511	8.503	21.486	58.347	1.00	64.36	C
ATOM	16398	CG	HIS	D	511	8.179	21.241	56.906	1.00	62.38	C
ATOM	16399	ND1	HIS	D	511	6.892	21.041	56.455	1.00	63.84	N
ATOM	16400	CD2	HIS	D	511	8.972	21.181	55.811	1.00	66.32	C
ATOM	16401	CE1	HIS	D	511	6.902	20.878	55.146	1.00	63.57	C
ATOM	16402	NE2	HIS	D	511	8.154	20.955	54.730	1.00	73.64	N
ATOM	16403	N	SER	D	512	8.977	23.937	60.874	1.00	67.88	N
ATOM	16404	CA	SER	D	512	8.979	24.200	62.315	1.00	66.81	C
ATOM	16405	C	SER	D	512	7.585	24.528	62.821	1.00	71.01	O
ATOM	16406	O	SER	D	512	6.820	25.209	62.139	1.00	74.14	O
ATOM	16407	CB	SER	D	512	9.925	25.348	62.650	1.00	65.09	C
ATOM	16408	OG	SER	D	512	9.640	25.873	63.933	1.00	67.24	O
ATOM	16409	O	LEU	D	513	4.587	26.291	64.390	1.00	72.08	O
ATOM	16410	N	LEU	D	513	7.252	24.052	64.017	1.00	74.01	N
ATOM	16411	CA	LEU	D	513	5.926	24.304	64.592	1.00	75.10	C
ATOM	16412	C	LEU	D	513	5.643	25.791	64.800	1.00	71.53	C
ATOM	16413	CB	LEU	D	513	5.780	23.557	65.915	1.00	78.75	C
ATOM	16414	CG	LEU	D	513	5.701	22.041	65.741	1.00	67.00	C
ATOM	16415	CD2	LEU	D	513	4.357	21.689	65.134	1.00	70.48	C
ATOM	16416	CD1	LEU	D	513	5.897	21.339	67.063	1.00	66.38	C
ATOM	16417	N	LEU	D	514	6.594	26.489	65.424	1.00	72.24	N
ATOM	16418	CA	LEU	D	514	6.470	27.930	65.695	1.00	68.55	C
ATOM	16419	C	LEU	D	514	6.345	28.717	64.408	1.00	68.90	C
ATOM	16420	O	LEU	D	514	5.586	29.688	64.328	1.00	72.81	O
ATOM	16421	CB	LEU	D	514	7.667	28.444	66.501	1.00	68.30	C
ATOM	16422	CG	LEU	D	514	7.583	28.219	68.015	1.00	74.81	C
ATOM	16423	CD1	LEU	D	514	8.947	28.263	68.672	1.00	82.56	C
ATOM	16424	CD2	LEU	D	514	6.662	29.252	68.646	1.00	82.14	C
ATOM	16425	N	TYR	D	515	7.091	28.290	63.399	1.00	69.58	N
ATOM	16426	CA	TYR	D	515	6.983	28.883	62.078	1.00	66.84	C
ATOM	16427	C	TYR	D	515	5.564	28.664	61.577	1.00	66.47	C
ATOM	16428	O	TYR	D	515	4.977	29.514	60.904	1.00	65.45	O
ATOM	16429	CB	TYR	D	515	8.013	28.275	61.105	1.00	61.81	C
ATOM	16430	CG	TYR	D	515	8.212	29.114	59.872	1.00	55.61	C
ATOM	16431	CD2	TYR	D	515	7.521	28.836	58.707	1.00	53.67	C
ATOM	16432	CD1	TYR	D	515	9.066	30.211	59.882	1.00	60.76	C
ATOM	16433	CE2	TYR	D	515	7.673	29.619	57.573	1.00	52.80	C
ATOM	16434	CE1	TYR	D	515	9.231	31.008	58.744	1.00	57.49	C
ATOM	16435	CZ	TYR	D	515	8.529	30.698	57.595	1.00	54.15	C
ATOM	16436	OH	TYR	D	515	8.675	31.462	56.458	1.00	57.77	O
ATOM	16437	N	GLU	D	516	5.003	27.513	61.916	1.00	70.26	N
ATOM	16438	CA	GLU	D	516	3.707	27.161	61.377	1.00	71.45	C
ATOM	16439	C	GLU	D	516	2.611	27.859	62.164	1.00	70.01	C
ATOM	16440	O	GLU	D	516	1.604	28.263	61.593	1.00	71.92	O
ATOM	16441	CB	GLU	D	516	3.525	25.643	61.369	1.00	77.66	C

ATOM	16442	CG	GLU	D	516	4.370	24.934	60.300	1.00	69.91	C
ATOM	16443	CD	GLU	D	516	3.889	23.524	60.010	1.00	75.36	C
ATOM	16444	OE1	GLU	D	516	3.578	22.794	60.975	1.00	79.99	O
ATOM	16445	OE2	GLU	D	516	3.806	23.149	58.820	1.00	75.98	O
ATOM	16446	N	TYR	D	517	2.825	28.028	63.467	1.00	72.20	N
ATOM	16447	CA	TYR	D	517	1.944	28.865	64.281	1.00	70.43	C
ATOM	16448	C	TYR	D	517	1.952	30.295	63.767	1.00	69.54	C
ATOM	16449	O	TYR	D	517	0.920	30.963	63.743	1.00	71.03	O
ATOM	16450	CB	TYR	D	517	2.368	28.847	65.749	1.00	70.08	C
ATOM	16451	CG	TYR	D	517	2.050	27.570	66.486	1.00	65.58	C
ATOM	16452	CD1	TYR	D	517	0.873	26.871	66.242	1.00	68.50	C
ATOM	16453	CD2	TYR	D	517	2.916	27.078	67.437	1.00	65.59	C
ATOM	16454	CE1	TYR	D	517	0.580	25.710	66.919	1.00	68.12	C
ATOM	16455	CE2	TYR	D	517	2.638	25.924	68.121	1.00	68.91	C
ATOM	16456	CZ	TYR	D	517	1.471	25.235	67.861	1.00	74.79	C
ATOM	16457	OH	TYR	D	517	1.213	24.066	68.555	1.00	79.25	O
ATOM	16458	N	PHE	D	518	3.132	30.757	63.368	1.00	66.55	N
ATOM	16459	CA	PHE	D	518	3.295	32.088	62.808	1.00	64.65	C
ATOM	16460	C	PHE	D	518	2.389	32.294	61.613	1.00	67.88	C
ATOM	16461	O	PHE	D	518	1.599	33.250	61.565	1.00	69.88	O
ATOM	16462	CB	PHE	D	518	4.751	32.335	62.383	1.00	64.28	C
ATOM	16463	CG	PHE	D	518	4.974	33.675	61.700	1.00	68.99	C
ATOM	16464	CD2	PHE	D	518	4.680	33.852	60.351	1.00	66.98	C
ATOM	16465	CD1	PHE	D	518	5.468	34.757	62.411	1.00	62.32	C
ATOM	16466	CE2	PHE	D	518	4.871	35.074	59.730	1.00	58.51	C
ATOM	16467	CE1	PHE	D	518	5.683	35.969	61.791	1.00	58.26	C
ATOM	16468	CZ	PHE	D	518	5.376	36.129	60.448	1.00	59.98	C
ATOM	16469	N	THR	D	519	2.536	31.414	60.630	1.00	66.05	N
ATOM	16470	CA	THR	D	519	1.857	31.605	59.357	1.00	66.34	C
ATOM	16471	C	THR	D	519	0.362	31.657	59.577	1.00	62.33	C
ATOM	16472	O	THR	D	519	-0.308	32.474	58.967	1.00	70.95	O
ATOM	16473	CB	THR	D	519	2.194	30.484	58.302	1.00	69.36	C
ATOM	16474	OG1	THR	D	519	1.706	29.203	58.741	1.00	67.83	O
ATOM	16475	CG2	THR	D	519	3.699	30.413	58.028	1.00	62.16	C
ATOM	16476	N	VAL	D	520	-0.157	30.813	60.464	1.00	60.68	N
ATOM	16477	CA	VAL	D	520	-1.605	30.690	60.619	1.00	71.95	C
ATOM	16478	C	VAL	D	520	-2.192	31.927	61.322	1.00	70.67	C
ATOM	16479	O	VAL	D	520	-3.183	32.498	60.856	1.00	67.48	O
ATOM	16480	CB	VAL	D	520	-1.989	29.389	61.374	1.00	73.40	C
ATOM	16481	CG1	VAL	D	520	-3.338	29.540	62.073	1.00	77.99	C
ATOM	16482	CG2	VAL	D	520	-2.029	28.213	60.410	1.00	70.40	C
ATOM	16483	N	TYR	D	521	-1.554	32.362	62.406	1.00	70.83	N
ATOM	16484	CA	TYR	D	521	-2.001	33.557	63.117	1.00	68.66	C
ATOM	16485	C	TYR	D	521	-1.949	34.800	62.248	1.00	69.23	C
ATOM	16486	O	TYR	D	521	-2.905	35.565	62.219	1.00	71.15	O
ATOM	16487	CB	TYR	D	521	-1.178	33.777	64.378	1.00	64.98	C
ATOM	16488	CG	TYR	D	521	-1.678	32.951	65.533	1.00	70.38	C
ATOM	16489	CD1	TYR	D	521	-2.881	33.266	66.157	1.00	75.30	C
ATOM	16490	CD2	TYR	D	521	-0.961	31.855	66.001	1.00	74.18	C
ATOM	16491	CE1	TYR	D	521	-3.362	32.525	67.214	1.00	71.71	C
ATOM	16492	CE2	TYR	D	521	-1.430	31.101	67.064	1.00	78.87	C
ATOM	16493	CZ	TYR	D	521	-2.639	31.445	67.665	1.00	81.17	C
ATOM	16494	OH	TYR	D	521	-3.128	30.715	68.723	1.00	79.79	O
ATOM	16495	N	ASN	D	522	-0.852	34.993	61.524	1.00	70.29	N
ATOM	16496	CA	ASN	D	522	-0.725	36.177	60.684	1.00	68.73	C
ATOM	16497	C	ASN	D	522	-1.851	36.280	59.663	1.00	63.90	C
ATOM	16498	O	ASN	D	522	-2.234	37.369	59.263	1.00	67.55	O
ATOM	16499	CB	ASN	D	522	0.623	36.197	59.961	1.00	65.57	C
ATOM	16500	CG	ASN	D	522	0.951	37.572	59.420	1.00	70.01	C
ATOM	16501	OD1	ASN	D	522	0.991	38.538	60.175	1.00	71.83	O
ATOM	16502	ND2	ASN	D	522	1.149	37.678	58.112	1.00	65.86	N
ATOM	16503	N	GLU	D	523	-2.369	35.133	59.238	1.00	66.52	N
ATOM	16504	CA	GLU	D	523	-3.461	35.081	58.268	1.00	66.59	C

ATOM	16505	C	GLU	D	523	-4.791	35.169	59.008	1.00	67.50	C
ATOM	16506	O	GLU	D	523	-5.739	35.807	58.552	1.00	62.35	O
ATOM	16507	CB	GLU	D	523	-3.396	33.788	57.436	1.00	67.91	C
ATOM	16508	CG	GLU	D	523	-4.442	33.678	56.313	1.00	73.30	C
ATOM	16509	CD	GLU	D	523	-4.316	32.394	55.478	1.00	82.31	C
ATOM	16510	OE1	GLU	D	523	-5.228	32.130	54.655	1.00	76.14	O
ATOM	16511	OE2	GLU	D	523	-3.309	31.657	55.644	1.00	80.76	O
ATOM	16512	N	LEU	D	524	-4.837	34.520	60.164	1.00	66.40	N
ATOM	16513	CA	LEU	D	524	-6.024	34.520	60.996	1.00	73.13	C
ATOM	16514	C	LEU	D	524	-6.351	35.924	61.537	1.00	75.97	C
ATOM	16515	O	LEU	D	524	-7.510	36.336	61.524	1.00	71.92	O
ATOM	16516	CB	LEU	D	524	-5.846	33.536	62.147	1.00	72.24	C
ATOM	16517	CG	LEU	D	524	-7.112	32.900	62.720	1.00	77.26	C
ATOM	16518	CD1	LEU	D	524	-8.096	32.604	61.618	1.00	75.53	C
ATOM	16519	CD2	LEU	D	524	-6.738	31.621	63.452	1.00	79.49	C
ATOM	16520	N	THR	D	525	-5.325	36.659	61.972	1.00	70.54	N
ATOM	16521	CA	THR	D	525	-5.517	37.950	62.623	1.00	67.01	C
ATOM	16522	C	THR	D	525	-5.995	39.039	61.680	1.00	69.54	C
ATOM	16523	O	THR	D	525	-6.143	40.180	62.098	1.00	73.35	O
ATOM	16524	CB	THR	D	525	-4.221	38.448	63.288	1.00	69.38	C
ATOM	16525	OG1	THR	D	525	-4.511	39.582	64.113	1.00	72.05	O
ATOM	16526	CG2	THR	D	525	-3.203	38.855	62.235	1.00	71.06	C
ATOM	16527	N	LYS	D	526	-6.231	38.697	60.416	1.00	70.27	N
ATOM	16528	CA	LYS	D	526	-6.695	39.677	59.434	1.00	71.61	C
ATOM	16529	C	LYS	D	526	-7.979	39.205	58.760	1.00	73.57	C
ATOM	16530	O	LYS	D	526	-8.424	39.794	57.778	1.00	74.01	O
ATOM	16531	CB	LYS	D	526	-5.612	39.964	58.381	1.00	70.85	C
ATOM	16532	CG	LYS	D	526	-4.666	41.105	58.749	1.00	65.93	C
ATOM	16533	CD	LYS	D	526	-5.407	42.428	58.770	1.00	68.04	C
ATOM	16534	CE	LYS	D	526	-4.668	43.473	59.603	1.00	67.55	C
ATOM	16535	NZ	LYS	D	526	-5.226	44.854	59.428	1.00	66.43	N
ATOM	16536	N	VAL	D	527	-8.569	38.142	59.300	1.00	75.94	N
ATOM	16537	CA	VAL	D	527	-9.895	37.681	58.878	1.00	82.84	C
ATOM	16538	C	VAL	D	527	-11.020	38.390	59.649	1.00	83.22	C
ATOM	16539	O	VAL	D	527	-10.972	38.490	60.879	1.00	82.60	O
ATOM	16540	CB	VAL	D	527	-10.037	36.155	59.059	1.00	79.96	C
ATOM	16541	CG2	VAL	D	527	-9.382	35.421	57.890	1.00	82.12	C
ATOM	16542	CG1	VAL	D	527	-11.494	35.763	59.195	1.00	79.28	C
ATOM	16543	O	LYS	D	528	-14.721	38.486	58.071	1.00	87.18	O
ATOM	16544	N	LYS	D	528	-12.022	38.884	58.918	1.00	84.10	N
ATOM	16545	CA	LYS	D	528	-13.152	39.604	59.521	1.00	87.04	C
ATOM	16546	C	LYS	D	528	-14.509	38.963	59.189	1.00	89.37	C
ATOM	16547	CB	LYS	D	528	-13.166	41.075	59.068	1.00	84.09	C
ATOM	16548	CG	LYS	D	528	-12.032	41.935	59.613	1.00	79.80	C
ATOM	16549	CD	LYS	D	528	-12.449	43.401	59.805	1.00	80.76	C
ATOM	16550	CE	LYS	D	528	-12.762	44.104	58.480	1.00	85.35	C
ATOM	16551	NZ	LYS	D	528	-13.247	45.517	58.656	1.00	76.60	N
ATOM	16552	O	TYR	D	529	-17.682	40.400	61.091	1.00	83.47	O
ATOM	16553	N	TYR	D	529	-15.423	38.974	60.163	1.00	89.86	N
ATOM	16554	CA	TYR	D	529	-16.785	38.456	59.988	1.00	86.58	C
ATOM	16555	C	TYR	D	529	-17.856	39.516	60.247	1.00	87.94	C
ATOM	16556	CB	TYR	D	529	-17.036	37.276	60.924	1.00	87.51	C
ATOM	16557	CG	TYR	D	529	-16.848	37.628	62.381	1.00	89.86	C
ATOM	16558	CD1	TYR	D	529	-15.623	37.437	63.002	1.00	91.02	C
ATOM	16559	CD2	TYR	D	529	-17.886	38.161	63.137	1.00	86.62	C
ATOM	16560	CE1	TYR	D	529	-15.438	37.755	64.331	1.00	89.33	C
ATOM	16561	CE2	TYR	D	529	-17.704	38.492	64.475	1.00	87.49	C
ATOM	16562	CZ	TYR	D	529	-16.476	38.282	65.066	1.00	91.72	C
ATOM	16563	OH	TYR	D	529	-16.266	38.591	66.393	1.00	92.50	O
ATOM	16564	O	VAL	D	530	-21.474	38.599	58.703	1.00	91.77	O
ATOM	16565	N	VAL	D	530	-18.973	39.402	59.535	1.00	84.05	N
ATOM	16566	CA	VAL	D	530	-20.113	40.266	59.757	1.00	86.45	C
ATOM	16567	C	VAL	D	530	-21.401	39.466	59.569	1.00	88.74	C

ATOM	16568	CB	VAL	D	530	-20.084	41.494	58.813	1.00	88.15	C
ATOM	16569	CG2	VAL	D	530	-21.100	42.549	59.257	1.00	87.80	C
ATOM	16570	CG1	VAL	D	530	-20.312	41.079	57.368	1.00	83.40	C
ATOM	16571	O	THR	D	531	-24.528	41.358	60.413	1.00	90.57	O
ATOM	16572	N	THR	D	531	-22.397	39.728	60.414	1.00	89.96	N
ATOM	16573	CA	THR	D	531	-23.711	39.092	60.289	1.00	92.67	C
ATOM	16574	C	THR	D	531	-24.816	40.165	60.288	1.00	91.02	C
ATOM	16575	CB	THR	D	531	-23.958	38.057	61.420	1.00	91.15	C
ATOM	16576	OG1	THR	D	531	-25.059	37.201	61.073	1.00	88.41	O
ATOM	16577	CG2	THR	D	531	-24.237	38.758	62.750	1.00	87.56	C
ATOM	16578	O	GLU	D	532	-27.506	42.956	60.510	1.00	98.64	O
ATOM	16579	N	GLU	D	532	-26.068	39.733	60.143	1.00	91.91	N
ATOM	16580	CA	GLU	D	532	-27.205	40.635	59.920	1.00	94.76	C
ATOM	16581	C	GLU	D	532	-27.318	41.805	60.914	1.00	97.43	C
ATOM	16582	CB	GLU	D	532	-28.505	39.830	59.938	1.00	95.39	C
ATOM	16583	CG	GLU	D	532	-29.724	40.601	59.447	1.00	99.12	C
ATOM	16584	CD	GLU	D	532	-30.970	39.735	59.372	1.00	103.87	C
ATOM	16585	OE1	GLU	D	532	-30.983	38.652	60.000	1.00	102.69	O
ATOM	16586	OE2	GLU	D	532	-31.932	40.136	58.680	1.00	105.14	O
ATOM	16587	O	GLY	D	533	-25.763	43.363	64.849	1.00	100.37	O
ATOM	16588	N	GLY	D	533	-27.202	41.513	62.206	1.00	91.25	N
ATOM	16589	CA	GLY	D	533	-27.320	42.539	63.225	1.00	91.88	C
ATOM	16590	C	GLY	D	533	-26.008	43.175	63.651	1.00	97.52	C
ATOM	16591	O	MET	D	534	-24.009	45.612	61.000	1.00	92.89	O
ATOM	16592	N	MET	D	534	-25.167	43.510	62.675	1.00	94.73	N
ATOM	16593	CA	MET	D	534	-23.888	44.168	62.949	1.00	91.67	C
ATOM	16594	C	MET	D	534	-23.738	45.512	62.206	1.00	91.40	C
ATOM	16595	CB	MET	D	534	-22.727	43.227	62.595	1.00	91.50	C
ATOM	16596	CG	MET	D	534	-22.625	41.999	63.502	1.00	88.22	C
ATOM	16597	SD	MET	D	534	-21.225	40.896	63.167	1.00	82.09	S
ATOM	16598	CE	MET	D	534	-19.830	41.932	63.617	1.00	83.55	C
ATOM	16599	O	ARG	D	535	-22.015	48.622	60.387	1.00	90.77	O
ATOM	16600	N	ARG	D	535	-23.307	46.539	62.935	1.00	82.88	N
ATOM	16601	CA	ARG	D	535	-23.152	47.876	62.373	1.00	86.13	C
ATOM	16602	C	ARG	D	535	-21.988	47.913	61.397	1.00	89.82	C
ATOM	16603	CB	ARG	D	535	-22.941	48.909	63.486	1.00	88.06	C
ATOM	16604	O	LYS	D	536	-19.341	45.029	62.205	1.00	84.86	O
ATOM	16605	N	LYS	D	536	-20.958	47.144	61.724	1.00	92.28	N
ATOM	16606	CA	LYS	D	536	-19.795	46.980	60.867	1.00	84.85	C
ATOM	16607	C	LYS	D	536	-19.159	45.608	61.132	1.00	83.30	C
ATOM	16608	CB	LYS	D	536	-18.790	48.113	61.105	1.00	77.78	C
ATOM	16609	O	PRO	D	537	-15.886	45.051	61.457	1.00	81.34	O
ATOM	16610	N	PRO	D	537	-18.441	45.067	60.137	1.00	82.93	N
ATOM	16611	CA	PRO	D	537	-17.602	43.866	60.282	1.00	84.93	C
ATOM	16612	C	PRO	D	537	-16.501	43.992	61.345	1.00	77.93	C
ATOM	16613	CB	PRO	D	537	-16.983	43.708	58.888	1.00	84.76	C
ATOM	16614	CG	PRO	D	537	-17.290	45.025	58.157	1.00	78.64	C
ATOM	16615	CD	PRO	D	537	-18.564	45.477	58.730	1.00	77.76	C
ATOM	16616	O	ALA	D	538	-14.338	40.881	62.295	1.00	82.98	O
ATOM	16617	N	ALA	D	538	-16.251	42.926	62.103	1.00	78.27	N
ATOM	16618	CA	ALA	D	538	-15.233	42.958	63.153	1.00	80.58	C
ATOM	16619	C	ALA	D	538	-14.147	41.888	62.985	1.00	85.44	C
ATOM	16620	CB	ALA	D	538	-15.882	42.810	64.516	1.00	81.46	C
ATOM	16621	O	PHE	D	539	-13.325	39.756	64.917	1.00	90.75	O
ATOM	16622	N	PHE	D	539	-13.012	42.129	63.645	1.00	82.99	N
ATOM	16623	CA	PHE	D	539	-11.872	41.212	63.684	1.00	77.67	C
ATOM	16624	C	PHE	D	539	-12.185	39.974	64.520	1.00	82.01	C
ATOM	16625	CB	PHE	D	539	-10.635	41.907	64.273	1.00	74.30	C
ATOM	16626	CG	PHE	D	539	-9.928	42.849	63.327	1.00	69.73	C
ATOM	16627	CD2	PHE	D	539	-9.491	44.092	63.769	1.00	73.86	C
ATOM	16628	CD1	PHE	D	539	-9.677	42.491	62.018	1.00	72.52	C
ATOM	16629	CE2	PHE	D	539	-8.831	44.966	62.917	1.00	73.59	C
ATOM	16630	CE1	PHE	D	539	-9.017	43.355	61.158	1.00	70.55	C

ATOM	16631	CZ	PHE	D	539	-8.592	44.592	61.607	1.00	72.92	C
ATOM	16632	O	LEU	D	540	-9.373	38.955	66.903	1.00	84.70	O
ATOM	16633	N	LEU	D	540	-11.162	39.176	64.801	1.00	76.93	N
ATOM	16634	CA	LEU	D	540	-11.283	38.078	65.754	1.00	85.02	C
ATOM	16635	C	LEU	D	540	-10.464	38.399	66.997	1.00	86.52	C
ATOM	16636	CB	LEU	D	540	-10.821	36.755	65.138	1.00	79.34	C
ATOM	16637	CG	LEU	D	540	-11.646	36.269	63.946	1.00	80.33	C
ATOM	16638	CD1	LEU	D	540	-10.836	35.351	63.054	1.00	86.01	C
ATOM	16639	CD2	LEU	D	540	-12.861	35.548	64.446	1.00	83.43	C
ATOM	16640	O	SER	D	541	-9.425	36.134	69.187	1.00	91.97	O
ATOM	16641	N	SER	D	541	-10.997	38.059	68.163	1.00	89.93	N
ATOM	16642	CA	SER	D	541	-10.306	38.342	69.412	1.00	89.66	C
ATOM	16643	C	SER	D	541	-9.330	37.232	69.738	1.00	90.17	C
ATOM	16644	CB	SER	D	541	-11.298	38.498	70.558	1.00	90.96	C
ATOM	16645	OG	SER	D	541	-11.718	37.226	71.009	1.00	89.03	O
ATOM	16646	N	GLY	D	542	-8.400	37.516	70.644	1.00	90.21	N
ATOM	16647	CA	GLY	D	542	-7.470	36.508	71.116	1.00	86.84	C
ATOM	16648	C	GLY	D	542	-8.245	35.316	71.639	1.00	91.54	C
ATOM	16649	O	GLY	D	542	-7.811	34.173	71.494	1.00	89.51	O
ATOM	16650	N	GLU	D	543	-9.404	35.598	72.235	1.00	92.65	N
ATOM	16651	CA	GLU	D	543	-10.311	34.566	72.721	1.00	91.72	C
ATOM	16652	C	GLU	D	543	-10.775	33.694	71.565	1.00	87.41	C
ATOM	16653	O	GLU	D	543	-10.660	32.472	71.619	1.00	91.13	O
ATOM	16654	CB	GLU	D	543	-11.519	35.188	73.438	1.00	86.05	C
ATOM	16655	N	GLN	D	544	-11.290	34.331	70.519	1.00	87.30	N
ATOM	16656	CA	GLN	D	544	-11.766	33.617	69.342	1.00	85.92	C
ATOM	16657	C	GLN	D	544	-10.583	32.940	68.664	1.00	91.98	C
ATOM	16658	O	GLN	D	544	-10.675	31.791	68.239	1.00	91.88	O
ATOM	16659	CB	GLN	D	544	-12.492	34.567	68.373	1.00	85.18	C
ATOM	16660	CG	GLN	D	544	-13.774	35.177	68.946	1.00	86.10	C
ATOM	16661	CD	GLN	D	544	-14.292	36.367	68.148	1.00	86.59	C
ATOM	16662	OE1	GLN	D	544	-14.068	37.520	68.513	1.00	91.05	O
ATOM	16663	NE2	GLN	D	544	-15.007	36.089	67.069	1.00	89.92	N
ATOM	16664	N	LYS	D	545	-9.462	33.650	68.594	1.00	92.25	N
ATOM	16665	CA	LYS	D	545	-8.265	33.135	67.941	1.00	90.16	C
ATOM	16666	C	LYS	D	545	-7.848	31.780	68.516	1.00	87.25	C
ATOM	16667	O	LYS	D	545	-7.779	30.796	67.783	1.00	87.47	O
ATOM	16668	CB	LYS	D	545	-7.118	34.144	68.061	1.00	90.07	C
ATOM	16669	N	LYS	D	546	-7.594	31.725	69.823	1.00	85.44	N
ATOM	16670	CA	LYS	D	546	-7.181	30.478	70.468	1.00	84.32	C
ATOM	16671	C	LYS	D	546	-8.217	29.394	70.249	1.00	87.23	C
ATOM	16672	O	LYS	D	546	-7.889	28.216	70.185	1.00	88.07	O
ATOM	16673	CB	LYS	D	546	-6.950	30.678	71.966	1.00	79.34	C
ATOM	16674	N	ALA	D	547	-9.474	29.806	70.130	1.00	92.01	N
ATOM	16675	CA	ALA	D	547	-10.561	28.869	69.882	1.00	90.20	C
ATOM	16676	C	ALA	D	547	-10.494	28.320	68.465	1.00	88.51	C
ATOM	16677	O	ALA	D	547	-10.397	27.115	68.283	1.00	91.88	O
ATOM	16678	CB	ALA	D	547	-11.906	29.528	70.135	1.00	88.28	C
ATOM	16679	N	ILE	D	548	-10.529	29.202	67.468	1.00	88.48	N
ATOM	16680	CA	ILE	D	548	-10.546	28.786	66.063	1.00	88.82	C
ATOM	16681	C	ILE	D	548	-9.308	27.956	65.709	1.00	87.92	C
ATOM	16682	O	ILE	D	548	-9.326	27.173	64.763	1.00	84.68	O
ATOM	16683	CB	ILE	D	548	-10.630	30.001	65.116	1.00	83.29	C
ATOM	16684	CG1	ILE	D	548	-11.727	30.954	65.568	1.00	86.79	C
ATOM	16685	CG2	ILE	D	548	-10.920	29.568	63.688	1.00	85.43	C
ATOM	16686	CD1	ILE	D	548	-11.715	32.250	64.835	1.00	87.54	C
ATOM	16687	N	VAL	D	549	-8.242	28.128	66.483	1.00	84.18	N
ATOM	16688	CA	VAL	D	549	-7.023	27.368	66.282	1.00	87.02	C
ATOM	16689	C	VAL	D	549	-7.107	26.009	66.977	1.00	92.14	C
ATOM	16690	O	VAL	D	549	-6.801	24.975	66.373	1.00	92.85	O
ATOM	16691	CB	VAL	D	549	-5.777	28.127	66.802	1.00	88.99	C
ATOM	16692	CG1	VAL	D	549	-4.543	27.221	66.765	1.00	84.61	C
ATOM	16693	CG2	VAL	D	549	-5.534	29.396	65.989	1.00	85.13	C

ATOM	16694	N	ASP	D	550	-7.516	26.013	68.245	1.00	92.88	N
ATOM	16695	CA	ASP	D	550	-7.617	24.777	69.030	1.00	93.93	C
ATOM	16696	C	ASP	D	550	-8.718	23.863	68.502	1.00	91.65	C
ATOM	16697	O	ASP	D	550	-8.698	22.651	68.715	1.00	93.79	O
ATOM	16698	CB	ASP	D	550	-7.877	25.093	70.508	1.00	96.72	C
ATOM	16699	CG	ASP	D	550	-6.598	25.380	71.283	1.00	100.41	C
ATOM	16700	OD1	ASP	D	550	-5.534	24.844	70.884	1.00	95.63	O
ATOM	16701	OD2	ASP	D	550	-6.665	26.133	72.291	1.00	94.42	O
ATOM	16702	N	LEU	D	551	-9.666	24.463	67.794	1.00	90.55	N
ATOM	16703	CA	LEU	D	551	-10.854	23.771	67.318	1.00	90.96	C
ATOM	16704	C	LEU	D	551	-10.688	23.240	65.905	1.00	94.13	C
ATOM	16705	O	LEU	D	551	-10.915	22.060	65.645	1.00	98.24	O
ATOM	16706	CB	LEU	D	551	-12.058	24.713	67.363	1.00	94.36	C
ATOM	16707	CG	LEU	D	551	-13.427	24.055	67.386	1.00	93.27	C
ATOM	16708	CD1	LEU	D	551	-13.536	23.198	68.638	1.00	93.09	C
ATOM	16709	CD2	LEU	D	551	-14.518	25.110	67.337	1.00	88.63	C
ATOM	16710	N	LEU	D	552	-10.294	24.116	64.991	1.00	90.44	N
ATOM	16711	CA	LEU	D	552	-10.262	23.757	63.583	1.00	91.41	C
ATOM	16712	C	LEU	D	552	-8.862	23.310	63.104	1.00	96.90	C
ATOM	16713	O	LEU	D	552	-8.689	22.168	62.647	1.00	97.51	O
ATOM	16714	CB	LEU	D	552	-10.780	24.929	62.738	1.00	91.50	C
ATOM	16715	CG	LEU	D	552	-12.303	25.042	62.542	1.00	94.80	C
ATOM	16716	CD1	LEU	D	552	-13.040	25.182	63.862	1.00	98.04	C
ATOM	16717	CD2	LEU	D	552	-12.682	26.194	61.614	1.00	94.15	C
ATOM	16718	N	PHE	D	553	-7.871	24.191	63.221	1.00	91.54	N
ATOM	16719	CA	PHE	D	553	-6.535	23.920	62.692	1.00	88.79	C
ATOM	16720	C	PHE	D	553	-5.832	22.730	63.354	1.00	92.76	C
ATOM	16721	O	PHE	D	553	-5.071	22.007	62.694	1.00	90.43	O
ATOM	16722	CB	PHE	D	553	-5.660	25.163	62.823	1.00	86.52	C
ATOM	16723	CG	PHE	D	553	-6.068	26.274	61.919	1.00	86.91	C
ATOM	16724	CD1	PHE	D	553	-6.962	27.232	62.345	1.00	83.10	C
ATOM	16725	CD2	PHE	D	553	-5.564	26.360	60.637	1.00	84.55	C
ATOM	16726	CE1	PHE	D	553	-7.348	28.252	61.512	1.00	81.39	C
ATOM	16727	CE2	PHE	D	553	-5.949	27.387	59.802	1.00	83.69	C
ATOM	16728	CZ	PHE	D	553	-6.843	28.331	60.243	1.00	79.36	C
ATOM	16729	N	LYS	D	554	-6.080	22.525	64.646	1.00	89.24	N
ATOM	16730	CA	LYS	D	554	-5.435	21.432	65.363	1.00	91.00	C
ATOM	16731	C	LYS	D	554	-6.194	20.116	65.214	1.00	93.57	C
ATOM	16732	O	LYS	D	554	-5.824	19.110	65.820	1.00	93.85	O
ATOM	16733	CB	LYS	D	554	-5.273	21.780	66.837	1.00	88.75	C
ATOM	16734	CG	LYS	D	554	-4.128	22.730	67.103	1.00	87.29	C
ATOM	16735	CD	LYS	D	554	-3.815	22.825	68.584	1.00	89.99	C
ATOM	16736	CE	LYS	D	554	-2.478	23.512	68.816	1.00	86.52	C
ATOM	16737	NZ	LYS	D	554	-2.115	23.606	70.257	1.00	84.81	N
ATOM	16738	N	THR	D	555	-7.244	20.126	64.395	1.00	96.92	N
ATOM	16739	CA	THR	D	555	-8.001	18.909	64.100	1.00	98.92	C
ATOM	16740	C	THR	D	555	-8.088	18.627	62.595	1.00	98.78	C
ATOM	16741	O	THR	D	555	-7.890	17.490	62.162	1.00	99.10	O
ATOM	16742	CB	THR	D	555	-9.426	18.979	64.663	1.00	95.70	C
ATOM	16743	OG1	THR	D	555	-10.165	19.966	63.941	1.00	99.10	O
ATOM	16744	CG2	THR	D	555	-9.409	19.332	66.146	1.00	94.53	C
ATOM	16745	N	ASN	D	556	-8.392	19.654	61.804	1.00	96.20	N
ATOM	16746	CA	ASN	D	556	-8.421	19.504	60.349	1.00	95.87	C
ATOM	16747	C	ASN	D	556	-7.086	19.874	59.713	1.00	94.62	C
ATOM	16748	O	ASN	D	556	-6.524	20.931	59.998	1.00	93.93	O
ATOM	16749	CB	ASN	D	556	-9.540	20.349	59.734	1.00	97.42	C
ATOM	16750	CG	ASN	D	556	-10.915	19.755	59.965	1.00	95.63	C
ATOM	16751	OD1	ASN	D	556	-11.126	19.019	60.925	1.00	100.65	O
ATOM	16752	ND2	ASN	D	556	-11.858	20.071	59.084	1.00	93.14	N
ATOM	16753	O	ARG	D	557	-4.421	21.324	57.597	1.00	86.49	O
ATOM	16754	N	ARG	D	557	-6.580	18.977	58.871	1.00	99.20	N
ATOM	16755	CA	ARG	D	557	-5.313	19.160	58.161	1.00	94.95	C
ATOM	16756	C	ARG	D	557	-5.308	20.495	57.420	1.00	89.93	C

ATOM	16757	CB	ARG	D	557	-5.089	17.996	57.185	1.00	91.68	C
ATOM	16758	CG	ARG	D	557	-3.665	17.834	56.695	1.00	91.98	C
ATOM	16759	CD	ARG	D	557	-2.927	16.719	57.437	1.00	91.48	C
ATOM	16760	NE	ARG	D	557	-1.489	16.982	57.499	1.00	92.43	N
ATOM	16761	CZ	ARG	D	557	-0.598	16.228	58.141	1.00	87.42	C
ATOM	16762	NH1	ARG	D	557	-0.969	15.130	58.792	1.00	83.34	N
ATOM	16763	NH2	ARG	D	557	0.676	16.582	58.129	1.00	79.73	N
ATOM	16764	O	LYS	D	558	-8.627	21.819	57.064	1.00	94.06	O
ATOM	16765	N	LYS	D	558	-6.319	20.693	56.589	1.00	89.93	N
ATOM	16766	CA	LYS	D	558	-6.528	21.972	55.942	1.00	88.59	C
ATOM	16767	C	LYS	D	558	-7.810	22.558	56.518	1.00	92.20	C
ATOM	16768	CB	LYS	D	558	-6.620	21.807	54.424	1.00	87.31	C
ATOM	16769	CG	LYS	D	558	-6.070	22.990	53.632	1.00	86.20	C
ATOM	16770	O	VAL	D	559	-9.399	26.183	55.221	1.00	91.02	O
ATOM	16771	N	VAL	D	559	-7.988	23.873	56.416	1.00	92.18	N
ATOM	16772	CA	VAL	D	559	-9.202	24.503	56.930	1.00	87.26	C
ATOM	16773	C	VAL	D	559	-9.962	25.301	55.871	1.00	90.34	C
ATOM	16774	CB	VAL	D	559	-8.882	25.416	58.105	1.00	84.86	C
ATOM	16775	CG1	VAL	D	559	-10.125	26.185	58.518	1.00	90.78	C
ATOM	16776	CG2	VAL	D	559	-8.344	24.588	59.266	1.00	87.60	C
ATOM	16777	O	THR	D	560	-12.931	27.021	56.491	1.00	94.65	O
ATOM	16778	N	THR	D	560	-11.245	24.979	55.712	1.00	93.82	N
ATOM	16779	CA	THR	D	560	-12.114	25.624	54.725	1.00	95.80	C
ATOM	16780	C	THR	D	560	-12.775	26.878	55.276	1.00	96.58	C
ATOM	16781	CB	THR	D	560	-13.244	24.679	54.257	1.00	96.41	C
ATOM	16782	OG1	THR	D	560	-12.825	23.317	54.403	1.00	98.47	O
ATOM	16783	CG2	THR	D	560	-13.666	24.970	52.815	1.00	94.03	C
ATOM	16784	N	VAL	D	561	-13.176	27.773	54.377	1.00	98.21	N
ATOM	16785	CA	VAL	D	561	-14.055	28.877	54.742	1.00	98.03	C
ATOM	16786	C	VAL	D	561	-15.459	28.313	54.939	1.00	102.59	C
ATOM	16787	O	VAL	D	561	-16.212	28.761	55.812	1.00	102.24	O
ATOM	16788	CB	VAL	D	561	-14.058	29.982	53.674	1.00	97.26	C
ATOM	16789	CG1	VAL	D	561	-15.109	31.045	53.987	1.00	96.94	C
ATOM	16790	CG2	VAL	D	561	-12.681	30.603	53.571	1.00	94.56	C
ATOM	16791	N	LYS	D	562	-15.793	27.309	54.130	1.00	104.51	N
ATOM	16792	CA	LYS	D	562	-17.031	26.559	54.301	1.00	103.19	C
ATOM	16793	C	LYS	D	562	-17.014	25.804	55.629	1.00	102.69	C
ATOM	16794	O	LYS	D	562	-18.060	25.519	56.196	1.00	105.23	O
ATOM	16795	CB	LYS	D	562	-17.242	25.589	53.136	1.00	104.29	C
ATOM	16796	N	GLN	D	563	-15.823	25.487	56.127	1.00	102.42	N
ATOM	16797	CA	GLN	D	563	-15.691	24.822	57.420	1.00	100.53	C
ATOM	16798	C	GLN	D	563	-15.660	25.834	58.564	1.00	101.32	C
ATOM	16799	O	GLN	D	563	-16.155	25.566	59.647	1.00	103.05	O
ATOM	16800	CB	GLN	D	563	-14.432	23.951	57.457	1.00	92.96	C
ATOM	16801	N	LEU	D	564	-15.071	26.998	58.334	1.00	99.26	N
ATOM	16802	CA	LEU	D	564	-15.032	28.023	59.371	1.00	101.42	C
ATOM	16803	C	LEU	D	564	-16.418	28.629	59.603	1.00	105.01	C
ATOM	16804	O	LEU	D	564	-16.832	28.846	60.749	1.00	101.53	O
ATOM	16805	CB	LEU	D	564	-14.046	29.130	59.002	1.00	101.63	C
ATOM	16806	CG	LEU	D	564	-14.151	30.378	59.884	1.00	95.64	C
ATOM	16807	CD1	LEU	D	564	-13.489	30.126	61.237	1.00	91.79	C
ATOM	16808	CD2	LEU	D	564	-13.578	31.607	59.182	1.00	84.35	C
ATOM	16809	N	LYS	D	565	-17.114	28.906	58.500	1.00	102.81	N
ATOM	16810	CA	LYS	D	565	-18.452	29.477	58.537	1.00	97.33	C
ATOM	16811	C	LYS	D	565	-19.452	28.540	59.212	1.00	99.96	C
ATOM	16812	O	LYS	D	565	-20.167	28.939	60.125	1.00	99.36	O
ATOM	16813	CB	LYS	D	565	-18.920	29.814	57.120	1.00	96.29	C
ATOM	16814	N	GLU	D	566	-19.488	27.284	58.784	1.00	102.64	N
ATOM	16815	CA	GLU	D	566	-20.515	26.358	59.262	1.00	104.30	C
ATOM	16816	C	GLU	D	566	-20.203	25.672	60.603	1.00	101.02	C
ATOM	16817	O	GLU	D	566	-21.117	25.320	61.348	1.00	97.05	O
ATOM	16818	CB	GLU	D	566	-20.785	25.301	58.184	1.00	104.50	C
ATOM	16819	CG	GLU	D	566	-21.547	25.855	56.971	1.00	110.38	C

ATOM	16820	CD	GLU	D	566	-20.948	25.438	55.632	1.00115.21	C
ATOM	16821	OE1	GLU	D	566	-20.939	26.273	54.694	1.00109.20	O
ATOM	16822	OE2	GLU	D	566	-20.486	24.279	55.520	1.00115.50	O
ATOM	16823	N	ASP	D	567	-18.926	25.501	60.924	1.00102.65	N
ATOM	16824	CA	ASP	D	567	-18.552	24.686	62.078	1.00103.96	C
ATOM	16825	C	ASP	D	567	-18.278	25.486	63.340	1.00106.78	C
ATOM	16826	O	ASP	D	567	-18.610	25.041	64.434	1.00111.62	O
ATOM	16827	CB	ASP	D	567	-17.319	23.844	61.757	1.00108.41	O
ATOM	16828	CG	ASP	D	567	-17.240	22.590	62.589	1.00110.14	C
ATOM	16829	OD1	ASP	D	567	-17.943	22.505	63.617	1.00109.68	O
ATOM	16830	OD2	ASP	D	567	-16.473	21.684	62.208	1.00115.10	O
ATOM	16831	N	TYR	D	568	-17.661	26.654	63.202	1.00106.86	N
ATOM	16832	CA	TYR	D	568	-17.279	27.425	64.381	1.00103.41	C
ATOM	16833	C	TYR	D	568	-18.481	28.045	65.102	1.00105.93	C
ATOM	16834	O	TYR	D	568	-18.535	28.069	66.334	1.00103.46	O
ATOM	16835	CB	TYR	D	568	-16.288	28.520	64.007	1.00100.47	C
ATOM	16836	CG	TYR	D	568	-15.920	29.370	65.194	1.00 97.65	C
ATOM	16837	CD1	TYR	D	568	-15.115	28.865	66.204	1.00 93.49	C
ATOM	16838	CD2	TYR	D	568	-16.394	30.669	65.319	1.00100.43	C
ATOM	16839	CE1	TYR	D	568	-14.782	29.632	67.301	1.00 92.41	C
ATOM	16840	CE2	TYR	D	568	-16.068	31.447	66.413	1.00 97.58	C
ATOM	16841	CZ	TYR	D	568	-15.260	30.922	67.402	1.00 92.89	C
ATOM	16842	OH	TYR	D	568	-14.927	31.685	68.496	1.00 87.33	O
ATOM	16843	N	PHE	D	569	-19.444	28.545	64.334	1.00105.50	N
ATOM	16844	CA	PHE	D	569	-20.620	29.178	64.915	1.00102.96	C
ATOM	16845	C	PHE	D	569	-21.748	28.171	65.156	1.00106.70	C
ATOM	16846	O	PHE	D	569	-21.697	27.365	66.091	1.00101.65	O
ATOM	16847	CB	PHE	D	569	-21.100	30.305	64.005	1.00103.07	C
ATOM	16848	CG	PHE	D	569	-19.987	31.183	63.487	1.00104.91	C
ATOM	16849	CD2	PHE	D	569	-19.585	31.110	62.164	1.00102.06	C
ATOM	16850	CD1	PHE	D	569	-19.353	32.093	64.319	1.00108.38	C
ATOM	16851	CE2	PHE	D	569	-18.567	31.923	61.677	1.00 99.52	C
ATOM	16852	CE1	PHE	D	569	-18.334	32.911	63.839	1.00105.63	C
ATOM	16853	CZ	PHE	D	569	-17.940	32.820	62.515	1.00100.60	C
ATOM	16854	O	VAL	D	578	-21.695	33.901	56.726	1.00 92.10	O
ATOM	16855	N	VAL	D	578	-24.253	34.649	58.039	1.00 92.98	N
ATOM	16856	CA	VAL	D	578	-22.904	35.043	58.435	1.00 93.58	C
ATOM	16857	C	VAL	D	578	-21.898	34.960	57.299	1.00 91.60	C
ATOM	16858	CB	VAL	D	578	-22.373	34.172	59.571	1.00 93.39	C
ATOM	16859	CG1	VAL	D	578	-20.950	34.596	59.920	1.00 91.40	C
ATOM	16860	CG2	VAL	D	578	-23.304	34.251	60.783	1.00 97.15	C
ATOM	16861	O	GLU	D	579	-18.575	36.738	57.524	1.00 90.95	O
ATOM	16862	N	GLU	D	579	-21.247	36.074	56.994	1.00 92.99	N
ATOM	16863	CA	GLU	D	579	-20.270	36.102	55.913	1.00 96.43	C
ATOM	16864	C	GLU	D	579	-18.825	36.263	56.409	1.00 98.25	C
ATOM	16865	CB	GLU	D	579	-20.614	37.215	54.928	1.00 96.17	C
ATOM	16866	CG	GLU	D	579	-21.472	36.755	53.769	1.00 99.19	C
ATOM	16867	CD	GLU	D	579	-20.742	36.856	52.443	1.00110.77	C
ATOM	16868	OE1	GLU	D	579	-20.612	37.986	51.920	1.00116.95	O
ATOM	16869	OE2	GLU	D	579	-20.289	35.810	51.930	1.00113.62	O
ATOM	16870	O	ILE	D	580	-15.888	36.636	53.672	1.00 92.17	O
ATOM	16871	N	ILE	D	580	-17.882	35.848	55.563	1.00 97.44	N
ATOM	16872	CA	ILE	D	580	-16.460	35.876	55.892	1.00 90.37	C
ATOM	16873	C	ILE	D	580	-15.647	36.693	54.880	1.00 92.50	C
ATOM	16874	CB	ILE	D	580	-15.881	34.458	55.959	1.00 91.56	C
ATOM	16875	CG1	ILE	D	580	-16.798	33.548	56.777	1.00 94.39	C
ATOM	16876	CG2	ILE	D	580	-14.487	34.482	56.551	1.00 91.71	C
ATOM	16877	CD1	ILE	D	580	-16.955	33.981	58.222	1.00 98.27	C
ATOM	16878	O	SER	D	581	-12.048	37.294	55.882	1.00 84.54	O
ATOM	16879	N	SER	D	581	-14.683	37.453	55.390	1.00 93.33	N
ATOM	16880	CA	SER	D	581	-13.805	38.263	54.558	1.00 89.37	C
ATOM	16881	C	SER	D	581	-12.337	37.947	54.880	1.00 84.76	C
ATOM	16882	CB	SER	D	581	-14.107	39.749	54.772	1.00 84.45	C

ATOM	16883	OG	SER	D	581	-13.585	40.544	53.723	1.00	83.89	O
ATOM	16884	O	GLY	D	582	-8.663	36.292	54.792	1.00	85.79	O
ATOM	16885	N	GLY	D	582	-11.418	38.404	54.032	1.00	84.51	N
ATOM	16886	CA	GLY	D	582	-9.997	38.209	54.264	1.00	81.46	C
ATOM	16887	C	GLY	D	582	-9.582	36.757	54.120	1.00	83.58	C
ATOM	16888	O	VAL	D	583	-12.077	34.883	51.778	1.00	88.83	O
ATOM	16889	N	VAL	D	583	-10.273	36.048	53.237	1.00	85.21	N
ATOM	16890	CA	VAL	D	583	-10.024	34.633	52.975	1.00	89.17	C
ATOM	16891	C	VAL	D	583	-11.057	34.212	51.933	1.00	91.94	C
ATOM	16892	CB	VAL	D	583	-10.132	33.772	54.257	1.00	85.05	C
ATOM	16893	CG1	VAL	D	583	-11.553	33.743	54.748	1.00	87.15	C
ATOM	16894	CG2	VAL	D	583	-9.610	32.374	54.024	1.00	85.34	C
ATOM	16895	O	GLU	D	584	-13.521	31.322	50.527	1.00	102.09	O
ATOM	16896	N	GLU	D	584	-10.805	33.120	51.215	1.00	95.68	N
ATOM	16897	CA	GLU	D	584	-11.644	32.761	50.070	1.00	94.19	C
ATOM	16898	C	GLU	D	584	-12.335	31.397	50.191	1.00	97.84	C
ATOM	16899	CB	GLU	D	584	-10.808	32.803	48.794	1.00	95.88	C
ATOM	16900	CG	GLU	D	584	-10.253	34.179	48.465	1.00	97.30	C
ATOM	16901	CD	GLU	D	584	-11.134	34.946	47.507	1.00	95.59	C
ATOM	16902	OE1	GLU	D	584	-10.584	35.697	46.671	1.00	94.93	O
ATOM	16903	OE2	GLU	D	584	-12.372	34.793	47.584	1.00	96.18	O
ATOM	16904	O	ASP	D	585	-12.426	27.759	52.044	1.00	92.04	O
ATOM	16905	N	ASP	D	585	-11.617	30.318	49.896	1.00	96.64	N
ATOM	16906	CA	ASP	D	585	-12.216	28.989	49.991	1.00	94.83	C
ATOM	16907	C	ASP	D	585	-11.675	28.266	51.209	1.00	93.37	C
ATOM	16908	CB	ASP	D	585	-11.940	28.168	48.731	1.00	96.52	C
ATOM	16909	CG	ASP	D	585	-11.883	29.021	47.480	1.00	97.56	C
ATOM	16910	OD1	ASP	D	585	-11.220	30.076	47.502	1.00	93.36	O
ATOM	16911	OD2	ASP	D	585	-12.499	28.632	46.470	1.00	103.86	O
ATOM	16912	O	ARG	D	586	-8.142	29.388	52.074	1.00	85.03	O
ATOM	16913	N	ARG	D	586	-10.353	28.221	51.288	1.00	94.33	N
ATOM	16914	CA	ARG	D	586	-9.665	27.585	52.394	1.00	91.41	C
ATOM	16915	C	ARG	D	586	-8.555	28.510	52.833	1.00	87.92	C
ATOM	16916	CB	ARG	D	586	-9.106	26.221	51.988	1.00	82.68	C
ATOM	16917	O	PHE	D	587	-5.488	27.343	53.581	1.00	78.93	O
ATOM	16918	N	PHE	D	587	-8.078	28.327	54.057	1.00	85.46	N
ATOM	16919	CA	PHE	D	587	-6.907	29.061	54.502	1.00	86.30	C
ATOM	16920	C	PHE	D	587	-5.660	28.557	53.777	1.00	84.99	C
ATOM	16921	CB	PHE	D	587	-6.724	28.942	56.018	1.00	88.60	C
ATOM	16922	CG	PHE	D	587	-7.711	29.752	56.814	1.00	89.08	C
ATOM	16923	CD1	PHE	D	587	-7.690	31.133	56.768	1.00	84.58	C
ATOM	16924	CD2	PHE	D	587	-8.654	29.129	57.614	1.00	89.48	C
ATOM	16925	CE1	PHE	D	587	-8.597	31.872	57.499	1.00	85.98	C
ATOM	16926	CE2	PHE	D	587	-9.558	29.864	58.349	1.00	80.37	C
ATOM	16927	CZ	PHE	D	587	-9.527	31.234	58.291	1.00	81.43	C
ATOM	16928	O	ASN	D	588	-1.885	27.529	53.369	1.00	75.65	O
ATOM	16929	N	ASN	D	588	-4.812	29.504	53.368	1.00	82.60	N
ATOM	16930	CA	ASN	D	588	-3.500	29.215	52.789	1.00	79.41	C
ATOM	16931	C	ASN	D	588	-2.572	28.473	53.754	1.00	77.23	C
ATOM	16932	CB	ASN	D	588	-2.821	30.511	52.347	1.00	75.29	C
ATOM	16933	CG	ASN	D	588	-3.624	31.277	51.313	1.00	71.60	C
ATOM	16934	OD1	ASN	D	588	-4.272	30.690	50.450	1.00	70.37	O
ATOM	16935	ND2	ASN	D	588	-3.564	32.601	51.387	1.00	72.12	N
ATOM	16936	O	ALA	D	589	-3.524	26.940	56.645	1.00	78.43	O
ATOM	16937	N	ALA	D	589	-2.552	28.909	55.009	1.00	76.07	N
ATOM	16938	CA	ALA	D	589	-1.673	28.316	56.012	1.00	76.41	C
ATOM	16939	C	ALA	D	589	-2.308	27.107	56.683	1.00	73.83	C
ATOM	16940	CB	ALA	D	589	-1.296	29.354	57.054	1.00	72.39	C
ATOM	16941	O	SER	D	590	0.276	25.029	58.934	1.00	74.48	O
ATOM	16942	N	SER	D	590	-1.476	26.279	57.305	1.00	72.65	N
ATOM	16943	CA	SER	D	590	-1.929	25.079	57.998	1.00	68.67	C
ATOM	16944	C	SER	D	590	-0.868	24.584	58.969	1.00	73.62	C
ATOM	16945	CB	SER	D	590	-2.280	23.977	57.000	1.00	79.41	C

ATOM	16946	OG	SER	D	590	-1.337	23.925	55.941	1.00	80.15	O
ATOM	16947	N	LEU	D	591	-1.251	23.659	59.840	1.00	76.95	N
ATOM	16948	CA	LEU	D	591	-0.344	23.148	60.855	1.00	76.47	C
ATOM	16949	C	LEU	D	591	0.159	21.749	60.513	1.00	82.87	C
ATOM	16950	O	LEU	D	591	0.082	20.835	61.345	1.00	83.71	O
ATOM	16951	CB	LEU	D	591	-1.030	23.133	62.218	1.00	78.81	C
ATOM	16952	CG	LEU	D	591	-1.503	24.500	62.715	1.00	86.24	C
ATOM	16953	CD1	LEU	D	591	-2.056	24.391	64.128	1.00	88.85	C
ATOM	16954	CD2	LEU	D	591	-0.374	25.531	62.647	1.00	80.55	C
ATOM	16955	N	GLY	D	592	0.682	21.598	59.296	1.00	75.87	N
ATOM	16956	CA	GLY	D	592	1.161	20.318	58.802	1.00	79.55	C
ATOM	16957	C	GLY	D	592	1.922	19.479	59.811	1.00	77.59	C
ATOM	16958	O	GLY	D	592	1.531	18.357	60.103	1.00	79.49	O
ATOM	16959	N	THR	D	593	2.988	20.044	60.365	1.00	76.99	N
ATOM	16960	CA	THR	D	593	3.871	19.326	61.273	1.00	74.14	C
ATOM	16961	C	THR	D	593	3.180	18.907	62.562	1.00	77.84	C
ATOM	16962	O	THR	D	593	3.511	17.882	63.146	1.00	79.38	O
ATOM	16963	CB	THR	D	593	5.094	20.184	61.628	1.00	75.33	C
ATOM	16964	OG1	THR	D	593	5.603	20.803	60.440	1.00	74.22	O
ATOM	16965	CG2	THR	D	593	6.187	19.344	62.279	1.00	74.16	C
ATOM	16966	N	TYR	D	594	2.225	19.705	63.015	1.00	78.93	N
ATOM	16967	CA	TYR	D	594	1.479	19.364	64.216	1.00	81.00	C
ATOM	16968	C	TYR	D	594	0.662	18.080	63.999	1.00	83.55	C
ATOM	16969	O	TYR	D	594	0.679	17.175	64.839	1.00	84.19	O
ATOM	16970	CB	TYR	D	594	0.583	20.534	64.619	1.00	81.66	C
ATOM	16971	CG	TYR	D	594	-0.325	20.294	65.807	1.00	82.17	C
ATOM	16972	CD1	TYR	D	594	0.090	20.608	67.097	1.00	83.37	C
ATOM	16973	CD2	TYR	D	594	-1.618	19.792	65.633	1.00	83.63	C
ATOM	16974	CE1	TYR	D	594	-0.747	20.415	68.190	1.00	84.05	C
ATOM	16975	CE2	TYR	D	594	-2.464	19.589	66.715	1.00	86.56	C
ATOM	16976	CE	TYR	D	594	-2.023	19.906	67.992	1.00	90.17	C
ATOM	16977	OH	TYR	D	594	-2.854	19.712	69.074	1.00	89.55	O
ATOM	16978	N	HIS	D	595	-0.036	17.996	62.869	1.00	80.90	N
ATOM	16979	CA	HIS	D	595	-0.802	16.796	62.534	1.00	82.76	C
ATOM	16980	C	HIS	D	595	0.098	15.604	62.199	1.00	83.97	C
ATOM	16981	O	HIS	D	595	-0.221	14.475	62.563	1.00	86.04	O
ATOM	16982	CB	HIS	D	595	-1.748	17.067	61.363	1.00	82.50	C
ATOM	16983	CG	HIS	D	595	-2.940	17.891	61.730	1.00	87.34	C
ATOM	16984	ND1	HIS	D	595	-4.164	17.745	61.112	1.00	94.49	N
ATOM	16985	CD2	HIS	D	595	-3.097	18.874	62.646	1.00	86.92	C
ATOM	16986	CE1	HIS	D	595	-5.022	18.603	61.633	1.00	91.58	C
ATOM	16987	NE2	HIS	D	595	-4.400	19.300	62.566	1.00	91.46	N
ATOM	16988	N	ASP	D	596	1.200	15.854	61.489	1.00	81.81	N
ATOM	16989	CA	ASP	D	596	2.212	14.822	61.243	1.00	83.17	C
ATOM	16990	C	ASP	D	596	2.622	14.175	62.542	1.00	84.55	C
ATOM	16991	O	ASP	D	596	2.587	12.957	62.687	1.00	91.34	O
ATOM	16992	CB	ASP	D	596	3.467	15.393	60.580	1.00	79.20	C
ATOM	16993	CG	ASP	D	596	3.275	15.682	59.120	1.00	78.87	C
ATOM	16994	OD2	ASP	D	596	4.001	16.561	58.593	1.00	74.38	O
ATOM	16995	OD1	ASP	D	596	2.392	15.039	58.505	1.00	79.87	O
ATOM	16996	N	LEU	D	597	3.016	15.015	63.485	1.00	83.57	N
ATOM	16997	CA	LEU	D	597	3.529	14.549	64.752	1.00	84.84	C
ATOM	16998	C	LEU	D	597	2.424	13.989	65.638	1.00	88.18	C
ATOM	16999	O	LEU	D	597	2.670	13.099	66.449	1.00	91.01	O
ATOM	17000	CB	LEU	D	597	4.271	15.686	65.449	1.00	83.73	C
ATOM	17001	CG	LEU	D	597	5.563	16.053	64.719	1.00	81.89	C
ATOM	17002	CD1	LEU	D	597	6.154	17.324	65.275	1.00	79.27	C
ATOM	17003	CD2	LEU	D	597	6.570	14.914	64.799	1.00	79.32	C
ATOM	17004	N	LEU	D	598	1.204	14.488	65.469	1.00	87.19	N
ATOM	17005	CA	LEU	D	598	0.072	13.994	66.256	1.00	92.51	C
ATOM	17006	C	LEU	D	598	-0.152	12.502	65.991	1.00	87.86	C
ATOM	17007	O	LEU	D	598	-0.535	11.760	66.888	1.00	88.12	O
ATOM	17008	CB	LEU	D	598	-1.201	14.800	65.950	1.00	90.22	C

ATOM	17009	CG	LEU	D	598	-2.272	14.987	67.029	1.00	83.55	C
ATOM	17010	CD1	LEU	D	598	-3.343	15.911	66.507	1.00	85.58	C
ATOM	17011	CD2	LEU	D	598	-2.901	13.676	67.463	1.00	91.67	C
ATOM	17012	N	LYS	D	599	0.092	12.055	64.766	1.00	87.76	N
ATOM	17013	CA	LYS	D	599	0.043	10.621	64.506	1.00	93.95	C
ATOM	17014	C	LYS	D	599	1.271	9.933	65.099	1.00	88.99	C
ATOM	17015	O	LYS	D	599	1.161	8.860	65.680	1.00	90.47	O
ATOM	17016	CB	LYS	D	599	-0.062	10.316	63.005	1.00	92.01	C
ATOM	17017	CG	LYS	D	599	-0.028	8.810	62.684	1.00	92.80	C
ATOM	17018	CD	LYS	D	599	-0.418	8.519	61.241	1.00	88.06	C
ATOM	17019	CE	LYS	D	599	-1.851	8.950	60.972	1.00	89.52	C
ATOM	17020	NZ	LYS	D	599	-2.221	8.803	59.536	1.00	94.44	N
ATOM	17021	N	ILE	D	600	2.430	10.573	64.973	1.00	89.23	N
ATOM	17022	CA	ILE	D	600	3.711	9.958	65.336	1.00	91.07	C
ATOM	17023	C	ILE	D	600	3.854	9.693	66.840	1.00	90.56	C
ATOM	17024	O	ILE	D	600	4.559	8.774	67.238	1.00	91.32	O
ATOM	17025	CB	ILE	D	600	4.913	10.833	64.845	1.00	90.38	C
ATOM	17026	CG1	ILE	D	600	4.891	10.974	63.316	1.00	89.23	C
ATOM	17027	CG2	ILE	D	600	6.259	10.272	65.318	1.00	86.18	C
ATOM	17028	CD1	ILE	D	600	6.111	10.411	62.606	1.00	91.13	C
ATOM	17029	N	ILE	D	601	3.181	10.469	67.684	1.00	91.73	N
ATOM	17030	CA	ILE	D	601	3.337	10.264	69.126	1.00	92.53	C
ATOM	17031	C	ILE	D	601	2.024	10.314	69.908	1.00	93.37	C
ATOM	17032	O	ILE	D	601	2.015	10.119	71.131	1.00	93.68	O
ATOM	17033	CB	ILE	D	601	4.313	11.298	69.730	1.00	93.72	C
ATOM	17034	CG1	ILE	D	601	4.367	12.554	68.854	1.00	92.00	C
ATOM	17035	CG2	ILE	D	601	5.705	10.690	69.875	1.00	91.12	C
ATOM	17036	CD1	ILE	D	601	5.375	13.589	69.296	1.00	94.23	C
ATOM	17037	N	LYS	D	602	0.926	10.549	69.193	1.00	93.53	N
ATOM	17038	CA	LYS	D	602	-0.392	10.756	69.799	1.00	96.62	C
ATOM	17039	C	LYS	D	602	-0.332	11.909	70.815	1.00	101.78	C
ATOM	17040	O	LYS	D	602	-0.343	13.080	70.417	1.00	99.50	O
ATOM	17041	CB	LYS	D	602	-0.901	9.471	70.454	1.00	98.20	C
ATOM	17042	CG	LYS	D	602	-0.579	8.196	69.674	1.00	94.33	C
ATOM	17043	CD	LYS	D	602	-1.025	8.281	68.222	1.00	93.73	C
ATOM	17044	CE	LYS	D	602	-2.528	8.457	68.091	1.00	93.38	C
ATOM	17045	NZ	LYS	D	602	-2.955	8.279	66.673	1.00	93.13	N
ATOM	17046	O	ASP	D	603	0.431	14.857	73.185	1.00	94.23	O
ATOM	17047	N	ASP	D	603	-0.283	11.564	72.105	1.00	101.32	N
ATOM	17048	CA	ASP	D	603	-0.025	12.497	73.217	1.00	95.45	C
ATOM	17049	C	ASP	D	603	-0.403	13.974	73.005	1.00	94.97	C
ATOM	17050	CB	ASP	D	603	1.460	12.420	73.585	1.00	90.78	C
ATOM	17051	CG	ASP	D	603	1.683	12.397	75.077	1.00	95.18	C
ATOM	17052	OD1	ASP	D	603	0.818	12.932	75.804	1.00	95.41	O
ATOM	17053	OD2	ASP	D	603	2.714	11.839	75.523	1.00	95.51	O
ATOM	17054	O	LYS	D	604	-1.714	17.835	73.132	1.00	90.92	O
ATOM	17055	N	LYS	D	604	-1.657	14.246	72.653	1.00	95.61	N
ATOM	17056	CA	LYS	D	604	-2.060	15.606	72.277	1.00	97.16	C
ATOM	17057	C	LYS	D	604	-1.801	16.631	73.390	1.00	94.46	C
ATOM	17058	CB	LYS	D	604	-3.540	15.644	71.873	1.00	92.66	C
ATOM	17059	CG	LYS	D	604	-3.927	16.913	71.127	1.00	91.07	C
ATOM	17060	CD	LYS	D	604	-5.426	17.176	71.157	1.00	91.73	C
ATOM	17061	CE	LYS	D	604	-5.736	18.597	70.697	1.00	89.66	C
ATOM	17062	NZ	LYS	D	604	-5.000	19.598	71.524	1.00	90.11	N
ATOM	17063	O	ASP	D	605	0.306	18.819	75.402	1.00	90.58	O
ATOM	17064	N	ASP	D	605	-1.682	16.149	74.622	1.00	92.84	N
ATOM	17065	CA	ASP	D	605	-1.244	16.997	75.723	1.00	93.17	C
ATOM	17066	C	ASP	D	605	0.125	17.595	75.406	1.00	93.74	C
ATOM	17067	CB	ASP	D	605	-1.183	16.202	77.030	1.00	92.34	C
ATOM	17068	CG	ASP	D	605	-2.534	16.063	77.690	1.00	96.36	C
ATOM	17069	OD1	ASP	D	605	-3.304	17.046	77.680	1.00	103.48	O
ATOM	17070	OD2	ASP	D	605	-2.831	14.971	78.218	1.00	100.82	O
ATOM	17071	O	PHE	D	606	3.518	18.965	73.863	1.00	80.95	O

ATOM	17072	N	PHE	D	606	1.071	16.703	75.121	1.00	90.98	N
ATOM	17073	CA	PHE	D	606	2.462	17.048	74.854	1.00	84.06	C
ATOM	17074	C	PHE	D	606	2.645	18.106	73.761	1.00	83.47	C
ATOM	17075	CB	PHE	D	606	3.224	15.779	74.473	1.00	84.03	C
ATOM	17076	CG	PHE	D	606	4.689	15.967	74.405	1.00	77.51	C
ATOM	17077	CD2	PHE	D	606	5.298	16.299	73.213	1.00	77.92	C
ATOM	17078	CD1	PHE	D	606	5.460	15.826	75.537	1.00	74.92	C
ATOM	17079	CE2	PHE	D	606	6.655	16.488	73.153	1.00	76.49	C
ATOM	17080	CE1	PHE	D	606	6.816	16.014	75.490	1.00	75.89	C
ATOM	17081	CZ	PHE	D	606	7.420	16.344	74.295	1.00	76.69	C
ATOM	17082	O	LEU	D	607	1.744	21.299	71.188	1.00	86.79	O
ATOM	17083	N	LEU	D	607	1.822	18.033	72.720	1.00	85.30	N
ATOM	17084	CA	LEU	D	607	1.922	18.938	71.573	1.00	85.67	C
ATOM	17085	C	LEU	D	607	1.432	20.338	71.901	1.00	89.04	C
ATOM	17086	CB	LEU	D	607	1.118	18.400	70.384	1.00	89.16	C
ATOM	17087	CG	LEU	D	607	1.755	17.461	69.359	1.00	81.37	C
ATOM	17088	CD1	LEU	D	607	2.238	16.179	70.012	1.00	85.96	C
ATOM	17089	CD2	LEU	D	607	0.757	17.146	68.251	1.00	86.94	C
ATOM	17090	O	ASP	D	608	0.998	23.563	74.595	1.00	83.97	O
ATOM	17091	N	ASP	D	608	0.638	20.438	72.967	1.00	90.56	N
ATOM	17092	CA	ASP	D	608	0.067	21.707	73.396	1.00	85.03	C
ATOM	17093	C	ASP	D	608	0.890	22.338	74.517	1.00	83.43	C
ATOM	17094	CB	ASP	D	608	-1.384	21.513	73.849	1.00	85.97	C
ATOM	17095	CG	ASP	D	608	-2.316	21.149	72.704	1.00	88.25	C
ATOM	17096	OD2	ASP	D	608	-3.542	21.069	72.934	1.00	89.43	O
ATOM	17097	OD1	ASP	D	608	-1.826	20.932	71.578	1.00	89.55	O
ATOM	17098	O	ASN	D	609	4.506	22.476	75.846	1.00	80.01	O
ATOM	17099	N	ASN	D	609	1.467	21.506	75.381	1.00	78.47	N
ATOM	17100	CA	ASN	D	609	2.254	22.008	76.510	1.00	79.90	C
ATOM	17101	C	ASN	D	609	3.381	22.924	76.062	1.00	78.76	C
ATOM	17102	CB	ASN	D	609	2.832	20.848	77.329	1.00	78.25	C
ATOM	17103	CG	ASN	D	609	3.633	21.314	78.542	1.00	77.39	C
ATOM	17104	OD1	ASN	D	609	3.659	22.502	78.875	1.00	79.84	O
ATOM	17105	ND2	ASN	D	609	4.276	20.367	79.219	1.00	74.29	N
ATOM	17106	O	GLU	D	610	6.326	25.843	75.918	1.00	80.55	O
ATOM	17107	N	GLU	D	610	3.077	24.213	75.963	1.00	78.61	N
ATOM	17108	CA	GLU	D	610	4.040	25.223	75.539	1.00	80.31	C
ATOM	17109	C	GLU	D	610	5.377	25.159	76.292	1.00	77.58	C
ATOM	17110	CB	GLU	D	610	3.425	26.624	75.684	1.00	75.97	C
ATOM	17111	O	GLU	D	611	8.861	23.282	77.278	1.00	77.23	O
ATOM	17112	N	GLU	D	611	5.458	24.346	77.341	1.00	75.69	N
ATOM	17113	CA	GLU	D	611	6.736	24.105	78.006	1.00	79.21	C
ATOM	17114	C	GLU	D	611	7.645	23.237	77.139	1.00	78.05	C
ATOM	17115	CB	GLU	D	611	6.530	23.447	79.375	1.00	80.70	C
ATOM	17116	O	ASN	D	612	9.260	21.535	73.494	1.00	78.39	O
ATOM	17117	N	ASN	D	612	7.043	22.460	76.240	1.00	79.26	N
ATOM	17118	CA	ASN	D	612	7.773	21.525	75.378	1.00	77.49	C
ATOM	17119	C	ASN	D	612	8.415	22.157	74.143	1.00	78.47	C
ATOM	17120	CB	ASN	D	612	6.843	20.404	74.901	1.00	74.15	C
ATOM	17121	CG	ASN	D	612	6.342	19.529	76.029	1.00	74.62	C
ATOM	17122	OD1	ASN	D	612	7.042	19.291	77.014	1.00	75.24	O
ATOM	17123	ND2	ASN	D	612	5.125	19.025	75.879	1.00	75.47	N
ATOM	17124	O	GLU	D	613	10.144	23.617	70.978	1.00	78.68	O
ATOM	17125	N	GLU	D	613	8.004	23.381	73.818	1.00	80.12	N
ATOM	17126	CA	GLU	D	613	8.384	24.027	72.557	1.00	83.07	C
ATOM	17127	C	GLU	D	613	9.848	23.848	72.149	1.00	81.09	C
ATOM	17128	CB	GLU	D	613	8.073	25.521	72.618	1.00	81.88	C
ATOM	17129	CG	GLU	D	613	6.590	25.832	72.643	1.00	84.62	C
ATOM	17130	CD	GLU	D	613	6.306	27.262	72.239	1.00	89.51	C
ATOM	17131	OE1	GLU	D	613	7.269	28.067	72.197	1.00	92.29	O
ATOM	17132	OE2	GLU	D	613	5.128	27.573	71.950	1.00	89.23	O
ATOM	17133	N	ASP	D	614	10.754	23.950	73.113	1.00	77.95	N
ATOM	17134	CA	ASP	D	614	12.173	23.860	72.815	1.00	82.02	C

ATOM	17135	C	ASP	D	614	12.538	22.541	72.150	1.00	79.20	C
ATOM	17136	O	ASP	D	614	12.982	22.545	71.004	1.00	78.65	O
ATOM	17137	CB	ASP	D	614	13.002	24.065	74.081	1.00	84.96	C
ATOM	17138	CG	ASP	D	614	13.169	25.527	74.421	1.00	88.51	C
ATOM	17139	OD1	ASP	D	614	14.199	26.111	74.020	1.00	86.51	O
ATOM	17140	OD2	ASP	D	614	12.259	26.096	75.066	1.00	95.60	O
ATOM	17141	N	ILE	D	615	12.333	21.420	72.839	1.00	80.22	N
ATOM	17142	CA	ILE	D	615	12.715	20.120	72.278	1.00	77.79	C
ATOM	17143	C	ILE	D	615	11.886	19.800	71.017	1.00	75.29	C
ATOM	17144	O	ILE	D	615	12.349	19.064	70.152	1.00	74.62	O
ATOM	17145	CB	ILE	D	615	12.598	18.964	73.339	1.00	75.99	C
ATOM	17146	CG1	ILE	D	615	13.103	17.609	72.784	1.00	76.14	C
ATOM	17147	CG2	ILE	D	615	11.177	18.853	73.874	1.00	74.61	C
ATOM	17148	CD1	ILE	D	615	14.642	17.472	72.608	1.00	72.93	C
ATOM	17149	N	LEU	D	616	10.693	20.376	70.874	1.00	72.35	N
ATOM	17150	CA	LEU	D	616	9.942	20.169	69.636	1.00	69.05	C
ATOM	17151	C	LEU	D	616	10.588	20.904	68.463	1.00	71.10	C
ATOM	17152	O	LEU	D	616	10.544	20.435	67.332	1.00	68.78	O
ATOM	17153	CB	LEU	D	616	8.488	20.609	69.788	1.00	74.20	C
ATOM	17154	CG	LEU	D	616	7.634	19.703	70.675	1.00	77.24	C
ATOM	17155	CD1	LEU	D	616	6.165	19.992	70.482	1.00	67.73	C
ATOM	17156	CD2	LEU	D	616	7.936	18.249	70.369	1.00	76.39	C
ATOM	17157	N	GLU	D	617	11.190	22.057	68.735	1.00	72.66	N
ATOM	17158	CA	GLU	D	617	11.936	22.777	67.710	1.00	69.45	C
ATOM	17159	C	GLU	D	617	13.254	22.068	67.418	1.00	69.78	C
ATOM	17160	O	GLU	D	617	13.645	21.925	66.271	1.00	70.91	O
ATOM	17161	CB	GLU	D	617	12.203	24.225	68.138	1.00	73.75	C
ATOM	17162	CG	GLU	D	617	11.000	25.154	67.994	1.00	72.71	C
ATOM	17163	CD	GLU	D	617	10.476	25.220	66.566	1.00	74.46	C
ATOM	17164	OE1	GLU	D	617	11.282	25.051	65.617	1.00	79.01	O
ATOM	17165	OE2	GLU	D	617	9.255	25.434	66.381	1.00	70.26	O
ATOM	17166	N	ASP	D	618	13.928	21.629	68.472	1.00	67.43	N
ATOM	17167	CA	ASP	D	618	15.174	20.904	68.362	1.00	66.26	C
ATOM	17168	C	ASP	D	618	14.975	19.622	67.551	1.00	69.35	C
ATOM	17169	O	ASP	D	618	15.881	19.145	66.877	1.00	66.96	O
ATOM	17170	CB	ASP	D	618	15.716	20.604	69.762	1.00	70.28	C
ATOM	17171	CG	ASP	D	618	16.637	19.395	69.801	1.00	75.12	C
ATOM	17172	OD2	ASP	D	618	17.875	19.579	69.761	1.00	73.34	O
ATOM	17173	OD1	ASP	D	618	16.117	18.261	69.906	1.00	78.28	O
ATOM	17174	N	ILE	D	619	13.771	19.082	67.591	1.00	66.09	N
ATOM	17175	CA	ILE	D	619	13.498	17.867	66.861	1.00	67.85	C
ATOM	17176	C	ILE	D	619	13.223	18.179	65.390	1.00	67.58	C
ATOM	17177	O	ILE	D	619	13.806	17.565	64.503	1.00	66.20	O
ATOM	17178	CB	ILE	D	619	12.333	17.099	67.503	1.00	69.08	C
ATOM	17179	CG1	ILE	D	619	12.863	16.244	68.659	1.00	70.96	C
ATOM	17180	CG2	ILE	D	619	11.649	16.210	66.503	1.00	71.83	C
ATOM	17181	CD1	ILE	D	619	11.780	15.581	69.464	1.00	65.58	C
ATOM	17182	N	VAL	D	620	12.366	19.156	65.124	1.00	69.34	N
ATOM	17183	CA	VAL	D	620	12.065	19.511	63.744	1.00	64.63	C
ATOM	17184	C	VAL	D	620	13.315	20.075	63.072	1.00	63.16	C
ATOM	17185	O	VAL	D	620	13.472	19.981	61.862	1.00	64.00	O
ATOM	17186	CB	VAL	D	620	10.902	20.498	63.673	1.00	60.02	C
ATOM	17187	CG1	VAL	D	620	10.572	20.861	62.231	1.00	64.25	C
ATOM	17188	CG2	VAL	D	620	9.695	19.879	64.327	1.00	66.59	C
ATOM	17189	N	LEU	D	621	14.223	20.628	63.864	1.00	62.81	N
ATOM	17190	CA	LEU	D	621	15.493	21.096	63.335	1.00	63.44	C
ATOM	17191	C	LEU	D	621	16.346	19.924	62.816	1.00	71.44	C
ATOM	17192	O	LEU	D	621	16.808	19.923	61.667	1.00	70.07	O
ATOM	17193	CB	LEU	D	621	16.267	21.857	64.398	1.00	63.36	C
ATOM	17194	CG	LEU	D	621	17.539	22.527	63.902	1.00	64.09	C
ATOM	17195	CD1	LEU	D	621	17.150	23.702	63.033	1.00	66.76	C
ATOM	17196	CD2	LEU	D	621	18.384	22.975	65.061	1.00	63.19	C
ATOM	17197	N	THR	D	622	16.562	18.936	63.674	1.00	68.23	N

ATOM	17198	CA	THR	D	622	17.330	17.748	63.299	1.00	68.42	C
ATOM	17199	C	THR	D	622	16.749	17.066	62.053	1.00	67.12	C
ATOM	17200	O	THR	D	622	17.477	16.745	61.120	1.00	72.61	O
ATOM	17201	CB	THR	D	622	17.390	16.741	64.470	1.00	63.24	C
ATOM	17202	OG1	THR	D	622	18.235	17.263	65.505	1.00	62.92	O
ATOM	17203	CG2	THR	D	622	17.933	15.400	64.005	1.00	76.41	C
ATOM	17204	N	LEU	D	623	15.436	16.873	62.032	1.00	65.03	N
ATOM	17205	CA	LEU	D	623	14.762	16.248	60.897	1.00	70.22	C
ATOM	17206	C	LEU	D	623	14.918	17.009	59.579	1.00	69.29	C
ATOM	17207	O	LEU	D	623	14.695	16.452	58.511	1.00	72.62	O
ATOM	17208	CB	LEU	D	623	13.268	16.094	61.189	1.00	71.43	C
ATOM	17209	CG	LEU	D	623	12.876	15.302	62.431	1.00	72.33	C
ATOM	17210	CD1	LEU	D	623	11.369	15.211	62.524	1.00	70.77	C
ATOM	17211	CD2	LEU	D	623	13.511	13.922	62.405	1.00	71.63	C
ATOM	17212	N	THR	D	624	15.270	18.286	59.649	1.00	67.16	N
ATOM	17213	CA	THR	D	624	15.404	19.082	58.443	1.00	61.80	C
ATOM	17214	C	THR	D	624	16.874	19.211	58.045	1.00	66.10	C
ATOM	17215	O	THR	D	624	17.185	19.533	56.906	1.00	72.30	O
ATOM	17216	CB	THR	D	624	14.778	20.476	58.623	1.00	66.11	C
ATOM	17217	OG1	THR	D	624	13.503	20.355	59.268	1.00	61.88	O
ATOM	17218	CG2	THR	D	624	14.572	21.139	57.287	1.00	64.92	C
ATOM	17219	N	LEU	D	625	17.771	18.917	58.981	1.00	67.62	N
ATOM	17220	CA	LEU	D	625	19.208	19.064	58.781	1.00	65.88	C
ATOM	17221	C	LEU	D	625	19.888	17.799	58.224	1.00	68.01	C
ATOM	17222	O	LEU	D	625	20.860	17.892	57.460	1.00	64.11	O
ATOM	17223	CB	LEU	D	625	19.863	19.464	60.101	1.00	61.08	C
ATOM	17224	CG	LEU	D	625	20.914	20.575	60.171	1.00	63.40	C
ATOM	17225	CD1	LEU	D	625	20.604	21.765	59.282	1.00	63.97	C
ATOM	17226	CD2	LEU	D	625	21.012	21.047	61.606	1.00	61.56	C
ATOM	17227	N	PHE	D	626	19.393	16.623	58.609	1.00	68.16	N
ATOM	17228	CA	PHE	D	626	20.008	15.359	58.183	1.00	65.07	C
ATOM	17229	C	PHE	D	626	19.037	14.440	57.468	1.00	71.36	C
ATOM	17230	O	PHE	D	626	17.820	14.568	57.606	1.00	72.57	O
ATOM	17231	CB	PHE	D	626	20.596	14.604	59.373	1.00	67.41	C
ATOM	17232	CG	PHE	D	626	21.424	15.452	60.273	1.00	62.54	C
ATOM	17233	CD1	PHE	D	626	22.761	15.661	60.004	1.00	57.09	C
ATOM	17234	CD2	PHE	D	626	20.860	16.044	61.396	1.00	62.98	C
ATOM	17235	CE1	PHE	D	626	23.524	16.456	60.833	1.00	63.19	C
ATOM	17236	CE2	PHE	D	626	21.617	16.833	62.230	1.00	65.01	C
ATOM	17237	CZ	PHE	D	626	22.949	17.045	61.952	1.00	66.61	C
ATOM	17238	O	GLU	D	627	18.491	10.135	56.214	1.00	81.77	O
ATOM	17239	N	GLU	D	627	19.591	13.496	56.717	1.00	74.35	N
ATOM	17240	CA	GLU	D	627	18.781	12.516	56.015	1.00	78.95	C
ATOM	17241	C	GLU	D	627	19.249	11.099	56.337	1.00	81.64	C
ATOM	17242	CB	GLU	D	627	18.824	12.764	54.507	1.00	82.90	C
ATOM	17243	CG	GLU	D	627	20.189	12.550	53.866	1.00	86.16	C
ATOM	17244	CD	GLU	D	627	20.085	12.107	52.405	1.00	92.67	C
ATOM	17245	OE1	GLU	D	627	19.113	11.396	52.058	1.00	92.54	O
ATOM	17246	OE2	GLU	D	627	20.973	12.469	51.601	1.00	83.87	O
ATOM	17247	O	ASP	D	628	20.404	9.923	59.422	1.00	85.37	O
ATOM	17248	N	ASP	D	628	20.503	10.982	56.755	1.00	80.10	N
ATOM	17249	CA	ASP	D	628	21.061	9.694	57.136	1.00	80.19	C
ATOM	17250	C	ASP	D	628	20.429	9.198	58.428	1.00	86.78	C
ATOM	17251	CB	ASP	D	628	22.572	9.790	57.309	1.00	80.83	C
ATOM	17252	CG	ASP	D	628	23.212	8.435	57.538	1.00	86.38	C
ATOM	17253	OD1	ASP	D	628	22.789	7.470	56.867	1.00	89.15	O
ATOM	17254	OD2	ASP	D	628	24.128	8.331	58.385	1.00	85.28	O
ATOM	17255	O	ARG	D	629	19.590	7.665	61.937	1.00	85.06	O
ATOM	17256	N	ARG	D	629	19.937	7.961	58.415	1.00	88.33	N
ATOM	17257	CA	ARG	D	629	19.276	7.369	59.578	1.00	84.92	C
ATOM	17258	C	ARG	D	629	20.121	7.425	60.858	1.00	84.01	C
ATOM	17259	CB	ARG	D	629	18.884	5.915	59.274	1.00	90.23	C
ATOM	17260	CG	ARG	D	629	19.409	4.881	60.275	1.00	95.94	C

ATOM	17261	CD	ARG	D	629	18.769	3.511	60.096	1.00	94.90	C
ATOM	17262	NE	ARG	D	629	19.544	2.643	59.219	1.00	93.72	N
ATOM	17263	CZ	ARG	D	629	19.419	2.625	57.896	1.00	103.09	C
ATOM	17264	NH1	ARG	D	629	18.549	3.437	57.299	1.00	97.98	N
ATOM	17265	NH2	ARG	D	629	20.163	1.797	57.168	1.00	102.20	N
ATOM	17266	O	GLU	D	630	22.467	8.611	63.846	1.00	86.11	O
ATOM	17267	N	GLU	D	630	21.430	7.229	60.746	1.00	79.80	N
ATOM	17268	CA	GLU	D	630	22.261	7.149	61.943	1.00	83.97	C
ATOM	17269	C	GLU	D	630	22.456	8.512	62.614	1.00	85.94	C
ATOM	17270	CB	GLU	D	630	23.623	6.533	61.612	1.00	81.77	C
ATOM	17271	O	MET	D	631	21.638	12.070	64.043	1.00	80.92	O
ATOM	17272	N	MET	D	631	22.624	9.552	61.799	1.00	84.50	N
ATOM	17273	CA	MET	D	631	22.818	10.913	62.295	1.00	81.59	C
ATOM	17274	C	MET	D	631	21.564	11.400	63.010	1.00	80.47	C
ATOM	17275	CB	MET	D	631	23.170	11.864	61.145	1.00	79.50	C
ATOM	17276	CG	MET	D	631	24.555	11.669	60.560	1.00	81.04	C
ATOM	17277	SD	MET	D	631	24.895	12.730	59.145	1.00	74.82	S
ATOM	17278	CE	MET	D	631	26.443	12.051	58.593	1.00	68.72	C
ATOM	17279	O	ILE	D	632	18.983	11.562	65.444	1.00	84.44	O
ATOM	17280	N	ILE	D	632	20.418	11.064	62.430	1.00	77.43	N
ATOM	17281	CA	ILE	D	632	19.135	11.307	63.049	1.00	79.28	C
ATOM	17282	C	ILE	D	632	19.133	10.800	64.489	1.00	83.31	C
ATOM	17283	CB	ILE	D	632	18.017	10.617	62.263	1.00	80.22	C
ATOM	17284	CG1	ILE	D	632	17.930	11.186	60.846	1.00	77.71	C
ATOM	17285	CG2	ILE	D	632	16.696	10.763	62.991	1.00	81.85	C
ATOM	17286	CD1	ILE	D	632	17.056	12.405	60.721	1.00	72.57	C
ATOM	17287	O	GLU	D	633	19.831	9.567	68.102	1.00	87.59	O
ATOM	17288	N	GLU	D	633	19.345	9.500	64.622	1.00	85.98	N
ATOM	17289	CA	GLU	D	633	19.251	8.816	65.897	1.00	83.71	C
ATOM	17290	C	GLU	D	633	20.229	9.347	66.960	1.00	83.77	C
ATOM	17291	CB	GLU	D	633	19.460	7.320	65.661	1.00	89.56	C
ATOM	17292	CG	GLU	D	633	18.455	6.723	64.672	1.00	87.59	C
ATOM	17293	CD	GLU	D	633	18.838	5.318	64.222	1.00	91.63	C
ATOM	17294	OE1	GLU	D	633	19.946	4.864	64.577	1.00	92.98	O
ATOM	17295	OE2	GLU	D	633	18.033	4.672	63.514	1.00	88.39	O
ATOM	17296	O	GLU	D	634	22.400	11.678	69.303	1.00	87.92	O
ATOM	17297	N	GLU	D	634	21.491	9.553	66.592	1.00	81.81	N
ATOM	17298	CA	GLU	D	634	22.499	10.031	67.542	1.00	79.91	C
ATOM	17299	C	GLU	D	634	22.127	11.392	68.129	1.00	89.33	C
ATOM	17300	CB	GLU	D	634	23.871	10.119	66.875	1.00	77.04	C
ATOM	17301	O	ARG	D	635	19.171	14.720	68.512	1.00	87.20	O
ATOM	17302	N	ARG	D	635	21.491	12.220	67.303	1.00	86.68	N
ATOM	17303	CA	ARG	D	635	21.119	13.572	67.695	1.00	84.31	C
ATOM	17304	C	ARG	D	635	19.685	13.635	68.215	1.00	87.90	C
ATOM	17305	CB	ARG	D	635	21.291	14.538	66.518	1.00	79.47	C
ATOM	17306	CG	ARG	D	635	22.501	15.447	66.647	1.00	76.10	C
ATOM	17307	CD	ARG	D	635	22.536	16.466	65.529	1.00	77.99	C
ATOM	17308	NE	ARG	D	635	21.325	17.284	65.494	1.00	77.01	N
ATOM	17309	CZ	ARG	D	635	21.319	18.615	65.511	1.00	77.20	C
ATOM	17310	NH1	ARG	D	635	20.162	19.286	65.488	1.00	69.37	N
ATOM	17311	NH2	ARG	D	635	22.474	19.276	65.550	1.00	73.88	N
ATOM	17312	O	LEU	D	636	16.402	11.011	70.325	1.00	90.21	O
ATOM	17313	N	LEU	D	636	19.050	12.471	68.332	1.00	85.81	N
ATOM	17314	CA	LEU	D	636	17.669	12.378	68.796	1.00	82.34	C
ATOM	17315	C	LEU	D	636	17.521	11.416	69.985	1.00	92.26	C
ATOM	17316	CB	LEU	D	636	16.772	11.923	67.651	1.00	79.24	C
ATOM	17317	CG	LEU	D	636	15.353	12.467	67.613	1.00	80.77	C
ATOM	17318	CD1	LEU	D	636	15.370	13.987	67.667	1.00	81.28	C
ATOM	17319	CD2	LEU	D	636	14.665	11.986	66.357	1.00	84.94	C
ATOM	17320	O	LYS	D	637	17.308	9.285	73.433	1.00	94.88	O
ATOM	17321	N	LYS	D	637	18.652	11.065	70.606	1.00	90.07	N
ATOM	17322	CA	LYS	D	637	18.723	10.006	71.617	1.00	87.65	C
ATOM	17323	C	LYS	D	637	17.839	10.238	72.858	1.00	92.83	C

ATOM	17324	CB	LYS	D	637	20.182	9.815	72.057	1.00	85.51	C
ATOM	17325	O	THR	D	638	14.699	11.831	73.589	1.00	92.90	O
ATOM	17326	N	THR	D	638	17.669	11.493	73.262	1.00	89.95	N
ATOM	17327	CA	THR	D	638	16.926	11.799	74.485	1.00	91.01	C
ATOM	17328	C	THR	D	638	15.454	11.383	74.451	1.00	93.10	C
ATOM	17329	CB	THR	D	638	16.983	13.297	74.798	1.00	91.34	C
ATOM	17330	OG1	THR	D	638	17.910	13.937	73.909	1.00	91.54	O
ATOM	17331	CG2	THR	D	638	17.414	13.519	76.239	1.00	87.14	C
ATOM	17332	O	TYR	D	639	12.197	9.447	77.380	1.00	84.64	O
ATOM	17333	N	TYR	D	639	15.056	10.537	75.404	1.00	98.20	N
ATOM	17334	CA	TYR	D	639	13.646	10.186	75.598	1.00	98.33	C
ATOM	17335	C	TYR	D	639	13.357	9.539	76.958	1.00	93.12	C
ATOM	17336	CB	TYR	D	639	13.176	9.260	74.483	1.00	93.63	C
ATOM	17337	CG	TYR	D	639	11.918	9.750	73.804	1.00	94.76	C
ATOM	17338	CD1	TYR	D	639	11.900	10.963	73.121	1.00	93.21	C
ATOM	17339	CD2	TYR	D	639	10.753	8.999	73.832	1.00	95.98	C
ATOM	17340	CE1	TYR	D	639	10.750	11.417	72.484	1.00	91.42	C
ATOM	17341	CE2	TYR	D	639	9.596	9.438	73.200	1.00	99.11	C
ATOM	17342	CZ	TYR	D	639	9.602	10.651	72.528	1.00	94.90	C
ATOM	17343	OH	TYR	D	639	8.461	11.097	71.905	1.00	89.94	O
ATOM	17344	O	ASP	D	644	10.310	5.587	71.685	1.00	100.02	O
ATOM	17345	N	ASP	D	644	9.967	6.260	74.446	1.00	92.70	N
ATOM	17346	CA	ASP	D	644	9.184	5.231	73.773	1.00	96.51	C
ATOM	17347	C	ASP	D	644	9.850	4.770	72.479	1.00	96.01	C
ATOM	17348	CB	ASP	D	644	7.774	5.734	73.477	1.00	93.25	C
ATOM	17349	CG	ASP	D	644	6.840	4.611	73.082	1.00	95.47	C
ATOM	17350	OD1	ASP	D	644	6.009	4.211	73.923	1.00	94.78	O
ATOM	17351	OD2	ASP	D	644	6.954	4.109	71.942	1.00	88.79	O
ATOM	17352	N	ASP	D	645	9.869	3.459	72.258	1.00	97.58	N
ATOM	17353	CA	ASP	D	645	10.636	2.868	71.161	1.00	96.15	C
ATOM	17354	C	ASP	D	645	9.897	2.868	69.813	1.00	96.64	C
ATOM	17355	O	ASP	D	645	10.487	3.208	68.788	1.00	95.08	O
ATOM	17356	CB	ASP	D	645	11.048	1.437	71.526	1.00	96.20	C
ATOM	17357	CG	ASP	D	645	12.265	0.957	70.741	1.00	106.87	C
ATOM	17358	OD1	ASP	D	645	13.072	0.182	71.302	1.00	114.09	O
ATOM	17359	OD2	ASP	D	645	12.421	1.353	69.564	1.00	106.37	O
ATOM	17360	N	LYS	D	646	8.624	2.477	69.797	1.00	95.99	N
ATOM	17361	CA	LYS	D	646	7.860	2.479	68.547	1.00	90.17	C
ATOM	17362	C	LYS	D	646	7.672	3.905	68.049	1.00	94.94	C
ATOM	17363	O	LYS	D	646	7.514	4.137	66.850	1.00	96.68	O
ATOM	17364	CB	LYS	D	646	6.502	1.806	68.724	1.00	84.13	C
ATOM	17365	O	VAL	D	647	9.074	7.265	66.955	1.00	87.27	O
ATOM	17366	N	VAL	D	647	7.685	4.858	68.978	1.00	96.02	N
ATOM	17367	CA	VAL	D	647	7.655	6.274	68.624	1.00	94.27	C
ATOM	17368	C	VAL	D	647	9.008	6.695	68.044	1.00	91.10	C
ATOM	17369	CB	VAL	D	647	7.313	7.162	69.840	1.00	92.13	C
ATOM	17370	O	MET	D	648	12.679	6.637	66.256	1.00	92.70	O
ATOM	17371	N	MET	D	648	10.083	6.389	68.766	1.00	90.39	N
ATOM	17372	CA	MET	D	648	11.437	6.725	68.316	1.00	92.36	C
ATOM	17373	C	MET	D	648	11.818	6.104	66.955	1.00	94.08	C
ATOM	17374	CB	MET	D	648	12.461	6.311	69.375	1.00	89.68	C
ATOM	17375	CG	MET	D	648	13.876	6.835	69.131	1.00	93.19	C
ATOM	17376	SD	MET	D	648	14.075	8.604	69.480	1.00	91.44	S
ATOM	17377	CE	MET	D	648	12.967	8.760	70.867	1.00	94.01	C
ATOM	17378	N	LYS	D	649	11.200	4.983	66.583	1.00	95.03	N
ATOM	17379	CA	LYS	D	649	11.360	4.464	65.227	1.00	90.63	C
ATOM	17380	C	LYS	D	649	10.590	5.355	64.268	1.00	90.77	C
ATOM	17381	O	LYS	D	649	11.161	5.917	63.339	1.00	95.63	O
ATOM	17382	CB	LYS	D	649	10.875	3.017	65.106	1.00	91.04	C
ATOM	17383	CG	LYS	D	649	11.951	1.973	65.325	1.00	91.21	C
ATOM	17384	CD	LYS	D	649	11.472	0.586	64.922	1.00	96.70	C
ATOM	17385	CE	LYS	D	649	12.573	-0.459	65.099	1.00	92.56	C
ATOM	17386	NZ	LYS	D	649	12.090	-1.834	64.782	1.00	92.29	N

ATOM	17387	N	GLN	D	650	9.292	5.487	64.509	1.00	87.72	N
ATOM	17388	CA	GLN	D	650	8.419	6.308	63.673	1.00	91.56	C
ATOM	17389	C	GLN	D	650	8.899	7.760	63.510	1.00	95.36	C
ATOM	17390	O	GLN	D	650	8.609	8.419	62.502	1.00	92.93	O
ATOM	17391	CB	GLN	D	650	7.008	6.305	64.256	1.00	90.05	C
ATOM	17392	CG	GLN	D	650	6.181	5.098	63.901	1.00	90.89	C
ATOM	17393	CD	GLN	D	650	5.253	5.375	62.746	1.00	94.42	C
ATOM	17394	OE1	GLN	D	650	5.217	6.489	62.224	1.00	93.68	O
ATOM	17395	NE2	GLN	D	650	4.492	4.366	62.338	1.00	96.36	N
ATOM	17396	N	LEU	D	651	9.623	8.251	64.513	1.00	95.16	N
ATOM	17397	CA	LEU	D	651	10.086	9.635	64.537	1.00	91.46	C
ATOM	17398	C	LEU	D	651	11.390	9.779	63.763	1.00	87.06	C
ATOM	17399	O	LEU	D	651	11.592	10.762	63.050	1.00	80.30	O
ATOM	17400	CB	LEU	D	651	10.261	10.107	65.988	1.00	90.45	C
ATOM	17401	CG	LEU	D	651	10.835	11.496	66.289	1.00	86.44	C
ATOM	17402	CD1	LEU	D	651	9.788	12.572	66.055	1.00	80.67	C
ATOM	17403	CD2	LEU	D	651	11.372	11.551	67.713	1.00	78.22	C
ATOM	17404	O	LYS	D	652	14.369	9.146	60.999	1.00	86.06	O
ATOM	17405	N	LYS	D	652	12.260	8.780	63.897	1.00	87.18	N
ATOM	17406	CA	LYS	D	652	13.561	8.774	63.226	1.00	85.70	C
ATOM	17407	C	LYS	D	652	13.428	8.797	61.708	1.00	85.82	C
ATOM	17408	CB	LYS	D	652	14.380	7.547	63.645	1.00	84.47	C
ATOM	17409	O	ARG	D	653	11.862	10.052	58.127	1.00	78.99	O
ATOM	17410	N	ARG	D	653	12.259	8.417	61.211	1.00	85.67	N
ATOM	17411	CA	ARG	D	653	12.053	8.351	59.779	1.00	83.78	C
ATOM	17412	C	ARG	D	653	11.500	9.652	59.224	1.00	77.66	C
ATOM	17413	CB	ARG	D	653	11.127	7.186	59.435	1.00	86.30	C
ATOM	17414	CG	ARG	D	653	11.533	5.880	60.079	1.00	81.74	C
ATOM	17415	CD	ARG	D	653	10.596	4.755	59.686	1.00	87.59	C
ATOM	17416	NE	ARG	D	653	11.045	3.487	60.240	1.00	87.21	N
ATOM	17417	CZ	ARG	D	653	10.240	2.483	60.566	1.00	84.35	C
ATOM	17418	NH1	ARG	D	653	8.932	2.596	60.388	1.00	78.14	N
ATOM	17419	NH2	ARG	D	653	10.751	1.366	61.078	1.00	87.63	N
ATOM	17420	O	ARG	D	654	11.389	13.485	59.940	1.00	82.16	O
ATOM	17421	N	ARG	D	654	10.628	10.311	59.982	1.00	82.33	N
ATOM	17422	CA	ARG	D	654	9.990	11.552	59.521	1.00	85.07	C
ATOM	17423	C	ARG	D	654	10.999	12.646	59.124	1.00	82.68	C
ATOM	17424	CB	ARG	D	654	9.040	12.100	60.595	1.00	83.71	C
ATOM	17425	CG	ARG	D	654	8.399	13.449	60.256	1.00	75.86	C
ATOM	17426	CD	ARG	D	654	7.250	13.307	59.280	1.00	78.23	C
ATOM	17427	NE	ARG	D	654	7.550	13.923	57.993	1.00	78.40	N
ATOM	17428	CZ	ARG	D	654	6.677	14.037	56.998	1.00	78.48	C
ATOM	17429	NH1	ARG	D	654	5.439	13.577	57.137	1.00	80.24	N
ATOM	17430	NH2	ARG	D	654	7.043	14.619	55.866	1.00	76.03	N
ATOM	17431	O	ARG	D	655	10.342	14.836	56.584	1.00	71.43	O
ATOM	17432	N	ARG	D	655	11.415	12.623	57.862	1.00	80.44	N
ATOM	17433	CA	ARG	D	655	12.300	13.642	57.327	1.00	74.97	C
ATOM	17434	C	ARG	D	655	11.518	14.896	56.952	1.00	73.73	C
ATOM	17435	CB	ARG	D	655	13.052	13.120	56.104	1.00	71.57	C
ATOM	17436	O	TYR	D	656	13.933	17.833	55.979	1.00	68.79	O
ATOM	17437	N	TYR	D	656	12.178	16.037	57.069	1.00	68.24	N
ATOM	17438	CA	TYR	D	656	11.656	17.262	56.489	1.00	70.03	C
ATOM	17439	C	TYR	D	656	12.744	17.910	55.653	1.00	70.41	C
ATOM	17440	CB	TYR	D	656	11.157	18.236	57.561	1.00	63.23	C
ATOM	17441	CG	TYR	D	656	9.832	17.859	58.177	1.00	62.05	C
ATOM	17442	CD1	TYR	D	656	8.653	18.053	57.487	1.00	61.36	C
ATOM	17443	CD2	TYR	D	656	9.765	17.313	59.452	1.00	67.14	C
ATOM	17444	CE1	TYR	D	656	7.448	17.717	58.038	1.00	64.06	C
ATOM	17445	CE2	TYR	D	656	8.557	16.964	60.013	1.00	67.58	C
ATOM	17446	CZ	TYR	D	656	7.397	17.175	59.300	1.00	70.34	C
ATOM	17447	OH	TYR	D	656	6.177	16.842	59.848	1.00	76.12	O
ATOM	17448	O	THR	D	657	11.463	20.933	53.926	1.00	62.38	O
ATOM	17449	N	THR	D	657	12.320	18.526	54.560	1.00	65.40	N

ATOM	17450	CA	THR	D	657	13.198	19.319	53.723	1.00	65.79	C
ATOM	17451	C	THR	D	657	12.654	20.742	53.718	1.00	58.31	C
ATOM	17452	CB	THR	D	657	13.263	18.763	52.287	1.00	65.82	C
ATOM	17453	OG1	THR	D	657	13.722	19.792	51.407	1.00	74.94	O
ATOM	17454	CG2	THR	D	657	11.880	18.325	51.816	1.00	59.93	C
ATOM	17455	O	GLY	D	658	13.595	23.650	55.607	1.00	61.00	O
ATOM	17456	N	GLY	D	658	13.510	21.729	53.485	1.00	59.66	N
ATOM	17457	CA	GLY	D	658	13.052	23.105	53.333	1.00	56.28	C
ATOM	17458	C	GLY	D	658	13.443	24.053	54.462	1.00	59.18	C
ATOM	17459	O	TRP	D	659	12.299	27.726	53.839	1.00	56.11	O
ATOM	17460	N	TRP	D	659	13.624	25.322	54.127	1.00	54.68	N
ATOM	17461	CA	TRP	D	659	13.838	26.353	55.128	1.00	57.20	C
ATOM	17462	C	TRP	D	659	12.877	27.546	54.918	1.00	60.28	C
ATOM	17463	CB	TRP	D	659	15.301	26.801	55.116	1.00	53.01	C
ATOM	17464	CG	TRP	D	659	16.191	25.658	55.448	1.00	56.69	C
ATOM	17465	CD1	TRP	D	659	16.709	24.732	54.573	1.00	54.12	C
ATOM	17466	CD2	TRP	D	659	16.639	25.275	56.746	1.00	58.67	C
ATOM	17467	NE1	TRP	D	659	17.452	23.811	55.251	1.00	55.83	N
ATOM	17468	CE2	TRP	D	659	17.431	24.112	56.587	1.00	58.17	C
ATOM	17469	CE3	TRP	D	659	16.451	25.794	58.029	1.00	54.19	C
ATOM	17470	CZ2	TRP	D	659	18.040	23.468	57.661	1.00	55.76	C
ATOM	17471	CZ3	TRP	D	659	17.063	25.152	59.101	1.00	56.52	C
ATOM	17472	CH2	TRP	D	659	17.847	24.000	58.908	1.00	59.11	C
ATOM	17473	O	GLY	D	660	13.654	30.771	55.515	1.00	58.03	O
ATOM	17474	N	GLY	D	660	12.693	28.334	55.971	1.00	55.23	N
ATOM	17475	CA	GLY	D	660	11.744	29.433	55.950	1.00	55.08	C
ATOM	17476	C	GLY	D	660	12.453	30.752	55.748	1.00	54.77	C
ATOM	17477	O	ARG	D	661	13.215	35.079	56.544	1.00	52.96	O
ATOM	17478	N	ARG	D	661	11.724	31.858	55.833	1.00	53.61	N
ATOM	17479	CA	ARG	D	661	12.313	33.140	55.482	1.00	52.26	C
ATOM	17480	C	ARG	D	661	12.661	33.992	56.694	1.00	50.62	C
ATOM	17481	CB	ARG	D	661	11.375	33.898	54.562	1.00	50.79	C
ATOM	17482	CG	ARG	D	661	11.014	33.138	53.298	1.00	56.48	C
ATOM	17483	CD	ARG	D	661	12.014	33.405	52.174	1.00	58.79	C
ATOM	17484	NE	ARG	D	661	12.403	34.813	52.122	1.00	59.60	N
ATOM	17485	CZ	ARG	D	661	13.371	35.308	51.358	1.00	58.74	C
ATOM	17486	NH1	ARG	D	661	14.075	34.514	50.557	1.00	60.23	N
ATOM	17487	NH2	ARG	D	661	13.653	36.600	51.415	1.00	58.91	N
ATOM	17488	O	LEU	D	662	12.805	32.231	60.432	1.00	56.83	O
ATOM	17489	N	LEU	D	662	12.369	33.487	57.895	1.00	52.90	N
ATOM	17490	CA	LEU	D	662	12.600	34.247	59.134	1.00	57.82	C
ATOM	17491	C	LEU	D	662	13.146	33.400	60.299	1.00	55.01	C
ATOM	17492	CB	LEU	D	662	11.290	34.934	59.578	1.00	57.43	C
ATOM	17493	CG	LEU	D	662	10.417	35.536	58.468	1.00	48.91	C
ATOM	17494	CD1	LEU	D	662	8.940	35.496	58.823	1.00	48.51	C
ATOM	17495	CD2	LEU	D	662	10.888	36.943	58.179	1.00	57.63	C
ATOM	17496	N	SER	D	663	13.966	34.012	61.152	1.00	54.03	N
ATOM	17497	CA	SER	D	663	14.529	33.342	62.323	1.00	55.39	C
ATOM	17498	C	SER	D	663	13.567	33.237	63.496	1.00	58.88	C
ATOM	17499	O	SER	D	663	12.599	33.993	63.587	1.00	57.93	O
ATOM	17500	CB	SER	D	663	15.765	34.081	62.792	1.00	59.22	C
ATOM	17501	OG	SER	D	663	15.394	35.350	63.287	1.00	58.14	O
ATOM	17502	N	ARG	D	664	13.856	32.322	64.416	1.00	56.13	N
ATOM	17503	CA	ARG	D	664	13.067	32.208	65.633	1.00	59.64	C
ATOM	17504	C	ARG	D	664	13.085	33.518	66.457	1.00	63.29	C
ATOM	17505	O	ARG	D	664	12.044	33.971	66.922	1.00	61.43	O
ATOM	17506	CB	ARG	D	664	13.561	31.049	66.496	1.00	57.66	C
ATOM	17507	CG	ARG	D	664	12.549	30.583	67.530	1.00	60.88	C
ATOM	17508	CD	ARG	D	664	13.140	29.565	68.503	1.00	66.97	C
ATOM	17509	NE	ARG	D	664	12.191	29.194	69.558	1.00	73.86	N
ATOM	17510	CZ	ARG	D	664	12.365	28.195	70.425	1.00	80.30	C
ATOM	17511	NH1	ARG	D	664	13.457	27.437	70.368	1.00	78.85	N
ATOM	17512	NH2	ARG	D	664	11.438	27.945	71.346	1.00	82.04	N

ATOM	17513	N	LYS	D	665	14.260	34.122	66.616	1.00	60.84	N
ATOM	17514	CA	LYS	D	665	14.407	35.306	67.445	1.00	58.65	C
ATOM	17515	C	LYS	D	665	13.464	36.428	66.972	1.00	65.35	C
ATOM	17516	O	LYS	D	665	12.880	37.159	67.770	1.00	67.18	O
ATOM	17517	CB	LYS	D	665	15.868	35.764	67.445	1.00	63.85	C
ATOM	17518	CG	LYS	D	665	16.082	37.154	67.998	1.00	67.98	C
ATOM	17519	CD	LYS	D	665	17.506	37.379	68.450	1.00	66.68	C
ATOM	17520	CE	LYS	D	665	17.590	38.607	69.360	1.00	75.58	C
ATOM	17521	NZ	LYS	D	665	18.958	38.876	69.909	1.00	79.10	N
ATOM	17522	N	LEU	D	666	13.272	36.526	65.670	1.00	62.85	N
ATOM	17523	CA	LEU	D	666	12.393	37.538	65.131	1.00	59.32	C
ATOM	17524	C	LEU	D	666	10.928	37.251	65.450	1.00	60.34	C
ATOM	17525	O	LEU	D	666	10.157	38.142	65.812	1.00	68.82	O
ATOM	17526	CB	LEU	D	666	12.570	37.636	63.619	1.00	58.85	C
ATOM	17527	CG	LEU	D	666	11.597	38.602	62.945	1.00	61.81	C
ATOM	17528	CD1	LEU	D	666	12.142	40.019	63.002	1.00	65.23	C
ATOM	17529	CD2	LEU	D	666	11.315	38.197	61.522	1.00	61.63	C
ATOM	17530	N	ILE	D	667	10.539	36.000	65.299	1.00	59.48	N
ATOM	17531	CA	ILE	D	667	9.136	35.650	65.349	1.00	57.42	C
ATOM	17532	C	ILE	D	667	8.652	35.503	66.790	1.00	65.78	C
ATOM	17533	O	ILE	D	667	7.514	35.873	67.119	1.00	65.42	O
ATOM	17534	CB	ILE	D	667	8.877	34.374	64.547	1.00	55.65	C
ATOM	17535	CG1	ILE	D	667	8.959	34.699	63.055	1.00	54.19	C
ATOM	17536	CG2	ILE	D	667	7.527	33.782	64.882	1.00	61.34	C
ATOM	17537	CD1	ILE	D	667	8.612	33.535	62.154	1.00	57.07	C
ATOM	17538	N	ASN	D	668	9.526	35.011	67.659	1.00	60.01	N
ATOM	17539	CA	ASN	D	668	9.138	34.790	69.039	1.00	60.52	C
ATOM	17540	C	ASN	D	668	10.341	34.819	69.969	1.00	61.80	C
ATOM	17541	O	ASN	D	668	10.551	33.913	70.773	1.00	65.57	O
ATOM	17542	CB	ASN	D	668	8.385	33.469	69.160	1.00	64.21	C
ATOM	17543	CG	ASN	D	668	7.508	33.406	70.389	1.00	69.39	C
ATOM	17544	OD1	ASN	D	668	7.633	32.496	71.212	1.00	68.37	O
ATOM	17545	ND2	ASN	D	668	6.613	34.376	70.524	1.00	65.43	N
ATOM	17546	N	GLY	D	669	11.140	35.868	69.830	1.00	60.48	N
ATOM	17547	CA	GLY	D	669	12.201	36.158	70.769	1.00	64.63	C
ATOM	17548	C	GLY	D	669	12.142	37.640	71.089	1.00	68.69	C
ATOM	17549	O	GLY	D	669	11.867	38.043	72.233	1.00	70.16	O
ATOM	17550	O	ILE	D	670	9.984	40.095	70.435	1.00	65.17	O
ATOM	17551	N	ILE	D	670	12.386	38.447	70.059	1.00	64.10	N
ATOM	17552	CA	ILE	D	670	12.395	39.902	70.167	1.00	66.16	C
ATOM	17553	C	ILE	D	670	11.112	40.438	70.830	1.00	66.91	C
ATOM	17554	CB	ILE	D	670	12.597	40.542	68.768	1.00	62.22	C
ATOM	17555	CG1	ILE	D	670	14.070	40.527	68.410	1.00	69.20	C
ATOM	17556	CG2	ILE	D	670	12.179	41.984	68.762	1.00	74.66	C
ATOM	17557	CD1	ILE	D	670	14.927	41.335	69.368	1.00	71.70	C
ATOM	17558	O	ARG	D	671	11.018	44.062	72.530	1.00	63.18	O
ATOM	17559	N	ARG	D	671	11.291	41.259	71.860	1.00	65.83	N
ATOM	17560	CA	ARG	D	671	10.148	41.817	72.575	1.00	64.25	C
ATOM	17561	C	ARG	D	671	10.032	43.326	72.393	1.00	62.38	C
ATOM	17562	CB	ARG	D	671	10.239	41.481	74.064	1.00	65.11	C
ATOM	17563	CG	ARG	D	671	10.272	39.995	74.362	1.00	67.90	C
ATOM	17564	CD	ARG	D	671	10.123	39.709	75.845	1.00	62.10	C
ATOM	17565	NE	ARG	D	671	10.222	38.279	76.125	1.00	72.93	C
ATOM	17566	CE	ARG	D	671	9.231	37.407	75.942	1.00	73.61	N
ATOM	17567	NH1	ARG	D	671	8.055	37.813	75.471	1.00	70.19	N
ATOM	17568	NH2	ARG	D	671	9.417	36.126	76.229	1.00	70.15	N
ATOM	17569	O	ASP	D	672	8.242	45.045	74.529	1.00	65.64	O
ATOM	17570	N	ASP	D	672	8.828	43.789	72.080	1.00	61.66	N
ATOM	17571	CA	ASP	D	672	8.545	45.215	72.154	1.00	64.01	C
ATOM	17572	C	ASP	D	672	8.708	45.704	73.597	1.00	64.15	C
ATOM	17573	CB	ASP	D	672	7.146	45.521	71.644	1.00	62.57	C
ATOM	17574	CG	ASP	D	672	6.733	46.946	71.928	1.00	61.69	C
ATOM	17575	OD1	ASP	D	672	7.240	47.874	71.253	1.00	59.94	O

ATOM	17576	OD2	ASP	D	672	5.901	47.125	72.835	1.00	65.14	O
ATOM	17577	O	LYS	D	673	8.570	46.757	77.142	1.00	73.93	O
ATOM	17578	N	LYS	D	673	9.377	46.839	73.779	1.00	53.56	N
ATOM	17579	CA	LYS	D	673	9.772	47.284	75.115	1.00	66.15	C
ATOM	17580	C	LYS	D	673	8.612	47.422	76.103	1.00	68.51	C
ATOM	17581	CB	LYS	D	673	10.514	48.622	75.027	1.00	70.31	C
ATOM	17582	O	GLN	D	674	5.357	47.112	78.109	1.00	77.21	O
ATOM	17583	N	GLN	D	674	7.672	48.293	75.776	1.00	73.49	N
ATOM	17584	CA	GLN	D	674	6.559	48.584	76.663	1.00	69.05	C
ATOM	17585	C	GLN	D	674	5.682	47.375	76.961	1.00	70.66	C
ATOM	17586	CB	GLN	D	674	5.722	49.698	76.066	1.00	73.23	C
ATOM	17587	CG	GLN	D	674	6.118	51.056	76.592	1.00	75.03	C
ATOM	17588	CD	GLN	D	674	6.067	52.096	75.526	1.00	72.37	C
ATOM	17589	OE1	GLN	D	674	5.817	51.784	74.360	1.00	83.79	O
ATOM	17590	NE2	GLN	D	674	6.315	53.341	75.900	1.00	65.74	N
ATOM	17591	O	SER	D	675	4.456	43.473	77.309	1.00	62.93	O
ATOM	17592	N	SER	D	675	5.308	46.631	75.935	1.00	66.06	N
ATOM	17593	CA	SER	D	675	4.366	45.547	76.131	1.00	60.94	C
ATOM	17594	C	SER	D	675	5.049	44.274	76.589	1.00	67.24	C
ATOM	17595	CB	SER	D	675	3.593	45.291	74.844	1.00	68.21	C
ATOM	17596	OG	SER	D	675	4.472	45.005	73.770	1.00	68.76	O
ATOM	17597	O	GLY	D	676	7.070	40.588	75.786	1.00	70.06	O
ATOM	17598	N	GLY	D	676	6.298	44.089	76.164	1.00	66.20	N
ATOM	17599	CA	GLY	D	676	7.033	42.867	76.447	1.00	67.65	C
ATOM	17600	C	GLY	D	676	6.599	41.693	75.590	1.00	64.06	C
ATOM	17601	O	LYS	D	677	6.668	41.608	71.983	1.00	63.19	O
ATOM	17602	N	LYS	D	677	5.697	41.949	74.645	1.00	66.64	N
ATOM	17603	CA	LYS	D	677	5.166	40.936	73.741	1.00	63.74	C
ATOM	17604	C	LYS	D	677	6.088	40.676	72.555	1.00	67.35	C
ATOM	17605	CB	LYS	D	677	3.794	41.347	73.204	1.00	63.19	C
ATOM	17606	CG	LYS	D	677	2.878	41.963	74.240	1.00	68.42	C
ATOM	17607	CD	LYS	D	677	1.492	41.344	74.218	1.00	70.19	C
ATOM	17608	CE	LYS	D	677	0.650	41.836	73.049	1.00	71.42	C
ATOM	17609	NZ	LYS	D	677	-0.706	41.191	73.031	1.00	70.68	N
ATOM	17610	N	THR	D	678	6.203	39.404	72.184	1.00	64.47	N
ATOM	17611	CA	THR	D	678	6.874	39.027	70.951	1.00	61.83	C
ATOM	17612	C	THR	D	678	5.979	39.317	69.770	1.00	62.74	C
ATOM	17613	O	THR	D	678	4.797	39.643	69.940	1.00	62.40	O
ATOM	17614	CB	THR	D	678	7.223	37.541	70.913	1.00	63.69	C
ATOM	17615	OG1	THR	D	678	6.049	36.790	70.566	1.00	58.93	O
ATOM	17616	CG2	THR	D	678	7.770	37.077	72.258	1.00	65.01	C
ATOM	17617	N	ILE	D	679	6.533	39.169	68.572	1.00	59.60	N
ATOM	17618	CA	ILE	D	679	5.744	39.319	67.361	1.00	64.56	C
ATOM	17619	C	ILE	D	679	4.634	38.249	67.320	1.00	64.55	C
ATOM	17620	O	ILE	D	679	3.534	38.504	66.825	1.00	66.83	O
ATOM	17621	CB	ILE	D	679	6.642	39.264	66.090	1.00	64.33	C
ATOM	17622	CG1	ILE	D	679	7.349	40.608	65.903	1.00	58.51	C
ATOM	17623	CG2	ILE	D	679	5.829	38.953	64.839	1.00	58.56	C
ATOM	17624	CD1	ILE	D	679	7.925	40.803	64.529	1.00	58.18	C
ATOM	17625	N	LEU	D	680	4.885	37.074	67.884	1.00	62.62	N
ATOM	17626	CA	LEU	D	680	3.874	36.026	67.829	1.00	64.76	C
ATOM	17627	C	LEU	D	680	2.805	36.244	68.886	1.00	63.18	C
ATOM	17628	O	LEU	D	680	1.646	35.874	68.691	1.00	67.34	O
ATOM	17629	CB	LEU	D	680	4.500	34.635	67.989	1.00	69.91	C
ATOM	17630	CG	LEU	D	680	3.520	33.476	67.745	1.00	65.95	C
ATOM	17631	CD1	LEU	D	680	2.838	33.603	66.381	1.00	60.90	C
ATOM	17632	CD2	LEU	D	680	4.206	32.137	67.900	1.00	61.42	C
ATOM	17633	N	ASP	D	681	3.197	36.845	70.002	1.00	67.65	N
ATOM	17634	CA	ASP	D	681	2.239	37.283	71.015	1.00	65.85	C
ATOM	17635	C	ASP	D	681	1.191	38.237	70.424	1.00	62.61	C
ATOM	17636	O	ASP	D	681	-0.006	38.025	70.596	1.00	68.85	O
ATOM	17637	CB	ASP	D	681	2.975	37.933	72.181	1.00	58.73	C
ATOM	17638	CG	ASP	D	681	3.658	36.918	73.064	1.00	62.38	C

ATOM	17639	OD1	ASP	D	681	3.069	35.836	73.290	1.00	67.15	O
ATOM	17640	OD2	ASP	D	681	4.786	37.188	73.532	1.00	66.71	O
ATOM	17641	N	PHE	D	682	1.637	39.254	69.695	1.00	61.76	N
ATOM	17642	CA	PHE	D	682	0.717	40.189	69.052	1.00	64.08	C
ATOM	17643	C	PHE	D	682	-0.192	39.514	68.040	1.00	65.08	C
ATOM	17644	O	PHE	D	682	-1.336	39.927	67.853	1.00	65.49	O
ATOM	17645	CB	PHE	D	682	1.474	41.324	68.355	1.00	66.11	C
ATOM	17646	CG	PHE	D	682	1.830	42.465	69.262	1.00	62.93	C
ATOM	17647	CD1	PHE	D	682	0.862	43.380	69.659	1.00	69.67	C
ATOM	17648	CD2	PHE	D	682	3.130	42.633	69.712	1.00	58.98	C
ATOM	17649	CE1	PHE	D	682	1.188	44.436	70.498	1.00	63.52	C
ATOM	17650	CE2	PHE	D	682	3.465	43.681	70.543	1.00	61.43	C
ATOM	17651	CZ	PHE	D	682	2.494	44.588	70.939	1.00	65.49	C
ATOM	17652	N	LEU	D	683	0.315	38.489	67.365	1.00	70.24	N
ATOM	17653	CA	LEU	D	683	-0.495	37.786	66.371	1.00	67.92	C
ATOM	17654	C	LEU	D	683	-1.524	36.892	67.073	1.00	70.35	C
ATOM	17655	O	LEU	D	683	-2.622	36.661	66.554	1.00	67.00	O
ATOM	17656	CB	LEU	D	683	0.395	36.974	65.425	1.00	70.54	C
ATOM	17657	CG	LEU	D	683	1.375	37.779	64.563	1.00	69.00	C
ATOM	17658	CD1	LEU	D	683	2.227	36.845	63.743	1.00	63.98	C
ATOM	17659	CD2	LEU	D	683	0.660	38.801	63.669	1.00	63.81	C
ATOM	17660	N	LYS	D	684	-1.163	36.399	68.256	1.00	70.54	N
ATOM	17661	CA	LYS	D	684	-2.117	35.709	69.115	1.00	70.96	C
ATOM	17662	C	LYS	D	684	-3.200	36.681	69.611	1.00	74.87	C
ATOM	17663	O	LYS	D	684	-4.393	36.403	69.490	1.00	79.21	O
ATOM	17664	CB	LYS	D	684	-1.399	35.053	70.292	1.00	71.39	C
ATOM	17665	CG	LYS	D	684	-0.511	33.865	69.905	1.00	71.02	C
ATOM	17666	CD	LYS	D	684	0.276	33.327	71.107	1.00	72.65	C
ATOM	17667	CE	LYS	D	684	0.905	31.958	70.804	1.00	70.93	C
ATOM	17668	NZ	LYS	D	684	1.675	31.377	71.947	1.00	75.29	N
ATOM	17669	N	SER	D	685	-2.790	37.832	70.139	1.00	70.96	N
ATOM	17670	CA	SER	D	685	-3.748	38.806	70.674	1.00	71.94	C
ATOM	17671	C	SER	D	685	-3.306	40.263	70.521	1.00	68.93	C
ATOM	17672	O	SER	D	685	-2.329	40.691	71.139	1.00	70.04	O
ATOM	17673	CB	SER	D	685	-4.001	38.528	72.155	1.00	76.33	C
ATOM	17674	OG	SER	D	685	-2.834	38.810	72.916	1.00	77.12	O
ATOM	17675	O	ASP	D	686	-5.064	44.438	69.273	1.00	71.55	O
ATOM	17676	N	ASP	D	686	-4.042	41.031	69.725	1.00	63.65	N
ATOM	17677	CA	ASP	D	686	-3.727	42.441	69.527	1.00	65.41	C
ATOM	17678	C	ASP	D	686	-4.934	43.347	69.837	1.00	70.35	C
ATOM	17679	CB	ASP	D	686	-3.244	42.663	68.093	1.00	68.25	C
ATOM	17680	CG	ASP	D	686	-2.589	44.021	67.889	1.00	72.53	C
ATOM	17681	OD2	ASP	D	686	-2.518	44.472	66.716	1.00	69.48	O
ATOM	17682	OD1	ASP	D	686	-2.146	44.629	68.899	1.00	72.59	O
ATOM	17683	O	GLY	D	687	-8.484	42.979	69.306	1.00	77.30	O
ATOM	17684	N	GLY	D	687	-5.812	42.892	70.732	1.00	69.79	N
ATOM	17685	CA	GLY	D	687	-7.010	43.638	71.090	1.00	72.00	C
ATOM	17686	C	GLY	D	687	-7.964	43.904	69.934	1.00	73.34	C
ATOM	17687	O	PHE	D	688	-8.705	45.950	66.204	1.00	69.80	O
ATOM	17688	N	PHE	D	688	-8.210	45.178	69.653	1.00	72.46	N
ATOM	17689	CA	PHE	D	688	-9.071	45.547	68.530	1.00	75.69	C
ATOM	17690	C	PHE	D	688	-8.222	45.936	67.325	1.00	69.07	C
ATOM	17691	CB	PHE	D	688	-10.022	46.700	68.906	1.00	77.54	C
ATOM	17692	CG	PHE	D	688	-11.029	46.350	69.985	1.00	81.62	C
ATOM	17693	CD1	PHE	D	688	-11.459	45.041	70.168	1.00	77.77	C
ATOM	17694	CD2	PHE	D	688	-11.551	47.341	70.818	1.00	81.32	C
ATOM	17695	CE1	PHE	D	688	-12.389	44.725	71.165	1.00	83.02	C
ATOM	17696	CE2	PHE	D	688	-12.486	47.031	71.810	1.00	74.83	C
ATOM	17697	CZ	PHE	D	688	-12.901	45.724	71.987	1.00	77.85	C
ATOM	17698	O	ALA	D	689	-6.066	45.769	64.265	1.00	63.61	O
ATOM	17699	N	ALA	D	689	-6.953	46.247	67.573	1.00	71.25	N
ATOM	17700	CA	ALA	D	689	-6.008	46.624	66.523	1.00	69.14	C
ATOM	17701	C	ALA	D	689	-5.834	45.524	65.457	1.00	68.95	C

ATOM	17702	CB	ALA	D	689	-4.661	46.980	67.144	1.00	67.10	C
ATOM	17703	O	ASN	D	690	-4.528	43.248	62.705	1.00	62.66	O
ATOM	17704	N	ASN	D	690	-5.430	44.330	65.900	1.00	66.68	N
ATOM	17705	CA	ASN	D	690	-5.192	43.163	65.034	1.00	67.10	C
ATOM	17706	C	ASN	D	690	-4.213	43.417	63.884	1.00	64.47	C
ATOM	17707	CB	ASN	D	690	-6.511	42.637	64.480	1.00	67.74	C
ATOM	17708	CG	ASN	D	690	-7.059	41.487	65.296	1.00	68.71	C
ATOM	17709	OD1	ASN	D	690	-6.902	41.443	66.515	1.00	71.72	O
ATOM	17710	ND2	ASN	D	690	-7.678	40.533	64.625	1.00	66.65	N
ATOM	17711	O	ARG	D	691	-1.027	41.942	63.692	1.00	61.84	O
ATOM	17712	N	ARG	D	691	-3.014	43.829	64.254	1.00	62.34	N
ATOM	17713	CA	ARG	D	691	-1.987	44.118	63.283	1.00	63.80	C
ATOM	17714	C	ARG	D	691	-1.293	42.814	62.856	1.00	61.87	C
ATOM	17715	CB	ARG	D	691	-0.989	45.127	63.867	1.00	66.49	C
ATOM	17716	CG	ARG	D	691	-1.640	46.441	64.330	1.00	65.33	C
ATOM	17717	CD	ARG	D	691	-0.743	47.292	65.247	1.00	57.69	C
ATOM	17718	NE	ARG	D	691	-0.623	46.714	66.580	1.00	65.00	N
ATOM	17719	CZ	ARG	D	691	-0.247	47.381	67.671	1.00	64.32	C
ATOM	17720	NH1	ARG	D	691	0.054	48.668	67.606	1.00	61.09	N
ATOM	17721	NH2	ARG	D	691	-0.178	46.756	68.837	1.00	62.48	N
ATOM	17722	O	ASN	D	692	1.573	42.901	61.573	1.00	57.27	O
ATOM	17723	N	ASN	D	692	-1.050	42.667	61.552	1.00	57.38	N
ATOM	17724	CA	ASN	D	692	-0.296	41.523	61.053	1.00	61.37	C
ATOM	17725	C	ASN	D	692	1.188	41.813	61.139	1.00	58.45	C
ATOM	17726	CB	ASN	D	692	-0.701	41.170	59.618	1.00	60.53	C
ATOM	17727	CG	ASN	D	692	-0.495	42.316	58.628	1.00	59.06	C
ATOM	17728	OD1	ASN	D	692	0.245	43.267	58.882	1.00	63.38	O
ATOM	17729	ND2	ASN	D	692	-1.142	42.209	57.478	1.00	55.28	N
ATOM	17730	O	PHE	D	693	4.949	42.829	60.561	1.00	54.50	O
ATOM	17731	N	PHE	D	693	2.005	40.853	60.711	1.00	59.16	N
ATOM	17732	CA	PHE	D	693	3.470	40.952	60.760	1.00	52.42	C
ATOM	17733	C	PHE	D	693	4.034	42.173	60.042	1.00	54.93	C
ATOM	17734	CB	PHE	D	693	4.110	39.682	60.172	1.00	60.28	C
ATOM	17735	CG	PHE	D	693	5.602	39.791	59.980	1.00	57.72	C
ATOM	17736	CD1	PHE	D	693	6.454	39.765	61.070	1.00	54.79	C
ATOM	17737	CD2	PHE	D	693	6.148	39.934	58.711	1.00	55.16	C
ATOM	17738	CE1	PHE	D	693	7.829	39.877	60.901	1.00	59.69	C
ATOM	17739	CE2	PHE	D	693	7.519	40.045	58.539	1.00	55.08	C
ATOM	17740	CZ	PHE	D	693	8.361	40.022	59.635	1.00	49.85	C
ATOM	17741	O	MET	D	694	4.394	45.876	58.807	1.00	59.29	O
ATOM	17742	N	MET	D	694	3.510	42.464	58.848	1.00	54.29	N
ATOM	17743	CA	MET	D	694	3.925	43.651	58.098	1.00	56.11	C
ATOM	17744	C	MET	D	694	3.616	44.931	58.855	1.00	57.96	C
ATOM	17745	CB	MET	D	694	3.251	43.715	56.720	1.00	56.37	C
ATOM	17746	CG	MET	D	694	4.047	43.118	55.577	1.00	54.77	C
ATOM	17747	SD	MET	D	694	5.593	43.974	55.178	1.00	64.34	S
ATOM	17748	CE	MET	D	694	6.773	43.050	56.126	1.00	58.55	C
ATOM	17749	O	GLN	D	695	3.434	47.384	61.909	1.00	61.78	O
ATOM	17750	N	GLN	D	695	2.482	44.974	59.546	1.00	53.31	N
ATOM	17751	CA	GLN	D	695	2.154	46.178	60.300	1.00	59.99	C
ATOM	17752	C	GLN	D	695	2.995	46.289	61.565	1.00	58.91	C
ATOM	17753	CB	GLN	D	695	0.656	46.230	60.635	1.00	60.47	C
ATOM	17754	CG	GLN	D	695	-0.224	46.562	59.441	1.00	56.23	C
ATOM	17755	CD	GLN	D	695	-1.695	46.403	59.763	1.00	62.52	C
ATOM	17756	OE1	GLN	D	695	-2.071	45.542	60.553	1.00	59.62	O
ATOM	17757	NE2	GLN	D	695	-2.535	47.248	59.166	1.00	58.50	N
ATOM	17758	O	LEU	D	696	5.992	46.305	64.288	1.00	60.97	O
ATOM	17759	N	LEU	D	696	3.235	45.165	62.238	1.00	51.85	N
ATOM	17760	CA	LEU	D	696	4.008	45.167	63.488	1.00	57.39	C
ATOM	17761	C	LEU	D	696	5.454	45.685	63.354	1.00	63.79	C
ATOM	17762	CB	LEU	D	696	4.048	43.761	64.086	1.00	52.54	C
ATOM	17763	CG	LEU	D	696	2.761	43.092	64.556	1.00	62.51	C
ATOM	17764	CD1	LEU	D	696	3.038	41.627	64.955	1.00	58.47	C

ATOM	17765	CD2	LEU	D	696	2.113	43.879	65.709	1.00	58.69	C
ATOM	17766	O	ILE	D	697	8.787	47.570	61.042	1.00	62.31	O
ATOM	17767	N	ILE	D	697	6.093	45.425	62.211	1.00	63.64	N
ATOM	17768	CA	ILE	D	697	7.493	45.822	62.039	1.00	58.59	C
ATOM	17769	C	ILE	D	697	7.663	47.160	61.318	1.00	61.58	C
ATOM	17770	CB	ILE	D	697	8.293	44.755	61.266	1.00	61.54	C
ATOM	17771	CG1	ILE	D	697	7.817	44.665	59.812	1.00	55.91	C
ATOM	17772	CG2	ILE	D	697	8.210	43.415	61.970	1.00	55.50	C
ATOM	17773	CD1	ILE	D	697	8.455	43.557	59.042	1.00	61.67	C
ATOM	17774	O	HIS	D	698	6.092	51.412	61.179	1.00	62.89	O
ATOM	17775	N	HIS	D	698	6.554	47.829	61.007	1.00	59.46	N
ATOM	17776	CA	HIS	D	698	6.602	49.179	60.447	1.00	62.72	C
ATOM	17777	C	HIS	D	698	6.030	50.207	61.417	1.00	60.73	C
ATOM	17778	CB	HIS	D	698	5.828	49.255	59.123	1.00	63.65	C
ATOM	17779	CG	HIS	D	698	6.578	48.707	57.947	1.00	62.80	C
ATOM	17780	ND1	HIS	D	698	6.554	47.374	57.602	1.00	60.63	N
ATOM	17781	CD2	HIS	D	698	7.373	49.316	57.035	1.00	64.50	C
ATOM	17782	CE1	HIS	D	698	7.303	47.181	56.533	1.00	59.74	C
ATOM	17783	NE2	HIS	D	698	7.812	48.344	56.167	1.00	66.66	N
ATOM	17784	O	ASP	D	699	6.502	50.918	64.924	1.00	59.16	O
ATOM	17785	N	ASP	D	699	5.451	49.720	62.503	1.00	61.38	N
ATOM	17786	CA	ASP	D	699	4.681	50.570	63.401	1.00	61.81	C
ATOM	17787	C	ASP	D	699	5.586	51.424	64.276	1.00	60.31	C
ATOM	17788	CB	ASP	D	699	3.763	49.706	64.261	1.00	63.00	C
ATOM	17789	CG	ASP	D	699	2.811	50.519	65.096	1.00	62.73	C
ATOM	17790	OD2	ASP	D	699	2.297	49.974	66.092	1.00	67.44	O
ATOM	17791	OD1	ASP	D	699	2.565	51.696	64.760	1.00	66.71	O
ATOM	17792	O	ASP	D	700	6.840	53.934	67.350	1.00	66.00	O
ATOM	17793	N	ASP	D	700	5.328	52.727	64.305	1.00	62.01	N
ATOM	17794	CA	ASP	D	700	6.196	53.626	65.063	1.00	59.06	C
ATOM	17795	C	ASP	D	700	5.961	53.571	66.580	1.00	58.92	C
ATOM	17796	CB	ASP	D	700	6.048	55.050	64.540	1.00	63.65	C
ATOM	17797	CG	ASP	D	700	6.822	55.274	63.241	1.00	67.55	C
ATOM	17798	OD2	ASP	D	700	6.319	56.001	62.352	1.00	66.33	O
ATOM	17799	OD1	ASP	D	700	7.942	54.725	63.118	1.00	57.64	O
ATOM	17800	N	SER	D	701	4.796	53.087	66.999	1.00	64.87	N
ATOM	17801	CA	SER	D	701	4.479	52.894	68.414	1.00	61.32	C
ATOM	17802	C	SER	D	701	5.041	51.576	68.949	1.00	56.69	C
ATOM	17803	O	SER	D	701	4.934	51.262	70.130	1.00	58.38	O
ATOM	17804	CB	SER	D	701	2.965	52.931	68.617	1.00	62.79	C
ATOM	17805	OG	SER	D	701	2.362	51.785	68.049	1.00	60.45	O
ATOM	17806	N	LEU	D	702	5.633	50.787	68.072	1.00	61.59	N
ATOM	17807	CA	LEU	D	702	6.305	49.576	68.531	1.00	58.95	C
ATOM	17808	C	LEU	D	702	7.815	49.696	68.327	1.00	58.57	C
ATOM	17809	O	LEU	D	702	8.276	50.471	67.480	1.00	59.60	O
ATOM	17810	CB	LEU	D	702	5.745	48.371	67.805	1.00	58.27	C
ATOM	17811	CG	LEU	D	702	4.281	48.174	68.151	1.00	55.89	C
ATOM	17812	CD1	LEU	D	702	3.686	47.045	67.345	1.00	57.02	C
ATOM	17813	CD2	LEU	D	702	4.193	47.868	69.611	1.00	54.49	C
ATOM	17814	N	THR	D	703	8.592	48.949	69.103	1.00	56.89	N
ATOM	17815	CA	THR	D	703	10.039	49.055	68.978	1.00	56.54	C
ATOM	17816	C	THR	D	703	10.649	48.067	67.967	1.00	60.94	C
ATOM	17817	O	THR	D	703	11.857	48.138	67.706	1.00	61.11	O
ATOM	17818	CB	THR	D	703	10.746	48.870	70.347	1.00	57.50	C
ATOM	17819	OG1	THR	D	703	10.041	47.909	71.133	1.00	62.20	O
ATOM	17820	CG2	THR	D	703	10.779	50.173	71.098	1.00	53.30	C
ATOM	17821	N	PHE	D	704	9.831	47.180	67.387	1.00	57.32	N
ATOM	17822	CA	PHE	D	704	10.340	46.148	66.458	1.00	63.93	C
ATOM	17823	C	PHE	D	704	11.109	46.770	65.289	1.00	59.84	C
ATOM	17824	O	PHE	D	704	12.246	46.400	65.020	1.00	60.85	O
ATOM	17825	CB	PHE	D	704	9.200	45.269	65.917	1.00	55.35	C
ATOM	17826	CG	PHE	D	704	8.511	44.451	66.973	1.00	55.46	C
ATOM	17827	CD1	PHE	D	704	9.254	43.682	67.871	1.00	52.91	C

ATOM	17828	CD2	PHE	D	704	7.111	44.471	67.086	1.00	54.68	C
ATOM	17829	CE1	PHE	D	704	8.630	42.934	68.853	1.00	54.25	C
ATOM	17830	CE2	PHE	D	704	6.467	43.726	68.058	1.00	52.72	C
ATOM	17831	CZ	PHE	D	704	7.224	42.955	68.952	1.00	60.32	C
ATOM	17832	N	LYS	D	705	10.468	47.718	64.618	1.00	55.86	N
ATOM	17833	CA	LYS	D	705	11.078	48.540	63.581	1.00	62.29	C
ATOM	17834	C	LYS	D	705	12.476	49.039	63.969	1.00	65.37	C
ATOM	17835	O	LYS	D	705	13.413	49.008	63.165	1.00	66.25	O
ATOM	17836	CB	LYS	D	705	10.157	49.725	63.277	1.00	56.61	C
ATOM	17837	CG	LYS	D	705	10.581	50.631	62.141	1.00	56.12	C
ATOM	17838	CD	LYS	D	705	9.424	51.577	61.787	1.00	55.39	C
ATOM	17839	CE	LYS	D	705	9.910	52.824	61.083	1.00	48.91	C
ATOM	17840	NZ	LYS	D	705	8.866	53.406	60.224	1.00	61.43	N
ATOM	17841	N	GLU	D	706	12.616	49.478	65.211	1.00	63.85	N
ATOM	17842	CA	GLU	D	706	13.892	49.984	65.685	1.00	68.04	C
ATOM	17843	C	GLU	D	706	14.950	48.875	65.856	1.00	64.14	C
ATOM	17844	O	GLU	D	706	16.085	49.032	65.413	1.00	66.86	O
ATOM	17845	CB	GLU	D	706	13.696	50.742	67.005	1.00	56.74	C
ATOM	17846	N	ASP	D	707	14.581	47.774	66.504	1.00	59.83	N
ATOM	17847	CA	ASP	D	707	15.513	46.669	66.731	1.00	67.63	C
ATOM	17848	C	ASP	D	707	15.972	46.035	65.415	1.00	65.61	C
ATOM	17849	O	ASP	D	707	17.117	45.589	65.290	1.00	68.47	O
ATOM	17850	CB	ASP	D	707	14.873	45.606	67.631	1.00	68.14	C
ATOM	17851	CG	ASP	D	707	14.870	46.005	69.099	1.00	68.72	C
ATOM	17852	OD1	ASP	D	707	14.886	47.217	69.374	1.00	67.52	O
ATOM	17853	OD2	ASP	D	707	14.860	45.111	69.978	1.00	76.05	O
ATOM	17854	N	ILE	D	708	15.061	46.002	64.445	1.00	61.78	N
ATOM	17855	CA	ILE	D	708	15.336	45.494	63.102	1.00	62.53	C
ATOM	17856	C	ILE	D	708	16.326	46.378	62.350	1.00	65.03	C
ATOM	17857	O	ILE	D	708	17.308	45.894	61.811	1.00	64.66	O
ATOM	17858	CB	ILE	D	708	14.041	45.372	62.276	1.00	55.32	C
ATOM	17859	CG1	ILE	D	708	13.193	44.209	62.780	1.00	53.12	C
ATOM	17860	CG2	ILE	D	708	14.337	45.166	60.823	1.00	54.14	C
ATOM	17861	CD1	ILE	D	708	11.872	44.067	62.059	1.00	57.52	C
ATOM	17862	N	GLN	D	709	16.075	47.681	62.326	1.00	71.59	N
ATOM	17863	CA	GLN	D	709	16.979	48.605	61.650	1.00	70.11	C
ATOM	17864	C	GLN	D	709	18.324	48.682	62.376	1.00	69.66	C
ATOM	17865	O	GLN	D	709	19.354	48.931	61.758	1.00	72.87	O
ATOM	17866	CB	GLN	D	709	16.341	49.994	61.538	1.00	72.08	C
ATOM	17867	CG	GLN	D	709	17.167	51.007	60.744	1.00	80.82	C
ATOM	17868	CD	GLN	D	709	17.461	50.576	59.300	1.00	88.53	C
ATOM	17869	OE1	GLN	D	709	16.765	49.730	58.724	1.00	89.87	O
ATOM	17870	NE2	GLN	D	709	18.495	51.171	58.709	1.00	88.92	N
ATOM	17871	N	LYS	D	710	18.313	48.449	63.684	1.00	64.14	N
ATOM	17872	CA	LYS	D	710	19.531	48.466	64.462	1.00	59.82	C
ATOM	17873	C	LYS	D	710	20.356	47.206	64.183	1.00	70.33	C
ATOM	17874	O	LYS	D	710	21.543	47.132	64.517	1.00	62.05	O
ATOM	17875	CB	LYS	D	710	19.212	48.574	65.954	1.00	66.68	C
ATOM	17876	N	ALA	D	711	19.720	46.215	63.563	1.00	71.18	N
ATOM	17877	CA	ALA	D	711	20.348	44.915	63.374	1.00	64.75	C
ATOM	17878	C	ALA	D	711	21.236	44.852	62.122	1.00	67.05	C
ATOM	17879	O	ALA	D	711	22.196	44.090	62.094	1.00	72.26	O
ATOM	17880	CB	ALA	D	711	19.287	43.825	63.332	1.00	67.28	C
ATOM	17881	N	GLN	D	712	20.946	45.644	61.096	1.00	62.50	N
ATOM	17882	CA	GLN	D	712	21.862	45.689	59.967	1.00	68.02	C
ATOM	17883	C	GLN	D	712	23.090	46.555	60.274	1.00	66.76	C
ATOM	17884	O	GLN	D	712	24.165	46.357	59.698	1.00	75.23	O
ATOM	17885	CB	GLN	D	712	21.149	46.193	58.715	1.00	74.61	C
ATOM	17886	CG	GLN	D	712	20.146	45.203	58.133	1.00	72.96	C
ATOM	17887	CD	GLN	D	712	18.771	45.371	58.722	1.00	68.17	C
ATOM	17888	OE1	GLN	D	712	18.463	46.418	59.289	1.00	76.22	O
ATOM	17889	NE2	GLN	D	712	17.930	44.352	58.588	1.00	61.08	N
ATOM	17890	O	ASP	D	718	33.262	47.863	51.123	1.00	103.64	O

ATOM	17891	N	ASP	D	718	31.856	46.661	53.339	1.00107.98	N
ATOM	17892	CA	ASP	D	718	32.921	45.985	52.601	1.00106.92	C
ATOM	17893	C	ASP	D	718	33.200	46.635	51.233	1.00103.34	C
ATOM	17894	CB	ASP	D	718	32.583	44.499	52.426	1.00106.30	C
ATOM	17895	CG	ASP	D	718	31.257	44.272	51.715	1.00106.45	C
ATOM	17896	OD2	ASP	D	718	31.262	44.145	50.469	1.00101.66	O
ATOM	17897	OD1	ASP	D	718	30.215	44.209	52.403	1.00104.81	O
ATOM	17898	N	SER	D	719	33.375	45.811	50.199	1.00 98.84	N
ATOM	17899	CA	SER	D	719	33.780	46.309	48.882	1.00 95.58	C
ATOM	17900	C	SER	D	719	32.725	46.109	47.798	1.00 88.33	C
ATOM	17901	O	SER	D	719	31.857	45.234	47.899	1.00 86.63	O
ATOM	17902	CB	SER	D	719	35.087	45.638	48.433	1.00 95.23	C
ATOM	17903	OG	SER	D	719	35.387	45.937	47.077	1.00 89.71	O
ATOM	17904	N	LEU	D	720	32.821	46.941	46.764	1.00 84.27	N
ATOM	17905	CA	LEU	D	720	32.018	46.802	45.556	1.00 76.84	C
ATOM	17906	C	LEU	D	720	32.165	45.394	44.997	1.00 79.89	C
ATOM	17907	O	LEU	D	720	31.197	44.621	44.948	1.00 70.16	O
ATOM	17908	CB	LEU	D	720	32.452	47.826	44.512	1.00 68.86	C
ATOM	17909	CG	LEU	D	720	31.704	47.795	43.186	1.00 63.97	C
ATOM	17910	CD1	LEU	D	720	30.223	47.877	43.472	1.00 59.09	C
ATOM	17911	CD2	LEU	D	720	32.156	48.931	42.267	1.00 58.04	C
ATOM	17912	N	HIS	D	721	33.400	45.078	44.599	1.00 80.94	N
ATOM	17913	CA	HIS	D	721	33.745	43.785	44.025	1.00 80.24	C
ATOM	17914	C	HIS	D	721	33.231	42.680	44.914	1.00 78.39	C
ATOM	17915	O	HIS	D	721	32.678	41.691	44.436	1.00 72.55	O
ATOM	17916	CB	HIS	D	721	35.254	43.658	43.833	1.00 85.26	C
ATOM	17917	CG	HIS	D	721	35.805	44.564	42.776	1.00 87.90	C
ATOM	17918	ND1	HIS	D	721	35.528	45.914	42.731	1.00 88.91	N
ATOM	17919	CD2	HIS	D	721	36.622	44.314	41.726	1.00 87.13	C
ATOM	17920	CE1	HIS	D	721	36.147	46.454	41.695	1.00 87.66	C
ATOM	17921	NE2	HIS	D	721	36.818	45.505	41.070	1.00 85.03	N
ATOM	17922	N	GLU	D	722	33.385	42.872	46.218	1.00 81.12	N
ATOM	17923	CA	GLU	D	722	32.868	41.910	47.177	1.00 84.05	C
ATOM	17924	C	GLU	D	722	31.346	41.807	47.076	1.00 80.93	C
ATOM	17925	O	GLU	D	722	30.834	40.730	46.802	1.00 78.05	O
ATOM	17926	CB	GLU	D	722	33.298	42.274	48.602	1.00 91.19	C
ATOM	17927	CG	GLU	D	722	34.776	41.989	48.889	1.00 93.57	C
ATOM	17928	CD	GLU	D	722	35.037	41.623	50.346	1.00 98.54	C
ATOM	17929	OE1	GLU	D	722	34.426	42.245	51.241	1.00106.59	O
ATOM	17930	OE2	GLU	D	722	35.845	40.704	50.598	1.00 95.90	O
ATOM	17931	N	HIS	D	723	30.638	42.923	47.262	1.00 81.03	N
ATOM	17932	CA	HIS	D	723	29.170	42.917	47.251	1.00 82.36	C
ATOM	17933	C	HIS	D	723	28.579	42.171	46.056	1.00 78.49	C
ATOM	17934	O	HIS	D	723	27.683	41.334	46.219	1.00 75.25	O
ATOM	17935	CB	HIS	D	723	28.604	44.347	47.264	1.00 74.38	C
ATOM	17936	CG	HIS	D	723	27.119	44.398	47.058	1.00 74.67	C
ATOM	17937	ND1	HIS	D	723	26.219	44.037	48.035	1.00 79.31	N
ATOM	17938	CD2	HIS	D	723	26.377	44.740	45.977	1.00 80.76	C
ATOM	17939	CE1	HIS	D	723	24.988	44.169	47.574	1.00 80.09	C
ATOM	17940	NE2	HIS	D	723	25.055	44.593	46.325	1.00 78.10	N
ATOM	17941	N	ILE	D	724	29.098	42.479	44.866	1.00 75.01	N
ATOM	17942	CA	ILE	D	724	28.529	41.990	43.615	1.00 73.26	C
ATOM	17943	C	ILE	D	724	28.758	40.485	43.451	1.00 76.24	C
ATOM	17944	O	ILE	D	724	27.898	39.763	42.937	1.00 74.99	O
ATOM	17945	CB	ILE	D	724	29.108	42.762	42.389	1.00 68.92	C
ATOM	17946	CG1	ILE	D	724	28.616	44.219	42.386	1.00 67.22	C
ATOM	17947	CG2	ILE	D	724	28.698	42.107	41.085	1.00 63.49	C
ATOM	17948	CD1	ILE	D	724	29.114	45.046	41.211	1.00 51.92	C
ATOM	17949	N	ALA	D	725	29.904	40.003	43.913	1.00 77.22	N
ATOM	17950	CA	ALA	D	725	30.272	38.613	43.680	1.00 75.52	C
ATOM	17951	C	ALA	D	725	29.324	37.654	44.401	1.00 77.91	C
ATOM	17952	O	ALA	D	725	28.800	36.725	43.791	1.00 77.29	O
ATOM	17953	CB	ALA	D	725	31.707	38.373	44.105	1.00 68.57	C

ATOM	17954	N	ASN	D	726	29.075	37.883	45.686	1.00	77.33	N
ATOM	17955	CA	ASN	D	726	28.209	36.961	46.416	1.00	83.32	C
ATOM	17956	C	ASN	D	726	26.750	37.379	46.321	1.00	77.94	C
ATOM	17957	O	ASN	D	726	25.906	36.880	47.064	1.00	77.54	O
ATOM	17958	CB	ASN	D	726	28.640	36.824	47.883	1.00	82.51	C
ATOM	17959	CG	ASN	D	726	29.333	38.062	48.405	1.00	85.97	C
ATOM	17960	OD1	ASN	D	726	29.181	39.143	47.844	1.00	85.08	O
ATOM	17961	ND2	ASN	D	726	30.101	37.912	49.486	1.00	87.16	N
ATOM	17962	O	LEU	D	727	25.189	36.697	43.430	1.00	82.88	O
ATOM	17963	N	LEU	D	727	26.459	38.294	45.403	1.00	76.83	N
ATOM	17964	CA	LEU	D	727	25.081	38.493	44.988	1.00	80.96	C
ATOM	17965	C	LEU	D	727	24.608	37.186	44.403	1.00	84.57	C
ATOM	17966	CB	LEU	D	727	24.936	39.594	43.946	1.00	76.19	C
ATOM	17967	CG	LEU	D	727	25.231	41.030	44.345	1.00	80.75	C
ATOM	17968	CD2	LEU	D	727	24.445	41.405	45.589	1.00	84.56	C
ATOM	17969	CD1	LEU	D	727	24.926	41.963	43.179	1.00	73.25	C
ATOM	17970	O	ALA	D	728	22.202	36.715	42.608	1.00	82.21	O
ATOM	17971	N	ALA	D	728	23.574	36.610	45.002	1.00	87.00	N
ATOM	17972	CA	ALA	D	728	22.981	35.401	44.459	1.00	82.87	C
ATOM	17973	C	ALA	D	728	22.656	35.637	42.981	1.00	81.20	C
ATOM	17974	CB	ALA	D	728	21.741	35.013	45.250	1.00	75.70	C
ATOM	17975	O	GLY	D	729	24.858	33.590	40.639	1.00	64.95	O
ATOM	17976	N	GLY	D	729	22.932	34.634	42.151	1.00	82.49	N
ATOM	17977	CA	GLY	D	729	22.744	34.717	40.712	1.00	72.97	C
ATOM	17978	C	GLY	D	729	23.893	34.026	39.996	1.00	66.43	C
ATOM	17979	O	SER	D	730	25.612	35.726	37.624	1.00	56.05	O
ATOM	17980	N	SER	D	730	23.783	33.908	38.673	1.00	60.78	N
ATOM	17981	CA	SER	D	730	24.882	33.431	37.831	1.00	54.68	C
ATOM	17982	C	SER	D	730	25.936	34.527	37.627	1.00	60.52	C
ATOM	17983	CB	SER	D	730	24.351	32.976	36.483	1.00	55.89	C
ATOM	17984	OG	SER	D	730	23.422	33.934	36.000	1.00	68.36	O
ATOM	17985	O	PRO	D	731	28.842	36.821	35.759	1.00	59.30	O
ATOM	17986	N	PRO	D	731	27.206	34.122	37.455	1.00	58.74	N
ATOM	17987	CA	PRO	D	731	28.285	35.104	37.324	1.00	50.79	C
ATOM	17988	C	PRO	D	731	28.220	35.784	35.964	1.00	52.88	C
ATOM	17989	CB	PRO	D	731	29.558	34.254	37.478	1.00	53.26	C
ATOM	17990	CG	PRO	D	731	29.096	32.978	38.134	1.00	48.52	C
ATOM	17991	CD	PRO	D	731	27.737	32.753	37.543	1.00	55.78	C
ATOM	17992	O	ALA	D	732	27.108	38.004	32.932	1.00	61.92	O
ATOM	17993	N	ALA	D	732	27.453	35.195	35.055	1.00	46.23	N
ATOM	17994	CA	ALA	D	732	27.250	35.754	33.738	1.00	52.70	C
ATOM	17995	C	ALA	D	732	26.738	37.214	33.780	1.00	55.32	C
ATOM	17996	CB	ALA	D	732	26.289	34.879	32.950	1.00	48.35	C
ATOM	17997	O	ILE	D	733	26.059	41.132	35.461	1.00	62.95	O
ATOM	17998	N	ILE	D	733	25.917	37.586	34.757	1.00	57.20	N
ATOM	17999	CA	ILE	D	733	25.361	38.956	34.767	1.00	57.57	C
ATOM	18000	C	ILE	D	733	26.189	39.920	35.597	1.00	54.52	C
ATOM	18001	CB	ILE	D	733	23.905	39.006	35.303	1.00	57.16	C
ATOM	18002	CG1	ILE	D	733	23.873	38.744	36.812	1.00	60.50	C
ATOM	18003	CG2	ILE	D	733	23.015	38.038	34.558	1.00	57.25	C
ATOM	18004	CD1	ILE	D	733	22.482	38.771	37.395	1.00	57.09	C
ATOM	18005	O	LYS	D	734	28.961	42.295	37.246	1.00	59.02	O
ATOM	18006	N	LYS	D	734	27.044	39.380	36.451	1.00	59.04	N
ATOM	18007	CA	LYS	D	734	27.819	40.198	37.384	1.00	63.02	C
ATOM	18008	C	LYS	D	734	28.658	41.255	36.670	1.00	58.03	C
ATOM	18009	CB	LYS	D	734	28.726	39.306	38.262	1.00	49.66	C
ATOM	18010	N	LYS	D	735	29.019	40.983	35.417	1.00	56.73	N
ATOM	18011	CA	LYS	D	735	29.877	41.861	34.614	1.00	52.14	C
ATOM	18012	C	LYS	D	735	29.133	43.111	34.105	1.00	56.86	C
ATOM	18013	O	LYS	D	735	29.732	44.174	33.911	1.00	50.76	O
ATOM	18014	CB	LYS	D	735	30.447	41.079	33.437	1.00	47.72	C
ATOM	18015	CG	LYS	D	735	31.316	41.867	32.470	1.00	50.07	C
ATOM	18016	CD	LYS	D	735	31.568	41.055	31.169	1.00	44.07	C

ATOM	18017	CE	LYS	D	735	32.830	41.510	30.487	1.00	47.58	C
ATOM	18018	NZ	LYS	D	735	32.948	41.047	29.089	1.00	39.67	N
ATOM	18019	N	GLY	D	736	27.832	42.976	33.876	1.00	52.29	N
ATOM	18020	CA	GLY	D	736	27.027	44.102	33.451	1.00	46.13	C
ATOM	18021	C	GLY	D	736	26.893	45.080	34.599	1.00	50.47	C
ATOM	18022	O	GLY	D	736	27.248	46.237	34.485	1.00	53.45	O
ATOM	18023	N	ILE	D	737	26.379	44.586	35.710	1.00	51.00	N
ATOM	18024	CA	ILE	D	737	26.307	45.333	36.941	1.00	51.25	C
ATOM	18025	C	ILE	D	737	27.560	46.150	37.227	1.00	52.57	C
ATOM	18026	O	ILE	D	737	27.488	47.366	37.404	1.00	50.71	O
ATOM	18027	CB	ILE	D	737	26.057	44.387	38.108	1.00	51.04	C
ATOM	18028	CG1	ILE	D	737	24.777	43.593	37.844	1.00	55.80	C
ATOM	18029	CG2	ILE	D	737	25.966	45.169	39.405	1.00	56.93	C
ATOM	18030	CD1	ILE	D	737	24.621	42.360	38.700	1.00	58.73	C
ATOM	18031	N	LEU	D	738	28.700	45.469	37.239	1.00	49.25	N
ATOM	18032	CA	LEU	D	738	29.982	46.059	37.608	1.00	48.60	C
ATOM	18033	C	LEU	D	738	30.476	47.129	36.639	1.00	47.73	C
ATOM	18034	O	LEU	D	738	31.068	48.119	37.054	1.00	50.87	O
ATOM	18035	CB	LEU	D	738	31.055	44.961	37.723	1.00	50.80	C
ATOM	18036	CG	LEU	D	738	32.455	45.468	38.057	1.00	52.38	C
ATOM	18037	CD1	LEU	D	738	32.410	46.167	39.415	1.00	53.18	C
ATOM	18038	CD2	LEU	D	738	33.523	44.365	38.052	1.00	60.92	C
ATOM	18039	N	GLN	D	739	30.287	46.924	35.346	1.00	47.25	N
ATOM	18040	CA	GLN	D	739	30.748	47.908	34.384	1.00	46.78	C
ATOM	18041	C	GLN	D	739	29.885	49.189	34.467	1.00	51.79	C
ATOM	18042	O	GLN	D	739	30.363	50.296	34.176	1.00	44.93	O
ATOM	18043	CB	GLN	D	739	30.725	47.332	32.965	1.00	48.55	C
ATOM	18044	CG	GLN	D	739	31.669	46.124	32.758	1.00	47.58	C
ATOM	18045	CD	GLN	D	739	33.128	46.518	32.718	1.00	51.17	C
ATOM	18046	OE1	GLN	D	739	33.565	47.223	31.816	1.00	53.75	O
ATOM	18047	NE2	GLN	D	739	33.890	46.072	33.705	1.00	55.97	N
ATOM	18048	N	THR	D	740	28.623	49.031	34.856	1.00	45.75	N
ATOM	18049	CA	THR	D	740	27.734	50.175	34.955	1.00	46.35	C
ATOM	18050	C	THR	D	740	28.200	51.116	36.049	1.00	47.97	C
ATOM	18051	O	THR	D	740	28.462	52.297	35.804	1.00	46.30	O
ATOM	18052	CB	THR	D	740	26.306	49.768	35.256	1.00	47.20	C
ATOM	18053	OG1	THR	D	740	25.821	48.906	34.219	1.00	44.98	O
ATOM	18054	CG2	THR	D	740	25.446	51.017	35.351	1.00	47.74	C
ATOM	18055	N	VAL	D	741	28.318	50.566	37.253	1.00	49.41	N
ATOM	18056	CA	VAL	D	741	28.833	51.286	38.405	1.00	45.40	C
ATOM	18057	C	VAL	D	741	30.185	51.919	38.089	1.00	49.78	C
ATOM	18058	O	VAL	D	741	30.463	53.031	38.527	1.00	55.41	O
ATOM	18059	CB	VAL	D	741	28.954	50.368	39.619	1.00	47.18	C
ATOM	18060	CG1	VAL	D	741	29.525	51.121	40.789	1.00	50.01	C
ATOM	18061	CG2	VAL	D	741	27.606	49.776	39.962	1.00	46.88	C
ATOM	18062	N	LYS	D	742	31.017	51.247	37.298	1.00	48.93	N
ATOM	18063	CA	LYS	D	742	32.318	51.834	36.995	1.00	49.63	C
ATOM	18064	C	LYS	D	742	32.180	53.005	36.043	1.00	47.44	C
ATOM	18065	O	LYS	D	742	32.957	53.952	36.122	1.00	49.58	O
ATOM	18066	CB	LYS	D	742	33.307	50.791	36.432	1.00	49.13	C
ATOM	18067	CG	LYS	D	742	33.737	49.757	37.494	1.00	52.39	C
ATOM	18068	CD	LYS	D	742	34.888	48.792	37.097	1.00	61.69	C
ATOM	18069	CE	LYS	D	742	35.515	49.079	35.734	1.00	57.40	C
ATOM	18070	NZ	LYS	D	742	36.694	48.210	35.518	1.00	69.04	N
ATOM	18071	N	VAL	D	743	31.205	52.939	35.141	1.00	47.56	N
ATOM	18072	CA	VAL	D	743	30.893	54.068	34.283	1.00	45.38	C
ATOM	18073	C	VAL	D	743	30.469	55.262	35.153	1.00	50.77	C
ATOM	18074	O	VAL	D	743	30.957	56.372	35.001	1.00	45.73	O
ATOM	18075	CB	VAL	D	743	29.752	53.768	33.291	1.00	47.74	C
ATOM	18076	CG1	VAL	D	743	29.145	55.101	32.772	1.00	43.88	C
ATOM	18077	CG2	VAL	D	743	30.245	52.928	32.147	1.00	43.61	C
ATOM	18078	N	VAL	D	744	29.566	55.003	36.080	1.00	46.31	N
ATOM	18079	CA	VAL	D	744	29.021	56.064	36.869	1.00	48.97	C

ATOM	18080	C	VAL	D	744	30.118	56.717	37.680	1.00	52.41	C
ATOM	18081	O	VAL	D	744	30.265	57.944	37.663	1.00	48.09	O
ATOM	18082	CB	VAL	D	744	27.919	55.565	37.774	1.00	47.56	C
ATOM	18083	CG1	VAL	D	744	27.543	56.663	38.745	1.00	47.82	C
ATOM	18084	CG2	VAL	D	744	26.738	55.125	36.918	1.00	46.07	C
ATOM	18085	N	ASP	D	745	30.922	55.891	38.346	1.00	56.35	N
ATOM	18086	CA	ASP	D	745	32.014	56.407	39.172	1.00	50.69	C
ATOM	18087	C	ASP	D	745	33.005	57.224	38.344	1.00	54.90	C
ATOM	18088	O	ASP	D	745	33.516	58.225	38.832	1.00	63.27	O
ATOM	18089	CB	ASP	D	745	32.735	55.271	39.906	1.00	53.67	C
ATOM	18090	CG	ASP	D	745	31.940	54.751	41.118	1.00	65.49	C
ATOM	18091	OD1	ASP	D	745	30.924	55.385	41.497	1.00	67.85	O
ATOM	18092	OD2	ASP	D	745	32.334	53.711	41.699	1.00	70.40	O
ATOM	18093	N	GLU	D	746	33.257	56.841	37.091	1.00	46.53	N
ATOM	18094	CA	GLU	D	746	34.107	57.680	36.243	1.00	48.24	C
ATOM	18095	C	GLU	D	746	33.453	59.061	35.992	1.00	54.09	C
ATOM	18096	O	GLU	D	746	34.107	60.090	36.088	1.00	61.00	O
ATOM	18097	CB	GLU	D	746	34.409	56.987	34.920	1.00	44.94	C
ATOM	18098	CG	GLU	D	746	35.279	57.766	33.918	1.00	44.08	C
ATOM	18099	CD	GLU	D	746	36.393	56.902	33.293	1.00	53.59	C
ATOM	18100	OE1	GLU	D	746	36.509	56.846	32.044	1.00	51.48	O
ATOM	18101	OE2	GLU	D	746	37.169	56.289	34.064	1.00	52.31	O
ATOM	18102	N	LEU	D	747	32.164	59.063	35.679	1.00	47.29	N
ATOM	18103	CA	LEU	D	747	31.471	60.255	35.247	1.00	53.70	C
ATOM	18104	C	LEU	D	747	31.491	61.290	36.375	1.00	59.84	C
ATOM	18105	O	LEU	D	747	31.739	62.474	36.152	1.00	55.82	O
ATOM	18106	CB	LEU	D	747	30.037	59.912	34.826	1.00	45.81	C
ATOM	18107	CG	LEU	D	747	29.950	59.088	33.544	1.00	46.85	C
ATOM	18108	CD1	LEU	D	747	28.509	58.781	33.169	1.00	44.80	C
ATOM	18109	CD2	LEU	D	747	30.676	59.791	32.419	1.00	50.38	C
ATOM	18110	N	VAL	D	748	31.274	60.801	37.589	1.00	58.63	N
ATOM	18111	CA	VAL	D	748	31.335	61.607	38.785	1.00	54.73	C
ATOM	18112	C	VAL	D	748	32.693	62.274	38.977	1.00	60.58	C
ATOM	18113	O	VAL	D	748	32.755	63.385	39.500	1.00	67.95	O
ATOM	18114	CB	VAL	D	748	30.990	60.761	40.002	1.00	55.36	C
ATOM	18115	CG1	VAL	D	748	31.067	61.582	41.276	1.00	63.39	C
ATOM	18116	CG2	VAL	D	748	29.603	60.183	39.829	1.00	52.69	C
ATOM	18117	N	LYS	D	749	33.771	61.629	38.535	1.00	59.82	N
ATOM	18118	CA	LYS	D	749	35.116	62.222	38.641	1.00	62.52	C
ATOM	18119	C	LYS	D	749	35.338	63.217	37.523	1.00	61.65	C
ATOM	18120	O	LYS	D	749	36.141	64.141	37.645	1.00	67.83	O
ATOM	18121	CB	LYS	D	749	36.237	61.169	38.574	1.00	63.75	C
ATOM	18122	CG	LYS	D	749	36.302	60.154	39.698	1.00	66.80	C
ATOM	18123	CD	LYS	D	749	37.626	59.381	39.657	1.00	64.14	C
ATOM	18124	CE	LYS	D	749	37.948	58.811	38.262	1.00	68.40	C
ATOM	18125	NZ	LYS	D	749	37.272	57.502	37.926	1.00	62.56	N
ATOM	18126	N	VAL	D	750	34.663	62.995	36.407	1.00	58.52	N
ATOM	18127	CA	VAL	D	750	34.761	63.917	35.286	1.00	63.77	C
ATOM	18128	C	VAL	D	750	34.009	65.216	35.631	1.00	62.57	C
ATOM	18129	O	VAL	D	750	34.378	66.294	35.176	1.00	62.68	O
ATOM	18130	CB	VAL	D	750	34.212	63.275	33.993	1.00	62.60	C
ATOM	18131	CG1	VAL	D	750	34.293	64.246	32.810	1.00	57.84	C
ATOM	18132	CG2	VAL	D	750	34.976	61.991	33.687	1.00	51.92	C
ATOM	18133	O	MET	D	751	31.959	66.812	39.286	1.00	71.54	O
ATOM	18134	N	MET	D	751	32.976	65.094	36.462	1.00	60.05	N
ATOM	18135	CA	MET	D	751	32.244	66.246	36.969	1.00	63.55	C
ATOM	18136	C	MET	D	751	32.750	66.659	38.351	1.00	68.41	C
ATOM	18137	CB	MET	D	751	30.745	65.947	37.041	1.00	63.49	C
ATOM	18138	CG	MET	D	751	30.128	65.392	35.773	1.00	63.29	C
ATOM	18139	SD	MET	D	751	29.589	66.623	34.581	1.00	65.71	S
ATOM	18140	CE	MET	D	751	31.114	66.985	33.737	1.00	58.90	C
ATOM	18141	O	GLY	D	752	34.158	67.474	41.989	1.00	78.89	O
ATOM	18142	N	GLY	D	752	34.066	66.807	38.478	1.00	63.30	N

ATOM	18143	CA	GLY	D	752	34.686	67.360	39.668	1.00	62.13	C
ATOM	18144	C	GLY	D	752	34.222	66.768	40.983	1.00	72.40	C
ATOM	18145	O	ARG	D	753	31.726	64.893	43.804	1.00	71.42	O
ATOM	18146	N	ARG	D	753	33.900	65.475	40.972	1.00	72.42	N
ATOM	18147	CA	ARG	D	753	33.455	64.744	42.166	1.00	72.24	C
ATOM	18148	C	ARG	D	753	32.077	65.169	42.667	1.00	69.00	C
ATOM	18149	CB	ARG	D	753	34.465	64.882	43.313	1.00	74.58	C
ATOM	18150	CG	ARG	D	753	35.369	63.679	43.516	1.00	77.55	C
ATOM	18151	CD	ARG	D	753	36.702	63.854	42.810	1.00	72.81	C
ATOM	18152	NE	ARG	D	753	37.461	62.611	42.799	1.00	79.02	N
ATOM	18153	CZ	ARG	D	753	38.607	62.438	42.148	1.00	82.11	C
ATOM	18154	NH1	ARG	D	753	39.131	63.441	41.454	1.00	78.31	N
ATOM	18155	NH2	ARG	D	753	39.227	61.262	42.191	1.00	79.09	N
ATOM	18156	O	HIS	D	754	28.984	64.443	40.856	1.00	70.75	O
ATOM	18157	N	HIS	D	754	31.285	65.822	41.827	1.00	70.20	N
ATOM	18158	CA	HIS	D	754	29.924	66.157	42.229	1.00	73.15	C
ATOM	18159	C	HIS	D	754	28.985	64.990	41.953	1.00	69.35	C
ATOM	18160	CB	HIS	D	754	29.420	67.406	41.495	1.00	75.39	C
ATOM	18161	CG	HIS	D	754	30.280	68.616	41.688	1.00	78.82	C
ATOM	18162	ND1	HIS	D	754	30.172	69.737	40.891	1.00	84.38	N
ATOM	18163	CD2	HIS	D	754	31.260	68.883	42.585	1.00	76.14	C
ATOM	18164	CE1	HIS	D	754	31.047	70.644	41.292	1.00	88.60	C
ATOM	18165	NE2	HIS	D	754	31.723	70.148	42.314	1.00	81.12	N
ATOM	18166	O	LYS	D	755	26.113	65.611	41.517	1.00	66.60	O
ATOM	18167	N	LYS	D	755	28.195	64.600	42.946	1.00	64.91	N
ATOM	18168	CA	LYS	D	755	27.045	63.742	42.694	1.00	64.03	C
ATOM	18169	C	LYS	D	755	26.125	64.392	41.653	1.00	64.69	C
ATOM	18170	CB	LYS	D	755	26.266	63.482	43.980	1.00	59.68	C
ATOM	18171	CG	LYS	D	755	27.080	62.848	45.074	1.00	64.43	C
ATOM	18172	CD	LYS	D	755	26.371	61.646	45.631	1.00	63.52	C
ATOM	18173	CE	LYS	D	755	26.885	61.303	46.995	1.00	64.02	C
ATOM	18174	NZ	LYS	D	755	26.501	62.393	47.925	1.00	67.46	N
ATOM	18175	O	PRO	D	756	22.805	63.919	41.785	1.00	62.40	O
ATOM	18176	N	PRO	D	756	25.372	63.573	40.901	1.00	62.46	N
ATOM	18177	CA	PRO	D	756	24.339	64.042	39.966	1.00	63.92	C
ATOM	18178	C	PRO	D	756	23.012	64.384	40.666	1.00	60.19	C
ATOM	18179	CB	PRO	D	756	24.152	62.843	39.036	1.00	56.26	C
ATOM	18180	CG	PRO	D	756	24.429	61.673	39.918	1.00	61.64	C
ATOM	18181	CD	PRO	D	756	25.567	62.114	40.808	1.00	61.51	C
ATOM	18182	O	GLU	D	757	19.611	63.592	41.631	1.00	59.25	O
ATOM	18183	N	GLU	D	757	22.132	65.153	40.022	1.00	56.51	N
ATOM	18184	CA	GLU	D	757	20.819	65.429	40.609	1.00	61.58	C
ATOM	18185	C	GLU	D	757	20.052	64.108	40.600	1.00	59.25	C
ATOM	18186	CB	GLU	D	757	20.054	66.563	39.848	1.00	66.95	C
ATOM	18187	CG	GLU	D	757	20.070	66.518	38.274	1.00	70.15	C
ATOM	18188	CD	GLU	D	757	19.206	67.613	37.531	1.00	78.92	C
ATOM	18189	OE1	GLU	D	757	18.493	68.413	38.194	1.00	74.31	O
ATOM	18190	OE2	GLU	D	757	19.245	67.661	36.260	1.00	70.44	O
ATOM	18191	N	ASN	D	758	19.927	63.544	39.411	1.00	62.27	N
ATOM	18192	CA	ASN	D	758	19.256	62.271	39.247	1.00	61.01	C
ATOM	18193	C	ASN	D	758	20.091	61.295	38.418	1.00	51.84	C
ATOM	18194	O	ASN	D	758	20.998	61.691	37.666	1.00	47.37	O
ATOM	18195	CB	ASN	D	758	17.890	62.477	38.577	1.00	63.60	C
ATOM	18196	CG	ASN	D	758	17.175	63.734	39.062	1.00	64.84	C
ATOM	18197	OD1	ASN	D	758	17.426	64.825	38.561	1.00	63.68	O
ATOM	18198	ND2	ASN	D	758	16.278	63.580	40.036	1.00	65.66	N
ATOM	18199	N	ILE	D	759	19.743	60.025	38.546	1.00	52.76	N
ATOM	18200	CA	ILE	D	759	20.279	58.956	37.703	1.00	45.73	C
ATOM	18201	C	ILE	D	759	19.100	58.194	37.126	1.00	46.99	C
ATOM	18202	O	ILE	D	759	18.347	57.561	37.873	1.00	48.26	O
ATOM	18203	CB	ILE	D	759	21.173	57.970	38.495	1.00	49.22	C
ATOM	18204	CG1	ILE	D	759	22.397	58.686	39.075	1.00	45.74	C
ATOM	18205	CG2	ILE	D	759	21.590	56.786	37.601	1.00	43.02	C

ATOM	18206	CD1	ILE	D	759	22.970	57.989	40.279	1.00	50.04	C
ATOM	18207	N	VAL	D	760	18.911	58.256	35.817	1.00	40.24	N
ATOM	18208	CA	VAL	D	760	17.773	57.553	35.239	1.00	46.00	C
ATOM	18209	C	VAL	D	760	18.188	56.250	34.550	1.00	42.60	C
ATOM	18210	O	VAL	D	760	19.027	56.242	33.657	1.00	39.29	O
ATOM	18211	CB	VAL	D	760	17.001	58.453	34.216	1.00	44.76	C
ATOM	18212	CG1	VAL	D	760	15.666	57.846	33.915	1.00	44.11	C
ATOM	18213	CG2	VAL	D	760	16.806	59.868	34.779	1.00	53.56	C
ATOM	18214	N	ILE	D	761	17.563	55.158	34.958	1.00	48.98	N
ATOM	18215	CA	ILE	D	761	17.853	53.856	34.374	1.00	46.55	C
ATOM	18216	C	ILE	D	761	16.658	53.253	33.641	1.00	48.61	C
ATOM	18217	O	ILE	D	761	15.644	52.923	34.241	1.00	55.49	O
ATOM	18218	CB	ILE	D	761	18.313	52.835	35.445	1.00	48.64	C
ATOM	18219	CG1	ILE	D	761	19.393	53.429	36.350	1.00	47.68	C
ATOM	18220	CG2	ILE	D	761	18.858	51.575	34.777	1.00	45.98	C
ATOM	18221	CD1	ILE	D	761	19.740	52.548	37.542	1.00	49.60	C
ATOM	18222	N	GLU	D	762	16.790	53.070	32.341	1.00	45.90	N
ATOM	18223	CA	GLU	D	762	15.773	52.340	31.595	1.00	55.25	C
ATOM	18224	C	GLU	D	762	15.581	50.872	32.031	1.00	58.61	C
ATOM	18225	O	GLU	D	762	16.542	50.190	32.418	1.00	56.83	O
ATOM	18226	CB	GLU	D	762	16.113	52.387	30.109	1.00	51.16	C
ATOM	18227	CG	GLU	D	762	15.043	51.814	29.228	1.00	58.86	C
ATOM	18228	CD	GLU	D	762	15.401	51.906	27.768	1.00	66.48	C
ATOM	18229	OE1	GLU	D	762	16.581	51.659	27.445	1.00	71.15	O
ATOM	18230	OE2	GLU	D	762	14.506	52.228	26.947	1.00	73.75	O
ATOM	18231	O	MET	D	763	12.814	47.415	30.622	1.00	75.85	O
ATOM	18232	N	MET	D	763	14.328	50.411	31.973	1.00	59.26	N
ATOM	18233	CA	MET	D	763	13.972	48.996	32.056	1.00	56.30	C
ATOM	18234	C	MET	D	763	13.455	48.478	30.706	1.00	65.44	C
ATOM	18235	CB	MET	D	763	12.915	48.773	33.124	1.00	59.82	C
ATOM	18236	CG	MET	D	763	12.899	49.845	34.178	1.00	66.70	C
ATOM	18237	SD	MET	D	763	14.216	49.660	35.391	1.00	88.06	S
ATOM	18238	CE	MET	D	763	13.840	48.023	36.048	1.00	78.47	C
ATOM	18239	O	ARG	D	919	18.630	36.376	29.528	1.00	81.88	O
ATOM	18240	N	ARG	D	919	16.635	34.352	27.266	1.00	88.74	N
ATOM	18241	CA	ARG	D	919	17.122	34.738	28.588	1.00	87.53	C
ATOM	18242	C	ARG	D	919	17.996	35.999	28.538	1.00	85.43	C
ATOM	18243	CB	ARG	D	919	17.892	33.583	29.236	1.00	84.24	C
ATOM	18244	CG	ARG	D	919	19.182	33.191	28.535	1.00	85.35	C
ATOM	18245	CD	ARG	D	919	19.893	32.098	29.327	1.00	86.97	C
ATOM	18246	NE	ARG	D	919	19.156	30.831	29.326	1.00	82.88	N
ATOM	18247	CZ	ARG	D	919	19.191	29.932	30.312	1.00	79.19	C
ATOM	18248	NH1	ARG	D	919	19.921	30.157	31.401	1.00	74.61	N
ATOM	18249	NH2	ARG	D	919	18.491	28.805	30.213	1.00	75.33	N
ATOM	18250	O	GLN	D	920	18.472	39.490	29.069	1.00	81.35	O
ATOM	18251	N	GLN	D	920	18.015	36.658	27.385	1.00	83.59	N
ATOM	18252	CA	GLN	D	920	18.723	37.921	27.260	1.00	83.23	C
ATOM	18253	C	GLN	D	920	17.986	39.025	28.035	1.00	84.49	C
ATOM	18254	CB	GLN	D	920	18.888	38.303	25.787	1.00	85.66	C
ATOM	18255	CG	GLN	D	920	19.770	37.349	24.987	1.00	91.08	C
ATOM	18256	CD	GLN	D	920	19.891	37.757	23.528	1.00	97.89	C
ATOM	18257	OE1	GLN	D	920	20.142	38.925	23.219	1.00	100.43	O
ATOM	18258	NE2	GLN	D	920	19.704	36.797	22.622	1.00	93.23	N
ATOM	18259	O	LEU	D	921	14.981	40.797	30.363	1.00	73.21	O
ATOM	18260	N	LEU	D	921	16.811	39.434	27.556	1.00	82.52	N
ATOM	18261	CA	LEU	D	921	16.060	40.496	28.221	1.00	82.10	C
ATOM	18262	C	LEU	D	921	15.519	40.016	29.581	1.00	79.68	C
ATOM	18263	CB	LEU	D	921	14.922	41.006	27.316	1.00	88.00	C
ATOM	18264	CG	LEU	D	921	15.272	41.891	26.094	1.00	87.01	C
ATOM	18265	CD1	LEU	D	921	14.049	42.155	25.200	1.00	78.44	C
ATOM	18266	CD2	LEU	D	921	15.909	43.218	26.501	1.00	77.89	C
ATOM	18267	O	VAL	D	922	16.166	38.978	33.320	1.00	69.92	O
ATOM	18268	N	VAL	D	922	15.683	38.730	29.867	1.00	78.65	N

ATOM	18269	CA	VAL	D	922	15.367	38.199	31.189	1.00	76.98	C
ATOM	18270	C	VAL	D	922	16.455	38.574	32.200	1.00	71.82	C
ATOM	18271	CB	VAL	D	922	15.208	36.658	31.160	1.00	80.78	C
ATOM	18272	CG2	VAL	D	922	14.280	36.222	30.020	1.00	71.18	C
ATOM	18273	CG1	VAL	D	922	14.709	36.150	32.507	1.00	81.78	C
ATOM	18274	O	GLU	D	923	19.921	40.739	33.435	1.00	64.38	O
ATOM	18275	N	GLU	D	923	17.711	38.420	31.795	1.00	74.73	N
ATOM	18276	CA	GLU	D	923	18.846	38.733	32.649	1.00	69.71	C
ATOM	18277	C	GLU	D	923	19.133	40.229	32.628	1.00	67.91	C
ATOM	18278	CB	GLU	D	923	20.085	37.943	32.204	1.00	63.06	C
ATOM	18279	O	THR	D	924	18.441	43.950	33.411	1.00	67.57	O
ATOM	18280	N	THR	D	924	18.494	40.926	31.691	1.00	71.61	N
ATOM	18281	CA	THR	D	924	18.606	42.384	31.608	1.00	69.16	C
ATOM	18282	C	THR	D	924	17.918	43.013	32.808	1.00	65.90	C
ATOM	18283	CB	THR	D	924	17.995	42.947	30.309	1.00	69.97	C
ATOM	18284	OG1	THR	D	924	18.873	42.684	29.205	1.00	70.98	O
ATOM	18285	CG2	THR	D	924	17.813	44.428	30.416	1.00	63.37	C
ATOM	18286	O	ARG	D	925	16.967	43.772	36.400	1.00	73.58	O
ATOM	18287	N	ARG	D	925	16.760	42.475	33.176	1.00	66.09	N
ATOM	18288	CA	ARG	D	925	16.026	43.005	34.317	1.00	67.03	C
ATOM	18289	C	ARG	D	925	16.856	42.845	35.595	1.00	67.62	C
ATOM	18290	CB	ARG	D	925	14.670	42.314	34.459	1.00	63.05	C
ATOM	18291	O	GLN	D	926	19.613	42.906	38.215	1.00	64.81	O
ATOM	18292	N	GLN	D	926	17.459	41.679	35.766	1.00	57.45	N
ATOM	18293	CA	GLN	D	926	18.224	41.397	36.971	1.00	66.41	C
ATOM	18294	C	GLN	D	926	19.361	42.401	37.122	1.00	65.51	C
ATOM	18295	CB	GLN	D	926	18.782	39.963	36.945	1.00	56.31	C
ATOM	18296	N	ILE	D	927	20.044	42.683	36.019	1.00	62.79	N
ATOM	18297	CA	ILE	D	927	21.138	43.641	36.024	1.00	58.45	C
ATOM	18298	C	ILE	D	927	20.619	45.042	36.388	1.00	61.81	C
ATOM	18299	O	ILE	D	927	21.248	45.769	37.147	1.00	60.84	O
ATOM	18300	CB	ILE	D	927	21.841	43.679	34.654	1.00	54.17	C
ATOM	18301	CG1	ILE	D	927	22.416	42.309	34.301	1.00	56.42	C
ATOM	18302	CG2	ILE	D	927	22.940	44.720	34.625	1.00	51.42	C
ATOM	18303	CD1	ILE	D	927	23.022	42.232	32.910	1.00	52.96	C
ATOM	18304	N	THR	D	928	19.454	45.410	35.871	1.00	56.90	N
ATOM	18305	CA	THR	D	928	18.971	46.777	36.077	1.00	64.69	C
ATOM	18306	C	THR	D	928	18.530	46.978	37.522	1.00	63.81	C
ATOM	18307	O	THR	D	928	18.850	47.995	38.132	1.00	58.68	O
ATOM	18308	CB	THR	D	928	17.801	47.160	35.138	1.00	60.34	C
ATOM	18309	OG1	THR	D	928	18.259	47.297	33.788	1.00	52.55	O
ATOM	18310	CG2	THR	D	928	17.288	48.488	35.541	1.00	68.45	C
ATOM	18311	N	LYS	D	929	17.817	46.000	38.068	1.00	60.55	N
ATOM	18312	CA	LYS	D	929	17.444	46.045	39.473	1.00	61.63	C
ATOM	18313	C	LYS	D	929	18.690	46.140	40.366	1.00	64.83	C
ATOM	18314	O	LYS	D	929	18.743	46.948	41.297	1.00	65.12	O
ATOM	18315	CB	LYS	D	929	16.612	44.824	39.843	1.00	56.45	C
ATOM	18316	N	HIS	D	930	19.710	45.342	40.061	1.00	67.77	N
ATOM	18317	CA	HIS	D	930	20.944	45.369	40.843	1.00	66.67	C
ATOM	18318	C	HIS	D	930	21.660	46.694	40.761	1.00	58.31	C
ATOM	18319	O	HIS	D	930	22.205	47.166	41.755	1.00	59.52	O
ATOM	18320	CB	HIS	D	930	21.906	44.272	40.395	1.00	65.67	C
ATOM	18321	CG	HIS	D	930	21.592	42.944	40.982	1.00	71.32	C
ATOM	18322	ND1	HIS	D	930	21.660	42.704	42.336	1.00	72.44	N
ATOM	18323	CD2	HIS	D	930	21.182	41.789	40.409	1.00	70.58	C
ATOM	18324	CE1	HIS	D	930	21.308	41.454	42.571	1.00	76.28	C
ATOM	18325	NE2	HIS	D	930	21.009	40.878	41.420	1.00	74.11	N
ATOM	18326	N	VAL	D	931	21.699	47.258	39.560	1.00	56.11	N
ATOM	18327	CA	VAL	D	931	22.385	48.522	39.354	1.00	60.24	C
ATOM	18328	C	VAL	D	931	21.670	49.615	40.150	1.00	58.67	C
ATOM	18329	O	VAL	D	931	22.318	50.444	40.789	1.00	53.73	O
ATOM	18330	CB	VAL	D	931	22.454	48.896	37.868	1.00	55.91	C
ATOM	18331	CG1	VAL	D	931	23.015	50.290	37.703	1.00	45.27	C

ATOM	18332	CG2	VAL	D	931	23.314	47.891	37.115	1.00	52.36	C
ATOM	18333	N	ALA	D	932	20.336	49.575	40.138	1.00	57.75	N
ATOM	18334	CA	ALA	D	932	19.529	50.508	40.917	1.00	61.22	C
ATOM	18335	C	ALA	D	932	19.863	50.397	42.413	1.00	65.68	C
ATOM	18336	O	ALA	D	932	20.204	51.400	43.048	1.00	63.31	O
ATOM	18337	CB	ALA	D	932	18.036	50.270	40.676	1.00	56.76	C
ATOM	18338	N	GLN	D	933	19.789	49.187	42.970	1.00	61.28	N
ATOM	18339	CA	GLN	D	933	20.069	49.015	44.394	1.00	60.94	C
ATOM	18340	C	GLN	D	933	21.472	49.518	44.753	1.00	59.31	C
ATOM	18341	O	GLN	D	933	21.661	50.141	45.783	1.00	57.75	O
ATOM	18342	CB	GLN	D	933	19.891	47.551	44.807	1.00	55.50	C
ATOM	18343	CG	GLN	D	933	20.257	47.223	46.278	1.00	62.05	C
ATOM	18344	CD	GLN	D	933	21.718	46.740	46.476	1.00	75.38	C
ATOM	18345	OE1	GLN	D	933	22.157	45.742	45.879	1.00	80.14	O
ATOM	18346	NE2	GLN	D	933	22.462	47.446	47.327	1.00	73.62	N
ATOM	18347	N	ILE	D	934	22.456	49.259	43.900	1.00	64.93	N
ATOM	18348	CA	ILE	D	934	23.837	49.604	44.245	1.00	61.09	C
ATOM	18349	C	ILE	D	934	24.037	51.112	44.171	1.00	61.40	C
ATOM	18350	O	ILE	D	934	24.574	51.715	45.097	1.00	59.43	O
ATOM	18351	CB	ILE	D	934	24.861	48.881	43.335	1.00	59.00	C
ATOM	18352	CG1	ILE	D	934	25.062	47.444	43.816	1.00	64.76	C
ATOM	18353	CG2	ILE	D	934	26.202	49.581	43.354	1.00	54.31	C
ATOM	18354	CD1	ILE	D	934	25.417	46.451	42.720	1.00	62.92	C
ATOM	18355	N	LEU	D	935	23.598	51.720	43.075	1.00	61.59	N
ATOM	18356	CA	LEU	D	935	23.738	53.163	42.915	1.00	63.95	C
ATOM	18357	C	LEU	D	935	23.060	53.911	44.069	1.00	61.36	C
ATOM	18358	O	LEU	D	935	23.649	54.816	44.632	1.00	60.22	O
ATOM	18359	CB	LEU	D	935	23.183	53.619	41.562	1.00	57.31	C
ATOM	18360	CG	LEU	D	935	24.039	53.137	40.389	1.00	58.15	C
ATOM	18361	CD2	LEU	D	935	25.534	53.048	40.767	1.00	51.98	C
ATOM	18362	CD1	LEU	D	935	23.824	54.003	39.164	1.00	53.65	C
ATOM	18363	O	ASP	D	936	22.096	55.103	47.505	1.00	69.36	O
ATOM	18364	N	ASP	D	936	21.861	53.482	44.453	1.00	64.01	N
ATOM	18365	CA	ASP	D	936	21.133	54.102	45.558	1.00	61.77	C
ATOM	18366	C	ASP	D	936	21.885	54.062	46.867	1.00	67.72	C
ATOM	18367	CB	ASP	D	936	19.783	53.430	45.792	1.00	68.66	C
ATOM	18368	CG	ASP	D	936	18.897	54.240	46.734	1.00	67.72	C
ATOM	18369	OD1	ASP	D	936	18.806	55.462	46.521	1.00	68.11	O
ATOM	18370	OD2	ASP	D	936	18.317	53.672	47.682	1.00	67.24	O
ATOM	18371	N	SER	D	937	22.258	52.854	47.280	1.00	60.23	N
ATOM	18372	CA	SER	D	937	22.974	52.669	48.534	1.00	61.50	C
ATOM	18373	C	SER	D	937	24.331	53.340	48.471	1.00	60.57	C
ATOM	18374	O	SER	D	937	24.914	53.668	49.495	1.00	65.56	O
ATOM	18375	CB	SER	D	937	23.131	51.182	48.861	1.00	64.89	C
ATOM	18376	OG	SER	D	937	24.082	50.565	48.014	1.00	67.83	O
ATOM	18377	N	ARG	D	938	24.825	53.550	47.261	1.00	62.28	N
ATOM	18378	CA	ARG	D	938	26.117	54.178	47.075	1.00	63.75	C
ATOM	18379	C	ARG	D	938	25.992	55.665	47.297	1.00	62.74	C
ATOM	18380	O	ARG	D	938	26.651	56.237	48.160	1.00	66.22	O
ATOM	18381	CB	ARG	D	938	26.660	53.895	45.672	1.00	66.74	C
ATOM	18382	CG	ARG	D	938	28.149	53.651	45.629	1.00	67.09	C
ATOM	18383	CD	ARG	D	938	28.466	52.315	44.991	1.00	61.82	C
ATOM	18384	NE	ARG	D	938	29.772	51.815	45.416	1.00	65.40	N
ATOM	18385	CE	ARG	D	938	30.918	52.152	44.842	1.00	63.79	C
ATOM	18386	NH1	ARG	D	938	30.928	52.992	43.816	1.00	64.97	N
ATOM	18387	NH2	ARG	D	938	32.054	51.648	45.289	1.00	70.37	N
ATOM	18388	N	MET	D	939	25.119	56.281	46.514	1.00	64.97	N
ATOM	18389	CA	MET	D	939	24.915	57.722	46.542	1.00	66.98	C
ATOM	18390	C	MET	D	939	24.274	58.260	47.816	1.00	68.07	C
ATOM	18391	O	MET	D	939	24.541	59.389	48.197	1.00	68.46	O
ATOM	18392	CB	MET	D	939	24.063	58.136	45.350	1.00	59.47	C
ATOM	18393	CG	MET	D	939	24.623	57.723	44.025	1.00	58.18	C
ATOM	18394	SD	MET	D	939	25.889	58.799	43.342	1.00	67.48	S

ATOM	18395	CE	MET	D	939	27.311	58.473	44.386	1.00	62.37	C
ATOM	18396	O	ASN	D	940	22.400	56.213	51.189	1.00	71.97	O
ATOM	18397	N	ASN	D	940	23.431	57.460	48.462	1.00	68.63	N
ATOM	18398	CA	ASN	D	940	22.605	57.958	49.563	1.00	69.15	C
ATOM	18399	C	ASN	D	940	22.912	57.288	50.885	1.00	72.35	C
ATOM	18400	CB	ASN	D	940	21.120	57.772	49.242	1.00	65.45	C
ATOM	18401	CG	ASN	D	940	20.732	58.387	47.915	1.00	69.01	O
ATOM	18402	OD1	ASN	D	940	21.256	59.430	47.524	1.00	72.21	C
ATOM	18403	ND2	ASN	D	940	19.813	57.742	47.210	1.00	66.45	N
ATOM	18404	O	THR	D	941	23.822	57.315	55.281	1.00	85.84	O
ATOM	18405	N	THR	D	941	23.718	57.951	51.696	1.00	78.38	N
ATOM	18406	CA	THR	D	941	24.215	57.326	52.907	1.00	78.27	C
ATOM	18407	C	THR	D	941	23.736	57.959	54.235	1.00	83.39	C
ATOM	18408	CB	THR	D	941	25.748	57.314	52.878	1.00	78.15	C
ATOM	18409	OG1	THR	D	941	26.250	57.081	54.199	1.00	91.56	O
ATOM	18410	CG2	THR	D	941	26.273	58.643	52.349	1.00	76.65	C
ATOM	18411	O	LYS	D	942	20.568	59.355	55.122	1.00	79.91	O
ATOM	18412	N	LYS	D	942	23.223	59.191	54.203	1.00	81.46	N
ATOM	18413	CA	LYS	D	942	22.882	59.902	55.442	1.00	78.72	C
ATOM	18414	C	LYS	D	942	21.452	59.624	55.921	1.00	76.51	C
ATOM	18415	CB	LYS	D	942	23.086	61.405	55.259	1.00	68.26	C
ATOM	18416	O	TYR	D	943	19.843	61.624	58.843	1.00	79.64	O
ATOM	18417	N	TYR	D	943	21.226	59.695	57.228	1.00	76.33	N
ATOM	18418	CA	TYR	D	943	19.892	59.451	57.777	1.00	78.37	C
ATOM	18419	C	TYR	D	943	19.200	60.723	58.297	1.00	83.20	C
ATOM	18420	CB	TYR	D	943	19.969	58.409	58.895	1.00	83.48	C
ATOM	18421	CG	TYR	D	943	20.376	57.031	58.414	1.00	84.45	C
ATOM	18422	CD1	TYR	D	943	19.420	56.069	58.108	1.00	86.15	C
ATOM	18423	CD2	TYR	D	943	21.710	56.696	58.254	1.00	81.03	C
ATOM	18424	CE1	TYR	D	943	19.786	54.810	57.666	1.00	86.89	C
ATOM	18425	CE2	TYR	D	943	22.084	55.450	57.821	1.00	86.28	C
ATOM	18426	CZ	TYR	D	943	21.121	54.508	57.521	1.00	91.33	C
ATOM	18427	OH	TYR	D	943	21.502	53.261	57.081	1.00	86.51	O
ATOM	18428	O	ASP	D	944	17.734	61.388	60.753	1.00	91.00	O
ATOM	18429	N	ASP	D	944	17.878	60.770	58.115	1.00	88.83	N
ATOM	18430	CA	ASP	D	944	17.032	61.895	58.523	1.00	83.65	C
ATOM	18431	C	ASP	D	944	17.076	62.130	60.018	1.00	89.75	C
ATOM	18432	CB	ASP	D	944	15.579	61.655	58.100	1.00	84.04	C
ATOM	18433	O	GLU	D	945	16.604	61.757	63.487	1.00	89.24	O
ATOM	18434	N	GLU	D	945	16.366	63.167	60.457	1.00	93.00	N
ATOM	18435	CA	GLU	D	945	16.273	63.500	61.871	1.00	95.36	C
ATOM	18436	C	GLU	D	945	15.873	62.248	62.624	1.00	94.43	C
ATOM	18437	CB	GLU	D	945	15.268	64.635	62.107	1.00	91.88	C
ATOM	18438	O	ASN	D	946	13.819	58.336	61.972	1.00	92.57	O
ATOM	18439	N	ASN	D	946	14.725	61.708	62.236	1.00	95.51	N
ATOM	18440	CA	ASN	D	946	14.159	60.529	62.868	1.00	94.66	C
ATOM	18441	C	ASN	D	946	14.612	59.245	62.195	1.00	91.86	C
ATOM	18442	CB	ASN	D	946	12.644	60.628	62.849	1.00	94.50	C
ATOM	18443	CG	ASN	D	946	12.137	61.184	61.546	1.00	98.77	C
ATOM	18444	OD1	ASN	D	946	12.738	60.953	60.494	1.00	98.07	O
ATOM	18445	ND2	ASN	D	946	11.048	61.945	61.603	1.00	100.16	N
ATOM	18446	O	ASP	D	947	16.005	56.064	60.079	1.00	86.15	O
ATOM	18447	N	ASP	D	947	15.892	59.203	61.847	1.00	94.58	N
ATOM	18448	CA	ASP	D	947	16.562	57.973	61.444	1.00	92.38	C
ATOM	18449	C	ASP	D	947	15.972	57.294	60.202	1.00	90.69	C
ATOM	18450	CB	ASP	D	947	16.566	56.995	62.616	1.00	91.85	C
ATOM	18451	CG	ASP	D	947	17.898	56.305	62.784	1.00	95.50	C
ATOM	18452	OD2	ASP	D	947	18.463	56.363	63.899	1.00	95.30	O
ATOM	18453	OD1	ASP	D	947	18.386	55.720	61.791	1.00	92.42	O
ATOM	18454	O	LYS	D	948	16.702	59.091	57.002	1.00	84.05	O
ATOM	18455	N	LYS	D	948	15.450	58.100	59.282	1.00	86.90	N
ATOM	18456	CA	LYS	D	948	15.073	57.615	57.959	1.00	84.50	C
ATOM	18457	C	LYS	D	948	16.164	57.989	56.945	1.00	83.55	C

ATOM	18458	CB	LYS	D	948	13.720	58.203	57.542	1.00	87.81	C
ATOM	18459	O	LEU	D	949	15.938	58.818	53.911	1.00	76.08	O
ATOM	18460	N	LEU	D	949	16.498	57.092	56.021	1.00	80.34	N
ATOM	18461	CA	LEU	D	949	17.530	57.402	55.024	1.00	79.81	C
ATOM	18462	C	LEU	D	949	17.123	58.603	54.161	1.00	74.97	C
ATOM	18463	CB	LEU	D	949	17.815	56.179	54.140	1.00	71.84	C
ATOM	18464	CG	LEU	D	949	19.252	56.036	53.619	1.00	78.06	C
ATOM	18465	CD1	LEU	D	949	19.648	54.559	53.476	1.00	86.78	C
ATOM	18466	CD2	LEU	D	949	19.443	56.762	52.299	1.00	74.75	C
ATOM	18467	O	ILE	D	950	19.385	59.811	51.212	1.00	72.87	O
ATOM	18468	N	ILE	D	950	18.103	59.387	53.723	1.00	71.41	N
ATOM	18469	CA	ILE	D	950	17.838	60.552	52.883	1.00	72.53	C
ATOM	18470	C	ILE	D	950	18.276	60.297	51.453	1.00	76.85	C
ATOM	18471	CB	ILE	D	950	18.564	61.808	53.392	1.00	74.64	C
ATOM	18472	CG1	ILE	D	950	18.315	62.004	54.886	1.00	77.35	C
ATOM	18473	CG2	ILE	D	950	18.110	63.023	52.627	1.00	71.21	C
ATOM	18474	CD1	ILE	D	950	19.305	62.920	55.549	1.00	77.61	C
ATOM	18475	O	ARG	D	951	17.358	62.318	47.709	1.00	71.63	O
ATOM	18476	N	ARG	D	951	17.407	60.632	50.505	1.00	76.93	N
ATOM	18477	CA	ARG	D	951	17.697	60.392	49.097	1.00	76.63	C
ATOM	18478	C	ARG	D	951	18.130	61.683	48.433	1.00	68.96	C
ATOM	18479	CB	ARG	D	951	16.481	59.802	48.361	1.00	74.96	C
ATOM	18480	CG	ARG	D	951	15.866	58.572	49.016	1.00	77.40	C
ATOM	18481	CD	ARG	D	951	16.473	57.239	48.554	1.00	73.12	C
ATOM	18482	NE	ARG	D	951	15.719	56.116	49.122	1.00	70.79	N
ATOM	18483	CZ	ARG	D	951	16.268	55.046	49.689	1.00	76.89	C
ATOM	18484	NH1	ARG	D	951	15.501	54.090	50.187	1.00	81.88	N
ATOM	18485	NH2	ARG	D	951	17.584	54.925	49.763	1.00	77.54	N
ATOM	18486	N	GLU	D	952	19.373	62.060	48.681	1.00	67.09	N
ATOM	18487	CA	GLU	D	952	19.970	63.223	48.042	1.00	69.76	C
ATOM	18488	C	GLU	D	952	20.067	63.086	46.513	1.00	70.77	C
ATOM	18489	O	GLU	D	952	19.774	64.036	45.778	1.00	71.14	O
ATOM	18490	CB	GLU	D	952	21.349	63.460	48.643	1.00	75.52	C
ATOM	18491	CG	GLU	D	952	22.143	64.554	47.985	1.00	81.34	C
ATOM	18492	CD	GLU	D	952	23.467	64.774	48.680	1.00	84.10	C
ATOM	18493	OE1	GLU	D	952	24.318	63.859	48.640	1.00	79.79	O
ATOM	18494	OE2	GLU	D	952	23.645	65.860	49.276	1.00	90.46	O
ATOM	18495	N	VAL	D	953	20.497	61.914	46.040	1.00	70.52	N
ATOM	18496	CA	VAL	D	953	20.527	61.622	44.602	1.00	68.55	C
ATOM	18497	C	VAL	D	953	19.360	60.704	44.280	1.00	64.64	C
ATOM	18498	O	VAL	D	953	19.170	59.708	44.968	1.00	62.47	O
ATOM	18499	CB	VAL	D	953	21.844	60.939	44.162	1.00	67.47	C
ATOM	18500	CG2	VAL	D	953	23.038	61.769	44.548	1.00	66.58	C
ATOM	18501	CG1	VAL	D	953	21.847	60.699	42.666	1.00	61.71	C
ATOM	18502	N	LYS	D	954	18.585	61.025	43.245	1.00	60.70	N
ATOM	18503	CA	LYS	D	954	17.393	60.227	42.920	1.00	57.36	C
ATOM	18504	C	LYS	D	954	17.619	59.222	41.773	1.00	52.59	C
ATOM	18505	O	LYS	D	954	18.007	59.584	40.650	1.00	50.46	O
ATOM	18506	CB	LYS	D	954	16.222	61.150	42.575	1.00	62.06	C
ATOM	18507	CG	LYS	D	954	16.401	62.566	43.089	1.00	63.04	C
ATOM	18508	CD	LYS	D	954	15.069	63.251	43.212	1.00	67.06	C
ATOM	18509	CE	LYS	D	954	15.199	64.774	43.330	1.00	72.24	C
ATOM	18510	NZ	LYS	D	954	13.849	65.424	43.268	1.00	62.83	N
ATOM	18511	N	VAL	D	955	17.362	57.954	42.062	1.00	48.50	N
ATOM	18512	CA	VAL	D	955	17.598	56.930	41.065	1.00	56.22	C
ATOM	18513	C	VAL	D	955	16.260	56.626	40.461	1.00	57.90	C
ATOM	18514	O	VAL	D	955	15.389	56.015	41.094	1.00	57.03	O
ATOM	18515	CB	VAL	D	955	18.252	55.648	41.640	1.00	56.39	C
ATOM	18516	CG1	VAL	D	955	18.407	54.617	40.555	1.00	54.04	C
ATOM	18517	CG2	VAL	D	955	19.600	55.965	42.264	1.00	47.07	C
ATOM	18518	N	ILE	D	956	16.101	57.097	39.233	1.00	50.81	N
ATOM	18519	CA	ILE	D	956	14.828	57.027	38.561	1.00	55.56	C
ATOM	18520	C	ILE	D	956	14.798	55.889	37.559	1.00	60.13	C

ATOM	18521	O	ILE	D	956	15.690	55.745	36.707	1.00	58.63	O
ATOM	18522	CB	ILE	D	956	14.503	58.359	37.873	1.00	59.28	C
ATOM	18523	CG1	ILE	D	956	14.313	59.437	38.944	1.00	59.36	C
ATOM	18524	CG2	ILE	D	956	13.258	58.216	37.050	1.00	61.10	C
ATOM	18525	CD1	ILE	D	956	14.784	60.819	38.530	1.00	63.75	C
ATOM	18526	N	THR	D	957	13.757	55.078	37.683	1.00	61.92	N
ATOM	18527	CA	THR	D	957	13.604	53.877	36.890	1.00	57.09	C
ATOM	18528	C	THR	D	957	12.415	53.986	35.934	1.00	59.60	C
ATOM	18529	O	THR	D	957	11.270	53.839	36.352	1.00	59.27	O
ATOM	18530	CB	THR	D	957	13.420	52.694	37.816	1.00	60.20	C
ATOM	18531	OG1	THR	D	957	12.188	52.857	38.519	1.00	68.68	O
ATOM	18532	CG2	THR	D	957	14.530	52.685	38.837	1.00	62.51	C
ATOM	18533	N	LEU	D	958	12.693	54.256	34.660	1.00	58.97	N
ATOM	18534	CA	LEU	D	958	11.656	54.436	33.629	1.00	56.44	C
ATOM	18535	C	LEU	D	958	11.364	53.167	32.830	1.00	64.46	C
ATOM	18536	O	LEU	D	958	12.293	52.480	32.363	1.00	61.47	O
ATOM	18537	CB	LEU	D	958	12.081	55.515	32.639	1.00	57.45	C
ATOM	18538	CG	LEU	D	958	11.544	56.940	32.591	1.00	56.13	C
ATOM	18539	CD1	LEU	D	958	11.660	57.599	33.925	1.00	55.40	C
ATOM	18540	CD2	LEU	D	958	12.372	57.674	31.573	1.00	52.03	C
ATOM	18541	N	LYS	D	959	10.083	52.868	32.637	1.00	64.32	N
ATOM	18542	CA	LYS	D	959	9.713	51.809	31.709	1.00	61.22	C
ATOM	18543	C	LYS	D	959	10.228	52.214	30.340	1.00	63.64	C
ATOM	18544	O	LYS	D	959	10.219	53.397	29.993	1.00	60.16	O
ATOM	18545	CB	LYS	D	959	8.202	51.587	31.685	1.00	65.95	C
ATOM	18546	N	SER	D	960	10.706	51.249	29.565	1.00	65.92	N
ATOM	18547	CA	SER	D	960	11.310	51.580	28.283	1.00	61.87	C
ATOM	18548	C	SER	D	960	10.279	52.078	27.272	1.00	54.26	C
ATOM	18549	O	SER	D	960	10.611	52.854	26.385	1.00	58.52	O
ATOM	18550	CB	SER	D	960	12.058	50.368	27.720	1.00	63.70	C
ATOM	18551	OG	SER	D	960	11.168	49.292	27.492	1.00	72.13	O
ATOM	18552	N	LYS	D	961	9.034	51.631	27.393	1.00	54.98	N
ATOM	18553	CA	LYS	D	961	8.003	52.045	26.438	1.00	59.70	C
ATOM	18554	C	LYS	D	961	7.888	53.567	26.370	1.00	59.50	C
ATOM	18555	O	LYS	D	961	7.700	54.124	25.288	1.00	58.26	O
ATOM	18556	CB	LYS	D	961	6.648	51.431	26.790	1.00	58.76	C
ATOM	18557	N	LEU	D	962	8.060	54.222	27.519	1.00	56.52	N
ATOM	18558	CA	LEU	D	962	7.941	55.675	27.639	1.00	61.24	C
ATOM	18559	C	LEU	D	962	8.890	56.438	26.731	1.00	61.86	C
ATOM	18560	O	LEU	D	962	8.459	57.297	25.960	1.00	65.39	O
ATOM	18561	CB	LEU	D	962	8.164	56.108	29.087	1.00	60.56	C
ATOM	18562	CG	LEU	D	962	6.998	55.760	30.021	1.00	62.36	C
ATOM	18563	CD1	LEU	D	962	7.197	56.346	31.396	1.00	58.88	C
ATOM	18564	CD2	LEU	D	962	5.680	56.245	29.425	1.00	68.48	C
ATOM	18565	N	VAL	D	963	10.178	56.140	26.823	1.00	57.60	N
ATOM	18566	CA	VAL	D	963	11.171	56.774	25.956	1.00	54.98	C
ATOM	18567	C	VAL	D	963	10.918	56.341	24.522	1.00	58.68	C
ATOM	18568	O	VAL	D	963	11.146	57.082	23.588	1.00	58.76	O
ATOM	18569	CB	VAL	D	963	12.613	56.392	26.385	1.00	57.26	C
ATOM	18570	CG1	VAL	D	963	13.657	56.760	25.311	1.00	52.44	C
ATOM	18571	CG2	VAL	D	963	12.942	57.022	27.705	1.00	56.30	C
ATOM	18572	N	SER	D	964	10.425	55.120	24.371	1.00	58.45	N
ATOM	18573	CA	SER	D	964	10.154	54.546	23.070	1.00	51.17	C
ATOM	18574	C	SER	D	964	8.912	55.191	22.450	1.00	65.77	C
ATOM	18575	O	SER	D	964	8.837	55.396	21.231	1.00	65.11	O
ATOM	18576	CB	SER	D	964	9.978	53.045	23.210	1.00	54.85	C
ATOM	18577	OG	SER	D	964	9.903	52.442	21.951	1.00	65.25	O
ATOM	18578	N	ASP	D	965	7.938	55.523	23.296	1.00	63.11	N
ATOM	18579	CA	ASP	D	965	6.784	56.304	22.846	1.00	62.21	C
ATOM	18580	C	ASP	D	965	7.247	57.700	22.479	1.00	59.15	C
ATOM	18581	O	ASP	D	965	6.817	58.270	21.471	1.00	61.83	O
ATOM	18582	CB	ASP	D	965	5.691	56.375	23.919	1.00	57.62	C
ATOM	18583	CG	ASP	D	965	4.895	55.082	24.042	1.00	57.46	C

ATOM	18584	OD1	ASP	D	965	4.904	54.277	23.088	1.00	53.47	O
ATOM	18585	OD2	ASP	D	965	4.245	54.880	25.096	1.00	66.21	O
ATOM	18586	N	PHE	D	966	8.134	58.238	23.306	1.00	57.41	N
ATOM	18587	CA	PHE	D	966	8.612	59.608	23.153	1.00	58.33	C
ATOM	18588	C	PHE	D	966	9.305	59.762	21.809	1.00	62.48	C
ATOM	18589	O	PHE	D	966	9.157	60.776	21.147	1.00	67.60	O
ATOM	18590	CB	PHE	D	966	9.550	59.966	24.309	1.00	57.68	C
ATOM	18591	CG	PHE	D	966	9.974	61.416	24.357	1.00	60.78	C
ATOM	18592	CD2	PHE	D	966	9.425	62.280	25.301	1.00	64.31	C
ATOM	18593	CD1	PHE	D	966	10.948	61.906	23.506	1.00	60.13	C
ATOM	18594	CE2	PHE	D	966	9.827	63.605	25.385	1.00	57.12	C
ATOM	18595	CE1	PHE	D	966	11.351	63.233	23.580	1.00	63.17	C
ATOM	18596	CZ	PHE	D	966	10.788	64.084	24.523	1.00	59.79	C
ATOM	18597	N	ARG	D	967	10.058	58.743	21.411	1.00	62.82	N
ATOM	18598	CA	ARG	D	967	10.793	58.776	20.153	1.00	65.75	C
ATOM	18599	C	ARG	D	967	9.841	58.836	18.946	1.00	64.06	C
ATOM	18600	O	ARG	D	967	10.099	59.544	17.969	1.00	60.92	O
ATOM	18601	CB	ARG	D	967	11.717	57.547	20.031	1.00	59.46	C
ATOM	18602	CG	ARG	D	967	12.808	57.446	21.094	1.00	61.92	C
ATOM	18603	CD	ARG	D	967	13.730	56.257	20.819	1.00	58.97	C
ATOM	18604	NE	ARG	D	967	14.597	56.596	19.716	1.00	56.61	N
ATOM	18605	CZ	ARG	D	967	15.888	56.827	19.831	1.00	56.56	C
ATOM	18606	NH1	ARG	D	967	16.475	56.672	20.999	1.00	53.15	N
ATOM	18607	NH2	ARG	D	967	16.590	57.174	18.764	1.00	61.85	N
ATOM	18608	N	LYS	D	968	8.762	58.059	19.013	1.00	65.13	N
ATOM	18609	CA	LYS	D	968	7.824	57.930	17.906	1.00	62.66	C
ATOM	18610	C	LYS	D	968	6.866	59.112	17.880	1.00	61.99	C
ATOM	18611	O	LYS	D	968	6.570	59.655	16.819	1.00	59.18	O
ATOM	18612	CB	LYS	D	968	7.051	56.612	18.001	1.00	62.57	C
ATOM	18613	N	ASP	D	969	6.409	59.533	19.050	1.00	61.98	N
ATOM	18614	CA	ASP	D	969	5.514	60.677	19.104	1.00	61.41	C
ATOM	18615	C	ASP	D	969	6.210	61.949	18.636	1.00	61.64	C
ATOM	18616	O	ASP	D	969	5.548	62.860	18.174	1.00	64.78	O
ATOM	18617	CB	ASP	D	969	4.942	60.862	20.511	1.00	62.07	C
ATOM	18618	CG	ASP	D	969	3.978	59.752	20.895	1.00	65.60	C
ATOM	18619	OD1	ASP	D	969	3.923	58.729	20.177	1.00	67.93	O
ATOM	18620	OD2	ASP	D	969	3.279	59.889	21.915	1.00	68.46	O
ATOM	18621	N	PHE	D	970	7.536	62.023	18.702	1.00	62.45	N
ATOM	18622	CA	PHE	D	970	8.186	63.259	18.246	1.00	60.97	C
ATOM	18623	C	PHE	D	970	9.294	63.052	17.220	1.00	60.58	C
ATOM	18624	O	PHE	D	970	10.149	63.914	17.033	1.00	63.63	O
ATOM	18625	CB	PHE	D	970	8.706	64.038	19.444	1.00	57.08	C
ATOM	18626	CG	PHE	D	970	7.649	64.298	20.469	1.00	66.51	C
ATOM	18627	CD1	PHE	D	970	6.659	65.238	20.232	1.00	69.70	C
ATOM	18628	CD2	PHE	D	970	7.615	63.586	21.650	1.00	64.82	C
ATOM	18629	CE1	PHE	D	970	5.682	65.472	21.162	1.00	71.94	C
ATOM	18630	CE2	PHE	D	970	6.632	63.816	22.580	1.00	66.65	C
ATOM	18631	CZ	PHE	D	970	5.665	64.755	22.336	1.00	70.63	C
ATOM	18632	N	GLN	D	971	9.236	61.917	16.532	1.00	61.78	N
ATOM	18633	CA	GLN	D	971	10.098	61.630	15.389	1.00	65.53	C
ATOM	18634	C	GLN	D	971	11.593	61.687	15.663	1.00	61.19	C
ATOM	18635	O	GLN	D	971	12.365	62.162	14.832	1.00	57.14	O
ATOM	18636	CB	GLN	D	971	9.759	62.569	14.238	1.00	68.63	C
ATOM	18637	CG	GLN	D	971	8.704	61.980	13.322	1.00	72.49	C
ATOM	18638	CD	GLN	D	971	8.047	63.009	12.424	1.00	85.49	C
ATOM	18639	OE1	GLN	D	971	8.541	64.137	12.279	1.00	86.83	O
ATOM	18640	NE2	GLN	D	971	6.918	62.630	11.819	1.00	79.47	N
ATOM	18641	O	PHE	D	972	13.486	58.589	17.860	1.00	59.32	O
ATOM	18642	N	PHE	D	972	11.989	61.197	16.830	1.00	62.37	N
ATOM	18643	CA	PHE	D	972	13.383	60.854	17.074	1.00	62.47	C
ATOM	18644	C	PHE	D	972	13.501	59.344	16.889	1.00	62.50	C
ATOM	18645	CB	PHE	D	972	13.831	61.269	18.474	1.00	57.52	C
ATOM	18646	CG	PHE	D	972	13.578	62.713	18.803	1.00	59.01	C

ATOM	18647	CD1	PHE	D	972	14.224	63.727	18.106	1.00	63.54	C
ATOM	18648	CD2	PHE	D	972	12.719	63.062	19.836	1.00	61.67	C
ATOM	18649	CE1	PHE	D	972	14.004	65.070	18.429	1.00	62.42	C
ATOM	18650	CE2	PHE	D	972	12.491	64.402	20.166	1.00	54.36	C
ATOM	18651	CZ	PHE	D	972	13.135	65.401	19.467	1.00	55.22	C
ATOM	18652	O	TYR	D	973	15.928	57.276	15.355	1.00	57.03	O
ATOM	18653	N	TYR	D	973	13.572	58.894	15.642	1.00	57.96	N
ATOM	18654	CA	TYR	D	973	13.518	57.460	15.393	1.00	61.21	C
ATOM	18655	C	TYR	D	973	14.850	56.756	15.656	1.00	64.76	C
ATOM	18656	CB	TYR	D	973	13.063	57.189	13.961	1.00	68.30	C
ATOM	18657	CG	TYR	D	973	11.672	57.697	13.684	1.00	68.87	C
ATOM	18658	CD1	TYR	D	973	10.637	57.437	14.566	1.00	67.03	C
ATOM	18659	CD2	TYR	D	973	11.398	58.451	12.554	1.00	67.81	C
ATOM	18660	CE1	TYR	D	973	9.373	57.895	14.329	1.00	68.17	C
ATOM	18661	CE2	TYR	D	973	10.131	58.919	12.310	1.00	68.79	C
ATOM	18662	CZ	TYR	D	973	9.125	58.639	13.200	1.00	70.96	C
ATOM	18663	OH	TYR	D	973	7.856	59.096	12.962	1.00	73.03	O
ATOM	18664	O	LYS	D	974	15.090	53.159	14.860	1.00	61.40	O
ATOM	18665	N	LYS	D	974	14.752	55.562	16.232	1.00	64.64	N
ATOM	18666	CA	LYS	D	974	15.913	54.712	16.428	1.00	58.12	C
ATOM	18667	C	LYS	D	974	16.048	53.828	15.215	1.00	55.57	C
ATOM	18668	CB	LYS	D	974	15.761	53.862	17.695	1.00	59.31	C
ATOM	18669	CG	LYS	D	974	17.060	53.289	18.255	1.00	55.13	C
ATOM	18670	CD	LYS	D	974	16.782	52.135	19.204	1.00	58.38	C
ATOM	18671	CE	LYS	D	974	15.748	52.533	20.242	1.00	60.45	C
ATOM	18672	NZ	LYS	D	974	15.416	51.439	21.198	1.00	65.63	N
ATOM	18673	O	VAL	D	975	19.962	52.500	13.739	1.00	58.93	O
ATOM	18674	N	VAL	D	975	17.214	53.827	14.569	1.00	58.51	N
ATOM	18675	CA	VAL	D	975	17.542	52.750	13.620	1.00	57.56	C
ATOM	18676	C	VAL	D	975	18.864	52.022	14.007	1.00	57.54	C
ATOM	18677	CB	VAL	D	975	17.640	53.266	12.168	1.00	56.60	C
ATOM	18678	CG1	VAL	D	975	17.764	52.087	11.218	1.00	54.66	C
ATOM	18679	CG2	VAL	D	975	16.425	54.094	11.806	1.00	58.20	C
ATOM	18680	O	ARG	D	976	22.095	49.571	14.636	1.00	59.15	O
ATOM	18681	N	ARG	D	976	18.725	50.854	14.625	1.00	55.77	N
ATOM	18682	CA	ARG	D	976	19.835	50.117	15.216	1.00	51.32	C
ATOM	18683	C	ARG	D	976	20.938	49.701	14.239	1.00	57.11	C
ATOM	18684	CB	ARG	D	976	19.307	48.865	15.901	1.00	48.68	C
ATOM	18685	CG	ARG	D	976	18.802	49.067	17.283	1.00	50.94	C
ATOM	18686	CD	ARG	D	976	17.986	47.859	17.722	1.00	65.01	C
ATOM	18687	NE	ARG	D	976	17.362	48.042	19.039	1.00	73.50	N
ATOM	18688	CZ	ARG	D	976	16.110	48.463	19.238	1.00	81.11	C
ATOM	18689	NH1	ARG	D	976	15.644	48.583	20.477	1.00	85.05	N
ATOM	18690	NH2	ARG	D	976	15.320	48.769	18.207	1.00	69.77	N
ATOM	18691	O	GLU	D	977	23.491	49.613	10.770	1.00	57.36	O
ATOM	18692	N	GLU	D	977	20.593	49.480	12.978	1.00	55.27	N
ATOM	18693	CA	GLU	D	977	21.560	48.938	12.026	1.00	54.41	C
ATOM	18694	C	GLU	D	977	22.568	49.972	11.510	1.00	57.38	C
ATOM	18695	CB	GLU	D	977	20.837	48.306	10.828	1.00	55.82	C
ATOM	18696	CG	GLU	D	977	19.933	47.096	11.149	1.00	61.00	C
ATOM	18697	CD	GLU	D	977	18.521	47.490	11.629	1.00	65.85	C
ATOM	18698	OE1	GLU	D	977	17.732	46.583	12.000	1.00	63.85	O
ATOM	18699	OE2	GLU	D	977	18.198	48.701	11.635	1.00	63.83	O
ATOM	18700	O	ILE	D	978	25.622	52.453	11.239	1.00	58.87	O
ATOM	18701	N	ILE	D	978	22.403	51.240	11.895	1.00	48.01	N
ATOM	18702	CA	ILE	D	978	23.207	52.322	11.318	1.00	51.82	C
ATOM	18703	C	ILE	D	978	24.602	52.388	11.930	1.00	55.64	C
ATOM	18704	CB	ILE	D	978	22.530	53.711	11.514	1.00	51.34	C
ATOM	18705	CG1	ILE	D	978	21.128	53.720	10.926	1.00	56.79	C
ATOM	18706	CG2	ILE	D	978	23.360	54.811	10.886	1.00	51.11	C
ATOM	18707	CD1	ILE	D	978	21.111	53.691	9.432	1.00	60.09	C
ATOM	18708	O	ASN	D	979	24.292	51.717	15.723	1.00	45.48	O
ATOM	18709	N	ASN	D	979	24.606	52.409	13.251	1.00	52.16	N

ATOM	18710	CA	ASN	D	979	25.794	52.537	14.050	1.00	44.90	C
ATOM	18711	C	ASN	D	979	25.401	52.222	15.476	1.00	47.56	C
ATOM	18712	CB	ASN	D	979	26.408	53.925	13.947	1.00	48.02	C
ATOM	18713	CG	ASN	D	979	25.456	55.052	14.412	1.00	53.03	C
ATOM	18714	OD1	ASN	D	979	25.044	55.112	15.575	1.00	48.61	O
ATOM	18715	ND2	ASN	D	979	25.139	55.959	13.497	1.00	44.52	N
ATOM	18716	O	ASN	D	980	25.338	53.167	19.864	1.00	50.42	O
ATOM	18717	N	ASN	D	980	26.299	52.512	16.409	1.00	44.35	O
ATOM	18718	CA	ASN	D	980	26.034	52.193	17.801	1.00	46.91	C
ATOM	18719	C	ASN	D	980	25.588	53.365	18.671	1.00	47.48	C
ATOM	18720	CB	ASN	D	980	27.275	51.565	18.425	1.00	44.58	C
ATOM	18721	CG	ASN	D	980	27.487	50.152	17.973	1.00	44.95	C
ATOM	18722	OD1	ASN	D	980	26.738	49.271	18.347	1.00	46.38	O
ATOM	18723	ND2	ASN	D	980	28.514	49.927	17.172	1.00	41.05	N
ATOM	18724	N	TYR	D	981	25.503	54.569	18.094	1.00	45.55	N
ATOM	18725	C	TYR	D	981	23.770	55.610	19.533	1.00	43.79	C
ATOM	18726	CA	TYR	D	981	25.146	55.765	18.862	1.00	46.49	C
ATOM	18727	O	TYR	D	981	23.495	56.230	20.559	1.00	48.95	O
ATOM	18728	CB	TYR	D	981	25.134	57.019	17.985	1.00	51.48	C
ATOM	18729	CG	TYR	D	981	26.463	57.487	17.399	1.00	52.27	C
ATOM	18730	CD2	TYR	D	981	26.628	58.805	16.964	1.00	46.65	C
ATOM	18731	CD1	TYR	D	981	27.544	56.625	17.272	1.00	50.15	C
ATOM	18732	CE2	TYR	D	981	27.842	59.242	16.421	1.00	55.32	C
ATOM	18733	CE1	TYR	D	981	28.757	57.049	16.723	1.00	47.16	C
ATOM	18734	CZ	TYR	D	981	28.907	58.344	16.297	1.00	52.76	C
ATOM	18735	OH	TYR	D	981	30.118	58.744	15.764	1.00	49.95	O
ATOM	18736	N	HIS	D	982	22.930	54.741	18.979	1.00	44.43	N
ATOM	18737	C	HIS	D	982	21.589	54.128	20.957	1.00	50.36	C
ATOM	18738	CA	HIS	D	982	21.584	54.560	19.499	1.00	43.22	C
ATOM	18739	O	HIS	D	982	20.632	54.411	21.675	1.00	47.37	O
ATOM	18740	CB	HIS	D	982	20.787	53.559	18.650	1.00	42.71	C
ATOM	18741	CG	HIS	D	982	21.233	52.132	18.795	1.00	47.36	C
ATOM	18742	ND1	HIS	D	982	21.939	51.466	17.814	1.00	46.41	N
ATOM	18743	CD2	HIS	D	982	21.039	51.235	19.792	1.00	48.82	C
ATOM	18744	CE1	HIS	D	982	22.172	50.226	18.208	1.00	48.21	C
ATOM	18745	NE2	HIS	D	982	21.640	50.061	19.405	1.00	46.70	N
ATOM	18746	N	HIS	D	983	22.650	53.443	21.398	1.00	47.97	N
ATOM	18747	C	HIS	D	983	22.883	54.316	23.673	1.00	39.40	C
ATOM	18748	CA	HIS	D	983	22.753	53.057	22.804	1.00	44.52	C
ATOM	18749	O	HIS	D	983	22.336	54.404	24.751	1.00	42.39	O
ATOM	18750	CB	HIS	D	983	23.971	52.131	23.063	1.00	45.92	C
ATOM	18751	CG	HIS	D	983	23.920	50.803	22.372	1.00	48.95	C
ATOM	18752	ND1	HIS	D	983	23.055	49.795	22.745	1.00	55.56	N
ATOM	18753	CD2	HIS	D	983	24.666	50.298	21.358	1.00	49.89	C
ATOM	18754	CE1	HIS	D	983	23.260	48.733	21.984	1.00	46.28	C
ATOM	18755	NE2	HIS	D	983	24.231	49.014	21.131	1.00	48.59	N
ATOM	18756	N	ALA	D	984	23.661	55.273	23.201	1.00	41.88	N
ATOM	18757	C	ALA	D	984	22.755	57.418	23.897	1.00	48.40	C
ATOM	18758	CA	ALA	D	984	23.955	56.466	23.974	1.00	42.42	C
ATOM	18759	O	ALA	D	984	22.295	57.928	24.917	1.00	49.04	O
ATOM	18760	CB	ALA	D	984	25.229	57.137	23.456	1.00	41.47	C
ATOM	18761	N	HIS	D	985	22.249	57.626	22.680	1.00	45.96	N
ATOM	18762	C	HIS	D	985	19.908	57.852	23.414	1.00	49.46	C
ATOM	18763	CA	HIS	D	985	20.993	58.349	22.478	1.00	48.71	C
ATOM	18764	O	HIS	D	985	19.200	58.645	24.040	1.00	51.97	O
ATOM	18765	CB	HIS	D	985	20.508	58.191	21.056	1.00	46.59	C
ATOM	18766	CG	HIS	D	985	21.410	58.798	20.045	1.00	37.91	C
ATOM	18767	ND1	HIS	D	985	22.409	59.675	20.383	1.00	41.20	N
ATOM	18768	CD2	HIS	D	985	21.446	58.679	18.701	1.00	36.43	C
ATOM	18769	CE1	HIS	D	985	23.038	60.064	19.289	1.00	50.04	C
ATOM	18770	NE2	HIS	D	985	22.478	59.468	18.255	1.00	42.79	N
ATOM	18771	N	ASP	D	986	19.799	56.532	23.517	1.00	43.55	N
ATOM	18772	C	ASP	D	986	18.990	56.369	25.827	1.00	55.33	C

ATOM	18773	CA	ASP	D	986	18.805	55.926	24.382	1.00	49.89	C
ATOM	18774	O	ASP	D	986	18.017	56.561	26.540	1.00	52.99	O
ATOM	18775	CB	ASP	D	986	18.867	54.408	24.298	1.00	45.97	C
ATOM	18776	CG	ASP	D	986	17.887	53.841	23.299	1.00	52.15	C
ATOM	18777	OD1	ASP	D	986	17.414	54.601	22.428	1.00	56.08	O
ATOM	18778	OD2	ASP	D	986	17.574	52.635	23.392	1.00	62.99	O
ATOM	18779	N	ALA	D	987	20.243	56.539	26.248	1.00	51.69	N
ATOM	18780	C	ALA	D	987	20.192	58.360	27.909	1.00	49.85	C
ATOM	18781	CA	ALA	D	987	20.527	56.899	27.633	1.00	51.01	C
ATOM	18782	O	ALA	D	987	19.686	58.694	28.983	1.00	48.97	O
ATOM	18783	CB	ALA	D	987	22.000	56.623	27.976	1.00	46.47	C
ATOM	18784	N	TYR	D	988	20.543	59.209	26.950	1.00	48.85	N
ATOM	18785	CA	TYR	D	988	20.218	60.632	26.962	1.00	53.09	C
ATOM	18786	C	TYR	D	988	18.711	60.849	27.107	1.00	56.27	C
ATOM	18787	O	TYR	D	988	18.243	61.445	28.077	1.00	54.05	O
ATOM	18788	CB	TYR	D	988	20.719	61.275	25.676	1.00	52.09	C
ATOM	18789	CG	TYR	D	988	20.331	62.734	25.481	1.00	63.83	C
ATOM	18790	CD1	TYR	D	988	21.027	63.745	26.128	1.00	62.08	C
ATOM	18791	CD2	TYR	D	988	19.305	63.101	24.614	1.00	65.43	C
ATOM	18792	CE1	TYR	D	988	20.711	65.057	25.945	1.00	58.62	C
ATOM	18793	CE2	TYR	D	988	18.971	64.435	24.417	1.00	63.93	C
ATOM	18794	CZ	TYR	D	988	19.681	65.411	25.092	1.00	67.76	C
ATOM	18795	OH	TYR	D	988	19.380	66.752	24.924	1.00	61.19	O
ATOM	18796	N	LEU	D	989	17.969	60.309	26.143	1.00	55.15	N
ATOM	18797	CA	LEU	D	989	16.524	60.380	26.124	1.00	50.69	C
ATOM	18798	C	LEU	D	989	15.890	59.902	27.415	1.00	52.78	C
ATOM	18799	O	LEU	D	989	14.803	60.343	27.777	1.00	58.09	O
ATOM	18800	CB	LEU	D	989	15.982	59.590	24.941	1.00	52.48	C
ATOM	18801	CG	LEU	D	989	16.125	60.298	23.593	1.00	52.89	C
ATOM	18802	CD1	LEU	D	989	15.608	59.445	22.476	1.00	56.70	C
ATOM	18803	CD2	LEU	D	989	15.382	61.627	23.600	1.00	58.18	C
ATOM	18804	N	ASN	D	990	16.559	59.017	28.133	1.00	54.38	N
ATOM	18805	CA	ASN	D	990	16.038	58.630	29.436	1.00	54.29	C
ATOM	18806	C	ASN	D	990	16.342	59.667	30.496	1.00	55.66	C
ATOM	18807	O	ASN	D	990	15.563	59.849	31.437	1.00	50.90	O
ATOM	18808	CB	ASN	D	990	16.591	57.289	29.868	1.00	47.51	C
ATOM	18809	CG	ASN	D	990	15.737	56.142	29.385	1.00	56.31	C
ATOM	18810	OD1	ASN	D	990	14.856	55.668	30.099	1.00	58.77	O
ATOM	18811	ND2	ASN	D	990	15.964	55.712	28.156	1.00	58.55	N
ATOM	18812	N	ALA	D	991	17.487	60.322	30.357	1.00	53.60	N
ATOM	18813	CA	ALA	D	991	17.853	61.365	31.295	1.00	57.30	C
ATOM	18814	C	ALA	D	991	16.820	62.488	31.193	1.00	54.46	C
ATOM	18815	O	ALA	D	991	16.265	62.908	32.191	1.00	54.86	O
ATOM	18816	CB	ALA	D	991	19.250	61.883	31.024	1.00	49.85	C
ATOM	18817	N	VAL	D	992	16.555	62.926	29.968	1.00	56.32	N
ATOM	18818	CA	VAL	D	992	15.609	64.003	29.692	1.00	55.49	C
ATOM	18819	C	VAL	D	992	14.202	63.701	30.191	1.00	56.50	C
ATOM	18820	O	VAL	D	992	13.697	64.398	31.052	1.00	60.20	O
ATOM	18821	CB	VAL	D	992	15.539	64.275	28.210	1.00	53.90	C
ATOM	18822	CG1	VAL	D	992	14.462	65.299	27.920	1.00	61.80	C
ATOM	18823	CG2	VAL	D	992	16.903	64.713	27.690	1.00	52.48	C
ATOM	18824	N	VAL	D	993	13.579	62.655	29.659	1.00	54.02	N
ATOM	18825	CA	VAL	D	993	12.256	62.251	30.106	1.00	54.88	C
ATOM	18826	C	VAL	D	993	12.232	62.006	31.627	1.00	61.68	C
ATOM	18827	O	VAL	D	993	11.210	62.204	32.297	1.00	61.13	O
ATOM	18828	CB	VAL	D	993	11.782	60.986	29.336	1.00	54.58	C
ATOM	18829	CG1	VAL	D	993	10.478	60.437	29.899	1.00	47.37	C
ATOM	18830	CG2	VAL	D	993	11.609	61.309	27.863	1.00	54.13	C
ATOM	18831	N	GLY	D	994	13.370	61.595	32.180	1.00	60.29	N
ATOM	18832	CA	GLY	D	994	13.476	61.368	33.613	1.00	54.25	C
ATOM	18833	C	GLY	D	994	13.426	62.677	34.386	1.00	60.11	C
ATOM	18834	O	GLY	D	994	12.591	62.870	35.257	1.00	58.88	O
ATOM	18835	N	THR	D	995	14.348	63.564	34.045	1.00	56.23	N

ATOM	18836	CA	THR	D	995	14.511	64.852	34.675	1.00	59.58	C
ATOM	18837	C	THR	D	995	13.268	65.728	34.473	1.00	66.76	C
ATOM	18838	O	THR	D	995	12.832	66.436	35.379	1.00	64.40	O
ATOM	18839	CB	THR	D	995	15.731	65.578	34.092	1.00	65.52	C
ATOM	18840	OG1	THR	D	995	16.862	64.699	34.102	1.00	67.92	O
ATOM	18841	CG2	THR	D	995	16.047	66.844	34.891	1.00	68.50	C
ATOM	18842	N	ALA	D	996	12.713	65.667	33.268	1.00	63.34	N
ATOM	18843	CA	ALA	D	996	11.513	66.410	32.939	1.00	69.49	C
ATOM	18844	C	ALA	D	996	10.386	66.021	33.886	1.00	67.67	C
ATOM	18845	O	ALA	D	996	9.921	66.838	34.679	1.00	69.04	O
ATOM	18846	CB	ALA	D	996	11.116	66.167	31.492	1.00	64.32	C
ATOM	18847	N	LEU	D	997	9.982	64.763	33.816	1.00	59.26	N
ATOM	18848	CA	LEU	D	997	8.867	64.258	34.601	1.00	61.41	C
ATOM	18849	C	LEU	D	997	8.975	64.609	36.083	1.00	70.55	C
ATOM	18850	O	LEU	D	997	8.053	65.171	36.672	1.00	72.09	O
ATOM	18851	CB	LEU	D	997	8.757	62.743	34.441	1.00	61.96	C
ATOM	18852	CG	LEU	D	997	7.783	62.186	33.404	1.00	59.31	C
ATOM	18853	CD1	LEU	D	997	8.335	60.906	32.786	1.00	61.21	C
ATOM	18854	CD2	LEU	D	997	6.473	61.899	34.083	1.00	59.24	C
ATOM	18855	N	ILE	D	998	10.109	64.287	36.687	1.00	70.45	N
ATOM	18856	CA	ILE	D	998	10.270	64.492	38.119	1.00	65.47	C
ATOM	18857	C	ILE	D	998	10.129	65.975	38.519	1.00	68.02	C
ATOM	18858	O	ILE	D	998	9.769	66.287	39.652	1.00	64.08	O
ATOM	18859	CB	ILE	D	998	11.618	63.956	38.589	1.00	55.83	C
ATOM	18860	CG1	ILE	D	998	11.570	63.651	40.075	1.00	56.70	C
ATOM	18861	CG2	ILE	D	998	12.739	64.917	38.250	1.00	56.20	C
ATOM	18862	CD1	ILE	D	998	12.741	62.849	40.549	1.00	66.67	C
ATOM	18863	O	LYS	D	999	8.543	69.895	37.156	1.00	74.23	O
ATOM	18864	N	LYS	D	999	10.404	66.868	37.570	1.00	68.45	N
ATOM	18865	CA	LYS	D	999	10.261	68.304	37.761	1.00	71.94	C
ATOM	18866	C	LYS	D	999	8.808	68.744	37.494	1.00	76.88	C
ATOM	18867	CB	LYS	D	999	11.220	69.056	36.843	1.00	70.30	C
ATOM	18868	CG	LYS	D	999	12.647	69.149	37.328	1.00	65.63	C
ATOM	18869	CD	LYS	D	999	13.519	69.640	36.179	1.00	66.68	C
ATOM	18870	CE	LYS	D	999	14.913	70.040	36.622	1.00	69.51	C
ATOM	18871	NZ	LYS	D	999	15.721	70.493	35.448	1.00	74.13	N
ATOM	18872	O	LYS	D1000		4.732	66.394	37.650	1.00	76.50	O
ATOM	18873	N	LYS	D1000		7.886	67.793	37.624	1.00	75.87	N
ATOM	18874	CA	LYS	D1000		6.464	68.045	37.532	1.00	72.63	C
ATOM	18875	C	LYS	D1000		5.724	66.880	38.190	1.00	72.11	C
ATOM	18876	CB	LYS	D1000		6.028	68.227	36.073	1.00	72.97	C
ATOM	18877	O	TYR	D1001		7.260	65.561	41.842	1.00	80.73	O
ATOM	18878	N	TYR	D1001		6.218	66.441	39.353	1.00	75.45	N
ATOM	18879	CA	TYR	D1001		5.574	65.368	40.128	1.00	79.11	C
ATOM	18880	C	TYR	D1001		6.184	65.067	41.504	1.00	80.87	C
ATOM	18881	CB	TYR	D1001		5.581	64.064	39.326	1.00	82.88	C
ATOM	18882	O	PRO	D1002		5.983	61.660	41.815	1.00	76.13	O
ATOM	18883	N	PRO	D1002		5.454	64.275	42.312	1.00	85.73	N
ATOM	18884	CA	PRO	D1002		5.912	63.424	43.425	1.00	83.01	C
ATOM	18885	C	PRO	D1002		6.321	62.011	42.944	1.00	79.60	C
ATOM	18886	CB	PRO	D1002		4.682	63.352	44.351	1.00	86.66	C
ATOM	18887	CG	PRO	D1002		3.729	64.410	43.865	1.00	80.52	C
ATOM	18888	CD	PRO	D1002		4.005	64.540	42.401	1.00	88.90	C
ATOM	18889	O	LYS	D1003		6.997	58.095	44.628	1.00	65.85	O
ATOM	18890	N	LYS	D1003		6.978	61.218	43.803	1.00	88.09	N
ATOM	18891	CA	LYS	D1003		7.797	60.049	43.398	1.00	73.77	C
ATOM	18892	C	LYS	D1003		7.180	58.638	43.528	1.00	72.84	C
ATOM	18893	CB	LYS	D1003		9.100	60.084	44.189	1.00	70.28	C
ATOM	18894	CG	LYS	D1003		9.604	61.506	44.404	1.00	73.34	C
ATOM	18895	CD	LYS	D1003		10.421	61.627	45.678	1.00	77.52	C
ATOM	18896	CE	LYS	D1003		10.365	63.037	46.251	1.00	61.92	C
ATOM	18897	NZ	LYS	D1003		10.937	64.049	45.329	1.00	63.91	N
ATOM	18898	O	LEU	D1004		7.717	54.713	41.440	1.00	66.18	O

ATOM	18899	N	LEU	D1004	6.889	58.069	42.362	1.00	71.15	N
ATOM	18900	CA	LEU	D1004	6.496	56.676	42.161	1.00	66.77	C
ATOM	18901	C	LEU	D1004	7.676	55.941	41.515	1.00	70.18	C
ATOM	18902	CB	LEU	D1004	5.264	56.612	41.246	1.00	66.82	C
ATOM	18903	CG	LEU	D1004	4.464	55.402	40.723	1.00	73.29	C
ATOM	18904	CD2	LEU	D1004	3.665	54.775	41.857	1.00	81.10	C
ATOM	18905	CD1	LEU	D1004	5.238	54.333	39.890	1.00	70.83	C
ATOM	18906	O	GLU	D1005	12.070	56.451	40.049	1.00	68.93	O
ATOM	18907	N	GLU	D1005	8.635	56.725	41.039	1.00	71.46	N
ATOM	18908	CA	GLU	D1005	9.686	56.236	40.156	1.00	72.41	C
ATOM	18909	C	GLU	D1005	11.070	56.457	40.764	1.00	68.34	C
ATOM	18910	CB	GLU	D1005	9.586	56.945	38.793	1.00	70.56	C
ATOM	18911	CG	GLU	D1005	9.647	58.473	38.925	1.00	67.82	C
ATOM	18912	CD	GLU	D1005	9.772	59.195	37.595	1.00	72.39	C
ATOM	18913	OE1	GLU	D1005	9.175	58.737	36.600	1.00	74.44	O
ATOM	18914	OE2	GLU	D1005	10.473	60.230	37.549	1.00	68.76	O
ATOM	18915	O	SER	D1006	11.755	55.088	44.262	1.00	78.13	O
ATOM	18916	N	SER	D1006	11.118	56.694	42.073	1.00	68.52	N
ATOM	18917	CA	SER	D1006	12.392	56.846	42.773	1.00	69.44	C
ATOM	18918	C	SER	D1006	12.659	55.605	43.603	1.00	77.23	C
ATOM	18919	CB	SER	D1006	12.403	58.088	43.652	1.00	72.58	C
ATOM	18920	OG	SER	D1006	13.446	58.960	43.254	1.00	74.18	O
ATOM	18921	O	GLU	D1007	13.161	51.934	44.903	1.00	77.13	O
ATOM	18922	N	GLU	D1007	13.915	55.168	43.593	1.00	71.99	N
ATOM	18923	CA	GLU	D1007	14.273	53.777	43.851	1.00	72.87	C
ATOM	18924	C	GLU	D1007	13.617	53.072	45.041	1.00	75.67	C
ATOM	18925	CB	GLU	D1007	15.783	53.665	43.989	1.00	72.73	C
ATOM	18926	CG	GLU	D1007	16.307	52.374	43.404	1.00	70.56	C
ATOM	18927	CD	GLU	D1007	16.190	51.218	44.358	1.00	72.04	C
ATOM	18928	OE1	GLU	D1007	16.510	51.414	45.562	1.00	68.49	O
ATOM	18929	OE2	GLU	D1007	15.784	50.121	43.903	1.00	72.25	O
ATOM	18930	O	PHE	D1008	12.414	54.642	49.043	1.00	77.05	O
ATOM	18931	N	PHE	D1008	13.573	53.701	46.206	1.00	75.79	N
ATOM	18932	CA	PHE	D1008	12.815	53.085	47.295	1.00	77.16	C
ATOM	18933	C	PHE	D1008	11.976	54.105	48.034	1.00	77.93	C
ATOM	18934	CB	PHE	D1008	13.747	52.371	48.269	1.00	77.67	C
ATOM	18935	O	VAL	D1009	8.389	54.469	46.286	1.00	82.87	O
ATOM	18936	N	VAL	D1009	10.781	54.362	47.496	1.00	82.43	N
ATOM	18937	CA	VAL	D1009	9.743	55.229	48.072	1.00	74.82	C
ATOM	18938	C	VAL	D1009	8.425	54.733	47.486	1.00	78.99	C
ATOM	18939	CB	VAL	D1009	9.954	56.716	47.716	1.00	73.35	C
ATOM	18940	CG1	VAL	D1009	8.656	57.497	47.851	1.00	73.94	C
ATOM	18941	CG2	VAL	D1009	11.067	57.341	48.561	1.00	77.29	C
ATOM	18942	O	TYR	D1010	4.802	53.578	49.717	1.00	83.80	O
ATOM	18943	N	TYR	D1010	7.357	54.587	48.281	1.00	78.17	N
ATOM	18944	CA	TYR	D1010	6.089	54.076	47.715	1.00	80.19	C
ATOM	18945	C	TYR	D1010	4.808	54.096	48.595	1.00	81.39	C
ATOM	18946	CB	TYR	D1010	6.309	52.623	47.234	1.00	76.06	C
ATOM	18947	CG	TYR	D1010	5.794	52.378	45.838	1.00	67.84	C
ATOM	18948	CD2	TYR	D1010	4.565	51.762	45.627	1.00	70.85	C
ATOM	18949	CD1	TYR	D1010	6.521	52.791	44.733	1.00	66.08	C
ATOM	18950	CE2	TYR	D1010	4.074	51.555	44.349	1.00	69.11	C
ATOM	18951	CE1	TYR	D1010	6.046	52.597	43.462	1.00	71.51	C
ATOM	18952	CE	TYR	D1010	4.825	51.972	43.270	1.00	77.53	C
ATOM	18953	OH	TYR	D1010	4.364	51.769	41.986	1.00	90.44	O
ATOM	18954	O	GLY	D1011	1.328	54.903	46.594	1.00	97.21	O
ATOM	18955	N	GLY	D1011	3.716	54.646	48.050	1.00	75.90	N
ATOM	18956	CA	GLY	D1011	2.412	54.578	48.693	1.00	83.14	C
ATOM	18957	C	GLY	D1011	1.239	55.000	47.815	1.00	91.93	C
ATOM	18958	O	ASP	D1012	-2.438	54.771	46.118	1.00	96.97	O
ATOM	18959	N	ASP	D1012	0.156	55.470	48.444	1.00	87.12	N
ATOM	18960	CA	ASP	D1012	-1.075	55.937	47.771	1.00	92.05	C
ATOM	18961	C	ASP	D1012	-1.357	55.323	46.379	1.00	99.07	C

ATOM	18962	CB	ASP	D1012	-1.063	57.475	47.657	1.00	80.22	C
ATOM	18963	CG	ASP	D1012	0.177	58.016	46.950	1.00	84.71	C
ATOM	18964	OD1	ASP	D1012	0.259	57.914	45.701	1.00	86.87	O
ATOM	18965	OD2	ASP	D1012	1.061	58.566	47.641	1.00	76.50	O
ATOM	18966	N	TYR	D1039	0.072	56.192	32.701	1.00	82.84	N
ATOM	18967	CA	TYR	D1039	1.436	56.729	32.690	1.00	81.33	C
ATOM	18968	C	TYR	D1039	1.776	57.398	31.358	1.00	78.56	C
ATOM	18969	O	TYR	D1039	2.518	58.385	31.320	1.00	72.35	O
ATOM	18970	CB	TYR	D1039	2.467	55.638	33.015	1.00	71.18	C
ATOM	18971	CG	TYR	D1039	3.545	56.131	33.975	1.00	72.83	C
ATOM	18972	CD2	TYR	D1039	3.836	55.440	35.153	1.00	73.62	C
ATOM	18973	CD1	TYR	D1039	4.237	57.318	33.729	1.00	76.68	C
ATOM	18974	CE2	TYR	D1039	4.810	55.904	36.050	1.00	68.13	C
ATOM	18975	CE1	TYR	D1039	5.211	57.789	34.618	1.00	74.92	C
ATOM	18976	CZ	TYR	D1039	5.491	57.074	35.775	1.00	69.95	C
ATOM	18977	OH	TYR	D1039	6.443	57.530	36.664	1.00	68.38	O
ATOM	18978	N	SER	D1040	1.220	56.870	30.271	1.00	74.87	N
ATOM	18979	CA	SER	D1040	1.349	57.528	28.979	1.00	74.59	C
ATOM	18980	C	SER	D1040	0.405	58.718	28.932	1.00	81.48	C
ATOM	18981	O	SER	D1040	0.522	59.594	28.066	1.00	77.73	O
ATOM	18982	CB	SER	D1040	1.058	56.560	27.835	1.00	71.04	C
ATOM	18983	OG	SER	D1040	2.221	55.806	27.509	1.00	86.22	O
ATOM	18984	N	ASN	D1041	-0.533	58.733	29.876	1.00	79.70	N
ATOM	18985	CA	ASN	D1041	-1.426	59.868	30.050	1.00	86.71	C
ATOM	18986	C	ASN	D1041	-0.680	61.067	30.622	1.00	82.02	C
ATOM	18987	O	ASN	D1041	-0.928	62.200	30.248	1.00	79.69	O
ATOM	18988	CB	ASN	D1041	-2.592	59.489	30.960	1.00	91.54	C
ATOM	18989	CG	ASN	D1041	-3.798	60.373	30.751	1.00	95.64	C
ATOM	18990	OD1	ASN	D1041	-3.670	61.574	30.501	1.00	96.67	O
ATOM	18991	ND2	ASN	D1041	-4.982	59.781	30.838	1.00	98.81	N
ATOM	18992	N	ILE	D1042	0.247	60.792	31.528	1.00	82.39	N
ATOM	18993	CA	ILE	D1042	1.062	61.817	32.165	1.00	78.06	C
ATOM	18994	C	ILE	D1042	2.128	62.345	31.214	1.00	77.77	C
ATOM	18995	O	ILE	D1042	2.507	63.513	31.263	1.00	80.50	O
ATOM	18996	CB	ILE	D1042	1.731	61.268	33.426	1.00	75.94	C
ATOM	18997	CG1	ILE	D1042	0.673	60.853	34.456	1.00	81.11	C
ATOM	18998	CG2	ILE	D1042	2.682	62.292	34.013	1.00	82.67	C
ATOM	18999	CD1	ILE	D1042	0.102	59.449	34.276	1.00	84.04	C
ATOM	19000	N	MET	D1043	2.600	61.464	30.339	1.00	80.95	N
ATOM	19001	CA	MET	D1043	3.552	61.825	29.291	1.00	81.68	C
ATOM	19002	C	MET	D1043	2.948	62.862	28.354	1.00	81.15	C
ATOM	19003	O	MET	D1043	3.651	63.686	27.758	1.00	77.57	O
ATOM	19004	CB	MET	D1043	3.975	60.581	28.509	1.00	75.57	C
ATOM	19005	CG	MET	D1043	4.994	59.715	29.239	1.00	76.47	C
ATOM	19006	SD	MET	D1043	6.600	60.517	29.242	1.00	73.78	S
ATOM	19007	CE	MET	D1043	6.925	60.610	27.480	1.00	63.32	C
ATOM	19008	N	ASN	D1044	1.628	62.795	28.232	1.00	80.80	N
ATOM	19009	C	ASN	D1044	1.089	65.187	28.024	1.00	84.86	C
ATOM	19010	CA	ASN	D1044	0.864	63.785	27.493	1.00	85.34	C
ATOM	19011	O	ASN	D1044	1.498	66.095	27.289	1.00	79.38	O
ATOM	19012	CB	ASN	D1044	-0.619	63.457	27.568	1.00	80.16	C
ATOM	19013	CG	ASN	D1044	-1.232	63.284	26.226	1.00	83.30	C
ATOM	19014	OD1	ASN	D1044	-0.707	63.786	25.226	1.00	85.21	O
ATOM	19015	ND2	ASN	D1044	-2.356	62.575	26.176	1.00	87.14	N
ATOM	19016	O	PHE	D1045	1.970	68.544	29.227	1.00	97.38	O
ATOM	19017	N	PHE	D1045	0.828	65.329	29.323	1.00	89.62	N
ATOM	19018	CA	PHE	D1045	0.751	66.629	29.982	1.00	95.36	C
ATOM	19019	C	PHE	D1045	2.019	67.420	29.714	1.00	90.82	C
ATOM	19020	CB	PHE	D1045	0.518	66.469	31.496	1.00	93.92	C
ATOM	19021	CG	PHE	D1045	-0.806	65.825	31.856	1.00	94.47	C
ATOM	19022	CD2	PHE	D1045	-1.008	65.287	33.123	1.00	93.83	C
ATOM	19023	CD1	PHE	D1045	-1.847	65.761	30.934	1.00	91.96	C
ATOM	19024	CE2	PHE	D1045	-2.220	64.694	33.463	1.00	97.54	C

ATOM	19025	CE1	PHE	D1045	-3.058	65.164	31.266	1.00	99.19	C
ATOM	19026	CZ	PHE	D1045	-3.246	64.633	32.534	1.00	99.46	C
ATOM	19027	O	PHE	D1046	4.344	68.895	27.860	1.00	85.71	O
ATOM	19028	N	PHE	D1046	3.153	66.807	30.008	1.00	93.60	N
ATOM	19029	CA	PHE	D1046	4.435	67.449	29.792	1.00	93.43	C
ATOM	19030	C	PHE	D1046	4.576	67.754	28.281	1.00	91.74	C
ATOM	19031	CB	PHE	D1046	5.564	66.563	30.419	1.00	84.59	C
ATOM	19032	CG	PHE	D1046	6.788	66.320	29.543	1.00	92.16	C
ATOM	19033	CD1	PHE	D1046	7.791	67.271	29.426	1.00	92.31	C
ATOM	19034	CD2	PHE	D1046	6.966	65.097	28.896	1.00	87.31	C
ATOM	19035	CE1	PHE	D1046	8.914	67.021	28.637	1.00	85.92	C
ATOM	19036	CE2	PHE	D1046	8.077	64.856	28.116	1.00	77.09	C
ATOM	19037	CZ	PHE	D1046	9.045	65.814	27.983	1.00	79.71	C
ATOM	19038	O	LYS	D1047	4.928	68.569	24.473	1.00	74.93	O
ATOM	19039	N	LYS	D1047	4.838	66.741	27.463	1.00	88.93	N
ATOM	19040	CA	LYS	D1047	5.461	66.971	26.162	1.00	84.40	C
ATOM	19041	C	LYS	D1047	4.553	67.591	25.110	1.00	75.29	C
ATOM	19042	CB	LYS	D1047	6.030	65.652	25.614	1.00	79.29	C
ATOM	19043	O	THR	D1048	2.122	69.461	22.899	1.00	71.64	O
ATOM	19044	N	THR	D1048	3.375	67.009	24.922	1.00	72.67	N
ATOM	19045	CA	THR	D1048	2.584	67.260	23.720	1.00	76.11	C
ATOM	19046	C	THR	D1048	1.857	68.601	23.740	1.00	73.09	C
ATOM	19047	CB	THR	D1048	1.556	66.132	23.493	1.00	80.29	C
ATOM	19048	OG1	THR	D1048	1.265	65.483	24.738	1.00	81.79	O
ATOM	19049	CG2	THR	D1048	2.104	65.095	22.524	1.00	76.60	C
ATOM	19050	O	THR	D1065	6.115	74.262	31.943	1.00	72.70	O
ATOM	19051	N	THR	D1065	5.129	72.832	29.776	1.00	78.70	N
ATOM	19052	CA	THR	D1065	4.238	73.211	30.863	1.00	70.22	C
ATOM	19053	C	THR	D1065	5.016	73.717	32.086	1.00	73.92	C
ATOM	19054	CB	THR	D1065	3.348	72.045	31.246	1.00	65.88	C
ATOM	19055	OG1	THR	D1065	4.091	71.121	32.042	1.00	77.51	O
ATOM	19056	CG2	THR	D1065	2.838	71.354	29.976	1.00	67.08	C
ATOM	19057	O	ASN	D1066	4.184	72.377	35.804	1.00	77.01	O
ATOM	19058	N	ASN	D1066	4.452	73.552	33.281	1.00	70.47	N
ATOM	19059	CA	ASN	D1066	5.025	74.191	34.463	1.00	75.79	C
ATOM	19060	C	ASN	D1066	4.999	73.306	35.707	1.00	78.04	C
ATOM	19061	CB	ASN	D1066	4.296	75.515	34.753	1.00	78.46	C
ATOM	19062	O	GLY	D1067	5.101	71.911	39.817	1.00	83.07	O
ATOM	19063	N	GLY	D1067	5.881	73.618	36.661	1.00	77.53	N
ATOM	19064	CA	GLY	D1067	6.114	72.780	37.831	1.00	84.50	C
ATOM	19065	C	GLY	D1067	5.000	72.691	38.860	1.00	88.22	C
ATOM	19066	O	GLU	D1068	2.160	73.605	41.834	1.00	89.42	O
ATOM	19067	N	GLU	D1068	3.959	73.507	38.675	1.00	93.30	N
ATOM	19068	CA	GLU	D1068	2.736	73.465	39.495	1.00	95.08	C
ATOM	19069	C	GLU	D1068	2.973	73.887	40.947	1.00	95.45	C
ATOM	19070	CB	GLU	D1068	2.115	72.063	39.459	1.00	90.83	C
ATOM	19071	O	THR	D1069	6.108	76.265	43.696	1.00	94.89	O
ATOM	19072	N	THR	D1069	4.092	74.566	41.173	1.00	93.53	N
ATOM	19073	CA	THR	D1069	4.461	75.042	42.497	1.00	88.09	C
ATOM	19074	C	THR	D1069	5.505	76.165	42.629	1.00	92.40	C
ATOM	19075	CB	THR	D1069	5.013	73.891	43.339	1.00	93.63	C
ATOM	19076	OG1	THR	D1069	5.385	74.389	44.631	1.00	90.19	O
ATOM	19077	CG2	THR	D1069	6.247	73.273	42.652	1.00	94.43	C
ATOM	19078	O	GLY	D1070	7.472	77.814	39.692	1.00	85.88	O
ATOM	19079	N	GLY	D1070	5.779	76.991	41.615	1.00	88.04	N
ATOM	19080	CA	GLY	D1070	5.384	76.848	40.230	1.00	87.54	C
ATOM	19081	C	GLY	D1070	6.703	76.874	39.514	1.00	85.47	C
ATOM	19082	O	GLU	D1071	7.531	74.958	36.068	1.00	77.26	O
ATOM	19083	N	GLU	D1071	6.992	75.841	38.733	1.00	91.87	N
ATOM	19084	CA	GLU	D1071	8.348	75.678	38.218	1.00	86.64	C
ATOM	19085	C	GLU	D1071	8.435	75.494	36.708	1.00	82.11	C
ATOM	19086	CB	GLU	D1071	9.024	74.501	38.917	1.00	85.10	C
ATOM	19087	O	ILE	D1072	11.734	74.495	34.399	1.00	81.19	O

ATOM	19088	N	ILE	D1072	9.563	75.930	36.160	1.00	84.26	N
ATOM	19089	CA	ILE	D1072	9.802	75.939	34.722	1.00	85.28	C
ATOM	19090	C	ILE	D1072	10.527	74.678	34.205	1.00	88.51	C
ATOM	19091	CB	ILE	D1072	10.603	77.182	34.348	1.00	89.44	C
ATOM	19092	CG1	ILE	D1072	11.735	77.394	35.361	1.00	85.75	C
ATOM	19093	CG2	ILE	D1072	9.681	78.399	34.352	1.00	93.62	C
ATOM	19094	CD1	ILE	D1072	12.653	78.546	35.028	1.00	83.56	C
ATOM	19095	O	VAL	D1073	11.781	72.465	31.243	1.00	82.83	O
ATOM	19096	N	VAL	D1073	9.774	73.825	33.522	1.00	87.83	N
ATOM	19097	CA	VAL	D1073	10.270	72.522	33.108	1.00	86.88	C
ATOM	19098	C	VAL	D1073	10.610	72.428	31.624	1.00	85.73	C
ATOM	19099	CB	VAL	D1073	9.248	71.430	33.414	1.00	85.57	C
ATOM	19100	CG1	VAL	D1073	9.956	70.095	33.534	1.00	83.78	C
ATOM	19101	CG2	VAL	D1073	8.473	71.766	34.682	1.00	79.70	C
ATOM	19102	N	TRP	D1074	9.578	72.306	30.791	1.00	85.60	N
ATOM	19103	CA	TRP	D1074	9.774	71.987	29.377	1.00	86.69	C
ATOM	19104	C	TRP	D1074	9.271	73.055	28.398	1.00	86.62	C
ATOM	19105	O	TRP	D1074	8.089	73.079	28.030	1.00	85.23	O
ATOM	19106	CB	TRP	D1074	9.098	70.651	29.052	1.00	85.08	C
ATOM	19107	CG	TRP	D1074	9.408	70.174	27.680	1.00	81.93	C
ATOM	19108	CD1	TRP	D1074	8.600	70.237	26.585	1.00	82.42	C
ATOM	19109	CD2	TRP	D1074	10.627	69.574	27.246	1.00	83.50	C
ATOM	19110	NE1	TRP	D1074	9.241	69.710	25.492	1.00	81.17	N
ATOM	19111	CE2	TRP	D1074	10.488	69.290	25.874	1.00	82.98	C
ATOM	19112	CE3	TRP	D1074	11.824	69.236	27.887	1.00	81.82	C
ATOM	19113	CZ2	TRP	D1074	11.500	68.689	25.131	1.00	77.09	C
ATOM	19114	CZ3	TRP	D1074	12.825	68.644	27.149	1.00	70.46	C
ATOM	19115	CH2	TRP	D1074	12.658	68.376	25.787	1.00	71.65	C
ATOM	19116	O	ASP	D1075	10.831	74.069	24.890	1.00	73.58	O
ATOM	19117	N	ASP	D1075	10.176	73.927	27.959	1.00	86.88	N
ATOM	19118	CA	ASP	D1075	9.848	74.889	26.914	1.00	85.34	C
ATOM	19119	C	ASP	D1075	9.803	74.201	25.559	1.00	79.86	C
ATOM	19120	CB	ASP	D1075	10.858	76.036	26.875	1.00	85.96	C
ATOM	19121	CG	ASP	D1075	10.687	76.913	25.647	1.00	89.97	C
ATOM	19122	OD2	ASP	D1075	11.711	77.364	25.092	1.00	91.61	O
ATOM	19123	OD1	ASP	D1075	9.525	77.129	25.229	1.00	92.82	O
ATOM	19124	O	LYS	D1076	8.581	73.360	21.544	1.00	76.52	O
ATOM	19125	N	LYS	D1076	8.602	73.807	25.138	1.00	78.12	N
ATOM	19126	CA	LYS	D1076	8.421	73.045	23.905	1.00	73.85	C
ATOM	19127	C	LYS	D1076	8.871	73.792	22.657	1.00	72.17	C
ATOM	19128	CB	LYS	D1076	6.954	72.621	23.743	1.00	62.68	C
ATOM	19129	O	GLY	D1077	11.694	74.768	20.184	1.00	93.11	O
ATOM	19130	N	GLY	D1077	9.586	74.898	22.832	1.00	75.86	N
ATOM	19131	CA	GLY	D1077	10.065	75.661	21.699	1.00	82.06	C
ATOM	19132	C	GLY	D1077	11.463	75.252	21.297	1.00	88.34	C
ATOM	19133	N	ARG	D1078	12.394	75.429	22.229	1.00	87.86	N
ATOM	19134	CA	ARG	D1078	13.817	75.287	21.945	1.00	87.94	C
ATOM	19135	C	ARG	D1078	14.452	74.061	22.625	1.00	82.45	C
ATOM	19136	O	ARG	D1078	15.643	73.797	22.447	1.00	79.49	O
ATOM	19137	CB	ARG	D1078	14.557	76.560	22.373	1.00	84.63	C
ATOM	19138	CG	ARG	D1078	14.430	76.854	23.857	1.00	90.11	C
ATOM	19139	CD	ARG	D1078	15.613	77.643	24.390	1.00	92.97	C
ATOM	19140	NE	ARG	D1078	15.488	77.893	25.823	1.00	90.94	N
ATOM	19141	CE	ARG	D1078	16.273	78.718	26.514	1.00	97.38	C
ATOM	19142	NH1	ARG	D1078	17.255	79.382	25.907	1.00	94.29	N
ATOM	19143	NH2	ARG	D1078	16.072	78.883	27.818	1.00	97.11	N
ATOM	19144	N	ASP	D1079	13.664	73.332	23.412	1.00	76.78	N
ATOM	19145	CA	ASP	D1079	14.137	72.105	24.034	1.00	72.41	C
ATOM	19146	C	ASP	D1079	14.172	70.990	22.975	1.00	75.30	C
ATOM	19147	O	ASP	D1079	15.251	70.546	22.571	1.00	70.13	O
ATOM	19148	CB	ASP	D1079	13.256	71.730	25.225	1.00	73.53	C
ATOM	19149	CG	ASP	D1079	13.597	72.527	26.470	1.00	75.30	C
ATOM	19150	OD1	ASP	D1079	14.689	73.138	26.487	1.00	75.16	O

ATOM	19151	OD2	ASP	D1079	12.789	72.533	27.430	1.00	74.76	O
ATOM	19152	N	PHE	D1080	13.003	70.586	22.480	1.00	70.94	N
ATOM	19153	CA	PHE	D1080	12.913	69.764	21.275	1.00	68.10	C
ATOM	19154	C	PHE	D1080	13.984	70.115	20.226	1.00	68.93	C
ATOM	19155	O	PHE	D1080	14.340	69.296	19.383	1.00	74.96	O
ATOM	19156	CB	PHE	D1080	11.526	69.898	20.636	1.00	71.08	C
ATOM	19157	CG	PHE	D1080	10.464	69.017	21.248	1.00	72.52	C
ATOM	19158	CD1	PHE	D1080	10.524	67.632	21.122	1.00	70.04	C
ATOM	19159	CD2	PHE	D1080	9.376	69.577	21.905	1.00	70.41	C
ATOM	19160	CE1	PHE	D1080	9.532	66.821	21.672	1.00	73.13	C
ATOM	19161	CE2	PHE	D1080	8.376	68.778	22.453	1.00	71.42	C
ATOM	19162	CZ	PHE	D1080	8.447	67.400	22.337	1.00	74.84	C
ATOM	19163	N	ALA	D1081	14.501	71.332	20.285	1.00	68.86	N
ATOM	19164	CA	ALA	D1081	15.540	71.770	19.374	1.00	70.29	C
ATOM	19165	C	ALA	D1081	16.881	71.231	19.811	1.00	68.80	C
ATOM	19166	O	ALA	D1081	17.631	70.694	18.990	1.00	68.76	O
ATOM	19167	CB	ALA	D1081	15.584	73.290	19.301	1.00	72.58	C
ATOM	19168	N	THR	D1082	17.194	71.391	21.098	1.00	64.18	N
ATOM	19169	CA	THR	D1082	18.491	70.941	21.610	1.00	74.60	C
ATOM	19170	C	THR	D1082	18.573	69.400	21.556	1.00	68.12	C
ATOM	19171	O	THR	D1082	19.561	68.852	21.081	1.00	61.66	O
ATOM	19172	CB	THR	D1082	18.771	71.463	23.049	1.00	77.12	C
ATOM	19173	OG1	THR	D1082	17.567	71.448	23.823	1.00	79.02	O
ATOM	19174	CG2	THR	D1082	19.309	72.899	23.009	1.00	65.90	C
ATOM	19175	N	VAL	D1083	17.509	68.732	22.006	1.00	64.79	N
ATOM	19176	CA	VAL	D1083	17.362	67.295	21.855	1.00	65.90	C
ATOM	19177	C	VAL	D1083	17.624	66.875	20.414	1.00	68.49	C
ATOM	19178	O	VAL	D1083	18.310	65.882	20.173	1.00	69.97	O
ATOM	19179	CB	VAL	D1083	15.965	66.805	22.294	1.00	62.18	C
ATOM	19180	CG1	VAL	D1083	15.736	65.370	21.862	1.00	59.83	C
ATOM	19181	CG2	VAL	D1083	15.824	66.905	23.793	1.00	63.27	C
ATOM	19182	N	ARG	D1084	17.117	67.629	19.451	1.00	67.06	N
ATOM	19183	CA	ARG	D1084	17.452	67.313	18.068	1.00	67.16	C
ATOM	19184	C	ARG	D1084	18.946	67.501	17.887	1.00	65.20	C
ATOM	19185	O	ARG	D1084	19.593	66.729	17.181	1.00	66.67	O
ATOM	19186	CB	ARG	D1084	16.673	68.182	17.073	1.00	64.17	C
ATOM	19187	N	LYS	D1085	19.500	68.512	18.551	1.00	66.68	N
ATOM	19188	CA	LYS	D1085	20.897	68.859	18.324	1.00	68.76	C
ATOM	19189	C	LYS	D1085	21.824	67.753	18.858	1.00	67.50	C
ATOM	19190	O	LYS	D1085	22.744	67.298	18.153	1.00	61.29	O
ATOM	19191	CB	LYS	D1085	21.221	70.209	18.966	1.00	61.74	C
ATOM	19192	N	VAL	D1086	21.549	67.327	20.092	1.00	62.84	N
ATOM	19193	CA	VAL	D1086	22.317	66.299	20.785	1.00	63.31	C
ATOM	19194	C	VAL	D1086	22.347	64.959	20.045	1.00	61.35	C
ATOM	19195	O	VAL	D1086	23.408	64.378	19.883	1.00	59.85	O
ATOM	19196	CB	VAL	D1086	21.769	66.077	22.202	1.00	64.89	C
ATOM	19197	CG1	VAL	D1086	22.194	64.712	22.741	1.00	61.95	C
ATOM	19198	CG2	VAL	D1086	22.227	67.207	23.117	1.00	56.55	C
ATOM	19199	O	LEU	D1087	21.567	62.624	16.516	1.00	60.57	O
ATOM	19200	N	LEU	D1087	21.190	64.492	19.572	1.00	61.47	N
ATOM	19201	CA	LEU	D1087	21.117	63.274	18.766	1.00	56.65	C
ATOM	19202	C	LEU	D1087	21.726	63.473	17.391	1.00	58.24	C
ATOM	19203	CB	LEU	D1087	19.674	62.791	18.589	1.00	53.98	C
ATOM	19204	CG	LEU	D1087	18.707	62.724	19.770	1.00	60.18	C
ATOM	19205	CD1	LEU	D1087	17.412	62.033	19.345	1.00	60.88	C
ATOM	19206	CD2	LEU	D1087	19.314	62.020	20.971	1.00	52.10	C
ATOM	19207	N	SER	D1088	22.425	64.582	17.190	1.00	56.04	N
ATOM	19208	CA	SER	D1088	23.014	64.851	15.889	1.00	55.98	C
ATOM	19209	C	SER	D1088	24.511	65.093	15.990	1.00	57.03	C
ATOM	19210	O	SER	D1088	25.195	65.195	14.961	1.00	57.33	O
ATOM	19211	CB	SER	D1088	22.325	66.058	15.250	1.00	66.28	C
ATOM	19212	OG	SER	D1088	20.998	66.163	15.736	1.00	71.37	O
ATOM	19213	N	MET	D1089	25.005	65.224	17.223	1.00	55.13	N

ATOM	19214	CA	MET	D1089	26.447	65.261	17.478	1.00	56.25	C
ATOM	19215	C	MET	D1089	27.127	64.106	16.760	1.00	59.64	C
ATOM	19216	O	MET	D1089	26.800	62.947	17.005	1.00	56.83	O
ATOM	19217	CB	MET	D1089	26.747	65.175	18.975	1.00	56.78	C
ATOM	19218	CG	MET	D1089	26.473	66.445	19.758	1.00	58.49	C
ATOM	19219	SD	MET	D1089	26.267	66.140	21.519	1.00	70.85	S
ATOM	19220	CE	MET	D1089	25.730	67.738	22.114	1.00	68.24	C
ATOM	19221	O	PRO	D1090	30.200	61.517	15.639	1.00	57.03	O
ATOM	19222	N	PRO	D1090	28.057	64.420	15.854	1.00	60.02	N
ATOM	19223	CA	PRO	D1090	28.791	63.390	15.118	1.00	61.68	C
ATOM	19224	C	PRO	D1090	29.769	62.594	16.017	1.00	59.43	C
ATOM	19225	CB	PRO	D1090	29.548	64.203	14.068	1.00	60.94	C
ATOM	19226	CG	PRO	D1090	29.809	65.494	14.753	1.00	63.91	C
ATOM	19227	CD	PRO	D1090	28.568	65.768	15.560	1.00	60.92	C
ATOM	19228	O	GLN	D1091	29.920	62.734	20.250	1.00	54.39	O
ATOM	19229	N	GLN	D1091	30.082	63.140	17.188	1.00	60.32	N
ATOM	19230	CA	GLN	D1091	31.038	62.581	18.132	1.00	56.85	C
ATOM	19231	C	GLN	D1091	30.348	61.991	19.355	1.00	58.82	C
ATOM	19232	CB	GLN	D1091	32.014	63.665	18.593	1.00	60.16	C
ATOM	19233	CG	GLN	D1091	33.272	63.173	19.309	1.00	59.76	C
ATOM	19234	CD	GLN	D1091	33.087	62.849	20.770	1.00	56.74	C
ATOM	19235	OE1	GLN	D1091	32.393	63.558	21.496	1.00	59.23	O
ATOM	19236	NE2	GLN	D1091	33.705	61.762	21.211	1.00	57.77	N
ATOM	19237	O	VAL	D1092	31.568	58.377	20.120	1.00	50.74	O
ATOM	19238	N	VAL	D1092	30.267	60.658	19.389	1.00	57.62	N
ATOM	19239	CA	VAL	D1092	29.801	59.903	20.557	1.00	55.07	C
ATOM	19240	C	VAL	D1092	30.914	58.945	20.975	1.00	52.53	C
ATOM	19241	CB	VAL	D1092	28.498	59.119	20.259	1.00	55.81	C
ATOM	19242	CG1	VAL	D1092	28.224	58.107	21.333	1.00	52.68	C
ATOM	19243	CG2	VAL	D1092	27.326	60.076	20.138	1.00	53.20	C
ATOM	19244	O	ASN	D1093	31.322	55.875	23.751	1.00	48.59	O
ATOM	19245	N	ASN	D1093	31.145	58.805	22.280	1.00	53.59	N
ATOM	19246	CA	ASN	D1093	32.181	57.927	22.815	1.00	47.63	C
ATOM	19247	C	ASN	D1093	31.826	56.440	22.764	1.00	51.00	C
ATOM	19248	CB	ASN	D1093	32.470	58.273	24.270	1.00	51.07	C
ATOM	19249	CG	ASN	D1093	33.033	59.642	24.440	1.00	49.29	C
ATOM	19250	OD1	ASN	D1093	33.942	60.050	23.726	1.00	52.09	O
ATOM	19251	ND2	ASN	D1093	32.493	60.373	25.397	1.00	53.31	N
ATOM	19252	O	ILE	D1094	34.004	53.639	21.251	1.00	45.78	O
ATOM	19253	N	ILE	D1094	32.083	55.782	21.645	1.00	49.41	N
ATOM	19254	CA	ILE	D1094	31.759	54.371	21.618	1.00	47.62	C
ATOM	19255	C	ILE	D1094	33.000	53.581	21.942	1.00	44.22	C
ATOM	19256	CB	ILE	D1094	31.135	53.973	20.305	1.00	50.50	C
ATOM	19257	CG1	ILE	D1094	29.699	54.485	20.337	1.00	46.98	C
ATOM	19258	CG2	ILE	D1094	31.134	52.446	20.111	1.00	41.03	C
ATOM	19259	CD1	ILE	D1094	29.008	54.284	19.091	1.00	49.89	C
ATOM	19260	O	VAL	D1095	32.783	50.066	24.166	1.00	41.19	O
ATOM	19261	N	VAL	D1095	32.913	52.902	23.071	1.00	41.19	N
ATOM	19262	CA	VAL	D1095	33.995	52.089	23.553	1.00	44.11	C
ATOM	19263	C	VAL	D1095	33.699	50.585	23.495	1.00	45.18	C
ATOM	19264	CB	VAL	D1095	34.340	52.483	24.964	1.00	45.83	C
ATOM	19265	CG1	VAL	D1095	35.315	51.465	25.568	1.00	46.40	C
ATOM	19266	CG2	VAL	D1095	34.916	53.889	24.945	1.00	47.84	C
ATOM	19267	O	LYS	D1096	36.668	48.038	23.559	1.00	41.53	O
ATOM	19268	N	LYS	D1096	34.470	49.901	22.656	1.00	44.89	N
ATOM	19269	CA	LYS	D1096	34.476	48.442	22.653	1.00	43.73	C
ATOM	19270	C	LYS	D1096	35.451	47.921	23.721	1.00	43.02	C
ATOM	19271	CB	LYS	D1096	34.847	47.929	21.278	1.00	40.81	C
ATOM	19272	CG	LYS	D1096	34.979	46.424	21.232	1.00	48.37	C
ATOM	19273	CD	LYS	D1096	33.667	45.754	21.646	1.00	49.52	C
ATOM	19274	CE	LYS	D1096	33.595	44.325	21.114	1.00	47.57	C
ATOM	19275	NZ	LYS	D1096	32.673	43.514	21.942	1.00	49.34	N
ATOM	19276	O	LYS	D1097	36.481	44.908	24.775	1.00	44.96	O

ATOM	19277	N	LYS	D1097	34.914	47.394	24.818	1.00	36.19	N
ATOM	19278	CA	LYS	D1097	35.734	46.909	25.940	1.00	38.78	C
ATOM	19279	C	LYS	D1097	36.789	45.836	25.524	1.00	46.22	C
ATOM	19280	CB	LYS	D1097	34.827	46.345	27.022	1.00	44.25	C
ATOM	19281	CG	LYS	D1097	35.537	45.942	28.271	1.00	42.88	C
ATOM	19282	CD	LYS	D1097	34.636	45.118	29.148	1.00	39.85	C
ATOM	19283	CE	LYS	D1097	35.351	44.771	30.467	1.00	46.22	C
ATOM	19284	NZ	LYS	D1097	36.639	44.036	30.186	1.00	63.44	N
ATOM	19285	O	THR	D1098	39.201	44.040	27.717	1.00	63.24	O
ATOM	19286	N	THR	D1098	38.032	46.005	25.971	1.00	46.31	N
ATOM	19287	CA	THR	D1098	39.101	45.083	25.579	1.00	52.94	C
ATOM	19288	C	THR	D1098	39.123	43.893	26.501	1.00	50.84	C
ATOM	19289	CB	THR	D1098	40.515	45.725	25.566	1.00	51.82	C
ATOM	19290	OG1	THR	D1098	40.834	46.251	26.856	1.00	46.35	O
ATOM	19291	CG2	THR	D1098	40.614	46.820	24.491	1.00	42.88	C
ATOM	19292	O	GLU	D1099	40.480	40.185	25.366	1.00	51.31	O
ATOM	19293	N	GLU	D1099	39.035	42.716	25.901	1.00	48.17	N
ATOM	19294	CA	GLU	D1099	38.886	41.469	26.642	1.00	55.10	C
ATOM	19295	C	GLU	D1099	40.064	40.502	26.477	1.00	51.27	C
ATOM	19296	CB	GLU	D1099	37.596	40.773	26.213	1.00	54.81	C
ATOM	19297	CG	GLU	D1099	36.426	41.727	26.020	1.00	53.56	C
ATOM	19298	CD	GLU	D1099	35.438	41.738	27.188	1.00	51.76	C
ATOM	19299	OE1	GLU	D1099	35.831	41.484	28.347	1.00	54.02	O
ATOM	19300	OE2	GLU	D1099	34.250	41.994	26.924	1.00	50.59	O
ATOM	19301	O	VAL	D1100	40.160	37.304	28.488	1.00	48.11	O
ATOM	19302	N	VAL	D1100	40.573	40.054	27.617	1.00	47.74	N
ATOM	19303	CA	VAL	D1100	41.601	39.054	27.723	1.00	45.54	C
ATOM	19304	C	VAL	D1100	40.970	37.657	27.638	1.00	49.05	C
ATOM	19305	CB	VAL	D1100	42.367	39.207	29.065	1.00	48.36	C
ATOM	19306	CG2	VAL	D1100	43.222	40.459	29.050	1.00	40.11	C
ATOM	19307	CG1	VAL	D1100	43.195	37.961	29.375	1.00	43.45	C
ATOM	19308	O	GLN	D1101	42.303	34.428	27.829	1.00	41.59	O
ATOM	19309	N	GLN	D1101	41.306	36.877	26.613	1.00	42.95	N
ATOM	19310	CA	GLN	D1101	40.676	35.562	26.438	1.00	44.91	C
ATOM	19311	C	GLN	D1101	41.117	34.549	27.521	1.00	44.56	C
ATOM	19312	CB	GLN	D1101	40.972	34.985	25.056	1.00	44.57	C
ATOM	19313	CG	GLN	D1101	40.474	35.791	23.859	1.00	45.69	C
ATOM	19314	CD	GLN	D1101	39.066	36.370	24.054	1.00	50.95	C
ATOM	19315	OE1	GLN	D1101	38.054	35.688	23.868	1.00	45.75	O
ATOM	19316	NE2	GLN	D1101	39.010	37.636	24.422	1.00	46.39	N
ATOM	19317	O	THR	D1102	38.888	31.459	27.798	1.00	48.21	O
ATOM	19318	N	THR	D1102	40.125	33.862	28.089	1.00	43.35	N
ATOM	19319	CA	THR	D1102	40.271	32.884	29.171	1.00	47.23	C
ATOM	19320	C	THR	D1102	39.565	31.563	28.831	1.00	45.48	C
ATOM	19321	CB	THR	D1102	39.669	33.393	30.484	1.00	50.46	C
ATOM	19322	OG1	THR	D1102	38.256	33.577	30.305	1.00	48.36	O
ATOM	19323	CG2	THR	D1102	40.315	34.679	30.909	1.00	41.38	C
ATOM	19324	O	GLY	D1103	41.283	28.197	29.433	1.00	37.18	O
ATOM	19325	N	GLY	D1103	39.668	30.583	29.721	1.00	36.36	N
ATOM	19326	CA	GLY	D1103	39.107	29.259	29.459	1.00	41.21	C
ATOM	19327	C	GLY	D1103	40.108	28.156	29.060	1.00	42.24	C
ATOM	19328	O	GLY	D1104	41.800	27.374	26.359	1.00	46.01	O
ATOM	19329	N	GLY	D1104	39.620	27.159	28.318	1.00	48.55	N
ATOM	19330	CA	GLY	D1104	40.431	26.059	27.818	1.00	39.55	C
ATOM	19331	C	GLY	D1104	41.743	26.430	27.144	1.00	44.69	C
ATOM	19332	O	PHE	D1105	44.620	26.527	24.500	1.00	46.50	O
ATOM	19333	N	PHE	D1105	42.804	25.690	27.458	1.00	42.65	N
ATOM	19334	CA	PHE	D1105	44.087	25.843	26.747	1.00	47.18	C
ATOM	19335	C	PHE	D1105	43.940	25.793	25.219	1.00	44.61	C
ATOM	19336	CB	PHE	D1105	45.092	24.769	27.207	1.00	34.85	C
ATOM	19337	CG	PHE	D1105	45.554	24.960	28.620	1.00	44.12	C
ATOM	19338	CD1	PHE	D1105	45.372	26.200	29.272	1.00	42.13	C
ATOM	19339	CD2	PHE	D1105	46.132	23.909	29.322	1.00	40.40	C

ATOM	19340	CE1	PHE	D1105	45.783	26.382	30.597	1.00	36.92	C
ATOM	19341	CE2	PHE	D1105	46.555	24.073	30.635	1.00	41.83	C
ATOM	19342	CZ	PHE	D1105	46.386	25.332	31.276	1.00	47.56	C
ATOM	19343	O	SER	D1106	40.953	23.507	24.017	1.00	41.15	O
ATOM	19344	N	SER	D1106	43.036	24.950	24.735	1.00	38.09	N
ATOM	19345	CA	SER	D1106	42.793	24.825	23.308	1.00	38.83	C
ATOM	19346	C	SER	D1106	41.569	23.986	23.073	1.00	40.13	C
ATOM	19347	CB	SER	D1106	43.975	24.157	22.603	1.00	53.41	C
ATOM	19348	OG	SER	D1106	44.006	22.757	22.877	1.00	41.48	O
ATOM	19349	O	LYS	D1107	41.854	21.089	22.289	1.00	47.45	O
ATOM	19350	N	LYS	D1107	41.245	23.785	21.801	1.00	46.51	N
ATOM	19351	CA	LYS	D1107	40.313	22.727	21.393	1.00	53.34	C
ATOM	19352	C	LYS	D1107	40.678	21.359	22.008	1.00	47.23	C
ATOM	19353	CB	LYS	D1107	40.271	22.628	19.871	1.00	54.15	C
ATOM	19354	CG	LYS	D1107	39.357	23.662	19.191	1.00	58.25	C
ATOM	19355	CD	LYS	D1107	39.479	23.568	17.663	1.00	59.84	C
ATOM	19356	CE	LYS	D1107	38.160	23.877	16.955	1.00	65.90	C
ATOM	19357	NZ	LYS	D1107	38.240	23.664	15.472	1.00	77.54	N
ATOM	19358	O	GLU	D1108	40.519	17.075	23.076	1.00	50.88	O
ATOM	19359	N	GLU	D1108	39.672	20.514	22.218	1.00	47.82	N
ATOM	19360	CA	GLU	D1108	39.806	19.373	23.125	1.00	49.28	C
ATOM	19361	C	GLU	D1108	40.066	18.023	22.442	1.00	53.05	C
ATOM	19362	CB	GLU	D1108	38.558	19.250	24.004	1.00	49.32	C
ATOM	19363	CG	GLU	D1108	38.744	19.823	25.413	1.00	48.97	C
ATOM	19364	CD	GLU	D1108	37.439	20.044	26.185	1.00	54.60	C
ATOM	19365	OE1	GLU	D1108	36.455	19.300	25.984	1.00	52.28	O
ATOM	19366	OE2	GLU	D1108	37.405	20.986	27.009	1.00	67.91	O
ATOM	19367	O	SER	D1109	42.116	17.151	19.693	1.00	54.41	O
ATOM	19368	N	SER	D1109	39.782	17.932	21.156	1.00	49.80	N
ATOM	19369	CA	SER	D1109	39.884	16.655	20.488	1.00	54.51	C
ATOM	19370	C	SER	D1109	41.353	16.332	20.213	1.00	54.03	C
ATOM	19371	CB	SER	D1109	39.057	16.642	19.199	1.00	56.40	C
ATOM	19372	OG	SER	D1109	39.713	17.352	18.169	1.00	68.66	O
ATOM	19373	O	ILE	D1110	42.520	13.497	18.430	1.00	51.31	O
ATOM	19374	N	ILE	D1110	41.750	15.138	20.620	1.00	52.94	N
ATOM	19375	CA	ILE	D1110	43.112	14.700	20.423	1.00	52.70	C
ATOM	19376	C	ILE	D1110	43.286	14.304	18.969	1.00	53.36	C
ATOM	19377	CB	ILE	D1110	43.447	13.576	21.362	1.00	51.82	C
ATOM	19378	CG1	ILE	D1110	43.208	14.069	22.788	1.00	50.07	C
ATOM	19379	CG2	ILE	D1110	44.895	13.124	21.162	1.00	56.66	C
ATOM	19380	CD1	ILE	D1110	43.156	12.978	23.835	1.00	54.69	C
ATOM	19381	O	LEU	D1111	46.497	13.566	17.726	1.00	55.45	O
ATOM	19382	N	LEU	D1111	44.247	14.951	18.322	1.00	51.61	N
ATOM	19383	CA	LEU	D1111	44.549	14.674	16.935	1.00	55.40	C
ATOM	19384	C	LEU	D1111	45.614	13.601	16.874	1.00	56.53	C
ATOM	19385	CB	LEU	D1111	45.019	15.935	16.228	1.00	59.25	C
ATOM	19386	CG	LEU	D1111	43.997	17.066	16.193	1.00	58.48	C
ATOM	19387	CD1	LEU	D1111	44.409	18.057	15.149	1.00	60.93	C
ATOM	19388	CD2	LEU	D1111	42.644	16.496	15.884	1.00	59.47	C
ATOM	19389	O	PRO	D1112	47.840	13.359	14.619	1.00	63.66	O
ATOM	19390	N	PRO	D1112	45.528	12.713	15.872	1.00	64.00	N
ATOM	19391	CA	PRO	D1112	46.541	11.663	15.674	1.00	61.98	C
ATOM	19392	C	PRO	D1112	47.849	12.252	15.166	1.00	62.74	C
ATOM	19393	CB	PRO	D1112	45.900	10.748	14.626	1.00	57.55	C
ATOM	19394	CG	PRO	D1112	44.996	11.643	13.861	1.00	60.16	C
ATOM	19395	CD	PRO	D1112	44.467	12.657	14.854	1.00	59.69	C
ATOM	19396	O	LYS	D1113	49.645	12.079	12.648	1.00	70.37	O
ATOM	19397	N	LYS	D1113	48.951	11.526	15.334	1.00	64.69	N
ATOM	19398	CA	LYS	D1113	50.270	12.048	14.986	1.00	62.19	C
ATOM	19399	C	LYS	D1113	50.377	12.534	13.537	1.00	69.22	C
ATOM	19400	CB	LYS	D1113	51.324	10.993	15.256	1.00	65.39	C
ATOM	19401	CG	LYS	D1113	51.140	9.725	14.471	1.00	67.45	C
ATOM	19402	CD	LYS	D1113	52.110	8.687	14.966	1.00	70.41	C

ATOM	19403	CE	LYS	D1113	52.322	7.575	13.957	1.00	71.10	C
ATOM	19404	NZ	LYS	D1113	53.510	6.759	14.348	1.00	70.18	N
ATOM	19405	O	ARG	D1114	53.072	15.807	11.373	1.00	84.09	O
ATOM	19406	N	ARG	D1114	51.296	13.473	13.318	1.00	69.37	N
ATOM	19407	CA	ARG	D1114	51.465	14.120	12.023	1.00	64.50	C
ATOM	19408	C	ARG	D1114	52.871	14.718	11.922	1.00	73.01	C
ATOM	19409	CB	ARG	D1114	50.386	15.198	11.816	1.00	75.37	C
ATOM	19410	O	ASP	D1117	53.966	19.730	14.547	1.00	89.70	O
ATOM	19411	N	ASP	D1117	52.536	19.099	11.678	1.00	82.70	N
ATOM	19412	CA	ASP	D1117	53.710	19.815	12.163	1.00	88.64	C
ATOM	19413	C	ASP	D1117	53.484	20.323	13.579	1.00	87.76	C
ATOM	19414	CB	ASP	D1117	54.057	20.988	11.240	1.00	88.87	C
ATOM	19415	O	LYS	D1118	50.133	21.986	15.497	1.00	79.14	O
ATOM	19416	N	LYS	D1118	52.744	21.422	13.693	1.00	87.27	N
ATOM	19417	CA	LYS	D1118	52.485	22.041	14.986	1.00	83.24	C
ATOM	19418	C	LYS	D1118	51.236	21.479	15.678	1.00	81.19	C
ATOM	19419	CB	LYS	D1118	52.349	23.552	14.825	1.00	82.08	C
ATOM	19420	O	LEU	D1119	52.157	20.438	18.904	1.00	64.52	O
ATOM	19421	N	LEU	D1119	51.425	20.414	16.453	1.00	71.83	N
ATOM	19422	CA	LEU	D1119	50.422	19.931	17.388	1.00	65.36	C
ATOM	19423	C	LEU	D1119	50.970	20.208	18.769	1.00	64.42	C
ATOM	19424	CB	LEU	D1119	50.142	18.439	17.198	1.00	62.67	C
ATOM	19425	CG	LEU	D1119	49.232	18.032	16.036	1.00	59.34	C
ATOM	19426	CD2	LEU	D1119	47.835	18.595	16.227	1.00	64.78	C
ATOM	19427	CD1	LEU	D1119	49.167	16.535	15.934	1.00	60.73	C
ATOM	19428	O	ILE	D1120	49.522	18.583	21.922	1.00	65.42	O
ATOM	19429	N	ILE	D1120	50.133	20.220	19.802	1.00	66.69	N
ATOM	19430	CA	ILE	D1120	50.657	20.533	21.123	1.00	60.13	C
ATOM	19431	C	ILE	D1120	50.516	19.306	21.995	1.00	64.06	C
ATOM	19432	CB	ILE	D1120	49.969	21.804	21.767	1.00	66.47	C
ATOM	19433	CG1	ILE	D1120	50.367	21.973	23.234	1.00	62.69	C
ATOM	19434	CG2	ILE	D1120	48.477	21.744	21.687	1.00	69.08	C
ATOM	19435	CD1	ILE	D1120	51.851	22.217	23.440	1.00	70.09	C
ATOM	19436	O	ALA	D1121	50.460	18.534	25.403	1.00	66.24	O
ATOM	19437	N	ALA	D1121	51.545	19.069	22.798	1.00	64.20	N
ATOM	19438	CA	ALA	D1121	51.736	17.814	23.499	1.00	63.15	C
ATOM	19439	C	ALA	D1121	50.738	17.619	24.630	1.00	63.32	C
ATOM	19440	CB	ALA	D1121	53.171	17.739	24.032	1.00	60.03	C
ATOM	19441	O	ARG	D1122	49.546	16.473	28.135	1.00	60.97	O
ATOM	19442	N	ARG	D1122	50.181	16.423	24.717	1.00	55.99	N
ATOM	19443	CA	ARG	D1122	49.266	16.132	25.798	1.00	58.40	C
ATOM	19444	C	ARG	D1122	50.041	16.073	27.095	1.00	59.05	C
ATOM	19445	CB	ARG	D1122	48.525	14.822	25.561	1.00	53.47	C
ATOM	19446	CG	ARG	D1122	47.386	14.929	24.587	1.00	56.10	C
ATOM	19447	CD	ARG	D1122	47.040	13.563	23.984	1.00	59.91	C
ATOM	19448	NE	ARG	D1122	46.831	12.529	24.993	1.00	58.90	N
ATOM	19449	CZ	ARG	D1122	46.877	11.223	24.744	1.00	57.97	C
ATOM	19450	NH1	ARG	D1122	47.121	10.783	23.513	1.00	58.78	N
ATOM	19451	NH2	ARG	D1122	46.683	10.351	25.726	1.00	55.82	N
ATOM	19452	O	LYS	D1123	53.747	16.251	26.606	1.00	60.30	O
ATOM	19453	N	LYS	D1123	51.261	15.557	27.040	1.00	58.73	N
ATOM	19454	CA	LYS	D1123	52.119	15.566	28.212	1.00	56.13	C
ATOM	19455	C	LYS	D1123	53.452	16.160	27.799	1.00	62.67	C
ATOM	19456	CB	LYS	D1123	52.282	14.171	28.801	1.00	58.70	C
ATOM	19457	CG	LYS	D1123	51.008	13.576	29.416	1.00	56.22	C
ATOM	19458	CD	LYS	D1123	50.693	14.155	30.787	1.00	48.14	C
ATOM	19459	CE	LYS	D1123	49.527	13.418	31.416	1.00	45.54	C
ATOM	19460	NZ	LYS	D1123	49.357	13.697	32.865	1.00	42.02	N
ATOM	19461	O	LYS	D1124	57.135	16.768	26.839	1.00	63.34	O
ATOM	19462	N	LYS	D1124	54.225	16.614	28.783	1.00	64.29	N
ATOM	19463	CA	LYS	D1124	55.491	17.289	28.515	1.00	66.11	C
ATOM	19464	C	LYS	D1124	56.430	16.357	27.769	1.00	65.96	C
ATOM	19465	CB	LYS	D1124	56.138	17.768	29.821	1.00	65.71	C

ATOM	19466	O	ASP	D1125	57.324	12.430	25.839	1.00	68.40	O
ATOM	19467	N	ASP	D1125	56.401	15.088	28.165	1.00	66.62	N
ATOM	19468	CA	ASP	D1125	57.286	14.080	27.582	1.00	75.11	C
ATOM	19469	C	ASP	D1125	56.709	13.382	26.336	1.00	72.26	C
ATOM	19470	CB	ASP	D1125	57.651	13.031	28.647	1.00	70.30	C
ATOM	19471	O	TRP	D1126	54.111	14.798	23.057	1.00	63.15	O
ATOM	19472	N	TRP	D1126	55.561	13.853	25.823	1.00	67.06	N
ATOM	19473	CA	TRP	D1126	54.920	13.206	24.662	1.00	62.19	C
ATOM	19474	C	TRP	D1126	55.000	14.019	23.381	1.00	63.88	C
ATOM	19475	CB	TRP	D1126	53.446	12.871	24.937	1.00	58.95	C
ATOM	19476	CG	TRP	D1126	53.245	11.891	26.072	1.00	63.67	C
ATOM	19477	CD1	TRP	D1126	54.217	11.266	26.793	1.00	57.12	C
ATOM	19478	CD2	TRP	D1126	51.992	11.451	26.629	1.00	62.20	C
ATOM	19479	NE1	TRP	D1126	53.655	10.473	27.760	1.00	56.75	N
ATOM	19480	CE2	TRP	D1126	52.293	10.562	27.678	1.00	56.60	C
ATOM	19481	CE3	TRP	D1126	50.651	11.729	26.342	1.00	59.05	C
ATOM	19482	CZ2	TRP	D1126	51.303	9.946	28.443	1.00	52.59	C
ATOM	19483	CZ3	TRP	D1126	49.669	11.113	27.106	1.00	54.70	C
ATOM	19484	CH2	TRP	D1126	50.002	10.236	28.145	1.00	48.38	C
ATOM	19485	O	ASP	D1127	54.524	12.933	20.295	1.00	67.15	O
ATOM	19486	N	ASP	D1127	56.080	13.805	22.648	1.00	66.71	N
ATOM	19487	CA	ASP	D1127	56.228	14.319	21.298	1.00	67.77	C
ATOM	19488	C	ASP	D1127	54.978	14.066	20.445	1.00	64.66	C
ATOM	19489	CB	ASP	D1127	57.456	13.671	20.662	1.00	68.30	C
ATOM	19490	CG	ASP	D1127	57.856	14.315	19.361	1.00	70.70	C
ATOM	19491	OD1	ASP	D1127	57.034	15.037	18.761	1.00	64.98	O
ATOM	19492	OD2	ASP	D1127	59.007	14.071	18.929	1.00	79.88	O
ATOM	19493	O	PRO	D1128	52.639	13.700	17.061	1.00	67.20	O
ATOM	19494	N	PRO	D1128	54.407	15.131	19.892	1.00	65.74	N
ATOM	19495	CA	PRO	D1128	53.243	14.974	19.008	1.00	66.88	C
ATOM	19496	C	PRO	D1128	53.551	14.214	17.712	1.00	63.98	C
ATOM	19497	CB	PRO	D1128	52.834	16.425	18.710	1.00	57.20	C
ATOM	19498	CG	PRO	D1128	53.320	17.187	19.878	1.00	60.75	C
ATOM	19499	CD	PRO	D1128	54.615	16.533	20.294	1.00	62.81	C
ATOM	19500	O	LYS	D1129	54.609	11.250	15.302	1.00	64.35	O
ATOM	19501	N	LYS	D1129	54.816	14.153	17.330	1.00	67.33	N
ATOM	19502	CA	LYS	D1129	55.200	13.440	16.103	1.00	72.25	C
ATOM	19503	C	LYS	D1129	54.964	11.937	16.258	1.00	63.73	C
ATOM	19504	CB	LYS	D1129	56.666	13.717	15.750	1.00	72.22	C
ATOM	19505	O	LYS	D1130	52.803	8.844	18.035	1.00	55.42	O
ATOM	19506	N	LYS	D1130	55.157	11.449	17.479	1.00	59.85	N
ATOM	19507	CA	LYS	D1130	54.876	10.069	17.846	1.00	59.43	C
ATOM	19508	C	LYS	D1130	53.441	9.853	18.351	1.00	62.36	C
ATOM	19509	CB	LYS	D1130	55.861	9.601	18.941	1.00	64.74	C
ATOM	19510	CG	LYS	D1130	57.346	9.833	18.615	1.00	69.30	C
ATOM	19511	CD	LYS	D1130	58.293	9.414	19.750	1.00	64.97	C
ATOM	19512	CE	LYS	D1130	59.744	9.483	19.266	1.00	72.81	C
ATOM	19513	NZ	LYS	D1130	60.753	9.051	20.266	1.00	74.61	N
ATOM	19514	O	TYR	D1131	49.514	11.090	20.405	1.00	54.11	O
ATOM	19515	N	TYR	D1131	52.941	10.809	19.141	1.00	64.65	N
ATOM	19516	CA	TYR	D1131	51.811	10.543	20.030	1.00	53.84	C
ATOM	19517	C	TYR	D1131	50.510	11.287	19.727	1.00	55.75	C
ATOM	19518	CB	TYR	D1131	52.239	10.842	21.456	1.00	54.32	C
ATOM	19519	CG	TYR	D1131	53.289	9.886	21.980	1.00	56.47	C
ATOM	19520	CD1	TYR	D1131	53.106	8.513	21.901	1.00	55.99	C
ATOM	19521	CD2	TYR	D1131	54.460	10.356	22.549	1.00	58.25	C
ATOM	19522	CE1	TYR	D1131	54.074	7.623	22.386	1.00	60.07	C
ATOM	19523	CE2	TYR	D1131	55.417	9.498	23.031	1.00	60.02	C
ATOM	19524	CZ	TYR	D1131	55.224	8.125	22.947	1.00	59.81	C
ATOM	19525	OH	TYR	D1131	56.176	7.261	23.440	1.00	59.71	O
ATOM	19526	O	GLY	D1132	50.101	14.045	20.601	1.00	56.47	O
ATOM	19527	N	GLY	D1132	50.494	12.109	18.694	1.00	54.56	N
ATOM	19528	CA	GLY	D1132	49.384	13.011	18.531	1.00	57.09	C

ATOM	19529	C	GLY	D1132	49.311	14.048	19.646	1.00	56.10	C
ATOM	19530	O	GLY	D1133	46.408	16.869	19.001	1.00	57.50	O
ATOM	19531	N	GLY	D1133	48.337	14.940	19.521	1.00	55.05	N
ATOM	19532	CA	GLY	D1133	48.140	16.029	20.472	1.00	58.82	C
ATOM	19533	C	GLY	D1133	47.081	17.050	20.034	1.00	59.17	C
ATOM	19534	O	PHE	D1134	47.323	20.460	19.220	1.00	63.74	O
ATOM	19535	N	PHE	D1134	46.946	18.134	20.800	1.00	55.12	N
ATOM	19536	CA	PHE	D1134	45.872	19.124	20.563	1.00	55.17	C
ATOM	19537	C	PHE	D1134	46.177	20.132	19.490	1.00	55.05	C
ATOM	19538	CB	PHE	D1134	45.544	19.879	21.845	1.00	44.37	C
ATOM	19539	CG	PHE	D1134	45.209	18.985	22.970	1.00	44.37	C
ATOM	19540	CD1	PHE	D1134	44.072	18.200	22.920	1.00	46.60	C
ATOM	19541	CD2	PHE	D1134	46.048	18.876	24.051	1.00	45.19	C
ATOM	19542	CE1	PHE	D1134	43.767	17.356	23.949	1.00	43.96	C
ATOM	19543	CE2	PHE	D1134	45.745	18.027	25.093	1.00	48.44	C
ATOM	19544	CZ	PHE	D1134	44.606	17.269	25.041	1.00	47.62	C
ATOM	19545	O	ASP	D1135	43.823	23.134	19.080	1.00	52.36	O
ATOM	19546	N	ASP	D1135	45.118	20.632	18.889	1.00	58.93	N
ATOM	19547	CA	ASP	D1135	45.221	21.621	17.831	1.00	62.14	C
ATOM	19548	C	ASP	D1135	44.743	23.011	18.275	1.00	59.36	C
ATOM	19549	CB	ASP	D1135	44.396	21.164	16.642	1.00	60.29	C
ATOM	19550	CG	ASP	D1135	44.825	21.803	15.370	1.00	68.29	C
ATOM	19551	OD2	ASP	D1135	43.946	22.056	14.513	1.00	74.10	O
ATOM	19552	OD1	ASP	D1135	46.042	22.048	15.231	1.00	72.24	O
ATOM	19553	O	SER	D1136	43.337	25.989	19.539	1.00	52.70	O
ATOM	19554	N	SER	D1136	45.383	24.041	17.734	1.00	58.04	N
ATOM	19555	CA	SER	D1136	44.853	25.402	17.744	1.00	53.04	C
ATOM	19556	C	SER	D1136	44.513	25.954	19.132	1.00	56.23	C
ATOM	19557	CB	SER	D1136	43.620	25.457	16.849	1.00	54.06	C
ATOM	19558	OG	SER	D1136	42.599	24.650	17.383	1.00	53.17	O
ATOM	19559	O	PRO	D1137	44.815	29.034	20.232	1.00	51.82	O
ATOM	19560	N	PRO	D1137	45.547	26.409	19.857	1.00	54.01	N
ATOM	19561	CA	PRO	D1137	45.458	26.970	21.209	1.00	51.25	C
ATOM	19562	C	PRO	D1137	44.747	28.307	21.215	1.00	51.29	C
ATOM	19563	CB	PRO	D1137	46.916	27.170	21.598	1.00	56.21	C
ATOM	19564	CG	PRO	D1137	47.564	27.521	20.293	1.00	57.48	C
ATOM	19565	CD	PRO	D1137	46.891	26.608	19.284	1.00	57.26	C
ATOM	19566	O	THR	D1138	45.165	30.663	23.974	1.00	43.52	O
ATOM	19567	N	THR	D1138	44.090	28.634	22.314	1.00	51.10	N
ATOM	19568	CA	THR	D1138	43.486	29.942	22.452	1.00	43.40	C
ATOM	19569	C	THR	D1138	44.517	30.916	22.955	1.00	46.97	C
ATOM	19570	CB	THR	D1138	42.308	29.919	23.419	1.00	49.56	C
ATOM	19571	OG1	THR	D1138	41.350	28.967	22.960	1.00	51.44	O
ATOM	19572	CG2	THR	D1138	41.654	31.316	23.535	1.00	45.81	C
ATOM	19573	O	VAL	D1139	43.814	34.476	23.623	1.00	46.98	O
ATOM	19574	N	VAL	D1139	44.643	32.035	22.247	1.00	46.58	N
ATOM	19575	CA	VAL	D1139	45.521	33.117	22.653	1.00	40.89	C
ATOM	19576	C	VAL	D1139	44.925	33.974	23.750	1.00	44.74	C
ATOM	19577	CB	VAL	D1139	45.852	34.046	21.485	1.00	40.44	C
ATOM	19578	CG1	VAL	D1139	46.978	34.961	21.873	1.00	43.07	C
ATOM	19579	CG2	VAL	D1139	46.199	33.249	20.251	1.00	45.69	C
ATOM	19580	O	ALA	D1140	44.195	37.179	25.545	1.00	49.84	O
ATOM	19581	N	ALA	D1140	45.680	34.165	24.818	1.00	42.14	N
ATOM	19582	CA	ALA	D1140	45.242	35.021	25.895	1.00	41.63	C
ATOM	19583	C	ALA	D1140	45.208	36.476	25.407	1.00	50.10	C
ATOM	19584	CB	ALA	D1140	46.141	34.861	27.088	1.00	40.05	C
ATOM	19585	O	TYR	D1141	48.510	37.300	23.306	1.00	44.04	O
ATOM	19586	N	TYR	D1141	46.330	36.910	24.853	1.00	47.09	N
ATOM	19587	CA	TYR	D1141	46.459	38.206	24.216	1.00	43.69	C
ATOM	19588	C	TYR	D1141	47.677	38.221	23.287	1.00	49.36	C
ATOM	19589	CB	TYR	D1141	46.576	39.334	25.258	1.00	41.63	C
ATOM	19590	CG	TYR	D1141	47.522	39.041	26.386	1.00	43.83	C
ATOM	19591	CD1	TYR	D1141	48.884	39.220	26.250	1.00	43.88	C

ATOM	19592	CD2	TYR	D1141	47.043	38.600	27.602	1.00	48.32	C
ATOM	19593	CE1	TYR	D1141	49.746	38.951	27.296	1.00	46.15	C
ATOM	19594	CE2	TYR	D1141	47.887	38.331	28.648	1.00	42.72	C
ATOM	19595	CZ	TYR	D1141	49.229	38.503	28.498	1.00	48.94	C
ATOM	19596	OH	TYR	D1141	50.047	38.235	29.570	1.00	47.21	O
ATOM	19597	O	SER	D1142	49.467	41.133	23.242	1.00	45.30	O
ATOM	19598	N	SER	D1142	47.771	39.260	22.464	1.00	44.94	N
ATOM	19599	CA	SER	D1142	48.945	39.456	21.638	1.00	43.34	C
ATOM	19600	C	SER	D1142	49.909	40.367	22.385	1.00	48.56	C
ATOM	19601	CB	SER	D1142	48.566	40.047	20.292	1.00	41.44	C
ATOM	19602	OG	SER	D1142	47.892	39.107	19.496	1.00	51.81	O
ATOM	19603	O	VAL	D1143	53.217	41.196	20.486	1.00	50.79	O
ATOM	19604	N	VAL	D1143	51.212	40.276	22.091	1.00	43.52	N
ATOM	19605	CA	VAL	D1143	52.142	41.263	22.620	1.00	47.60	C
ATOM	19606	C	VAL	D1143	52.994	41.843	21.503	1.00	51.99	C
ATOM	19607	CB	VAL	D1143	53.072	40.698	23.719	1.00	44.58	C
ATOM	19608	CG2	VAL	D1143	53.759	39.449	23.254	1.00	51.20	C
ATOM	19609	CG1	VAL	D1143	52.298	40.440	24.984	1.00	49.01	C
ATOM	19610	O	LEU	D1144	56.277	43.522	22.217	1.00	53.05	O
ATOM	19611	N	LEU	D1144	53.434	43.087	21.702	1.00	51.92	N
ATOM	19612	CA	LEU	D1144	54.346	43.764	20.797	1.00	48.34	C
ATOM	19613	C	LEU	D1144	55.800	43.384	21.085	1.00	54.36	C
ATOM	19614	CB	LEU	D1144	54.185	45.272	20.913	1.00	54.28	C
ATOM	19615	CG	LEU	D1144	55.192	46.069	20.086	1.00	57.77	C
ATOM	19616	CD1	LEU	D1144	54.831	46.007	18.636	1.00	53.19	C
ATOM	19617	CD2	LEU	D1144	55.229	47.493	20.567	1.00	63.96	C
ATOM	19618	O	VAL	D1145	58.736	43.254	18.145	1.00	52.81	O
ATOM	19619	N	VAL	D1145	56.505	42.899	20.069	1.00	51.59	N
ATOM	19620	CA	VAL	D1145	57.885	42.515	20.265	1.00	52.09	C
ATOM	19621	C	VAL	D1145	58.808	43.326	19.371	1.00	50.80	C
ATOM	19622	CB	VAL	D1145	58.086	41.006	20.011	1.00	54.44	C
ATOM	19623	CG1	VAL	D1145	59.525	40.588	20.333	1.00	47.24	C
ATOM	19624	CG2	VAL	D1145	57.086	40.211	20.835	1.00	49.07	C
ATOM	19625	O	VAL	D1146	62.511	44.264	20.749	1.00	53.96	O
ATOM	19626	N	VAL	D1146	59.662	44.121	20.001	1.00	49.27	N
ATOM	19627	CA	VAL	D1146	60.708	44.833	19.278	1.00	54.91	C
ATOM	19628	C	VAL	D1146	62.061	44.216	19.610	1.00	54.10	C
ATOM	19629	CB	VAL	D1146	60.727	46.322	19.625	1.00	58.71	C
ATOM	19630	CG1	VAL	D1146	61.831	47.016	18.856	1.00	58.95	C
ATOM	19631	CG2	VAL	D1146	59.370	46.955	19.313	1.00	58.49	C
ATOM	19632	O	ALA	D1147	64.469	43.207	16.592	1.00	60.01	O
ATOM	19633	N	ALA	D1147	62.701	43.633	18.610	1.00	54.04	N
ATOM	19634	CA	ALA	D1147	63.866	42.805	18.870	1.00	60.22	C
ATOM	19635	C	ALA	D1147	64.622	42.509	17.596	1.00	62.12	C
ATOM	19636	CB	ALA	D1147	63.451	41.507	19.534	1.00	55.60	C
ATOM	19637	O	LYS	D1148	65.527	38.837	17.358	1.00	62.12	O
ATOM	19638	N	LYS	D1148	65.447	41.469	17.656	1.00	61.97	N
ATOM	19639	CA	LYS	D1148	66.158	40.970	16.485	1.00	62.50	C
ATOM	19640	C	LYS	D1148	65.927	39.475	16.389	1.00	58.57	C
ATOM	19641	CB	LYS	D1148	67.657	41.289	16.557	1.00	64.42	C
ATOM	19642	CG	LYS	D1148	68.037	42.675	16.027	1.00	66.88	C
ATOM	19643	CD	LYS	D1148	69.449	42.712	15.392	1.00	72.11	C
ATOM	19644	CE	LYS	D1148	69.557	43.827	14.316	1.00	72.99	C
ATOM	19645	NE	LYS	D1148	70.896	43.967	13.640	1.00	70.34	N
ATOM	19646	O	VAL	D1149	67.099	37.700	12.946	1.00	66.14	O
ATOM	19647	N	VAL	D1149	66.161	38.907	15.221	1.00	57.71	N
ATOM	19648	CA	VAL	D1149	65.998	37.466	15.068	1.00	65.10	C
ATOM	19649	C	VAL	D1149	66.870	36.970	13.900	1.00	61.02	C
ATOM	19650	CB	VAL	D1149	64.489	37.106	14.884	1.00	62.49	C
ATOM	19651	CG1	VAL	D1149	63.948	37.697	13.607	1.00	59.41	C
ATOM	19652	CG2	VAL	D1149	64.269	35.592	14.942	1.00	73.44	C
ATOM	19653	O	GLU	D1150	66.690	33.987	11.716	1.00	66.53	O
ATOM	19654	N	GLU	D1150	67.393	35.752	13.995	1.00	68.90	N

ATOM	19655	CA	GLU	D1150	68.298	35.213	12.966	1.00	67.64	C
ATOM	19656	C	GLU	D1150	67.559	34.852	11.695	1.00	64.62	C
ATOM	19657	CB	GLU	D1150	69.025	33.976	13.475	1.00	64.81	C
ATOM	19658	CG	GLU	D1150	69.896	34.201	14.679	1.00	71.36	C
ATOM	19659	CD	GLU	D1150	70.410	32.898	15.265	1.00	80.66	C
ATOM	19660	OE1	GLU	D1150	71.343	32.947	16.101	1.00	81.43	O
ATOM	19661	OE2	GLU	D1150	69.873	31.829	14.888	1.00	80.95	O
ATOM	19662	O	LYS	D1151	69.356	34.650	8.342	1.00	74.65	O
ATOM	19663	N	LYS	D1151	67.908	35.499	10.589	1.00	68.76	N
ATOM	19664	CA	LYS	D1151	67.236	35.243	9.315	1.00	70.25	C
ATOM	19665	C	LYS	D1151	68.134	34.469	8.356	1.00	72.14	C
ATOM	19666	CB	LYS	D1151	66.785	36.557	8.664	1.00	64.85	C
ATOM	19667	O	GLY	D1152	69.475	31.680	8.217	1.00	77.95	O
ATOM	19668	N	GLY	D1152	67.529	33.597	7.561	1.00	65.16	N
ATOM	19669	CA	GLY	D1152	68.268	32.896	6.528	1.00	77.40	C
ATOM	19670	C	GLY	D1152	69.270	31.858	7.010	1.00	81.11	C
ATOM	19671	O	LYS	D1153	72.494	29.825	8.019	1.00	81.39	O
ATOM	19672	N	LYS	D1153	69.894	31.177	6.049	1.00	82.76	N
ATOM	19673	CA	LYS	D1153	70.804	30.070	6.328	1.00	82.57	C
ATOM	19674	C	LYS	D1153	71.992	30.547	7.152	1.00	81.18	C
ATOM	19675	CB	LYS	D1153	71.282	29.423	5.019	1.00	78.13	C
ATOM	19676	O	SER	D1154	74.308	33.163	9.697	1.00	74.50	O
ATOM	19677	N	SER	D1154	72.421	31.779	6.885	1.00	80.67	N
ATOM	19678	CA	SER	D1154	73.584	32.377	7.549	1.00	81.75	C
ATOM	19679	C	SER	D1154	73.365	32.764	9.014	1.00	78.19	C
ATOM	19680	CB	SER	D1154	74.029	33.619	6.789	1.00	77.47	C
ATOM	19681	OG	SER	D1154	74.588	34.550	7.693	1.00	86.13	O
ATOM	19682	O	LYS	D1155	72.357	34.868	12.250	1.00	71.91	O
ATOM	19683	N	LYS	D1155	72.120	32.662	9.472	1.00	78.68	N
ATOM	19684	CA	LYS	D1155	71.739	33.016	10.833	1.00	74.85	C
ATOM	19685	C	LYS	D1155	72.027	34.500	11.124	1.00	72.81	C
ATOM	19686	CB	LYS	D1155	72.455	32.103	11.834	1.00	71.10	C
ATOM	19687	O	LYS	D1156	69.880	37.168	10.858	1.00	75.89	O
ATOM	19688	N	LYS	D1156	71.896	35.348	10.105	1.00	68.82	N
ATOM	19689	CA	LYS	D1156	72.179	36.772	10.259	1.00	73.20	C
ATOM	19690	C	LYS	D1156	71.060	37.482	11.037	1.00	76.40	C
ATOM	19691	CB	LYS	D1156	72.374	37.430	8.891	1.00	72.13	C
ATOM	19692	O	LEU	D1157	70.383	41.156	11.382	1.00	71.86	O
ATOM	19693	N	LEU	D1157	71.430	38.430	11.899	1.00	67.00	N
ATOM	19694	CA	LEU	D1157	70.449	39.157	12.711	1.00	73.83	C
ATOM	19695	C	LEU	D1157	69.739	40.273	11.942	1.00	71.56	C
ATOM	19696	CB	LEU	D1157	71.106	39.749	13.966	1.00	68.99	C
ATOM	19697	CG	LEU	D1157	71.502	38.773	15.076	1.00	70.73	C
ATOM	19698	CD1	LEU	D1157	71.693	39.491	16.401	1.00	71.01	C
ATOM	19699	CD2	LEU	D1157	70.475	37.671	15.221	1.00	73.32	C
ATOM	19700	O	LYS	D1158	66.109	41.168	13.253	1.00	65.58	O
ATOM	19701	N	LYS	D1158	68.408	40.216	11.934	1.00	66.37	N
ATOM	19702	CA	LYS	D1158	67.573	41.271	11.368	1.00	67.66	C
ATOM	19703	C	LYS	D1158	66.725	41.889	12.472	1.00	68.34	C
ATOM	19704	CB	LYS	D1158	66.676	40.720	10.260	1.00	70.65	C
ATOM	19705	CG	LYS	D1158	66.709	41.516	8.956	1.00	77.17	C
ATOM	19706	CD	LYS	D1158	66.317	42.970	9.164	1.00	76.29	C
ATOM	19707	CE	LYS	D1158	66.441	43.762	7.863	1.00	85.79	C
ATOM	19708	NE	LYS	D1158	67.801	43.649	7.232	1.00	87.20	N
ATOM	19709	N	SER	D1159	66.701	43.218	12.553	1.00	67.23	N
ATOM	19710	CA	SER	D1159	65.852	43.878	13.532	1.00	62.62	C
ATOM	19711	C	SER	D1159	64.395	43.687	13.145	1.00	62.02	C
ATOM	19712	O	SER	D1159	64.049	43.695	11.968	1.00	60.30	O
ATOM	19713	CB	SER	D1159	66.170	45.357	13.635	1.00	65.01	C
ATOM	19714	OG	SER	D1159	65.561	46.051	12.563	1.00	78.09	O
ATOM	19715	N	VAL	D1160	63.541	43.501	14.141	1.00	63.43	N
ATOM	19716	CA	VAL	D1160	62.142	43.200	13.870	1.00	58.55	C
ATOM	19717	C	VAL	D1160	61.190	43.893	14.853	1.00	55.74	C

ATOM	19718	O	VAL	D1160	61.542	44.190	16.004	1.00	52.89	O
ATOM	19719	CB	VAL	D1160	61.869	41.661	13.899	1.00	56.56	C
ATOM	19720	CG1	VAL	D1160	62.464	40.968	12.677	1.00	52.94	C
ATOM	19721	CG2	VAL	D1160	62.400	41.044	15.183	1.00	59.05	C
ATOM	19722	O	LYS	D1161	57.316	43.620	13.611	1.00	57.45	O
ATOM	19723	N	LYS	D1161	59.980	44.129	14.354	1.00	53.44	N
ATOM	19724	CA	LYS	D1161	58.848	44.623	15.119	1.00	54.42	C
ATOM	19725	C	LYS	D1161	57.701	43.708	14.765	1.00	53.47	C
ATOM	19726	CB	LYS	D1161	58.528	46.084	14.770	1.00	55.27	C
ATOM	19727	CG	LYS	D1161	57.935	46.863	15.904	1.00	56.32	C
ATOM	19728	CD	LYS	D1161	57.879	48.358	15.597	1.00	67.77	C
ATOM	19729	CE	LYS	D1161	56.971	48.677	14.410	1.00	68.29	C
ATOM	19730	NZ	LYS	D1161	56.985	50.114	14.021	1.00	59.52	N
ATOM	19731	O	GLU	D1162	55.280	42.381	17.650	1.00	52.40	O
ATOM	19732	N	GLU	D1162	57.166	42.999	15.746	1.00	52.20	N
ATOM	19733	CA	GLU	D1162	56.185	41.959	15.458	1.00	50.54	C
ATOM	19734	C	GLU	D1162	55.096	41.886	16.525	1.00	53.97	C
ATOM	19735	CB	GLU	D1162	56.870	40.583	15.355	1.00	55.91	C
ATOM	19736	CG	GLU	D1162	57.860	40.418	14.213	1.00	58.64	C
ATOM	19737	CD	GLU	D1162	58.312	38.961	14.028	1.00	62.41	C
ATOM	19738	OE1	GLU	D1162	58.281	38.188	15.011	1.00	59.10	O
ATOM	19739	OE2	GLU	D1162	58.698	38.587	12.895	1.00	66.87	O
ATOM	19740	O	LEU	D1163	53.338	38.480	16.554	1.00	52.70	O
ATOM	19741	N	LEU	D1163	53.981	41.250	16.159	1.00	53.70	N
ATOM	19742	CA	LEU	D1163	52.967	40.778	17.102	1.00	49.42	C
ATOM	19743	C	LEU	D1163	53.151	39.307	17.436	1.00	52.40	C
ATOM	19744	CB	LEU	D1163	51.564	40.981	16.535	1.00	56.94	C
ATOM	19745	CG	LEU	D1163	51.070	42.426	16.539	1.00	58.22	C
ATOM	19746	CD1	LEU	D1163	49.581	42.473	16.229	1.00	56.61	C
ATOM	19747	CD2	LEU	D1163	51.402	43.096	17.869	1.00	45.81	C
ATOM	19748	O	LEU	D1164	51.554	37.724	20.819	1.00	51.82	O
ATOM	19749	N	LEU	D1164	53.091	38.967	18.714	1.00	52.98	N
ATOM	19750	CA	LEU	D1164	53.213	37.573	19.098	1.00	46.22	C
ATOM	19751	C	LEU	D1164	51.985	37.092	19.858	1.00	51.78	C
ATOM	19752	CB	LEU	D1164	54.467	37.368	19.946	1.00	47.64	C
ATOM	19753	CG	LEU	D1164	54.688	35.935	20.448	1.00	50.88	C
ATOM	19754	CD1	LEU	D1164	55.103	34.958	19.317	1.00	46.46	C
ATOM	19755	CD2	LEU	D1164	55.706	35.944	21.566	1.00	46.21	C
ATOM	19756	O	GLY	D1165	51.270	33.531	21.306	1.00	55.26	O
ATOM	19757	N	GLY	D1165	51.426	35.964	19.441	1.00	52.96	N
ATOM	19758	CA	GLY	D1165	50.309	35.397	20.169	1.00	46.95	C
ATOM	19759	C	GLY	D1165	50.748	34.641	21.415	1.00	46.09	C
ATOM	19760	O	ILE	D1166	48.459	34.300	24.544	1.00	48.71	O
ATOM	19761	N	ILE	D1166	50.561	35.243	22.587	1.00	43.32	N
ATOM	19762	CA	ILE	D1166	50.740	34.560	23.866	1.00	45.81	C
ATOM	19763	C	ILE	D1166	49.515	33.728	24.237	1.00	48.86	C
ATOM	19764	CB	ILE	D1166	51.007	35.552	25.010	1.00	43.81	C
ATOM	19765	CG1	ILE	D1166	52.229	36.400	24.691	1.00	48.86	C
ATOM	19766	CG2	ILE	D1166	51.225	34.815	26.306	1.00	39.65	C
ATOM	19767	CD1	ILE	D1166	53.422	35.566	24.280	1.00	43.60	C
ATOM	19768	O	THR	D1167	48.977	31.724	26.792	1.00	41.07	O
ATOM	19769	N	THR	D1167	49.662	32.397	24.248	1.00	42.52	N
ATOM	19770	CA	THR	D1167	48.528	31.497	24.457	1.00	40.68	C
ATOM	19771	C	THR	D1167	48.168	31.386	25.932	1.00	43.69	C
ATOM	19772	CB	THR	D1167	48.813	30.076	23.910	1.00	43.21	C
ATOM	19773	OG1	THR	D1167	49.450	29.294	24.928	1.00	53.98	O
ATOM	19774	CG2	THR	D1167	49.691	30.139	22.673	1.00	40.61	C
ATOM	19775	O	ILE	D1168	47.779	30.256	29.602	1.00	45.56	O
ATOM	19776	N	ILE	D1168	46.971	30.879	26.225	1.00	37.87	N
ATOM	19777	CA	ILE	D1168	46.523	30.773	27.608	1.00	36.34	C
ATOM	19778	C	ILE	D1168	47.435	29.900	28.468	1.00	42.05	C
ATOM	19779	CB	ILE	D1168	45.063	30.260	27.674	1.00	39.81	C
ATOM	19780	CG1	ILE	D1168	44.106	31.428	27.345	1.00	40.86	C

ATOM	19781	CG2	ILE	D1168	44.730	29.740	29.064	1.00	35.61	C
ATOM	19782	CD1	ILE	D1168	42.717	31.022	26.902	1.00	37.91	C
ATOM	19783	O	MET	D1169	50.608	28.248	30.011	1.00	41.62	O
ATOM	19784	N	MET	D1169	47.855	28.764	27.916	1.00	45.63	N
ATOM	19785	CA	MET	D1169	48.728	27.831	28.609	1.00	39.08	C
ATOM	19786	C	MET	D1169	50.065	28.470	28.934	1.00	41.41	C
ATOM	19787	CB	MET	D1169	48.929	26.567	27.748	1.00	40.51	C
ATOM	19788	CG	MET	D1169	49.781	25.475	28.383	1.00	40.88	C
ATOM	19789	SD	MET	D1169	49.412	23.852	27.632	1.00	48.74	S
ATOM	19790	CE	MET	D1169	50.518	23.943	26.235	1.00	39.69	C
ATOM	19791	O	GLU	D1170	52.878	31.834	29.249	1.00	52.26	O
ATOM	19792	N	GLU	D1170	50.601	29.265	28.010	1.00	39.65	N
ATOM	19793	CA	GLU	D1170	51.888	29.893	28.266	1.00	43.90	C
ATOM	19794	C	GLU	D1170	51.829	31.265	28.943	1.00	46.32	C
ATOM	19795	CB	GLU	D1170	52.690	30.004	26.964	1.00	47.68	C
ATOM	19796	CG	GLU	D1170	51.967	30.627	25.806	1.00	51.89	C
ATOM	19797	CD	GLU	D1170	52.703	30.445	24.469	1.00	57.07	C
ATOM	19798	OE1	GLU	D1170	52.591	31.370	23.613	1.00	56.11	O
ATOM	19799	OE2	GLU	D1170	53.389	29.397	24.275	1.00	50.53	O
ATOM	19800	O	ARG	D1171	51.963	34.241	31.326	1.00	52.25	O
ATOM	19801	N	ARG	D1171	50.629	31.781	29.216	1.00	48.94	N
ATOM	19802	CA	ARG	D1171	50.486	33.140	29.780	1.00	47.62	C
ATOM	19803	C	ARG	D1171	51.249	33.260	31.105	1.00	50.41	C
ATOM	19804	CB	ARG	D1171	48.988	33.506	29.969	1.00	44.03	C
ATOM	19805	CG	ARG	D1171	48.715	34.826	30.704	1.00	49.84	C
ATOM	19806	CD	ARG	D1171	47.207	35.088	30.880	1.00	50.48	C
ATOM	19807	NE	ARG	D1171	46.932	36.214	31.761	1.00	44.33	N
ATOM	19808	CZ	ARG	D1171	45.706	36.627	32.107	1.00	54.49	C
ATOM	19809	NH1	ARG	D1171	44.604	36.018	31.655	1.00	51.59	N
ATOM	19810	NH2	ARG	D1171	45.577	37.668	32.915	1.00	46.24	N
ATOM	19811	O	SER	D1172	53.890	33.225	33.899	1.00	62.56	O
ATOM	19812	N	SER	D1172	51.126	32.255	31.970	1.00	47.78	N
ATOM	19813	CA	SER	D1172	51.766	32.344	33.285	1.00	53.21	C
ATOM	19814	C	SER	D1172	53.278	32.415	33.193	1.00	58.39	C
ATOM	19815	CB	SER	D1172	51.378	31.169	34.180	1.00	53.59	C
ATOM	19816	OG	SER	D1172	50.023	31.267	34.568	1.00	69.79	O
ATOM	19817	O	SER	D1173	56.873	33.376	31.942	1.00	56.14	O
ATOM	19818	N	SER	D1173	53.887	31.583	32.341	1.00	53.56	N
ATOM	19819	CA	SER	D1173	55.350	31.597	32.221	1.00	51.19	C
ATOM	19820	C	SER	D1173	55.832	32.873	31.575	1.00	48.64	C
ATOM	19821	CB	SER	D1173	55.872	30.408	31.415	1.00	42.97	C
ATOM	19822	OG	SER	D1173	54.818	29.560	31.042	1.00	55.66	O
ATOM	19823	O	PHE	D1174	56.306	36.692	30.876	1.00	57.89	O
ATOM	19824	N	PHE	D1174	55.081	33.392	30.605	1.00	51.56	N
ATOM	19825	CA	PHE	D1174	55.442	34.668	29.966	1.00	49.98	C
ATOM	19826	C	PHE	D1174	55.423	35.842	30.931	1.00	54.36	C
ATOM	19827	CB	PHE	D1174	54.520	34.989	28.788	1.00	49.69	C
ATOM	19828	CG	PHE	D1174	54.638	36.418	28.302	1.00	52.96	C
ATOM	19829	CD2	PHE	D1174	53.666	37.368	28.632	1.00	47.89	C
ATOM	19830	CD1	PHE	D1174	55.719	36.819	27.524	1.00	48.34	C
ATOM	19831	CE2	PHE	D1174	53.786	38.678	28.197	1.00	47.70	C
ATOM	19832	CE1	PHE	D1174	55.830	38.134	27.085	1.00	45.96	C
ATOM	19833	CZ	PHE	D1174	54.859	39.059	27.423	1.00	48.11	C
ATOM	19834	O	GLU	D1175	55.773	38.014	34.304	1.00	60.90	O
ATOM	19835	N	GLU	D1175	54.417	35.902	31.803	1.00	53.21	N
ATOM	19836	CA	GLU	D1175	54.280	37.046	32.706	1.00	52.62	C
ATOM	19837	C	GLU	D1175	55.282	36.985	33.853	1.00	56.31	C
ATOM	19838	CB	GLU	D1175	52.853	37.139	33.249	1.00	50.09	C
ATOM	19839	CG	GLU	D1175	51.806	37.505	32.193	1.00	48.52	C
ATOM	19840	CD	GLU	D1175	50.415	37.696	32.790	1.00	50.84	C
ATOM	19841	OE1	GLU	D1175	50.326	37.833	34.031	1.00	55.61	O
ATOM	19842	OE2	GLU	D1175	49.414	37.704	32.031	1.00	51.67	O
ATOM	19843	O	LYS	D1176	58.867	36.546	35.488	1.00	68.67	O

ATOM	19844	N	LYS	D1176	55.605	35.784	34.318	1.00	57.32	N
ATOM	19845	CA	LYS	D1176	56.657	35.636	35.327	1.00	56.81	C
ATOM	19846	C	LYS	D1176	58.036	36.003	34.774	1.00	64.76	C
ATOM	19847	CB	LYS	D1176	56.698	34.209	35.873	1.00	60.32	C
ATOM	19848	N	ASN	D1177	58.292	35.710	33.505	1.00	64.74	N
ATOM	19849	CA	ASN	D1177	59.638	35.903	32.978	1.00	66.35	C
ATOM	19850	C	ASN	D1177	59.687	36.250	31.502	1.00	62.29	O
ATOM	19851	O	ASN	D1177	60.121	35.434	30.694	1.00	68.25	O
ATOM	19852	CB	ASN	D1177	60.478	34.637	33.218	1.00	69.04	C
ATOM	19853	CG	ASN	D1177	61.666	34.896	34.124	1.00	76.60	C
ATOM	19854	OD1	ASN	D1177	62.643	35.540	33.719	1.00	79.39	O
ATOM	19855	ND2	ASN	D1177	61.585	34.410	35.363	1.00	71.79	N
ATOM	19856	N	PRO	D1178	59.270	37.470	31.146	1.00	61.51	N
ATOM	19857	CA	PRO	D1178	59.122	37.876	29.739	1.00	58.12	C
ATOM	19858	C	PRO	D1178	60.391	37.718	28.880	1.00	59.24	C
ATOM	19859	O	PRO	D1178	60.293	37.162	27.783	1.00	59.94	O
ATOM	19860	CB	PRO	D1178	58.719	39.354	29.843	1.00	59.05	C
ATOM	19861	CG	PRO	D1178	58.108	39.478	31.187	1.00	62.62	C
ATOM	19862	CD	PRO	D1178	58.865	38.534	32.077	1.00	59.48	C
ATOM	19863	N	ILE	D1179	61.538	38.198	29.353	1.00	60.66	N
ATOM	19864	CA	ILE	D1179	62.768	38.130	28.571	1.00	58.14	C
ATOM	19865	C	ILE	D1179	63.123	36.684	28.285	1.00	62.08	C
ATOM	19866	O	ILE	D1179	63.374	36.307	27.138	1.00	64.38	O
ATOM	19867	CB	ILE	D1179	63.950	38.800	29.291	1.00	64.14	C
ATOM	19868	CG1	ILE	D1179	63.628	40.254	29.633	1.00	67.15	C
ATOM	19869	CG2	ILE	D1179	65.196	38.745	28.431	1.00	61.68	C
ATOM	19870	CD1	ILE	D1179	64.706	40.906	30.516	1.00	74.10	C
ATOM	19871	N	ASP	D1180	63.129	35.871	29.334	1.00	64.66	N
ATOM	19872	CA	ASP	D1180	63.461	34.459	29.197	1.00	60.16	C
ATOM	19873	C	ASP	D1180	62.500	33.822	28.205	1.00	59.37	C
ATOM	19874	O	ASP	D1180	62.928	33.098	27.304	1.00	63.04	O
ATOM	19875	CB	ASP	D1180	63.412	33.757	30.568	1.00	69.41	C
ATOM	19876	CG	ASP	D1180	64.094	32.378	30.569	1.00	80.61	O
ATOM	19877	OD1	ASP	D1180	65.116	32.198	29.867	1.00	89.01	C
ATOM	19878	OD2	ASP	D1180	63.611	31.467	31.289	1.00	79.52	O
ATOM	19879	N	PHE	D1181	61.208	34.133	28.347	1.00	61.37	N
ATOM	19880	CA	PHE	D1181	60.153	33.546	27.514	1.00	50.99	C
ATOM	19881	C	PHE	D1181	60.378	33.857	26.037	1.00	52.70	C
ATOM	19882	O	PHE	D1181	60.300	32.963	25.189	1.00	55.57	O
ATOM	19883	CB	PHE	D1181	58.764	34.035	27.965	1.00	52.06	C
ATOM	19884	CG	PHE	D1181	57.621	33.444	27.175	1.00	50.25	C
ATOM	19885	CD2	PHE	D1181	57.203	34.024	25.974	1.00	48.75	C
ATOM	19886	CD1	PHE	D1181	56.971	32.314	27.622	1.00	48.76	C
ATOM	19887	CE2	PHE	D1181	56.176	33.467	25.229	1.00	43.53	C
ATOM	19888	CE1	PHE	D1181	55.935	31.759	26.886	1.00	47.94	C
ATOM	19889	CZ	PHE	D1181	55.536	32.340	25.693	1.00	48.12	C
ATOM	19890	N	LEU	D1182	60.678	35.112	25.730	1.00	50.02	N
ATOM	19891	CA	LEU	D1182	60.866	35.513	24.340	1.00	57.08	C
ATOM	19892	C	LEU	D1182	62.239	35.113	23.797	1.00	58.40	C
ATOM	19893	O	LEU	D1182	62.408	34.958	22.587	1.00	55.96	O
ATOM	19894	CB	LEU	D1182	60.673	37.024	24.180	1.00	57.45	C
ATOM	19895	CG	LEU	D1182	59.279	37.557	24.526	1.00	56.51	C
ATOM	19896	CD1	LEU	D1182	59.298	39.074	24.694	1.00	55.18	C
ATOM	19897	CD2	LEU	D1182	58.307	37.162	23.468	1.00	50.81	C
ATOM	19898	N	GLU	D1183	63.219	34.970	24.685	1.00	57.75	N
ATOM	19899	CA	GLU	D1183	64.532	34.490	24.275	1.00	57.58	C
ATOM	19900	C	GLU	D1183	64.366	33.086	23.707	1.00	55.42	C
ATOM	19901	O	GLU	D1183	64.945	32.741	22.680	1.00	58.96	O
ATOM	19902	CB	GLU	D1183	65.515	34.502	25.446	1.00	57.22	C
ATOM	19903	N	ALA	D1184	63.508	32.304	24.343	1.00	54.26	N
ATOM	19904	CA	ALA	D1184	63.295	30.925	23.934	1.00	49.84	C
ATOM	19905	C	ALA	D1184	62.568	30.783	22.598	1.00	58.19	C
ATOM	19906	O	ALA	D1184	62.711	29.760	21.937	1.00	65.71	O

ATOM	19907	CB	ALA	D1184	62.536	30.184	25.011	1.00	51.80	C
ATOM	19908	N	LYS	D1185	61.777	31.780	22.199	1.00	57.59	N
ATOM	19909	CA	LYS	D1185	61.036	31.685	20.937	1.00	53.65	C
ATOM	19910	C	LYS	D1185	61.938	32.040	19.759	1.00	54.68	C
ATOM	19911	O	LYS	D1185	61.557	31.878	18.593	1.00	49.00	O
ATOM	19912	CB	LYS	D1185	59.798	32.595	20.941	1.00	49.45	C
ATOM	19913	CG	LYS	D1185	58.730	32.210	21.966	1.00	51.90	C
ATOM	19914	CD	LYS	D1185	57.510	31.595	21.302	1.00	48.25	C
ATOM	19915	CE	LYS	D1185	56.747	30.798	22.271	1.00	51.85	C
ATOM	19916	NZ	LYS	D1185	55.685	29.901	21.565	1.00	61.29	N
ATOM	19917	O	GLY	D1186	65.177	34.842	18.142	1.00	59.59	O
ATOM	19918	N	GLY	D1186	63.131	32.537	20.071	1.00	56.19	N
ATOM	19919	CA	GLY	D1186	64.081	32.925	19.045	1.00	57.70	C
ATOM	19920	C	GLY	D1186	64.378	34.413	18.976	1.00	59.74	C
ATOM	19921	O	TYR	D1187	65.470	36.488	21.670	1.00	61.77	O
ATOM	19922	N	TYR	D1187	63.742	35.204	19.838	1.00	53.91	N
ATOM	19923	CA	TYR	D1187	63.966	36.652	19.829	1.00	59.59	C
ATOM	19924	C	TYR	D1187	65.232	37.006	20.586	1.00	57.78	C
ATOM	19925	CB	TYR	D1187	62.777	37.416	20.434	1.00	54.80	C
ATOM	19926	CG	TYR	D1187	61.519	37.350	19.605	1.00	55.22	C
ATOM	19927	CD1	TYR	D1187	61.494	37.864	18.311	1.00	56.44	C
ATOM	19928	CD2	TYR	D1187	60.351	36.796	20.119	1.00	50.66	C
ATOM	19929	CE1	TYR	D1187	60.350	37.819	17.545	1.00	46.28	C
ATOM	19930	CE2	TYR	D1187	59.200	36.747	19.361	1.00	48.37	C
ATOM	19931	CZ	TYR	D1187	59.214	37.256	18.071	1.00	48.72	C
ATOM	19932	OH	TYR	D1187	58.091	37.186	17.304	1.00	46.19	O
ATOM	19933	O	LYS	D1188	66.736	40.618	20.054	1.00	58.89	O
ATOM	19934	N	LYS	D1188	66.033	37.898	20.014	1.00	54.81	N
ATOM	19935	CA	LYS	D1188	67.259	38.345	20.662	1.00	63.26	C
ATOM	19936	C	LYS	D1188	67.262	39.858	20.878	1.00	66.03	C
ATOM	19937	CB	LYS	D1188	68.489	37.938	19.837	1.00	64.01	C
ATOM	19938	CG	LYS	D1188	68.525	36.466	19.431	1.00	66.95	C
ATOM	19939	CD	LYS	D1188	69.967	35.942	19.360	1.00	75.60	C
ATOM	19940	CE	LYS	D1188	70.111	34.761	18.398	1.00	77.03	C
ATOM	19941	NZ	LYS	D1188	69.167	33.633	18.685	1.00	70.80	N
ATOM	19942	O	GLU	D1189	66.426	43.335	21.556	1.00	67.28	O
ATOM	19943	N	GLU	D1189	67.873	40.279	21.984	1.00	66.33	N
ATOM	19944	CA	GLU	D1189	68.024	41.691	22.284	1.00	65.18	C
ATOM	19945	C	GLU	D1189	66.663	42.369	22.269	1.00	65.95	C
ATOM	19946	CB	GLU	D1189	68.983	42.340	21.291	1.00	69.79	C
ATOM	19947	CG	GLU	D1189	70.389	41.734	21.345	1.00	74.29	C
ATOM	19948	CD	GLU	D1189	71.321	42.258	20.261	1.00	73.75	C
ATOM	19949	OE1	GLU	D1189	71.884	43.361	20.432	1.00	80.72	O
ATOM	19950	OE2	GLU	D1189	71.502	41.563	19.241	1.00	74.50	O
ATOM	19951	N	VAL	D1190	65.757	41.814	23.049	1.00	66.38	N
ATOM	19952	CA	VAL	D1190	64.440	42.371	23.188	1.00	58.93	C
ATOM	19953	C	VAL	D1190	64.519	43.649	23.998	1.00	68.43	C
ATOM	19954	O	VAL	D1190	65.236	43.711	24.998	1.00	72.38	O
ATOM	19955	CB	VAL	D1190	63.518	41.389	23.875	1.00	61.68	C
ATOM	19956	CG1	VAL	D1190	62.137	42.001	24.068	1.00	61.21	C
ATOM	19957	CG2	VAL	D1190	63.473	40.078	23.081	1.00	60.68	C
ATOM	19958	N	LYS	D1191	63.798	44.674	23.558	1.00	65.21	N
ATOM	19959	CA	LYS	D1191	63.688	45.903	24.323	1.00	66.14	C
ATOM	19960	C	LYS	D1191	62.558	45.771	25.334	1.00	64.49	C
ATOM	19961	O	LYS	D1191	61.404	46.058	25.021	1.00	61.14	O
ATOM	19962	CB	LYS	D1191	63.449	47.098	23.399	1.00	63.50	C
ATOM	19963	N	LYS	D1192	62.902	45.333	26.541	1.00	63.54	N
ATOM	19964	CA	LYS	D1192	61.923	45.084	27.591	1.00	63.90	C
ATOM	19965	C	LYS	D1192	60.897	46.212	27.748	1.00	61.58	C
ATOM	19966	O	LYS	D1192	59.711	45.940	27.905	1.00	65.93	O
ATOM	19967	CB	LYS	D1192	62.639	44.833	28.926	1.00	66.80	C
ATOM	19968	N	ASP	D1193	61.329	47.469	27.665	1.00	64.49	N
ATOM	19969	CA	ASP	D1193	60.415	48.608	27.885	1.00	64.17	C

ATOM	19970	C	ASP	D1193	59.396	48.806	26.753	1.00	66.47	C
ATOM	19971	O	ASP	D1193	58.578	49.735	26.794	1.00	68.71	O
ATOM	19972	CB	ASP	D1193	61.215	49.907	28.080	1.00	60.70	C
ATOM	19973	N	LEU	D1194	59.446	47.940	25.744	1.00	59.03	N
ATOM	19974	CA	LEU	D1194	58.576	48.059	24.573	1.00	59.61	C
ATOM	19975	C	LEU	D1194	57.597	46.887	24.402	1.00	60.65	C
ATOM	19976	O	LEU	D1194	56.836	46.836	23.436	1.00	63.17	O
ATOM	19977	CB	LEU	D1194	59.424	48.195	23.303	1.00	56.75	C
ATOM	19978	CG	LEU	D1194	59.773	49.596	22.803	1.00	63.60	C
ATOM	19979	CD1	LEU	D1194	60.491	50.409	23.877	1.00	67.72	C
ATOM	19980	CD2	LEU	D1194	60.587	49.539	21.518	1.00	57.91	C
ATOM	19981	N	ILE	D1195	57.629	45.933	25.320	1.00	60.05	N
ATOM	19982	CA	ILE	D1195	56.726	44.803	25.227	1.00	54.63	C
ATOM	19983	C	ILE	D1195	55.330	45.253	25.628	1.00	55.58	C
ATOM	19984	O	ILE	D1195	55.021	45.350	26.810	1.00	58.04	O
ATOM	19985	CB	ILE	D1195	57.170	43.647	26.126	1.00	51.40	C
ATOM	19986	CG1	ILE	D1195	58.562	43.145	25.714	1.00	57.23	C
ATOM	19987	CG2	ILE	D1195	56.174	42.517	26.041	1.00	48.37	C
ATOM	19988	CD1	ILE	D1195	59.241	42.268	26.750	1.00	51.13	C
ATOM	19989	N	ILE	D1196	54.479	45.542	24.659	1.00	48.81	N
ATOM	19990	CA	ILE	D1196	53.151	46.012	25.018	1.00	52.90	C
ATOM	19991	C	ILE	D1196	52.115	44.907	24.889	1.00	47.36	C
ATOM	19992	O	ILE	D1196	51.978	44.286	23.840	1.00	47.77	O
ATOM	19993	CB	ILE	D1196	52.738	47.228	24.165	1.00	53.74	C
ATOM	19994	CG1	ILE	D1196	53.689	48.396	24.442	1.00	48.27	C
ATOM	19995	CG2	ILE	D1196	51.289	47.616	24.443	1.00	43.90	C
ATOM	19996	CD1	ILE	D1196	53.616	49.500	23.450	1.00	50.62	C
ATOM	19997	N	LYS	D1197	51.424	44.657	25.996	1.00	44.21	N
ATOM	19998	CA	LYS	D1197	50.223	43.831	26.023	1.00	48.08	C
ATOM	19999	C	LYS	D1197	49.140	44.374	25.069	1.00	49.53	C
ATOM	20000	O	LYS	D1197	48.899	45.569	25.017	1.00	51.92	O
ATOM	20001	CB	LYS	D1197	49.663	43.768	27.437	1.00	44.98	C
ATOM	20002	CG	LYS	D1197	49.274	42.385	27.860	1.00	54.16	C
ATOM	20003	CD	LYS	D1197	48.684	42.356	29.268	1.00	63.57	C
ATOM	20004	CE	LYS	D1197	47.243	42.867	29.299	1.00	57.92	C
ATOM	20005	NZ	LYS	D1197	46.514	42.282	30.455	1.00	65.08	N
ATOM	20006	O	LEU	D1198	46.396	41.837	22.691	1.00	43.88	O
ATOM	20007	N	LEU	D1198	48.503	43.482	24.328	1.00	40.52	N
ATOM	20008	CA	LEU	D1198	47.471	43.835	23.394	1.00	43.10	C
ATOM	20009	C	LEU	D1198	46.371	42.802	23.442	1.00	45.34	C
ATOM	20010	CB	LEU	D1198	48.019	43.941	21.973	1.00	44.16	C
ATOM	20011	CG	LEU	D1198	49.058	45.041	21.777	1.00	44.83	C
ATOM	20012	CD1	LEU	D1198	49.807	44.886	20.465	1.00	41.12	C
ATOM	20013	CD2	LEU	D1198	48.387	46.417	21.855	1.00	51.40	C
ATOM	20014	O	PRO	D1199	43.699	43.246	22.250	1.00	48.12	O
ATOM	20015	N	PRO	D1199	45.384	43.002	24.327	1.00	47.14	N
ATOM	20016	CA	PRO	D1199	44.206	42.123	24.298	1.00	43.00	C
ATOM	20017	C	PRO	D1199	43.368	42.360	23.039	1.00	45.26	C
ATOM	20018	CB	PRO	D1199	43.440	42.520	25.548	1.00	45.25	C
ATOM	20019	CG	PRO	D1199	44.417	43.385	26.374	1.00	43.92	C
ATOM	20020	CD	PRO	D1199	45.307	44.021	25.389	1.00	44.46	C
ATOM	20021	O	LYS	D1200	40.145	42.729	23.830	1.00	56.51	O
ATOM	20022	N	LYS	D1200	42.331	41.564	22.818	1.00	41.47	N
ATOM	20023	CA	LYS	D1200	41.315	41.999	21.872	1.00	55.25	C
ATOM	20024	C	LYS	D1200	40.404	42.957	22.664	1.00	44.94	C
ATOM	20025	CB	LYS	D1200	40.562	40.795	21.281	1.00	55.55	C
ATOM	20026	CG	LYS	D1200	39.529	40.150	22.190	1.00	49.60	C
ATOM	20027	CD	LYS	D1200	38.872	38.946	21.520	1.00	50.10	C
ATOM	20028	CE	LYS	D1200	38.523	39.203	20.080	1.00	48.90	C
ATOM	20029	NZ	LYS	D1200	37.530	38.196	19.625	1.00	53.14	N
ATOM	20030	N	TYR	D1201	39.917	44.041	22.112	1.00	59.28	N
ATOM	20031	CA	TYR	D1201	39.937	44.436	20.742	1.00	57.66	C
ATOM	20032	C	TYR	D1201	40.743	45.730	20.712	1.00	53.01	C

ATOM	20033	O	TYR	D1201	40.171	46.785	20.555	1.00	55.87	O
ATOM	20034	CB	TYR	D1201	38.497	44.671	20.277	1.00	51.45	C
ATOM	20035	CG	TYR	D1201	37.550	43.494	20.528	1.00	51.32	C
ATOM	20036	CD1	TYR	D1201	37.197	43.098	21.815	1.00	47.10	C
ATOM	20037	CD2	TYR	D1201	36.984	42.803	19.460	1.00	48.72	C
ATOM	20038	CE1	TYR	D1201	36.341	42.021	22.025	1.00	47.60	C
ATOM	20039	CE2	TYR	D1201	36.120	41.747	19.658	1.00	49.57	C
ATOM	20040	CZ	TYR	D1201	35.803	41.352	20.935	1.00	52.96	C
ATOM	20041	OH	TYR	D1201	34.943	40.281	21.088	1.00	55.42	O
ATOM	20042	N	SER	D1202	42.056	45.636	20.912	1.00	54.90	N
ATOM	20043	CA	SER	D1202	42.901	46.809	21.030	1.00	49.55	C
ATOM	20044	C	SER	D1202	42.740	47.737	19.832	1.00	49.55	C
ATOM	20045	O	SER	D1202	42.639	47.286	18.682	1.00	50.24	O
ATOM	20046	CB	SER	D1202	44.365	46.397	21.195	1.00	44.93	C
ATOM	20047	OG	SER	D1202	44.604	45.976	22.521	1.00	42.23	O
ATOM	20048	N	LEU	D1203	42.724	49.036	20.116	1.00	47.79	N
ATOM	20049	CA	LEU	D1203	42.325	50.050	19.146	1.00	47.32	C
ATOM	20050	C	LEU	D1203	43.495	50.817	18.587	1.00	48.17	C
ATOM	20051	O	LEU	D1203	44.306	51.372	19.341	1.00	51.50	O
ATOM	20052	CB	LEU	D1203	41.337	51.039	19.787	1.00	49.86	C
ATOM	20053	CG	LEU	D1203	40.796	52.150	18.879	1.00	42.87	C
ATOM	20054	CD1	LEU	D1203	39.975	51.535	17.772	1.00	46.99	C
ATOM	20055	CD2	LEU	D1203	39.980	53.137	19.679	1.00	49.56	C
ATOM	20056	N	PHE	D1204	43.552	50.877	17.263	1.00	50.13	N
ATOM	20057	CA	PHE	D1204	44.575	51.638	16.558	1.00	54.21	C
ATOM	20058	C	PHE	D1204	43.975	52.667	15.591	1.00	57.33	C
ATOM	20059	O	PHE	D1204	43.000	52.376	14.875	1.00	56.45	O
ATOM	20060	CB	PHE	D1204	45.490	50.704	15.770	1.00	54.55	C
ATOM	20061	CG	PHE	D1204	46.118	49.608	16.593	1.00	60.62	C
ATOM	20062	CD1	PHE	D1204	47.387	49.779	17.136	1.00	56.35	C
ATOM	20063	CD2	PHE	D1204	45.453	48.393	16.800	1.00	55.10	C
ATOM	20064	CE1	PHE	D1204	47.977	48.781	17.874	1.00	53.88	C
ATOM	20065	CE2	PHE	D1204	46.048	47.378	17.542	1.00	52.41	C
ATOM	20066	CZ	PHE	D1204	47.308	47.571	18.077	1.00	53.77	C
ATOM	20067	O	GLU	D1205	46.514	54.817	13.747	1.00	62.65	O
ATOM	20068	N	GLU	D1205	44.565	53.858	15.545	1.00	52.05	N
ATOM	20069	CA	GLU	D1205	44.224	54.802	14.484	1.00	54.32	C
ATOM	20070	C	GLU	D1205	45.324	54.842	13.426	1.00	59.76	C
ATOM	20071	CB	GLU	D1205	43.980	56.210	15.034	1.00	57.84	C
ATOM	20072	CG	GLU	D1205	43.531	57.173	13.944	1.00	57.59	C
ATOM	20073	CD	GLU	D1205	43.081	58.516	14.473	1.00	59.48	C
ATOM	20074	OE1	GLU	D1205	42.801	59.417	13.637	1.00	63.67	O
ATOM	20075	OE2	GLU	D1205	43.003	58.676	15.715	1.00	60.25	O
ATOM	20076	O	LEU	D1206	45.444	57.310	10.886	1.00	65.69	O
ATOM	20077	N	LEU	D1206	44.921	54.888	12.162	1.00	56.85	N
ATOM	20078	CA	LEU	D1206	45.870	54.958	11.070	1.00	57.16	C
ATOM	20079	C	LEU	D1206	45.696	56.265	10.292	1.00	56.42	C
ATOM	20080	CB	LEU	D1206	45.710	53.735	10.168	1.00	61.72	C
ATOM	20081	CG	LEU	D1206	45.524	52.435	10.953	1.00	58.28	C
ATOM	20082	CD1	LEU	D1206	44.076	51.969	10.917	1.00	57.22	C
ATOM	20083	CD2	LEU	D1206	46.449	51.353	10.459	1.00	67.36	C
ATOM	20084	O	GLU	D1207	43.383	56.912	7.746	1.00	62.93	O
ATOM	20085	N	GLU	D1207	45.834	56.227	8.975	1.00	57.61	N
ATOM	20086	CA	GLU	D1207	45.684	57.449	8.181	1.00	60.48	C
ATOM	20087	C	GLU	D1207	44.208	57.802	7.975	1.00	62.35	C
ATOM	20088	CB	GLU	D1207	46.402	57.294	6.827	1.00	61.60	C
ATOM	20089	CG	GLU	D1207	45.535	56.823	5.651	1.00	59.53	C
ATOM	20090	CD	GLU	D1207	45.054	55.387	5.790	1.00	66.54	C
ATOM	20091	OE1	GLU	D1207	44.330	54.902	4.893	1.00	66.98	O
ATOM	20092	OE2	GLU	D1207	45.411	54.738	6.793	1.00	67.25	O
ATOM	20093	O	ASN	D1208	40.362	59.088	8.522	1.00	67.37	O
ATOM	20094	N	ASN	D1208	43.894	59.098	8.080	1.00	67.22	N
ATOM	20095	CA	ASN	D1208	42.549	59.652	7.835	1.00	62.47	C

ATOM	20096	C	ASN	D1208	41.509	59.318	8.876	1.00	60.51	C
ATOM	20097	CB	ASN	D1208	41.985	59.193	6.480	1.00	65.09	C
ATOM	20098	CG	ASN	D1208	42.666	59.850	5.309	1.00	68.24	C
ATOM	20099	OD1	ASN	D1208	42.888	61.058	5.301	1.00	67.80	O
ATOM	20100	ND2	ASN	D1208	43.012	59.047	4.307	1.00	65.85	N
ATOM	20101	O	GLY	D1209	39.574	57.015	11.787	1.00	55.20	O
ATOM	20102	N	GLY	D1209	41.887	59.290	10.147	1.00	64.24	N
ATOM	20103	CA	GLY	D1209	40.963	58.868	11.184	1.00	58.26	C
ATOM	20104	C	GLY	D1209	40.455	57.436	11.040	1.00	57.21	C
ATOM	20105	O	ARG	D1210	41.942	54.842	11.930	1.00	60.49	O
ATOM	20106	N	ARG	D1210	40.985	56.689	10.076	1.00	54.34	N
ATOM	20107	CA	ARG	D1210	40.629	55.279	9.952	1.00	59.77	C
ATOM	20108	C	ARG	D1210	40.969	54.526	11.243	1.00	58.27	C
ATOM	20109	CB	ARG	D1210	41.338	54.642	8.764	1.00	58.72	C
ATOM	20110	CG	ARG	D1210	40.779	53.304	8.364	1.00	60.33	C
ATOM	20111	CD	ARG	D1210	41.408	52.856	7.079	1.00	63.03	C
ATOM	20112	NE	ARG	D1210	42.864	52.908	7.175	1.00	65.36	N
ATOM	20113	CZ	ARG	D1210	43.656	51.838	7.171	1.00	65.66	C
ATOM	20114	NH1	ARG	D1210	44.967	51.993	7.265	1.00	66.52	N
ATOM	20115	NH2	ARG	D1210	43.142	50.616	7.067	1.00	57.99	N
ATOM	20116	N	LYS	D1211	40.139	53.554	11.594	1.00	57.29	N
ATOM	20117	CA	LYS	D1211	40.352	52.800	12.817	1.00	56.52	C
ATOM	20118	C	LYS	D1211	40.235	51.289	12.586	1.00	60.05	C
ATOM	20119	O	LYS	D1211	39.384	50.802	11.814	1.00	56.79	O
ATOM	20120	CB	LYS	D1211	39.383	53.286	13.900	1.00	52.87	C
ATOM	20121	CG	LYS	D1211	39.858	54.603	14.545	1.00	53.72	C
ATOM	20122	CD	LYS	D1211	38.835	55.263	15.477	1.00	57.64	C
ATOM	20123	CE	LYS	D1211	39.421	56.531	16.118	1.00	61.05	C
ATOM	20124	NZ	LYS	D1211	38.821	56.867	17.454	1.00	62.32	N
ATOM	20125	N	ARG	D1212	41.153	50.564	13.214	1.00	57.67	N
ATOM	20126	CA	ARG	D1212	41.102	49.113	13.255	1.00	50.87	C
ATOM	20127	C	ARG	D1212	41.179	48.658	14.696	1.00	50.83	C
ATOM	20128	O	ARG	D1212	41.919	49.218	15.500	1.00	50.88	O
ATOM	20129	CB	ARG	D1212	42.241	48.482	12.458	1.00	53.85	C
ATOM	20130	CG	ARG	D1212	42.248	48.785	10.993	1.00	54.78	C
ATOM	20131	CD	ARG	D1212	41.051	48.210	10.285	1.00	58.57	C
ATOM	20132	NE	ARG	D1212	40.417	49.233	9.448	1.00	65.76	N
ATOM	20133	CZ	ARG	D1212	40.163	49.067	8.161	1.00	62.80	C
ATOM	20134	NH1	ARG	D1212	40.480	47.934	7.575	1.00	71.69	N
ATOM	20135	NH2	ARG	D1212	39.612	50.023	7.458	1.00	61.94	N
ATOM	20136	N	MET	D1213	40.400	47.646	15.019	1.00	50.29	N
ATOM	20137	CA	MET	D1213	40.560	46.935	16.269	1.00	49.36	C
ATOM	20138	C	MET	D1213	41.244	45.572	16.055	1.00	47.52	C
ATOM	20139	O	MET	D1213	41.012	44.872	15.062	1.00	47.51	O
ATOM	20140	CB	MET	D1213	39.206	46.724	16.935	1.00	49.26	C
ATOM	20141	CG	MET	D1213	38.581	47.923	17.551	1.00	46.21	C
ATOM	20142	SD	MET	D1213	37.023	47.443	18.322	1.00	46.92	S
ATOM	20143	CE	MET	D1213	36.281	46.545	16.954	1.00	39.65	C
ATOM	20144	N	LEU	D1214	42.050	45.179	17.026	1.00	52.38	N
ATOM	20145	CA	LEU	D1214	42.810	43.950	16.935	1.00	50.32	C
ATOM	20146	C	LEU	D1214	41.967	42.765	17.376	1.00	51.85	C
ATOM	20147	O	LEU	D1214	41.591	42.681	18.534	1.00	53.58	O
ATOM	20148	CB	LEU	D1214	44.074	44.064	17.781	1.00	51.92	C
ATOM	20149	CG	LEU	D1214	45.102	42.941	17.713	1.00	61.97	C
ATOM	20150	CD1	LEU	D1214	45.925	43.076	16.453	1.00	58.99	C
ATOM	20151	CD2	LEU	D1214	45.992	42.958	18.967	1.00	55.10	C
ATOM	20152	N	ALA	D1215	41.672	41.857	16.442	1.00	56.88	N
ATOM	20153	CA	ALA	D1215	40.899	40.645	16.728	1.00	57.45	C
ATOM	20154	C	ALA	D1215	41.793	39.460	17.096	1.00	56.70	C
ATOM	20155	O	ALA	D1215	41.387	38.560	17.831	1.00	53.84	O
ATOM	20156	CB	ALA	D1215	40.039	40.282	15.546	1.00	60.57	C
ATOM	20157	O	SER	D1216	45.336	40.119	15.716	1.00	67.35	O
ATOM	20158	N	SER	D1216	43.001	39.467	16.554	1.00	58.38	N

ATOM	20159	CA	SER	D1216	44.043	38.493	16.888	1.00	65.53	C
ATOM	20160	C	SER	D1216	45.347	39.050	16.340	1.00	67.56	C
ATOM	20161	CB	SER	D1216	43.757	37.102	16.300	1.00	61.29	C
ATOM	20162	OG	SER	D1216	44.270	36.996	14.988	1.00	64.20	O
ATOM	20163	O	ALA	D1217	48.776	39.037	13.865	1.00	68.99	O
ATOM	20164	N	ALA	D1217	46.460	38.342	16.556	1.00	66.54	N
ATOM	20165	CA	ALA	D1217	47.751	38.781	16.024	1.00	61.46	C
ATOM	20166	C	ALA	D1217	47.785	38.668	14.494	1.00	67.35	C
ATOM	20167	CB	ALA	D1217	48.887	37.986	16.644	1.00	61.22	C
ATOM	20168	O	GLY	D1218	44.776	37.710	10.904	1.00	78.12	O
ATOM	20169	N	GLY	D1218	46.694	38.162	13.908	1.00	66.19	N
ATOM	20170	CA	GLY	D1218	46.559	38.038	12.467	1.00	63.02	C
ATOM	20171	C	GLY	D1218	45.157	38.303	11.919	1.00	73.93	C
ATOM	20172	N	GLU	D1219	44.386	39.169	12.583	1.00	64.82	N
ATOM	20173	CA	GLU	D1219	43.091	39.613	12.061	1.00	64.63	C
ATOM	20174	C	GLU	D1219	42.648	40.985	12.608	1.00	62.13	C
ATOM	20175	O	GLU	D1219	42.719	41.242	13.811	1.00	59.69	O
ATOM	20176	CB	GLU	D1219	42.026	38.577	12.362	1.00	65.74	C
ATOM	20177	CG	GLU	D1219	40.883	38.605	11.390	1.00	71.02	C
ATOM	20178	CD	GLU	D1219	40.420	37.207	11.030	1.00	82.18	C
ATOM	20179	OE1	GLU	D1219	39.820	37.030	9.947	1.00	83.46	O
ATOM	20180	OE2	GLU	D1219	40.666	36.282	11.837	1.00	88.59	O
ATOM	20181	N	LEU	D1220	42.185	41.862	11.718	1.00	61.60	N
ATOM	20182	CA	LEU	D1220	41.712	43.191	12.116	1.00	53.41	C
ATOM	20183	C	LEU	D1220	40.208	43.328	12.011	1.00	52.79	C
ATOM	20184	O	LEU	D1220	39.585	42.706	11.159	1.00	54.75	O
ATOM	20185	CB	LEU	D1220	42.384	44.268	11.281	1.00	49.95	C
ATOM	20186	CG	LEU	D1220	43.856	44.481	11.651	1.00	60.40	C
ATOM	20187	CD1	LEU	D1220	44.450	45.619	10.847	1.00	58.18	C
ATOM	20188	CD2	LEU	D1220	44.036	44.717	13.153	1.00	53.99	C
ATOM	20189	N	GLN	D1221	39.642	44.131	12.910	1.00	52.30	N
ATOM	20190	CA	GLN	D1221	38.223	44.505	12.894	1.00	48.47	C
ATOM	20191	C	GLN	D1221	38.059	46.001	12.652	1.00	51.00	C
ATOM	20192	O	GLN	D1221	38.954	46.784	12.945	1.00	49.28	O
ATOM	20193	CB	GLN	D1221	37.533	44.114	14.205	1.00	47.17	C
ATOM	20194	CG	GLN	D1221	37.031	42.672	14.209	1.00	51.72	C
ATOM	20195	CD	GLN	D1221	36.281	42.287	15.480	1.00	54.81	C
ATOM	20196	OE1	GLN	D1221	35.867	43.145	16.267	1.00	49.81	O
ATOM	20197	NE2	GLN	D1221	36.096	40.984	15.680	1.00	52.94	N
ATOM	20198	N	LYS	D1222	36.908	46.383	12.104	1.00	54.57	N
ATOM	20199	CA	LYS	D1222	36.603	47.779	11.773	1.00	51.37	C
ATOM	20200	C	LYS	D1222	36.424	48.605	13.029	1.00	47.02	C
ATOM	20201	O	LYS	D1222	35.646	48.247	13.901	1.00	52.40	O
ATOM	20202	CB	LYS	D1222	35.341	47.862	10.912	1.00	47.19	C
ATOM	20203	CG	LYS	D1222	35.516	47.333	9.519	1.00	49.68	C
ATOM	20204	CD	LYS	D1222	34.236	47.461	8.714	1.00	61.03	C
ATOM	20205	CE	LYS	D1222	33.317	46.263	8.873	1.00	58.92	C
ATOM	20206	NZ	LYS	D1222	31.895	46.705	8.661	1.00	61.57	N
ATOM	20207	O	GLY	D1223	36.359	52.646	15.168	1.00	51.15	O
ATOM	20208	N	GLY	D1223	37.130	49.716	13.126	1.00	51.54	N
ATOM	20209	CA	GLY	D1223	37.040	50.525	14.330	1.00	53.51	C
ATOM	20210	C	GLY	D1223	36.332	51.865	14.214	1.00	52.48	C
ATOM	20211	O	ASN	D1224	32.917	52.325	12.415	1.00	54.27	O
ATOM	20212	N	ASN	D1224	35.711	52.147	13.066	1.00	56.32	N
ATOM	20213	CA	ASN	D1224	35.007	53.431	12.876	1.00	50.23	C
ATOM	20214	C	ASN	D1224	33.487	53.303	12.912	1.00	53.22	C
ATOM	20215	CB	ASN	D1224	35.385	54.081	11.558	1.00	48.77	C
ATOM	20216	CG	ASN	D1224	36.873	54.292	11.407	1.00	54.79	C
ATOM	20217	OD1	ASN	D1224	37.563	53.496	10.753	1.00	52.38	O
ATOM	20218	ND2	ASN	D1224	37.375	55.381	11.979	1.00	48.66	N
ATOM	20219	O	GLU	D1225	31.522	56.540	12.372	1.00	56.05	O
ATOM	20220	N	GLU	D1225	32.850	54.308	13.495	1.00	50.16	N
ATOM	20221	CA	GLU	D1225	31.393	54.431	13.505	1.00	59.08	C

ATOM	20222	C	GLU	D1225	30.893	55.508	12.513	1.00	50.77	C
ATOM	20223	CB	GLU	D1225	30.917	54.753	14.918	1.00	54.93	C
ATOM	20224	CG	GLU	D1225	29.556	54.202	15.195	1.00	58.49	C
ATOM	20225	CD	GLU	D1225	29.564	52.733	15.556	1.00	53.65	C
ATOM	20226	OE1	GLU	D1225	29.887	52.460	16.733	1.00	56.81	O
ATOM	20227	OE2	GLU	D1225	29.248	51.863	14.683	1.00	57.25	O
ATOM	20228	O	LEU	D1226	27.029	56.747	11.344	1.00	56.42	O
ATOM	20229	N	LEU	D1226	29.778	55.274	11.826	1.00	54.49	N
ATOM	20230	CA	LEU	D1226	29.315	56.218	10.780	1.00	57.08	C
ATOM	20231	C	LEU	D1226	28.188	57.152	11.240	1.00	53.45	C
ATOM	20232	CB	LEU	D1226	28.869	55.448	9.524	1.00	57.03	C
ATOM	20233	CG	LEU	D1226	28.125	56.141	8.371	1.00	61.38	C
ATOM	20234	CD1	LEU	D1226	28.746	57.480	8.008	1.00	63.08	C
ATOM	20235	CD2	LEU	D1226	28.078	55.246	7.137	1.00	56.82	C
ATOM	20236	O	ALA	D1227	27.157	60.588	9.835	1.00	62.08	O
ATOM	20237	N	ALA	D1227	28.538	58.407	11.517	1.00	54.65	N
ATOM	20238	CA	ALA	D1227	27.536	59.413	11.884	1.00	54.12	C
ATOM	20239	C	ALA	D1227	26.711	59.804	10.665	1.00	59.00	C
ATOM	20240	CB	ALA	D1227	28.194	60.635	12.486	1.00	50.48	C
ATOM	20241	O	LEU	D1228	23.181	60.697	11.043	1.00	64.16	O
ATOM	20242	N	LEU	D1228	25.523	59.224	10.542	1.00	63.61	N
ATOM	20243	CA	LEU	D1228	24.596	59.584	9.472	1.00	59.89	C
ATOM	20244	C	LEU	D1228	23.704	60.729	9.931	1.00	62.58	C
ATOM	20245	CB	LEU	D1228	23.744	58.389	9.078	1.00	57.41	C
ATOM	20246	CG	LEU	D1228	22.914	58.506	7.806	1.00	62.17	C
ATOM	20247	CD1	LEU	D1228	23.807	58.315	6.598	1.00	62.14	C
ATOM	20248	CD2	LEU	D1228	21.765	57.503	7.813	1.00	62.04	C
ATOM	20249	N	PRO	D1229	23.528	61.755	9.084	1.00	69.44	N
ATOM	20250	CA	PRO	D1229	22.629	62.863	9.436	1.00	62.95	C
ATOM	20251	C	PRO	D1229	21.239	62.383	9.870	1.00	60.84	C
ATOM	20252	O	PRO	D1229	20.705	61.443	9.282	1.00	60.82	O
ATOM	20253	CB	PRO	D1229	22.555	63.663	8.138	1.00	68.86	C
ATOM	20254	CG	PRO	D1229	23.869	63.371	7.449	1.00	66.63	C
ATOM	20255	CD	PRO	D1229	24.128	61.931	7.747	1.00	66.95	C
ATOM	20256	N	SER	D1230	20.673	63.017	10.896	1.00	65.03	N
ATOM	20257	CA	SER	D1230	19.346	62.655	11.405	1.00	63.17	C
ATOM	20258	C	SER	D1230	18.265	62.683	10.329	1.00	68.98	C
ATOM	20259	O	SER	D1230	17.228	62.042	10.480	1.00	71.42	O
ATOM	20260	CB	SER	D1230	18.938	63.587	12.536	1.00	67.77	C
ATOM	20261	OG	SER	D1230	20.077	64.104	13.198	1.00	73.52	O
ATOM	20262	N	LYS	D1231	18.502	63.426	9.250	1.00	67.05	N
ATOM	20263	CA	LYS	D1231	17.558	63.471	8.143	1.00	67.07	C
ATOM	20264	C	LYS	D1231	17.354	62.089	7.588	1.00	69.08	C
ATOM	20265	O	LYS	D1231	16.231	61.597	7.432	1.00	64.63	O
ATOM	20266	CB	LYS	D1231	18.060	64.376	7.020	1.00	72.99	C
ATOM	20267	CG	LYS	D1231	18.686	65.690	7.455	1.00	75.34	C
ATOM	20268	CD	LYS	D1231	19.504	66.243	6.299	1.00	70.98	C
ATOM	20269	CE	LYS	D1231	20.647	67.109	6.780	1.00	71.90	C
ATOM	20270	NZ	LYS	D1231	21.649	67.259	5.691	1.00	67.81	N
ATOM	20271	N	TYR	D1232	18.479	61.465	7.282	1.00	71.06	N
ATOM	20272	CA	TYR	D1232	18.475	60.216	6.556	1.00	66.44	C
ATOM	20273	C	TYR	D1232	18.009	59.083	7.451	1.00	63.35	C
ATOM	20274	O	TYR	D1232	17.433	58.106	6.984	1.00	67.74	O
ATOM	20275	CB	TYR	D1232	19.865	59.947	5.995	1.00	71.39	C
ATOM	20276	CG	TYR	D1232	20.390	61.036	5.070	1.00	72.42	C
ATOM	20277	CD1	TYR	D1232	19.525	61.845	4.345	1.00	70.03	C
ATOM	20278	CD2	TYR	D1232	21.752	61.247	4.926	1.00	70.40	C
ATOM	20279	CE1	TYR	D1232	20.008	62.831	3.508	1.00	71.65	C
ATOM	20280	CE2	TYR	D1232	22.241	62.223	4.096	1.00	71.54	C
ATOM	20281	CZ	TYR	D1232	21.369	63.015	3.386	1.00	73.50	C
ATOM	20282	OH	TYR	D1232	21.873	63.987	2.549	1.00	71.78	O
ATOM	20283	N	VAL	D1233	18.239	59.228	8.747	1.00	65.59	N
ATOM	20284	CA	VAL	D1233	17.857	58.194	9.694	1.00	63.93	C

ATOM	20285	C	VAL	D1233	16.349	58.168	9.841	1.00	65.28	C
ATOM	20286	O	VAL	D1233	15.732	57.112	9.750	1.00	69.95	O
ATOM	20287	CB	VAL	D1233	18.533	58.413	11.068	1.00	64.55	C
ATOM	20288	CG1	VAL	D1233	17.873	57.565	12.164	1.00	50.25	C
ATOM	20289	CG2	VAL	D1233	20.022	58.123	10.957	1.00	63.97	C
ATOM	20290	N	ASN	D1234	15.759	59.336	10.072	1.00	69.30	N
ATOM	20291	CA	ASN	D1234	14.307	59.465	10.132	1.00	68.14	C
ATOM	20292	C	ASN	D1234	13.658	58.961	8.861	1.00	68.15	C
ATOM	20293	O	ASN	D1234	12.660	58.236	8.888	1.00	67.04	O
ATOM	20294	CB	ASN	D1234	13.925	60.911	10.374	1.00	61.11	C
ATOM	20295	CG	ASN	D1234	13.851	61.236	11.836	1.00	70.64	C
ATOM	20296	OD1	ASN	D1234	14.306	60.448	12.675	1.00	69.24	O
ATOM	20297	ND2	ASN	D1234	13.256	62.390	12.167	1.00	66.45	N
ATOM	20298	N	PHE	D1235	14.265	59.333	7.744	1.00	68.71	N
ATOM	20299	CA	PHE	D1235	13.760	58.948	6.446	1.00	67.08	C
ATOM	20300	C	PHE	D1235	13.706	57.440	6.292	1.00	71.95	C
ATOM	20301	O	PHE	D1235	12.704	56.903	5.825	1.00	74.91	O
ATOM	20302	CB	PHE	D1235	14.614	59.557	5.339	1.00	71.94	C
ATOM	20303	CG	PHE	D1235	14.417	58.897	4.012	1.00	77.52	C
ATOM	20304	CD1	PHE	D1235	13.208	59.010	3.347	1.00	77.80	C
ATOM	20305	CD2	PHE	D1235	15.432	58.145	3.440	1.00	76.59	C
ATOM	20306	CE1	PHE	D1235	13.008	58.390	2.139	1.00	79.65	C
ATOM	20307	CE2	PHE	D1235	15.244	57.520	2.221	1.00	80.38	C
ATOM	20308	CZ	PHE	D1235	14.027	57.647	1.566	1.00	84.11	C
ATOM	20309	N	LEU	D1236	14.773	56.755	6.698	1.00	69.70	N
ATOM	20310	CA	LEU	D1236	14.886	55.326	6.450	1.00	65.89	C
ATOM	20311	C	LEU	D1236	13.971	54.523	7.371	1.00	66.01	O
ATOM	20312	O	LEU	D1236	13.561	53.407	7.030	1.00	65.04	O
ATOM	20313	CB	LEU	D1236	16.346	54.873	6.596	1.00	72.26	C
ATOM	20314	CG	LEU	D1236	17.298	55.113	5.411	1.00	73.62	C
ATOM	20315	CD1	LEU	D1236	18.742	55.089	5.871	1.00	72.62	C
ATOM	20316	CD2	LEU	D1236	17.101	54.104	4.275	1.00	68.28	C
ATOM	20317	N	TYR	D1237	13.659	55.093	8.532	1.00	65.20	N
ATOM	20318	CA	TYR	D1237	12.664	54.523	9.448	1.00	70.00	C
ATOM	20319	C	TYR	D1237	11.237	54.644	8.927	1.00	73.56	C
ATOM	20320	O	TYR	D1237	10.451	53.702	9.029	1.00	77.67	O
ATOM	20321	CB	TYR	D1237	12.728	55.201	10.811	1.00	71.48	C
ATOM	20322	CG	TYR	D1237	11.785	54.591	11.827	1.00	73.83	C
ATOM	20323	CD2	TYR	D1237	10.529	55.143	12.070	1.00	76.20	C
ATOM	20324	CD1	TYR	D1237	12.151	53.458	12.541	1.00	73.46	C
ATOM	20325	CE2	TYR	D1237	9.665	54.582	13.009	1.00	78.87	C
ATOM	20326	CE1	TYR	D1237	11.301	52.890	13.481	1.00	80.25	C
ATOM	20327	CZ	TYR	D1237	10.058	53.452	13.714	1.00	83.72	C
ATOM	20328	OH	TYR	D1237	9.217	52.877	14.651	1.00	79.87	O
ATOM	20329	N	LEU	D1238	10.891	55.815	8.403	1.00	69.83	N
ATOM	20330	CA	LEU	D1238	9.574	55.999	7.791	1.00	74.93	C
ATOM	20331	C	LEU	D1238	9.462	55.209	6.486	1.00	75.49	C
ATOM	20332	O	LEU	D1238	8.488	54.481	6.275	1.00	72.85	O
ATOM	20333	CB	LEU	D1238	9.291	57.485	7.556	1.00	69.55	C
ATOM	20334	CG	LEU	D1238	8.962	58.230	8.854	1.00	69.30	C
ATOM	20335	CD1	LEU	D1238	9.016	59.744	8.702	1.00	67.98	C
ATOM	20336	CD2	LEU	D1238	7.610	57.796	9.388	1.00	70.43	C
ATOM	20337	N	ALA	D1239	10.482	55.316	5.639	1.00	73.11	N
ATOM	20338	CA	ALA	D1239	10.464	54.665	4.334	1.00	70.70	C
ATOM	20339	C	ALA	D1239	10.498	53.150	4.406	1.00	74.17	C
ATOM	20340	O	ALA	D1239	10.252	52.483	3.407	1.00	78.82	O
ATOM	20341	CB	ALA	D1239	11.613	55.152	3.495	1.00	70.56	C
ATOM	20342	N	SER	D1240	10.805	52.593	5.570	1.00	74.28	N
ATOM	20343	CA	SER	D1240	10.857	51.137	5.687	1.00	83.79	C
ATOM	20344	C	SER	D1240	9.658	50.591	6.451	1.00	84.75	C
ATOM	20345	O	SER	D1240	9.432	49.381	6.485	1.00	90.92	O
ATOM	20346	CB	SER	D1240	12.162	50.687	6.364	1.00	84.46	C
ATOM	20347	OG	SER	D1240	12.411	51.406	7.563	1.00	83.40	O

ATOM	20348	O	HIS	D1241	6.081	52.816	7.641	1.00	90.94	O
ATOM	20349	N	HIS	D1241	8.891	51.485	7.059	1.00	81.70	N
ATOM	20350	CA	HIS	D1241	7.747	51.081	7.861	1.00	87.08	C
ATOM	20351	C	HIS	D1241	6.415	51.660	7.357	1.00	93.15	C
ATOM	20352	CB	HIS	D1241	7.965	51.494	9.319	1.00	87.34	C
ATOM	20353	CG	HIS	D1241	8.939	50.629	10.060	1.00	85.75	C
ATOM	20354	ND1	HIS	D1241	10.251	50.995	10.273	1.00	83.08	N
ATOM	20355	CD2	HIS	D1241	8.786	49.422	10.654	1.00	82.95	C
ATOM	20356	CE1	HIS	D1241	10.865	50.050	10.961	1.00	81.99	C
ATOM	20357	NE2	HIS	D1241	9.997	49.084	11.205	1.00	87.40	N
ATOM	20358	O	TYR	D1242	2.453	49.948	7.212	1.00	100.18	O
ATOM	20359	N	TYR	D1242	5.657	50.855	6.614	1.00	96.19	N
ATOM	20360	CA	TYR	D1242	4.280	51.211	6.276	1.00	95.47	C
ATOM	20361	C	TYR	D1242	3.365	50.758	7.411	1.00	99.65	C
ATOM	20362	CB	TYR	D1242	3.849	50.582	4.952	1.00	91.41	C
ATOM	20363	O	GLU	D1243	1.072	52.075	10.886	1.00	81.28	O
ATOM	20364	N	GLU	D1243	3.636	51.278	8.607	1.00	95.13	N
ATOM	20365	CA	GLU	D1243	2.874	50.931	9.797	1.00	93.77	C
ATOM	20366	C	GLU	D1243	2.187	52.164	10.375	1.00	89.55	C
ATOM	20367	CB	GLU	D1243	3.783	50.287	10.846	1.00	92.04	C
ATOM	20368	N	GLU	D1250	-5.094	56.743	8.687	1.00	98.00	N
ATOM	20369	CA	GLU	D1250	-5.025	57.755	9.732	1.00	96.79	C
ATOM	20370	C	GLU	D1250	-4.374	59.036	9.209	1.00	98.56	C
ATOM	20371	O	GLU	D1250	-3.588	59.002	8.262	1.00	96.62	O
ATOM	20372	CB	GLU	D1250	-4.260	57.223	10.941	1.00	95.93	C
ATOM	20373	CG	GLU	D1250	-4.514	58.009	12.208	1.00	100.92	C
ATOM	20374	CD	GLU	D1250	-3.239	58.497	12.846	1.00	100.22	C
ATOM	20375	OE1	GLU	D1250	-2.273	57.707	12.900	1.00	98.68	O
ATOM	20376	OE2	GLU	D1250	-3.202	59.669	13.285	1.00	103.15	O
ATOM	20377	N	ASP	D1251	-4.713	60.163	9.829	1.00	98.72	N
ATOM	20378	CA	ASP	D1251	-4.242	61.469	9.384	1.00	97.90	C
ATOM	20379	C	ASP	D1251	-2.729	61.595	9.478	1.00	97.52	C
ATOM	20380	O	ASP	D1251	-2.074	61.990	8.515	1.00	98.02	O
ATOM	20381	CB	ASP	D1251	-4.903	62.579	10.205	1.00	105.56	C
ATOM	20382	CG	ASP	D1251	-6.351	62.262	10.559	1.00	109.73	C
ATOM	20383	OD1	ASP	D1251	-6.678	61.066	10.741	1.00	102.26	O
ATOM	20384	OD2	ASP	D1251	-7.159	63.213	10.659	1.00	116.67	O
ATOM	20385	N	ASN	D1252	-2.181	61.264	10.645	1.00	98.72	N
ATOM	20386	CA	ASN	D1252	-0.743	61.359	10.877	1.00	94.46	C
ATOM	20387	C	ASN	D1252	0.049	60.418	9.970	1.00	91.03	C
ATOM	20388	O	ASN	D1252	1.057	60.814	9.380	1.00	86.93	O
ATOM	20389	CB	ASN	D1252	-0.425	61.067	12.347	1.00	97.92	C
ATOM	20390	N	GLU	D1253	-0.432	59.182	9.847	1.00	90.97	N
ATOM	20391	CA	GLU	D1253	0.239	58.151	9.059	1.00	89.45	C
ATOM	20392	C	GLU	D1253	0.224	58.434	7.548	1.00	91.56	C
ATOM	20393	O	GLU	D1253	0.887	57.748	6.775	1.00	88.21	O
ATOM	20394	CB	GLU	D1253	-0.394	56.782	9.340	1.00	86.80	C
ATOM	20395	N	GLN	D1254	-0.532	59.443	7.128	1.00	95.26	N
ATOM	20396	CA	GLN	D1254	-0.576	59.829	5.722	1.00	92.58	C
ATOM	20397	C	GLN	D1254	0.491	60.888	5.439	1.00	89.53	C
ATOM	20398	O	GLN	D1254	1.215	60.795	4.451	1.00	88.00	O
ATOM	20399	CB	GLN	D1254	-1.981	60.337	5.346	1.00	96.78	C
ATOM	20400	CG	GLN	D1254	-2.023	61.697	4.637	1.00	99.98	C
ATOM	20401	CD	GLN	D1254	-3.420	62.086	4.165	1.00	104.29	C
ATOM	20402	OE1	GLN	D1254	-4.163	61.260	3.630	1.00	97.43	O
ATOM	20403	NE2	GLN	D1254	-3.780	63.352	4.363	1.00	106.41	N
ATOM	20404	N	LYS	D1255	0.596	61.871	6.332	1.00	91.31	N
ATOM	20405	CA	LYS	D1255	1.562	62.963	6.225	1.00	88.72	C
ATOM	20406	C	LYS	D1255	2.991	62.421	6.173	1.00	91.83	C
ATOM	20407	O	LYS	D1255	3.919	63.098	5.721	1.00	92.06	O
ATOM	20408	CB	LYS	D1255	1.396	63.908	7.415	1.00	85.52	C
ATOM	20409	CG	LYS	D1255	1.626	65.381	7.125	1.00	95.08	C
ATOM	20410	CD	LYS	D1255	1.548	66.189	8.424	1.00	96.83	C

ATOM	20411	CE	LYS	D1255	1.255	67.668	8.182	1.00	95.46	C
ATOM	20412	NE	LYS	D1255	1.251	68.441	9.462	1.00	84.43	N
ATOM	20413	N	GLN	D1256	3.143	61.186	6.648	1.00	89.87	N
ATOM	20414	CA	GLN	D1256	4.430	60.503	6.734	1.00	88.96	C
ATOM	20415	C	GLN	D1256	4.710	59.636	5.509	1.00	87.62	C
ATOM	20416	O	GLN	D1256	5.853	59.527	5.069	1.00	86.30	O
ATOM	20417	CB	GLN	D1256	4.491	59.652	8.010	1.00	86.61	C
ATOM	20418	CG	GLN	D1256	4.665	60.470	9.289	1.00	82.87	C
ATOM	20419	CD	GLN	D1256	4.555	59.630	10.545	1.00	81.03	C
ATOM	20420	OE1	GLN	D1256	4.222	58.449	10.485	1.00	79.22	O
ATOM	20421	NE2	GLN	D1256	4.833	60.240	11.694	1.00	85.78	N
ATOM	20422	N	LEU	D1257	3.681	59.014	4.951	1.00	86.37	N
ATOM	20423	CA	LEU	D1257	3.857	58.405	3.645	1.00	86.11	C
ATOM	20424	C	LEU	D1257	4.122	59.525	2.631	1.00	85.40	C
ATOM	20425	O	LEU	D1257	4.741	59.302	1.602	1.00	87.02	O
ATOM	20426	CB	LEU	D1257	2.643	57.560	3.254	1.00	86.75	C
ATOM	20427	CG	LEU	D1257	2.792	56.038	3.393	1.00	89.67	C
ATOM	20428	CD1	LEU	D1257	1.439	55.342	3.306	1.00	87.52	C
ATOM	20429	CD2	LEU	D1257	3.751	55.466	2.340	1.00	90.64	C
ATOM	20430	N	PHE	D1258	3.686	60.740	2.953	1.00	87.88	N
ATOM	20431	CA	PHE	D1258	3.922	61.896	2.092	1.00	89.23	C
ATOM	20432	C	PHE	D1258	5.395	62.268	2.007	1.00	86.13	C
ATOM	20433	O	PHE	D1258	5.980	62.240	0.927	1.00	86.05	O
ATOM	20434	CB	PHE	D1258	3.122	63.104	2.583	1.00	92.62	C
ATOM	20435	N	VAL	D1259	5.990	62.618	3.146	1.00	89.73	N
ATOM	20436	CA	VAL	D1259	7.391	63.055	3.193	1.00	89.01	C
ATOM	20437	C	VAL	D1259	8.343	61.985	2.639	1.00	82.38	C
ATOM	20438	O	VAL	D1259	9.399	62.304	2.096	1.00	82.92	O
ATOM	20439	CB	VAL	D1259	7.798	63.439	4.632	1.00	86.74	C
ATOM	20440	CG1	VAL	D1259	7.547	62.286	5.571	1.00	86.92	C
ATOM	20441	CG2	VAL	D1259	9.249	63.907	4.700	1.00	88.62	C
ATOM	20442	N	GLU	D1260	7.949	60.722	2.734	1.00	78.04	N
ATOM	20443	CA	GLU	D1260	8.723	59.653	2.119	1.00	82.32	C
ATOM	20444	C	GLU	D1260	8.840	59.849	0.608	1.00	87.27	C
ATOM	20445	O	GLU	D1260	9.862	59.513	0.024	1.00	83.63	O
ATOM	20446	CB	GLU	D1260	8.108	58.285	2.421	1.00	81.84	C
ATOM	20447	N	GLN	D1261	7.802	60.392	-0.030	1.00	89.56	N
ATOM	20448	CA	GLN	D1261	7.874	60.656	-1.471	1.00	86.06	C
ATOM	20449	C	GLN	D1261	8.605	61.958	-1.744	1.00	84.43	C
ATOM	20450	O	GLN	D1261	9.217	62.128	-2.795	1.00	81.72	O
ATOM	20451	CB	GLN	D1261	6.487	60.688	-2.106	1.00	86.96	C
ATOM	20452	CG	GLN	D1261	5.915	59.309	-2.373	1.00	89.01	C
ATOM	20453	CD	GLN	D1261	5.268	58.711	-1.146	1.00	89.57	C
ATOM	20454	OE1	GLN	D1261	5.707	57.680	-0.633	1.00	91.68	O
ATOM	20455	NE2	GLN	D1261	4.214	59.362	-0.661	1.00	86.45	N
ATOM	20456	N	HIS	D1262	8.543	62.877	-0.790	1.00	84.99	N
ATOM	20457	CA	HIS	D1262	9.413	64.043	-0.810	1.00	85.60	C
ATOM	20458	C	HIS	D1262	10.817	63.601	-0.343	1.00	91.36	C
ATOM	20459	O	HIS	D1262	11.317	64.047	0.705	1.00	90.40	O
ATOM	20460	CB	HIS	D1262	8.869	65.163	0.090	1.00	86.56	C
ATOM	20461	CG	HIS	D1262	7.440	65.544	-0.179	1.00	92.40	C
ATOM	20462	ND1	HIS	D1262	6.546	64.722	-0.834	1.00	89.81	N
ATOM	20463	CD2	HIS	D1262	6.752	66.671	0.131	1.00	90.10	C
ATOM	20464	CE1	HIS	D1262	5.373	65.326	-0.919	1.00	88.09	C
ATOM	20465	NE2	HIS	D1262	5.473	66.511	-0.345	1.00	86.20	N
ATOM	20466	O	LYS	D1263	13.238	60.611	-2.550	1.00	76.13	O
ATOM	20467	N	LYS	D1263	11.438	62.702	-1.107	1.00	85.78	N
ATOM	20468	CA	LYS	D1263	12.757	62.193	-0.748	1.00	85.90	C
ATOM	20469	C	LYS	D1263	13.585	61.608	-1.910	1.00	84.05	C
ATOM	20470	CB	LYS	D1263	12.617	61.147	0.350	1.00	91.55	C
ATOM	20471	O	HIS	D1264	18.046	61.399	-2.800	1.00	77.73	O
ATOM	20472	N	HIS	D1264	14.709	62.274	-2.122	1.00	83.08	N
ATOM	20473	CA	HIS	D1264	15.718	61.986	-3.123	1.00	80.06	C

ATOM	20474	C	HIS	D1264	16.897	61.429	-2.343	1.00	82.17	C
ATOM	20475	CB	HIS	D1264	16.090	63.272	-3.844	1.00	74.24	C
ATOM	20476	CG	HIS	D1264	16.149	64.452	-2.923	1.00	73.14	C
ATOM	20477	ND1	HIS	D1264	15.037	64.941	-2.268	1.00	75.08	N
ATOM	20478	CD2	HIS	D1264	17.191	65.210	-2.505	1.00	76.68	C
ATOM	20479	CE1	HIS	D1264	15.388	65.958	-1.500	1.00	74.10	C
ATOM	20480	NE2	HIS	D1264	16.690	66.143	-1.628	1.00	73.99	N
ATOM	20481	O	TYR	D1265	19.411	59.198	0.106	1.00	76.90	O
ATOM	20482	N	TYR	D1265	16.567	61.017	-1.127	1.00	83.30	N
ATOM	20483	CA	TYR	D1265	17.530	60.646	-0.105	1.00	80.64	C
ATOM	20484	C	TYR	D1265	18.318	59.376	-0.412	1.00	76.20	C
ATOM	20485	CB	TYR	D1265	16.797	60.504	1.227	1.00	77.44	C
ATOM	20486	CG	TYR	D1265	16.492	61.837	1.863	1.00	76.46	C
ATOM	20487	CD1	TYR	D1265	16.912	63.021	1.266	1.00	76.86	C
ATOM	20488	CD2	TYR	D1265	15.815	61.916	3.072	1.00	74.44	C
ATOM	20489	CE1	TYR	D1265	16.654	64.246	1.849	1.00	76.60	C
ATOM	20490	CE2	TYR	D1265	15.556	63.138	3.662	1.00	72.17	C
ATOM	20491	CZ	TYR	D1265	15.975	64.300	3.045	1.00	73.63	C
ATOM	20492	OH	TYR	D1265	15.722	65.520	3.633	1.00	77.62	O
ATOM	20493	N	LEU	D1266	17.756	58.511	-1.253	1.00	74.40	N
ATOM	20494	CA	LEU	D1266	18.391	57.264	-1.669	1.00	71.72	C
ATOM	20495	C	LEU	D1266	19.774	57.530	-2.258	1.00	76.75	C
ATOM	20496	O	LEU	D1266	20.753	56.893	-1.882	1.00	75.17	O
ATOM	20497	CB	LEU	D1266	17.526	56.536	-2.700	1.00	70.11	C
ATOM	20498	CG	LEU	D1266	16.296	55.713	-2.312	1.00	71.98	C
ATOM	20499	CD1	LEU	D1266	16.668	54.261	-2.116	1.00	74.09	C
ATOM	20500	CD2	LEU	D1266	15.622	56.243	-1.072	1.00	73.57	C
ATOM	20501	N	ASP	D1267	19.837	58.466	-3.198	1.00	76.75	N
ATOM	20502	CA	ASP	D1267	21.100	58.946	-3.741	1.00	79.47	C
ATOM	20503	C	ASP	D1267	22.033	59.383	-2.623	1.00	78.58	C
ATOM	20504	O	ASP	D1267	23.212	59.043	-2.600	1.00	73.49	O
ATOM	20505	CB	ASP	D1267	20.875	60.137	-4.683	1.00	81.55	C
ATOM	20506	CG	ASP	D1267	20.360	59.729	-6.041	1.00	85.41	C
ATOM	20507	OD1	ASP	D1267	20.642	58.588	-6.475	1.00	82.29	O
ATOM	20508	OD2	ASP	D1267	19.683	60.570	-6.677	1.00	86.55	O
ATOM	20509	N	GLU	D1268	21.482	60.152	-1.696	1.00	76.50	N
ATOM	20510	CA	GLU	D1268	22.288	60.820	-0.690	1.00	80.17	C
ATOM	20511	C	GLU	D1268	22.828	59.869	0.397	1.00	78.36	C
ATOM	20512	O	GLU	D1268	23.979	60.009	0.817	1.00	75.78	O
ATOM	20513	CB	GLU	D1268	21.475	61.966	-0.074	1.00	77.28	C
ATOM	20514	CG	GLU	D1268	20.895	62.890	-1.145	1.00	80.97	C
ATOM	20515	CD	GLU	D1268	20.448	64.239	-0.618	1.00	81.31	C
ATOM	20516	OE1	GLU	D1268	20.894	65.262	-1.178	1.00	85.48	O
ATOM	20517	OE2	GLU	D1268	19.642	64.281	0.337	1.00	83.08	O
ATOM	20518	N	ILE	D1269	22.025	58.901	0.839	1.00	73.89	N
ATOM	20519	CA	ILE	D1269	22.489	57.988	1.875	1.00	72.98	C
ATOM	20520	C	ILE	D1269	23.472	57.009	1.269	1.00	73.35	C
ATOM	20521	O	ILE	D1269	24.315	56.470	1.964	1.00	74.12	O
ATOM	20522	CB	ILE	D1269	21.342	57.221	2.557	1.00	72.33	C
ATOM	20523	CG1	ILE	D1269	20.695	56.245	1.578	1.00	77.21	C
ATOM	20524	CG2	ILE	D1269	20.323	58.184	3.125	1.00	69.31	C
ATOM	20525	CD1	ILE	D1269	19.261	55.896	1.928	1.00	81.99	C
ATOM	20526	N	ILE	D1270	23.363	56.785	-0.034	1.00	74.44	N
ATOM	20527	CA	ILE	D1270	24.341	55.982	-0.743	1.00	71.02	C
ATOM	20528	C	ILE	D1270	25.637	56.782	-0.834	1.00	71.77	C
ATOM	20529	O	ILE	D1270	26.731	56.240	-0.717	1.00	70.55	O
ATOM	20530	CB	ILE	D1270	23.839	55.587	-2.145	1.00	70.54	C
ATOM	20531	CG1	ILE	D1270	22.766	54.501	-2.050	1.00	71.18	C
ATOM	20532	CG2	ILE	D1270	24.974	55.107	-3.023	1.00	71.28	C
ATOM	20533	CD1	ILE	D1270	23.240	53.199	-1.490	1.00	75.55	C
ATOM	20534	N	GLU	D1271	25.503	58.086	-1.029	1.00	76.44	N
ATOM	20535	CA	GLU	D1271	26.663	58.962	-1.101	1.00	74.69	C
ATOM	20536	C	GLU	D1271	27.379	58.983	0.242	1.00	72.61	C

ATOM	20537	O	GLU	D1271	28.608	58.992	0.295	1.00	74.74	O
ATOM	20538	CB	GLU	D1271	26.256	60.384	-1.516	1.00	73.67	C
ATOM	20539	CG	GLU	D1271	25.823	60.526	-2.977	1.00	83.64	C
ATOM	20540	CD	GLU	D1271	26.887	60.058	-3.971	1.00	86.80	C
ATOM	20541	OE1	GLU	D1271	26.510	59.542	-5.049	1.00	93.45	O
ATOM	20542	OE2	GLU	D1271	28.094	60.218	-3.681	1.00	79.27	O
ATOM	20543	N	GLN	D1272	26.597	59.000	1.319	1.00	68.90	N
ATOM	20544	CA	GLN	D1272	27.121	58.926	2.678	1.00	69.60	C
ATOM	20545	C	GLN	D1272	27.920	57.641	2.911	1.00	68.05	C
ATOM	20546	O	GLN	D1272	29.053	57.678	3.381	1.00	63.68	O
ATOM	20547	CB	GLN	D1272	25.982	58.994	3.682	1.00	67.85	C
ATOM	20548	CG	GLN	D1272	25.264	60.290	3.714	1.00	67.13	C
ATOM	20549	CD	GLN	D1272	25.980	61.333	4.534	1.00	68.21	C
ATOM	20550	OE1	GLN	D1272	26.487	61.052	5.617	1.00	68.66	O
ATOM	20551	NE2	GLN	D1272	26.021	62.549	4.022	1.00	66.87	N
ATOM	20552	N	ILE	D1273	27.297	56.515	2.574	1.00	66.57	N
ATOM	20553	CA	ILE	D1273	27.875	55.181	2.723	1.00	64.90	C
ATOM	20554	C	ILE	D1273	29.178	55.038	1.948	1.00	69.74	C
ATOM	20555	O	ILE	D1273	30.190	54.581	2.482	1.00	66.93	O
ATOM	20556	CB	ILE	D1273	26.872	54.092	2.252	1.00	62.03	C
ATOM	20557	CG1	ILE	D1273	25.764	53.896	3.290	1.00	65.17	C
ATOM	20558	CG2	ILE	D1273	27.575	52.775	1.989	1.00	63.98	C
ATOM	20559	CD1	ILE	D1273	24.525	53.221	2.752	1.00	62.92	C
ATOM	20560	N	SER	D1274	29.144	55.448	0.688	1.00	70.16	N
ATOM	20561	CA	SER	D1274	30.275	55.297	-0.215	1.00	70.88	C
ATOM	20562	C	SER	D1274	31.489	56.133	0.191	1.00	69.01	C
ATOM	20563	O	SER	D1274	32.626	55.667	0.117	1.00	68.26	O
ATOM	20564	CB	SER	D1274	29.845	55.660	-1.638	1.00	72.68	C
ATOM	20565	OG	SER	D1274	30.974	55.871	-2.467	1.00	78.82	O
ATOM	20566	N	GLU	D1275	31.230	57.370	0.602	1.00	72.70	N
ATOM	20567	CA	GLU	D1275	32.261	58.323	1.014	1.00	67.35	C
ATOM	20568	C	GLU	D1275	33.012	57.803	2.231	1.00	70.09	C
ATOM	20569	O	GLU	D1275	34.239	57.770	2.258	1.00	73.53	O
ATOM	20570	CB	GLU	D1275	31.615	59.673	1.301	1.00	68.96	C
ATOM	20571	CG	GLU	D1275	32.488	60.703	1.980	1.00	82.59	C
ATOM	20572	CD	GLU	D1275	31.742	62.022	2.231	1.00	89.14	C
ATOM	20573	OE1	GLU	D1275	30.719	62.283	1.550	1.00	86.53	O
ATOM	20574	OE2	GLU	D1275	32.182	62.794	3.115	1.00	93.83	O
ATOM	20575	N	PHE	D1276	32.245	57.380	3.224	1.00	69.57	N
ATOM	20576	CA	PHE	D1276	32.756	56.782	4.445	1.00	64.38	C
ATOM	20577	C	PHE	D1276	33.571	55.552	4.125	1.00	67.37	C
ATOM	20578	O	PHE	D1276	34.654	55.338	4.662	1.00	64.93	O
ATOM	20579	CB	PHE	D1276	31.584	56.416	5.351	1.00	62.94	C
ATOM	20580	CG	PHE	D1276	31.978	55.814	6.660	1.00	61.45	C
ATOM	20581	CD2	PHE	D1276	31.892	54.449	6.860	1.00	54.43	C
ATOM	20582	CD1	PHE	D1276	32.388	56.616	7.712	1.00	60.62	C
ATOM	20583	CE2	PHE	D1276	32.228	53.887	8.077	1.00	52.20	C
ATOM	20584	CE1	PHE	D1276	32.731	56.057	8.930	1.00	57.88	C
ATOM	20585	CZ	PHE	D1276	32.647	54.681	9.106	1.00	53.57	C
ATOM	20586	N	SER	D1277	33.017	54.755	3.225	1.00	68.09	N
ATOM	20587	CA	SER	D1277	33.546	53.450	2.896	1.00	63.85	C
ATOM	20588	C	SER	D1277	34.936	53.599	2.303	1.00	71.05	C
ATOM	20589	O	SER	D1277	35.858	52.840	2.628	1.00	70.74	O
ATOM	20590	CB	SER	D1277	32.601	52.738	1.923	1.00	64.19	C
ATOM	20591	OG	SER	D1277	32.871	51.360	1.823	1.00	68.14	O
ATOM	20592	N	LYS	D1278	35.087	54.602	1.445	1.00	74.31	N
ATOM	20593	CA	LYS	D1278	36.344	54.819	0.744	1.00	72.10	C
ATOM	20594	C	LYS	D1278	37.373	55.411	1.702	1.00	69.22	C
ATOM	20595	O	LYS	D1278	38.576	55.312	1.478	1.00	69.93	O
ATOM	20596	CB	LYS	D1278	36.139	55.734	-0.470	1.00	66.73	C
ATOM	20597	N	ARG	D1279	36.905	56.021	2.781	1.00	66.35	N
ATOM	20598	CA	ARG	D1279	37.830	56.606	3.740	1.00	66.14	C
ATOM	20599	C	ARG	D1279	38.413	55.546	4.668	1.00	66.19	C

ATOM	20600	O	ARG	D1279	39.618	55.511	4.898	1.00	66.85	O
ATOM	20601	CB	ARG	D1279	37.148	57.690	4.572	1.00	60.08	C
ATOM	20602	CG	ARG	D1279	38.113	58.637	5.293	1.00	67.47	C
ATOM	20603	CD	ARG	D1279	37.340	59.697	6.086	1.00	67.43	C
ATOM	20604	NE	ARG	D1279	38.175	60.790	6.596	1.00	82.20	N
ATOM	20605	CZ	ARG	D1279	37.996	62.085	6.311	1.00	86.95	C
ATOM	20606	NH1	ARG	D1279	37.003	62.470	5.511	1.00	85.81	N
ATOM	20607	NH2	ARG	D1279	38.811	63.002	6.829	1.00	82.87	N
ATOM	20608	N	VAL	D1280	37.559	54.686	5.207	1.00	65.21	N
ATOM	20609	CA	VAL	D1280	37.969	53.880	6.341	1.00	62.08	C
ATOM	20610	C	VAL	D1280	37.713	52.389	6.213	1.00	62.83	C
ATOM	20611	O	VAL	D1280	38.312	51.617	6.934	1.00	64.98	O
ATOM	20612	CB	VAL	D1280	37.284	54.353	7.633	1.00	57.01	C
ATOM	20613	CG2	VAL	D1280	35.780	54.112	7.568	1.00	53.99	C
ATOM	20614	CG1	VAL	D1280	37.589	55.800	7.877	1.00	59.09	C
ATOM	20615	N	ILE	D1281	36.825	51.972	5.325	1.00	62.86	N
ATOM	20616	CA	ILE	D1281	36.507	50.559	5.247	1.00	60.50	C
ATOM	20617	C	ILE	D1281	37.440	49.874	4.244	1.00	66.26	C
ATOM	20618	O	ILE	D1281	37.963	48.782	4.497	1.00	65.01	O
ATOM	20619	CB	ILE	D1281	35.040	50.334	4.874	1.00	57.56	C
ATOM	20620	CG1	ILE	D1281	34.223	50.017	6.127	1.00	63.88	C
ATOM	20621	CG2	ILE	D1281	34.899	49.140	3.971	1.00	58.36	C
ATOM	20622	CD1	ILE	D1281	34.281	51.049	7.220	1.00	60.62	C
ATOM	20623	O	LEU	D1282	39.201	47.843	1.546	1.00	73.66	O
ATOM	20624	N	LEU	D1282	37.642	50.532	3.110	1.00	68.17	N
ATOM	20625	CA	LEU	D1282	38.623	50.110	2.114	1.00	67.07	C
ATOM	20626	C	LEU	D1282	38.331	48.718	1.543	1.00	73.43	C
ATOM	20627	CB	LEU	D1282	40.032	50.148	2.715	1.00	59.44	C
ATOM	20628	CG	LEU	D1282	40.738	51.506	2.878	1.00	66.99	C
ATOM	20629	CD2	LEU	D1282	41.959	51.406	3.803	1.00	60.94	C
ATOM	20630	CD1	LEU	D1282	39.815	52.609	3.365	1.00	60.01	C
ATOM	20631	O	ALA	D1283	35.176	47.825	-1.363	1.00	77.98	O
ATOM	20632	N	ALA	D1283	37.111	48.518	1.047	1.00	66.26	N
ATOM	20633	CA	ALA	D1283	36.780	47.292	0.330	1.00	62.31	C
ATOM	20634	C	ALA	D1283	36.361	47.641	-1.083	1.00	76.18	C
ATOM	20635	CB	ALA	D1283	35.684	46.529	1.039	1.00	64.17	C
ATOM	20636	O	ASP	D1284	35.188	48.046	-4.691	1.00	77.57	O
ATOM	20637	N	ASP	D1284	37.338	47.735	-1.974	1.00	77.12	N
ATOM	20638	CA	ASP	D1284	37.107	48.294	-3.298	1.00	75.89	C
ATOM	20639	C	ASP	D1284	36.139	47.483	-4.159	1.00	77.97	C
ATOM	20640	CB	ASP	D1284	38.447	48.467	-4.007	1.00	78.60	C
ATOM	20641	CG	ASP	D1284	39.369	49.430	-3.266	1.00	85.99	C
ATOM	20642	OD1	ASP	D1284	38.865	50.140	-2.363	1.00	84.55	O
ATOM	20643	OD2	ASP	D1284	40.581	49.487	-3.587	1.00	85.47	O
ATOM	20644	O	ALA	D1285	33.092	45.420	-5.260	1.00	79.18	O
ATOM	20645	N	ALA	D1285	36.360	46.175	-4.285	1.00	75.06	N
ATOM	20646	CA	ALA	D1285	35.480	45.328	-5.099	1.00	75.11	C
ATOM	20647	C	ALA	D1285	34.063	45.257	-4.528	1.00	75.94	C
ATOM	20648	CB	ALA	D1285	36.059	43.926	-5.234	1.00	75.79	C
ATOM	20649	N	ASN	D1286	33.957	45.004	-3.226	1.00	74.71	N
ATOM	20650	CA	ASN	D1286	32.676	44.997	-2.527	1.00	75.24	C
ATOM	20651	C	ASN	D1286	31.939	46.333	-2.653	1.00	77.89	C
ATOM	20652	O	ASN	D1286	30.714	46.368	-2.703	1.00	78.78	O
ATOM	20653	CB	ASN	D1286	32.872	44.672	-1.045	1.00	76.38	C
ATOM	20654	CG	ASN	D1286	32.909	43.182	-0.762	1.00	77.89	C
ATOM	20655	OD1	ASN	D1286	32.839	42.354	-1.674	1.00	73.75	O
ATOM	20656	ND2	ASN	D1286	33.020	42.834	0.520	1.00	77.50	N
ATOM	20657	N	LEU	D1287	32.686	47.429	-2.703	1.00	75.40	N
ATOM	20658	CA	LEU	D1287	32.087	48.754	-2.832	1.00	76.73	C
ATOM	20659	C	LEU	D1287	31.393	48.965	-4.179	1.00	81.76	C
ATOM	20660	O	LEU	D1287	30.260	49.452	-4.228	1.00	80.69	O
ATOM	20661	CB	LEU	D1287	33.139	49.845	-2.631	1.00	72.16	C
ATOM	20662	CG	LEU	D1287	32.637	51.278	-2.834	1.00	79.52	C

ATOM	20663	CD1	LEU	D1287	31.407	51.571	-1.980	1.00	75.85	C
ATOM	20664	CD2	LEU	D1287	33.738	52.285	-2.551	1.00	74.39	C
ATOM	20665	N	ASP	D1288	32.081	48.615	-5.263	1.00	81.81	N
ATOM	20666	CA	ASP	D1288	31.541	48.783	-6.608	1.00	79.52	C
ATOM	20667	C	ASP	D1288	30.329	47.890	-6.831	1.00	83.92	C
ATOM	20668	O	ASP	D1288	29.366	48.296	-7.493	1.00	83.95	O
ATOM	20669	CB	ASP	D1288	32.604	48.483	-7.667	1.00	80.41	C
ATOM	20670	CG	ASP	D1288	33.605	49.606	-7.822	1.00	85.33	C
ATOM	20671	OD1	ASP	D1288	33.260	50.763	-7.504	1.00	86.54	O
ATOM	20672	OD2	ASP	D1288	34.740	49.332	-8.266	1.00	91.19	O
ATOM	20673	N	LYS	D1289	30.381	46.671	-6.299	1.00	81.27	N
ATOM	20674	CA	LYS	D1289	29.242	45.771	-6.417	1.00	84.65	C
ATOM	20675	C	LYS	D1289	28.015	46.433	-5.761	1.00	82.50	C
ATOM	20676	O	LYS	D1289	26.910	46.390	-6.301	1.00	82.37	O
ATOM	20677	CB	LYS	D1289	29.551	44.404	-5.789	1.00	80.28	C
ATOM	20678	N	VAL	D1290	28.230	47.077	-4.620	1.00	77.40	N
ATOM	20679	CA	VAL	D1290	27.159	47.765	-3.917	1.00	76.61	C
ATOM	20680	C	VAL	D1290	26.643	48.938	-4.740	1.00	80.98	C
ATOM	20681	O	VAL	D1290	25.436	49.091	-4.923	1.00	83.43	O
ATOM	20682	CB	VAL	D1290	27.620	48.272	-2.538	1.00	72.95	C
ATOM	20683	CG1	VAL	D1290	26.576	49.165	-1.940	1.00	76.43	C
ATOM	20684	CG2	VAL	D1290	27.876	47.113	-1.611	1.00	75.07	C
ATOM	20685	N	LEU	D1291	27.562	49.761	-5.237	1.00	82.53	N
ATOM	20686	CA	LEU	D1291	27.212	50.901	-6.080	1.00	79.66	C
ATOM	20687	C	LEU	D1291	26.420	50.469	-7.309	1.00	81.37	C
ATOM	20688	O	LEU	D1291	25.405	51.075	-7.655	1.00	81.65	O
ATOM	20689	CB	LEU	D1291	28.472	51.646	-6.519	1.00	81.58	C
ATOM	20690	CG	LEU	D1291	29.235	52.437	-5.457	1.00	79.62	C
ATOM	20691	CD1	LEU	D1291	30.549	52.966	-6.025	1.00	80.46	C
ATOM	20692	CD2	LEU	D1291	28.368	53.569	-4.940	1.00	80.57	C
ATOM	20693	N	SER	D1292	26.887	49.410	-7.960	1.00	82.36	N
ATOM	20694	CA	SER	D1292	26.271	48.944	-9.193	1.00	83.33	C
ATOM	20695	C	SER	D1292	24.914	48.302	-8.941	1.00	83.35	C
ATOM	20696	O	SER	D1292	23.983	48.506	-9.711	1.00	87.27	O
ATOM	20697	CB	SER	D1292	27.195	47.961	-9.910	1.00	86.48	C
ATOM	20698	OG	SER	D1292	28.404	48.597	-10.290	1.00	89.86	O
ATOM	20699	O	ALA	D1293	21.318	47.840	-7.597	1.00	81.91	O
ATOM	20700	N	ALA	D1293	24.802	47.528	-7.868	1.00	83.71	N
ATOM	20701	CA	ALA	D1293	23.527	46.914	-7.513	1.00	82.77	C
ATOM	20702	C	ALA	D1293	22.484	47.980	-7.214	1.00	79.72	C
ATOM	20703	CB	ALA	D1293	23.684	45.979	-6.319	1.00	77.60	C
ATOM	20704	O	TYR	D1294	20.155	50.973	-7.468	1.00	79.47	O
ATOM	20705	N	TYR	D1294	22.907	49.040	-6.531	1.00	77.13	N
ATOM	20706	CA	TYR	D1294	22.002	50.128	-6.179	1.00	80.97	C
ATOM	20707	C	TYR	D1294	21.378	50.777	-7.404	1.00	80.14	C
ATOM	20708	CB	TYR	D1294	22.718	51.203	-5.368	1.00	76.85	C
ATOM	20709	CG	TYR	D1294	21.903	52.468	-5.287	1.00	75.51	C
ATOM	20710	CD2	TYR	D1294	22.296	53.609	-5.967	1.00	74.78	C
ATOM	20711	CD1	TYR	D1294	20.723	52.512	-4.553	1.00	73.65	C
ATOM	20712	CE2	TYR	D1294	21.550	54.766	-5.908	1.00	77.62	C
ATOM	20713	CE1	TYR	D1294	19.971	53.662	-4.488	1.00	75.28	C
ATOM	20714	CZ	TYR	D1294	20.388	54.790	-5.172	1.00	76.43	C
ATOM	20715	OH	TYR	D1294	19.650	55.948	-5.126	1.00	77.84	O
ATOM	20716	O	ASN	D1295	19.672	51.425	-10.676	1.00	82.86	O
ATOM	20717	N	ASN	D1295	22.232	51.129	-8.360	1.00	78.64	N
ATOM	20718	CA	ASN	D1295	21.783	51.754	-9.591	1.00	82.87	C
ATOM	20719	C	ASN	D1295	20.728	50.916	-10.293	1.00	84.31	C
ATOM	20720	CB	ASN	D1295	22.955	51.992	-10.541	1.00	80.45	C
ATOM	20721	CG	ASN	D1295	22.512	52.606	-11.854	1.00	93.18	C
ATOM	20722	OD1	ASN	D1295	21.585	53.429	-11.888	1.00	98.30	O
ATOM	20723	ND2	ASN	D1295	23.154	52.200	-12.947	1.00	84.99	N
ATOM	20724	O	LYS	D1296	17.825	48.340	-11.418	1.00	80.27	O
ATOM	20725	N	LYS	D1296	21.013	49.625	-10.430	1.00	76.52	N

ATOM	20726	CA	LYS	D1296	20.177	48.742	-11.219	1.00	77.99	C
ATOM	20727	C	LYS	D1296	18.763	48.620	-10.669	1.00	79.50	C
ATOM	20728	CB	LYS	D1296	20.828	47.360	-11.328	1.00	78.86	C
ATOM	20729	CG	LYS	D1296	20.318	46.292	-10.378	1.00	78.04	C
ATOM	20730	CD	LYS	D1296	20.673	44.913	-10.947	1.00	84.52	C
ATOM	20731	CE	LYS	D1296	20.271	43.767	-10.029	1.00	88.93	C
ATOM	20732	NZ	LYS	D1296	20.468	42.428	-10.673	1.00	87.88	N
ATOM	20733	O	HIS	D1297	15.717	50.199	-7.693	1.00	75.92	O
ATOM	20734	N	HIS	D1297	18.607	48.851	-9.370	1.00	79.71	N
ATOM	20735	CA	HIS	D1297	17.302	48.740	-8.733	1.00	78.19	C
ATOM	20736	C	HIS	D1297	16.661	50.103	-8.472	1.00	77.50	C
ATOM	20737	CB	HIS	D1297	17.417	47.965	-7.422	1.00	75.72	C
ATOM	20738	CG	HIS	D1297	17.540	46.485	-7.604	1.00	83.50	C
ATOM	20739	ND1	HIS	D1297	16.477	45.692	-7.980	1.00	83.51	C
ATOM	20740	CD2	HIS	D1297	18.596	45.650	-7.451	1.00	84.63	N
ATOM	20741	CE1	HIS	D1297	16.873	44.433	-8.051	1.00	82.92	C
ATOM	20742	NE2	HIS	D1297	18.154	44.380	-7.732	1.00	83.44	N
ATOM	20743	O	ARG	D1298	14.462	53.470	-8.772	1.00	74.67	O
ATOM	20744	N	ARG	D1298	17.162	51.145	-9.131	1.00	76.23	N
ATOM	20745	CA	ARG	D1298	16.647	52.499	-8.922	1.00	78.67	C
ATOM	20746	C	ARG	D1298	15.167	52.613	-9.296	1.00	78.65	C
ATOM	20747	CB	ARG	D1298	17.470	53.524	-9.712	1.00	75.16	C
ATOM	20748	O	ASP	D1299	11.156	51.283	-9.629	1.00	81.76	O
ATOM	20749	N	ASP	D1299	14.700	51.732	-10.180	1.00	82.35	N
ATOM	20750	CA	ASP	D1299	13.293	51.720	-10.602	1.00	82.29	C
ATOM	20751	C	ASP	D1299	12.359	51.056	-9.592	1.00	80.20	C
ATOM	20752	CB	ASP	D1299	13.142	51.017	-11.954	1.00	83.25	C
ATOM	20753	O	LYS	D1300	12.023	51.798	-6.697	1.00	80.19	O
ATOM	20754	N	LYS	D1300	12.905	50.225	-8.707	1.00	81.99	N
ATOM	20755	CA	LYS	D1300	12.107	49.588	-7.662	1.00	76.96	C
ATOM	20756	C	LYS	D1300	11.520	50.667	-6.738	1.00	79.01	C
ATOM	20757	CB	LYS	D1300	12.955	48.574	-6.883	1.00	71.52	C
ATOM	20758	O	PRO	D1301	11.495	51.064	-3.580	1.00	84.47	O
ATOM	20759	N	PRO	D1301	10.441	50.340	-6.007	1.00	77.92	N
ATOM	20760	CA	PRO	D1301	9.784	51.381	-5.202	1.00	76.38	C
ATOM	20761	C	PRO	D1301	10.602	51.797	-3.983	1.00	81.47	C
ATOM	20762	CB	PRO	D1301	8.482	50.711	-4.772	1.00	74.37	C
ATOM	20763	CG	PRO	D1301	8.809	49.249	-4.765	1.00	74.49	C
ATOM	20764	CD	PRO	D1301	9.738	49.048	-5.918	1.00	71.29	C
ATOM	20765	O	ILE	D1302	12.226	52.333	-0.513	1.00	81.63	O
ATOM	20766	N	ILE	D1302	10.282	52.943	-3.392	1.00	83.79	N
ATOM	20767	CA	ILE	D1302	11.044	53.468	-2.257	1.00	85.84	C
ATOM	20768	C	ILE	D1302	11.150	52.505	-1.074	1.00	81.91	C
ATOM	20769	CB	ILE	D1302	10.439	54.786	-1.732	1.00	81.37	C
ATOM	20770	CG1	ILE	D1302	10.362	55.823	-2.848	1.00	83.20	C
ATOM	20771	CG2	ILE	D1302	11.254	55.319	-0.570	1.00	79.69	C
ATOM	20772	CD1	ILE	D1302	8.975	55.960	-3.458	1.00	97.70	C
ATOM	20773	N	ARG	D1303	10.035	51.892	-0.691	1.00	79.40	N
ATOM	20774	CA	ARG	D1303	10.008	51.023	0.485	1.00	83.40	C
ATOM	20775	C	ARG	D1303	10.940	49.830	0.324	1.00	82.38	C
ATOM	20776	O	ARG	D1303	11.674	49.483	1.246	1.00	80.31	O
ATOM	20777	CB	ARG	D1303	8.586	50.522	0.768	1.00	82.96	C
ATOM	20778	N	GLU	D1304	10.891	49.203	-0.848	1.00	82.54	N
ATOM	20779	CA	GLU	D1304	11.727	48.047	-1.141	1.00	86.26	C
ATOM	20780	C	GLU	D1304	13.201	48.450	-1.092	1.00	83.00	C
ATOM	20781	O	GLU	D1304	14.018	47.775	-0.472	1.00	82.91	O
ATOM	20782	CB	GLU	D1304	11.367	47.443	-2.509	1.00	81.51	C
ATOM	20783	N	GLN	D1305	13.525	49.572	-1.724	1.00	80.52	N
ATOM	20784	CA	GLN	D1305	14.896	50.054	-1.766	1.00	83.11	C
ATOM	20785	C	GLN	D1305	15.408	50.467	-0.379	1.00	82.75	C
ATOM	20786	O	GLN	D1305	16.523	50.115	-0.001	1.00	80.85	O
ATOM	20787	CB	GLN	D1305	15.016	51.226	-2.748	1.00	82.35	C
ATOM	20788	CG	GLN	D1305	15.010	50.812	-4.223	1.00	81.37	C

ATOM	20789	CD	GLN	D1305	15.063	52.001	-5.176	1.00	83.50	C
ATOM	20790	OE1	GLN	D1305	15.609	53.058	-4.848	1.00	86.73	O
ATOM	20791	NE2	GLN	D1305	14.487	51.834	-6.361	1.00	82.91	N
ATOM	20792	N	ALA	D1306	14.593	51.197	0.378	1.00	82.21	N
ATOM	20793	CA	ALA	D1306	15.000	51.711	1.691	1.00	79.35	C
ATOM	20794	C	ALA	D1306	15.487	50.625	2.650	1.00	80.20	C
ATOM	20795	O	ALA	D1306	16.449	50.830	3.384	1.00	81.16	O
ATOM	20796	CB	ALA	D1306	13.859	52.477	2.328	1.00	79.25	C
ATOM	20797	O	GLU	D1307	17.208	47.227	3.995	1.00	81.55	O
ATOM	20798	N	GLU	D1307	14.826	49.474	2.634	1.00	81.25	N
ATOM	20799	CA	GLU	D1307	15.154	48.380	3.536	1.00	80.57	C
ATOM	20800	C	GLU	D1307	16.445	47.680	3.137	1.00	80.84	C
ATOM	20801	CB	GLU	D1307	14.000	47.383	3.585	1.00	83.44	C
ATOM	20802	CG	GLU	D1307	12.741	48.003	4.151	1.00	91.47	C
ATOM	20803	CD	GLU	D1307	11.551	47.072	4.141	1.00	100.88	C
ATOM	20804	OE1	GLU	D1307	11.664	45.963	3.565	1.00	105.06	O
ATOM	20805	OE2	GLU	D1307	10.504	47.463	4.710	1.00	95.69	O
ATOM	20806	N	ASN	D1308	16.688	47.597	1.833	1.00	80.51	N
ATOM	20807	CA	ASN	D1308	17.928	47.027	1.315	1.00	77.81	C
ATOM	20808	C	ASN	D1308	19.120	47.945	1.543	1.00	77.48	C
ATOM	20809	O	ASN	D1308	20.257	47.487	1.633	1.00	77.65	O
ATOM	20810	CB	ASN	D1308	17.799	46.722	-0.177	1.00	79.15	C
ATOM	20811	CG	ASN	D1308	17.036	45.447	-0.445	1.00	81.42	C
ATOM	20812	OD1	ASN	D1308	17.593	44.349	-0.363	1.00	81.35	O
ATOM	20813	ND2	ASN	D1308	15.754	45.581	-0.768	1.00	76.10	N
ATOM	20814	N	ILE	D1309	18.858	49.245	1.615	1.00	76.12	N
ATOM	20815	CA	ILE	D1309	19.903	50.199	1.922	1.00	73.28	C
ATOM	20816	C	ILE	D1309	20.381	49.911	3.326	1.00	71.29	C
ATOM	20817	O	ILE	D1309	21.569	49.964	3.603	1.00	70.31	O
ATOM	20818	CB	ILE	D1309	19.409	51.653	1.813	1.00	69.94	C
ATOM	20819	CG1	ILE	D1309	18.988	51.958	0.383	1.00	75.78	C
ATOM	20820	CG2	ILE	D1309	20.495	52.613	2.192	1.00	65.28	C
ATOM	20821	CD1	ILE	D1309	20.063	51.659	-0.628	1.00	76.65	C
ATOM	20822	N	ILE	D1310	19.429	49.604	4.203	1.00	74.75	N
ATOM	20823	CA	ILE	D1310	19.698	49.333	5.609	1.00	71.66	C
ATOM	20824	C	ILE	D1310	20.622	48.143	5.741	1.00	66.82	C
ATOM	20825	O	ILE	D1310	21.505	48.116	6.593	1.00	61.90	O
ATOM	20826	CB	ILE	D1310	18.400	49.069	6.379	1.00	67.55	C
ATOM	20827	CG1	ILE	D1310	17.648	50.384	6.573	1.00	69.47	C
ATOM	20828	CG2	ILE	D1310	18.687	48.429	7.722	1.00	62.19	C
ATOM	20829	CD1	ILE	D1310	16.216	50.207	7.007	1.00	68.73	C
ATOM	20830	N	HIS	D1311	20.409	47.165	4.874	1.00	68.10	N
ATOM	20831	CA	HIS	D1311	21.256	45.984	4.822	1.00	71.86	C
ATOM	20832	C	HIS	D1311	22.714	46.400	4.588	1.00	71.33	C
ATOM	20833	O	HIS	D1311	23.641	45.863	5.205	1.00	66.93	O
ATOM	20834	CB	HIS	D1311	20.772	45.041	3.717	1.00	72.13	C
ATOM	20835	CG	HIS	D1311	19.604	44.183	4.107	1.00	73.59	C
ATOM	20836	ND1	HIS	D1311	18.572	43.893	3.241	1.00	72.40	N
ATOM	20837	CD2	HIS	D1311	19.331	43.508	5.250	1.00	78.18	C
ATOM	20838	CE1	HIS	D1311	17.706	43.095	3.839	1.00	70.43	C
ATOM	20839	NE2	HIS	D1311	18.144	42.842	5.058	1.00	70.22	N
ATOM	20840	N	LEU	D1312	22.897	47.399	3.728	1.00	69.39	N
ATOM	20841	CA	LEU	D1312	24.225	47.841	3.299	1.00	68.01	C
ATOM	20842	C	LEU	D1312	25.102	48.412	4.409	1.00	65.69	C
ATOM	20843	O	LEU	D1312	26.329	48.453	4.274	1.00	61.12	O
ATOM	20844	CB	LEU	D1312	24.099	48.890	2.197	1.00	67.86	C
ATOM	20845	CG	LEU	D1312	23.402	48.533	0.891	1.00	69.13	C
ATOM	20846	CD1	LEU	D1312	23.337	49.788	0.038	1.00	73.71	C
ATOM	20847	CD2	LEU	D1312	24.129	47.430	0.156	1.00	69.86	C
ATOM	20848	N	PHE	D1313	24.489	48.870	5.496	1.00	62.14	N
ATOM	20849	CA	PHE	D1313	25.269	49.401	6.610	1.00	61.10	C
ATOM	20850	C	PHE	D1313	26.109	48.314	7.260	1.00	63.08	C
ATOM	20851	O	PHE	D1313	27.004	48.607	8.058	1.00	60.95	O

ATOM	20852	CB	PHE	D1313	24.366	50.055	7.644	1.00	58.44	C
ATOM	20853	CG	PHE	D1313	23.795	51.329	7.181	1.00	59.03	C
ATOM	20854	CD1	PHE	D1313	24.566	52.473	7.169	1.00	59.92	C
ATOM	20855	CD2	PHE	D1313	22.508	51.385	6.701	1.00	59.62	C
ATOM	20856	CE1	PHE	D1313	24.050	53.657	6.715	1.00	61.81	C
ATOM	20857	CE2	PHE	D1313	21.986	52.566	6.247	1.00	61.90	C
ATOM	20858	CZ	PHE	D1313	22.753	53.704	6.254	1.00	60.04	C
ATOM	20859	N	THR	D1314	25.812	47.063	6.920	1.00	61.09	N
ATOM	20860	CA	THR	D1314	26.598	45.952	7.408	1.00	60.64	C
ATOM	20861	C	THR	D1314	28.042	46.178	6.988	1.00	61.04	C
ATOM	20862	O	THR	D1314	28.961	46.097	7.796	1.00	60.63	O
ATOM	20863	CB	THR	D1314	26.070	44.634	6.868	1.00	69.83	C
ATOM	20864	OG1	THR	D1314	24.763	44.395	7.417	1.00	73.41	O
ATOM	20865	CG2	THR	D1314	27.006	43.494	7.223	1.00	60.40	C
ATOM	20866	N	LEU	D1315	28.215	46.520	5.718	1.00	63.65	N
ATOM	20867	CA	LEU	D1315	29.502	46.934	5.179	1.00	58.98	C
ATOM	20868	C	LEU	D1315	30.262	47.922	6.072	1.00	62.50	C
ATOM	20869	O	LEU	D1315	31.457	47.748	6.310	1.00	59.58	O
ATOM	20870	CB	LEU	D1315	29.292	47.565	3.813	1.00	63.18	C
ATOM	20871	CG	LEU	D1315	30.538	48.113	3.138	1.00	66.17	C
ATOM	20872	CD1	LEU	D1315	31.334	46.971	2.560	1.00	57.68	C
ATOM	20873	CD2	LEU	D1315	30.137	49.117	2.067	1.00	69.09	C
ATOM	20874	N	THR	D1316	29.560	48.946	6.568	1.00	57.39	N
ATOM	20875	CA	THR	D1316	30.185	50.033	7.315	1.00	51.26	C
ATOM	20876	C	THR	D1316	30.202	49.835	8.836	1.00	52.11	C
ATOM	20877	O	THR	D1316	30.840	50.605	9.544	1.00	49.95	O
ATOM	20878	CB	THR	D1316	29.478	51.403	7.024	1.00	59.43	C
ATOM	20879	OG1	THR	D1316	28.181	51.450	7.655	1.00	57.77	O
ATOM	20880	CG2	THR	D1316	29.338	51.633	5.541	1.00	53.49	C
ATOM	20881	N	ASN	D1317	29.499	48.826	9.340	1.00	55.33	N
ATOM	20882	CA	ASN	D1317	29.387	48.631	10.786	1.00	50.55	C
ATOM	20883	C	ASN	D1317	30.711	48.367	11.490	1.00	56.71	C
ATOM	20884	O	ASN	D1317	31.588	47.665	10.957	1.00	52.17	O
ATOM	20885	CB	ASN	D1317	28.451	47.472	11.094	1.00	51.20	C
ATOM	20886	CG	ASN	D1317	27.005	47.867	11.055	1.00	57.42	C
ATOM	20887	OD1	ASN	D1317	26.668	49.050	10.980	1.00	59.88	O
ATOM	20888	ND2	ASN	D1317	26.128	46.872	11.110	1.00	60.68	N
ATOM	20889	O	LEU	D1318	31.075	46.307	13.598	1.00	53.89	O
ATOM	20890	N	LEU	D1318	30.836	48.917	12.697	1.00	52.79	N
ATOM	20891	CA	LEU	D1318	31.934	48.576	13.606	1.00	53.03	C
ATOM	20892	C	LEU	D1318	32.059	47.040	13.771	1.00	54.66	C
ATOM	20893	CB	LEU	D1318	31.708	49.255	14.962	1.00	49.76	C
ATOM	20894	CG	LEU	D1318	32.734	48.975	16.059	1.00	56.14	C
ATOM	20895	CD2	LEU	D1318	32.156	49.131	17.461	1.00	46.80	C
ATOM	20896	CD1	LEU	D1318	33.954	49.842	15.881	1.00	52.08	C
ATOM	20897	O	GLY	D1319	34.150	44.786	12.092	1.00	52.57	O
ATOM	20898	N	GLY	D1319	33.259	46.545	14.069	1.00	53.75	N
ATOM	20899	CA	GLY	D1319	33.437	45.120	14.337	1.00	46.12	C
ATOM	20900	C	GLY	D1319	33.741	44.272	13.113	1.00	46.05	C
ATOM	20901	O	ALA	D1320	31.877	42.200	10.958	1.00	64.07	O
ATOM	20902	N	ALA	D1320	33.530	42.970	13.205	1.00	48.28	N
ATOM	20903	CA	ALA	D1320	33.961	42.050	12.146	1.00	49.48	C
ATOM	20904	C	ALA	D1320	33.104	42.136	10.878	1.00	55.46	C
ATOM	20905	CB	ALA	D1320	33.965	40.628	12.670	1.00	40.69	C
ATOM	20906	O	PRO	D1321	32.432	39.924	8.759	1.00	65.81	O
ATOM	20907	N	PRO	D1321	33.756	42.154	9.705	1.00	49.06	N
ATOM	20908	CA	PRO	D1321	33.109	42.170	8.390	1.00	58.21	C
ATOM	20909	C	PRO	D1321	32.194	40.980	8.191	1.00	63.69	C
ATOM	20910	CB	PRO	D1321	34.286	42.110	7.413	1.00	65.30	C
ATOM	20911	CG	PRO	D1321	35.412	42.696	8.158	1.00	62.64	C
ATOM	20912	CD	PRO	D1321	35.217	42.283	9.588	1.00	59.57	C
ATOM	20913	O	ALA	D1322	29.250	41.433	5.403	1.00	75.79	O
ATOM	20914	N	ALA	D1322	31.159	41.156	7.379	1.00	72.71	N

ATOM	20915	CA	ALA	D1322	30.130	40.138	7.217	1.00	72.26	C
ATOM	20916	C	ALA	D1322	29.390	40.317	5.907	1.00	73.22	C
ATOM	20917	CB	ALA	D1322	29.147	40.179	8.381	1.00	68.04	C
ATOM	20918	O	ALA	D1323	26.247	39.820	5.494	1.00	79.57	O
ATOM	20919	N	ALA	D1323	28.921	39.203	5.359	1.00	79.53	N
ATOM	20920	CA	ALA	D1323	28.144	39.222	4.134	1.00	80.23	C
ATOM	20921	C	ALA	D1323	26.781	39.866	4.383	1.00	78.25	C
ATOM	20922	CB	ALA	D1323	27.988	37.809	3.581	1.00	79.70	C
ATOM	20923	O	PHE	D1324	25.105	41.265	1.024	1.00	77.26	O
ATOM	20924	N	PHE	D1324	26.237	40.475	3.340	1.00	76.40	N
ATOM	20925	CA	PHE	D1324	24.940	41.124	3.399	1.00	74.83	C
ATOM	20926	C	PHE	D1324	24.361	41.143	1.994	1.00	76.23	C
ATOM	20927	CB	PHE	D1324	25.063	42.548	3.963	1.00	75.62	C
ATOM	20928	CG	PHE	D1324	26.129	43.373	3.299	1.00	72.30	C
ATOM	20929	CD2	PHE	D1324	25.833	44.157	2.196	1.00	73.71	C
ATOM	20930	CD1	PHE	D1324	27.432	43.359	3.773	1.00	73.02	C
ATOM	20931	CE2	PHE	D1324	26.820	44.904	1.579	1.00	71.43	C
ATOM	20932	CE1	PHE	D1324	28.420	44.111	3.160	1.00	70.65	C
ATOM	20933	CZ	PHE	D1324	28.114	44.878	2.064	1.00	67.44	C
ATOM	20934	O	LYS	D1325	21.254	43.039	1.081	1.00	72.97	O
ATOM	20935	N	LYS	D1325	23.042	41.024	1.872	1.00	83.39	N
ATOM	20936	CA	LYS	D1325	22.408	41.017	0.552	1.00	79.77	C
ATOM	20937	C	LYS	D1325	21.778	42.360	0.210	1.00	72.20	C
ATOM	20938	CB	LYS	D1325	21.352	39.911	0.475	1.00	79.34	C
ATOM	20939	O	TYR	D1326	20.671	42.976	-3.784	1.00	85.57	O
ATOM	20940	N	TYR	D1326	21.863	42.744	-1.060	1.00	79.90	N
ATOM	20941	CA	TYR	D1326	21.111	43.878	-1.596	1.00	78.68	C
ATOM	20942	C	TYR	D1326	20.198	43.373	-2.714	1.00	84.25	C
ATOM	20943	CB	TYR	D1326	22.045	44.971	-2.112	1.00	77.67	C
ATOM	20944	CG	TYR	D1326	21.345	46.248	-2.545	1.00	76.75	C
ATOM	20945	CD1	TYR	D1326	20.943	47.198	-1.613	1.00	75.90	C
ATOM	20946	CD2	TYR	D1326	21.110	46.510	-3.884	1.00	77.17	C
ATOM	20947	CE1	TYR	D1326	20.309	48.373	-2.007	1.00	79.40	C
ATOM	20948	CE2	TYR	D1326	20.486	47.673	-4.287	1.00	79.22	C
ATOM	20949	CZ	TYR	D1326	20.083	48.604	-3.349	1.00	80.69	C
ATOM	20950	OH	TYR	D1326	19.457	49.759	-3.762	1.00	77.67	O
ATOM	20951	O	PHE	D1327	18.171	40.416	-2.634	1.00	88.03	O
ATOM	20952	N	PHE	D1327	18.891	43.398	-2.449	1.00	84.63	N
ATOM	20953	CA	PHE	D1327	17.889	42.702	-3.258	1.00	84.57	C
ATOM	20954	C	PHE	D1327	18.276	41.258	-3.523	1.00	84.79	C
ATOM	20955	CB	PHE	D1327	17.652	43.434	-4.568	1.00	84.46	C
ATOM	20956	CG	PHE	D1327	16.855	44.689	-4.406	1.00	85.64	C
ATOM	20957	CD2	PHE	D1327	15.471	44.660	-4.490	1.00	84.74	C
ATOM	20958	CD1	PHE	D1327	17.485	45.896	-4.144	1.00	82.79	C
ATOM	20959	CE2	PHE	D1327	14.726	45.818	-4.335	1.00	80.58	C
ATOM	20960	CE1	PHE	D1327	16.754	47.053	-3.991	1.00	83.56	C
ATOM	20961	CZ	PHE	D1327	15.365	47.015	-4.084	1.00	83.92	C
ATOM	20962	O	ASP	D1328	20.968	38.245	-4.547	1.00	89.77	O
ATOM	20963	N	ASP	D1328	18.722	40.969	-4.740	1.00	89.84	N
ATOM	20964	CA	ASP	D1328	19.079	39.600	-5.109	1.00	89.46	C
ATOM	20965	C	ASP	D1328	20.574	39.328	-4.972	1.00	89.69	C
ATOM	20966	CB	ASP	D1328	18.623	39.301	-6.537	1.00	87.83	C
ATOM	20967	CG	ASP	D1328	18.935	40.432	-7.491	1.00	90.81	C
ATOM	20968	OD1	ASP	D1328	18.318	40.488	-8.576	1.00	93.38	O
ATOM	20969	OD2	ASP	D1328	19.789	41.278	-7.148	1.00	92.83	O
ATOM	20970	O	THR	D1329	22.852	40.617	-2.972	1.00	87.27	O
ATOM	20971	N	THR	D1329	21.401	40.310	-5.330	1.00	89.27	N
ATOM	20972	CA	THR	D1329	22.849	40.121	-5.326	1.00	84.59	C
ATOM	20973	C	THR	D1329	23.390	40.015	-3.904	1.00	86.26	C
ATOM	20974	CB	THR	D1329	23.590	41.264	-6.072	1.00	85.09	C
ATOM	20975	OG1	THR	D1329	23.279	42.525	-5.477	1.00	79.51	O
ATOM	20976	CG2	THR	D1329	23.205	41.297	-7.551	1.00	85.68	C
ATOM	20977	N	THR	D1330	24.454	39.233	-3.751	1.00	82.60	N

ATOM	20978	CA	THR	D1330	25.068	38.986	-2.456	1.00	78.63	C
ATOM	20979	C	THR	D1330	26.481	39.541	-2.366	1.00	80.15	C
ATOM	20980	O	THR	D1330	27.340	39.196	-3.178	1.00	78.58	O
ATOM	20981	CB	THR	D1330	25.120	37.492	-2.156	1.00	81.06	C
ATOM	20982	OG1	THR	D1330	23.786	37.017	-1.961	1.00	89.99	O
ATOM	20983	CG2	THR	D1330	25.943	37.220	-0.904	1.00	72.68	C
ATOM	20984	N	ILE	D1331	26.714	40.390	-1.369	1.00	78.24	N
ATOM	20985	CA	ILE	D1331	28.042	40.925	-1.104	1.00	78.56	C
ATOM	20986	C	ILE	D1331	28.788	40.097	-0.051	1.00	82.56	C
ATOM	20987	O	ILE	D1331	28.389	40.059	1.117	1.00	77.26	O
ATOM	20988	CB	ILE	D1331	27.980	42.383	-0.631	1.00	78.43	C
ATOM	20989	CG1	ILE	D1331	26.984	43.173	-1.481	1.00	76.20	C
ATOM	20990	CG2	ILE	D1331	29.366	43.021	-0.688	1.00	74.36	C
ATOM	20991	CD1	ILE	D1331	27.374	43.265	-2.939	1.00	82.43	C
ATOM	20992	N	ASP	D1332	29.877	39.456	-0.480	1.00	81.82	N
ATOM	20993	CA	ASP	D1332	30.716	38.637	0.393	1.00	84.58	C
ATOM	20994	C	ASP	D1332	31.513	39.437	1.419	1.00	84.24	C
ATOM	20995	O	ASP	D1332	31.488	40.673	1.442	1.00	81.01	O
ATOM	20996	CB	ASP	D1332	31.697	37.803	-0.435	1.00	79.65	C
ATOM	20997	CG	ASP	D1332	31.010	36.734	-1.241	1.00	87.39	C
ATOM	20998	OD1	ASP	D1332	30.198	35.978	-0.661	1.00	89.22	O
ATOM	20999	OD2	ASP	D1332	31.277	36.654	-2.460	1.00	89.10	O
ATOM	21000	N	ARG	D1333	32.249	38.694	2.239	1.00	82.03	N
ATOM	21001	CA	ARG	D1333	32.985	39.239	3.366	1.00	81.47	C
ATOM	21002	C	ARG	D1333	34.355	39.752	2.952	1.00	79.67	C
ATOM	21003	O	ARG	D1333	35.034	39.132	2.139	1.00	83.23	O
ATOM	21004	CB	ARG	D1333	33.124	38.163	4.434	1.00	78.73	C
ATOM	21005	CG	ARG	D1333	33.643	38.626	5.770	1.00	75.16	C
ATOM	21006	CD	ARG	D1333	33.583	37.463	6.740	1.00	75.73	C
ATOM	21007	NE	ARG	D1333	33.760	36.199	6.028	1.00	79.05	N
ATOM	21008	CZ	ARG	D1333	34.235	35.089	6.579	1.00	85.76	C
ATOM	21009	NH1	ARG	D1333	34.586	35.090	7.856	1.00	86.45	N
ATOM	21010	NH2	ARG	D1333	34.366	33.981	5.854	1.00	88.51	N
ATOM	21011	N	LYS	D1334	34.753	40.887	3.518	1.00	74.96	N
ATOM	21012	CA	LYS	D1334	36.061	41.471	3.239	1.00	73.92	C
ATOM	21013	C	LYS	D1334	36.965	41.430	4.467	1.00	71.89	C
ATOM	21014	O	LYS	D1334	37.193	42.456	5.109	1.00	73.30	O
ATOM	21015	CB	LYS	D1334	35.910	42.916	2.758	1.00	80.46	C
ATOM	21016	N	ARG	D1335	37.481	40.245	4.789	1.00	73.95	N
ATOM	21017	CA	ARG	D1335	38.298	40.061	5.985	1.00	66.62	C
ATOM	21018	C	ARG	D1335	39.564	40.890	5.900	1.00	62.64	C
ATOM	21019	O	ARG	D1335	40.082	41.131	4.818	1.00	60.94	O
ATOM	21020	CB	ARG	D1335	38.651	38.591	6.186	1.00	65.50	C
ATOM	21021	CG	ARG	D1335	37.463	37.654	6.168	1.00	76.39	C
ATOM	21022	CD	ARG	D1335	37.356	36.833	7.454	1.00	84.65	C
ATOM	21023	NE	ARG	D1335	38.419	35.834	7.615	1.00	87.67	N
ATOM	21024	CZ	ARG	D1335	38.325	34.562	7.228	1.00	86.78	C
ATOM	21025	NH1	ARG	D1335	39.342	33.730	7.423	1.00	96.54	N
ATOM	21026	NH2	ARG	D1335	37.219	34.120	6.644	1.00	82.71	N
ATOM	21027	N	TYR	D1336	40.041	41.352	7.047	1.00	64.80	N
ATOM	21028	CA	TYR	D1336	41.297	42.083	7.111	1.00	63.55	C
ATOM	21029	C	TYR	D1336	42.348	41.154	7.656	1.00	62.06	C
ATOM	21030	O	TYR	D1336	42.605	41.153	8.864	1.00	62.28	O
ATOM	21031	CB	TYR	D1336	41.180	43.329	7.996	1.00	60.48	C
ATOM	21032	CG	TYR	D1336	40.190	44.339	7.491	1.00	63.34	C
ATOM	21033	CD1	TYR	D1336	40.228	44.788	6.168	1.00	64.16	C
ATOM	21034	CD2	TYR	D1336	39.202	44.845	8.330	1.00	63.59	C
ATOM	21035	CE1	TYR	D1336	39.305	45.719	5.701	1.00	62.90	C
ATOM	21036	CE2	TYR	D1336	38.273	45.775	7.869	1.00	62.42	C
ATOM	21037	CZ	TYR	D1336	38.327	46.205	6.557	1.00	61.57	C
ATOM	21038	OH	TYR	D1336	37.409	47.131	6.123	1.00	62.66	O
ATOM	21039	O	THR	D1337	45.478	39.351	8.901	1.00	69.99	O
ATOM	21040	N	THR	D1337	42.949	40.364	6.765	1.00	66.93	N

ATOM	21041	CA	THR	D1337	43.855	39.274	7.152	1.00	58.38	C
ATOM	21042	C	THR	D1337	45.124	39.784	7.813	1.00	61.94	C
ATOM	21043	CB	THR	D1337	44.240	38.421	5.947	1.00	60.83	C
ATOM	21044	OG1	THR	D1337	45.144	39.152	5.105	1.00	72.31	O
ATOM	21045	CG2	THR	D1337	43.003	38.060	5.161	1.00	58.23	C
ATOM	21046	O	SER	D1338	45.813	42.916	9.039	1.00	61.27	O
ATOM	21047	N	SER	D1338	45.799	40.720	7.168	1.00	53.74	N
ATOM	21048	CA	SER	D1338	47.015	41.273	7.732	1.00	59.69	C
ATOM	21049	C	SER	D1338	46.783	42.167	8.965	1.00	65.65	C
ATOM	21050	CB	SER	D1338	47.760	42.061	6.662	1.00	55.46	C
ATOM	21051	OG	SER	D1338	48.851	42.744	7.248	1.00	68.18	O
ATOM	21052	N	THR	D1339	47.693	42.081	9.931	1.00	63.61	N
ATOM	21053	CA	THR	D1339	47.701	42.979	11.081	1.00	61.97	C
ATOM	21054	C	THR	D1339	48.938	43.855	11.015	1.00	62.67	C
ATOM	21055	O	THR	D1339	49.177	44.700	11.886	1.00	64.31	O
ATOM	21056	CB	THR	D1339	47.704	42.210	12.416	1.00	68.63	C
ATOM	21057	OG1	THR	D1339	48.690	41.168	12.367	1.00	71.84	O
ATOM	21058	CG2	THR	D1339	46.352	41.592	12.686	1.00	63.79	C
ATOM	21059	N	LYS	D1340	49.716	43.630	9.962	1.00	64.04	N
ATOM	21060	CA	LYS	D1340	51.003	44.280	9.771	1.00	65.67	C
ATOM	21061	C	LYS	D1340	50.903	45.798	9.912	1.00	65.37	C
ATOM	21062	O	LYS	D1340	51.697	46.403	10.627	1.00	65.13	O
ATOM	21063	CB	LYS	D1340	51.577	43.891	8.400	1.00	66.14	C
ATOM	21064	CG	LYS	D1340	53.010	44.352	8.147	1.00	78.10	C
ATOM	21065	CD	LYS	D1340	53.677	43.570	7.002	1.00	83.62	C
ATOM	21066	CE	LYS	D1340	54.024	42.124	7.413	1.00	97.08	C
ATOM	21067	NZ	LYS	D1340	54.738	41.317	6.359	1.00	93.37	N
ATOM	21068	N	GLU	D1341	49.898	46.394	9.265	1.00	65.33	N
ATOM	21069	CA	GLU	D1341	49.737	47.852	9.207	1.00	66.56	C
ATOM	21070	C	GLU	D1341	49.587	48.524	10.574	1.00	64.01	C
ATOM	21071	O	GLU	D1341	49.747	49.740	10.717	1.00	68.52	O
ATOM	21072	CB	GLU	D1341	48.522	48.215	8.347	1.00	66.90	C
ATOM	21073	CG	GLU	D1341	47.174	47.870	8.988	1.00	62.56	C
ATOM	21074	CD	GLU	D1341	46.015	48.640	8.370	1.00	67.65	C
ATOM	21075	OE1	GLU	D1341	46.286	49.667	7.725	1.00	71.70	O
ATOM	21076	OE2	GLU	D1341	44.840	48.230	8.530	1.00	69.35	O
ATOM	21077	N	VAL	D1342	49.265	47.732	11.577	1.00	59.89	N
ATOM	21078	CA	VAL	D1342	48.931	48.289	12.859	1.00	65.04	C
ATOM	21079	C	VAL	D1342	50.187	48.604	13.690	1.00	65.27	C
ATOM	21080	O	VAL	D1342	50.148	49.450	14.590	1.00	66.22	O
ATOM	21081	CB	VAL	D1342	47.946	47.326	13.586	1.00	67.96	C
ATOM	21082	CG1	VAL	D1342	48.471	46.850	14.927	1.00	61.91	C
ATOM	21083	CG2	VAL	D1342	46.560	47.987	13.692	1.00	61.15	C
ATOM	21084	N	LEU	D1343	51.311	47.974	13.351	1.00	65.10	N
ATOM	21085	CA	LEU	D1343	52.551	48.164	14.111	1.00	66.77	C
ATOM	21086	C	LEU	D1343	53.176	49.555	13.934	1.00	70.89	C
ATOM	21087	O	LEU	D1343	54.097	49.904	14.664	1.00	70.76	O
ATOM	21088	CB	LEU	D1343	53.589	47.094	13.733	1.00	66.09	C
ATOM	21089	CG	LEU	D1343	53.339	45.609	14.021	1.00	62.90	C
ATOM	21090	CD1	LEU	D1343	54.129	44.785	13.034	1.00	60.29	C
ATOM	21091	CD2	LEU	D1343	53.732	45.221	15.440	1.00	56.77	C
ATOM	21092	N	ASP	D1344	52.685	50.341	12.972	1.00	76.30	N
ATOM	21093	CA	ASP	D1344	53.125	51.736	12.794	1.00	73.60	C
ATOM	21094	C	ASP	D1344	51.978	52.730	13.051	1.00	73.33	C
ATOM	21095	O	ASP	D1344	52.138	53.947	12.890	1.00	73.09	O
ATOM	21096	CB	ASP	D1344	53.688	51.958	11.383	1.00	75.24	C
ATOM	21097	CG	ASP	D1344	54.886	51.061	11.069	1.00	81.07	C
ATOM	21098	OD1	ASP	D1344	55.906	51.114	11.802	1.00	74.73	O
ATOM	21099	OD2	ASP	D1344	54.805	50.301	10.077	1.00	86.28	O
ATOM	21100	N	ALA	D1345	50.822	52.210	13.453	1.00	71.52	N
ATOM	21101	CA	ALA	D1345	49.662	53.059	13.724	1.00	63.84	C
ATOM	21102	C	ALA	D1345	49.799	53.727	15.073	1.00	60.65	C
ATOM	21103	O	ALA	D1345	50.890	53.825	15.609	1.00	65.32	O

ATOM	21104	CB	ALA	D1345	48.371	52.249	13.662	1.00	61.62	C
ATOM	21105	N	THR	D1346	48.686	54.195	15.620	1.00	56.80	N
ATOM	21106	CA	THR	D1346	48.693	54.794	16.935	1.00	48.52	C
ATOM	21107	C	THR	D1346	47.784	53.997	17.827	1.00	56.54	C
ATOM	21108	O	THR	D1346	46.586	53.913	17.560	1.00	57.63	O
ATOM	21109	CB	THR	D1346	48.234	56.246	16.893	1.00	56.55	C
ATOM	21110	OG1	THR	D1346	49.118	56.974	16.041	1.00	59.84	O
ATOM	21111	CG2	THR	D1346	48.195	56.891	18.315	1.00	47.01	C
ATOM	21112	N	LEU	D1347	48.357	53.406	18.875	1.00	53.65	N
ATOM	21113	CA	LEU	D1347	47.604	52.598	19.828	1.00	53.02	C
ATOM	21114	C	LEU	D1347	46.873	53.515	20.794	1.00	53.37	C
ATOM	21115	O	LEU	D1347	47.444	54.489	21.269	1.00	54.34	O
ATOM	21116	CB	LEU	D1347	48.539	51.629	20.581	1.00	52.43	C
ATOM	21117	CG	LEU	D1347	48.053	50.808	21.786	1.00	48.92	C
ATOM	21118	CD2	LEU	D1347	49.205	50.053	22.475	1.00	49.38	C
ATOM	21119	CD1	LEU	D1347	46.949	49.833	21.411	1.00	50.83	C
ATOM	21120	N	ILE	D1348	45.609	53.218	21.079	1.00	50.35	N
ATOM	21121	CA	ILE	D1348	44.836	54.110	21.932	1.00	52.14	C
ATOM	21122	C	ILE	D1348	44.321	53.411	23.170	1.00	49.79	C
ATOM	21123	O	ILE	D1348	43.332	52.718	23.114	1.00	50.81	O
ATOM	21124	CB	ILE	D1348	43.639	54.724	21.167	1.00	53.92	C
ATOM	21125	CG1	ILE	D1348	44.128	55.406	19.885	1.00	54.02	C
ATOM	21126	CG2	ILE	D1348	42.862	55.695	22.049	1.00	45.33	C
ATOM	21127	CD1	ILE	D1348	43.038	56.039	19.080	1.00	45.77	C
ATOM	21128	N	HIS	D1349	44.977	53.607	24.301	1.00	50.73	N
ATOM	21129	CA	HIS	D1349	44.471	53.041	25.538	1.00	48.15	C
ATOM	21130	C	HIS	D1349	43.308	53.855	26.056	1.00	47.38	C
ATOM	21131	O	HIS	D1349	43.428	55.062	26.224	1.00	52.01	O
ATOM	21132	CB	HIS	D1349	45.572	52.980	26.585	1.00	50.16	C
ATOM	21133	CG	HIS	D1349	46.656	52.008	26.257	1.00	56.48	C
ATOM	21134	ND1	HIS	D1349	46.417	50.660	26.088	1.00	54.95	N
ATOM	21135	CD2	HIS	D1349	47.986	52.184	26.073	1.00	53.69	C
ATOM	21136	CE1	HIS	D1349	47.556	50.047	25.820	1.00	55.78	C
ATOM	21137	NE2	HIS	D1349	48.521	50.949	25.806	1.00	55.54	N
ATOM	21138	N	GLN	D1350	42.188	53.195	26.318	1.00	47.31	N
ATOM	21139	CA	GLN	D1350	40.949	53.882	26.719	1.00	49.90	C
ATOM	21140	C	GLN	D1350	40.434	53.535	28.110	1.00	46.43	C
ATOM	21141	O	GLN	D1350	40.377	52.355	28.477	1.00	50.56	O
ATOM	21142	CB	GLN	D1350	39.825	53.569	25.735	1.00	47.74	C
ATOM	21143	CG	GLN	D1350	40.092	53.885	24.298	1.00	47.88	C
ATOM	21144	CD	GLN	D1350	38.824	53.744	23.480	1.00	57.52	C
ATOM	21145	OE1	GLN	D1350	38.352	52.629	23.231	1.00	62.55	O
ATOM	21146	NE2	GLN	D1350	38.238	54.876	23.090	1.00	52.39	N
ATOM	21147	N	SER	D1351	40.004	54.551	28.857	1.00	43.97	N
ATOM	21148	CA	SER	D1351	39.277	54.334	30.102	1.00	40.98	C
ATOM	21149	C	SER	D1351	37.870	53.892	29.782	1.00	36.21	C
ATOM	21150	O	SER	D1351	37.472	53.862	28.632	1.00	35.56	O
ATOM	21151	CB	SER	D1351	39.247	55.604	30.961	1.00	49.66	C
ATOM	21152	OG	SER	D1351	38.521	56.635	30.313	1.00	49.94	O
ATOM	21153	O	ILE	D1352	34.113	53.198	28.942	1.00	46.00	O
ATOM	21154	N	ILE	D1352	37.115	53.532	30.801	1.00	33.71	N
ATOM	21155	CA	ILE	D1352	35.857	52.869	30.555	1.00	35.35	C
ATOM	21156	C	ILE	D1352	34.907	53.736	29.716	1.00	47.21	C
ATOM	21157	CB	ILE	D1352	35.171	52.451	31.890	1.00	43.00	C
ATOM	21158	CG1	ILE	D1352	34.095	51.392	31.629	1.00	44.53	C
ATOM	21159	CG2	ILE	D1352	34.603	53.679	32.655	1.00	40.77	C
ATOM	21160	CD1	ILE	D1352	33.333	50.947	32.866	1.00	39.42	C
ATOM	21161	O	THR	D1353	34.133	57.278	27.124	1.00	50.51	O
ATOM	21162	N	THR	D1353	35.001	55.069	29.843	1.00	48.80	N
ATOM	21163	CA	THR	D1353	34.113	55.976	29.106	1.00	45.94	C
ATOM	21164	C	THR	D1353	34.734	56.467	27.823	1.00	48.70	C
ATOM	21165	CB	THR	D1353	33.732	57.252	29.891	1.00	43.81	C
ATOM	21166	OG1	THR	D1353	34.908	58.042	30.075	1.00	53.01	O

ATOM	21167	CG2	THR	D1353	33.100	56.946	31.229	1.00	43.68	C
ATOM	21168	O	GLY	D1354	37.805	58.509	25.612	1.00	57.73	O
ATOM	21169	N	GLY	D1354	35.945	56.025	27.524	1.00	46.74	N
ATOM	21170	CA	GLY	D1354	36.672	56.553	26.374	1.00	44.62	C
ATOM	21171	C	GLY	D1354	37.130	58.002	26.511	1.00	49.68	C
ATOM	21172	O	LEU	D1355	39.218	61.127	27.298	1.00	60.80	O
ATOM	21173	N	LEU	D1355	36.762	58.675	27.609	1.00	47.77	N
ATOM	21174	CA	LEU	D1355	37.090	60.093	27.790	1.00	51.53	C
ATOM	21175	C	LEU	D1355	38.592	60.303	27.987	1.00	63.30	C
ATOM	21176	CB	LEU	D1355	36.326	60.685	28.975	1.00	49.57	C
ATOM	21177	CG	LEU	D1355	34.803	60.757	28.809	1.00	52.50	C
ATOM	21178	CD2	LEU	D1355	34.439	61.618	27.631	1.00	49.88	C
ATOM	21179	CD1	LEU	D1355	34.097	61.191	30.076	1.00	38.15	C
ATOM	21180	O	TYR	D1356	41.115	57.456	28.449	1.00	59.80	O
ATOM	21181	N	TYR	D1356	39.175	59.560	28.928	1.00	58.75	N
ATOM	21182	CA	TYR	D1356	40.601	59.665	29.157	1.00	52.92	C
ATOM	21183	C	TYR	D1356	41.311	58.665	28.292	1.00	52.66	C
ATOM	21184	CB	TYR	D1356	40.946	59.410	30.605	1.00	52.76	C
ATOM	21185	CG	TYR	D1356	40.194	60.237	31.610	1.00	56.22	C
ATOM	21186	CD1	TYR	D1356	40.582	61.542	31.891	1.00	57.50	C
ATOM	21187	CD2	TYR	D1356	39.132	59.694	32.322	1.00	54.15	C
ATOM	21188	CE1	TYR	D1356	39.923	62.291	32.834	1.00	61.20	C
ATOM	21189	CE2	TYR	D1356	38.463	60.431	33.274	1.00	59.74	C
ATOM	21190	CZ	TYR	D1356	38.858	61.738	33.522	1.00	66.59	C
ATOM	21191	OH	TYR	D1356	38.192	62.484	34.465	1.00	66.34	O
ATOM	21192	N	GLU	D1357	42.152	59.130	27.387	1.00	52.48	N
ATOM	21193	CA	GLU	D1357	42.914	58.159	26.636	1.00	54.43	C
ATOM	21194	C	GLU	D1357	44.440	58.390	26.691	1.00	58.23	C
ATOM	21195	O	GLU	D1357	44.912	59.495	26.961	1.00	59.23	O
ATOM	21196	CB	GLU	D1357	42.385	58.094	25.192	1.00	52.92	C
ATOM	21197	CG	GLU	D1357	42.573	59.300	24.302	1.00	58.49	C
ATOM	21198	CD	GLU	D1357	41.829	59.137	22.963	1.00	64.87	C
ATOM	21199	OE1	GLU	D1357	42.397	59.496	21.905	1.00	59.31	O
ATOM	21200	OE2	GLU	D1357	40.670	58.643	22.967	1.00	64.50	O
ATOM	21201	N	THR	D1358	45.194	57.304	26.496	1.00	58.32	N
ATOM	21202	CA	THR	D1358	46.645	57.341	26.313	1.00	48.68	C
ATOM	21203	C	THR	D1358	46.955	56.896	24.903	1.00	52.73	C
ATOM	21204	O	THR	D1358	46.613	55.772	24.522	1.00	60.60	O
ATOM	21205	CB	THR	D1358	47.377	56.421	27.295	1.00	50.23	C
ATOM	21206	OG1	THR	D1358	47.107	56.828	28.635	1.00	54.59	O
ATOM	21207	CG2	THR	D1358	48.886	56.456	27.053	1.00	49.18	C
ATOM	21208	N	ARG	D1359	47.596	57.753	24.119	1.00	54.31	N
ATOM	21209	CA	ARG	D1359	47.857	57.446	22.709	1.00	54.33	C
ATOM	21210	C	ARG	D1359	49.332	57.163	22.497	1.00	62.73	C
ATOM	21211	O	ARG	D1359	50.183	57.869	23.040	1.00	64.94	O
ATOM	21212	CB	ARG	D1359	47.401	58.595	21.797	1.00	59.89	C
ATOM	21213	CG	ARG	D1359	45.891	58.892	21.862	1.00	57.69	C
ATOM	21214	CD	ARG	D1359	45.463	59.935	20.830	1.00	58.97	C
ATOM	21215	NE	ARG	D1359	44.058	59.788	20.452	1.00	56.23	N
ATOM	21216	CZ	ARG	D1359	43.629	59.640	19.203	1.00	53.40	C
ATOM	21217	NH1	ARG	D1359	44.490	59.636	18.199	1.00	50.30	N
ATOM	21218	NH2	ARG	D1359	42.336	59.503	18.958	1.00	50.94	N
ATOM	21219	N	ILE	D1360	49.634	56.124	21.715	1.00	60.73	N
ATOM	21220	CA	ILE	D1360	51.004	55.647	21.560	1.00	56.66	C
ATOM	21221	C	ILE	D1360	51.411	55.422	20.112	1.00	62.47	C
ATOM	21222	O	ILE	D1360	51.027	54.417	19.499	1.00	61.61	O
ATOM	21223	CB	ILE	D1360	51.223	54.330	22.295	1.00	58.57	C
ATOM	21224	CG1	ILE	D1360	50.657	54.398	23.713	1.00	59.05	C
ATOM	21225	CG2	ILE	D1360	52.701	53.989	22.292	1.00	58.59	C
ATOM	21226	CD1	ILE	D1360	51.403	55.319	24.610	1.00	56.92	C
ATOM	21227	N	ASP	D1361	52.212	56.334	19.571	1.00	60.48	N
ATOM	21228	CA	ASP	D1361	52.618	56.222	18.181	1.00	63.36	C
ATOM	21229	C	ASP	D1361	53.672	55.130	18.010	1.00	68.56	C

ATOM	21230	O	ASP	D1361	54.791	55.248	18.493	1.00	71.56	O
ATOM	21231	CB	ASP	D1361	53.142	57.552	17.667	1.00	67.27	C
ATOM	21232	CG	ASP	D1361	53.301	57.570	16.165	1.00	71.14	C
ATOM	21233	OD1	ASP	D1361	52.795	56.647	15.500	1.00	69.36	O
ATOM	21234	OD2	ASP	D1361	53.930	58.516	15.646	1.00	76.69	O
ATOM	21235	O	LEU	D1362	55.983	52.119	15.888	1.00	70.72	O
ATOM	21236	N	LEU	D1362	53.303	54.065	17.313	1.00	68.22	N
ATOM	21237	CA	LEU	D1362	54.160	52.897	17.222	1.00	69.25	C
ATOM	21238	C	LEU	D1362	55.137	52.987	16.056	1.00	72.60	C
ATOM	21239	CB	LEU	D1362	53.313	51.625	17.101	1.00	69.48	C
ATOM	21240	CG	LEU	D1362	52.273	51.410	18.210	1.00	69.34	C
ATOM	21241	CD1	LEU	D1362	51.650	50.013	18.137	1.00	59.51	C
ATOM	21242	CD2	LEU	D1362	52.873	51.692	19.583	1.00	60.27	C
ATOM	21243	O	SER	D1363	58.387	54.631	14.134	1.00	75.38	O
ATOM	21244	N	SER	D1363	55.035	54.033	15.248	1.00	72.97	N
ATOM	21245	CA	SER	D1363	56.016	54.224	14.185	1.00	74.58	C
ATOM	21246	C	SER	D1363	57.348	54.668	14.792	1.00	75.81	C
ATOM	21247	CB	SER	D1363	55.522	55.241	13.154	1.00	73.59	C
ATOM	21248	OG	SER	D1363	55.085	56.437	13.780	1.00	75.61	O
ATOM	21249	O	GLN	D1364	60.525	54.529	17.596	1.00	79.90	O
ATOM	21250	N	GLN	D1364	57.299	55.078	16.058	1.00	73.18	N
ATOM	21251	CA	GLN	D1364	58.480	55.521	16.804	1.00	77.88	C
ATOM	21252	C	GLN	D1364	59.331	54.368	17.338	1.00	79.70	C
ATOM	21253	CB	GLN	D1364	58.041	56.414	17.969	1.00	68.70	C
ATOM	21254	CG	GLN	D1364	57.803	57.857	17.597	1.00	78.87	C
ATOM	21255	CD	GLN	D1364	56.963	58.026	16.341	1.00	84.46	C
ATOM	21256	OE1	GLN	D1364	56.213	57.126	15.947	1.00	83.71	O
ATOM	21257	NE2	GLN	D1364	57.085	59.186	15.703	1.00	85.92	N
ATOM	21258	O	LEU	D1365	61.188	50.654	17.481	1.00	83.27	O
ATOM	21259	N	LEU	D1365	58.711	53.206	17.504	1.00	76.00	N
ATOM	21260	CA	LEU	D1365	59.375	52.088	18.147	1.00	70.76	C
ATOM	21261	C	LEU	D1365	60.184	51.276	17.134	1.00	76.91	C
ATOM	21262	CB	LEU	D1365	58.344	51.230	18.870	1.00	66.09	C
ATOM	21263	CG	LEU	D1365	57.376	52.073	19.718	1.00	75.55	C
ATOM	21264	CD1	LEU	D1365	56.340	51.217	20.422	1.00	67.07	C
ATOM	21265	CD2	LEU	D1365	58.108	52.965	20.726	1.00	72.34	C
ATOM	21266	O	GLY	D1366	62.883	50.631	15.139	1.00	93.43	O
ATOM	21267	N	GLY	D1366	59.758	51.300	15.879	1.00	77.33	N
ATOM	21268	CA	GLY	D1366	60.505	50.655	14.814	1.00	79.49	C
ATOM	21269	C	GLY	D1366	61.909	51.216	14.658	1.00	89.40	C
TER										
ATOM	21270	P	G E	1	6.565	47.540	40.092	1.00	95.23	P
ATOM	21271	OP1	G E	1	6.252	48.948	39.738	1.00	79.66	O
ATOM	21272	OP2	G E	1	5.488	46.664	40.636	1.00	83.74	O
ATOM	21273	OP3	G E	1	7.127	46.891	38.878	1.00	93.40	O
ATOM	21274	O5'	G E	1	7.703	47.551	41.207	1.00	75.87	O
ATOM	21275	C5'	G E	1	8.781	48.466	41.144	1.00	65.48	C
ATOM	21276	C4'	G E	1	9.330	48.754	42.519	1.00	72.78	C
ATOM	21277	O4'	G E	1	8.539	49.798	43.157	1.00	72.57	O
ATOM	21278	C3'	G E	1	9.309	47.606	43.528	1.00	68.57	C
ATOM	21279	O3'	G E	1	10.364	46.664	43.368	1.00	77.57	O
ATOM	21280	C2'	G E	1	9.361	48.353	44.850	1.00	66.29	C
ATOM	21281	O2'	G E	1	10.663	48.853	45.103	1.00	64.03	O
ATOM	21282	C1'	G E	1	8.439	49.536	44.544	1.00	74.43	C
ATOM	21283	N9	G E	1	7.047	49.161	44.852	1.00	73.36	N
ATOM	21284	C8	G E	1	6.017	48.877	43.982	1.00	69.51	C
ATOM	21285	N7	G E	1	4.930	48.520	44.608	1.00	72.56	N
ATOM	21286	C5	G E	1	5.267	48.556	45.962	1.00	68.71	C
ATOM	21287	C4	G E	1	6.575	48.940	46.126	1.00	66.81	C
ATOM	21288	N1	G E	1	5.259	48.439	48.291	1.00	62.46	N
ATOM	21289	C2	G E	1	6.575	48.823	48.347	1.00	64.05	C
ATOM	21290	N3	G E	1	7.287	49.094	47.267	1.00	66.14	N
ATOM	21291	C6	G E	1	4.509	48.279	47.129	1.00	65.32	C

ATOM	21292	O6	G E	1	3.333	47.921	47.217	1.00	65.23	O
ATOM	21293	N2	G E	1	7.134	48.915	49.570	1.00	58.94	N
ATOM	21294	O5'	G E	2	10.014	45.088	45.365	1.00	69.47	O
ATOM	21295	C4'	G E	2	10.593	45.454	47.680	1.00	65.88	C
ATOM	21296	C3'	G E	2	10.004	44.152	48.210	1.00	64.56	C
ATOM	21297	C2'	G E	2	9.193	44.641	49.400	1.00	64.14	C
ATOM	21298	P	G E	2	10.186	45.107	43.778	1.00	72.23	P
ATOM	21299	OP1	G E	2	11.476	44.434	43.459	1.00	85.77	O
ATOM	21300	OP2	G E	2	8.928	44.570	43.213	1.00	62.78	O
ATOM	21301	C5'	G E	2	11.066	45.458	46.246	1.00	58.21	C
ATOM	21302	O4'	G E	2	9.512	46.418	47.867	1.00	71.37	O
ATOM	21303	O3'	G E	2	10.994	43.206	48.569	1.00	66.96	O
ATOM	21304	O2'	G E	2	10.061	44.980	50.472	1.00	70.22	O
ATOM	21305	C1'	G E	2	8.608	45.934	48.842	1.00	61.39	C
ATOM	21306	N9	G E	2	7.298	45.681	48.207	1.00	66.02	N
ATOM	21307	C8	G E	2	6.964	45.704	46.867	1.00	65.79	C
ATOM	21308	N7	G E	2	5.710	45.417	46.639	1.00	63.16	N
ATOM	21309	C5	G E	2	5.178	45.179	47.904	1.00	63.68	C
ATOM	21310	C4	G E	2	6.146	45.338	48.882	1.00	64.29	C
ATOM	21311	N1	G E	2	3.777	44.687	49.699	1.00	61.01	N
ATOM	21312	C2	G E	2	4.809	44.873	50.588	1.00	60.27	C
ATOM	21313	N3	G E	2	6.035	45.206	50.227	1.00	61.90	N
ATOM	21314	C6	G E	2	3.855	44.829	48.306	1.00	65.74	C
ATOM	21315	O6	G E	2	2.850	44.643	47.586	1.00	59.83	O
ATOM	21316	N2	G E	2	4.537	44.698	51.890	1.00	62.01	N
ATOM	21317	O5'	A E	3	9.769	41.648	50.143	1.00	65.70	O
ATOM	21318	C4'	A E	3	9.436	41.448	52.515	1.00	59.04	C
ATOM	21319	C3'	A E	3	8.876	40.040	52.440	1.00	57.59	C
ATOM	21320	C2'	A E	3	7.567	40.161	53.202	1.00	61.10	C
ATOM	21321	P	A E	3	10.633	41.663	48.814	1.00	63.16	P
ATOM	21322	OP1	A E	3	11.939	41.060	49.187	1.00	71.16	O
ATOM	21323	OP2	A E	3	9.778	41.118	47.740	1.00	53.61	O
ATOM	21324	C5'	A E	3	10.387	41.817	51.410	1.00	62.83	C
ATOM	21325	O4'	A E	3	8.256	42.303	52.449	1.00	64.37	O
ATOM	21326	O3'	A E	3	9.753	39.070	52.986	1.00	62.69	O
ATOM	21327	O2'	A E	3	7.814	40.152	54.606	1.00	60.71	O
ATOM	21328	C1'	A E	3	7.109	41.563	52.795	1.00	59.30	C
ATOM	21329	N9	A E	3	6.175	41.563	51.646	1.00	62.07	N
ATOM	21330	C8	A E	3	6.395	41.900	50.332	1.00	55.43	C
ATOM	21331	N7	A E	3	5.318	41.808	49.578	1.00	56.87	N
ATOM	21332	C5	A E	3	4.312	41.399	50.459	1.00	62.54	C
ATOM	21333	C4	A E	3	4.837	41.252	51.731	1.00	58.49	C
ATOM	21334	N1	A E	3	2.257	40.728	51.421	1.00	61.17	N
ATOM	21335	C2	A E	3	2.914	40.624	52.576	1.00	59.27	C
ATOM	21336	N3	A E	3	4.187	40.866	52.837	1.00	56.35	N
ATOM	21337	C6	A E	3	2.924	41.120	50.318	1.00	64.02	C
ATOM	21338	N6	A E	3	2.211	41.198	49.187	1.00	58.83	N
ATOM	21339	O5'	A E	4	8.438	36.905	53.151	1.00	57.84	O
ATOM	21340	C4'	A E	4	7.070	36.148	54.994	1.00	60.90	C
ATOM	21341	C3'	A E	4	6.480	34.963	54.238	1.00	61.42	C
ATOM	21342	C2'	A E	4	4.987	35.133	54.497	1.00	59.57	C
ATOM	21343	P	A E	4	9.717	37.550	52.459	1.00	59.04	P
ATOM	21344	OP1	A E	4	10.912	36.919	53.059	1.00	59.47	O
ATOM	21345	OP2	A E	4	9.436	37.524	50.997	1.00	52.22	O
ATOM	21346	C5'	A E	4	8.430	36.617	54.541	1.00	63.07	C
ATOM	21347	O4'	A E	4	6.095	37.208	54.787	1.00	52.03	O
ATOM	21348	O3'	A E	4	6.999	33.697	54.642	1.00	56.29	O
ATOM	21349	O2'	A E	4	4.651	34.706	55.804	1.00	61.21	O
ATOM	21350	C1'	A E	4	4.844	36.648	54.448	1.00	53.37	C
ATOM	21351	N9	A E	4	4.441	37.095	53.103	1.00	55.97	N
ATOM	21352	C8	A E	4	5.222	37.586	52.100	1.00	56.04	C
ATOM	21353	N7	A E	4	4.557	37.891	51.019	1.00	58.86	N
ATOM	21354	C5	A E	4	3.242	37.576	51.327	1.00	60.96	C

ATOM	21355	C4	A E	4	3.154	37.082	52.615	1.00	61.17	C
ATOM	21356	N1	A E	4	0.899	37.294	51.192	1.00	65.84	N
ATOM	21357	C2	A E	4	0.969	36.827	52.452	1.00	66.32	C
ATOM	21358	N3	A E	4	2.031	36.689	53.253	1.00	55.75	N
ATOM	21359	C6	A E	4	2.047	37.679	50.589	1.00	62.27	C
ATOM	21360	N6	A E	4	1.992	38.138	49.336	1.00	64.58	N
ATOM	21361	O5'	A E	5	5.354	32.120	53.516	1.00	62.30	O
ATOM	21362	C4'	A E	5	3.090	31.755	54.217	1.00	62.87	C
ATOM	21363	C3'	A E	5	2.827	30.868	53.020	1.00	61.44	C
ATOM	21364	C2'	A E	5	1.497	31.397	52.508	1.00	63.89	C
ATOM	21365	P	A E	5	6.906	32.413	53.665	1.00	63.51	P
ATOM	21366	OP1	A E	5	7.535	31.253	54.353	1.00	59.76	O
ATOM	21367	OP2	A E	5	7.361	32.788	52.307	1.00	56.76	O
ATOM	21368	C5'	A E	5	4.533	31.831	54.635	1.00	61.74	C
ATOM	21369	O4'	A E	5	2.616	33.057	53.783	1.00	58.03	O
ATOM	21370	O3'	A E	5	2.805	29.499	53.360	1.00	66.75	O
ATOM	21371	O2'	A E	5	0.440	30.921	53.321	1.00	66.00	O
ATOM	21372	C1'	A E	5	1.661	32.894	52.751	1.00	61.74	C
ATOM	21373	N9	A E	5	2.123	33.594	51.539	1.00	63.17	N
ATOM	21374	C8	A E	5	3.370	34.074	51.244	1.00	62.66	C
ATOM	21375	N7	A E	5	3.445	34.653	50.068	1.00	63.95	N
ATOM	21376	C5	A E	5	2.164	34.555	49.556	1.00	62.57	C
ATOM	21377	C4	A E	5	1.344	33.904	50.455	1.00	63.48	C
ATOM	21378	N1	A E	5	0.270	34.714	48.158	1.00	66.27	N
ATOM	21379	C2	A E	5	-0.395	34.070	49.119	1.00	63.78	C
ATOM	21380	N3	A E	5	0.043	33.628	50.293	1.00	62.99	N
ATOM	21381	C6	A E	5	1.581	34.980	48.346	1.00	67.39	C
ATOM	21382	N6	A E	5	2.239	35.625	47.375	1.00	67.66	N
ATOM	21383	O5'	U E	6	2.201	28.236	51.278	1.00	59.43	O
ATOM	21384	C4'	U E	6	-0.098	28.176	50.552	1.00	66.25	C
ATOM	21385	C3'	U E	6	0.304	27.500	49.258	1.00	69.39	C
ATOM	21386	C2'	U E	6	-0.479	28.281	48.216	1.00	70.79	C
ATOM	21387	P	U E	6	3.373	28.407	52.335	1.00	59.85	P
ATOM	21388	OP1	U E	6	3.599	27.175	53.135	1.00	57.76	O
ATOM	21389	OP2	U E	6	4.489	29.033	51.593	1.00	68.72	O
ATOM	21390	C5'	U E	6	0.867	28.004	51.698	1.00	65.74	C
ATOM	21391	O4'	U E	6	-0.204	29.577	50.193	1.00	69.01	O
ATOM	21392	O3'	U E	6	0.039	26.109	49.263	1.00	79.41	O
ATOM	21393	O2'	U E	6	-1.827	27.846	48.185	1.00	74.86	O
ATOM	21394	C1'	U E	6	-0.436	29.697	48.805	1.00	67.99	C
ATOM	21395	N1	U E	6	0.633	30.530	48.204	1.00	67.27	N
ATOM	21396	C2	U E	6	0.326	31.148	47.022	1.00	65.76	C
ATOM	21397	N3	U E	6	1.326	31.906	46.471	1.00	64.69	N
ATOM	21398	C4	U E	6	2.587	32.113	46.979	1.00	63.10	C
ATOM	21399	C5	U E	6	2.843	31.436	48.211	1.00	61.78	C
ATOM	21400	C6	U E	6	1.884	30.684	48.767	1.00	67.94	C
ATOM	21401	O2	U E	6	-0.761	31.023	46.507	1.00	70.09	O
ATOM	21402	O4	U E	6	3.370	32.838	46.360	1.00	64.21	O
ATOM	21403	O5'	U E	7	-0.115	24.785	47.162	1.00	78.58	O
ATOM	21404	C4'	U E	7	-0.441	25.485	44.883	1.00	79.10	C
ATOM	21405	C3'	U E	7	0.102	25.477	43.475	1.00	81.36	C
ATOM	21406	C2'	U E	7	-0.402	26.789	42.895	1.00	82.73	C
ATOM	21407	P	U E	7	0.897	25.118	48.330	1.00	78.92	P
ATOM	21408	OP1	U E	7	1.171	23.858	49.062	1.00	71.09	O
ATOM	21409	OP2	U E	7	2.003	25.896	47.718	1.00	76.15	O
ATOM	21410	C5'	U E	7	0.359	24.653	45.843	1.00	82.44	C
ATOM	21411	O4'	U E	7	-0.416	26.881	45.271	1.00	82.64	O
ATOM	21412	O3'	U E	7	-0.315	24.326	42.779	1.00	86.89	O
ATOM	21413	O2'	U E	7	-1.746	26.672	42.455	1.00	89.24	O
ATOM	21414	C1'	U E	7	-0.357	27.703	44.123	1.00	79.04	C
ATOM	21415	N1	U E	7	0.894	28.490	44.196	1.00	74.52	N
ATOM	21416	C2	U E	7	1.195	29.399	43.197	1.00	72.02	C
ATOM	21417	N3	U E	7	2.381	30.061	43.378	1.00	67.88	N

ATOM	21418	C4	U E	7	3.266	29.925	44.428	1.00	67.51	C
ATOM	21419	C5	U E	7	2.885	28.976	45.424	1.00	67.55	C
ATOM	21420	C6	U E	7	1.737	28.313	45.272	1.00	72.02	C
ATOM	21421	O2	U E	7	0.494	29.609	42.222	1.00	73.56	O
ATOM	21422	O4	U E	7	4.284	30.612	44.439	1.00	66.68	O
ATOM	21423	P	G E	8	0.755	23.174	42.484	1.00	93.49	P
ATOM	21424	OP1	G E	8	0.019	21.892	42.330	1.00	97.31	O
ATOM	21425	OP2	G E	8	1.838	23.266	43.505	1.00	89.80	O
ATOM	21426	O5'	G E	8	1.310	23.624	41.063	1.00	91.05	O
ATOM	21427	C5'	G E	8	0.392	24.100	40.088	1.00	90.17	C
ATOM	21428	C4'	G E	8	0.938	25.252	39.282	1.00	89.46	C
ATOM	21429	O4'	G E	8	1.043	26.461	40.086	1.00	85.77	O
ATOM	21430	C3'	G E	8	2.331	25.082	38.715	1.00	84.90	C
ATOM	21431	O3'	G E	8	2.368	24.222	37.597	1.00	90.92	O
ATOM	21432	C2'	G E	8	2.719	26.517	38.403	1.00	85.39	C
ATOM	21433	O2'	G E	8	2.058	26.962	37.228	1.00	89.75	O
ATOM	21434	C1'	G E	8	2.117	27.252	39.607	1.00	83.83	C
ATOM	21435	N9	G E	8	3.111	27.432	40.691	1.00	73.99	N
ATOM	21436	C8	G E	8	3.213	26.707	41.855	1.00	78.47	C
ATOM	21437	N7	G E	8	4.207	27.082	42.617	1.00	75.23	N
ATOM	21438	C5	G E	8	4.802	28.117	41.907	1.00	68.17	C
ATOM	21439	C4	G E	8	4.145	28.340	40.721	1.00	66.93	C
ATOM	21440	N1	G E	8	6.200	29.854	41.246	1.00	65.41	N
ATOM	21441	C2	G E	8	5.482	29.992	40.094	1.00	66.46	C
ATOM	21442	N3	G E	8	4.427	29.255	39.776	1.00	68.32	N
ATOM	21443	C6	G E	8	5.924	28.920	42.233	1.00	68.36	C
ATOM	21444	O6	G E	8	6.635	28.875	43.246	1.00	74.28	O
ATOM	21445	N2	G E	8	5.912	30.950	39.265	1.00	62.57	N
ATOM	21446	O5'	G E	9	4.439	23.269	36.531	1.00	86.74	O
ATOM	21447	C4'	G E	9	5.808	25.232	36.136	1.00	83.47	C
ATOM	21448	C3'	G E	9	7.241	25.506	35.706	1.00	78.39	C
ATOM	21449	C2'	G E	9	7.311	27.024	35.662	1.00	77.27	C
ATOM	21450	P	G E	9	3.323	22.923	37.612	1.00	97.72	P
ATOM	21451	OP1	G E	9	2.538	21.770	37.095	1.00	94.26	O
ATOM	21452	OP2	G E	9	3.966	22.806	38.949	1.00	86.40	O
ATOM	21453	C5'	G E	9	5.624	23.948	36.904	1.00	84.88	C
ATOM	21454	O4'	G E	9	5.458	26.359	36.986	1.00	84.01	O
ATOM	21455	O3'	G E	9	7.553	24.894	34.474	1.00	89.81	O
ATOM	21456	O2'	G E	9	6.753	27.515	34.453	1.00	81.62	O
ATOM	21457	C1'	G E	9	6.392	27.404	36.823	1.00	77.34	C
ATOM	21458	N9	G E	9	7.126	27.555	38.098	1.00	68.62	N
ATOM	21459	C8	G E	9	7.036	26.728	39.195	1.00	69.29	C
ATOM	21460	N7	G E	9	7.796	27.091	40.190	1.00	66.82	N
ATOM	21461	C5	G E	9	8.427	28.233	39.717	1.00	63.62	C
ATOM	21462	C4	G E	9	8.032	28.536	38.433	1.00	66.94	C
ATOM	21463	N1	G E	9	9.754	30.133	39.546	1.00	57.76	N
ATOM	21464	C2	G E	9	9.308	30.353	38.259	1.00	64.91	C
ATOM	21465	N3	G E	9	8.426	29.571	37.651	1.00	68.25	N
ATOM	21466	C6	G E	9	9.357	29.074	40.359	1.00	59.67	C
ATOM	21467	O6	G E	9	9.808	28.939	41.500	1.00	62.84	O
ATOM	21468	N2	G E	9	9.799	31.419	37.604	1.00	61.31	N
ATOM	21469	O5'	G E	10	9.984	25.229	35.004	1.00	77.12	O
ATOM	21470	C4'	G E	10	11.406	27.016	34.168	1.00	79.93	C
ATOM	21471	C3'	G E	10	12.822	27.534	34.369	1.00	72.95	C
ATOM	21472	C2'	G E	10	12.600	28.996	34.740	1.00	74.09	C
ATOM	21473	P	G E	10	8.999	24.238	34.247	1.00	87.44	P
ATOM	21474	OP1	G E	10	9.295	24.358	32.793	1.00	100.20	O
ATOM	21475	OP2	G E	10	9.037	22.911	34.911	1.00	80.35	O
ATOM	21476	C5'	G E	10	11.249	25.542	34.454	1.00	77.39	C
ATOM	21477	O4'	G E	10	10.587	27.815	35.080	1.00	82.07	O
ATOM	21478	O3'	G E	10	13.630	27.330	33.225	1.00	78.76	O
ATOM	21479	O2'	G E	10	12.270	29.753	33.582	1.00	74.99	O
ATOM	21480	C1'	G E	10	11.350	28.876	35.615	1.00	72.31	C

ATOM	21481	N9	G E	10	11.680	28.471	37.004	1.00	67.65	N
ATOM	21482	C8	G E	10	11.145	27.350	37.608	1.00	65.47	C
ATOM	21483	N7	G E	10	11.568	27.149	38.824	1.00	62.38	N
ATOM	21484	C5	G E	10	12.447	28.195	39.047	1.00	56.68	C
ATOM	21485	C4	G E	10	12.535	29.023	37.944	1.00	59.65	C
ATOM	21486	N1	G E	10	13.973	29.627	40.030	1.00	50.54	N
ATOM	21487	C2	G E	10	14.003	30.383	38.898	1.00	54.45	C
ATOM	21488	N3	G E	10	13.291	30.129	37.805	1.00	60.32	N
ATOM	21489	C6	G E	10	13.207	28.484	40.203	1.00	56.31	C
ATOM	21490	O6	G E	10	13.248	27.855	41.271	1.00	54.73	O
ATOM	21491	N2	G E	10	14.824	31.445	38.942	1.00	53.36	N
ATOM	21492	O5'	U E	11	15.989	27.150	34.012	1.00	65.80	O
ATOM	21493	C4'	U E	11	16.992	29.258	34.605	1.00	60.35	C
ATOM	21494	C3'	U E	11	18.274	28.694	35.170	1.00	56.82	C
ATOM	21495	C2'	U E	11	18.397	29.461	36.467	1.00	56.76	C
ATOM	21496	P	U E	11	14.869	26.306	33.278	1.00	73.66	P
ATOM	21497	OP1	U E	11	15.275	26.143	31.864	1.00	75.39	O
ATOM	21498	OP2	U E	11	14.601	25.126	34.151	1.00	67.37	O
ATOM	21499	C5'	U E	11	16.316	28.442	33.540	1.00	66.74	C
ATOM	21500	O4'	U E	11	16.141	29.357	35.770	1.00	56.79	O
ATOM	21501	O3'	U E	11	19.390	28.852	34.328	1.00	58.90	O
ATOM	21502	O2'	U E	11	18.793	30.794	36.181	1.00	52.71	O
ATOM	21503	C1'	U E	11	16.942	29.486	36.922	1.00	50.50	C
ATOM	21504	N1	U E	11	16.592	28.403	37.876	1.00	52.41	N
ATOM	21505	C2	U E	11	17.081	28.505	39.173	1.00	49.69	C
ATOM	21506	N3	U E	11	16.694	27.510	40.033	1.00	47.05	N
ATOM	21507	C4	U E	11	15.873	26.436	39.743	1.00	55.42	C
ATOM	21508	C5	U E	11	15.391	26.411	38.390	1.00	52.28	C
ATOM	21509	C6	U E	11	15.755	27.368	37.524	1.00	54.05	C
ATOM	21510	O2	U E	11	17.818	29.411	39.538	1.00	53.18	O
ATOM	21511	O4	U E	11	15.619	25.616	40.635	1.00	55.15	O
ATOM	21512	O5'	G E	12	21.437	28.284	35.701	1.00	48.01	O
ATOM	21513	C4'	G E	12	22.214	30.020	37.219	1.00	50.52	C
ATOM	21514	C3'	G E	12	23.333	29.200	37.829	1.00	46.18	C
ATOM	21515	C2'	G E	12	23.079	29.342	39.324	1.00	46.37	C
ATOM	21516	P	G E	12	20.588	27.789	34.441	1.00	58.38	P
ATOM	21517	OP1	G E	12	21.384	27.956	33.202	1.00	57.21	O
ATOM	21518	OP2	G E	12	19.992	26.472	34.780	1.00	51.92	O
ATOM	21519	C5'	G E	12	21.850	29.639	35.804	1.00	52.03	C
ATOM	21520	O4'	G E	12	21.091	29.822	38.122	1.00	49.28	O
ATOM	21521	O3'	G E	12	24.598	29.690	37.427	1.00	49.16	O
ATOM	21522	O2'	G E	12	23.549	30.595	39.789	1.00	51.75	O
ATOM	21523	C1'	G E	12	21.557	29.384	39.380	1.00	48.94	C
ATOM	21524	N9	G E	12	20.930	28.080	39.714	1.00	42.18	N
ATOM	21525	C8	G E	12	20.245	27.247	38.880	1.00	44.97	C
ATOM	21526	N7	G E	12	19.750	26.202	39.476	1.00	42.87	N
ATOM	21527	C5	G E	12	20.122	26.362	40.794	1.00	39.40	C
ATOM	21528	C4	G E	12	20.841	27.512	40.961	1.00	39.99	C
ATOM	21529	N1	G E	12	20.416	26.091	43.063	1.00	39.70	N
ATOM	21530	C2	G E	12	21.129	27.248	43.136	1.00	39.58	C
ATOM	21531	N3	G E	12	21.372	28.018	42.099	1.00	41.79	N
ATOM	21532	C6	G E	12	19.868	25.546	41.914	1.00	40.17	C
ATOM	21533	O6	G E	12	19.253	24.466	41.963	1.00	47.37	O
ATOM	21534	N2	G E	12	21.569	27.604	44.345	1.00	38.16	N
ATOM	21535	O5'	C E	13	26.222	28.504	38.957	1.00	41.23	O
ATOM	21536	C4'	C E	13	26.870	29.052	41.187	1.00	39.52	C
ATOM	21537	C3'	C E	13	27.580	27.739	41.458	1.00	38.00	C
ATOM	21538	C2'	C E	13	27.026	27.351	42.817	1.00	38.23	C
ATOM	21539	P	C E	13	25.894	28.747	37.426	1.00	48.63	P
ATOM	21540	OP1	C E	13	26.964	29.559	36.808	1.00	45.15	O
ATOM	21541	OP2	C E	13	25.485	27.377	36.961	1.00	44.35	O
ATOM	21542	C5'	C E	13	26.845	29.488	39.749	1.00	38.26	C
ATOM	21543	O4'	C E	13	25.524	28.791	41.659	1.00	41.30	O

ATOM	21544	O3'	C E	13	28.980	27.844	41.393	1.00	42.96	O
ATOM	21545	O2'	C E	13	27.644	28.121	43.839	1.00	41.78	O
ATOM	21546	C1'	C E	13	25.565	27.795	42.668	1.00	42.17	C
ATOM	21547	N1	C E	13	24.709	26.664	42.260	1.00	40.78	N
ATOM	21548	C2	C E	13	24.305	25.797	43.251	1.00	39.86	C
ATOM	21549	N3	C E	13	23.539	24.736	42.936	1.00	43.15	N
ATOM	21550	C4	C E	13	23.184	24.515	41.670	1.00	43.15	C
ATOM	21551	C5	C E	13	23.585	25.391	40.643	1.00	40.09	C
ATOM	21552	C6	C E	13	24.349	26.447	40.970	1.00	43.00	C
ATOM	21553	O2	C E	13	24.669	26.035	44.403	1.00	46.51	O
ATOM	21554	N4	C E	13	22.425	23.441	41.392	1.00	41.84	N
ATOM	21555	O5'	G E	14	29.690	25.579	42.119	1.00	39.26	O
ATOM	21556	C4'	G E	14	29.707	24.900	44.396	1.00	34.75	C
ATOM	21557	C3'	G E	14	30.046	23.453	44.053	1.00	35.08	C
ATOM	21558	C2'	G E	14	29.103	22.701	44.976	1.00	38.00	C
ATOM	21559	P	G E	14	29.840	26.577	40.905	1.00	40.70	P
ATOM	21560	OP1	G E	14	31.245	27.026	40.815	1.00	42.74	O
ATOM	21561	OP2	G E	14	29.175	25.932	39.737	1.00	36.94	O
ATOM	21562	C5'	G E	14	30.142	25.930	43.402	1.00	32.14	C
ATOM	21563	O4'	G E	14	28.259	24.888	44.532	1.00	36.07	O
ATOM	21564	O3'	G E	14	31.424	23.127	44.199	1.00	41.24	O
ATOM	21565	O2'	G E	14	29.586	22.733	46.310	1.00	35.49	O
ATOM	21566	C1'	G E	14	27.840	23.583	44.884	1.00	43.72	C
ATOM	21567	N9	G E	14	26.927	23.057	43.849	1.00	40.81	N
ATOM	21568	C8	G E	14	26.794	23.450	42.542	1.00	39.28	C
ATOM	21569	N7	G E	14	25.929	22.722	41.885	1.00	39.13	N
ATOM	21570	C5	G E	14	25.485	21.785	42.814	1.00	37.26	C
ATOM	21571	C4	G E	14	26.093	21.964	44.030	1.00	38.92	C
ATOM	21572	N1	G E	14	24.398	20.039	43.888	1.00	40.51	N
ATOM	21573	C2	G E	14	25.060	20.297	45.059	1.00	39.62	C
ATOM	21574	N3	G E	14	25.945	21.260	45.185	1.00	37.39	N
ATOM	21575	C6	G E	14	24.553	20.731	42.693	1.00	41.47	C
ATOM	21576	O6	G E	14	23.898	20.384	41.708	1.00	39.51	O
ATOM	21577	N2	G E	14	24.757	19.493	46.099	1.00	39.39	N
ATOM	21578	O5'	C E	15	31.465	20.610	44.249	1.00	30.78	O
ATOM	21579	C4'	C E	15	30.994	19.286	46.183	1.00	42.18	C
ATOM	21580	C3'	C E	15	31.208	17.937	45.483	1.00	33.15	C
ATOM	21581	C2'	C E	15	29.970	17.179	45.912	1.00	37.81	C
ATOM	21582	P	C E	15	32.059	21.823	43.451	1.00	37.51	P
ATOM	21583	OP1	C E	15	33.508	21.855	43.654	1.00	36.06	O
ATOM	21584	OP2	C E	15	31.488	21.745	42.088	1.00	39.53	O
ATOM	21585	C5'	C E	15	31.761	20.454	45.621	1.00	39.97	C
ATOM	21586	O4'	C E	15	29.567	19.527	46.043	1.00	35.28	O
ATOM	21587	O3'	C E	15	32.430	17.332	45.851	1.00	44.46	O
ATOM	21588	O2'	C E	15	30.119	16.793	47.271	1.00	36.53	O
ATOM	21589	C1'	C E	15	28.902	18.294	45.829	1.00	40.32	C
ATOM	21590	N1	C E	15	28.256	18.338	44.489	1.00	38.61	N
ATOM	21591	C2	C E	15	27.158	17.512	44.194	1.00	41.77	C
ATOM	21592	N3	C E	15	26.577	17.535	42.963	1.00	39.17	N
ATOM	21593	C4	C E	15	27.057	18.370	42.042	1.00	40.35	C
ATOM	21594	C5	C E	15	28.156	19.236	42.302	1.00	37.08	C
ATOM	21595	C6	C E	15	28.725	19.181	43.522	1.00	38.37	C
ATOM	21596	O2	C E	15	26.737	16.754	45.080	1.00	47.27	O
ATOM	21597	N4	C E	15	26.479	18.379	40.839	1.00	37.84	N
ATOM	21598	O5'	U E	16	32.012	14.951	45.111	1.00	41.41	O
ATOM	21599	C4'	U E	16	30.788	13.120	46.025	1.00	43.66	C
ATOM	21600	C3'	U E	16	31.087	12.200	44.838	1.00	42.40	C
ATOM	21601	C2'	U E	16	29.711	11.662	44.496	1.00	43.91	C
ATOM	21602	P	U E	16	33.106	16.102	45.030	1.00	39.27	P
ATOM	21603	OP1	U E	16	34.307	15.856	45.825	1.00	40.83	O
ATOM	21604	OP2	U E	16	33.318	16.345	43.578	1.00	38.96	O
ATOM	21605	C5'	U E	16	31.779	14.222	46.296	1.00	37.80	C
ATOM	21606	O4'	U E	16	29.515	13.716	45.683	1.00	43.82	O

ATOM	21607	O3'	U E	16	32.016	11.186	45.131	1.00	49.59	O
ATOM	21608	O2'	U E	16	29.329	10.645	45.406	1.00	43.03	O
ATOM	21609	C1'	U E	16	28.838	12.898	44.755	1.00	44.57	C
ATOM	21610	N1	U E	16	28.648	13.668	43.517	1.00	39.74	N
ATOM	21611	C2	U E	16	27.596	13.224	42.780	1.00	37.91	C
ATOM	21612	N3	U E	16	27.387	13.917	41.617	1.00	40.25	N
ATOM	21613	C4	U E	16	28.143	14.967	41.130	1.00	37.46	C
ATOM	21614	C5	U E	16	29.257	15.355	41.951	1.00	35.66	C
ATOM	21615	C6	U E	16	29.471	14.700	43.114	1.00	37.44	C
ATOM	21616	O2	U E	16	26.895	12.318	43.179	1.00	38.39	O
ATOM	21617	O4	U E	16	27.815	15.454	40.046	1.00	40.65	O
ATOM	21618	O5'	U E	17	31.955	9.892	42.934	1.00	40.01	O
ATOM	21619	C4'	U E	17	30.231	8.349	42.254	1.00	50.17	C
ATOM	21620	C3'	U E	17	30.648	8.044	40.828	1.00	43.60	C
ATOM	21621	C2'	U E	17	29.284	7.946	40.184	1.00	47.72	C
ATOM	21622	P	U E	17	32.950	10.564	43.974	1.00	50.35	P
ATOM	21623	OP1	U E	17	33.730	9.530	44.692	1.00	51.52	O
ATOM	21624	OP2	U E	17	33.602	11.630	43.179	1.00	46.96	O
ATOM	21625	C5'	U E	17	31.271	8.720	43.278	1.00	44.59	C
ATOM	21626	O4'	U E	17	29.234	9.400	42.063	1.00	49.58	O
ATOM	21627	O3'	U E	17	31.428	6.868	40.675	1.00	53.45	O
ATOM	21628	O2'	U E	17	28.630	6.772	40.637	1.00	45.65	O
ATOM	21629	C1'	U E	17	28.571	9.150	40.835	1.00	45.05	C
ATOM	21630	N1	U E	17	28.659	10.326	39.965	1.00	41.69	N
ATOM	21631	C2	U E	17	27.964	10.226	38.783	1.00	45.05	C
ATOM	21632	N3	U E	17	28.084	11.312	37.954	1.00	42.37	N
ATOM	21633	C4	U E	17	28.825	12.452	38.214	1.00	42.35	C
ATOM	21634	C5	U E	17	29.528	12.450	39.451	1.00	39.67	C
ATOM	21635	C6	U E	17	29.431	11.406	40.266	1.00	41.55	C
ATOM	21636	O2	U E	17	27.268	9.260	38.511	1.00	45.84	O
ATOM	21637	O4	U E	17	28.851	13.360	37.385	1.00	43.50	O
ATOM	21638	O5'	G E	18	31.361	5.973	38.279	1.00	41.46	O
ATOM	21639	C4'	G E	18	29.487	4.638	37.617	1.00	42.24	C
ATOM	21640	C3'	G E	18	29.845	4.493	36.152	1.00	42.98	C
ATOM	21641	C2'	G E	18	28.554	4.938	35.469	1.00	41.78	C
ATOM	21642	P	G E	18	32.349	6.584	39.357	1.00	50.12	P
ATOM	21643	OP1	G E	18	33.232	5.501	39.824	1.00	44.84	O
ATOM	21644	OP2	G E	18	32.920	7.779	38.720	1.00	44.06	O
ATOM	21645	C5'	G E	18	30.641	4.797	38.561	1.00	44.08	C
ATOM	21646	O4'	G E	18	28.663	5.837	37.656	1.00	46.80	O
ATOM	21647	O3'	G E	18	30.265	3.172	35.809	1.00	46.35	O
ATOM	21648	O2'	G E	18	27.546	3.952	35.564	1.00	45.79	O
ATOM	21649	C1'	G E	18	28.131	6.095	36.374	1.00	45.09	C
ATOM	21650	N9	G E	18	28.705	7.353	35.877	1.00	40.09	N
ATOM	21651	C8	G E	18	29.681	8.108	36.469	1.00	38.16	C
ATOM	21652	N7	G E	18	30.016	9.116	35.732	1.00	40.43	N
ATOM	21653	C5	G E	18	29.222	8.988	34.586	1.00	41.21	C
ATOM	21654	C4	G E	18	28.416	7.894	34.662	1.00	34.08	C
ATOM	21655	N1	G E	18	28.216	9.322	32.520	1.00	37.27	N
ATOM	21656	C2	G E	18	27.481	8.193	32.696	1.00	36.96	C
ATOM	21657	N3	G E	18	27.517	7.430	33.773	1.00	34.92	N
ATOM	21658	C6	G E	18	29.119	9.815	33.433	1.00	40.61	C
ATOM	21659	O6	G E	18	29.738	10.847	33.168	1.00	42.18	O
ATOM	21660	N2	G E	18	26.665	7.936	31.690	1.00	36.99	N
ATOM	21661	O5'	G E	19	30.923	3.074	33.362	1.00	38.95	O
ATOM	21662	C4'	G E	19	29.158	2.984	31.745	1.00	39.47	C
ATOM	21663	C3'	G E	19	30.058	3.115	30.544	1.00	38.92	C
ATOM	21664	C2'	G E	19	29.348	4.203	29.736	1.00	39.21	C
ATOM	21665	P	G E	19	31.520	2.894	34.820	1.00	42.79	P
ATOM	21666	OP1	G E	19	31.795	1.445	35.033	1.00	48.56	O
ATOM	21667	OP2	G E	19	32.632	3.854	34.869	1.00	36.41	O
ATOM	21668	C5'	G E	19	29.773	2.356	32.957	1.00	36.72	C
ATOM	21669	O4'	G E	19	28.774	4.367	32.039	1.00	43.01	O

ATOM	21670	O3'	G E	19	30.274	1.881	29.853	1.00	38.16	O
ATOM	21671	O2'	G E	19	28.236	3.670	29.038	1.00	35.67	O
ATOM	21672	C1'	G E	19	28.829	5.127	30.857	1.00	40.90	C
ATOM	21673	N1	G E	19	30.442	9.631	29.098	1.00	36.09	N
ATOM	21674	N9	G E	19	29.717	6.280	31.079	1.00	37.40	N
ATOM	21675	C8	G E	19	30.614	6.452	32.094	1.00	40.40	C
ATOM	21676	N7	G E	19	31.297	7.564	32.004	1.00	39.04	N
ATOM	21677	C5	G E	19	30.802	8.163	30.858	1.00	37.04	C
ATOM	21678	C6	G E	19	31.152	9.405	30.271	1.00	39.73	C
ATOM	21679	O6	G E	19	31.994	10.217	30.695	1.00	41.71	O
ATOM	21680	C2	G E	19	29.467	8.794	28.582	1.00	40.14	C
ATOM	21681	N2	G E	19	28.856	9.172	27.449	1.00	43.29	N
ATOM	21682	N3	G E	19	29.107	7.655	29.141	1.00	41.27	N
ATOM	21683	C4	G E	19	29.833	7.390	30.267	1.00	38.96	C
ATOM	21684	O5'	C E	20	31.184	2.530	27.581	1.00	39.62	O
ATOM	21685	C4'	C E	20	31.373	4.318	26.017	1.00	42.43	C
ATOM	21686	C3'	C E	20	32.181	4.976	24.926	1.00	44.32	C
ATOM	21687	C2'	C E	20	31.358	6.229	24.643	1.00	40.14	C
ATOM	21688	P	C E	20	31.553	1.717	28.885	1.00	38.29	P
ATOM	21689	OP1	C E	20	31.608	0.320	28.369	1.00	41.52	O
ATOM	21690	OP2	C E	20	32.692	2.384	29.540	1.00	37.33	O
ATOM	21691	C5'	C E	20	32.112	3.375	26.933	1.00	40.70	C
ATOM	21692	O4'	C E	20	30.821	5.438	26.783	1.00	44.44	O
ATOM	21693	O3'	C E	20	32.321	4.120	23.794	1.00	41.16	O
ATOM	21694	O2'	C E	20	30.195	5.870	23.933	1.00	48.28	O
ATOM	21695	C1'	C E	20	30.913	6.621	26.041	1.00	39.83	C
ATOM	21696	N1	C E	20	31.913	7.482	26.699	1.00	42.73	N
ATOM	21697	C2	C E	20	32.195	8.772	26.219	1.00	40.91	C
ATOM	21698	N3	C E	20	33.155	9.485	26.859	1.00	44.89	N
ATOM	21699	C4	C E	20	33.799	8.976	27.932	1.00	42.56	C
ATOM	21700	C5	C E	20	33.508	7.683	28.443	1.00	37.43	C
ATOM	21701	C6	C E	20	32.570	6.985	27.799	1.00	40.76	C
ATOM	21702	O2	C E	20	31.601	9.241	25.240	1.00	38.22	O
ATOM	21703	N4	C E	20	34.724	9.725	28.543	1.00	43.29	N
ATOM	21704	O5'	G E	21	33.944	5.545	22.521	1.00	43.46	O
ATOM	21705	C4'	G E	21	33.473	7.656	21.547	1.00	43.17	C
ATOM	21706	C3'	G E	21	34.895	7.851	21.093	1.00	43.94	C
ATOM	21707	C2'	G E	21	35.254	9.216	21.658	1.00	44.74	C
ATOM	21708	P	G E	21	33.687	4.051	22.942	1.00	46.60	P
ATOM	21709	OP1	G E	21	33.500	3.288	21.694	1.00	39.36	O
ATOM	21710	OP2	G E	21	34.758	3.625	23.883	1.00	51.37	O
ATOM	21711	C5'	G E	21	33.066	6.219	21.641	1.00	44.31	C
ATOM	21712	O4'	G E	21	33.445	8.269	22.863	1.00	39.35	O
ATOM	21713	O3'	G E	21	35.021	7.755	19.703	1.00	47.18	O
ATOM	21714	O2'	G E	21	34.727	10.255	20.849	1.00	51.38	O
ATOM	21715	C1'	G E	21	34.503	9.195	22.981	1.00	39.41	C
ATOM	21716	N9	G E	21	35.350	8.775	24.098	1.00	41.54	N
ATOM	21717	C8	G E	21	35.319	7.557	24.741	1.00	42.27	C
ATOM	21718	N7	G E	21	36.143	7.493	25.731	1.00	35.02	N
ATOM	21719	C5	G E	21	36.785	8.711	25.727	1.00	37.88	C
ATOM	21720	C4	G E	21	36.301	9.524	24.729	1.00	42.22	C
ATOM	21721	N1	G E	21	38.130	10.509	26.216	1.00	48.23	N
ATOM	21722	C2	G E	21	37.585	11.246	25.208	1.00	42.46	C
ATOM	21723	N3	G E	21	36.650	10.781	24.412	1.00	42.45	N
ATOM	21724	C6	G E	21	37.789	9.220	26.563	1.00	39.32	C
ATOM	21725	O6	G E	21	38.362	8.717	27.522	1.00	43.50	O
ATOM	21726	N2	G E	21	38.081	12.482	25.074	1.00	46.97	N
ATOM	21727	O5'	U E	22	37.453	8.159	19.509	1.00	45.99	O
ATOM	21728	C4'	U E	22	38.670	10.207	19.380	1.00	42.54	C
ATOM	21729	C3'	U E	22	40.078	9.647	19.324	1.00	42.49	C
ATOM	21730	C2'	U E	22	40.754	10.359	20.484	1.00	52.22	C
ATOM	21731	P	U E	22	36.342	7.109	19.097	1.00	48.30	P
ATOM	21732	OP1	U E	22	36.193	7.107	17.628	1.00	49.69	O

ATOM	21733	OP2	U E	22	36.655	5.849	19.806	1.00	50.25	O
ATOM	21734	C5'	U E	22	37.612	9.345	18.766	1.00	48.05	C
ATOM	21735	O4'	U E	22	38.402	10.349	20.801	1.00	37.69	O
ATOM	21736	O3'	U E	22	40.708	9.876	18.079	1.00	48.39	O
ATOM	21737	O2'	U E	22	41.043	11.701	20.104	1.00	53.00	O
ATOM	21738	C1'	U E	22	39.617	10.407	21.512	1.00	44.66	C
ATOM	21739	N1	U E	22	39.617	9.303	22.507	1.00	42.02	N
ATOM	21740	C2	U E	22	40.434	9.394	23.600	1.00	40.35	C
ATOM	21741	N3	U E	22	40.336	8.373	24.490	1.00	41.28	N
ATOM	21742	C4	U E	22	39.508	7.278	24.439	1.00	38.94	C
ATOM	21743	C5	U E	22	38.671	7.232	23.297	1.00	35.83	C
ATOM	21744	C6	U E	22	38.754	8.227	22.402	1.00	43.00	C
ATOM	21745	O2	U E	22	41.211	10.295	23.779	1.00	48.21	O
ATOM	21746	O4	U E	22	39.545	6.487	25.383	1.00	41.67	O
ATOM	21747	O5'	U E	23	43.001	8.837	18.054	1.00	48.92	O
ATOM	21748	C4'	U E	23	44.706	10.110	19.155	1.00	49.93	C
ATOM	21749	C3'	U E	23	45.737	8.997	19.188	1.00	47.46	C
ATOM	21750	C2'	U E	23	46.157	8.961	20.650	1.00	51.49	C
ATOM	21751	P	U E	23	41.573	8.713	17.378	1.00	52.76	P
ATOM	21752	OP1	U E	23	41.707	9.041	15.946	1.00	58.09	O
ATOM	21753	OP2	U E	23	41.007	7.413	17.778	1.00	48.57	O
ATOM	21754	C5'	U E	23	43.720	10.054	18.018	1.00	48.12	C
ATOM	21755	O4'	U E	23	44.020	9.991	20.424	1.00	44.11	O
ATOM	21756	O3'	U E	23	46.808	9.270	18.316	1.00	59.20	O
ATOM	21757	O2'	U E	23	47.108	9.984	20.896	1.00	45.50	O
ATOM	21758	C1'	U E	23	44.855	9.346	21.362	1.00	46.21	C
ATOM	21759	N1	U E	23	44.092	8.224	21.965	1.00	43.42	N
ATOM	21760	C2	U E	23	44.384	7.877	23.260	1.00	44.81	C
ATOM	21761	N3	U E	23	43.596	6.893	23.813	1.00	41.19	N
ATOM	21762	C4	U E	23	42.541	6.231	23.217	1.00	38.17	C
ATOM	21763	C5	U E	23	42.305	6.642	21.888	1.00	37.11	C
ATOM	21764	C6	U E	23	43.047	7.609	21.324	1.00	43.03	C
ATOM	21765	O2	U E	23	45.283	8.413	23.866	1.00	49.36	O
ATOM	21766	O4	U E	23	41.929	5.351	23.836	1.00	37.29	O
ATOM	21767	O5'	U E	24	48.248	7.244	18.333	1.00	49.29	O
ATOM	21768	C4'	U E	24	50.202	6.850	19.715	1.00	53.25	C
ATOM	21769	C3'	U E	24	50.337	5.359	19.427	1.00	50.46	C
ATOM	21770	C2'	U E	24	50.460	4.779	20.823	1.00	49.92	C
ATOM	21771	P	U E	24	47.373	8.125	17.345	1.00	49.87	P
ATOM	21772	OP1	U E	24	48.322	8.790	16.426	1.00	51.51	O
ATOM	21773	OP2	U E	24	46.241	7.352	16.788	1.00	48.36	O
ATOM	21774	C5'	U E	24	49.550	7.697	18.658	1.00	51.44	C
ATOM	21775	O4'	U E	24	49.419	6.906	20.927	1.00	45.42	O
ATOM	21776	O3'	U E	24	51.455	5.069	18.602	1.00	60.55	O
ATOM	21777	O2'	U E	24	51.766	5.030	21.319	1.00	47.23	O
ATOM	21778	C1'	U E	24	49.502	5.673	21.605	1.00	48.58	C
ATOM	21779	N1	U E	24	48.130	5.131	21.763	1.00	45.89	N
ATOM	21780	C2	U E	24	47.940	4.313	22.846	1.00	45.39	C
ATOM	21781	N3	U E	24	46.649	3.842	23.044	1.00	45.41	N
ATOM	21782	C4	U E	24	45.525	4.146	22.257	1.00	45.74	C
ATOM	21783	C5	U E	24	45.832	5.007	21.161	1.00	42.61	C
ATOM	21784	C6	U E	24	47.073	5.479	20.957	1.00	41.09	C
ATOM	21785	O2	U E	24	48.886	4.044	23.548	1.00	47.88	O
ATOM	21786	O4	U E	24	44.390	3.687	22.516	1.00	37.96	O
ATOM	21787	O5'	U E	25	51.772	2.568	19.023	1.00	42.07	O
ATOM	21788	C4'	U E	25	52.660	1.576	21.008	1.00	49.70	C
ATOM	21789	C3'	U E	25	52.275	0.156	20.619	1.00	51.46	C
ATOM	21790	C2'	U E	25	51.556	-0.335	21.859	1.00	50.34	C
ATOM	21791	P	U E	25	51.641	3.638	17.857	1.00	60.88	P
ATOM	21792	OP1	U E	25	52.927	3.715	17.132	1.00	61.11	O
ATOM	21793	OP2	U E	25	50.442	3.304	17.069	1.00	61.35	O
ATOM	21794	C5'	U E	25	52.901	2.529	19.867	1.00	49.70	C
ATOM	21795	O4'	U E	25	51.538	2.037	21.791	1.00	51.00	O

ATOM	21796	O3'	U E	25	53.397	-0.638	20.285	1.00	57.57	O
ATOM	21797	O2'	U E	25	52.504	-0.685	22.853	1.00	45.43	O
ATOM	21798	C1'	U E	25	50.818	0.934	22.300	1.00	49.27	C
ATOM	21799	N1	U E	25	49.415	0.990	21.787	1.00	44.33	N
ATOM	21800	C2	U E	25	48.441	0.379	22.542	1.00	46.26	C
ATOM	21801	N3	U E	25	47.167	0.432	22.028	1.00	41.84	N
ATOM	21802	C4	U E	25	46.751	1.055	20.871	1.00	45.35	C
ATOM	21803	C5	U E	25	47.808	1.662	20.122	1.00	40.08	C
ATOM	21804	C6	U E	25	49.056	1.607	20.605	1.00	48.22	C
ATOM	21805	O2	U E	25	48.702	-0.176	23.602	1.00	51.98	O
ATOM	21806	O4	U E	25	45.545	1.041	20.575	1.00	46.15	O
ATOM	21807	O5'	A E	26	52.472	-3.004	20.305	1.00	44.36	O
ATOM	21808	C4'	A E	26	52.164	-4.488	22.167	1.00	52.34	C
ATOM	21809	C3'	A E	26	51.343	-5.451	21.313	1.00	53.87	C
ATOM	21810	C2'	A E	26	50.217	-5.825	22.277	1.00	52.95	C
ATOM	21811	P	A E	26	53.255	-1.973	19.389	1.00	55.88	P
ATOM	21812	OP1	A E	26	54.646	-2.476	19.319	1.00	60.65	O
ATOM	21813	OP2	A E	26	52.521	-1.692	18.130	1.00	44.78	O
ATOM	21814	C5'	A E	26	53.082	-3.529	21.458	1.00	45.65	C
ATOM	21815	O4'	A E	26	51.168	-3.749	22.903	1.00	52.49	O
ATOM	21816	O3'	A E	26	52.097	-6.563	20.833	1.00	54.60	O
ATOM	21817	O2'	A E	26	50.642	-6.731	23.285	1.00	55.65	O
ATOM	21818	C1'	A E	26	49.965	-4.485	22.959	1.00	50.68	C
ATOM	21819	N9	A E	26	48.935	-3.790	22.197	1.00	47.05	N
ATOM	21820	C8	A E	26	49.082	-2.977	21.105	1.00	44.81	C
ATOM	21821	N7	A E	26	47.936	-2.619	20.605	1.00	47.75	N
ATOM	21822	C5	A E	26	46.995	-3.255	21.420	1.00	43.25	C
ATOM	21823	C4	A E	26	47.608	-3.999	22.396	1.00	42.80	C
ATOM	21824	N1	A E	26	44.974	-3.984	22.339	1.00	41.65	N
ATOM	21825	C2	A E	26	45.721	-4.674	23.223	1.00	49.26	C
ATOM	21826	N3	A E	26	47.052	-4.750	23.354	1.00	42.69	N
ATOM	21827	C6	A E	26	45.598	-3.252	21.396	1.00	43.79	C
ATOM	21828	N6	A E	26	44.897	-2.551	20.474	1.00	48.65	N
ATOM	21829	O5'	G E	27	50.562	-7.907	19.373	1.00	50.89	O
ATOM	21830	C4'	G E	27	48.900	-9.275	20.403	1.00	55.32	C
ATOM	21831	C3'	G E	27	48.297	-9.550	19.035	1.00	59.46	C
ATOM	21832	C2'	G E	27	46.809	-9.426	19.334	1.00	52.05	C
ATOM	21833	P	G E	27	51.939	-7.136	19.327	1.00	54.23	P
ATOM	21834	OP1	G E	27	52.966	-8.219	19.245	1.00	63.86	O
ATOM	21835	OP2	G E	27	51.918	-6.174	18.207	1.00	44.82	O
ATOM	21836	C5'	G E	27	50.333	-8.851	20.400	1.00	48.46	C
ATOM	21837	O4'	G E	27	48.068	-8.203	20.935	1.00	57.87	O
ATOM	21838	O3'	G E	27	48.690	-10.820	18.526	1.00	59.15	O
ATOM	21839	O2'	G E	27	46.345	-10.583	20.013	1.00	51.72	O
ATOM	21840	C1'	G E	27	46.800	-8.249	20.329	1.00	52.25	C
ATOM	21841	N9	G E	27	46.511	-7.004	19.602	1.00	51.27	N
ATOM	21842	C8	G E	27	47.325	-6.153	18.890	1.00	51.16	C
ATOM	21843	N7	G E	27	46.665	-5.201	18.279	1.00	47.24	N
ATOM	21844	C5	G E	27	45.348	-5.487	18.585	1.00	45.04	C
ATOM	21845	C4	G E	27	45.229	-6.593	19.379	1.00	45.99	C
ATOM	21846	N1	G E	27	43.000	-5.407	18.711	1.00	40.24	N
ATOM	21847	C2	G E	27	42.995	-6.521	19.521	1.00	47.70	C
ATOM	21848	N3	G E	27	44.110	-7.158	19.891	1.00	47.69	N
ATOM	21849	C6	G E	27	44.170	-4.826	18.210	1.00	44.33	C
ATOM	21850	O6	G E	27	44.148	-3.850	17.485	1.00	53.13	O
ATOM	21851	N2	G E	27	41.806	-6.980	19.949	1.00	43.74	N
ATOM	21852	P	A E	28	48.578	-11.231	16.967	1.00	57.96	P
ATOM	21853	OP1	A E	28	47.828	-10.334	16.075	1.00	56.24	O
ATOM	21854	OP2	A E	28	48.146	-12.646	17.063	1.00	61.16	O
ATOM	21855	O5'	A E	28	50.082	-11.220	16.446	1.00	61.41	O
ATOM	21856	C5'	A E	28	50.921	-10.080	16.592	1.00	62.41	C
ATOM	21857	C4'	A E	28	52.142	-10.174	15.710	1.00	63.43	C
ATOM	21858	O4'	A E	28	53.088	-11.127	16.263	1.00	65.42	O

ATOM	21859	C3'	A E	28	51.887	-10.623	14.283	1.00	65.05	C
ATOM	21860	O3'	A E	28	52.827	-9.971	13.442	1.00	63.84	O
ATOM	21861	C2'	A E	28	52.226	-12.108	14.331	1.00	62.36	C
ATOM	21862	O2'	A E	28	52.581	-12.638	13.081	1.00	65.69	O
ATOM	21863	C1'	A E	28	53.401	-12.106	15.295	1.00	64.34	C
ATOM	21864	N9	A E	28	53.629	-13.355	16.026	1.00	67.64	N
ATOM	21865	C8	A E	28	52.713	-14.160	16.653	1.00	66.36	C
ATOM	21866	N7	A E	28	53.253	-15.189	17.279	1.00	68.23	N
ATOM	21867	C5	A E	28	54.616	-15.045	17.063	1.00	65.56	C
ATOM	21868	C4	A E	28	54.861	-13.912	16.308	1.00	64.39	C
ATOM	21869	N1	A E	28	56.958	-15.405	17.091	1.00	62.90	N
ATOM	21870	C2	A E	28	57.039	-14.282	16.362	1.00	70.68	C
ATOM	21871	N3	A E	28	56.067	-13.469	15.920	1.00	63.98	N
ATOM	21872	C6	A E	28	55.726	-15.815	17.460	1.00	64.91	C
ATOM	21873	N6	A E	28	55.620	-16.918	18.189	1.00	65.70	N
ATOM	21874	P	G E	29	52.414	-8.604	12.735	1.00	66.72	P
ATOM	21875	OP1	G E	29	53.490	-8.054	11.879	1.00	74.17	O
ATOM	21876	OP2	G E	29	51.932	-7.772	13.855	1.00	67.80	O
ATOM	21877	O5'	G E	29	51.183	-9.021	11.806	1.00	68.58	O
ATOM	21878	C5'	G E	29	51.334	-9.309	10.423	1.00	63.66	C
ATOM	21879	C4'	G E	29	50.697	-10.632	10.094	1.00	72.88	C
ATOM	21880	O4'	G E	29	49.271	-10.482	9.856	1.00	74.06	O
ATOM	21881	C3'	G E	29	51.175	-11.350	8.846	1.00	69.98	C
ATOM	21882	O3'	G E	29	52.458	-11.933	8.973	1.00	71.61	O
ATOM	21883	C2'	G E	29	50.066	-12.369	8.641	1.00	73.72	C
ATOM	21884	O2'	G E	29	50.208	-13.435	9.567	1.00	77.65	O
ATOM	21885	C1'	G E	29	48.831	-11.550	9.030	1.00	78.42	C
ATOM	21886	N9	G E	29	48.105	-11.046	7.838	1.00	74.99	N
ATOM	21887	C8	G E	29	47.370	-11.826	6.967	1.00	73.86	C
ATOM	21888	N7	G E	29	46.833	-11.166	5.977	1.00	71.41	N
ATOM	21889	C5	G E	29	47.251	-9.862	6.202	1.00	71.59	C
ATOM	21890	C4	G E	29	48.041	-9.773	7.337	1.00	71.06	C
ATOM	21891	N1	G E	29	47.602	-7.586	6.040	1.00	76.52	N
ATOM	21892	C2	G E	29	48.370	-7.597	7.176	1.00	79.95	C
ATOM	21893	N3	G E	29	48.628	-8.691	7.884	1.00	71.81	N
ATOM	21894	C6	G E	29	46.983	-8.676	5.462	1.00	72.14	C
ATOM	21895	O6	G E	29	46.318	-8.494	4.437	1.00	67.61	O
ATOM	21896	N2	G E	29	48.856	-6.392	7.536	1.00	88.01	N
ATOM	21897	P	C E	30	53.442	-11.984	7.700	1.00	73.49	P
ATOM	21898	OP1	C E	30	54.623	-12.769	8.141	1.00	75.25	O
ATOM	21899	OP2	C E	30	53.633	-10.635	7.127	1.00	73.01	O
ATOM	21900	O5'	C E	30	52.618	-12.787	6.597	1.00	66.74	O
ATOM	21901	C5'	C E	30	52.260	-14.140	6.807	1.00	70.25	C
ATOM	21902	C4'	C E	30	51.355	-14.644	5.720	1.00	75.11	C
ATOM	21903	O4'	C E	30	50.143	-13.853	5.673	1.00	77.87	O
ATOM	21904	C3'	C E	30	51.896	-14.550	4.306	1.00	80.50	C
ATOM	21905	O3'	C E	30	52.839	-15.568	4.003	1.00	80.79	O
ATOM	21906	C2'	C E	30	50.623	-14.604	3.466	1.00	79.43	C
ATOM	21907	O2'	C E	30	50.149	-15.938	3.351	1.00	84.06	O
ATOM	21908	C1'	C E	30	49.642	-13.828	4.349	1.00	76.89	C
ATOM	21909	N1	C E	30	49.473	-12.421	3.911	1.00	74.78	N
ATOM	21910	C2	C E	30	48.654	-12.142	2.804	1.00	77.05	C
ATOM	21911	N3	C E	30	48.495	-10.860	2.409	1.00	75.23	N
ATOM	21912	C4	C E	30	49.110	-9.884	3.061	1.00	73.74	C
ATOM	21913	C5	C E	30	49.944	-10.135	4.187	1.00	75.41	C
ATOM	21914	C6	C E	30	50.095	-11.405	4.576	1.00	73.81	C
ATOM	21915	O2	C E	30	48.084	-13.068	2.203	1.00	71.78	O
ATOM	21916	N4	C E	30	48.924	-8.642	2.628	1.00	70.04	N
ATOM	21917	P	U E	31	54.066	-15.261	3.010	1.00	79.33	P
ATOM	21918	OP1	U E	31	54.979	-16.423	3.161	1.00	85.47	O
ATOM	21919	OP2	U E	31	54.603	-13.892	3.237	1.00	80.53	O
ATOM	21920	O5'	U E	31	53.386	-15.241	1.565	1.00	75.03	O
ATOM	21921	C5'	U E	31	52.713	-16.391	1.073	1.00	80.15	C

ATOM	21922	C4'	U E	31	51.905	-16.112	-0.173	1.00	85.66	C
ATOM	21923	O4'	U E	31	50.787	-15.234	0.127	1.00	88.76	O
ATOM	21924	C3'	U E	31	52.605	-15.403	-1.321	1.00	89.15	C
ATOM	21925	O3'	U E	31	53.486	-16.224	-2.062	1.00	90.58	O
ATOM	21926	C2'	U E	31	51.427	-14.887	-2.131	1.00	87.95	C
ATOM	21927	O2'	U E	31	50.811	-15.954	-2.839	1.00	80.37	O
ATOM	21928	C1'	U E	31	50.482	-14.450	-1.013	1.00	86.06	C
ATOM	21929	N1	U E	31	50.661	-13.020	-0.679	1.00	83.02	N
ATOM	21930	C2	U E	31	49.975	-12.123	-1.460	1.00	87.44	C
ATOM	21931	N3	U E	31	50.160	-10.803	-1.135	1.00	89.45	N
ATOM	21932	C4	U E	31	50.958	-10.305	-0.125	1.00	89.06	C
ATOM	21933	C5	U E	31	51.648	-11.302	0.636	1.00	85.19	C
ATOM	21934	C6	U E	31	51.478	-12.593	0.338	1.00	82.18	C
ATOM	21935	O2	U E	31	49.251	-12.481	-2.369	1.00	90.78	O
ATOM	21936	O4	U E	31	51.027	-9.088	0.051	1.00	89.98	O
ATOM	21937	P	A E	32	54.754	-15.563	-2.795	1.00	92.11	P
ATOM	21938	OP1	A E	32	55.606	-16.709	-3.167	1.00	100.71	O
ATOM	21939	OP2	A E	32	55.315	-14.460	-1.980	1.00	91.52	O
ATOM	21940	O5'	A E	32	54.167	-14.916	-4.126	1.00	97.47	O
ATOM	21941	C5'	A E	32	54.035	-15.682	-5.317	1.00	103.40	C
ATOM	21942	C4'	A E	32	53.311	-14.906	-6.384	1.00	103.70	C
ATOM	21943	O4'	A E	32	52.150	-14.278	-5.783	1.00	103.83	O
ATOM	21944	C1'	A E	32	51.963	-12.987	-6.320	1.00	109.36	C
ATOM	21945	C2'	A E	32	52.970	-12.806	-7.450	1.00	112.54	C
ATOM	21946	O2'	A E	32	52.380	-13.258	-8.662	1.00	113.41	O
ATOM	21947	C3'	A E	32	54.083	-13.746	-7.008	1.00	113.66	C
ATOM	21948	O3'	A E	32	54.951	-14.142	-8.065	1.00	114.39	O
ATOM	21949	N9	A E	32	52.160	-11.999	-5.242	1.00	104.59	N
ATOM	21950	C8	A E	32	52.792	-12.162	-4.035	1.00	101.60	C
ATOM	21951	N7	A E	32	52.793	-11.083	-3.291	1.00	103.79	N
ATOM	21952	C5	A E	32	52.114	-10.145	-4.060	1.00	107.85	C
ATOM	21953	C4	A E	32	51.721	-10.700	-5.264	1.00	108.52	C
ATOM	21954	N1	A E	32	51.093	-8.155	-4.822	1.00	110.68	N
ATOM	21955	C2	A E	32	50.784	-8.826	-5.937	1.00	111.03	C
ATOM	21956	N3	A E	32	51.047	-10.091	-6.255	1.00	110.84	N
ATOM	21957	C6	A E	32	51.770	-8.797	-3.847	1.00	109.33	C
ATOM	21958	N6	A E	32	52.074	-8.114	-2.742	1.00	111.86	N
ATOM	21959	P	G E	33	56.233	-13.243	-8.457	1.00	115.95	P
ATOM	21960	OP1	G E	33	56.631	-13.607	-9.841	1.00	113.16	O
ATOM	21961	OP2	G E	33	57.213	-13.298	-7.341	1.00	103.78	O
ATOM	21962	O5'	G E	33	55.683	-11.749	-8.531	1.00	119.71	O
ATOM	21963	C5'	G E	33	55.057	-11.258	-9.706	1.00	123.34	C
ATOM	21964	C4'	G E	33	54.810	-9.774	-9.621	1.00	129.17	C
ATOM	21965	O4'	G E	33	53.941	-9.469	-8.497	1.00	126.53	O
ATOM	21966	C1'	G E	33	54.276	-8.196	-7.968	1.00	128.15	C
ATOM	21967	N9	G E	33	54.682	-8.337	-6.554	1.00	123.84	N
ATOM	21968	C8	G E	33	55.261	-9.416	-5.920	1.00	119.95	C
ATOM	21969	N7	G E	33	55.494	-9.197	-4.652	1.00	118.04	N
ATOM	21970	C5	G E	33	55.049	-7.896	-4.438	1.00	120.91	C
ATOM	21971	C4	G E	33	54.552	-7.351	-5.604	1.00	123.81	C
ATOM	21972	N3	G E	33	54.026	-6.121	-5.812	1.00	126.77	N
ATOM	21973	C2	G E	33	54.015	-5.387	-4.711	1.00	126.44	C
ATOM	21974	N2	G E	33	53.527	-4.135	-4.743	1.00	127.95	N
ATOM	21975	N1	G E	33	54.488	-5.833	-3.502	1.00	124.48	N
ATOM	21976	C6	G E	33	55.033	-7.097	-3.262	1.00	125.50	C
ATOM	21977	O6	G E	33	55.429	-7.393	-2.124	1.00	127.27	O
ATOM	21978	C2'	G E	33	55.406	-7.627	-8.823	1.00	134.54	C
ATOM	21979	O2'	G E	33	54.828	-6.863	-9.873	1.00	138.27	O
ATOM	21980	C3'	G E	33	56.029	-8.909	-9.362	1.00	133.47	C
ATOM	21981	O3'	G E	33	56.851	-8.723	-10.496	1.00	137.66	O
ATOM	21982	P	A E	34	58.427	-8.505	-10.286	1.00	141.07	P
ATOM	21983	OP1	A E	34	58.996	-8.245	-11.634	1.00	140.99	O
ATOM	21984	OP2	A E	34	58.947	-9.642	-9.482	1.00	139.98	O

ATOM	21985	O5'	A E	34	58.518	-7.172	-9.405	1.00139.94	O
ATOM	21986	C5'	A E	34	59.002	-7.183	-8.064	1.00137.58	C
ATOM	21987	C4'	A E	34	59.936	-6.021	-7.821	1.00139.71	C
ATOM	21988	O4'	A E	34	60.388	-5.526	-9.108	1.00142.05	O
ATOM	21989	C1'	A E	34	60.465	-4.118	-9.094	1.00139.17	C
ATOM	21990	N9	A E	34	59.459	-3.589	-10.035	1.00140.95	N
ATOM	21991	C8	A E	34	58.733	-2.436	-9.891	1.00142.55	C
ATOM	21992	N7	A E	34	57.917	-2.199	-10.888	1.00144.80	N
ATOM	21993	C5	A E	34	58.116	-3.265	-11.752	1.00145.72	C
ATOM	21994	C4	A E	34	59.071	-4.130	-11.246	1.00144.84	C
ATOM	21995	N3	A E	34	59.505	-5.265	-11.830	1.00145.01	N
ATOM	21996	C2	A E	34	58.894	-5.470	-12.998	1.00142.38	C
ATOM	21997	N1	A E	34	57.962	-4.726	-13.606	1.00144.86	N
ATOM	21998	C6	A E	34	57.543	-3.593	-12.997	1.00146.85	C
ATOM	21999	N6	A E	34	56.615	-2.845	-13.600	1.00146.62	N
ATOM	22000	C2'	A E	34	60.201	-3.654	-7.665	1.00137.04	C
ATOM	22001	O2'	A E	34	61.441	-3.587	-6.974	1.00125.78	O
ATOM	22002	C3'	A E	34	59.341	-4.794	-7.131	1.00141.53	C
ATOM	22003	O3'	A E	34	59.353	-4.885	-5.713	1.00144.18	O
ATOM	22004	P	A E	35	58.278	-4.075	-4.823	1.00143.61	P
ATOM	22005	OP1	A E	35	56.942	-4.678	-5.076	1.00136.24	O
ATOM	22006	OP2	A E	35	58.795	-3.948	-3.432	1.00131.76	O
ATOM	22007	O5'	A E	35	58.270	-2.606	-5.435	1.00143.93	O
ATOM	22008	C5'	A E	35	57.448	-1.596	-4.872	1.00141.77	C
ATOM	22009	C4'	A E	35	56.970	-0.621	-5.917	1.00143.86	C
ATOM	22010	O4'	A E	35	57.316	-1.097	-7.242	1.00145.47	O
ATOM	22011	C1'	A E	35	56.331	-0.689	-8.169	1.00144.09	C
ATOM	22012	C2'	A E	35	55.273	0.103	-7.410	1.00143.32	C
ATOM	22013	O2'	A E	35	55.602	1.479	-7.495	1.00143.98	O
ATOM	22014	C3'	A E	35	55.469	-0.409	-5.990	1.00144.09	C
ATOM	22015	O3'	A E	35	54.992	0.478	-4.998	1.00148.39	O
ATOM	22016	N9	A E	35	55.765	-1.878	-8.827	1.00143.46	N
ATOM	22017	C8	A E	35	55.820	-3.189	-8.426	1.00143.15	C
ATOM	22018	N7	A E	35	55.218	-4.012	-9.251	1.00144.08	N
ATOM	22019	C5	A E	35	54.738	-3.184	-10.260	1.00145.35	C
ATOM	22020	C4	A E	35	55.067	-1.866	-10.007	1.00144.10	C
ATOM	22021	N1	A E	35	53.693	-2.380	-12.222	1.00146.83	N
ATOM	22022	C2	A E	35	54.088	-1.157	-11.844	1.00146.43	C
ATOM	22023	N3	A E	35	54.775	-0.795	-10.764	1.00145.75	N
ATOM	22024	C6	A E	35	54.008	-3.437	-11.437	1.00145.96	C
ATOM	22025	N6	A E	35	53.611	-4.657	-11.817	1.00144.94	N
ATOM	22026	P	A E	36	53.505	0.305	-4.417	1.00154.02	P
ATOM	22027	OP1	A E	36	53.271	-1.147	-4.197	1.00148.18	O
ATOM	22028	OP2	A E	36	53.334	1.274	-3.301	1.00149.73	O
ATOM	22029	O5'	A E	36	52.566	0.749	-5.623	1.00148.79	O
ATOM	22030	C5'	A E	36	52.691	2.034	-6.217	1.00150.95	C
ATOM	22031	C4'	A E	36	51.775	2.163	-7.404	1.00151.52	C
ATOM	22032	O4'	A E	36	52.282	1.356	-8.498	1.00149.40	O
ATOM	22033	C1'	A E	36	51.211	0.767	-9.205	1.00148.97	C
ATOM	22034	N9	A E	36	51.331	-0.699	-9.089	1.00147.70	N
ATOM	22035	C8	A E	36	51.831	-1.422	-8.030	1.00144.54	C
ATOM	22036	N7	A E	36	51.808	-2.720	-8.224	1.00143.52	N
ATOM	22037	C5	A E	36	51.257	-2.864	-9.495	1.00145.75	C
ATOM	22038	C4	A E	36	50.958	-1.624	-10.039	1.00147.32	C
ATOM	22039	N3	A E	36	50.417	-1.383	-11.249	1.00145.95	N
ATOM	22040	C2	A E	36	50.186	-2.522	-11.900	1.00143.76	C
ATOM	22041	N1	A E	36	50.418	-3.782	-11.509	1.00143.90	N
ATOM	22042	C6	A E	36	50.962	-3.994	-10.288	1.00144.99	C
ATOM	22043	N6	A E	36	51.192	-5.255	-9.906	1.00141.62	N
ATOM	22044	C2'	A E	36	49.909	1.289	-8.596	1.00150.42	C
ATOM	22045	O2'	A E	36	49.507	2.448	-9.312	1.00151.73	O
ATOM	22046	C3'	A E	36	50.360	1.649	-7.185	1.00151.84	C
ATOM	22047	O3'	A E	36	49.524	2.592	-6.534	1.00156.60	O

ATOM	22048	P	U E	37	49.346	2.565	-4.932	1.00159.49	P
ATOM	22049	OP1	U E	37	48.055	3.234	-4.628	1.00160.38	O
ATOM	22050	OP2	U E	37	50.587	3.048	-4.273	1.00155.77	O
ATOM	22051	O5'	U E	37	49.174	1.022	-4.578	1.00150.11	O
ATOM	22052	C5'	U E	37	47.895	0.412	-4.620	1.00144.76	C
ATOM	22053	C4'	U E	37	47.735	-0.413	-5.866	1.00140.43	C
ATOM	22054	O4'	U E	37	48.988	-1.082	-6.159	1.00143.52	O
ATOM	22055	C1'	U E	37	48.744	-2.383	-6.638	1.00137.66	C
ATOM	22056	C2'	U E	37	47.231	-2.538	-6.803	1.00133.79	C
ATOM	22057	O2'	U E	37	46.883	-2.135	-8.120	1.00135.00	O
ATOM	22058	C3'	U E	37	46.714	-1.532	-5.782	1.00136.73	C
ATOM	22059	O3'	U E	37	45.398	-1.069	-6.035	1.00141.57	O
ATOM	22060	N1	U E	37	49.324	-3.338	-5.663	1.00134.38	N
ATOM	22061	C2	U E	37	49.500	-4.660	-6.040	1.00129.88	C
ATOM	22062	N3	U E	37	50.056	-5.464	-5.068	1.00125.09	N
ATOM	22063	C4	U E	37	50.457	-5.095	-3.793	1.00124.38	C
ATOM	22064	C5	U E	37	50.251	-3.711	-3.486	1.00127.25	C
ATOM	22065	C6	U E	37	49.713	-2.906	-4.410	1.00132.04	C
ATOM	22066	O2	U E	37	49.177	-5.089	-7.140	1.00128.75	O
ATOM	22067	O4	U E	37	50.943	-5.941	-3.034	1.00118.09	O
ATOM	22068	P	A E	38	44.133	-2.046	-5.872	1.00139.49	P
ATOM	22069	OP1	A E	38	42.925	-1.189	-5.745	1.00135.96	O
ATOM	22070	OP2	A E	38	44.427	-3.063	-4.824	1.00132.57	O
ATOM	22071	O5'	A E	38	44.053	-2.795	-7.273	1.00132.36	O
ATOM	22072	C5'	A E	38	43.116	-3.836	-7.475	1.00129.31	C
ATOM	22073	C4'	A E	38	43.784	-5.120	-7.895	1.00125.39	C
ATOM	22074	O4'	A E	38	45.184	-5.131	-7.519	1.00126.60	O
ATOM	22075	C1'	A E	38	45.607	-6.461	-7.299	1.00119.15	C
ATOM	22076	C2'	A E	38	44.380	-7.374	-7.402	1.00118.27	C
ATOM	22077	O2'	A E	38	44.379	-7.986	-8.683	1.00118.77	O
ATOM	22078	C3'	A E	38	43.225	-6.377	-7.263	1.00121.03	C
ATOM	22079	O3'	A E	38	42.010	-6.770	-7.883	1.00120.80	O
ATOM	22080	N9	A E	38	46.307	-6.554	-6.003	1.00114.42	N
ATOM	22081	C8	A E	38	46.555	-5.521	-5.139	1.00118.88	C
ATOM	22082	N7	A E	38	47.223	-5.875	-4.068	1.00117.42	N
ATOM	22083	C5	A E	38	47.442	-7.234	-4.234	1.00109.86	C
ATOM	22084	C4	A E	38	46.892	-7.670	-5.428	1.00111.43	C
ATOM	22085	N1	A E	38	48.147	-9.465	-3.873	1.00100.53	N
ATOM	22086	C2	A E	38	47.569	-9.747	-5.050	1.00104.40	C
ATOM	22087	N3	A E	38	46.925	-8.936	-5.893	1.00108.76	N
ATOM	22088	C6	A E	38	48.100	-8.186	-3.430	1.00103.62	C
ATOM	22089	N6	A E	38	48.671	-7.887	-2.256	1.00102.77	N
ATOM	22090	P	G E	39	41.331	-8.214	-7.650	1.00126.07	P
ATOM	22091	OP1	G E	39	42.233	-9.297	-8.132	1.00123.51	O
ATOM	22092	OP2	G E	39	40.001	-8.122	-8.307	1.00125.48	O
ATOM	22093	O5'	G E	39	41.033	-8.303	-6.081	1.00116.97	O
ATOM	22094	C5'	G E	39	42.025	-8.679	-5.136	1.00108.81	C
ATOM	22095	C4'	G E	39	42.492	-10.103	-5.312	1.00101.07	C
ATOM	22096	O4'	G E	39	43.942	-10.117	-5.290	1.00 99.73	O
ATOM	22097	C3'	G E	39	42.060	-11.058	-4.205	1.00 97.59	C
ATOM	22098	O3'	G E	39	40.832	-11.709	-4.506	1.00104.13	O
ATOM	22099	C2'	G E	39	43.246	-12.004	-4.047	1.00 91.72	C
ATOM	22100	O2'	G E	39	43.192	-13.061	-4.990	1.00 76.79	O
ATOM	22101	C1'	G E	39	44.415	-11.094	-4.401	1.00 95.77	C
ATOM	22102	N9	G E	39	44.949	-10.373	-3.233	1.00 90.21	N
ATOM	22103	C8	G E	39	44.899	-9.010	-3.058	1.00 90.53	C
ATOM	22104	N7	G E	39	45.449	-8.606	-1.951	1.00 88.46	N
ATOM	22105	C5	G E	39	45.895	-9.782	-1.361	1.00 88.41	C
ATOM	22106	C4	G E	39	45.598	-10.881	-2.142	1.00 87.24	C
ATOM	22107	N1	G E	39	46.845	-11.330	0.083	1.00 82.80	N
ATOM	22108	C2	G E	39	46.497	-12.350	-0.764	1.00 82.05	C
ATOM	22109	N3	G E	39	45.862	-12.179	-1.910	1.00 84.96	N
ATOM	22110	C6	G E	39	46.575	-9.984	-0.136	1.00 82.27	C

ATOM	22111	O6	G E	39	46.930	-9.137	0.688	1.00	78.34	O
ATOM	22112	N2	G E	39	46.842	-13.581	-0.373	1.00	84.82	N
ATOM	22113	P	C E	40	39.677	-11.796	-3.394	1.00	97.38	P
ATOM	22114	OP1	C E	40	39.120	-13.174	-3.397	1.00	89.56	O
ATOM	22115	OP2	C E	40	38.775	-10.622	-3.545	1.00	87.22	O
ATOM	22116	O5'	C E	40	40.496	-11.598	-2.047	1.00	94.09	O
ATOM	22117	C5'	C E	40	40.047	-12.158	-0.831	1.00	86.92	C
ATOM	22118	C4'	C E	40	41.094	-13.041	-0.207	1.00	85.73	C
ATOM	22119	O4'	C E	40	42.428	-12.518	-0.445	1.00	82.26	O
ATOM	22120	C3'	C E	40	41.008	-13.162	1.299	1.00	79.31	C
ATOM	22121	O3'	C E	40	40.010	-14.079	1.692	1.00	80.24	O
ATOM	22122	C2'	C E	40	42.422	-13.578	1.675	1.00	76.89	C
ATOM	22123	O2'	C E	40	42.633	-14.952	1.392	1.00	77.98	O
ATOM	22124	C1'	C E	40	43.242	-12.754	0.684	1.00	79.74	C
ATOM	22125	N1	C E	40	43.634	-11.438	1.235	1.00	76.87	N
ATOM	22126	C2	C E	40	44.491	-11.329	2.335	1.00	75.74	C
ATOM	22127	N3	C E	40	44.818	-10.101	2.792	1.00	75.76	N
ATOM	22128	C4	C E	40	44.342	-9.003	2.204	1.00	74.33	C
ATOM	22129	C5	C E	40	43.479	-9.084	1.077	1.00	77.18	C
ATOM	22130	C6	C E	40	43.161	-10.306	0.633	1.00	77.32	C
ATOM	22131	O2	C E	40	44.932	-12.336	2.900	1.00	76.26	O
ATOM	22132	N4	C E	40	44.712	-7.820	2.700	1.00	70.13	N
ATOM	22133	P	A E	41	38.948	-13.677	2.817	1.00	74.74	P
ATOM	22134	OP1	A E	41	37.869	-14.693	2.786	1.00	73.03	O
ATOM	22135	OP2	A E	41	38.639	-12.229	2.694	1.00	75.38	O
ATOM	22136	O5'	A E	41	39.757	-13.872	4.170	1.00	74.72	O
ATOM	22137	C5'	A E	41	40.450	-15.079	4.429	1.00	70.99	C
ATOM	22138	C4'	A E	41	41.503	-14.856	5.472	1.00	69.57	C
ATOM	22139	O4'	A E	41	42.518	-13.966	4.951	1.00	71.14	O
ATOM	22140	C3'	A E	41	41.024	-14.158	6.725	1.00	65.43	C
ATOM	22141	O3'	A E	41	40.379	-15.041	7.616	1.00	69.16	O
ATOM	22142	C2'	A E	41	42.309	-13.556	7.273	1.00	66.74	C
ATOM	22143	O2'	A E	41	43.096	-14.542	7.917	1.00	62.95	O
ATOM	22144	C1'	A E	41	43.019	-13.153	5.987	1.00	68.22	C
ATOM	22145	N9	A E	41	42.784	-11.737	5.632	1.00	71.61	N
ATOM	22146	C8	A E	41	42.049	-11.238	4.579	1.00	70.18	C
ATOM	22147	N7	A E	41	42.045	-9.927	4.506	1.00	67.35	N
ATOM	22148	C5	A E	41	42.825	-9.538	5.586	1.00	65.02	C
ATOM	22149	C4	A E	41	43.292	-10.640	6.287	1.00	65.94	C
ATOM	22150	N1	A E	41	43.988	-8.221	7.149	1.00	62.65	N
ATOM	22151	C2	A E	41	44.357	-9.377	7.731	1.00	65.22	C
ATOM	22152	N3	A E	41	44.072	-10.636	7.383	1.00	60.50	N
ATOM	22153	C6	A E	41	43.205	-8.272	6.056	1.00	58.73	C
ATOM	22154	N6	A E	41	42.834	-7.140	5.479	1.00	62.78	N
ATOM	22155	P	A E	42	39.114	-14.558	8.473	1.00	65.29	P
ATOM	22156	OP1	A E	42	38.897	-15.644	9.462	1.00	62.48	O
ATOM	22157	OP2	A E	42	38.031	-14.060	7.580	1.00	62.93	O
ATOM	22158	O5'	A E	42	39.662	-13.320	9.299	1.00	64.65	O
ATOM	22159	C5'	A E	42	40.475	-13.532	10.443	1.00	61.32	C
ATOM	22160	C4'	A E	42	41.117	-12.249	10.900	1.00	59.42	C
ATOM	22161	O4'	A E	42	41.552	-11.490	9.750	1.00	58.05	O
ATOM	22162	C3'	A E	42	40.231	-11.279	11.661	1.00	50.76	C
ATOM	22163	O3'	A E	42	40.120	-11.629	13.034	1.00	57.26	O
ATOM	22164	C2'	A E	42	40.949	-9.958	11.458	1.00	54.37	C
ATOM	22165	O2'	A E	42	42.026	-9.871	12.374	1.00	53.77	O
ATOM	22166	C1'	A E	42	41.533	-10.120	10.052	1.00	55.76	C
ATOM	22167	N9	A E	42	40.811	-9.393	8.982	1.00	55.93	N
ATOM	22168	C8	A E	42	40.012	-9.925	7.999	1.00	58.11	C
ATOM	22169	N7	A E	42	39.539	-9.033	7.153	1.00	58.15	N
ATOM	22170	C5	A E	42	40.071	-7.823	7.593	1.00	55.28	C
ATOM	22171	C4	A E	42	40.864	-8.038	8.711	1.00	56.77	C
ATOM	22172	N1	A E	42	40.611	-5.512	7.795	1.00	58.99	N
ATOM	22173	C2	A E	42	41.338	-5.873	8.859	1.00	56.39	C

ATOM	22174	N3	A E	42	41.526	-7.086	9.395	1.00	56.51	N
ATOM	22175	C6	A E	42	39.957	-6.486	7.129	1.00	58.53	C
ATOM	22176	N6	A E	42	39.235	-6.105	6.072	1.00	60.64	N
ATOM	22177	P	G E	43	38.732	-11.479	13.840	1.00	52.97	P
ATOM	22178	OP1	G E	43	37.604	-11.800	12.935	1.00	48.29	O
ATOM	22179	OP2	G E	43	38.838	-12.222	15.098	1.00	54.63	O
ATOM	22180	O5'	G E	43	38.706	-9.937	14.243	1.00	54.05	O
ATOM	22181	C5'	G E	43	39.839	-9.313	14.844	1.00	53.45	C
ATOM	22182	C4'	G E	43	39.770	-7.800	14.772	1.00	49.52	C
ATOM	22183	O4'	G E	43	39.736	-7.396	13.377	1.00	49.93	O
ATOM	22184	C3'	G E	43	38.541	-7.168	15.420	1.00	49.78	C
ATOM	22185	O3'	G E	43	38.875	-5.863	15.888	1.00	50.76	O
ATOM	22186	C2'	G E	43	37.580	-7.036	14.244	1.00	49.19	C
ATOM	22187	O2'	G E	43	36.574	-6.057	14.394	1.00	51.47	O
ATOM	22188	C1'	G E	43	38.536	-6.685	13.111	1.00	51.47	C
ATOM	22189	N9	G E	43	38.025	-7.095	11.804	1.00	53.48	N
ATOM	22190	C8	G E	43	37.518	-8.333	11.465	1.00	48.94	C
ATOM	22191	N7	G E	43	37.129	-8.379	10.224	1.00	48.01	N
ATOM	22192	C5	G E	43	37.385	-7.106	9.725	1.00	52.18	C
ATOM	22193	C4	G E	43	37.939	-6.302	10.698	1.00	52.14	C
ATOM	22194	N1	G E	43	37.564	-5.215	8.374	1.00	55.78	N
ATOM	22195	C2	G E	43	38.109	-4.511	9.420	1.00	55.87	C
ATOM	22196	N3	G E	43	38.326	-5.016	10.629	1.00	52.45	N
ATOM	22197	C6	G E	43	37.159	-6.546	8.438	1.00	56.80	C
ATOM	22198	O6	G E	43	36.678	-7.088	7.435	1.00	56.79	O
ATOM	22199	N2	G E	43	38.438	-3.234	9.159	1.00	62.46	N
ATOM	22200	P	U E	44	39.184	-5.622	17.435	1.00	46.52	P
ATOM	22201	OP1	U E	44	39.755	-6.822	18.054	1.00	51.63	O
ATOM	22202	OP2	U E	44	39.896	-4.327	17.535	1.00	54.04	O
ATOM	22203	O5'	U E	44	37.745	-5.585	18.102	1.00	53.25	O
ATOM	22204	C5'	U E	44	36.753	-4.635	17.724	1.00	44.60	C
ATOM	22205	C4'	U E	44	35.537	-4.787	18.601	1.00	42.89	C
ATOM	22206	O4'	U E	44	34.657	-5.791	18.026	1.00	39.90	O
ATOM	22207	C3'	U E	44	35.843	-5.256	20.024	1.00	44.60	C
ATOM	22208	O3'	U E	44	34.860	-4.733	20.925	1.00	41.76	O
ATOM	22209	C2'	U E	44	35.684	-6.763	19.899	1.00	42.63	C
ATOM	22210	O2'	U E	44	35.471	-7.448	21.109	1.00	42.52	O
ATOM	22211	C1'	U E	44	34.482	-6.849	18.951	1.00	45.56	C
ATOM	22212	N1	U E	44	34.413	-8.115	18.213	1.00	43.61	N
ATOM	22213	C2	U E	44	33.499	-9.078	18.603	1.00	45.58	C
ATOM	22214	N3	U E	44	33.530	-10.272	17.888	1.00	43.58	N
ATOM	22215	C4	U E	44	34.381	-10.546	16.833	1.00	41.27	C
ATOM	22216	C5	U E	44	35.296	-9.513	16.483	1.00	43.74	C
ATOM	22217	C6	U E	44	35.289	-8.361	17.178	1.00	47.88	C
ATOM	22218	O2	U E	44	32.743	-8.904	19.526	1.00	44.94	O
ATOM	22219	O4	U E	44	34.294	-11.622	16.259	1.00	47.54	O
ATOM	22220	O5'	U E	45	36.445	-4.644	22.897	1.00	43.40	O
ATOM	22221	C4'	U E	45	37.427	-6.182	24.493	1.00	41.83	C
ATOM	22222	C3'	U E	45	38.286	-5.184	25.242	1.00	39.42	C
ATOM	22223	C2'	U E	45	39.658	-5.863	25.213	1.00	41.61	C
ATOM	22224	P	U E	45	35.298	-3.804	22.164	1.00	44.21	P
ATOM	22225	OP1	U E	45	34.148	-3.664	23.112	1.00	41.59	O
ATOM	22226	OP2	U E	45	35.969	-2.627	21.608	1.00	38.40	O
ATOM	22227	C5'	U E	45	36.154	-5.634	23.878	1.00	39.84	C
ATOM	22228	O4'	U E	45	38.329	-6.690	23.447	1.00	39.32	O
ATOM	22229	O3'	U E	45	37.803	-4.894	26.550	1.00	41.19	O
ATOM	22230	O2'	U E	45	39.707	-6.948	26.135	1.00	49.65	O
ATOM	22231	C1'	U E	45	39.670	-6.450	23.803	1.00	38.94	C
ATOM	22232	N1	U E	45	40.257	-5.504	22.825	1.00	43.39	N
ATOM	22233	C2	U E	45	41.598	-5.185	22.903	1.00	44.03	C
ATOM	22234	N3	U E	45	42.052	-4.263	21.986	1.00	42.63	N
ATOM	22235	C4	U E	45	41.330	-3.624	21.004	1.00	42.60	C
ATOM	22236	C5	U E	45	39.955	-3.994	20.986	1.00	46.36	C

ATOM	22237	C6	U E	45	39.480	-4.888	21.870	1.00	49.02	C
ATOM	22238	O2	U E	45	42.337	-5.672	23.735	1.00	45.43	O
ATOM	22239	O4	U E	45	41.873	-2.827	20.239	1.00	45.78	O
ATOM	22240	O5'	A E	46	39.597	-3.508	27.753	1.00	39.66	O
ATOM	22241	C4'	A E	46	41.550	-4.608	28.694	1.00	38.34	C
ATOM	22242	C3'	A E	46	42.228	-3.365	29.212	1.00	39.13	C
ATOM	22243	C2'	A E	46	43.594	-3.420	28.549	1.00	39.94	C
ATOM	22244	P	A E	46	38.091	-3.454	27.226	1.00	38.63	P
ATOM	22245	OP1	A E	46	37.257	-3.454	28.448	1.00	38.55	O
ATOM	22246	OP2	A E	46	38.107	-2.412	26.130	1.00	32.83	O
ATOM	22247	C5'	A E	46	40.042	-4.531	28.654	1.00	45.14	C
ATOM	22248	O4'	A E	46	42.051	-4.737	27.338	1.00	40.61	O
ATOM	22249	O3'	A E	46	42.264	-3.327	30.618	1.00	41.16	O
ATOM	22250	O2'	A E	46	44.379	-4.400	29.219	1.00	49.57	O
ATOM	22251	C1'	A E	46	43.232	-3.987	27.180	1.00	38.24	C
ATOM	22252	N9	A E	46	43.040	-3.017	26.062	1.00	45.40	N
ATOM	22253	C8	A E	46	41.861	-2.730	25.404	1.00	36.88	C
ATOM	22254	N7	A E	46	41.992	-1.920	24.364	1.00	37.67	N
ATOM	22255	C5	A E	46	43.348	-1.626	24.312	1.00	40.16	C
ATOM	22256	C4	A E	46	44.003	-2.316	25.325	1.00	44.88	C
ATOM	22257	N1	A E	46	45.489	-0.752	23.700	1.00	47.57	N
ATOM	22258	C2	A E	46	45.975	-1.462	24.715	1.00	40.94	C
ATOM	22259	N3	A E	46	45.327	-2.254	25.556	1.00	44.34	N
ATOM	22260	C6	A E	46	44.153	-0.807	23.470	1.00	44.16	C
ATOM	22261	N6	A E	46	43.734	-0.081	22.431	1.00	43.67	N
ATOM	22262	O5'	A E	47	43.683	-1.399	31.433	1.00	46.41	O
ATOM	22263	C4'	A E	47	46.073	-1.758	31.358	1.00	39.06	C
ATOM	22264	C3'	A E	47	46.280	-0.290	31.672	1.00	44.64	C
ATOM	22265	C2'	A E	47	47.223	0.190	30.570	1.00	46.59	C
ATOM	22266	P	A E	47	42.176	-1.899	31.355	1.00	45.56	P
ATOM	22267	OP1	A E	47	41.637	-2.123	32.715	1.00	40.95	O
ATOM	22268	OP2	A E	47	41.507	-1.027	30.378	1.00	41.39	O
ATOM	22269	C5'	A E	47	44.737	-2.294	31.807	1.00	46.05	C
ATOM	22270	O4'	A E	47	46.150	-1.830	29.922	1.00	37.81	O
ATOM	22271	O3'	A E	47	46.718	-0.056	32.999	1.00	55.42	O
ATOM	22272	O2'	A E	47	48.577	-0.068	30.886	1.00	45.58	O
ATOM	22273	C1'	A E	47	46.814	-0.699	29.403	1.00	36.79	C
ATOM	22274	N9	A E	47	45.922	-0.034	28.435	1.00	40.00	N
ATOM	22275	C8	A E	47	44.554	-0.095	28.379	1.00	40.29	C
ATOM	22276	N7	A E	47	44.035	0.533	27.342	1.00	37.27	N
ATOM	22277	C5	A E	47	45.109	1.086	26.696	1.00	36.27	C
ATOM	22278	C4	A E	47	46.288	0.725	27.348	1.00	42.41	C
ATOM	22279	N1	A E	47	46.458	2.242	25.158	1.00	43.47	N
ATOM	22280	C2	A E	47	47.508	1.814	25.886	1.00	41.80	C
ATOM	22281	N3	A E	47	47.537	1.055	26.987	1.00	41.65	N
ATOM	22282	C6	A E	47	45.201	1.881	25.548	1.00	40.69	C
ATOM	22283	N6	A E	47	44.147	2.298	24.821	1.00	39.06	N
ATOM	22284	O5'	A E	48	46.627	2.403	32.978	1.00	41.23	O
ATOM	22285	C4'	A E	48	48.276	3.844	32.018	1.00	40.86	C
ATOM	22286	C3'	A E	48	47.443	5.121	32.165	1.00	36.21	C
ATOM	22287	C2'	A E	48	47.565	5.734	30.781	1.00	39.69	C
ATOM	22288	P	A E	48	46.076	1.183	33.807	1.00	41.34	P
ATOM	22289	OP1	A E	48	46.553	1.264	35.192	1.00	39.27	O
ATOM	22290	OP2	A E	48	44.618	1.041	33.604	1.00	41.93	O
ATOM	22291	C5'	A E	48	47.996	2.731	32.992	1.00	38.68	C
ATOM	22292	O4'	A E	48	47.987	3.396	30.674	1.00	39.60	O
ATOM	22293	O3'	A E	48	47.909	5.971	33.200	1.00	43.19	O
ATOM	22294	O2'	A E	48	48.843	6.315	30.622	1.00	41.16	O
ATOM	22295	C1'	A E	48	47.524	4.489	29.895	1.00	43.07	C
ATOM	22296	N9	A E	48	46.166	4.211	29.359	1.00	39.62	N
ATOM	22297	C8	A E	48	45.187	3.368	29.831	1.00	36.45	C
ATOM	22298	N7	A E	48	44.099	3.343	29.065	1.00	40.87	N
ATOM	22299	C5	A E	48	44.358	4.240	28.034	1.00	32.61	C

ATOM	22300	C4	A E	48	45.631	4.773	28.210	1.00	39.11	C
ATOM	22301	N1	A E	48	44.202	5.592	26.120	1.00	44.21	N
ATOM	22302	C2	A E	48	45.449	6.007	26.413	1.00	43.68	C
ATOM	22303	N3	A E	48	46.237	5.674	27.429	1.00	41.65	N
ATOM	22304	C6	A E	48	43.612	4.689	26.933	1.00	38.70	C
ATOM	22305	N6	A E	48	42.376	4.303	26.605	1.00	38.20	N
ATOM	22306	O5'	A E	49	46.802	8.212	32.805	1.00	36.95	O
ATOM	22307	C4'	A E	49	47.607	9.851	31.257	1.00	41.27	C
ATOM	22308	C3'	A E	49	46.396	10.778	31.455	1.00	38.05	C
ATOM	22309	C2'	A E	49	45.974	11.069	30.027	1.00	35.19	C
ATOM	22310	P	A E	49	46.965	7.090	33.909	1.00	44.19	P
ATOM	22311	OP1	A E	49	47.765	7.714	34.978	1.00	45.28	O
ATOM	22312	OP2	A E	49	45.678	6.440	34.257	1.00	40.36	O
ATOM	22313	C5'	A E	49	47.936	8.934	32.395	1.00	37.31	C
ATOM	22314	O4'	A E	49	47.270	9.058	30.102	1.00	34.23	O
ATOM	22315	O3'	A E	49	46.694	11.930	32.214	1.00	43.85	O
ATOM	22316	O2'	A E	49	46.834	12.044	29.479	1.00	35.89	O
ATOM	22317	C1'	A E	49	46.265	9.707	29.346	1.00	41.48	C
ATOM	22318	N9	A E	49	45.081	8.822	29.345	1.00	35.92	N
ATOM	22319	C8	A E	49	44.713	7.930	30.337	1.00	35.25	C
ATOM	22320	N7	A E	49	43.587	7.285	30.056	1.00	40.19	N
ATOM	22321	C5	A E	49	43.203	7.804	28.811	1.00	37.27	C
ATOM	22322	C4	A E	49	44.115	8.743	28.371	1.00	36.19	C
ATOM	22323	N1	A E	49	42.015	8.222	26.804	1.00	31.83	N
ATOM	22324	C2	A E	49	42.975	9.097	26.528	1.00	35.24	C
ATOM	22325	N3	A E	49	44.047	9.429	27.227	1.00	39.57	N
ATOM	22326	C6	A E	49	42.111	7.563	27.965	1.00	37.37	C
ATOM	22327	N6	A E	49	41.154	6.681	28.241	1.00	45.42	N
ATOM	22328	O5'	U E	50	44.509	13.099	32.719	1.00	36.83	O
ATOM	22329	C4'	U E	50	43.605	14.175	30.756	1.00	38.55	C
ATOM	22330	C3'	U E	50	42.229	14.401	31.395	1.00	40.44	C
ATOM	22331	C2'	U E	50	41.274	13.938	30.305	1.00	36.40	C
ATOM	22332	P	U E	50	45.731	12.383	33.444	1.00	47.45	P
ATOM	22333	OP1	U E	50	46.434	13.424	34.211	1.00	42.35	O
ATOM	22334	OP2	U E	50	45.312	11.147	34.149	1.00	48.12	O
ATOM	22335	C5'	U E	50	44.775	14.023	31.682	1.00	35.40	C
ATOM	22336	O4'	U E	50	43.449	12.983	29.975	1.00	38.18	O
ATOM	22337	O3'	U E	50	42.013	15.758	31.729	1.00	51.65	O
ATOM	22338	O2'	U E	50	41.028	14.996	29.399	1.00	38.56	O
ATOM	22339	C1'	U E	50	42.095	12.839	29.590	1.00	38.02	C
ATOM	22340	N1	U E	50	41.602	11.479	29.933	1.00	35.86	N
ATOM	22341	C2	U E	50	40.672	10.958	29.074	1.00	40.78	C
ATOM	22342	N3	U E	50	40.172	9.720	29.422	1.00	36.55	N
ATOM	22343	C4	U E	50	40.496	8.979	30.545	1.00	43.01	C
ATOM	22344	C5	U E	50	41.462	9.612	31.402	1.00	38.18	C
ATOM	22345	C6	U E	50	41.966	10.803	31.072	1.00	37.40	C
ATOM	22346	O2	U E	50	40.359	11.566	28.061	1.00	38.63	O
ATOM	22347	O4	U E	50	39.961	7.868	30.757	1.00	42.69	O
ATOM	22348	P	A E	51	41.581	16.220	33.209	1.00	47.64	P
ATOM	22349	OP1	A E	51	40.129	16.275	33.210	1.00	40.12	O
ATOM	22350	OP2	A E	51	42.237	15.309	34.199	1.00	43.84	O
ATOM	22351	O5'	A E	51	42.444	17.544	33.477	1.00	40.14	O
ATOM	22352	C5'	A E	51	42.437	18.687	32.667	1.00	38.23	C
ATOM	22353	C4'	A E	51	43.239	18.626	31.394	1.00	39.49	C
ATOM	22354	O4'	A E	51	42.603	19.581	30.540	1.00	41.15	O
ATOM	22355	C3'	A E	51	44.744	18.992	31.417	1.00	48.16	C
ATOM	22356	O3'	A E	51	45.584	17.833	31.264	1.00	43.16	O
ATOM	22357	C2'	A E	51	44.942	19.913	30.213	1.00	47.24	C
ATOM	22358	O2'	A E	51	45.434	19.198	29.098	1.00	49.47	O
ATOM	22359	C1'	A E	51	43.531	20.378	29.878	1.00	48.28	C
ATOM	22360	N9	A E	51	43.275	21.794	30.196	1.00	43.77	N
ATOM	22361	C8	A E	51	42.729	22.660	29.289	1.00	42.31	C
ATOM	22362	N7	A E	51	42.598	23.865	29.731	1.00	46.41	N

ATOM	22363	C5	A E	51	43.094	23.784	31.017	1.00	43.77	C
ATOM	22364	C4	A E	51	43.523	22.507	31.326	1.00	41.40	C
ATOM	22365	N1	A E	51	43.760	24.400	33.212	1.00	48.01	N
ATOM	22366	C2	A E	51	44.144	23.102	33.360	1.00	41.58	C
ATOM	22367	N3	A E	51	44.048	22.106	32.488	1.00	44.19	N
ATOM	22368	C6	A E	51	43.221	24.766	32.014	1.00	44.37	C
ATOM	22369	N6	A E	51	42.835	26.008	31.801	1.00	42.69	N
ATOM	22370	P	A E	52	46.997	17.631	32.011	1.00	46.70	P
ATOM	22371	OP1	A E	52	47.404	16.257	31.592	1.00	55.60	O
ATOM	22372	OP2	A E	52	46.921	17.927	33.460	1.00	36.44	O
ATOM	22373	O5'	A E	52	48.023	18.641	31.339	1.00	39.30	O
ATOM	22374	C5'	A E	52	48.407	18.550	29.975	1.00	44.26	C
ATOM	22375	C4'	A E	52	49.645	19.373	29.694	1.00	45.81	C
ATOM	22376	O4'	A E	52	49.284	20.765	29.524	1.00	52.63	O
ATOM	22377	C3'	A E	52	50.687	19.374	30.802	1.00	50.21	C
ATOM	22378	O3'	A E	52	51.603	18.307	30.657	1.00	51.85	O
ATOM	22379	C2'	A E	52	51.363	20.726	30.660	1.00	48.70	C
ATOM	22380	O2'	A E	52	52.377	20.672	29.672	1.00	51.70	O
ATOM	22381	C1'	A E	52	50.221	21.602	30.165	1.00	48.09	C
ATOM	22382	N9	A E	52	49.540	22.249	31.300	1.00	51.94	N
ATOM	22383	C8	A E	52	48.501	21.688	31.998	1.00	47.51	C
ATOM	22384	N7	A E	52	48.071	22.405	32.987	1.00	45.29	N
ATOM	22385	C5	A E	52	48.868	23.540	32.942	1.00	48.31	C
ATOM	22386	C4	A E	52	49.795	23.463	31.917	1.00	51.15	C
ATOM	22387	N1	A E	52	49.787	25.658	33.459	1.00	52.87	N
ATOM	22388	C2	A E	52	50.645	25.448	32.439	1.00	49.52	C
ATOM	22389	N3	A E	52	50.727	24.400	31.608	1.00	53.72	N
ATOM	22390	C6	A E	52	48.868	24.705	33.746	1.00	54.27	C
ATOM	22391	N6	A E	52	48.019	24.875	34.778	1.00	44.75	N
ATOM	22392	O5'	G E	53	53.263	19.132	32.363	1.00	51.75	O
ATOM	22393	C4'	G E	53	52.917	20.730	34.172	1.00	51.45	C
ATOM	22394	C3'	G E	53	53.073	21.043	35.656	1.00	49.45	C
ATOM	22395	C2'	G E	53	51.895	21.972	35.933	1.00	50.33	C
ATOM	22396	P	G E	53	52.492	17.823	31.893	1.00	53.21	P
ATOM	22397	OP1	G E	53	53.504	16.884	31.321	1.00	63.21	O
ATOM	22398	OP2	G E	53	51.608	17.332	32.980	1.00	46.52	O
ATOM	22399	C5'	G E	53	53.479	19.390	33.744	1.00	49.48	C
ATOM	22400	O4'	G E	53	51.478	20.760	33.945	1.00	48.30	O
ATOM	22401	O3'	G E	53	54.350	21.588	35.964	1.00	50.58	O
ATOM	22402	O2'	G E	53	52.155	23.280	35.450	1.00	52.32	O
ATOM	22403	C1'	G E	53	50.825	21.354	35.044	1.00	48.54	C
ATOM	22404	N9	G E	53	50.044	20.314	35.739	1.00	44.38	N
ATOM	22405	C8	G E	53	49.988	18.992	35.426	1.00	42.49	C
ATOM	22406	N7	G E	53	49.203	18.300	36.220	1.00	46.90	N
ATOM	22407	C5	G E	53	48.680	19.217	37.123	1.00	43.03	C
ATOM	22408	C4	G E	53	49.192	20.476	36.829	1.00	49.11	C
ATOM	22409	N1	G E	53	47.519	20.290	38.840	1.00	46.90	N
ATOM	22410	C2	G E	53	48.079	21.478	38.483	1.00	45.04	C
ATOM	22411	N3	G E	53	48.933	21.633	37.480	1.00	45.06	N
ATOM	22412	C6	G E	53	47.751	19.079	38.202	1.00	42.49	C
ATOM	22413	O6	G E	53	47.155	18.107	38.663	1.00	40.84	O
ATOM	22414	N2	G E	53	47.696	22.510	39.246	1.00	47.08	N
ATOM	22415	O5'	G E	54	54.077	22.263	38.391	1.00	50.86	O
ATOM	22416	C4'	G E	54	53.098	24.229	39.363	1.00	55.89	C
ATOM	22417	C3'	G E	54	53.540	23.913	40.783	1.00	52.35	C
ATOM	22418	C2'	G E	54	52.234	24.002	41.562	1.00	57.64	C
ATOM	22419	P	G E	54	55.014	21.417	37.422	1.00	55.29	P
ATOM	22420	OP1	G E	54	56.322	22.129	37.350	1.00	58.97	O
ATOM	22421	OP2	G E	54	54.930	20.023	37.901	1.00	47.03	O
ATOM	22422	C5'	G E	54	53.969	23.671	38.266	1.00	53.42	C
ATOM	22423	O4'	G E	54	51.776	23.648	39.264	1.00	53.52	O
ATOM	22424	O3'	G E	54	54.527	24.826	41.236	1.00	63.52	O
ATOM	22425	O2'	G E	54	51.888	25.365	41.798	1.00	57.57	O

ATOM	22426	C1'	G E	54	51.234	23.456	40.550	1.00	52.04	C
ATOM	22427	N1	G E	54	48.380	20.037	43.021	1.00	48.77	N
ATOM	22428	N9	G E	54	50.896	22.025	40.719	1.00	52.30	N
ATOM	22429	C8	G E	54	51.378	20.957	39.984	1.00	50.17	C
ATOM	22430	N7	G E	54	50.860	19.804	40.335	1.00	46.09	N
ATOM	22431	C5	G E	54	49.975	20.113	41.339	1.00	42.55	C
ATOM	22432	C6	G E	54	49.118	19.290	42.097	1.00	46.55	C
ATOM	22433	O6	G E	54	48.934	18.085	42.060	1.00	40.94	O
ATOM	22434	C2	G E	54	48.459	21.382	43.189	1.00	44.18	C
ATOM	22435	N2	G E	54	47.658	21.882	44.131	1.00	52.06	N
ATOM	22436	N3	G E	54	49.244	22.162	42.483	1.00	47.65	N
ATOM	22437	C4	G E	54	49.973	21.480	41.584	1.00	49.94	C
ATOM	22438	O5'	C E	55	55.073	24.185	43.643	1.00	70.81	O
ATOM	22439	C4'	C E	55	54.208	25.046	45.716	1.00	66.91	C
ATOM	22440	C3'	C E	55	54.332	24.016	46.837	1.00	70.99	C
ATOM	22441	C2'	C E	55	52.880	23.722	47.174	1.00	73.43	C
ATOM	22442	P	C E	55	55.733	24.385	42.202	1.00	63.73	P
ATOM	22443	OP1	C E	55	56.593	25.582	42.305	1.00	75.51	O
ATOM	22444	OP2	C E	55	56.297	23.092	41.752	1.00	67.13	O
ATOM	22445	C5'	C E	55	55.332	25.089	44.717	1.00	70.84	C
ATOM	22446	O4'	C E	55	53.032	24.610	44.989	1.00	63.47	O
ATOM	22447	O3'	C E	55	55.158	24.374	47.949	1.00	86.67	O
ATOM	22448	O2'	C E	55	52.283	24.780	47.905	1.00	82.63	O
ATOM	22449	C1'	C E	55	52.257	23.741	45.790	1.00	65.91	C
ATOM	22450	N1	C E	55	52.211	22.381	45.203	1.00	59.51	N
ATOM	22451	C2	C E	55	51.278	21.517	45.790	1.00	59.08	C
ATOM	22452	N3	C E	55	51.161	20.249	45.333	1.00	56.11	N
ATOM	22453	C4	C E	55	51.936	19.809	44.337	1.00	56.01	C
ATOM	22454	C5	C E	55	52.903	20.663	43.712	1.00	55.69	C
ATOM	22455	C6	C E	55	53.007	21.931	44.178	1.00	59.69	C
ATOM	22456	O2	C E	55	50.564	21.923	46.727	1.00	59.47	O
ATOM	22457	N4	C E	55	51.747	18.543	43.948	1.00	48.08	N
ATOM	22458	O5'	U E	56	54.443	24.729	50.408	1.00	84.49	O
ATOM	22459	C4'	U E	56	52.249	23.978	51.129	1.00	84.59	C
ATOM	22460	C3'	U E	56	51.194	22.883	51.278	1.00	83.42	C
ATOM	22461	C2'	U E	56	49.887	23.669	51.370	1.00	89.00	C
ATOM	22462	P	U E	56	54.763	25.510	49.039	1.00	88.97	P
ATOM	22463	OP1	U E	56	53.596	26.331	48.637	1.00	88.44	O
ATOM	22464	OP2	U E	56	56.040	26.229	49.241	1.00	93.51	O
ATOM	22465	C5'	U E	56	53.562	23.606	50.481	1.00	85.81	C
ATOM	22466	O4'	U E	56	51.592	24.986	50.333	1.00	88.01	O
ATOM	22467	O3'	U E	56	51.388	22.095	52.437	1.00	85.83	O
ATOM	22468	O2'	U E	56	49.605	24.012	52.720	1.00	92.23	O
ATOM	22469	C1'	U E	56	50.203	24.950	50.578	1.00	87.09	C
ATOM	22470	N1	U E	56	49.432	25.046	49.312	1.00	80.36	N
ATOM	22471	C2	U E	56	49.119	26.302	48.798	1.00	89.59	C
ATOM	22472	N3	U E	56	48.357	26.298	47.639	1.00	88.55	N
ATOM	22473	C4	U E	56	47.852	25.194	46.971	1.00	81.82	C
ATOM	22474	C5	U E	56	48.192	23.971	47.601	1.00	74.71	C
ATOM	22475	C6	U E	56	48.926	23.929	48.715	1.00	76.57	C
ATOM	22476	O2	U E	56	49.517	27.344	49.312	1.00	91.95	O
ATOM	22477	O4	U E	56	47.169	25.292	45.938	1.00	87.78	O
ATOM	22478	P	A E	57	51.653	20.516	52.339	1.00	93.72	P
ATOM	22479	OP1	A E	57	53.085	20.381	51.944	1.00	80.38	O
ATOM	22480	OP2	A E	57	51.113	19.876	53.577	1.00	79.22	O
ATOM	22481	O5'	A E	57	50.741	20.025	51.123	1.00	78.62	O
ATOM	22482	C5'	A E	57	49.729	19.043	51.328	1.00	67.84	C
ATOM	22483	C4'	A E	57	49.865	17.875	50.380	1.00	62.91	C
ATOM	22484	O4'	A E	57	50.428	18.331	49.116	1.00	64.21	O
ATOM	22485	C3'	A E	57	50.767	16.736	50.857	1.00	62.55	C
ATOM	22486	O3'	A E	57	50.248	15.504	50.370	1.00	57.21	O
ATOM	22487	C2'	A E	57	52.081	17.039	50.146	1.00	65.80	C
ATOM	22488	O2'	A E	57	52.940	15.937	49.972	1.00	69.67	O

ATOM	22489	C1'	A E	57	51.584	17.571	48.813	1.00	59.45	C
ATOM	22490	N9	A E	57	52.554	18.439	48.160	1.00	57.90	N
ATOM	22491	C8	A E	57	52.877	19.720	48.526	1.00	57.78	C
ATOM	22492	N7	A E	57	53.793	20.255	47.763	1.00	60.41	N
ATOM	22493	C5	A E	57	54.093	19.250	46.850	1.00	50.72	C
ATOM	22494	C4	A E	57	53.335	18.122	47.079	1.00	53.33	C
ATOM	22495	N1	A E	57	55.044	18.048	45.057	1.00	55.30	N
ATOM	22496	C2	A E	57	54.250	17.021	45.395	1.00	51.04	C
ATOM	22497	N3	A E	57	53.368	16.962	46.392	1.00	58.40	N
ATOM	22498	C6	A E	57	54.987	19.197	45.783	1.00	51.01	C
ATOM	22499	N6	A E	57	55.777	20.220	45.461	1.00	51.28	N
ATOM	22500	P	G E	58	49.465	14.516	51.356	1.00	65.53	P
ATOM	22501	OP1	G E	58	50.029	14.622	52.726	1.00	65.55	O
ATOM	22502	OP2	G E	58	49.329	13.218	50.636	1.00	60.24	O
ATOM	22503	O5'	G E	58	47.997	15.114	51.443	1.00	61.70	O
ATOM	22504	C5'	G E	58	47.577	15.961	52.503	1.00	60.67	C
ATOM	22505	C4'	G E	58	46.250	16.565	52.137	1.00	61.26	C
ATOM	22506	O4'	G E	58	46.467	17.592	51.138	1.00	53.52	O
ATOM	22507	C3'	G E	58	45.298	15.576	51.476	1.00	54.33	C
ATOM	22508	O3'	G E	58	44.496	14.885	52.413	1.00	50.05	O
ATOM	22509	C2'	G E	58	44.512	16.438	50.506	1.00	52.43	C
ATOM	22510	O2'	G E	58	43.495	17.149	51.196	1.00	52.69	O
ATOM	22511	C1'	G E	58	45.570	17.436	50.069	1.00	51.05	C
ATOM	22512	N9	G E	58	46.368	16.985	48.917	1.00	47.23	N
ATOM	22513	C8	G E	58	46.558	15.752	48.350	1.00	52.57	C
ATOM	22514	N7	G E	58	47.403	15.786	47.346	1.00	51.76	N
ATOM	22515	C5	G E	58	47.807	17.103	47.262	1.00	43.92	C
ATOM	22516	C4	G E	58	47.172	17.843	48.226	1.00	50.24	C
ATOM	22517	N1	G E	58	48.781	19.115	46.652	1.00	51.80	N
ATOM	22518	C2	G E	58	48.097	19.754	47.653	1.00	55.48	C
ATOM	22519	N3	G E	58	47.258	19.162	48.483	1.00	53.34	N
ATOM	22520	C6	G E	58	48.690	17.764	46.376	1.00	48.43	C
ATOM	22521	O6	G E	58	49.362	17.335	45.436	1.00	54.57	O
ATOM	22522	N2	G E	58	48.327	21.061	47.748	1.00	53.77	N
ATOM	22523	P	U E	59	44.476	13.291	52.419	1.00	52.75	P
ATOM	22524	OP1	U E	59	43.322	12.787	53.212	1.00	48.76	O
ATOM	22525	OP2	U E	59	45.869	12.887	52.737	1.00	64.75	O
ATOM	22526	O5'	U E	59	44.201	12.895	50.903	1.00	51.99	O
ATOM	22527	C5'	U E	59	42.872	12.856	50.413	1.00	51.73	C
ATOM	22528	C4'	U E	59	42.837	12.520	48.945	1.00	52.68	C
ATOM	22529	O4'	U E	59	42.913	11.086	48.776	1.00	53.34	O
ATOM	22530	C3'	U E	59	41.584	12.911	48.172	1.00	52.93	C
ATOM	22531	O3'	U E	59	41.579	14.297	47.850	1.00	54.45	O
ATOM	22532	C2'	U E	59	41.666	11.987	46.963	1.00	50.06	C
ATOM	22533	O2'	U E	59	42.587	12.510	46.019	1.00	49.98	O
ATOM	22534	C1'	U E	59	42.281	10.717	47.581	1.00	48.90	C
ATOM	22535	N1	U E	59	41.270	9.689	47.898	1.00	50.86	N
ATOM	22536	C2	U E	59	40.870	8.919	46.835	1.00	49.48	C
ATOM	22537	N3	U E	59	39.925	7.979	47.125	1.00	50.03	N
ATOM	22538	C4	U E	59	39.354	7.730	48.337	1.00	50.23	C
ATOM	22539	C5	U E	59	39.819	8.563	49.406	1.00	46.94	C
ATOM	22540	C6	U E	59	40.750	9.497	49.159	1.00	50.39	C
ATOM	22541	O2	U E	59	41.325	9.067	45.715	1.00	45.79	O
ATOM	22542	O4	U E	59	38.504	6.837	48.392	1.00	57.71	O
ATOM	22543	O5'	C E	60	40.926	16.500	46.831	1.00	48.01	O
ATOM	22544	C4'	C E	60	41.846	18.512	47.871	1.00	49.97	C
ATOM	22545	C3'	C E	60	41.653	19.319	46.606	1.00	48.81	C
ATOM	22546	C2'	C E	60	42.943	20.131	46.526	1.00	47.83	C
ATOM	22547	P	C E	60	40.479	14.971	46.882	1.00	48.27	P
ATOM	22548	OP1	C E	60	40.596	14.383	45.521	1.00	46.47	O
ATOM	22549	OP2	C E	60	39.170	14.898	47.557	1.00	45.39	O
ATOM	22550	C5'	C E	60	40.985	17.275	48.022	1.00	47.37	C
ATOM	22551	O4'	C E	60	43.258	18.189	47.856	1.00	49.15	O

ATOM	22552	O3'	C E	60	40.489	20.113	46.651	1.00	50.18	O
ATOM	22553	O2'	C E	60	42.915	21.251	47.402	1.00	47.99	O
ATOM	22554	C1'	C E	60	43.958	19.136	47.072	1.00	44.48	C
ATOM	22555	N1	C E	60	44.680	18.432	45.996	1.00	46.49	N
ATOM	22556	C2	C E	60	45.649	19.128	45.285	1.00	44.76	C
ATOM	22557	N3	C E	60	46.338	18.511	44.297	1.00	47.10	N
ATOM	22558	C4	C E	60	46.111	17.223	44.033	1.00	48.65	C
ATOM	22559	C5	C E	60	45.134	16.475	44.742	1.00	45.37	C
ATOM	22560	C6	C E	60	44.437	17.113	45.701	1.00	48.57	C
ATOM	22561	O2	C E	60	45.860	20.300	45.560	1.00	44.97	O
ATOM	22562	N4	C E	60	46.819	16.652	43.054	1.00	43.79	N
ATOM	22563	O5'	C E	61	40.778	21.455	44.551	1.00	42.10	O
ATOM	22564	C4'	C E	61	42.113	23.463	44.320	1.00	39.44	C
ATOM	22565	C3'	C E	61	41.925	23.616	42.829	1.00	44.24	C
ATOM	22566	C2'	C E	61	43.347	23.857	42.340	1.00	44.36	C
ATOM	22567	P	C E	61	39.753	20.499	45.288	1.00	43.90	P
ATOM	22568	OP1	C E	61	38.599	21.377	45.643	1.00	49.28	O
ATOM	22569	OP2	C E	61	39.466	19.300	44.514	1.00	39.12	O
ATOM	22570	C5'	C E	61	41.008	22.757	45.059	1.00	40.57	C
ATOM	22571	O4'	C E	61	43.345	22.718	44.430	1.00	44.58	O
ATOM	22572	O3'	C E	61	41.015	24.638	42.488	1.00	41.48	O
ATOM	22573	O2'	C E	61	43.767	25.194	42.577	1.00	43.23	O
ATOM	22574	C1'	C E	61	44.134	22.932	43.273	1.00	45.59	C
ATOM	22575	N1	C E	61	44.417	21.633	42.638	1.00	40.43	N
ATOM	22576	C2	C E	61	45.428	21.544	41.692	1.00	42.46	C
ATOM	22577	N3	C E	61	45.690	20.353	41.109	1.00	46.50	N
ATOM	22578	C4	C E	61	44.981	19.269	41.420	1.00	47.75	C
ATOM	22579	C5	C E	61	43.918	19.334	42.369	1.00	44.61	C
ATOM	22580	C6	C E	61	43.681	20.524	42.953	1.00	47.31	C
ATOM	22581	O2	C E	61	46.100	22.540	41.410	1.00	43.32	O
ATOM	22582	N4	C E	61	45.293	18.123	40.794	1.00	43.77	N
ATOM	22583	O5'	G E	62	41.069	24.519	40.013	1.00	42.18	O
ATOM	22584	C4'	G E	62	42.597	25.546	38.476	1.00	38.60	C
ATOM	22585	C3'	G E	62	41.989	24.957	37.223	1.00	39.79	C
ATOM	22586	C2'	G E	62	43.207	24.329	36.536	1.00	39.17	C
ATOM	22587	P	G E	62	40.062	24.456	41.225	1.00	37.32	P
ATOM	22588	OP1	G E	62	39.170	25.663	41.108	1.00	46.04	O
ATOM	22589	OP2	G E	62	39.386	23.157	41.224	1.00	36.49	O
ATOM	22590	C5'	G E	62	41.643	25.751	39.616	1.00	42.92	C
ATOM	22591	O4'	G E	62	43.602	24.564	38.866	1.00	42.86	O
ATOM	22592	O3'	G E	62	41.345	25.923	36.401	1.00	42.58	O
ATOM	22593	O2'	G E	62	43.942	25.280	35.789	1.00	43.61	O
ATOM	22594	C1'	G E	62	44.066	23.889	37.728	1.00	40.14	C
ATOM	22595	N1	G E	62	45.382	19.288	36.089	1.00	39.73	N
ATOM	22596	N9	G E	62	43.923	22.449	37.932	1.00	43.47	N
ATOM	22597	C8	G E	62	43.079	21.848	38.804	1.00	42.71	C
ATOM	22598	N7	G E	62	43.136	20.566	38.691	1.00	47.85	N
ATOM	22599	C5	G E	62	44.036	20.331	37.672	1.00	41.03	C
ATOM	22600	C6	G E	62	44.463	19.096	37.119	1.00	43.88	C
ATOM	22601	O6	G E	62	44.095	17.969	37.466	1.00	44.09	O
ATOM	22602	C2	G E	62	45.827	20.523	35.658	1.00	47.22	C
ATOM	22603	N2	G E	62	46.714	20.505	34.645	1.00	44.45	N
ATOM	22604	N3	G E	62	45.416	21.691	36.185	1.00	43.77	N
ATOM	22605	C4	G E	62	44.526	21.495	37.177	1.00	37.59	C
ATOM	22606	P	U E	63	39.810	26.371	36.579	1.00	42.94	P
ATOM	22607	OP1	U E	63	39.836	27.582	37.393	1.00	40.37	O
ATOM	22608	OP2	U E	63	38.889	25.260	36.857	1.00	39.89	O
ATOM	22609	O5'	U E	63	39.395	26.861	35.139	1.00	42.56	O
ATOM	22610	C5'	U E	63	39.921	28.045	34.563	1.00	38.43	C
ATOM	22611	C4'	U E	63	39.242	28.338	33.250	1.00	39.69	C
ATOM	22612	O4'	U E	63	39.655	27.367	32.257	1.00	43.89	O
ATOM	22613	C3'	U E	63	37.714	28.269	33.285	1.00	43.16	C
ATOM	22614	O3'	U E	63	37.186	29.168	32.289	1.00	43.94	O

ATOM	22615	C2'	U E	63	37.460	26.811	32.891	1.00	36.83	C
ATOM	22616	O2'	U E	63	36.155	26.492	32.437	1.00	45.10	O
ATOM	22617	C1'	U E	63	38.520	26.626	31.808	1.00	44.35	C
ATOM	22618	N1	U E	63	38.935	25.224	31.592	1.00	44.59	N
ATOM	22619	C2	U E	63	38.540	24.580	30.438	1.00	42.79	C
ATOM	22620	N3	U E	63	38.997	23.271	30.298	1.00	45.85	N
ATOM	22621	C4	U E	63	39.785	22.579	31.184	1.00	44.03	C
ATOM	22622	C5	U E	63	40.133	23.332	32.360	1.00	50.25	C
ATOM	22623	C6	U E	63	39.724	24.586	32.522	1.00	40.34	C
ATOM	22624	O2	U E	63	37.862	25.133	29.585	1.00	33.95	O
ATOM	22625	O4	U E	63	40.114	21.411	30.975	1.00	47.47	O
ATOM	22626	O5'	U E	64	35.803	30.953	33.424	1.00	41.91	O
ATOM	22627	C4'	U E	64	33.440	31.165	33.821	1.00	42.09	C
ATOM	22628	C3'	U E	64	33.404	32.588	34.378	1.00	41.97	C
ATOM	22629	C2'	U E	64	32.705	32.391	35.712	1.00	38.70	C
ATOM	22630	P	U E	64	37.132	30.768	32.552	1.00	39.73	P
ATOM	22631	OP1	U E	64	36.938	31.397	31.228	1.00	39.87	O
ATOM	22632	OP2	U E	64	38.264	31.219	33.414	1.00	38.08	O
ATOM	22633	C5'	U E	64	34.520	30.872	32.826	1.00	39.65	C
ATOM	22634	O4'	U E	64	33.652	30.343	34.986	1.00	37.95	O
ATOM	22635	O3'	U E	64	32.753	33.502	33.518	1.00	44.31	O
ATOM	22636	O2'	U E	64	31.311	32.204	35.525	1.00	42.20	O
ATOM	22637	C1'	U E	64	33.289	31.057	36.151	1.00	42.27	C
ATOM	22638	N1	U E	64	34.491	31.249	36.979	1.00	49.29	N
ATOM	22639	C2	U E	64	34.269	31.710	38.260	1.00	48.00	C
ATOM	22640	N3	U E	64	35.421	31.865	38.987	1.00	46.72	N
ATOM	22641	C4	U E	64	36.720	31.642	38.548	1.00	47.34	C
ATOM	22642	C5	U E	64	36.850	31.180	37.198	1.00	44.25	C
ATOM	22643	C6	U E	64	35.750	30.996	36.473	1.00	44.31	C
ATOM	22644	O2	U E	64	33.147	31.916	38.707	1.00	46.78	O
ATOM	22645	O4	U E	64	37.658	31.844	39.320	1.00	49.11	O
ATOM	22646	O5'	A E	65	33.349	35.792	34.404	1.00	48.59	O
ATOM	22647	C4'	A E	65	32.367	36.374	36.565	1.00	46.16	C
ATOM	22648	C3'	A E	65	33.331	37.547	36.723	1.00	51.97	C
ATOM	22649	C2'	A E	65	33.749	37.426	38.178	1.00	50.42	C
ATOM	22650	P	A E	65	33.459	34.882	33.087	1.00	42.17	P
ATOM	22651	OP1	A E	65	32.675	35.386	31.947	1.00	48.18	O
ATOM	22652	OP2	A E	65	34.882	34.637	32.769	1.00	50.95	O
ATOM	22653	C5'	A E	65	32.143	35.845	35.169	1.00	43.34	C
ATOM	22654	O4'	A E	65	32.901	35.345	37.435	1.00	47.21	O
ATOM	22655	O3'	A E	65	32.714	38.793	36.442	1.00	52.22	O
ATOM	22656	O2'	A E	65	32.683	37.880	38.998	1.00	52.26	O
ATOM	22657	C1'	A E	65	33.848	35.908	38.330	1.00	47.13	C
ATOM	22658	N9	A E	65	35.184	35.428	37.926	1.00	49.05	N
ATOM	22659	C8	A E	65	35.432	34.755	36.754	1.00	47.67	C
ATOM	22660	N7	A E	65	36.681	34.464	36.549	1.00	49.55	N
ATOM	22661	C5	A E	65	37.324	34.970	37.658	1.00	52.33	C
ATOM	22662	C4	A E	65	36.427	35.582	38.514	1.00	50.10	C
ATOM	22663	N1	A E	65	39.024	35.561	39.166	1.00	57.37	N
ATOM	22664	C2	A E	65	38.056	36.122	39.897	1.00	48.65	C
ATOM	22665	N3	A E	65	36.750	36.184	39.669	1.00	52.15	N
ATOM	22666	C6	A E	65	38.685	34.960	38.016	1.00	58.93	C
ATOM	22667	N6	A E	65	39.637	34.395	37.269	1.00	55.86	N
ATOM	22668	P	U E	66	33.517	39.961	35.683	1.00	58.08	P
ATOM	22669	OP1	U E	66	32.731	41.201	35.932	1.00	60.45	O
ATOM	22670	OP2	U E	66	33.894	39.528	34.324	1.00	52.28	O
ATOM	22671	O5'	U E	66	34.875	40.143	36.485	1.00	59.94	O
ATOM	22672	C5'	U E	66	34.938	40.996	37.614	1.00	56.45	C
ATOM	22673	C4'	U E	66	36.354	41.165	38.090	1.00	57.89	C
ATOM	22674	O4'	U E	66	36.934	39.862	38.327	1.00	61.77	O
ATOM	22675	C3'	U E	66	37.316	41.819	37.113	1.00	58.07	C
ATOM	22676	O3'	U E	66	37.231	43.229	37.112	1.00	60.04	O
ATOM	22677	C2'	U E	66	38.669	41.304	37.580	1.00	61.69	C

ATOM	22678	O2'	U E	66	39.133	42.047	38.696	1.00	62.25	O
ATOM	22679	C1'	U E	66	38.317	39.896	38.051	1.00	60.83	C
ATOM	22680	N1	U E	66	38.630	38.862	37.042	1.00	59.18	N
ATOM	22681	C2	U E	66	39.935	38.410	36.993	1.00	61.88	C
ATOM	22682	N3	U E	66	40.166	37.442	36.046	1.00	64.10	N
ATOM	22683	C4	U E	66	39.259	36.889	35.166	1.00	65.93	C
ATOM	22684	C5	U E	66	37.924	37.416	35.284	1.00	59.68	C
ATOM	22685	C6	U E	66	37.662	38.355	36.206	1.00	58.78	C
ATOM	22686	O2	U E	66	40.820	38.835	37.726	1.00	59.07	O
ATOM	22687	O4	U E	66	39.641	36.012	34.377	1.00	63.52	O
ATOM	22688	O5'	C E	67	39.004	43.604	35.398	1.00	60.10	O
ATOM	22689	C4'	C E	67	41.277	44.124	35.072	1.00	69.04	C
ATOM	22690	C3'	C E	67	40.953	44.815	33.761	1.00	73.57	C
ATOM	22691	C2'	C E	67	41.819	44.068	32.742	1.00	75.96	C
ATOM	22692	P	C E	67	37.531	44.035	35.767	1.00	64.03	P
ATOM	22693	OP1	C E	67	37.534	45.482	36.070	1.00	78.96	O
ATOM	22694	OP2	C E	67	36.646	43.532	34.675	1.00	60.49	O
ATOM	22695	C5'	C E	67	40.135	44.146	36.040	1.00	61.41	C
ATOM	22696	O4'	C E	67	41.564	42.745	34.705	1.00	75.39	O
ATOM	22697	O3'	C E	67	41.186	46.214	33.862	1.00	76.35	O
ATOM	22698	O2'	C E	67	43.152	44.551	32.738	1.00	76.25	O
ATOM	22699	C1'	C E	67	41.828	42.646	33.322	1.00	77.35	C
ATOM	22700	N1	C E	67	40.812	41.759	32.680	1.00	75.79	N
ATOM	22701	C2	C E	67	40.203	40.696	33.377	1.00	71.83	C
ATOM	22702	N3	C E	67	39.295	39.911	32.731	1.00	72.98	N
ATOM	22703	C4	C E	67	38.987	40.130	31.441	1.00	70.41	C
ATOM	22704	C5	C E	67	39.600	41.182	30.698	1.00	66.11	C
ATOM	22705	C6	C E	67	40.493	41.947	31.351	1.00	73.17	C
ATOM	22706	O2	C E	67	40.481	40.492	34.571	1.00	76.14	O
ATOM	22707	N4	C E	67	38.088	39.337	30.839	1.00	70.41	N
ATOM	22708	O5'	A E	68	41.140	47.125	31.578	1.00	69.20	O
ATOM	22709	C4'	A E	68	42.861	48.024	30.214	1.00	48.30	C
ATOM	22710	C3'	A E	68	44.190	48.737	30.196	1.00	49.02	C
ATOM	22711	C2'	A E	68	43.960	49.880	29.219	1.00	49.72	C
ATOM	22712	P	A E	68	40.387	47.276	32.962	1.00	75.60	P
ATOM	22713	OP1	A E	68	40.645	48.649	33.492	1.00	68.69	O
ATOM	22714	OP2	A E	68	38.957	46.890	32.802	1.00	74.53	O
ATOM	22715	C5'	A E	68	42.538	47.324	31.494	1.00	49.13	C
ATOM	22716	O4'	A E	68	41.879	49.061	29.997	1.00	47.56	O
ATOM	22717	O3'	A E	68	45.241	47.874	29.828	1.00	55.31	O
ATOM	22718	O2'	A E	68	44.114	49.481	27.873	1.00	48.93	O
ATOM	22719	C1'	A E	68	42.489	50.204	29.464	1.00	51.10	C
ATOM	22720	N1	A E	68	43.687	55.033	30.448	1.00	52.72	N
ATOM	22721	N9	A E	68	42.320	51.305	30.422	1.00	42.90	N
ATOM	22722	C8	A E	68	41.623	51.337	31.602	1.00	50.76	C
ATOM	22723	N7	A E	68	41.667	52.499	32.218	1.00	46.35	N
ATOM	22724	C5	A E	68	42.465	53.266	31.382	1.00	46.83	C
ATOM	22725	C6	A E	68	42.906	54.591	31.450	1.00	52.26	C
ATOM	22726	N6	A E	68	42.614	55.443	32.437	1.00	47.28	N
ATOM	22727	C2	A E	68	44.002	54.227	29.433	1.00	47.73	C
ATOM	22728	N3	A E	68	43.633	52.967	29.250	1.00	50.10	N
ATOM	22729	C4	A E	68	42.868	52.548	30.277	1.00	48.25	C
ATOM	22730	P	A E	69	46.576	47.789	30.703	1.00	50.93	P
ATOM	22731	OP1	A E	69	47.482	46.838	29.984	1.00	51.78	O
ATOM	22732	OP2	A E	69	46.225	47.545	32.118	1.00	45.63	O
ATOM	22733	O5'	A E	69	47.195	49.247	30.556	1.00	49.02	O
ATOM	22734	C5'	A E	69	47.657	49.717	29.305	1.00	49.69	C
ATOM	22735	C4'	A E	69	48.086	51.151	29.412	1.00	58.03	C
ATOM	22736	O4'	A E	69	46.926	52.004	29.617	1.00	49.94	O
ATOM	22737	C3'	A E	69	48.984	51.471	30.588	1.00	54.96	C
ATOM	22738	O3'	A E	69	50.337	51.112	30.343	1.00	63.92	O
ATOM	22739	C2'	A E	69	48.756	52.966	30.759	1.00	55.06	C
ATOM	22740	O2'	A E	69	49.456	53.676	29.753	1.00	56.85	O

ATOM	22741	C1'	A E	69	47.261	53.075	30.459	1.00	49.96	C
ATOM	22742	N9	A E	69	46.435	52.965	31.671	1.00	47.16	N
ATOM	22743	C8	A E	69	45.748	51.866	32.108	1.00	49.60	C
ATOM	22744	N7	A E	69	45.089	52.064	33.234	1.00	52.85	N
ATOM	22745	C5	A E	69	45.360	53.384	33.547	1.00	51.55	C
ATOM	22746	C4	A E	69	46.186	53.951	32.591	1.00	52.32	C
ATOM	22747	N1	A E	69	45.440	55.461	34.648	1.00	58.37	N
ATOM	22748	C2	A E	69	46.225	55.882	33.645	1.00	53.96	C
ATOM	22749	N3	A E	69	46.650	55.219	32.579	1.00	57.38	N
ATOM	22750	C6	A E	69	44.974	54.200	34.622	1.00	53.50	C
ATOM	22751	N6	A E	69	44.195	53.799	35.621	1.00	54.57	N
ATOM	22752	P	C E	70	51.274	50.553	31.526	1.00	61.77	P
ATOM	22753	OP1	C E	70	52.592	50.256	30.930	1.00	62.18	O
ATOM	22754	OP2	C E	70	50.536	49.486	32.245	1.00	60.20	O
ATOM	22755	O5'	C E	70	51.492	51.815	32.472	1.00	56.07	O
ATOM	22756	C5'	C E	70	52.035	53.013	31.939	1.00	60.49	C
ATOM	22757	C4'	C E	70	51.894	54.157	32.905	1.00	67.36	C
ATOM	22758	O4'	C E	70	50.497	54.531	33.048	1.00	65.76	O
ATOM	22759	C3'	C E	70	52.335	53.867	34.328	1.00	71.13	C
ATOM	22760	O3'	C E	70	53.740	53.911	34.476	1.00	76.95	O
ATOM	22761	C2'	C E	70	51.582	54.928	35.123	1.00	68.52	C
ATOM	22762	O2'	C E	70	52.206	56.196	35.002	1.00	67.97	O
ATOM	22763	C1'	C E	70	50.254	54.970	34.369	1.00	61.09	C
ATOM	22764	N1	C E	70	49.277	54.062	34.995	1.00	60.57	N
ATOM	22765	C2	C E	70	48.576	54.562	36.088	1.00	63.54	C
ATOM	22766	N3	C E	70	47.678	53.760	36.712	1.00	65.52	N
ATOM	22767	C4	C E	70	47.478	52.510	36.288	1.00	59.37	C
ATOM	22768	C5	C E	70	48.190	51.978	35.176	1.00	56.98	C
ATOM	22769	C6	C E	70	49.075	52.779	34.563	1.00	57.98	C
ATOM	22770	O2	C E	70	48.797	55.732	36.445	1.00	65.86	O
ATOM	22771	N4	C E	70	46.578	51.774	36.939	1.00	56.26	N
ATOM	22772	P	U E	71	54.450	53.323	35.790	1.00	79.61	P
ATOM	22773	OP1	U E	71	53.877	52.027	36.227	1.00	79.04	O
ATOM	22774	OP2	U E	71	55.896	53.426	35.482	1.00	84.40	O
ATOM	22775	O5'	U E	71	54.085	54.367	36.924	1.00	78.11	O
ATOM	22776	C5'	U E	71	54.441	54.093	38.260	1.00	84.55	C
ATOM	22777	C4'	U E	71	53.916	55.134	39.204	1.00	86.44	C
ATOM	22778	O4'	U E	71	52.543	55.457	38.874	1.00	83.64	O
ATOM	22779	C1'	U E	71	51.776	55.567	40.049	1.00	83.88	C
ATOM	22780	C2'	U E	71	52.728	55.486	41.236	1.00	92.33	C
ATOM	22781	O2'	U E	71	53.154	56.801	41.562	1.00	95.07	O
ATOM	22782	C3'	U E	71	53.869	54.675	40.647	1.00	93.33	C
ATOM	22783	O3'	U E	71	55.103	54.874	41.292	1.00	97.95	O
ATOM	22784	N1	U E	71	50.787	54.473	40.028	1.00	80.54	N
ATOM	22785	C2	U E	71	49.891	54.323	41.066	1.00	85.00	C
ATOM	22786	N3	U E	71	49.010	53.285	40.896	1.00	82.05	N
ATOM	22787	C4	U E	71	48.922	52.416	39.833	1.00	79.35	C
ATOM	22788	C5	U E	71	49.882	52.646	38.802	1.00	77.11	C
ATOM	22789	C6	U E	71	50.753	53.646	38.931	1.00	76.67	C
ATOM	22790	O2	U E	71	49.867	55.033	42.059	1.00	88.38	O
ATOM	22791	O4	U E	71	48.061	51.534	39.844	1.00	80.16	O
ATOM	22792	P	U E	72	56.036	53.621	41.606	1.00	97.20	P
ATOM	22793	OP1	U E	72	57.433	54.102	41.487	1.00	105.98	O
ATOM	22794	OP2	U E	72	55.604	52.468	40.779	1.00	102.31	O
ATOM	22795	O5'	U E	72	55.690	53.300	43.126	1.00	106.19	O
ATOM	22796	C5'	U E	72	55.572	54.357	44.065	1.00	108.78	C
ATOM	22797	C4'	U E	72	54.595	54.023	45.161	1.00	111.50	C
ATOM	22798	O4'	U E	72	53.235	54.157	44.680	1.00	110.53	O
ATOM	22799	C1'	U E	72	52.404	53.225	45.351	1.00	115.27	C
ATOM	22800	C2'	U E	72	53.278	52.472	46.352	1.00	118.31	C
ATOM	22801	O2'	U E	72	53.256	53.168	47.590	1.00	116.24	O
ATOM	22802	C3'	U E	72	54.635	52.601	45.691	1.00	118.77	C
ATOM	22803	O3'	U E	72	55.709	52.335	46.560	1.00	123.53	O

ATOM	22804	N1	U E	72	51.809	52.292	44.368	1.00107.06	N
ATOM	22805	C2	U E	72	50.747	51.539	44.823	1.00109.81	C
ATOM	22806	N3	U E	72	50.209	50.668	43.920	1.00109.98	N
ATOM	22807	C4	U E	72	50.622	50.475	42.628	1.00105.50	C
ATOM	22808	C5	U E	72	51.734	51.282	42.224	1.00102.56	C
ATOM	22809	C6	U E	72	52.283	52.142	43.089	1.00103.01	C
ATOM	22810	O2	U E	72	50.298	51.635	45.947	1.00112.39	O
ATOM	22811	O4	U E	72	50.020	49.650	41.946	1.00107.02	O
ATOM	22812	F	G E	73	56.398	50.890	46.500	1.00132.81	F
ATOM	22813	OP1	G E	73	57.399	50.818	47.593	1.00139.58	O
ATOM	22814	OP2	G E	73	56.824	50.679	45.091	1.00126.38	O
ATOM	22815	O5'	G E	73	55.217	49.869	46.847	1.00136.77	O
ATOM	22816	C5'	G E	73	54.891	49.561	48.198	1.00137.96	C
ATOM	22817	C4'	G E	73	53.806	48.512	48.319	1.00140.59	C
ATOM	22818	O4'	G E	73	52.691	48.842	47.450	1.00136.93	O
ATOM	22819	C1'	G E	73	52.079	47.656	46.982	1.00137.75	C
ATOM	22820	N9	G E	73	52.216	47.595	45.518	1.00133.10	N
ATOM	22821	C8	G E	73	53.250	48.065	44.743	1.00130.05	C
ATOM	22822	N7	G E	73	53.084	47.823	43.472	1.00128.73	N
ATOM	22823	C5	G E	73	51.875	47.141	43.417	1.00130.10	C
ATOM	22824	C4	G E	73	51.329	46.985	44.672	1.00131.37	C
ATOM	22825	N3	G E	73	50.174	46.386	45.038	1.00131.49	N
ATOM	22826	C2	G E	73	49.524	45.900	43.993	1.00132.77	C
ATOM	22827	N2	G E	73	48.354	45.269	44.172	1.00135.54	N
ATOM	22828	N1	G E	73	49.982	45.998	42.698	1.00132.17	N
ATOM	22829	C6	G E	73	51.172	46.616	42.307	1.00129.90	C
ATOM	22830	O6	G E	73	51.504	46.659	41.115	1.00130.88	O
ATOM	22831	C2'	G E	73	52.798	46.475	47.635	1.00141.41	C
ATOM	22832	O2'	G E	73	52.122	46.140	48.839	1.00142.46	O
ATOM	22833	C3'	G E	73	54.165	47.085	47.921	1.00144.01	C
ATOM	22834	O3'	G E	73	54.901	46.384	48.912	1.00150.12	O
ATOM	22835	F	A E	74	56.159	45.467	48.496	1.00155.47	F
ATOM	22836	OP1	A E	74	56.596	44.713	49.701	1.00157.01	O
ATOM	22837	OP2	A E	74	57.137	46.318	47.771	1.00149.45	O
ATOM	22838	O5'	A E	74	55.558	44.429	47.446	1.00154.48	O
ATOM	22839	C5'	A E	74	56.352	43.378	46.910	1.00154.39	C
ATOM	22840	C4'	A E	74	55.616	42.064	46.960	1.00154.54	C
ATOM	22841	O4'	A E	74	55.647	41.544	48.318	1.00156.22	O
ATOM	22842	C1'	A E	74	54.397	40.975	48.648	1.00155.90	C
ATOM	22843	N9	A E	74	53.782	41.808	49.704	1.00156.84	N
ATOM	22844	C8	A E	74	54.410	42.802	50.419	1.00155.62	C
ATOM	22845	N7	A E	74	53.648	43.395	51.303	1.00155.47	N
ATOM	22846	C5	A E	74	52.429	42.747	51.167	1.00154.82	C
ATOM	22847	C4	A E	74	52.491	41.765	50.190	1.00154.92	C
ATOM	22848	N3	A E	74	51.486	40.954	49.810	1.00152.44	N
ATOM	22849	C2	A E	74	50.385	41.207	50.512	1.00151.27	C
ATOM	22850	N1	A E	74	50.177	42.117	51.472	1.00150.50	N
ATOM	22851	C6	A E	74	51.203	42.918	51.832	1.00151.05	C
ATOM	22852	N6	A E	74	51.012	43.825	52.792	1.00149.08	N
ATOM	22853	C2'	A E	74	53.557	40.948	47.372	1.00154.80	C
ATOM	22854	O2'	A E	74	53.836	39.740	46.681	1.00154.06	O
ATOM	22855	C3'	A E	74	54.133	42.135	46.618	1.00153.53	C
ATOM	22856	O3'	A E	74	53.874	42.103	45.224	1.00152.10	O
ATOM	22857	F	G E	75	52.544	42.788	44.639	1.00146.90	F
ATOM	22858	OP1	G E	75	52.334	44.038	45.411	1.00145.25	O
ATOM	22859	OP2	G E	75	52.643	42.840	43.156	1.00143.46	O
ATOM	22860	O5'	G E	75	51.374	41.772	45.019	1.00148.33	O
ATOM	22861	C5'	G E	75	50.022	42.066	44.693	1.00147.11	C
ATOM	22862	C4'	G E	75	49.053	41.271	45.535	1.00148.16	C
ATOM	22863	O4'	G E	75	49.452	41.325	46.929	1.00150.26	O
ATOM	22864	C1'	G E	75	48.310	41.355	47.760	1.00148.94	C
ATOM	22865	N9	G E	75	48.328	42.611	48.534	1.00148.88	N
ATOM	22866	C8	G E	75	48.941	43.791	48.186	1.00147.01	C

ATOM	22867	N7	G E	75	48.785	44.729	49.080	1.00148.07	N
ATOM	22868	C5	G E	75	48.027	44.131	50.081	1.00148.04	C
ATOM	22869	C4	G E	75	47.731	42.824	49.753	1.00148.42	C
ATOM	22870	N3	G E	75	47.027	41.914	50.460	1.00147.96	N
ATOM	22871	C2	G E	75	46.581	42.415	51.600	1.00147.93	C
ATOM	22872	N2	G E	75	45.857	41.643	52.422	1.00147.61	N
ATOM	22873	N1	G E	75	46.809	43.706	52.015	1.00146.03	N
ATOM	22874	C6	G E	75	47.538	44.659	51.308	1.00144.57	C
ATOM	22875	O6	G E	75	47.685	45.797	51.772	1.00139.39	O
ATOM	22876	C2'	G E	75	47.076	41.245	46.865	1.00147.13	C
ATOM	22877	O2'	G E	75	46.718	39.875	46.765	1.00148.14	O
ATOM	22878	C3'	G E	75	47.613	41.768	45.537	1.00148.27	C
ATOM	22879	O3'	G E	75	46.878	41.323	44.408	1.00150.53	O
ATOM	22880	P	A E	76	45.722	42.237	43.759	1.00150.69	P
ATOM	22881	OP1	A E	76	46.335	43.489	43.238	1.00144.97	O
ATOM	22882	OP2	A E	76	44.913	41.381	42.855	1.00146.82	O
ATOM	22883	O5'	A E	76	44.791	42.603	44.994	1.00147.34	O
ATOM	22884	C5'	A E	76	43.386	42.719	44.849	1.00143.76	C
ATOM	22885	C4'	A E	76	42.683	42.270	46.101	1.00143.72	C
ATOM	22886	O4'	A E	76	43.653	42.083	47.168	1.00146.91	O
ATOM	22887	C1'	A E	76	43.084	42.460	48.405	1.00143.60	C
ATOM	22888	N9	A E	76	43.835	43.606	48.957	1.00142.79	N
ATOM	22889	C8	A E	76	43.715	44.107	50.227	1.00143.64	C
ATOM	22890	N7	A E	76	44.481	45.142	50.470	1.00143.76	N
ATOM	22891	C5	A E	76	45.150	45.352	49.273	1.00143.13	C
ATOM	22892	C4	A E	76	44.757	44.418	48.329	1.00143.50	C
ATOM	22893	N3	A E	76	45.215	44.336	47.069	1.00143.20	N
ATOM	22894	C2	A E	76	46.120	45.276	46.812	1.00140.20	C
ATOM	22895	N1	A E	76	46.585	46.240	47.616	1.00140.09	N
ATOM	22896	C6	A E	76	46.113	46.305	48.881	1.00141.86	C
ATOM	22897	N6	A E	76	46.583	47.264	49.684	1.00140.53	N
ATOM	22898	C2'	A E	76	41.622	42.814	48.145	1.00144.26	C
ATOM	22899	O2'	A E	76	40.851	41.628	48.278	1.00145.52	O
ATOM	22900	C3'	A E	76	41.683	43.249	46.689	1.00141.88	C
ATOM	22901	O3'	A E	76	40.426	43.236	46.032	1.00143.83	O
ATOM	22902	P	A E	77	39.703	44.617	45.624	1.00142.34	P
ATOM	22903	OP1	A E	77	38.372	44.667	46.290	1.00130.82	O
ATOM	22904	OP2	A E	77	39.796	44.757	44.144	1.00130.87	O
ATOM	22905	O5'	A E	77	40.623	45.752	46.266	1.00140.99	O
ATOM	22906	C5'	A E	77	40.351	46.295	47.553	1.00136.60	C
ATOM	22907	C4'	A E	77	41.461	47.217	47.984	1.00134.19	C
ATOM	22908	O4'	A E	77	42.732	46.638	47.595	1.00136.93	O
ATOM	22909	C1'	A E	77	43.616	47.647	47.162	1.00132.46	C
ATOM	22910	C2'	A E	77	42.924	48.991	47.358	1.00126.45	C
ATOM	22911	O2'	A E	77	43.288	49.501	48.630	1.00125.36	O
ATOM	22912	C3'	A E	77	41.457	48.589	47.330	1.00127.61	C
ATOM	22913	O3'	A E	77	40.607	49.502	47.996	1.00126.90	O
ATOM	22914	N9	A E	77	43.963	47.389	45.752	1.00131.87	N
ATOM	22915	C8	A E	77	43.218	46.700	44.827	1.00132.34	C
ATOM	22916	N7	A E	77	43.783	46.625	43.649	1.00132.11	N
ATOM	22917	C5	A E	77	44.983	47.303	43.815	1.00126.49	C
ATOM	22918	C4	A E	77	45.111	47.782	45.103	1.00128.16	C
ATOM	22919	N1	A E	77	47.093	48.276	43.399	1.00117.84	N
ATOM	22920	C2	A E	77	47.079	48.674	44.675	1.00119.44	C
ATOM	22921	N3	A E	77	46.147	48.479	45.605	1.00125.13	N
ATOM	22922	C6	A E	77	46.037	47.575	42.932	1.00123.18	C
ATOM	22923	N6	A E	77	46.037	47.173	41.660	1.00127.93	N
ATOM	22924	P	A E	78	40.120	50.835	47.249	1.00129.66	P
ATOM	22925	OP1	A E	78	39.021	51.444	48.048	1.00125.09	O
ATOM	22926	OP2	A E	78	39.897	50.494	45.819	1.00126.79	O
ATOM	22927	O5'	A E	78	41.390	51.795	47.324	1.00122.42	O
ATOM	22928	C5'	A E	78	41.894	52.239	48.574	1.00119.29	C
ATOM	22929	C4'	A E	78	43.244	52.890	48.423	1.00113.82	C

ATOM	22930	O4'	A E	78	44.220	51.919	47.956	1.00115.44	O
ATOM	22931	C1'	A E	78	45.161	52.557	47.114	1.00110.69	C
ATOM	22932	C2'	A E	78	44.819	54.048	47.092	1.00108.89	C
ATOM	22933	O2'	A E	78	45.531	54.704	48.132	1.00109.77	O
ATOM	22934	C3'	A E	78	43.330	54.003	47.395	1.00108.87	C
ATOM	22935	O3'	A E	78	42.789	55.229	47.843	1.00107.83	O
ATOM	22936	N9	A E	78	45.044	51.987	45.761	1.00109.60	N
ATOM	22937	C8	A E	78	44.088	51.150	45.247	1.00112.25	C
ATOM	22938	N7	A E	78	44.264	50.849	43.984	1.00110.08	N
ATOM	22939	C5	A E	78	45.408	51.554	43.640	1.00103.40	C
ATOM	22940	C4	A E	78	45.891	52.260	44.724	1.00102.89	C
ATOM	22941	N1	A E	78	47.216	52.455	42.451	1.00 94.64	N
ATOM	22942	C2	A E	78	47.557	53.077	43.587	1.00 96.85	C
ATOM	22943	N3	A E	78	46.970	53.048	44.773	1.00 98.93	N
ATOM	22944	C6	A E	78	46.124	51.666	42.439	1.00 97.88	C
ATOM	22945	N6	A E	78	45.788	51.047	41.303	1.00 93.79	N
ATOM	22946	P	G E	79	41.401	55.755	47.226	1.00106.15	P
ATOM	22947	OP1	G E	79	40.420	55.816	48.337	1.00108.98	O
ATOM	22948	OP2	G E	79	41.069	54.962	46.018	1.00112.58	O
ATOM	22949	O5'	G E	79	41.737	57.229	46.728	1.00104.51	O
ATOM	22950	C5'	G E	79	42.082	57.483	45.374	1.00 97.15	C
ATOM	22951	C4'	G E	79	43.576	57.547	45.190	1.00 93.68	C
ATOM	22952	O4'	G E	79	44.102	56.208	44.991	1.00 99.70	O
ATOM	22953	C1'	G E	79	45.188	56.246	44.089	1.00 94.81	C
ATOM	22954	C2'	G E	79	45.425	57.708	43.710	1.00 88.21	C
ATOM	22955	O2'	G E	79	46.378	58.249	44.604	1.00 86.30	O
ATOM	22956	C3'	G E	79	44.058	58.314	43.972	1.00 87.44	C
ATOM	22957	O3'	G E	79	44.106	59.705	44.187	1.00 80.97	O
ATOM	22958	N9	G E	79	44.870	55.395	42.920	1.00 91.88	N
ATOM	22959	C8	G E	79	43.851	54.468	42.837	1.00 93.87	C
ATOM	22960	N7	G E	79	43.810	53.846	41.687	1.00 90.19	N
ATOM	22961	C5	G E	79	44.868	54.391	40.968	1.00 84.77	C
ATOM	22962	C4	G E	79	45.538	55.342	41.707	1.00 85.83	C
ATOM	22963	N1	G E	79	46.425	54.889	39.299	1.00 72.60	N
ATOM	22964	C2	G E	79	47.025	55.817	40.109	1.00 75.16	C
ATOM	22965	N3	G E	79	46.613	56.077	41.336	1.00 80.54	N
ATOM	22966	C6	G E	79	45.323	54.117	39.655	1.00 76.38	C
ATOM	22967	O6	G E	79	44.860	53.307	38.854	1.00 73.53	O
ATOM	22968	N2	G E	79	48.081	56.478	39.607	1.00 68.84	N
ATOM	22969	P	U E	80	43.570	60.695	43.049	1.00 85.80	P
ATOM	22970	OP1	U E	80	42.267	60.152	42.589	1.00 87.64	O
ATOM	22971	OP2	U E	80	43.615	62.093	43.558	1.00 85.76	O
ATOM	22972	O5'	U E	80	44.613	60.519	41.865	1.00 78.27	O
ATOM	22973	C5'	U E	80	45.778	61.319	41.782	1.00 76.54	C
ATOM	22974	C4'	U E	80	46.353	61.306	40.385	1.00 77.78	C
ATOM	22975	O4'	U E	80	46.677	59.946	39.994	1.00 79.03	O
ATOM	22976	C3'	U E	80	45.435	61.806	39.281	1.00 73.41	C
ATOM	22977	O3'	U E	80	45.442	63.220	39.185	1.00 74.12	O
ATOM	22978	C2'	U E	80	45.994	61.122	38.038	1.00 74.87	C
ATOM	22979	O2'	U E	80	47.110	61.840	37.535	1.00 75.23	O
ATOM	22980	C1'	U E	80	46.486	59.785	38.605	1.00 73.13	C
ATOM	22981	N1	U E	80	45.533	58.667	38.375	1.00 73.83	N
ATOM	22982	C2	U E	80	45.561	58.039	37.141	1.00 70.98	C
ATOM	22983	N3	U E	80	44.666	57.008	36.985	1.00 69.58	N
ATOM	22984	C4	U E	80	43.764	56.546	37.919	1.00 67.78	C
ATOM	22985	C5	U E	80	43.795	57.236	39.168	1.00 70.70	C
ATOM	22986	C6	U E	80	44.658	58.243	39.350	1.00 74.59	C
ATOM	22987	O2	U E	80	46.325	58.377	36.253	1.00 67.69	O
ATOM	22988	O4	U E	80	43.021	55.608	37.633	1.00 67.57	O
ATOM	22989	P	G E	81	44.080	64.046	38.981	1.00 74.66	P
ATOM	22990	OP1	G E	81	42.905	63.195	39.313	1.00 71.50	O
ATOM	22991	OP2	G E	81	44.257	65.323	39.707	1.00 79.69	O
ATOM	22992	O5'	G E	81	44.096	64.409	37.432	1.00 62.93	O

ATOM	22993	C5'	G E	81	45.204	65.093	36.872	1.00	64.16	C
ATOM	22994	C4'	G E	81	44.968	65.456	35.431	1.00	70.45	C
ATOM	22995	O4'	G E	81	45.108	64.280	34.597	1.00	70.65	O
ATOM	22996	C3'	G E	81	43.596	66.038	35.127	1.00	73.88	C
ATOM	22997	O3'	G E	81	43.728	66.990	34.075	1.00	74.32	O
ATOM	22998	C2'	G E	81	42.793	64.831	34.645	1.00	69.39	C
ATOM	22999	O2'	G E	81	41.745	65.182	33.756	1.00	65.92	O
ATOM	23000	C1'	G E	81	43.871	63.968	33.965	1.00	71.56	C
ATOM	23001	N9	G E	81	43.703	62.514	34.131	1.00	64.49	N
ATOM	23002	C8	G E	81	43.434	61.821	35.291	1.00	64.81	C
ATOM	23003	N7	G E	81	43.394	60.529	35.130	1.00	62.62	N
ATOM	23004	C5	G E	81	43.682	60.357	33.788	1.00	58.82	C
ATOM	23005	C4	G E	81	43.890	61.559	33.166	1.00	56.91	C
ATOM	23006	N1	G E	81	44.101	59.445	31.683	1.00	56.16	N
ATOM	23007	C2	G E	81	44.283	60.702	31.158	1.00	51.15	C
ATOM	23008	N3	G E	81	44.192	61.799	31.874	1.00	60.03	N
ATOM	23009	C6	G E	81	43.797	59.176	33.018	1.00	59.18	C
ATOM	23010	O6	G E	81	43.653	58.016	33.411	1.00	59.39	O
ATOM	23011	N2	G E	81	44.578	60.806	29.858	1.00	52.72	N
ATOM	23012	P	G E	82	43.963	68.527	34.457	1.00	82.15	P
ATOM	23013	OP1	G E	82	43.925	69.361	33.219	1.00	71.57	O
ATOM	23014	OP2	G E	82	45.128	68.560	35.376	1.00	74.97	O
ATOM	23015	O5'	G E	82	42.673	68.872	35.319	1.00	73.79	O
ATOM	23016	C5'	G E	82	41.456	69.229	34.681	1.00	77.47	C
ATOM	23017	C4'	G E	82	40.886	70.482	35.292	1.00	79.35	C
ATOM	23018	O4'	G E	82	41.915	71.511	35.327	1.00	81.71	O
ATOM	23019	C3'	G E	82	39.736	71.135	34.540	1.00	79.68	C
ATOM	23020	O3'	G E	82	38.482	70.532	34.806	1.00	70.00	O
ATOM	23021	C2'	G E	82	39.840	72.578	35.004	1.00	85.49	C
ATOM	23022	O2'	G E	82	39.381	72.689	36.345	1.00	84.54	O
ATOM	23023	C1'	G E	82	41.353	72.763	35.004	1.00	83.80	C
ATOM	23024	N9	G E	82	41.847	73.138	33.665	1.00	82.91	N
ATOM	23025	C8	G E	82	42.567	72.343	32.809	1.00	86.07	C
ATOM	23026	N7	G E	82	42.867	72.921	31.677	1.00	89.35	N
ATOM	23027	C5	G E	82	42.312	74.182	31.790	1.00	88.41	C
ATOM	23028	C4	G E	82	41.678	74.334	33.007	1.00	89.48	C
ATOM	23029	N1	G E	82	41.636	76.356	31.385	1.00	90.53	N
ATOM	23030	C2	G E	82	41.036	76.407	32.618	1.00	89.94	C
ATOM	23031	N3	G E	82	41.027	75.412	33.484	1.00	90.73	N
ATOM	23032	C6	G E	82	42.317	75.259	30.875	1.00	88.93	C
ATOM	23033	O6	G E	82	42.829	75.309	29.753	1.00	92.09	O
ATOM	23034	N2	G E	82	40.428	77.553	32.937	1.00	97.09	N
ATOM	23035	O5'	C E	83	36.962	72.296	33.808	1.00	86.87	O
ATOM	23036	C4'	C E	83	36.165	74.410	34.606	1.00	86.66	C
ATOM	23037	C3'	C E	83	35.232	74.665	33.430	1.00	87.37	C
ATOM	23038	C2'	C E	83	35.650	76.055	32.973	1.00	86.65	C
ATOM	23039	P	C E	83	37.234	70.730	33.807	1.00	80.03	P
ATOM	23040	OP1	C E	83	36.080	70.071	34.469	1.00	73.58	O
ATOM	23041	OP2	C E	83	37.598	70.448	32.398	1.00	72.70	O
ATOM	23042	C5'	C E	83	36.409	72.961	34.933	1.00	82.60	C
ATOM	23043	O4'	C E	83	37.415	75.029	34.193	1.00	86.80	O
ATOM	23044	O3'	C E	83	33.856	74.562	33.760	1.00	85.70	O
ATOM	23045	O2'	C E	83	35.107	77.042	33.831	1.00	88.86	O
ATOM	23046	C1'	C E	83	37.161	76.008	33.201	1.00	87.59	C
ATOM	23047	N1	C E	83	37.892	75.663	31.960	1.00	88.73	N
ATOM	23048	C2	C E	83	37.951	76.615	30.934	1.00	88.02	C
ATOM	23049	N3	C E	83	38.604	76.329	29.786	1.00	89.51	N
ATOM	23050	C4	C E	83	39.188	75.141	29.635	1.00	89.38	C
ATOM	23051	C5	C E	83	39.143	74.148	30.657	1.00	85.01	C
ATOM	23052	C6	C E	83	38.489	74.442	31.790	1.00	87.31	C
ATOM	23053	O2	C E	83	37.407	77.712	31.088	1.00	90.33	O
ATOM	23054	N4	C E	83	39.822	74.910	28.483	1.00	90.43	N
ATOM	23055	O5'	A E	84	32.739	75.731	31.812	1.00	89.23	O

ATOM	23056	C4'	A E	84	32.329	78.080	31.450	1.00	78.97	C
ATOM	23057	C3'	A E	84	31.630	77.878	30.116	1.00	80.40	C
ATOM	23058	C2'	A E	84	32.389	78.818	29.191	1.00	84.99	C
ATOM	23059	P	A E	84	32.768	74.343	32.596	1.00	87.12	P
ATOM	23060	OP1	A E	84	31.448	74.110	33.235	1.00	75.76	O
ATOM	23061	OP2	A E	84	33.330	73.360	31.637	1.00	89.35	O
ATOM	23062	C5'	A E	84	32.233	76.921	32.408	1.00	82.29	C
ATOM	23063	O4'	A E	84	33.719	78.292	31.086	1.00	82.34	O
ATOM	23064	O3'	A E	84	30.242	78.129	30.174	1.00	83.71	O
ATOM	23065	O2'	A E	84	31.947	80.160	29.350	1.00	86.59	O
ATOM	23066	C1'	A E	84	33.812	78.697	29.735	1.00	83.95	C
ATOM	23067	N9	A E	84	34.600	77.697	28.989	1.00	86.25	N
ATOM	23068	C8	A E	84	34.822	76.389	29.339	1.00	86.44	C
ATOM	23069	N7	A E	84	35.557	75.731	28.472	1.00	90.07	N
ATOM	23070	C5	A E	84	35.841	76.659	27.474	1.00	89.27	C
ATOM	23071	C4	A E	84	35.254	77.876	27.786	1.00	86.08	C
ATOM	23072	N1	A E	84	36.671	77.702	25.501	1.00	90.23	N
ATOM	23073	C2	A E	84	36.040	78.805	25.933	1.00	88.50	C
ATOM	23074	N3	A E	84	35.323	78.989	27.041	1.00	87.18	N
ATOM	23075	C6	A E	84	36.587	76.586	26.267	1.00	89.66	C
ATOM	23076	N6	A E	84	37.217	75.490	25.833	1.00	86.28	N
ATOM	23077	O5'	C E	85	29.391	78.364	27.791	1.00	83.30	O
ATOM	23078	C4'	C E	85	29.878	80.401	26.624	1.00	81.53	C
ATOM	23079	C3'	C E	85	29.368	79.875	25.299	1.00	82.67	C
ATOM	23080	C2'	C E	85	30.502	80.213	24.340	1.00	82.04	C
ATOM	23081	P	C E	85	29.250	77.463	29.097	1.00	91.54	P
ATOM	23082	OP1	C E	85	27.877	77.554	29.654	1.00	79.77	O
ATOM	23083	OP2	C E	85	29.793	76.138	28.711	1.00	95.81	O
ATOM	23084	C5'	C E	85	29.264	79.775	27.846	1.00	80.24	C
ATOM	23085	O4'	C E	85	31.296	80.114	26.582	1.00	82.80	O
ATOM	23086	O3'	C E	85	28.125	80.439	24.933	1.00	81.87	O
ATOM	23087	O2'	C E	85	30.421	81.565	23.915	1.00	80.38	O
ATOM	23088	C1'	C E	85	31.730	80.044	25.238	1.00	82.77	C
ATOM	23089	N1	C E	85	32.425	78.753	25.026	1.00	86.62	N
ATOM	23090	C2	C E	85	33.265	78.558	23.910	1.00	86.72	C
ATOM	23091	N3	C E	85	33.879	77.355	23.767	1.00	85.46	N
ATOM	23092	C4	C E	85	33.695	76.388	24.667	1.00	83.59	C
ATOM	23093	C5	C E	85	32.860	76.567	25.808	1.00	81.70	C
ATOM	23094	C6	C E	85	32.257	77.749	25.942	1.00	83.50	C
ATOM	23095	O2	C E	85	33.432	79.456	23.063	1.00	78.61	O
ATOM	23096	N4	C E	85	34.326	75.229	24.472	1.00	78.02	N
ATOM	23097	O5'	C E	86	27.750	79.634	22.579	1.00	74.06	O
ATOM	23098	C4'	C E	86	28.823	80.802	20.730	1.00	78.89	C
ATOM	23099	C3'	C E	86	28.520	79.744	19.691	1.00	79.59	C
ATOM	23100	C2'	C E	86	29.857	79.558	19.004	1.00	82.30	C
ATOM	23101	P	C E	86	27.107	79.583	24.042	1.00	80.52	P
ATOM	23102	OP1	C E	86	25.798	80.276	24.067	1.00	92.22	O
ATOM	23103	OP2	C E	86	27.141	78.186	24.526	1.00	88.25	O
ATOM	23104	C5'	C E	86	27.881	80.872	21.902	1.00	80.79	C
ATOM	23105	O4'	C E	86	30.159	80.470	21.177	1.00	81.16	O
ATOM	23106	O3'	C E	86	27.489	80.104	18.810	1.00	83.19	O
ATOM	23107	O2'	C E	86	30.107	80.606	18.083	1.00	85.76	O
ATOM	23108	C1'	C E	86	30.812	79.689	20.188	1.00	85.81	C
ATOM	23109	N1	C E	86	31.120	78.357	20.758	1.00	81.72	N
ATOM	23110	C2	C E	86	31.938	77.469	20.057	1.00	80.86	C
ATOM	23111	N3	C E	86	32.187	76.255	20.606	1.00	83.20	N
ATOM	23112	C4	C E	86	31.653	75.913	21.784	1.00	82.25	C
ATOM	23113	C5	C E	86	30.805	76.794	22.507	1.00	80.44	C
ATOM	23114	C6	C E	86	30.572	77.982	21.950	1.00	81.81	C
ATOM	23115	O2	C E	86	32.431	77.801	18.965	1.00	77.95	O
ATOM	23116	N4	C E	86	31.925	74.706	22.283	1.00	79.69	N
ATOM	23117	O5'	G E	87	26.795	77.822	18.014	1.00	88.54	O
ATOM	23118	C4'	G E	87	28.052	77.219	16.033	1.00	83.72	C

ATOM	23119	C3'	G E	87	28.090	75.804	15.496	1.00	79.36	C
ATOM	23120	C2'	G E	87	29.573	75.466	15.553	1.00	80.37	C
ATOM	23121	P	G E	87	26.218	79.141	18.691	1.00	90.94	P
ATOM	23122	OP1	G E	87	25.280	79.728	17.697	1.00	96.11	O
ATOM	23123	OP2	G E	87	25.795	78.839	20.090	1.00	85.69	O
ATOM	23124	C5'	G E	87	26.730	77.659	16.608	1.00	86.71	C
ATOM	23125	O4'	G E	87	29.074	77.229	17.062	1.00	85.28	O
ATOM	23126	O3'	G E	87	27.528	75.693	14.201	1.00	88.67	O
ATOM	23127	O2'	G E	87	30.265	76.019	14.447	1.00	76.48	O
ATOM	23128	C1'	G E	87	30.003	76.189	16.827	1.00	83.15	C
ATOM	23129	N9	G E	87	30.017	75.281	17.999	1.00	81.21	N
ATOM	23130	C8	G E	87	29.350	75.449	19.197	1.00	82.18	C
ATOM	23131	N7	G E	87	29.549	74.480	20.058	1.00	72.75	N
ATOM	23132	C5	G E	87	30.408	73.617	19.384	1.00	74.14	C
ATOM	23133	C4	G E	87	30.707	74.092	18.120	1.00	72.56	C
ATOM	23134	N1	G E	87	31.776	71.827	18.825	1.00	61.13	N
ATOM	23135	C2	G E	87	32.011	72.378	17.596	1.00	70.48	C
ATOM	23136	N3	G E	87	31.495	73.526	17.181	1.00	75.39	N
ATOM	23137	C6	G E	87	30.974	72.381	19.807	1.00	66.50	C
ATOM	23138	O6	G E	87	30.826	71.806	20.894	1.00	63.03	O
ATOM	23139	N2	G E	87	32.823	71.693	16.787	1.00	66.24	N
ATOM	23140	O5'	A E	88	27.828	73.248	13.730	1.00	82.91	O
ATOM	23141	C4'	A E	88	29.931	72.257	12.988	1.00	80.89	C
ATOM	23142	C3'	A E	88	29.352	70.987	12.393	1.00	77.02	C
ATOM	23143	C2'	A E	88	28.813	70.264	13.615	1.00	73.21	C
ATOM	23144	P	A E	88	26.702	74.373	13.791	1.00	86.45	P
ATOM	23145	OP1	A E	88	26.217	74.513	12.393	1.00	82.93	O
ATOM	23146	OP2	A E	88	25.722	74.098	14.876	1.00	79.82	O
ATOM	23147	C5'	A E	88	28.996	73.441	12.931	1.00	82.14	C
ATOM	23148	O4'	A E	88	30.266	71.939	14.371	1.00	74.49	O
ATOM	23149	O3'	A E	88	30.406	70.233	11.819	1.00	74.59	O
ATOM	23150	O2'	A E	88	28.650	68.874	13.443	1.00	68.75	O
ATOM	23151	C1'	A E	88	29.872	70.613	14.657	1.00	73.09	C
ATOM	23152	N9	A E	88	29.397	70.541	16.042	1.00	69.68	N
ATOM	23153	C8	A E	88	28.568	71.353	16.780	1.00	70.84	C
ATOM	23154	N7	A E	88	28.361	70.937	18.013	1.00	68.18	N
ATOM	23155	C5	A E	88	29.117	69.771	18.084	1.00	66.35	C
ATOM	23156	C4	A E	88	29.752	69.524	16.876	1.00	70.39	C
ATOM	23157	N1	A E	88	30.156	67.797	18.801	1.00	68.16	N
ATOM	23158	C2	A E	88	30.701	67.693	17.578	1.00	65.94	C
ATOM	23159	N3	A E	88	30.561	68.501	16.539	1.00	65.40	N
ATOM	23160	C6	A E	88	29.343	68.832	19.103	1.00	59.72	C
ATOM	23161	N6	A E	88	28.825	68.871	20.331	1.00	53.99	N
ATOM	23162	P	G E	89	30.076	69.314	10.560	1.00	83.94	P
ATOM	23163	OP1	G E	89	30.468	70.001	9.302	1.00	82.69	O
ATOM	23164	OP2	G E	89	28.672	68.883	10.801	1.00	78.81	O
ATOM	23165	O5'	G E	89	31.054	68.074	10.709	1.00	80.20	O
ATOM	23166	C5'	G E	89	31.374	67.537	11.987	1.00	78.63	C
ATOM	23167	C4'	G E	89	32.015	66.182	11.849	1.00	73.78	C
ATOM	23168	O4'	G E	89	31.159	65.347	11.027	1.00	74.43	O
ATOM	23169	C3'	G E	89	33.370	66.189	11.162	1.00	69.31	C
ATOM	23170	O3'	G E	89	34.103	65.072	11.636	1.00	72.51	O
ATOM	23171	C2'	G E	89	32.999	65.960	9.704	1.00	73.60	C
ATOM	23172	O2'	G E	89	34.044	65.442	8.907	1.00	75.79	O
ATOM	23173	C1'	G E	89	31.844	64.975	9.843	1.00	75.23	C
ATOM	23174	N9	G E	89	30.871	65.026	8.758	1.00	76.61	N
ATOM	23175	C8	G E	89	30.462	66.132	8.056	1.00	83.53	C
ATOM	23176	N7	G E	89	29.546	65.863	7.159	1.00	80.86	N
ATOM	23177	C5	G E	89	29.330	64.498	7.292	1.00	83.33	C
ATOM	23178	C4	G E	89	30.139	63.966	8.278	1.00	78.65	C
ATOM	23179	N1	G E	89	28.544	62.313	7.045	1.00	72.67	N
ATOM	23180	C2	G E	89	29.376	61.897	8.042	1.00	66.40	C
ATOM	23181	N3	G E	89	30.208	62.687	8.703	1.00	66.91	N

ATOM	23182	C6	G E	89	28.444	63.627	6.593	1.00	81.55	C
ATOM	23183	O6	G E	89	27.648	63.900	5.686	1.00	77.16	O
ATOM	23184	N2	G E	89	29.307	60.592	8.319	1.00	69.41	N
ATOM	23185	P	U E	90	35.650	65.221	12.009	1.00	75.56	P
ATOM	23186	OP1	U E	90	36.376	64.554	10.900	1.00	63.51	O
ATOM	23187	OP2	U E	90	35.959	66.630	12.378	1.00	77.65	O
ATOM	23188	O5'	U E	90	35.807	64.349	13.324	1.00	65.11	O
ATOM	23189	C5'	U E	90	35.111	64.642	14.531	1.00	61.22	C
ATOM	23190	C4'	U E	90	35.166	63.444	15.446	1.00	73.56	C
ATOM	23191	O4'	U E	90	33.937	62.699	15.231	1.00	69.27	O
ATOM	23192	C3'	U E	90	36.336	62.478	15.136	1.00	70.71	C
ATOM	23193	O3'	U E	90	37.194	62.051	16.237	1.00	66.08	O
ATOM	23194	C2'	U E	90	35.681	61.313	14.397	1.00	61.67	C
ATOM	23195	O2'	U E	90	36.262	60.049	14.633	1.00	75.63	O
ATOM	23196	C1'	U E	90	34.224	61.360	14.865	1.00	68.26	C
ATOM	23197	N1	U E	90	33.325	60.959	13.770	1.00	69.81	N
ATOM	23198	C2	U E	90	32.577	59.811	13.949	1.00	60.02	C
ATOM	23199	N3	U E	90	31.813	59.452	12.859	1.00	51.13	N
ATOM	23200	C4	U E	90	31.747	60.105	11.633	1.00	58.03	C
ATOM	23201	C5	U E	90	32.572	61.267	11.517	1.00	57.90	C
ATOM	23202	C6	U E	90	33.326	61.633	12.563	1.00	66.00	C
ATOM	23203	O2	U E	90	32.591	59.213	15.017	1.00	58.46	O
ATOM	23204	O4	U E	90	31.006	59.675	10.739	1.00	56.40	O
ATOM	23205	P	C E	91	36.723	61.666	17.726	1.00	67.32	P
ATOM	23206	OP1	C E	91	35.278	61.874	17.868	1.00	74.39	O
ATOM	23207	OP2	C E	91	37.272	60.370	18.157	1.00	74.34	O
ATOM	23208	O5'	C E	91	37.417	62.749	18.635	1.00	62.25	O
ATOM	23209	C5'	C E	91	36.691	63.916	18.973	1.00	69.09	C
ATOM	23210	C4'	C E	91	36.989	65.042	18.024	1.00	71.06	C
ATOM	23211	O4'	C E	91	35.743	65.750	17.746	1.00	68.09	O
ATOM	23212	C3'	C E	91	37.959	66.065	18.607	1.00	72.12	C
ATOM	23213	O3'	C E	91	38.875	66.573	17.638	1.00	71.33	O
ATOM	23214	C2'	C E	91	37.034	67.159	19.115	1.00	71.59	C
ATOM	23215	O2'	C E	91	37.588	68.455	19.207	1.00	80.19	O
ATOM	23216	C1'	C E	91	35.857	67.100	18.145	1.00	67.56	C
ATOM	23217	N1	C E	91	34.655	67.534	18.872	1.00	69.20	N
ATOM	23218	C2	C E	91	34.022	68.733	18.529	1.00	64.98	C
ATOM	23219	N3	C E	91	32.987	69.189	19.278	1.00	56.48	N
ATOM	23220	C4	C E	91	32.621	68.514	20.362	1.00	60.86	C
ATOM	23221	C5	C E	91	33.276	67.307	20.770	1.00	62.10	C
ATOM	23222	C6	C E	91	34.293	66.876	20.018	1.00	63.78	C
ATOM	23223	O2	C E	91	34.419	69.310	17.514	1.00	66.11	O
ATOM	23224	N4	C E	91	31.603	68.966	21.080	1.00	53.64	N
ATOM	23225	O5'	G E	92	39.411	68.980	17.501	1.00	76.80	O
ATOM	23226	C4'	G E	92	39.262	70.460	15.611	1.00	85.76	C
ATOM	23227	C3'	G E	92	40.377	71.205	16.337	1.00	90.78	C
ATOM	23228	C2'	G E	92	39.630	71.889	17.465	1.00	86.83	C
ATOM	23229	P	G E	92	39.990	67.638	18.112	1.00	72.76	P
ATOM	23230	OP1	G E	92	41.277	67.405	17.405	1.00	76.98	O
ATOM	23231	OP2	G E	92	39.955	67.737	19.605	1.00	50.98	O
ATOM	23232	C5'	G E	92	39.085	69.057	16.114	1.00	82.07	C
ATOM	23233	O4'	G E	92	38.038	71.199	15.880	1.00	77.71	O
ATOM	23234	O3'	G E	92	40.986	72.177	15.494	1.00	92.66	O
ATOM	23235	O2'	G E	92	40.288	73.000	18.037	1.00	87.81	O
ATOM	23236	C1'	G E	92	38.301	72.238	16.799	1.00	83.52	C
ATOM	23237	N9	G E	92	37.242	72.254	17.796	1.00	83.77	N
ATOM	23238	C8	G E	92	37.221	71.375	18.846	1.00	77.60	C
ATOM	23239	N7	G E	92	36.245	71.587	19.667	1.00	73.89	N
ATOM	23240	C5	G E	92	35.603	72.687	19.127	1.00	77.96	C
ATOM	23241	C4	G E	92	36.212	73.130	17.972	1.00	79.49	C
ATOM	23242	N1	G E	92	34.143	74.429	18.774	1.00	78.23	N
ATOM	23243	C2	G E	92	34.821	74.794	17.636	1.00	81.51	C
ATOM	23244	N3	G E	92	35.892	74.165	17.174	1.00	81.00	N

ATOM	23245	C6	G E	92	34.469	73.364	19.606	1.00	74.96	C
ATOM	23246	O6	G E	92	33.807	73.099	20.617	1.00	72.10	O
ATOM	23247	N2	G E	92	34.327	75.858	16.983	1.00	81.48	N
ATOM	23248	O5'	G E	93	42.006	74.447	15.696	1.00	93.62	O
ATOM	23249	C4'	G E	93	40.467	76.183	16.350	1.00	93.82	C
ATOM	23250	C3'	G E	93	40.412	77.492	17.109	1.00	94.25	C
ATOM	23251	C2'	G E	93	38.935	77.854	17.080	1.00	91.44	C
ATOM	23252	P	G E	93	42.328	72.918	15.975	1.00	92.59	P
ATOM	23253	OP1	G E	93	43.439	72.507	15.068	1.00	91.32	O
ATOM	23254	OP2	G E	93	42.455	72.782	17.455	1.00	83.02	O
ATOM	23255	C5'	G E	93	41.609	75.292	16.755	1.00	92.48	C
ATOM	23256	O4'	G E	93	39.200	75.539	16.632	1.00	87.55	O
ATOM	23257	O3'	G E	93	41.255	78.456	16.513	1.00	94.54	O
ATOM	23258	O2'	G E	93	38.597	78.451	15.838	1.00	96.39	O
ATOM	23259	C1'	G E	93	38.281	76.476	17.145	1.00	87.99	C
ATOM	23260	N9	G E	93	37.949	76.059	18.519	1.00	87.30	N
ATOM	23261	C8	G E	93	38.524	74.991	19.164	1.00	85.58	C
ATOM	23262	N7	G E	93	38.067	74.788	20.365	1.00	84.89	N
ATOM	23263	C5	G E	93	37.119	75.781	20.523	1.00	85.52	C
ATOM	23264	C4	G E	93	37.025	76.584	19.395	1.00	86.55	C
ATOM	23265	N1	G E	93	35.472	77.153	21.404	1.00	84.48	N
ATOM	23266	C2	G E	93	35.443	77.894	20.236	1.00	85.60	C
ATOM	23267	N3	G E	93	36.217	77.651	19.184	1.00	84.63	N
ATOM	23268	C6	G E	93	36.299	76.049	21.643	1.00	86.17	C
ATOM	23269	O6	G E	93	36.272	75.423	22.715	1.00	82.53	O
ATOM	23270	N2	G E	93	34.573	78.926	20.203	1.00	87.28	N
ATOM	23271	O5'	U E	94	41.855	80.115	18.270	1.00	94.08	O
ATOM	23272	C4'	U E	94	39.929	81.517	18.844	1.00	95.16	C
ATOM	23273	C3'	U E	94	40.567	81.856	20.180	1.00	95.98	C
ATOM	23274	C2'	U E	94	39.353	81.913	21.101	1.00	96.07	C
ATOM	23275	P	U E	94	42.518	79.018	17.318	1.00	92.15	P
ATOM	23276	OP1	U E	94	43.070	77.942	18.172	1.00	96.82	O
ATOM	23277	OP2	U E	94	43.409	79.639	16.298	1.00	94.67	O
ATOM	23278	C5'	U E	94	40.837	80.974	17.763	1.00	94.01	C
ATOM	23279	O4'	U E	94	38.898	80.551	19.204	1.00	94.55	O
ATOM	23280	O3'	U E	94	41.353	83.036	20.171	1.00	95.59	O
ATOM	23281	O2'	U E	94	38.623	83.119	20.913	1.00	92.19	O
ATOM	23282	C1'	U E	94	38.515	80.753	20.557	1.00	90.98	C
ATOM	23283	N1	U E	94	38.733	79.513	21.349	1.00	93.66	N
ATOM	23284	C2	U E	94	37.997	79.391	22.526	1.00	92.80	C
ATOM	23285	N3	U E	94	38.218	78.252	23.263	1.00	87.88	N
ATOM	23286	C4	U E	94	39.094	77.235	22.947	1.00	91.82	C
ATOM	23287	C5	U E	94	39.830	77.433	21.727	1.00	90.60	C
ATOM	23288	C6	U E	94	39.637	78.535	20.987	1.00	90.41	C
ATOM	23289	O2	U E	94	37.191	80.230	22.894	1.00	90.36	O
ATOM	23290	O4	U E	94	39.182	76.264	23.708	1.00	92.62	O
ATOM	23291	O5'	G E	95	41.882	83.539	22.583	1.00	92.32	O
ATOM	23292	C4'	G E	95	40.125	84.575	23.883	1.00	90.86	C
ATOM	23293	C3'	G E	95	40.813	84.408	25.225	1.00	96.01	C
ATOM	23294	C2'	G E	95	39.700	83.821	26.086	1.00	98.66	C
ATOM	23295	P	G E	95	42.583	83.179	21.200	1.00	98.41	P
ATOM	23296	OP1	G E	95	43.438	84.308	20.761	1.00	98.86	O
ATOM	23297	OP2	G E	95	43.208	81.841	21.357	1.00	102.66	O
ATOM	23298	C5'	G E	95	41.024	84.663	22.681	1.00	90.38	C
ATOM	23299	O4'	G E	95	39.270	83.407	23.786	1.00	89.99	O
ATOM	23300	O3'	G E	95	41.349	85.622	25.723	1.00	99.59	O
ATOM	23301	O2'	G E	95	38.775	84.828	26.483	1.00	94.33	O
ATOM	23302	C1'	G E	95	39.004	82.900	25.080	1.00	95.25	C
ATOM	23303	N9	G E	95	39.495	81.507	25.167	1.00	95.35	N
ATOM	23304	C8	G E	95	40.255	80.825	24.241	1.00	91.84	C
ATOM	23305	N7	G E	95	40.530	79.604	24.605	1.00	89.35	N
ATOM	23306	C5	G E	95	39.919	79.461	25.848	1.00	94.81	C
ATOM	23307	C4	G E	95	39.274	80.627	26.209	1.00	95.37	C

ATOM	23308	N1	G E	95	39.147	78.649	27.889	1.00	91.35	N
ATOM	23309	C2	G E	95	38.538	79.845	28.154	1.00	92.37	C
ATOM	23310	N3	G E	95	38.572	80.885	27.338	1.00	93.00	N
ATOM	23311	C6	G E	95	39.873	78.352	26.743	1.00	94.63	C
ATOM	23312	O6	G E	95	40.374	77.223	26.623	1.00	92.26	O
ATOM	23313	N2	G E	95	37.882	79.917	29.318	1.00	89.73	N
ATOM	23314	O5'	C E	96	42.161	85.860	28.100	1.00	95.56	O
ATOM	23315	C4'	C E	96	41.623	84.691	30.131	1.00	104.32	C
ATOM	23316	C3'	C E	96	42.073	84.021	31.421	1.00	109.86	C
ATOM	23317	C2'	C E	96	40.868	83.166	31.779	1.00	109.30	C
ATOM	23318	P	C E	96	42.688	85.626	26.614	1.00	95.15	P
ATOM	23319	OP1	C E	96	43.466	86.818	26.190	1.00	99.14	O
ATOM	23320	OP2	C E	96	43.324	84.284	26.557	1.00	103.94	O
ATOM	23321	C5'	C E	96	42.712	85.155	29.201	1.00	99.04	O
ATOM	23322	O4'	C E	96	40.822	83.678	29.468	1.00	100.85	O
ATOM	23323	O3'	C E	96	42.406	84.948	32.431	1.00	113.64	O
ATOM	23324	O2'	C E	96	39.831	83.966	32.329	1.00	112.42	O
ATOM	23325	C1'	C E	96	40.433	82.688	30.398	1.00	106.44	C
ATOM	23326	N1	C E	96	41.109	81.418	30.043	1.00	106.73	N
ATOM	23327	C2	C E	96	40.728	80.237	30.694	1.00	101.91	C
ATOM	23328	N3	C E	96	41.360	79.089	30.368	1.00	99.86	N
ATOM	23329	C4	C E	96	42.322	79.087	29.446	1.00	99.60	C
ATOM	23330	C5	C E	96	42.731	80.268	28.772	1.00	100.32	C
ATOM	23331	C6	C E	96	42.103	81.398	29.102	1.00	104.02	C
ATOM	23332	O2	C E	96	39.827	80.263	31.551	1.00	102.01	O
ATOM	23333	N4	C E	96	42.910	77.926	29.163	1.00	100.03	N
ATOM	23334	P	U E	97	43.284	84.510	33.707	1.00	126.52	P
ATOM	23335	OP1	U E	97	42.839	85.364	34.844	1.00	123.78	O
ATOM	23336	OP2	U E	97	44.703	84.526	33.258	1.00	124.59	O
ATOM	23337	O5'	U E	97	42.865	82.999	34.045	1.00	125.95	O
ATOM	23338	C5'	U E	97	42.402	82.631	35.346	1.00	126.76	C
ATOM	23339	C4'	U E	97	43.316	81.643	36.050	1.00	129.14	C
ATOM	23340	O4'	U E	97	43.339	80.376	35.337	1.00	120.40	O
ATOM	23341	C3'	U E	97	44.787	82.040	36.178	1.00	130.68	C
ATOM	23342	O3'	U E	97	45.039	82.902	37.280	1.00	128.80	O
ATOM	23343	C2'	U E	97	45.501	80.698	36.292	1.00	124.21	C
ATOM	23344	O2'	U E	97	45.467	80.209	37.624	1.00	121.51	O
ATOM	23345	C1'	U E	97	44.627	79.799	35.412	1.00	124.67	C
ATOM	23346	N1	U E	97	45.127	79.599	34.022	1.00	128.68	N
ATOM	23347	C2	U E	97	46.403	79.938	33.533	1.00	128.45	C
ATOM	23348	N3	U E	97	46.603	79.623	32.206	1.00	127.17	N
ATOM	23349	C4	U E	97	45.730	79.011	31.329	1.00	118.08	C
ATOM	23350	C5	U E	97	44.465	78.678	31.901	1.00	111.86	C
ATOM	23351	C6	U E	97	44.228	78.971	33.182	1.00	117.52	C
ATOM	23352	O2	U E	97	47.315	80.492	34.132	1.00	128.73	O
ATOM	23353	O4	U E	97	46.080	78.799	30.167	1.00	118.62	O
TER										
ATOM	23354	P	DG F	1	36.387	20.424	20.252	1.00	75.89	P
ATOM	23355	OP1	DG F	1	35.674	21.057	19.098	1.00	71.24	O
ATOM	23356	OP2	DG F	1	36.897	21.240	21.385	1.00	60.36	O
ATOM	23357	OP3	DG F	1	37.523	19.606	19.744	1.00	63.64	O
ATOM	23358	O5'	DG F	1	35.363	19.382	20.866	1.00	65.62	O
ATOM	23359	C5'	DG F	1	34.771	19.641	22.111	1.00	62.89	C
ATOM	23360	C4'	DG F	1	33.731	18.592	22.402	1.00	60.01	C
ATOM	23361	O4'	DG F	1	34.382	17.381	22.856	1.00	50.49	O
ATOM	23362	C3'	DG F	1	32.714	18.985	23.482	1.00	56.00	C
ATOM	23363	O3'	DG F	1	31.417	19.011	22.932	1.00	61.01	O
ATOM	23364	C2'	DG F	1	32.828	17.890	24.527	1.00	52.79	C
ATOM	23365	C1'	DG F	1	33.536	16.767	23.776	1.00	51.94	C
ATOM	23366	N9	DG F	1	34.289	15.934	24.694	1.00	44.00	N
ATOM	23367	C8	DG F	1	35.280	16.323	25.558	1.00	45.62	C
ATOM	23368	N7	DG F	1	35.686	15.366	26.344	1.00	42.38	N
ATOM	23369	C5	DG F	1	34.895	14.277	25.967	1.00	48.32	C

ATOM	23370	C4	DG	F	1	34.015	14.634	24.981	1.00	46.33	C
ATOM	23371	N1	DG	F	1	33.881	12.186	25.804	1.00	43.81	N
ATOM	23372	C2	DG	F	1	33.050	12.652	24.799	1.00	40.37	C
ATOM	23373	N3	DG	F	1	33.093	13.866	24.336	1.00	43.25	N
ATOM	23374	C6	DG	F	1	34.872	12.940	26.440	1.00	44.38	C
ATOM	23375	O6	DG	F	1	35.573	12.429	27.321	1.00	49.11	O
ATOM	23376	N2	DG	F	1	32.169	11.789	24.281	1.00	38.56	N
ATOM	23377	O5'	DC	F	2	29.593	17.762	24.160	1.00	53.16	O
ATOM	23378	C4'	DC	F	2	28.658	15.656	23.563	1.00	53.87	C
ATOM	23379	C3'	DC	F	2	27.658	15.684	24.696	1.00	50.96	C
ATOM	23380	C2'	DC	F	2	27.812	14.291	25.279	1.00	51.55	C
ATOM	23381	P	DC	F	2	30.147	19.225	23.891	1.00	63.03	P
ATOM	23382	OP1	DC	F	2	29.160	19.919	23.032	1.00	58.68	O
ATOM	23383	OP2	DC	F	2	30.586	19.780	25.193	1.00	57.44	O
ATOM	23384	C5'	DC	F	2	29.128	17.004	23.087	1.00	51.87	C
ATOM	23385	O4'	DC	F	2	29.767	14.958	24.132	1.00	49.28	O
ATOM	23386	O3'	DC	F	2	26.343	15.848	24.208	1.00	59.40	O
ATOM	23387	C1'	DC	F	2	29.245	13.903	24.901	1.00	52.40	C
ATOM	23388	N1	DC	F	2	30.092	13.677	26.088	1.00	44.36	N
ATOM	23389	C2	DC	F	2	30.034	12.436	26.725	1.00	39.89	C
ATOM	23390	N3	DC	F	2	30.792	12.240	27.831	1.00	42.21	N
ATOM	23391	C4	DC	F	2	31.584	13.212	28.287	1.00	42.90	C
ATOM	23392	C5	DC	F	2	31.648	14.494	27.643	1.00	44.28	C
ATOM	23393	C6	DC	F	2	30.885	14.681	26.562	1.00	42.91	C
ATOM	23394	O2	DC	F	2	29.273	11.551	26.270	1.00	37.21	O
ATOM	23395	N4	DC	F	2	32.323	12.962	29.378	1.00	36.28	N
ATOM	23396	P	DC	F	3	25.151	16.120	25.251	1.00	58.90	P
ATOM	23397	OP1	DC	F	3	24.011	16.547	24.418	1.00	65.70	O
ATOM	23398	OP2	DC	F	3	25.735	16.895	26.375	1.00	46.31	O
ATOM	23399	O5'	DC	F	3	24.782	14.706	25.897	1.00	52.05	O
ATOM	23400	C5'	DC	F	3	24.169	13.697	25.118	1.00	56.24	C
ATOM	23401	C4'	DC	F	3	24.137	12.387	25.877	1.00	53.21	C
ATOM	23402	O4'	DC	F	3	25.491	11.940	26.176	1.00	48.14	O
ATOM	23403	C3'	DC	F	3	23.483	12.455	27.240	1.00	50.30	C
ATOM	23404	O3'	DC	F	3	22.088	12.420	27.095	1.00	60.19	O
ATOM	23405	C2'	DC	F	3	23.986	11.164	27.853	1.00	48.55	C
ATOM	23406	C1'	DC	F	3	25.428	11.102	27.324	1.00	47.13	C
ATOM	23407	N1	DC	F	3	26.419	11.548	28.329	1.00	41.57	N
ATOM	23408	C2	DC	F	3	26.700	10.709	29.406	1.00	39.47	C
ATOM	23409	N3	DC	F	3	27.587	11.104	30.331	1.00	38.87	N
ATOM	23410	C4	DC	F	3	28.173	12.292	30.229	1.00	42.11	C
ATOM	23411	C5	DC	F	3	27.867	13.195	29.147	1.00	42.57	C
ATOM	23412	C6	DC	F	3	26.993	12.781	28.230	1.00	41.02	C
ATOM	23413	O2	DC	F	3	26.131	9.612	29.478	1.00	46.33	O
ATOM	23414	N4	DC	F	3	29.055	12.634	31.184	1.00	33.74	N
ATOM	23415	O5'	DA	F	4	21.405	12.032	29.546	1.00	53.15	O
ATOM	23416	C4'	DA	F	4	21.453	9.968	30.836	1.00	54.66	C
ATOM	23417	C3'	DA	F	4	21.138	10.561	32.183	1.00	48.49	C
ATOM	23418	C2'	DA	F	4	22.119	9.771	33.047	1.00	48.52	C
ATOM	23419	P	DA	F	4	21.104	12.955	28.259	1.00	59.81	P
ATOM	23420	OP1	DA	F	4	19.757	12.689	27.694	1.00	62.43	O
ATOM	23421	OP2	DA	F	4	21.531	14.309	28.664	1.00	44.43	O
ATOM	23422	C5'	DA	F	4	20.906	10.714	29.618	1.00	53.31	C
ATOM	23423	O4'	DA	F	4	22.900	9.937	30.828	1.00	52.48	O
ATOM	23424	O3'	DA	F	4	19.794	10.264	32.552	1.00	54.52	O
ATOM	23425	C1'	DA	F	4	23.352	9.719	32.152	1.00	46.32	C
ATOM	23426	N9	DA	F	4	24.313	10.753	32.491	1.00	46.78	N
ATOM	23427	C8	DA	F	4	24.562	11.907	31.802	1.00	41.96	C
ATOM	23428	N7	DA	F	4	25.489	12.658	32.361	1.00	43.58	N
ATOM	23429	C5	DA	F	4	25.852	11.945	33.502	1.00	38.49	C
ATOM	23430	C4	DA	F	4	25.142	10.778	33.599	1.00	38.83	C
ATOM	23431	N1	DA	F	4	26.892	11.281	35.506	1.00	44.84	N
ATOM	23432	C2	DA	F	4	26.131	10.201	35.472	1.00	35.39	C

ATOM	23433	N3	DA	F	4	25.230	9.861	34.569	1.00	37.65	N
ATOM	23434	C6	DA	F	4	26.764	12.203	34.520	1.00	40.16	C
ATOM	23435	N6	DA	F	4	27.520	13.287	34.550	1.00	34.07	N
ATOM	23436	O5'	DA	F	5	19.812	10.386	35.118	1.00	57.75	O
ATOM	23437	C4'	DA	F	5	20.395	8.805	36.770	1.00	41.99	C
ATOM	23438	C3'	DA	F	5	19.887	9.743	37.829	1.00	47.58	C
ATOM	23439	C2'	DA	F	5	21.046	9.720	38.834	1.00	47.74	C
ATOM	23440	P	DA	F	5	19.111	10.990	33.818	1.00	57.73	P
ATOM	23441	OP1	DA	F	5	17.700	10.555	33.751	1.00	63.66	O
ATOM	23442	OP2	DA	F	5	19.610	12.366	33.912	1.00	42.48	O
ATOM	23443	C5'	DA	F	5	19.739	9.007	35.438	1.00	47.11	C
ATOM	23444	O4'	DA	F	5	21.776	9.194	36.651	1.00	40.28	O
ATOM	23445	O3'	DA	F	5	18.676	9.265	38.381	1.00	53.66	O
ATOM	23446	C1'	DA	F	5	22.261	9.616	37.912	1.00	39.40	C
ATOM	23447	N9	DA	F	5	22.989	10.867	37.716	1.00	41.81	N
ATOM	23448	C8	DA	F	5	22.904	11.712	36.634	1.00	42.42	C
ATOM	23449	N7	DA	F	5	23.680	12.768	36.721	1.00	39.80	N
ATOM	23450	C5	DA	F	5	24.328	12.606	37.937	1.00	38.57	C
ATOM	23451	C4	DA	F	5	23.919	11.434	38.563	1.00	39.67	C
ATOM	23452	N1	DA	F	5	25.737	12.929	39.802	1.00	44.01	N
ATOM	23453	C2	DA	F	5	25.241	11.782	40.282	1.00	38.40	C
ATOM	23454	N3	DA	F	5	24.326	10.972	39.749	1.00	34.28	N
ATOM	23455	C6	DA	F	5	25.296	13.375	38.604	1.00	41.25	C
ATOM	23456	N6	DA	F	5	25.798	14.500	38.113	1.00	38.41	N
ATOM	23457	O5'	DG	F	6	18.455	10.615	40.510	1.00	56.24	O
ATOM	23458	C4'	DG	F	6	19.587	10.173	42.540	1.00	51.45	C
ATOM	23459	C3'	DG	F	6	19.132	11.414	43.259	1.00	51.43	C
ATOM	23460	C2'	DG	F	6	20.449	11.886	43.859	1.00	52.48	C
ATOM	23461	P	DG	F	6	17.695	10.270	39.162	1.00	63.41	P
ATOM	23462	OP1	DG	F	6	16.514	9.445	39.436	1.00	65.82	O
ATOM	23463	OP2	DG	F	6	17.622	11.618	38.552	1.00	44.20	O
ATOM	23464	C5'	DG	F	6	18.631	9.645	41.494	1.00	48.86	C
ATOM	23465	O4'	DG	F	6	20.793	10.619	41.896	1.00	50.21	O
ATOM	23466	O3'	DG	F	6	18.205	11.090	44.277	1.00	62.65	O
ATOM	23467	C1'	DG	F	6	21.447	11.529	42.765	1.00	50.04	C
ATOM	23468	N9	DG	F	6	21.924	12.687	42.007	1.00	44.03	N
ATOM	23469	C8	DG	F	6	21.530	13.075	40.759	1.00	39.96	C
ATOM	23470	N7	DG	F	6	22.143	14.147	40.339	1.00	44.62	N
ATOM	23471	C5	DG	F	6	22.998	14.493	41.376	1.00	41.24	C
ATOM	23472	C4	DG	F	6	22.881	13.604	42.408	1.00	41.62	C
ATOM	23473	N1	DG	F	6	24.614	15.517	42.690	1.00	42.98	N
ATOM	23474	C2	DG	F	6	24.426	14.576	43.664	1.00	44.10	C
ATOM	23475	N3	DG	F	6	23.551	13.589	43.578	1.00	43.22	N
ATOM	23476	C6	DG	F	6	23.922	15.558	41.485	1.00	44.75	C
ATOM	23477	O6	DG	F	6	24.169	16.459	40.663	1.00	45.12	O
ATOM	23478	N2	DG	F	6	25.187	14.694	44.759	1.00	44.86	N
ATOM	23479	O5'	DC	F	7	18.433	13.178	45.745	1.00	59.63	O
ATOM	23480	C4'	DC	F	7	19.791	13.917	47.593	1.00	56.09	C
ATOM	23481	C3'	DC	F	7	19.166	15.286	47.715	1.00	57.26	C
ATOM	23482	C2'	DC	F	7	20.410	16.165	47.837	1.00	54.23	C
ATOM	23483	P	DC	F	7	17.358	12.259	45.000	1.00	66.61	P
ATOM	23484	OP1	DC	F	7	16.519	11.602	46.025	1.00	72.14	O
ATOM	23485	OP2	DC	F	7	16.789	13.106	43.949	1.00	54.50	O
ATOM	23486	C5'	DC	F	7	18.886	12.833	47.036	1.00	53.94	C
ATOM	23487	O4'	DC	F	7	20.893	14.148	46.691	1.00	56.23	O
ATOM	23488	O3'	DC	F	7	18.357	15.367	48.876	1.00	61.97	O
ATOM	23489	C1'	DC	F	7	21.395	15.458	46.909	1.00	55.75	C
ATOM	23490	N1	DC	F	7	21.546	16.131	45.611	1.00	49.37	N
ATOM	23491	C2	DC	F	7	22.505	17.118	45.473	1.00	45.54	C
ATOM	23492	N3	DC	F	7	22.650	17.724	44.287	1.00	43.75	N
ATOM	23493	C4	DC	F	7	21.863	17.389	43.274	1.00	43.15	C
ATOM	23494	C5	DC	F	7	20.870	16.381	43.397	1.00	42.47	C
ATOM	23495	C6	DC	F	7	20.749	15.782	44.573	1.00	45.83	C

ATOM	23496	O2	DC	F	7	23.204	17.410	46.437	1.00	50.96	O
ATOM	23497	N4	DC	F	7	22.038	18.027	42.117	1.00	41.51	N
ATOM	23498	O5'	DG	F	8	18.289	17.839	49.377	1.00	47.18	O
ATOM	23499	C4'	DG	F	8	20.054	18.988	50.522	1.00	48.34	C
ATOM	23500	C3'	DG	F	8	19.443	20.381	50.414	1.00	47.87	C
ATOM	23501	C2'	DG	F	8	20.611	21.190	49.852	1.00	47.99	C
ATOM	23502	P	DG	F	8	17.342	16.602	49.048	1.00	63.80	P
ATOM	23503	OP1	DG	F	8	16.469	16.261	50.192	1.00	64.71	O
ATOM	23504	OP2	DG	F	8	16.773	16.912	47.724	1.00	58.51	O
ATOM	23505	C5'	DG	F	8	19.060	17.846	50.552	1.00	47.72	C
ATOM	23506	O4'	DG	F	8	20.889	18.871	49.354	1.00	47.05	O
ATOM	23507	O3'	DG	F	8	19.073	20.834	51.697	1.00	49.79	O
ATOM	23508	C1'	DG	F	8	21.326	20.160	48.952	1.00	47.81	C
ATOM	23509	N9	DG	F	8	21.036	20.314	47.528	1.00	47.09	N
ATOM	23510	C8	DG	F	8	20.136	19.582	46.780	1.00	46.24	C
ATOM	23511	N7	DG	F	8	20.089	19.938	45.524	1.00	44.78	N
ATOM	23512	C5	DG	F	8	21.025	20.973	45.435	1.00	41.36	C
ATOM	23513	C4	DG	F	8	21.601	21.225	46.655	1.00	44.72	C
ATOM	23514	N1	DG	F	8	22.381	22.674	44.662	1.00	38.79	N
ATOM	23515	C2	DG	F	8	22.901	22.845	45.915	1.00	41.42	C
ATOM	23516	N3	DG	F	8	22.545	22.140	46.966	1.00	44.24	N
ATOM	23517	C6	DG	F	8	21.421	21.737	44.325	1.00	43.10	C
ATOM	23518	O6	DG	F	8	21.001	21.669	43.159	1.00	52.65	O
ATOM	23519	N2	DG	F	8	23.818	23.806	46.047	1.00	42.17	N
ATOM	23520	O5'	DC	F	9	18.604	23.295	51.390	1.00	48.45	O
ATOM	23521	C4'	DC	F	9	20.232	25.070	51.433	1.00	48.37	C
ATOM	23522	C3'	DC	F	9	19.314	26.187	50.885	1.00	47.21	C
ATOM	23523	C2'	DC	F	9	20.144	26.729	49.726	1.00	42.11	C
ATOM	23524	P	DC	F	9	17.917	21.929	51.878	1.00	56.04	P
ATOM	23525	OP1	DC	F	9	17.658	21.970	53.329	1.00	67.09	O
ATOM	23526	OP2	DC	F	9	16.803	21.613	50.973	1.00	51.30	O
ATOM	23527	C5'	DC	F	9	19.556	23.954	52.207	1.00	42.98	C
ATOM	23528	O4'	DC	F	9	20.867	24.509	50.260	1.00	47.17	O
ATOM	23529	O3'	DC	F	9	19.103	27.210	51.883	1.00	50.10	O
ATOM	23530	C1'	DC	F	9	20.822	25.449	49.187	1.00	47.52	C
ATOM	23531	N1	DC	F	9	20.104	24.842	48.034	1.00	40.92	N
ATOM	23532	C2	DC	F	9	20.375	25.299	46.753	1.00	39.51	C
ATOM	23533	N3	DC	F	9	19.716	24.759	45.712	1.00	38.61	N
ATOM	23534	C4	DC	F	9	18.802	23.805	45.922	1.00	41.47	C
ATOM	23535	C5	DC	F	9	18.495	23.339	47.230	1.00	41.39	C
ATOM	23536	C6	DC	F	9	19.167	23.878	48.248	1.00	42.14	C
ATOM	23537	O2	DC	F	9	21.223	26.172	46.605	1.00	40.94	O
ATOM	23538	N4	DC	F	9	18.170	23.288	44.860	1.00	39.20	N
ATOM	23539	O5'	DA	F	10	18.299	29.194	50.468	1.00	41.87	O
ATOM	23540	C4'	DA	F	10	19.731	30.538	49.133	1.00	42.47	C
ATOM	23541	C3'	DA	F	10	18.632	31.355	48.520	1.00	42.31	C
ATOM	23542	C2'	DA	F	10	18.917	31.211	47.027	1.00	46.13	C
ATOM	23543	P	DA	F	10	17.914	28.315	51.725	1.00	48.28	P
ATOM	23544	OP1	DA	F	10	18.026	29.251	52.867	1.00	44.89	O
ATOM	23545	OP2	DA	F	10	16.674	27.566	51.414	1.00	44.47	O
ATOM	23546	C5'	DA	F	10	19.423	30.034	50.519	1.00	42.12	C
ATOM	23547	O4'	DA	F	10	19.846	29.407	48.238	1.00	49.28	O
ATOM	23548	O3'	DA	F	10	18.741	32.717	48.949	1.00	60.36	O
ATOM	23549	C1'	DA	F	10	19.547	29.816	46.926	1.00	41.47	C
ATOM	23550	N9	DA	F	10	18.683	28.824	46.300	1.00	39.91	N
ATOM	23551	C8	DA	F	10	17.972	27.834	46.910	1.00	42.50	C
ATOM	23552	N7	DA	F	10	17.258	27.092	46.068	1.00	46.50	N
ATOM	23553	C5	DA	F	10	17.522	27.653	44.822	1.00	44.18	C
ATOM	23554	C4	DA	F	10	18.395	28.720	44.955	1.00	41.46	C
ATOM	23555	N1	DA	F	10	17.572	28.095	42.510	1.00	46.48	N
ATOM	23556	C2	DA	F	10	18.406	29.091	42.803	1.00	46.08	C
ATOM	23557	N3	DA	F	10	18.875	29.480	43.982	1.00	43.01	N
ATOM	23558	C6	DA	F	10	17.097	27.334	43.502	1.00	48.23	C

ATOM	23559	N6	DA	F	10	16.249	26.332	43.188	1.00	43.63	N
ATOM	23560	O5'	DC	F	11	17.281	33.890	47.217	1.00	49.91	O
ATOM	23561	C4'	DC	F	11	17.848	34.600	45.001	1.00	57.62	C
ATOM	23562	C3'	DC	F	11	16.483	35.183	44.649	1.00	49.73	C
ATOM	23563	C2'	DC	F	11	16.063	34.364	43.433	1.00	53.33	C
ATOM	23564	P	DC	F	11	17.495	33.743	48.778	1.00	55.52	P
ATOM	23565	OP1	DC	F	11	18.017	35.036	49.259	1.00	56.84	O
ATOM	23566	OP2	DC	F	11	16.288	33.078	49.297	1.00	56.13	O
ATOM	23567	C5'	DC	F	11	18.208	34.651	46.464	1.00	57.86	C
ATOM	23568	O4'	DC	F	11	17.765	33.225	44.613	1.00	49.37	O
ATOM	23569	O3'	DC	F	11	16.610	36.560	44.292	1.00	55.92	O
ATOM	23570	C1'	DC	F	11	16.960	33.122	43.471	1.00	50.47	C
ATOM	23571	N1	DC	F	11	16.170	31.898	43.562	1.00	46.38	N
ATOM	23572	C2	DC	F	11	15.625	31.364	42.400	1.00	48.89	C
ATOM	23573	N3	DC	F	11	14.862	30.261	42.487	1.00	46.42	N
ATOM	23574	C4	DC	F	11	14.628	29.715	43.668	1.00	49.36	C
ATOM	23575	C5	DC	F	11	15.154	30.272	44.878	1.00	46.20	C
ATOM	23576	C6	DC	F	11	15.911	31.352	44.775	1.00	41.39	C
ATOM	23577	O2	DC	F	11	15.859	31.914	41.316	1.00	51.46	O
ATOM	23578	N4	DC	F	11	13.875	28.613	43.699	1.00	50.23	N
ATOM	23579	O5'	DC	F	12	14.600	37.012	42.785	1.00	57.51	O
ATOM	23580	C4'	DC	F	12	14.341	36.613	40.473	1.00	63.22	C
ATOM	23581	C3'	DC	F	12	12.861	36.948	40.485	1.00	60.88	C
ATOM	23582	C2'	DC	F	12	12.294	35.801	39.651	1.00	62.34	C
ATOM	23583	P	DC	F	12	15.300	37.495	44.121	1.00	69.03	P
ATOM	23584	OP1	DC	F	12	15.765	38.889	43.988	1.00	67.25	O
ATOM	23585	OP2	DC	F	12	14.297	37.125	45.136	1.00	64.15	O
ATOM	23586	C5'	DC	F	12	15.171	37.265	41.555	1.00	56.50	C
ATOM	23587	O4'	DC	F	12	14.348	35.194	40.650	1.00	52.01	O
ATOM	23588	O3'	DC	F	12	12.646	38.198	39.844	1.00	72.91	O
ATOM	23589	C1'	DC	F	12	13.276	34.657	39.914	1.00	55.76	C
ATOM	23590	N1	DC	F	12	12.688	33.572	40.681	1.00	51.90	N
ATOM	23591	C2	DC	F	12	11.876	32.670	40.031	1.00	58.43	C
ATOM	23592	N3	DC	F	12	11.329	31.652	40.734	1.00	53.67	N
ATOM	23593	C4	DC	F	12	11.574	31.537	42.030	1.00	50.76	C
ATOM	23594	C5	DC	F	12	12.401	32.462	42.720	1.00	50.11	C
ATOM	23595	C6	DC	F	12	12.937	33.457	42.009	1.00	52.51	C
ATOM	23596	O2	DC	F	12	11.675	32.822	38.817	1.00	62.14	O
ATOM	23597	N4	DC	F	12	11.010	30.522	42.682	1.00	52.75	N
ATOM	23598	O5'	DC	F	13	10.213	38.172	39.134	1.00	66.35	O
ATOM	23599	C4'	DC	F	13	9.523	36.964	37.159	1.00	71.91	C
ATOM	23600	C3'	DC	F	13	8.072	37.213	37.506	1.00	78.38	C
ATOM	23601	C2'	DC	F	13	7.457	35.817	37.349	1.00	75.88	C
ATOM	23602	P	DC	F	13	11.259	39.002	40.024	1.00	75.86	P
ATOM	23603	OP1	DC	F	13	11.510	40.310	39.383	1.00	69.16	O
ATOM	23604	OP2	DC	F	13	10.885	38.961	41.465	1.00	64.33	O
ATOM	23605	C5'	DC	F	13	10.502	37.947	37.761	1.00	64.50	C
ATOM	23606	O4'	DC	F	13	9.807	35.634	37.642	1.00	75.91	O
ATOM	23607	O3'	DC	F	13	7.520	38.145	36.566	1.00	88.18	O
ATOM	23608	C1'	DC	F	13	8.604	34.893	37.766	1.00	71.10	C
ATOM	23609	N1	DC	F	13	8.508	34.368	39.186	1.00	70.34	N
ATOM	23610	C2	DC	F	13	7.812	33.191	39.432	1.00	64.03	C
ATOM	23611	O2	DC	F	13	7.266	32.615	38.487	1.00	63.39	O
ATOM	23612	N3	DC	F	13	7.741	32.722	40.703	1.00	61.02	N
ATOM	23613	C4	DC	F	13	8.347	33.383	41.695	1.00	59.70	C
ATOM	23614	N4	DC	F	13	8.252	32.882	42.927	1.00	62.49	N
ATOM	23615	C5	DC	F	13	9.079	34.579	41.466	1.00	55.72	C
ATOM	23616	C6	DC	F	13	9.130	35.035	40.212	1.00	64.02	C
ATOM	23617	O5'	DA	F	14	5.052	38.327	37.039	1.00	86.83	O
ATOM	23618	C4'	DA	F	14	3.476	36.674	36.257	1.00	87.96	C
ATOM	23619	C3'	DA	F	14	2.450	37.479	37.072	1.00	90.40	C
ATOM	23620	C2'	DA	F	14	2.539	36.878	38.461	1.00	83.55	C
ATOM	23621	P	DA	F	14	6.388	39.204	37.007	1.00	97.39	P

ATOM	23622	OP1	DA	F	14	6.295	40.211	35.925	1.00	91.70	O
ATOM	23623	OP2	DA	F	14	6.655	39.661	38.389	1.00	93.74	O
ATOM	23624	C5'	DA	F	14	4.734	37.454	35.941	1.00	85.97	C
ATOM	23625	O4'	DA	F	14	3.819	35.511	37.065	1.00	82.10	O
ATOM	23626	O3'	DA	F	14	1.131	37.362	36.538	1.00	90.00	O
ATOM	23627	C1'	DA	F	14	2.940	35.441	38.160	1.00	82.36	C
ATOM	23628	N9	DA	F	14	3.609	34.842	39.299	1.00	75.57	N
ATOM	23629	C8	DA	F	14	4.619	35.395	40.032	1.00	71.33	C
ATOM	23630	N7	DA	F	14	4.988	34.662	41.054	1.00	71.60	N
ATOM	23631	C5	DA	F	14	4.142	33.571	41.004	1.00	67.85	C
ATOM	23632	C4	DA	F	14	3.275	33.669	39.935	1.00	73.02	C
ATOM	23633	N1	DA	F	14	3.076	31.533	41.494	1.00	69.25	N
ATOM	23634	C2	DA	F	14	2.296	31.761	40.431	1.00	68.69	C
ATOM	23635	N3	DA	F	14	2.318	32.790	39.587	1.00	70.67	N
ATOM	23636	C6	DA	F	14	4.026	32.439	41.812	1.00	67.21	C
ATOM	23637	N6	DA	F	14	4.811	32.220	42.870	1.00	69.98	N
ATOM	23638	O5'	DA	F	15	-0.931	37.587	37.995	1.00	85.01	O
ATOM	23639	C4'	DA	F	15	-2.608	35.909	38.457	1.00	85.17	C
ATOM	23640	C3'	DA	F	15	-3.046	36.421	39.815	1.00	82.60	C
ATOM	23641	C2'	DA	F	15	-3.055	35.121	40.609	1.00	81.52	C
ATOM	23642	P	DA	F	15	0.006	38.415	36.998	1.00	92.15	P
ATOM	23643	OP1	DA	F	15	-0.767	38.750	35.779	1.00	96.58	O
ATOM	23644	OP2	DA	F	15	0.669	39.475	37.798	1.00	81.55	O
ATOM	23645	C5'	DA	F	15	-2.089	36.957	37.493	1.00	84.96	C
ATOM	23646	O4'	DA	F	15	-1.561	34.963	38.766	1.00	83.96	O
ATOM	23647	O3'	DA	F	15	-4.349	36.994	39.726	1.00	85.99	O
ATOM	23648	C1'	DA	F	15	-1.805	34.418	40.056	1.00	80.68	C
ATOM	23649	N9	DA	F	15	-0.627	34.634	40.879	1.00	75.46	N
ATOM	23650	C8	DA	F	15	0.360	35.560	40.683	1.00	74.08	C
ATOM	23651	N7	DA	F	15	1.296	35.535	41.602	1.00	73.13	N
ATOM	23652	C5	DA	F	15	0.894	34.522	42.458	1.00	72.20	C
ATOM	23653	C4	DA	F	15	-0.294	33.959	42.030	1.00	74.52	C
ATOM	23654	N1	DA	F	15	0.800	32.986	44.244	1.00	71.54	N
ATOM	23655	C2	DA	F	15	-0.346	32.540	43.711	1.00	71.16	C
ATOM	23656	N3	DA	F	15	-0.975	32.957	42.615	1.00	72.41	N
ATOM	23657	C6	DA	F	15	1.457	33.996	43.631	1.00	70.29	C
ATOM	23658	N6	DA	F	15	2.593	34.447	44.162	1.00	70.15	N
ATOM	23659	O5'	DT	F	16	-5.144	37.242	42.111	1.00	75.84	O
ATOM	23660	C4'	DT	F	16	-6.232	35.527	43.430	1.00	77.90	C
ATOM	23661	C3'	DT	F	16	-6.097	36.404	44.664	1.00	80.57	C
ATOM	23662	C2'	DT	F	16	-5.757	35.350	45.705	1.00	77.00	C
ATOM	23663	P	DT	F	16	-4.852	38.091	40.792	1.00	77.39	P
ATOM	23664	OP1	DT	F	16	-6.160	38.571	40.286	1.00	88.33	O
ATOM	23665	OP2	DT	F	16	-3.767	39.069	41.042	1.00	75.53	O
ATOM	23666	C5'	DT	F	16	-6.150	36.246	42.094	1.00	72.79	C
ATOM	23667	O4'	DT	F	16	-5.121	34.598	43.560	1.00	84.27	O
ATOM	23668	O3'	DT	F	16	-7.312	37.092	44.966	1.00	87.33	O
ATOM	23669	C1'	DT	F	16	-4.719	34.542	44.930	1.00	82.32	C
ATOM	23670	N1	DT	F	16	-3.325	35.105	45.076	1.00	72.85	N
ATOM	23671	C2	DT	F	16	-2.597	34.792	46.200	1.00	73.04	C
ATOM	23672	N3	DT	F	16	-1.357	35.366	46.248	1.00	71.21	N
ATOM	23673	C4	DT	F	16	-0.787	36.207	45.315	1.00	69.22	C
ATOM	23674	C5	DT	F	16	-1.598	36.502	44.171	1.00	71.02	C
ATOM	23675	C6	DT	F	16	-2.816	35.948	44.104	1.00	71.85	C
ATOM	23676	O2	DT	F	16	-3.010	34.054	47.088	1.00	71.96	O
ATOM	23677	O4	DT	F	16	0.331	36.674	45.451	1.00	73.52	O
ATOM	23678	C7	DT	F	16	-1.075	37.414	43.098	1.00	70.84	C
ATOM	23679	P	DT	F	17	-7.252	38.573	45.601	1.00	84.83	P
ATOM	23680	OP1	DT	F	17	-6.054	39.249	45.056	1.00	84.10	O
ATOM	23681	OP2	DT	F	17	-8.581	39.204	45.421	1.00	84.10	O
ATOM	23682	O5'	DT	F	17	-7.012	38.315	47.157	1.00	73.60	O
ATOM	23683	O3'	DT	F	17	-7.886	38.885	50.766	1.00	80.41	O
ATOM	23684	C1'	DT	F	17	-5.104	36.600	50.061	1.00	76.43	C

ATOM	23685	C2'	DT	F	17	-5.791	37.604	51.001	1.00	76.07	C
ATOM	23686	C3'	DT	F	17	-6.774	38.296	50.055	1.00	76.65	C
ATOM	23687	C4'	DT	F	17	-7.242	37.107	49.222	1.00	81.96	C
ATOM	23688	C5'	DT	F	17	-7.856	37.450	47.873	1.00	73.06	C
ATOM	23689	O4'	DT	F	17	-6.038	36.303	49.032	1.00	77.08	O
ATOM	23690	N1	DT	F	17	-3.830	37.151	49.453	1.00	75.25	N
ATOM	23691	C2	DT	F	17	-2.645	37.011	50.147	1.00	70.20	C
ATOM	23692	N3	DT	F	17	-1.550	37.569	49.540	1.00	69.20	N
ATOM	23693	C4	DT	F	17	-1.519	38.238	48.332	1.00	70.23	C
ATOM	23694	C5	DT	F	17	-2.792	38.356	47.651	1.00	69.28	C
ATOM	23695	C6	DT	F	17	-3.876	37.819	48.239	1.00	69.90	C
ATOM	23696	O2	DT	F	17	-2.565	36.430	51.212	1.00	69.47	O
ATOM	23697	O4	DT	F	17	-0.481	38.697	47.866	1.00	74.62	O
ATOM	23698	C7	DT	F	17	-2.877	39.063	46.328	1.00	67.42	C
ATOM	23699	P	DT	F	18	-7.898	40.450	51.179	1.00	76.25	P
ATOM	23700	OP1	DT	F	18	-9.211	40.667	51.824	1.00	88.44	O
ATOM	23701	OP2	DT	F	18	-7.525	41.307	50.028	1.00	70.66	O
ATOM	23702	O5'	DT	F	18	-6.747	40.586	52.284	1.00	68.29	O
ATOM	23703	C5'	DT	F	18	-6.857	39.892	53.497	1.00	70.66	C
ATOM	23704	C4'	DT	F	18	-5.577	39.998	54.302	1.00	70.71	C
ATOM	23705	O4'	DT	F	18	-4.524	39.206	53.684	1.00	79.76	O
ATOM	23706	C3'	DT	F	18	-4.964	41.380	54.382	1.00	68.39	C
ATOM	23707	O3'	DT	F	18	-5.664	42.208	55.303	1.00	70.95	O
ATOM	23708	C2'	DT	F	18	-3.566	41.015	54.876	1.00	68.90	C
ATOM	23709	C1'	DT	F	18	-3.261	39.796	53.988	1.00	70.96	C
ATOM	23710	N1	DT	F	18	-2.542	40.180	52.700	1.00	66.81	N
ATOM	23711	C2	DT	F	18	-1.165	40.169	52.674	1.00	67.14	C
ATOM	23712	N3	DT	F	18	-0.614	40.579	51.491	1.00	64.49	N
ATOM	23713	C4	DT	F	18	-1.277	41.001	50.361	1.00	68.15	C
ATOM	23714	C5	DT	F	18	-2.717	41.013	50.459	1.00	66.68	C
ATOM	23715	C6	DT	F	18	-3.270	40.609	51.607	1.00	66.93	C
ATOM	23716	O2	DT	F	18	-0.476	39.813	53.625	1.00	67.36	O
ATOM	23717	O4	DT	F	18	-0.684	41.345	49.347	1.00	68.19	O
ATOM	23718	C7	DT	F	18	-3.553	41.457	49.299	1.00	57.91	C
ATOM	23719	P	DC	F	19	-5.544	43.809	55.187	1.00	70.57	P
ATOM	23720	OP1	DC	F	19	-6.582	44.387	56.065	1.00	81.94	O
ATOM	23721	OP2	DC	F	19	-5.518	44.247	53.776	1.00	61.69	O
ATOM	23722	O5'	DC	F	19	-4.119	44.101	55.836	1.00	58.15	O
ATOM	23723	C5'	DC	F	19	-3.296	45.091	55.285	1.00	55.51	C
ATOM	23724	C4'	DC	F	19	-1.891	44.965	55.832	1.00	63.89	C
ATOM	23725	O4'	DC	F	19	-1.229	43.787	55.259	1.00	69.82	O
ATOM	23726	C3'	DC	F	19	-0.991	46.127	55.491	1.00	64.58	C
ATOM	23727	O3'	DC	F	19	-1.095	47.119	56.485	1.00	62.39	O
ATOM	23728	C2'	DC	F	19	0.388	45.470	55.467	1.00	65.41	C
ATOM	23729	C1'	DC	F	19	0.066	44.138	54.801	1.00	63.73	C
ATOM	23730	N1	DC	F	19	0.050	44.206	53.282	1.00	65.29	N
ATOM	23731	C2	DC	F	19	1.264	44.295	52.561	1.00	63.88	C
ATOM	23732	N3	DC	F	19	1.218	44.365	51.208	1.00	68.15	N
ATOM	23733	C4	DC	F	19	0.046	44.340	50.571	1.00	69.38	C
ATOM	23734	C5	DC	F	19	-1.195	44.249	51.278	1.00	68.43	C
ATOM	23735	C6	DC	F	19	-1.145	44.180	52.615	1.00	64.37	C
ATOM	23736	O2	DC	F	19	2.340	44.322	53.166	1.00	58.88	O
ATOM	23737	N4	DC	F	19	0.063	44.412	49.238	1.00	64.31	N
ATOM	23738	O5'	DC	F	20	0.798	48.634	55.803	1.00	65.56	O
ATOM	23739	C4'	DC	F	20	3.169	48.768	56.377	1.00	64.07	C
ATOM	23740	C3'	DC	F	20	3.471	50.066	55.635	1.00	63.25	C
ATOM	23741	C2'	DC	F	20	4.631	49.658	54.746	1.00	63.66	C
ATOM	23742	P	DC	F	20	-0.790	48.636	56.097	1.00	62.64	P
ATOM	23743	OP1	DC	F	20	-1.037	49.473	57.289	1.00	67.96	O
ATOM	23744	OP2	DC	F	20	-1.487	48.913	54.825	1.00	63.76	O
ATOM	23745	C5'	DC	F	20	1.736	48.619	56.886	1.00	60.12	C
ATOM	23746	O4'	DC	F	20	3.471	47.705	55.428	1.00	58.83	O
ATOM	23747	O3'	DC	F	20	3.872	51.069	56.546	1.00	65.04	O

ATOM	23748	C1'	DC	F	20	4.278	48.211	54.391	1.00	57.63	C
ATOM	23749	N1	DC	F	20	3.548	48.087	53.133	1.00	58.52	N
ATOM	23750	C2	DC	F	20	4.201	48.362	51.931	1.00	63.12	C
ATOM	23751	N3	DC	F	20	3.516	48.243	50.776	1.00	65.41	N
ATOM	23752	C4	DC	F	20	2.246	47.859	50.786	1.00	63.29	C
ATOM	23753	C5	DC	F	20	1.559	47.564	52.002	1.00	62.40	C
ATOM	23754	C6	DC	F	20	2.245	47.689	53.142	1.00	62.76	C
ATOM	23755	O2	DC	F	20	5.390	48.709	51.949	1.00	62.36	O
ATOM	23756	N4	DC	F	20	1.622	47.757	49.607	1.00	63.79	N
TER											
HETATM	23757	O	HOH	S	3	28.258	-10.786	36.710	1.00	49.68	O
HETATM	23758	O	HOH	S	5	52.598	29.337	31.629	1.00	44.36	O
HETATM	23759	O	HOH	S	8	20.912	-0.705	37.229	1.00	50.62	O
HETATM	23760	O	HOH	S	12	-26.744	77.531	-13.678	1.00	52.18	O
HETATM	23761	O	HOH	S	16	18.633	24.061	39.010	1.00	56.87	O
HETATM	23762	O	HOH	S	17	43.996	34.071	29.891	1.00	44.67	O
HETATM	23763	O	HOH	S	19	26.844	6.726	27.881	1.00	47.77	O
HETATM	23764	O	HOH	S	22	-11.897	90.858	-12.266	1.00	41.90	O
HETATM	23765	O	HOH	S	24	-5.108	98.270	-13.393	1.00	59.19	O
HETATM	23766	O	HOH	S	26	-25.174	91.323	-4.262	1.00	39.06	O
HETATM	23767	O	HOH	S	28	23.944	0.317	42.413	1.00	47.34	O
HETATM	23768	O	HOH	S	29	49.118	30.034	32.173	1.00	46.34	O
HETATM	23769	O	HOH	S	30	-9.681	97.245	-9.548	1.00	39.58	O
HETATM	23770	O	HOH	S	31	24.274	3.908	29.296	1.00	46.04	O
HETATM	23771	O	HOH	S	34	22.123	23.201	38.032	1.00	55.73	O
HETATM	23772	O	HOH	S	49	27.847	30.581	29.661	1.00	47.72	O
HETATM	23773	O	HOH	S	58	17.600	27.178	62.121	1.00	53.78	O
HETATM	23774	O	HOH	S	63	24.402	21.173	39.663	1.00	38.04	O
HETATM	23775	O	HOH	S	66	20.436	88.920	-50.935	1.00	51.17	O
HETATM	23776	O	HOH	S	83	15.057	63.506	46.203	1.00	54.19	O
HETATM	23777	O	HOH	S	84	-11.677	53.438	-23.776	1.00	56.42	O
HETATM	23778	O	HOH	S	85	-1.355	70.085	-13.656	1.00	71.89	O
HETATM	23779	O	HOH	S	86	-39.078	55.902	-27.104	1.00	73.87	O
HETATM	23780	O	HOH	S	87	-12.500	80.709	4.150	1.00	58.06	O
HETATM	23781	O	HOH	S	88	-5.235	115.444	-11.711	1.00	61.83	O
HETATM	23782	O	HOH	S	89	-5.307	114.195	-6.818	1.00	50.26	O
HETATM	23783	O	HOH	S	90	0.014	110.207	1.744	1.00	74.93	O
HETATM	23784	O	HOH	S	91	-16.938	116.582	-12.733	1.00	38.02	O
HETATM	23785	O	HOH	S	92	-24.198	122.431	-18.017	1.00	43.60	O
HETATM	23786	O	HOH	S	93	-22.551	121.930	-15.210	1.00	42.18	O
HETATM	23787	O	HOH	S	94	-22.832	116.900	-22.076	1.00	33.71	O
HETATM	23788	O	HOH	S	95	-16.276	118.948	-24.048	1.00	42.23	O
HETATM	23789	O	HOH	S	96	-7.529	117.399	-24.460	1.00	54.18	O
HETATM	23790	O	HOH	S	97	-3.004	102.312	-27.221	1.00	51.81	O
HETATM	23791	O	HOH	S	98	-25.937	112.773	-28.012	1.00	43.62	O
HETATM	23792	O	HOH	S	99	-31.786	120.707	-21.586	1.00	44.43	O
HETATM	23793	O	HOH	S	100	-29.993	122.705	-19.294	1.00	36.89	O
HETATM	23794	O	HOH	S	102	-13.125	100.496	-15.326	1.00	35.52	O
HETATM	23795	O	HOH	S	103	-17.536	94.769	-21.737	1.00	41.03	O
HETATM	23796	O	HOH	S	104	-15.396	95.088	-19.009	1.00	46.13	O
HETATM	23797	O	HOH	S	105	-10.516	97.199	-19.846	1.00	36.06	O
HETATM	23798	O	HOH	S	106	-6.613	94.605	-19.389	1.00	55.42	O
HETATM	23799	O	HOH	S	107	-17.725	96.110	-15.125	1.00	44.51	O
HETATM	23800	O	HOH	S	108	-16.802	85.471	-12.906	1.00	50.83	O
HETATM	23801	O	HOH	S	109	-14.860	106.226	-25.142	1.00	37.21	O
HETATM	23802	O	HOH	S	110	-12.684	105.000	-25.088	1.00	34.34	O
HETATM	23803	O	HOH	S	111	-5.064	111.567	-46.540	1.00	70.85	O
HETATM	23804	O	HOH	S	112	-18.884	105.302	-26.112	1.00	45.87	O
HETATM	23805	O	HOH	S	113	16.417	79.779	-72.486	1.00	73.75	O
HETATM	23806	O	HOH	S	114	2.632	72.459	-58.182	1.00	65.38	O
HETATM	23807	O	HOH	S	115	51.072	3.945	29.467	1.00	48.41	O
HETATM	23808	O	HOH	S	116	41.217	21.541	14.226	1.00	66.44	O
HETATM	23809	O	HOH	S	117	24.484	-4.498	29.329	1.00	64.75	O

HETATM23810	O	HOH	S	118	28.328	-1.772	19.345	1.00	44.30	O
HETATM23811	O	HOH	S	119	21.127	0.031	29.041	1.00	54.51	O
HETATM23812	O	HOH	S	120	14.483	-4.692	35.415	1.00	67.64	O
HETATM23813	O	HOH	S	121	-8.347	76.414	-3.222	1.00	62.56	O
HETATM23814	O	HOH	S	122	-13.881	80.057	-9.160	1.00	42.17	O
HETATM23815	O	HOH	S	123	-18.249	68.882	-12.545	1.00	44.76	O
HETATM23816	O	HOH	S	124	-7.559	67.810	-5.810	1.00	63.53	O
HETATM23817	O	HOH	S	125	-19.838	81.249	-11.789	1.00	39.05	O
HETATM23818	O	HOH	S	126	-23.667	84.109	-17.042	1.00	47.01	O
HETATM23819	O	HOH	S	127	-22.890	76.088	-21.812	1.00	42.36	O
HETATM23820	O	HOH	S	128	-21.611	71.658	-21.954	1.00	50.94	O
HETATM23821	O	HOH	S	129	11.999	54.335	17.093	1.00	60.05	O
HETATM23822	O	HOH	S	130	43.901	5.482	32.290	1.00	41.35	O
HETATM23823	O	HOH	S	131	40.151	31.967	35.033	1.00	54.44	O
HETATM23824	O	HOH	S	132	-14.850	92.402	-5.571	1.00	42.60	O
HETATM23825	O	HOH	S	133	-13.001	97.969	-2.552	1.00	54.55	O
HETATM23826	O	HOH	S	134	-15.027	85.491	-15.679	1.00	45.50	O
HETATM23827	O	HOH	S	135	-18.765	89.579	-11.650	1.00	54.10	O
HETATM23828	O	HOH	S	136	-14.647	95.855	-8.577	1.00	43.28	O
HETATM23829	O	HOH	S	137	-9.041	99.586	-16.055	1.00	42.72	O
HETATM23830	O	HOH	S	138	-19.396	111.754	-21.489	1.00	48.31	O
HETATM23831	O	HOH	S	139	-35.173	117.162	-32.786	1.00	55.38	O
HETATM23832	O	HOH	S	140	-31.387	115.184	-25.096	1.00	38.04	O
HETATM23833	O	HOH	S	141	-35.689	119.074	-26.998	1.00	58.80	O
HETATM23834	O	HOH	S	142	-51.531	110.751	-14.476	1.00	61.44	O
HETATM23835	O	HOH	S	143	-3.492	104.729	-5.040	1.00	59.82	O
HETATM23836	O	HOH	S	144	-11.961	68.255	-0.557	1.00	45.06	O
HETATM23837	O	HOH	S	145	40.043	-0.361	23.104	1.00	39.02	O
HETATM23838	O	HOH	S	146	37.771	-1.554	23.774	1.00	31.44	O
HETATM23839	O	HOH	S	147	33.883	4.703	30.376	1.00	35.17	O
HETATM23840	O	HOH	S	148	39.536	-2.026	17.974	1.00	51.83	O
HETATM23841	O	HOH	S	149	42.442	3.270	20.744	1.00	42.88	O
HETATM23842	O	HOH	S	150	27.281	19.616	38.577	1.00	38.65	O
HETATM23843	O	HOH	S	151	23.899	25.411	36.341	1.00	44.94	O
HETATM23844	O	HOH	S	152	29.242	27.507	31.270	1.00	40.97	O
HETATM23845	O	HOH	S	153	32.277	27.994	32.791	1.00	42.53	O
HETATM23846	O	HOH	S	154	37.267	25.650	39.359	1.00	38.64	O
HETATM23847	O	HOH	S	155	39.977	20.825	40.592	1.00	41.38	O
HETATM23848	O	HOH	S	157	60.092	-6.383	31.497	1.00	54.89	O
HETATM23849	O	HOH	S	158	32.016	30.136	41.114	1.00	56.65	O
HETATM23850	O	HOH	S	159	38.784	66.437	33.999	1.00	63.08	O
HETATM23851	O	HOH	S	160	36.587	72.974	27.965	1.00	81.92	O
HETATM23852	O	HOH	S	161	41.786	66.203	31.813	1.00	53.74	O
HETATM23853	O	HOH	S	162	62.657	37.974	32.271	1.00	62.54	O
HETATM23854	O	HOH	S	163	47.674	47.151	27.536	1.00	54.19	O
HETATM23855	O	HOH	S	164	1.867	35.930	55.550	1.00	51.99	O
HETATM23856	O	HOH	S	165	-29.552	110.441	-24.068	1.00	48.11	O
HETATM23857	O	HOH	S	166	37.281	13.304	29.079	1.00	45.93	O
TER										
HETATM23858	O2	EDO	G	1	-18.620	112.623	-31.738	1.00	42.29	O
HETATM23859	C2	EDO	G	1	-19.259	113.704	-32.442	1.00	47.67	C
HETATM23860	C1	EDO	G	1	-20.770	113.455	-32.474	1.00	52.14	C
HETATM23861	O1	EDO	G	1	-21.297	113.414	-31.130	1.00	47.34	O
HETATM23862	O2	EDO	G	2	-23.869	122.514	-27.072	1.00	54.91	O
HETATM23863	C2	EDO	G	2	-22.904	122.612	-26.025	1.00	43.42	C
HETATM23864	C1	EDO	G	2	-23.244	123.768	-25.104	1.00	47.39	C
HETATM23865	O1	EDO	G	2	-22.901	125.014	-25.704	1.00	46.57	O
HETATM23866	O2	EDO	G	3	-16.327	113.930	-21.535	1.00	53.44	O
HETATM23867	C2	EDO	G	3	-17.456	114.819	-21.322	1.00	48.59	C
HETATM23868	C1	EDO	G	3	-18.318	114.734	-22.572	1.00	50.17	C
HETATM23869	O1	EDO	G	3	-18.468	113.321	-22.818	1.00	51.48	O
TER										
END										

Example 2: S. pyogenes (Sp) SpCas9 truncations from Crystal Structure

[00105] Figures 3A-B pertain to SpCas9 truncations from full length SpCas9. These figures show Surveyor gel test results of SpCas9 truncation mutants from the crystal structure that retain cleavage activity (A) and a table showing the amino acid truncations and flexible (GGGS) or rigid (A(EAAAK)) linker substitutions of the lanes of the gels of Figure 3A (B)

[00106] In this Example, SpCas9 sequences were analyzed by 1. Comparing against orthologs (*S. aureus*, *S. thermophilus* CRISPR1, *S. thermophilus* CRISPR3, and *N. meningitidis*), including smaller Cas9s (*S. aureus*, *S. thermophilus* CRISPR1, and *N. meningitidis*) for regions that are conserved or variable, and 2. Boundaries identified by crystallography as being potentially non-critical for contacting target DNA:sgRNA duplex. A region of SpCas9 (helical domain 2) was not present in many smaller Cas9 orthologs, and predicted to be dispensable for function. Two similar sets of truncations were made, one by sequence alignment with smaller Cas9s, one by crystal prediction. In addition, several sets of flexible glycine-serine (GlyGlyGlySer) or rigid alpha-helical linkers (Ala(GluAlaAlaAlaLys)Ala) in groups of 3, 6, 9, or 12 repeats were also used to replace helical domain 2 for potential structural stabilization and/or aiding of retaining SpCas9:sgRNA specificity. All of the helical region 2 truncations and linker substitutions retained SpCas9 activity. SpCas9 was truncated systematically in Helical 1, 2, and 3 domains, as well as the C'-terminal putative PAM-recognizing domain. Truncation mutants were transfected into HEK 293FT cells as follows: 400ng of truncation Cas9 plasmid and 100ng of sgRNA co-transfected into 200,000 cells by Lipofectamine 2000. DNAs from cells were harvested for SURVEYOR analysis.

[00107] Below: full length SpCas9 DNA sequence and sequences of the subdomains; followed by helical domain 2 truncation and variants.

[00108] > Full length NLS-SpCas9-NLS

[00109] ATGGCCCCAAAGAAGAAGCGGAAGGTCGGTATCCACGGAGTCCCAGCAG
 CCGACAAGAAGTACAGCATCGGCCTGGACATCGGCACCAACTCTGTGGGCTGGGCC
 GTGATCACCGACGAGTACAAGGTGCCAGCAAGAAATTCAAGGTGCTGGGCAACAC
 CGACCGGCACAGCATCAAGAAGAACCTGATCGGAGCCCTGCTGTTTCGACAGCGGCG
 AACAGCCGAGGCCACCCGGCTGAAGAGAACCGCCAGAAGAAGATACACCAGACG
 GAAGAACCGGATCTGCTATCTGCAAGAGATCTTCAGCAACGAGATGGCCAAGGTGG
 ACGACAGCTTCTCCACAGACTGGAAGAGTCCTTCCTGGTGGAAGAGGATAAGAAG

CACGAGCGGCACCCCATCTTCGGCAACATCGTGGACGAGGTGGCCTACCACGAGAA
GTACCCACCATCTACCACCTGAGAAAGAACTGGTGGACAGCACCGACAAGGCCG
ACCTGCGGCTGATCTATCTGGCCCTGGCCACATGATCAAGTTCGGGGCCACTTCC
TGATCGAGGGCGACCTGAACCCCGACAACAGCGACGTGGACAAGCTGTTTCATCCAG
CTGGTGCAGACCTACAACCAGCTGTTTCGAGGAAAACCCCATCAACGCCAGCGGCGT
GGACGCCAAGGCCATCCTGTCTGCCAGACTGAGCAAGAGCAGACGGCTGGAAAATC
TGATCGCCAGCTGCCCGGCGAGAAGAAGAATGGCCTGTTTCGGAAACCTGATTGCC
CTGAGCCTGGGCCTGACCCCAACTTCAAGAGCAACTTCGACCTGGCCGAGGATGC
CAAACCTGCAGCTGAGCAAGGACACCTACGACGACGACCTGGACAACCTGCTGGCCC
AGATCGGCGACCAGTACGCCGACCTGTTTCTGGCCGCCAAGAACCTGTCCGACGCC
ATCCTGCTGAGCGACATCCTGAGAGTGAACACCGAGATCACCAAGGCCCCCTGAG
CGCCTCTATGATCAAGAGATACGACGAGCACCACCAGGACCTGACCCTGCTGAAAG
CTCTCGTGCGGCAGCAGCTGCCTGAGAAGTACAAAGAGATTTTCTTCGACCAGAGCA
AGAACGGCTACGCCGGCTACATTGACGGCGGAGCCAGCCAGGAAGAGTTCTACAAG
TTCATCAAGCCCATCCTGGAAAAGATGGACGGCACCGAGGAACTGCTCGTGAAGCT
GAACAGAGAGGACCTGCTGCGGAAGCAGCGGACCTTCGACAACGGCAGCATCCCC
ACCAGATCCACCTGGGAGAGCTGCACGCCATTCTGCGGCGGCAGGAAGATTTTTAC
CCATTCTGAAGGACAACCGGGAAAAGATCGAGAAGATCCTGACCTTCCGCATCCC
CTACTACGTGGGCCCTCTGGCCAGGGGAAAACAGCAGATTTCGCCTGGATGACCAGAA
AGAGCGAGGAAACCATCACCCCTGGAACTTCGAGGAAGTGGTGGACAAGGGCGCT
TCCGCCAGAGCTTCATCGAGCGGATGACCAACTTCGATAAGAACCTGCCAACGA
GAAGGTGCTGCCAAGCACAGCCTGCTGTACGAGTACTTCACCGTGTATAACGAGCT
GACCAAAGTGAAATACGTGACCGAGGGAATGAGAAAGCCCGCCTTCTGAGCGGCG
AGCAGAAAAAGGCCATCGTGGACCTGCTGTTCAAGACCAACCGGAAAGTGACCGTG
AAGCAGCTGAAAGAGGACTACTTCAAGAAAATCGAGTGCTTCGACTCCGTGGAAAT
CTCCGGCGTGGAAGATCGGTTCAACGCCTCCCTGGGCACATAACCACGATCTGCTGAA
AATTATCAAGGACAAGGACTTCTGGACAATGAGGAAAACGAGGACATTCTGGAAG
ATATCGTGCTGACCCTGACACTGTTTGAGGACAGAGAGATGATCGAGGAACGGCTG
AAAACCTATGCCACCTGTTTCGACGACAAAAGTGATGAAGCAGCTGAAGCGGCGGAG
ATACACCGGCTGGGGCAGGCTGAGCCGGAAGCTGATCAACGGCATCCGGGACAAGC
AGTCCGGCAAGACAATCCTGGATTTCTGAAGTCCGACGGCTTCGCCAACAGAAAC

TTCATGCAGCTGATCCACGACGACAGCCTGACCTTTAAAGAGGACATCCAGAAAGC
CCAGGTGTCCGGCCAGGGCGATAGCCTGCACGAGCACATTGCCAATCTGGCCGGCA
GCCCCGCCATTAAGAAGGGCATCCTGCAGACAGTGAAGGTGGTGGACGAGCTCGTG
AAAGTGATGGGCCGGCACAAGCCCCGAGAACATCGTGATCGAAATGGCCAGAGAGA
ACCAGACCACCCAGAAGGGACAGAAGAACAGCCGCGAGAGAATGAAGCGGATCGA
AGAGGGCATCAAAGAGCTGGGCAGCCAGATCCTGAAAGAACACCCCCGTGGAAAAC
ACCCAGCTGCAGAACGAGAAGCTGTACCTGTACTACCTGCAGAATGGGCGGGATAT
GTACGTGGACCAGGAACTGGACATCAACCGGCTGTCCGACTACGATGTGGACCATA
TCGTGCCTCAGAGCTTTCTGAAGGACGACTCCATCGACAACAAGGTGCTGACCAGA
AGCGACAAGAACCGGGGCAAGAGCGACAACGTGCCCTCCGAAGAGGTTCGTGAAGA
AGATGAAGAACTACTGGCGGCAGCTGCTGAACGCCAAGCTGATTACCCAGAGAAAG
TTCGACAATCTGACCAAGGCCGAGAGAGGGCGGCCTGAGCGAACTGGATAAGGCCGG
CTTCATCAAGAGACAGCTGGTGGAAACCCGGCAGATCACAAAGCACGTGGCACAGA
TCCTGGACTCCC GGATGAACACTAAGTACGACGAGAATGACAAGCTGATCCGGGAA
GTGAAAGTGATCACCTGAAGTCCAAGCTGGTGTCCGATTTCCGGAAGGATTTCCAG
TTTTACAAAGTGCGCGAGATCAACA ACTACCACCACGCCACGACGCCTACCTGAA
CGCCGTTCGTGGGAACCGCCCTGATCAAAAAGTACCCTAAGCTGGAAAGCGAGTTCG
TGTACGGCGACTACAAGGTGTACGACGTGCGGAAGATGATCGCCAAGAGCGAGCAG
GAAATCGGCAAGGCTACCGCCAAGTACTTCTTCTACAGCAACATCATGAACTTTTTTC
AAGACCGAGATTACCCTGGCCAACGGCGAGATCCGGAAGCGGCCTCTGATCGAGAC
AAACGGCGAAACCGGGGAGATCGTGTGGGATAAGGGCCGGGATTTTGCCACCGTGC
GGAAAGTGCTGAGCATGCCCAAGTGAATATCGTGAAAAAGACCGAGGTGCAGACA
GGCGGCTTCAGCAAAGAGTCTATCCTGCCCAAGAGGAACAGCGATAAGCTGATCGC
CAGAAAGAAGGACTGGGACCCTAAGAAGTACGGCGGCTTCGACAGCCCCACCGTGG
CCTATTCTGTGCTGGTGGTGGCCAAAGTGGAAAAGGGCAAGTCCAAGAACTGAAG
AGTGTGAAAGAGCTGCTGGGGATCACCATCATGGAAAGAAGCAGCTTCGAGAAGAA
TCCCATCGACTTTCTGGAAGCCAAGGGCTACAAAGAAGTGAAAAAGGACCTGATCA
TCAAGCTGCCTAAGTACTCCCTGTTTCGAGCTGGAAAACGGCCGGAAGAGAATGCTG
GCCTCTGCCGGCGAACTGCAGAAGGGAAACGAACTGGCCCTGCCCTCCAAATATGT
GAACTTCCTGTACCTGGCCAGCCACTATGAGAAGCTGAAGGGCTCCCCCGAGGATA
ATGAGCAGAAACAGCTGTTTGTGGAACAGCACAAGCACTACCTGGACGAGATCATC

GAGCAGATCAGCGAGTTCTCCAAGAGAGTGATCCTGGCCGACGCTAATCTGGACAA
 AGTGCTGTCCGCCTACAACAAGCACCCGGGATAAGCCCATCAGAGAGCAGGCCGAGA
 ATATCATCCACCTGTTTACCCTGACCAATCTGGGAGCCCCTGCCGCCTTCAAGTACTT
 TGACACCACCATCGACCGGAAGAGGTACACCAGCACCAAAGAGGTGCTGGACGCCA
 CCCTGATCCACCAGAGCATCACCGGCCTGTACGAGACACGGATCGACCTGTCTCAGC
 TGGGAGGCGACAAAAGGCCGGCGGCCACGAAAAAGGCCGGCCAGGCACAAAAAGAA
 AAAGtaa

[00110] >N'-terminal NLS

[00111] ATGGCCCCAAAGAAGAAGCGGAAGGTTCGGTATCCACGGAGTCCCAGCAG
 CC

[00112] >RuvCI domain

[00113] GACAAGAAGTACAGCATCGGCCTGGACATCGGCACCAACTCTGTGGGCTG
 GGCCGTGATCACCGACGAGTACAAGGTGCCAGCAAGAAATTCAAGGTGCTGGGCA
 ACACCGACCGGCACAGCATCAAGAAGAACCTGATCGGAGCCCTGCTGTTTCGACAGC
 GGCGAAACA

[00114] >Bridging helix

[00115] GCCGAGGCCACCCGGCTGAAGAGAACCGCCAGAAGAAGATACACCAGAC
 GGAAGAACCGGATCTGCTATCTGCAAGAGATCTTC

[00116] >Helical domain 1

[00117] AGCAACGAGATGGCCAAGGTGGACGACAGCTTCTTCCACAGACTGGAAG
 AGTCCTTCTGTTGGAAGAGGATAAGAAGCACGAGCGGCACCCCATCTTCGGCAAC
 ATCGTGGACGAGGTGGCCTACCACGAGAAGTACCCACCATCTACCACCTGAGAAA
 GAAACTGGTGGACAGCACCGACAAGGCCGACCTGCGGCTGATCTATCTGGCCCTGG
 CCCACATGATCAAGTTCCGGGGCCACTTCCTGATCGAGGGCGAC

[00118] >Helical domain 2 (dispensable)

[00119] CTGAACCCCGACAACAGCGACGTGGACAAGCTGTTCATCCAGCTGGTGCA
 GACCTACAACCAGCTGTTCGAGGAAAACCCCATCAACGCCAGCGGCCGTGGACGCCA
 AGGCCATCCTGTCTGCCAGACTGAGCAAGAGCAGACGGCTGGAAAATCTGATCGCC
 CAGCTGCCCCGGCGAGAAGAAGAATGGCCTGTTCGGAAACCTGATTGCCCTGAGCCT
 GGGCCTGACCCCAACTTCAAGAGCAACTTCGACCTGGCCGAGGATGCCAAACTGC
 AGCTGAGCAAGGACACCTACGACGACGACCTGGACAACCTGCTGGCCCAGATCGGC

GACCAGTACGCCGACCTGTTTCTGGCCGCCAAGAACCTGTCCGACGCCATCCTGCTG
AGCGACATCCTGAGAGTGAACACCGAG

[00120] >Helical domain 3

[00121] ATCACCAAGGCCCCCTGAGCGCCTCTATGATCAAGAGATACGACGAGCA
CCACCAGGACCTGACCCTGCTGAAAGCTCTCGTGCGGCAGCAGCTGCCTGAGAAGT
ACAAAGAGATTTTCTTCGACCAGAGCAAGAACGGCTACGCCGGCTACATTGACGGC
GGAGCCAGCCAGGAAGAGTTCTACAAGTTCATCAAGCCCATCCTGGAAAAGATGGA
CGGCACCGAGGAACTGCTCGTGAAGCTGAACAGAGAGGACCTGCTGCGGAAGCAGC
GGACCTTCGACAACGGCAGCATCCCCACCAGATCCACCTGGGAGAGCTGCACGCC
ATTCTGCGGCGGCAGGAAGATTTTTACCCATTCTGAAAGGACAACCGGGAAAAGAT
CGAGAAGATCCTGACCTCCGCATCCCCTACTACGTGGGCCCTCTGGCCAGGGGAAA
CAGCAGATTTCGCTGGATGACCAGAAAGAGCGAGGAAACCATCACCCCCTGGAACT
TCGAGGAAGTGGTGGACAAGGGCGCTTCCGCCCAGAGCTTCATCGAGCGGATGACC
AACTTCGATAAGAACCTGCCCAACGAGAAGGTGCTGCCCAAGCACAGCCTGCTGTA
CGAGTACTTCACCGTGTATAACGAGCTGACCAAAGTGAAATACGTGACCGAGGGAA
TGAGAAAGCCCGCCTTCCTGAGCGGCGAGCAGAAAAAGGCCATCGTGGACCTGCTG
TTCAAGACCAACCGGAAAGTGACCGTGAAGCAGCTGAAAGAGGACTACTTCAAGAA
AATCGAGTGCTTCGACTCCGTGGAAATCTCCGGCGTGGAAAGATCGGTTCAACGCCTC
CCTGGGCACATACCACGATCTGCTGAAAATTATCAAGGACAAGGACTTCCTGGACA
ATGAGGAAAACGAGGACATTTCTGGAAGATATCGTGCTGACCCTGACACTGTTTGAG
GACAGAGAGATGATCGAGGAACGGCTGAAAACCTATGCCACCTGTTCGACGACAAA
AGTGATGAAGCAGCTGAAGCGGCGGAGATACACCGGCTGGGGCAGGCTGAGCCGG
AAGCTGATCAACGGCATCCGGGACAAGCAGTCCGGCAAGACAATCCTGGATTTCT
GAAGTCCGACGGCTTCGCCAACAGAACTTCATGCAGCTGATCCACGACGACAGCC
TGACCTTTAAAGAGGACATCCAGAAAGCC

[00122] >Flexible linker

[00123] CAGGTGTCCGGCCAGGGCGAT

[00124] >RuvC II

[00125] ATCGTGATCGAAATGGCCAGAGAG

[00126] >HNH

[00127] GACTACGATGTGGACCATATCGTGCCTCAGAGCTTTCTGAAGGACGACTC
CATCGACAACAAGGTGCTGACCAGAAGCGACAAGAAC

[00128] >RuvCIII

[00129] CACCACGCCCACGACGCCTACCTG

[00130] >C-terminal (PAM recognizing domain)

[00131] ACCGAGGTGCAGACAGGCGGCTTCAGCAAAGAGTCTATCCTGCCCAAGA
GGAACAGCGATAAGCTGATCGCCAGAAAGAAGGACTGGGACCCTAAGAAGTACGG
CGGCTTCGACAGCCCCACCGTGGCCTATTCTGTGCTGGTGGTGGCCAAAGTGGAAAA
GGGCAAGTCCAAGAACTGAAGAGTGTGAAAGAGCTGCTGGGGATCACCATCATGG
AAAGAAGCAGCTTCGAGAAGAATCCCATCGACTTTCTGGAAGCCAAGGGCTACAAA
GAAGTGAAAAAGGACCTGATCATCAAGCTGCCTAAGTACTCCCTGTTTCGAGCTGGA
AAACGGCCGGAAGAGAATGCTGGCCTCTGCCGGCGAACTGCAGAAGGGAAACGAA
CTGGCCCTGCCCTCCAAATATGTGAACTTCCTGTACCTGGCCAGCCACTATGAGAAG
CTGAAGGGCTCCCCGAGGATAATGAGCAGAAACAGCTGTTTGTGGAACAGCACAA
GCACTACCTGGACGAGATCATCGAGCAGATCAGCGAGTTCTCCAAGAGAGTGATCC
TGGCCGACGCTAATCTGGACAAAGTGCTGTCCGCCTACAACAAGCACCGGGATAAG
CCCATCAGAGAGCAGGCCGAGAATATCATCCACCTGTTTACCCTGACCAATCTGGGA
GCCCTGCCGCCTTCAAGTACTTTGACACCACCATCGACCGGAAGAGGTACACCAGC
ACCAAAGAGGTGCTGGACGCCACCCTGATCCACCAGAGCATCACCGGCCTGTACGA
GACACGGATCGACCTGTCTCAGCTGGGAGGCGAC

[00132] C'-NLS

[00133] AAAAGGCCGCGGCCACGAAAAAGGCCGGCCAGGCACAAAAAGAAAAAG

[00134] 6. Sp_Δ_hel 2(174-311) helical domain 2 deletion (from ortholog alignment)

[00135] ATGGCCCCAAAGAAGAAGCGGAAGGTTCGGTATCCACGGAGTCCCAGCAG
CCGACAAGAAGTACAGCATCGGCCTGGACATCGGCACCAACTCTGTGGGCTGGGCC
GTGATCACCGACGAGTACAAGGTGCCAGCAAGAAATTCAAGGTGCTGGGCAACAC
CGACCGGCACAGCATCAAGAAGAACCTGATCGGAGCCCTGCTGTTTCGACAGCGGCG
AAACAGCCGAGGCCACCCGGCTGAAGAGAACCGCCAGAAGAAGATACACCAGACG
GAAGAACCGGATCTGCTATCTGCAAGAGATCTTCAGCAACGAGATGGCCAAGGTGG
ACGACAGCTTCTTCCACAGACTGGAAGAGTCCTTCCCTGGTGGAAAGAGGATAAGAAG
CACGAGCGGCACCCCATCTTCGGCAACATCGTGGACGAGGTGGCCTACCACGAGAA

GTACCCACCATCTACCACCTGAGAAAGAACTGGTGGACAGCACCGACAAGGCCG
ACCTGCGGCTGATCTATCTGGCCCTGGCCACATGATCAAGTTCCGGGGCCACTTCC
TGATCGAGGGCGACATACCAAGGC_aCC_aCTGAGCGCCTCTATGATCAAGAGATACG
ACGAGCACCACCAGGACCTGACCCTGCTGAAAGCTCTCGTGCGGCAGCAGCTGCCT
GAGAAGTACAAAGAGATTTTCTTCGACCAGAGCAAGAACGGCTACGCCGGCTACAT
TGACGGCGGAGCCAGCCAGGAAGAGTTCTACAAGTTCATCAAGCCCATCCTGGAAA
AGATGGACGGCACCGAGGA_aCTGCTCGTGAAGCTGAACAGAGAGGACCTGCTGCGG
AAGCAGCGGACCTTCGACAACGGCAGCATCCCCACCAGATCCACCTGGGAGAGCT
GCACGCCATTCTGCGGCGGCAGGAAGATTTTTACCCATTCTGAAGGACAACCGGG
AAAAGATCGAGAAGATCCTGACCTTCGCATCCCCTACTACGTGGGCCCTCTGGCCA
GGGAAACAGCAGATTCGCCTGGATGACCAGAAAGAGCGAGGAAACCATCACCCC
CTGGA_aCTTCGAGGAAGTGGTGGACAAGGGCGCTTCGGCCAGAGCTTCATCGAGC
GGATGACCAACTTCGATAAGAACCTGCCCAACGAGAAGGTGCTGCCCAAGCACAGC
CTGCTGTACGAGTACTTCACCGTGTATAACGAGCTGACCAAAGTGAAATACGTGACC
GAGGGAATGAGAAAGCCCGCCTTCCTGAGCGGCGAGCAGAAAAAGGCCATCGTGG
ACCTGCTGTTCAAGACCAACCGGAAAGTGACCGTGAAGCAGCTGAAAGAGGACTAC
TTCAAGAAAATCGAGTGCTTCGACTCCGTGGAAATCTCCGGCGTGGAAGATCGGTTC
AACGCCTCCCTGGGCACATAACCACGATCTGCTGAAAATTATCAAGGACAAGGACTT
CCTGGACAATGAGGAAAACGAGGACATTCTGGAAGATATCGTGCTGACCCTGACAC
TGTTTGAGGACAGAGAGATGATCGAGGAACGGCTGAAAACCTATGCCACCTGTTTC
GACGACAAAGTGATGAAGCAGCTGAAGCGGCGGAGATACACCGGCTGGGGCAGGC
TGAGCCGGAAGCTGATCAACGGCATCCGGGACAAGCAGTCCGGCAAGACAATCCTG
GATTTCTGAAGTCCGACGGCTTCGCCAACAGAACTTCATGCAGCTGATCCACGAC
GACAGCCTGACCTTTAAAGAGGACATCCAGAAAGCCCAGGTGTCCGGCCAGGGCGA
TAGCCTGCACGAGCACATTGCCAATCTGGCCGGCAGCCCCGCCATTAAGAAGGGCA
TCCTGCAGACAGTGAAGGTGGTGGACGAGCTCGTGAAAGTGATGGGCCGGCACAAG
CCCGAGAACATCGTGATCGAAATGGCCAGAGAGAACCAGACCACCCAGAAGGGAC
AGAAGAACAGCCGCGAGAGAATGAAGCGGATCGAAGAGGGCATCAAAGAGCTGGG
CAGCCAGATCCTGAAAGAACACCCCGTGGAAAACACCCAGCTGCAGAACGAGAAG
CTGTACCTGTACTACCTGCAGAATGGGCGGGATATGTACGTGGACCAGGAACTGGA
CATCAACCGGCTGTCCGACTACGATGTGGACCATATCGTGCCTCAGAGCTTTCTGAA

GGACGACTCCATCGACAACAAGGTGCTGACCAGAAGCGACAAGAACCGGGGCAAG
AGCGACAACGTGCCCTCCGAAGAGGTTCGTGAAGAAGATGAAGAATACTGGCGGCA
GCTGCTGAACGCCAAGCTGATTACCCAGAGAAAGTTCGACAATCTGACCAAGGCCG
AGAGAGGGCGGCCTGAGCGAACTGGATAAAGGCCGGCTTCATCAAGAGACAGCTGGTG
GAAACCCGGCAGATCACAAAGCACGTGGCACAGATCCTGGACTCCCGGATGAACAC
TAAGTACGACGAGAATGACAAGCTGATCCGGGAAGTGAAAGTGATCACCTGAAGT
CCAAGCTGGTGTCCGATTTCCGGAAGGATTTCCAGTTTTTACAAAGTGCGCGAGATCA
ACAATAACCACCACGCCACGACGCCTACCTGAACGCCGTCGTGGGAACCGCCCTG
ATCAAAAAGTACCCTAAGCTGGAAAGCGAGTTCGTGTACGGCGACTACAAGGTGTA
CGACGTGCGGAAGATGATCGCCAAGAGCGAGCAGGAAATCGGCAAGGCTACCGCC
AAGTACTTCTTCTACAGCAACATCATGAACTTTTTCAAGACCGAGATTACCCTGGCC
AACGGCGAGATCCGGAAGCGGCCTCTGATCGAGACAAACGGCGAAACCGGGGAGA
TCGTGTGGGATAAAGGGCCGGGATTTTGCCACCGTGCGGAAAGTGCTGAGCATGCCC
CAAGTGAATATCGTGAAAAGACCGAGGTGCAGACAGGCGGCTTCAGCAAAGAGTC
TATCCTGCCCAAGAGGAACAGCGATAAGCTGATCGCCAGAAAGAAGGACTGGGACC
CTAAGAAGTACGGCGGCTTCGACAGCCCCACCGTGGCCTATTCTGTGCTGGTGGTGG
CCAAAGTGGAAAAGGGCAAGTCCAAGAAACTGAAGAGTGTGAAAGAGCTGCTGGG
GATCACCATCATGGAAAGAAGCAGCTTCGAGAAGAATCCCATCGACTTTCTGGAAG
CCAAGGGCTACAAAGAAGTGAAAAGGACCTGATCATCAAGCTGCCTAAGTACTCC
CTGTTTCGAGCTGGAAAACGGCCGGAAGAGAATGCTGGCCTCTGCCGGCGAACTGCA
GAAGGGAAACGAACTGGCCCTGCCCTCCAAATATGTGAACTTCCTGTACCTGGCCA
GCCACTATGAGAAGCTGAAGGGCTCCCCCGAGGATAATGAGCAGAAACAGCTGTTT
GTGGAACAGCACAAAGCACTACCTGGACGAGATCATCGAGCAGATCAGCGAGTTCTC
CAAGAGAGTGATCCTGGCCGACGCTAATCTGGACAAAGTGCTGTCCGCCTACAACA
AGCACCGGGATAAGCCCATCAGAGAGCAGGCCGAGAATATCATCCACCTGTTTACC
CTGACCAATCTGGGAGCCCCTGCCGCCTTCAAGTACTTTGACACCACCATCGACCGG
AAGAGGTACACCAGCACCAAAGAGGTGCTGGACGCCACCCTGATCCACCAGAGCAT
CACCGGCCTGTACGAGACACGGATCGACCTGTCTCAGCTGGGAGGCGACAAAAGGC
CGGCGGCCACGAAAAGGCCGGCCAGGCCAAAAAAGAAAAAGtaa

[00136] 7. Sp_Δ_hel 2-(GGGS)3 helical domain 2 deletion (from ortholog alignment)

[00137] ATGGCCCCAAAGAAGAAGCGGAAGGTCCGTATCCACGGAGTCCCAGCAG
CCGACAAGAAGTACAGCATCGGCCTGGACATCGGCACCAACTCTGTGGGCTGGGCC
GTGATCACCGACGAGTACAAGGTGCCAGCAAGAAATTCAAGGTGCTGGGCAACAC
CGACCGGCACAGCATCAAGAAGAACCTGATCGGAGCCCTGCTGTTTCGACAGCGGCG
AAACAGCCGAGGCCACCCGGCTGAAGAGAACCGCCAGAAGAAGATACACCAGACG
GAAGAACCGGATCTGCTATCTGCAAGAGATCTTCAGCAACGAGATGGCCAAGGTGG
ACGACAGCTTCTTCCACAGACTGGAAGAGTCCTTCCTGGTGGAAAGAGGATAAGAAG
CACGAGCGGCACCCCATCTTCGGCAACATCGTGGACGAGGTGGCCTACCACGAGAA
GTACCCACCATCTACCACCTGAGAAAGAACTGGTGGACAGCACCGACAAGGCCG
ACCTGCGGCTGATCTATCTGGCCCTGGCCACATGATCAAGTTCGGGGGCCACTTCC
TGATCGAGGGCGACGGTGGCGGTGGCtegGGTGGCGGTGGCtegGGTGGCGGTGGCteg
ATCACCAAGGCCCCCTGAGCGCCTCTATGATCAAGAGATACGACGAGCACCACCA
GGACCTGACCCTGCTGAAAGCTCTCGTGCAGCAGCAGCTGCCTGAGAAGTACAAAG
AGATTTTCTTCGACCAGAGCAAGAACGGCTACGCCGGCTACATTGACGGCGGAGCC
AGCCAGGAAGAGTTCTACAAGTTCATCAAGCCCATCCTGGAAAAGATGGACGGCAC
CGAGGAACTGCTCGTGAAGCTGAACAGAGAGGACCTGCTGCGGAAGCAGCGGACCT
TCGACAACGGCAGCATCCCCACCAGATCCACCTGGGAGAGCTGCACGCCATTCTG
CGGCGGCAGGAAGATTTTTTACCCATTCTGAAGGACAACCGGGAAAAGATCGAGAA
GATCCTGACCTTCCGCATCCCCTACTACGTGGGCCCTCTGGCCAGGGGAAACAGCAG
ATTCCGCTGGATGACCAGAAAGAGCGAGGAAACCATCACCCCTGGAACCTTCGAGG
AAGTGGTGGACAAGGGCGCTTCCGCCAGAGCTTCATCGAGCGGATGACCAACTTC
GATAAGAACCTGCCAACGAGAAGGTGCTGCCAAGCACAGCCTGCTGTACGAGTA
CTTCACCGTGTATAACGAGCTGACCAAAGTGAAATACGTGACCGAGGGAATGAGAA
AGCCCGCCTTCTGAGCGGCGAGCAGAAAAGGCCATCGTGGACCTGCTGTTCAAG
ACCAACCGGAAAGTGACCGTGAAGCAGCTGAAAGAGGACTACTTCAAGAAAATCGA
GTGCTTCGACTCCGTGGAAATCTCCGGCGTGGAAAGATCGGTTCAACGCCTCCCTGGG
CACATAACCAGATCTGCTGAAAATTATCAAGGACAAGGACTTCTGGACAATGAGG
AAAACGAGGACATTCTGGAAGATATCGTGCTGACCCTGACACTGTTTGAGGACAGA
GAGATGATCGAGGAACGGCTGAAAACCTATGCCACCTGTTTCGACGACAAAGTGAT
GAAGCAGCTGAAGCGGCGGAGATACACCGGCTGGGGCAGGCTGAGCCGGAAGCTG
ATCAACGGCATCCGGGACAAGCAGTCCGGCAAGACAATCCTGGATTTCTGAAGTC

CGACGGCTTCGCCAACAGAACTTCATGCAGCTGATCCACGACGACAGCCTGACCTT
TAAAGAGGACATCCAGAAAGCCCAGGTGTCCGGCCAGGGCGATAGCCTGCACGAGC
ACATTGCCAATCTGGCCGGCAGCCCCGCCATTAAGAAGGGGCATCCTGCAGACAGTG
AAGGTGGTGGACGAGCTCGTGAAAGTGATGGGCCGGCACAAGCCCCGAGAACATCGT
GATCGAAATGGCCAGAGAGAACCAGACCACCCAGAAGGGACAGAAGAACAGCCGC
GAGAGAATGAAGCGGATCGAAGAGGGCATCAAAGAGCTGGGCAGCCAGATCCTGA
AAGAACACCCCGTGGAAAACACCCAGCTGCAGAACGAGAAGCTGTACCTGTACTAC
CTGCAGAATGGGCCGGGATATGTACGTGGACCAGGAACTGGACATCAACCGGCTGTC
CGACTACGATGTGGACCATATCGTGCCTCAGAGCTTTCTGAAGGACGACTCCATCGA
CAACAAGGTGCTGACCAGAAGCGACAAGAACCGGGGCAAGAGCGACAACGTGCC
TCCGAAGAGGTCTGTGAAGAAGATGAAGAACTACTGGCGGCAGCTGCTGAACGCCAA
GCTGATTACCCAGAGAAAGTTCGACAATCTGACCAAGGCCGAGAGAGGGCGGCCTGA
GCGAACTGGATAAAGGCCGGCTTCATCAAGAGACAGCTGGTGGAAACCCGGCAGATC
ACAAAGCACGTGGCACAGATCCTGGACTCCCGGATGAACACTAAGTACGACGAGAA
TGACAAGCTGATCCGGGAAGTGAAAGTGATCACCTGAAGTCCAAGCTGGTGTCCG
ATTTCCGGAAGGATTTCCAGTTTTACAAAGTGCGCGAGATCAACAACCTACCACCACG
CCCACGACGCCTACCTGAACGCCGTCTGTGGGAACCGCCCTGATCAAAAAGTACCCT
AAGCTGGAAAGCGAGTTCGTGTACGGCGACTACAAGGTGTACGACGTGCGGAAGAT
GATCGCCAAGAGCGAGCAGGAAATCGGCAAGGCTACCGCCAAGTACTTCTTCTACA
GCAACATCATGAACTTTTTCAAGACCGAGATTACCCTGGCCAACGGCGAGATCCGG
AAGCGGCCTCTGATCGAGACAAACGGCGAAACCGGGGAGATCGTGTGGGATAAGG
GCCGGGATTTTGCCACCGTGCGGAAAGTGCTGAGCATGCCCAAGTGAATATCGTG
AAAAAGACCGAGGTGCAGACAGGCGGCTTCAGCAAAGAGTCTATCCTGCCCAAGAG
GAACAGCGATAAGCTGATCGCCAGAAAGAAGGACTGGGACCCTAAGAAGTACGGC
GGCTTCGACAGCCCCACCGTGGCCTATTCTGTGCTGGTGGTGGCCAAAGTGGAAAAG
GGCAAGTCCAAGAAACTGAAGAGTGTGAAAGAGCTGCTGGGGATCACCATCATGGA
AAGAAGCAGCTTCGAGAAGAATCCCATCGACTTCTGGAAGCCAAGGGCTACAAAG
AAGTGAAAAAGGACCTGATCATCAAGCTGCCTAAGTACTCCCTGTTTCGAGCTGGAA
AACGGCCGGAAGAGAATGCTGGCCTCTGCCGGCGAACTGCAGAAGGGAAACGAAC
TGGCCCTGCCCTCCAAATATGTGAACTTCTGTACCTGGCCAGCCACTATGAGAAGC
TGAAGGGCTCCCCCGAGGATAATGAGCAGAAACAGCTGTTTGTGGAACAGCACAAG

CACTACCTGGACGAGATCATCGAGCAGATCAGCGAGTTCTCCAAGAGAGTGATCCT
 GGCCGACGCTAATCTGGACAAAGTGCTGTCCGCCTACAACAAGCACCCGGGATAAGC
 CCATCAGAGAGCAGGCCGAGAATATCATCCACCTGTTTACCCTGACCAATCTGGGA
 GCCCCTGCCGCCTTCAAGTACTTTGACACCACCATCGACCCGGAAGAGGTACACCAGC
 ACCAAAGAGGTGCTGGACGCCACCCTGATCCACCAGAGCATCACCCGGCCTGTACGA
 GACACGGATCGACCTGTCTCAGCTGGGAGGGCGACAAAAGGCCGGCGGCCACGAAA
 AAGGCCGGCCAGGCCAAAAAAGAAAAAGtaa

[00138] 8. Sp_Δ_hel 2-(GGGGS)6 helical domain 2 deletion (from ortholog alignment)

[00139] ATGGCCCCAAAGAAGAAGCGGAAGGTTCGGTATCCACGGAGTCCCAGCAG
 CCGACAAGAAGTACAGCATCGGCCTGGACATCGGCACCAACTCTGTGGGCTGGGCC
 GTGATCACCGACGAGTACAAGGTGCCAGCAAGAAATTCAAGGTGCTGGGCAACAC
 CGACCCGGCACAGCATCAAGAAGAACCTGATCGGAGCCCTGCTGTTTCGACAGCGGCG
 AACAGCCGAGGCCACCCGGCTGAAGAGAACCGCCAGAAGAAGATACACCAGACG
 GAAGAACCGGATCTGCTATCTGCAAGAGATCTTCAGCAACGAGATGGCCAAGGTGG
 ACGACAGCTTCTTCCACAGACTGGAAGAGTCCTTCTGGTGGGAAGAGGATAAGAAG
 CACGAGCGGCACCCCATCTTCGGCAACATCGTGGACGAGGTGGCCTACCACGAGAA
 GTACCCACCATCTACCACCTGAGAAAGAAACTGGTGGACAGCACCCGACAAGGCCG
 ACCTGCGGCTGATCTATCTGGCCCTGGCCACATGATCAAGTTCGGGGGCCACTTCC
 TGATCGAGGGCGACGGTGGCGGTGGCtegGGTGGCGGTGGCtegGGTGGCGGTGGCteg
 GGTGGCGGTGGCtegGGTGGCGGTGGCtegGGTGGCGGTGGCtegATCACCAAGGCCCCC
 CTGAGCGCCTCTATGATCAAGAGATACGACGAGCACCCAGGACCTGACCCTGCT
 GAAAGCTCTCGTGCGGCAGCAGCTGCCTGAGAAGTACAAAGAGATTTTCTTCGACC
 AGAGCAAGAACGGCTACGCCGGCTACATTGACGGCGGAGCCAGCCAGGAAGAGTTC
 TACAAGTTCATCAAGCCCATCCTGGAAAAGATGGACGGCACCCGAGGAACTGCTCGT
 GAAGCTGAACAGAGAGGACCTGCTGCGGAAGCAGCGGACCTTCGACAACGGCAGC
 ATCCCCCACCAGATCCACCTGGGAGAGCTGCACGCCATTCTGCGGCGGCAGGAAGA
 TTTTACCATTCTGAAGGACAACCGGGAAAAGATCGAGAAGATCCTGACCTTCG
 CATCCCCTACTACGTGGGCCCTCTGGCCAGGGGAAACAGCAGATTTCGCTGGATGA
 CCAGAAAGAGCGAGGAAACCATCACCCCTGGAACCTTCGAGGAAGTGGTGGACAA
 GGGCGCTTCCGCCAGAGCTTCATCGAGCGGATGACCAACTTCGATAAGAACCTGC
 CCAACGAGAAGGTGCTGCCCAAGCACAGCCTGCTGTACGAGTACTTCACCGTGTAT

AACGAGCTGACCAAAGTGAAATACGTGACCGAGGGAATGAGAAAGCCCGCCTTCCT
GAGCGGCGAGCAGAAAAAGGCCATCGTGGACCTGCTGTTCAAGACCAACCGGAAA
GTGACCGTGAAGCAGCTGAAAGAGGACTACTTCAAGAAAATCGAGTGCTTCGACTC
CGTGGAATCTCCGGCGTGGAAGATCGGTTCAACGCCTCCCTGGGACACATAACCACG
ATCTGCTGAAAATTATCAAGGACAAGGACTTCCTGGACAATGAGGAAAACGAGGAC
ATTCTGGAAGATATCGTGCTGACCCTGACACTGTTTIGAGGACAGAGAGATGATCGA
GGAACGGCTGAAAACCTATGCCACCTGTTTCGACGACAAAAGTGATGAAGCAGCTGA
AGCGGCGGAGATACACCGGCTGGGGCAGGCTGAGCCGGAAGCTGATCAACGGCATC
CGGGACAAGCAGTCCGGCAAGACAATCCTGGATTTCTGAAGTCCGACGGCTTCGC
CAACAGAACTTCATGCAGCTGATCCACGACGACAGCCTGACCTTTAAAGAGGACA
TCCAGAAAGCCCAGGTGTCCGGCCAGGGCGATAGCCTGCACGAGCACATTGCCAAT
CTGGCCGGCAGCCCCGCCATTAAGAAGGGCATCCTGCAGACAGTGAAGGTGGTGG
CGAGCTCGTGAAAGTGATGGGCCGGCACAAGCCCGAGAACATCGTGATCGAAATGG
CCAGAGAGAACCAGACCACCAGAAGGGACAGAAGAACAGCCGCGAGAGAATGAA
GCGGATCGAAGAGGGCATCAAAGAGCTGGGCAGCCAGATCCTGAAAGAACACCCC
GTGGAAAACACCCAGCTGCAGAACGAGAAGCTGTACCTGTACTACCTGCAGAATGG
GCGGGATATGTACGTGGACCAGGAACTGGACATCAACCGGCTGTCCGACTACGATG
TGGACCATATCGTGCTCAGAGCTTTCTGAAGGACGACTCCATCGACAACAAGGTGC
TGACCAGAAGCGACAAGAACCGGGGCAAGAGCGACAACGTGCCCTCCGAAGAGGT
CGTGAAGAAGATGAAGAACTACTGGCGGCAGCTGCTGAACGCCAAGCTGATTACC
AGAGAAAGTTCGACAATCTGACCAAGGCCGAGAGAGGGCGGCCTGAGCGAACTGGAT
AAGGCCGGCTTCATCAAGAGACAGCTGGTGGAAACCCGGCAGATCACAAAGCACGT
GGCACAGATCCTGGACTCCCGGATGAACACTAAGTACGACGAGAATGACAAGCTGA
TCCGGGAAGTGAAAGTGATCACCCCTGAAGTCCAAGCTGGTGTCCGATTTCCGGAAG
GATTTCCAGTTTTACAAAGTGCGCGAGATCAACAACCTACCACCACGCCACGACGCC
TACCTGAACGCCGTCGTGGGAACCGCCCTGATCAAAAAGTACCCTAAGCTGGAAAG
CGAGTTCGTGTACGGCGACTACAAGGTGTACGACGTGCGGAAGATGATCGCCAAGA
GCGAGCAGGAAATCGGCAAGGCTACCGCCAAGTACTTCTTCTACAGCAACATCATG
AACTTTTTCAAGACCGAGATTACCCTGGCCAACGGCGAGATCCGGAAGCGGCCTCT
GATCGAGACAAACGGCGAAACCGGGGAGATCGTGTGGGATAAGGGCCGGGATTTTG
CCACCGTGCGGAAAGTGCTGAGCATGCCCAAGTGAATATCGTGAAAAAGACCGAG

GTGCAGACAGGCGGCTTCAGCAAAGAGTCTATCCTGCCCAAGAGGAACAGCGATAA
 GCTGATCGCCAGAAAGAAGGACTGGGACCCTAAGAAGTACGGCGGCTTCGACAGCC
 CCACCGTGGCCTATTCTGTGCTGGTGGTGGCCAAAGTGGAAAAGGGCAAGTCCAAG
 AACTGAAGAGTGTGAAAGAGCTGCTGGGGATCACCATCATGGAAAGAAGCAGCTT
 CGAGAAGAATCCCATCGACTTTCTGGAAGCCAAGGGCTACAAAGAAGTGAAAAAGG
 ACCTGATCATCAAGCTGCCAAGTACTCCCTGTTGAGCTGGAAAACGGCCGGAAG
 AGAATGCTGGCCTCTGCCGGCGAACTGCAGAAGGGAAACGAACTGGCCCTGCCCTC
 CAAATATGTGAACTTCTGTACCTGGCCAGCCACTATGAGAAGCTGAAGGGCTCCCC
 CGAGGATAATGAGCAGAAACAGCTGTTTGTGGAACAGCACAAGCACTACCTGGACG
 AGATCATCGAGCAGATCAGCGAGTTCTCCAAGAGAGTGATCCTGGCCGACGCTAAT
 CTGGACAAAGTGCTGTCCGCCTACAACAAGCACCCGGGATAAGCCCATCAGAGAGCA
 GGCCGAGAATATCATCCACCTGTTTACCCTGACCAATCTGGGAGCCCCTGCCGCCTT
 CAAGTACTTTGACACCACCATCGACCGGAAGAGGTACACCAGCACCAAAGAGGTGC
 TGGACGCCACCCTGATCCACCAGAGCATCACCGGCTGTACGAGACACGGATCGAC
 CTGTCTCAGCTGGGAGGCGACAAAAGGCCGGCGGCCACGAAAAAGGCCGGCCAGG
 CAAAAAGAAAAAGtaa

[00140] 9. Sp_Δ_hel 2-(GGGS)9 helical domain 2 deletion (from ortholog alignment)

[00141] ATGGCCCCAAAGAAGAAGCGGAAGGTTCGGTATCCACGGAGTCCCAGCAG
 CCGACAAGAAGTACAGCATCGGCCTGGACATCGGCACCAACTCTGTGGGCTGGGCC
 GTGATCACCGACGAGTACAAGGTGCCAGCAAGAAATTCAGGTGCTGGGCAACAC
 CGACCGGCACAGCATCAAGAAGAACCTGATCGGAGCCCTGCTGTTGACAGCGGCG
 AACAGCCGAGGCCACCCGGCTGAAGAGAACCGCCAGAAGAAGATACACCAGACG
 GAAGAACCGGATCTGCTATCTGCAAGAGATCTTCAGCAACGAGATGGCCAAGGTGG
 ACGACAGCTTCTTCCACAGACTGGAAGAGTCCTTCTGGTGGAAAGAGGATAAGAAG
 CACGAGCGGCACCCCATCTTCGGCAACATCGTGGACGAGGTGGCCTACCACGAGAA
 GTACCCACCATCTACCACCTGAGAAAGAACTGGTGGACAGCACCGACAAGGCCG
 ACCTGCGGCTGATCTATCTGGCCCTGGCCCACATGATCAAGTTCGGGGCCACTTCC
 TGATCGAGGGCGACGGTGGCGGTGGCtegGGTGGCGGTGGCtegGGTGGCGGTGGCteg
 GGTGGCGGTGGCtegGGTGGCGGTGGCtegGGTGGCGGTGGCtegGGTGGCGGTGGCtegG
 GTGGCGGTGGCtegGGTGGCGGTGGCtegATCACCAAGGCCCCCTGAGCGCCTCTATG
 ATCAAGAGATACGACGAGCACACCAGGACCTGACCCTGCTGAAAGCTCTCGTGCG

GCAGCAGCTGCCTGAGAAGTACAAAGAGATTTTCTTCGACCAGAGCAAGAACGGCT
ACGCCGGCTACATTGACGGCGGAGCCAGCCAGGAAGAGTTCTACAAGTTCATCAAG
CCCATCCTGGAAAAGATGGACGGCACCCGAGGAAGCTGCTCGTGAAGCTGAACAGAGA
GGACCTGCTGCGGAAGCAGCGGACCTTCGACAACGGCAGCATCCCCACCAGATCC
ACCTGGGAGAGCTGCACGCCATTCTGCGGCGGCAGGAAGATTTTTACCCATTCTGA
AGGACAACCGGGAAAAGATCGAGAAGATCCTGACCTTCCGCATCCCCTACTACGTG
GGCCCTCTGGCCAGGGGAAAACAGCAGATTTCGCTGGATGACCAGAAAAGAGCGAGG
AAACCATCACCCCCTGGAAGCTTCGAGGAAGTGGTGGACAAGGGCGCTTCCGCCAG
AGCTTCATCGAGCGGATGACCAACTTCGATAAGAACCTGCCAACGAGAAGGTGCT
GCCCAAGCACAGCCTGCTGTACGAGTACTTCACCGTGTATAACGAGCTGACCAAAG
TGAAATACGTGACCGAGGGAATGAGAAAGCCCGCCTTCCTGAGCGGCGAGCAGAAA
AAGGCCATCGTGGACCTGCTGTTCAAGACCAACCGGAAAAGTGACCGTGAAGCAGCT
GAAAGAGGACTACTTCAAGAAAATCGAGTGCTTCGACTCCGTGGAAATCTCCGGCG
TGGAAGATCGGTTCAACGCCTCCCTGGGCACATAACCACGATCTGCTGAAAATTATCA
AGGACAAGGACTTCCTGGACAATGAGGAAAACGAGGACATTCTGGAAGATATCGTG
CTGACCCTGACACTGTTTGAGGACAGAGAGATGATCGAGGAACGGCTGAAAACCTA
TGCCACCTGTTTCGACGACAAAGTGATGAAGCAGCTGAAGCGGCGGAGATACACCG
GCTGGGGCAGGCTGAGCCGGAAGCTGATCAACGGCATCCGGGACAAGCAGTCCGGC
AAGACAATCCTGGATTTCTGAAGTCCGACGGCTTCGCCAACAGAACTTCATGCAG
CTGATCCACGACGACAGCCTGACCTTTAAAGAGGACATCCAGAAAGCCCAGGTGTC
CGGCCAGGGCGATAGCCTGCACGAGCACATTGCCAATCTGGCCGGCAGCCCCGCCA
TTAAGAAGGGCATCCTGCAGACAGTGAAGGTGGTGGACGAGCTCGTGAAAGTGATG
GGCCGGCACAAGCCCAGAACATCGTGATCGAAATGGCCAGAGAGAACCAGACCA
CCCAGAAGGGACAGAAGAACAGCCGCGAGAGAATGAAGCGGATCGAAGAGGGCAT
CAAAGAGCTGGGCAGCCAGATCCTGAAAGAACACCCCGTGGAACACCCAGCTGC
AGAACGAGAAGCTGTACCTGTACTACCTGCAGAATGGGCGGGATATGTACGTGGAC
CAGGAACTGGACATCAACCGGCTGTCCGACTACGATGTGGACCATATCGTGCCTCA
GAGCTTTCTGAAGGACGACTCCATCGACAACAAGGTGCTGACCAGAAGCGACAAGA
ACCGGGGCAAGAGCGACAACGTGCCCTCCGAAGAGGTCTGTGAAGAAGATGAAGAA
CTACTGGCGGCAGCTGCTGAACGCCAAGCTGATTACCCAGAGAAAGTTCGACAATC
TGACCAAGGCCGAGAGAGGGCGGCCTGAGCGAACTGGATAAGGCCGGCTTCATCAAG

AGACAGCTGGTGGAAACCCGGCAGATCACAAAGCACGTGGCACAGATCCTGGACTC
 CCGGATGAACACTAAGTACGACGAGAATGACAAGCTGATCCGGGAAGTGAAAGTGA
 TCACCCTGAAGTCCAAGCTGGTGTCCGATTTCCGGAAGGATTTCCAGTTTTACAAAG
 TGCGCGAGATCAACAACCTACCACCACGCCACGACGCCTACCTGAACGCCGTCGTG
 GGAACCGCCCTGATCAAAAAGTACCCTAAGCTGGAAAGCGAGTTCGTGTACGGCGA
 CTACAAGGTGTACGACGTGCGGAAGATGATCGCCAAGAGCGAGCAGGAAATCGGCA
 AGGCTACCGCCAAGTACTTCTTCTACAGCAACATCATGAACTTTTTCAAGACCGAGA
 TTACCCTGGCCAACGGCGAGATCCGGAAGCGGCCTCTGATCGAGACAAACGGCGAA
 ACCGGGGAGATCGTGTGGGATAAGGGCCGGGATTTTGCCACCGTGCGGAAAGTGCT
 GAGCATGCCCAAGTGAATATCGTGAAAAGACCGAGGTGCAGACAGGCGGCTTCA
 GCAAAGAGTCTATCCTGCCCAAGAGGAACAGCGATAAGCTGATCGCCAGAAAGAAG
 GACTGGGACCCTAAGAAGTACGGCGGCTTCGACAGCCCCACCGTGGCCTATTCTGTG
 CTGGTGGTGGCCAAAGTGGAAAAGGGCAAGTCCAAGAACTGAAGAGTGTGAAAG
 AGCTGCTGGGGATCACCATCATGGAAAGAAGCAGCTTCGAGAAGAATCCCATCGAC
 TTTCTGGAAGCCAAGGGCTACAAAGAAGTGAAAAGGACCTGATCATCAAGCTGCC
 TAAGTACTCCCTGTTTCGAGCTGGAAAACGGCCGGAAGAGAATGCTGGCCTCTGCCG
 GCGAACTGCAGAAGGGAAACGAACTGGCCCTGCCCTCCAAATATGTGAACTTCCTG
 TACCTGGCCAGCCACTATGAGAAGCTGAAGGGCTCCCCCGAGGATAATGAGCAGAA
 ACAGCTGTTTGTGGAACAGCACAAGCACTACCTGGACGAGATCATCGAGCAGATCA
 GCGAGTTCTCCAAGAGAGTGATCCTGGCCGACGCTAATCTGGACAAAGTGCTGTCCG
 CCTACAACAAGCACCGGGATAAGCCCATCAGAGAGCAGGCCGAGAATATCATCCAC
 CTGTTTACCCTGACCAATCTGGGAGCCCCTGCCGCCTTCAAGTACTTTGACACCACC
 ATCGACCGGAAGAGGTACACCAGCACCAAAGAGGTGCTGGACGCCACCCTGATCCA
 CCAGAGCATCACCGGCCTGTACGAGACACGGATCGACCTGTCTCAGCTGGGAGGCG
 ACAAAGGCCGGCGGCCACGAAAAAGGCCGGCCAGGCAAAAAAGAAAAAGtaa

[00142] 10. Sp_Δ_hel 2-(GGGS)₁₂ helical domain 2 deletion (from ortholog alignment)

[00143] ATGGCCCCAAAGAAGAAGCGGAAGGTCCGTATCCACGGAGTCCCAGCAG
 CCGACAAGAAGTACAGCATCGGCCTGGACATCGGCACCAACTCTGTGGGCTGGGCC
 GTGATCACCGACGAGTACAAGGTGCCAGCAAGAAATCAAGGTGCTGGGCAACAC
 CGACCGGCACAGCATCAAGAAGAACCTGATCGGAGCCCTGCTGTTTCGACAGCGGCG
 AACAGCCGAGGCCACCCGGCTGAAGAGAACCGCCAGAAGAAGATACACCAGACG

GAAGAACCGGATCTGCTATCTGCAAGAGATCTTCAGCAACGAGATGGCCAAGGTGG
ACGACAGCTTCTTCCACAGACTGGAAGAGTCCTTCCTGGTGGAAGAGGATAAGAAG
CACGAGCGGCACCCCATCTTCGGCAACATCGTGGACGAGGTGGCCTACCACGAGAA
GTACCCACCATCTACCACCTGAGAAAGAAACTGGTGGACAGCACCGACAAGGCCG
ACCTGCGGCTGATCTATCTGGCCCTGGCCCACATGATCAAGTTCGGGGCCACTTCC
TGATCGAGGGCGACGGTGGCGGTGGCtcgGGTGGCGGTGGCtcgGGTGGCGGTGGCtcg
GGTGGCGGTGGCtcgGGTGGCGGTGGCtcgGGTGGCGGTGGCtcgGGTGGCGGTGGCtcgG
GTGGCGGTGGCtcgGGTGGCGGTGGCtcgGGTGGCGGTGGCtcgGGTGGCGGTGGCtcgGG
TGGCGGTGGCtcgATCACCAAGGCCCCCTGAGCGCCTCTATGATCAAGAGATACGAC
GAGCACCACCAGGACCTGACCCTGCTGAAAGCTCTCGTGCGGCAGCAGCTGCCTGA
GAAGTACAAAGAGATTTTCTTCGACCAGAGCAAGAACGGCTACGCCGGCTACATTG
ACGGCGGAGCCAGCCAGGAAGAGTTCTACAAGTTCATCAAGCCCATCCTGGAAAAG
ATGGACGGCACCGAGGAACTGCTCGTGAAGCTGAACAGAGAGGACCTGCTGCGGAA
GCAGCGGACCTTCGACAACGGCAGCATCCCCACCAGATCCACCTGGGAGAGCTGC
ACGCCATTCTGCGGCGGCAGGAAGATTTTTTACCATTCTGAAGGACAACCGGGAA
AAGATCGAGAAGATCCTGACCTTCGCATCCCCTACTACGTGGGCCCTCTGGCCAGG
GGAAACAGCAGATTCGCCTGGATGACCAGAAAGAGCGAGGAAACCATCACCCCTG
GAACTTCGAGGAAGTGGTGGACAAGGGCGCTTCCGCCAGAGCTTCATCGAGCGGA
TGACCAACTTCGATAAGAACCTGCCCAACGAGAAGGTGCTGCCCAAGCACAGCCTG
CTGTACGAGTACTTCACCGTGTATAACGAGCTGACCAAAGTGAAATACGTGACCGA
GGGAATGAGAAAGCCCGCCTTCCTGAGCGGCGAGCAGAAAAAGGCCATCGTGGACC
TGCTGTTCAAGACCAACCGGAAAGTGACCGTGAAGCAGCTGAAAGAGGACTACTTC
AAGAAAATCGAGTGCTTCGACTCCGTGGAAATCTCCGGCGTGGAAGATCGGTTCAA
CGCCTCCCTGGGCACATACCACGATCTGCTGAAAATTATCAAGGACAAGGACTTCCT
GGACAATGAGGAAAACGAGGACATTCTGGAAGATATCGTGCTGACCCTGACACTGT
TTGAGGACAGAGAGATGATCGAGGAACGGCTGAAAACCTATGCCACCTGTTTCGAC
GACAAAGTGATGAAGCAGCTGAAGCGGCGGAGATACACCGGCTGGGGCAGGCTGA
GCCGGAAGCTGATCAACGGCATCCGGGACAAGCAGTCCGGCAAGACAATCCTGGAT
TTCCTGAAGTCCGACGGCTTCGCCAACAGAACTTCATGCAGCTGATCCACGACGAC
AGCCTGACCTTTAAAGAGGACATCCAGAAAGCCCAGGTGTCCGGCCAGGGCGATAG
CCTGCACGAGCACATTGCCAATCTGGCCGGCAGCCCCGCCATTAAGAAGGGCATCC

TGCAGACAGTGAAGGTGGTGGACGAGCTCGTGAAAGTGATGGGCGGCACAAGCCC
GAGAACATCGTGATCGAAATGGCCAGAGAGAACCAGACCACCCAGAAGGGACAGA
AGAACAGCCGCGAGAGAATGAAGCGGATCGAAGAGGGCATCAAAGAGCTGGGCAG
CCAGATCCTGAAAGAACACCCCGTGGAAAACACCCAGCTGCAGAACGAGAAGCTGT
ACCTGTACTACCTGCAGAATGGGCGGGATATGTACGTGGACCAGGAACTGGACATC
AACCGGCTGTCCGACTACGATGTGGACCATATCGTGCCTCAGAGCTTTCTGAAGGAC
GACTCCATCGACAACAAGGTGCTGACCAGAAGCGACAAGAACCGGGGCAAGAGCG
ACAACGTGCCCTCCGAAGAGGTCGTGAAGAAGATGAAGA ACTACTGGCGGCAGCTG
CTGAACGCCAAGCTGATTACCCAGAGAAAGTTCGACAATCTGACCAAGGCCGAGAG
AGGCGGCCTGAGCGAACTGGATAAGGCCGGCTTCATCAAGAGACAGCTGGTGGAAA
CCCGGCAGATCACAAAGCACGTGGCACAGATCCTGGACTCCCGGATGAACACTAAG
TACGACGAGAATGACAAGCTGATCCGGGAAGTGAAAGTGATCACCTGAAGTCCAA
GCTGGTGTCCGATTTCCGGAAGGATTTCCAGTTTTACAAAGTGCGCGAGATCAACAA
CTACCACCACGCCACGACGCCTACCTGAACGCCGTCTGTGGGAACCGCCCTGATCA
AAAAGTACCCTAAGCTGGAAAGCGAGTTCGTGTACGGCGACTACAAGGTGTACGAC
GTGCGGAAGATGATCGCCAAGAGCGAGCAGGAAATCGGCAAGGCTACCGCCAAGT
ACTTCTTCTACAGCAACATCATGAACTTTTTCAAGACCGAGATTACCCTGGCCAACG
GCGAGATCCGGAAGCGGCCTCTGATCGAGACAAACGGCGAAACCGGGGAGATCGT
GTGGGATAAGGGCCGGGATTTTGCCACCGTGCGGAAAGTGCTGAGCATGCCCAAG
TGAATATCGTGAAAAAGACCGAGGTGCAGACAGGCCGGCTTCAGCAAAGAGTCTATC
CTGCCCAAGAGGAACAGCGATAAGCTGATCGCCAGAAAGAAGGACTGGGACCCTA
AGAAGTACGGCGGCTTCGACAGCCCCACCGTGGCCTATTCTGTGCTGGTGGTGGCCA
AAGTGGAAAAGGGCAAGTCCAAGAAACTGAAGAGTGTGAAAGAGCTGCTGGGGAT
CACCATCATGGAAAGAAGCAGCTTCGAGAAGAATCCCATCGACTTTCTGGAAGCCA
AGGGCTACAAAGAAGTGAAAAAGGACCTGATCATCAAGCTGCCTAAGTACTCCCTG
TTCGAGCTGGAAAACGGCCGGAAGAGAATGCTGGCCTCTGCCGGCGAACTGCAGAA
GGGAAACGAACTGGCCCTGCCCTCCAAATATGTGAACTTCCTGTACCTGGCCAGCCA
CTATGAGAAGCTGAAGGGCTCCCCGAGGATAATGAGCAGAAACAGCTGTTTGTGG
AACAGCACAAGCACTACCTGGACGAGATCATCGAGCAGATCAGCGAGTTCTCCAAG
AGAGTGATCCTGGCCGACGCTAATCTGGACAAAGTGCTGTCCGCCTACAACAAGCA
CCGGGATAAGCCCATCAGAGAGCAGGCCGAGAATATCATCCACCTGTTTACCCTGA

CCAATCTGGGAGCCCCTGCCGCCTTCAAGTACTTTGACACCACCATCGACCGGAAGA
 GGTACACCAGCACCAAAGAGGTGCTGGACGCCACCCTGATCCACCAGAGCATCACC
 GGCCTGTACGAGACACGGATCGACCTGTCTCAGCTGGGAGGCGACAAAAGGCCGGC
 GGCCACGAAAAAGGCCGGCCAGGCCAAAAAAGAAAAAGtaa

[00144] 11. Sp_Δ_hel 2-A(EAAAK)3A helical domain 2 deletion (from ortholog alignment)

[00145] ATGGCCCCAAAGAAGAAGCGGAAGGTTCGGTATCCACGGAGTCCCAGCAG
 CCGACAAGAAGTACAGCATCGGCCTGGACATCGGCACCAACTCTGTGGGCTGGGCC
 GTGATCACCGACGAGTACAAGGTGCCCAGCAAGAAATTCAAGGTGCTGGGCAACAC
 CGACCGGCACAGCATCAAGAAGAACCTGATCGGAGCCCTGCTGTTCGACAGCGGCG
 AACAGCCGAGGCCACCCGGCTGAAGAGAACCGCCAGAAGAAGATACACCAGACG
 GAAGAACCGGATCTGCTATCTGCAAGAGATCTTCAGCAACGAGATGGCCAAGGTGG
 ACGACAGCTTCTCCACAGACTGGAAGAGTCCTTCCTGGTGGAAAGAGGATAAGAAG
 CACGAGCGGCACCCCATCTTCGGCAACATCGTGGACGAGGTGGCCTACCACGAGAA
 GTACCCACCATCTACCACCTGAGAAAGAAACTGGTGGACAGCACCGACAAGGCCG
 ACCTGCGGCTGATCTATCTGGCCCTGGCCCACATGATCAAGTTCCGGGGCCACTTCC
 TGATCGAGGGCGAC_{get}GAAGCTGCTGCTAAAGAAGCTGCTGCTAAAGAAGCTGCTG
 CTAAAG_{ct}ATCACCAAGGCCCCCTGAGCGCCTCTATGATCAAGAGATACGACGAGC
 ACCACCAGGACCTGACCCTGCTGAAAGCTCTCGTGCGGCAGCAGCTGCCTGAGAAG
 TACAAAGAGATTTTCTTCGACCAGAGCAAGAACGGCTACGCCGGCTACATTGACGG
 CGGAGCCAGCCAGGAAGAGTTCTACAAGTTCATCAAGCCCATCCTGGAAAAGATGG
 ACGGCACCGAGGAAGACTGCTCGTGAAGCTGAACAGAGAGGACCTGCTGCGGAAGCA
 GCGGACCTTCGACAACGGCAGCATCCCCACCAGATCCACCTGGGAGAGCTGCACG
 CCATTCTGCGGCGGCAGGAAGATTTTTACCCATTCTGAAGGACAACCGGGAAAAG
 ATCGAGAAGATCCTGACCTTCCGCATCCCCTACTACGTGGGCCCTCTGGCCAGGGGA
 AACAGCAGATTCGCCTGGATGACCAGAAAGAGCGAGGAAACCATCACCCCTGGAA
 CTTCGAGGAAGTGGTGGACAAGGGCGCTTCCGCCAGAGCTTCATCGAGCGGATGA
 CCAACTTCGATAAGAACCTGCCCAACGAGAAGGTGCTGCCAAGCACAGCCTGCTG
 TACGAGTACTTCACCGTGTATAACGAGCTGACCAAAGTGAAATACGTGACCGAGGG
 AATGAGAAAGCCCGCCTTCTGAGCGGCGAGCAGAAAAAGGCCATCGTGGACCTGC
 TGTTCAAGACCAACCGGAAAGTGACCGTGAAGCAGCTGAAAGAGGACTACTTCAAG
 AAAATCGAGTGCTTCGACTCCGTGGAAATCTCCGGCGTGGAAGATCGGTTCAACGCC

TCCCTGGGCACATAACCACGATCTGCTGAAAATTATCAAGGACAAGGACTTCCTGGAC
AATGAGGAAAACGAGGACATTCTGGAAGATATCGTGCTGACCCTGACACTGTTTGA
GGACAGAGAGATGATCGAGGAACGGCTGAAAACCTATGCCACCTGTTCGACGACA
AAGTGATGAAGCAGCTGAAGCGGCGGAGATACACCGGCTGGGGCAGGCTGAGCCG
GAAGCTGATCAACGGCATCCGGGACAAGCAGTCCGGCAAGACAATCCTGGATTTCC
TGAAGTCCGACGGCTTCGCCAACAGAACTTCATGCAGCTGATCCACGACGACAGC
CTGACCTTTAAAGAGGACATCCAGAAAGCCCAGGTGTCCGGCCAGGGCGATAGCCT
GCACGAGCACATTGCCAATCTGGCCGGCAGCCCCGCCATTAAGAAGGGCATCCTGC
AGACAGTGAAGGTGGTGGACGAGCTCGTGAAAGTGATGGGCCGGCACAAGCCCGA
GAACATCGTGATCGAAATGGCCAGAGAGAACCAGACCACCCAGAAGGGGACAGAAG
AACAGCCGCGAGAGAATGAAGCGGATCGAAGAGGGCATCAAAGAGCTGGGCAGCC
AGATCCTGAAAGAACACCCCGTGGAAAACACCCAGCTGCAGAACGAGAAGCTGTAC
CTGTACTACCTGCAGAATGGGCGGGATATGTACGTGGACCAGGAACTGGACATCAA
CCGGCTGTCCGACTACGATGTGGACCATATCGTGCCTCAGAGCTTTCTGAAGGACGA
CTCCATCGACAACAAGGTGCTGACCAGAAGCGACAAGAACCGGGGCAAGAGCGAC
AACGTGCCCTCCGAAGAGGTCTGTGAAGAAGATGAAGAACTACTGGCAGGAGCTGCT
GAACGCCAAGCTGATTACCCAGAGAAAGTTCGACAATCTGACCAAGGCCGAGAGAG
GCGGCCTGAGCGAACTGGATAAGGCCGGCTTCATCAAGAGACAGCTGGTGGAAACC
CGGCAGATCACAAAGCACGTGGCACAGATCCTGGACTCCCGGATGAACACTAAGTA
CGACGAGAATGACAAGCTGATCCGGGAAGTGAAAGTGATCACCTGAAGTCCAAGC
TGGTGTCCGATTTCCGGAAGGATTTCCAGTTTTACAAAGTGCGCGAGATCAACA
ACTACCACGCCACGACGCTACCTGAACGCCGTCGTGGGAACCGCCCTGATCAAA
AAGTACCCTAAGCTGGAAAGCGAGTTCGTGTACGGCGACTACAAGGTGTACGACGT
GCGGAAGATGATCGCCAAGAGCGAGCAGGAAATCGGCAAGGCTACCGCCAAGTAC
TTCTTCTACAGCAACATCATGAACTTTTTCAAGACCGAGATTACCCTGGCCAACGGC
GAGATCCGGAAGCGGCCTCTGATCGAGACAAACGGCGAAACCGGGGAGATCGTGTG
GGATAAGGGCCGGGATTTTGCCACCGTGCGGAAAGTGCTGAGCATGCCCCAAGTGA
ATATCGTGAAAAAGACCGAGGTGCAGACAGGCGGCTTCAGCAAAGAGTCTATCCTG
CCCAAGAGGAACAGCGATAAGCTGATCGCCAGAAAGAAGGACTGGGACCCTAAGA
AGTACGGCGGCTTCGACAGCCCCACCGTGGCCTATTCTGTGCTGGTGGTGGCCAAAG
TGAAAAGGGCAAGTCCAAGAACTGAAGAGTGTGAAAGAGCTGCTGGGGATCAC

CATCATGGAAAGAAGCAGCTTCGAGAAGAATCCCATCGACTTTCTGGAAGCCAAGG
 GCTACAAAGAAGTGAAAAAGGACCTGATCATCAAGCTGCCTAAGTACTCCCTGTTC
 GAGCTGGAAAACGGCCGGAAGAGAATGCTGGCCTCTGCCGGCGAACTGCAGAAGG
 GAAACGAACTGGCCCTGCCCTCCAAATATGTGAACTTCCTGTACCTGGCCAGCCACT
 ATGAGAAGCTGAAGGGCTCCCCGAGGATAATGAGCAGAAACAGCTGTTTGTGGAA
 CAGCACAAGCACTACCTGGACGAGATCATCGAGCAGATCAGCGAGTTCTCCAAGAG
 AGTGATCCTGGCCGACGCTAATCTGGACAAAGTGCTGTCCGCCTACAACAAGCACC
 GGGATAAGCCATCAGAGAGCAGGCCGAGAATATCATCCACCTGTTTACCCTGACC
 AATCTGGGAGCCCCTGCCGCCTTCAAGTACTTTGACACCACCATCGACCGGAAGAG
 GTACACCAGCACCAAAGAGGTGCTGGACGCCACCCTGATCCACCAGAGCATCACCG
 GCCTGTACGAGACACGGATCGACCTGTCTCAGCTGGGAGGGCGACAAAAGGCCGGCG
 GCCACGAAAAGGCCGGCCAGGCAAAAAAGAAAAAGtaa

[00146] 12. Sp_Δ_hel 2-A(EAAAK)3ALEA(EAAAK)3A helical domain 2 deletion (from ortholog alignment)

[00147] ATGGCCCCAAAGAAGAAGCGGAAGGTCCGTATCCACGGAGTCCCAGCAG
 CCGACAAGAAGTACAGCATCGGCCTGGACATCGGCACCAACTCTGTGGGCTGGGCC
 GTGATCACCGACGAGTACAAGGTGCCAGCAAGAAATTCAAGGTGCTGGGCAACAC
 CGACCGGCACAGCATCAAGAAGAACCTGATCGGAGCCCTGCTGTTTCGACAGCGGCG
 AAACAGCCGAGGCCACCCGGCTGAAGAGAACCGCCAGAAGAAGATACACCAGACG
 GAAGAACCGGATCTGCTATCTGCAAGAGATCTTCAGCAACGAGATGGCCAAGGTGG
 ACGACAGCTTCTTCCACAGACTGGAAGAGTCCTTCCCTGGTGAAGAGGATAAGAAG
 CACGAGCGGCACCCCATCTTCGGCAACATCGTGGACGAGGTGGCCTACCACGAGAA
 GTACCCACCATCTACCACCTGAGAAAGAACTGGTGGACAGCACCGACAAGGCCG
 ACCTGCGGCTGATCTATCTGGCCCTGGCCCACATGATCAAGTTCCGGGGCCACTTCC
 TGATCGAGGGCGAC_{get}GAAGCCGCTGCTAAAGAAGC_cGCTGCTAAAGAAGC_cGCTGC
 TAAAG_{cc}CTGGAG_{gct}GAAGC_cGCTGCTAAAGAAGC_cGCTGCTAAAGAAGCCGCTGCT
 AAA_{gct}ATCACCAAGGCCCCCTGAGCGCCTCTATGATCAAGAGATACGACGAGCAC
 CACCAGGACCTGACCCTGCTGAAAGCTCTCGTGC_{GGC}CAGCAGCTGCCTGAGAAGTA
 CAAAGAGATTTTCTTCGACCAGAGCAAGAACGGCTACGCCGGCTACATTGACGGCG
 GAGCCAGCCAGGAAGAGTTCTACAAGTTCATCAAGCCATCCTGGAAAAGATGGAC
 GGCACCGAGGAACTGCTCGTGAAGCTGAACAGAGAGGACCTGCTGCGGAAGCAGC

GGACCTTCGACAACGGCAGCATCCCCACCAGATCCACCTGGGAGAGCTGCACGCC
ATTCTGCGGCGGCAGGAAGATTTTTACCCATTCCTGAAGGACAACCGGGAAAAGAT
CGAGAAGATCCTGACCTCCGCATCCCCTACTACGTGGGCCCTCTGGCCAGGGGAAA
CAGCAGATTCGCCTGGATGACCAGAAAGAGCGAGGAAACCATCACCCCCTGGA
ACTTCGATAAGAACCTGCCAACGAGAAGGTGCTGCCAAGCACAGCCTGCTGTA
CGAGTACTTCACCGTGTATAACGAGCTGACCAAAGTGAAATACGTGACCGAGGGAA
TGAGAAAGCCCGCCTTCCTGAGCGGGCAGCAGAAAAAGGCCATCGTGGACCTGCTG
TTCAAGACCAACCGGAAAGTGACCGTGAAGCAGCTGAAAGAGGACTACTTCAAGAA
AATCGAGTGCTTCGACTCCGTGGAAATCTCCGGCGTGGAAAGATCGGTTCAACGCCTC
CCTGGGCACATAACCACGATCTGCTGAAAATTATCAAGGACAAGGACTTCCTGGACA
ATGAGGAAAACGAGGACATTCTGGAAGATATCGTGCTGACCCTGACACTGTTTGAG
GACAGAGAGATGATCGAGGAACGGCTGAAAACCTATGCCACCTGTTTCGACGACAA
AGTGATGAAGCAGCTGAAGCGGCGGAGATACACCGGCTGGGGCAGGCTGAGCCGG
AAGCTGATCAACGGCATCCGGGACAAGCAGTCCGGCAAGACAATCCTGGATTTCT
GAAGTCCGACGGCTTCGCCAACAGAACTTCATGCAGCTGATCCACGACGACAGCC
TGACCTTTAAAGAGGACATCCAGAAAGCCCAGGTGTCCGGCCAGGGCGATAGCCTG
CACGAGCACATTGCCAATCTGGCCGGCAGCCCCGCCATTAAGAAGGGCATCCTGCA
GACAGTGAAGGTGGTGGACGAGCTCGTGAAAGTGATGGGCCGGCACAAGCCCGAG
AACATCGTGATCGAAATGGCCAGAGAGAACCAGACCACCAGAAGGGACAGAAGA
ACAGCCGCGAGAGAATGAAGCGGATCGAAGAGGGCATCAAAGAGCTGGGCAGCCA
GATCCTGAAAGAACAACCCCGTGGAAAACACCCAGCTGCAGAACGAGAAGCTGTACC
TGTA
CTACCTGCAGAATGGGCGGGATATGTACGTGGACCAGGAACTGGACATCAAC
CGGCTGTCCGACTACGATGTGGACCATATCGTGCCTCAGAGCTTTCTGAAGGACGAC
TCCATCGACAACAAGGTGCTGACCAGAAGCGACAAGAACC
GGGGCAAGAGCGACA
ACGTGCCCTCCGAAGAGGTCTGTGAAGAAGATGAAGAACTACTGGCGGCAGCTGCTG
AACGCCAAGCTGATTACCCAGAGAAAGTTCGACAATCTGACCAAGGCCGAGAGAGG
CGGCCTGAGCGAACTGGATAAGGCCGGCTTCATCAAGAGACAGCTGGTGGAAACCC
GGCAGATCACAAAGCACGTGGCACAGATCCTGGACTCCCGGATGAACACTAAGTAC
GACGAGAATGACAAGCTGATCCGGGAAGTGAAAGTGATCACCTGAAGTCCAAGCT
GGTGTCCGATTTCCGGAAGGATTTCCAGTTTTACAAAGTGCGCGAGATCAACA
ACTA

CCACCACGCCACGACGCCTACCTGAACGCCGTCGTGGGAACCGCCCTGATCAAAA
 AGTACCCTAAGCTGGAAAGCGAGTTCGTGTACGGCGACTACAAGGTGTACGACGTG
 CGGAAGATGATCGCCAAGAGCGAGCAGGAAATCGGCAAGGCTACCGCCAAGTACTT
 CTTCTACAGCAACATCATGAACTTTTTCAAGACCGAGATTACCCTGGCCAACGGCGA
 GATCCGGAAGCGGCCTCTGATCGAGACAAACGGCGAAACCGGGGAGATCGTGTGGG
 ATAAGGGCCGGGATTTTGCCACCGTGCGGAAAGTGCTGAGCATGCCCCAAGTGAAT
 ATCGTGAAAAAGACCGAGGTGCAGACAGGCGGCTTCAGCAAAGAGTCTATCCTGCC
 CAAGAGGAACAGCGATAAGCTGATCGCCAGAAAGAAGGACTGGGACCCTAAGAAG
 TACGGCGGCTTCGACAGCCCCACCGTGGCCTATTCTGTGCTGGTGGTGGCCAAAGTG
 GAAAAGGGCAAGTCCAAGAAACTGAAGAGTGTGAAAGAGCTGCTGGGGATCACCA
 TCATGGAAAGAAGCAGCTTCGAGAAGAATCCCATCGACTTTCTGGAAGCCAAGGGC
 TACAAAGAAGTGAAAAAGGACCTGATCATCAAGCTGCCTAAGTACTCCCTGTTGGA
 GCTGGAAAACGGCCGGAAGAGAATGCTGGCCTCTGCCGGCGAACTGCAGAAGGGA
 AACGAACTGGCCCTGCCCTCCAAATATGTGAACTTCCTGTACCTGGCCAGCCACTAT
 GAGAAGCTGAAGGGCTCCCCCGAGGATAATGAGCAGAAACAGCTGTTTGTGGAACA
 GCACAAGCACTACCTGGACGAGATCATCGAGCAGATCAGCGAGTTCTCCAAGAGAG
 TGATCCTGGCCGACGCTAATCTGGACAAAGTGCTGTCCGCCTACAACAAGCACCGG
 GATAAGCCCATCAGAGAGCAGGCCGAGAATATCATCCACCTGTTTACCCTGACCAA
 TCTGGGAGCCCCTGCCGCCTTCAAGTACTTTGACACCACCATCGACCGGAAGAGGTA
 CACCAGCACCAAAGAGGTGCTGGACGCCACCCTGATCCACCAGAGCATCACCGGCC
 TGTACGAGACACGGATCGACCTGTCTCAGCTGGGAGGCGACAAAAGGCCGGCGGCC
 ACGAAAAAGGCCGGCCAGGCAAAAAAGAAAAAGtaa

[00148] 13. Sp_Δ_hel 2-A(EAAAK)3ALEA(EAAAK)3ALEA(EAAAK)3A helical domain 2
 deletion (from ortholog alignment)

[00149] ATGGCCCCAAAGAAGAAGCGGAAGGTTCGGTATCCACGGAGTCCCAGCAG
 CCGACAAGAAGTACAGCATCGGCCTGGACATCGGCACCAACTCTGTGGGCTGGGCC
 GTGATCACCGACGAGTACAAGGTGCCAGCAAGAAATTCAAGGTGCTGGGCAACAC
 CGACCGGCACAGCATCAAGAAGAACCTGATCGGAGCCCTGCTGTTTCGACAGCGGCG
 AACAGCCGAGGCCACCCGGCTGAAGAGAACCGCCAGAAGAAGATACACCAGACG
 GAAGAACCGGATCTGCTATCTGCAAGAGATCTTCAGCAACGAGATGGCCAAGGTGG
 ACGACAGCTTCTCCACAGACTGGAAGAGTCCTTCCTGGTGGAAAGAGGATAAGAAG

CACGAGCGGCACCCCATCTTCGGCAACATCGTGGACGAGGTGGCCTACCACGAGAA
GTACCCACCATCTACCACCTGAGAAAGAACTGGTGGACAGCACCGACAAGGCCG
ACCTGCGGCTGATCTATCTGGCCCTGGCCACATGATCAAGTTCGGGGGCCACTTCC
TGATCGAGGGCGAC_{gct}GAAGCTGCTGCTAAAGAAGCTGCTGCTAAAGAAGCTGCTG
CTAAAG_{cc}CTGGAG_{gct}GAAGCTGCTGCTAAAGAAGCTGCTGCTAAAGAAGCTGCTGC
TAAAG_{cc}CTGGAG_{gct}GAAGCTGCTGCTAAAGAAGCTGCTGCTAAAGAAGCTGCTGCT
AAAG_{ct}ATCACCAAGGCCCCCTGAGCGCCTCTATGATCAAGAGATACGACGAGCAC
CACCAGGACCTGACCCTGCTGAAAGCTCTCGTGCGGCAGCAGCTGCCTGAGAAGTA
CAAAGAGATTTTCTTCGACCAGAGCAAGAACGGCTACGCCGGCTACATTGACGGCG
GAGCCAGCCAGGAAGAGTTCTACAAGTTCATCAAGCCCATCCTGGAAAAGATGGAC
GGCACCGAGGAACTGCTCGTGAAGCTGAACAGAGAGGACCTGCTGCGGAAGCAGC
GGACCTTCGACAACGGCAGCATCCCCACCAGATCCACCTGGGAGAGCTGCACGCC
ATTCTGCGGCGGCAGGAAGATTTTTACCCATTCCTGAAGGACAACCGGGAAAAGAT
CGAGAAGATCCTGACCTTCGCATCCCCTACTACGTGGGCCCTCTGGCCAGGGGAAA
CAGCAGATTCGCCTGGATGACCAGAAAGAGCGAGGAAACCATCACCCCTGGAACT
TCGAGGAAGTGGTGGACAAGGGCGCTTCCGCCAGAGCTTCATCGAGCGGATGACC
AACTTCGATAAGAACCTGCCCAACGAGAAGGTGCTGCCCAAGCACAGCCTGCTGTA
CGAGTACTTCACCGTGTATAACGAGCTGACCAAAGTGAAATACGTGACCGAGGGAA
TGAGAAAGCCCGCCTTCCTGAGCGGCGAGCAGAAAAAGGCCATCGTGGACCTGCTG
TTCAAGACCAACCGGAAAGTGACCGTGAAGCAGCTGAAAGAGGACTACTTCAAGAA
AATCGAGTGCTTCGACTCCGTGGAAATCTCCGGCGTGGAAAGATCGGTTCAACGCCTC
CCTGGGCACATAACCACGATCTGCTGAAAATTATCAAGGACAAGGACTTCCTGGACA
ATGAGGAAAACGAGGACATTCTGGAAGATATCGTGCTGACCCTGACACTGTTTGAG
GACAGAGAGATGATCGAGGAACGGCTGAAAACCTATGCCACCTGTTCGACGACAA
AGTGATGAAGCAGCTGAAGCGGCGGAGATACACCGGCTGGGGCAGGCTGAGCCGG
AAGCTGATCAACGGCATCCGGGACAAGCAGTCCGGCAAGACAATCCTGGATTTCT
GAAGTCCGACGGCTTCGCCAACAGAACTTCATGCAGCTGATCCACGACGACAGCC
TGACCTTTAAAGAGGACATCCAGAAAGCCAGGTGTCCGGCCAGGGCGATAGCCTG
CACGAGCACATTGCCAATCTGGCCGGCAGCCCCGCCATTAAGAAGGGCATCCTGCA
GACAGTGAAGGTGGTGGACGAGCTCGTGAAAGTGATGGGCCGGCACAAGCCCGAG
AACATCGTGATCGAAATGGCCAGAGAGAACCAGACCACCCAGAAGGGACAGAAGA

ACAGCCGCGAGAGAATGAAGCGGATCGAAGAGGGCATCAAAGAGCTGGGCAGCCA
GATCCTGAAAGAACACCCCGTGGAAAACACCCAGCTGCAGAACGAGAAGCTGTACC
TGTACTACCTGCAGAATGGGCGGGATATGTACGTGGACCAGGAAGTGGACATCAAC
CGGCTGTCCGACTACGATGTGGACCATATCGTGCCTCAGAGCTTTCTGAAGGACGAC
TCCATCGACAACAAGGTGCTGACCAGAAGCGACAAGAACCGGGGCAAGAGCGACA
ACGTGCCCTCCGAAGAGGTTCGTGAAGAAGATGAAGAAGTACTGGCGGCAGCTGCTG
AACGCCAAGCTGATTACCCAGAGAAAGTTCGACAATCTGACCAAGGCCGAGAGAGG
CGGCCTGAGCGAACTGGATAAGGCCGGCTTCATCAAGAGACAGCTGGTGGAAACCC
GGCAGATCACAAAGCACGTGGCACAGATCCTGGACTCCCGGATGAACACTAAGTAC
GACGAGAATGACAAGCTGATCCGGGAAGTGAAAGTGATCACCTGAAGTCCAAGCT
GGTGTCCGATTTCCGGAAGGATTTCCAGTTTTACAAAGTGCGCGAGATCAACAATA
CCACCACGCCACGACGCCTACCTGAACGCCGTCGTGGGAACCGCCCTGATCAAAA
AGTACCCTAAGCTGGAAAGCGAGTTCGTGTACGGCGACTACAAGGTGTACGACGTG
CGGAAGATGATCGCCAAGAGCGAGCAGGAAATCGGCAAGGCTACCGCCAAGTACTT
CTTCTACAGCAACATCATGAACTTTTTCAAGACCGAGATTACCCTGGCCAACGGCGA
GATCCGGAAGCGGCCTCTGATCGAGACAAACGGCGAAACCGGGGAGATCGTGTGGG
ATAAGGGCCGGGATTTTGCCACCGTGCGGAAAGTGCTGAGCATGCCCAAGTGAAT
ATCGTGAAAAAGACCGAGGTGCAGACAGGCGGCTTCAGCAAAGAGTCTATCCTGCC
CAAGAGGAACAGCGATAAGCTGATCGCCAGAAAGAAGGACTGGGACCCTAAGAAG
TACGGCGGCTTCGACAGCCCCACCGTGGCCTATTCTGTGCTGGTGGTGGCCAAAGTG
GAAAAGGGCAAGTCCAAGAAACTGAAGAGTGTGAAAGAGCTGCTGGGGATCACCA
TCATGGAAAGAAGCAGCTTCGAGAAGAATCCCATCGACTTTCTGGAAGCCAAGGGC
TACAAAGAAGTGAAAAAGGACCTGATCATCAAGCTGCCTAAGTACTCCCTGTTGGA
GCTGGAAAACGGCCGGAAGAGAATGCTGGCCTCTGCCGGCGAACTGCAGAAGGGA
AACGAACTGGCCCTGCCCTCCAAATATGTGAACTTCCTGTACCTGGCCAGCCACTAT
GAGAAGCTGAAGGGCTCCCCGAGGATAATGAGCAGAAACAGCTGTTTGTGGAACA
GCACAAGCACTACCTGGACGAGATCATCGAGCAGATCAGCGAGTTCTCCAAGAGAG
TGATCCTGGCCGACGTAATCTGGACAAAGTGTGTCCGCCTACAACAAGCACCGG
GATAAGCCCATCAGAGAGCAGGCCGAGAATATCATCCACCTGTTTACCCTGACCAA
TCTGGGAGCCCCTGCCGCCTTCAAGTACTTTGACACCACCATCGACCGGAAGAGGTA
CACCAGCACCAAAGAGGTGCTGGACGCCACCCTGATCCACCAGAGCATCACCGGCC

TGTACGAGACACGGATCGACCTGTCTCAGCTGGGAGGCGACAAAAGGCCGGCGGCC
ACGAAAAGGCCGGCCAGGCAAAAAGAAAAAGtaa

[00150] 14. Sp_del_hel 2-A(EAAAK)3LE(EAAAK)3LE(EAAAK)3LE(EAAAK)312A
helical domain 2 deletion (from ortholog alignment)

[00151] ATGGCCCCAAAGAAGAAGCGGAAGGTCCGTATCCACGGAGTCCCAGCAG
CCGACAAGAAGTACAGCATCGGCCTGGACATCGGCACCAACTCTGTGGGCTGGGCC
GTGATCACCGACGAGTACAAGGTGCCAGCAAGAAATTC AAGGTGCTGGGCAACAC
CGACCGGCACAGCATCAAGAAGAACCTGATCGGAGCCCTGCTGTTTCGACAGCGGCG
AAACAGCCGAGGCCACCCGGCTGAAGAGAACC GCCAGAAGAAGATACACCAGACG
GAAGAACCGGATCTGCTATCTGCAAGAGATCTTCAGCAACGAGATGGCCAAGGTGG
ACGACAGCTTCTTCCACAGACTGGAAGAGTCCTTCCCTGGTGG AAGAGGATAAGAAG
CACGAGCGGCACCCCATCTTCGGCAACATCGTGGACGAGGTGGCCTACCACGAGAA
GTACCCACCATCTACCACCTGAGAAAGAACTGGTGGACAGCACCGACAAGGCCG
ACCTGCGGCTGATCTATCTGGCCCTGGCCACATGATCAAGTTCGGGGGCCACTTCC
TGATCGAGGGCGAC_{get}GAAGCTGCTGCTAAAGAAGCTGCTGCTAAAGAAGCTGCTG
CTAAAG_{gcc}CTGGAG_{get}GAAGCTGCTGCTAAAGAAGCTGCTGCTAAAGAAGCTGCTGC
TAAAG_{gcc}CTGGAG_{get}GAAGCTGCTGCTAAAGAAGCTGCTGCTAAAGAAGCTGCTGCT
AAAG_{gcc}CTGGAG_{get}GAAGCTGCTGCTAAAGAAGCTGCTGCTAAAGAAGCTGCTGCTA
AA_{get}ATCACCAAGGCCCCCTGAGCGCCTCTATGATCAAGAGATACGACGAGCACC
ACCAGGACCTGACCCTGCTGAAAGCTCTCGTGCGGCAGCAGCTGCCTGAGAAGTAC
AAAGAGATTTTCTTCGACCAGAGCAAGAACGGCTACGCCGGCTACATTGACGGCGG
AGCCAGCCAGGAAGAGTTCTACAAGTTCATCAAGCCCATCCTGGAAAAGATGGACG
GCACCGAGGA_{act}GCTCGTGAAGCTGAACAGAGAGGACCTGCTGCGGAAGCAGCG
GACCTTCGACAACGGCAGCATCCCCACCAGATCCACCTGGGAGAGCTGCACGCCA
TTCTGCGGCGGCAGGAAGATTTTTACCCATTCCTGAAGGACAACCGGGAAAAGATC
GAGAAGATCCTGACCTTCCGCATCCCCTACTACGTGGGCCCTCTGGCCAGGGGAAAC
AGCAGATTCGCCTGGATGACCAGAAAGAGCGAGGAAACCATCACCCCTGGA_{act}TT
CGAGGAAGTGGTGGACAAGGGCGCTTCCGCCAGAGCTTCATCGAGCGGATGACCA
ACTTCGATAAGA_{act}CTGCCCAACGAGAAGGTGCTGCCCAAGCACAGCCTGCTGTAC
GAGTACTTCACCGTGTATAACGAGCTGACCAAAGTGAAATACGTGACCGAGGGAAT
GAGAAAGCCCGCCTTCCCTGAGCGGCGAGCAGAAAAGGCCATCGTGGACCTGCTGT

TCAAGACCAACCGGAAAGTGACCGTGAAGCAGCTGAAAGAGGACTACTTCAAGAAA
ATCGAGTGCTTCGACTCCGTGGAAATCTCCGGCGTGGAAGATCGGTTCAACGCCTCC
CTGGGCACATAACCAGATCTGCTGAAAATTATCAAGGACAAGGACTTCCTGGACAA
TGAGGAAAACGAGGACATTCTGGAAGATATCGTGCTGACCCTGACACTGTTTGAGG
ACAGAGAGATGATCGAGGAACGGCTGAAAACCTATGCCACCTGTTTCGACGACAAA
GTGATGAAGCAGCTGAAGCGGGCGGAGATACACCGGCTGGGGCAGGCTGAGCCGGA
AGCTGATCAACGGCATCCGGGACAAGCAGTCCGGCAAGACAATCCTGGATTTCTG
AAGTCCGACGGCTTCGCCAACAGAACTTCATGCAGCTGATCCACGACGACAGCCT
GACCTTTAAAGAGGACATCCAGAAAGCCCAGGTGTCCGGCCAGGGCGATAGCCTGC
ACGAGCACATTGCCAATCTGGCCGGCAGCCCCGCCATTAAGAAGGGCATCCTGCAG
ACAGTGAAGGTGGTGGACGAGCTCGTGAAAGTGATGGGCCGGCACAAGCCCGAGA
ACATCGTGATCGAAATGGCCAGAGAGAACCAGACCACCCAGAAGGGACAGAAGAA
CAGCCGCGAGAGAATGAAGCGGATCGAAGAGGGCATCAAAGAGCTGGGCAGCCAG
ATCCTGAAAGAACACCCCGTGGAAAACACCCAGCTGCAGAACGAGAAGCTGTACCT
GTACTACCTGCAGAATGGGCGGGATATGTACGTGGACCAGGAACTGGACATCAACC
GGCTGTCCGACTACGATGTGGACCATATCGTGCCTCAGAGCTTTCTGAAGGACGACT
CCATCGACAACAAGGTGCTGACCAGAAGCGACAAGAACCAGGGGCAAGAGCGACAA
CGTGCCCTCCGAAGAGGTCTGTGAAGAAGATGAAGAAGTACTGGCGGCAGCTGCTGA
ACGCCAAGCTGATTACCCAGAGAAAGTTCGACAATCTGACCAAGGCCGAGAGAGGC
GGCCTGAGCGAACTGGATAAAGGCCGGCTTCATCAAGAGACAGCTGGTGGAAACCCG
GCAGATCACAAAGCACGTGGCACAGATCCTGGACTCCCGGATGAACACTAAGTACG
ACGAGAATGACAAGCTGATCCGGGAAGTGAAAGTGATCACCTGAAGTCCAAGCTG
GTGTCCGATTTCCGGAAGGATTTCCAGTTTTTACAAAGTGCGCGAGATCAACAACACTAC
CACCACGCCACGACGCCTACCTGAACGCCGTCTGTGGGAACCGCCCTGATCAAAAA
GTACCCTAAGCTGGAAAGCGAGTTCGTGTACGGCGACTACAAGGTGTACGACGTGC
GGAAGATGATCGCCAAGAGCGAGCAGGAAATCGGCAAGGCTACCGCCAAGTACTTC
TTCTACAGCAACATCATGAACTTTTTCAAGACCGAGATTACCCTGGCCAACGGCGAG
ATCCGGAAGCGGCCTCTGATCGAGACAAACGGCGAAACCGGGGAGATCGTGTGGGA
TAAGGGCCGGGATTTTGCCACCGTGCGGAAAGTGCTGAGCATGCCCAAGTGAATA
TCGTGAAAAAGACCGAGGTGCAGACAGGCGGCTTCAGCAAAGAGTCTATCCTGCC
AAGAGGAACAGCGATAAGCTGATCGCCAGAAAGAAGGACTGGGACCCTAAGAAGT

ACGGCGGCTTCGACAGCCCCACCGTGGCCTATTCTGTGCTGGTGGTGGCCAAAGTGG
AAAAGGGCAAGTCCAAGAACTGAAGAGTGTGAAAGAGCTGCTGGGGATCACCATC
ATGGAAAGAAGCAGCTTCGAGAAGAATCCCATCGACTTTCTGGAAGCCAAGGGCTA
CAAAGAAGTGAAAAAGGACCTGATCATCAAGCTGCCTAAGTACTCCCTGTTCGAGC
TGGAAAACGGCCGGAAGAGAATGCTGGCCTCTGCCGGCGAACTGCAGAAGGGAAA
CGAACTGGCCCTGCCCTCCAAATATGTGAACTTCCTGTACCTGGCCAGCCACTATGA
GAAGCTGAAGGGCTCCCCGAGGATAATGAGCAGAAACAGCTGTTTGTGGAACAGC
ACAAGCACTACCTGGACGAGATCATCGAGCAGATCAGCGAGTTCTCCAAGAGAGTG
ATCCTGGCCGACGCTAATCTGGACAAAGTGCTGTCCGCCTACAACAAGCACCCGGGA
TAAGCCCATCAGAGAGCAGGCCGAGAATATCATCCACCTGTTTACCCTGACCAATCT
GGGAGCCCCTGCCGCCTTCAAGTACTTTGACACCACCATCGACCCGGAAGAGGTACA
CCAGCACCAAAGAGGTGCTGGACGCCACCCTGATCCACCAGAGCATCACCGGCCTG
TACGAGACACGGATCGACCTGTCTCAGCTGGGAGGCGACAAAAGGCCGGCGGCCAC
GAAAAAGGCCGGCCAGGCAAAAAAGAAAAAGtaa

[00152] 30. Sp_{del} (175-307) (from crystal data)

[00153] ATGGCCCCAAAGAAGAAGCGGAAGGTTCGGTATCCACGGAGTCCCAGCAG
CCGACAAGAAGTACAGCATCGGCCTGGACATCGGCACCAACTCTGTGGGCTGGGCC
GTGATCACCGACGAGTACAAGGTGCCAGCAAGAAATTCAAGGTGCTGGGCAACAC
CGACCCGGCACAGCATCAAGAAGAACCTGATCGGAGCCCTGCTGTTCGACAGCGGCG
AAACAGCCGAGGCCACCCGGCTGAAGAGAACCGCCAGAAGAAGATACACCAGACG
GAAGAACCGGATCTGCTATCTGCAAGAGATCTTCAGCAACGAGATGGCCAAGGTGG
ACGACAGCTTCTTCCACAGACTGGAAGAGTCCTTCCCTGGTGGAAAGAGGATAAGAAG
CACGAGCGGCACCCCATCTTCGGCAACATCGTGGACGAGGTGGCCTACCACGAGAA
GTACCCACCATCTACCACCTGAGAAAGAACTGGTGGACAGCACCGACAAGGCCG
ACCTGCGGCTGATCTATCTGGCCCTGGCCACATGATCAAGTTCGGGGGCCACTTCC
TGATCGAGGGCGACCTGGTGAACACCGAGATCACCAAGGCCCCCCTGAGCGCCTCT
ATGATCAAGAGATACGACGAGCACCACCAGGACCTGACCCTGCTGAAAGCTCTCGT
GCGGCAGCAGCTGCCTGAGAAGTACAAAGAGATTTTCTTCGACCAGAGCAAGAACG
GCTACGCCGGCTACATTGACGGCGGAGCCAGCCAGGAAGAGTTCTACAAGTTCATC
AAGCCCATCCTGGAAAAGATGGACGGCACCCGAGGAACTGCTCGTGAAGCTGAACAG
AGAGGACCTGCTGCGGAAGCAGCGGACCTTCGACAACGGCAGCATCCCCACCAGA

TCCACCTGGGAGAGCTGCACGCCATTCTGCGGCGGCAGGAAGATTTTTACCCATTCC
TGAAGGACAACCGGGAAAAGATCGAGAAGATCCTGACCTTCCGCATCCCCTACTAC
GTGGGCCCTCTGGCCAGGGGAAACAGCAGATTGCGCTGGATGACCAGAAAGAGCGA
GGAAACCATCACCCCCTGGAACCTTCGAGGAAGTGGTGGACAAGGGCGCTTCCGCCC
AGAGCTTCATCGAGCGGATGACCAACTTCGATAAGAACCTGCCAACGAGAAGGTG
CTGCCAAGCACAGCCTGCTGTACGAGTACTTCACCGTGTATAACGAGCTGACCAA
GTGAAATACGTGACCGAGGGAATGAGAAAGCCCGCCTTCCTGAGCGGCGAGCAGAA
AAAGGCCATCGTGGACCTGCTGTTCAAGACCAACCGGAAAGTGACCGTGAAGCAGC
TGAAAGAGGACTACTTCAAGAAAATCGAGTGCTTCGACTCCGTGGAAATCTCCGGC
GTGGAAGATCGGTTCAACGCCTCCCTGGGCACATAACCACGATCTGCTGAAAATTATC
AAGGACAAGGACTTCCTGGACAATGAGGAAAACGAGGACATTCTGGAAGATATCGT
GCTGACCCTGACACTGTTTGAGGACAGAGAGATGATCGAGGAACGGCTGAAAACCT
ATGCCACCTGTTTCGACGACAAAGTGATGAAGCAGCTGAAGCGGCGGAGATACACC
GGCTGGGGCAGGCTGAGCCGGAAGCTGATCAACGGCATCCGGGACAAGCAGTCCGG
CAAGACAATCCTGGATTTCTGAAGTCCGACGGCTTCGCCAACAGAACTTCATGCA
GCTGATCCACGACGACAGCCTGACCTTTAAAGAGGACATCCAGAAAGCCCAGGTGT
CCGGCCAGGGCGATAGCCTGCACGAGCACATTGCCAATCTGGCCGGCAGCCCCGCC
ATTAAGAAGGGCATCCTGCAGACAGTGAAGGTGGTGGACGAGCTCGTGAAAGTGAT
GGGCCGGCACAAGCCCGAGAACATCGTGATCGAAATGGCCAGAGAGAACCAGACC
ACCCAGAAGGGACAGAAGAACAGCCGCGAGAGAATGAAGCGGATCGAAGAGGGCA
TCAAAGAGCTGGGCAGCCAGATCCTGAAAGAACACCCCGTGGAAAACACCCAGCTG
CAGAACGAGAAGCTGTACCTGTACTACCTGCAGAATGGGCGGGATATGTACGTGGA
CCAGGAACTGGACATCAACCGGCTGTCCGACTACGATGTGGACCATATCGTGCCTCA
GAGCTTTCTGAAGGACGACTCCATCGACAACAAGGTGCTGACCAGAAGCGACAAGA
ACCGGGGCAAGAGCGACAACGTGCCCTCCGAAGAGGTTCGTGAAGAAGATGAAGAA
CTACTGGCGGCAGCTGCTGAACGCCAAGCTGATTACCCAGAGAAAGTTCGACAATC
TGACCAAGGCCGAGAGAGGGCGGCCTGAGCGAACTGGATAAGGCCGGCTTCATCAAG
AGACAGCTGGTGGAAACCCGGCAGATCACAAGCACGTGGCACAGATCCTGGACTC
CCGGATGAACACTAAGTACGACGAGAATGACAAGCTGATCCGGGAAGTGAAAGTGA
TCACCCTGAAGTCCAAGCTGGTGTCCGATTTCCGGAAGGATTTCCAGTTTTACAAAG
TGCGCGAGATCAACAACCTACCACCACGCCACGACGCCTACCTGAACGCCGTCGTG

GGAACCGCCCTGATCAAAAAGTACCCTAAGCTGGAAAGCGAGTTCGTGTACGGCGA
CTACAAGGTGTACGACGTGCGGAAGATGATCGCCAAGAGCGAGCAGGAAATCGGCA
AGGCTACCGCCAAGTACTTCTTCTACAGCAACATCATGAACTTTTTCAAGACCGAGA
TTACCCTGGCCAACGGCGAGATCCGGAAGCGGCCTCTGATCGAGACAAACGGCGAA
ACCGGGGAGATCGTGTGGGATAAAGGGCCGGGATTTTGCCACCGTGCGGAAAGTGCT
GAGCATGCCCAAGTGAATATCGTGAAAAGACCGAGGTGCAGACAGGCGGCTTCA
GCAAAGAGTCTATCCTGCCCAAGAGGAACAGCGATAAGCTGATCGCCAGAAAGAAG
GACTGGGACCCTAAGAAGTACGGCGGCTTCGACAGCCCCACCGTGGCCTATTCTGTG
CTGGTGGTGGCCAAAGTGGAAAAGGGCAAGTCCAAGAACTGAAGAGTGTGAAAG
AGCTGCTGGGGATCACCATCATGGAAAGAAGCAGCTTCGAGAAGAATCCCATCGAC
TTTCTGGAAGCCAAGGGCTACAAAGAAGTGAAAAGGACCTGATCATCAAGCTGCC
TAAGTACTCCCTGTTTCGAGCTGGAAAACGGCCGGAAGAGAATGCTGGCCTCTGCCG
GCGAACTGCAGAAGGGAAACGAACTGGCCCTGCCCTCCAAATATGTGAACTTCCTG
TACCTGGCCAGCCACTATGAGAAGCTGAAGGGCTCCCCGAGGATAATGAGCAGAA
ACAGCTGTTTGTGGAACAGCACAAGCACTACCTGGACGAGATCATCGAGCAGATCA
GCGAGTTCTCCAAGAGAGTGATCCTGGCCGACGCTAATCTGGACAAAGTGCTGTCCG
CCTACAACAAGCACC GGATAAGCCCATCAGAGAGCAGGCCGAGAATATCATCCAC
CTGTTTACCCTGACCAATCTGGGAGCCCCTGCCGCCTTCAAGTACTTTGACACCACC
ATCGACCGGAAGAGGTACACCAGCACCAAAGAGGTGCTGGACGCCACCCTGATCCA
CCAGAGCATCACCGGCTGTACGAGACACGGATCGACCTGTCTCAGCTGGGAGGCG
ACAAAAGGCCGGCGGCCACGAAAAAGGCCGGCCAGGCAAAAAAGAAAAAGtaa

[00154] 31. Sp_del (1098-end)

[00155] ATGGCCCCAAAGAAGAAGCGGAAGGTTCGGTATCCACGGAGTCCCAGCAG
CCGACAAGAAGTACAGCATCGGCCTGGACATCGGCACCAACTCTGTGGGCTGGGCC
GTGATCACCGACGAGTACAAGGTGCCAGCAAGAAATTCAAGGTGCTGGGCAACAC
CGACCGGCACAGCATCAAGAAGAACCTGATCGGAGCCCTGCTGTTTCGACAGCGGCG
AAACAGCCGAGGCCACCCGGCTGAAGAGAACC GCCAGAAGAAGATACACCAGACG
GAAGAACCGGATCTGCTATCTGCAAGAGATCTTCAGCAACGAGATGGCCAAGGTGG
ACGACAGCTTCTTCCACAGACTGGAAGAGTCCTTCCCTGGTGGAAAGAGGATAAGAAG
CACGAGCGGCACCCCATCTTCGGCAACATCGTGGACGAGGTGGCCTACCACGAGAA
GTACCCACCATCTACCACCTGAGAAAGAACTGGTGGACAGCACCGACAAGGCCG

ACCTGCGGCTGATCTATCTGGCCCTGGCCCACATGATCAAGTTCCGGGGCCACTTCC
TGATCGAGGGCGACCTGAACCCCGACAACAGCGACGTGGACAAGCTGTTCATCCAG
CTGGTGCAGACCTACAACCAGCTGTTTCGAGGAAAACCCCATCAACGCCAGCGGCGT
GGACGCCAAGGCCATCCTGTCTGCCAGACTGAGCAAGAGCAGACGGCTGGAAAATC
TGATCGCCCAGCTGCCCCGGCGAGAAGAAGAATGGCCTGTTTCGGAAACCTGATTGCC
CTGAGCCTGGGCTGACCCCAACTTCAAGAGCAACTTCGACCTGGCCGAGGATGC
CAAACCTGCAGCTGAGCAAGGACACCTACGACGACGACCTGGACAACCTGCTGGCCC
AGATCGGCGACCAGTACGCCGACCTGTTTCTGGCCGCCAAGAACCTGTCCGACGCC
ATCCTGCTGAGCGACATCCTGAGAGTGAACACCGAGATCACCAAGGCCCCCTGAG
CGCCTCTATGATCAAGAGATACGACGAGCACCACCAGGACCTGACCCTGCTGAAAG
CTCTCGTGCGGCAGCAGCTGCCTGAGAAGTACAAAGAGATTTTCTTCGACCAGAGCA
AGAACGGCTACGCCGGCTACATTGACGGCGGAGCCAGCCAGGAAGAGTTCTACAAG
TTCATCAAGCCCATCCTGGAAAAGATGGACGGCACCGAGGAACTGCTCGTGAAGCT
GAACAGAGAGGACCTGCTGCGGAAGCAGCGGACCTTCGACAACGGCAGCATCCCC
ACCAGATCCACCTGGGAGAGCTGCACGCCATTCTGCGGGCGGCAGGAAGATTTTTAC
CCATTCCTGAAGGACAACCGGGAAAAGATCGAGAAGATCCTGACCTTCCGCATCCC
CTACTACGTGGGCCCTCTGGCCAGGGGAAACAGCAGATTTCGCCTGGATGACCAGAA
AGAGCGAGGAAACCATCACCCCTGGAACCTTCGAGGAAGTGGTGGACAAGGGCGCT
TCCGCCCAGAGCTTCATCGAGCGGATGACCAACTTCGATAAGAACCTGCCCAACGA
GAAGGTGCTGCCAAGCACAGCCTGCTGTACGAGTACTTCACCGTGTATAACGAGCT
GACCAAAGTGAAATACGTGACCGAGGGAATGAGAAAGCCCGCCTTCCTGAGCGGCG
AGCAGAAAAAGGCCATCGTGGACCTGCTGTTCAAGACCAACCGGAAAGTGACCGTG
AAGCAGCTGAAAGAGGACTACTTCAAGAAAATCGAGTGCTTCGACTCCGTGGAAAT
CTCCGGCGTGGAAGATCGGTTCAACGCCTCCCTGGGCACATACCACGATCTGCTGAA
AATTATCAAGGACAAGGACTTCCTGGACAATGAGGAAAACGAGGACATTCTGGAAG
ATATCGTGCTGACCCTGACACTGTTTGAGGACAGAGAGATGATCGAGGAACGGCTG
AAAACCTATGCCACCTGTTTCGACGACAAAAGTGATGAAGCAGCTGAAGCGGCGGAG
ATACACCGGCTGGGGCAGGCTGAGCCGGAAGCTGATCAACGGCATCCGGGACAAGC
AGTCCGGCAAGACAATCCTGGATTTCTGAAGTCCGACGGCTTCGCCAACAGAAAC
TTCATGCAGCTGATCCACGACGACAGCCTGACCTTTAAAGAGGACATCCAGAAAGC
CCAGGTGTCCGGCCAGGGCGATAGCCTGCACGAGCACATTGCCAATCTGGCCGGCA

GCCCCGCCATTAAGAAGGGCATCCTGCAGACAGTGAAGGTGGTGGACGAGCTCGTG
AAAGTGATGGGCCGGCACAAGCCCCGAGAACATCGTGATCGAAATGGCCAGAGAGA
ACCAGACCACCCAGAAGGGACAGAAGAACAGCCGCGAGAGAATGAAGCGGATCGA
AGAGGGCATCAAAGAGCTGGGCAGCCAGATCCTGAAAGAACACCCCGTGGAAAAC
ACCCAGCTGCAGAACGAGAAGCTGTACCTGTACTACCTGCAGAATGGGCGGGATAT
GTACGTGGACCAGGAACTGGACATCAACCGGCTGTCCGACTACGATGTGGACCATA
TCGTGCCTCAGAGCTTTTCTGAAGGACGACTCCATCGACAACAAGGTGCTGACCAGA
AGCGACAAGAACCGGGGCAAGAGCGACAACGTGCCCTCCGAAGAGGTTCGTGAAGA
AGATGAAGAATACTGGCGGCAGCTGCTGAACGCCAAGCTGATTACCCAGAGAAAG
TTCGACAATCTGACCAAGGCCGAGAGAGGGCGGCCTGAGCGAACTGGATAAGGCCGG
CTTCATCAAGAGACAGCTGGTGGAAACCCGGCAGATCACAAAGCACGTGGCACAGA
TCCTGGACTCCCGGATGAACACTAAGTACGACGAGAATGACAAGCTGATCCGGGAA
GTGAAAGTGATCACCCCTGAAGTCCAAGCTGGTGTCCGATTTCCGGAAGGATTTCCAG
TTTTACAAAGTGCGCGAGATCAACAATACTACCACCACGCCACGACGCCTACCTGAA
CGCCGTTCGTGGGAACCGCCCTGATCAAAAAGTACCCTAAGCTGGAAAGCGAGTTCG
TGTACGGCGACTACAAGGTGTACGACGTGCGGAAGATGATCGCCAAGAGCGAGCAG
GAAATCGGCAAGGCTACCGCCAAGTACTTCTTCTACAGCAACATCATGAACTTTTTTC
AAGACCGAGATTACCCTGGCCAACGGCGAGATCCGGAAGCGGCCTCTGATCGAGAC
AAACGGCGAAACCGGGGAGATCGTGTGGGATAAGGGCCGGGATTTTGCCACCGTGC
GGAAAGTGCTGAGCATGCCCAAGTGAATATCGTGAAAAAGACCAAAAAGGCCGGCG
GCCACGAAAAAGGCCGGCCAGGCAAAAAAGAAAAAGtaa

[00156] 32. Sp_del (175-307)-(GGGGS)3

[00157] ATGGCCCCAAAGAAGAAGCGGAAGGTTCGGTATCCACGGAGTCCCAGCAG
CCGACAAGAAGTACAGCATCGGCCTGGACATCGGCACCAACTCTGTGGGCTGGGCC
GTGATCACCGACGAGTACAAGGTGCCAGCAAGAAATTCAAGGTGCTGGGCAACAC
CGACCGGCACAGCATCAAGAAGAACCTGATCGGAGCCCTGCTGTTCGACAGCGGCG
AACAGCCGAGGCCACCCGGCTGAAGAGAACCGCCAGAAGAAGATACACCAGACG
GAAGAACCGGATCTGCTATCTGCAAGAGATCTTCAGCAACGAGATGGCCAAGGTGG
ACGACAGCTTCTTCCACAGACTGGAAGAGTCCTTCCCTGGTGGAAAGAGGATAAGAAG
CACGAGCGGCACCCCATCTTCGGCAACATCGTGGACGAGGTGGCCTACCACGAGAA
GTACCCACCATCTACCACCTGAGAAAGAACTGGTGGACAGCACCGACAAGGCCG

ACCTGCGGCTGATCTATCTGGCCCTGGCCCACATGATCAAGTTCCGGGGCCACTTCC
TGATCGAGGGCGACCTGGGTGGaGGTGGCtcgGGTGGaGGTGGCtcgGGTGGaGGTGGCt
cgGTGAACACCGAGATCACCAAGGCCCCCTGAGCGCCTCTATGATCAAGAGATACG
ACGAGCACCACCAGGACCTGACCCTGCTGAAAGCTCTCGTGCGGCAGCAGCTGCCT
GAGAAGTACAAAGAGATTTTCTTCGACCAGAGCAAGAACGGCTACGCCGGCTACAT
TGACGGCGGAGCCAGCCAGGAAGAGTTCTACAAGTTCATCAAGCCCATCCTGGAAA
AGATGGACGGCACCGAGGAAGTCTCGTGAAGCTGAACAGAGAGGACCTGCTGCGG
AAGCAGCGGACCTTCGACAACGGCAGCATCCCCACCAGATCCACCTGGGAGAGCT
GCACGCCATTCTGCGGCGGCAGGAAGATTTTTACCCATTCTGAAGGACAACCGGG
AAAAGATCGAGAAGATCCTGACCTTCGCGCATCCCCTACTACGTGGGCCCTCTGGCCA
GGGGAAACAGCAGATTCGCCTGGATGACCAGAAAGAGCGAGGAAACCATCACCCC
CTGGAACCTTCGAGGAAGTGGTGGACAAGGGCGCTTCGCCCAGAGCTTCATCGAGC
GGATGACCAACTTCGATAAGAACCCTGCCCAACGAGAAGGTGCTGCCCAAGCACAGC
CTGCTGTACGAGTACTTCACCGTGTATAACGAGCTGACCAAAGTGAAATACGTGACC
GAGGGAATGAGAAAGCCCGCCTTCCTGAGCGGCGAGCAGAAAAAGGCCATCGTGG
ACCTGCTGTTCAAGACCAACCGGAAAGTGACCGTGAAGCAGCTGAAAGAGGACTAC
TTCAAGAAAATCGAGTGCTTCGACTCCGTGGAAATCTCCGGCGTGGAAGATCGGTTC
AACGCCTCCCTGGGCACATAACCACGATCTGCTGAAAATTATCAAGGACAAGGACTT
CCTGGACAATGAGGAAAACGAGGACATTCTGGAAGATATCGTGCTGACCCTGACAC
TGTTTGAGGACAGAGAGATGATCGAGGAACGGCTGAAAACCTATGCCACCTGTTTC
GACGACAAAGTGATGAAGCAGCTGAAGCGGCGGAGATACACCGGCTGGGGCAGGC
TGAGCCGGAAGCTGATCAACGGCATCCGGGACAAGCAGTCCGGCAAGACAATCCTG
GATTTCTGAAGTCCGACGGCTTCGCCAACAGAACTTCATGCAGCTGATCCACGAC
GACAGCCTGACCTTTAAAGAGGACATCCAGAAAGCCCAGGTGTCCGGCCAGGGCGA
TAGCCTGCACGAGCACATTGCCAATCTGGCCGGCAGCCCCGCCATTAAGAAGGGCA
TCCTGCAGACAGTGAAGGTGGTGGACGAGCTCGTGAAAGTGATGGGCCGGCACAAG
CCCGAGAACATCGTGATCGAAATGGCCAGAGAGAACCAGACCACCCAGAAGGGAC
AGAAGAACAGCCGCGAGAGAATGAAGCGGATCGAAGAGGGCATCAAAGAGCTGGG
CAGCCAGATCCTGAAAGAACACCCCGTGGAAAACACCCAGCTGCAGAACGAGAAG
CTGTACCTGTACTACCTGCAGAATGGGCGGGATATGTACGTGGACCAGGAACTGGA
CATCAACCGGCTGTCCGACTACGATGTGGACCATATCGTGCCTCAGAGCTTTCTGAA

GGACGACTCCATCGACAACAAGGTGCTGACCAGAAGCGACAAGAACCGGGGCAAG
AGCGACAACGTGCCCTCCGAAGAGGTTCGTGAAGAAGATGAAGAATACTGGCGGCA
GCTGCTGAACGCCAAGCTGATTACCCAGAGAAAGTTCGACAATCTGACCAAGGCCG
AGAGAGGGCGGCCTGAGCGAACTGGATAAAGGCCGGCTTCATCAAGAGACAGCTGGTG
GAAACCCGGCAGATCACAAAGCACGTGGCACAGATCCTGGACTCCC GGATGAACAC
TAAGTACGACGAGAATGACAAGCTGATCCGGGAAGTGAAAGTGATCACCTGAAGT
CCAAGCTGGTGTCCGATTTCCGGAAGGATTTCCAGTTTTTACAAAGTGCGCGAGATCA
ACA ACTACCACCACGCCACGACGCCTACCTGAACGCCGTCGTGGGAACCGCCCTG
ATCAAAAAGTACCCTAAGCTGGAAAGCGAGTTCGTGTACGGCGACTACAAGGTGTA
CGACGTGCGGAAGATGATCGCCAAGAGCGAGCAGGAAATCGGCAAGGCTACCGCC
AAGTACTTCTTCTACAGCAACATCATGAACTTTTTCAAGACCGAGATTACCCTGGCC
AACGGCGAGATCCGGAAGCGGCCTCTGATCGAGACAAACGGCGAAACCGGGGAGA
TCGTGTGGGATAAAGGGCCGGGATTTTGCCACCGTGCGGAAAGTGCTGAGCATGCCC
CAAGTGAATATCGTGAAAAAGACCGAGGTGCAGACAGGCGGCTTCAGCAAAGAGTC
TATCCTGCCCAAGAGGAACAGCGATAAGCTGATCGCCAGAAAGAAGGACTGGGACC
CTAAGAAGTACGGCGGCTTCGACAGCCCCACCGTGGCCTATTCTGTGCTGGTGGTGG
CCAAAGTGGA AAAAGGGCAAGTCCAAGAAACTGAAGAGTGTGAAAGAGCTGCTGGG
GATCACCATCATGGAAAGAAGCAGCTTCGAGAAGAATCCCATCGACTTTCTGGAAG
CCAAGGGCTACAAAGAAGTGAAAAAGGACCTGATCATCAAGCTGCCTAAGTACTCC
CTGTTTCGAGCTGGAAAACGGCCGGAAGAGAATGCTGGCCTCTGCCGGCGAACTGCA
GAAGGGAAACGAACTGGCCCTGCCCTCCAAATATGTGAACTTCCTGTACCTGGCCA
GCCACTATGAGAAGCTGAAGGGCTCCCCCGAGGATAATGAGCAGAAACAGCTGTTT
GTGGAACAGCACAAAGCACTACCTGGACGAGATCATCGAGCAGATCAGCGAGTTCTC
CAAGAGAGTGATCCTGGCCGACGCTAATCTGGACAAAGTGCTGTCCGCTACAACA
AGCACCGGGATAAGCCCATCAGAGAGCAGGCCGAGAATATCATCCACCTGTTTACC
CTGACCAATCTGGGAGCCCCTGCCGCCTTCAAGTACTTTGACACCACCATCGACCGG
AAGAGGTACACCAGCACCAAAGAGGTGCTGGACGCCACCCTGATCCACCAGAGCAT
CACCGGCCTGTACGAGACACGGATCGACCTGTCTCAGCTGGGAGGCGACAAAAGGC
CGGCGGCCACGAAAAAGGCCGGCCAGGCCAAAAAAGAAAAAGtaa

[00158] 33. Sp_del (175-307)-(GGGGS)6

[00159] ATGGCCCCAAAGAAGAAGCGGAAGGTCCGTATCCACGGAGTCCCAGCAG
CCGACAAGAAGTACAGCATCGGCCTGGACATCGGCACCAACTCTGTGGGCTGGGCC
GTGATCACCGACGAGTACAAGGTGCCAGCAAGAAATTC AAGGTGCTGGGCAACAC
CGACCGGCACAGCATCAAGAAGAACCTGATCGGAGCCCTGCTGTTTCGACAGCGGCG
AAACAGCCGAGGCCACCCGGCTGAAGAGAACCGCCAGAAGAAGATACACCAGACG
GAAGAACCGGATCTGCTATCTGCAAGAGATCTTCAGCAACGAGATGGCCAAGGTGG
ACGACAGCTTCTTCCACAGACTGGAAGAGTCCTTCCCTGGTGG AAGAGGATAAGAAG
CACGAGCGGCACCCCATCTTCGGCAACATCGTGGACGAGGTGGCCTACCACGAGAA
GTACCCACCATCTACCACCTGAGAAAGAACTGGTGGACAGCACCGACAAGGCCG
ACCTGCGGCTGATCTATCTGGCCCTGGCCACATGATCAAGTTCGGGGGCCACTTCC
TGATCGAGGGCGACCTGGGTGGaGGTGGCtegGGTGGaGGTGGCtegGGTGGaGGTGGCt
cgGGTGGaGGTGGCtegGGTGGaGGTGGCtegGGTGGaGGTGGCtegGTGAACACCGAGAT
CACCAAGGCCCCCTGAGCGCCTCTATGATCAAGAGATACGACGAGCACACCAGG
ACCTGACCCTGCTGAAAGCTCTCGTGC GGCAGCAGCTGCCTGAGAAGTACAAAGAG
ATTTTCTTCGACCAGAGCAAGAACGGCTACGCCGGCTACATTGACGGCGGAGCCAG
CCAGGAAGAGTTCTACAAGTTCATCAAGCCATCCTGGAAAAGATGGACGGCACCG
AGGAACTGCTCGTGAAGCTGAACAGAGAGGACCTGCTGCGGAAGCAGCGGACCTTC
GACAACGGCAGCATCCCCACCAGATCCACCTGGGAGAGCTGCACGCCATTCTGCG
GCGGCAGGAAGATTTTTACCCATTCCTGAAGGACAACCGGGAAAAGATCGAGAAGA
TCCTGACCTTCCGCATCCCCTACTACGTGGGCCCTCTGGCCAGGGGAAACAGCAGAT
TCGCCTGGATGACCAGAAAGAGCGAGGAAACCATCACCCCTGGA ACTTCGAGGAA
GTGGTGGACAAGGGCGCTTCCGCCAGAGCTTCATCGAGCGGATGACCAACTTCGA
TAAGAACCTGCCAACGAGAAGGTGCTGCCAAGCACAGCCTGCTGTACGAGTACT
TCACCGTGTATAACGAGCTGACCAAAGTGAAATACGTGACCGAGGGAATGAGAAAG
CCCGCCTTCTGAGCGGCGAGCAGAAAAAGGCCATCGTGGACCTGCTGTTCAAGAC
CAACCGGAAAGTGACCGTGAAGCAGCTGAAAGAGGACTACTTCAAGAAAATCGAGT
GCTTCGACTCCGTGGAAATCTCCGGCGTGG AAGATCGGTTCAACGCCTCCCTGGGCA
CATAACGATCTGCTGAAAATTATCAAGGACAAGGACTTCCTGGACAATGAGGAA
AACGAGGACATTCTGGAAGATATCGT GCTGACCCTGACACTGTTTGAGGACAGAGA
GATGATCGAGGAACGGCTGAAAACCTATGCCACCTGTTTCGACGACAAAGTGATGA
AGCAGCTGAAGCGGCGGAGATACACCGGCTGGGGCAGGCTGAGCCGGAAGCTGAT

CAACGGCATCCGGGACAAGCAGTCCGGCAAGACAATCCTGGATTTCTGAAGTCCG
ACGGCTTCGCCAACAGAACTTCATGCAGCTGATCCACGACGACAGCCTGACCTTTA
AAGAGGACATCCAGAAAGCCCAGGTGTCCGGCCAGGGCGATAGCCTGCACGAGCAC
ATTGCCAATCTGGCCGGCAGCCCCGCCATTAAGAAGGGGCATCCTGCAGACAGTGAA
GGTGGTGGACGAGCTCGTGAAAGTGATGGGCCGGCACAAGCCCAGAACATCGTGA
TCGAAATGGCCAGAGAGAACCAGACCACCAGAAGGGACAGAAGAACAGCCGCGA
GAGAATGAAGCGGATCGAAGAGGGCATCAAAGAGCTGGGCAGCCAGATCCTGAAA
GAACACCCCGTGGAAAACACCCAGCTGCAGAACGAGAAGCTGTACCTGTACTACCT
GCAGAATGGGCGGGATATGTACGTGGACCAGGAACTGGACATCAACCGGCTGTCCG
ACTACGATGTGGACCATATCGTGCCTCAGAGCTTTTCTGAAGGACGACTCCATCGACA
ACAAGGTGCTGACCAGAAGCGACAAGAACCGGGGCAAGAGCGACAACGTGCCCTC
CGAAGAGGTTCGTGAAGAAGATGAAGAACTACTGGCGGCAGCTGCTGAACGCCAAGC
TGATTACCCAGAGAAAGTTCGACAATCTGACCAAGGCCGAGAGAGGGCGGCCTGAGC
GAACTGGATAAGGCCGGCTTCATCAAGAGACAGCTGGTGGAAACCCGGCAGATCAC
AAAGCACGTGGCACAGATCCTGGACTCCCGGATGAACACTAAGTACGACGAGAATG
ACAAGCTGATCCGGGAAGTGAAAGTGATCACCTGAAGTCCAAGCTGGTGTCCGAT
TTCCGGAAGGATTTCCAGTTTTTACAAAGTGCGCGAGATCAACAACCTACCACCACGCC
CACGACGCCTACCTGAACGCCGTTCGTGGGAACCGCCCTGATCAAAAAGTACCCTAA
GCTGGAAAGCGAGTTCGTGTACGGCGACTACAAGGTGTACGACGTGCGGAAGATGA
TCGCCAAGAGCGAGCAGGAAATCGGCAAGGCTACCGCCAAGTACTTCTTCTACAGC
AACATCATGAACTTTTTCAAGACCGAGATTACCCTGGCCAACGGCGAGATCCGGAA
GCGGCCTCTGATCGAGACAAACGGCGAAACCGGGGAGATCGTGTGGGATAAGGGCC
GGGATTTTGCCACCGTGC GGAAAGTGCTGAGCATGCCCAAGTGAATATCGTGAAA
AAGACCGAGGTGCAGACAGGCGGCTTCAGCAAAGAGTCTATCCTGCCCAAGAGGAA
CAGCGATAAGCTGATCGCCAGAAAGAAGGACTGGGACCCTAAGAAGTACGGCGGCT
TCGACAGCCCCACCGTGGCCTATTCTGTGCTGGTGGTGGCCAAAGTGGAAAAGGGC
AAGTCCAAGAACTGAAGAGTGTGAAAGAGCTGCTGGGGATCACCATCATGGAAAG
AAGCAGCTTCGAGAAGAATCCCATCGACTTTCTGGAAGCCAAGGGCTACAAAGAAG
TGAAAAGGACCTGATCATCAAGCTGCCTAAGTACTCCCTGTTCGAGCTGGAAAAC
GGCCGGAAGAGAATGCTGGCCTCTGCCGGCGAACTGCAGAAGGGAAACGAACTGG
CCCTGCCCTCCAAATATGTGAACTTCCTGTACCTGGCCAGCCACTATGAGAAGCTGA

AGGGCTCCCCCGAGGATAATGAGCAGAAACAGCTGTTTGTGGAACAGCACAAGCAC
TACCTGGACGAGATCATCGAGCAGATCAGCGAGTTCTCCAAGAGAGTGATCCTGGC
CGACGCTAATCTGGACAAAGTGCTGTCCGCCTACAACAAGCACCGGGATAAGCCCA
TCAGAGAGCAGGCCGAGAATATCATCCACCTGTTTACCCTGACCAATCTGGGAGCCC
CTGCCGCCTTCAAGTACTTTGACACCACCATCGACCGGAAGAGGTACACCAGCACC
AAAGAGGTGCTGGACGCCACCCCTGATCCACCAGAGCATCACCGGCCTGTACGAGAC
ACGGATCGACCTGTCTCAGCTGGGAGGCGACAAAAGGCCGGCGGCCACGAAAAAG
GCCGGCCAGGCAAAAAAGAAAAAGtaa

[00160] 34. Sp_del (175-307)-(GGGGS)9

[00161] ATGGCCCCAAAGAAGAAGCGGAAGGTTCGGTATCCACGGAGTCCCAGCAG
CCGACAAGAAGTACAGCATCGGCCTGGACATCGGCACCAACTCTGTGGGCTGGGCC
GTGATCACCGACGAGTACAAGGTGCCAGCAAGAAATTCAAGGTGCTGGGCAACAC
CGACCGGCACAGCATCAAGAAGAACCTGATCGGAGCCCTGCTGTTTCGACAGCGGCG
AAACAGCCGAGGCCACCCGGCTGAAGAGAACCGCCAGAAGAAGATACACCAGACG
GAAGAACCGGATCTGCTATCTGCAAGAGATCTTCAGCAACGAGATGGCCAAGGTGG
ACGACAGCTTCTTCCACAGACTGGAAGAGTCCTTCCCTGGTGGAAAGAGGATAAGAAG
CACGAGCGGCACCCCATCTTCGGCAACATCGTGGACGAGGTGGCCTACCACGAGAA
GTACCCACCATCTACCACCTGAGAAAGAAACTGGTGGACAGCACCGACAAGGCCG
ACCTGCGGCTGATCTATCTGGCCCTGGCCCACATGATCAAGTTCCGGGGCCACTTCC
TGATCGAGGGCGACCTGGGTGGaGGTGGCtegGGTGGaGGTGGCtegGGTGGaGGTGGCt
egGGTGGaGGTGGCtegGGTGGaGGTGGCtegGGTGGaGGTGGCtegGGTGGaGGTGGCt
egGGTGGaGGTGGCtegGGTGGaGGTGGCtegGTGAACACCGAGATACCAAGGCCCCCTG
AGCGCCTCTATGATCAAGAGATACGACGAGCACCACCAGGACCTGACCTGCTGAA
AGCTCTCGTGCGGCAGCAGCTGCCTGAGAAGTACAAAGAGATTTTCTTCGACCAGA
GCAAGAACGGCTACGCCGGCTACATTGACGGCGGAGCCAGCCAGGAAGAGTTCTAC
AAGTTCATCAAGCCCATCCTGGAAAAGATGGACGGCACCGAGGAAGTCTCGTGAA
GCTGAACAGAGAGGACCTGCTGCGGAAGCAGCGGACCTTCGACAACGGCAGCATCC
CCCACCAGATCCACCTGGGAGAGCTGCACGCCATTCTGCGGCGGCAGGAAGATTTTT
ACCCATTCTGAAGGACAACCGGGAAAAGATCGAGAAGATCCTGACCTTCCGCATC
CCCTACTACGTGGGCCCTCTGGCCAGGGGAAAACAGCAGATTCGCCTGGATGACCAG
AAAGAGCGAGGAAACCATCACCCCTGGAACCTTCGAGGAAGTGGTGGACAAGGGC

GCTTCCGCCAGAGCTTCATCGAGCGGATGACCAACTTCGATAAGAACCTGCCAAC
GAGAAGGTGCTGCCAAGCACAGCCTGCTGTACGAGTACTTCACCGTGTATAACGA
GCTGACCAAAGTGAAATACGTGACCGAGGGAATGAGAAAGCCCGCCTTCCTGAGCG
GCGAGCAGAAAAAGGCCATCGTGGACCTGCTGTTCAAGACCAACCGGAAAGTGACC
GTGAAGCAGCTGAAAGAGGACTACTTCAAGAAAATCGAGTGCTTCGACTCCGTGGA
AATCTCCGGCGTGGAAGATCGGTTCAACGCCTCCCTGGGCACATAACCAGATCTGCT
GAAAATTATCAAGGACAAGGACTTCCTGGACAATGAGGAAAACGAGGACATTCTGG
AAGATATCGTGCTGACCCTGACACTGTTTGAGGACAGAGAGATGATCGAGGAACGG
CTGAAAACCTATGCCACCTGTTTCGACGACAAAAGTGATGAAGCAGCTGAAGCGGCG
GAGATACACCGGCTGGGGCAGGCTGAGCCGGAAGCTGATCAACGGCATCCGGGACA
AGCAGTCCGGCAAGACAATCCTGGATTTCTGAAGTCCGACGGCTTCGCCAACAGA
AACTTCATGCAGCTGATCCACGACGACAGCCTGACCTTTAAAGAGGACATCCAGAA
AGCCCAGGTGTCCGGCCAGGGCGATAGCCTGCACGAGCACATTGCCAATCTGGCCG
GCAGCCCCGCCATTAAGAAGGGCATCCTGCAGACAGTGAAGGTGGTGGACGAGCTC
GTGAAAGTGATGGGCCGGCACAAGCCCCGAGAACATCGTGATCGAAATGGCCAGAGA
GAACCAGACCACCAGAAGGGACAGAAGAACAGCCGCGAGAGAATGAAGCGGATC
GAAGAGGGCATCAAAGAGCTGGGCAGCCAGATCCTGAAAGAACACCCCGTGGAAA
ACACCCAGCTGCAGAACGAGAAGCTGTACCTGTACTACCTGCAGAATGGGCGGGAT
ATGTACGTGGACCAGGAACTGGACATCAACCGGCTGTCCGACTACGATGTGGACCA
TATCGTGCCTCAGAGCTTTCTGAAGGACGACTCCATCGACAACAAGGTGCTGACCAG
AAGCGACAAGAACCGGGGCAAGAGCGACAACGTGCCCTCCGAAGAGGTGCTGAAG
AAGATGAAGAACTACTGGCGGCAGCTGCTGAACGCCAAGCTGATTACCCAGAGAAA
GTTTCGACAATCTGACCAAGGCCGAGAGAGGGCGGCCTGAGCGAACTGGATAAGGCCG
GCTTCATCAAGAGACAGCTGGTGGAAACCCGGCAGATCACAAAGCACGTGGCACAG
ATCCTGGACTCCCGGATGAACACTAAGTACGACGAGAATGACAAGCTGATCCGGGA
AGTGAAAGTGATCACCTGAAGTCCAAGCTGGTGTCCGATTTCCGGAAGGATTTCCA
GTTTTACAAAGTGCGCGAGATCAACAACCTACCACCACGCCACGACGCCTACCTGA
ACGCCGTGCTGGGAACCGCCCTGATCAAAAAGTACCCTAAGCTGGAAAGCGAGTTC
GTGTACGGCGACTACAAGGTGTACGACGTGCGGAAGATGATCGCCAAGAGCGAGCA
GGAAATCGGCAAGGCTACCGCCAAGTACTTCTTCTACAGCAACATCATGAACTTTTT
CAAGACCGAGATTACCCTGGCCAACGGCGAGATCCGGAAGCGGCCTCTGATCGAGA

CAAACGGCGAAACCGGGGAGATCGTGTGGGATAAAGGGCCGGGATTTTGCCACCGTG
 CGGAAAGTGCTGAGCATGCCCAAGTGAATATCGTGAAAAAGACCGAGGTGCAGAC
 AGGCGGCTTCAGCAAAGAGTCTATCCTGCCCAAGAGGAACAGCGATAAGCTGATCG
 CCAGAAAGAAGGACTGGGACCCTAAGAAGTACGGCGGCTTCGACAGCCCCACCGTG
 GCCTATTCTGTGCTGGTGGTGGCCAAAGTGGAAAAGGGCAAGTCCAAGAAACTGAA
 GAGTGTGAAAGAGCTGCTGGGGATCACCATCATGGAAAGAAGCAGCTTCGAGAAGA
 ATCCCATCGACTTTCTGGAAGCCAAGGGCTACAAAGAAGTGAAAAAGGACCTGATC
 ATCAAGCTGCCTAAGTACTCCCTGTTCGAGCTGGAAAACGGCCGGAAGAGAATGCT
 GGCTCTGCCGGCGAACTGCAGAAGGGAAACGAACTGGCCCTGCCCTCCAAATATG
 TGAACTTCCTGTACCTGGCCAGCCACTATGAGAAGCTGAAGGGCTCCCCGAGGAT
 AATGAGCAGAAACAGCTGTTTGTGGAACAGCACAAAGCACTACCTGGACGAGATCAT
 CGAGCAGATCAGCGAGTTCTCCAAGAGAGTGATCCTGGCCGACGCTAATCTGGACA
 AAGTGCTGTCCGCCTACAACAAGCACCGGGATAAGCCCATCAGAGAGCAGGCCGAG
 AATATCATCCACCTGTTTACCCTGACCAATCTGGGAGCCCCTGCCGCCTTCAAGTAC
 TTTGACACCACCATCGACCGGAAGAGGTACACCAGCACCAAAGAGGTGCTGGACGC
 CACCCTGATCCACCAGAGCATCACCGGCCTGTACGAGACACGGATCGACCTGTCTCA
 GCTGGGAGGCGACAAAAGGCCGGCGGCCACGAAAAAGGCCGGCCAGGCCAAAAAAG
 AAAAAGtaa

[00162] 35. Sp__del (175-307)-(GGGGS)12

[00163] ATGGCCCCAAAGAAGAAGCGGAAGGTTCGGTATCCACGGAGTCCCAGCAG
 CCGACAAGAAGTACAGCATCGGCCTGGACATCGGCACCAACTCTGTGGGCTGGGCC
 GTGATCACCGACGAGTACAAGGTGCCAGCAAGAAATTCAAGGTGCTGGGCAACAC
 CGACCGGCACAGCATCAAGAAGAACCTGATCGGAGCCCTGCTGTTTCGACAGCGGCG
 AACAGCCGAGGCCACCCGGCTGAAGAGAACCGCCAGAAGAAGATACACCAGACG
 GAAGAACCGGATCTGCTATCTGCAAGAGATCTTCAGCAACGAGATGGCCAAGGTGG
 ACGACAGCTTCTTCCACAGACTGGAAGAGTCCTTCTGGTGGAAAGAGGATAAGAAG
 CACGAGCGGCACCCCATCTTCGGCAACATCGTGGACGAGGTGGCCTACCACGAGAA
 GTACCCACCATCTACCACCTGAGAAAGAAACTGGTGGACAGCACCGACAAGGCCG
 ACCTGCGGCTGATCTATCTGGCCCTGGCCCACATGATCAAGTTCCGGGGCCACTTCC
 TGATCGAGGGCGACCTGGGTGGaGGTGGttegGGTGGCGGTGGCtegGGTGGaGGTGGate
 gGGTGGCGGTGGttegGGTGGaGGTGGCtegGGcGGaGGTGGategGGTGGCGGTGGCtegGG

TGGaGGTGGCtegGGTGGaGGTGGCtegGGTGGCGGTGGatcgGGTGGaGGTGGatcgGGTGG
GaGGTGGttcgGTGAACACCGAGATCACCAAGGCCCCCCTGAGCGCCTCTATGATCAA
GAGATACGACGAGCACCACCAGGACCTGACCCTGCTGAAAGCTCTCGTGCGGCAGC
AGCTGCCTGAGAAGTACAAAGAGATTTTCTTCGACCAGAGCAAGAACGGCTACGCC
GGCTACATTGACGGCGGAGCCAGCCAGGAAGAGTTCTACAAGTTCATCAAGCCCAT
CCTGGAAAAGATGGACGGCACCGAGGAAGTCTCGTGAAGCTGAACAGAGAGGAC
CTGCTGCGGAAGCAGCGGACCTTCGACAACGGCAGCATCCCCACCAGATCCACCT
GGGAGAGCTGCACGCCATTCTGCGGGCGGAGGAAGATTTTTACCCATTCTGAAGG
ACAACCGGGAAAAGATCGAGAAGATCCTGACCTTCCGCATCCCCTACTACGTGGGC
CCTCTGGCCAGGGGAAAACAGCAGATTTCGCTGGATGACCAGAAAAGAGCGAGGAAA
CCATCACCCCCTGGAAGTTCGAGGAAGTGGTGGACAAGGGCGCTTCCGCCAGAGC
TTCATCGAGCGGATGACCAACTTCGATAAGAACCTGCCAACGAGAAGGTGCTGCC
CAAGCACAGCCTGCTGTACGAGTACTTCACCGTGTATAACGAGCTGACCAAAGTGA
AATACGTGACCGAGGGAATGAGAAAAGCCCGCCTTCCTGAGCGGCGAGCAGAAAAA
GGCCATCGTGGACCTGCTGTTCAAGACCAACCGGAAAAGTGACCGTGAAGCAGCTGA
AAGAGGACTACTTCAAGAAAATCGAGTGCTTCGACTCCGTGGAAATCTCCGGCGTG
GAAGATCGGTTCAACGCCTCCCTGGGCACATAACCACGATCTGCTGAAAATTATCAAG
GACAAGGACTTCCTGGACAATGAGGAAAACGAGGACATTCTGGAAGATATCGTGCT
GACCCTGACACTGTTTGAGGACAGAGAGATGATCGAGGAACGGCTGAAAACCTATG
CCCACCTGTTTCGACGACAAAAGTGATGAAGCAGCTGAAGCGGCGGAGATACACCGGC
TGGGGCAGGCTGAGCCGGAAGCTGATCAACGGCATCCGGGACAAGCAGTCCGGCAA
GACAATCCTGGATTTCTGAAGTCCGACGGCTTCGCCAACAGAACTTCATGCAGCT
GATCCACGACGACAGCCTGACCTTTAAAGAGGACATCCAGAAAAGCCCAGGTGTCCG
GCCAGGGCGATAGCCTGCACGAGCACATTGCCAATCTGGCCGGCAGCCCCGCCATT
AAGAAGGGCATCCTGCAGACAGTGAAGGTGGTGGACGAGCTCGTGAAAGTGATGGG
CCGGCACAAGCCCAGAACATCGTGATCGAAATGGCCAGAGAGAACCAGACCACCC
AGAAGGGACAGAAGAACAGCCGCGAGAGAATGAAGCGGATCGAAGAGGGCATCAA
AGAGCTGGGCAGCCAGATCCTGAAAGAACACCCCGTGGAAAACACCCAGCTGCAGA
ACGAGAAGCTGTACCTGTACTACCTGCAGAATGGGCCGGGATATGTACGTGGACCAG
GAACTGGACATCAACCGGCTGTCCGACTACGATGTGGACCATATCGTGCTCAGAG
CTTTCTGAAGGACGACTCCATCGACAACAAGGTGCTGACCAGAAGCGACAAGAACC

GGGGCAAGAGCGACAACGTGCCCTCCGAAGAGGTCGTGAAGAAGATGAAGA ACTA
 CTGGCGGCAGCTGCTGAACGCCAAGCTGATTACCCAGAGAAAGTTCGACAATCTGA
 CCAAGGCCGAGAGAGGGCGGCTGAGCGAACTGGATAAGGCCGGCTTCATCAAGAG
 ACAGCTGGTGGAAACCCGGCAGATCACAAAGCACGTGGCACAGATCCTGGACTCCC
 GGATGAACACTAAGTACGACGAGAATGACAAGCTGATCCGGGAAGTGAAAGTGATC
 ACCCTGAAGTCCAAGCTGGTGTCCGATTTCCGGAAGGATTTCCAGTTTTACAAAGTG
 CGCGAGATCAACA ACTACCACCAGCCCACGACGCCTACCTGAACGCCGTCGTGGG
 AACCGCCCTGATCAAAAAGTACCCTAAGCTGGAAAGCGAGTTCGTGTACGGCGACT
 ACAAGGTGTACGACGTGCGGAAGATGATCGCCAAGAGCGAGCAGGAAATCGGCAA
 GGCTACCGCCAAGTACTTCTTCTACAGCAACATCATGAACTTTTTCAAGACCGAGAT
 TACCCTGGCCAACGGCGAGATCCGGAAGCGGCCTCTGATCGAGACAAACGGCGAAA
 CCGGGGAGATCGTGTGGGATAAGGGCCGGGATTTTGCCACCGTGCGGAAAGTGCTG
 AGCATGCCCAAGTGAATATCGTGAAAAAGACCGAGGTGCAGACAGGCGGCTTCAG
 CAAAGAGTCTATCCTGCCCAAGAGGAACAGCGATAAGCTGATCGCCAGAAAGAAGG
 ACTGGGACCCTAAGAAGTACGGCGGCTTCGACAGCCCCACCGTGGCCTATTCTGTGC
 TGGTGGTGGCCAAAGTGGAAAAGGGCAAGTCCAAGAACTGAAGAGTGTGAAAGA
 GCTGCTGGGGATCACCATCATGGAAAGAAGCAGCTTCGAGAAGAATCCCATCGACT
 TTCTGGAAGCCAAGGGCTACAAAGAAGTGAAAAAGGACCTGATCATCAAGCTGCCT
 AAGTACTCCCTGTTCGAGCTGGAAAACGGCCGGAAGAGAATGCTGGCCTCTGCCGG
 CGAACTGCAGAAGGGAAACGAACTGGCCCTGCCCTCCAAATATGTGAACTTCCTGT
 ACCTGGCCAGCCACTATGAGAAGCTGAAGGGCTCCCCGAGGATAATGAGCAGAAA
 CAGCTGTTTGTGGAACAGCACAAGCACTACCTGGACGAGATCATCGAGCAGATCAG
 CGAGTTCTCCAAGAGAGTGATCCTGGCCGACGCTAATCTGGACAAAGTGCTGTCCGC
 CTACAACAAGCACCGGGATAAGCCCATCAGAGAGCAGGCCGAGAATATCATCCACC
 TGTTTACCCTGACCAATCTGGGAGCCCCTGCCGCCTTCAAGTACTTTGACACCACCA
 TCGACCGGAAGAGGTACACCAGCACCAAAGAGGTGCTGGACGCCACCCTGATCCAC
 CAGAGCATCACCGGCCTGTACGAGACACGGATCGACCTGTCTCAGCTGGGAGGGCGA
 CAAAAGGCCGGCGGCCACGAAAAAGGCCGGCCAGGCCAAAAAAGAAAAAGtaa

[00164] 36. Sp_del(175-307)-A(EAAAK)3A

[00165] ATGGCCCCAAAGAAGAAGCGGAAGGTCCGTATCCACGGAGTCCCAGCAG
 CCGACAAGAAGTACAGCATCGGCCTGGACATCGGCACCAACTCTGTGGGCTGGGCC

GTGATCACCGACGAGTACAAGGTGCCAGCAAGAAATTCAAGGTGCTGGGCAACAC
CGACCGGCACAGCATCAAGAAGAACCTGATCGGAGCCCTGCTGTTTCGACAGCGGCG
AAACAGCCGAGGCCACCCGGCTGAAGAGAACCGCCAGAAGAAGATACACCAGACG
GAAGAACCGGATCTGCTATCTGCAAGAGATCTTCAGCAACGAGATGGCCAAGGTGG
ACGACAGCTTCTTCCACAGACTGGAAGAGTCCTTCTGGTGGAAAGAGGATAAGAAG
CACGAGCGGCACCCCATCTTCGGCAACATCGTGGACGAGGTGGCCTACCACGAGAA
GTACCCACCATCTACCACCTGAGAAAGAAACTGGTGGACAGCACCCGACAAGGCCG
ACCTGCGGCTGATCTATCTGGCCCTGGCCCACATGATCAAGTTCCGGGGCCACTTCC
TGATCGAGGGCGACCTG_{gct}GAAGCTGCTGCTAAAGAAGCTGCTGCTAAAGAAGCTG
CTGCTAAAG_{gct}GTGAACACCCGAGATCACCAAGGCCCCCTGAGCGCCTCTATGATCAA
GAGATACGACGAGCACACCAGGACCTGACCCTGCTGAAAGCTCTCGTGCGGCAGC
AGCTGCCTGAGAAGTACAAAGAGATTTTCTTCGACCAGAGCAAGAACGGCTACGCC
GGCTACATTGACGGCGGAGCCAGCCAGGAAGAGTTCTACAAGTTCATCAAGCCCAT
CCTGGAAAAGATGGACGGCACCCGAGGA_{ACT}GCTCGTGAAGCTGAACAGAGAGGAC
CTGCTGCGGAAGCAGCGGACCTTCGACAACGGCAGCATCCCCACCAGATCCACCT
GGGAGAGCTGCACGCCATTCTGCGGCGGCAGGAAGATTTTTACCCATTCTGAAGG
ACAACCGGGAAAAGATCGAGAAGATCCTGACCTTCCGCATCCCCTACTACGTGGGC
CCTCTGGCCAGGGGAAACAGCAGATTCGCTGGATGACCAGAAAGAGCGAGGAAA
CCATCACCCCTGGA_{ACT}TCGAGGAAGTGGTGGACAAGGGCGCTTCCGCCAGAGC
TTCATCGAGCGGATGACCA_{ACT}TCGATAAGAACCTGCCAACGAGAAGGTGCTGCC
CAAGCACAGCCTGCTGTACGAGTACTTCACCGTGTATAACGAGCTGACCAAAGTGA
AATACGTGACCGAGGGAATGAGAAAGCCCGCCTTCTGAGCGGCGAGCAGAAAAA
GGCCATCGTGGACCTGCTGTTCAAGACCAACCGGAAAGTGACCGTGAAGCAGCTGA
AAGAGGACTACTTCAAGAAAATCGAGTGCTTCGACTCCGTGGAAATCTCCGGCGTG
GAAGATCGGTTCAACGCCTCCCTGGGCACATAACCAGATCTGCTGAAAATTATCAAG
GACAAGGACTTCTGGACAATGAGGAAAACGAGGACATTCTGGAAGATATCGTGCT
GACCCTGACACTGTTTGAGGACAGAGAGATGATCGAGGAACGGCTGAAAACCTATG
CCCACCTGTTTCGACGACAAAGTGATGAAGCAGCTGAAGCGGCGGAGATACACCGGC
TGGGGCAGGCTGAGCCGGAAGCTGATCAACGGCATCCGGGACAAGCAGTCCGGCAA
GACAATCCTGGATTTCTGAAGTCCGACGGCTTCGCCAACAGAACTTCATGCAGCT
GATCCACGACGACAGCCTGACCTTTAAAGAGGACATCCAGAAAGCCCAGGTGTCCG

GCCAGGGCGATAGCCTGCACGAGCACATTGCCAATCTGGCCGGCAGCCCCGCCATT
AAGAAGGGCATCCTGCAGACAGTGAAGGTGGTGGACGAGCTCGTGAAAGTGATGGG
CCGGCACAAGCCCCGAGAACATCGTGATCGAAATGGCCAGAGAGAACCAGACCACCC
AGAAGGGACAGAAGAACAGCCGCGAGAGAATGAAGCGGATCGAAGAGGGGCATCAA
AGAGCTGGGCAGCCAGATCCTGAAAGAACACCCCGTGGAAAACACCCAGCTGCAGA
ACGAGAAGCTGTACCTGTACTACCTGCAGAATGGGCGGGATATGTACGTGGACCAG
GAACTGGACATCAACCGGCTGTCCGACTACGATGTGGACCATATCGTGCCTCAGAG
CTTTCTGAAGGACGACTCCATCGACAACAAGGTGCTGACCAGAAGCGACAAGAACC
GGGGCAAGAGCGACAACGTGCCCTCCGAAGAGGTCTGTGAAGAAGATGAAGAATA
CTGGCGGCAGCTGCTGAACGCCAAGCTGATTACCCAGAGAAAGTTCGACAATCTGA
CCAAGGCCGAGAGAGGGCGGCCTGAGCGAACTGGATAAGGCCGGCTTCATCAAGAG
ACAGCTGGTGGAAACCCGGCAGATCACAAAGCACGTGGCACAGATCCTGGACTCCC
GGATGAACACTAAGTACGACGAGAATGACAAGCTGATCCGGGAAGTGAAAGTGATC
ACCCTGAAGTCCAAGCTGGTGTCCGATTTCCGGAAGGATTTCCAGTTTTACAAAGTG
CGCGAGATCAACAACCTACCACCACGCCACGACGCCTACCTGAACGCCGTCGTGGG
AACCGCCCTGATCAAAAAGTACCCTAAGCTGGAAAGCGAGTTCGTGTACGGCGACT
ACAAGGTGTACGACGTGCGGAAGATGATCGCCAAGAGCGAGCAGGAAATCGGCAA
GGCTACCGCCAAGTACTTCTTCTACAGCAACATCATGAACTTTTTCAAGACCGAGAT
TACCCTGGCCAACGGCGAGATCCGGAAGCGGCCTCTGATCGAGACAAACGGCGAAA
CCGGGGAGATCGTGTGGGATAAGGGCCGGGATTTTGCCACCGTGCGGAAAGTGCTG
AGCATGCCCAAGTGAATATCGTGAAAAAGACCGAGGTGCAGACAGGGCGGCTTCAG
CAAAGAGTCTATCCTGCCAAGAGGAACAGCGATAAGCTGATCGCCAGAAAGAAGG
ACTGGGACCCTAAGAAGTACGGCGGCTTCGACAGCCCCACCGTGGCCTATTCTGTGC
TGGTGGTGGCCAAAGTGGAAAAGGGCAAGTCCAAGAACTGAAGAGTGTGAAAGA
GCTGCTGGGGATCACCATCATGGAAAGAAGCAGCTTCGAGAAGAATCCCATCGACT
TTCTGGAAGCCAAGGGCTACAAAGAAGTGAAAAAGGACCTGATCATCAAGCTGCCT
AAGTACTCCCTGTTTCGAGCTGGAAAACGGCCGGAAGAGAATGCTGGCCTCTGCCGG
CGAACTGCAGAAGGGAAACGAACTGGCCCTGCCCTCCAAATATGTGAACTTCTGT
ACCTGGCCAGCCACTATGAGAAGCTGAAGGGCTCCCCGAGGATAATGAGCAGAAA
CAGCTGTTTGTGGAACAGCACAAAGCACTACCTGGACGAGATCATCGAGCAGATCAG
CGAGTTCTCCAAGAGAGTGATCCTGGCCGACGCTAATCTGGACAAAGTGCTGTCCGC

CTACAACAAGCACCGGGATAAGCCCATCAGAGAGCAGGCCGAGAATATCATCCACC
 TGTTTACCCTGACCAATCTGGGAGCCCCTGCCGCCTTCAAGTACTTTGACACCACCA
 TCGACCGGAAGAGGTACACCAGCACCAAAGAGGTGCTGGACGCCACCCTGATCCAC
 CAGAGCATCACCGGCCTGTACGAGACACGGATCGACCTGTCTCAGCTGGGAGGGCA
 CAAAAGGCCGGCGGCCACGAAAAAGGCCGGCCAGGCCAAAAAGAAAAAGtaa

[00166] 37. Sp_del(175-307)-A(EAAAK)3ALEA(EAAAK)3A

[00167] ATGGCCCCAAAGAAGAAGCGGAAGGTTCGGTATCCACGGAGTCCCAGCAG
 CCGACAAGAAGTACAGCATCGGCCTGGACATCGGCACCAACTCTGTGGGCTGGGCC
 GTGATCACCGACGAGTACAAGGTGCCAGCAAGAAATTCAAGGTGCTGGGCAACAC
 CGACCGGCACAGCATCAAGAAGAACCTGATCGGAGCCCTGCTGTTTCGACAGCGGCG
 AACAGCCGAGGCCACCCGGCTGAAGAGAACCGCCAGAAGAAGATACACCAGACG
 GAAGAACCGGATCTGCTATCTGCAAGAGATCTTCAGCAACGAGATGGCCAAGGTGG
 ACGACAGCTTCTTCCACAGACTGGAAGAGTCCTTCCTGGTGGAAGAGGATAAGAAG
 CACGAGCGGCACCCCATCTTCGGCAACATCGTGGACGAGGTGGCCTACCACGAGAA
 GTACCCACCATCTACCACCTGAGAAAGAACTGGTGGACAGCACCGACAAGGCCG
 ACCTGCGGCTGATCTATCTGGCCCTGGCCCACATGATCAAGTTCGGGGCCACTTCC
 TGATCGAGGGCGACCTG_{gct}GAAGCCGCTGCTAAAGAAGC_cGCTGCTAAAGAAGC_cGC
 TGCTAAAG_{cc}CTGGAG_{gct}GAAGC_cGCTGCTAAAGAAGC_cGCTGCTAAAGAAGCCGCT
 GCTAAAG_{gct}GTGAACACCGAGATCACCAAGGCCCCCTGAGCGCCTCTATGATCAAG
 AGATACGACGAGCACCACCAGGACCTGACCCTGCTGAAAGCTCTCGTGCCGGCAGCA
 GCTGCCTGAGAAGTACAAAGAGATTTTCTTCGACCAGAGCAAGAACGGCTACGCCG
 GCTACATTGACGGCGGAGCCAGCCAGGAAGAGTTCTACAAGTTCATCAAGCCCATC
 CTGGAAAAGATGGACGGCACCGAGGAACTGCTCGTGAAGCTGAACAGAGAGGACCT
 GCTGCGGAAGCAGCGGACCTTCGACAACGGCAGCATCCCCACCAGATCCACCTGG
 GAGAGCTGCACGCCATTCTGCGGCGGCAGGAAGATTTTTACCCATTCTGAAGGACA
 ACCGGGAAAAGATCGAGAAGATCCTGACCTTCCGCATCCCCTACTACGTGGGCCCTC
 TGGCCAGGGGAAACAGCAGATTCGCCTGGATGACCAGAAAGAGCGAGGAAACCAT
 CACCCCTGGAACCTTCGAGGAAGTGGTGGACAAGGGCGCTTCCGCCAGAGCTTCA
 TCGAGCGGATGACCAACTTCGATAAGAACCTGCCCAACGAGAAGGTGCTGCCCAAG
 CACAGCCTGCTGTACGAGTACTTCACCGTGTATAACGAGCTGACCAAAGTGAAATAC
 GTGACCGAGGGAATGAGAAAGCCCGCCTTCCTGAGCGGCGAGCAGAAAAAGGCCA

TCGTGGACCTGCTGTTCAAGACCAACCGGAAAGTGACCGTGAAGCAGCTGAAAGAG
GACTACTTCAAGAAAATCGAGTGCTTCGACTCCGTGGAAATCTCCGGCGTGGAAGAT
CGGTTCAACGCCTCCCTGGGCACATAACCACGATCTGCTGAAAATTATCAAGGACAA
GGACTTCCTGGACAATGAGGAAAACGAGGACATTCTGGAAGATATCGTGCTGACCC
TGACACTGTTTGAGGACAGAGAGATGATCGAGGAACGGCTGAAAACCTATGCCAC
CTGTTTCGACGACAAAGTGATGAAGCAGCTGAAGCGGCGGAGATACACCGGCTGGGG
CAGGCTGAGCCGGAAGCTGATCAACGGCATCCGGGACAAGCAGTCCGGCAAGACA
ATCCTGGATTTCTGAAGTCCGACGGCTTCGCCAACAGAACTTCATGCAGCTGATC
CACGACGACAGCCTGACCTTTAAAGAGGACATCCAGAAAGCCCAGGTGTCCGGCCA
GGGCGATAGCCTGCACGAGCACATTGCCAATCTGGCCGGCAGCCCCGCCATTAAGA
AGGGCATCCTGCAGACAGTGAAGGTGGTGGACGAGCTCGTGAAAGTGATGGGCCGG
CACAAGCCCGAGAACATCGTGATCGAAATGGCCAGAGAGAACCAGACCACCCAGA
AGGGACAGAAGAACAGCCGCGAGAGAATGAAGCGGATCGAAGAGGGCATCAAAGA
GCTGGGCAGCCAGATCCTGAAAGAACACCCCGTGGAAAACACCCAGCTGCAGAACG
AGAAGCTGTACCTGTACTACCTGCAGAATGGGCGGGATATGTACGTGGACCAGGAA
CTGGACATCAACCGGCTGTCCGACTACGATGTGGACCATATCGTGCCTCAGAGCTTT
CTGAAGGACGACTCCATCGACAACAAGGTGCTGACCAGAAGCGACAAGAACCGGG
GCAAGAGCGACAACGTGCCCTCCGAAGAGGTCGTGAAGAAGATGAAGAACTACTGG
CGGCAGCTGCTGAACGCCAAGCTGATTACCCAGAGAAAGTTCGACAATCTGACCAA
GGCCGAGAGAGGGCGGCCTGAGCGAACTGGATAAGGCCGGCTTCATCAAGAGACAG
CTGGTGGAAACCCGGCAGATCACAAAGCACGTGGCACAGATCCTGGACTCCCGGAT
GAACACTAAGTACGACGAGAATGACAAGCTGATCCGGGAAGTGAAAGTGATCACCC
TGAAGTCCAAGCTGGTGTCCGATTTCCGGAAGGATTTCCAGTTTTACAAAGTGCGCG
AGATCAACAACCTACCACCACGCCACGACGCCTACCTGAACGCCGTCGTGGGAACC
GCCCTGATCAAAAAGTACCCTAAGCTGGAAAGCGAGTTCGTGTACGGCGACTACAA
GGTGTACGACGTGCGGAAGATGATCGCCAAGAGCGAGCAGGAAATCGGCAAGGCT
ACCGCCAAGTACTTCTTCTACAGCAACATCATGAACTTTTTCAAGACCGAGATTACC
CTGGCCAACGGCGAGATCCGGAAGCGGCCTCTGATCGAGACAAACGGCGAAACCGG
GGAGATCGTGTGGGATAAGGGCCGGGATTTTGCCACCGTGCGGAAAGTGCTGAGCA
TGCCCCAAGTGAATATCGTGAAAAGACCGAGGTGCAGACAGGCGGCTTCAGCAA
GAGTCTATCCTGCCCAAGAGGAACAGCGATAAGCTGATCGCCAGAAAGAAGGACTG

GGACCCTAAGAAGTACGGCGGCTTCGACAGCCCCACCGTGGCCTATTCTGTGCTGGT
 GGTGGCCAAAGTGGAAAAGGGCAAGTCCAAGAACTGAAGAGTGTGAAAGAGCTG
 CTGGGGATCACCATCATGGAAAGAAGCAGCTTCGAGAAGAATCCCATCGACTTTCT
 GGAAGCCAAGGGCTACAAAGAAGTGAAAAAGGACCTGATCATCAAGCTGCCTAAGT
 ACTCCCTGTTTCGAGCTGGAAAACGGCCGGAAGAGAATGCTGGCCTCTGCCGGCGAA
 CTGCAGAAGGGAAACGAACTGGCCCTGCCCTCCAAATATGTGAACTTCTGTACCTG
 GCCAGCCACTATGAGAAGCTGAAGGGCTCCCCGAGGATAATGAGCAGAAACAGCT
 GTTTGTGGAACAGCACAAGCACTACCTGGACGAGATCATCGAGCAGATCAGCGAGT
 TCTCCAAGAGAGTGATCCTGGCCGACGCTAATCTGGACAAAGTGCTGTCCGCCTACA
 ACAAGCACCGGGATAAGCCCATCAGAGAGCAGGCCGAGAATATCATCCACCTGTTT
 ACCCTGACCAATCTGGGAGCCCCCTGCCGCCTTCAAGTACTTTGACACCACCATCGAC
 CGGAAGAGGTACACCAGCACCAAAGAGGTGCTGGACGCCACCCTGATCCACCAGAG
 CATCACCGGCCTGTACGAGACACGGATCGACCTGTCTCAGCTGGGAGGGCGACAAA
 GGCCGGCGGCCACGAAAAAGGCCGGCCAGGCCAAAAAAGAAAAAGtaa

[00168] 38. Sp_{del}(175-307)-A(EAAAK)3ALEA(EAAAK)3ALEA(EAAAK)3A

[00169] ATGGCCCCAAAGAAGAAGCGGAAGGTTCGGTATCCACGGAGTCCCAGCAG
 CCGACAAGAAGTACAGCATCGGCCTGGACATCGGCACCAACTCTGTGGGGCTGGGCC
 GTGATCACCGACGAGTACAAGGTGCCAGCAAGAAATTCAAGGTGCTGGGCAACAC
 CGACCGGCACAGCATCAAGAAGAACCTGATCGGAGCCCTGCTGTTTCGACAGCGGCG
 AACAGCCGAGGCCACCCGGCTGAAGAGAACCGCCAGAAGAAGATACACCAGACG
 GAAGAACCGGATCTGCTATCTGCAAGAGATCTTCAGCAACGAGATGGCCAAGGTGG
 ACGACAGCTTCTTCCACAGACTGGAAGAGTCCTTCCCTGGTGGAAAGAGGATAAGAAG
 CACGAGCGGCACCCCATCTTCGGCAACATCGTGGACGAGGTGGCCTACCACGAGAA
 GTACCCACCATCTACCACCTGAGAAAGAACTGGTGGACAGCACCGACAAGGCCG
 ACCTGCGGCTGATCTATCTGGCCCTGGCCACATGATCAAGTTCGGGGGCCACTTCC
 TGATCGAGGGCGACCTG_{gct}GAAGCTGCTGCTAAAGAAGCTGCTGCTAAAGAAGCTG
 CTGCTAAAG_{gcc}CTGGAG_{gct}GAAGCTGCTGCTAAAGAAGCTGCTGCTAAAGAAGCTGC
 TGCTAAAG_{gcc}CTGGAG_{gct}GAAGCTGCTGCTAAAGAAGCTGCTGCTAAAGAAGCTGCT
 GCTAAAG_{gct}GTGAACACCGAGATCACCAAGGCCCCCCCTGAGCGCCTCTATGATCAAG
 AGATACGACGAGCACCACCAGGACCTGACCCTGCTGAAAGCTCTCGTGCGGCAGCA
 GCTGCCTGAGAAGTACAAAGAGATTTTCTTCGACCAGAGCAAGAACGGCTACGCCG

GCTACATTGACGGCGGAGCCAGCCAGGAAGAGTTCTACAAGTTCATCAAGCCCATC
CTGGAAAAGATGGACGGCACCGAGGAACTGCTCGTGAAGCTGAACAGAGAGGACCT
GCTGCGGAAGCAGCGGACCTTCGACAACGGCAGCATCCCCACCAGATCCACCTGG
GAGAGCTGCACGCCATTCTGCGGGCGGCAGGAAGATTTTTACCCATTCTGAAGGACA
ACCGGGAAAAGATCGAGAAGATCCTGACCTTCCGCATCCCCTACTACGTGGGCCCCTC
TGGCCAGGGGAAACAGCAGATTTCGCCTGGATGACCAGAAAGAGCGAGGAAACCAT
CACCCCCTGGAACCTTCGAGGAAGTGGTGGACAAGGGCGCTTCCGCCAGAGCTTCA
TCGAGCGGATGACCAACTTCGATAAGAACCTGCCCAACGAGAAGGTGCTGCCCAAG
CACAGCCTGCTGTACGAGTACTTCACCGTGTATAACGAGCTGACCAAAGTGAAATAC
GTGACCGAGGGGAATGAGAAAGCCCCTTCCCTGAGCGGCGAGCAGAAAAAGGCCA
TCGTGGACCTGCTGTTCAAGACCAACCGGAAAGTGACCGTGAAGCAGCTGAAAGAG
GACTACTTCAAGAAAATCGAGTGCTTCGACTCCGTGGAAATCTCCGGCGTGGAAGAT
CGTTCAACGCCTCCCTGGGCACATAACCACGATCTGCTGAAAATTATCAAGGACAA
GGACTTCCCTGGACAATGAGGAAAACGAGGACATTCTGGAAGATATCGTGCTGACCC
TGACACTGTTTGAGGACAGAGAGATGATCGAGGAACGGCTGAAAACCTATGCCAC
CTGTTTCGACGACAAAGTGATGAAGCAGCTGAAGCGGCGGAGATACACCGGCTGGGG
CAGGCTGAGCCGGAAGCTGATCAACGGCATCCGGGACAAGCAGTCCGGCAAGACA
ATCCTGGATTTCTGAAGTCCGACGGCTTCGCCAACAGAACTTCATGCAGCTGATC
CACGACGACAGCCTGACCTTTAAAGAGGACATCCAGAAAGCCCAGGTGTCCGGCCA
GGGCGATAGCCTGCACGAGCACATTGCCAATCTGGCCGGCAGCCCCGCCATTAAGA
AGGGCATCCTGCAGACAGTGAAGGTGGTGGACGAGCTCGTGAAAGTGATGGGCCGG
CACAAGCCCGAGAACATCGTGATCGAAATGGCCAGAGAGAACCAGACCACCCAGA
AGGGACAGAAGAACAGCCGCGAGAGAATGAAGCGGATCGAAGAGGGCATCAAAGA
GCTGGGCAGCCAGATCCTGAAAGAACACCCCGTGGAAAACACCCAGCTGCAGAACG
AGAAGCTGTACCTGTACTACCTGCAGAATGGGCGGGATATGTACGTGGACCAGGAA
CTGGACATCAACCGGCTGTCCGACTACGATGTGGACCATATCGTGCCTCAGAGCTTT
CTGAAGGACGACTCCATCGACAACAAGGTGCTGACCAGAAGCGACAAGAACCGGG
GCAAGAGCGACAACGTGCCCTCCGAAGAGGTCTGTGAAGAAGATGAAGAACTACTGG
CGGCAGCTGCTGAACGCCAAGCTGATTACCCAGAGAAAGTTCGACAATCTGACCAA
GGCCGAGAGAGGGCGGCCTGAGCGAACTGGATAAGGCCGGCTTCATCAAGAGACAG
CTGGTGGAAACCCGGCAGATCACAAGCACGTGGCACAGATCCTGGACTCCCGGAT

GAACACTAAGTACGACGAGAATGACAAGCTGATCCGGGAAGTGAAAGTGATCACCC
TGAAGTCCAAGCTGGTGTCCGATTTCCGGAAGGATTTCCAGTTTACAAAGTGCGCG
AGATCAACAACACTACCACCACGCCACGACGCCTACCTGAACGCCGTCTGTGGGAACC
GCCCTGATCAAAAAGTACCCTAAGCTGGAAAGCGAGTTCGTGTACGGCGACTACAA
GGTGTACGACGTGCGGAAGATGATCGCCAAGAGCGAGCAGGAAATCGGCAAGGCT
ACCGCCAAGTACTTCTTCTACAGCAACATCATGAACTTTTTCAAGACCGAGATTACC
CTGGCCAACGGCGAGATCCGGAAGCGGCCTCTGATCGAGACAAACGGCGAAACCGG
GGAGATCGTGTGGGATAAGGGCCGGGATTTTGGCACCGTGCGGAAAGTGCTGAGCA
TGCCCCAAGTGAATATCGTGAAAAAGACCGAGGTGCAGACAGGCGGCTTCAGCAAA
GAGTCTATCCTGCCCAAGAGGAACAGCGATAAGCTGATCGCCAGAAAGAAGGACTG
GGACCCTAAGAAGTACGGCGGCTTCGACAGCCCCACCGTGGCCTATTCTGTGCTGGT
GGTGGCCAAAGTGGAAAAGGGCAAGTCCAAGAACTGAAGAGTGTGAAAGAGCTG
CTGGGGATCACCATCATGGAAAGAAGCAGCTTCGAGAAGAATCCCATCGACTTCT
GGAAGCCAAGGGCTACAAAGAAGTGAAAAAGGACCTGATCATCAAGCTGCCTAAGT
ACTCCCTGTTTCGAGCTGGAAAACGGCCCGGAAGAGAATGCTGGCCTCTGCCGGCGAA
CTGCAGAAGGGAAACGAACTGGCCCTGCCCTCCAAATATGTGAACTTCTGTACCTG
GCCAGCCACTATGAGAAGCTGAAGGGCTCCCCCGAGGATAATGAGCAGAAACAGCT
GTTTGTGGAACAGCACAAGCACTACCTGGACGAGATCATCGAGCAGATCAGCGAGT
TCTCCAAGAGAGTGATCCTGGCCGACGCTAATCTGGACAAAGTGCTGTCCGCCTACA
ACAAGCACCGGGATAAGCCCATCAGAGAGCAGGCCGAGAATATCATCCACCTGTTT
ACCCTGACCAATCTGGGAGCCCCTGCCGCCTTCAAGTACTTTGACACCACCATCGAC
CGGAAGAGGTACACCAGCACCAAAGAGGTGCTGGACGCCACCCTGATCCACCAGAG
CATCACCGGCCTGTACGAGACACGGATCGACCTGTCTCAGCTGGGAGGCGACAAAA
GGCCGGCGGCCACGAAAAAGGCCGGCCAGGCAAAAAAGAAAAAGtaa

[00170] 39. Sp_del(175-307)-A(EAAAK)3LE(EAAAK)3LE(EAAAK)3LE(EAAAK)312A

[00171] ATGGCCCCAAAGAAGAAGCGGAAGGTCCGTATCCACGGAGTCCCAGCAG
CCGACAAGAAGTACAGCATCGGCCTGGACATCGGCACCAACTCTGTGGGCTGGGCC
GTGATCACCGACGAGTACAAGGTGCCAGCAAGAAATTCAAGGTGCTGGGCAACAC
CGACCGGCACAGCATCAAGAAGAACCTGATCGGAGCCCTGCTGTTTCGACAGCGGCG
AAACAGCCGAGGCCACCCGGCTGAAGAGAACCGCCAGAAGAAGATACACCAGACG
GAAGAACCGGATCTGCTATCTGCAAGAGATCTTCAGCAACGAGATGGCCAAGGTGG

ACGACAGCTTCTTCCACAGACTGGAAGAGTCCTTCCCTGGTGGGAAGAGGATAAGAAG
CACGAGCGGCACCCCATCTTCGGCAACATCGTGGACGAGGTGGCCTACCACGAGAA
GTACCCACCATCTACCACCTGAGAAAAGAACTGGTGGACAGCACCGACAAGGCCG
ACCTGCGGCTGATCTATCTGGCCCTGGCCCACATGATCAAGTTCCGGGGCCACTTCC
TGATCGAGGGCGACCTG_{gct}GAAGCTGCTGCTAAAGAAGCTGCTGCTAAAGAAGCTG
CTGCTAAAG_{cc}CTGGAG_{gct}GAAGCTGCTGCTAAAGAAGCTGCTGCTAAAGAAGCTGC
TGCTAAAG_{cc}CTGGAG_{gct}GAAGCTGCTGCTAAAGAAGCTGCTGCTAAAGAAGCTGCT
GCTAAAG_{cc}CTGGAG_{gct}GAAGCTGCTGCTAAAGAAGCTGCTGCTAAAGAAGCTGCTG
CTAAAG_{gct}GTGAACACCGAGATCACCAAGGCCCCCTGAGCGCCTCTATGATCAAGA
GATACGACGAGCACACCAGGACCTGACCCTGCTGAAAGCTCTCGTGCGGCAGCAG
CTGCCTGAGAAGTACAAAGAGATTTTCTTCGACCAGAGCAAGAACGGCTACGCCGG
CTACATTGACGGCGGAGCCAGCCAGGAAGAGTTCTACAAGTTCATCAAGCCCATCC
TGAAAAGATGGACGGCACCGAGGAAGCTGCTCGTGAAGCTGAACAGAGAGGACCT
GCTGCGGAAGCAGCGGACCTTCGACAACGGCAGCATCCCCACCAGATCCACCTGG
GAGAGCTGCACGCCATTCTGCGGCGGCAGGAAGATTTTTACCCATTCTGAAGGACA
ACCGGGAAAAGATCGAGAAGATCCTGACCTTCCGCATCCCCTACTACGTGGGCCCTC
TGGCCAGGGGAAACAGCAGATTTCGCCTGGATGACCAGAAAGAGCGAGGAAACCAT
CACCCCCTGGAACTTCGAGGAAGTGGTGGACAAGGGCGCTTCCGCCAGAGCTTCA
TCGAGCGGATGACCAACTTCGATAAGAACCTGCCCAACGAGAAGGTGCTGCCCAAG
CACAGCCTGCTGTACGAGTACTTCACCGTGTATAACGAGCTGACCAAAGTGAAATAC
GTGACCGAGGGAATGAGAAAGCCCGCCTTCCCTGAGCGGCGAGCAGAAAAAGGCCA
TCGTGGACCTGCTGTTCAAGACCAACCGGAAAGTGACCGTGAAGCAGCTGAAAGAG
GACTACTTCAAGAAAATCGAGTGCTTCGACTCCGTGGAAATCTCCGGCGTGGAAGAT
CGGTTCAACGCCTCCCTGGGCACATACCACGATCTGCTGAAAATTATCAAGGACAA
GGACTTCCCTGGACAATGAGGAAAACGAGGACATTCTGGAAGATATCGTGCTGACCC
TGACACTGTTTGAGGACAGAGAGATGATCGAGGAACGGCTGAAAACCTATGCCAC
CTGTTTCGACGACAAAGTGATGAAGCAGCTGAAGCGGCGGAGATAACCGGCTGGGG
CAGGCTGAGCCGGAAGCTGATCAACGGCATCCGGGACAAGCAGTCCGGCAAGACA
ATCCTGGATTTCCCTGAAGTCCGACGGCTTCGCCAACAGAACTTCATGCAGCTGATC
CACGACGACAGCCTGACCTTTAAAGAGGACATCCAGAAAGCCCAGGTGTCCGGCCA
GGGCGATAGCCTGCACGAGCACATTGCCAATCTGGCCGGCAGCCCCGCCATTAAGA

AGGGCATCCTGCAGACAGTGAAGGTGGTGGACGAGCTCGTGAAAGTGATGGGCCGG
CACAAGCCCGAGAACATCGTGATCGAAATGGCCAGAGAGAACCAGACCACCCAGA
AGGGACAGAAGAACAGCCGCGAGAGAATGAAGCGGATCGAAGAGGGGCATCAAAGA
GCTGGGCAGCCAGATCCTGAAAGAACACCCCGTGGAAAACACCCAGCTGCAGAACG
AGAAGCTGTACCTGTACTACCTGCAGAATGGGCGGGATATGTACGTGGACCAGGAA
CTGGACATCAACCGGCTGTCCGACTACGATGTGGACCATATCGTGCCTCAGAGCTTT
CTGAAGGACGACTCCATCGACAACAAGGTGCTGACCAGAAGCGACAAGAACCGGG
GCAAGAGCGACAACGTGCCCTCCGAAGAGGTCGTGAAGAAGATGAAGAACTACTGG
CGGCAGCTGCTGAACGCCAAGCTGATTACCCAGAGAAAGTTCGACAATCTGACCAA
GGCCGAGAGAGGCGGCCTGAGCGAACTGGATAAGGCCGGCTTCATCAAGAGACAG
CTGGTGGAAACCCGGCAGATCACAAAGCACGTGGCACAGATCCTGGACTCCCGGAT
GAACACTAAGTACGACGAGAATGACAAGCTGATCCGGGAAGTGAAAGTGATCACCC
TGAAGTCCAAGCTGGTGTCCGATTTCCGGAAGGATTTCCAGTTTTACAAAGTGCGCG
AGATCAACAACCTACCACCACGCCACGACGCCTACCTGAACGCCGTCTGTTGGAAACC
GCCCTGATCAAAAAGTACCCTAAGCTGGAAAGCGAGTTCGTGTACGGCGACTACAA
GGTGTACGACGTGCGGAAGATGATCGCCAAGAGCGAGCAGGAAATCGGCAAGGCT
ACCGCCAAGTACTTCTTCTACAGCAACATCATGAACTTTTTCAAGACCGAGATTACC
CTGGCCAACGGCGAGATCCGGAAGCGGCCTCTGATCGAGACAAACGGCGAAACCGG
GGAGATCGTGTGGGATAAGGGCCGGGATTTTGCCACCGTGCGGAAAGTGCTGAGCA
TGCCCCAAGTGAATATCGTGAAAAAGACCGAGGTGCAGACAGGCGGCTTCAGCAA
GAGTCTATCCTGCCAAGAGGAACAGCGATAAGCTGATCGCCAGAAAGAAGGACTG
GGACCCTAAGAAGTACGGCGGCTTCGACAGCCCCACCGTGGCCTATTCTGTGCTGGT
GGTGGCCAAAGTGGAAGGGCAAGTCCAAGAACTGAAGAGTGTGAAAGAGCTG
CTGGGGATCACCATCATGGAAAGAAGCAGCTTCGAGAAGAATCCCATCGACTTTCT
GGAAGCCAAGGGCTACAAAGAAGTGAAAAAGGACCTGATCATCAAGCTGCCTAAGT
ACTCCCTGTTTCGAGCTGGAAAACGGCCGGAAGAGAATGCTGGCCTCTGCCGGCGAA
CTGCAGAAGGGAAACGAACTGGCCCTGCCCTCCAAATATGTGAACTTCTGTACCTG
GCCAGCCACTATGAGAAGCTGAAGGGCTCCCCGAGGATAATGAGCAGAAACAGCT
GTTTGTGGAACAGCACAAAGCACTACCTGGACGAGATCATCGAGCAGATCAGCGAGT
TCTCCAAGAGAGTGATCCTGGCCGACGCTAATCTGGACAAAGTGCTGTCCGCCTACA
ACAAGCACCGGGATAAGCCCATCAGAGAGCAGGCCGAGAATATCATCCACCTGTTT

ACCCTGACCAATCTGGGAGCCCCTGCCGCCTTCAAGTACTTTGACACCACCATCGAC
 CGGAAGAGGTACACCAGCACCAAAGAGGTGCTGGACGCCACCCTGATCCACCAGAG
 CATCACCGGCCTGTACGAGACACGGATCGACCTGTCTCAGCTGGGAGGCGACAAAA
 GGCCGGCGGCCACGAAAAAGGCCGGCCAGGCCAAAAAAGAAAAAGtaa

[00172] *Example 3: New nickases*

[00173] Figures 2A-C pertain to new SpCas9 nickases and provide A. Schematic showing catalytic domains of SpCas9, and sites of mutagenesis for putative new nickases. RuvC domains I, II, and III are shown in orange, HNH domain in white between RuvCII and RuvCIII. Domain sizes not drawn to scale. B. Schematic showing locations of sgRNAs used for testing double nicking: when sgRNAs are transfected singly (A1 or C1 alone) with SpCas9 nickases, no indels should result. The combination of A1 + C1, used in combination with RuvCIII mutation nickases result in 5'-overhang, where as D1 + A1 and C7 + A1 would result in 3'-overhangs. Conversely, those three combinations used with HNH mutation nickases would result in 3'-, 5'-, and 5'-overhangs, respectively. C. Surveyor test showing 1 HNH mutant that retains nuclease activity (N854A), and 1 HNH mutant that shows nickase activity (N863A), as well as 2 RuvCIII mutants that show nickase activity (H983A, D986A).

[00174] In this Example, five potential nicking mutation sites were chosen based on sequence homology between Cas9 orthologs. And three additional sites were chosen based on herein crystallography data. A subset of these sets of nickase mutant Cas9s were re-cloned to incorporate both N' and C'-NLS sequences that are identical to those of optimized SpCas9. Sequences are below.

[00175] Nickase mutants were re-cloned to incorporated designated mutations into pAAV-vector under Cbh promoter and sequence validated.

[00176] Nuclease and double-nicking activities for all potential nickases were tested in HEK 293FT cells as follows: co-transfection of 400ng of nickase and 100 ng of U6-driven sgRNA (100ng for one guide, or 50ng each for a pair of sgRNAs) by Lipofectamine 2000 into ~200,000 cells. DNAs from transfected cells were collected for SURVEYOR analysis. Nickases do not result in indel mutations when co-transfected with a single sgRNA, but do when co-transfected with a pair of appropriately off-set sgRNAs. Based on data from the original D10A SpCas9 nickase, the pair of sgRNA chosen (A1/C1) for RuvC domain mutants have 0-bp offset and 5'-overhang for maximal cleavage.

[00177]	Homology set:	Mutant domain	Functional?
	Cbh-hSpCas9(D10A)-NLS	RuvCI	nickase activity
	Cbh-hSpCas9(E762A)-NLS	RuvCII	
	Cbh-hSpCas9(H840A)-NLS	HNH	no activity
	Cbh-hSpCas9(N854A)-NLS	HNH	wt nuclease activity
	Cbh-hSpCas9(N863A)-NLS	HNH	nickase activity
	Cbh-hSpCas9(D986A)-NLS	RuvCIII	
[00178]	Crystal set set:	Mutant domain	Functional?
	NLS-S15A-NLS	RuvCI	wt nuclease activity
	NLS-E762A-NLS	RuvCII	catalytically dead
	NLS-H982A-NLS	RuvCIII	wt nuclease activity
	NLS-H983A-NLS	RuvCIII	nickase activity
	NLS-D986A-NLS	RuvCIII	nickase activity

[00179] >NLS-S15A-NLS

[00180] ATGGCCCCAAAGAAGAAGCGGAAGGTTCGGTATCCACGGAGTCCCAGCAG
 CCGACAAGAAGTACAGCATCGGCCTGGACATCGGCACCAACgcccGTGGGCTGGGCCG
 TGATCACCGACGAGTACAAGGTGCCAGCAAGAAATTCAAGGTGCTGGGCAACACC
 GACCGGCACAGCATCAAGAAGAACCTGATCGGAGCCCTGCTGTTCGACAGCGGCGA
 AACAGCCGAGGCCACCCGGCTGAAGAGAACCGCCAGAAGAAGATACACCAGACGG
 AAGAACCGGATCTGCTATCTGCAAGAGATCTTCAGCAACGAGATGGCCAAGGTGGA
 CGACAGCTTCTTCCACAGACTGGAAGAGTCTTCTGCTGGTGGAAAGAGGATAAGAAGC
 ACGAGCGGCACCCCATCTTCGGCAACATCGTGGACGAGGTGGCCTACCACGAGAAG
 TACCCACCATCTACCACCTGAGAAAGAACTGGTGGACAGCACCGACAAGGCCGA
 CCTGCGGCTGATCTATCTGGCCCTGGCCCACATGATCAAGTTCGGGGGCCACTTCT
 GATCGAGGGCGACCTGAACCCCGACAACAGCGACGTGGACAAGCTGTTCATCCAGC
 TGGTGCAGACCTACAACCAGCTGTTCGAGGAAAACCCCATCAACGCCAGCGGCGTG
 GACGCCAAGGCCATCCTGTCTGCCAGACTGAGCAAGAGCAGACGGCTGGAAAATCT
 GATCGCCAGCTGCCCGGCGAGAAGAAGAATGGCCTGTTCGGAAACCTGATTGCC
 TGAGCCTGGGCCTGACCCCCAACTTCAAGAGCAACTTCGACCTGGCCGAGGATGCC
 AAAGTGCAGCTGAGCAAGGACACCTACGACGACGACCTGGACAACCTGCTGGCCCA
 GATCGGCGACCAGTACGCCGACCTGTTTCTGGCCGCCAAGAACCTGTCCGACGCCAT

CCTGCTGAGCGACATCCTGAGAGTGAACACCGAGATCACCAAGGCCCCCTGAGCG
CCTCTATGATCAAGAGATACGACGAGCACCACCAGGACCTGACCCTGCTGAAAGCT
CTCGTGCGGCAGCAGCTGCCTGAGAAGTACAAAGAGATTTTCTTCGACCAGAGCAA
GAACGGCTACGCCGGCTACATTGACGGCGGAGCCAGCCAGGAAGAGTTCTACAAGT
TCATCAAGCCCATCCTGGAAAAGATGGACGGCACCGAGGAACTGCTCGTGAAGCTG
AACAGAGAGGACCTGCTGCGGAAGCAGCGGACCTTCGACAACGGCAGCATCCCCCA
CCAGATCCACCTGGGAGAGCTGCACGCCATTCTGCGGGCGGCAGGAAGATTTTTACCC
ATTCCTGAAGGACAACCGGGAAAAGATCGAGAAGATCCTGACCTTCCGCATCCCCT
ACTACGTGGGCCCTCTGGCCAGGGGAAACAGCAGATTCGCCTGGATGACCAGAAAG
AGCGAGGAAACCATCACCCCCTGGAACCTTCGAGGAAGTGGTGGACAAGGGCGCTTC
CGCCAGAGCTTCATCGAGCGGATGACCAACTTCGATAAGAACCTGCCCAACGAGA
AGGTGCTGCCCAAGCACAGCCTGCTGTACGAGTACTTCACCGTGTATAACGAGCTGA
CCAAAGTGAAATACGTGACCGAGGGAATGAGAAAGCCCGCCTTCCTGAGCGGCGAG
CAGAAAAGGCCATCGTGGACCTGCTGTTCAAGACCAACCGGAAAGTGACCGTGAA
GCAGCTGAAAGAGGACTACTTCAAGAAAATCGAGTGCTTCGACTCCGTGGAAATCT
CCGGCGTGGAAAGATCGGTTCAACGCCTCCCTGGGCACATAACCACGATCTGCTGAAA
ATTATCAAGGACAAGGACTTCCTGGACAATGAGGAAAACGAGGACATTCTGGAAGA
TATCGTGCTGACCCTGACACTGTTTGAGGACAGAGAGATGATCGAGGAACGGCTGA
AAACCTATGCCACCTGTTCGACGACAAAGTGATGAAGCAGCTGAAGCGGCGGAGA
TACACCGGCTGGGGCAGGCTGAGCCGGAAGCTGATCAACGGCATCCGGGACAAGCA
GTCCGGCAAGACAATCCTGGATTTCTGAAGTCCGACGGCTTCGCCAACAGAACTT
CATGCAGCTGATCCACGACGACAGCCTGACCTTTAAAGAGGACATCCAGAAAGCCC
AGGTGTCCGGCCAGGGCGATAGCCTGCACGAGCACATTGCCAATCTGGCCGGCAGC
CCCGCCATTAAGAAGGGCATCCTGCAGACAGTGAAGGTGGTGGACGAGCTCGTGAA
AGTGATGGGCCCGGCACAAGCCCGAGAACATCGTGATCGAAATGGCCAGAGAGAAC
CAGACCACCCAGAAGGGACAGAAGAACAGCCGCGAGAGAATGAAGCGGATCGAAG
AGGGCATCAAAGAGCTGGGCAGCCAGATCCTGAAAGAACACCCCGTGGAAAACAC
CCAGCTGCAGAACGAGAAGCTGTACCTGTACTACCTGCAGAATGGGCGGGATATGT
ACGTGGACCAGGAACTGGACATCAACCGGCTGTCCGACTACGATGTGGACCATATC
GTGCCTCAGAGCTTTCTGAAGGACGACTCCATCGACAACAAGGTGCTGACCAGAAG
CGACAAGAACCGGGGCAAGAGCGACAACGTGCCCTCCGAAGAGGTGCTGAAGAAG

ATGAAGA ACTACTGGCGGCAGCTGCTGAACGCCAAGCTGATTACCCAGAGAAAGTT
CGACAATCTGACCAAGGCCGAGAGAGGGCGGCCTGAGCGAACTGGATAAGGCCGGCT
TCATCAAGAGACAGCTGGTGGAAACCCGGCAGATCACAAAGCACGTGGCACAGATC
CTGGACTCCCGGATGAACACTAAGTACGACGAGAATGACAAGCTGATCCGGGAAGT
GAAAGTGATCACCTGAAGTCCAAGCTGGTGTCCGATTTCCGGAAGGATTTCCAGTT
TTACAAAGTGCGCGAGATCAACA ACTACCACCACGCCACGACGCCTACCTGAACG
CCGTCGTGGGAACCGCCCTGATCAAAAAGTACCCTAAGCTGGAAAGCGAGTTCGTG
TACGGCGACTACAAGGTGTACGACGTGCGGAAGATGATCGCCAAGAGCGAGCAGGA
AATCGGCAAGGCTACCGCCAAGTACTTCTTCTACAGCAACATCATGAACTTTTTCAA
GACCGAGATTACCCTGGCCAACGGCGAGATCCGGAAGCGGCCTCTGATCGAGACAA
ACGGCGAAACCGGGGAGATCGTGTGGGATAAGGGCCGGGATTTTGCCACCGTGCGG
AAAGTGCTGAGCATGCCCAAGTGAATATCGTGAAAAAGACCGAGGTGCAGACAGG
CGGCTTCAGCAAAGAGTCTATCCTGCCCAAGAGGAACAGCGATAAGCTGATCGCCA
GAAAGAAGGACTGGGACCCTAAGAAGTACGGCGGCTTCGACAGCCCCACCGTGGCC
TATTCTGTGCTGGTGGTGGCCAAAGTGGAAAAGGGCAAGTCCAAGAACTGAAGAG
TGTGAAAGAGCTGCTGGGGATCACCATCATGGAAAGAAGCAGCTTCGAGAAGAATC
CCATCGACTTTCTGGAAGCCAAGGGCTACAAAGAAGTGAAAAAGGACCTGATCATC
AAGCTGCCTAAGTACTCCCTGTTTCGAGCTGGAAAACGGCCGGAAGAGAATGCTGGC
CTCTGCCGGCGAACTGCAGAAGGGAAACGAACTGGCCCTGCCCTCCAAATATGTGA
ACTTCCTGTACCTGGCCAGCCACTATGAGAAGCTGAAGGGCTCCCCGAGGATAAT
GAGCAGAAACAGCTGTTTGTGGAACAGCACAAAGCACTACCTGGACGAGATCATCGA
GCAGATCAGCGAGTTCTCCAAGAGAGTGATCCTGGCCGACGCTAATCTGGACAAAG
TGCTGTCCGCCTACAACAAGCACCGGGATAAGCCCATCAGAGAGCAGGCCGAGAAT
ATCATCCACCTGTTTACCCTGACCAATCTGGGAGCCCCTGCCGCCTTCAAGTACTTTG
ACACCACCATCGACCGGAAGAGGTACACCAGCACCAAAGAGGTGCTGGACGCCACC
CTGATCCACCAGAGCATCACCGGCCTGTACGAGACACGGATCGACCTGTCTCAGCTG
GGAGGCGACAAAAGGCCGGCGGCCACGAAAAAGGCCGGCCAGGCCAAAAAAGAAA
AAGtaa

[00181] >NLS-E762A-NLS

[00182] ATGGCCCCAAAGAAGAAGCGGAAGGTCCGTATCCACGGAGTCCAGCAG
CCGACAAGAAGTACAGCATCGGCCTGGACATCGGCACCAACTCTGTGGGCTGGGCC

GTGATCACCGACGAGTACAAGGTGCCAGCAAGAAATTCAAGGTGCTGGGCAACAC
CGACCGGCACAGCATCAAGAAGAACCTGATCGGAGCCCTGCTGTTTCGACAGCGGCG
AAACAGCCGAGGCCACCCGGCTGAAGAGAACCGCCAGAAGAAGATACACCAGACG
GAAGAACCGGATCTGCTATCTGCAAGAGATCTTCAGCAACGAGATGGCCAAGGTGG
ACGACAGCTTCTTCCACAGACTGGAAGAGTCCTTCCTGGTGGAAAGAGGATAAGAAG
CACGAGCGGCACCCCATCTTCGGCAACATCGTGGACGAGGTGGCCTACCACGAGAA
GTACCCACCATCTACCACCTGAGAAAGAAACTGGTGGACAGCACCCGACAAGGCCG
ACCTGCGGCTGATCTATCTGGCCCTGGCCACATGATCAAGTTCCGGGGCCACTTCC
TGATCGAGGGCGACCTGAACCCCGACAACAGCGACGTGGACAAGCTGTTTCATCCAG
CTGGTGCAGACCTACAACCAGCTGTTTCGAGGAAAACCCCATCAACGCCAGCGGCGT
GGACGCCAAGGCCATCCTGTCTGCCAGACTGAGCAAGAGCAGACGGCTGGAAAATC
TGATCGCCCAGCTGCCCCGGCGAGAAGAAGAATGGCCTGTTTCGGAAACCTGATTGCC
CTGAGCCTGGGCCTGACCCCAACTTCAAGAGCAACTTCGACCTGGCCGAGGATGC
CAAAGTGCAGCTGAGCAAGGACACCTACGACGACGACCTGGACAACCTGCTGGCCC
AGATCGGCGACCAGTACGCCGACCTGTTTCTGGCCGCCAAGAACCTGTCCGACGCC
ATCCTGCTGAGCGACATCCTGAGAGTGAACACCGAGATCACCAAGGCCCCCTGAG
CGCCTCTATGATCAAGAGATACGACGAGCACCACCAGGACCTGACCCTGCTGAAAG
CTCTCGTGCGGCAGCAGCTGCCTGAGAAGTACAAAGAGATTTTCTTCGACCAGAGCA
AGAACGGCTACGCCGGCTACATTGACGGCGGAGCCAGCCAGGAAGAGTTCTACAAG
TTCATCAAGCCCATCCTGGAAAAGATGGACGGCACCCGAGGAACTGCTCGTGAAGCT
GAACAGAGAGGACCTGCTGCGGAAGCAGCGGACCTTCGACAACGGCAGCATCCCC
ACCAGATCCACCTGGGAGAGCTGCACGCCATTCTGCGGGCGGCAGGAAGATTTTAC
CCATTCTGAAGGACAACCGGGAAAAGATCGAGAAGATCCTGACCTTCCGCATCCC
CTACTACGTGGGCCCTCTGGCCAGGGGAAACAGCAGATTTCGCTGGATGACCAGAA
AGAGCGAGGAAACCATCACCCCTGGAACCTTCGAGGAAGTGGTGGACAAGGGCGCT
TCCGCCAGAGCTTCATCGAGCGGATGACCAACTTCGATAAGAACCTGCCCAACGA
GAAGGTGCTGCCAAGCACAGCCTGCTGTACGAGTACTTCACCGTGTATAACGAGCT
GACCAAAGTGAAATACGTGACCGAGGGAATGAGAAAGCCCGCCTTCTGAGCGGCG
AGCAGAAAAAGGCCATCGTGGACCTGCTGTTCAAGACCAACCGGAAAGTGACCGTG
AAGCAGCTGAAAGAGGACTACTTCAAGAAAATCGAGTGCTTCGACTCCGTGGAAAT
CTCCGGCGTGGAAGATCGGTTCAACGCCTCCCTGGGCACATACCACGATCTGCTGAA

AATTATCAAGGACAAGGACTTCCTGGACAATGAGGAAAACGAGGACATTCTGGAAG
ATATCGTGCTGACCCTGACACTGTTTGAGGACAGAGAGATGATCGAGGAACGGCTG
AAAACCTATGCCACCTGTTTCGACGACAAAGTGATGAAGCAGCTGAAGCGGCGGAG
ATACACCGGCTGGGGCAGGCTGAGCCGGAAGCTGATCAACGGCATCCGGGACAAGC
AGTCCGGCAAGACAATCCTGGATTTCTGAAGTCCGACGGCTTCGCCAACAGAAAC
TTCATGCAGCTGATCCACGACGACAGCCTGACCTTTAAAGAGGACATCCAGAAAGC
CCAGGTGTCCGGCCAGGGCGATAGCCTGCACGAGCACATTGCCAATCTGGCCGGCA
GCCCCGCCATTAAGAAGGGCATCCTGCAGACAGTGAAGGTGGTGGACGAGCTCGTG
AAAGTGATGGGCCGGCACAAGCCCCGAGAACATCGTGATCGccATGGCCAGAGAGAA
CCAGACCACCCAGAAGGGACAGAAGAACAGCCGCGAGAGAATGAAGCGGATCGAA
GAGGGCATCAAAGAGCTGGGCAGCCAGATCCTGAAAGAACACCCCCGTGGAAAACA
CCCAGCTGCAGAACGAGAAGCTGTACCTGTACTACCTGCAGAATGGGCGGGATATG
TACGTGGACCAGGAACTGGACATCAACCGGCTGTCCGACTACGATGTGGACCATAT
CGTGCCTCAGAGCTTTCTGAAGGACGACTCCATCGACAACAAGGTGCTGACCAGAA
GCGACAAGAACCGGGGCAAGAGCGACAACGTGCCCTCCGAAGAGGTTCGTGAAGAA
GATGAAGAACTACTGGCGGCAGCTGCTGAACGCCAAGCTGATTACCCAGAGAAAGT
TCGACAATCTGACCAAGGCCGAGAGAGGGCGGCCTGAGCGAACTGGATAAGGCCGGC
TTCATCAAGAGACAGCTGGTGGAAACCCGGCAGATCACAAAGCACGTGGCACAGAT
CCTGGACTCCCGGATGAACACTAAGTACGACGAGAATGACAAGCTGATCCGGGAAG
TGAAAGTGATCACCTGAAGTCCAAGCTGGTGTCCGATTTCCGGAAGGATTTCCAGT
TTTACAAAGTGCGCGAGATCAACAACCTACCACCACGCCACGACGCCTACCTGAAC
GCCGTTCGTGGGAACCGCCCTGATCAAAAAGTACCCTAAGCTGGAAAGCGAGTTCGT
GTACGGCGACTACAAGGTGTACGACGTGCGGAAGATGATCGCCAAGAGCGAGCAGG
AAATCGGCAAGGCTACCGCCAAGTACTTCTTCTACAGCAACATCATGAACTTTTTCA
AGACCGAGATTACCCTGGCCAACGGCGAGATCCGGAAGCGGCCCTCTGATCGAGACA
AACGGCGAAACCGGGGAGATCGTGTGGGATAAGGGCCGGGATTTTGCCACCGTGCG
GAAAGTGCTGAGCATGCCCAAGTGAATATCGTGAAAAAGACCGAGGTGCAGACAG
GCGGCTTCAGCAAAGAGTCTATCCTGCCCAAGAGGAACAGCGATAAGCTGATCGCC
AGAAAGAAGGACTGGGACCCTAAGAAGTACGGCGGCTTCGACAGCCCCACCGTGGC
CTATTCTGTGCTGGTGGTGGCCAAAGTGGAAGGGCAAGTCCAAGAACTGAAGA
GTGTGAAAGAGCTGCTGGGGATCACCATCATGGAAAGAAGCAGCTTCGAGAAGAAT

CCCATCGACTTTCTGGAAGCCAAGGGCTACAAAGAAGTGAAAAAGGACCTGATCAT
 CAAGCTGCCTAAGTACTCCCTGTTTCGAGCTGGAAAACGGCCGGAAGAGAATGCTGG
 CCTCTGCCGGCGAACTGCAGAAGGGAAACGAACTGGCCCTGCCCTCCAAATATGTG
 AACTTCCTGTACCTGGCCAGCCACTATGAGAAGCTGAAGGGCTCCCCCGAGGATAA
 TGAGCAGAAACAGCTGTTTGTGGAACAGCACAAAGCACTACCTGGACGAGATCATCG
 AGCAGATCAGCGAGTTCTCCAAGAGAGTGATCCTGGCCGACGCTAATCTGGACAAA
 GTGCTGTCCGCCTACAACAAGCACCGGGATAAGCCCATCAGAGAGCAGGCCGAGAA
 TATCATCCACCTGTTTACCCTGACCAATCTGGGAGCCCCTGCCGCCTTCAAGTACTTT
 GACACCACCATCGACCGGAAGAGGTACACCAGCACCAAAGAGGTGCTGGACGCCAC
 CCTGATCCACCAGAGCATCACCGGCCTGTACGAGACACGGATCGACCTGTCTCAGCT
 GGGAGGCGACAAAAGGCCGGCGGCCACGAAAAAGGCCGGCCAGGCCAAAAAAGAA
 AAAGtaa

[00183] >NLS-H982A-NLS

[00184] ATGGCCCCAAAGAAGAAGCGGAAGGTTCGGTATCCACGGAGTCCCAGCAG
 CCGACAAGAAGTACAGCATCGGCCTGGACATCGGCACCAACTCTGTGGGCTGGGCC
 GTGATCACCGACGAGTACAAGGTGCCAGCAAGAAATTCAAGGTGCTGGGCAACAC
 CGACCGGCACAGCATCAAGAAGAACCTGATCGGAGCCCTGCTGTTTCGACAGCGGCG
 AACAGCCGAGGCCACCCGGCTGAAGAGAACCGCCAGAAGAAGATACACCAGACG
 GAAGAACCGGATCTGCTATCTGCAAGAGATCTTCAGCAACGAGATGGCCAAGGTGG
 ACGACAGCTTCTTCCACAGACTGGAAGAGTCCTTCCCTGGTGGAAAGAGGATAAGAAG
 CACGAGCGGCACCCCATCTTCGGCAACATCGTGGACGAGGTGGCCTACCACGAGAA
 GTACCCACCATCTACCACCTGAGAAAGAAACTGGTGGACAGCACCGACAAGGCCG
 ACCTGCGGCTGATCTATCTGGCCCTGGCCCACATGATCAAGTTCGGGGCCACTTCC
 TGATCGAGGGCGACCTGAACCCCGACAACAGCGACGTGGACAAGCTGTTTCATCCAG
 CTGGTGCAGACCTACAACCAGCTGTTTCGAGGAAAACCCCATCAACGCCAGCGGCGT
 GGACGCCAAGGCCATCCTGTCTGCCAGACTGAGCAAGAGCAGACGGCTGGAAAATC
 TGATCGCCCAGCTGCCC GGCGAGAAGAAGAATGGCCTGTTTCGGAAACCTGATTGCC
 CTGAGCCTGGGCCTGACCCCAACTTCAAGAGCAACTTCGACCTGGCCGAGGATGC
 CAAACTGCAGCTGAGCAAGGACACCTACGACGACGACCTGGACAACCTGCTGGCCC
 AGATCGGCGACCAGTACGCCGACCTGTTTCTGGCCGCCAAGAACCTGTCCGACGCC
 ATCCTGCTGAGCGACATCCTGAGAGTGAACACCGAGATCACCAAGGCCCCCCCTGAG

CGCCTCTATGATCAAGAGATACGACGAGCACCACCAGGACCTGACCCTGCTGAAAG
CTCTCGTGCGGCAGCAGCTGCCTGAGAAGTACAAAGAGATTTTCTTCGACCAGAGCA
AGAACGGCTACGCCGGCTACATTGACGGCGGAGCCAGCCAGGAAGAGTTCTACAAG
TTCATCAAGCCCATCCTGGAAAAGATGGACGGCACCAGGAACTGCTCGTGAAGCT
GAACAGAGAGGACCTGCTGCGGAAGCAGCGGACCTTCGACAACGGCAGCATCCCC
ACCAGATCCACCTGGGAGAGCTGCACGCCATTCTGCGGGCGGCAGGAAGATTTTTAC
CCATTCCCTGAAGGACAACCGGGAAAAGATCGAGAAGATCCTGACCTTCCGCATCCC
CTACTACGTGGGCCCTCTGGCCAGGGGAAAACAGCAGATTTCGCTGGATGACCAGAA
AGAGCGAGGAAACCATCACCCCCTGGAACCTTCGAGGAAGTGGTGGACAAGGGCGCT
TCCGCCCAGAGCTTCATCGAGCGGATGACCAACTTCGATAAGAACCTGCCCAACGA
GAAGGTGCTGCCAAGCACAGCCTGCTGTACGAGTACTTCACCGTGTATAACGAGCT
GACCAAAGTGAAATACGTGACCGAGGGAATGAGAAAGCCCGCCTTCTGAGCGGCG
AGCAGAAAAAGGCCATCGTGGACCTGCTGTTCAAGACCAACCGGAAAGTGACCGTG
AAGCAGCTGAAAGAGGACTACTTCAAGAAAATCGAGTGCTTCGACTCCGTGGAAAT
CTCCGGCGTGGAAGATCGGTTCAACGCCTCCCTGGGCACATAACCACGATCTGCTGAA
AATTATCAAGGACAAGGACTTCCCTGGACAATGAGGAAAACGAGGACATTCTGGAAG
ATATCGTGCTGACCCTGACACTGTTTGAGGACAGAGAGATGATCGAGGAACGGCTG
AAAACCTATGCCACCTGTTCGACGACAAAAGTGATGAAGCAGCTGAAGCGGCGGAG
ATACACCGGCTGGGGCAGGCTGAGCCGGAAGCTGATCAACGGCATCCGGGACAAGC
AGTCCGGCAAGACAATCCTGGATTTCTGAAGTCCGACGGCTTCGCCAACAGAAAC
TTCATGCAGCTGATCCACGACGACAGCCTGACCTTTAAAGAGGACATCCAGAAAGC
CCAGGTGTCCGGCCAGGGCGATAGCCTGCACGAGCACATTGCCAATCTGGCCGGCA
GCCCCGCCATTAAGAAGGGCATCCTGCAGACAGTGAAGGTGGTGGACGAGCTCGTG
AAAGTGATGGGCCGGCACAAGCCCGAGAACATCGTGATCGAAATGGCCAGAGAGA
ACCAGACCACCCAGAAGGGACAGAAGAACAGCCGCGAGAGAATGAAGCGGATCGA
AGAGGGCATCAAAGAGCTGGGCAGCCAGATCCTGAAAGAACACCCCGTGGAAAAC
ACCCAGCTGCAGAACGAGAAGCTGTACCTGTACTACCTGCAGAATGGGCGGGATAT
GTACGTGGACCAGGAACTGGACATCAACCGGCTGTCCGACTACGATGTGGACCATA
TCGTGCCTCAGAGCTTTCTGAAGGACGACTCCATCGACAACAAGGTGCTGACCAGA
AGCGACAAGAACCGGGGCAAGAGCGACAACGTGCCCTCCGAAGAGGTTCGTGAAGA
AGATGAAGAACTACTGGCGGCAGCTGCTGAACGCCAAGCTGATTACCCAGAGAAAG

TTCGACAATCTGACCAAGGCCGAGAGAGGGCGGCCTGAGCGAACTGGATAAAGGCCGG
 CTTTCATCAAGAGACAGCTGGTGGAAACCCGGCAGATCACAAAGCACGTGGCACAGA
 TCCTGGACTCCC GGATGAACACTAAGTACGACGAGAATGACAAGCTGATCCGGGAA
 GTGAAAGTGATCACCCCTGAAGTCCAAGCTGGTGTCCGATTTCCGGAAGGATTTCCAG
 TTTTACAAAGTGCGCGAGATCAACAACACTAC^{gcc}CACGCCACGACGCCTACCTGAAC
 GCCGTCGTGGGAACCGCCCTGATCAAAAAGTACCCTAAGCTGGAAAGCGAGTTTCGT
 GTACGGCGACTACAAGGTGTACGACGTGCGGAAGATGATCGCCAAGAGCGAGCAGG
 AAATCGGCAAGGCTACCGCCAAGTACTTCTTCTACAGCAACATCATGAACTTTTTCA
 AGACCGAGATTACCCTGGCCAACGGCGAGATCCGGAAGCGGCCTCTGATCGAGACA
 AACGGCGAAACCGGGGAGATCGTGTGGGATAAGGGGCCGGGATTTTGCCACCGTGC
 GAAAGTGCTGAGCATGCCCAAGTGAATATCGTGAAAAAGACCGAGGTGCAGACAG
 GCGGCTTCAGCAAAGAGTCTATCCTGCCCAAGAGGAACAGCGATAAGCTGATCGCC
 AGAAAGAAGGACTGGGACCCTAAGAAGTACGGCGGCTTCGACAGCCCCACCGTGGC
 CTATTCTGTGCTGGTGGTGGCCAAAGTGGAAAAGGGCAAGTCCAAGAACTGAAGA
 GTGTGAAAGAGCTGCTGGGGATCACCATCATGGAAAGAAGCAGCTTCGAGAAGAAT
 CCCATCGACTTTCTGGAAGCCAAGGGCTACAAAGAAGTGAAAAAGGACCTGATCAT
 CAAGCTGCCTAAGTACTCCCTGTTTCGAGCTGGAAAACGGCCGGAAGAGAATGCTGG
 CCTCTGCCGGCGAACTGCAGAAGGGAAACGAACTGGCCCTGCCCTCCAAATATGTG
 AACTTCCTGTACCTGGCCAGCCACTATGAGAAGCTGAAGGGCTCCCCGAGGATAA
 TGAGCAGAAACAGCTGTTTGTGGAACAGCACAAAGCACTACCTGGACGAGATCATCG
 AGCAGATCAGCGAGTTCTCCAAGAGAGTGATCCTGGCCGACGCTAATCTGGACAAA
 GTGCTGTCCGCCTACAACAAGCACCGGGATAAGCCCATCAGAGAGCAGGCCGAGAA
 TATCATCCACCTGTTTACCCTGACCAATCTGGGAGCCCCTGCCGCCTTCAAGTACTTT
 GACACCACCATCGACCGGAAGAGGTACACCAGCACCAAAGAGGTGCTGGACGCCAC
 CCTGATCCACCAGAGCATCACCGGCCTGTACGAGACACGGATCGACCTGTCTCAGCT
 GGGAGGCGACAAAAGGCCGGCGGCCACGAAAAAGGCCGGCCAGGCCAAAAAAGAA
 AAAG^{taa}

[00185] >NLS-H983A-NLS

[00186] ATGGCCCCAAAGAAGAAGCGGAAGGTTCGGTATCCACGGAGTCCCAGCAG
 CCGACAAGAAGTACAGCATCGGCCTGGACATCGGCACCAACTCTGTGGGCTGGGCC
 GTGATCACCGACGAGTACAAGGTGCCCAGCAAGAAATTC AAGGTGCTGGGCAACAC

CGACCGGCACAGCATCAAGAAGAACCTGATCGGAGCCCTGCTGTTTCGACAGCGGCG
AAACAGCCGAGGCCACCCGGCTGAAGAGAACCGCCAGAAGAAGATACACCAGACG
GAAGAACCGGATCTGCTATCTGCAAGAGATCTTCAGCAACGAGATGGCCAAGGTGG
ACGACAGCTTCTTCCACAGACTGGAAGAGTCCTTCCCTGGTGGAAAGAGGATAAGAAG
CACGAGCGGCACCCCATCTTCGGCAACATCGTGGACGAGGTGGCCTACCACGAGAA
GTACCCACCATCTACCACCTGAGAAAGAACTGGTGGACAGCACCGACAAGGCCG
ACCTGCGGCTGATCTATCTGGCCCTGGCCACATGATCAAGTTCGGGGGCCACTTCC
TGATCGAGGGCGACCTGAACCCCGACAACAGCGACGTGGACAAGCTGTTTCATCCAG
CTGGTGCAGACCTACAACCAGCTGTTTCGAGGAAAACCCCATCAACGCCAGCGGCGT
GGACGCCAAGGCCATCCTGTCTGCCAGACTGAGCAAGAGCAGACGGCTGGAAAATC
TGATCGCCCAGCTGCCCGGCGAGAAGAAGAATGGCCTGTTTCGGAAACCTGATTGCC
CTGAGCCTGGGCCTGACCCCAACTTCAAGAGCAACTTCGACCTGGCCGAGGATGC
CAAACCTGCAGCTGAGCAAGGACACCTACGACGACGACCTGGACAACCTGCTGGCCC
AGATCGGCGACCAGTACGCCGACCTGTTTCTGGCCGCCAAGAACCTGTCCGACGCC
ATCCTGCTGAGCGACATCCTGAGAGTGAACACCGAGATCACCAAGGCCCCCCCTGAG
CGCCTCTATGATCAAGAGATACGACGAGCACCACCAGGACCTGACCCTGCTGAAAG
CTCTCGTGGCGCAGCAGCTGCCTGAGAAGTACAAAGAGATTTTCTTCGACCAGAGCA
AGAACGGCTACGCCGGCTACATTGACGGCGGAGCCAGCCAGGAAGAGTTCTACAAG
TTCATCAAGCCCATCCTGGAAAAGATGGACGGCACCCGAGGAACTGCTCGTGAAGCT
GAACAGAGAGGACCTGCTGCGGAAGCAGCGGACCTTCGACAACGGCAGCATCCCCC
ACCAGATCCACCTGGGAGAGCTGCACGCCATTCTGCGGCGGCAGGAAGATTTTTAC
CCATTCTGAAGGACAACCGGGAAAAGATCGAGAAGATCCTGACCTTCCGCATCCC
CTACTACGTGGGCCCTCTGGCCAGGGGAAAACAGCAGATTTCGCTGGATGACCAGAA
AGAGCGAGGAAACCATCACCCCTGGAACTTCGAGGAAGTGGTGGACAAGGGCGCT
TCCGCCAGAGCTTCATCGAGCGGATGACCAACTTCGATAAGAACCTGCCCAACGA
GAAGGTGCTGCCAAGCACAGCCTGCTGTACGAGTACTTCACCGTGTATAACGAGCT
GACCAAAGTGAAATACGTGACCGAGGGAATGAGAAAGCCCGCCTTCTGAGCGGCG
AGCAGAAAAAGGCCATCGTGGACCTGCTGTTCAAGACCAACCGGAAAGTGACCGTG
AAGCAGCTGAAAGAGGACTACTTCAAGAAAATCGAGTGCTTCGACTCCGTGGAAAT
CTCCGGCGTGGAAGATCGGTTCAACGCCTCCCTGGGCACATAACCAGATCTGCTGAA
AATTATCAAGGACAAGGACTTCTGGACAATGAGGAAAACGAGGACATTCTGGAAG

ATATCGTGCTGACCCTGACACTGTTTGAGGACAGAGAGATGATCGAGGAACGGCTG
AAAACCTATGCCACCTGTTCGACGACAAAGTGATGAAGCAGCTGAAGCGGCGGAG
ATACACCGGCTGGGGCAGGCTGAGCCGGAAGCTGATCAACGGCATCCGGGACAAGC
AGTCCGGCAAGACAATCCTGGATTTCTGAAGTCCGACGGCTTCGCCAACAGAAAC
TTCATGCAGCTGATCCACGACGACAGCCTGACCTTTAAAGAGGACATCCAGAAAGC
CCAGGTGTCCGGCCAGGGCGATAGCCTGCACGAGCACATTGCCAATCTGGCCGGCA
GCCCCGCCATTAAGAAGGGCATCCTGCAGACAGTGAAGGTGGTGGACGAGCTCGTG
AAAGTGATGGGCCGGCACAAGCCCCGAGAACATCGTGATCGAAATGGCCAGAGAGA
ACCAGACCACCAGAAGGGACAGAAGAACAGCCGCGAGAGAATGAAGCGGATCGA
AGAGGGCATCAAAGAGCTGGGCAGCCAGATCCTGAAAGAACACCCCGTGGAAAAC
ACCCAGCTGCAGAACGAGAAGCTGTACCTGTACTACCTGCAGAATGGGGCGGATAT
GTACGTGGACCAGGAACTGGACATCAACCGGCTGTCCGACTACGATGTGGACCATA
TCGTGCCTCAGAGCTTCTGAAGGACGACTCCATCGACAACAAGGTGCTGACCAGA
AGCGACAAGAACCGGGGCAAGAGCGACAACGTGCCCTCCGAAGAGGTGCTGAAGA
AGATGAAGAACTACTGGCCGGCAGCTGCTGAACGCCAAGCTGATTACCCAGAGAAAG
TTCGACAATCTGACCAAGGCCGAGAGAGGGCGGCCTGAGCGAACTGGATAAGGCCGG
CTTCATCAAGAGACAGCTGGTGGAAACCCGGCAGATCACAAAGCACGTGGCACAGA
TCCTGGACTCCCGGATGAACACTAAGTACGACGAGAATGACAAGCTGATCCGGGAA
GTGAAAGTGATCACCTGAAGTCCAAGCTGGTGTCCGATTTCCGGAAGGATTTCCAG
TTTTACAAAGTGCGCGAGATCAACAACCTACCAC_{gcc}GCCCACGACGCCTACCTGAAC
GCCGTCGTGGGAACCGCCCTGATCAAAAAGTACCCTAAGCTGGAAAGCGAGTTCGT
GTACGGCGACTACAAGGTGTACGACGTGCGGAAGATGATCGCCAAGAGCGAGCAGG
AAATCGGCAAGGCTACCGCCAAGTACTTCTTCTACAGCAACATCATGAACTTTTTCA
AGACCGAGATTACCCTGGCCAACGGCGAGATCCGGAAGCGGCCTCTGATCGAGACA
AACGGCGAAACCGGGGAGATCGTGTGGGATAAGGGCCGGGATTTTGCCACCGTGGC
GAAAGTGCTGAGCATGCCCAAGTGAATATCGTGAAAAAGACCGAGGTGCAGACAG
GCGGCTTCAGCAAAGAGTCTATCCTGCCCAAGAGGAACAGCGATAAGCTGATCGCC
AGAAAGAAGGACTGGGACCCTAAGAAGTACGGCGGCTTCGACAGCCCCACCGTGGC
CTATTCTGTGCTGGTGGTGGCCAAAGTGGAAAAGGGCAAGTCCAAGAACTGAAGA
GTGTGAAAGAGCTGCTGGGGATCACCATCATGGAAAGAAGCAGCTTCGAGAAGAAT
CCCATCGACTTCTGGAAGCCAAGGGCTACAAAGAAGTGA AAAAGGACCTGATCAT

CAAGCTGCCTAAGTACTCCCTGTTTCGAGCTGGAAAACGGCCGGAAGAGAATGCTGG
CCTCTGCCGGCGAACTGCAGAAGGGAAACGAACTGGCCCTGCCCTCCAAATATGTG
AACTTCTGTACCTGGCCAGCCACTATGAGAAGCTGAAGGGCTCCCCGAGGATAA
TGAGCAGAAACAGCTGTTTGTGGAACAGCACAAGCACTACCTGGACGAGATCATCG
AGCAGATCAGCGAGTTCTCCAAGAGAGTGATCCTGGCCGACGCTAATCTGGACAAA
GTGCTGTCCGCCTACAACAAGCACCGGGATAAGCCCATCAGAGAGCAGGCCGAGAA
TATCATCCACCTGTTTACCCTGACCAATCTGGGAGCCCCTGCCGCCTTCAAGTACTTT
GACACCACCATCGACCGGAAGAGGTACACCAGCACCAAAGAGGTGCTGGACGCCAC
CCTGATCCACCAGAGCATCACCGGCCTGTACGAGACACGGATCGACCTGTCTCAGCT
GGGAGGCGACAAAAGGCCGGCGGCCACGAAAAAGGCCGGCCAGGCCAAAAAAGAA
AAAGtaa

[00187] >NLS-D986A-NLS

[00188] ATGGCCCCAAAGAAGAAGCGGAAGGTCCGGTATCCACGGAGTCCCAGCAG
CCGACAAGAAGTACAGCATCGGCCTGGACATCGGCACCAACTCTGTGGGCTGGGCC
GTGATCACCGACGAGTACAAGGTGCCAGCAAGAAATTCAAGGTGCTGGGCAACAC
CGACCGGCACAGCATCAAGAAGAACCTGATCGGAGCCCTGCTGTTTCGACAGCGGCG
AAACAGCCGAGGCCACCCGGCTGAAGAGAACCGCCAGAAGAAGATACACCAGACG
GAAGAACCGGATCTGCTATCTGCAAGAGATCTTCAGCAACGAGATGGCCAAGGTGG
ACGACAGCTTCTTCCACAGACTGGAAGAGTCCTTCTGGTGGAAAGAGGATAAGAAG
CACGAGCGGCACCCCATCTTCGGCAACATCGTGGACGAGGTGGCCTACCACGAGAA
GTACCCACCATCTACCACCTGAGAAAGAAACTGGTGGACAGCACCGACAAGGCCG
ACCTGCGGCTGATCTATCTGGCCCTGGCCCACATGATCAAGTTCCGGGGCCACTTCC
TGATCGAGGGCGACCTGAACCCCGACAACAGCGACGTGGACAAGCTGTTTCATCCAG
CTGGTGCAGACCTACAACCAGCTGTTTCGAGGAAAACCCCATCAACGCCAGCGGCGT
GGACGCCAAGGCCATCCTGTCTGCCAGACTGAGCAAGAGCAGACGGCTGGAAAATC
TGATCGCCCAGCTGCCCCGGCGAGAAGAAGAATGGCCTGTTTCGGAAACCTGATTGCC
CTGAGCCTGGGCCTGACCCCAACTTCAAGAGCAACTTCGACCTGGCCGAGGATGC
CAAACCTGCAGCTGAGCAAGGACACCTACGACGACGACCTGGACAACCTGCTGGCCC
AGATCGGCGACCAGTACGCCGACCTGTTTCTGGCCGCCAAGAACCTGTCCGACGCC
ATCCTGCTGAGCGACATCCTGAGAGTGAACACCGAGATCACCAAGGCCCCCTGAG
CGCCTCTATGATCAAGAGATACGACGAGCACACCAGGACCTGACCCTGCTGAAAG

CTCTCGTGCGGCAGCAGCTGCCTGAGAAGTACAAAGAGATTTTCTTCGACCAGAGCA
AGAACGGCTACGCCGGCTACATTGACGGCGGAGCCAGCCAGGAAGAGTTCTACAAG
TTCATCAAGCCCATCCTGGAAAAGATGGACGGCACCCGAGGAACTGCTCGTGAAGCT
GAACAGAGAGGACCTGCTGCGGAAGCAGCGGACCTTCGACAACGGCAGCATCCCC
ACCAGATCCACCTGGGAGAGCTGCACGCCATTCTGCGGCGGCAGGAAGATTTTTAC
CCATTCTGAAGGACAACCGGGAAAAGATCGAGAAGATCCTGACCTTCCGCATCCC
CTACTACGTGGGCCCTCTGGCCAGGGGAAAACAGCAGATTTCGCCTGGATGACCAGAA
AGAGCGAGGAAACCATCACCCCCTGGAACCTTCGAGGAAGTGGTGGACAAGGGCGCT
TCCGCCCAGAGCTTCATCGAGCGGATGACCAACTTCGATAAGAACCTGCCCAACGA
GAAGGTGCTGCCAAGCACAGCCTGCTGTACGAGTACTTCACCGTGTATAACGAGCT
GACCAAAGTGAAATACGTGACCGAGGGAATGAGAAAGCCCGCCTTCCTGAGCGGCG
AGCAGAAAAAGGCCATCGTGGACCTGCTGTTCAAGACCAACCGGAAAGTGACCGTG
AAGCAGCTGAAAGAGGACTACTTCAAGAAAATCGAGTGCTTCGACTCCGTGGAAAT
CTCCGGCGTGGAAGATCGGTTCAACGCCTCCCTGGGCACATAACCACGATCTGCTGAA
AATTATCAAGGACAAGGACTTCCTGGACAATGAGGAAAACGAGGACATTCTGGAAG
ATATCGTGCTGACCCTGACACTGTTTGAGGACAGAGAGATGATCGAGGAACGGCTG
AAAACCTATGCCACCTGTTTCGACGACAAAAGTGATGAAGCAGCTGAAGCGGCGGAG
ATACACCGGCTGGGGCAGGCTGAGCCGGAAGCTGATCAACGGCATCCGGGACAAGC
AGTCCGGCAAGACAATCCTGGATTTCTGAAGTCCGACGGCTTCGCCAACAGAAAC
TTCATGCAGCTGATCCACGACGACAGCCTGACCTTTAAAGAGGACATCCAGAAAGC
CCAGGTGTCCGGCCAGGGCGATAGCCTGCACGAGCACATTGCCAATCTGGCCGGCA
GCCCCGCCATTAAGAAGGGCATCCTGCAGACAGTGAAGGTGGTGGACGAGCTCGTG
AAAGTGATGGGCCGGCACAAGCCCGAGAACATCGTGATCGAAATGGCCAGAGAGA
ACCAGACCACCCAGAAGGGACAGAAGAACAGCCGCGAGAGAATGAAGCGGATCGA
AGAGGGCATCAAAGAGCTGGGCAGCCAGATCCTGAAAGAACACCCCGTGGAAAAC
ACCCAGCTGCAGAACGAGAAGCTGTACCTGTACTACCTGCAGAATGGGCGGGATAT
GTACGTGGACCAGGAACTGGACATCAACCGGCTGTCCGACTACGATGTGGACCATA
TCGTGCCTCAGAGCTTTCTGAAGGACGACTCCATCGACAACAAGGTGCTGACCAGA
AGCGACAAGAACCGGGGCAAGAGCGACAACGTGCCCTCCGAAGAGGTTCGTGAAGA
AGATGAAGAACTACTGGCGGCAGCTGCTGAACGCCAAGCTGATTACCCAGAGAAAG
TTCGACAATCTGACCAAGGCCGAGAGAGGGCGGCCTGAGCGAACTGGATAAGGCCGG

CTTTCATCAAGAGACAGCTGGTGGAAACCCGGCAGATCACAAAGCACGTGGCACAGA
 TCCTGGACTCCC GGATGAACACTAAGTACGACGAGAATGACAAGCTGATCCGGGAA
 GTGAAAGTGATCACCTGAAGTCCAAGCTGGTGTCCGATTTCCGGAAGGATTTCCAG
 TTTTACAAAGTGCGCGAGATCAACA ACTACCACCACGCCACGcCGCCTACCTGAAC
 GCCGTCGTGGGAACCGCCCTGATCAAAAAGTACCCTAAGCTGGAAAGCGAGTTCGT
 GTACGGCGACTACAAGGTGTACGACGTGCGGAAGATGATCGCCAAGAGCGAGCAGG
 AAATCGGCAAGGCTACCGCCAAGTACTTCTTCTACAGCAACATCATGAACTTTTTCA
 AGACCGAGATTACCCTGGCCAACGGCGAGATCCGGAAGCGGCCTCTGATCGAGACA
 AACGGCGAAACCGGGGAGATCGTGTGGGATAAGGGGCCGGGATTTTGCCACCGTGCG
 GAAAGTGCTGAGCATGCCCAAGTGAATATCGTGAAAAAGACCGAGGTGCAGACAG
 GCGGCTTCAGCAAAGAGTCTATCCTGCCCAAGAGGAACAGCGATAAGCTGATCGCC
 AGAAAGAAGGACTGGGACCCTAAGAAGTACGGCGGCTTCGACAGCCCCACCGTGGC
 CTATTCTGTGCTGGTGGTGGCCAAAGTGGAAAAGGGCAAGTCCAAGAACTGAAGA
 GTGTGAAAGAGCTGCTGGGGATCACCATCATGGAAAGAAGCAGCTTCGAGAAGAAT
 CCCATCGACTTTCTGGAAGCCAAGGGCTACAAAGAAGTGAAAAAGGACCTGATCAT
 CAAGCTGCCTAAGTACTCCCTGTTCGAGCTGGAAAACGGCCGGAAGAGAATGCTGG
 CCTCTGCCGGCGAACTGCAGAAGGGAAACGAACTGGCCCTGCCCTCCAAATATGTG
 AACTTCCTGTACCTGGCCAGCCACTATGAGAAGCTGAAGGGCTCCCCCGAGGATAA
 TGAGCAGAAACAGCTGTTTGTGGAACAGCACAAGCACTACCTGGACGAGATCATCG
 AGCAGATCAGCGAGTTCTCCAAGAGAGTGATCCTGGCCGACGCTAATCTGGACAAA
 GTGCTGTCCGCCTACAACAAGCACCGGGATAAGCCCATCAGAGAGCAGGCCGAGAA
 TATCATCCACCTGTTTACCCTGACCAATCTGGGAGCCCCCTGCCGCCTTCAAGTACTTT
 GACACCACCATCGACCGGAAGAGGTACACCAGCACCAAAGAGGTGCTGGACGCCAC
 CCTGATCCACCAGAGCATCACCGGCCTGTACGAGACACGGATCGACCTGTCTCAGCT
 GGGAGGCGACAAAAGGCCGGCGGCCACGAAAAAGGCCGGCCAGGCCAAAAAAGAA
 AAAG

Example 4: Truncating and Creating Chimeric Cas9s based on S. pyogenes Cas9 Crystal Structure Herein

[00189] Figures 5A-C pertain to truncating and creating chimeric Cas9s based on the herein crystal structure. These figures provide schematics illustrating A. SpCas9 mutants designed for

mapping out essential functional domains of Cas9 for truncation of protein. B. chimeric Cas9s that contain sequences (regions in pink) from Cas9 from *S. thermophilus CRISPR 1*, *S. thermophilus CRISPR 3*, *Staphylococcus aureus*, *Neisseria meningitidis*, or other Cas9 orthologs. C. Designs for creating chemically inducible dimerization of SpCas9. The chemically inducible SpCas9 functions.

[00190] DNA sequences for chimeric Cas9s are optimized for human expression by GenScript and synthesized de novo. Chimeric Cas9 proteins can be constructed by cloning and ligating individual functional domains from Cas9 orthologs (i.e. by PCR-amplifying individual functional domains from a desired Cas9 ortholog, then assembling the pieces together by either Gibson or Golden Gate-cloning). Additionally, a set of chemically-inducible Cas9s were constructed as two-component systems, where one portion of the Cas9 protein is fused to FKBP, and the remainder fused to FRB (e.g. FKBP-Cas9(amino acids 1-1098), FRB-Cas(1099-1368)). In absence of chemical induction, co-transfection of the two inducible Cas9 components have no catalytic activity, but the functional assembly of the components may be induced using Rapamycin [5 nM to 10 μ M].

Example 5: Crystal Structure of Cas9 in complex with guide RNA and Target DNA

[00191] Cas9 is an RNA-guided nuclease from the microbial CRISPR-Cas system that can be targeted to specific genomic loci by single guide RNAs (sgRNAs). Applicants report the crystal structure of *Streptococcus pyogenes* Cas9 in complex with sgRNA and its target DNA at 2.4 Å resolution. The structure revealed a bilobed architecture composed of target recognition and nuclease lobes, accommodating a sgRNA:DNA duplex in a positively-charged groove at their interface. Whereas the recognition lobe is essential for sgRNA and DNA binding, the nuclease lobe contains the HNH and RuvC nuclease domains, which are properly positioned for the cleavage of complementary and non-complementary strands of the target DNA, respectively. This high-resolution structure and accompanying functional analyses elucidate the molecular mechanism of RNA-guided DNA targeting by Cas9, paving the way for rational design of new and versatile genome-editing technologies.

[00192] The CRISPR (clustered regularly interspaced palindromic repeat)-Cas system is a naturally occurring microbial adaptive immune system for defense against invading phages and other mobile genetic elements (Deveau et al., 2010; Horvath and Barrangou, 2010; Marraffini

and Sontheimer, 2010; Terns and Terns, 2011). Three types (I–III) of CRISPR-Cas systems have been functionally identified across a wide range of microbial species (Barrangou et al., 2007; Brouns et al., 2008; Marraffini and Sontheimer, 2008), each containing a cluster of CRISPR-associated (Cas) genes and its corresponding CRISPR array. These characteristic CRISPR arrays consist of repetitive sequences (direct repeats, referred to as repeats) interspaced by short stretches of non-repetitive sequences (spacers) derived from short segments of foreign genetic material (protospacers). The CRISPR array is transcribed and processed into short CRISPR RNAs (crRNAs), which direct Cas proteins to the target nucleic acids, DNA or RNA, via Watson-Crick base pairing to facilitate the nucleic acid destruction.

[00193] Type I and III CRISPR systems utilize ensembles of Cas proteins in complex with crRNA to mediate recognition and subsequent degradation of target nucleic acids (Spilman et al., 2013; Wiedenheft et al., 2011). In contrast, the Type II CRISPR system achieves recognition and cleavage of the target DNA (Garneau et al., 2010) via a single enzyme called Cas9 (Sapranauskas et al., 2011) along with two non-coding RNAs, the crRNA and a trans-activating crRNA (tracrRNA) (Deltcheva et al., 2011). The crRNA hybridizes with the tracrRNA to form a crRNA:tracrRNA duplex, which is then loaded onto Cas9 to direct cleavage of cognate DNA sequences bearing appropriate protospacer adjacent motifs (PAM) (Mojica et al., 2009).

[00194] The Type II CRISPR system was the first to be adapted for facilitating genome editing in eukaryotic cells (Cong et al., 2013; Mali et al., 2013b). The Cas9 protein from *Streptococcus pyogenes*, along with a single guide RNA (sgRNA), a synthetic fusion of crRNA and minimal tracrRNA (Jinek et al., 2012), could be programmed to instruct cleavage of virtually any sequence preceding a 5'-NGG PAM sequence in mammalian cells (Cong et al., 2013; Mali et al., 2013b). This unprecedented flexibility has enabled a broad range of applications including rapid generation of genetically modified cells and animal models (Gratz et al., 2013; Hwang et al., 2013; Wang et al., 2013; Yang et al., 2013), and genome-scale genetic screening (Qi et al., 2013; Shalem et al., 2014; Wang et al., 2014).

[00195] However, despite brisk progress in the development of the Cas9 technology, the mechanism of how the Cas9–sgRNA complex recognizes and cleaves its target DNA remains to be elucidated. Up to date, biochemical analyses at the domain levels have enabled site-specific engineering to convert the native Cas9 into a DNA nicking enzyme (Gasiunas et al., 2012; Jinek et al., 2012; Sapranauskas et al., 2011) that facilitates homology-directed repair in eukaryotic

cells (Cong et al., 2013; Mali et al., 2013b) and further cleaves DNA with improved specificity given appropriately paired sgRNAs (Mali et al., 2013a; Ran et al., 2013). Moreover, a catalytically inactive Cas9 can serve as a RNA-guided DNA-binding platform to target effector domains and modulate endogenous transcription (Gilbert et al., 2013; Konermann et al., 2013; Maeder et al., 2013; Perez-Pinera et al., 2013; Qi et al., 2013). These Cas9 engineering advances represent just the first steps of what is possible in fully realizing the potential of this flexible RNA-guided genome positioning system. A precise structural information on Cas9 will thus not only enhance the understanding of how this elegant RNA-guided microbial adaptive immune system functions, but also inform further improvements of Cas9 targeting specificity, simplification of in vitro and in vivo delivery, and engineering of Cas9 for novel functions and optimized features.

[00196] In this example, Applicants report the crystal structure of *S. pyogenes* Cas9 in complex with sgRNA and its target DNA at 2.4 Å resolution. This high-resolution structure along with functional analysis reveals the key functional interactions that integrate the guide RNA, target DNA, and Cas9 protein, paving the way towards enhancing Cas9 function as well as engineering novel applications.

[00197] Overall structure of the Cas9–sgRNA–DNA ternary complex: Applicants solved the crystal structure of full-length *S. pyogenes* Cas9 (residues 1–1368; D10A/C80L/C574E/H840A) in complex with a 98-nucleotide (nt) sgRNA and a 23-nt target DNA, at 2.4 Å resolution, by the SAD (single-wavelength anomalous dispersion) method using a SeMet-labeled protein (Fig. 15 and Table 1). To improve the solution behavior of Cas9, Applicants replaced two less conserved cysteine residues (Cys80 and Cys574) with leucine and glutamic acid, respectively. This C80L/C574E mutant retained the ability to efficiently cleave genomic DNA in human embryonic kidney 293FT (HEK293FT) cells, confirming that these mutations have no effects on Cas9 nuclease function (Fig. 16). Additionally, to prevent cleavage of the target DNA during crystallization, Applicants replaced the two catalytic residues, Asp10 from the RuvC domain and His840 from the HNH domain, with alanine.

	Native Cas9	SeMet Cas9
Data collection		
Beamline	SPring-8 BL32XU	SPring-8 BL41XU
Wavelength (Å)	1.000	0.9791

Space group	<i>P1</i>	<i>P1</i>
Cell dimensions		
<i>a</i> , <i>b</i> , <i>c</i> (Å)	76.7, 105.7, 126.8	76.2, 104.5, 125.5
α , β , γ (°)	97.7, 98.4, 100.3	97.0, 98.2, 101.1
Resolution (Å)	50–2.4	50–2.6
	(2.54–2.4)	(2.67–2.6)
R_{sym}	0.07 (1.53)	0.167 (1.96)
$I/\sigma I$	22.53 (1.45)	12.62 (1.44)
Completeness (%)	98.2 (96.3)	99.9 (99.9)
Redundancy	7.93 (7.88)	19.1 (15.9)
CC(1/2)	0.999 (0.671)	0.999 (0.736)
Refinement		
Resolution (Å)	50–2.4	
No. reflections	146,862	
$R_{\text{work}}/R_{\text{free}}$	0.241 / 0.276	
No. atoms		
Protein	19,021	
Nucleic acid	5,013	
Solvent	200	
<i>B</i> -factors		
Protein	72.6	
Nucleic acid	72.6	
Solvent	53.3	
R.m.s deviations		
Bond lengths (Å)	0.002	
Bond angles (°)	0.454	
Ramachandran plot		
Favored region	96.8%	
Allowed region	3.2%	
Outlier region	0.0%	
*Highest resolution shell is shown in parenthesis.		

[00198] The crystallographic asymmetric unit contained two Cas9–sgRNA–DNA ternary complexes (Mol A and Mol B). Although there are conformational differences between the two complexes, sgRNA and DNA are recognized by Cas9 in a similar manner. Most notably, while the HNH domain in Mol A is connected with the RuvC domain by a disordered linker, the HNH domain in Mol B is not visible in the electron density map, indicating the flexible nature of the HNH domain. Thus, Applicants first describe the structural features of Mol A unless otherwise

stated, and then discuss the structural differences between the two complexes, which suggest the conformational flexibility of Cas9.

[00199] The crystal structure revealed that Cas9 consists of two lobes, a recognition (REC) lobe and a nuclease (NUC) lobe (Fig. 8A–C). The REC lobe can be divided into three regions, a long α -helix referred to as Bridge helix (BH) (residues 60–93), the REC1 (residues 94–179 and 308–713), and REC2 (residues 180–307) domains (Fig. 8A–C). The NUC lobe consists of the RuvC (residues 1–59, 718–769, and 909–1098), HNH (residues 775–908), and PAM-interacting (PI) (residues 1099–1368) domains (Fig. 8A–C). The negatively-charged sgRNA:DNA hybrid duplex is accommodated in a positively-charged groove at the interface between the REC and NUC lobes (Fig. 8D). In the NUC lobe, the RuvC domain is assembled from the three split RuvC motifs (RuvC I–III), which interfaces with the PI domain to form a positively-charged surface that interacts with the 3' tail of the sgRNA (Fig. 8D). The HNH domain lies in between the RuvC II–III motifs and forms only a few contacts with the rest of the protein.

[00200] The REC lobe of Cas9 interacted with the repeat:anti-repeat duplex: The REC lobe comprises the REC1 and REC2 domains. REC1 adopted an elongated, α -helical structure comprising 26 α -helices ($\alpha 2$ – $\alpha 5$ and $\alpha 12$ – $\alpha 33$) and two β -sheets ($\beta 6/\beta 10$ and $\beta 7$ – $\beta 9$), whereas REC2 adopted a six-helix bundle structure ($\alpha 6$ – $\alpha 11$) (Figs. 9A and 17). A Dali search (Holm and Rosenstrom, 2010) revealed that the REC lobe did not share structural similarity with other known proteins, indicating that it is a Cas9-specific functional domain.

[00201] The REC lobe is one of the least conserved regions across the three families of Cas9 within the Type II CRISPR system (IIA, IIB and IIC) and many Cas9s contain significantly shorter REC lobes (Figs. 18, 19). Applicants hypothesized that truncations in the REC lobe could be tolerated. As expected, and consistent with the observation that the REC2 domain does not contact the bound sgRNA:DNA hybrid duplex, a Cas9 mutant lacking the REC2 domain ($\Delta 175$ –307) showed ~50% of the wild-type Cas9 activity (Fig. 9B), indicating that the REC2 domain is not critical for DNA cleavage. The lower cleavage efficiency may be attributed in part to the reduced levels of Cas9 ($\Delta 175$ –307) expression relative to that of the wild-type protein (Fig. 9C). In striking contrast, deletion of the crRNA repeat-interacting region ($\Delta 97$ –150) or tracrRNA anti-repeat-interacting region ($\Delta 312$ –409) of the REC1 domain abolished DNA cleavage activity (Fig. 9B), indicating that the recognition of the repeat:anti-repeat duplex by the REC1 domain is critical for Cas9 function.

[00202] The PAM-interacting (PI) domain confers PAM specificity: The NUC lobe contains the PI domain, which adopts an elongated structure comprising seven α -helices (α 47– α 53), a three-stranded antiparallel β -sheet (β 18– β 20), a five-stranded antiparallel β -sheet (β 21– β 23, β 26 and β 27), and two-stranded antiparallel β -sheet (β 24 and β 25) (Figs. 9D and 17). Similar to the REC lobe, the PI domain also represents a novel protein fold unique to the Cas9 family.

[00203] The locations of the bound complementary strand DNA and the active site of the RuvC domain in the present structure suggest that the PI domain is positioned to recognize the PAM sequence on the non-complementary strand of the target DNA. Applicants tested whether replacement of the *S. pyogenes* Cas9 (SpCas9; Cas9 in this study) PI domain with that of an orthologous Cas9 protein recognizing a different PAM would be sufficient to alter SpCas9 PAM specificity. The *Streptococcus thermophilus* CRISPR-3 Cas9 (St3Cas9) shares ~60% sequence identity with SpCas9; furthermore, their crRNA repeats and tracrRNAs are interchangeable (Fonfara et al., 2013). However, SpCas9 and St3Cas9 require different PAM sequences (5'-NGG for Cas9 and 5'-NGGNG for St3Cas9) for target DNA cleavage (Fonfara et al., 2013).

[00204] Applicants swapped the two PI domains to generate two chimeras, Sp-St3Cas9 (SpCas9 with the PI domain of St3Cas9) and St3-SpCas9 (St3Cas9 with the PI domain of SpCas9), and examined their cleavage activities for target DNA sequences bearing 5'-NGG PAM (5'-GGGCT) or 5'-NGGNG PAM (5'-GGGCG) (Fig. 9E). SpCas9 and St3-SpCas9, but not St3Cas9, cleaved the target DNA with 5'-NGG PAM (Fig. 9E), indicating that the PI domain of SpCas9 is required for the recognition of 5'-NGG PAM and is sufficient to alter the PAM recognition of St3Cas9. Sp-St3Cas9 retained cleavage activity for the target DNA with 5'-NGG PAM, albeit at a lower level than that of SpCas9 (Fig. 9E). Additionally, deletion of the PI domain (Δ 1099–1368) abolished the cleavage activity (Fig. 9E), indicating that the PI domain is critical for Cas9 function. These results reveal that the PI domain is a major determinant of PAM specificity.

[00205] The RuvC domain targets the non-complementary strand DNA: The RuvC domain consists of a six-stranded mixed β -sheet (β 1, β 2, β 5, β 11, β 14 and β 17) flanked by α -helices (α 34, α 35 and α 40– α 46) and two additional two-stranded antiparallel β -sheets (β 3/ β 4 and β 15/ β 16) (Figs. 10A and 17). It shares structural similarity with retroviral integrase superfamily members characterized by an RNase H fold, such as *Escherichia coli* RuvC (PDB code 1HJR,

13% identity, root-mean-square deviation (rmsd) of 3.4 Å for 123 equivalent C α atoms) (Ariyoshi et al., 1994) and *Thermus thermophilus* RuvC (PDB code 4LD0, 17% identity, rmsd of 3.4 Å for 129 equivalent C α atoms) (Ariyoshi et al., 1994) and *Thermus thermophilus* RuvC (PDB code 4LD0, 17% identity, rmsd of 3.4 Å for 129 equivalent C α atoms) (Gorecka et al., 2013) (Fig. 10B). RuvC nucleases have four catalytic residues (e.g., Asp7, Glu70, His143 and Asp146 in *T. thermophilus* RuvC), and cleave Holliday junctions through a two-metal mechanism (Ariyoshi et al., 1994; Chen et al., 2013; Gorecka et al., 2013). Asp10 (Ala), Glu762, His983 and Asp986 of the Cas9 RuvC domain are located at positions similar to those of the catalytic residues of *T. thermophilus* RuvC (Fig. 10A, B), consistent with the previous results that the D10A mutation abolished cleavage of the non-complementary DNA strand and that Cas9 requires Mg²⁺ ions for cleavage activity (Gasiunas et al., 2012; Jinek et al., 2012). Moreover, alanine substitution of Glu762, His983 or Asp986 also converted Cas9 into nickases (Fig. 10C, D). Each nickase mutant was able to facilitate targeted double strand breaks using pairs of juxtaposed sgRNAs (Fig. 10C, D), as demonstrated with the D10A nickase previously (Ran et al., 2013). This combination of structural observations and mutational analysis suggest that the Cas9 RuvC domain cleaves the non-complementary strand of the target DNA through the two-metal mechanism previously observed for other retroviral integrase superfamily nucleases.

[00206] It is important to note that there are key structural dissimilarities between the Cas9 RuvC domain and RuvC nucleases, explaining their functional differences. Unlike the Cas9 RuvC domain, RuvC nucleases forms a dimer and recognize a Holliday junction (Gorecka et al., 2013) (Fig. 10B). In addition to the conserved RNase H fold, the RuvC domain of Cas9 has additional structural elements involved in the interactions with the guide:DNA duplex (an end-capping loop between α 43 and α 44), and the PI domain/stem loop 3 (β -hairpin formed by β 3 and β 4) (Fig. 10A).

[00207] The HNH domain targets the complementary strand DNA: The HNH domain comprises a two-stranded antiparallel β -sheet (β 12 and β 13) flanked by four α -helices (α 36– α 42) (Fig. 10E). Likewise, it shares structural similarity with HNH endonucleases characterized by a $\beta\beta\alpha$ -metal fold, such as the phage T4 endonuclease VII (Endo VII) (Biertumpfel et al., 2007) (PDB code 2QNC, 8% identity, rmsd of 2.6 Å for 60 equivalent C α atoms) (Fig. 10F) and *Vibrio vulnificus* nuclease (Li et al., 2003) (PDB code 1OUP, 8% identity, rmsd of 2.9 Å for 78

equivalent C α atoms). HNH nucleases have three catalytic residues (e.g., Asp40, His41, and Asn62 in Endo VII), and cleave nucleic acid substrates through a single-metal mechanism (Biertumpfel et al., 2007; Li et al., 2003). In the structure of the Endo VII N62D mutant in complex with a Holliday junction, a Mg²⁺ ion is coordinated by Asp40, Asp62, and oxygen atoms of the scissile phosphate group of the substrate, while His41 acts as a general base to activate a water molecule for catalysis (Fig. 10F). Asp839, His840, and Asn863 of the Cas9 HNH domain correspond to Asp40, His41, and Asn62 of Endo VII, respectively (Fig. 10E), consistent with the observation that His840 is critical for the cleavage of the complementary DNA strand (Gasiunas et al., 2012; Jinek et al., 2012). The N863A mutant functions as a nickase (Fig. 10C, D), indicating that Asn863 participates in catalysis. These observations suggest that the Cas9 HNH domain may cleave the complementary strand of the target DNA through a single-metal mechanism as observed for other HNH superfamily nucleases. However, in the present structure, Asn863 of Cas9 is located at a position different from that of Asn62 in Endo VII (Biertumpfel et al., 2007), whereas Asp839 and His840 (Ala) of Cas9 are located at positions similar to those of Asp40 and His41 of Endo VII, respectively (Fig. 10E, F). This might be due to the absence of divalent ions, such as Mg²⁺, in Applicants' crystallization solution, suggesting that Asn863 can point towards the active site and participate in catalysis. Whereas the HNH domain shares a $\beta\beta\alpha$ -metal fold with other HNN endonuclease, their overall structures are different (Fig. 10E, F), consistent with the differences in their substrate specificities.

[00208] sgRNA recognizes target DNA via Watson-Crick base pairing: The sgRNA consists of crRNA- and tracrRNA-derived sequences connected by an artificial tetraloop (Fig. 11A). The crRNA sequence can be subdivided into guide (20-nt) and repeat (12-nt) regions, and the tracrRNA sequence likewise into anti-repeat (14-nt) and three tracrRNA stem loops (Fig. 11A). The crystal structure reveals that the sgRNA binds the target DNA to form a T-shaped architecture comprising a guide:DNA duplex, repeat:anti-repeat duplex and stem loops 1–3 (Fig. 11A, B). The repeat:anti-repeat duplex and stem loop 1 are connected by a single nucleotide (A51), and stem loops 1 and 2 are connected by a 5-nt single-stranded linker (nucleotides 63–67).

[00209] The guide (nucleotides 1–20) and target DNA (nucleotides 3'–23') form the guide:DNA hybrid duplex via 20 Watson-Crick base pairs, with the conformation of the duplex distorted from a canonical A-form RNA duplex (Figs. 11B and 20). The crRNA repeat

(nucleotides 21–32) and tracrRNA anti-repeat (nucleotides 37–50) form the repeat:anti-repeat duplex via nine Watson-Crick base pairs (U22:A49–A26:U45 and G29:C40–A32:U37) (Fig. 11A, B). Within this region, G27, A28, A41, A42, G43, and U44 are unpaired, with A28 and U44 flipped out from the duplex (Fig. 11C). The nucleobases of G27 and A41 stack with the A26:U45 and G29:C40 pairs, respectively, and the 2-amino group of G27 interacts with the backbone phosphate group between G43 and U44, stabilizing the duplex structure (Fig. 11C). G21 and U50 form a wobble base pair at the three-way junction between the guide:DNA/repeat:anti-repeat duplexes and stem loop 1, stabilizing the T-shaped architecture (Fig. 11C).

[00210] As expected from the RNA-fold predictions of the nucleotide sequence, the tracrRNA 3' tail (nucleotides 68–81 and 82–96) form stem loops 2 and 3 via four and six Watson-Crick base pairs (A69:U80–U72:A77 and G82:C96–G87:C91), respectively (Fig. 11A, B). Previously unappreciated, nucleotides 52–62 also form a stem loop (stem loop 1) via three Watson-Crick base pairs (G53:C61, G54:C60 and C55:G58), with U59 flipped out from the stem (Fig. 11A, B). Stem loop 1 is stabilized by the G62–G53:C61 stacking interaction and the G62–A51/A52 polar interactions (Fig. 11C).

[00211] The guide:DNA and repeat:anti-repeat duplexes are accommodated and deeply buried in a positively-charged groove at the interface of the two lobes, while the rest of the sgRNA extensively interacts with the positively-charged surface on the back side of the protein (Fig. 8D). In Mol A, the 3'-terminal bases of the target DNA (3'-ACC complementary to the PAM) are not visible in the electron density map. In contrast, the two adjacent bases (3'-AC) in Mol B are not recognized by Cas9, although they are structurally ordered due to the crystal packing interactions and are visible in the electron density map. These observations suggest that the 3'-ACC sequence complementary to the PAM (5'-TGG) is not recognized by Cas9, consistent with the previous biochemical data demonstrating that Cas9-catalyzed DNA cleavage requires the 5'-NGG PAM on the non-complementary strand, but not the 3'-NCC sequence on the complementary strand (Jinek et al., 2012).

[00212] Previous studies showed that although sgRNA with a 48-nt tracrRNA tail (referred to as sgRNA(+48)) is a minimal region for the Cas9-catalyzed DNA cleavage *in vitro* (Jinek et al., 2012), sgRNAs with extended tracrRNA tails, sgRNA(+67) and sgRNA(+85), dramatically improved Cas9 cleavage activity *in vivo* (Hsu et al., 2013). The present structure revealed that

sgRNA(+48), sgRNA(+67) and sgRNA(+85) contain stem loop 1, stem loops 1–2 and stem loops 1–3, respectively (Fig. 11A, B). These observations indicated that, whereas stem loop 1 is essential for the formation of the functional Cas9-sgRNA complex, stem loops 2 and 3 further support the stable complex formation as well as enhance sgRNA stability, thus improving the *in vivo* activity.

[00213] To confirm the significance of each sgRNA structural component on Cas9 function, Applicants tested a number of sgRNAs with mutations in the repeat:anti-repeat duplex, stem loops 1–3, and the linker between stem loops 1 and 2. Applicants' results revealed that, whereas stem loops 2 and 3 as well as the linker region can tolerate a large number of mutations, the repeat:anti-repeat duplex and stem loop 1 are critical for Cas9 function (Fig. 11D). Moreover, the sgRNA sequence can tolerate a large number of mutations (Fig. 11D, reconstructed sgRNA). These results highlight the functional significance of the structure-dependent recognition of the repeat:anti-repeat duplex by Cas9.

[00214] Conserved arginine cluster on Bridge helix play a critical role in sgRNA:DNA interaction: The crRNA guide region is primarily recognized by the REC lobe (Fig. 12A). The backbone phosphate groups of the crRNA guide region (nucleotides 4–6 and 13–20) interact with the REC1 domain (Arg165, Gly166, Arg403, Asn407, Lys510, Tyr515 and Arg661) and Bridge helix (Ala59, Arg63, Arg66, Arg70, Arg71, Arg74 and Arg78) (Fig. 12B), and the 2'-hydroxyl groups of C15, U16 and G19 hydrogen bond with Tyr450, Arg447/Ile448 and Thr404 in the REC1 domain (Fig. 12B), respectively. These observations suggested that the Watson-Crick faces of eight PAM-proximal nucleotides of the Cas9-bound sgRNA are exposed to the solvent, thus serving as a nucleation site for pairing with the target complementary strand. This is consistent with previous reports that the 10–12 bp PAM-proximal "seed" region is critical for Cas9-catalyzed DNA cleavage (Cong et al., 2013; Fu et al., 2013; Hsu et al., 2013; Jinek et al., 2012; Mali et al., 2013a; Pattanayak et al., 2013).

[00215] Mutational analysis demonstrated that the R66A, R70A and R74A mutations on Bridge helix markedly reduced DNA cleavage activities (Fig. 12C), highlighting the functional significance of the recognition of the sgRNA "seed" region by the Bridge helix. Although Arg78 and Arg165 also interact with the "seed" region, the R78A and R165A mutants showed only moderately decreased activities (Fig. 12C). These results may reflect that, whereas Arg66, Arg70 and Arg74 form bifurcated salt bridges with the sgRNA backbone, Arg78 and Arg165 form a

single salt bridge with the sgRNA backbone. A cluster of arginine residues on the Bridge helix are highly conserved among Cas9 proteins in the Type II-A–C systems (Figs. 18, 19), suggesting that the Bridge helix is a universal structural feature of Cas9 proteins involved in recognition of the sgRNA and target DNA. This notion is supported by a previous observation that a strictly conserved arginine residue, equivalent to Arg70 of *S. pyogenes* Cas9, is essential for the function of *Francisella novicida* Cas9 in the Type II-B system (Sampson et al., 2013). Moreover, the alanine mutation of the repeat:anti-repeat duplex-interacting residues (Arg75 and Lys163) and stem loop 1-interacting residue (Arg69) resulted in decreased DNA cleavage activity (Fig. 12C), confirming the functional importance of the recognition of the repeat:anti-repeat duplex and stem loop 1 by Cas9.

[00216] The crRNA guide region is recognized by Cas9 in a sequence-independent manner except for the U16–Arg447 and G18–Arg71 interactions (Fig. 12A, B). This base-specific G18–Arg71 interaction may partly explain the observed preference of Cas9 for sgRNAs having guanines in the four PAM-proximal guide sequences (Wang et al., 2014).

[00217] The REC1 and RuvC domains facilitate RNA-guided DNA targeting: Cas9 recognizes the 20-bp DNA target site in a sequence-independent manner (Fig. 12A). The backbone phosphate groups of the target DNA (nucleotides 1', 9'–11', 13', and 20') interact with the REC1 (Asn497, Trp659, Arg661 and Gln695), RuvC (Gln926), and PI (Glu1108) domains. The C2' atoms of the target DNA (nucleotides 5', 7', 8', 11', 19', and 20') form van der Waals interactions with the REC1 domain (Leu169, Tyr450, Met495, Met694 and His698) and RuvC domain (Ala728) (Fig. 12D). These interactions are likely to contribute towards discriminating between DNA vs. RNA targets by Cas9. The terminal base pair of the guide:DNA duplex (G1:C20') is recognized by the RuvC domain via end-capping interactions (Fig. 12D); the nucleobases of sgRNA G1 and target DNA C20' interact with the side chains of Tyr1013 and Val1015, respectively, whereas the 2'-hydroxyl and phosphate groups of sgRNA G1 interact with Val1009 and Gln926, respectively. These end-capping interactions are consistent with the previous observation that Cas9 recognizes a 17–20-bp guide:DNA duplex, and that extended guide sequences are degraded in cells and do not contribute to improving sequence specificity (Mali et al., 2013a; Ran et al., 2013). Taken together, these structural findings explain the RNA-guided DNA targeting mechanism of Cas9.

[00218] The repeat:anti-repeat duplex is recognized by the REC and NUC lobes in a sequence-dependent manner: The repeat:anti-repeat duplex is extensively recognized by the REC and NUC lobes (Fig. 12A). The backbone phosphate groups of the crRNA repeat (nucleotides 24, 26, and 27) and anti-repeat (nucleotides 41, 45, 46, and 48–50) interact with the REC1 domain (Arg115, His116, His160, Lys163, Arg340, and Arg403), PI domain (Lys1113), and Bridge helix (Lys76) (Fig. 12E, F). The 2'-hydroxyl groups of the crRNA repeat (nucleotides 22–24) and anti-repeat (nucleotides 43–45 and 47) hydrogen bond with the REC1 domain (Leu101, Ser104, Phe105, Ile135, Tyr359, and Gln402) and the PI domain (Ile1110 and Tyr1131).

[00219] In contrast to the sequence-independent recognition of the guide region, there are sequence-dependent interactions between Cas9 and the repeat:anti-repeat duplex. The nucleobase of the flipped U44 is sandwiched between the side chains of Tyr325 and His328, with its N3 atom hydrogen bonded with the carbonyl group of Tyr325, while that of unpaired G43 stacks with the side chain of Tyr359 and hydrogen bonds with the side chain of Asp364 (Fig. 12A, F). Finally, the nucleobases of U23/A49 and A42/G43 hydrogen bond with the side chain of Arg1122 and the main-chain carbonyl group of Phe351, respectively.

[00220] In the present structure, the repeat:anti-repeat duplex is recognized primarily by the REC lobe, which is divergent in sequence and length among Cas9 orthologs within the Type II-A–C systems (Figs. 18, 19), consistent with the previous observation that Cas9 and sgRNA are interchangeable only between closely related Type II systems (Fonfara et al., 2013). The three PAM-distal base pairs (C30:G39–A32:U37) are not recognized by Cas9 and protrude from the complex (Fig. 12A), consistent with a proposed model in which a Cas9-bound repeat:anti-repeat duplex is processed by the host RNase III enzyme (Deltcheva et al., 2011).

[00221] The nucleobases of G21 and U50 in the G21:U50 wobble pair stack with the terminal C20:G1' pair in the guide:DNA duplex and the side chain of Tyr72 on Bridge helix, respectively, with the U50 O4 atom hydrogen bonded with the side chain of Arg75 (Fig. 12E). Notably, A51 adopts the syn-conformation, and is oriented in the direction opposite to U50 (Figs. 11C and 12G). The nucleobase of A51 is sandwiched between the Phe1105 side chain in the PI domain and the U63 nucleobase in the linker, with its N7 and N1 atoms hydrogen bonded with the main-chain amide group of Phe1105 and the G62 2'-hydroxyl group in stem loop 1, respectively (Fig. 12G). Whereas a repeat:anti-repeat duplex is diverse in sequence and length among the Type II-

A–C systems, the G21:U50 base pair is highly conserved among Cas9s (Fonfara et al., 2013), suggesting that this wobble pairing is a universal structural feature involved in the three-way junction formation.

[00222] To verify the sequence-dependent recognition of the repeat:anti-repeat duplex, Applicants evaluated the effect of repeat:anti-repeat mutations on Cas9-mediated DNA cleavage, and found multiple mutations that significantly reduce Cas9 activity (Fig. 12C). Notably, replacement of G43, which forms a base-specific hydrogen bond with Asp364, with adenine reduced Cas9 activity by over 3-fold. In addition, replacement of the flipped U44 in the repeat:anti-repeat duplex with adenine resulted in over a 5-fold drop in cleavage activity, whereas replacement of U44 with another pyrimidine base (cytosine) did not significantly affect cleavage activity (Fig. 12C). These results suggest that base-specific recognition of G43 and U44 could play an important role in sgRNA recognition by Cas9.

[00223] sgRNA stem loops 1–3 interact with Cas9: Stem loop 1 is primarily recognized by the REC lobe together with the PI domain (Fig. 12A). The backbone phosphate groups of stem loop 1 (nucleotides 52, 53, and 59–61) interact with the REC1 domain (Leu455, Ser460, Arg467, Thr472, and Ile473), PI domain (Lys1123 and Lys1124), and Bridge helix (Arg70 and Arg74), with the 2'-hydroxyl group of G58 hydrogen bonded with Leu455 in the REC1 domain. A52 interacts with Phe1105 through a face-to-edge π - π stacking interaction (Fig. 12G), and the flipped U59 nucleobase hydrogen bonds with the side chain of Asn77 (Fig. 12H).

[00224] Stem loops 2 and 3, and the single-stranded linker are primarily recognized by the NUC lobe (Fig. 12A); this contrasts with stem loop 1 and the guide:DNA/repeat:anti-repeat duplexes, which are recognized by both of the NUC and REC lobes. The backbone phosphate groups of the linker (nucleotides 63–65 and 67) interact with the RuvC domain (Glu57, Lys742, and Lys1097), PI domain (Thr1102), and Bridge helix (Arg69), with the 2'-hydroxyl groups of U64 and A65 hydrogen bonded with Glu57 and His721, respectively (Fig. 12D). The nucleobase of C67 hydrogen bonds with the main-chain amide group of Val1100 (Fig. 12I).

[00225] Stem loop 2 is recognized by Cas9 via the interactions between the NUC lobe and the non-Watson-Crick A68:G81 pair, which is formed by direct (between the A68 N6 and G81 O6 atoms) and water-mediated (between the A68 N1 and G81 N1 atoms) hydrogen-bonding interactions (Fig. 12J). The nucleobases of A68 and G81 contact the side chains of Ser1351 and Tyr1356, respectively, with the A68:G81 pair recognized by Thr1358 via a water-mediated

hydrogen bond (Fig. 12J). The 2'-hydroxyl group of A68 hydrogen bonds with the side chain of His1349, and the 2-amino group of G81 hydrogen bonds with the main-chain carbonyl group of Lys33 (Fig. 12J).

[00226] Stem loop 3 interacts with the NUC lobe more extensively relative to stem loop 2 (Fig. 12K). The backbone phosphate groups of C91 and G92 interact with the RuvC domain (Arg40 and Lys44) (Fig. 12K), while the nucleobases of G89 and U90 hydrogen bond with Gln1272 and Glu1225/Ala1227, respectively (Fig. 12K). The nucleobases of A88 and C91 are recognized by the side chain of Asn46 via multiple hydrogen-bonding interactions (Fig. 12K).

[00227] Structural flexibility of Cas9 and sgRNA: Although the HNH domain cleaves the complementary strand of the target DNA at a position three nucleotides upstream of the PAM sequence (Gasiunas et al., 2012; Jinek et al., 2012), in the present structure the HNH domain is positioned away from the scissile phosphate group of the bound complementary strand (Fig. 13A). A structural comparison of Mol A and Mol B provided mechanistic insights into the complementary strand cleavage by the HNH domain. In Mol A, the HNH domain is followed by the $\alpha 40$ helix of the RuvC domain, which is connected with the $\alpha 41$ helix by an $\alpha 40$ - $\alpha 41$ linker (residues 919-925) (Fig. 13A). Whereas in Mol A residues 913-925 form the C-terminal portion of the $\alpha 43$ helix and $\alpha 43$ - $\alpha 44$ linker, in Mol B these residues form an extended α -helix, which is directed toward the cleavage site of the complementary strand (Fig. 13A). These observations suggest that the HNH domain can approach and cleave the target DNA through conformational changes in the segment connecting the HNH and RuvC domains.

[00228] Moreover, the structural comparison revealed a conformational flexibility between the REC and NUC lobes (Fig. 13B). Compared to Mol A, Mol B adopts a more open conformation, in which the two lobes are rotated by 15° at a hinge loop between Bridge helix and the strand $\beta 5$ in the RuvC domain (Fig. 13B). The bound sgRNA also undergoes an accompanying conformational change at the single-stranded linker, which interacts with the hinge loop (Fig. 13C). Applicants also observed an accompanying displacement of the $\beta 17$ - $\beta 18$ loop of the PI domain, which interacts with the repeat:anti-repeat duplex and the $\alpha 2$ - $\alpha 3$ loop of the REC1 domain (Fig. 13B). Notably, there is no direct contact between the two lobes in the present structure, except for the interactions between the $\alpha 2$ - $\alpha 3$ and $\beta 17$ - $\beta 18$ loops (Fig. 13D),

suggesting that Cas9 is highly flexible in the absence of the sgRNA. The flexible nature of Cas9 is likely to play a role in the assembly of the Cas9–sgRNA–DNA ternary complex.

[00229] The crystal structure of Cas9 in complex with guide RNA and target DNA reveals that the 20-bp heteroduplex formed by the crRNA guide region and the complementary strand of the target DNA is accommodated in the positively-charged groove at the interface between the REC and NUC lobes of Cas9, with the scissile phosphate group of the target properly positioned for cleavage by the HNH domain. Although the present structure does not contain the non-complementary DNA strand, the position of the bound complementary strand suggests that the scissile phosphate of the non-complementary strand is located in the vicinity of the active site of the RuvC domain, consistent with previous biochemical data (Gasiunas et al., 2012; Jinek et al., 2012). Furthermore, Applicants' structural and functional analyses indicate that the PI domain participates in the recognition of the PAM sequence of the non-complementary strand.

[00230] Based on these observations, Applicants propose a model for the Cas9-catalyzed RNA-guided DNA cleavage (Fig. 14). Cas9 recognizes the PAM-proximal guide region and repeat:anti-repeat duplex of sgRNA to form a Cas9–sgRNA binary complex. The binary complex subsequently recognizes the DNA sequence complementary to the 20-nt guide region of the bound sgRNA, forming the final Cas9–sgRNA–target DNA ternary complex. During the ternary complex formation, the PI domain recognizes the PAM sequence of the non-complementary strand, facilitating the R-loop formation. Upon assembly of the ternary complex, the mobile HNH domain approaches and cleaves the complementary strand in the guide:DNA duplex, whereas the RuvC domain cleaves the single-stranded, non-complementary strand.

[00231] Applicants' crystal structure provides a critical step towards understanding the molecular mechanism of RNA-guided DNA targeting by Cas9. Further structural and functional studies with *S. pyogenes* Cas9 or related orthologs, including the structural determination of the Cas9–sgRNA–DNA ternary complex containing the non-complementary strand, may be important for illuminating details such as Cas9-mediated recognition of PAM sequences on the target DNA or mismatch tolerance between the sgRNA:DNA duplex. However, the present structural and functional analyses already provide a useful scaffold for rational engineering of Cas9-based genome modulating technologies. Applicants reported, for example, an *S. pyogenes* Cas9 truncation mutant (Fig. 9B) that will facilitate packaging of Cas9 into size-constrained viral vectors for *in vivo* and therapeutic applications. Similarly, future engineering of the PI domain

allows for programming of PAM specificity, improving target site recognition fidelity, and increasing the versatility of the Cas9 genome engineering platform.

[00232] Experimental Procedures

Protein preparation: The gene encoding full-length *S. pyogenes* Cas9 (residues 1–1368) was cloned between the *NdeI* and *XhoI* sites of the modified pCold-GST vector (TaKaRa). The protein was expressed at 20°C in *Escherichia coli* Rosetta 2 (DE3) (Novagen), and was purified by Ni-NTA Superflow resin (QIAGEN). The eluted protein was incubated overnight at 4°C with TEV protease to remove the GST-tag, and further purified by chromatography on Ni-NTA, Mono S (GE Healthcare) and HiLoad Superdex 200 16/60 (GE Healthcare) columns. The SeMet-labeled protein was prepared using a similar protocol for the native protein. The sgRNA was *in vitro* transcribed by T7 polymerase using a PCR-amplified template, and was purified on 10% denaturing polyacrylamide gel electrophoresis. The target DNA was purchased from Sigma-Aldrich. The purified Cas9 protein was mixed with sgRNA and DNA (molar ratio 1:1.5:2), and then the complex was purified using a Superdex 200 Increase column (GE Healthcare) in a buffer containing 10 mM Tris-HCl, pH 8.0, 150 mM NaCl and 1 mM DTT.

[00233] Crystallography: The purified Cas9–sgRNA–DNA complex was crystallized at 20°C by the hanging-drop vapor diffusion method. Crystals were obtained by mixing 1 µl of complex solution ($A_{260\text{ nm}} = 15$) and 1 µl of reservoir solution (12% PEG 3,350, 100 mM Tris-HCl, pH 8.0, 200 mM ammonium acetate, 150 mM NaCl and 100 mM NDSB-256). The SeMet-labeled protein was crystallized under conditions similar to those for the native protein. X-ray diffraction data were collected at 100 K on the beamlines BL32XU and BL41XU at SPring-8 (Hyogo, Japan). The crystals were cryoprotected in reservoir solution supplemented with 25% ethylene glycol. X-ray diffraction data were processed using XDS (Kabsch, 2010). The structure was determined by the SAD method, using the 2.8 Å resolution data from the SeMet-labeled crystal. Forty of the potential 44 Se atoms were located using SHELXD (Sheldrick, 2008) and autoSHARP (deLaFortelle and Bricogne, 1997). The initial phases were calculated using autoSHARP, and further improved by 2-fold NCS averaging using DM (Winn et al., 2011). The model was automatically built using PHENIX AutoSol (Adams et al., 2002), followed by manual model building using COOT (Emsley and Cowtan, 2004) and refinement using PHENIX (Adams et al., 2002). The resulting model was further refined using for native 2.4 Å resolution data.

[00234] Cell culture and transfection: Human embryonic kidney (HEK) cell line 293FT (Life Technologies) or mouse Neuro 2a (Sigma-Aldrich) cell line was maintained in Dulbecco's modified Eagle's Medium (DMEM) supplemented with 10% fetal bovine serum (HyClone), 2 mM GlutaMAX (Life Technologies), 100 U/ml penicillin, and 100 µg/ml streptomycin at 37°C with 5% CO₂ incubation. Cells were seeded onto 24-well plates (Corning) at a density of 120,000 cells/well, 24 h prior to transfection. Cells were transfected using Lipofectamine 2000 (Life Technologies) at 70–80% confluency following the manufacturer's recommended protocol. A total of 400 ng Cas9 plasmid and 100 ng of U6::sgRNA PCR product was transfected.

[00235] SURVEYOR nuclease assay for genome modification: 293FT cells were transfected with DNA as described above. Cells were incubated at 37°C for 72 h post-transfection prior to genomic DNA extraction. Genomic DNA was extracted using the QuickExtract DNA Extraction Solution (Epicentre) following the manufacturer's protocol. Briefly, pelleted cells were resuspended in QuickExtract solution and incubated at 65°C for 15 min, 68°C for 15 min, and 98°C for 10 min.

[00236] The genomic region flanking the CRISPR target site for each gene was PCR amplified, and products were purified using QiaQuick Spin Column (Qiagen) following the manufacturer's protocol. 400 ng total of the purified PCR products were mixed with 2 µl 10X Taq DNA Polymerase PCR buffer (Enzymatics) and ultrapure water to a final volume of 20 µl, and subjected to a re-annealing process to enable heteroduplex formation: 95°C for 10 min, 95°C to 85°C ramping at – 2°C/s, 85°C to 25°C at – 0.25°C/s, and 25°C hold for 1 min. After re-annealing, products were treated with SURVEYOR nuclease and SURVEYOR enhancer S (Transgenomics) following the manufacturer's recommended protocol, and analyzed on 4–20% Novex TBE poly-acrylamide gels (Life Technologies). Gels were stained with SYBR Gold DNA stain (Life Technologies) for 30 min and imaged with a Gel Doc gel imaging system (Bio-rad). Quantification was based on relative band intensities. Indel percentage was determined by the formula, $100 \times (1 - (1 - (b + c) / (a + b + c))^{1/2})$, where *a* is the integrated intensity of the undigested PCR product, and *b* and *c* are the integrated intensities of each cleavage product.

[00237] Western blot: HEK 293FT cells were transfected and lysed in 1X RIPA buffer (Sigma-Aldrich) supplemented with Protease Inhibitor (Roche). Lysates were loaded onto Bolt 4–12% Bis-Tris Plus Gel (Invitrogen) and transferred to nitrocellulose membranes. Membranes were blocked in Tris-buffered saline containing 0.1% Tween-20 and 5% blocking agent (G-

Biosciences). Membrane was probed with rabbit anti-FLAG (1:5000, Abcam), HRP-conjugated anti-GAPDH (1:5,000 Cell Signaling Technology), and HRP-conjugated anti-rabbit (1:1000). Blots were visualized on Gel Doc XR+ System (Bio-rad).

[00238] Sequence Information:

Italic: 3XFLAG sequence

Underlined: NLS sequences

Wildtype SpCas9

ATGGACTATAAGGACCAGCAGCGAGACTACAAGGATCATGATATTGATTACAAAGACGATGACGATAAGATGGCCCCAAAGAAGAAGCGGAAG
GTCCGGTATCCACCGAGTCCACAGCCGACAAGAAGTACAGCATCGGCCTGGACATCGGCACCAACTCTGTGGGCTGGGCCGTGATCACCGAC
GAGTACAAGGTGCCAGCAAGAAATTCAGGGTCTGGGCAACACCGACCGGCACAGCATCAAGAAGAACCCTGATCGGAGCCCTGCTGTTGAC
AGCGGCGAAACAGCCGAGGCCACCCGGCTGAAGAGAACCGCCAGAAGAAGATACACCAGACGGGAAGAACCCGGATCTGCTATCTGCAAGAGATC
TTCAGCAACGAGATGGCCAAGGTGGACGACAGCTTCTTCCACAGACTGGAAGAGTCTTCTGTTGGAAGAGGATAAGAAGCAGGAGCGGCAC
CCCATCTTCGGCAACATCGTGGACGAGGTGGCCTACCAGGAGAAGTACCCACCATCTACCACCTGAGAAAGAAACTGGTGGACAGCACCAGC
AAGGCCGACCTGCGCTGATCTATCTGGCCTGGCCACATGATCAAGTTCGGGGCCACTTCTGATCGAGGGCGACCTGAACCCCGACAAC
AGCGACGTGGACAAGCTGTTTCATCCAGCTGGTGCAGACCTACAACCAGCTGTTTCGAGGAAAACCCCATCAACGCCAGCGGCGTGGACGCCAAG
GCCATCTGTCTGCCAGACTGAGCAAGAGCAGACGGCTGGAAAATCTGATCGCCAGCTGCCCGCGAGAAGAAGAATGGCCTGTTCCGCAAC
CTGATTGCCCTGAGCCTGGCCCTGACCCCAACTTCAAGAGCAACTTCGACCTGGCCGAGGATGCCAACTGCAGCTGAGCAAGGACACCTAC
GACGACGACCTGGACAACCTGCTGGCCAGATCGGCGACAGTACGCCGACCTGTTTCTGGCCGCAAGAACCCTGTCGACGCCATCCTGCTG
AGCGACATCCTGAGAGTGAACACCGAGATCACCAAGGCCCCCTGAGCGCCTCTATGATCAAGAGATACGACGAGCACCACCAGGACCTGACC
CTGCTGAAAAGCTCTCGTCCCGCAGCAGCTGCCCTGAGAAGTACAAGAGATTTTCTTCGACCAGCAAGAACCGGTACGCCGGCTACATTGAC
GGCGGAGCCAGCCAGGAAGAGTTCACAAGTTCATCAAGCCATCCTGGAAAAGATGGACGGCACCAGGAACTGCTCGTGAAGCTGAACAGA
GAGGACCTGCTGCCAAGCAGCGGACCTTCGACAACCGGACGATCCCCACCAGATCCACCTGGGAGAGCTGCACGCCATTCTCGCGCGCAG
GAAGATTTTACCCATTCTGAAGGACAACCGGAAAAGATCGAGAAGATCCTGACCTTCGGCATCCCCTACTACGTGGGCCCTCTGGCCAGG
GGAAACAGCAGATTCGCCTGGATGACCAGAAAGAGCGGAGGAAACCATCACCCCTGGAACTTCGAGGAAGTGGTGGACAAGGGCGCTTCGCC
CAGAGCTTCATCGAGCGGATGACCAACTTCGATAAGAACCCTGCCAACGAGAAGGTGCTGCCAACGACAGCCTGCTGTACGAGTACTTCACC
GTGTATAACGAGCTGACCAAAGTGAATAACGTGACCGAGGGAATGAGAAAGCCCGCCTTCTGAGCGGCGAGCAGAAAAAGGCCATCGTGGAC
CTGCTGTTCAAGACCAACCGAAAAGTGAACGTGAAGCAGCTGAAAGAGGACTACTTCAAGAAAATCGAGTCTTCCACTCCGTTGAAAATCTCC
GGCGTGGAAAGATCGGTTCAACGCCTCCCTGGGCACATACCACGATCTGCTGAAAATTATCAAGGACAAGGACTTCTGGACAATGAGGAAAAC
GAGGACATTCTGGAAGATATCGTGTGACCCCTGACACTGTTTGGAGACAGAGAGATGATCGAGGAACCGGCTGAAAACCTATGCCACCTGTT
GACGACAAGTGTGAAGCAGCTGAAGCGGGGAGATACACCGGCTGGGGCAGGCTGAGCCGGAAGCTGATCAACGGCATCCGGGACAAGCAG
TCCGGCAAGACAATCCTGGATTTCTGAAGTCCGACGGCTTCGCCAACAGAAAACCTCATGCAGCTGATCCACGACGACAGCCTGACCTTTAAA
GAGGACATCCAGAAAGCCAGGTGTCCGGCCAGGGCGATAGCCTGCACGAGCACATTGCCAATCTGGCCGCGACCCCGCATTAAAGAAGGGC
ATCCTGCAGACAGTGAAGGTGGTGGACGAGCTCGTGAAGTGTGGCCCGGCACAAGCCGAGAACATCGTGATCGAAATGGCCAGAGAGAAC
CAGACCACCCAGAAGGGACAGAAGAACAGCCGCGAGAGAATGAAGCGGATCGAAGAGGGCATCAAGAGCTGGGCAGCCAGATCCTGAAAGAA
CACCCCGTGGAAAACACCCAGCTGCAGAACGAGAAGCTGTACCTGTACTACCTGCAGAATGGCCGGGATATGTACGTGGACCAGGAACCTGGAC
ATCAACCGGCTGTCCGACTACGATGTGGACCATATCGTGCCTCAGAGCTTTCTGAAGGACGACTCCATCGACAACAAGGTGCTGACCAGAAGC
GACAAGAACCGGGCAAGAGCGACAACCTGCCCTCCGAAGAGGTGCTGAAGAAGATGAAGAACTACTGGCGGCAGCTGCTGAACGCCAAGCTG
ATTACCCAGAGAAAGTTTCGACAATCTGACCAAGGCCGAGAGAGGGCGCCTGAGCGAACTGGATAAGGCCGGCTTCATCAAGAGACAGCTGGT
GAAACCCGGCAGATCACAAGCAAGTGGCACAGATCCTGGACTCCCGGATGAACACTAAGTACGACGAGAATGACAAGCTGATCCGGGAAGTG
AAAGTGTACCCCTGAAGTCCAAGCTGGTGTCCGATTTCCGGAAGGATTTCCAGTTTACAAAGTGCAGGAGATCAACAACCTACCACCAGCC
CACGACGCCCTACCTGAACGCCGTGTTGGAAACCGCCTGATCAAAAAGTACCCTAAGCTGGAAAGCGAGTTCGTTACGGCGACTACAAGGTG
TACGACGTGCGGAAGATGATCGCCAAGAGCGAGCAGGAAATCGGCAAGGCTACCGCAAGTACTTCTTCTACAGCAACATCATGAACTTTTTC
AAGACCGAGATTACCTGGCCAACGGCGAGATCCGGAAGCGGCTCTGATCGAGACAAACGGCGAAAACCGGGGAGATCGTGTGGATAAGGGC
CGGGATTTTCCACCGTGGGAAAAGTCTGAGCATGCCCAAGTGAATATCGTGAAAAAGACCGAGGTGCAGACAGCGGGCTTCAGCAAAAGAG
TCTATCCTGCCAAGAGGAACAGGATAAGCTGATCGCCAGAAAGAGGACTGGGACCCTAAGAAATACGGCGGCTTCGACAGCCCCACCGTG
GCCTATTCTGTGCTGGTGGTGGCCAAAGTGGAAAAGGGCAAGTCCAAGAACTGAAGAGTGTGAAGAGCTGCTGGGGATCACCATCATGGAA

AGAAGCAGCTTCGAGAAGAATCCCATCGACTTTCTGGAAGCCAAGGGCTACAAAGAAGTGAAAAGGACCTGATCATCAAGCTGCCTAAGTAC
TCCTGTTCGAGCTGAAAACGGCCGGGAAGAGAATGCTGGCTCTGCCGGCAACTGCAGAAGGGAAACGAACTGGCCCTGCCCTCCAAATAT
GTGAACTTCTGTACCTGGCCAGCCACTATGAGAAGCTGAAGGGCTCCCCGAGGAT AATGAGCAGAAACAGCTGTTTGTGGAACAGCACAAG
CACTACCTGGACGAGATCATCGAGCAGATCAGCGAGTTCTCCAAGAGAGTGATCCTGGCCGACGGTAATCTGGACAAAGTGCTGTCCGCCTAC
AACAAGCACCGGGATAAGCCCATCAGAGAGCAGGCCGAGAATATCATCCACTGTTTACCCTGACCAATCTGGGAGCCCTGCCGCTCAAG
TACTTTGACACCACCATCGACCGGAAGAGGTACACCAGCACCAAGAGGTGCTGGACGCCACCCTGATCCACCAGAGCATCACCGCCTGTAC
GAGACACGGATCGACCTGTCTCAGCTGGGAGGGACAAAAGGCCGGCCACGAAAAAGGCCGGCCAGGCAAAAAGAAAAAG

Sp_del(97-150)

ATGGACTATAAGGACCAGCAGGAGACTACAAGGATCATGATATTGATTACAAAGACGATGACGATAAGATGGCCCCAAAGAAGAAGCGGAAG
GTCGGTATCCACGGAGTCCCAGCAGCCGACAAGAAGTACAGCATCGCCCTGGACATCGGCACCAACTCTGTGGGCTGGCCGTGATCACCGAC
GAGTACAAGGTGCCAGCAAGAAATTC AAGGTGCTGGGCAACACCGACCGGCACAGCA TCAAGAAGAACCTGATCGGAGCCCTGCTGTTTCGAC
AGCGCGAAACAGCCGAGGCCACCCGCTGAAGAGAACC GCCAGAAGAAGATACACCAGACGGAAAGACCGGATCTGCTATCTGCAAGAGATC
TTCAGCAACGAGATGGCCAAGGTGGACGACAGCCTGCGGCTGATCTATCTGGCCCTGGCCACATGATCAAGTTCGGGGCCACTTCCTGATC
GAGGGCGACCTGAACCCGACAACAGCGACGTGGACAAGCTGTTTATCCAGCTGGTGCAGACCTACAACCAGCTGTTCGAGGAAAACCCCATC
AACGCCAGCGGGCTGGACGCCAAGGCCATCCTGTCTGCCAGACTGAGCAAGAGCAGACGGCTGGAAAATCTGATCGCCAGCTGCCGGCGAG
AAGAAGAATGGCCTGTTGGAAAACCTGATGGCCTGAGCCTGGGCTGACCCCAACTTCAAGAGCAACTTCGACCTGGCCGAGGATGCCAAA
CTGCAGCTGAGCAAGGACACCTACGACGACGACCTGGACAACCTGCTGGCCAGATCGGCGACCAGTACGCCGACCTGTTTCTGGCCGCAAG
AACCTGTCCGACGCCATCCTGCTGAGCGACATCCTGAGAGTGAACACCGAGATCACCAAGGCCCCCTGAGCGCCTCTATGATCAAGAGATAC
GACGAGCACCACCAGGACCTGACCTGCTGAAAGCTCTGTCGGCAGCAGCTGCCTGAGAAGTACAAAGAGATTTTCTTCGACCAGAGCAAG
AACGGCTACGCCGGCTACATTGACGGCGGAGCCAGCCAGGAAGAGTTCTACAAGTTCATCAAGCCCATCCTGGAAAAGATGGACGGCACCGAG
GAACTGCTCGTGAAGCTGAACAGAGAGGACCTGCTGCGGAAGCAGCGGACCTTCGACAACGGCAGCATCCCCACCAGATCCACCTGGGAGAG
CTGCACGCCATTCTGCGGGCGCAGGAAGATTTTACCCATTCTGAAAGGACAACCGGAAAAGATCGAGAAGATCCTGACCTTCGCATCCCC
TACTACGTGGGCCCTCTGGCCAGGGGAAAACAGCAGATTCGCTGGATGACCAGAAAGAGCGAGGAAACCATCACCCCTGGAACCTCGAGGAA
GTGGTGGACAAGGGCGCTTCGCCCCAGAGCTTCATCGAGCGGATGACCAACTTCGAT AAGAACCTGCCAACGAGAAGGTGCTGCCAAGCAC
AGCCTGCTGTACGAGTACTTCACCGTGTATAACGAGCTGACCAAAGTGAATAACGTGACCGAGGGAATGAGAAAAGCCCGCTTCTGAGCGGC
GAGCAGAAAAAGGCCATCGTGGACCTGCTGTTCAAGACCAACCGGAAAAGTGACCGTGAAGCAGCTGAAAGAGGACTACTTCAAGAAAATCGAG
TGCTTCGACTCCGTGGAATCTCOGGCTGGAAGATCGGTTCAACGCCCTCCCTGGGCACATACCACGATCTGCTGAAAATTC AAGGACAAG
GACTTCTCGACAAATGAGGAAAACGAGGACATTCGGAAGATATCGTGTGACCCCTGACACTGTTTGAGGACAGAGAGATGATCGAGGAAACGG
CTGAAAACCTATGCCACCTGTTTCGACGACAAAAGTGATGAAGCAGCTGAAGCGCGGAGATACACCGGCTGGGGCAGGCTGAGCCGGAAGCTG
ATCAACGGCATCCGGGACAAGCAGTCCGGCAAGACAATCCTGGATTTCTGAAAGTCCGACGGCTTCGCCAACAGAAAACCTTCATGCAGCTGATC
CAGCAGCAGCCTGACCTTTAAAGAGGACATCCAGAAAAGCCAGGTGTCGGCCAGGGCGATAGCCTGCACGAGCATTGCCAATCTGGCC
GGCAGCCCCGCCATTAAGAAGGGCATCCTGCAGACAGTGAAGGTGGTGGACGAGCTCGTGAAGTGATGGGCCGACAAAGCCGAGAACATC
GTGATCGAAATGGCCAGAGAGAACCAGACCACCCAGAAGGACAGAAGAACAGCCGAGAGAAATGAAGCCGATCGAAGAGGGCATCAAAGAG
CTGGGCAGCCAGATCCTGAAAGAACACCCCGTGGAAAACACCCAGCTGCAGAACGAGAAGCTGTACCTGTACTACCTGCAGAAATGGGCGGGAT
ATGTACGTGGACCAGAACTGGACATCAACCGGCTGTCCGACTACGATGTGGACCATATCGTGCCTCAGAGCTTTCTGAAGGACGACTCCATC
GACAACAAGGTGCTGACCAGAAGCGACAAGAACC GGGGCAAGAGCGACAACGTGCCCTCCGAAAGAGTCTGTAAGAAGATGAAGAACTACTGG
CGGCAGCTGCTGAACGCCAAGCTGATTACCCAGAGAAAAGTTCGACAATCTGACCAAGGCCGAGAGAGGGCGCTGAGCGAAGTGGATAAGGCC
GGCTTCATCAAGAGACAGCTGGTGGAAAACCCGGCAGATCACAAGCACAGTGGCACAGATCCTGGACTCCCGGATGAACACTAAGTACGACGAG
AATGACAAGCTGATCCGGGAAGTGAAGTGATCACCTGAAGTCCAAGCTGGTGTCCGATTTCCGGAAGGATTTCCAGTTTTACAAAGTGCGC
GAGATCAACAACCTACCACCAGCCACGACGCTACCTGAACGCCGTGTTGGGAACCGCCCTGATCAAAAAGTACCCTAAGCTGGAAGCGGAG
TTCGTGTACGGGACTACAAGGTGTACGACGTGCGGAAGATGATCGCCAAGAGCGAGCAGGAAATCGGCAAGGCTACCGCCAAGTACTTCTTC
TACAGCAACATCATGAACTTTTTCAAGACCGAGATTACCCTGGCCAACCGGCGAGATCCGGAAGCGGCCCTGTGATCGAGACAAACGGCGAAACC
GGGGAGATCGTGTGGGATAAGGGCCGGGATTTTGCCACCGTGCAGAAAAGTGTGAGCATGCCCAAGTGAATATCGTGA AAAAGACCGAGGTG
CAGACAGGGCGCTTCAGCAAAGAGTCTATCCTGCCAAGAGGAACAGCGATAAGCTGATCGCCAGAAAAGAGGACTGGGACCCTAAGAAGTAC
GGCGGCTTCGACAGCCCCACCGTGGCCTATTTCTGTGCTGGTGGTGGCCAAAGTGGAAAAGGGCAAGTCCAAGAAACTGAAGAGTGTGAAGAG
CTGCTGGGGATCACCATCATGGAAGAAGCAGCTTCGAGAAGAATCCCATCGACTTTCTGGAAGCCAAGGGCTACAAAGAAGTGA AAAAGGAC
CTGATCATCAAGCTGCCTAAGTACTCCCTGTTTCGAGCTGGAAAACCGCCGGAAGAGAATGCTGGCCTCTGCCGGCAACTGCAGAAGGGAAAAC
GAACTGGCCCTGCCCTCCAAATATGTGAACTTCTGTACCTGGCCAGCCACTATGAGAAGCTGAAGGGCTCCCCGAGGATAATGAGCAGAAA

CAGCTGTTTGTGGAACAGCACAAGCACTACCTGGACGAGATCATCGAGCAGATCAGCGAGTTCTCCAAGAGAGTGATCCTGGCCGACGCTAAT
CTGGACAAAAGTGCTGTCCGCCTACAACAAGCACCGGGATAAGCCCATCAGAGAGCAGGCCGAGAATATCATCCACCTGTTTACCCTGACCAAT
CTGGGAGCCCTGCCGCCTTCAAGTACTTTGACACCACCATCGACCGGAAGAGGTACACCAGCACCAAAGAGGTGCTGGACGCCACCCTGATC
CACCAGAGCATCACCGGCCTGTACGAGACACGGATCGACCTGTCTCAGCTGGGAGGGCACAAAAAGGCCGGGGCCACGAAAAAGGCCGGCCAG
GCAAAAAAGAAAAAG

Sp_del (175-307)

ATGGACTATAAGGACCAGGACGGAGACTACAAGGATCATGATATTGATTACAAAGACGATGACGATAAGATGGCCCCAAAGAAGAAGCGGAAG
GTCCGTATCCACGGAGTCCCAGCAGCCGACAAGAAGTACAGCATCGGCCTGGACATCGGCACCAACTCTGTGGGCTGGCCGTGATCACCGAC
GAGTACAAGGTGCCAGCAAGAAATCAAGGTGCTGGGCAACACCGACCGGCACAGCATCAAGAAGAACCTGATCGGAGCCCTGCTGTTGAC
AGCGGCGAAACAGCCGAGGCCACCCGGCTGAAGAGAACCGCCAGAAGAAGATACACCAGACGGAAGAACC GGATCTGCTATCTGCAAGAGATC
TTCAGCAACGAGATGGCCAAGGTGGACGACAGCTTCTTCCACAGACTGGAAGAGTCTTCTCGTGGTGAAGAGGATAAGAAGCACGAGCGGCAC
CCCATCTTCCGCAACATCGTGGACGAGGTGGCCTACCACGAGAAGTACCCACCATCTACCACCTGAGAAAGAAACTGGTGGACAGCACCGAC
AAGGCCGACCTGCGCTGATCTATCTGGCCCTGGCCACATGATCAAGTTCGGGGCCACTTCTGATCGAGGGCGACCTGGTGAACACCGAG
ATCACCAGGGCCCCCTGAGCGCCTATGATCAAGAGATACGACGAGCACACCAGGACCTGACCCTGCTGAAAGCTCTCGTGGCCAGCAG
CTGCCTGAGAAGTACAAGAGATTTTCTTCCGACCAGAGCAAGAACGGCTACGCCGGCTACATTGACGGCGGAGCCAGCCAGGAAGAGTTCTAC
AAGTTCATCAAGCCCATCCTGAAAAAGATGGACGGCACCGAGGAAGTCTCGTGAAGCTGAACAGAGAGGACCTGCTGCGGAAGCAGCGGACC
TTCGACAACGGCAGCATCCCCACCAGATCCACCTGGGAGAGCTGCACGCCATTCTGGCGGGCAGGAAGATTTTTACCCATTCTGAAGGAC
AACCGGGAAAAGATCGAGAAGATCCTGACCTTCCGCATCCCTACTACGTGGCCCTCTGGCCAGGGAAACAGCAGATTCCGCTGGATGACC
AGAAAGAGCGAGGAAACCATCACCCCTGGAACCTCGAGGAAGTGGTGGACAAGGGCGCTCCGCCAGAGCTTCTCGAGGGATGACCAAC
TTCGATAAGAACCTGCCAACGAGAAGGTGCTGCCAAGCACAGCCTGCTGTACGAGTACTTACCCTGTATAACGAGCTGACCAAAGTGAAA
TACGTGACCGAGGGAATGAGAAAGCCCGCTTCTGAGCGGCGAGCAGAAAAAGGCCATCGTGGACCTGCTGTTCAAGACCAACCGGAAAGTG
ACCGTGAAGCAGCTGAAAGAGGACTACTTCAAGAAAATCGAGTGGTTCGACTCCGTGGAAATCTCCGGCTGGAAGATCGGTTCAACGCTCC
CTGGGCACATACCAGATCTGCTGAAAATTATCAAGGACAAGGACTTCTGGACAATGAGGAAAACGAGGACATTCTGGAAGATATCGTGTG
ACCCTGACACTGTTTGGAGACAGAGAGATGATCGAGGAACGGCTGAAAACCTATGCCACCTGTTGACGACAAAAGTGATGAAGCAGCTGAAG
CGCCGGAGATACACCGCTCGGGCAGGCTGAGCCGGAAGCTGATCAACGGCATCCGGACAAGCAGTCCGGCAAGACAATCCTGGATTTCTG
AAGTCCGACGGCTTCGCCAACAGAACTTCTGACGCTGATCCACGACGACAGCTGACCTTTAAGAGGACATCCAGAAAGCCAGGTGTC
GGCCAGGGGATAGCCTGCACGAGCAGATGCCAATCTGGCCGCGAGCCCGCCATTAAAGAGGGCATCCTGCAGACAGTGAAGGTGGTGGAC
GAGCTCGTGAAGTGATGGCCGGCACAAGCCCGAGAACATCGTGTGAAATGGCCAGAGAGAACCAGACCACCCAGAAGGGACAGAAGAAC
AGCCCGAGAGAATGAAGCCGATCGAAGAGGGCATCAAAGAGCTGGCGAGCCAGATCCTGAAAGAACCCCGTGGAAAACACCCAGCTGCAG
AACGAGAAGCTGTACCTGTACTACCTGCAGAATGGCGGGATATGTACGTGGACCAGGAAGTGGACATCAACCGGCTGTCCGACTACGATGTG
GACCATATCGTGCCTCAGAGCTTTCTGAAGGACGACTCCATCGACAACAAGGTGCTGACCAGAGCGACAAGAACCAGGGGCAAGAGCGACAAC
GTGCCCTCGAAGAGGTGCTGAAGAAGATGAAGAACTACTGGCGGACGCTGCTGAACGCCAAGCTGATTACCCAGAGAAAGTTCGACAATCTG
ACCAAGGCCGAGAGAGGGCGCTGAGCGAAGTGGATAAGGCCGGCTTCTCAAGAGACAGCTGGTGGAAACCCGGCAGATCACAAAGCAGTG
GCACAGATCCTGGACTCCCGGATGAACACTAAGTACGACGAGAATGACAAGCTGATCCGGGAAGTGAAGTGATCACCTGAAGTCCAAGCTG
GTGTCCGATTTCCGGAAGGATTTCCAGTTTTACAAAGTGGCGAGATCAACAACCTACCACCAGCCACGACGCTACCTGAACGCGCTGCTG
GGAACCGCCCTGATCAAAAAGTACCCTAAGCTGGAAGCGAGTTCGTGTACGGGACTACAAGGTGTACGACGTGGGGAAGATGATCGCCAAG
AGCGAGCAGGAAATCGGCAAGGCTACCCCAAGTACTTCTTACAGCAACATCATGAACCTTTTCAAGACCGAGATTACCCTGCCAACGGC
GAGATCCGGAAGCGGCTCTGATCGAGACAAACGGCGAAACCCGGGAGATCGTGTGGGATAAGGGCCGGGATTTTCCACCGTGGGAAAGTG
CTGAGCATGCCCAAGTGAATATCGTGA AAAAGACCGAGGTGCAGACAGGCGGCTTCCAGCAAAGAGTCTATCCTGCCAAGAGGAACAGCGAT
AAGCTGATCGCCAGAAAGAAGGACTGGGACCTAAGAAGTACGGCGGCTTCCAGACGCCACCCTGGCCTATTCTGTGCTGGTGGTGGCCAAA
GTGGAAGGGCAAGTCCAAGAACTGAAGAGTGTGAAGAGCTGCTGGGGATCACCATCATGGAAAGAAGCAGCTTCGAGAAGAATCCCATC
GACTTTCTGGAAGCCAAGGGCTACAAAGAAGTGA AAAAGGACCTGATCATCAAGCTGCCTAAGTACTCCCTGTTCCGAGCTGGAAAACGGCCGG
AAGAGAATGCTGGCCTCTGCCGGGAACTGCAGAAGGGAAACGAAGTGGCCCTGCCCTCCAAATATGTGAACCTTCTGTACCTGGCCAGCCAC
TATGAGAAGCTGAAGGGCTCCCCGAGGATAATGAGCAGAAACAGCTGTTTGTGGAACAGCACAAAGCACTACCTGGACGAGATCATCGAGCAG
ATCAGCGAGTTCTCAAGAGAGTGATCCTGGCCGACGCTAATCTGGACAAGTGTGTCGGCTACAACAAGCACCGGGATAAGCCCATCAGA
GAGCAGGGCGAGAATATCATCCACCTGTTTACCCTGACCAATCTGGGAGCCCTGCCGCTTCAAGTACTTTGACACCACCATCGACCGGAAG
AGGTACACCAGCACAAAGAGGTGCTGGACGCCACCCTGATCCACCAGAGCATCACCGCCTGTACGAGACACGGATCGACCTGTCTCAGCTG
GGAGGGCACAAAAAGGCCGGCGCCACGAAAAAGGCCGGCCAGGCAAAAAAGAAAAAG

Sp_del(312-409)

ATGGACTATAAGGACCAGCAGGAGACTACAAGGATCATGATATTGATTACAAAGACGATGACGATAAGATGGCCCCAAAGAAGAAGCGGAAG
GTCCGGTATCCACGGAGTCCCAGCAGCCGACAAGAAGTACAGCATCGCCCTGGACATCGGCACCAACTCTGTGGGCTGGGCCGTGATCACCGAC
GAGTACAAGGTGCCAGCAAGAAATTC AAGGTGCTGGGCAACACCGACCCGGCACAGCATCAAGAAGAACCTGATCGGAGCCCTGCTGTTCCGAC
AGCGGGCAAAACAGCCGAGGCCACCCGGCTGAAGAGAACC GCCAGAAGAAGATACACCAGACGGAAGAACC GGATCTGCTATCTGCAAGAGATC
TTCAGCAACGAGATGGCCAAGGTGGACGACAGCTTCTTCCACAGACTGGAAGAGTCCTTCTGTTGGAAGAGGATAAGAAGCAGGACCGGCAC
CCCATCTTCGGCAACATCGTGGACGAGGTGGCTACCACGAGAAGTACCCACCATCTACCACCTGAGAAAGAACTGGTGGACAGCACCGAC
AAGGCCGACCTGCGCTGATCTATCTGGCCCTGGCCACATGATCAAGTTCGGGGCCACTTCTGATCGAGGGGACCTGAACCCGACAAC
AGCGACGTGGACAAGCTGTTCCATCCAGCTGGTGCAGACCTACAACCAGCTGTTCCAGGAAAACCCCATCAACGCCAGCGGCTGGACGCCAAG
GCCATCCTGTCTGCCAGACTGAGCAAGAGCAGACGGCTGGAAAATCTGATCGCCAGCTGCCCGGAGAGAAGAAGTGGCCTGTTCCGAAAAC
CTGATTGCCCTGAGCTGGGCTGACCCCAACTTCAAGAGCAACTTCGACCTGGCCGAGGATGCCAACTGCAGCTGAGCAAGGACACCTAC
GACGACGACCTGGACAACCTGCTGGCCAGATCGCCGACCAAGTACGCCGACCTGTTTCTGGCCCAAGAACCTGTCGACGCCATCCTGCTG
AGCGACATCCTGAGAGTGAACACCGAGATCCCCACCAGATCCACCTGGGAGAGCTGCACGCCATCTGCGGGGCGCAGGAAGATTTTACCCA
TTCTGAGGACAACCGGAAAAGATCGAGAAGATCCTGACCTTCGCATCCCTACTACGTGGGCCCTCTGGCCAGGGGAAACAGCAGATTC
GCCTGGATGACCAGAAAGAGCGAGGAAACCATCACCCCTGGAACCTCGAGGAAGTGGTGGACAAGGGCGCTTCCGCCAGAGCTTCATCGAG
CGGATGACCAACTTCGATAAGAACCTGCCAACGAGAAGGTGCTGCCAAGCACAGCCTGCTGTACGAGTACTTACCCTGTATAACGAGCTG
ACCAAAGTGAATACGTGACCCGAGGGAAATGAGAAAAGCCCGCTTCTGAGCGGCGAGCAGAAAAGGCCATCGTGGACCTGCTGTTCAAGACC
AACC GGAAAGT GACCGTGAAGCAGCTGAAAGAGGACTACTTCAAGAAAATCGAGTGCCTCGACTCCGTGGAATCTCCGGCGTGAAGATCGG
TTC AACCGCTCCCTGGGCACATAACCAGATCTGCTGAAAATTATCAAGGACAAGGACTTCTGGACAATGAGGAAAACGAGGACATTCGGAA
GATATCGTCTGACCTGACACTGTTTGAGGACAGAGAGATGATCGAGGAACGGCTGAAAACCTATGCCACCTGTTCCGACGACAAAGTGATG
AAGCAGCTGAAGCGCGGAGATACACCGGCTGGGGCAGGCTGAGCCGGAAGCTGATCAACGGCATCCGGGACAAGCAGTCCGGCAAGACAATC
CTGGATTTCTGAAGTCCGACGGCTTCGCCAACAGAACTTCATGCAGCTGATCCACGACGACAGCCTGACCTTTAAGAGGACATCCAGAAA
GCCCAGGTGTCGGCCAGGGCGATAGCCTGCACGAGCAGATTGCCAATCTGGCCGCGAGCCCGCCATTAGAAGGGCATCCTGCAGACAGTG
AAGGTGGTGGACGAGCTCGTGAAGTGATGGGCCGGCACAAGCCGAGAACATCGTGTGAAAATGGCCAGAGAGAACCAGACCACCCAGAAG
GGACAGAAGAACAGCCGCGAGAGAATGAAGCCGATCGAAGAGGGCATCAAAGAGCTGGGCAGCCAGATCCTGAAAGAACACCCCGTGGAAAAC
ACCCAGCTGCAGAACGAGAAGCTGTACCTGTACTACCTGCAGAAATGGCGGGATATGTACGTGGACCAGGAACTGGACATCAACCGGCTGTCC
GACTACGATGTGGACCATATCGTGCCTCAGAGCTTCTGAAGGACGACTCCATCGACAACAAGGTGCTGACCAGAAGCGACAAGAACC GGCC
AAGAGCGACAACGTGCCCTCCGAAGAGGTGCTGAAGAAGTGAAGAACTACTGGCGGAGCTGCTGAACGCCAAGCTGATTACCCAGAGAAAAG
TTCGACAATCTGACCAAGGCCAGAGAGGGCCCTGAGCGAAGCTGGATAAGGCCGGCTTCATCAAGAGACAGCTGGTGGAAACCCGGCAGATC
ACAAAGCAGTGGCACAGATCCTGGACTCCCGATGAACACTAAGTACGACGAGAATGACAAGCTGATCCGGGAAGTGAAGTGATCACCCCTG
AAGTCCAAGCTGGTGTCCGATTTCCGGAAGGATTTCCAGTTTTACAAAGTGGCGAGATCAACAACCTACCACCAGCCACGACGCTACCTG
AAGCCCGTCTGGGAAACCGCCCTGATCAAAAAGTACCTAAGCTGAAAAGCGAGTTCGTGTACGGCGACTACAAGGTGACGAGTGGGAAAG
ATGATCGCCAAGAGCGAGCAGGAAATCGGCAAGGCTACCGCCAAGTACTTCTCTACAGCAACATCATGAACTTTTTCAAGACCGAGATTACC
CTGGCCAACGGCGAGATCCGGAAGCGGCTCTGATCGAGACAAACGGCGAAAACCGGGGAGATCGTGTGGGATAAGGGCCGGGATTTTGCCACC
GTGGGAAAAGTGTGAGCATGCCCAAGTGAATATCGTGA AAAAGACCGAGGTGCAGACAGGGCGCTTACGCAAAGAGTCTATCCTGCCAAAG
AGGAACAGCGATAAGCTGATCGCCAGAAAAGAAGGACTGGGACCCTAAGAAGTACGGCGGCTTCGACAGGCCACCCTGGCCTATTCTGTGCTG
GTGGTGGCCAAAGTGGAAAAGGGCAAGTCCAAGAACTGAAGAGTGTGAAGAGCTGCTGGGATCACCATCATGGAAAAGAAGCAGCTTCGAG
AAGAATCCATCGACTTTCTGGAAGCCAAGGGCTACAAAGAAGTGA AAAAGGACCTGATCATCAAGCTGCCTAAGTACTCCCTGTTCCGAGCTG
GAAAACGGCCGGAAGAGAAATGCTGGCCTCTGCCGGCAACTGCAGAAGGGAAAACGAACCTGGCCCTGCCCTCCAAATATGTGAACCTTCTGTAC
CTGGCCAGCCACTATGAGAAGCTGAAGGGCTCCCCGAGGATAATGAGCAGAAAACAGCTGTTTGTGGAACAGCACAAAGCACTACCTGGACGAG
ATCATCGAGCAGATCAGCGAGTCTCCAAGAGAGTGTCTGGCCGACGCTAATCTGGACAAAGTGTGTCCGCTACAACAAGCACCCGGAT
AAGCCCATCAGAGAGCAGGGCCGAGAATATCATCCACCTGTTTACCCTGACCAATCTGGGAGCCCTGCCGCTTCAAGTACTTTGACACCACC
ATCGACCGGAAGAGGTACACCAGCACAAAGAGGTGCTGGACGCCACCCTGATCCACCAGAGCATCACCGGCTGTACGAGACACGGATCGAC
CTGTCTCAGCTGGGAGCGCACAAAGGCCGGCGCCACGAAAAGGCCGGCCAGGCCAAAAAGAAAAAG

Sp_del (1098-end)

ATGGACTATAAGGACCAGCAGGAGACTACAAGGATCATGATATTGATTACAAAGACGATGACGATAAGATGGCCCCAAAGAAGAAGCGGAAG
GTCCGGTATCCACGGAGTCCCAGCAGCCGACAAGAAGTACAGCATCGCCCTGGACATCGGCACCAACTCTGTGGGCTGGGCCGTGATCACCGAC

GAGTACAAGGTGCCAGCAAGAAATTC AAGGTGCTGGGCAACACCGACCGGCACAGCATCAAGAAGAACCTGATCGGAGCCCTGCTGTTGAC
 AGCGGGCAACAGCCGAGGCCACCGGCTGAAGAGAACCGCCAGAAGAAGATACACCAGACGGAAAGAACCGGATCTGCTATCTGCAAGAGATC
 TTCAGCAACGAGATGGCCAAGGTGGACGACAGCTTCTTCCACAGACTGGAAGAGTCTTCTGGTGGAAAGAGGATAAGAAGCACAGCGGCAC
 CCCATCTTCGGCAACATCGTGGACGAGGTGGCCTACCAGGAGAAGTACCCACCATCTACCACCTGAGAAAGAAACTGGTGGACAGCACCGAC
 AAGGCCGACCTGCGCTGATCTATCTGGCCCTGGCCACATGATCAAGTTCGGGGCCACTTCTGATCGAGGGCGACCTGAACCCCGACAAC
 AGCGACGTGGACAAGCTGTTCACTCAGCTGGTGCAGACCTACAACCAGCTGTTGAGGAAAACCCCATCAACGCCAGCGGCTGGACGCCAAG
 GCCATCTGTCTGCCAGACTGAGCAAGAGCAGACGGCTGGAAAATCTGATCGCCAGCTGCCCGGCGAGAAGAAGAATGGCCTGTTGGAAAAC
 CTGATTGCCCTGAGCTGGCCTGACCCCACTTCAAGAGCAACTTCGACCTGGCCGAGGATGCCAACTGCAGCTGAGCAAGGACACCTAC
 GACGACGACCTGGACAACCTGCTGGCCAGATCGCCGACCACTGACCCGACCTGTTTCTGGCCGCAAGAACCTGTCCGACGCCATCCTGCTG
 AGCGACATCCTGAGAGTGAACACCGAGATCACCAAGGCCCCCTGAGCGCCTCTATGATCAAGAGATACGACGAGCACCACCAGGACCTGACC
 CTGCTGAAAGCTCTCGTGGCCAGCAGCTGCCTGAGAAGTACAAGAGATTTTCTCGACCAGCAAGAAGCGCTACGCCGCTACATTGAC
 GCGGAGCCAGCCAGGAAGGTTCTACAAGTTCATCAAGCCATCCTGGAAAAGATGGACGGCACCGAGGAACTGCTCGTGAAGCTGAACAGA
 GAGGACCTGCTGGGAAGCAGCGGACCTTCGACAACGGCAGCATCCCCACCAGATCCACCTGGGAGAGCTGCACGCCATTCGCGGCGCAG
 GAAGATTTTACCATTCTGAAGGACAACCGGAAAAGATCGAGAAGATCCTGACCTTCGGCATCCCCTACTACGTGGGCCCTCTGGCCAGG
 GGAAACAGCAGATTCGCTGGATGACCAGAAAGAGCGAGGAAACCATCACCCCTGGAACTTCGAGGAAGTGGTGGACAAGGGCGCTTCGGCC
 CAGAGCTTCATCGAGCGGATGACCAACTTCGATAAGAACCTGCCAACGAGAAGGTGCTGCCAAGCACAGCCTGCTGTACGAGTACTTCACC
 GTGTATAACGAGCTGACCAAGTGAATACGTGACCGAGGGAATGAGAAAGCCCGCCTTCTGAGCGGGCAGCAGAAAAAGGCCATCGTGGAC
 CTGCTGTCAAGACCAACCGAAAAGTGACCGTGAAGCAGCTGAAAGAGGACTACTTCAAGAAAATCGAGTCTTCGACTCCGTGGAAATCTCC
 GCGTGGAAAGATCGGTTCAACGCCTCCTGGGCACATACCAAGATCTGCTGAAAATTATCAAGGACAAGGACTTCTGGACAATGAGGAAAAC
 GAGGACATTCGGAAGATATCGTGTGACCTGACACTGTTTGGAGACAGAGAGATGATCGAGGAACGGCTGAAAACCTATGCCACCTGTTT
 GACGACAAAGTGTGAAGCAGCTGAAGCGGCGGAGATACACCGGCTGGGGCAGGCTGAGCCGGAAGCTGATCAACGGCATCCGGGACAAGCAG
 TCCGGCAAGACAATCCTGGATTTCTGAAGTCCGACGGCTTCGCCAACAGAACTTCATGCAGCTGATCCACGACGACAGCCTGACCTTTAAA
 GAGGACATCCAGAAAGCCAGGTGTCCGGCCAGGGCGATAGCCTGCACGAGCACATTGCCAATCTGGCCGGCAGCCCGCCATTAAGAAGGGC
 ATCCTGCAGACAGTGAAGGTGGTGGACGAGCTCGTGAAGTGTGGCCGGCACAAGCCCGAGAACATCGTGTGCAATGGCCAGAGAGAAC
 CAGACCACCAGAAGGGACAGAAGAACAGCCCGGAGAGAATGAAGCGGATCGAAGAGGGCATCAAAGAGCTGGGACCCAGATCCTGAAAGAA
 CACCCCGTGGAAAACACCCAGCTGCAGAACGAGAAGCTGTACCTGTACTACCTGCAGAATGGGCGGATATGTAAGTGGACCAGGAACCTGGAC
 ATCAACCGGCTGTCCGACTACGATGTGGACCATATCGTGCCTCAGAGCTTCTGAAGGACGACTCCATCGACAACAAGGTGCTGACCAGAAGC
 GACAAGAACCGGGCAAGAGCGACAACCTGCCCTCCGAAGAGGTGCTGAAGAAGATGAAGAAGTACTGGCCGACGCTGCTGAACGCCAAGCTG
 ATTACCCAGAGAAAGTTCGACAATCTGACCAAGGCCGAGAGAGGGCGGCTGAGCGAAGCTGGATAAGGCCGGCTTCATCAAGAGACAGCTGGT
 GAAACCCGGCAGATCACAAGCAGCTGGCACAGATCCTGGACTCCCGATGAACACTAAGTACGACGAGAATGACAAGCTGATCCGGGAAGTG
 AAAGTGTACCCCTGAAGTCCAAGCTGGTGTCCGATTTCCGGAAGGATTTCCAGTTTACAAGTGGCGGAGATCAACAACCTACCACCAGCC
 CAGCAGCCTACCTGAACGCCGTGTTGGAAACCGCCCTGATCAAAAAGTACCCTAAGCTGGAAAGCGAGTTCGTGTACGGCGACTACAAGGTG
 TACGACGTGGGAAGATGATCGCCAAGAGCGAGCAGGAAATCGGCAAGGCTACCGCAAGTACTTCTTCTACAGCAACATCATGAACCTTTTC
 AAGACCGAGATTACCCTGGCCAACGGCGAGATCCGGAAGCGGCTCTGATCGAGACAAACGGGAAACCGGGGAGATCGTGTGGGATAAGGGC
 CGGGATTTGCCACCGTGGGAAAGTGTGAGCATGCCCAAGTGAATATCGTGA AAAAGACC AAAAGGCCGGCGCCACGAAAAAGGCCGGC
CAGGCAAAAAGAAAAAG

St3Cas9

ATGGACTATAAGGACCACGACGGAGACTACAAGGATCATGATATTGATTACAAGAGGATGACGATAAGATGGCCCAAGAAGAAGCGGAAG
GTCCGTATCCACGGAGTCCCAGCAGCCACCAAGCCCTACAGCATCGGCCTGGACATCGGCACCAATAGCGTGGGCTGGCCGTGACCACCGAC
 AACTACAAGGTGCCAGCAAGAAATGAAGGTGCTGGGCAACACCTCCAAGAAGTACATCAAGAAAAACCTGCTGGCGTGTCTGTTGAC
 AGCGGATACAGCCGAGGGCAGACGGCTGAAGAGAACCGCCAGACGGCGGTACACCCGGCGGAAACAGAATCCTGTATCTGCAAGAGATC
 TTCAGCACCGAGATGGCTACCCTGGACGACGCCCTTCTTCCAGCGGCTGGACGACAGCTTCTGGTGGCCGACGACAAGCGGGACAGCAAGTAC
 CCCATCTTCGGCAACCTGGTGGAAAGAGAAGGCCTACCAGGACGAGTTCGCCACCATCTACCACCTGAGAAAGTACCTGGCCGACAGCACCAAG
 AAGGCCGACCTGAGACTGGTGTATCTGGCCCTGGCCACATGATCAAGTACCGGGGCCACTTCTGATCGAGGGCGAGTTCAACAGCAAGAAC
 AACGACATCCAGAAGAACTCCAGGACTTCTGGACACCTACAACGCCATCTTCGAGAGCGACCTGTCCCTGGAAAACAGCAAGCAGCTGGAA
 GAGATCGTGAAGGACAAGATCAGCAAGCTGGAAAAGAAGGACCGCATCCTGAAGCTGTTCCCGGCGAGAAGAACAGCGGAATCTTCAGCGAG
 TTTCTGAAGCTGATCGTGGGCAACAGCGCCACTTCAGAAAGTGCCTTCAACCTGGACGAGAAAGCCAGCCTGCACCTCAGCAAGAGAGCTAC
 GACGAGGACCTGGAAACCTGCTGGGATATATCGCGCAGGACTACAGCGACGTGTTCTGAAGGCCAAGAAGCTGTACGACGCTATCCTGCTG

AGCGGCTTCTGACCGTGACCGACAACGAGACAGAGGCCCACTGAGCAGCGCCATGATTAAGCGGTACAACGAGCACAAGAGGATCTGGCT
 CTGCTGAAAAGTACATCCGGAAACATCAGCCTGAAAACCTACAATGAGGTGTTCAAGGACGACACCAAGAACGGCTACGCCGGCTACATCGAC
 GGCAAGACCAACCAGGAAGAGGAAGATTTCTATGTGTACCTGAAGAAGCTGCTGGCCGAGTTCCGAGGGGGCCGACTACTTTCTGGAAAAATC
 GACCGCGAGGATTTCTGCGGAAGCAGCGGACCTTCGACAACGGCAGCATCCCCTACCAGATCCATCTGCAGGAAATGCGGGCCATCCTGGAC
 AAGCAGGCCAAGTCTACCCATTCTGGCCAAGAACAAGAGGGATCGAGAAGATCCTGACCTCCGCATCCCTACTACGTGGGCCCCCTG
 GCCAGAGGCAACAGCGATTTTGCCTGGTCCATCCGGAAGCGCAATGAGAAGATCACCCCTGGAACCTCGAGGACGTGATCGACAAAAGAGTCC
 AGCGCCGAGGCCTTCATCAACCGGATGACCAGCTTCGACCTGTACCTGCCCGAGGAAAAGGTGCTGCCAAGCACAGCCTGCTGTACGAGACA
 TTCAATGTGTATAACGAGCTGACCAAAGTGGGTTTATCGCCGAGTCTATGCGGGACTACCAGTTCTGGACTCCAAGCAGAAAAAGGACATC
 GTGCGGCTGTACTTCAAGGACAAGCGGAAAAGTACCGGATAAAGGACATCATCGAGTACCTGCACGCCATCTACGGCTACGATGGCATCGAGCTG
 AAGGGCATCGAGAAGCAGTTCAACTCCAGCCTGAGCACATACCAGCAGCTGCTGAACAATTATCAACGACAAAAGATTTCTGGACGACTCCAGC
 AACGAGGCCATCATCGAAGAGATCATCCACACCCTGACCATCTTTGAGGACCGCGAGATGATCAAGCAGCGGCTGAGCAAGTTCGAGAACATC
 TTCGACAAGAGCGTCTGAAAAAGCTGAGCAGACGGCACTACACCGGCTGGGGCAAGCTGAGCGCCAAGCTGATCAACGGCATCCGGGACGAG
 AAGTCCGGCAACACAATCTGGACTACCTGATCGACGACGGCATCAGCAACCGGAACCTCATGCAGCTGATCCACGACGACGCCCTGAGCTTC
 AAGAAGAAGATCCAGAAGGCCAGATCATCGGGACGAGGACAAGGGCAACATCAAAGAAGTCGTGAAGTCCCTGCCCGGACGCCCGCCATC
 AAGAAGGGAATCCTGCAGAGCATCAAGATCGTGGACGAGCTCGTGAAGTGTGGCGGCAGAAAAGCCCGAGAGCATCGTGGTGGTGGTGGAA
 ATGGCTAGAGAGAACCAGTACACCAATCAGGGCAAGAGCAACAGCCAGCAGAGACTGAAGAGACTGGAAAAGTCCCTGAAAGAGCTGGGCAGC
 AAGATTCTGAAAGAGAATATCCCTGCCAAGCTGTCCAAGATCGACAACAACGCCCTGCAGAACGACCGGCTGTACCTGTACTACCTGCAGAAT
 GGCAAGGACATGTATACAGGCGAAGCCTGGATATCGACCGCCTGAGCAACTACGACATCGACCATATTATCCCCAGGCCTTCCTGAAAGAC
 AACAGCATTGACAACAAGTCTGGTGTCTCCGCCAGCAACCGGGCAAGTCCGATGATGTGCCAGCCTGGAAGTCGTAAAAAGAGAAAAG
 ACCTTCTGGTATCAGCTGCTGAAAAGCAAGCTGATTAGCCAGAGGAAGTTCGACAACCTGACCAAGGCCGAGAGAGGCCGCTGAGCCTGAA
 GATAAGGCCGGCTTCATCCAGAGACAGCTGGTGGAAACCCGGCAGATCACCAGCACGTTGCCAGACTGCTGGATGAGAAGTTTAAACAACAAG
 AAGGACGAGAACAACCGGGCCGTGGCGACCGTGAAGATCATCACCTGAAGTCCACCCTGGTGTCCAGTTCGGGAAGGACTTCGAGCTGTAT
 AAAGTGGCGGAGATCAATGACTTTCACCACGCCACGACGCTACCTGAATGCCGTGGTGGCTTCGCCCTGCTGAAGAAGTACCCTAAGCTG
 GAACCCGAGTTCGTGTACGGCGACTACCCCAAGTACAACCTCCTTCAGAGAGCGGAAGTCCGCCACCGAGAAGGTGTACTTCTACTCCAACATC
 ATGAATATCTTTAAGAAGTCCATCTCCCTGGCCGATGGCAGAGTGTGAGAGCGGCCCTGATCGAAGTGAACGAAGAGACAGGGCAGAGCGTG
 TGGAAACAAGAAAGCGACCTGGCCACCGTGGCGGGGTGCTGAGTTATCCTCAAGTGAATGTGTAAGAAGGTGGAAGAACAAGAACCCAGGC
 CTGGATCGGGGCAAGCCAAAGGGCTGTTCAACGCCAACCTGTCCAGCAAGCCTAAGCCCAACTCCAACGAGAATCTCGTGGGGGCCAAAGAG
 TACCTGGACCCTAAGAAGTACGGGTACGGCGGATACGCCGGCATCTCCAATAGCTTACCCGTGCTCGTGAAGGGCACAAATCGAGAAGGGCGCT
 AAGAAAAAGATCACAACCGTCTGGAATTTAGGGGATCTCTATCCTGGACCGGATCAACTACCGGAAGGATAAGCTGAACCTTCTGCTGGAA
 AAAGGCTACAAGGACATTGAGCTGATTATCGAGCTGCCTAAGTACTCCCTGTTCAAGTGTGAGCGACGGCTCCAGACGGATGCTGGCCTCCATC
 CTGTCCACCAACAACAAGCGGGGAGATCCACAAGGGAAACCAGATCTTCTGAGCCAGAAATTTGTGAAACTGCTGTACCACGCCAAGCGG
 ATCTCCAACACCATCAATGAGAAACCAGGAAATACGTGGAAAACCACAAGAAAGATTTGAGGAACTGTTCTACTACATCCTGGAGTTCAAC
 GAGAACTATGTGGAGCCAAGAAGAACGGCAAACCTGCTGAACTCCGCTTCCAGAGCTGGCAGAACCACAGCATCGACGAGCTGTGCAGCTCC
 TTCATCGGCCCTACCGGCAGCGAGCGGAAGGGACTGTTTGAAGTACCTCCAGAGGCTCTGCCCGGACTTTGAGTTCCTGGGAGTGAAGATC
 CCCGGTACAGAGACTACACCCCTCTAGTCTGCTGAAGGACGCCACCCTGATCCACCAGAGCGTGACCGGCTGTACGAAACCCGGATCGAC
 CTGGCTAAGCTGGCGGAGGGAAAAAGGCCGGCGCCACGAAAAAGGCCGGCCAGGCAAAAAAGAAAAAG

SpCas9(C80L, C574A)

ATGGACAAGAAGTACAGCATCGGCCTGGACATCGGCACCAACTCTGTGGGCTGGGCCGTGATCACCGACGAGTACAAGGTGCCAGCAAGAAA
 TTCAAGGTGCTGGGCAACACCGACCGGCACAGCATCAAGAAGAACCTGATCGGAGCCCTGCTGTTCCGACAGCGGGAAACAGCCGAGGCCACC
 CGGCTGAAGAGAACCGCCAGAAGAAGATACACCAGACGGGAAGAACCAGATCctgTATCTGCAAGAGATCTTCAGCAACGAGATGGCCAAGGTG
 GACGACAGCTTCTTCCACAGACTGGAAGAGTCCCTCCTGGTGGAAAGAGGATAAGAAGCAGAGCGGCACCCCATCTTCGGCAACATCGTGGAC
 GAGGTGGCTACCAGGAGAAGTACCCACCATCTACCACCTGAGAAGAAAAGTGGTGGACAGCACCGACAAGGCCGACCTGCGGCTGATCTAT
 CTGGCCCTGGCCACATGATCAAGTTCGGGGCCACTTCTGATCGAGGGCGACCTGAACCCCGACAACAGCGACGTGGACAAGCTGTTTCATC
 CAGCTGGTGCAGACCTACAACCAGCTGTTTCGAGGAAAACCCCATCAACGCCAGCGGCTGGACGCCAAGGCCATCCTGTCTGCCAGACTGAGC
 AAGAGCAGACGGCTGGAAAATCTGATCGCCAGCTGCCGGCGAGAAGAAGATGGCCTGTTTCGAAAACCTGATTGCCCTGAGCCTGGGCTG
 ACCCCCAACTTCAAGAGCAACTTCGACCTGGCCGAGGATGCCAACTGCAGCTGAGCAAGGACACCTACGACGACGACCTGGACAACCTGCTG
 GCCCAGATCGGGACACAGTACGCGACCTGTTTCTGGCCGCAAGAACCTGTCCGACGCCATCCTGCTGAGCGACATCCTGAGAGTGAACACC
 GAGATACCAAGGCCCCCTGAGCGCTCTATGATCAAGAGATACGACGAGCACACCAGGACCTGACCCTGCTGAAAGCTCTCGTGGCGCAG

CAGCTGCCTGAGAAGTACAAAGAGATTTTCTTCGACCAGAGCAAGAACGGCTACGCCGGCTACATTGACGGCGGAGCCAGCCAGGAAGAGTTC
TACAAGTTCATCAAGCCCATCCTGGAAAAGATGGACGGCACCGGAGGAAGTCTCGTGAAGCTGAACAGAGAGGACCTGCTCGGGAAGCAGCGG
ACCTTCGACAACGGCAGCATCCCCACCAGATCCACCTGGGAGAGCTGCACGCCATTCTGCGGCGGAGGAAAGATTTTACCATTTCCTGAAG
GACAACCGGGAAAAGATCGAGAAGATCCTGACCTTCGGCATCCCCTACTACGTTGGGCCCTCTGGCCAGGGGAAACAGCAGATTCCGCTGGATG
ACCAGAAAAGAGCGAGGAAACCATCACCCCTGGAACCTCGAGGAAGTGGTGGACAAGGGCGCTTCGCCCCAGAGCTTCATCGAGCGGATGAACC
AACTTCGATAAAGAACCTGCCCAACGAGAAGGTGCTGCCAAGCACAGCCTGCTGTACGAGTACTTCACCGTGTATAACGAGCTGACCAAAGTG
AAATACGTGACCGAGGGAATGAGAAAGCCCGCCTTCTGAGCGGGCAGCAGAAAAAGGCCATCGTGGACCTGCTGTTCAAGACCAACCGGAAA
GTGACCGTGAAGCAGCTGAAAGAGGACTACTTCAAGAAAATCGAG_{gag}TTCGACTCCGTGGAAATCTCCGGCGTGGAAAGATCGGTTCAACGCC
TCCTGGGCACATACCAGATCTGCTGAAAATTATCAAGGACAAGGACTTCTGGACAATGAGGAAAACAGGACATTCTGGAAGATATCGTG
CTGACCCTGACACTGTTTGGAGCAGAGAGATGATCGAGGAACGGCTGAAAACCTATGCCACCTGTTTCGACGACAAAAGTGATGAAGCAGCTG
AAGCGGGGAGATACACCGGCTGGGCGAGGCTGAGCCGGAAGCTGATCAACGGCATCCGGGACAAGCAGTCCGGCAAGACAATCCTGGATTC
CTGAAGTCCGACGGCTTCGCCAACAGAACTTCATGCAGCTGATCCACGACGACAGCCTGACCTTTAAGAGGACATCCAGAAAGCCAGGTG
TCCGGCCAGGGCGATAGCTGCACGAGCACATTGCCAATCTGGCCGCGAGCCCGCCATTAGAAGGGCATCCTGCAGACAGTGAAGTGGTG
GACGAGCTCGTGAAGTGTGGGCGGCGACAAGCCCGAGAACATCGTGTGAAATGGCCAGAGAGAACCAGACCACCCAGAAGGGACAGAAG
AACAGCCGCGAGAGAATGAAGCGGATCGAAGAGGGCATCAAAGAGCTGGGCGACCCAGATCCTGAAAGAACCACCCGTTGAAAACACCCAGCTG
CAGAACGAGAAGCTGTACCTGTACTACCTGCAGAATGGGGGGATATGTACGTTGGACCAGGAAGTGGACATCAACCGGCTGTCCGACTACGAT
GTGGACCATATCGTGCCTCAGAGCTTTCTGAAGGACGACTCCATCGACAACAAGGTGCTGACCAGAAGCGACAAGAACCAGGGCAAGAGCGAC
AACGTGCCCTCCGAAGAGGTGCTGAAGAAGATGAAGAAGTACTGGCGGCGAGCTGCTGAACGCCAAAGCTGATTAACCCAGAGAAAAGTTCCGACAAT
CTGACCAAGGCGAGAGAGGGCGGCTGAGCGAACTGGATAAAGGCGGCTTCATCAAGAGACAGCTGGTGGAAAACCCGCGAGATCACAAAGCAC
GTGGCACAGATCCTGGACTCCCGGATGAACACTAAGTAGGACGAGAATGACAAGCTGATCCGGGAAGTGAAGTGTACCCCTGAAGTCCAAG
CTGGTGTCCGATTTCCGGAAGGATTTCCAGTTTTACAAAGTGGCGAGATCAACAAGTACCACCAGCCACGACGCTACCTGAACGCCGCTC
GTGGGAACCGCCCTGATCAAAAAGTACCCTAAGCTGGAAAAGCGAGTTCGTGTACGGCGACTACAAGGTGTACGACGTGCGGAAGATGATCGCC
AAGAGCGAGCAGGAAATCGGCAAGGCTACCGCAAGTACTTCTTCTACAGCAACATCATGAAGTTCCTCAAGACCGAGATTACCCCTGGCCAAC
GGCGAGATCCGGAAGCGGCTCTGATCGAGACAAACGGCGAAACCGGGGAGATCGTGTGGATGAAGGGCCGGGATTTGCCACCGTCCGGA
GTGCTGAGCATGCCCAAGTGAATATCGTGAAAAGACCGAGGTGCAGACAGGCGGCTTCAGCAAAGAGTCTATCCTGCCAAGAGGAACAGC
GATAAGCTGATCCGCAGAAAGAAGGACTGGGACCCTAAGAAGTACGGCGGCTTCGACAGCCCAACCGTGGCCTATTCGTGCTGGTGGTGGCC
AAAGTGGAAAAGGGCAAGTCCAAGAACTGAAGAGTGTGAAAGAGCTGCTGGGGATCACCATCATGGAAAGAAGCAGCTTCGAGAAGAATCCC
ATCGACTTCTGGAAGCCAAGGGCTACAAAAGAGTGA AAAAGGACCTGATCATCAAGCTGCCTAAGTACTCCCTGTTTCGAGCTGGAAAACGGC
CGGAAGAGAATGCTGGCCTCTGCCGGCAACTGCAGAAGGGAACGAAGTGGCCCTGCCCTCCAAAATGTGAACTTCCTGTACCTGGCCAGC
CACTATGAGAAGCTGAAGGGCTCCCCGAGGATAATGAGCAGAAACAGCTGTTTGTGGAACAGCACAAGCACTACCTGGACGAGATCATCGAG
CAGATCAGCGAGTTCCTCAAGAGAGTGTCTGCGCGAGCTAATCTGGACAAAGTGTGTCCGCTACAACAAGCACCAGGATAAGCCCATC
AGAGAGCAGGCCGAGAATATCATCCACCTGTTTACCCTGACCAATCTGGGAGCCCTGCCGCTTCAAGTACTTTGACACCACCATCGACCGG
AAGAGGTACACCAGCACCAAGAGGTGCTGGACGCCACCTGATCCACCAGAGCATCACCAGGCTGTACGAGACACGGATCGACCTGTCTCAG
CTGGGAGGGCAG

Sp_St3 Cas9 chimera (St3 in bold)

ATGGACTATAAGGACCAGCAGGAGACTACAAGGATCATGATATTGATTACAAAGACGATGACGATAAGATGGCCCCAAAGAAGAAGCGGAAG
GTCCGGTATCCACGGAGTCCCAGCAGCCGACAAGAAGTACAGCATCGGCCTGGACATCGGCACCAACTCTGTGGGCTGGGCCGTGATCACCGAC
GAGTACAAGGTGCCAGCAAGAAATCAAGGTGCTGGGCAACACCGACCGGCACAGCATCAAGAAAGACCTGATCGGAGCCCTGCTGTTCCGAC
AGCGGCGAAACAGCCGAGGCCACCCGGCTGAAGAGAACCGCCAGAAGAAGATACACCAGACGGAAGAACCGGATCTGCTATCTGCAAGAGATC
TTCAGCAACGAGATGGCCAAGGTGGACGACAGCTTCTTCCACAGACTGGAAGAGTCTTCTGTTGGAAAGAGGATAAGAAGCACGAGCGGCAC
CCCATCTTCGGCAACATCGTGGACGAGGTGGCCTACCAGGAGAAGTACCCACCATCTACCCTGAGAAAAGAACTGGTGGACAGCACCGAC
AAGGCCGACCTGCGGCTGATCTATCTGGCCCTGGCCACATGATCAAGTTCGGGGGCCACTTCTGATCGAGGGCGACCTGAACCCCGACAAC
AGCGACGTGGACAAGCTGTTTCATCCAGCTGGTGCAGACCTACAACCAGCTGTTCCAGGAAAACCCCATCAACGCCAGCGGCGTGGACGCCAAG
GCCATCTGTCTGCCAGACTGAGCAAGAGCAGACGGCTGGAAAATCTGATCGCCAGCTGCCCGCGAGAAGAAGAATGGCCTGTTCCGAAAAC
CTGATTGCCCTGAGCCTGGCCCTGACCCCAACTTCAAGAGCAACTTCGACCTGCCGAGGATGCCAAACTGCAGCTGAGCAAGGACACCTAC
GACGACGACCTGGACAACCTGCTGGCCAGATCGGCGACCAAGTACGCCAGCTGTTTCTGGCCGCAAGAAGCTGTCCGACGCCATCTGCTG
AGCGACATCTGAGAGTGAACACCGAGATCACCAAGGCCCCCTGAGCGCCTCTATGATCAAGAGATACGACGAGCACCACCAGGACCTGACC

CTGCTGAAAGCTCTCGTCCGGCAGCAGCTGCCTGAGAAGTACAAAGAGATTTTCTTCGACCAGAGCAAGAACGGCTACGCCGGCTACATTGAC
GGCGGAGCCAGCCAGGAAGAGTTCTACAAGTTCATCAAGCCCATCCTGGAAAAGATGGACGGCACCGAGGAACTGCTCGTGAAGCTGAACAGA
GAGGACCTGCTGCGGAAGCAGCGGACCTTCGACAACGGCAGCATCCCCACCAGATCCACCTGGGAGAGCTGCACGCCATTCTGCGGGCCGAG
GAAGATTTTTACCCATTCTGAAGGACAACCGGAAAAGATCGAGAAGATCCTGACCTTCGGCATCCCCTACTACGTGGGCCCTCTGGCCAGG
GGAAACAGCAGATTGCGCTGCATGACCAGAAAGAGCGAGGAAACCATCACCCCTGGAACTTCGAGGAAGTGGTGGACAAGGGCCGCTCCGCC
CAGAGCTTCATCGAGCGGATGACCAACTTCGATAAGAACCTGCCAACGAGAAGGTGCTGCCAACGACAGCCTGCTGTACGAGTACTTCACC
GTGTATAACGAGCTGACCAAAGTGAATAACGTGACCGAGGGAATGAGAAAGCCCGCTTCCTGAGCGGCGAGCAGAAAAAGGCCATCGTGGAC
CTGCTGTTCAAGACCAACCGGAAAGTACCCTGAGCAGCTGAAAGAGGACTACTTCAAGAAAAATCGAGTCTCGACTCCGTGGAAATCTCC
GGCGTGGAAAGATCGGTTCAACGCCTCCCTGGGCACATACCACGATCTGCTGAAAATTATCAAGGACAAGGACTTCTGGACAATGAGGAAAAAC
GAGGACATTCTGGAAGATATCGTGTGACCCTGACACTGTTTGAGGACAGAGAGATGATCGAGGAACGGCTGAAAACCTATGCCACCTGTTT
GACGACAAAGTGTGAAGCAGCTGAAGCGGCGGAGATACACCGGCTGGGGCAGGCTGAGCCGGAAAGCTGATCAACGGCATCCGGGACAAGCAG
TCGGCAAGACAATCCTGGATTTCTGAAGTCCGACGGCTTCGCCAACAGAACTTCATGCAGCTGATCCACGACGACAGCCTGACCTTAAA
GAGGACATCCAGAAAGCCAGGTGTCGGCCAGGGCGATAGCCTGCACGAGCACATTGCCAATCTGGCCGGCAGCCCGCCATTAGAAGGGC
ATCCTGCAGACAGTGAAGGTGGTGGACGAGCTCGTGAAGTGTGGGCCGGCACAAGCCGAGAACATCGTGTGAAAATGGCCAGAGAGAAC
CAGACCACCCAGAAGGGACAGAAGAAGACGCGGAGAGAAATGAAGCGGATCGAAGAGGGCATCAAAGAGCTGGGCAGCCAGATCCTGAAAGAA
CACCCCGTGGAAAACCCAGCTGCAGAACGAGAAGCTGTACCTGTACTACCTGCAGAAATGGCCGGGATATGTACGTGGACCAGGAAGTGGAC
ATCAACCGGCTGTCCGACTACGATGTGGACCATATCGTGCCTCAGAGCTTCTGAAGGACGACTCCATCGACAACAAGGTGCTGACCAGAAGC
GACAAGAACCGGGCAAGAGCGACAACCTGCCCTCCGAAGAGGTGCTGAAGAAGATGAAGAATCTGCGCCGAGCTGCTGAACGCCAAGCTG
ATTACCCAGAGAAAGTTCGACAATCTGACCAAGGCCGAGAGGGCCCTGAGCGAACTGGATAAGGCCGCTTCATCAAGAGACAGCTGGTG
GAAACCCGGCAGATCACAAGCACGTGGCACAGATCCTGACTCCCGATGAACACTAAGTACGACGAGAATGACAAGCTGATCCGGGAAGTG
AAAGTGTACCCCTGAAGTCCAAGCTGGTGTCCGATTTCCGGAAGGATTTCCAGTTTTACAAAGTGGCGGAGATCAACAATACCACCAGCC
CACGACGCTACCTGAACGCCGCTCGTGGAAACCGCCCTGATCAAAAAGTACCCTAAGCTGGAAAGCGAGTTCGTGTACGGCGACTACAAGGTG
TACGACGTGCGGAAGATGATCGCAAGAGCGAGCAGGAAATCGGCAAGGCTACGCCAAGTACTTCTTCTACAGCAACATCATGAACTTTTTC
AAGACCGAGATTACCTGGCCAACGGCGAGATCCGGAAGCGCCCTCTGATCGAGACAACCGCGAAACCGGGGAGATCGTGTGGGATAAGGGC
CGGGATTTGCCACCGTCCGAAAGTCTGAGCATGCCCAAGTGAATATCGTGAAAAAGACCCTGGAAGAACAGAACCCAGGCTGGATCGG
GGCAAGCCAAAGGGCTGTTCAACGCCAACCTGTCCAGCAAGCCTAAGCCCACTCCAACGAGAATCTCGTGGGGCCAAAGAGTACCTGGA
CCCTAAGAAGTACGGGTACGGCGGATACGCCGCATCTCCAATAGCTTACCCTGCTCGTGAAGGGCACAATCGAGAAGGGCGCTAAGAAAA
AGATCACAACAGTCTGGAATTTAGGGGATCTCTATCCTGGACCGGATCAACTACCGGAAGGATAAGCTGAACTTTCTGCTGGAAAAAGGC
TACAAGGACATTGAGCTGATTATCGAGCTGCCTAAGTACTCCCTGTTTCAACTGAGCGACGGCTCCAGACGGATGCTGGCCTCCATCCTGTC
CACCAACAACAAGCGGGGGCAGATCCACAAGGGAAACAGATCTTCTGAGCCAGAAATTTGTGAAACTGCTGTACCACGCCAAGCGGATCT
CCAACACCATCAATGAGAACCACCGGAAATACGTGGAAAACCAAGAAGAGTTTTGAGGAACTGTTCTACTACATCCTGGAGTTCAACGAG
AACTATGTGGGAGCCAAGAAGAACGGCAAACTGCTGAACTCCGCCTCCAGAGCTGGCAGAACACAGCATCGACGAGCTGTGCAGCTCCTT
CATCGGCCCTACCGCAGCGAGCGGAAGGGACTGTTGAGCTGACCTCCAGAGGCTCTGCCCGGACTTTGAGTTCTGGGAGTGAAGATCC
CCCGGTACAGAGACTACACCCCTCTAGTCTGCTGAAGGACGCCACCCTGATCCACCAGAGCGTGACCGGCTGTACGAAACCGGATCGAC
CTGGCTAAGCTGGCGAGGGGAAAAAGCCGGCGCCACGAAAAAGCCGGCCAGGCAAAAAAGAAAAAG

St3_Sp Cas9 chimera (St3 in bold)

ATGGCCCCAAGAAGAAGCGGAAGGTGGTATCCACGGAGTCCACGAGCC**atg**ACCAAGCCCTACAGCATCGGCCTGGACATCGGCACCAAT
AGCGTGGGCTGGCCGTGACCACCGACA**ACTACAAGGTGCCAGCAAGAAAATGAAGGTGCTGGGCAACACCTCCAAGAAGTACATCAAGAA**
AAACCTGCTGGCGTCTGCTGTT**CGACAGCGGCATTACAGCCGAGGGCAGACGGCTGAAGAGAACC**CCAGACGGCGGTACACCCGGCGGA
GAAACAGAATCCTGTATCTGCAAGAGATCTT**CAGCACCAGATGGCTACCCTGGACGACGCTTCTCCAGCGGCTGGACGACAGCTTCTG**
GTGCCGACGACAAGCGGGACAGCAAGTACCCATCTT**CGCAACCTGGTGGAAAGAAAGCCCTACCACGACGAGTTCCCCACCATCTACCA**
CCTGAGAAAGTACCTGGCCGACAGCACAAGAAGCCGACCTGAGACTGGTGTATCTGGCCCTGGCCACATGATCAAGTACCGGGGCCACT
TCCTGATCGAGGGCGAGTTCAACAGCAAGAACAACGACATCCAGAAGAACTTCCAGGACTTCTGGACACCTACAACGCCATCTTCGAGAGC
GACCTGTCCCTGGAAAACAGCAAGCAGCTGGAAAGAGATCGTGAAGGACAAGATCAGCAAGCTGGAAAAGAAAGGACCGCATCCTGAAGCTGTT
CCCCGGCAGAGAAGAAGCGGAAATCTT**CAGCGAGTTTCTGAAGCTGATCGTGGCAACCGCCGACTTCAGAAAGTGTCTCAACCTGGACG**
AGAAAGCCAGCCTGC**ACTTCAGCAAAGAGAGCTACGACGAGGACCTGAAACCCCTGCTGGGATATATCGCCGACGACTACAGCGAGCTGTT**
CTGAAGGCCAAGAAGCTGTACGACGCTATCCTGCTGAGCGGCTTCTGACCGT**GACCGACAACGAGACAGAGGCCACTGAGCAGCGCCAT**
GATTAAGCGGTACAACGAGCACAAGAGGATCTGGCTCTGCTGAAGAGTACATCCGGAACATCAGCCTGAAAACCTACAATGAGGTGTTCA

AGGACGACACCAAGAACGGCTACGCCGGCTACATCGACGGCAAGACCAACCAGGAAGAGGAAGATTTCTATGTGTACCTGAAGAAGCTGCTG
GCCGAGTTCCAGGGGGCCGACTACTTTCTGGAAAAATCGACCGCGAGGATTTCTCGGGAAGCAGCGGACCTTCGACAACGGCAGCATCCC
GTACCAGATCCATCTCGAGGAAATGCCGGCCATCCTGGACAAGCAGGGCAAGTTCTACCCATTCTGGCCAAGAACAAAGAGCGGATCGAGA
AGATCCTGACCTTCCGCATCCCTTACTACGTGGGCCCCCTGGCCAGAGGCAACAGCGATTTTGCCTGGTCCATCCGGAAGCCCAATGAGAAG
ATCACCCCTGGAAGTTCCAGGACGTGATCGACAAAGAGTCCAGCGCCGAGGCCCTTTCATCAACCGGATGACCAGCTTCGACCTGTACCTGCC
CGAGGAAAAGGTGCTGCCCAAGCACAGCCTGCTGTACGAGACATTCAATGTGTATAACGAGCTGACCAAAGTGGGGTTATCGCCGAGTCTA
TGGGGACTACCAGTTCTGGACTCCAAGCAGAAAAAGGACATCGTGGGCTGTACTTCAAGGACAAGCGGAAAGTACCATAAGGACATC
ATCGAGTACCTGCACGCCATCTACGGCTACGATGGCATCGAGCTGAAGGGCATCGAGAAGCAGTTCAACTCCAGCCTGAGCACATACCACGA
CCTGCTGAACATTATCAACGACAAAAGATTTCTGGAGACTCCAGCAACGAGGCCATCATCGAAGAGATCATCCACACCCTGACCATCTTTG
AGGACCGCAGATGATCAAGCAGCGGCTGAGCAAGTTCGAGAACATCTTCGACAAGAGCGTGTGAAAAAGCTGAGCAGACGGCACTACACC
GGCTGGGGCAAGCTGAGCGCCAAAGCTGATCAACGGCATCCGGGACGAGAAGTCCGGCAACACAATCCTGGACTACCTGATCGACGACGGCAT
CAGCAACCGGAAGTTTCATGCAGCTGATCCACGACGACGCCCTGAGCTTCAAGAAGAAGATCCAGAAGGCCAGATCATCGGGACGAGGACA
AGGGCAACATCAAAGAAGTCTGAAGTCCCTGCCCGCAGCCCGCCATCAAGAAGGGAACTCCTGCAGAGCATCAAGATCGTGGACGAGCTC
GTAAAAGTATGGGCGCAGAAAGCCCGAGAGCATCGTGGTGGTGGTGGAAATGGCTAGAGAGAACCAGTACACCAATCAGGGCAAGAGCAA
CAGCCAGCAGAGACTGAAGAGACTGGAAAAGTCCCTGAAAGAGCTGGCAGCAAGATTCTGAAAGAGAATATCCCTGCCAAGCTGTCCAAGA
TCGACAACAACGCCCTGCAGAACGACCGCTGTACCTGTACTACCTGCAGAATGGCAAGGACATGTATACAGGGCAGCAGCTGGATATCGAC
CGCTGAGCAACTACGACATCGACCATATTATCCCCAGGCCCTCCTGAAAGACAACAGCATTGACAACAAAGTGTGGTGTCTCCGGCAG
CAACCGCGCAAGTCCGATGATGTGCCAGCCTGGAAGTCTGAAAAAGAGAAAAGACCTTCTGGTATCAGCTGCTGAAAAGCAAGCTGATTA
GCCAGAGGAAGTTCCACAACCTGACCAAGGCCGAGAGAGGGCCCTGAGCCCTGAAGATAAGGCCGGCTTTCATCCAGAGACAGCTGGTGGAA
ACCCGGCAGATCACCAAGCAGTGGCCAGACTGCTGGATGAGAAGTTTAAACAAGAAGGACGAGAACAACCGGCCGTCCGGACCGTGA
GATCATCACCTGAAGTCCACCTGGTGTCCAGTTCGGAAAGACTTCGAGCTGTATAAAGTGGCGAGATCAATGACTTTCACCACGCC
ACGACGGCTACCTGAATGCCGTGGTGGCTTCCGGCCTGCTGAAGAAGTACCCTAAGCTGGAACCCGAGTTCGTGTACGGCAGTACCCCAAG
TACAACCTCTCAGAGAGCGGAAGTCCGGCACCGAGAAGGTGTACTTCTACTCCAACATCATGAATATCTTTAAGAAGTCCATCTCCCTGGC
CGATGGCAGAGTATCGAGCGCCCTGATCGAAGTGAACGAAGAGACAGCCGAGAGCGTGTGGAACAAAAGAAAGCGACCTGGCCACCGTGC
GGCGGGTCTGAGTTATCCTCAAGTGAATGTCTGAAGAAGACCGAGGTGCAGACAGGGCGCTTCAGCAAAGAGTCTATCCTGCCAAGAGGA
ACAGCGATAAGCTGATCGCCAGAAAGAGGACTGGGACCTAAGAAGTACGGCGGCTTCGACAGCCCCACCGTGGCTATTTCTGTCTGGTGG
TGGCCAAAGTGGAAAAGGGCAAGTCCAAGAACTGAAGAGTGTGAAAGAGCTGCTGGGGATCACCATCATGGAAGAAGCAGCTTCGAGAAGA
ATCCCATCGACTTTCTGGAAGCCAAGGGCTACAAAGAAGTGA AAAAGGACCTGATCATCAAGCTGCCTAAGTACTCCCTGTTCCGAGCTGGAAA
ACGGCCGGAAGAGAATGCTGGCCTCTGCCGGCAACTGCAGAAGGGAAACGAACCTGGCCCTGCCCTCCAAATATGTGAAGTCTCTGTACCTGG
CCAGCCACTATGAGAAGCTGAAGGGTCCCCGAGGATAATGAGCAGAACAGCTGTTTGTGGAACAGCACAAGCCTACCTGGACGAGATCA
TCGAGCAGATCAGCGAGTTCTCCAAGAGAGTGTCTGGCCGACGCTAATCTGGACAAGTGTGTCCGCTACAACAAGCACCAGGATGAGC
CCATCAGAGAGCAGGCCGAGAATATCATCCACCTGTTTACCCTGACCAATCTGGAGCCCTGCCGCTCAAGTACTTTGACACCACCATCG
ACCGGAAGAGGTACACCAGCACAAAGAGGTGCTGGACGCCACCTGATCCACCAGAGCATCACCGCCTGTACGAGACACGGATCGACCTGT
CTCAGCTGGGAGGCGACAAAAGGCCGGGGCCACGAAAAGGCCGGCCAGGCAAAAAGAAAAAG

SpCas9 nickases
Mutated residues (changed to GCC) **bolded** in order: D10, E762, N863, H983, D986

ATGGACTATAAGGACCAGGAGGAGACTACAAGGATCATGATATTGATTACAAAAGCAGTACCGATAAAGTGGCCCCAAAAGAAAGCGGAAAGTTCGGTATCCAGGAGTCCAGCA
GCCGACAAGAAGTACAGCATCGGCCGACATCGGCACCAACTCTGTGGCTGGGCGGTGATCACCGACGAGTACAAGGTGCCAGCAAGAAATCAAGGTGCTGGGCAACCCGA
CCGGCACAGCATCAAGAAGAACCTGATCGGAGCCCTGCTGTTCCGACAGCGGCGAAACAGCCGAGGCCACCCGGCTGAAGAGAACCAGCAGAAAGATACACCAGACGGAAGAACCG
GATCTGCTATCTGCAAGAGATCTTACGCAACGAGATGGCCAAAGGTGGACGACAGCTTCTCCACAGACTGGAAGAGTCCCTTCTGGTGGAAAGAGGATAAGAAGCAGGAGCCGACCC
CATCTTCCGCAACATCGTGGACGAGGTGGCTTACCACGAGAAGTACCCAGCATCTACCACTGAGAAGAAAGTGGTGGACAGCACCAGCAAGGCCACCTGCCGCTGATGATCT
GGCCCTGGCCACATGATCAAGTTCGGGGCCACTTCTGATCGAGGGCGACTGAACCCCGACAACAGCGAGTGGACAAGCTGTTCAATCCAGCTGGTGCAGACCTACAACAGCT
GTTCCAGGAAAACCCCAACGACGCGAGCGGCTGGACGCCAAGGCCATCCTGTCTGCCAGACTGAGCAAGAGCAGACGAGCTGGAAAATCTGATCGCCAGCTGCCCGGCGAGAAGAA
GAATGGCTGTTCGGCAACCTGATTCGCTGAGCTGGCCGTGACCCCAACTTCAAGAGCAACTTCGACCTGGCCGAGGATGCCAACTGCAGCTGAGCAAGGACACTACGACGA
CGACCTGGACAACCTGCTGGCCAGATCGGGACAGTACGCCGACCTGTTTCTGGCGCCAAAGAACTGTCGACGCTCCTGCTGAGGACATCTGAGAGTGAACACCGAGAT
CACCAAGGCCCCCTGAGCCCTCTATGATCAAGAGATACGACGAGCAGCACCAGGACCTGACCTGCTGAAAAGCTCTCGTGGCCAGCAGCTGCTGAGAAGTACAAGAGATTTT
CTTCGACGAGAGCAAGAACCGGCTACCCGGCTACATTCGACGGCGGAGCCAGCCAGGAAAGTCTTACAAGTTCATCAAGCCCATCCTGGAAAAGATGGACGGCAGCCAGGAACTGCT
CGTGAAGCTGAACAGAGAGGACCTGCTGGGAAGCAGCGGACCTTCGACAAGGGCAGCATCCCCACCAGATCCACCTGGGAGAGCTGCACGCCATTCCTGGCGCGCAGGAAAGTTT
TTACCCATTCCTGAAGGACAACCGGGAAGAGATCGAGAAGATCCTGACCTTCGGCATCCCTACTACGTGGGCCCTCTGGCCAGGGGAAACAGCAGATTCGGCTGGAAGACGAGAA
GAGGAGGAAACCATCACCCCTGGAAGTTCGAGGAAGTGGTGGACAAGGGCGCTCCCGCCAGAGCTTCATCGAGCGGATGACCAACTTCGATAAGAACCTGCCAAGCAGAAAGT
GCTGCCAAGCAGCAGCTGCTGTACGAGTACTTACCGGTGATAAOCAGCTGACCAAAGTGAATACCTGACCGAGGGAATGAGAAGGCCCGCTTCTGAGCGCGCAGCAGAAAAA

GCCCATCGTGGACCTGCTGTTCAAGACCAACCGGAAAGTGACCGTGAAGCAGCTGAAAGAGGACTACTTCAAGAAAATCGAGTGCCTCGACTCGGTGGAAAATCTCCGGCGTGGAA
 TCGGTTCACAGCCCTCCCTGGGCACATACCCAGCATCTGCTGAAAAATATCAAGGACAAAGGACTTCCCTGGACAAATGAGGAAAACGAGGACATTCCTGGAGATATCGTGCAGCCCTGAC
 ACTGTTTGAGGACAGAGATGATCGAGGAACCGCTGAAAACCTATGCCACCTGTTGACGACAAAGTGATGAAAGCAGCTGAAGCGCGGAGATACACCGGCTGGGACAGCTGAG
 CCGGAAGCTGATCAACCGCATCCGGGACAAGCAGTCCGGCAAGCAATCCTGGATTCCTGAACTCCGACGGCTTCGCCAACAGAACTTCATGCAGCTGATCCACGACGACAGCCT
 GACCTTTAAAGAGGACATCCAGAAAGCCAGGTGTCGGCCAGGGCGATAGCCTGCACGAGCAGATTGCCAATCTGGCCGACGCCCCGCTTAAAGAAAGGACATCCGACAGAGT
 GAAGTGGTGGACGAGCTGTAAGTATGATGGCCGGCAGCAGGGAGAACATCGTATCGAAAATGGCCAGAGAGAACAGCAGCCACCCAGAAAGGACAGAAAGAACAGCCCGCAGAA
 GAATGAAGCCGGATCGAAGAGCCGATCAAAAGAGCTGGGACGCGAGATCCTGAAAGAACACCCCGTGGAAAACACCCAGCTGCAGAACGAGAAGCTGTACCTGTACTACCTGCGAATG
 GGCGGATATGTACGTGGACCGAACTGGACATCAACCCGCTGTCCGACTACGATGTGGACCAATCGTGCCTCAGAGCTTCTGAAGGACGACTCCATGCAGAACAGGTGCTGA
 CCAGAAGCGACAAGAACCGGGGCAAGAGCGACAAGCTGCCCTCCGAAAGAGTGTGAAAGAGATGAAGAACTACTGGCGGACGCTGCTGAACCCCAAGCTGATACCCAGAGAAAG
 TTCGACAATCTGACCAAGCCGAGAGAGGGCGCTGAGCGAACTGGATAAAGCCGCTTCATCAAGAGACAGCTGGTGGAAAACCCGCGAGATCACAAAGCAGTGGCAGAGATCCTG
 GACTCCCGGATGAACACTAAGTACGACGAGAATGACAAGCTGATCCGGGAAGTAAAGTGTACCCCTGAAGTCCAAGCTGGTGTCCGATTTCCGGAAAGGATTTCCAGTTTTACAAA
 GTGGCGGAGATCAACAACCTACCACGAGCCACGAGCCCTACCTGAACCGCTGCTGGAAACCGCCCTGATCAAAAAGTACCCTAAGCTGCAAAAGGAGTTCCTGTACGGCGACTA
 CAAGGTGTACGAGCTGGGAGATGATCGCCAGAGCCAGCAGGAAATCGCCAGGCTACCAGGAGTACTTCTTACAGACAACTCATGAACTTTTCAAGACCCGAGATTAACCT
 GGCCAACGGGAGATCCGGAAGCGGCTCTGATCGAGACAACGGGAAACCGGGGAGATCGTGTGGGATAAGGGCCGGGATTTGCCACCTGCGGAAAGTGTGAGCATGCCCA
 AGTGAATATCGTGAAGAAAGACCGAGGTGCAGACAGGCGCTCAGCAAGAGTCTATCCTGCCAAGAGGAACAGCGATAAGCTGATCGCCAGAAAGAAAGGACTGGGACCTAAGAA
 GTACGGGGCTTCGACAGCCCAAGCTGGCTTATCTGTGCTGGTGGTGGCCAAAGTGGAAAAGGGCAAGTCCAAAGAACTGAAGAGTGTGAAGAGCTGCTGGGATCACCATCAT
 GGAAAGAGCAGCTTCGGAAGAAATCCCATCGACTTCTGGAAAGCCAGGGGTACAAGAAGTGAAGAAAGGACCTGATCATCAAGCTGCCAAGTACTGCCCTGTTCCAGGTGGAAAA
 CGGCCGAAAGAAATGCTGGCTCTCGCGGCACTGCAGAAAGGAAACGAACTGGCCCTGCCCTCCAAATATGTGAATCTCTGTACCTGGCCAGCCACTATGAGAAGCTGAAGGG
 CTCCCCGAGGATATGAGCAGAAACAGCTGTTGTGGACAGCACAAGCACTACCTGGACGAGATCATCGAGCAGATCAGCGAGTTCCTCAAGAGAGTATCCTGGCCGAGCTAA
 TCTGGACAAGTGTCTGCCCTACAAACAGCAGCCGGATTAAGCCATCAGAGAGCAGGCGGAGAAATATCATCCACCTGTTTACCCCTGACCAATCTGGAGGCCCCGCGCTCAA
 GTACTTTGACACCACCATCGACCGGAAAGAGGTACACCAGCACCAGAGGTGCTGGACGCCACCTGATCCACCAGAGCATCACCGGCTGTACGAGACAGGATCGACCTGTCTCA
 GCTGGGAGCGACAAAAGCGCGCGCCACGAAAAGGCCCGCCAGGCAAAAAGAAAAAG

SpCas9 point mutants

Mutated residues (changed to GCC) **bolded** in order: R63A, R66A, R69A, R70A, R74A, R75A, R78A, K163A, R165A, K510A

ATGGACTATAAGGACCAGCAGGAGACTACAAGGATCATGATATTGATTACAAGACGATGACGATAAGTGGCCCCAAAGAAGAAGCGGAAAGGTGGGTATCCACGGAGTCCGACGA
 GCCGACAAGAAGTACAGCATCGGCCCTGGACATCGGCCACCAACTCTGTGGGCTGGGCGGTGATCACCGACGAGTACAAGGTGGCCAGCAAGAAATCAAGGTGCTGGGCAACCCGAC
 CGGACACGCAATCAAGAAGAACCCTGATCGGAGCCCCTGCTGTGGACAGCGCGCAAAACAGCGAGGCCACCCCGGCTGAAGAGAAACCGGAGAGATACACAGAGCGGAAAGAACCG
 GATCTGCTATCTGCAAGAGATCTTCAAGCAAGGAGATGGCCAGGTTGACGACAGCTTCTTCCACAGACTGGAAGAGTCTTCTGGTGGAAAGGATTAAGAAGCAGCAGCGGCAAC
 CCATCTTCGGCAACATCGTGGAGAGGTGGCTACCCAGAGAGTACCCACCATCTACACCTGAGAAAGAACTGGTGGACAGCAGCAGCAGGCGGACCTGGGGCTGATCTATC
 TGGCCCTGGCCACATGATCAAGTTCGGGCGCCACTTCTGATCGAGGGGACCTGAACCCGACACAGCGAGTGGACAAGCTGTTTATCCAGCTGGTGCAGACCTACAACCAG
 CTGTTGAGGAAAACCCGATCAACGCCAGCGGCTGGACGCAAGGCCATCCTGCTGCGCAGCTGAGCAAGAGCAGCAGGCTGGAAAATCTGATCGCCAGCTGCCCGGAGAG
 AAGAAATGGCCCTGTTCCGCAACCTGATTCGCCCTGAGCCCTGGCCCTGACCCGCAACTTCAAGAGCAACTTCGACCTGGCCGAGGATGCCAACTGCAGCTGAGCAAGGACACCTACGAC
 GACGACCTGGACAACCTGCTGGCCGAGTTCGGCGACAGTACGCCGACCTGTTTCTGGCCGCAAGAACCCTGTCGACGCCATCCTGCTGAGCGACATCCTGAGAGTGAACACCGAG
 ATCACCAAGGCCCCCTGAGCGCTCTATGATCAAGAGATACGACGAGCAGCCAGGACCTGACCCCTGCTGAAGCTCTGCTGGCCAGCAGCTGCTGAGAAGTACAAGAGATTT
 TTCTTCGACCAAGCAAGAACCGGCTACATTTGACGGGAGCCAGCCAGGAAAGTTCACAACTTCAAGCCATCAAGCCCATGCTGGAAAAGATGGACGCGCAGATACACCGCTGGGACAGCT
 CTGCTGAAAGCTGAACAGAGAGGACCTGCTGGGAAAGCAGCGGACCTTCGACAACGGGAGCATCCCCACAGATCCACCTGGGAGAGCTGCAGCCGCTTTCGGGCGGAGGAAAGAT
 TTTTACCCATTCCTGAAGGACAACCGGAAAAGAATGAGAAGAATCTGACCTTCGCAATCCCTACTACGTTGGCCCTGTCGGCAGGGAAACAGCAGATTCGCTGGATGACGAGA
 AAGAGGAGGAAACCAATCACCCCTGAACTTCGAGGAGTGGTGGACAAGGGGCTTCCGCCAGAGCTTCATCGAGCGGATGACCAACTTCGATAAGAACCCTGCCAACGAGAAAG
 GTGCTGCCAAGCAGACCTGCTGTACGAGTACTTACCCGTGATATAACGAGCTGACCAAGTGAATACGTTGACCGAGGAAATGAGAAGGCCGCGCTTCTGAGCGGAGCAGAAA
 AAGGCCATCGTGGACCTGCTGTTCAAGACCAACCGGAAAGTGACCGTGAAGCAGCTGAAAGAGGACTACTTCAAGAAAATCGAGTGCCTCGACTCGGTGGAAAATCTCCGGCGTGGAA
 AGATCGGTTCAACCCCTCCCTGGGCACATACCCAGATCTGCTGAAAAATATCAAGGACAAAGGACTTCCCTGGACAATGAGGAAAACGAGGACATTCGGAAGATATCGTGTGACCC
 GACTGTTTGGACAGAGAGATGATCGAGGAACCGCTGAAAACCTATGCCACCTGTTTCGACGACAAAGTATGAAAGCAGCTGAAGCGCGGAGATACACCGCTGGGACAGCT
 GAGCCGGAAGCTGATCAACCGGATCCGGGACAAGCAGTCCGGCAAGACAATCCTGGATTTCCCTGAAGTCCGACCGCTTCCGCAACAGAACTTCATCGAGCTGATCCACGACGAG
 CCTGACCTTTAAGAGGACATCCAGAAAGCCAGGTGTCGGCCAGGGGATAGCCTGCACGAGCAGATTCGCAATCTGGCCGACGCCCCGCCATTAAGAAGGGCATCTGACAGAC
 AGTGAAGTGGTGGACGAGCTGTAAGTGTATGGCCGGCAGCAGCCGAGAACATCGTATCGAAAATGGCCAGAGAGAACAGACCACCCAGAAAGGACAGAGAAGAACAGCCCGGA
 GAGAAATGAAGCGGATCGAAGAGGGCATCAAGAGCTGGCCAGCCAGATCCTGAAAGAACCCCGTGGAAAACCCAGCTGCAGAACGAGAAAGCTGTACCTGTACTACCTGCAGAA
 TGGCCGGGATATGATCGTGGACAGGAACTGGACATCAACCGGCTGTCGGACTACGATGTGGACCATATCGTGCCTCAGAGCTTCTGAAGGACGACTCCATCGACAACAAGGTGCT
 GACCAGAAAGGACAAGAACCGGGCAAGAGGACACCTGCCCTCCGAAAGAGTGTGAAAGAGATGAAGAACTACTGGCGGACGCTGCTGAAGCCCAAGCTGATTAACCCAGAGAAA
 GTTTCGACAATCTGACCAAGCCGAGAGAGGCGGCTGAGCGAACTGGATTAAGCCCGCTTCATCAAGAGACAGCTGGTGGAAACCCGCGAGATCACAAAGCAGCTGGCAGATCCT
 GGACTCCCGGATGAACACTAAGTACGAGGAGAAATGACAAGCTGATCCGGGAAGTGAAGTGTATCACCTGAAGTCCAGAGCTGGTGTCCGATTTCCGGAAGGATTTCCAGTTTTACAA
 AGTGGCGGAGATCAACAACCTACCCACGCGCCAGCAGCCTACCTGAACCGCTGCTGGAAACCGGCTGATCAAAAAGTACCCTAAGCTGGAAAAGCAGTTCGTGTACCGGAGTA
 CAAGGTGTACGAGCTGGGAAAGTATCGCCAGAGGAGCAGGAAATCGGCAAGCTACCGCAAGTACTTCTTACAGCAACATCATGAACTTTTCAAGACCCGAGATTAACCT
 GGCCAACGGGAGATCCGGAAGCGGCTCTGATCGAGACAACCGGGAACCGGGGAGATCGTGTGGGATAAGGCCCGGATTTTCCACCGTGGGAAAGTGTGAGCATGCCCA
 AGTGAATATCGTGAAGAAAGACCGAGGTGCAGACAGGCGCTTCAGCAAGAGTCTATCCTGCCAAGAGGAAACAGCGATTAAGCTGATCGCCAGAAAGAAAGGACTGGGACCTAAGAA
 GTACGGCGGCTTCGACAGCCCAAGCTGGCTTATCTGTGCTGGTGGTGGCCAAAGTGGAAAAGGGCAAGTCCAAAGAACTGAAGAGTGTGAAGAGCTGCTGGGATCACCATCAT
 GGAAGAAAGCAGCTTCGAGAAAGATCCCATCGACTTCTGGAAGCCAAAGGCTACAAAGAAAGTGAAGAAAGGACCTGATCATCAAGCTGCTAAGTACTCCCTGTTTCGAGCTGGAAA
 CGGCCGGAAGAGATGCTGGCTTCTGGCGCAAGCTGAGAGAGGCAAGCTGCCCTCCGCAAAATATGTGAACTTCTGTACCTGAGCTGAGCTGAGCTGAGCTGAGCTGAGCTGAGCT
 CTCCCCGAGGATATGAGCAGAAACAGCTGTTTGTGGACAGCACAAGCACTACCTGGACGAGATCATCGAGCAGATCAGCGAGTTCCTCAAGAGAGTGTGCTGGCCAGCGCTAA
 TCTGGACAAGTGTCTGCCCTACAAACAGCAGCCGGATTAAGCCATCAGAGAGCAGGCGGAGAAATATCATCCACCTGTTTACCCCTGACCAATCTGGAGGCCCCGCGCTCAA
 GTACTTTGACACCACCATCGACCGGAAAGAGGTACACCAGCACCAGAGGTGCTGGACGCCACCTGATCCACCAGAGCATCACCGGCTGTACGAGACAGGATCGACCTGTCTCA

GCTGGGAGGGACAAAAGGCCGGCGCCACGAAAAAGCCGGCCAGGCAAAAAAGAAAAAG

sgRNA sequences:

guide sequence underlined

+83

GAGUCCGAGCAGAAGAAGAAGCCCCAGAGCUAGAAAUAGCAAGUUGGGGUUAGGCUAGUCCGUUAUCAACUUGAAAAAGUGGCACCGAGUCGGUGCUUUU

+47

GAGUCCGAGCAGAAGAAGAAGULUUUAGAGCUAGAAAUAGCAAGUUAUUUUUUAAGGCUAGUCCGUUUU

+67

GAGUCCGAGCAGAAGAAGAAGULUUUAGAGCUAGAAAUAGCAAGUUAUUUUUUAAGGCUAGUCCGUUAUCAACUUGAAAAAGUGUUUU

mutate proximal crRNA:tracrRNA duplex

GAGUCCGAGCAGAAGAAGAAGCCCCAGAGCUAGAAAUAGCAAGUUGGGGUUAGGCUAGUCCGUUAUCAACUUGAAAAAGUGGCACCGAGUCGGUGCUUUU

truncate distal crRNA:tracrRNA duplex

GAGUCCGAGCAGAAGAAGAAGULUUUAGAGCUAGAAAUAGCAAGUUAUUUUUUAAGGCUAGUCCGUUAUCAACUUGAAAAAGUGGCACCGAGUCGGUGCUUUU

remove crRNA:tracrRNA duplex bulge

GAGUCCGAGCAGAAGAAGAAGULUUUAGAGCUAGAAAUAGCUUUUUUUUAAGGCUAGUCCGUUAUCAACUUGAAAAAGUGGCACCGAGUCGGUGCUUUU

abolish stemloop 1

GAGUCCGAGCAGAAGAAGAAGULUUUAGAGCUAGAAAUAGCAAGUUAUUUUUUAUUUCUAGUUAAGUUAUCAACUUGAAAAAGUGGCACCGAGUCGGUGCUUUU

mutate stemloop 1

GAGUCCGAGCAGAAGAAGAAGULUUUAGAGCUAGAAAUAGCAAGUUAUUUUUUAAGCCUAGUCCGUUAUCAACUUGAAAAAGUGGCACCGAGUCGGUGCUUUU

truncate linker

GAGUCCGAGCAGAAGAAGAAGULUUUAGAGCUAGAAAUAGCAAGUUAUUUUUUAAGGCUAGUCCGUUAUCAACUUGAAAAAGUGGCACCGAGUCGGUGCUUUU

replace stemloop 2

GAGUCCGAGCAGAAGAAGAAGULUUUAGAGCUAGAAAUAGCAAGUUAUUUUUUAAGGCUAGUCCGUUAUCAACCGCGAAAGGGGGGACCGAGUCGGUGCUUUU

lengthen stemloop 2

GAGUCCGAGCAGAAGAAGAAGULUUUAGAGCUAGAAAUAGCAAGUUAUUUUUUAAGGCUAGUCCGUUAUCAACUUGAAAAUUAAGUUGGCACCGAGUCGGUGCUUUU

mutate stemloop 3

GAGUCCGAGCAGAAGAAGAAGULUUUAGAGCUAGAAAUAGCAAGUUAUUUUUUAAGGCUAGUCCGUUAUCAACUUGAAAAAGUGGCACCGCGGGGGGCUUUU

lengthen stemloop 3

GAGUCCGAGCAGAAGAAGAAGULUUUAGAGCUAGAAAUAGCAAGUUAUUUUUUAAGGCUAGUCCGUUAUCAACUUGAAAAAGUGGCACCGAAAGUUGGGUGCUUUU

reconstructed sgRNA

GAGUCCGAGCAGAAGAAGAAGCCCCAGAGCAUUAGCAAGUUGGGGUUAGGCUAGUCCGUUAUCAAGGGCAGCCCGGACCGAGUCGGUGCUUUU

G43A

GAGUCCGAGCAGAAGAAGAAGULUUUAGAGCUAGAAAUAGCAACUUAUUUUUUAAGGCUAGUCCGUUAUCAACUUGAAAAAGUGGCACCGAGUCGGUGCUUUU

U44G

GAGUCCGAGCAGAAGAAGAAGULUUUAGAGCUAGAAAUAGCAAGUUAUUUUUUAAGGCUAGUCCGUUAUCAACUUGAAAAAGUGGCACCGAGUCGGUGCUUUU

U44C

GAGUCCGAGCAGAAGAAGAAGULUUUAGAGCUAGAAAUAGCAAGCUUUUUUUAAGGCUAGUCCGUUAUCAACUUGAAAAAGUGGCACCGAGUCGGUGCUUUU

Primers

Cas9	Target	PAM	SURVEYOR primer F	SURVEYOR PRIMER R
Sp	GAGTCCGAGCAGAAGAAGAA	GGG	CCATCCCCTTCTGTGAATGT	GGAGATTGGAGACACGGAGA
St3	GCTCCCATCACATCAACCGG	TGGCG	same	same

* * *

[00239] While preferred embodiments of the present invention have been shown and described herein, it will be obvious to those skilled in the art that such embodiments are provided by way of example only. Numerous variations, changes, and substitutions will now occur to those skilled in the art without departing from the invention. It should be understood that various alternatives to the embodiments of the invention described herein may be employed in practicing

the invention. It is intended that the following claims define the scope of the invention and that methods and structures within the scope of these claims and their equivalents be covered thereby.

[00240] References:

1. Urnov, F.D., Rebar, E.J., Holmes, M.C., Zhang, H.S. & Gregory, P.D. Genome editing with engineered zinc finger nucleases. *Nat. Rev. Genet.* **11**, 636-646 (2010).
2. Bogdanove, A.J. & Voytas, D.F. TAL effectors: customizable proteins for DNA targeting. *Science* **333**, 1843-1846 (2011).
3. Stoddard, B.L. Homing endonuclease structure and function. *Q. Rev. Biophys.* **38**, 49-95 (2005).
4. Bae, T. & Schneewind, O. Allelic replacement in *Staphylococcus aureus* with inducible counter-selection. *Plasmid* **55**, 58-63 (2006).
5. Sung, C.K., Li, H., Claverys, J.P. & Morrison, D.A. An *rpsL* cassette, janus, for gene replacement through negative selection in *Streptococcus pneumoniae*. *Appl. Environ. Microbiol.* **67**, 5190-5196 (2001).
6. Sharan, S.K., Thomason, L.C., Kuznetsov, S.G. & Court, D.L. Recombineering: a homologous recombination-based method of genetic engineering. *Nat. Protoc.* **4**, 206-223 (2009).
7. Jinek, M. et al. A programmable dual-RNA-guided DNA endonuclease in adaptive bacterial immunity. *Science* **337**, 816-821 (2012).
8. Deveau, H., Garneau, J.E. & Moineau, S. CRISPR/Cas system and its role in phage-bacteria interactions. *Annu. Rev. Microbiol.* **64**, 475-493 (2010).
9. Horvath, P. & Barrangou, R. CRISPR/Cas, the immune system of bacteria and archaea. *Science* **327**, 167-170 (2010).
10. Terns, M.P. & Terns, R.M. CRISPR-based adaptive immune systems. *Curr. Opin. Microbiol.* **14**, 321-327 (2011).
11. van der Oost, J., Jore, M.M., Westra, E.R., Lundgren, M. & Brouns, S.J. CRISPR-based adaptive and heritable immunity in prokaryotes. *Trends. Biochem. Sci.* **34**, 401-407 (2009).
12. Brouns, S.J. et al. Small CRISPR RNAs guide antiviral defense in prokaryotes. *Science* **321**, 960-964 (2008).

13. Carte, J., Wang, R., Li, H., Terns, R.M. & Terns, M.P. Cas6 is an endoribonuclease that generates guide RNAs for invader defense in prokaryotes. *Genes Dev.* **22**, 3489-3496 (2008).
14. Deltcheva, E. et al. CRISPR RNA maturation by trans-encoded small RNA and host factor RNase III. *Nature* **471**, 602-607 (2011).
15. Hatoum-Aslan, A., Maniv, I. & Marraffini, L.A. Mature clustered, regularly interspaced, short palindromic repeats RNA (crRNA) length is measured by a ruler mechanism anchored at the precursor processing site. *Proc. Natl. Acad. Sci. U.S.A.* **108**, 21218-21222 (2011).
16. Haurwitz, R.E., Jinek, M., Wiedenheft, B., Zhou, K. & Doudna, J.A. Sequence- and structure-specific RNA processing by a CRISPR endonuclease. *Science* **329**, 1355-1358 (2010).
17. Deveau, H. et al. Phage response to CRISPR-encoded resistance in *Streptococcus thermophilus*. *J. Bacteriol.* **190**, 1390-1400 (2008).
18. Gasiunas, G., Barrangou, R., Horvath, P. & Siksnys, V. Cas9-crRNA ribonucleoprotein complex mediates specific DNA cleavage for adaptive immunity in bacteria. *Proc. Natl. Acad. Sci. U.S.A.* (2012).
19. Makarova, K.S., Aravind, L., Wolf, Y.I. & Koonin, E.V. Unification of Cas protein families and a simple scenario for the origin and evolution of CRISPR-Cas systems. *Biol. Direct.* **6**, 38 (2011).
20. Barrangou, R. RNA-mediated programmable DNA cleavage. *Nat. Biotechnol.* **30**, 836-838 (2012).
21. Brouns, S.J. Molecular biology. A Swiss army knife of immunity. *Science* **337**, 808-809 (2012).
22. Carroll, D. A CRISPR Approach to Gene Targeting. *Mol. Ther.* **20**, 1658-1660 (2012).
23. Bikard, D., Hatoum-Aslan, A., Mucida, D. & Marraffini, L.A. CRISPR interference can prevent natural transformation and virulence acquisition during in vivo bacterial infection. *Cell Host Microbe* **12**, 177-186 (2012).
24. Sapranauskas, R. et al. The *Streptococcus thermophilus* CRISPR/Cas system provides immunity in *Escherichia coli*. *Nucleic Acids Res.* (2011).

25. Semenova, E. et al. Interference by clustered regularly interspaced short palindromic repeat (CRISPR) RNA is governed by a seed sequence. *Proc. Natl. Acad. Sci. U.S.A.* (2011).
26. Wiedenheft, B. et al. RNA-guided complex from a bacterial immune system enhances target recognition through seed sequence interactions. *Proc. Natl. Acad. Sci. U.S.A.* (2011).
27. Zahner, D. & Hakenbeck, R. The *Streptococcus pneumoniae* beta-galactosidase is a surface protein. *J. Bacteriol.* **182**, 5919-5921 (2000).
28. Marraffini, L.A., Dedent, A.C. & Schneewind, O. Sortases and the art of anchoring proteins to the envelopes of gram-positive bacteria. *Microbiol. Mol. Biol. Rev.* **70**, 192-221 (2006).
29. Motamedi, M.R., Szigety, S.K. & Rosenberg, S.M. Double-strand-break repair recombination in *Escherichia coli*: physical evidence for a DNA replication mechanism in vivo. *Genes Dev.* **13**, 2889-2903 (1999).
30. Hosaka, T. et al. The novel mutation K87E in ribosomal protein S12 enhances protein synthesis activity during the late growth phase in *Escherichia coli*. *Mol. Genet. Genomics* **271**, 317-324 (2004).
31. Costantino, N. & Court, D.L. Enhanced levels of lambda Red-mediated recombinants in mismatch repair mutants. *Proc. Natl. Acad. Sci. U.S.A.* **100**, 15748-15753 (2003).
32. Edgar, R. & Qimron, U. The *Escherichia coli* CRISPR system protects from lambda lysogenization, lysogens, and prophage induction. *J. Bacteriol.* **192**, 6291-6294 (2010).
33. Marraffini, L.A. & Sontheimer, E.J. Self versus non-self discrimination during CRISPR RNA-directed immunity. *Nature* **463**, 568-571 (2010).
34. Fischer, S. et al. An archaeal immune system can detect multiple Protospacer Adjacent Motifs (PAMs) to target invader DNA. *J. Biol. Chem.* **287**, 33351-33363 (2012).
35. Gudbergsdottir, S. et al. Dynamic properties of the *Sulfolobus* CRISPR/Cas and CRISPR/Cmr systems when challenged with vector-borne viral and plasmid genes and protospacers. *Mol. Microbiol.* **79**, 35-49 (2011).
36. Wang, H.H. et al. Genome-scale promoter engineering by coselection MAGE. *Nat Methods* **9**, 591-593 (2012).
37. Cong L, Ran FA, Cox D, Lin S, Barretto R, Habib N, Hsu PD, Wu X, Jiang W, Marraffini LA, Zhang F. Multiplex Genome Engineering Using CRISPR/Cas Systems. *Science*. 2013 Feb 15;339(6121):819-23.

38. Mali, P., Yang, L., Esvelt, K.M., Aach, J., Guell, M., DiCarlo, J.E., Norville, J.E., and Church, G.M. (2013b). RNA-guided human genome engineering via Cas9. *Science* 339, 823-826.
39. Hoskins, J. et al. Genome of the bacterium *Streptococcus pneumoniae* strain R6. *J. Bacteriol.* **183**, 5709-5717 (2001).
40. Havarstein, L.S., Coomaraswamy, G. & Morrison, D.A. An unmodified heptadecapeptide pheromone induces competence for genetic transformation in *Streptococcus pneumoniae*. *Proc. Natl. Acad. Sci. U.S.A.* **92**, 11140-11144 (1995).
41. Horinouchi, S. & Weisblum, B. Nucleotide sequence and functional map of pC194, a plasmid that specifies inducible chloramphenicol resistance. *J. Bacteriol.* **150**, 815-825 (1982).
42. Horton, R.M. In Vitro Recombination and Mutagenesis of DNA : SOEing Together Tailor-Made Genes. *Methods Mol. Biol.* **15**, 251-261 (1993).
43. Podbielski, A., Spellerberg, B., Woischnik, M., Pohl, B. & Luttmann, R. Novel series of plasmid vectors for gene inactivation and expression analysis in group A streptococci (GAS). *Gene* **177**, 137-147 (1996).
44. Husmann, L.K., Scott, J.R., Lindahl, G. & Stenberg, L. Expression of the Arp protein, a member of the M protein family, is not sufficient to inhibit phagocytosis of *Streptococcus pyogenes*. *Infection and immunity* **63**, 345-348 (1995).
45. Gibson, D.G. et al. Enzymatic assembly of DNA molecules up to several hundred kilobases. *Nat Methods* **6**, 343-345 (2009).
46. Garneau J. E. et al. The CRISPR/Cas bacterial immune system cleaves bacteriophage and plasmid DNA. *Nature* 468,67-71(04 November 2010)
47. Barrangou R. et al. CRISPR provides acquired resistance against viruses in prokaryotes. *Science*. 2007 Mar 23;315(5819):1709-12.
48. Ishino Y. et al. Nucleotide sequence of the iap gene, responsible for alkaline phosphatase isozyme conversion in *Escherichia coli*, and identification of the gene product. *J Bacteriol.* 1987 Dec;169(12):5429-33.
49. Mojica F. J. M et al. Biological significance of a family of regularly spaced repeats in the genomes of Archaea, Bacteria and mitochondria. *Molecular Microbiology* (2000) 36(1), 244-246.
50. Jansen R. et al. Identification of genes that are associated with DNA repeats in prokaryotes. *Molecular Microbiology* (2002) 43(6), 1565-1575.

51. Gouet, P., Courcelle, E., Stuart, D.I., and Metz, F. (1999). ESPript: analysis of multiple sequence alignments in PostScript. *Bioinformatics* 15, 305-308.
52. Notredame, C., Higgins, D.G., and Heringa, J. (2000). T-Coffee: A novel method for fast and accurate multiple sequence alignment. *J Mol Biol* 302, 205-217.
53. Adams, P.D., Grosse-Kunstleve, R.W., Hung, L.W., Ioerger, T.R., McCoy, A.J., Moriarty, N.W., Read, R.J., Sacchettini, J.C., Sauter, N.K., and Terwilliger, T.C. (2002). PHENIX: building new software for automated crystallographic structure determination. *Acta Crystallogr D Biol Crystallogr* 58, 1948-1954.
54. Ariyoshi, M., Vassylyev, D.G., Iwasaki, H., Nakamura, H., Shinagawa, H., and Morikawa, K. (1994). Atomic structure of the RuvC resolvase: a holliday junction-specific endonuclease from *E. coli*. *Cell* 78, 1063-1072.
55. Biertumpfel, C., Yang, W., and Suck, D. (2007). Crystal structure of T4 endonuclease VII resolving a Holliday junction. *Nature* 449, 616-620.
56. Chen, L., Shi, K., Yin, Z., and Aihara, H. (2013). Structural asymmetry in the *Thermus thermophilus* RuvC dimer suggests a basis for sequential strand cleavages during Holliday junction resolution. *Nucleic acids research* 41, 648-656.
57. de la Fortelle, E., and Bricogne, G. (1997). Maximum-likelihood heavy-atom parameter refinement for multiple isomorphous replacement and multiwavelength anomalous diffraction methods. *Methods Enzymol* 276, 472-494.
58. Emsley, P., and Cowtan, K. (2004). Coot: model-building tools for molecular graphics. *Acta Crystallogr D Biol Crystallogr* 60, 2126-2132.
59. Fonfara, I., Le Rhun, A., Chylinski, K., Makarova, K.S., Lecrivain, A.L., Bzdrenga, J., Koonin, E.V., and Charpentier, E. (2013). Phylogeny of Cas9 determines functional exchangeability of dual-RNA and Cas9 among orthologous type II CRISPR-Cas systems. *Nucleic acids research*.
60. Fu, Y., Foden, J.A., Khayter, C., Maeder, M.L., Reyon, D., Joung, J.K., and Sander, J.D. (2013). High-frequency off-target mutagenesis induced by CRISPR-Cas nucleases in human cells. *Nature biotechnology* 31, 822-826.
61. Gilbert, L.A., Larson, M.H., Morsut, L., Liu, Z., Brar, G.A., Torres, S.E., Stern-Ginossar, N., Brandman, O., Whitehead, E.H., Doudna, J.A., et al. (2013). CRISPR-mediated modular RNA-guided regulation of transcription in eukaryotes. *Cell* 154, 442-451.

62. Gorecka, K.M., Komorowska, W., and Nowotny, M. (2013). Crystal structure of RuvC resolvase in complex with Holliday junction substrate. *Nucleic Acids Res* 41, 9945-9955.
63. Gratz, S.J., Cummings, A.M., Nguyen, J.N., Hamm, D.C., Donohue, L.K., Harrison, M.M., Wildonger, J., and O'Connor-Giles, K.M. (2013). Genome engineering of *Drosophila* with the CRISPR RNA-guided Cas9 nuclease. *Genetics* 194, 1029-1035.
64. Holm, L., and Rosenstrom, P. (2010). Dali server: conservation mapping in 3D. *Nucleic acids research* 38, W545-549.
65. Hsu, P.D., Scott, D.A., Weinstein, J.A., Ran, F.A., Konermann, S., Agarwala, V., Li, Y., Fine, E.J., Wu, X., Shalem, O., et al. (2013). DNA targeting specificity of RNA-guided Cas9 nucleases. *Nature biotechnology* 31, 827-832.
66. Hwang, W.Y., Fu, Y., Reyon, D., Maeder, M.L., Tsai, S.Q., Sander, J.D., Peterson, R.T., Yeh, J.R., and Joung, J.K. (2013). Efficient genome editing in zebrafish using a CRISPR-Cas system. *Nature biotechnology* 31, 227-229.
67. Kabsch, W. (2010). Xds. *Acta crystallographica Section D, Biological crystallography* 66, 125-132.
68. Konermann, S., Brigham, M.D., Trevino, A.E., Hsu, P.D., Heidenreich, M., Cong, L., Platt, R.J., Scott, D.A., Church, G.M., and Zhang, F. (2013). Optical control of mammalian endogenous transcription and epigenetic states. *Nature* 500, 472-476.
69. Li, C.L., Hor, L.I., Chang, Z.F., Tsai, L.C., Yang, W.Z., and Yuan, H.S. (2003). DNA binding and cleavage by the periplasmic nuclease Vvn: a novel structure with a known active site. *The EMBO journal* 22, 4014-4025.
70. Maeder, M.L., Linder, S.J., Cascio, V.M., Fu, Y., Ho, Q.H., and Joung, J.K. (2013). CRISPR RNA-guided activation of endogenous human genes. *Nature methods* 10, 977-979.
71. Mali, P., Aach, J., Stranges, P.B., Esvelt, K.M., Moosburner, M., Kosuri, S., Yang, L., and Church, G.M. (2013a). CAS9 transcriptional activators for target specificity screening and paired nickases for cooperative genome engineering. *Nature biotechnology* 31, 833-838.
72. Marraffini, L.A., and Sontheimer, E.J. (2008). CRISPR interference limits horizontal gene transfer in staphylococci by targeting DNA. *Science* 322, 1843-1845.
73. Marraffini, L.A., and Sontheimer, E.J. (2010). CRISPR interference: RNA-directed adaptive immunity in bacteria and archaea. *Nat Rev Genet* 11, 181-190.

74. Mojica, F.J., Diez-Villasenor, C., Garcia-Martinez, J., and Almendros, C. (2009). Short motif sequences determine the targets of the prokaryotic CRISPR defence system. *Microbiology* 155, 733-740.
75. Pattanayak, V., Lin, S., Guilinger, J.P., Ma, E., Doudna, J.A., and Liu, D.R. (2013). High-throughput profiling of off-target DNA cleavage reveals RNA-programmed Cas9 nuclease specificity. *Nature biotechnology* 31, 839-843.
76. Perez-Pinera, P., Kocak, D.D., Vockley, C.M., Adler, A.F., Kadi, A.M., Polstein, L.R., Thakore, P.I., Glass, K.A., Ousterout, D.G., Leong, K.W., et al. (2013). RNA-guided gene activation by CRISPR-Cas9-based transcription factors. *Nature methods* 10, 973-976.
77. Qi, L.S., Larson, M.H., Gilbert, L.A., Doudna, J.A., Weissman, J.S., Arkin, A.P., and Lim, W.A. (2013). Repurposing CRISPR as an RNA-guided platform for sequence-specific control of gene expression. *Cell* 152, 1173-1183.
78. Ran, F.A., Hsu, P.D., Lin, C.Y., Gootenberg, J.S., Konermann, S., Trevino, A.E., Scott, D.A., Inoue, A., Matoba, S., Zhang, Y., et al. (2013). Double nicking by RNA-guided CRISPR Cas9 for enhanced genome editing specificity. *Cell* 154, 1380-1389.
79. Sampson, T.R., Saroj, S.D., Llewellyn, A.C., Tzeng, Y.L., and Weiss, D.S. (2013). A CRISPR/Cas system mediates bacterial innate immune evasion and virulence. *Nature* 497, 254-257.
80. Shalem, O., Sanjana, N.E., Hartenian, E., Shi, X., Scott, D.A., Mikkelsen, T.S., Heckl, D., Ebert, B.L., Root, D.E., Doench, J.G., et al. (2014). Genome-scale CRISPR-Cas9 knockout screening in human cells. *Science* 343, 84-87.
81. Sheldrick, G.M. (2008). A short history of SHELX. *Acta crystallographica Section A, Foundations of crystallography* 64, 112-122.
82. Spilman, M., Cocozaki, A., Hale, C., Shao, Y., Ramia, N., Terns, R., Terns, M., Li, H., and Stagg, S. (2013). Structure of an RNA silencing complex of the CRISPR-Cas immune system. *Molecular cell* 52, 146-152.
83. Wang, H., Yang, H., Shivalila, C.S., Dawlaty, M.M., Cheng, A.W., Zhang, F., and Jaenisch, R. (2013). One-step generation of mice carrying mutations in multiple genes by CRISPR/Cas-mediated genome engineering. *Cell* 153, 910-918.
84. Wang, T., Wei, J.J., Sabatini, D.M., and Lander, E.S. (2014). Genetic screens in human cells using the CRISPR-Cas9 system. *Science* 343, 80-84.

85. Wiedenheft, B., Lander, G.C., Zhou, K., Jore, M.M., Brouns, S.J., van der Oost, J., Doudna, J.A., and Nogales, E. (2011). Structures of the RNA-guided surveillance complex from a bacterial immune system. *Nature* 477, 486-489.
86. Winn, M.D., Ballard, C.C., Cowtan, K.D., Dodson, E.J., Emsley, P., Evans, P.R., Keegan, R.M., Krissinel, E.B., Leslie, A.G., McCoy, A., et al. (2011). Overview of the CCP4 suite and current developments. *Acta crystallographica Section D, Biological crystallography* 67, 235-242.
87. Yang, H., Wang, H., Shivalila, C.S., Cheng, A.W., Shi, L., and Jaenisch, R. (2013). One-step generation of mice carrying reporter and conditional alleles by CRISPR/Cas-mediated genome engineering. *Cell* 154, 1370-1379.

WHAT IS CLAIMED IS:

1. A computer-assisted method for identifying or designing potential compounds to fit within or bind to CRISPR-cas9 system or a functional portion thereof or vice versa (a computer-assisted method for identifying or designing potential CRISPR-cas9 systems or a functional portion thereof for binding to desired compounds) comprising:

using a computer system, e.g., a programmed computer comprising a processor, a data storage system, an input device, and an output device, the steps of:

(a) inputting into the programmed computer through said input device data comprising the three-dimensional co-ordinates of a subset of the atoms from or pertaining to the CRISPR-cas9 crystal structure of Example 1 ("the Crystal Structure Table"), e.g., in the CRISPR-cas9 system binding domain or alternatively or additionally in domains that vary based on variance among cas9 orthologs or as to cas9s or as to nickases or as to functional groups, optionally with structural information from CRISPR-cas9 system complex(es), thereby generating a data set;

(b) comparing, using said processor, said data set to a computer database of structures stored in said computer data storage system, e.g., structures of compounds that bind or putatively bind or that are desired to bind to a CRISPR-cas9 system or as to cas9 orthologs (e.g., as cas9s or as to domains or regions that vary amongst cas9 orthologs) or as to the CRISPR-cas9 crystal structure of Example 1 ("the Crystal Structure Table") or as to nickases or as to functional groups;

(c) selecting from said database, using computer methods, structure(s)—e.g., CRISPR-cas9 structures that may bind to desired structures, desired structures that may bind to certain CRISPR-cas9 structures, portions of the CRISPR-cas9 system that may be manipulated, e.g., based on data from other portions of the CRISPR-cas9 crystal structure and/or from cas9 orthologs, truncated cas9s, novel nickases or particular functional groups, or positions for attaching functional groups or functional-group-CRISPR-cas9 systems;

(d) constructing, using computer methods, a model of the selected structure(s); and

(e) outputting to said output device the selected structure(s);

and optionally synthesizing one or more of the selected structure(s);

and further optionally testing said synthesized selected structure(s) as or in a CRISPR-cas9 system.

2. A computer-assisted method for identifying or designing potential CRISPR-cas9 systems (e.g., with regard to predicting areas of the CRISPR-cas9 system to be able to be manipulated—for instance, based on crystal structure data or based on data of cas9 orthologs, or with respect to where a functional group such as an activator or repressor can be attached to the CRISPR-cas9 system, or as to cas9 truncations or as to designing nickases), comprising:

using a computer system, e.g., a programmed computer comprising a processor, a data storage system, an input device, and an output device, the steps of:

(a) inputting into the programmed computer through said input device data comprising the three-dimensional co-ordinates of a subset of the atoms from or pertaining to the CRISPR-cas9 crystal structure of Example 1 (“the Crystal Structure Table”), e.g., in the CRISPR-cas9 system binding domain or alternatively or additionally in domains that vary based on variance among cas9 orthologs or as to cas9s or as to nickases or as to functional groups, optionally with structural information from CRISPR-cas9 system complex(es), thereby generating a data set;

(b) comparing, using said processor, said data set to a computer database of structures stored in said computer data storage system, e.g., structures of compounds that bind or putatively bind or that are desired to bind to a CRISPR-cas9 system or as to cas9 orthologs (e.g., as cas9s or as to domains or regions that vary amongst cas9 orthologs) or as to the CRISPR-cas9 crystal structure of Example 1 (“the Crystal Structure Table”) or as to nickases or as to functional groups;

(c) selecting from said database, using computer methods, structure(s)—e.g., CRISPR-cas9 structures that may bind to desired structures, desired structures that may bind to certain CRISPR-cas9 structures, portions of the CRISPR-cas9 system that may be manipulated, e.g., based on data from other portions of the CRISPR-cas9 crystal structure and/or from cas9 orthologs, truncated cas9s, novel nickases or particular functional groups, or positions for attaching functional groups or functional-group-CRISPR-cas9 systems;

(d) constructing, using computer methods, a model of the selected structure(s); and

(e) outputting to said output device the selected structure(s);

and optionally synthesizing one or more of the selected structure(s);

and further optionally testing said synthesized selected structure(s) as or in a CRISPR-cas9 system.

3. A computer-assisted method for identifying or designing potential compounds to fit within or bind to CRISPR-cas9 system or a functional portion thereof or vice versa (a computer-assisted method for identifying or designing potential CRISPR-cas9 systems or a functional portion thereof for binding to desired compounds) comprising:

providing the co-ordinates of at least two atoms of the CRISPR-cas9 crystal structure of Example 1 (“the Crystal Structure Table”), e.g., at least two atoms of the Crystal Structure Table of the CRISPR-cas9 crystal structure or co-ordinates of at least a sub-domain of the CRISPR-cas9 crystal structure (“selected co-ordinates”), providing the structure of a candidate comprising a binding molecule or of portions of the CRISPR-cas9 system that may be manipulated, e.g., based on data from other portions of the CRISPR-cas9 crystal structure and/or from cas9 orthologs, or the structure of functional groups, and fitting the structure of the candidate to the selected co-ordinates, to thereby obtain product data comprising CRISPR-cas9 structures that may bind to desired structures, desired structures that may bind to certain CRISPR-cas9 structures, portions of the CRISPR-cas9 system that may be manipulated, truncated cas9s, novel nickases, or particular functional groups, or positions for attaching functional groups or functional-group-CRISPR-cas9 systems, with output thereof; and optionally synthesizing compound(s) from said product data and further optionally comprising testing said synthesized compound(s) as or in a CRISPR-cas9 system.

4. A computer-assisted method for identifying or designing potential CRISPR-cas9 systems (e.g., with regard to predicting areas of the CRISPR-cas9 system to be able to be manipulated—for instance, based on crystal structure data or based on data of cas9 orthologs, or with respect to where a functional group such as an activator or repressor can be attached to the CRISPR-cas9 system, or as to cas9 truncations or as to designing nickases), comprising:

providing the co-ordinates of at least two atoms of the CRISPR-cas9 crystal structure of Example 1 (“the Crystal Structure Table”), e.g., at least two atoms of the Crystal Structure Table of the CRISPR-cas9 crystal structure or co-ordinates of at least a sub-domain of the CRISPR-cas9 crystal structure (“selected co-ordinates”), providing the structure of a candidate comprising a binding molecule or of portions of the CRISPR-cas9 system that may be manipulated, e.g., based on data from other portions of the CRISPR-cas9 crystal structure and/or from cas9 orthologs, or the structure of functional groups, and fitting the structure of the candidate to the selected co-ordinates, to thereby obtain product data comprising CRISPR-cas9

structures that may bind to desired structures, desired structures that may bind to certain CRISPR-cas9 structures, portions of the CRISPR-cas9 system that may be manipulated, truncated cas9s, novel nickases, or particular functional groups, or positions for attaching functional groups or functional-group-CRISPR-cas9 systems, with output thereof; and optionally synthesizing compound(s) from said product data and further optionally comprising testing said synthesized compound(s) as or in a CRISPR-cas9 system.

5. The method of any one of claims 1-4 testing further comprising analyzing the CRISPR-cas9 system resulting from said synthesized selected structure(s), e.g., with respect to binding, or performing a desired function.

6. An output in any of the methods of claims 1-5 comprising data transmission, e.g., transmission of information via telecommunication, telephone, video conference, mass communication, e.g., presentation such as a computer presentation (eg POWERPOINT), internet, email, documentary communication such as a computer program (eg WORD) document and the like.

7. A computer readable media containing: atomic co-ordinate data according to the Crystal Structure Table of Example 1 ("the Crystal Structure Table") and/or the Figures, said data defining the three dimensional structure of CRISPR-cas9 or at least one sub-domain thereof, or structure factor data for CRISPR-cas9, said structure factor data being derivable from the atomic co-ordinate data of Crystal Structure Table and/or the Figures.

8. The computer readable media of claim 7 further comprising any data of the foregoing methods.

9. A computer system for generating or performing rational design as in the methods of claims 1-5 containing either: atomic co-ordinate data according to the Crystal Structure Table of Example 1 ("the Crystal Structure Table") and/or the Figures, said data defining the three dimensional structure of CRISPR-cas9 or at least one sub-domain thereof, or structure factor data for CRISPR-cas9, said structure factor data being derivable from the atomic co-ordinate data of the Crystal Structure Table of Example 1 ("the Crystal Structure Table") and/or the Figures.

10. A method of doing business comprising providing to a user the computer system or the media or the three dimensional structure of CRISPR-cas9 or at least one sub-domain thereof, or structure factor data for CRISPR-cas9, said structure set forth in and said structure factor data being derivable from the atomic co-ordinate data of the Crystal Structure Table of

Example 1 (“the Crystal Structure Table”) and/or the Figures, or the herein computer media or a herein data transmission.

11. A CRISPR-cas9 (*S. pyogenes*) system having the crystal structure of Example 1 (“the Crystal Structure Table”) and/or having an X-ray diffraction pattern corresponding to or resulting from any or all of the foregoing and/or a crystal having the structure defined by at least 2, at least 50, at least 100 or all co-ordinates of the Crystal Structure Table.

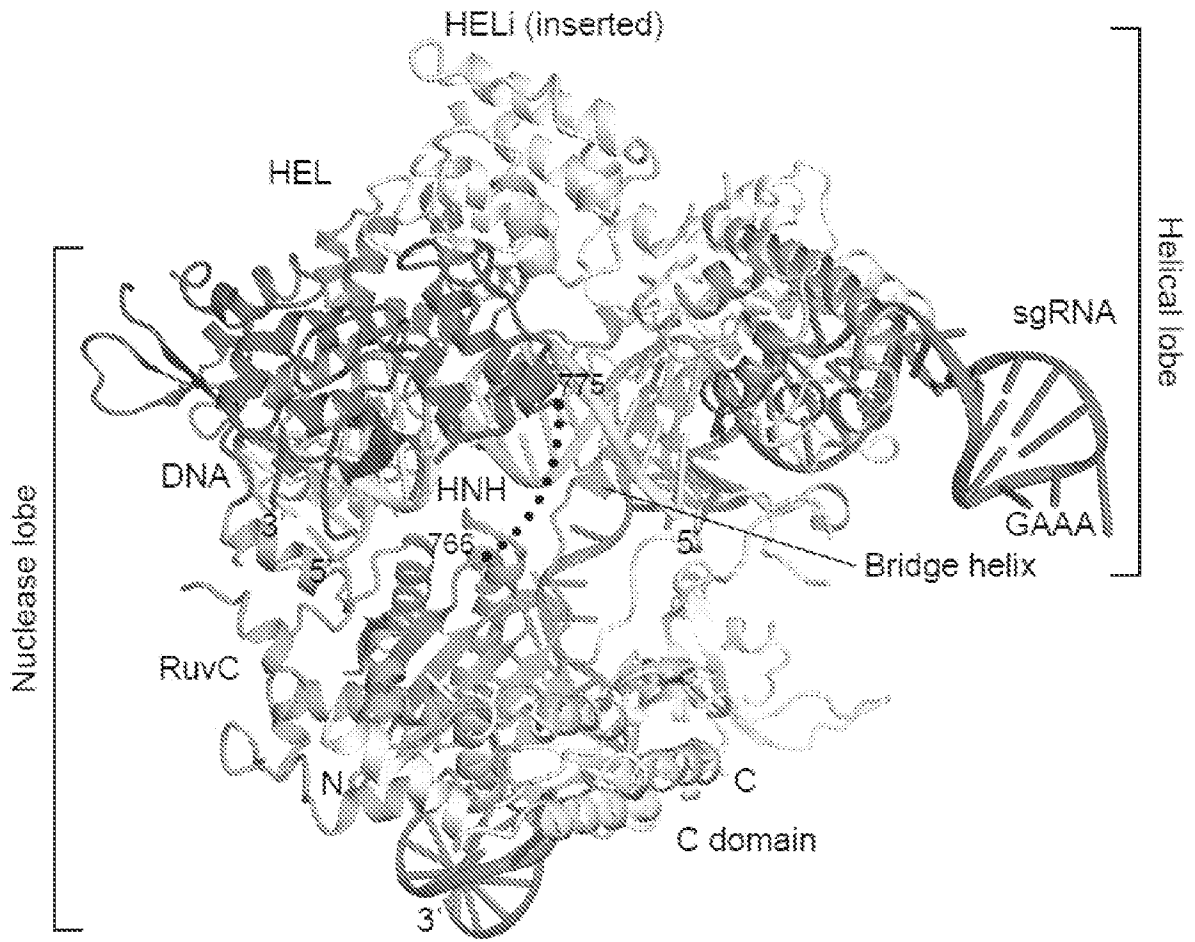

FIG. 1A

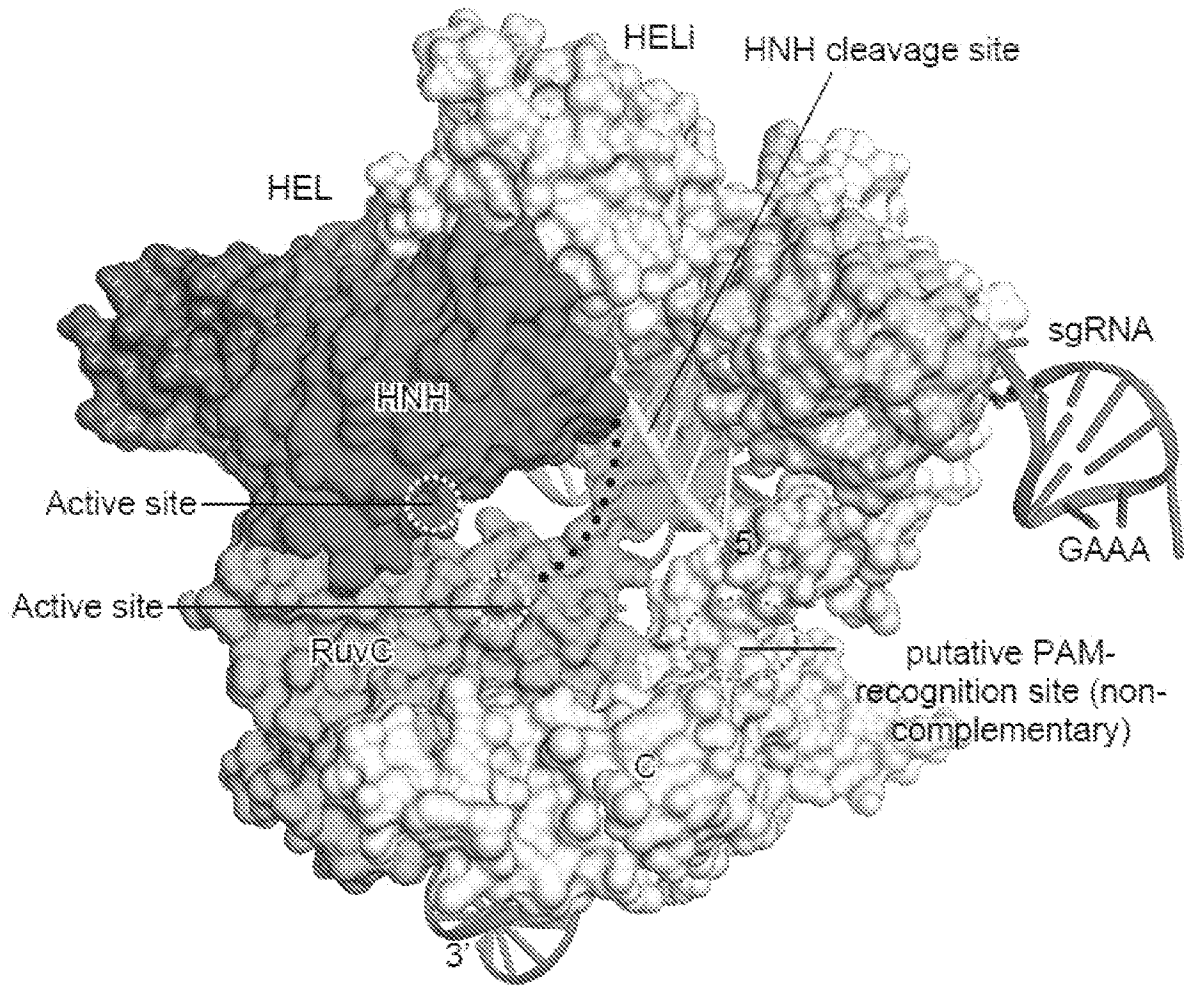

FIG. 1B

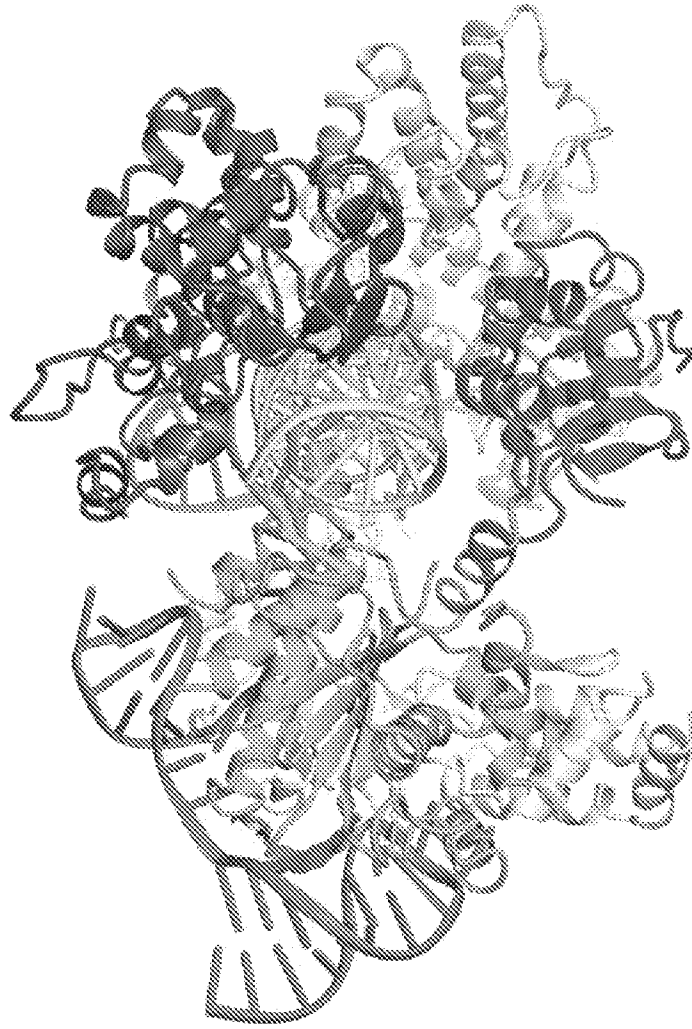

FIG. 1C

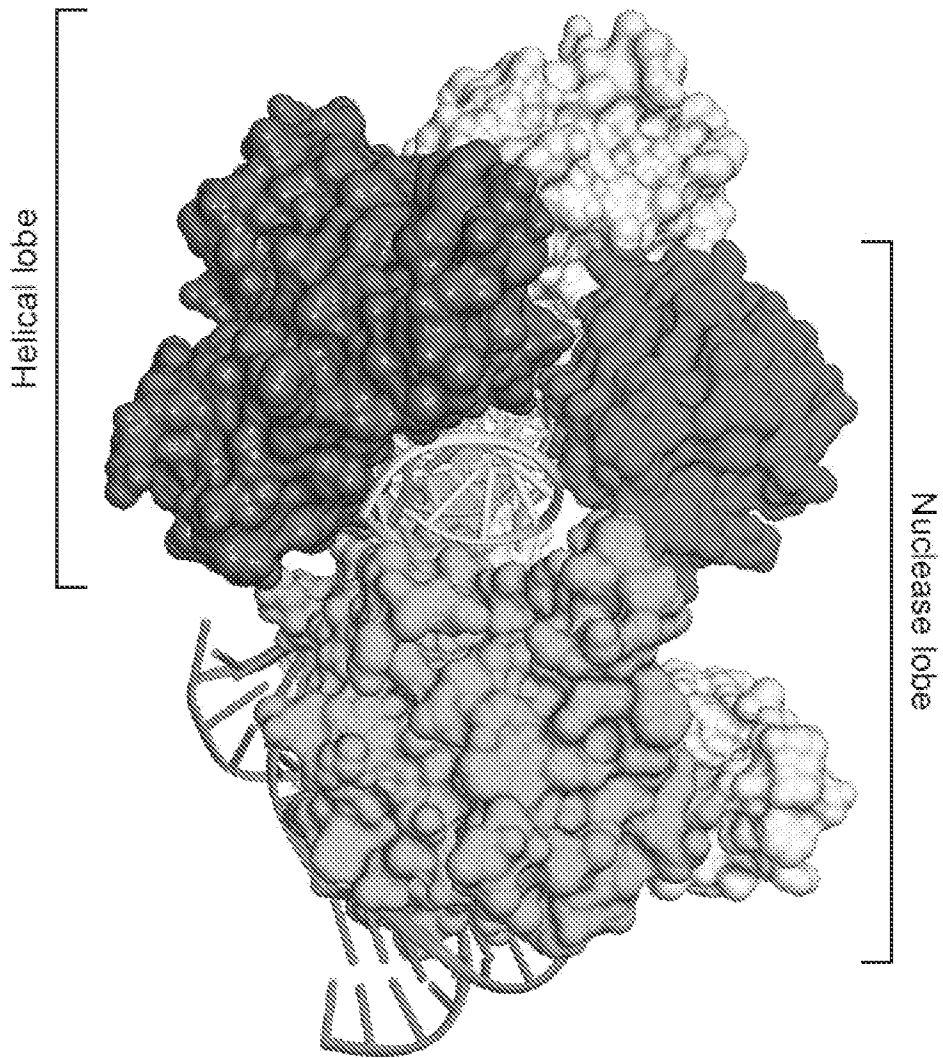

FIG. 1D

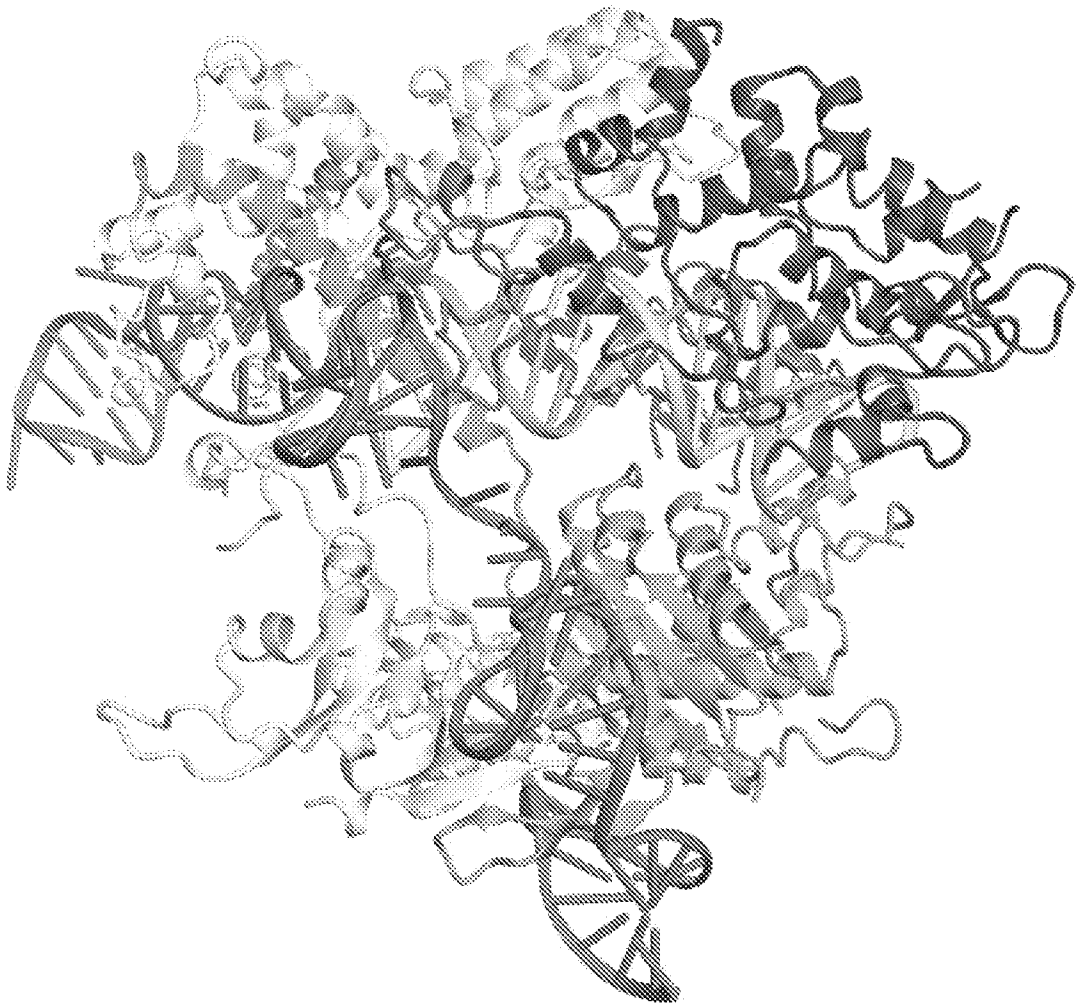

FIG. 1E

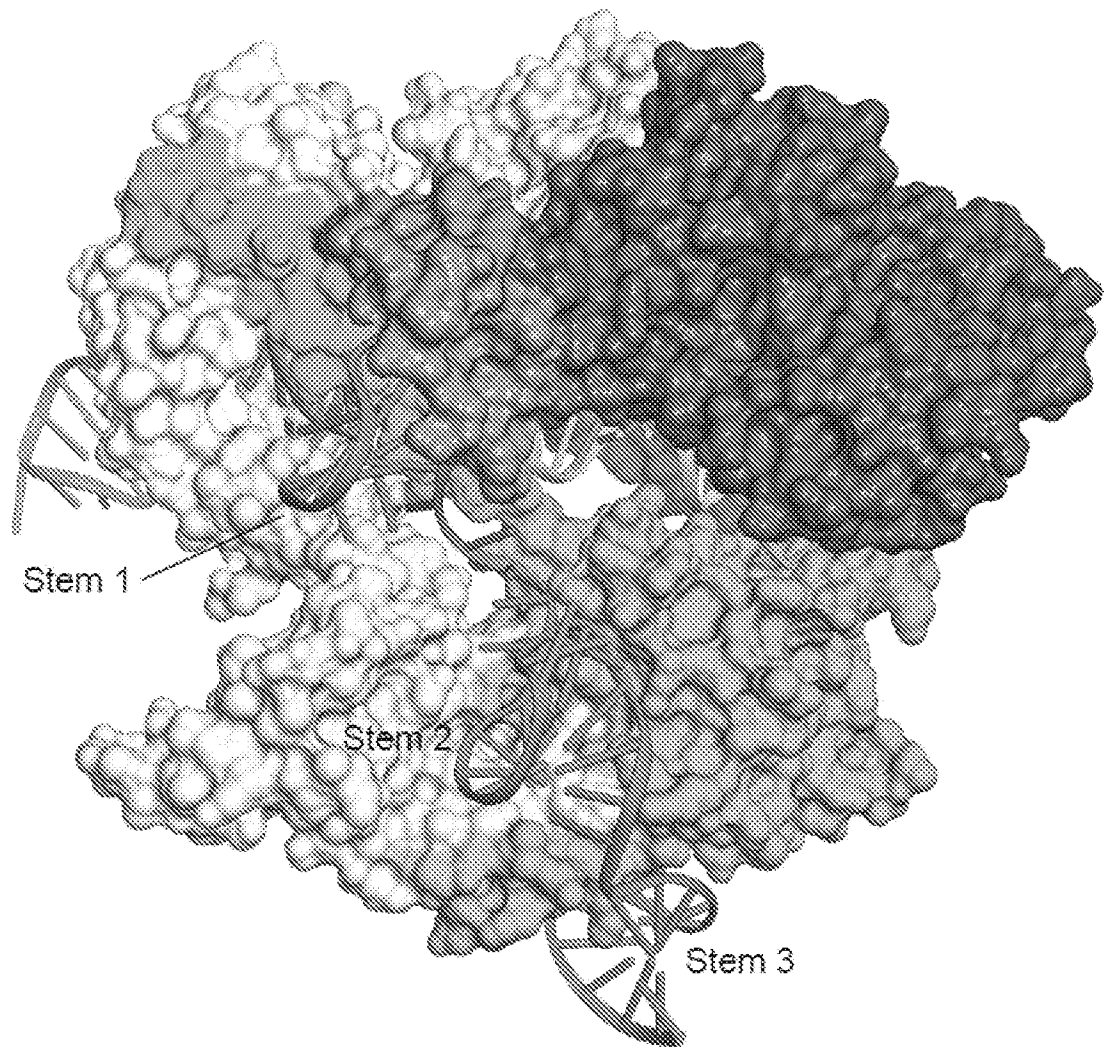
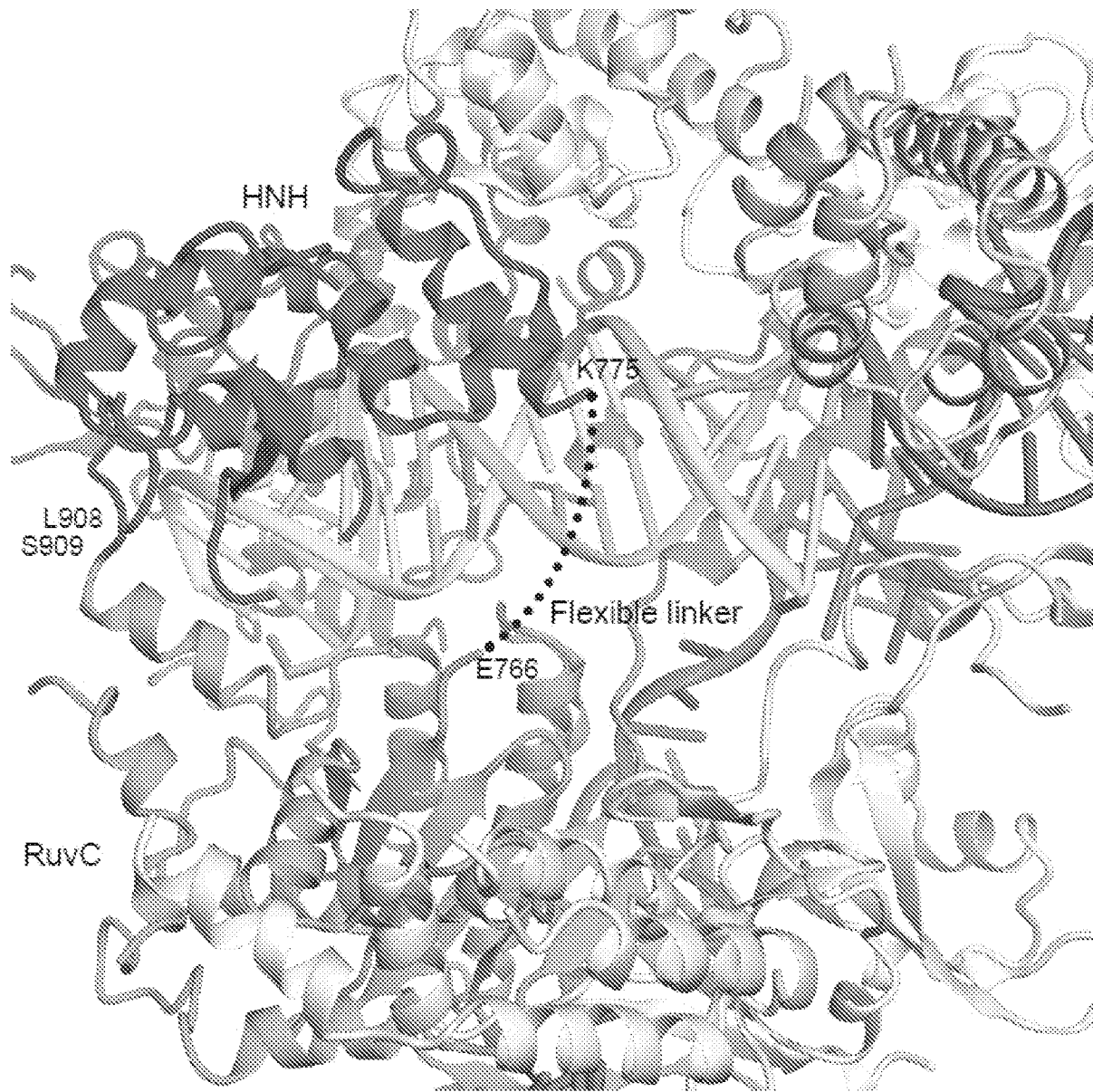
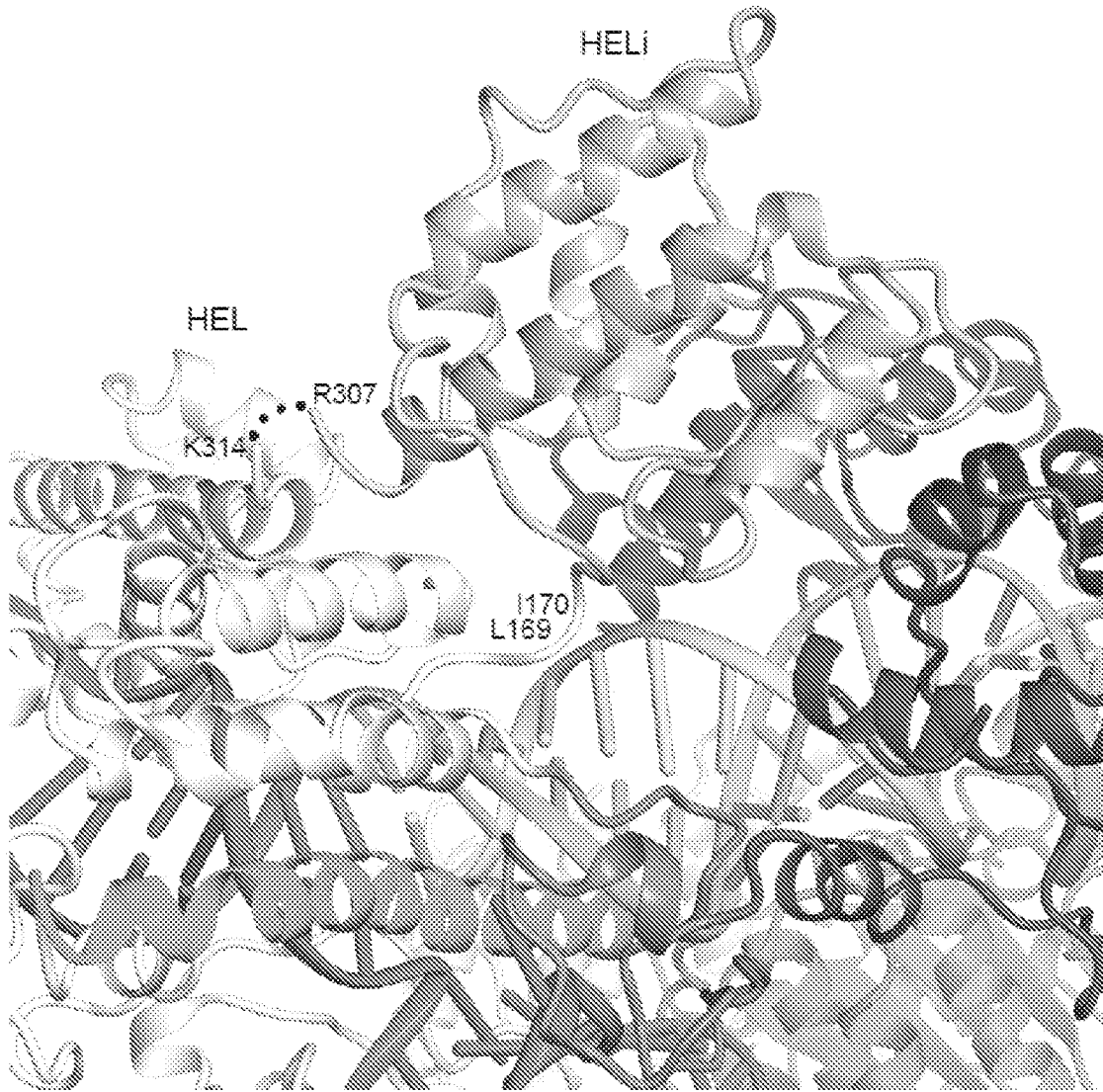

FIG. 1F



RuvC (E766)-linker-Effector-linker-RuvC (S909)

FIG. 1G



HEL (L169)-linker-Effector-linker-HEL (K314)

FIG. 1H

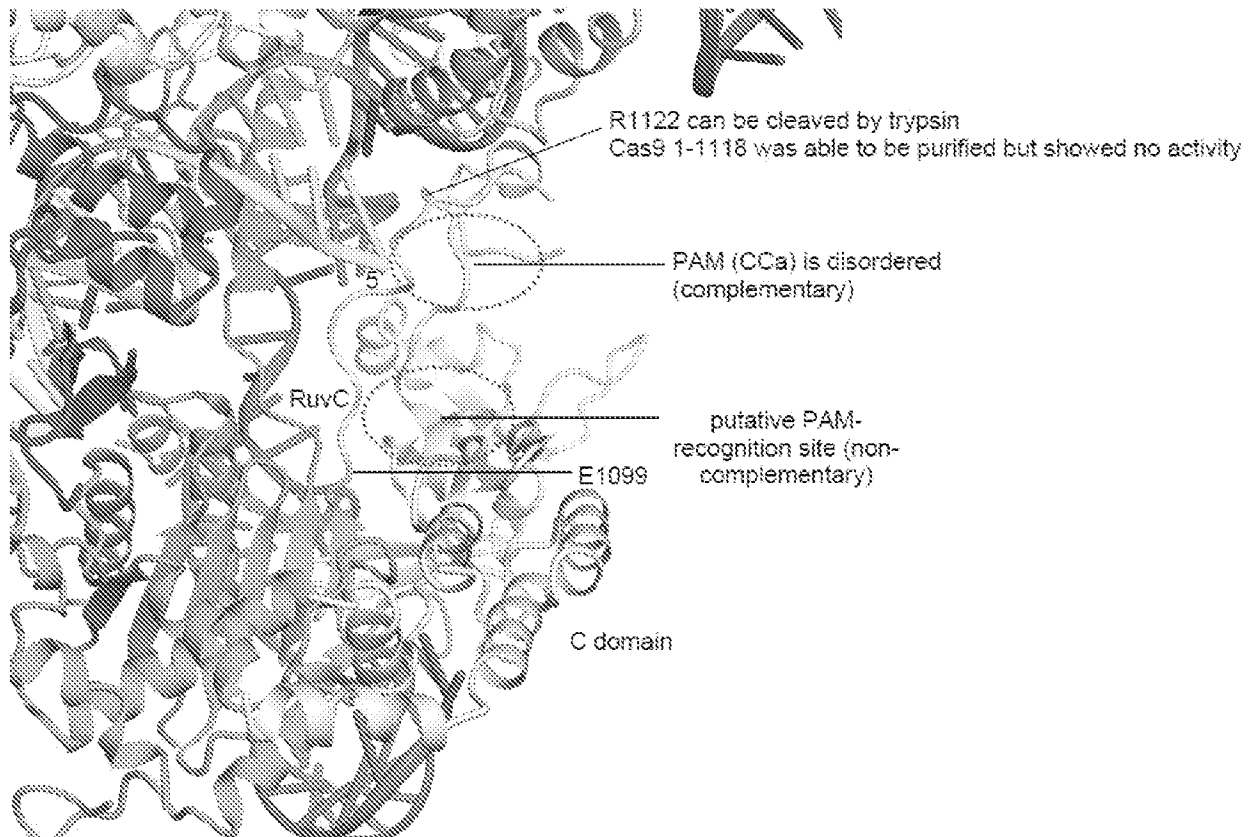

FIG. 11

Longer stem 2 seems make no clash with Cas9, consistent with your data showing that longer stem 2 (called L1 8-10) were tolerated stem 2 → Longer stem 2

3 bp are not recognized by Cas9 and may be able to be shortened; Jinek et al. did not test shorter stems than +23 3 bp stem → 0, 1, 2 bp stem

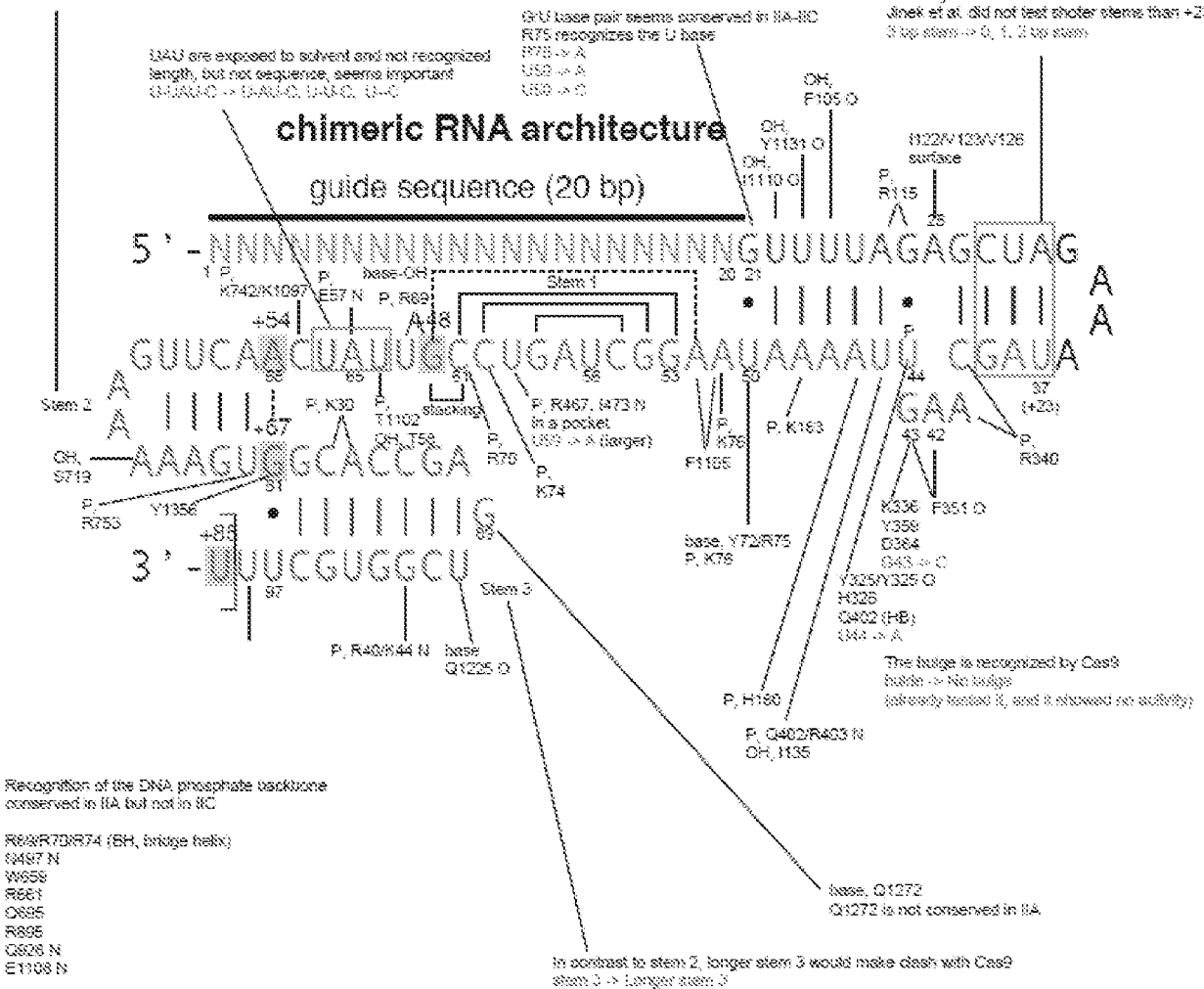

FIG. 1J

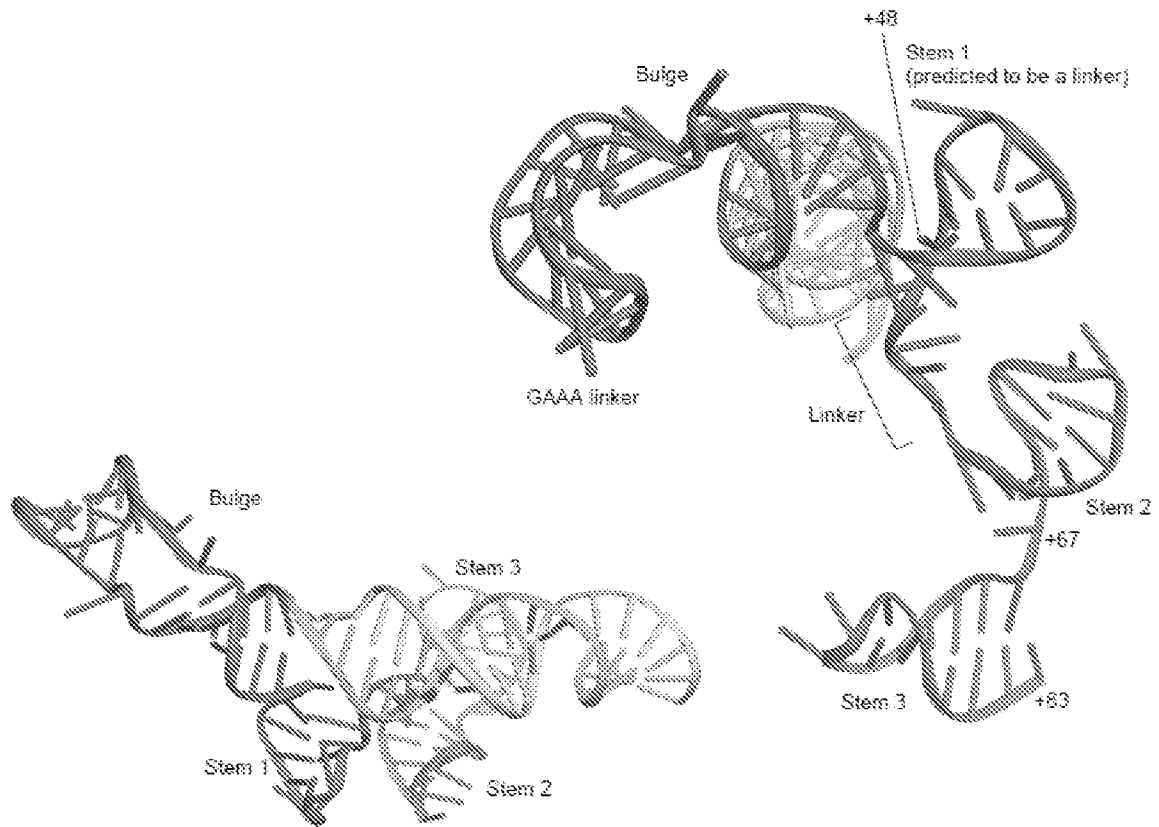

FIG. 1K

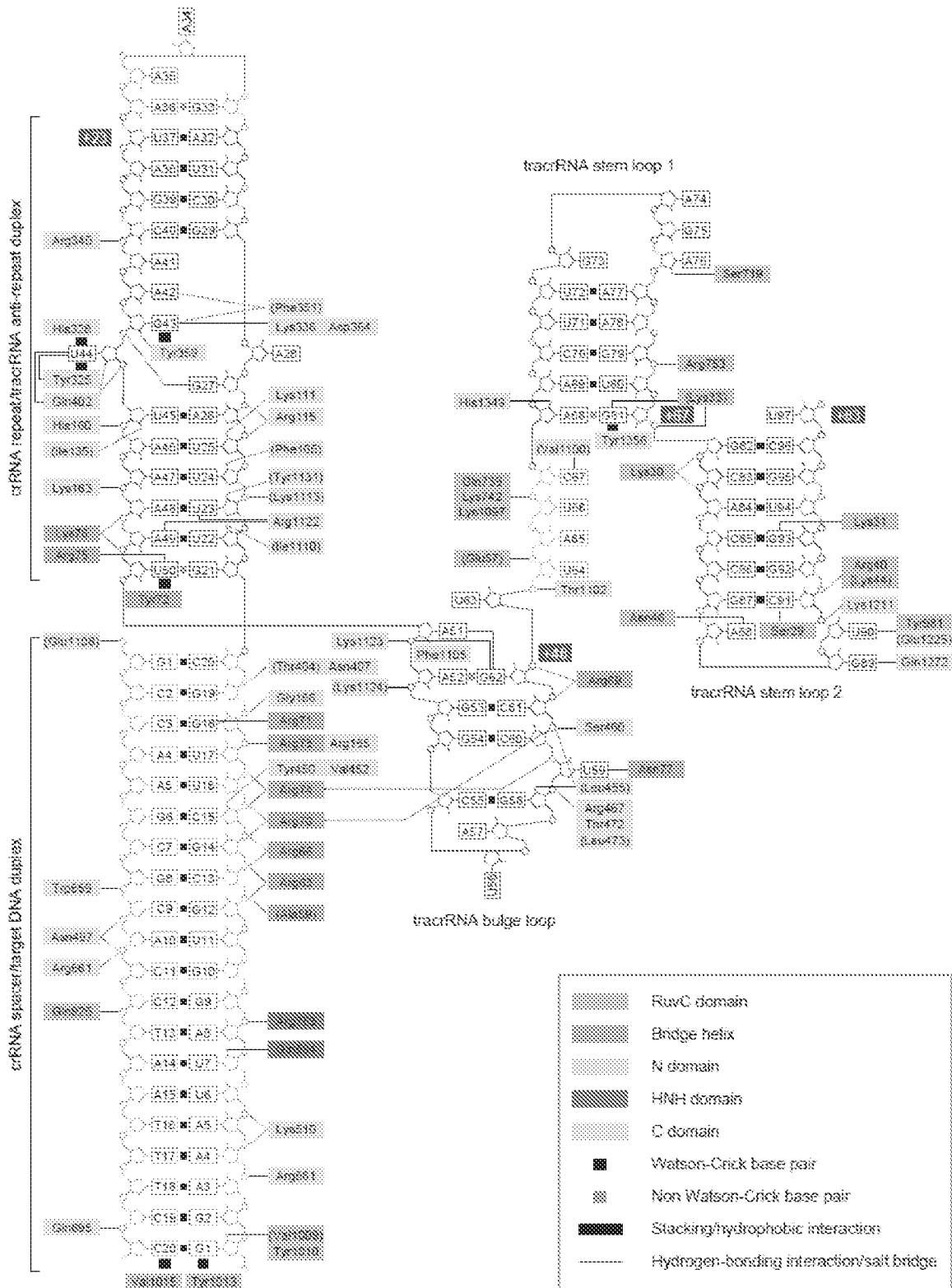

FIG. 1L

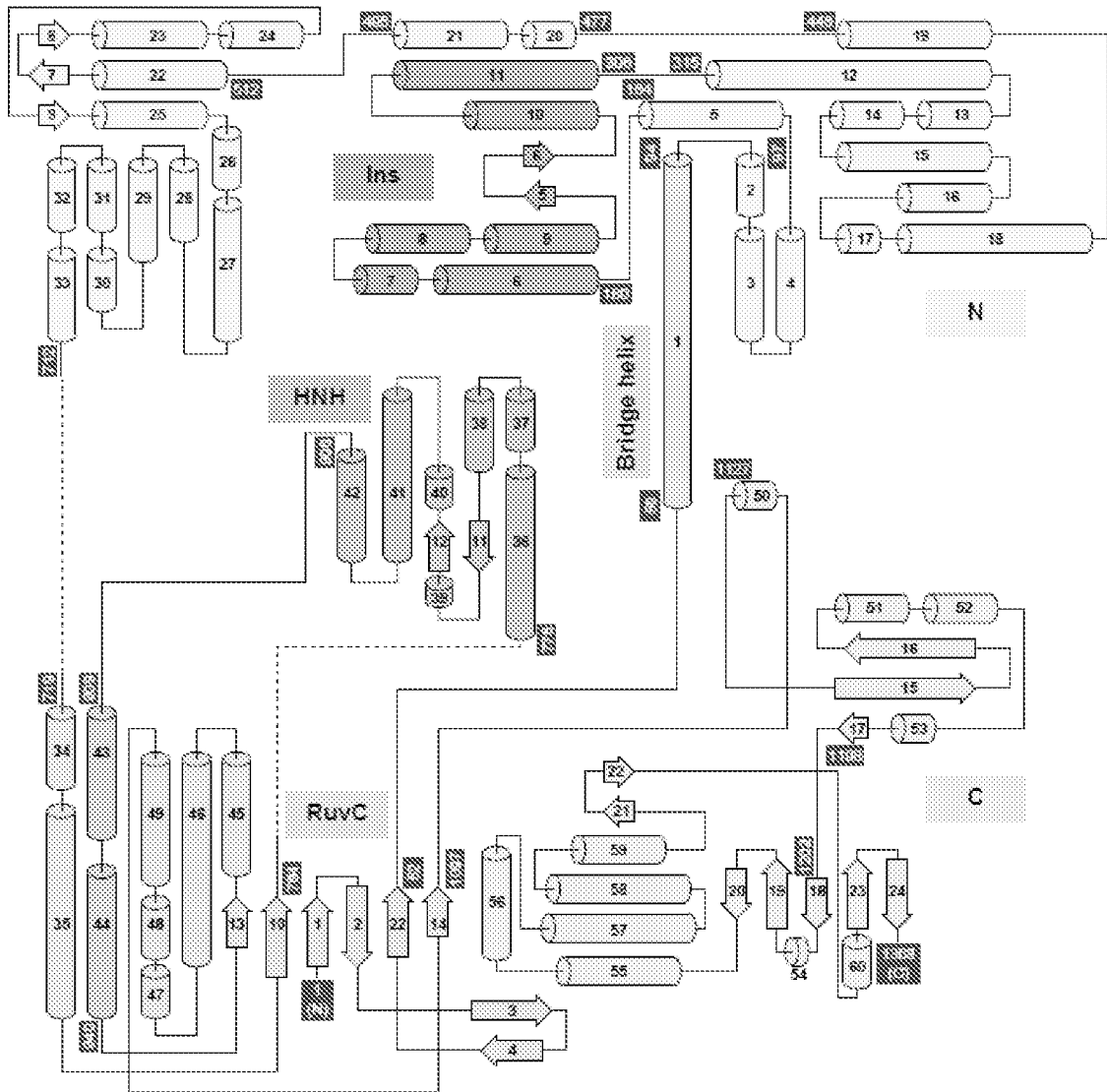

FIG. 1M

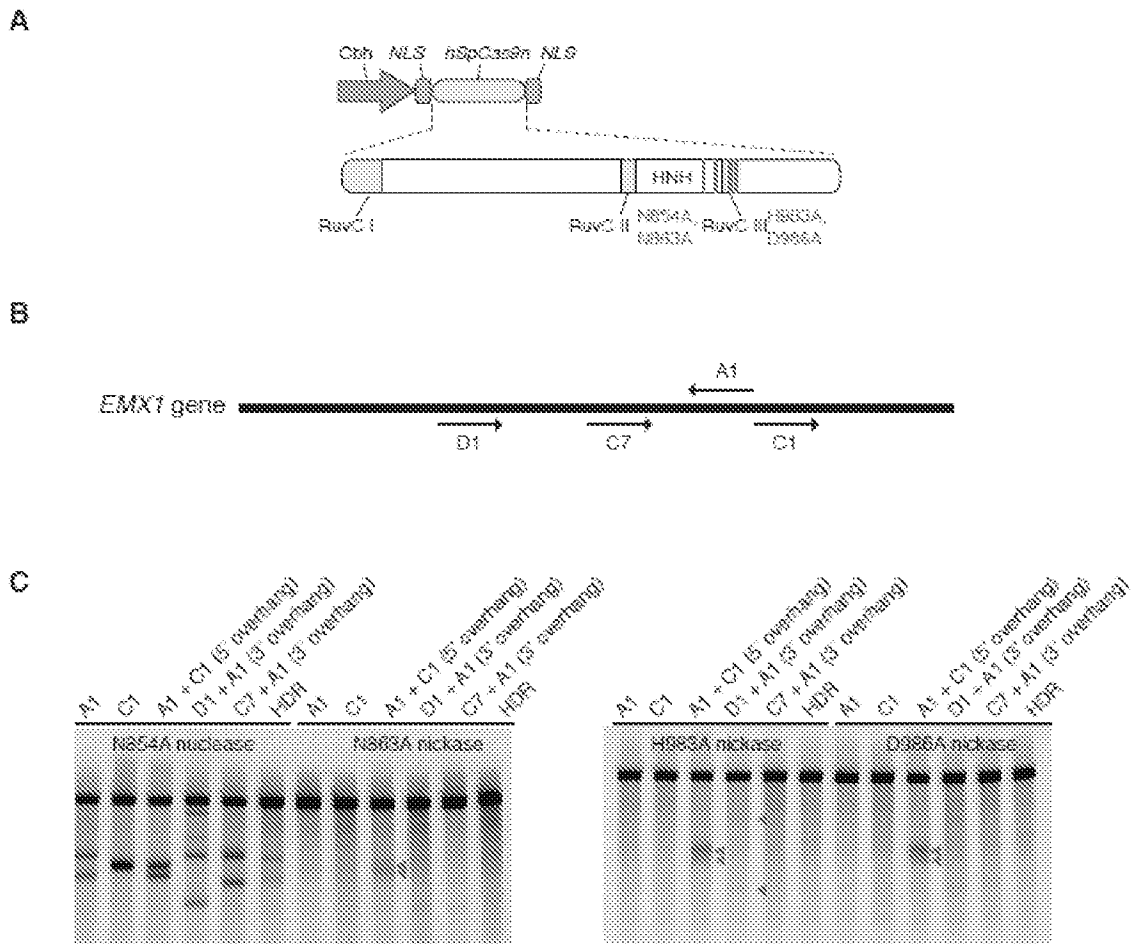
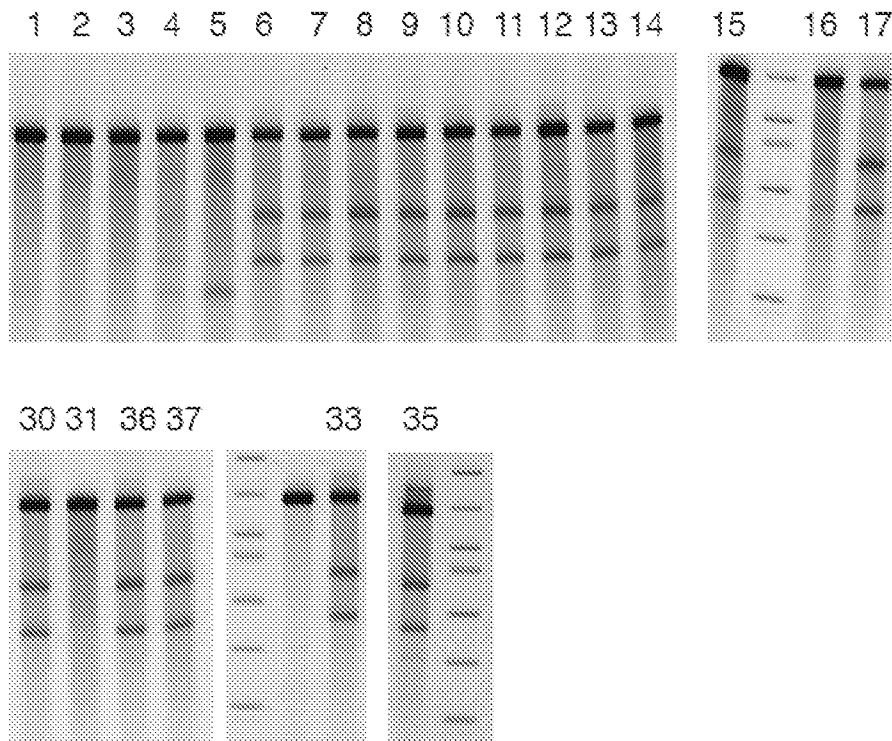

FIG. 2A-C

A



B

1	Sp_Δ_hel 1(87-173)
2	Sp_Δ_hel 1(87-102)
3	Sp_Δ_hel 1(103-121)
4	Sp_Δ_hel 1(122-134)
5	Sp_Δ_hel 1(135-173)
6	Sp_Δ_hel 2(174-311)
7	Sp_Δ_hel 2-(GGGGS)3
8	Sp_Δ_hel 2-(GGGGS)6
9	Sp_Δ_hel 2-(GGGGS)9
11	Sp_Δ_hel 2-A(EAAAK)3A
12	Sp_Δ_hel 2-A(EAAAK)6A
13	Sp_Δ_hel 2-A(EAAAK)9A
14	Sp_Δ_hel 2-A(EAAAK)12A
15	Sp_Δ_hel 2(174-182)
16	Sp_Δ_hel 2(183-190)
17	Sp_Δ_hel 2(191-219)

30	Sp_Δ (175-307)
31	Sp_Δ (1098-1368)
36	Sp_Δ(175-307)-A(EAAAK)3A
37	Sp_Δ(175-307)-A(EAAAK)6A
33	Sp_Δ (175-307)-(GGGGS)6
35	Sp_Δ (175-307)-(GGGGS)12

FIG. 3A-B

sgRNA mutations

Region of mutation	Activity (indel %)	Specific description of mutation	Complete Sequence	Length
Stem 1	14.33	Proximal poly U tract switch to C	eCCCCagagctgAAMtagcaagtTtGGGGtaaggctagtcogtttcaacttGMAAaagtgaccacAGToggtgcTTTT	81
Stem 1	14.74	Distal CUA to CCC	atTTtaggcCGSAAAGBQaaatTaaatTaaagctagtcogtttcaacttGMAAaagtgaccacAGToggtgcTTTT	81
Stem 1	15.16	Truncate distal UA	gtTTtaggcGAAAgcaagtTaaatTaaagctagtcogtttcaacttGMAAaagtgaccacAGToggtgcTTTT	77
Stem 1	16.05	Truncate distal CUA	gtTTtaggcGAAAcagttTaaatTaaagctagtcogtttcaacttGMAAaagtgaccacAGToggtgcTTTT	75
Stem 1	18.19	Truncate distal CUA and Loop 1	gtTTtaggcGAAAtagcTtTaaatTaaagctagtcogtttcaacttGMAAaagtgaccacAGToggtgcTTTT	72
Bulge	NONE	Replace Bulge with A-U pair	gtTTtaggcGAAAtagcTtTaaatTaaagctagtcogtttcaacttGMAAaagtgaccacAGToggtgcTTTT	79
Bulge	1.30	Replace Bulge with C-G pair (keep G43)	gtTTtaggcGAAAtagcTtTaaatTaaagctagtcogtttcaacttGMAAaagtgaccacAGToggtgcTTTT	79
Bulge	21.55	Replace Bulge with C-AAG pair	gtTTtaggcGAAAtagcTtTaaatTaaagctagtcogtttcaacttGMAAaagtgaccacAGToggtgcTTTT	81
Bulge	17.55	Replace Bulge with T-AAG pair	gtTTtagTgcTaaGAAAtagcTtTaaatTaaagctagtcogtttcaacttGMAAaagtgaccacAGToggtgcTTTT	91
Bulge	19.84	Replace Bulge with G-AAG pair	gtTTtagGcTaaGAAAtagcTtTaaatTaaagctagtcogtttcaacttGMAAaagtgaccacAGToggtgcTTTT	91
Bulge	12.11	Replace Bulge with A-TTG (keep G43)	gtTTtagGcTaaGAAAtagcTtTaaatTaaagctagtcogtttcaacttGMAAaagtgaccacAGToggtgcTTTT	81
Bulge	5.44	Replace Bulge with A-AAC (remove G43)	gtTTtagGcTaaGAAAtagcTtTaaatTaaagctagtcogtttcaacttGMAAaagtgaccacAGToggtgcTTTT	81
Bulge	14.74	Replace Bulge with A-AAA (remove G43)	gtTTtagGcTaaGAAAtagcTtTaaatTaaagctagtcogtttcaacttGMAAaagtgaccacAGToggtgcTTTT	81
Bulge	10.63	Replace Bulge with A-AAT (remove G43)	gtTTtagGcTaaGAAAtagcTtTaaatTaaagctagtcogtttcaacttGMAAaagtgaccacAGToggtgcTTTT	81
Linker 1	14.58	Shorten Linker 1 (del UAUC)	gtTTtagGcTaaGAAAtagcTtTaaatTaaagctagtcogtttcaacttGMAAaagtgaccacAGToggtgcTTTT	77
Linker 1	14.99	Change Linker 1 (UAUC to AJIAG)	gtTTtagGcTaaGAAAtagcTtTaaatTaaagctagtcogtttcaacttGMAAaagtgaccacAGToggtgcTTTT	81
Stem 2	20.35	Replace Stem 2 with G-C track	gtTTtagGcTaaGAAAtagcTtTaaatTaaagctagtcogtttcaacttGMAAaagtgaccacAGToggtgcTTTT	82
Stem 2	16.87	Replace and lengthen Stem 2 with G-C track	gtTTtagGcTaaGAAAtagcTtTaaatTaaagctagtcogtttcaacttGMAAaagtgaccacAGToggtgcTTTT	82
Loop 2	17.57	Change Loop 2 sequence	gtTTtagGcTaaGAAAtagcTtTaaatTaaagctagtcogtttcaacttGMAAaagtgaccacAGToggtgcTTTT	81
Stem 3	13.07	Replace Stem 3 with G-C track	gtTTtagGcTaaGAAAtagcTtTaaatTaaagctagtcogtttcaacttGMAAaagtgaccacAGToggtgcTTTT	81
Stem 3	20.05	Add 1 bp to Stem 3	gtTTtagGcTaaGAAAtagcTtTaaatTaaagctagtcogtttcaacttGMAAaagtgaccacAGToggtgcTTTT	83
Stem 3	12.86	Add 2 bp to Stem 3	gtTTtagGcTaaGAAAtagcTtTaaatTaaagctagtcogtttcaacttGMAAaagtgaccacAGToggtgcTTTT	85
Cass contact (S1)	16.35	mutate G-U44 to C44 (basepairing)	gtTTtagGcTaaGAAAtagcTtTaaatTaaagctagtcogtttcaacttGMAAaagtgaccacAGToggtgcTTTT	81
Cass contact		mutate G-U44 to U-G44	gtTTtagGcTaaGAAAtagcTtTaaatTaaagctagtcogtttcaacttGMAAaagtgaccacAGToggtgcTTTT	81

FIG. 4A

(S1)NONE	(wobble pairing)		
Cas9			
contact			
(S1)	mutate G-U44 to A44 (non-	gttttaagagctagAAtagcaagAtaataaaggctagtcogttatcaacttGAAaagtgccacagAGTcgggtgcTTTT	81
Cas9	basepairing)		
contact			
(S1)	mutate G-U50 to C50	gttttaagagctagAAtagcaagtttaaaaCaaggctagtcogttatcaacttGAAaagtgccacagAGTcgggtgcTTTT	81
Cas9	(basepairing)		
contact			
(S1)	mutate G-U50 to U-G50	TtttttagagctagAAtagcaagtttaaaaCaaggctagtcogttatcaacttGAAaagtgccacagAGTcgggtgcTTTT	81
Cas9	(wobble pairing)		
contact			
(S1)	mutate G-U50 to A50 (non-	gttttaagagctagAAtagcaagtttaaaaCaaggctagtcogttatcaacttGAAaagtgccacagAGTcgggtgcTTTT	81
Cas9	basepairing)		
contact			
(L1)	mutate U59 to A (larger)	gttttaagagctagAAtagcaagtttaaaaCaaggctagtcogttatcaacttGAAaagtgccacagAGTcgggtgcTTTT	81
Cas9			
contact			
(L1)	mutate U59 to C (transition)	gttttaagagctagAAtagcaagtttaaaaCaaggctagtcogttatcaacttGAAaagtgccacagAGTcgggtgcTTTT	81
Cas9			
contact			
(L3)	Change Loop 3 from G89 to	gttttaagagctagAAtagcaagtttaaaaCaaggctagtcogttatcaacttGAAaagtgccacagAGTcgggtgcTTTT	81
Cas9	A		
contact			
(L3)	Change Loop 3 from G89 to	gttttaagagctagAAtagcaagtttaaaaCaaggctagtcogttatcaacttGAAaagtgccacagAGTcgggtgcTTTT	81
Cas9	C		
contact			
(L3)	Change Loop 3 from G89 to	gttttaagagctagAAtagcaagtttaaaaCaaggctagtcogttatcaacttGAAaagtgccacagAGTcgggtgcTTTT	81
Cas9	T		
contact			
(S3)	mutate U90 to A (larger)	gttttaagagctagAAtagcaagtttaaaaCaaggctagtcogttatcaacttGAAaagtgccacagAGTcgggtgcTTTT	81
Cas9			
contact			
(S3)	mutate U90 to C (transition)	gttttaagagctagAAtagcaagtttaaaaCaaggctagtcogttatcaacttGAAaagtgccacagAGTcgggtgcTTTT	81
WT	WT	gttttaagagctagAAtagcaagtttaaaaCaaggctagtcogttatcaacttGAAaagtgccacagAGTcgggtgcTTTT	81
MS2	MS2	gttttaagagctagAAtagcaagtttaaaaCaaggctagtcogttatcaacttGAAaagtgccacagAGTcgggtgcTTTT	81
addition	MS2 in loop 1	gttttaagagctagAAtagcaagtttaaaaCaaggctagtcogttatcaacttGAAaagtgccacagAGTcgggtgcTTTT	111
MS2	MS2 in loop 2	gttttaagagctagAAtagcaagtttaaaaCaaggctagtcogttatcaacttGAAaagtgccacagAGTcgggtgcTTTT	111
addition	MS2 in loop 1+2	gttttaagagctagAAtagcaagtttaaaaCaaggctagtcogttatcaacttGAAaagtgccacagAGTcgggtgcTTTT	141

FIG. 4B

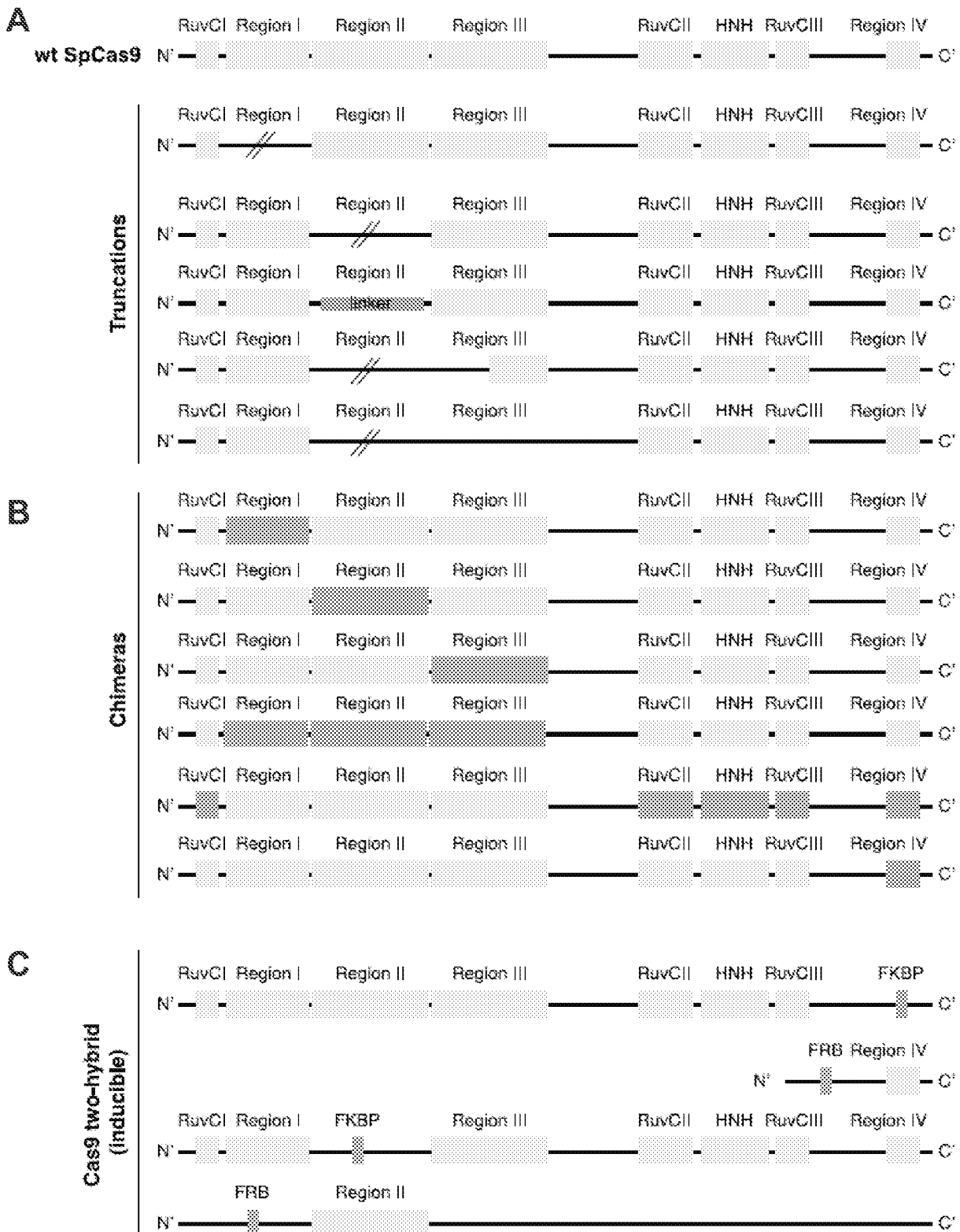

FIG. 5A-C

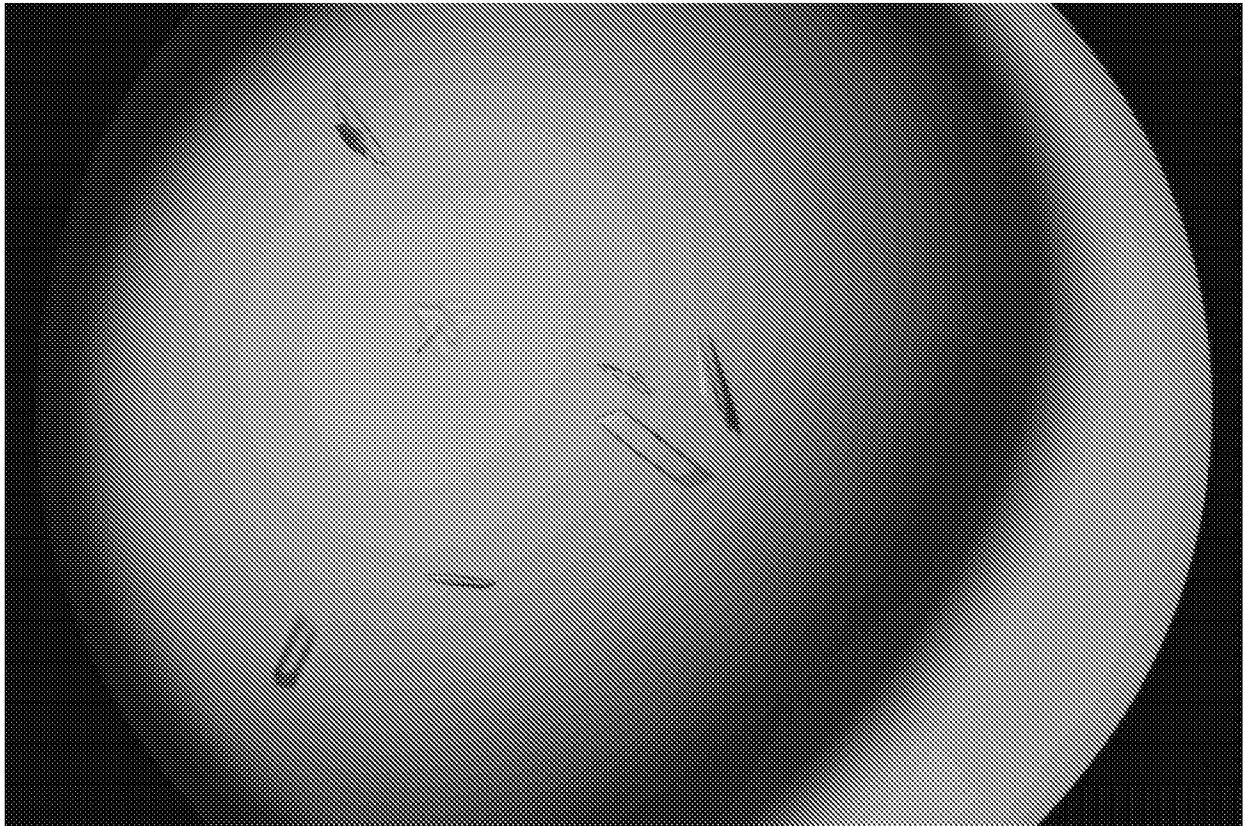

FIG. 6

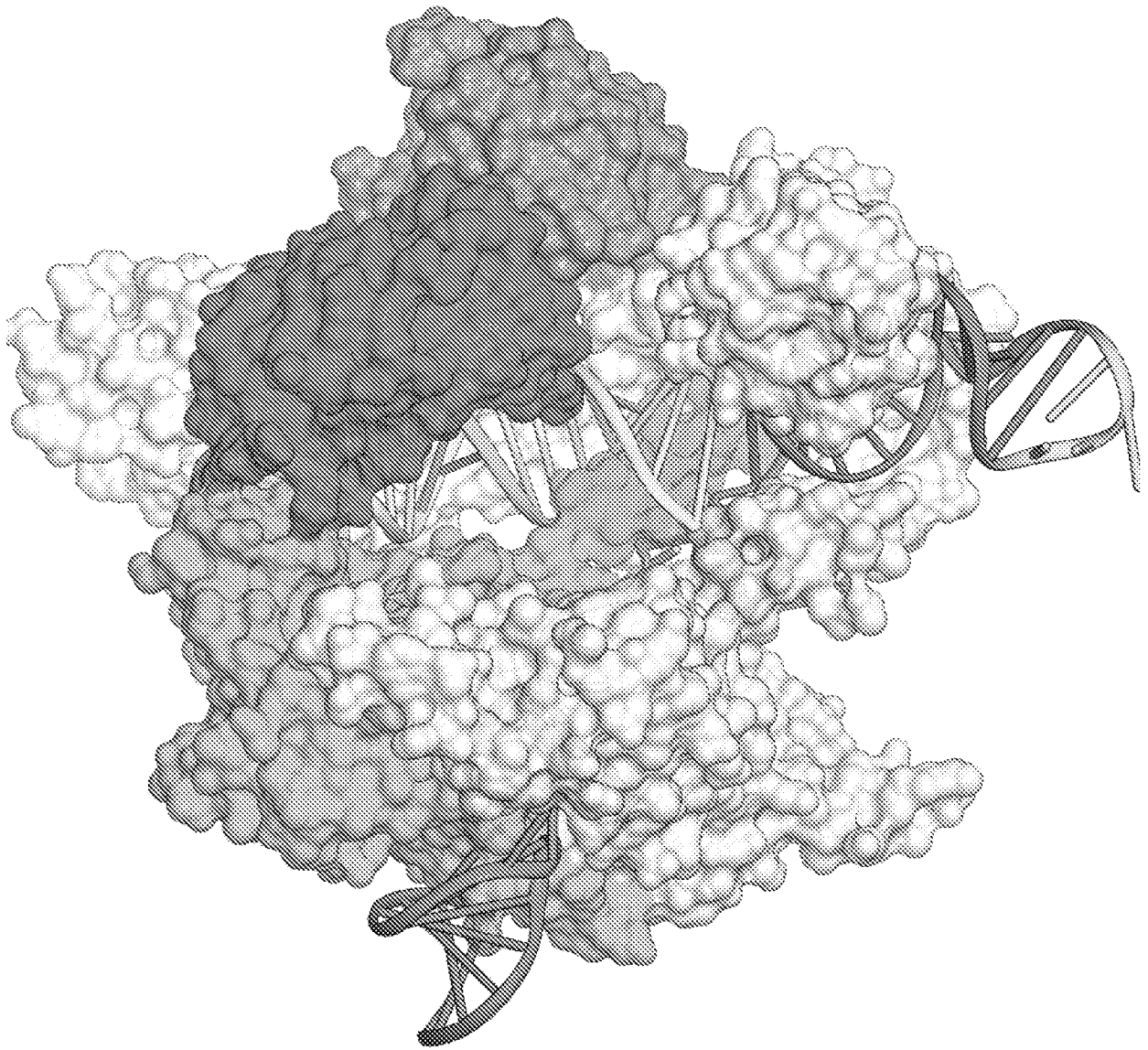
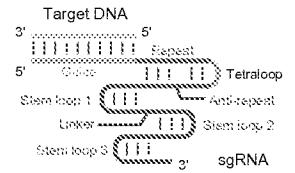
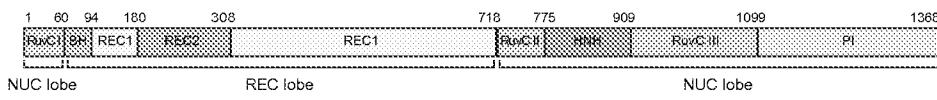
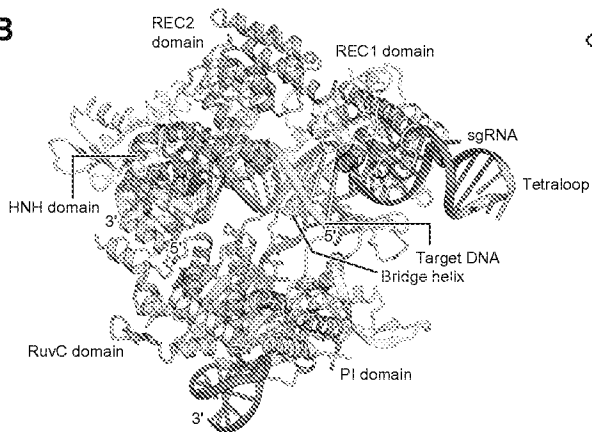

FIG. 7

A



B



180°

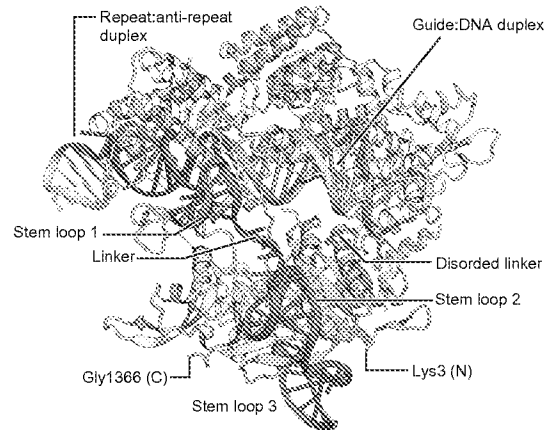

C

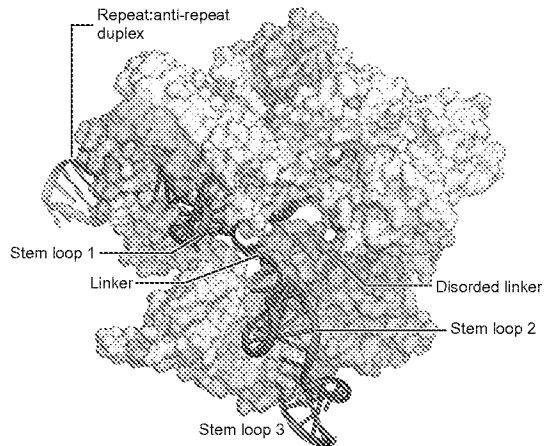
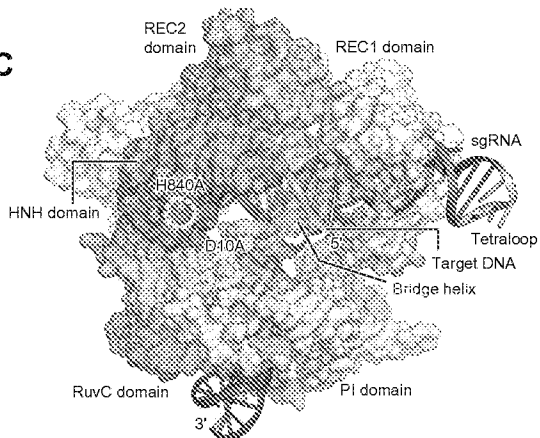

D

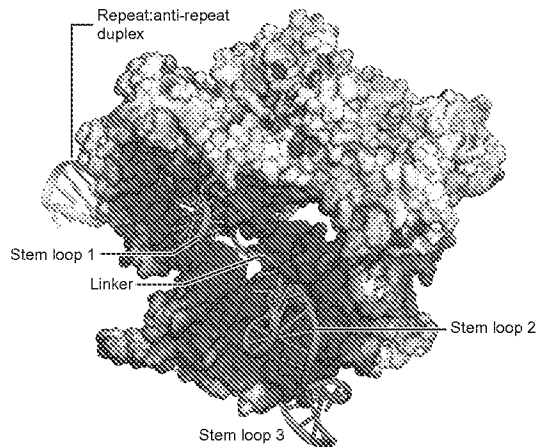
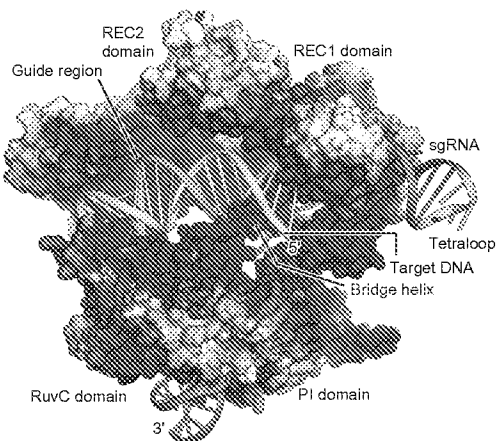

FIG. 8A-D

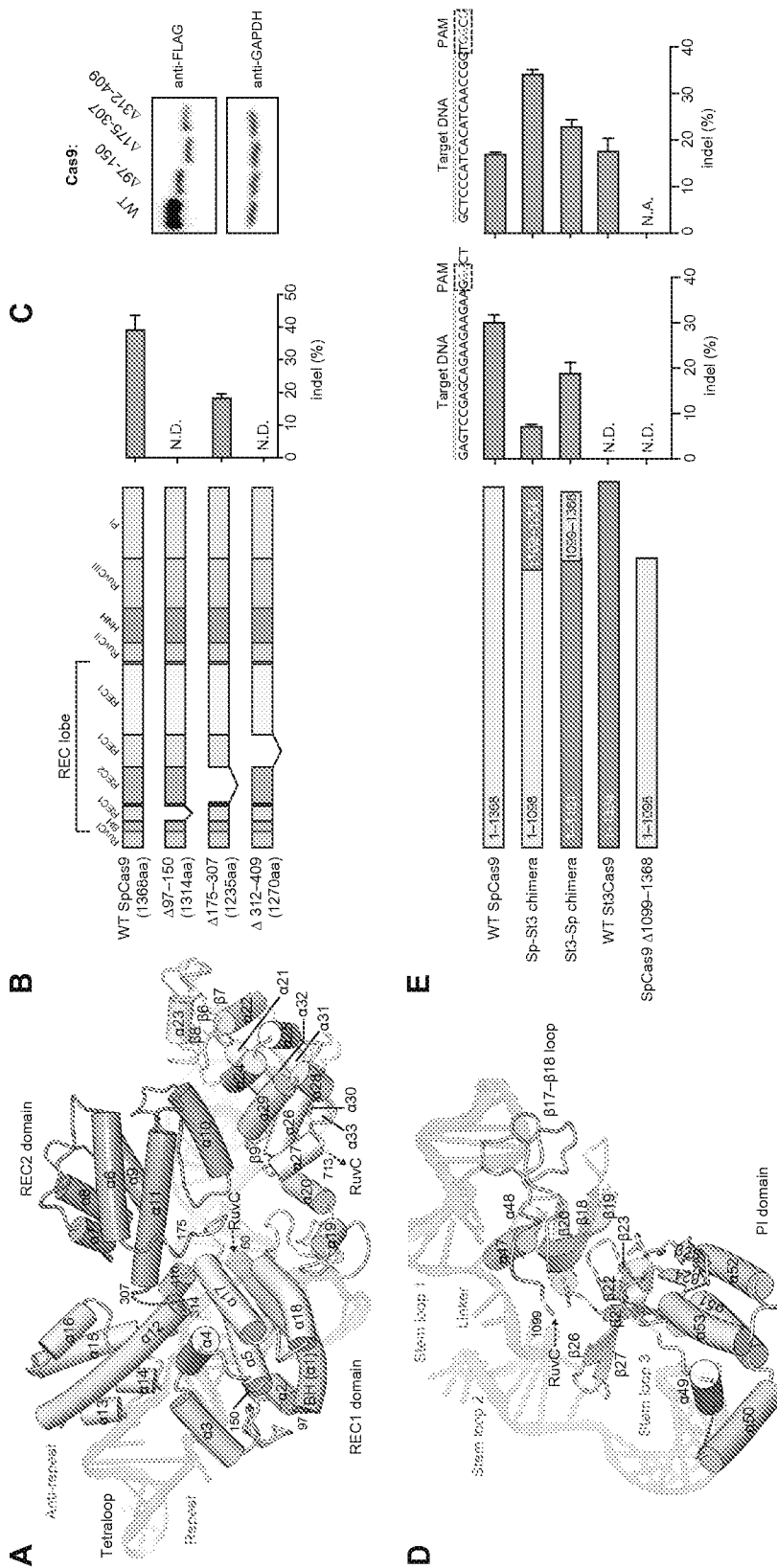

FIG. 9A-E

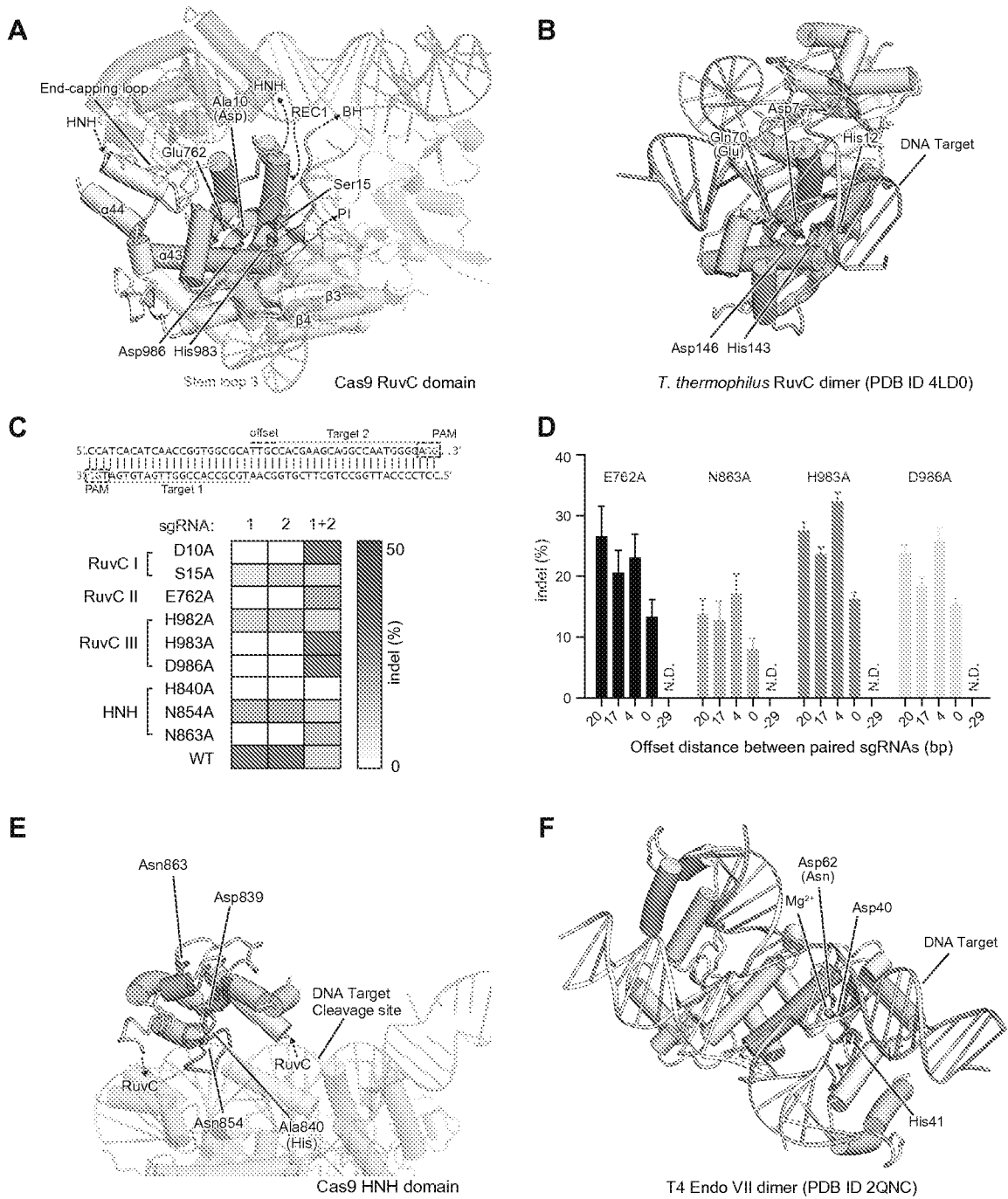

FIG. 10A-F

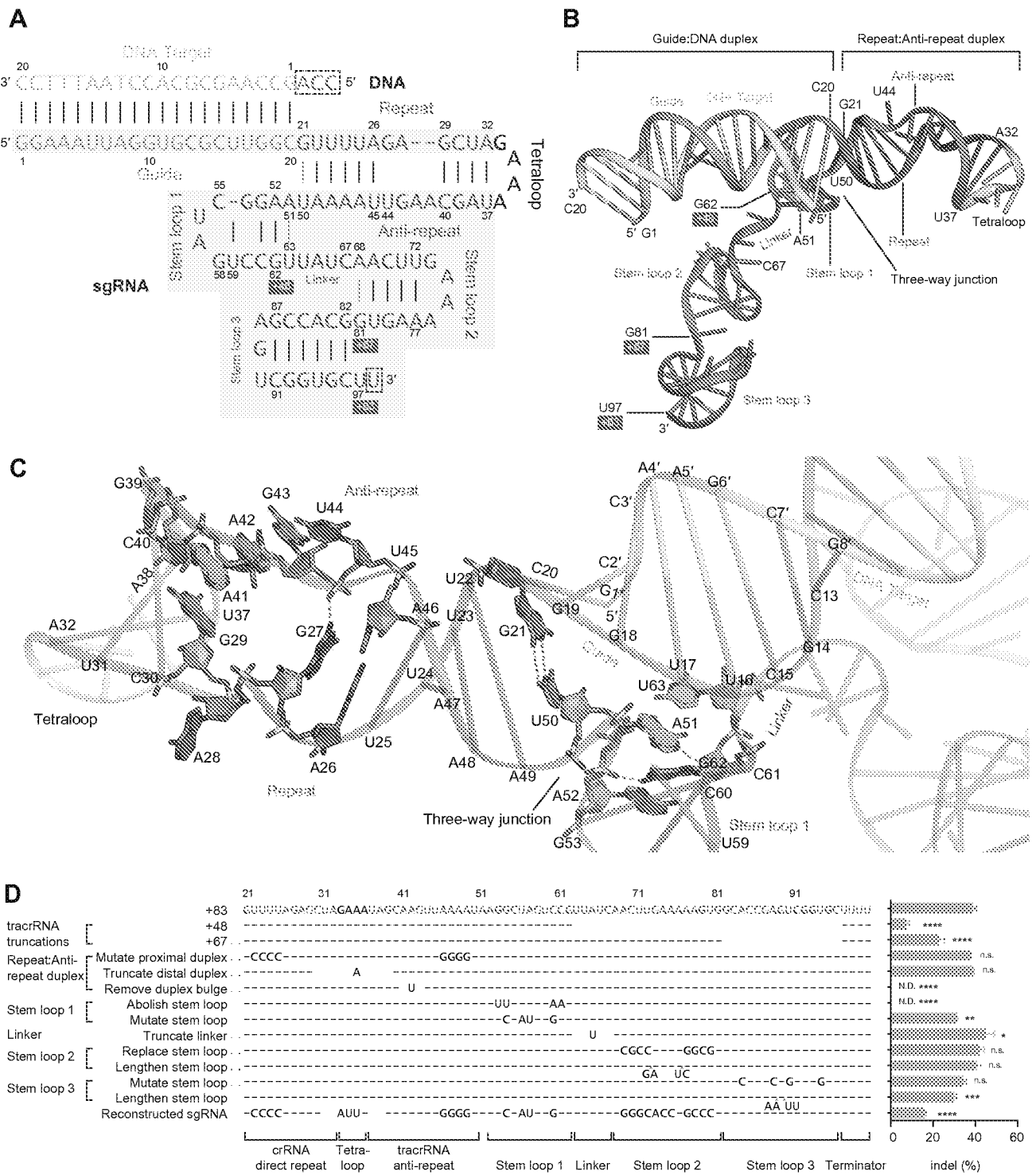

FIG. 11A-D

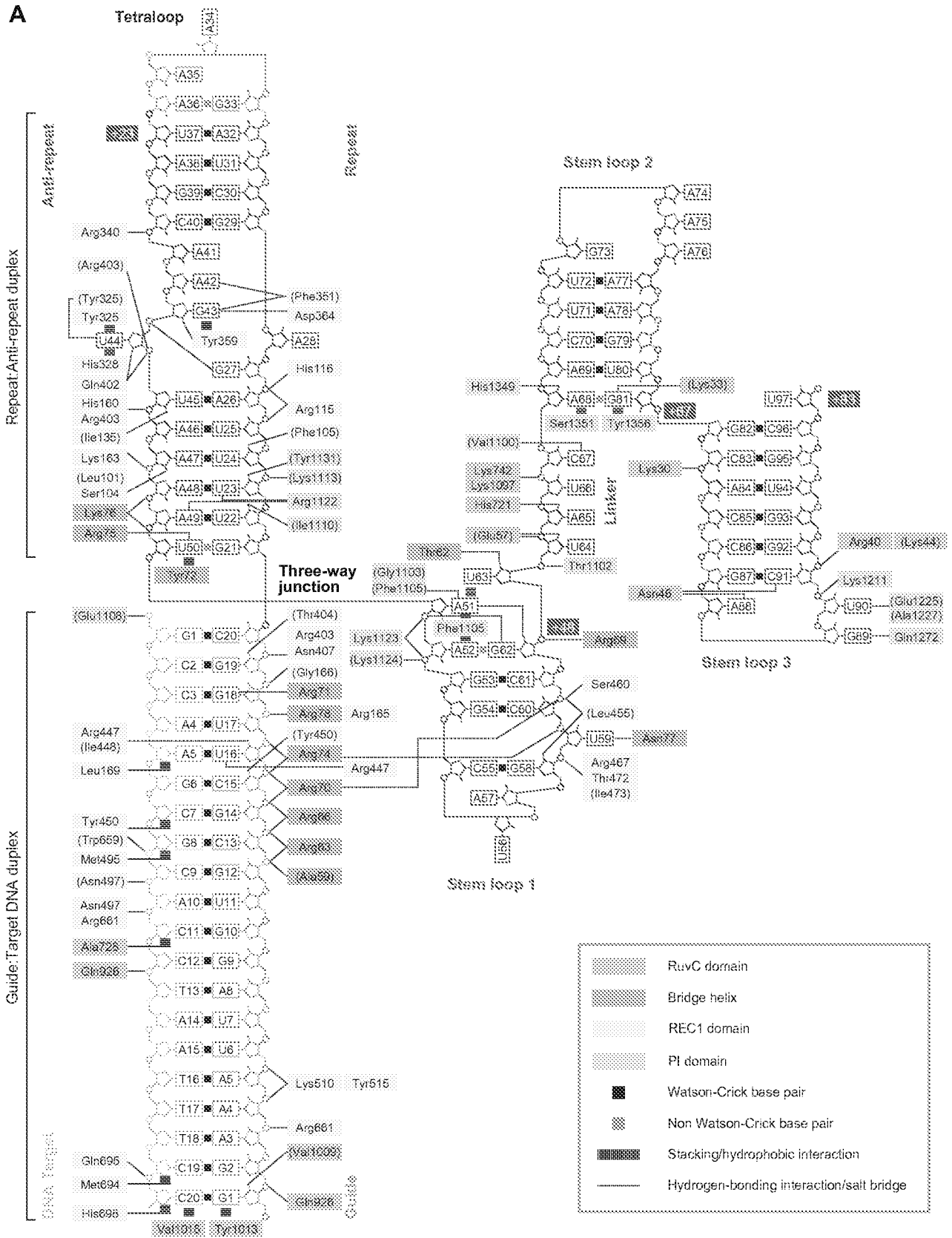

FIG. 12A

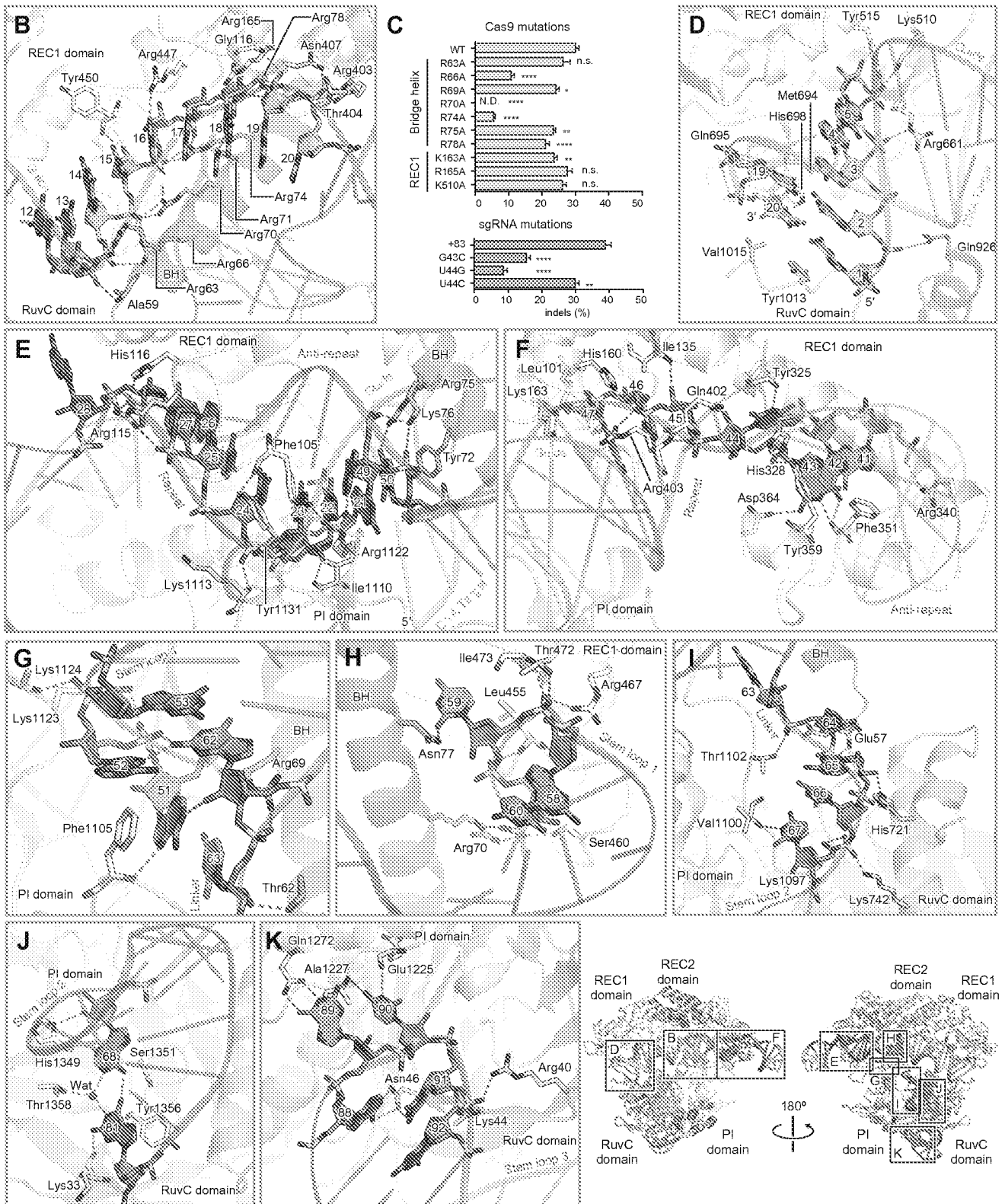

FIG. 12B-K

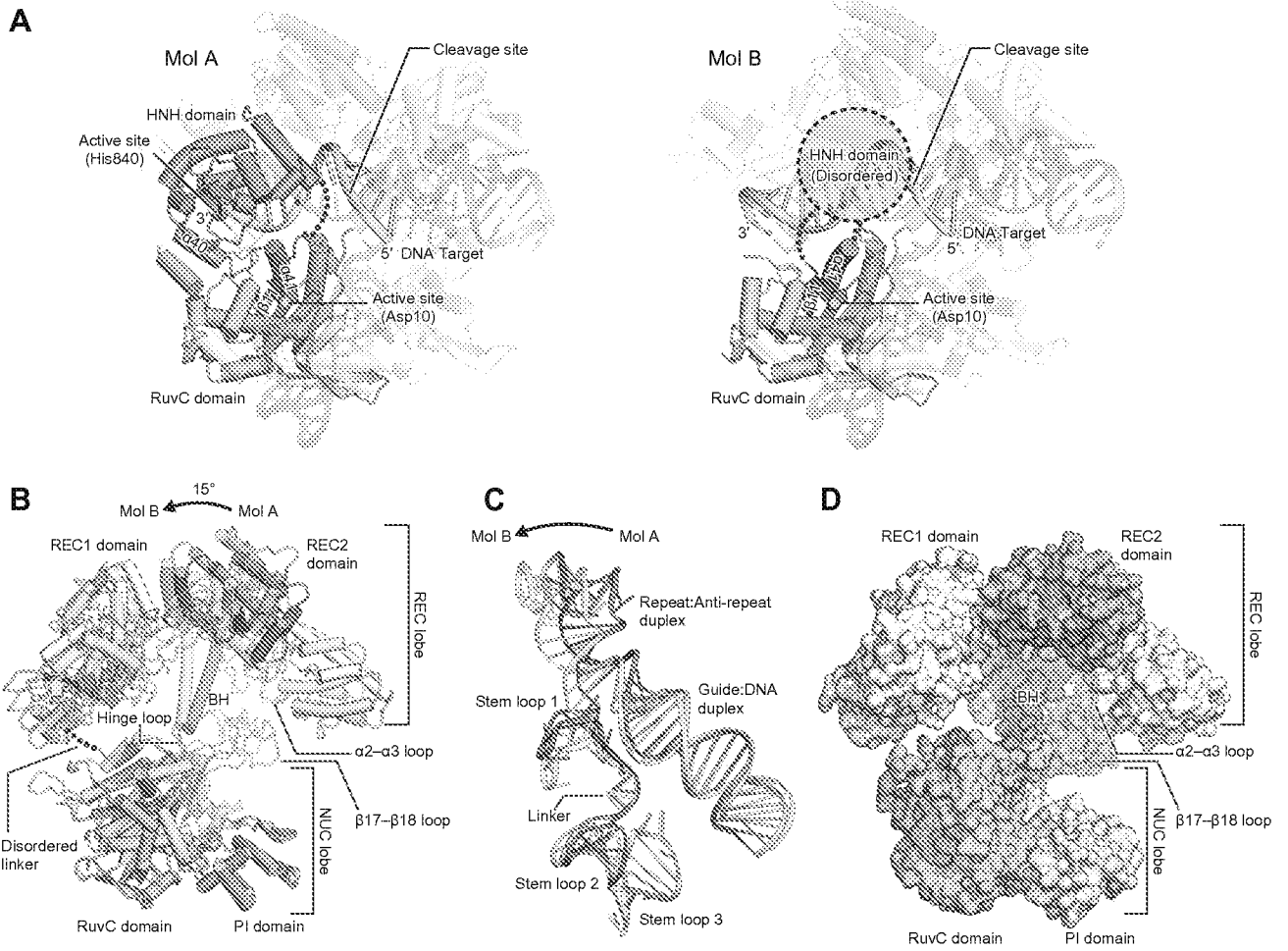

FIG. 13A-D

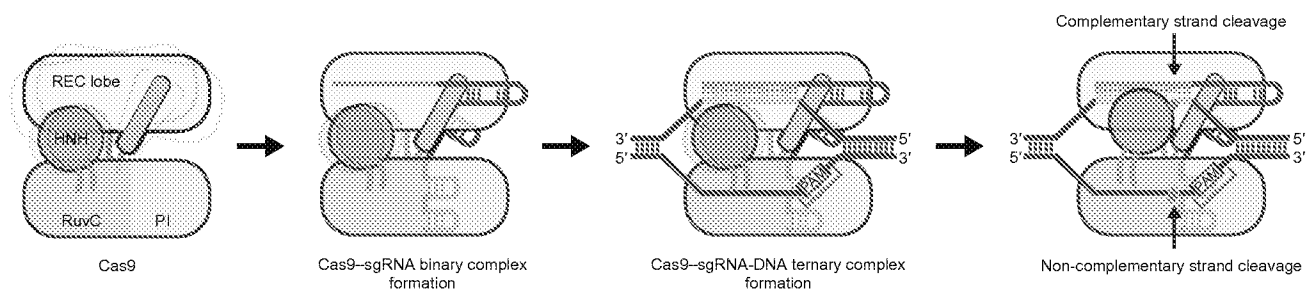

FIG. 14

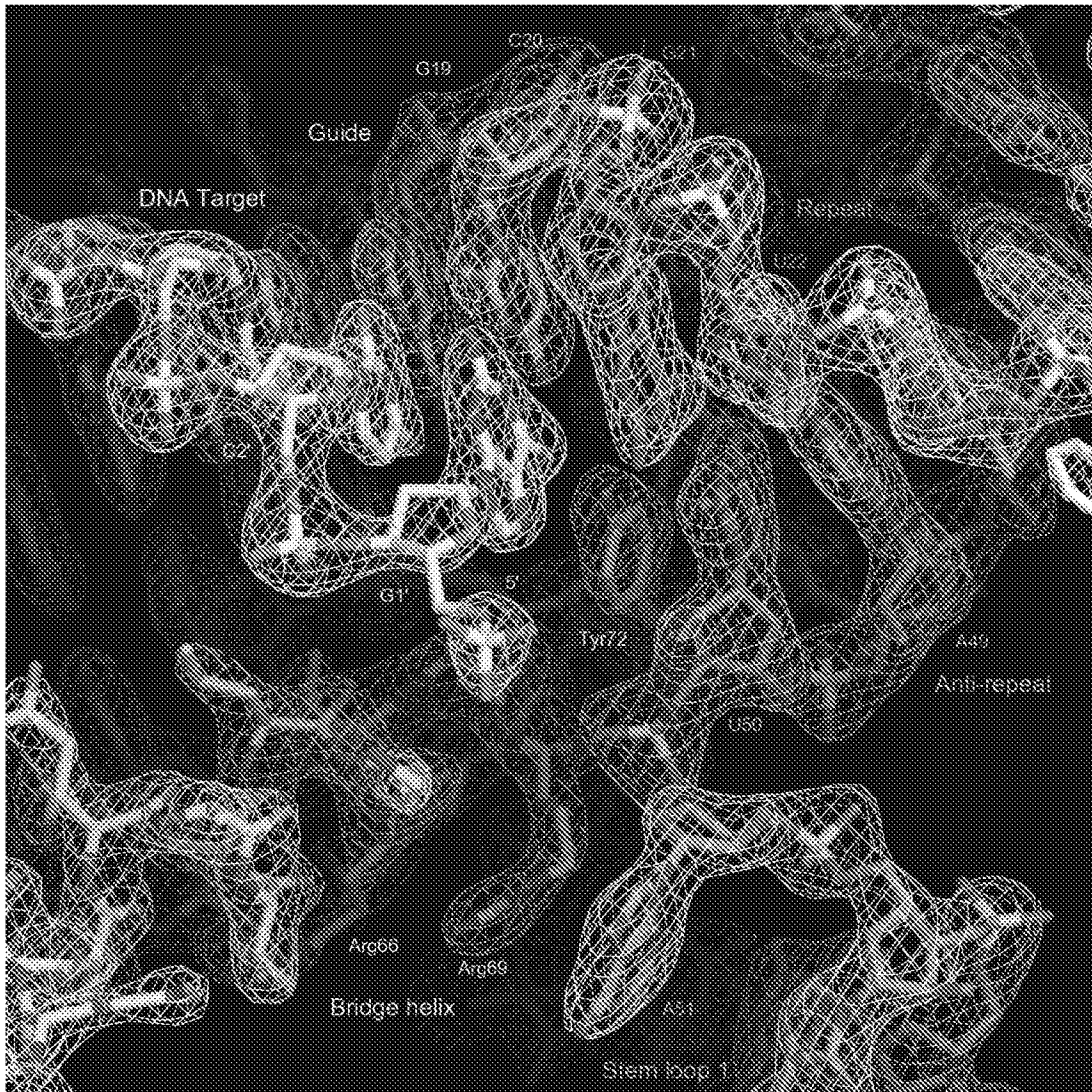

FIG. 15

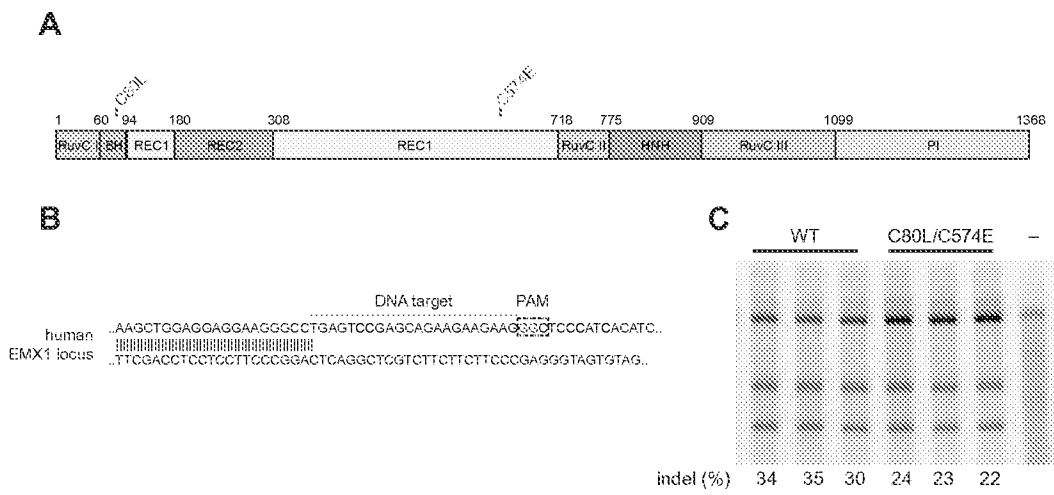

FIG. 16A-C

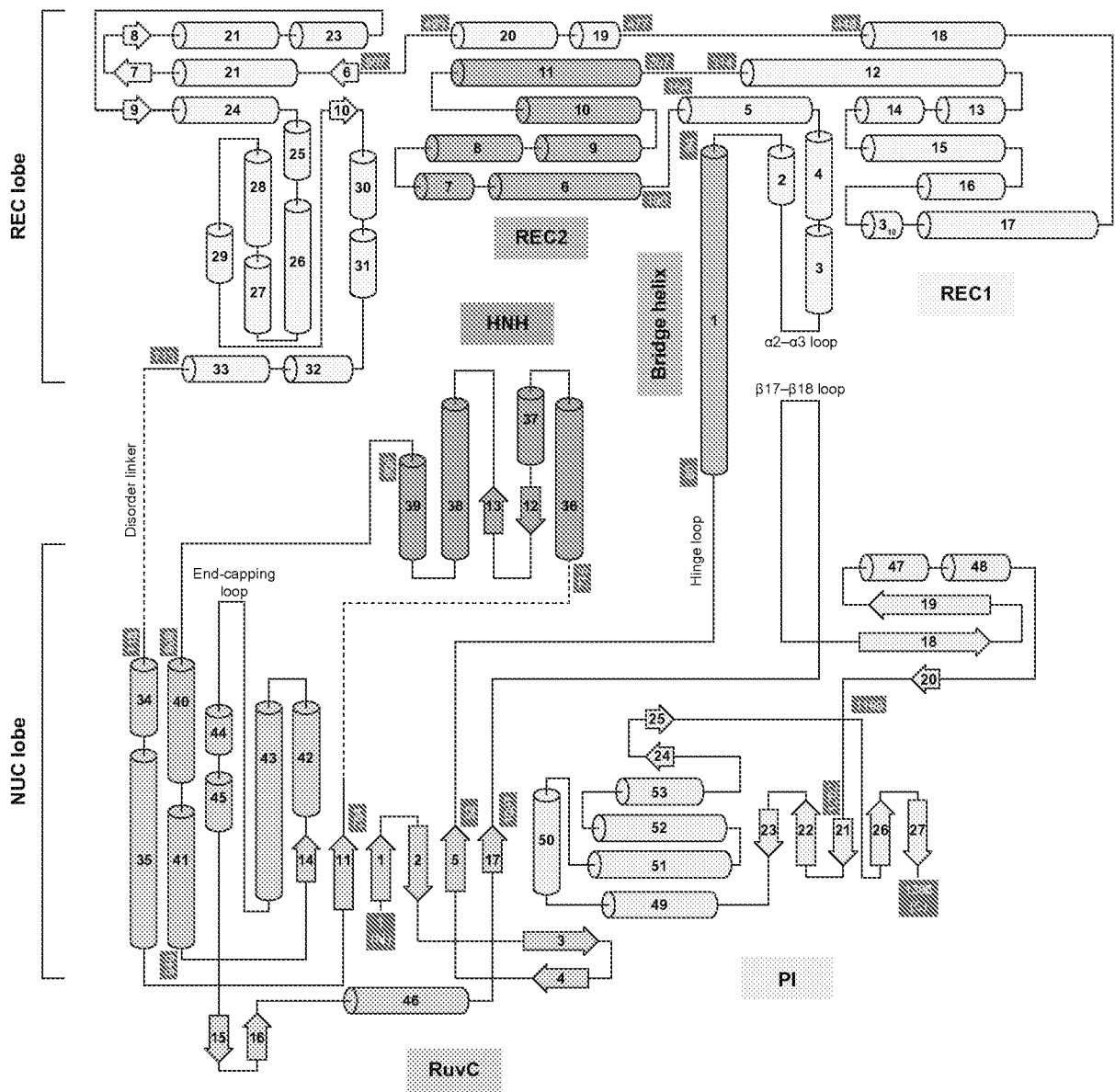

FIG. 17

A

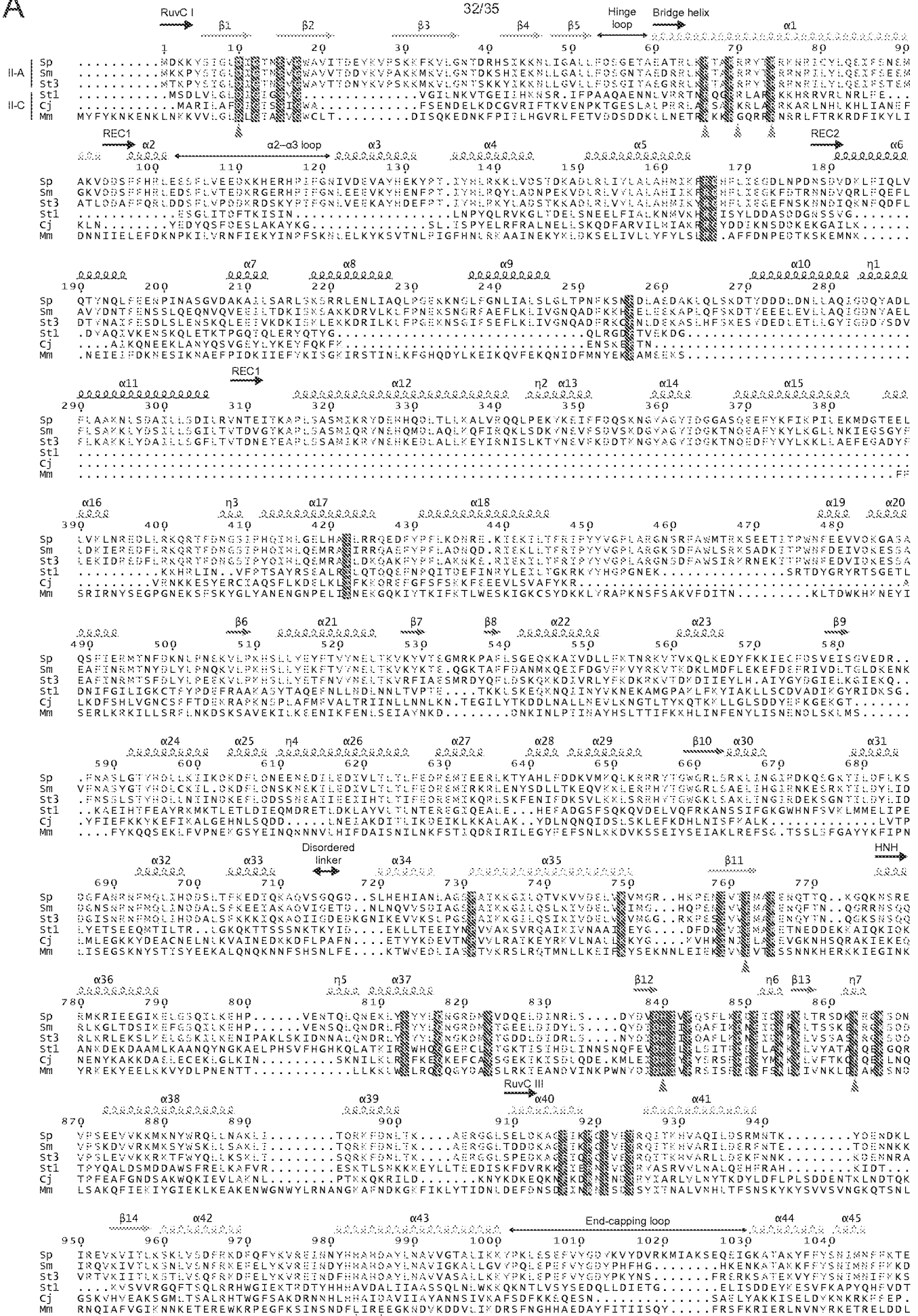

FIG. 18A

B

WO 2015/089364

PCT/US2014/069925

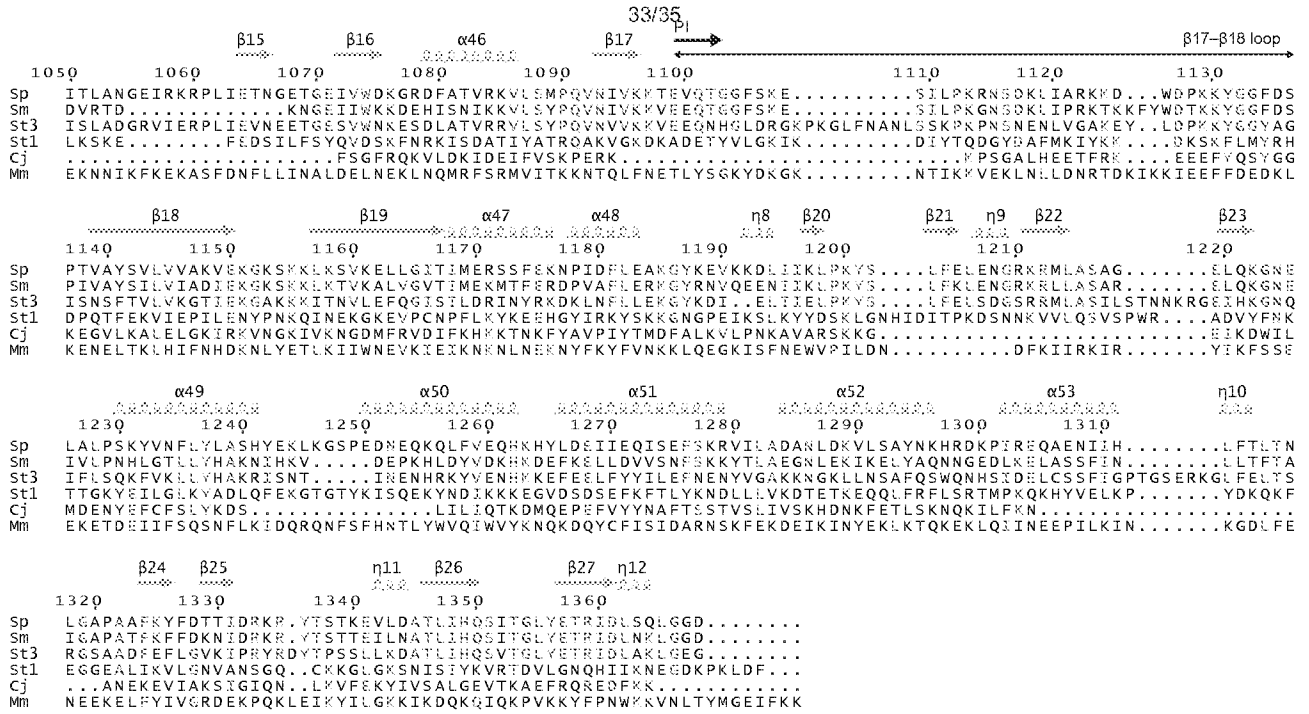

FIG. 18B

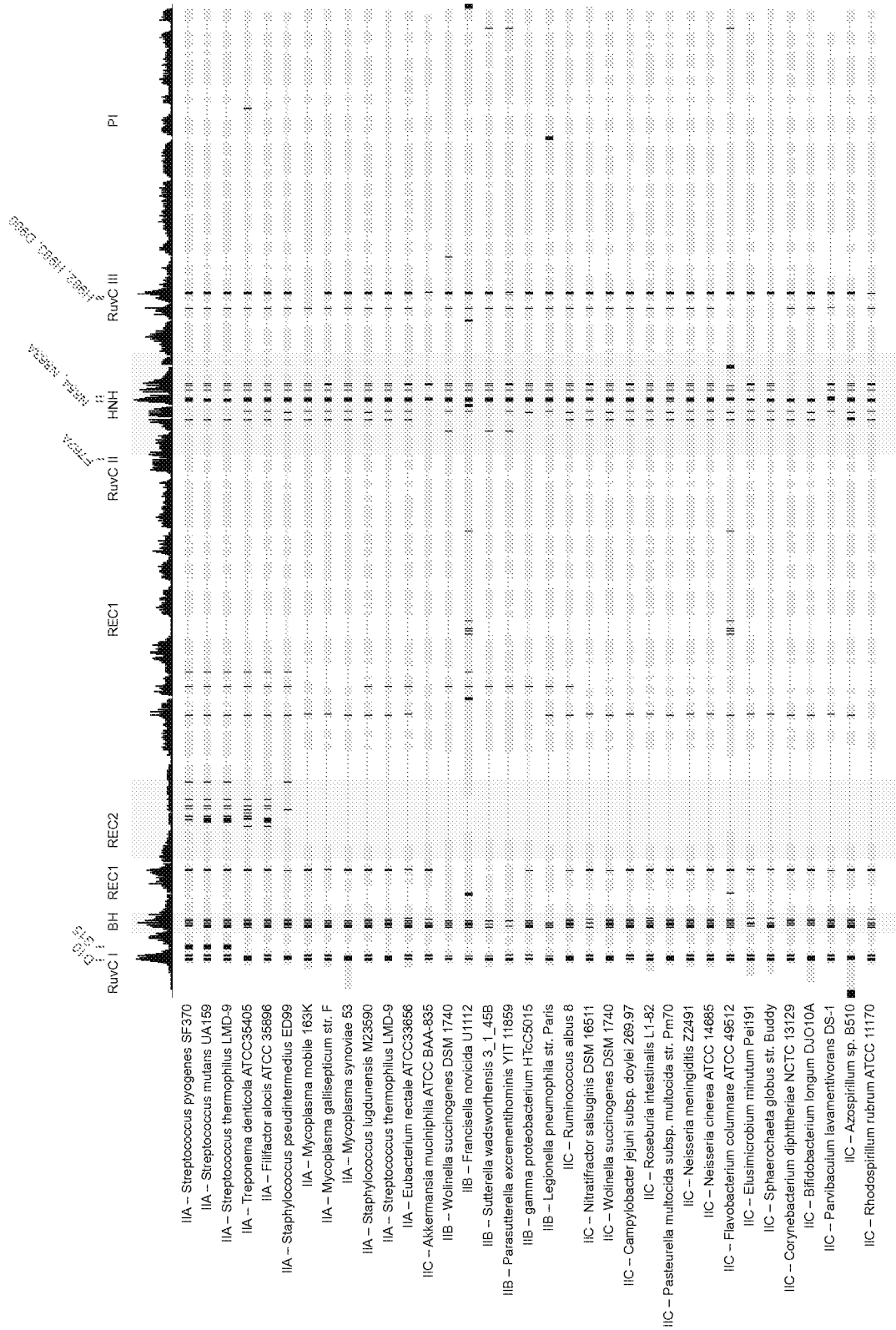

FIG. 19

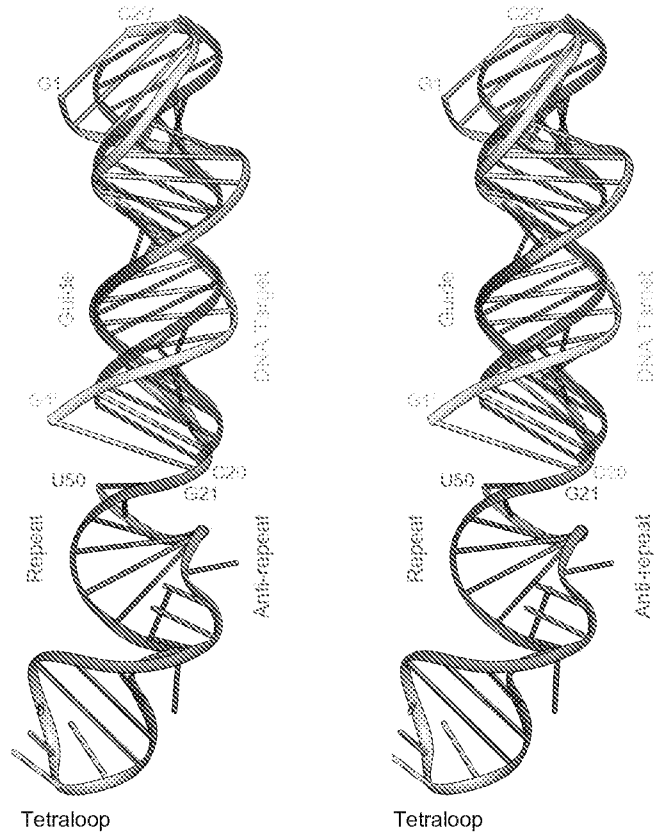

FIG. 20

INTERNATIONAL SEARCH REPORT

International application No
PCT/US2014/069925

A. CLASSIFICATION OF SUBJECT MATTER
INV. G06F19/16 C12N9/22
ADD.
According to International Patent Classification (IPC) or to both national classification and IPC

B. FIELDS SEARCHED
Minimum documentation searched (classification system followed by classification symbols)
G06F C12N
Documentation searched other than minimum documentation to the extent that such documents are included in the fields searched

Electronic data base consulted during the international search (name of data base and, where practicable, search terms used)
EPO-Internal

C. DOCUMENTS CONSIDERED TO BE RELEVANT

Category*	Citation of document, with indication, where appropriate, of the relevant passages	Relevant to claim No.
X	M. JINEK ET AL: "A Programmable Dual-RNA-Guided DNA Endonuclease in Adaptive Bacterial Immunity (Supplementary Material)", SCIENCE, vol. 337, no. 6096, 28 June 2012 (2012-06-28), pages 816-821, XP055067740, ISSN: 0036-8075, DOI: 10.1126/science.1225829	11
Y	the whole document, e.g. pg. 816 ----- -/--	1-10

Further documents are listed in the continuation of Box C.

See patent family annex.

* Special categories of cited documents :

- "A" document defining the general state of the art which is not considered to be of particular relevance
- "E" earlier application or patent but published on or after the international filing date
- "L" document which may throw doubts on priority claim(s) or which is cited to establish the publication date of another citation or other special reason (as specified)
- "O" document referring to an oral disclosure, use, exhibition or other means
- "P" document published prior to the international filing date but later than the priority date claimed

- "T" later document published after the international filing date or priority date and not in conflict with the application but cited to understand the principle or theory underlying the invention
- "X" document of particular relevance; the claimed invention cannot be considered novel or cannot be considered to involve an inventive step when the document is taken alone
- "Y" document of particular relevance; the claimed invention cannot be considered to involve an inventive step when the document is combined with one or more other such documents, such combination being obvious to a person skilled in the art
- "&" document member of the same patent family

Date of the actual completion of the international search 23 April 2015	Date of mailing of the international search report 04/05/2015
Name and mailing address of the ISA/ European Patent Office, P.B. 5818 Patentlaan 2 NL - 2280 HV Rijswijk Tel. (+31-70) 340-2040, Fax: (+31-70) 340-3016	Authorized officer Wimmer, Georg

INTERNATIONAL SEARCH REPORT

International application No
PCT/US2014/069925

C(Continuation). DOCUMENTS CONSIDERED TO BE RELEVANT		
Category*	Citation of document, with indication, where appropriate, of the relevant passages	Relevant to claim No.
Y	<p>PRASHANT MALI ET AL: "CAS9 transcriptional activators for target specificity screening and paired nickases for cooperative genome engineering", NATURE BIOTECHNOLOGY, vol. 31, no. 9, 1 August 2013 (2013-08-01), pages 833-838, XP055149275, ISSN: 1087-0156, DOI: 10.1038/nbt.2675 the whole document, e.g. pgs. 833, 837, Fig. 1</p> <p style="text-align: center;">-----</p>	1-10
Y	<p>XING ZHU ET AL: "Crystal structure of Cmr2 suggests a nucleotide cyclase-related enzyme in type III CRISPR-Cas systems", FEBS LETTERS, ELSEVIER, AMSTERDAM, NL, vol. 586, no. 6, 20 February 2012 (2012-02-20), pages 939-945, XP028472097, ISSN: 0014-5793, DOI: 10.1016/J.FEBSLET.2012.02.036 [retrieved on 2012-02-28] the whole document, e.g. abstract, pg. 940</p> <p style="text-align: center;">-----</p>	1-10
T	<p>NISHIMASU HIROSHI ET AL: "Crystal Structure of Cas9 in Complex with Guide RNA and Target DNA", CELL, CELL PRESS, US, vol. 156, no. 5, 13 February 2014 (2014-02-13), pages 935-949, XP028667665, ISSN: 0092-8674, DOI: 10.1016/J.CELL.2014.02.001 the whole document</p> <p style="text-align: center;">-----</p>	