



US00D934875S

(12) **United States Design Patent**
Lau

(10) **Patent No.:** **US D934,875 S**

(45) **Date of Patent:** **** Nov. 2, 2021**

(54) **DESKTOP RISER**

(71) Applicant: **COLEBROOK BOSSON & SAUNDERS (PRODUCTS) LIMITED**, London (GB)

(72) Inventor: **Alex Lau**, London (GB)

(73) Assignee: **COLEBROOK BOSSON & SAUNDERS (PRODUCTS) LIMITED**, London (GB)

(**) Term: **15 Years**

(21) Appl. No.: **29/712,185**

(22) Filed: **Nov. 6, 2019**

(51) **LOC (13) Cl.** **14-02**

(52) **U.S. Cl.**
USPC **D14/451**

(58) **Field of Classification Search**
USPC D14/224, 239, 251, 253, 316, 375, 376, D14/432, 439, 447, 451, 452, 457; D6/396, 444, 449, 510, 511, 513, 655, D6/675, 675.1, 691.9; D34/38; D8/349, D8/355, 363, 373, 380; 108/51.3; 248/121, 124.1, 127, 201, 205.1, 313, 248/415, 917-24; 312/223.3; 211/134, 211/151; D19/87
CPC G06F 3/0412; G06F 3/016; G06F 3/0488; G06F 3/011; G06F 3/038; G06F 3/03543; G06F 3/0338; G06F 3/0202; G06F 3/0219; G06F 3/0213; G06F 1/1616; G06F 3/023; G06F 3/04883; G02F 1/13338; G09G 3/3648

See application file for complete search history.

(56) **References Cited**

U.S. PATENT DOCUMENTS

D233,392 S * 10/1974 Hutchison D6/691.6
D426,989 S * 6/2000 Pagnon D6/691.6

D501,339 S * 2/2005 Lai D6/691
D557,521 S * 12/2007 Good D6/691.1
D569,132 S * 5/2008 Sexton D6/656.18
D592,892 S * 5/2009 Sexton D6/691
D642,174 S * 7/2011 Hirota D14/390
D671,339 S * 11/2012 Nakamura D6/691
D873,586 S * 1/2020 Chang D6/656.16
D882,313 S * 4/2020 Page D6/691
D882,988 S * 5/2020 Hu D6/656.17

(Continued)

Primary Examiner — Katie Jane Stofko

(74) *Attorney, Agent, or Firm* — Michael Best & Friedrich LLP

(57) **CLAIM**

The ornamental design for a desktop riser, as shown and described.

DESCRIPTION

FIG. 1 is a top perspective view of a desktop riser with the legs extended;
FIG. 2 is a bottom perspective view of FIG. 1;
FIG. 3 is a top view of FIG. 1;
FIG. 4 is a bottom view of FIG. 1;
FIG. 5 is a left-side view of FIG. 1;
FIG. 6 is a right-side view of FIG. 1;
FIG. 7 is a front view of FIG. 1;
FIG. 8 is a rear view of FIG. 1;
FIG. 9 is a top perspective view of the design of FIG. 1 with the legs folded;
FIG. 10 is a bottom perspective view of FIG. 9;
FIG. 11 is a top view of FIG. 9;
FIG. 12 is a bottom view of FIG. 9;
FIG. 13 is a left-side view of FIG. 9;
FIG. 14 is a right-side view of FIG. 9;
FIG. 15 is a front view of FIG. 9; and,
FIG. 16 is a rear view of FIG. 9.

The broken lines shown on the drawings depict portions of the desktop riser that form no part of the claimed design.

1 Claim, 12 Drawing Sheets

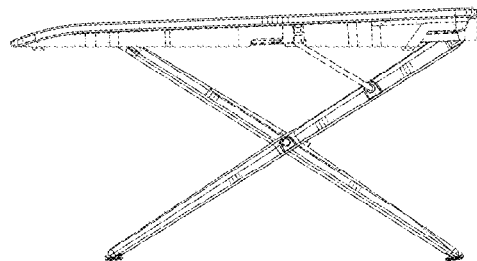
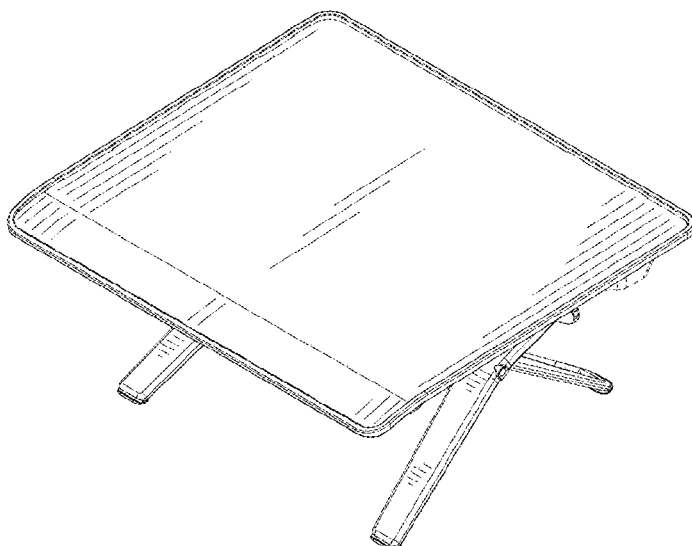

(56)

References Cited

U.S. PATENT DOCUMENTS

D889,169 S * 7/2020 Hu D6/656.16
2018/0206630 A1 * 7/2018 Chang A47B 13/081

* cited by examiner

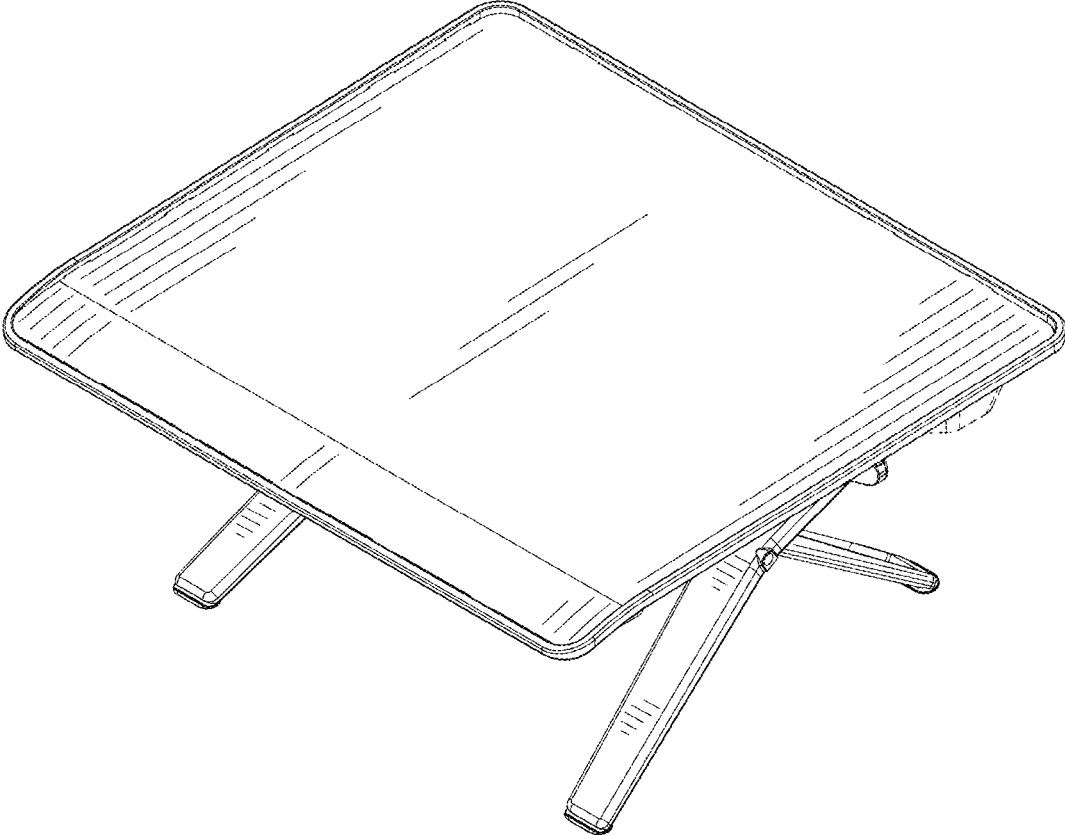

FIG. 1

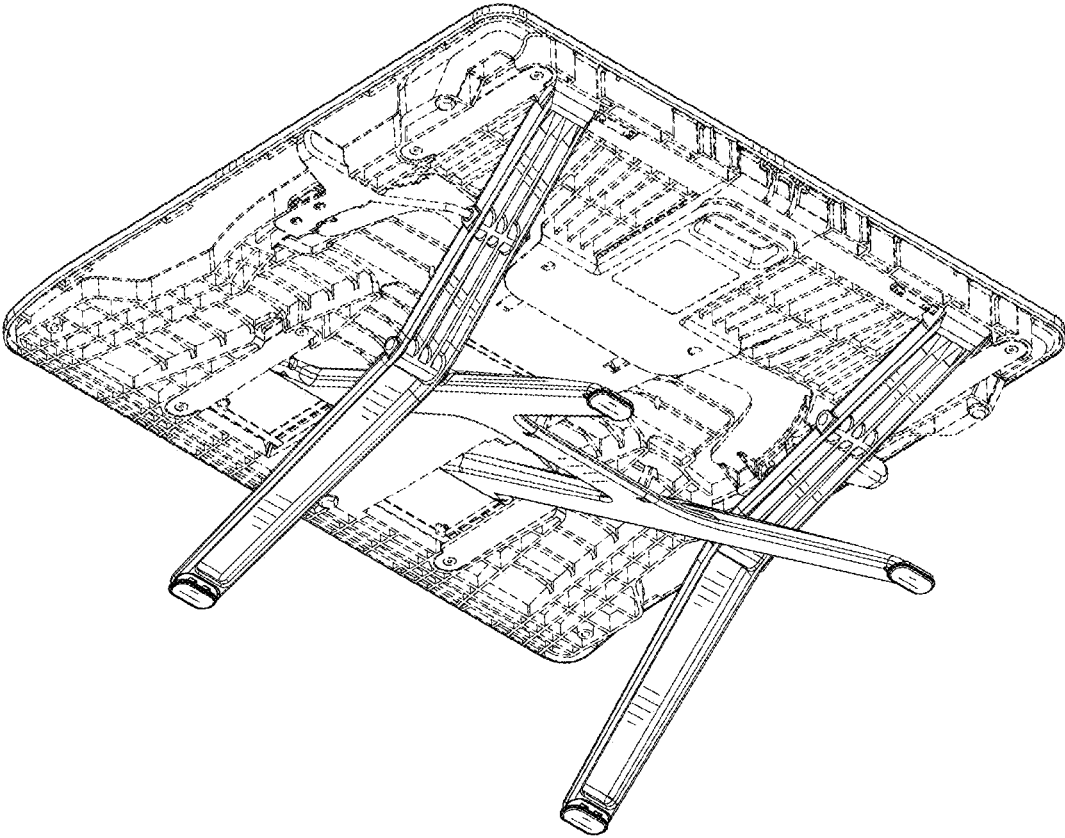

FIG. 2

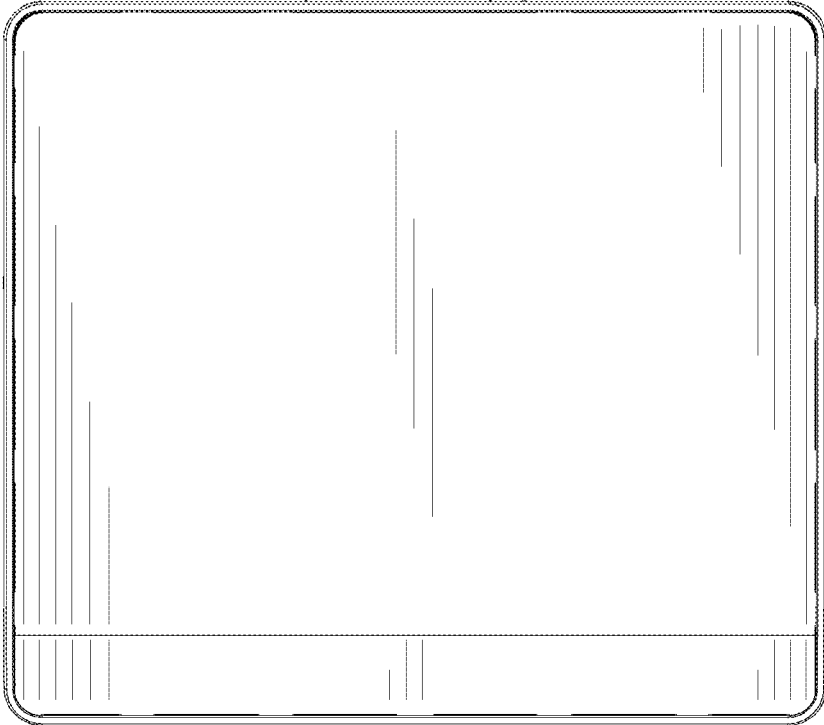

FIG. 3

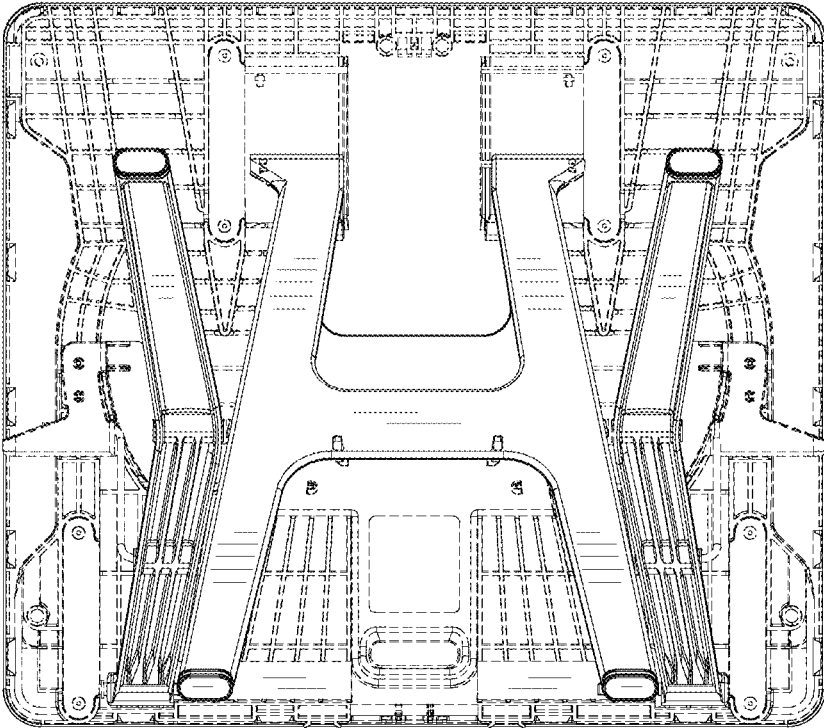

FIG. 4

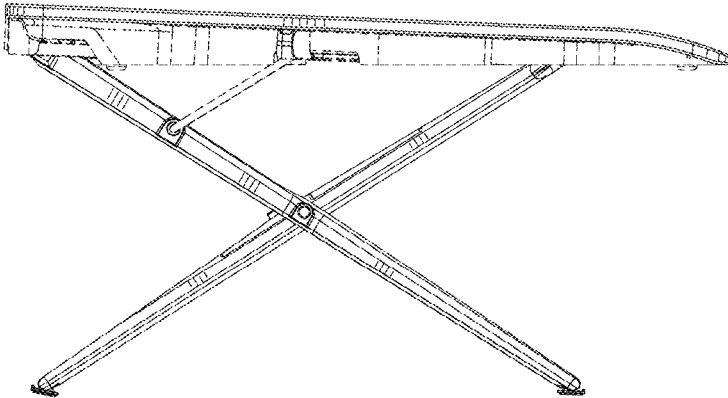

FIG. 5

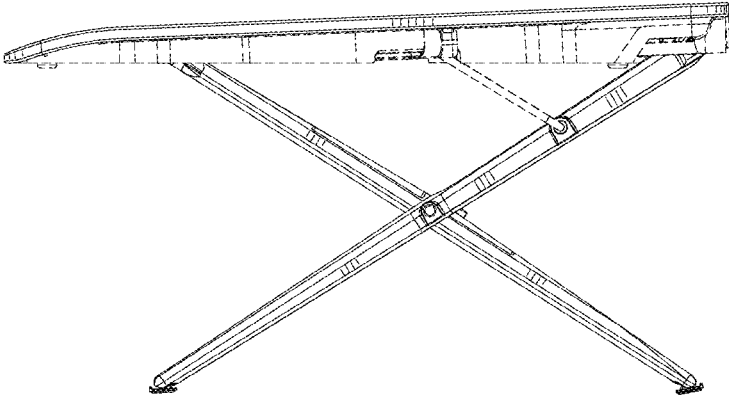

FIG. 6

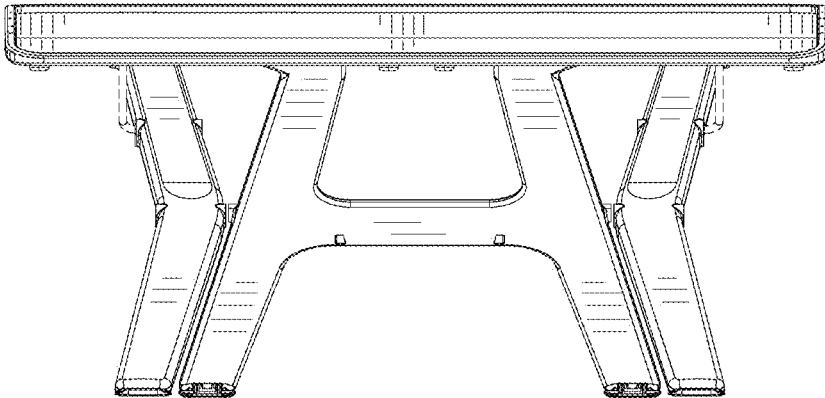

FIG. 7

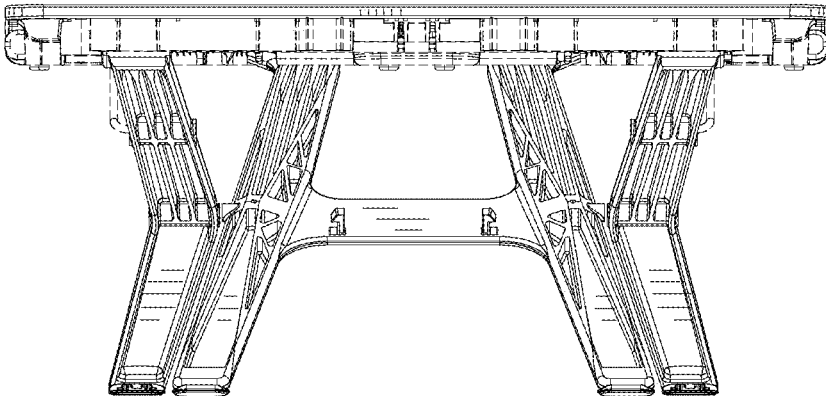

FIG. 8

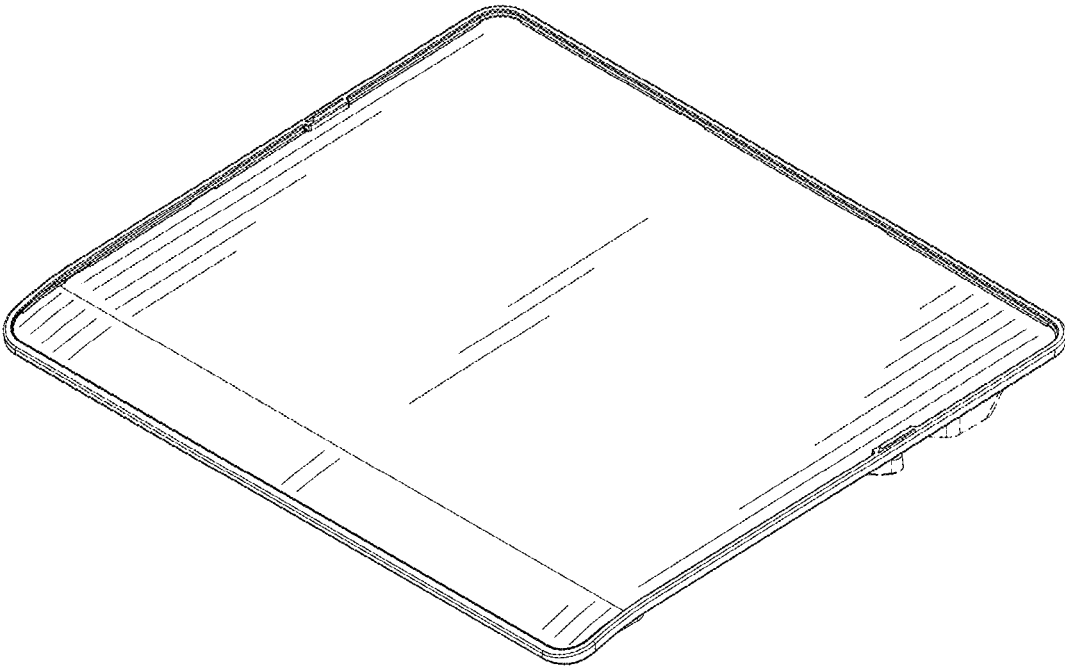

FIG. 9

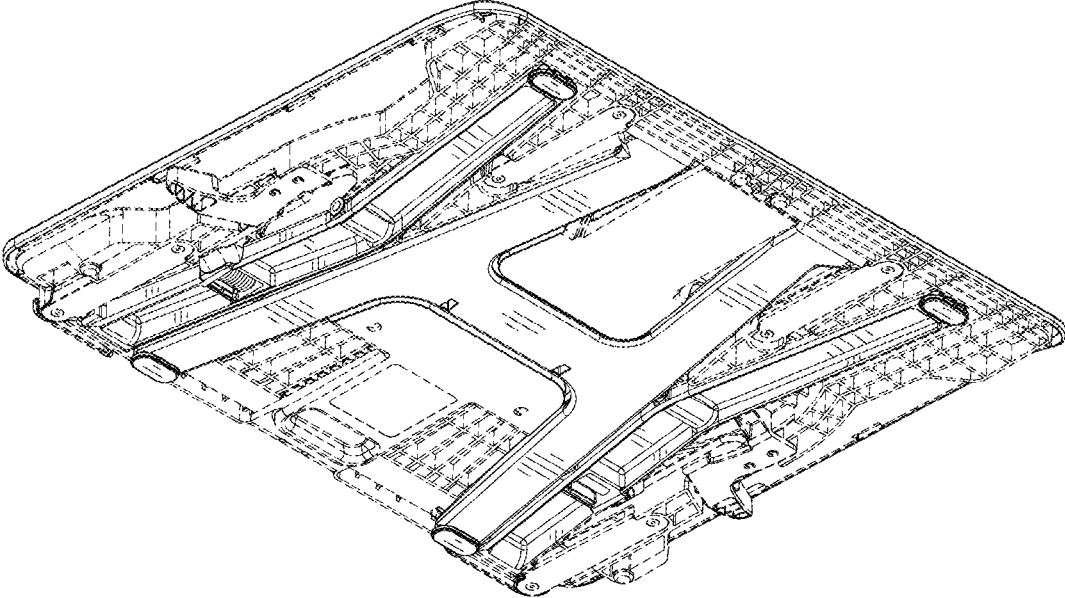

FIG. 10

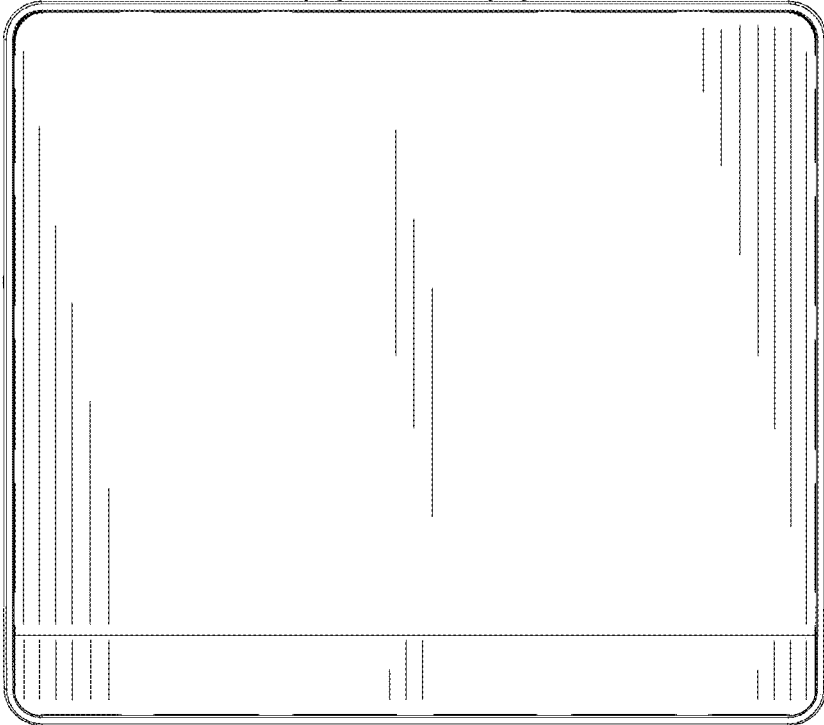

FIG. 11

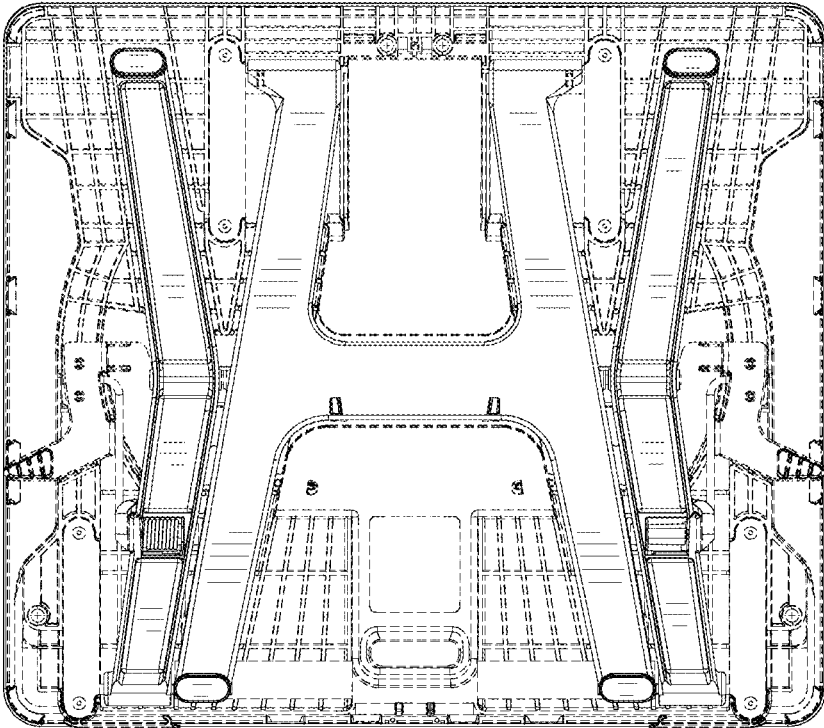

FIG. 12



FIG. 13



FIG. 14



FIG. 15

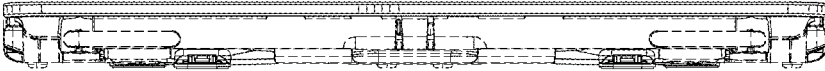

FIG. 16