



US00D563105S

(12) **United States Design Patent**  
**Rothschild**

(10) **Patent No.:** **US D563,105 S**

(45) **Date of Patent:** **\*\* Mar. 4, 2008**

(54) **STORAGE BIN WITH LID**

(75) Inventor: **Wayne H. Rothschild**, Northbrook, IL (US)

(73) Assignee: **International Holdings LLC**, Northfield, IL (US)

(\*\*) Term: **14 Years**

(21) Appl. No.: **29/259,699**

(22) Filed: **May 12, 2006**

**Related U.S. Application Data**

(63) Continuation-in-part of application No. 11/263,424, filed on Oct. 31, 2005, which is a continuation-in-part of application No. 11/046,423, filed on Jan. 28, 2005.

- (51) **LOC (8) Cl.** ..... **03-01**
  - (52) **U.S. Cl.** ..... **D3/302; D3/276**
  - (58) **Field of Classification Search** ..... D3/201, D3/260, 273, 276, 284–286, 302, 305, 904–905; D7/605, 607; D21/397; 190/1–2, 107; 229/103, 229/117.09, 117.35; 273/285–286; 383/4, 383/6, 40, 97, 110
- See application file for complete search history.

**References Cited**

**U.S. PATENT DOCUMENTS**

170,991 A	12/1875	Conover	
1,269,276 A	6/1918	Harris	
1,365,831 A	1/1921	Hyatt	
1,467,690 A	9/1923	Schwarz	
1,985,111 A	12/1934	Shofer et al.	
2,085,038 A *	6/1937	Perreton	229/103
2,105,953 A	1/1938	Quellette	
2,479,203 A	8/1949	Brown	
2,636,313 A	4/1953	Shank	
2,768,719 A *	10/1956	Morris et al.	190/107
2,831,624 A	4/1958	Lever	
3,044,211 A	7/1962	Palm	
3,097,782 A	7/1963	Koropatkin et al.	
3,262,283 A	7/1966	Taylor	

3,375,008 A	3/1968	Atkinson
3,542,569 A	11/1970	Farquhar
3,627,541 A	12/1971	Farquhar
3,747,832 A	7/1973	Chapman
3,976,113 A	8/1976	Kim
4,019,675 A	4/1977	Andersson et al.
4,091,852 A	5/1978	Jordan et al.
4,126,213 A	11/1978	McDonald

(Continued)

**OTHER PUBLICATIONS**

Foldable Storage Box Small Grey at dwell. Downloaded Jun. 22, 2007 at <http://dwell.co.uk/product.php?prod=102584>.\*

(Continued)

*Primary Examiner*—Philip S. Hyder  
*Assistant Examiner*—RoseLynne (Ulm) Cody  
(74) *Attorney, Agent, or Firm*—Nixon Peabody LLP

(57) **CLAIM**

The ornamental design for a storage bin with lid, as shown and described.

**DESCRIPTION**

FIG. 1 is a perspective view of a storage bin and lid showing my new design.

FIG. 2 is an exploded perspective view of the storage bin and lid shown in FIG. 1 with the lid removed from the storage bin.

FIG. 3 is a top view of the storage bin and lid shown in FIG. 1.

FIG. 4 is a bottom view of the storage bin and lid shown in FIG. 1.

FIG. 5 is a side view of the storage bin and lid shown in FIG. 1; the opposite side being a mirror image thereof; and,

FIG. 6 is an end view of the storage bin and lid shown in FIG. 1; the opposite end being a mirror image thereof.

All broken lines shown are for illustrative purposes only and form no part of the claimed design.

**1 Claim, 6 Drawing Sheets**

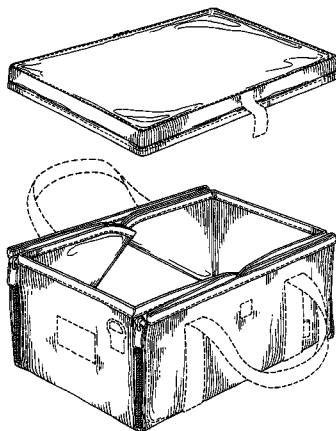

U.S. PATENT DOCUMENTS

4,199,097 A 4/1980 Christenson  
 4,206,868 A 6/1980 Stephens  
 4,306,658 A 12/1981 Montealegre  
 4,340,169 A 7/1982 Webinger  
 4,375,111 A 3/1983 Hall  
 4,451,001 A 5/1984 Webinger  
 4,489,815 A \* 12/1984 Martinez et al. .... 190/1  
 4,661,195 A 4/1987 Hopson  
 4,681,195 A 7/1987 Trahan et al.  
 4,712,673 A 12/1987 Moore  
 4,738,545 A 4/1988 Westgor  
 4,765,533 A 8/1988 Hoshiko et al.  
 4,791,883 A 12/1988 Lehman et al.  
 4,930,680 A 6/1990 Hanus  
 4,984,906 A \* 1/1991 Little ..... 383/4  
 5,016,813 A 5/1991 Simons  
 5,033,668 A 7/1991 Cohen et al.  
 5,035,013 A 7/1991 Bloom  
 5,088,139 A 2/1992 Bloom  
 5,100,151 A \* 3/1992 Lyon et al. .... 273/285  
 5,136,738 A 8/1992 Denson  
 5,207,376 A 5/1993 Cohen et al.  
 5,255,841 A 10/1993 Ritter  
 5,294,040 A 3/1994 Cohen et al.  
 5,370,460 A 12/1994 Nelson  
 5,630,543 A 5/1997 Dugan  
 5,788,350 A 8/1998 Fladung  
 5,853,121 A 12/1998 Francisco  
 5,904,230 A \* 5/1999 Peterson ..... 190/107  
 6,048,249 A 4/2000 Vandenberg  
 6,050,483 A 4/2000 Haraldsson et al.  
 6,053,634 A 4/2000 Kay  
 6,059,179 A 5/2000 Giampapa  
 6,079,616 A 6/2000 Chinks et al.  
 6,146,238 A 11/2000 Daiber  
 D435,342 S 12/2000 Mogil  
 D435,968 S 1/2001 Mogil  
 D436,442 S 1/2001 Mogil  
 6,203,017 B1 \* 3/2001 Schultz ..... 273/285  
 6,247,328 B1 6/2001 Mogil  
 6,523,989 B2 2/2003 Carty  
 6,572,436 B1 6/2003 So

6,663,459 B2 12/2003 Ostolaza  
 6,676,010 B1 1/2004 Roseth et al.  
 6,736,309 B1 5/2004 Westerman et al.  
 D493,618 S \* 8/2004 DeCarlo et al. .... D3/302  
 D494,758 S \* 8/2004 DeCarlo et al. .... D3/302  
 D500,205 S \* 12/2004 DeCarlo et al. .... D3/302  
 D510,189 S \* 10/2005 Greiner ..... D3/295  
 D518,637 S \* 4/2006 DeCarlo et al. .... D3/302  
 7,044,277 B2 \* 5/2006 Redzisz ..... 190/107  
 7,143,932 B2 \* 12/2006 Wang ..... 229/117.35  
 7,188,713 B1 \* 3/2007 Espar et al. .... 190/2  
 2006/0177154 A1 \* 8/2006 Morrissey, Jr. .... 383/4

OTHER PUBLICATIONS

Information brochure from Homegrown Kids—Toy Taco [www.toydirectory.com/monthly/toyfairpreview/Homegrown/index.asp](http://www.toydirectory.com/monthly/toyfairpreview/Homegrown/index.asp); 1 page.  
 Information brochure from Parents of Innovation—Romp’n Run [www.parentsofinvention.com/home.html](http://www.parentsofinvention.com/home.html); 1 page.  
 Information brochure from Homegrown Kids—Activity Cooler [www.toydirectory.com/monthly/toyfairpreview/Homegrown/index.asp](http://www.toydirectory.com/monthly/toyfairpreview/Homegrown/index.asp); 1 page.  
 Photo image from Parentsoup—Manicure Lap Desk [www.parentsoup.com/specialevents/holiday2004/photo/0..654798.655903.00.html](http://www.parentsoup.com/specialevents/holiday2004/photo/0..654798.655903.00.html); 1 page.  
 Photographs of packaging and Product—Marshmallow—Create-A-Room—School Bus Autobus; (Apr. 2005); 9 pages.  
 Photographs of packaging and product—Worlds Apart—Ready Room™ Collection—Pack & Playmates Truck; (Apr. 2005); 8 pages.  
 Photographs of packaging and product—Worlds Apart—Ready Room™ Collection—Pack & Playmates Cottage; (Apr. 2005); 18 pages.  
 Photographs of packaging and product—Worlds Apart—Ready Room™ Fold-away soft storage—Pack & Playmates Fire Truck; (Apr. 2005); 11 pages.  
 Toys Et Cetera Fall 2005 Catalog Description of a Play Mat (printed from the Internet on Oct. 4, 2005); 1 page.  
 Product Information Sheet for Clink-Proof 6-Pack Wetsuit: Flat Lunch Pack Tote; Herrington Catalog.com, “Wetsuit for 6-Packs Gives You A Clink-Proof Way To BYOB!” 2 page (printed from the Internet on Dec. 6, 2005).

\* cited by examiner

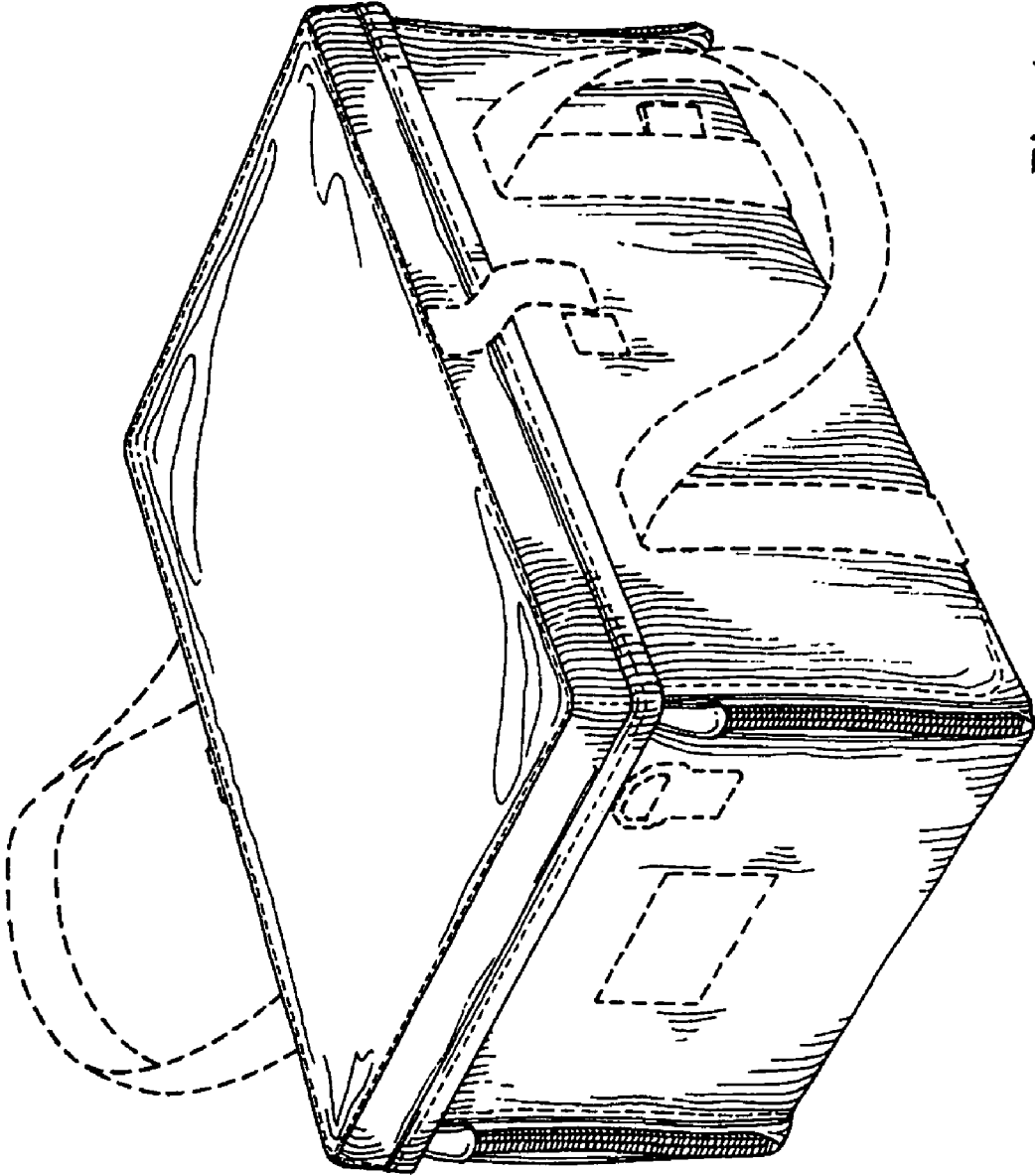

Fig. 1

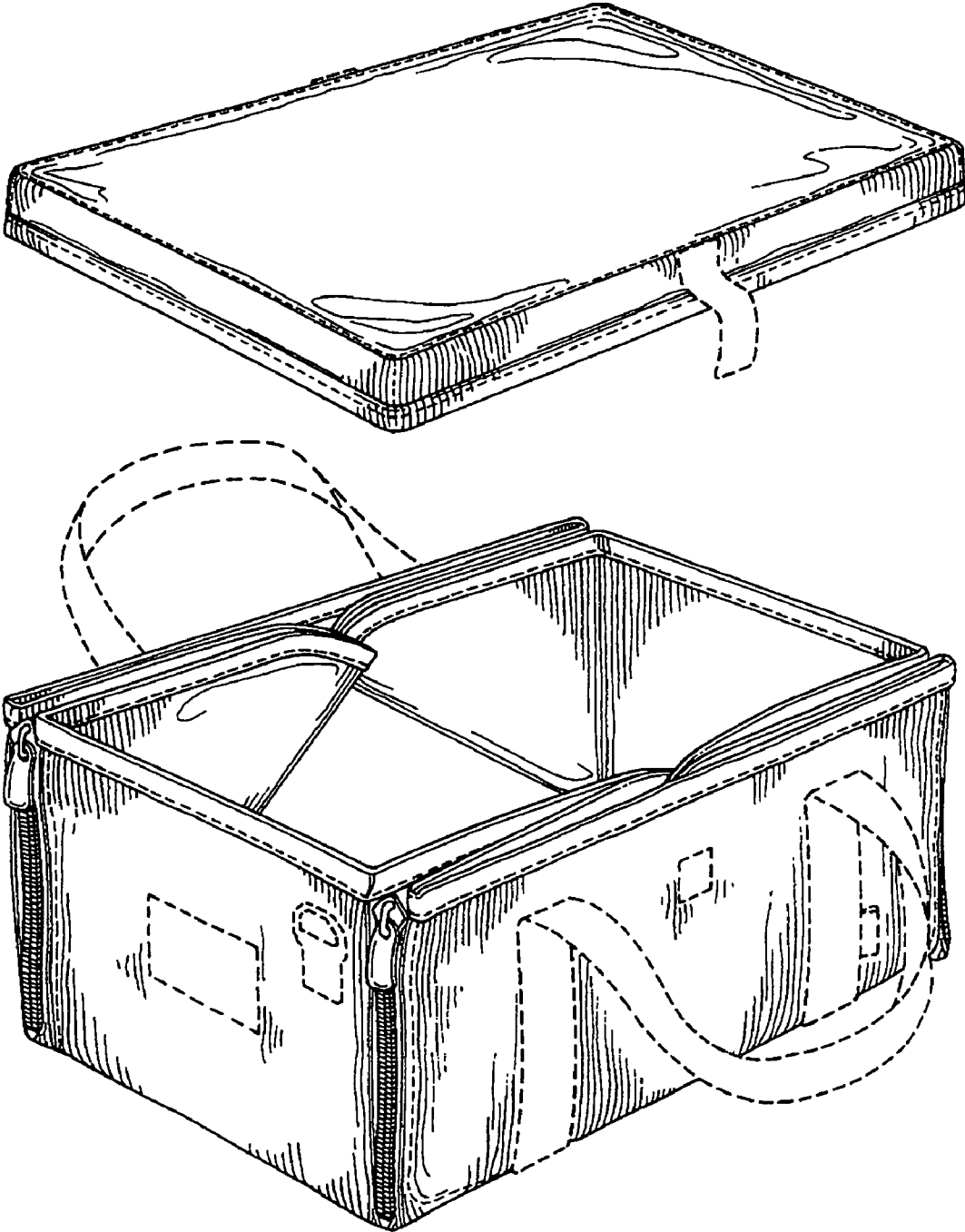

Fig. 2

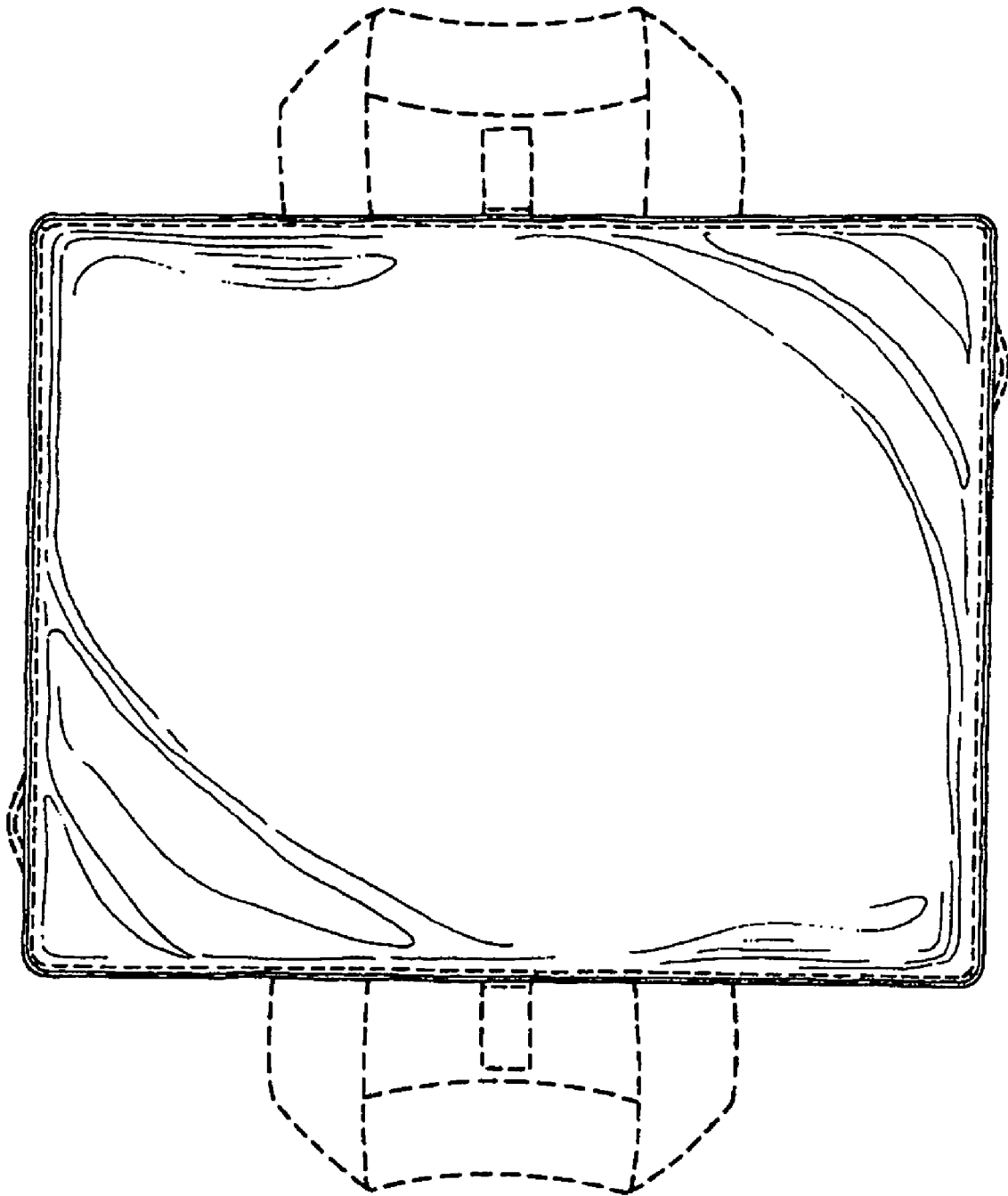

Fig. 3

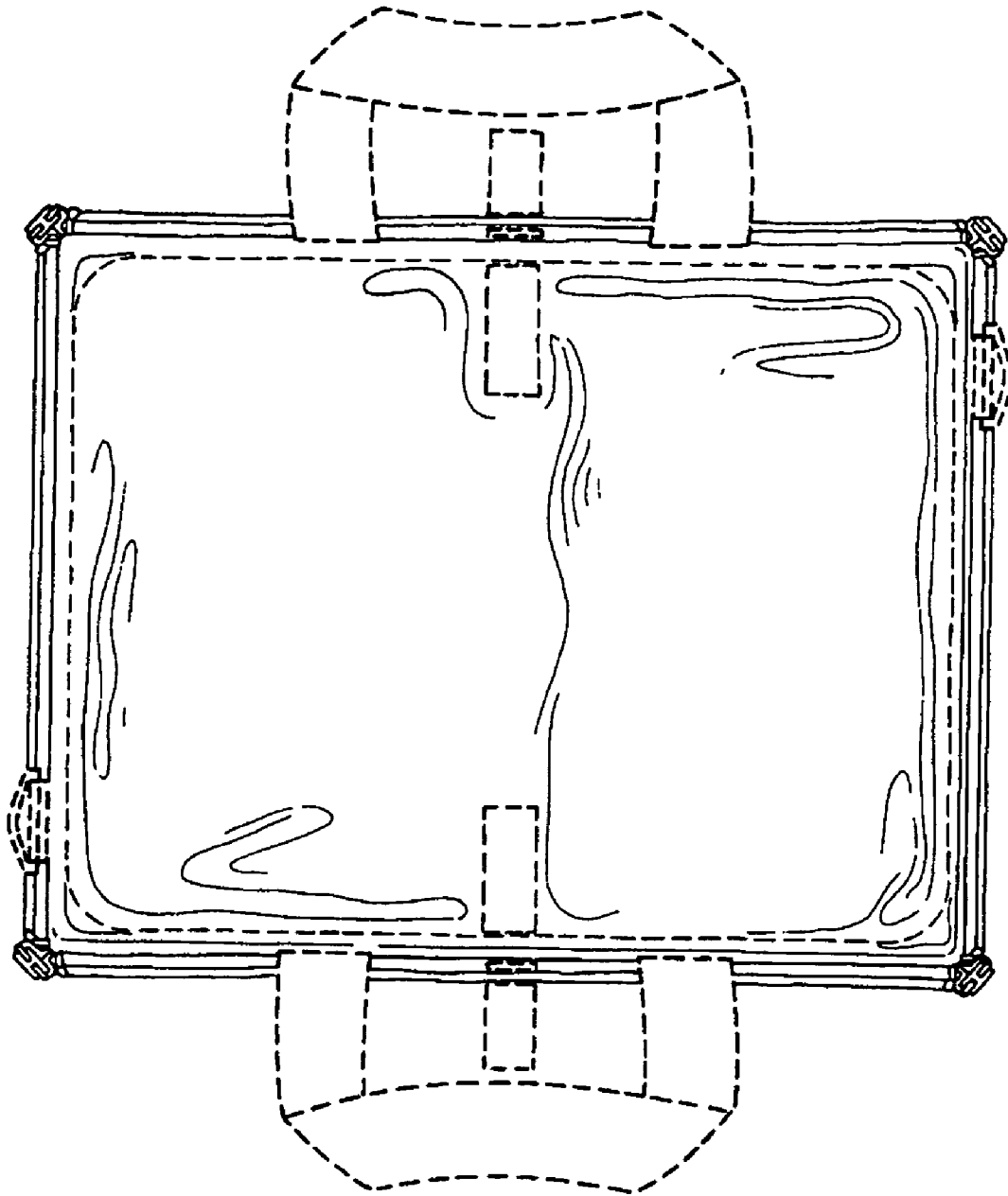

Fig. 4

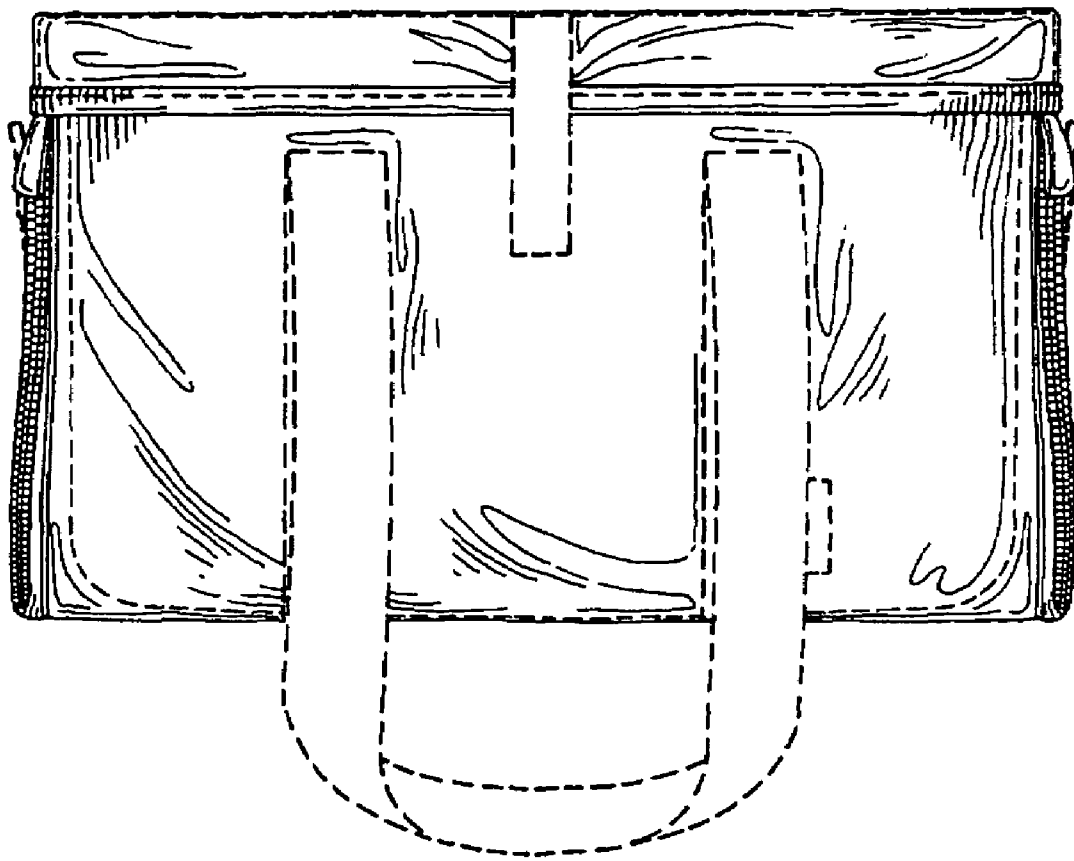

Fig. 5

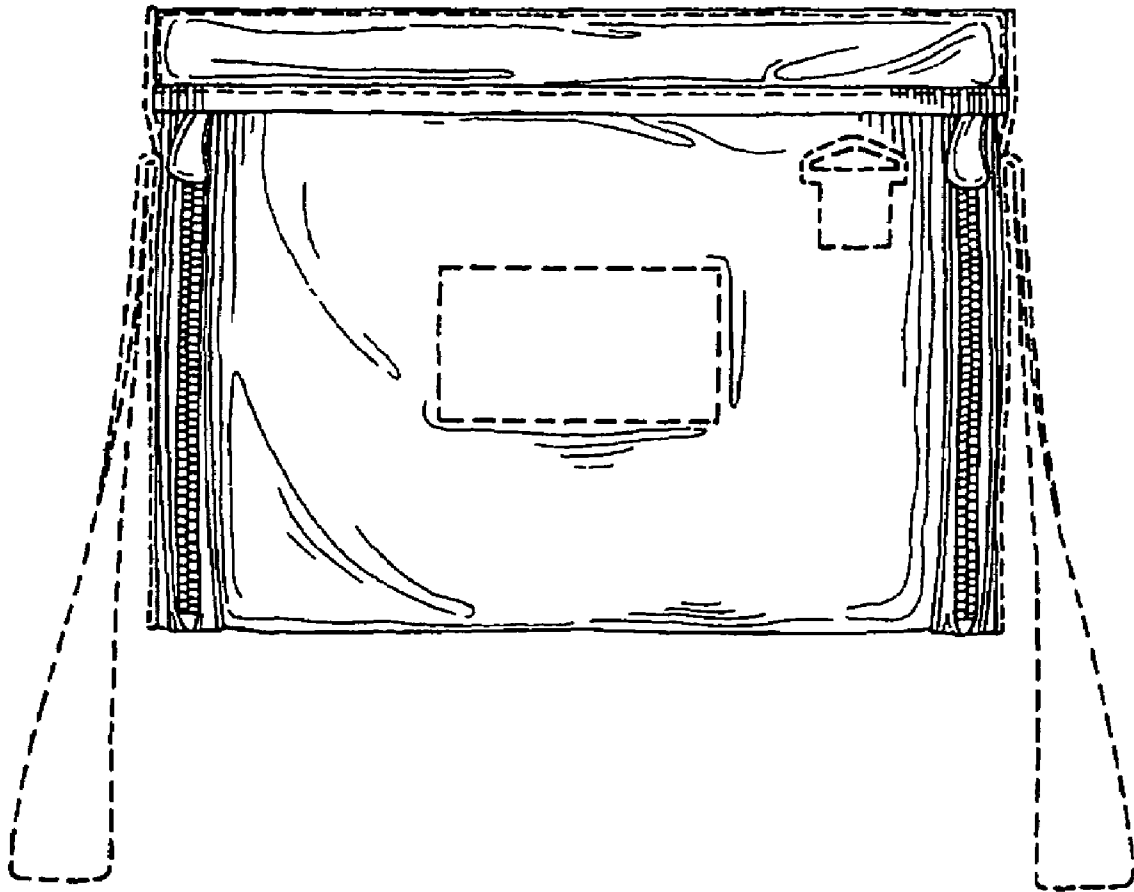

Fig. 6