



US00D760679S

(12) **United States Design Patent**
Lee

(10) **Patent No.:** **US D760,679 S**

(45) **Date of Patent:** **** Jul. 5, 2016**

(54) **TV RECEIVER**

(71) Applicant: **LG ELECTRONICS INC.**, Seoul (KR)

(72) Inventor: **Yongsok Lee**, Seoul (KR)

(73) Assignee: **LG ELECTRONICS INC.**, Seoul (KR)

(**) Term: **15 Years**

(21) Appl. No.: **29/530,848**

(22) Filed: **Jun. 19, 2015**

(30) **Foreign Application Priority Data**

Dec. 19, 2014 (KR) 30-2014-0062166

(51) **LOC (10) Cl.** **14-03**

(52) **U.S. Cl.**

USPC **D14/126**

(58) **Field of Classification Search**

USPC D14/125-134, 239, 371, 136, 374-377,
D14/440, 450, 448, 336, 342, 159; 312/7.2;
348/836, 838, 180, 184, 325, 739;
248/917-924, 465; 345/104, 133, 156,
345/168, 87, 173; D21/329, 515, 577, 622,
D21/333, 433, 448, 452, 450, 331, 505;
D10/15, 26; 446/484, 175, 356;
D6/477, 479, 300; D20/10, 19, 39
CPC ... G06F 1/1601; G06F 1/1643; H05K 5/0004;
H05K 5/0017; H05K 5/02; H05K 5/0217;
H04N 13/0459

See application file for complete search history.

(56) **References Cited**

U.S. PATENT DOCUMENTS

D512,424 S * 12/2005 Kim D14/375
7,143,478 B2 * 12/2006 Quijano F16M 11/00
16/409
D537,079 S * 2/2007 Park D14/375
D616,401 S * 5/2010 Choi D14/126
D631,042 S * 1/2011 Chen D14/337
D637,573 S * 5/2011 Lee D14/126
D642,145 S * 7/2011 Kim D14/126
D672,356 S * 12/2012 Quijano D14/447
D682,797 S * 5/2013 Lee D14/126
D695,244 S * 12/2013 Wolff D14/126
D696,666 S * 12/2013 Drew D14/375

D730,854 S * 6/2015 Jung D14/126
D732,495 S * 6/2015 Liao D14/126
2006/0237599 A1 * 10/2006 Ternus F16M 11/10
248/176.1
2013/0176672 A1 * 7/2013 Richard F16M 11/10
361/679.22

* cited by examiner

Primary Examiner — Raphael Barkai

(74) *Attorney, Agent, or Firm* — Birch, Stewart, Kolasch & Birch, LLP

(57) **CLAIM**

The ornamental design for a TV receiver, as shown and described.

DESCRIPTION

FIG. 1 is a front, right side, perspective view of a TV receiver showing our new design;
FIG. 2 is a front view thereof;
FIG. 3 is a rear view thereof;
FIG. 4 is a left side view thereof;
FIG. 5 is a right side view thereof;
FIG. 6 is a top view thereof;
FIG. 7 is a bottom view thereof; and,
FIG. 8 is a front, right side, perspective view of a TV receiver after slightly tilting the display back;
FIG. 9 is a front view thereof;
FIG. 10 is a rear view thereof;
FIG. 11 is a left side view thereof;
FIG. 12 is a right side view thereof;
FIG. 13 is a top view thereof;
FIG. 14 is a bottom view thereof;
FIG. 15 is a front, right side, perspective view of a TV receiver after fully tilting the display back;
FIG. 16 is a front view thereof;
FIG. 17 is a rear view thereof;
FIG. 18 is a left side view thereof;
FIG. 19 is a right side view thereof;
FIG. 20 is a top view thereof; and,
FIG. 21 is a bottom view thereof.
The broken lines indicate unclaimed portion of the article that form no part of the claimed design.

1 Claim, 9 Drawing Sheets

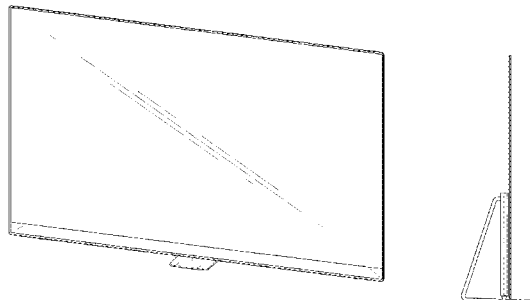

FIG. 1

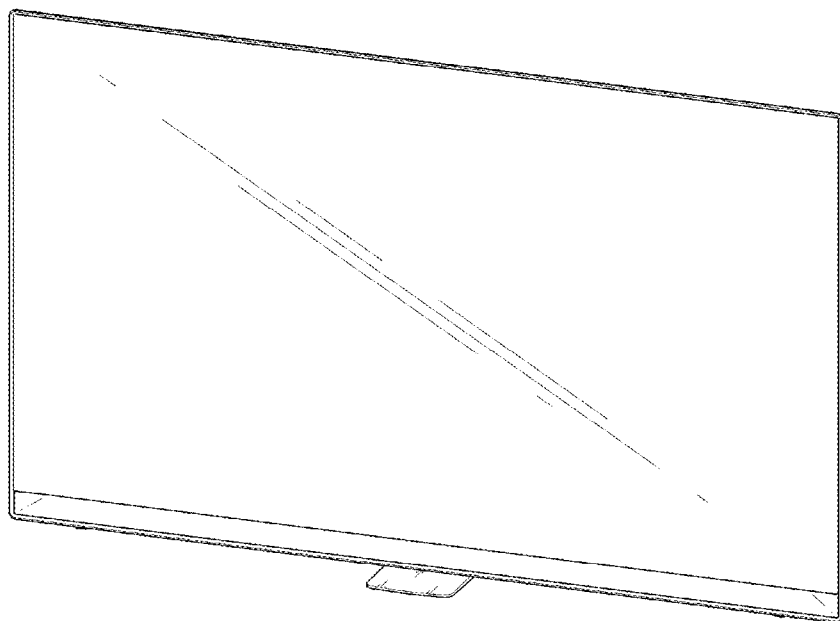

FIG. 2

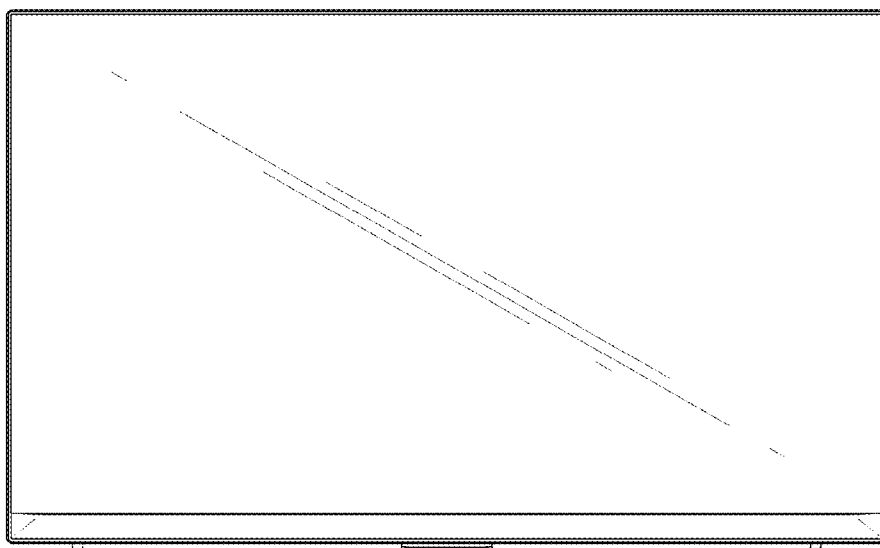

FIG. 3

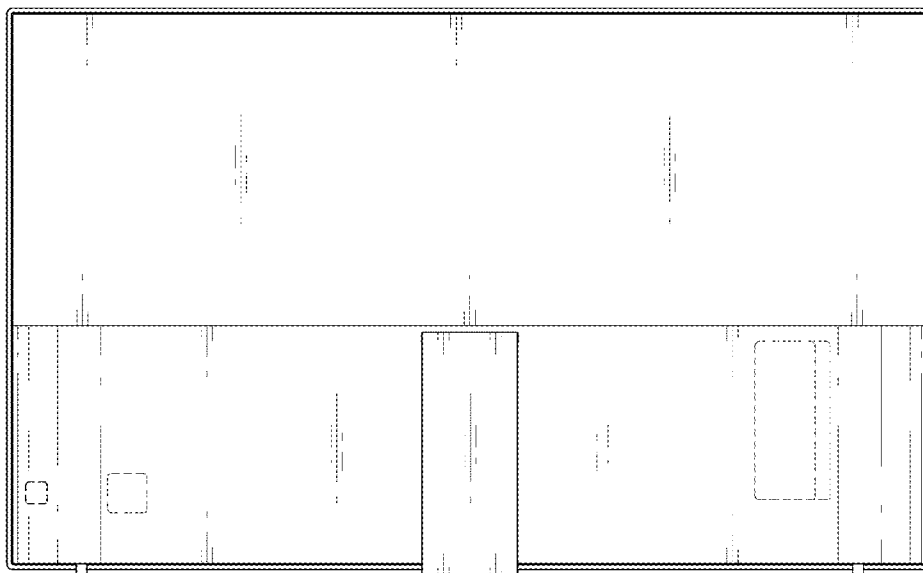

FIG. 4

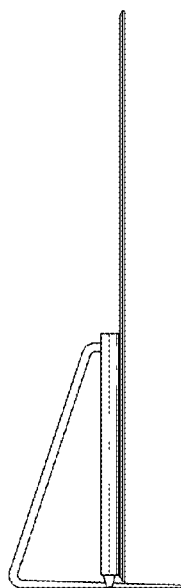

FIG. 5

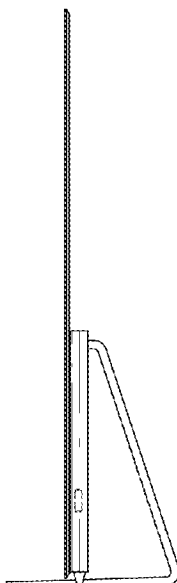

FIG. 6

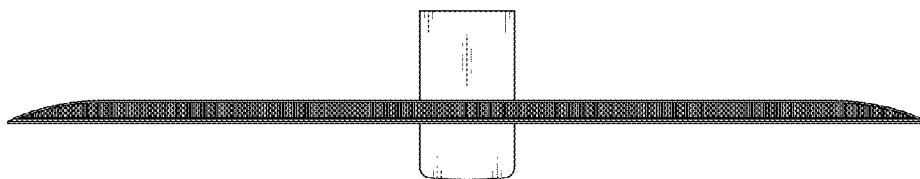

FIG. 7

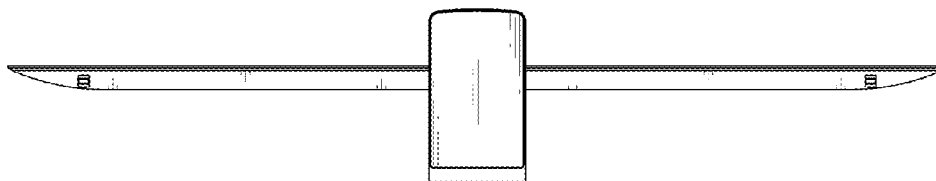

FIG. 8

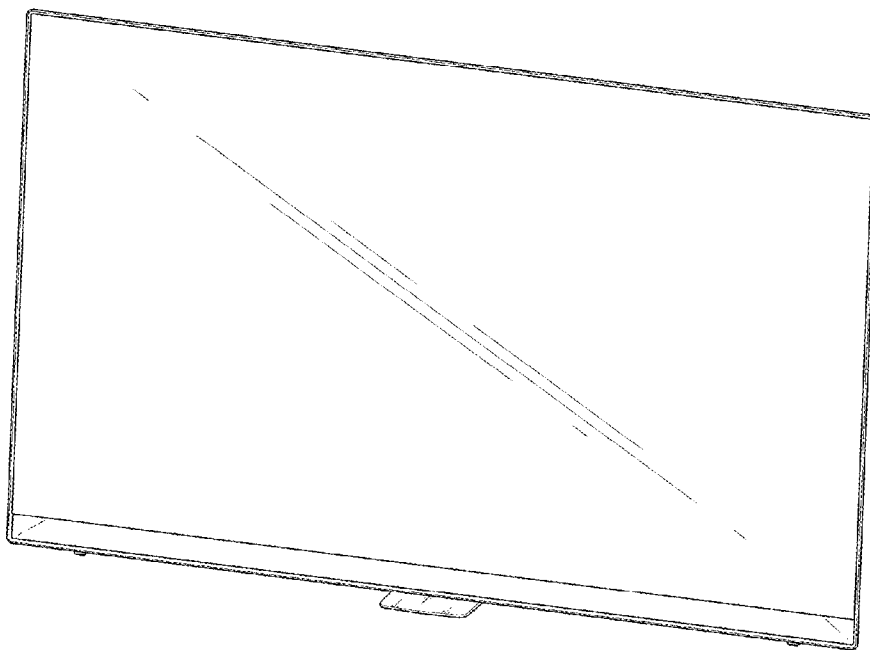

FIG. 9

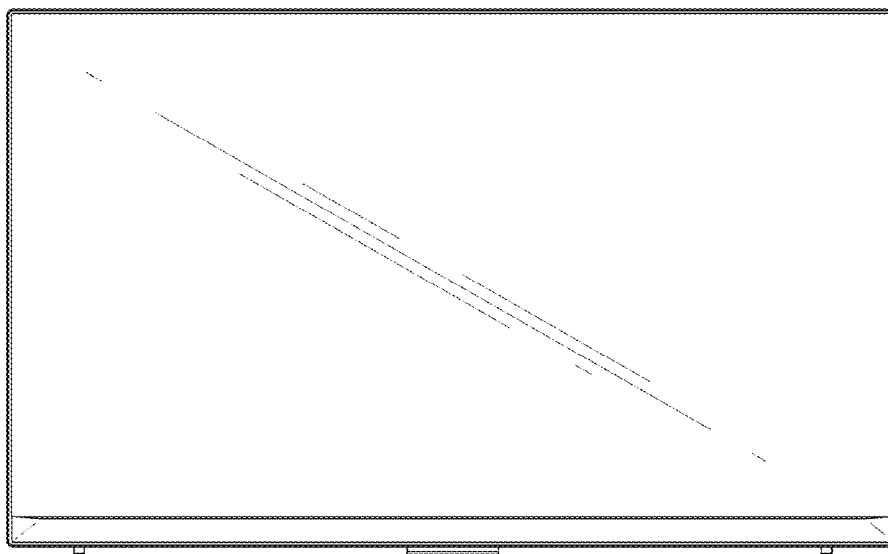

FIG. 10

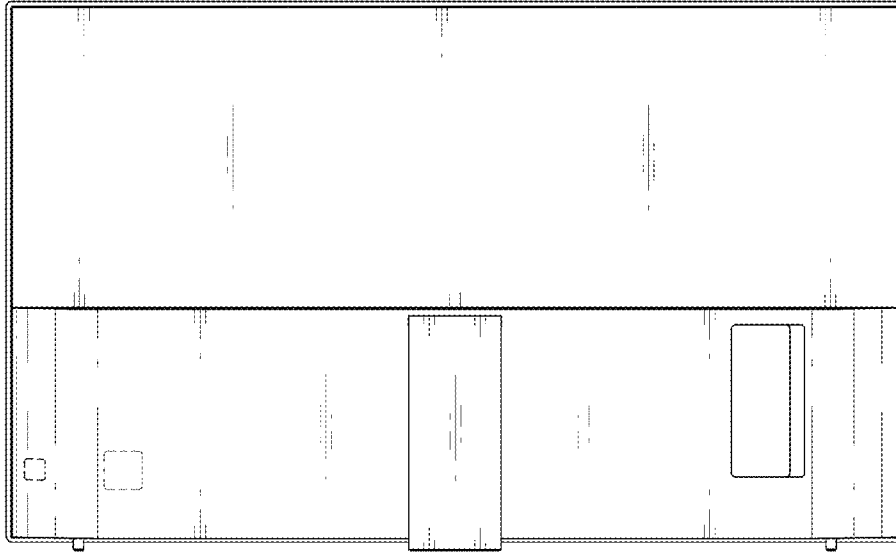

FIG. 11

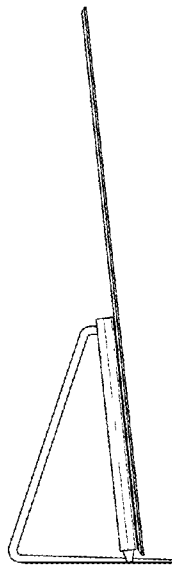

FIG. 12

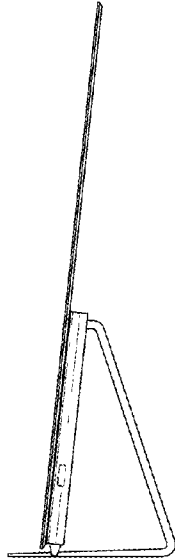

FIG. 13

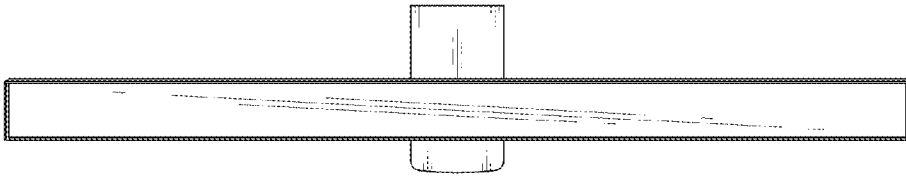

FIG. 14

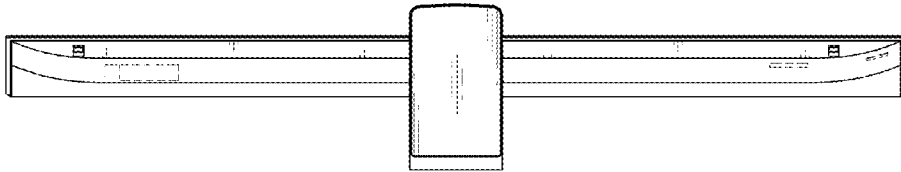

FIG. 15

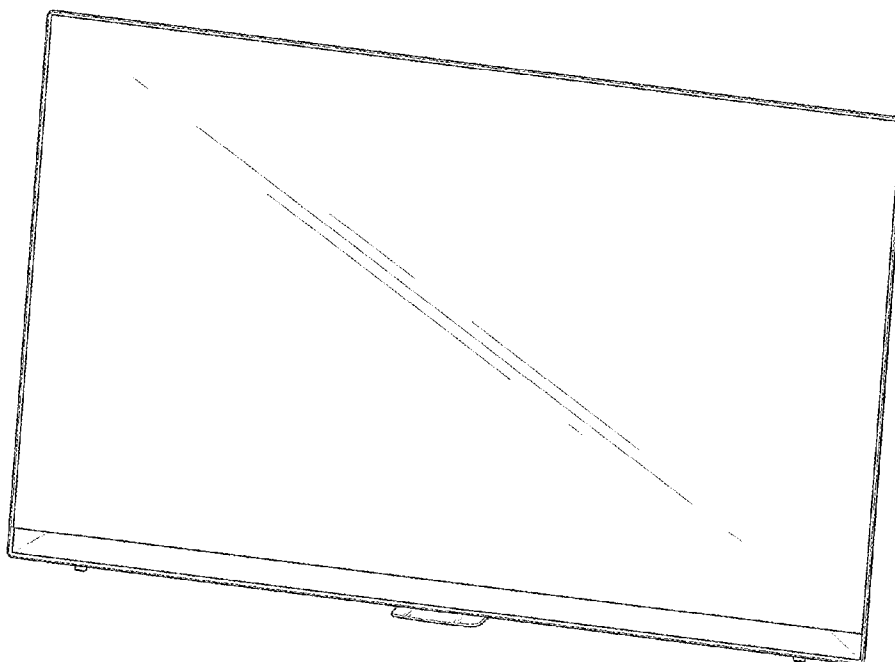

FIG. 16

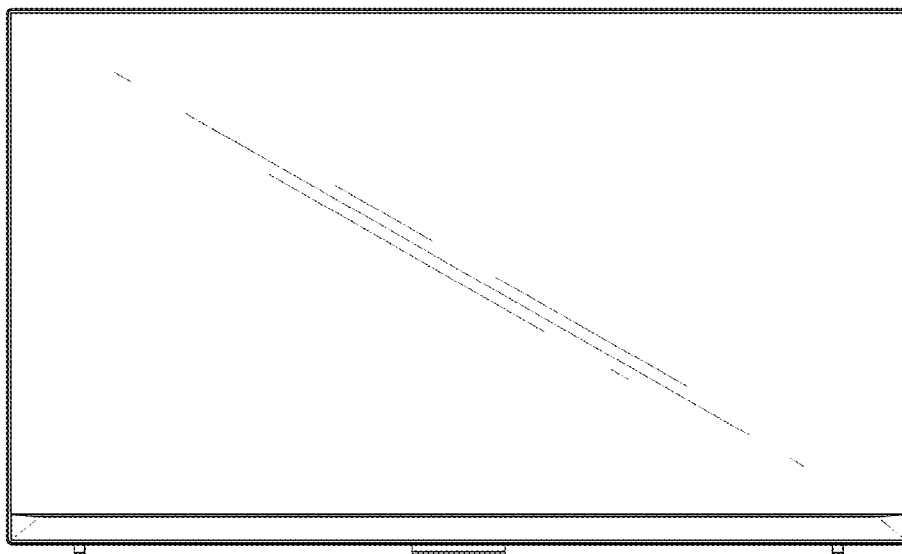

FIG. 17

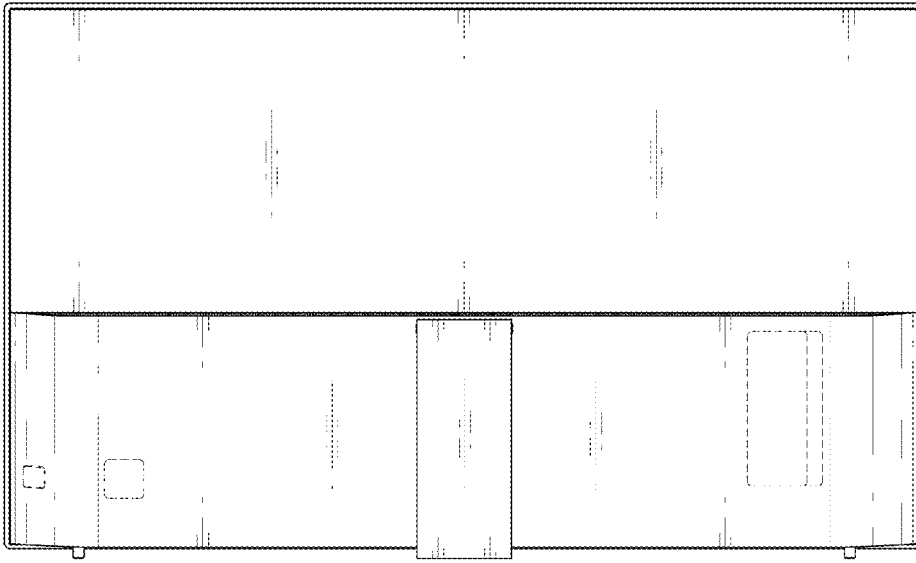

FIG. 18

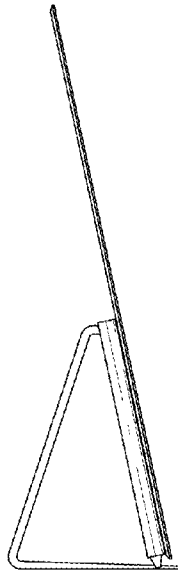

FIG. 19

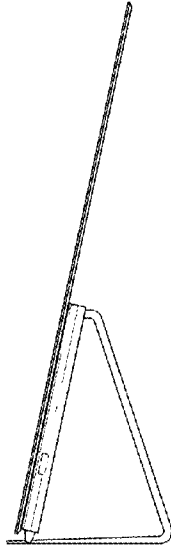

FIG. 20

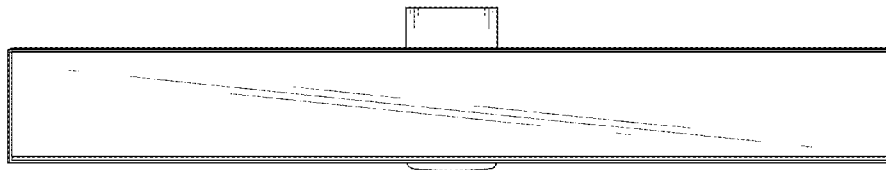

FIG. 21

