



US00RE45775E

(19) **United States**
(12) **Reissued Patent**
Agee et al.

(10) **Patent Number:** **US RE45,775 E**
(45) **Date of Reissued Patent:** **Oct. 20, 2015**

(54) **METHOD AND SYSTEM FOR ROBUST, SECURE, AND HIGH-EFFICIENCY VOICE AND PACKET TRANSMISSION OVER AD-HOC, MESH, AND MIMO COMMUNICATION NETWORKS**

(52) **U.S. Cl.**
CPC *H04W 52/265* (2013.01); *H04B 7/0413* (2013.01); *H04B 7/0417* (2013.01); *H04B7/0456* (2013.01); *H04L 27/26* (2013.01); *H04L 27/2605* (2013.01); *H04L 27/2607* (2013.01); *H04W 24/02* (2013.01); *H04W 28/06* (2013.01); *H04W 52/42* (2013.01); *H04W 16/14* (2013.01); *H04W 88/08* (2013.01); *Y02B 60/50* (2013.01)

(71) Applicant: **Comcast Cable Communications, LLC**, Philadelphia, PA (US)

(72) Inventors: **Brian G Agee**, San Jose, CA (US); **Matthew C. Bromberg**, Leominster, MA (US)

(58) **Field of Classification Search**
CPC ... H04L 1/0054; H04L 7/042; H04L 27/2647; H04L 1/006; H04L 5/0007; H04L 47/10; H04L 1/06; H04L 12/52; H04L 45/28; H04L 27/2605; H04L 27/2607; H04L 27/26; H04G 3/3052; H04M 7/006; H04M 3/56; H04M 3/561; H04W 84/08; H04W 74/06; H04W 28/04; H04W 84/12; H04W 52/265; H04W 52/42; H04W 52/241; H04B 7/0417; H04B 7/0413; H04B 7/0443; H04B 7/0456
USPC 375/219, 232, 259, 260, 267, 299, 341, 375/343, 345, 346, 265; 370/329, 334, 343, 370/338, 208, 206, 252, 322
See application file for complete search history.

(73) Assignee: **Comcast Cable Communications, LLC**, Philadelphia, PA (US)

(21) Appl. No.: **14/253,563**

(22) Filed: **Apr. 15, 2014**

Related U.S. Patent Documents

Reissue of:

(64) Patent No.: **8,363,744**
Issued: **Jan. 29, 2013**
Appl. No.: **11/880,825**
Filed: **Jul. 23, 2007**

(56) **References Cited**

U.S. Applications:

(63) Continuation-in-part of application No. 09/878,789, filed on Jun. 10, 2001, now Pat. No. 7,248,841.

(60) Provisional application No. 60/243,831, filed on Oct. 27, 2000, provisional application No. 60/211,462, filed on Jun. 13, 2000.

U.S. PATENT DOCUMENTS

(51) **Int. Cl.**
H04B 7/02 (2006.01)
H04L 1/02 (2006.01)
H04W 52/26 (2009.01)
H04B 7/04 (2006.01)
H04L 27/26 (2006.01)
H04W 28/06 (2009.01)
H04W 24/02 (2009.01)
H04W 52/42 (2009.01)
H04W 16/14 (2009.01)
H04W 88/08 (2009.01)

3,717,814	A	2/1973	Gans
3,986,124	A	10/1976	Mitchell, Jr.
4,210,871	A	7/1980	Hill et al.
4,328,585	A	5/1982	Monsen
4,337,376	A	6/1982	Gruenberg
4,347,498	A	8/1982	Lee et al.
4,369,520	A	1/1983	Cerny, Jr. et al.
4,481,670	A	11/1984	Freeburg
4,517,669	A	5/1985	Freeburg et al.
4,519,096	A	5/1985	Cerny, Jr.
4,532,626	A	7/1985	Flores et al.
4,550,443	A	10/1985	Freeburg
4,587,651	A	5/1986	Nelson et al.
4,596,986	A	6/1986	Andrews et al.
4,599,720	A	7/1986	Kunzinger
4,670,906	A	6/1987	Thro
4,710,944	A	12/1987	Nossen
4,714,923	A	12/1987	Tassle et al.
4,719,591	A	1/1988	Hopfield et al.
4,780,885	A	10/1988	Paul et al.

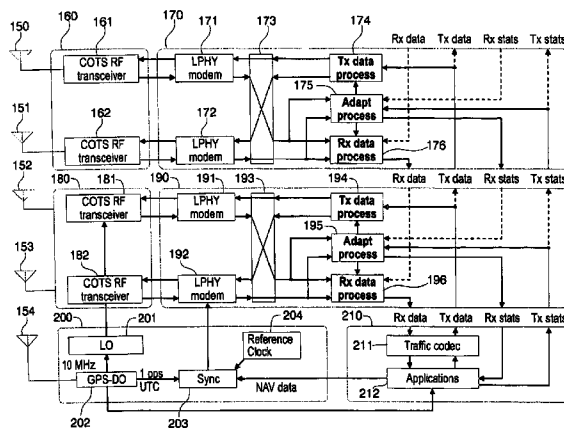

US RE45,775 E

4,789,983 A	12/1988	Acampora et al.	5,566,209 A	10/1996	Forssen et al.	
4,829,554 A	5/1989	Barnes et al.	5,574,979 A *	11/1996	West	455/63.1
4,870,657 A	9/1989	Bergmans et al.	5,579,341 A	11/1996	Smith et al.	
4,891,802 A	1/1990	Jasmer et al.	5,588,038 A	12/1996	Snyder	
4,920,529 A	4/1990	Sasaki et al.	5,592,471 A	1/1997	Briskman	
4,965,732 A	10/1990	Roy, III et al.	5,592,490 A	1/1997	Barratt et al.	370/310
4,983,988 A	1/1991	Franke	5,594,731 A	1/1997	Reissner	
4,998,078 A	3/1991	Hulkko	5,610,617 A	3/1997	Gans et al.	
5,014,219 A	5/1991	White	5,614,914 A	3/1997	Bolgiano et al.	
5,063,351 A	11/1991	Goldthorp et al.	5,615,211 A	3/1997	Santore et al.	
5,093,781 A	3/1992	Castelaz	5,615,409 A	3/1997	Forssen et al.	
5,101,501 A	3/1992	Gilhousen et al.	5,621,769 A	4/1997	Wan et al.	
5,103,459 A	4/1992	Gilhousen et al.	5,621,786 A	4/1997	Fischer et al.	
5,109,390 A	4/1992	Gilhousen et al.	5,625,880 A	4/1997	Goldburg et al.	455/381
5,134,685 A	7/1992	Rosenbluth	5,627,829 A	5/1997	Gleeson et al.	
5,134,715 A	7/1992	Parl et al.	5,627,863 A	5/1997	Aslanis et al.	
5,202,699 A	4/1993	Hemmie et al.	5,627,878 A	5/1997	Strauch et al.	
5,203,029 A	4/1993	Betzl et al.	5,627,879 A	5/1997	Russell et al.	
5,228,025 A	7/1993	Le Floch et al.	5,634,004 A	5/1997	Gopinath et al.	
5,228,113 A	7/1993	Shelton	5,634,199 A	5/1997	Gerlach et al.	455/63
5,229,782 A	7/1993	Hemmie et al.	5,636,242 A	6/1997	Tsujimoto	
5,237,318 A	8/1993	Auclair et al.	5,640,414 A	6/1997	Blakeney, II et al.	
5,237,586 A	8/1993	Bottomley	5,642,353 A	6/1997	Roy, III et al.	370/329
5,239,673 A	8/1993	Natarajan	5,642,405 A	6/1997	Fischer et al.	
5,253,327 A	10/1993	Yoshihara	5,644,622 A	7/1997	Russell et al.	
5,255,210 A	10/1993	Gardner et al.	5,649,286 A	7/1997	Frerking	
5,260,968 A	11/1993	Gardner et al.	5,649,287 A	7/1997	Forssen et al.	
5,262,789 A	11/1993	Silverstein	5,654,959 A	8/1997	Baker et al.	
5,267,261 A	11/1993	Blakeney, II et al.	5,655,019 A	8/1997	McKernan et al.	
5,271,038 A	12/1993	Cai	5,657,142 A	8/1997	Fahim	
5,274,841 A	12/1993	Natarajan et al.	5,657,374 A	8/1997	Russell et al.	
5,274,844 A	12/1993	Harrison et al.	5,666,126 A	9/1997	Lange	
5,282,222 A	1/1994	Fattouche et al.	5,668,562 A	9/1997	Cutrer et al.	
5,293,175 A	3/1994	Hemmie et al.	5,668,610 A	9/1997	Bossard et al.	
5,295,159 A	3/1994	Kerpez	5,668,717 A	9/1997	Spall	
5,299,148 A	3/1994	Gardner et al.	5,668,802 A	9/1997	Chalmers et al.	
5,300,941 A	4/1994	Hemmie et al.	5,673,252 A	9/1997	Johnson et al.	
5,307,376 A	4/1994	Castelain et al.	5,673,290 A	9/1997	Cioffi	
5,307,459 A	4/1994	Petersen et al.	5,691,727 A	11/1997	Cyys	
5,313,220 A	5/1994	Hemmie et al.	5,696,766 A	12/1997	Yeung et al.	
5,315,584 A	5/1994	Savary et al.	5,703,938 A	12/1997	Lucas et al.	
5,317,439 A	5/1994	Fatehi et al.	5,710,758 A	1/1998	Soliman et al.	
5,321,727 A	6/1994	Bonnet et al.	5,712,641 A	1/1998	Casabona et al.	
5,325,403 A	6/1994	Siwiak et al.	5,719,583 A	2/1998	Kanai	
5,345,599 A	9/1994	Paulraj et al.	5,721,725 A	2/1998	Want et al.	
5,371,733 A	12/1994	Denneau et al.	5,721,733 A	2/1998	Wang et al.	
5,371,734 A	12/1994	Fischer	5,724,666 A *	3/1998	Dent	455/562.1
5,377,230 A	12/1994	Golden	5,729,825 A	3/1998	Kostreski et al.	
5,387,885 A	2/1995	Chi	5,732,075 A	3/1998	Tangemann et al.	
5,388,097 A	2/1995	Baughner et al.	5,732,113 A	3/1998	Schmidl et al.	
5,394,559 A	2/1995	Hemmie et al.	5,737,327 A	4/1998	Ling et al.	
5,402,138 A	3/1995	Hulett et al.	5,742,911 A	4/1998	Dumbrill et al.	
5,416,468 A	5/1995	Baumann	5,745,551 A	4/1998	Strauch et al.	
5,437,052 A	7/1995	Hemmie et al.	5,748,683 A	5/1998	Smith et al.	
5,440,319 A	8/1995	Raymond et al.	5,752,173 A	5/1998	Tsujimoto	
5,446,736 A	8/1995	Gleeson et al.	5,771,352 A	6/1998	Nakamura et al.	395/200.57
5,448,255 A	9/1995	Hulett et al.	5,790,516 A	8/1998	Gudmundson et al.	370/210
5,459,725 A	10/1995	Bodner et al.	5,790,784 A	8/1998	Beale et al.	
5,459,873 A	10/1995	Moore et al.	5,790,959 A	8/1998	Scherer	
5,461,627 A	10/1995	Rypinski	5,793,258 A	8/1998	Lange	
5,471,647 A	11/1995	Gerlach et al.	5,794,119 A	8/1998	Evans et al.	
5,479,444 A	12/1995	Malkamaki et al.	5,796,922 A	8/1998	Smith	
5,479,447 A	12/1995	Chow et al.	5,809,019 A	9/1998	Ichihara et al.	
5,493,695 A	2/1996	Aitkenhead et al.	5,809,020 A	9/1998	Bruckert et al.	
5,495,479 A	2/1996	Galaand et al.	5,809,133 A	9/1998	Bartkowiak et al.	
5,504,936 A	4/1996	Lee	5,809,282 A	9/1998	Cooper et al.	
5,510,799 A	4/1996	Wishart	5,809,431 A	9/1998	Bustamante et al.	
5,515,378 A	5/1996	Roy, III et al.	5,812,542 A	9/1998	Bruckert et al.	
5,519,731 A	5/1996	Cioffi	5,815,488 A	9/1998	Williams et al.	
5,523,768 A	6/1996	Hemmie et al.	5,815,810 A	9/1998	Gallant et al.	
5,537,435 A	7/1996	Carney et al.	5,815,811 A	9/1998	Pinard et al.	
5,539,832 A	7/1996	Weinstein et al.	5,818,830 A	10/1998	Daane et al.	
5,546,090 A	8/1996	Roy, III et al.	5,818,832 A	10/1998	McCallister	
5,548,819 A	8/1996	Robb	5,825,645 A	10/1998	Konar et al.	
5,550,810 A	8/1996	Monogioudis et al.	5,828,658 A	10/1998	Ottersten et al.	370/310
5,553,062 A	9/1996	Schilling et al.	5,841,971 A	11/1998	Longginou et al.	
5,553,094 A	9/1996	Johnson et al.	5,844,886 A	12/1998	Szentesi	
5,561,841 A	10/1996	Markus	5,844,939 A	12/1998	Scherer et al.	
5,564,070 A	10/1996	Want et al.	5,852,633 A	12/1998	Levin et al.	375/260

US RE45,775 E

5,852,651 A	12/1998	Fischer et al.	6,023,203 A	2/2000	Parish	333/126
5,854,903 A	12/1998	Morrison et al.	6,023,616 A	2/2000	Briskman	
5,857,142 A	1/1999	Lin et al.	6,031,833 A	2/2000	Fickes et al.	
5,861,844 A	1/1999	Gilmore et al.	6,034,966 A	3/2000	Ota	
5,864,543 A	1/1999	Hoole	6,035,000 A	3/2000	Bingham	
5,864,550 A	1/1999	Posti	6,037,898 A	3/2000	Parish et al.	342/174
5,867,478 A	2/1999	Baum et al.	6,038,251 A	3/2000	Chen	
5,867,485 A	2/1999	Chambers et al.	6,038,430 A	3/2000	Thomson et al.	
5,870,385 A	2/1999	Ahmadi et al.	6,040,851 A	3/2000	Cheng et al.	
5,873,048 A	2/1999	Yun	6,041,088 A	3/2000	McCallister	
5,875,186 A	2/1999	Belanger et al.	6,044,062 A	3/2000	Brownrigg et al.	370/238
5,875,396 A	2/1999	Stockton et al.	6,046,978 A	4/2000	Melnik	
5,878,036 A	3/1999	Spartz et al.	6,047,023 A	4/2000	Arnstein	
5,884,181 A	3/1999	Arnold et al.	6,047,189 A	4/2000	Yun et al.	455/452
5,886,988 A	3/1999	Yun et al.	6,047,331 A	4/2000	Medard et al.	
5,887,156 A	3/1999	Subramanian et al.	6,049,307 A	4/2000	Lim	
5,890,055 A	3/1999	Chu et al.	6,058,105 A	5/2000	Hochwald et al.	
5,890,064 A	3/1999	Widergen et al.	6,058,106 A	5/2000	Cudak et al.	
5,892,796 A	4/1999	Rypinski	6,061,327 A	5/2000	Demoulin et al.	
5,894,590 A	4/1999	Vatt et al.	6,061,389 A	5/2000	Ishifuji et al.	
5,896,391 A	4/1999	Solheim et al.	6,061,441 A	5/2000	Krenn	
5,898,455 A	4/1999	Barakat et al.	6,061,562 A	5/2000	Martin et al.	
5,898,904 A	4/1999	Wang	6,064,662 A	5/2000	Gitlin et al.	
5,901,180 A	5/1999	Aslanis et al.	6,064,692 A	5/2000	Chow	
5,905,721 A	5/1999	Liu et al.	6,064,882 A	5/2000	Coyne et al.	
5,907,544 A	5/1999	Rypinski	6,067,290 A	5/2000	Paulraj et al.	370/329
5,907,816 A	5/1999	Newman et al.	6,067,291 A	5/2000	Kammerman et al.	
5,909,429 A	6/1999	Satyanarayana et al.	6,069,887 A	5/2000	Geiger et al.	
5,909,470 A	6/1999	Barratt et al.	6,069,894 A	5/2000	Holender et al.	370/397
5,909,471 A	6/1999	Yun	6,072,769 A	6/2000	Ho	
5,911,120 A	6/1999	Jarett et al.	6,072,770 A	6/2000	Ho et al.	
5,912,921 A	6/1999	Warren et al.	6,072,990 A	6/2000	Agrawal et al.	
5,920,818 A	7/1999	Frodigh et al.	6,073,235 A	6/2000	Foladare et al.	
5,920,865 A	7/1999	Ariga	6,075,812 A	6/2000	Cafarella et al.	
5,923,700 A	7/1999	Zhang	6,078,566 A	6/2000	Kikinis	
5,924,039 A	7/1999	Hugenberg et al.	6,078,611 A	6/2000	La Rosa et al.	
5,925,097 A	7/1999	Gopinath et al.	6,081,601 A	6/2000	Raivisto	
5,930,243 A	7/1999	Parish et al.	6,088,327 A	7/2000	Muschallik et al.	370/210
5,933,420 A	8/1999	Jaszewski et al.	6,088,408 A	7/2000	Calderbank et al.	
5,933,421 A	8/1999	Alamouti et al.	6,088,431 A	7/2000	LaDue	
5,936,578 A	8/1999	Driessen et al.	6,088,572 A	7/2000	Vatt et al.	
5,936,949 A	8/1999	Pasternak et al.	6,088,588 A	7/2000	Osborne	
5,937,042 A	8/1999	Sofman	6,091,932 A	7/2000	Langlais	
5,940,755 A	8/1999	Scott	6,092,096 A	7/2000	Lewis	
5,943,023 A	8/1999	Sanford	6,094,427 A	7/2000	Yi	
5,946,631 A	8/1999	Melnik	6,097,703 A	8/2000	Larsen et al.	370/254
5,949,758 A	9/1999	Kober	6,097,707 A	8/2000	Hodzic et al.	370/321
5,949,769 A	9/1999	Davidson et al.	6,097,771 A	8/2000	Foschini	
5,952,896 A	9/1999	Mett et al.	6,097,951 A	8/2000	Ernam et al.	
5,953,311 A	9/1999	Davies et al.	6,101,174 A	8/2000	Langston	
5,953,325 A	9/1999	Willars	6,101,399 A	8/2000	Raleigh et al.	455/561
5,958,018 A	9/1999	Eng et al.	6,104,712 A	8/2000	Robert et al.	370/389
5,960,039 A	9/1999	Martin et al.	6,108,565 A *	8/2000	Scherzer	455/562.1
5,960,344 A	9/1999	Mahany	6,111,857 A	8/2000	Soliman et al.	
5,963,863 A	10/1999	Berggren	6,112,056 A	8/2000	Langston	
5,966,094 A	10/1999	Ward et al.	6,115,406 A	9/2000	Mesecher	
5,970,092 A	10/1999	Currivan	6,115,409 A	9/2000	Upadhyay et al.	
5,973,642 A	10/1999	Li et al.	6,115,411 A	9/2000	van Driest	
5,974,322 A	10/1999	Carlsson et al.	6,115,427 A	9/2000	Calderbank et al.	
5,978,117 A	11/1999	Koonen	6,115,580 A	9/2000	Chuprun et al.	455/1
5,978,364 A	11/1999	Melnik	6,118,976 A	9/2000	Arias et al.	
5,978,365 A	11/1999	Yi	6,118,987 A	9/2000	Hiramatsu et al.	
5,978,650 A	11/1999	Fischer et al.	6,125,149 A	9/2000	Jafarkhani et al.	
5,982,327 A	11/1999	Vook et al.	6,128,276 A	10/2000	Agee	370/208
5,987,328 A	11/1999	Ephremides et al.	6,141,335 A	10/2000	Kuwahara et al.	
5,991,628 A	11/1999	Pedziwiatr et al.	6,141,393 A	10/2000	Thomas et al.	
5,999,826 A	12/1999	Whinnett	6,141,567 A	10/2000	Youssefmir et al.	455/562
6,005,853 A	12/1999	Wang et al.	6,144,711 A	11/2000	Raleigh et al.	
6,006,069 A	12/1999	Langston	6,154,661 A	11/2000	Goldburg	455/562
6,006,110 A	12/1999	Raleigh	6,167,099 A	12/2000	Rader et al.	
6,008,923 A	12/1999	Samdahl et al.	6,177,906 B1	1/2001	Petrus	342/378
6,009,124 A	12/1999	Smith et al.	6,185,258 B1	2/2001	Alamouti et al.	
6,012,084 A	1/2000	Fielding et al.	6,185,440 B1	2/2001	Barratt et al.	455/562
6,014,089 A	1/2000	Tracy et al.	6,188,736 B1	2/2001	Lo et al.	
6,016,313 A	1/2000	Foster, Jr. et al.	6,208,683 B1	3/2001	Mizuguchi et al.	
6,018,659 A	1/2000	Ayyagari et al.	6,219,341 B1	4/2001	Varanasi	370/252
6,018,660 A	1/2000	Alperovich et al.	6,243,369 B1	6/2001	Grimwood et al.	
6,021,158 A	2/2000	Schurr et al.	6,249,250 B1	6/2001	Namekata et al.	
6,021,309 A	2/2000	Sherman et al.	6,266,528 B1	7/2001	Farzaneh	455/423

US RE45,775 E

6,275,543	B1	8/2001	Petrus et al.	375/324	6,839,574	B2	1/2005	Petrus et al.	
6,292,135	B1	9/2001	Takatori et al.		6,842,487	B1	1/2005	Larsson	
6,292,559	B1	9/2001	Gaikwad et al.		6,865,237	B1	3/2005	Boariu et al.	
6,300,881	B1	10/2001	Yee et al.		6,865,377	B1	3/2005	Lindskog et al.	455/101
6,317,411	B1*	11/2001	Whinnett et al.	370/204	6,888,809	B1	5/2005	Foschini et al.	
6,317,466	B1	11/2001	Foschini et al.		6,888,882	B1	5/2005	Dogan	375/220
6,351,499	B1	2/2002	Paulraj et al.		6,888,899	B2*	5/2005	Raleigh et al.	375/299
6,353,604	B2	3/2002	Grimwood et al.		6,894,993	B2	5/2005	Yu et al.	370/329
6,359,923	B1	3/2002	Agee et al.	375/130	6,915,438	B2	7/2005	Boros	713/322
6,362,781	B1	3/2002	Thomas et al.		6,928,287	B2	8/2005	Trott et al.	455/447
6,363,107	B1	3/2002	Scott		6,931,030	B1	8/2005	Dogan	370/509
6,373,432	B1	4/2002	Rabinowitz et al.		6,931,262	B2	8/2005	Steele	
6,377,631	B1	4/2002	Raleigh		6,931,583	B2	8/2005	Trott et al.	714/780
6,377,636	B1	4/2002	Paulraj et al.		6,937,665	B1	8/2005	Vandenameele	
6,385,264	B1	5/2002	Terasawa et al.		6,950,630	B2	9/2005	Chauvin et al.	
6,393,073	B1	5/2002	Eilts		6,950,979	B2	9/2005	Zhang et al.	714/801
6,411,799	B1*	6/2002	Padovani	455/69	6,952,454	B1	10/2005	Jalali et al.	
RE37,802	E	7/2002	Fattouche et al.		6,954,643	B2	10/2005	Petrus	455/437
6,418,299	B1	7/2002	Ramanathan		6,957,042	B2	10/2005	Williams	
6,441,784	B1	8/2002	Flore et al.	342/377	6,961,388	B2	11/2005	Ling et al.	
6,459,171	B1	10/2002	Leifer	307/52	6,963,742	B2	11/2005	Boros et al.	455/424
6,463,295	B1	10/2002	Yun	455/522	6,965,774	B1	11/2005	Kasapi et al.	455/450
6,466,557	B1	10/2002	Doi		6,965,788	B1	11/2005	Barratt et al.	455/574
6,473,467	B1	10/2002	Wallace et al.		6,970,682	B2	11/2005	Crilly, Jr. et al.	
6,493,331	B1	12/2002	Walton et al.		6,973,314	B2	12/2005	Wilson et al.	
6,493,335	B1*	12/2002	Darcie et al.	370/344	6,975,666	B2	12/2005	Affes et al.	
6,504,506	B1	1/2003	Thomas et al.		6,982,968	B1	1/2006	Barratt et al.	370/328
6,512,737	B1	1/2003	Agee	370/208	6,983,127	B1	1/2006	Da Torre et al.	
6,542,556	B1	4/2003	Kuchi et al.		6,985,466	B1	1/2006	Yun et al.	370/335
6,546,055	B1	4/2003	Schmidl et al.		6,987,819	B2	1/2006	Thomas et al.	
6,549,581	B1	4/2003	Izumi		6,996,060	B1	2/2006	Dahlby et al.	370/230
6,564,036	B1	5/2003	Kasapi	455/1	6,996,163	B2	2/2006	Bhora et al.	375/150
6,570,527	B1	5/2003	Lindskog et al.	342/174	6,999,771	B1	2/2006	Kasapi et al.	455/450
6,590,532	B1	7/2003	Ogawa et al.		6,999,794	B1	2/2006	Lindskog et al.	
6,594,473	B1	7/2003	Dabak et al.		7,003,310	B1	2/2006	Youssefmir et al.	455/522
6,597,678	B1	7/2003	Kuwahara et al.		7,006,579	B2	2/2006	Kuchi et al.	
6,600,914	B2	7/2003	Uhlik et al.	455/404	7,016,429	B1	3/2006	Dogan et al.	375/279
6,615,024	B1	9/2003	Boros et al.	455/674	7,020,072	B1	3/2006	Li et al.	
6,621,851	B1	9/2003	Agee et al.	375/130	7,020,107	B2	3/2006	Kasapi et al.	370/329
6,633,616	B2	10/2003	Crawford		7,020,110	B2	3/2006	Walton et al.	
6,636,493	B1	10/2003	Doi et al.		7,020,490	B2	3/2006	Khatri	
6,647,078	B1	11/2003	Thomas et al.		7,024,163	B1	4/2006	Barratt et al.	455/69
6,650,714	B2	11/2003	Dogan et al.	375/343	7,027,415	B1	4/2006	Dahlby et al.	370/322
6,650,881	B1	11/2003	Dogan		7,027,523	B2	4/2006	Jalali et al.	
6,651,210	B1	11/2003	Trott et al.	714/758	7,027,837	B1	4/2006	Uhlik et al.	
6,654,590	B2	11/2003	Boros et al.		7,031,679	B2	4/2006	Persson et al.	455/137
6,668,161	B2	12/2003	Boros et al.		7,035,358	B1	4/2006	Sankaran et al.	375/344
6,678,253	B1	1/2004	Heath, Jr. et al.		7,035,661	B1	4/2006	Yun	455/522
6,683,915	B1	1/2004	Trott et al.	375/262	7,036,067	B2	4/2006	Roy et al.	714/758
6,684,366	B1	1/2004	Trott et al.	714/790	7,039,016	B1	5/2006	Lindskog et al.	370/252
6,687,492	B1*	2/2004	Sugar et al.	455/276.1	7,039,363	B1	5/2006	Kasapi et al.	
6,690,747	B2	2/2004	Petrus et al.	375/324	7,039,441	B1	5/2006	Reudink et al.	
6,693,982	B1	2/2004	Naguib et al.		7,042,856	B2	5/2006	Walton et al.	
6,711,412	B1	3/2004	Tellado et al.		7,043,259	B1	5/2006	Trott	455/458
6,714,585	B1	3/2004	Wang et al.		7,047,045	B2	5/2006	Steele et al.	
6,731,689	B2	5/2004	Dogan	375/259	7,050,832	B2	5/2006	Kasapi	
6,731,705	B2	5/2004	Kasapi et al.	375/346	7,054,301	B1	5/2006	Sousa et al.	370/343
6,735,258	B1	5/2004	Trott et al.	375/308	7,054,397	B1	5/2006	Kawanabe	
6,738,020	B1	5/2004	Lindskog et al.	342/377	7,062,294	B1	6/2006	Rogard et al.	
6,744,823	B1	6/2004	Kamemura et al.		7,068,628	B2	6/2006	Li et al.	
6,747,594	B2	6/2004	Lindskog et al.	342/174	7,072,413	B2	7/2006	Walton et al.	
6,751,187	B2	6/2004	Walton et al.		7,079,480	B2	7/2006	Agee	370/204
6,757,265	B1	6/2004	Sebastian et al.		7,106,781	B2	9/2006	Agee et al.	375/141
6,760,599	B1	7/2004	Uhlik	455/525	7,110,349	B2	9/2006	Branlund et al.	370/203
6,768,747	B1	7/2004	Dogan	370/509	7,110,381	B1*	9/2006	O'Sullivan et al.	370/338
6,771,706	B2	8/2004	Ling et al.		7,111,223	B2	9/2006	Roy et al.	714/758
6,778,513	B2	8/2004	Kasapi et al.	370/330	7,116,722	B2	10/2006	Foschini et al.	
6,785,341	B2	8/2004	Walton et al.		7,133,459	B2	11/2006	Onggosani et al.	
6,785,520	B2	8/2004	Sugar et al.		7,139,592	B2	11/2006	Leifer et al.	
6,788,948	B2	9/2004	Lindskog et al.	455/504	7,149,238	B2	12/2006	Agee et al.	375/141
6,795,409	B1	9/2004	Youssefmir et al.	370/328	7,149,239	B2	12/2006	Hudson	
6,795,413	B1	9/2004	Uhlik	370/330	7,151,795	B1	12/2006	Goldburg	375/227
6,801,589	B1	10/2004	Dogan	375/343	7,158,493	B1	1/2007	Uhlik et al.	370/329
6,802,038	B1	10/2004	Yu	714/758	7,164,669	B2	1/2007	Li et al.	
6,826,240	B1	11/2004	Thomas et al.		7,164,725	B2	1/2007	Frank	
6,834,249	B2	12/2004	Orchard	702/141	7,164,726	B1	1/2007	Trott	375/267
6,836,469	B1	12/2004	Wu		7,164,739	B1	1/2007	Trott	375/347
6,836,673	B1	12/2004	Trott		7,206,293	B2	4/2007	Kasapi et al.	370/312
6,839,573	B1	1/2005	Youssefmir et al.		7,206,554	B1	4/2007	Lindskog	455/101

US RE45,775 E

7,221,699	B1	5/2007	Lindskog	375/147	2002/0181509	A1	12/2002	Mody et al.	
7,227,855	B1	6/2007	Barratt et al.	370/343	2002/0193146	A1	12/2002	Wallace et al.	
7,242,720	B2	7/2007	Sugiyama et al.		2003/0032423	A1	2/2003	Boros et al.	
7,248,841	B2	7/2007	Agee et al.		2003/0072382	A1	4/2003	Raleigh et al.	
7,257,101	B2	8/2007	Petrus et al.	370/332	2003/0086366	A1	5/2003	Branlund et al.	370/208
7,263,082	B1	8/2007	Lindskog	370/335	2003/0087673	A1	5/2003	Walton et al.	
7,266,685	B1	9/2007	Meandzija et al.	713/156	2003/0123384	A1	7/2003	Agee	370/208
7,269,224	B2	9/2007	Stuber et al.		2003/0124976	A1*	7/2003	Tamaki et al.	455/15
7,269,389	B2	9/2007	Petrus et al.	455/69	2003/0169720	A1	9/2003	Sebastian et al.	
7,277,679	B1	10/2007	Barratt et al.	455/101	2004/0012387	A1	1/2004	Shattil	324/225
7,299,071	B1	11/2007	Barratt et al.		2004/0095907	A1	5/2004	Agee et al.	370/334
7,299,073	B2	11/2007	Wilson et al.		2004/0100897	A1	5/2004	Shattil	
7,302,565	B2	11/2007	Meandzija et al.	713/155	2004/0131025	A1	7/2004	Dohler et al.	
7,310,538	B2	12/2007	Steele et al.		2004/0180625	A1	9/2004	Steele et al.	
7,336,626	B1	2/2008	Barratt et al.	370/281	2004/0193982	A1	9/2004	Bhora et al.	714/726
7,336,719	B2*	2/2008	Gore et al.	375/267	2005/0047480	A1	3/2005	Carbonari	
7,339,906	B1	3/2008	Dahlby et al.	370/329	2005/0147076	A1*	7/2005	Sadowsky et al.	370/343
7,339,908	B2	3/2008	Uhlik et al.	370/331	2005/0197748	A1	9/2005	Holst et al.	
7,339,981	B2	3/2008	Dogan	375/219	2006/0078059	A1	4/2006	Ok et al.	
7,342,912	B1	3/2008	Kerr et al.	370/347	2006/0193373	A1	8/2006	Agee et al.	375/141
7,349,371	B2	3/2008	Schein et al.	370/329	2007/0009012	A1	1/2007	Carrivan et al.	
7,352,774	B2	4/2008	Uhlik et al.	370/474	2007/0042753	A1	2/2007	Uhlik et al.	455/406
7,362,799	B1	4/2008	Petrus	375/224	2007/0133496	A1	6/2007	Barratt et al.	370/343
7,363,376	B2	4/2008	Uhlik et al.	709/227	2007/0140374	A1*	6/2007	Raleigh et al.	375/267
7,366,223	B1	4/2008	Chen et al.	375/132	2007/0153731	A1	7/2007	Fine	
7,372,911	B1	5/2008	Lindskog et al.	375/267	2007/0165552	A1	7/2007	Kasapi et al.	370/312
7,386,043	B2	6/2008	Goldburg	375/227	2007/0202890	A1	8/2007	Feher	
7,386,781	B2	6/2008	Persson et al.	714/822	2007/0217439	A1	9/2007	Lemaire et al.	
7,389,111	B2	6/2008	Petrus	455/436	2007/0268980	A1	11/2007	Brannstorm et al.	375/265
7,397,804	B2	7/2008	Dulin et al.		2007/0283230	A1	12/2007	Brannstrom et al.	714/777
7,406,261	B2	7/2008	Shattil et al.		2007/0294494	A1	12/2007	Conti et al.	
7,406,315	B2	7/2008	Uhlik et al.		2007/0294496	A1	12/2007	Goss et al.	
7,411,977	B1	8/2008	Chen et al.	370/468	2008/0075033	A1*	3/2008	Shattil	370/328
7,418,043	B2	8/2008	Shattil et al.		2008/0088517	A1	4/2008	Ansari et al.	343/745
7,420,984	B2	9/2008	Chen et al.	370/437	2008/0090575	A1*	4/2008	Barak et al.	455/444
7,424,002	B2	9/2008	Barratt et al.	370/343	2008/0101502	A1	5/2008	Navidpour et al.	375/296
7,430,197	B1	9/2008	Uhlik	370/347	2008/0130611	A1	6/2008	Branlund et al.	370/342
7,430,246	B1	9/2008	Trott	375/267	2008/0162770	A1	7/2008	Titiano et al.	
7,430,606	B1	9/2008	Meandzija et al.	709/229	2008/0181170	A1	7/2008	Branlund et al.	370/328
7,433,347	B1	10/2008	Trott et al.	370/347	2008/0232238	A1	9/2008	Agee	370/208
7,433,418	B1	10/2008	Dogan et al.	375/285	2009/0011755	A1	1/2009	Hadad	
7,460,835	B1	12/2008	Petrus		2009/0046681	A1	2/2009	Kalogridis et al.	
7,594,010	B2	9/2009	Dohler et al.		2009/0049220	A1	2/2009	Conti et al.	
7,606,204	B2	10/2009	Sebastian et al.		2009/0116541	A1	5/2009	Farrokhi et al.	375/136
7,688,710	B2	3/2010	Wu et al.		2009/0213731	A1	8/2009	Bhasin et al.	
7,760,814	B2	7/2010	Jungnickel et al.		2009/0268662	A1	10/2009	Larsson et al.	
7,801,247	B2	9/2010	Onggosani et al.		2009/0298504	A1	12/2009	Lee et al.	
7,813,441	B2	10/2010	Jalali et al.		2010/0020907	A1	1/2010	Rezvani et al.	375/347
7,817,597	B2*	10/2010	Usuda et al.	370/329	2010/0046413	A1	2/2010	Jin et al.	
7,920,501	B2	4/2011	Larsson et al.		2010/0067362	A1	3/2010	Sakaguchi et al.	
7,934,036	B2	4/2011	Conti et al.		2010/0080317	A1	4/2010	Narasimhan et al.	375/267
7,986,742	B2	7/2011	Ketchum et al.		2010/0111141	A1	5/2010	Curivan et al.	
8,055,828	B2	11/2011	Conti et al.		2010/0113023	A1	5/2010	Huang et al.	
8,081,595	B2*	12/2011	Zhang et al.	370/318	2010/0162075	A1	6/2010	Brannstrom et al.	714/752
8,098,568	B2	1/2012	Laroia et al.		2010/0174599	A1	7/2010	Rosenblatt et al.	705/14.37
8,108,641	B2	1/2012	Goss et al.		2010/0214145	A1	8/2010	Narasimhan et al.	341/155
8,117,367	B2	2/2012	Conti et al.		2010/0246454	A1	9/2010	Ansari et al.	370/278
8,121,101	B2	2/2012	Kalogridis et al.		2010/0254325	A1	10/2010	Narasimhan et al.	370/329
8,131,297	B2	3/2012	Lee et al.		2010/0303052	A1	12/2010	Visuri et al.	
8,189,612	B2	5/2012	Lemaire et al.		2010/0303160	A1	12/2010	Rezvani et al.	375/260
8,447,306	B2	5/2013	Lee et al.		2011/0019608	A1	1/2011	Dohler et al.	
2001/0031019	A1	10/2001	Jafarkhani et al.		2011/0145459	A1	6/2011	Conti et al.	
2001/0033622	A1	10/2001	Jongren et al.	375/267	2011/0145460	A1	6/2011	Conti et al.	
2001/0036843	A1	11/2001	Thompson		2011/0173363	A1	7/2011	Conti et al.	
2001/0050964	A1	12/2001	Foschini et al.		2011/0258049	A1	10/2011	Ramer et al.	
2001/0053143	A1	12/2001	Li et al.		2012/0020329	A1	1/2012	Lee et al.	
2002/0003774	A1	1/2002	Wang et al.		2012/0147937	A1	6/2012	Goss et al.	
2002/0041635	A1	4/2002	Ma et al.		2013/0176968	A1	7/2013	Heath, Jr. et al.	
2002/0044524	A1	4/2002	Laroia et al.						
2002/0062472	A1	5/2002	Medlock et al.						
2002/0111142	A1	8/2002	Klimovitch						
2002/0111144	A1	8/2002	Schiff						
2002/0122381	A1	9/2002	Wu		CN	1310894	A	8/2001	
2002/0122465	A1	9/2002	Agee et al.	375/141	CN	1841953	A	10/2006	
2002/0150109	A1	10/2002	Agee	370/400	CN	101860391	A	10/2010	
2002/0154705	A1	10/2002	Walton et al.		EP	0253465	A1	1/1988	
2002/0155818	A1	10/2002	Boros et al.	455/674	EP	0253465	B1	10/1991	
2002/0159506	A1	10/2002	Alamouti et al.		EP	0881782	A2	12/1998	
2002/0181390	A1	12/2002	Mody et al.		EP	0940934	A2	9/1999	
					EP	0940937	A2	9/1999	

FOREIGN PATENT DOCUMENTS

EP	0949769	A1	10/1999
EP	0999717	A2	5/2000
EP	1059737	A1	12/2000
EP	1527641	A2	5/2005
EP	1744575	A2	1/2007
EP	2239990	A1	10/2010
EP	2264965	A2	12/2010
EP	2317664	A2	5/2011
JP	H05327612	A	12/1993
JP	H09139704	A	5/1997
WO	9120135	A1	12/1991
WO	9522873	A2	8/1995
WO	9630964	A1	10/1996
WO	97000543	A1	1/1997
WO	9809381	A1	3/1998
WO	9809385	A2	3/1998
WO	9809395	A1	3/1998
WO	9827669	A1	6/1998
WO	9834351	A2	8/1998
WO	9834424	A2	8/1998
WO	9837638	A2	8/1998
WO	WO9837638	A3	8/1998
WO	9908451	A2	2/1999
WO	WO9908451	A3	2/1999
WO	9837638	A3	3/1999
WO	9908451	A3	4/1999
WO	9940689	A1	8/1999
WO	0011823	A1	3/2000
WO	0025485	A1	5/2000

OTHER PUBLICATIONS

B. Agee, J. Reed, "A Technique for Instantaneous Tracking of Frequency Agile Signals in the Presence of Spectrally Correlated Interference," in Proc. Twenty-Sixth Asilomar Conference on Signals, Systems and Computers, Nov. 1992.

S.M. Alamouti, "A simple transmit diversity technique for wireless communications," IEEE Journal on Selected Areas in Communications (JSAC), pp. 1451-1458, vol. 16, No. 8, Oct. 1998.

Chunlong Guo, et al., "Low power distributed MAC for ad hoc sensor radio networks," Dept. of Electr. Eng. & Comput. Sci., California Univ., Berkeley, CA, Global Telecommunications Conference, 2001. GLOBECOM '01. IEEE vol. 5.

R. Pabst, "Relay-based deployment concepts for wireless and mobile broadband radio," IEEE Communications Magazine, 2004, 10 pages.

I. Akyildiz, "A Survey on Wireless Mesh Networks," Communications Magazine, IEEE, 2005, p. S23-S30.

B. Xu, "The role of ad hoc networking in future wireless communications," Technology Proceedings, 2003, p. 1353-1358.

J. Chuang, "Beyond 3G: Wideband wireless data access based on OFDM and dynamic packet assignment," Communications Magazine, IEEE, 2000, pp. 78-87.

Y. Li, "Transmitter diversity for OFDM systems and its impact on high-rate data wireless networks," IEEE Journal on Selected Areas in Communications, 1999, pp. 1233-1243.

R. Becher, "Broadband wireless access and future communication networks," Proceedings of the IEEE, 2001, pp. 58-75.

R. Grunheid, "Self-organised beamforming and opportunistic scheduling in an OFDM-based cellular network," IEEE 2006, pp. 813-817.

K. Aretz, "The future of wireless communications beyond the third generation," Computer Networks, Elsevier Science, 2001, pp. 83-92.

A. Dowler, "Performance evaluation of channel estimation techniques for a mobile fourth generation wide area OFDM system," IEEE 56th, 2002, 5 pages.

M. Flament, "Propagation and Interference Issues in a 60 GHz Mobile Network," Proc. of the 2nd Personal Computing and Communications Workshop, 1999, 5 pages.

Whu, Enrique Uffe. "MIMO-OFDM Systems for High Data Rate Wireless Networks." Proj. Report for EE360 Advanced Wireless Networks: MIMO-OFDM Wireless Networks, 2003, pp. 1-7.

Gkelias, Athanasios, and Kin K. Leung. "Multiple antenna techniques for wireless mesh networks." Wireless Mesh Networks. Springer US, 2007, pp. 1-33.

Stuber, Gordon L., et al. "Broadband MIMO-OFDM wireless communications." Proceedings of the IEEE 92.2 (2004): 271-294.

Furukawa, Hiroshi, Kojiro Harnage, and Akihisa Ushirokawa. "SSDT-site selection diversity transmission power control for CDMA forward link." Selected Areas in Communications, IEEE Journal on 18.8, Aug. 2000, pp. 1546-1554.

Rashid-Farrokhi, F., L. Tassiulas, and K. J. R. Liu. "Joint power control and beamforming for capacity improvement in wireless networks with antenna arrays." Global Telecommunications Conference, 1996. GLOBECOM'96. Communications: The Key to Global Prosperity. vol. 1. IEEE, 1996, pp. 555-559.

Office Action from U.S. Appl. No. 13/840,949 mailed Jun. 16, 2014.

Office Action from U.S. Appl. No. 14/309,332, mailed Aug. 27, 2014.

Office Action from U.S. Appl. No. 14/480,535 mailed Nov. 4, 2014.

Office Action from U.S. Appl. No. 13/840,630 mailed Aug. 21, 2014.

L. Delaney, B. Agee, M. Buckner, R. Buehrer, J. Cafarella, P. Dickenson, J. Freebersyser, R. Gonzales, A. Ivers., Kind, G. Minden, J. Mitola, R. Nowak, G. Roussos, R. Tingley, C. Ford, N. Haller, Toward a Universal Radio Frequency System for Special Operations Forces, National Research Council, 2009, Washington, DC: The National Academies Press.

T. Rappaport, B. Woerner, J. Reed, "Wireless Personal Communications: Trends and Challenges," pp. 69-80, 1994.

G. Raleigh et al., "A Blind Adaptive Transmit Antenna Algorithm for Wireless Communication," in IEEE International Communications Conference on Communications, Jun. 1995.

D. Gerlach, A. Paulraj, "Spectrum Reuse Using Transmitting Antenna Arrays with Feedback," in Proc. International Conference on Acoustics, Speech, and Signal Processing, pp. 97-100, Apr. 1994.

D. Gerlach, A. Paulraj, "Adaptive Transmitting Antenna Arrays with Feedback," in IEEE Signal Processing Letters, vol. 1, No. 10, pp. 150-152, Oct. 1994.

D. Gerlach, A. Paulraj, "Adaptive Transmitting Antenna Methods for Multipath Environments," Global Tele Conf., 1994.

G. Raleigh, V. Jones, "Multivariate Modulation and Coding for Wireless Communication," in IEEE Journal on Selected Areas in Communications, vol. 17, No. 5, May 1999.

S. Swales, M. Beach, D. Edwards, J. McGeehan, "The performance enhancement of multibeam adaptive base station for antennas for cellular land mobile radio systems," IEEE Trans. Vehic. Tech., vol. VT-39, pp. 56-67, Feb. 1990.

P. Chow, J. Tu, J. Cioffi, "Performance Evaluation of a Multichannel Transceiver System for ADSL and VHDLSL Services," IEEE Journal on Selected Areas in Comm., vol. 8, No. 4, Aug. 1991.

B. Agee, P. Kelly, D. Gerlach, "The backtalk airlink for full exploitation of spectral and spatial diversity in Wireless Communication Systems," Proc. Fourth Workshop on Smart Antennas in Wireless Mobile Communications, Jul. 1997.

R. Cheng, S. Verdu, "Gaussian Multiaccess Channels with ISI: Capacity Region and Multiuser Water-Filling," IEEE Transactions on Information Theory, vol. 39, No. 3, May 1993.

J. Litva, T. Lo, "Digital Beamforming in Wireless Communications," 1996.

F. Rashid-Farrokhi, L. Tassiulas, K.J. Liu, "Joint optimal power control and beamforming in wireless networks using antenna rays," IEEE Transactions on Communications, vol. 46, No. 10, pp. 1313-1324, Oct. 1998.

G. Raleigh, J. Cioffi, "Spatio-Temporal Coding for Wireless Communications," IEEE Trans. Comm., Mar. 1998, vol. 46, No. 3, pp. 357-366.

G. Raleigh, J. Cioffi, "Spatio-Temporal Coding for Wireless Communications," Proc. 1996 Global Telecommunications Conf., pp. 1809-1814, Nov. 1996.

G. Foschini, M. Gans, "On Limits of Wireless Communication in a Fading Environment When Using Multiple Antennas," Wireless Personal Comm., vol. 6, No. 3, pp. 311-335, Mar. 1998.

T.M. Cover, J.A. Thomas, "Elements of Information Theory," 1991.

K. Boulle, G. Femenias, R. Augsti, "An Overview of Trellis Coded Modulation Research in Cost 231," in IEEE PIMRC '94, pp. 105-109, Sep. 1994.

W. Gardner, "Multiplication of Cellular Radio Capacity by Blind Adaptive Spatial Filtering," Proc. IEEE International Conference on Selected Topics in Wireless Communication, Jun. 1992, pp. 102-106.

- R.S. Cheng, S. Verdu, "On Limiting Characterizations of Memoryless Multiuser Capacity Regions," *IEEE Transactions on Information Theory*, vol. 39, No. 2, Mar. 1993.
- Chunchang et al., "On the Performance of Eigen Based Beamforming in LTE-Advanced," Sep. 2009, Personal, Indoor and Mobile Radio Communications (PIMRC), 2009 IEEE 20th International Symposium on.
- J.H. Chang et al., "Joint Transmitter and Receiver Beamforming for Maximum Capacity in Spatial Division Multiaccess," *Proc. 35th Annual Allerton Conf. on Communication, Control and Computing in Spatial Division Multiaccess*, 1997.
- L. Delaney, B. Agee, M. Buckner, R. Bruehrer, J. Cafarella, P. Dickenson, J. Freeberysyer, R. Gonzales, A. Ivers, Kind, G. Minden, J. Mitola, R. Nowak, G. Roussos, R. Tingley, C. Ford, N. Haller, *Toward a Universal Radio Frequency System for Special Operations Forces*, National Research Council, 2009, Washington, DC: The National Academies Press.
- Bromberg, M. Agee, B., "Optimization of Spatially Adaptive Reciprocal Multipoint Communication Networks," *IEEE Transactions on Communications*, vol. 51, No. 8, Aug. 2003.
- 3rd Generation Partnership Project 2, "Physical Layer Standard for cdma2000 Spread Spectrum Systems," Release 0, 3GPP2 C.S0002-02, Version 1.13, Apr. 24, 2001.
- 3rd Generation Partnership Project 2, "Medium Access Control (MAC) Standard for cdma 2000 Spread Spectrum Systems," Release 0—Addendum 2, 3GPP2 C.S0003-0-2, Version 1.0, Apr. 24, 2001.
- 3rd Generation Partnership Project 2, "Signaling Link Access Control (LAC) Standard for cdma 2000 Spread Spectrum Systems—Addendum 2," 3GPP2 C.S0004-0-2, Version 1.0, Apr. 24, 2001.
- 3rd Generation Partnership Project 2, "Upper Layer (Layer 3) Signaling Standard for cdma 2000 Spread Spectrum Systems," Release 0 Addendum 2, 3GPP2 C.S0005-0-2, Version 1.0, Apr. 24, 2001.
- 3rd Generation Partnership Project, Technical Specification Group GSM/EDGE "Radio Access Network; Digital cellular telecommunications system (Phase 2+); Multiplexing and multiple access on the radio path," Release 4, 3GPP TS 45.002, V4.3.1, Apr. 2001.
- 3rd Generation Partnership Project, Technical Specification Group GSM/EDGE Radio Access Network, "Digital cellular telecommunications system (Phase 2+); Modulation," Release 4, 3GPP TS 45.004, V4.0.0, Apr. 2001.
- Notice of Allowance from U.S. Appl. No. 13/010,629 mailed Aug. 27, 2014.
- Office Action from U.S. Appl. No. 09/878,789 mailed Oct. 12, 2005.
- Office Action from U.S. Appl. No. 09/878,789 mailed May 2, 2006.
- Office Action from U.S. Appl. No. 09/878,789 mailed Oct. 19, 2006.
- Notice of Allowance from U.S. Appl. No. 09/878,789 mailed Feb. 13, 2007.
- Office Action from U.S. Appl. No. 11/880,825 mailed Jul. 16, 2010.
- Office Action from U.S. Appl. No. 11/880,825 mailed Mar. 31, 2011.
- Notice of Allowance from U.S. Appl. No. 11/880,825 mailed Apr. 3, 2012.
- Notice of Allowance from U.S. Appl. No. 11/880,825 mailed Sep. 21, 2012.
- Office Action from U.S. Appl. No. 13/010,629 mailed Aug. 14, 2012.
- Office Action from U.S. Appl. No. 13/010,629 mailed May 21, 2013.
- Office Action from U.S. Appl. No. 13/010,629 mailed Aug. 15, 2013.
- Notice of Allowance from U.S. Appl. No. 13/010,629 mailed Dec. 23, 2013.
- Notice of Allowance from U.S. Appl. No. 13/010,629 mailed Apr. 30, 2014.
- Office Action from U.S. Appl. No. 13/022,615 mailed Nov. 21, 2011.
- Notice of Allowance from U.S. Appl. No. 13/022,615 mailed Apr. 16, 2012.
- Notice of Allowance from U.S. Appl. No. 13/022,615 mailed Mar. 12, 2013.
- Office Action from U.S. Appl. No. 13/022,623 mailed Oct. 6, 2011.
- Notice of Allowance from U.S. Appl. No. 13/022,623 mailed Jul. 12, 2012.
- Office Action from U.S. Appl. No. 13/022,619 mailed Dec. 23, 2011.
- Notice of Allowance from U.S. Appl. No. 13/022,619 mailed Apr. 27, 2012.
- Notice of Allowance from U.S. Appl. No. 13/022,619 mailed Apr. 1, 2013.
- Office Action from U.S. Appl. No. 13/022,622 mailed Dec. 15, 2011.
- Notice of Allowance from U.S. Appl. No. 13/022,622 mailed Aug. 17, 2012.
- Notice of Allowance from U.S. Appl. No. 10/039,521 mailed Dec. 1, 2005.
- Vaidyanathan, Palghat P., and Bojan Vrcelj. "Fast and robust blind-equalization based on cyclic prefix." *IEEE International Conference on Communications*. vol. 1., 2002, 5 pages.
- Vaidyanathan, Palghat P., and Bojan Vrcelj. "On power allocation for generalized cyclic-prefix based channel-equalizers." *Circuits and Systems*, 2002. ISCAS 2002. IEEE International Symposium on. vol. 1. IEEE, 2002, 4 pages.
- Vaidyanathan, P. P., and Bojan Vrcelj. "Theory of fractionally spaced cyclic-prefix equalizers." *Acoustics, Speech, and Signal Processing (ICASSP)*, 2002 IEEE International Conference on. vol. 2. IEEE, 2002, 4 pages.
- Visotsky, et al., "Optimum Beamforming Using Transmit Antenna Arrays," *Vehicular Technology Conference*, 1999 IEEE 4th, vol. 1, pp. 851-856.
- Office Action from U.S. Appl. No. 14/480,542 mailed Dec. 8, 2014.
- Notice of Allowance from U.S. Appl. No. 14/253,593 mailed Dec. 15, 2014.
- Office Action from U.S. Appl. No. 14/253,616, mailed Jan. 20, 2015.
- A. Duel-Hallen, "Equalizers for Multiple Input Multiple Output Channels and PAM Systems with Cyclostationary Input Sequences," *IEEE Journ. On Sel. Areas in Comm.*, vol. 10(3), pp. 630-639, Apr. 1992.
- J. Yang and S. Roy, "On Joint Transmitter and Receiver Optimization for Multiple-input Multiple-output (MIMO) Transmission Systems," *IEEE Trans. Commun*, vol. 42-(12), pp. 3221-3231, Dec. 1994.
- J. Yang and S. Roy, "Joint Transmitter-Receiver Optimization for Multi-Input Multi-Output Systems with Decision Feedback," *IEEE Trans. Information Theory*, vol. 40(5), pp. 1334-1347, Sep. 1994.
- D.C. Cox and R.P. Leck, "Distributions of Multipath Delay Spread and Average Excess Delay for 910 Mhz Urban Mobile Radio Paths," *IEEE Trans. Antennas and Prop.*, vol. AP-23, pp. 206-213, Mar. 1975.
- S.B. Weinstein and P.M. Ebert, "Data Transmission by Frequency-Division Multiplexing Using the Discrete Fourier Transform," *IEEE Transactions on Communications*, vol. 19(5), pp. 628-634, Oct. 1971.
- A. Ruiz, J.M. Cioffi, and S. Kasturia, "Discrete Multiple Tone Modulation with Coset Coding for the Spectrally Shaped Channel," *IEEE Trans. Commun*, vol. 40(6), pp. 1012-1029, Jun. 1992.
- R.M. Gray, "On the Asymptotic Eigenvalue Distribution of Toeplitz Matrices," *IEEE Trans. Information Theory*, vol. 18, pp. 725-730, Jun. 1972.
- G. Forney, "Maximum-Likelihood Sequence Estimation of Digital Sequences in the Presence of Intersymbol Interference," *IEEE Trans. Inform. Theory*, vol. IT-18(3), pp. 363-378, May 1972.
- J.L. Holsinger, "Digital Communications Over Fixed Time-Continuous Channels With Memory, with Special Application to Telephone Channels," *M.I.T. Research Laboratory Electronics Report*, vol. 430, 1964.
- W. R. Braun and U. Dersch, "A Physical Mobile Radio Channel Model," *IEEE Trans. Vehicular Technology*, vol. 40, pp. 472-482, May 1991.
- S. Kasturia, J. Aslanis, and J.M. Cioffi, "Vector Coding for Partial-Response Channels," *IEEE Transactions on Information Theory*, vol. 36(4), pp. 741-762, Jul. 1990.
- Justin C.-I. Chuang, "Burst Coherent Demodulation with Combined Symbol Timing, Frequency Offset Estimation, and Diversity Selection," *IEEE Transactions on Communications*, vol. 39, No. 7, pp. 1157-1164, Jul. 1991.
- Leonard J. Cimini, Jr., "Analysis and Simulation of a Digital Mobile Channel Using Orthogonal Frequency Division Multiplexing," *IEEE Transactions on Communications*, ol. Co. 33, No. 7, pp. 665-675, Jul. 1985.
- Office Action from U.S. Appl. No. 14/309,332, mailed Feb. 17, 2015.
- Office Action from U.S. Appl. No. 13/840,949, mailed Feb. 18, 2015.
- Matsumoto, Tadashi. "A Technical Survey and Future Prospects of Adaptive Array Antennas in Mobile Communications." *NTT Docomo Technical Journal* 5.4 (1998): p. 25-36.

- R. T. Compton, Jr., "Adaptive Antennas—Concepts and Performance," Prentice-Hall, Englewood Cliffs (1988). pp. 6-11.
- J. Hirono, M. Saito and C. Kamise, Digital Terrestrial Television Broadcasting with OFDM—A Study on the Performance of Single Frequency Networks—International Broadcasting Convention, p. 178-183 (Sep. 1996).
- P.A. Voois, "Two-dimensional Signal Processing for Magnetic Storage Systems," Ph.D. Thesis, Stanford University, Stanford, CA, pp. 1-136 (Dec. 1993).
- Ohkawa, Kouichi, "Performance of Multicarrier Trellis-Coded 8PSK Using Frequency Hopping in Rayleigh Fading Channels," National Conference Publication—Institution of Engineers, Australia, National Conference, vol. 1, p. 145-149, Nov. 20-24, 1994.
- Ichikawa, Hirofumi, "Frequency Diversity Effects in Multicarrier Digital Radio Systems," Electronics and Communications in Japan, Part 1, vol. 74, No. 8, p. 70-77, Aug. 1991.
- Del Re, Enrico, "Digital Multicarrier Demodulator for Regenerative Communication Satellites," Alta Frequenza, vol. 57, No. 10, p. 545-559, Dec. 1988.
- C.E. Shannon, "Mathematical Theory of Communications: Part 1 and Part II," The Bell System Technical Journal, pp. 379-423, 623-656, 1948.
- R.J. Muirhead, Aspects of Multivariate Statistical Theory, New York: John Wiley, chapters 4 and 5, 1982.
- W.C. Jakes, Microwave Mobile Communications. New York: John Wiley, chapters 1, 5 and 6, 1974.
- A.E. Bryson and T.C. Ho, Applied Optimal Control, Washington D.C. Hemisphere Publishing, pp. 24-29, 1968.
- E. Biglieri, D. Divsalar, P.J. McLane, and M.K. Simon, Introduction to Trellis Coded Modulation with Applications. New York: Macmillan Publishing, 1991.
- P. Lancaster, Theory of Matrices. New York: Academic Press, chapter 2, 1969.
- Office Action from U.S. Appl. No. 13/010,629, mailed Mar. 12, 2015.
- Office Action from U.S. Appl. No. 13/840,630, mailed Mar. 13, 2015.
- Yu, Wei, et al. "Iterative water-filling for Gaussian vector multiple-access channels." Information Theory, IEEE Transactions on 50.1 (2004): 145-152.
- Liejun, Wang. "An improved water-filling power allocation method in MIMO OFDM systems." Information technology journal 10.3 (2011): 639-647.
- Palomar, Daniel Pérez, and Javier Rodriguez Fonollosa. "Practical algorithms for a family of waterfilling solutions." Signal Processing, IEEE Transactions on 53.2 (2005): 686-695.
- Cioffi, John M. "Chapter 4: Multi-Channel Modulation." Lectures on Digital Communications, Stanford University, Available from <http://www.stanford.edu/class/ee379c> (2001): 288-421.
- Tehrani, Ardavan Maleki, et al. "An implementation of discrete multi-tone over slowly time-varying multiple-input/ multiple-output channels." Global Telecommunications Conference, 1998. GLOBECOM 1998. The Bridge to Global Integration. IEEE. vol. 5. IEEE, 1998.
- Wong, Cheong Yui, et al. "Multiuser OFDM with adaptive subcarrier, bit, and power allocation." Selected Areas in Communications, IEEE Journal on 17.10 (1999): 1747-1758.
- Shen, Zukang. "Multiuser OFDM Capacity Analysis with Partial Channel Information." Multiuser Wireless Communications Course Project, Fall (2002), 11 pages.
- Agee, B., "Capacity Analysis of LMS Network Scenarios Operating in a Part 15; Network Environment," Apr. 25, 1999.
- Agee, B., "Introduction of Smart Antennas Into the Metricom Wireless Data; Network Overview, Players, and Application," Aug. 6, 1999.
- Agee, B., "4G Airlink Enhancements to the Metricom Ricochet System," 4G; Airlink/Technology Concepts, Dec. 21, 1999.
- Agee, B., Young, D., "Blind Capture and Geolocation of General Spatially; Self-Coherent Waveforms Using Multiplatform Score," Maple Press, 1990.
- Biedka, T., Agee, B., "Subinterval Cyclic Music—Robust DF with Error in Cycle; Frequency Knowledge," 1991.
- Mendoza, R., Reed, J., Hsia, T., Agee, B., "Interference Rejection Using Time-; Dependent Constant Modulus Algorithms," 1989.
- Schell, S., Calabretta, R., Gardner, W., Agee, B., "Cyclic Music Algorithms for; Signal-Selective Direction Estimation," 1989.
- Agee, B., C. Kamise, "WLAN Reconnaissance," Jan. 13, 2003.
- Agee, B., Protean Radio Networks, "The PHY-IASM MIMO Network Capable; Transceiver; Concept and IP Overview," May 20, 2004.
- Agee, B., "Orion Phase A Algorithms," Final Design Review, Algorithms; Overview; Jul. 17-18, 1996 (FDR Date), Jul. 19, 1996.
- Bromberg, M., Agee, B., "Using Channel Reciprocity to Optimize Network; Capacity," May 11, 2000.
- Bromberg, M., Agee, B., "An Analysis of the LEGO Algorithm for Optimizing the Performance of Wireless Networks," Thirty Fourth Asilomar Conf Signals, Systems, and Computers, Oct. 2000, and in Proceedings of the Thirty Fifth Asilomar Conf Signals, Systems, and Computers, Nov. 2001.
- Bromberg, M. Agee, B., "The LEGO Technique for Optimizing the Performance of; Wireless, MultiUser, MIMO Channel, TDD Networks," Dec. 28, 2000.
- Bromberg, M. Agee, B., "The LEGO Technique for Locally Enabled Global; Optimization of Reciprocal Multinode Communication Networks," Feb. 5, 2001.
- Agee, B., Young, D., "Blind Capture and TDOA Estimation of Stationary; Waveforms Using Multiplatform Temporal Cross Coherence Restoral," Nov. 4, 1990.
- IEEE Std 802.16e™-2005 and IEEE Std 802.16™-2004/Cor1-2005 (Amendment and Corrigendum to IEEE Std 802.16-2004), "IEEE Standard for Local and metropolitan area networks, Part 16: Air Interface for Fixed and Mobile Broadband Wireless Access Systems, Amendment 2: Physical and Medium Access Control Layers for Combined Fixed and Mobile Operation in Licensed Bands and Corrigendum 1," Feb. 28, 2006.
- IEEE Std 802.11a-1999 (R2003) (Supplement to IEEE Std 802.11-1999); [Adopted by ISO/IEC and redesignated as ISO/IEC 8802-11:1999/Amd; 1:2000(E)], "Supplement to IEEE Standard for Information technology—Telecommunications and information exchange between systems—Local and metropolitan area networks—Specific requirements, Part 11: Wireless LAN Medium Access Control (MAC) and Physical Layer (PHY) specifications, High-speed Physical Layer in the 5 GHz Band," Reaffirmed Jun. 12, 2003.
- IEEE Std 802.11b-1999 (R2003) (Supplement to ANSI/IEEE Std 802.11, 1999; Edition) "Supplement to IEEE Standard for Information technology—Telecommunications and information exchange between systems—Local and metropolitan area networks—Specific requirements, Part 11: Wireless LAN Medium Access Control (MAC) and Physical Layer (PHY) specifications, Higher-Speed Physical Layer Extension in the 2.4 GHz Band," Reaffirmation Jun. 12, 2003, Approved Sep. 16, 1999.
- IEEE Std 802.11g™-2003, (Amendment to IEEE Std 802.11™, 1999 Edition (Reaff 2003) as amended by IEEE Stds 802.11a™-1999, 802.11b™-1999, 802.11b™-1999/Cor 1-2001, and 802.11d™-2001), "IEEE Standard for Information technology—Telecommunications and information exchange between systems—Local and metropolitan area networks—Specific requirements, Part 11: Wireless LAN Medium Access Control (MAC) and Physical Layer (PHY) specifications, Amendment 4: Further Higher Data Rate Extension in the 2.4 GHz Band", Oct. 29, 2009.
- IEEE Std 802.16™-2009 (Revision of IEEE Std 802.16-2004), "IEEE Standard for Local and metropolitan area networks, Part 16: Air Interface for Broadband Wireless Access Systems," May 29, 2009.
- IEEE Std 802.11 e/D4.3, May 2003 (Draft Supplement to IEEE Std 802.11, 1999; Edition), "Draft Supplement to Standard for Telecommunications and Information Exchange Between Systems—LAN/MAN Specific Requirements—Part 11: Wireless Medium Access Control (MAC) and Physical Layer (PHY) specifications: Medium Access Control (MAC) Enhancements for Quality of Service (QoS)," Copyright 2003.
- 3GPP TS 36.101 V8.0.0 (Dec. 2007) Technical Specification, "3rd Generation Partnership Project; Technical Specification Group Radio Access Network; Evolved Universal Terrestrial Radio Access (E-UTRA); User Equipment (UE) radio transmission and reception (Release 8)," Copyright 2007.

- G. Foschini, "Layered Space-Time Architecture for Wireless Communication in a Fading Environment When Using Multi-Element Antennas," *Bell Labs Technical Journal*, 41-59, 1996.
- Bahadori, M. and Psounis, K., "On the Performance of Multiuser MIMO Mesh Networks," University of Southern California, pp. 1-12, Aug. 2010.
- Hieu, Nguyen Trung, et al. "FPGA Design and Implementation of MIMO-OFDM SDM Systems for High Speed Wireless Communications Networks." *International Journal of Research in Wireless Systems*, vol. 2, No. 2, pp. 26-33, Jun. 2013.
- Pascual-Iserte, Antonio, Ana I. Pérez-Neira, and Miguel Ángel Lagunas. "An approach to optimum joint beamforming design in a MIMO-OFDM multiuser system." *EURASIP Journal on Wireless Communications and Networking* 2004.2, pp. 210-221, 2004.
- Xiang, Weidong, et al. "A high-speed four-transmitter four-receiver MIMO OFDM testbed: Experimental results and analyses." *EURASIP Journal on Applied Signal Processing*, vol. 2006, pp. 1-10, 2006.
- 3rd Generation Partnership Project, Technical Specification Group Radio Access Network, "RLC protocol specification," Release 1999, 3GPP TS 25.322, V3.6.0, Mar. 2001.
- 3rd Generation Partnership Project, Technical Specification Group Radio Access Network, "RRC Protocol Specification," Release 1999, 3GPP TS 25.331, V3.6.0, Mar. 2001.
- M. Bromberg, B. Agee, "The LEGO Approach for Achieving Max-Min Capacity in Reciprocal Multipoint Networks," in Proc. Thirty Fourth Asilomar Conf Signals, Systems, and Computers, Oct. 2000.
- B. Agee, "Exploitation of Internode MIMO Channel Diversity in Spatially Distributed Multipoint Networks," in Proc. Tenth Annual Virginia Tech Symposium on Wireless Personal Comm., Jun. 2000.
- B. Agee, S. Bruzzone, M. Bromberg, "Exploitation of Signal Structure in Array-Based Blind Copy and Copy-Aided DF Systems," in Proc. 1998 Intl. Conf on Acoustics, Speech and Signal Proc., pp. 2489-2492, vol. 4, May 1998.
- M. Bromberg, B. Agee, "Direction Finding for Unstructured Emitters in the Presence of Structured Interferers," in Proc. 1998 Intl. Conf on Acoustics, Speech and Signal Processing, pp. 2537-2540, vol. 4, May 13, 1998.
- J. Fite, S. Bruzzone, B. Agee, "Blind Separation of Voice Modulated Single-Side-Band Using the Multi-Target Variable Modulus Algorithm," in Proc. 1996 Conf on Acoustics, Speech and Signal Processing, pp. 2726-2729, vol. 5, May 1996.
- B. Agee, S. Bruzzone, "Exploitation of Signal Structure in Array-Based Blind Copy and Copy-Aided DF Systems," in Proc. 1994 CRASP Conf on Co-Channel Demodulation, Jun. 1994.
- B. Agee, K. Cohen, J. Reed, T. Hsia, "Simulation Performance of a Blind Adaptive Array for a Realistic Mobile Channel," in Proc. 1993 Conf on Vehicular Technology, May 18, 1993.
- B. Agee, "The Property Restoral Approach to Blind Adaptive Signal Extraction," Ph.D. Dissertation, Dept. of Electrical Engineering, University of California, Davis, CA, Jun. 1989.
- B. Agee, S. Schell, W. Gardner, "The SCORE Approach to Blind Adaptive Signal Extraction: An Application of the Theory of Spectral Correlation," in Proc. Fourth ASSP Workshop on Spectrum Estimation and Modelling, p. 277, Aug. 1988.
- B. Agee, "The Least-Squares CMA: A New Approach to Rapid Correction of Constant Modulus Signals," in Proc. 1986 International Conf on Acoustics, Speech and Signal Processing, vol. 2, p. 19.2.1, Apr. 1986, Tokyo, Japan.
- M.G. Bromberg, B. Agee, "Transmit Beamforming for Optimizing Network Capacity," Jun. 26, 2001.
- Swales, et. al., "The Performance Enhancement of Multibeam Adaptive Base-Station Antennas for Cellular Land Mobile Radio Systems," *IEEE Trans. Veh. Technol.* vol. 39 No. 1 Feb. 1990.
- B. Agee, "Convergent Behavior of Modulus-Restoring Adaptive Arrays in Gaussian Interference Environments," in Proc. Twenty-Second Asilomar Conf Signals, Systems and Computers, Nov. 1988.
- S. Schell, B. Agee, "Application of the SCORE Algorithm and SCORE Extensions to Sorting in the Rank-L Spectral Self-Coherence Environment," in Proc. Twenty-Second Asilomar Conf Signals, Systems, Comp., Nov. 1988.
- Agee, B., "Array-Based Techniques for Wireless Telephony," 1995 IEEE; Communications Theory Workshop, Apr. 25, 1995.
- Kelly, P., Agee, B., Radix Technologies, Inc., "The Backtalk Communications; Airlink," Jan. 18, 1998.
- Bromberg, M.C., "Reliable, High Capacity, Multipoint, Wireless Information; Networks," Date Unknown.
- Bromberg, M.C., "Optimizing MIMO Multipoint Wireless Networks Assuming; Gaussian Other-User Interference." *IEEE Transactions on Information Theory*, vol. 49, No. 10, Oct. 2003. (IEEE Proof).
- Agee, B., "Technical Evaluation of Wireless Broadband Issues & Equipment; Alternatives EPRI," BWA Technical Evaluation Final Report Nov. 19, 1999.
- Y. Li, H. Murata, S. Yoshida, "Near Capacity Multiple Access Scheme for Interference Channel Using Complex-Valued Signals," *Electronics Letters*, Oct. 29, 1998, vol. 34, No. 22.
- B. Agee, M. Bromberg, D. Gerlach, M. Ho, M. Jesse, D. Stephenson, R. Mechaley, T. Golden, D. Nix, R. Naish, D. Gibbons, R. Maxwell, E. Hoole, and D. Ryan, "Highly bandwidth-efficient communications," US Patent, Aug. 27, 1998.
- N.R. Goodman, "Statistical analysis based on a certain multivariate complex Gaussian distribution (an introduction)," *Annals of Mathematical Statistics*, vol. 34, No. 1, pp. 152-177, Mar. 1963.
- M. Hata, "Empirical formula for propagation loss in land mobile radio services," *IEEE Transactions on Vehicular Technology*, vol. VT-29, pp. 317-325, Aug. 1980.
- Hara, Shinsuke, S. Hane, and Y. Hara. "Adaptive antenna array for reliable OFDM transmission." *Proc. 6th Int. OFDM Workshop*. 2000.
- Kim, Chan Kyu, Kwangchun Lee, and Yong Soo Cho. "Adaptive beamforming algorithm for OFDM systems with antenna arrays." *Consumer Electronics, IEEE Transactions on* 46.4 (2000): 1052-1058.
- Kapoor, Samir, Daniel J. Marchok, and Yih-Fang Huang. "Adaptive interference suppression in multiuser wireless OFDM systems using antenna arrays." *Signal Processing, IEEE Transactions on* 47.12 (1999): 3381-3391.
- Kim, Chan Kyu, Songin Choi, and Yong Soo Cho. "Adaptive beamforming for an OFDM system." *Vehicular Technology Conference, 1999 IEEE 49th. vol. 1. IEEE*, 1999.
- Yoshino, Hitoshi, and Andreas Czulwik. "Adaptive co-channel interference (CCI) cancellation for OFDM communication systems." *Broadband Communications, 2000. Proceedings. 2000 International Zurich Seminar on. IEEE*, 2000.
- Fujii, Takeo, and Masao Nakagawa. "Indoor multi-base stations system with simultaneous transmission using OFDM adaptive array antenna." *Personal, Indoor and Mobile Radio Communications, 2000. PIMRC 2000. The 11th IEEE International Symposium on. vol. 2. IEEE*, 2000.
- Morinaga, Norihiko, Masao Nakagawa, and Ryuji Kohno. "New concepts and technologies for achieving highly reliable and high-capacity multimedia wireless communications systems." *Communications Magazine, IEEE* 35.1 (1997): 34-40.
- Kohno, Ryuji. "Evolution and demands of SoC in ITS and mobile communication systems." *Semiconductor Manufacturing, 2000. Proceedings of ISSM 2000. The Ninth International Symposium on. IEEE*, 2000.
- Steiner, Bernd. "Uplink performance of a multicarrier-CDMA mobile radio system concept." *Vehicular Technology Conference, 1997. IEEE 47th. vol. 3. IEEE*, 1997.
- Paulraj et al., *Space-Time Processing for Wireless Communications*, Nov. 1997, *IEEE Signal Processing Magazine*.
- Paulraj et al., *Taxonomy of space-time processing for wireless networks*, Feb. 1, 1998, *IEEE Proceedings: Radar, Sonar & Navigation*, GB, Institution of Electrical Engineers, vol. 145, No. 1.
- B. Widrow et al., "Adaptive Antenna Systems," *Proc. IEEE*, vol. 55, No. 12, pp. 2143-2159 (Dec. 1967).
- S.P. Applebaum, "Adaptive Arrays," *IEEE Trans. Antennas & Propag.*, vol. AP-24, No. 5, pp. 585-598 (Sep. 1976).
- Ye (Geoffrey) Li, Senior Member, IEEE, Nambirajan Seshadri, Senior Member, IEEE, and Sirikiat Ariyavisitkul, Senior Member, IEEE; "Channel Estimation for OFDM Systems with Transmitter Diversity in Mobile Wireless Channels"; *IEEE Journal on Selected Areas in Communications*, vol. 17, No. 3, Mar. 1999, pp. 461-471.

- Georgios B. Giannakis, Fellow, IEEE, and Cihan Tepedelenioglu: "Basis Expansion Models and Diversity Techniques for Blind Identification and Equalization of Time-Varying Channels"; Proceedings of the IEEE, vol. 86, No. 10, Oct. 1998, pp. 1969-1986.
- Ove Edfors, Magnus Sandell, Jan-Jaap van de Beek, Sarah Kate Wilson, Per Ola Borjesson; "Analysis of DFT-based channel estimators for OFDM"; presented in part at the 1995 Vehicular Technology Conference (VTC'96) in Chicago, IL, Jul. 25-28, 1995, pp. 815-819.
- A.J. Paulraj and Boon Chong Ng; "Space-Time Modems for Wireless Personal Communications"; IEEE Personal Communications; Feb. 1998, pp. 36-48.
- H. Sari, G. Karam, and I. Jeanclaude; "Transmission Techniques for Digital Terrestrial TV Broadcasting"; IEEE Communications Magazine, Feb. 1995; pp. 100-109.
- Martin V. Clark, Senior Member, IEEE; "Adaptive Frequency-Domain Equalization and Diversity Combining from Broadband Wireless Communications"; IEEE Journal on Selected Areas in Communications, vol. 16, No. 8, Oct. 1998; pp. 1385-1395.
- Friedlander "Direction Finding Using an Interpolated Array", 1990 IEEE Publication, pp. 2951-2954.
- Friedlander et al. "Direction Finding for Wideband Signals Using an Interpolated Array", 1991, IEEE Publication, pp. 583-587.
- Search Report for International Application No. PCT/US98/27154 mailed Apr. 29, 1999.
- Carbonelli et al., "Evaluation of Near-End Crosstalk Noise Affecting ADSL Systems," Singapore ICCS Conference, Nov. 1994, pp. 630-634.
- Sendonaris et al., "Joint Signaling Strategies for Approaching the Capacity of Twisted Pair Channels," IEEE Transactions on Communications, vol. 46, No. 5, May 1998, pp. 673-685.
- Bingham, "Multicarrier Modulation for Data Transmission: An Idea Whose Time Has Come," IEEE Communications Magazine, May 1990, pp. 5-14.
- Barton et al., "Optimization of Discrete Multitone to Maintain Spectrum Compatibility with Other Transmission Systems on Twisted Copper Pairs," IEEE Journal on Selected Areas in Communications, vol. 13, No. 9, Dec. 1995, pp. 1558-1563.
- Kerpez, "Near-End Crosstalk is Almost Gaussian," IEEE Transactions on Communications, vol. 41, No. 1, Jan. 1993, pp. 670-672.
- Kalet, "The Multitone Channel," IEEE Transactions on Communications, vol. 37, No. 2, Feb. 1989, pp. 119-124.
- Aslanis, Jr. et al., "Achievable Information Rates on Digital Subscriber Loops: Limiting Information Rates with Crosstalk Noise," IEEE Transactions on Communications, vol. 40, No. 2, Feb. 1992, pp. 361-372.
- Chow et al., "A Practical Discrete Multitone Transceiver Loading Algorithm for Data Transmission over Spectrally Shaped Channels," IEEE Transactions on Communications, vol. 43, No. 2/3/4, Feb./Mar./Apr. 1995, pp. 773-775.
- Kalet et al., "On the Capacity of a Twisted-Wire Pair: Gaussian Model," IEEE Transactions on Communications, vol. 38, No. 3, Mar. 1990, pp. 379-383.
- Werner, "The HDSL Environment," IEEE Journal on Selected Areas in Communications, vol. 9, No. 6, Aug. 1991, pp. 785-800.
- Andrew Sendonaris, Joint Signaling Strategies for Maximizing the Capacity of Twisted Pair Loops, (13 pp.), Oct. 1995.
- Sourour, Essam A., "Performance of Orthogonal Multicarrier CDMA in a Multipath Fading Channel," IEEE Transactions on Communications, vol. 44, No. 3, p. 356-367, Mar. 1996.
- Gudmundson, Mikael, "Spectral Efficiency of a Multitone Frequency Hopping System for Personal Communication Systems," IEEE Vehicular Technology Conference, Part 3 (of 3) Stockholm, vol. 3, p. 1650-1654, Jun. 8-10, 1994.
- Gulliver, T. Aaron, "Order Statistics Diversity Combining in Worst Case Noise and Multitone Jamming," IEEE Vehicular Technology Conference, vol. 2, p. 804-809, Jul. 25-28, 1995.
- Monnier, R., "Digital Television Broadcasting with High Spectral Efficiency," IEEE Conference Publication No. 358, p. 380-384, Jul. 1992.
- Omori, Youko, "Multicarrier 16QAM System in Land Mobile Communications," IEICE Transactions on Communications, vol. E77-B, No. 5, p. 634-640, May 1994.
- Ananasso, Fulvio, "Clock Synchronous Multicarrier Demodulator for Multi-Frequency TDMA Communications Satellites," IEEE International Conference on Communications, vol. 3, p. 1059-1063, 1990.
- Friese, M., "Multicarrier Modulation with Low Peak-to-Average Power Ratio," Electronics Letters, vol. 32, No. 8, p. 713-714, Apr. 11, 1996.
- Benyassine, Adil, "Optimal Subchannel Structuring and Basis Selection for Discrete Multicarrier Modulation," IEEE Communication Theory Mini-Conference, Proceedings, CTMC, p. 97-101, 1995.
- Sawahashi, M., "Multicarrier 16QAM Transmission with Diversity Reception," Electronics Letters, vol. 32, No. 6, p. 522-523, Mar. 14, 1996.
- Daffara, Flavio, "A New Frequency Detector for Orthogonal Multicarrier Transmission Techniques," IEEE 45th Vehicular Technology Conference, p. 804-809, Jul. 25-28, 1995.
- S. A. Fectel and H. Meyr, "Optimal Feedforward Estimation of Frequency-Selective Fading Radio Channels using Statistical Channel Information," in Proc. SUPERCOMM/ICC '92, vol. 2, (Chicago, IL), pp. 677-681, 1992.
- L.H. Brandenburg and A.D. Wyner, "Capacity of the Gaussian channel with Memory: The Multivariate Case," Bell Syst. Tech. Journ., vol. 53(5), pp. 745-778, May-Jun. 1974.
- J. Salz, Digital Transmission Over Cross-Coupled Linear Channels, AT & T Tech. Journ., vol. 64(6), pp. 1147-1159, Jul.-Aug. 1985.
- Bromberg, M., Agee, B., "Optimization of Spatially Adaptive Reciprocal Multipoint Communication Networks," IEEE Transactions on Communications, vol. 51, No. 8, Aug. 2003.
- B. Agee, R. Kleinman, J. Reed, "Soft Synchronization of Direct Sequence Spread Spectrum Signals," IEEE Trans. Comm., vol. COM-44, No. 11, pp. 1527-1536, Nov. 1996.
- B. Agee, "Solving the Near-Far Problem: Exploitation of Spatial and Spectral Diversity in Wireless Personal Communication Networks," (1994).
- R. Mendoza, J. Reed, T. Hsia, B. Agee, "Interference Rejection Using Time-Dependent Constant Modulus Algorithms and a Hybrid CMA/SCD," IEEE Trans. ASSP, Jul. 1991.
- B. Agee, S. Schell, W. Gardner, "Spectral Self-Coherence Restoral: A New Approach to Blind Adaptive Signal Extraction Using Antenna Arrays," IEEE Proceedings, vol. 78, No. 4, pp. 753-767, Apr. 1990.
- B. Agee, M. Bromberg, "Exploitation of MIMO Network Diversity in Multipoint Communication Networks," presented at the *Thirty-Fifth Asilomar Conference Signals, Systems, and Computers*, Nov. 2001.
- M. Bromberg, B. Agee, "The LEGO Approach for Achieving Max-Min Capacity in Reciprocal Multipoint Networks," in Proc. *Thirty Fourth Asilomar Conf. Signals, Systems, and Computers*, Oct. 2000.
- B. Agee, "Exploitation of Inernode MIMO Channel Diversity in Spatially Distributed Multipoint Networks," in Proc. *Tenth Annual Virginia Tech Symposium on Wireless Personal Comm.*, Jun. 2000.
- B. Agee, S. Bruzzone, M. Bromberg, "Exploitation of Signal Structure in Array-Based Blind Copy and Copy-Aided DF Systems," in Proc. *1998 Intl. Conf. on Acoustics, Speech and Signal Proc.*, pp. 2489-2492, vol. 4, May 1998.
- M. Bromberg, B. Agee, "Direction Finding for Unstructured Emitters in the Presence of Structured Interferers," in Proc. *1998 Intl. Conf. on Acoustics, Speech and Signal Processing*, pp. 2537-2540, vol. 4, May 13, 1998.
- E. Krzysiak, D. Branlund, B. Agee, "New Copy-Aided Techniques for Superresolution Direction Finding and Geolocation," in Proc. *Fourth Southwest Institute Conference on Direction Finding*, Nov. 1997.
- J. Treichler, B. Agee, "A New Approach to Multipath Correction of Constant Modulus Signals," IEEE Trans. Acoustics, Speech and Signal Processing, vol. ASSP-31, No. 2, Apr. 1983.
- W. Gardner, B. Agee, "Two-Stage Adaptive Noise Cancellation for Intermittent-Signal Applications," IEEE Trans. Information Theory, vol. IT-26, No. 6, Nov. 1980.
- B. Agee, "Blind Detection, Separation, and Location of Dense Co-Channel Emitters Using Multiplatform Spatial-Coherence Restoral," in Proc. *2006 IEEE Workshop on Sensor Array and Multichannel Processing*, Jul. 2006.

- J. Fite, S. Bruzzone, B. Agee, "Blind Separation of Voice Modulated Single-Side-Band Using the Multi-Target Variable Modulus Algorithm," in *Proc. 1996 Conf. on Acoustics, Speech and Signal Processing*, pp. 2726-2729, vol. 5, May 1996.
- B. Agee, S. Bruzzone, "Exploitation of Signal Structure in Array-Based Blind Copy and Copy-Aided DF Systems," in *Proc. 1994 CRASP Conf. on Co-Channel Demodulation*, Jun. 1994.
- B. Agee, "On the Performance Bounds Adhered to by Copy-Aided DF Algorithms," presented at *Twenty-Seventh Asilomar Conference on Signals, Systems and Computers*, Nov. 1993.
- B. Agee, K. Cohen, J. Reed, T. Hsia, "Simulation Performance of a Blind Adaptive Array for a Realistic Mobile Channel," in *Proc. 1993 Conf. on Vehicular Technology*, May 18, 1993.
- B. Agee, J. Reed, "A Technique for Instantaneous Tracking of Frequency Hopping Signals in the Presence of Spectrally Correlated Interference," in *Proc. Twenty-Sixth Asilomar Conference on Signals, Systems and Computers*, Nov. 1992.
- B. Agee, *The Property Restoral Approach to Blind Adaptive Signal Extraction*, Ph. D. Dissertation, Dept. of Electrical Engineering, University of California, Davis, CA, Jun. 1989.
- B. Agee, "Maximum-Likelihood Approaches to Blind Adaptive Signal Extraction Using Narrowband Antenna Arrays," in *Proc. Twenty-Fifth Asilomar Conference on Signals, Systems and Computers*, Nov. 1991.
- B. Agee, "The Copy/DF Approach to Signal-Specific Emitter Location," in *Proc. Twenty-Fifth Asilomar Conference on Signals, Systems and Computers*, Nov. 1991.
- B. Agee, R. Calabretta, "ARMA-Like and ML-Like Copy/DF Approaches for Signal-Specific Emitter Location," in *Proc. Fifth ASSP Workshop on Spectrum Estimation and Modelling*, 1990.
- B. Agee, S. Venkataraman, "Adaptive Demodulation of PCM Signals In the Frequency Domain," in *Proc. Twenty-Third Asilomar Conference on Signals, Systems and Computers*, Nov. 1989.
- S. Schell, B. Agee, "Application of the SCORE Algorithm and SCORE Extensions to Sorting in the Rank-L Spectral Self-Coherence Environment," in *Proc. Twenty-Second Asilomar Conf. Signals, Systems, Comp.*, Nov. 1988.
- B. Agee, "The Baseband Modulus Restoral Approach to Blind Adaptive Signal; Demodulation," 1988 Digital Signal Processing; Workshop, Sep. 1988.
- B. Agee, S. Schell, W. Gardner, "The SCORE Approach to Blind Adaptive Signal Extraction; An Application of the Theory of Spectral Correlation," in *Proc. Fourth ASSP Workshop on Spectrum Estimation and Modelling*, p. 277, Aug. 1988.
- B. Agee, "The Least-Squares CMA: A New Approach to Rapid Correction of Constant Modulus Signals," in *Proc. 1986 International Conf. on Acoustics, Speech and Signal Processing*, vol. 2, p. 19.2.1, Apr. 1986, Tokyo, Japan.
- M.C. Bromberg, B. Agee, "The Transmit Beamforming for Optimizing Network; Capacity," Jun. 26, 2001.
- B. Agee, "Blind Separation and Capture of Communication Signals Using a Multitarget Constant Modulus Beamformer," Adapted from a paper published in *Proc. 1989 IEEE Military Comm. Conference*, Oct. 1989.
- B. Agee, "Fast Acquisition of Burst and Transient Signals Using a Predictive Adaptive Beamformer," Adapted from a paper published in *Proc. 1989 IEEE Military Communications Conference*, Oct. 1989.
- B. Agee, "Convergent Behavior of Modulus-Restoring Adaptive Arrays in Gaussian Interference Environments," in *Proc. Twenty-Second Asilomar Conf. Signals, Systems and Computers*, Nov. 1988.
- Swales, et. al., *IEEE Trans. Veh. Technol.* vol. 39 No. 1 Feb. 1990.
- Agee, B., Reed, J., Kleinman, R., "Application of Eigenstructure Techniques to Blind Despreading of Direct-Sequence Spread Spectrum Signals," Dec. 3, 1990.
- Agee, B., "Array-Based Techniques for Wireless Telephony," 1995 IEEE Communications Theory Workshop, Apr. 25, 1995.
- Kelly, P., Agee, B., Radix Technologies, Inc., "The Backtalk Communications; Airlink," Jan. 18, 1998.
- B. Agee, C. Clark, Radix Technologies, "Technical Challenges to Network Based; Commercial Geolocation, A Defense Technologist's Perspective," 1997 MPRG Symposium on Wireless Personal Communications, Jun. 12, 1997.
- Agee, B., "Efficient Allocation of RF Transceiver Resources in Spatially; Adaptable; Communication Networks," Jun. 4, 2003.
- Bromberg, M., "A Quick Primer on the LEGO Algorithm," 2002. Radix Technologies, "Live Data MT-CMA Test," 1997.
- Agee, B., "LMS/Part 15 Internetwork Interference Study Results-to-Date," Feb. 23, 2001.
- Agee, B., Kelly, Phillip, Radix Technologies, "The Backtalk™ Airlink for Full Exploitation of Spectral and Spatial Diversity in Wireless Communication Systems," Fourth Workshop on Smart Antennas in Wireless Mobile Communications, Jul. 24, 1997.
- Bromberg, M.C., "A Hilbert Space Algebra", Masters Thesis in Mathematics, May 1986.
- Bromberg, M.C., Brown, D., "The Use of Programmable DSPs in Antenna Array; Processing," May 28, 2008.
- Bromberg, M.C. "Reliable, High Capacity, Multipoint, Wireless Information Networks," Date Unknown.
- Bromberg, M.C., "Optimizing MIMO Multipoint Wireless Networks Assuming Gaussian Other-User Interference." *IEEE Transactions on Information Theory*, vol. 49, No. 10, Oct. 2003. (IEEE Proof).
- Bromberg, M., Agee, B., "Using Channel Reciprocity to Optimize Network Capacity," Oct. 2, 2000.
- Agee, B. "Full-Duplex LPI/AJ Communications Using Blindly-Adapted; Retrodirective Antenna Arrays," Project "Backtalk" Final Report (Annotated; Briefing), Mar. 31, 1994.
- Agee, B., "Technical Evaluation of Wireless Broadband Issues & Equipment ;Alternatives EPRI," BWA Technical Evaluation Final Report Nov. 19, 1999.
- Agee, B., "4G Network Enhancements Using the ETSI Digital Audio Broadcast; Standard," DAB Application to 4G GWCom Network Jan. 4, 2001.
- Agee, B., "Capacity Analysis of LMS Network Scenarios Operating in a Part 15 Network Environment," Apr. 25, 1999.
- Agee, B., "Introduction of Smart Antennas Into the Metricom Wireless Data Network Overview, Players, and Application," Aug. 6, 1999.
- Agee, B., "4G Airlink Enhancements to the Metricom Recochet System," 4G Airlink/Technology Concepts, Dec. 21, 1999.
- Stutzman, W., Barts, M., "The Stub Loaded Helix Antenna," 1999.
- Agee, B., "Performance of the Multitarget Modulus Restoral Algorithm Against the KEYSTROKE Data Set," Apr. 6, 1990.
- Agee, B., Young, D., "Blind Capture and Geolocation of General Spatially Self-Coherent Waveforms Using Multiplatform SCORE," Maple Press, 1990.
- Biedka, T., Agee, B., "Subinterval Cyclic Music—Robust DF with Error in Cycle Frequency Knowledge," 1991.
- Bromberg, M., Agee, B., "The LEGO Approach for Achieving Max-Min Capacity In Reciprocal Multipoint Networks," 2001.
- Mendoza, R., Reed, J., Hsia, T., Agee, B., "Interference Rejection Using Time-Dependent Constant Modulus Algorithms," 1989.
- Schell, S., Calabretta, R., Gardner, W., Agee, B., "Cyclic Music Algorithms for Signal-Selective Direction Estimation," 1989.
- Agee, B., Protean Radio Networks, "WLAN Reconnaissance," Jan. 13, 2003.
- Agee, B., Protean Radio Networks, "The PHY-IASM MIMO Network Capable Transceiver: Concept and IP Overview," May 20, 2004.
- Agee, B., "Orion Phase A Algorithms," Final Design Review, Algorithms Overview Jul. 17-18, 1996 (FDR Date), Jul. 19, 1996.
- Bromberg, M., Agee, B., "Using Channel Reciprocity to Optimize Network Capacity," May 11, 2000.
- Bromberg, M., Agee, B., "An Analysis of the LEGO Algorithm for Optimizing the Performance of Wireless of Wireless Networks," *Thirty Fourth Asilomar Conf. Signals, Systems, and Computers*, Oct. 2000, and in *Proceedings of the Thirty Fifth Asilomar Conf. Signals, Systems, and Computers*, Nov. 2001.
- Bromberg, M. Agee, B., "The LEGO Technique for Optimizing the Performance of Wireless, MultiUser, MIMO Channel, TDD Networks," Dec. 28, 2000.
- Bromberg, M. Agee, B., "The LEGO Technique for Locally Enabled Global Optimization of Reciprocal Multinode Communication Networks," Feb. 5, 2001.
- Agee, B., "OFDM-Based SSICS Capabilities Demonstration," Aug. 11, 2000.

- Agee, B., Young, D., "Blind Capture and Geolocation of General Spatially Coherent Waveforms Using Multiplatform SCORE," Presented in Proc. Twenty-Fourth Asilomar Conf. on Signals, Systems, and Computers, 1990. Maple Press.
- Agee, B., Young, D., "Blind Capture and TDOA Estimation of Stationary Waveforms Using Multiplatform Temporal Cross Coherence Restoral," Nov. 4, 1990.
- Office Action Summary from U.S. Appl. No. 09/878,789 which was mailed on Apr. 25, 2005.
- Office Action Summary from U.S. Appl. No. 09/878,789 which was mailed on Oct. 12, 2005.
- Office Action Summary from U.S. Appl. No. 09/878,789 which was mailed on Oct. 19, 2006.
- Notice of Allowance from U.S. Appl. No. 09/878,789 which was mailed on Dec. 13, 2007.
- IEEE Std 802.16e™-2005 and IEEE Std 802.16™-2004/Cor1-2005 (Amendment and Corrigendum to "IEEE Std 802.16/2004), IEEE Standard for Local and metropolitan area networks, Part 16: Air Interface for Fixed and Mobile Broadband Wireless Access Systems, Amendment 2: Physical and Medium Access Control Layers for Combined Fixed and Mobile Operation in Licensed Bands and Corrigendum 1," Feb. 28, 2006.
- IEEE Std 802.11a-1999 (R2003) (Supplement to IEEE Std 802.11-1999) [Adopted by ISO/IEC and redesignated as ISO/IEC 8802-11:1999/Amd 1:2000(E)], "Supplement to IEEE Standard for Information technology—Telecommunications and information exchange between systems—Local and metropolitan area networks—Specific requirements, Part 11: Wireless LAN Medium Access Control (MAC) and Physical Layer (PHY) specifications, Higher-Speed physical Layer in the 5 GHz Band," Reaffirmed Jun. 12, 2003.
- IEEE Std 802.11b-1999 (R2003) (Supplement to ANSI/IEEE Std 802.11, 1999 Edition) "Supplement to IEEE Standard for Information technology—Telecommunications and information exchange between systems—Local and metropolitan area networks—Specific requirements, Part 11: Wireless LAN Medium Access Control (MAC) and Physical Layer (PHY) specifications, Higher-Speed Physical Layer Extension in the 2.4 GHz Band," Reaffirmation Jun. 12, 2003, Approved Sep. 16, 1999.
- IEEE Std 802.11g™-2003, (Amendment to IEEE Std 802.11™, 1999 Edition (Reaff 2003) as amended by IEEE Stds 802.11a™-1999, 802.11b™-1999, 802.11b™-1999/Cor 1-2001, and 802.11d™-2001), "IEEE Standard for Information technology—Telecommunications and information exchange between systems—Local and metropolitan area networks—Specific requirements, Part 11: Wireless LAN Medium Access Control (MAC) and Physical Layer (PHY) specifications, Amendment 4: Further Higher Data Rate Extension in the 2.4 GHz Band," Jun. 27, 2003.
- IEEE Std 802.11n™-2009, (Amendment to IEEE Std 802.11™-2007, as amended by IEEE Std 802.11k™-2008, IEEE Std 802.11r™-2008, IEEE Std 802.11y™-2008, and IEEE Std 802.11w™-2009), "IEEE Standard for Information technology—Telecommunications and information exchange between systems—Local and metropolitan area networks—Specific requirements, Part 11: Wireless LAN Medium Access Control (MAC) and Physical Layer (PHY) specifications, Amendment 5: Enhancements for Higher Throughput," Oct. 29, 2009.
- IEEE Std 802.16™-2009 (Revision of IEEE Std 802.16/2004), "IEEE Standard for Local and metropolitan area networks, Part 16: Air Interface for Broadband Wireless Access Systems," May 29, 2009.
- IEEE Std 802.11 e/D4.3, May 2003 (Draft Supplement to IEEE Std 802.11, 1999 Edition), "Draft Supplement to Standard for Telecommunications and Information Exchange Between Systems—LAN/MAN Specific Requirements—Part 11: Wireless Medium Access Control (MAC) and Physical Layer (PHY) specification: Medium Access Control (MAC) Enhancements for Quality of Service (QoS)," Copyright 2003.
- 3GPP TS 36.101 V8.0.0 (Dec. 2007) *Technical Specification*, "3rd Generation Partnership Project: Technical Specification Group Radio Access Network; Evolved Universal Terrestrial Radio Access (E-UTRA); User Equipment (UE) radio transmission and reception (Release 8)," Copyright 2007.
- 3GPP TS 36.101 V9.5.0 (Oct. 2010) *Technical Specification*, 3rd Generation Partnership Project; Technical Specification Group Radio Access Network; Evolved Universal Terrestrial Radio Access (E-UTRA); User Equipment (UE) radio transmission and reception (Release 9), Copyright 2010.
- Office Action from U.S. Appl. No. 13/022,615 which was mailed on Nov. 21, 2011.
- Office Action from U.S. Appl. No. 13/022,619 which was mailed on Dec. 23, 2011.
- Office Action from U.S. Appl. No. 13/022,622 which was mailed on Dec. 15, 2011.
- Office Action from U.S. Appl. No. 13/022,623 which was mailed on Oct. 6, 2011.
- Chunchang et al, "On the Performance of Eigen Based Beamforming in LTE-Advanced," Sep. 2009, Personal, Indoor and Mobile Radio Communications (PIMRC), 2009 IEEE 20th International Symposium on.
- Farrokh Rashid-Farrokhi, "Transmit Beamforming and Power Control for Cellular Wireless Systems," IEEE Journal on Selected Areas in Communications, vol. 16, No. 8, Oct. 1998.
- J. H. Chang et al., "Joint Transmitter and Receiver Beamforming for Maximum Capacity in Spatial Division Multiaccess." Proc. 35th Annual Allerton Conf. on Communication, Control and Computing in Spatial Division Multiaccess, 1997.
- S. Verdu, "The Capacity Region of the Symbol-Asynchronous Gaussian Multiple-Access Channel," *IEEE Transactions on Information Theory*, vol. 35, No. 4, Jul. 1989.
- B. Suard, G. Xu, H. Liu, T. Kailath, "Uplink Channel Capacity of Space-Division-Multiple-Access Schemes," *IEEE Transactions on Information Theory*, vol. 44, No. 4, Jul. 1998.
- B. Suard, G. Xu, H. Liu, T. Kailath, "Channel Capacity of Spatial Division Multiple Access Schemes," *1994 Conference Record of the Twenty-Eighth Asilomar Conference on Signals, Systems, and Computers*, vol. 2, pp. 1159-1163, 1994.
- G. Raleigh, V. Jones, "Adaptive Antenna Transmission for Frequency Duplex Digital Wireless Communication," *Proc. IEEE ICC*, vol. 2, pp. 641-646, Jun. 1997.
- 3rd Generation Partnership Project, Technical Specification Group GERAN, "Digital cellular telecommunications system (Phase 2+); Physical layer on the radio path; General description," Release 4, 3GPP TS 45.001, V4.0.1, Oct. 2000.
- 3rd Generation Partnership Project, Technical Specification Group GSM/EDGE "Radio Access Network; Digital cellular telecommunications system (Phase 2+); Multiplexing and multiple access on the radio path," Release 4, 3GPP TS 45.002, V4.3.0, Apr. 2001.
- 3rd Generation Partnership Project, Technical Specification Group GERAN, "Channel coding," Release 4, 3GPP TS 45.003, V4.0.0, Jan. 2001.
- 3rd Generation Partnership Project, Technical Specification Group GSM/EDGE Radio Access Network, "Digital cellular telecommunications system (Phase 2+); Modulation," Release 4, 3GPP TS 45.004, V4.0.0, Apr. 2001.
- 3rd Generation Partnership Project, Technical Specification Group GSM/EDGE Radio Access Network, "Digital cellular telecommunications system (Phase 2+); Radio transmission and reception," Release 4, 3GPP TS 45.005, V4.3.0, Apr. 2001.
- 3rd Generation Partnership Project, Technical Specification Group GSM/EDGE Radio Access Network, "Digital cellular telecommunications system (Phase 2+); Radio subsystem link control," Release 4, 3GPP TS 45.008, V4.3.0, Apr. 2001.
- 3rd Generation Partnership Project, Technical Specification Group GERAN, "Link Adaptation," Release 4, 3GPP TS 45.009, V4.0.0, Jan. 2001.
- 3rd Generation Partnership Project, Technical Specification Group GSM/EDGE Radio Access Network, "Digital cellular telecommunications system (Phase 2+); Radio subsystem synchronization," Release 4, 3GPP TS 45.010, V4.0.0, Apr. 2001.
- 3rd Generation Partnership Project, Technical Specification Group Radio Access Network, "Physical channels and mapping of transport channels onto physical channels (FDD)," Release 199, 3GPP TS 25.211, V3.6.0, Mar. 2001.

(56)

References Cited

OTHER PUBLICATIONS

3rd Generation Partnership Project, Technical Specification Group Radio Access Network, "Multiplexing and channel coding (FDD)," Release 1999, 3GPP TS 25.212, V3.5.0, Dec. 2000.

3rd Generation Partnership Project, Technical Specification Group Radio Access Network, "Spreading and modulation (FDD)," Release 1999, 3GPP TS 25.213, V3.5.0, Mar. 2001.

3rd Generation Partnership Project, Technical Specification Group Radio Access Network, "Physical layer procedures (FDD)," Release 1999, 3GPP TS 25.214, V3.6.0, Mar. 2001.

3rd Generation Partnership Project, Technical Specification Group Radio Access Network, "Physical channels and mapping of transport channels onto physical channels (TDD)," Release 1999, 3GPP TS 25.221, V3.6.0, Mar. 2001.

3rd Generation Partnership Project, Technical Specification Group Radio Access Network, "Multiplexing and channel coding (TDD)," Release 1999, 3GPP TS 25.222, V3.6.0, Mar. 2001.

3rd Generation Partnership Project, Technical Specification Group Radio Access Network, "Spreading and modulation (TDD)," Release 1999, 3GPP TS 25.223, V3.5.0, Mar. 2001.

3rd Generation Partnership Project, Technical Specification Group Radio Access Network, "Physical Layer Procedures (TDD)," Release 1999, 3GPP TS 25.224, V3.6.0, Mar. 2001.

3rd Generation Partnership Project, Technical Specification Group Radio Access Network, "MAC protocol specification," Release 1999, 3GPP TS 25.321, V3.7.0, Mar. 2001.

3rd Generation Partnership Project, Technical Specification Group Radio Access Network, "Packet Data Convergence Protocol (PDCP) Specification," Release 1999, 3GPP TS 25.323, V3.4.0, Mar. 2001.

Office Action Summary in U.S. Appl. No. 13/010,629 dated Aug. 14, 2012.

Notice of Allowance in U.S. Appl. No. 13/022,615 mailed Apr. 16, 2012.

Notice of Allowance in U.S. Appl. No. 13/022,619 mailed Apr. 27, 2012.

Notice of Allowance in U.S. Appl. No. 13/022,622 dated Aug. 17, 2012.

* cited by examiner

Primary Examiner — Charles Craver

(74) *Attorney, Agent, or Firm* — Banner & Witcoff, Ltd.

(57)

ABSTRACT

Using at least one MIMO-capable transceiver allows weighting calculations for signals transmitted and received, and enables individual packets to adapt, in a scalable, flexible, and responsive fashion to the real-world dynamics of a continuously varying communications network environment. The method and system of this invention use adaptively-derived diversity means to rapidly and efficiently distinguish the desired signal from noise, network interference, and external interference impinging on the network's transceivers and can transmit with lessened overhead. ADC operations and signal transformations continuously update combiner weights to match dynamically-varying environmental and traffic conditions, thereby continuously matching necessitated signal and waveform transformations with environmental and signal effects and sources. Successive iterations of the adaptation algorithm let each node's multipoint combiner and distribution weights approach the MIMO channel's Shannon capacity in high-rate networks, or to minimize power needed to close links at a specified rate in low-rate networks, e.g. Voice-Over-IP networks.

98 Claims, 54 Drawing Sheets

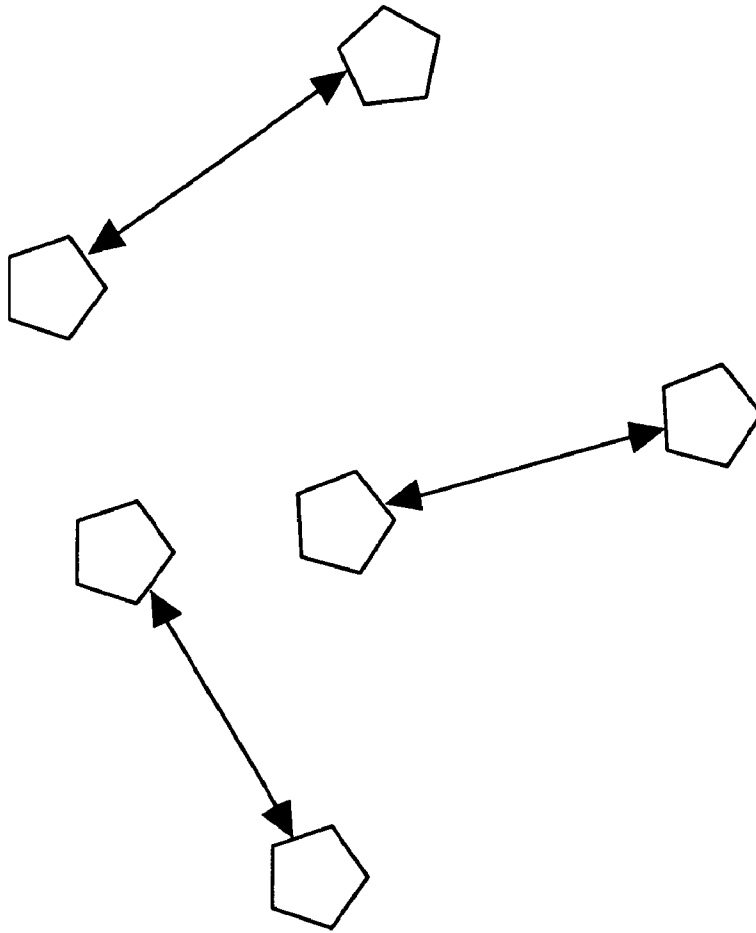

FIG. 1
Prior Art

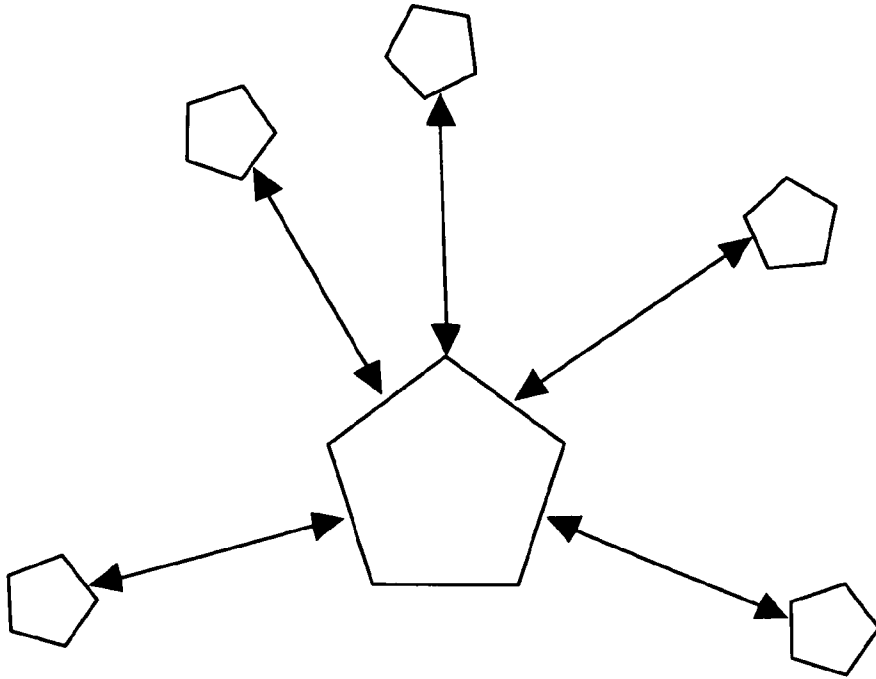

FIG. 2
Prior Art

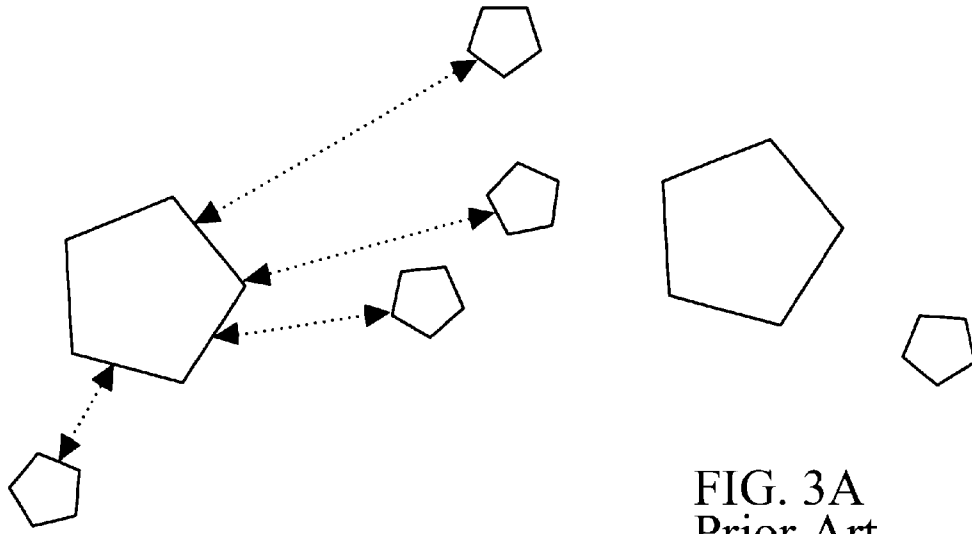

FIG. 3A
Prior Art

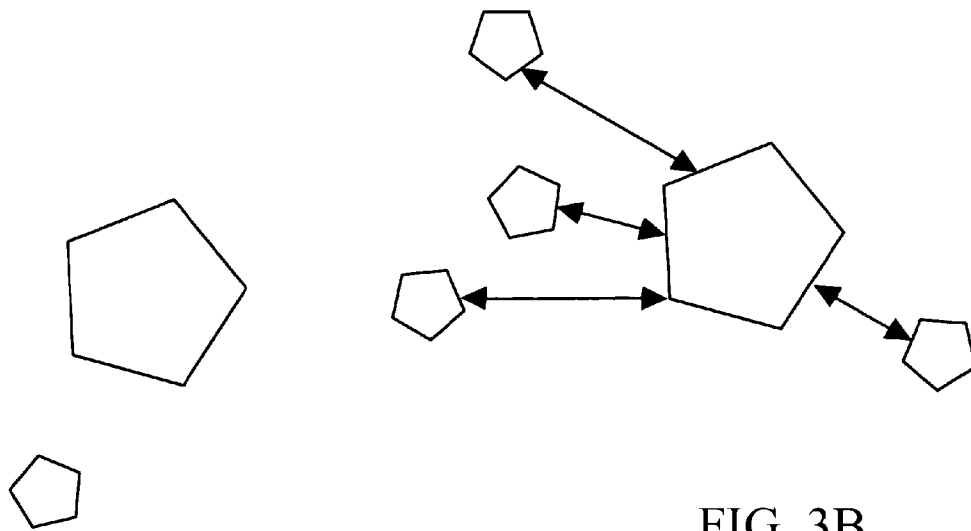

FIG. 3B
Prior Art

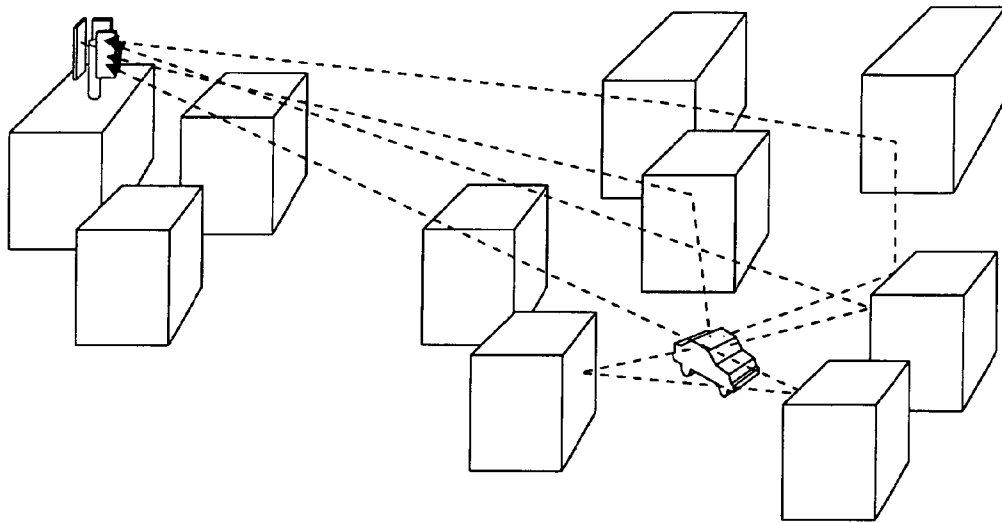

FIG. 4
Prior Art

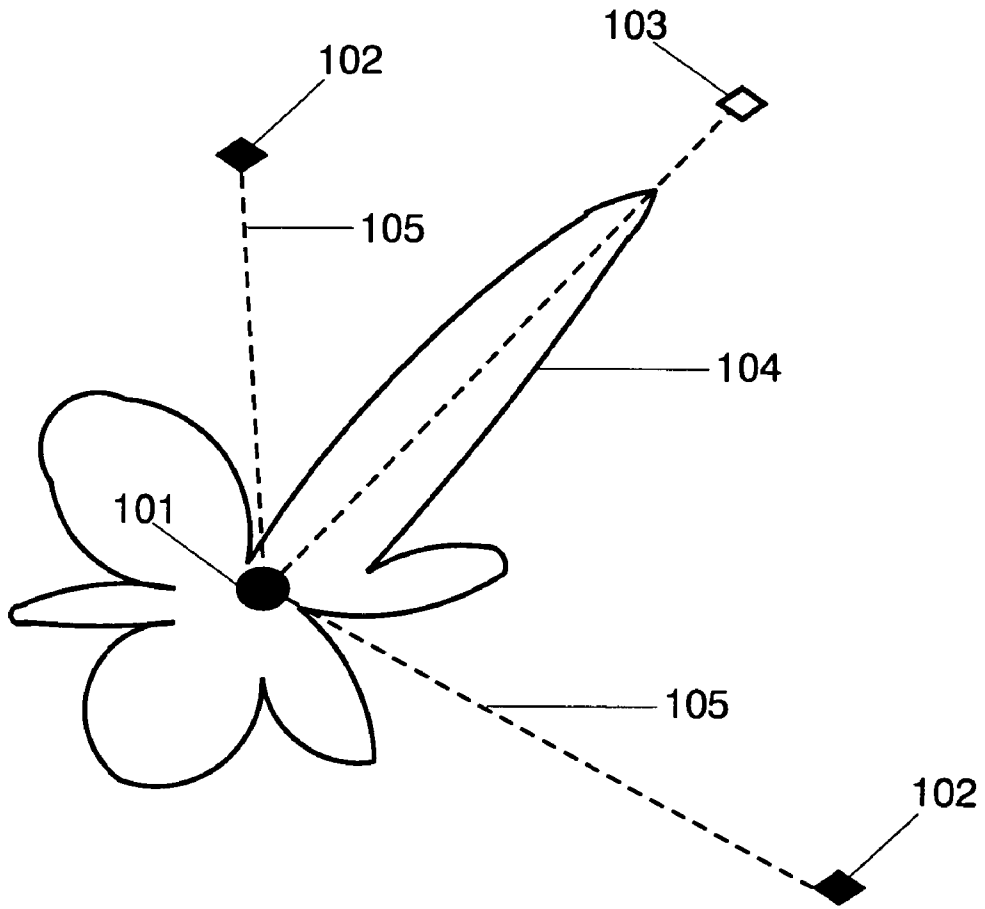
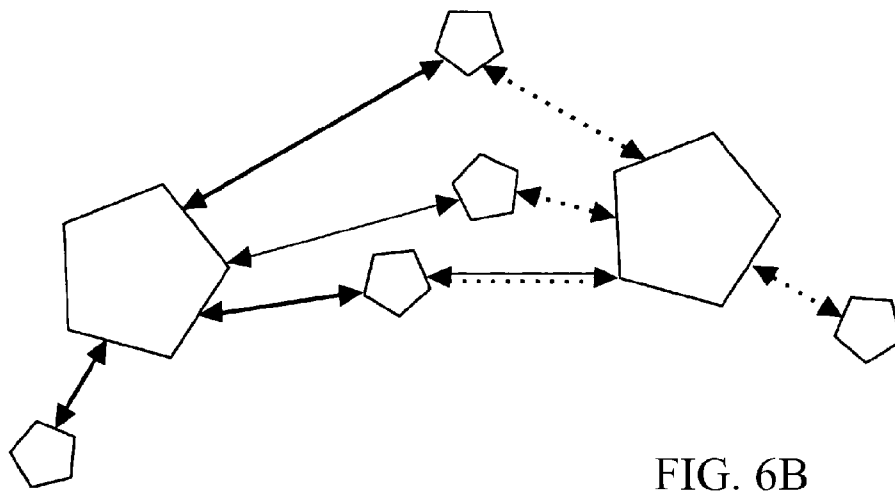
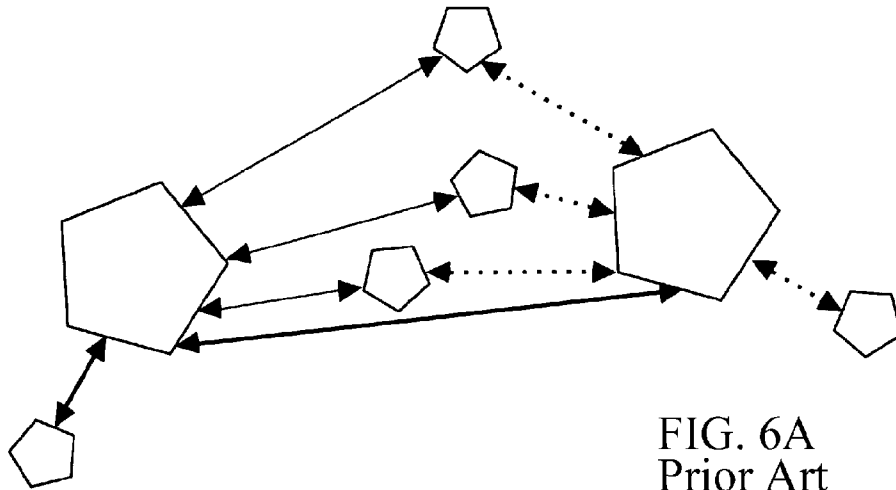

FIG. 5
Prior Art



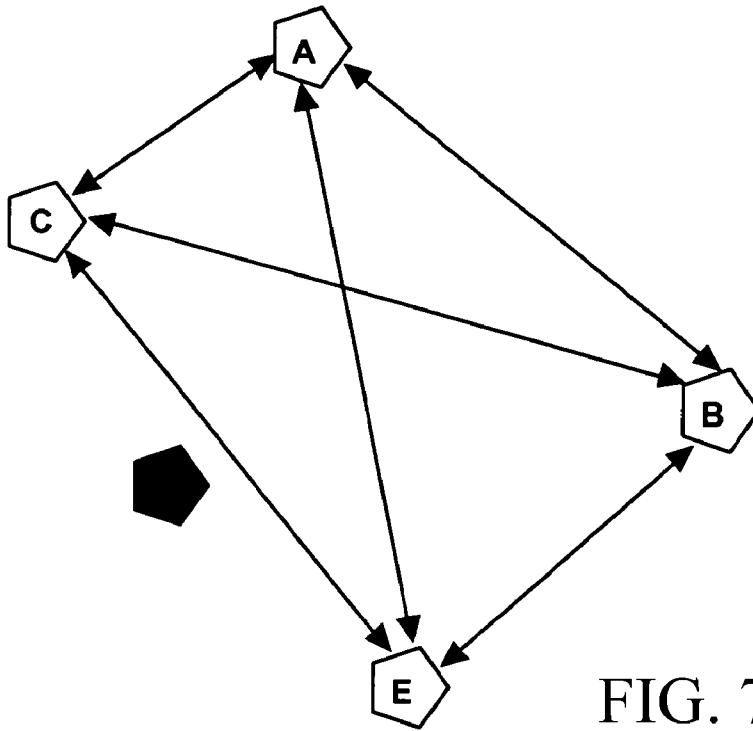

FIG. 7A
Prior Art

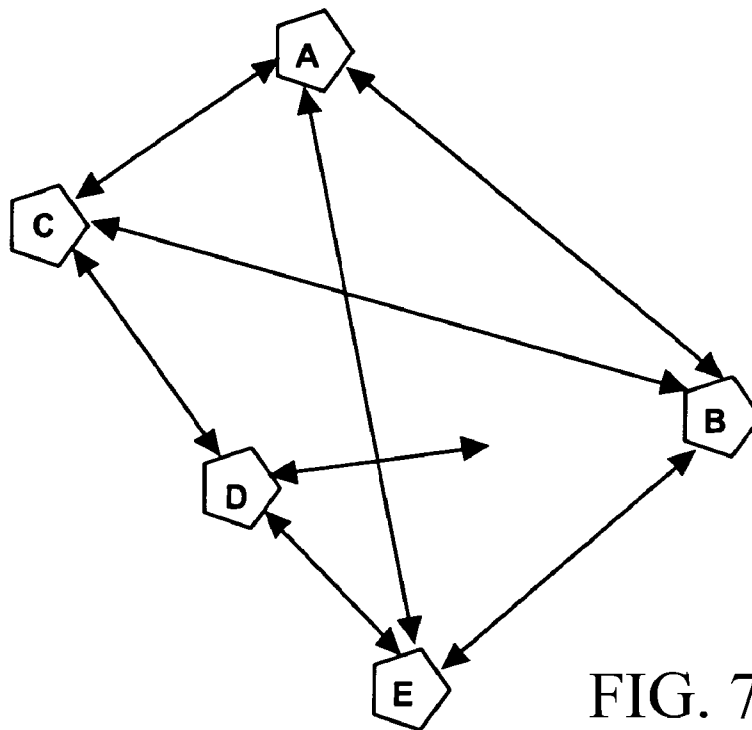

FIG. 7B
Prior Art

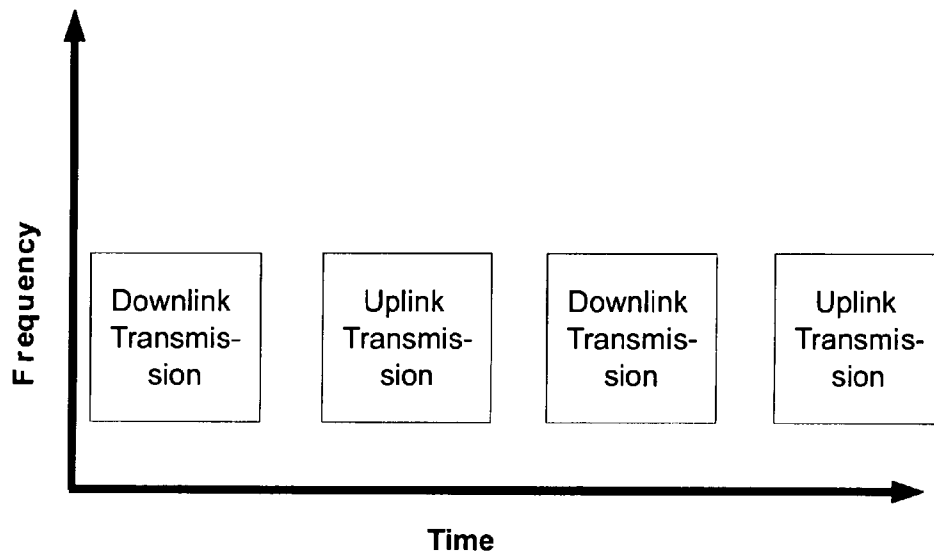

FIG. 8
Prior Art

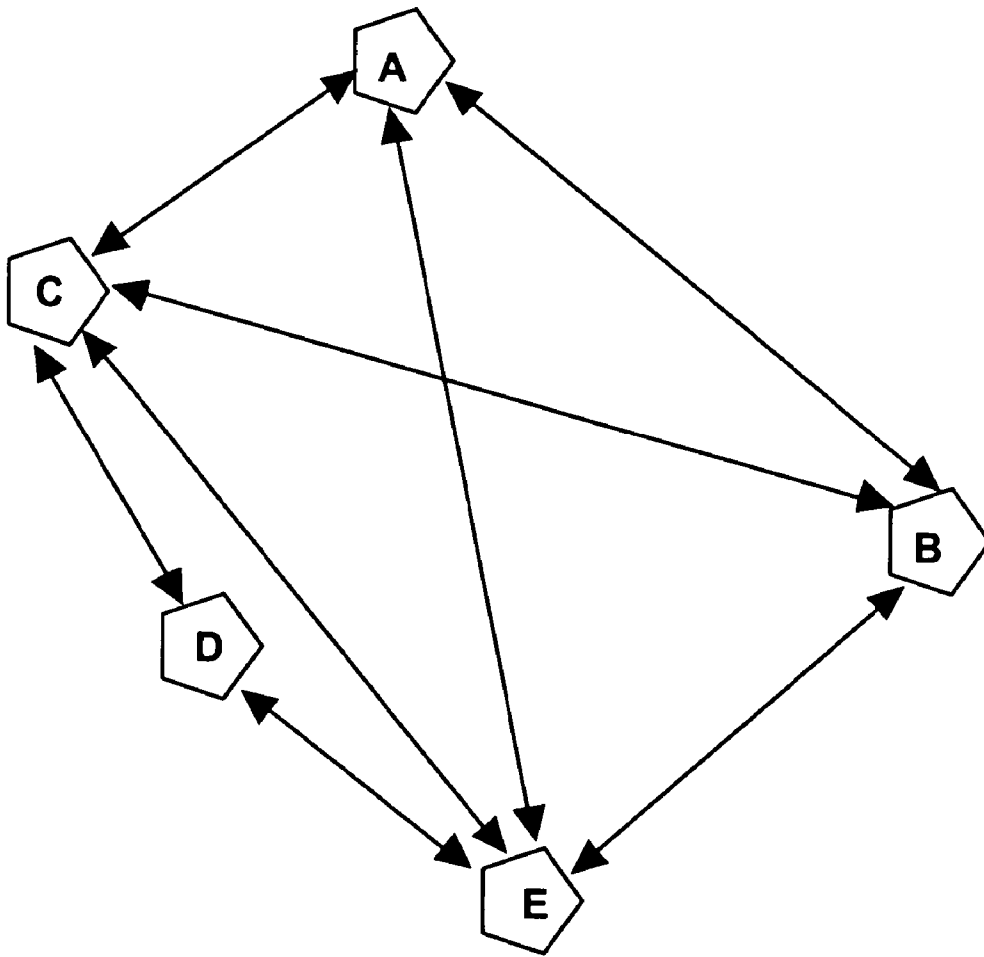

FIG. 9
Prior Art

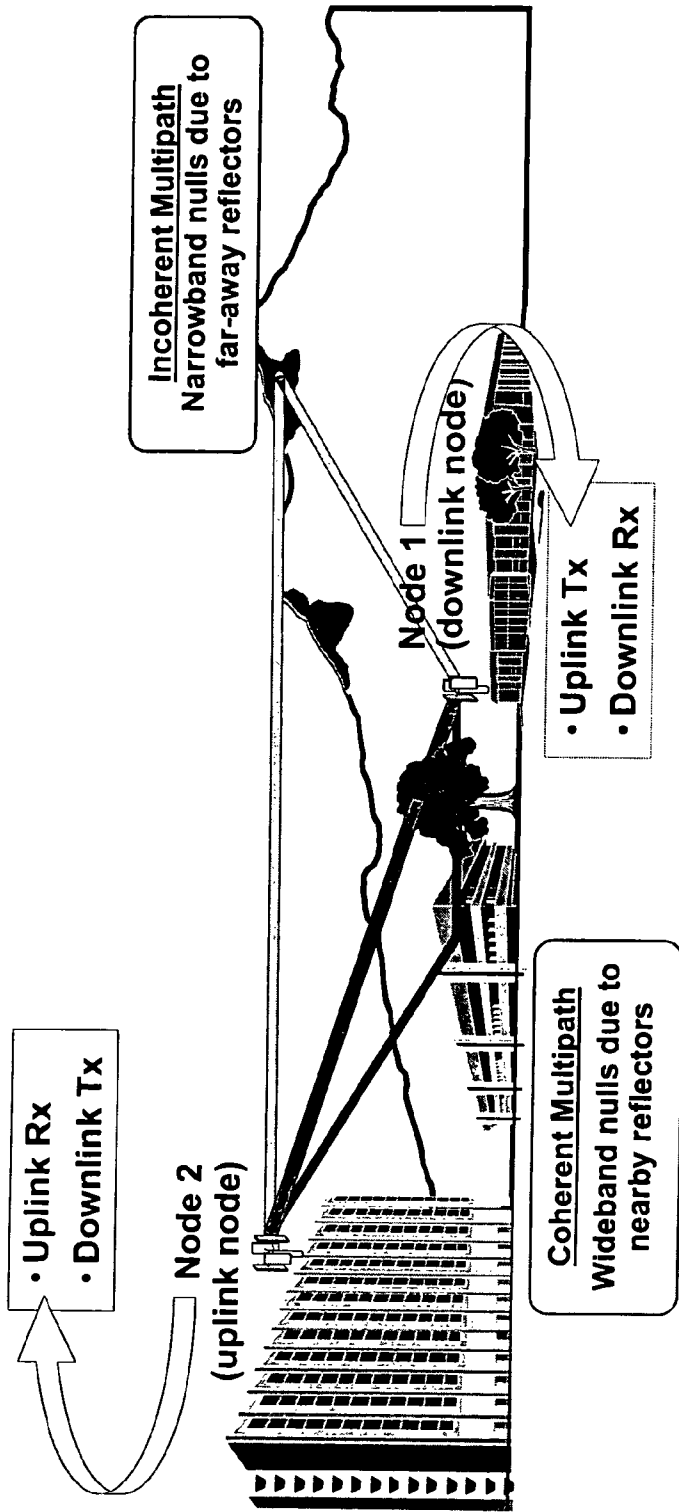

FIG. 10
Prior Art

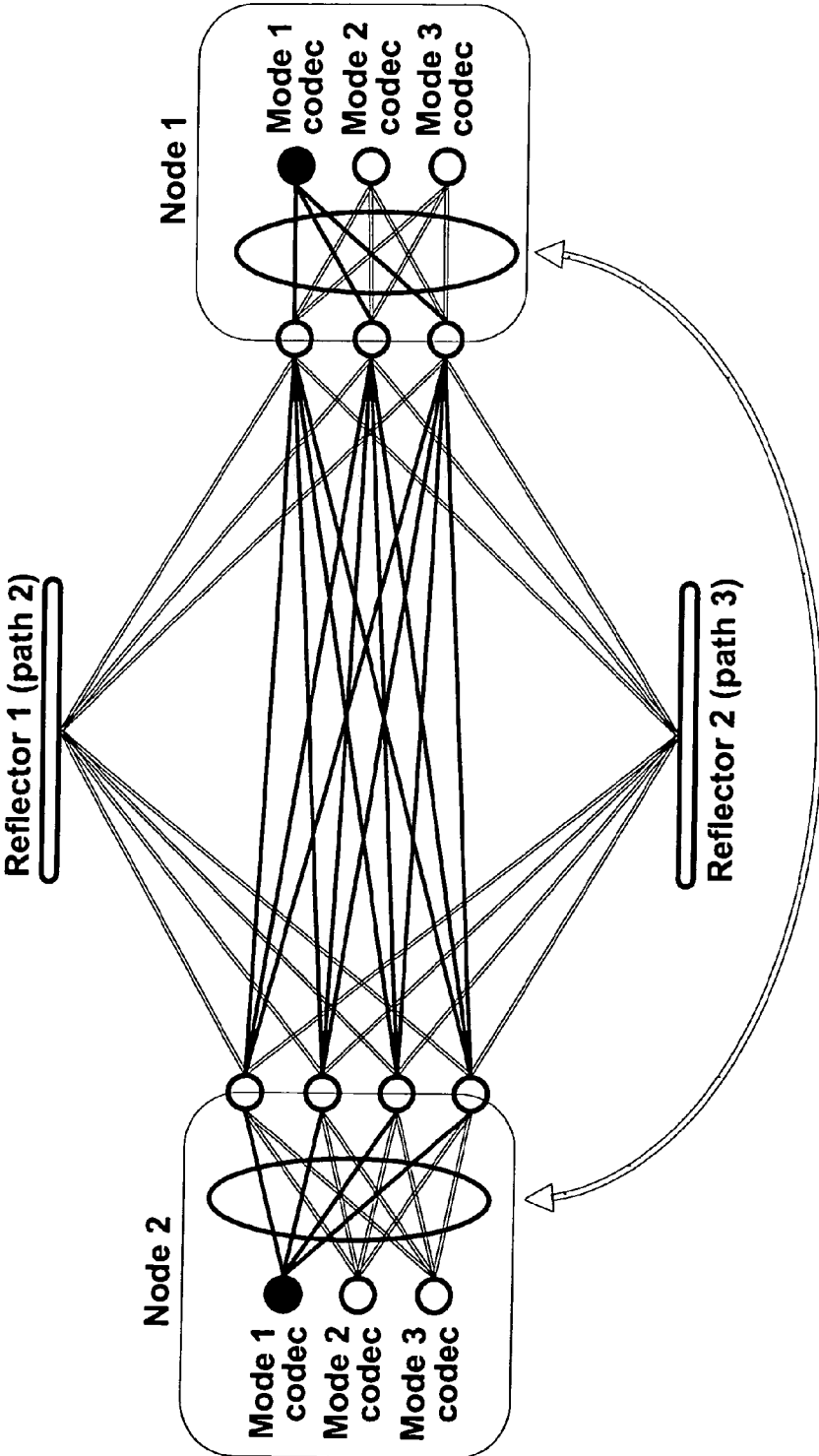

FIG. 11
Prior Art

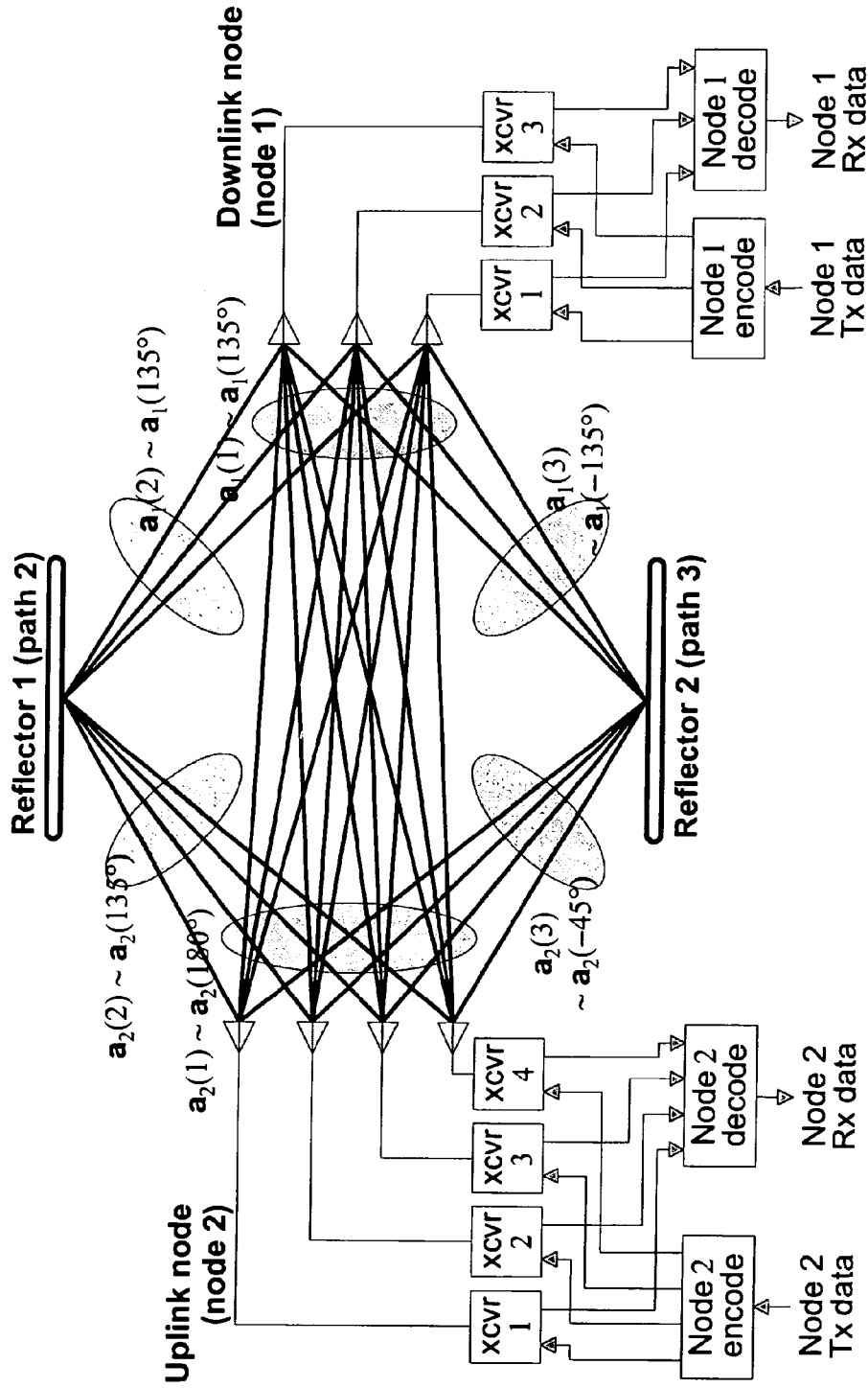
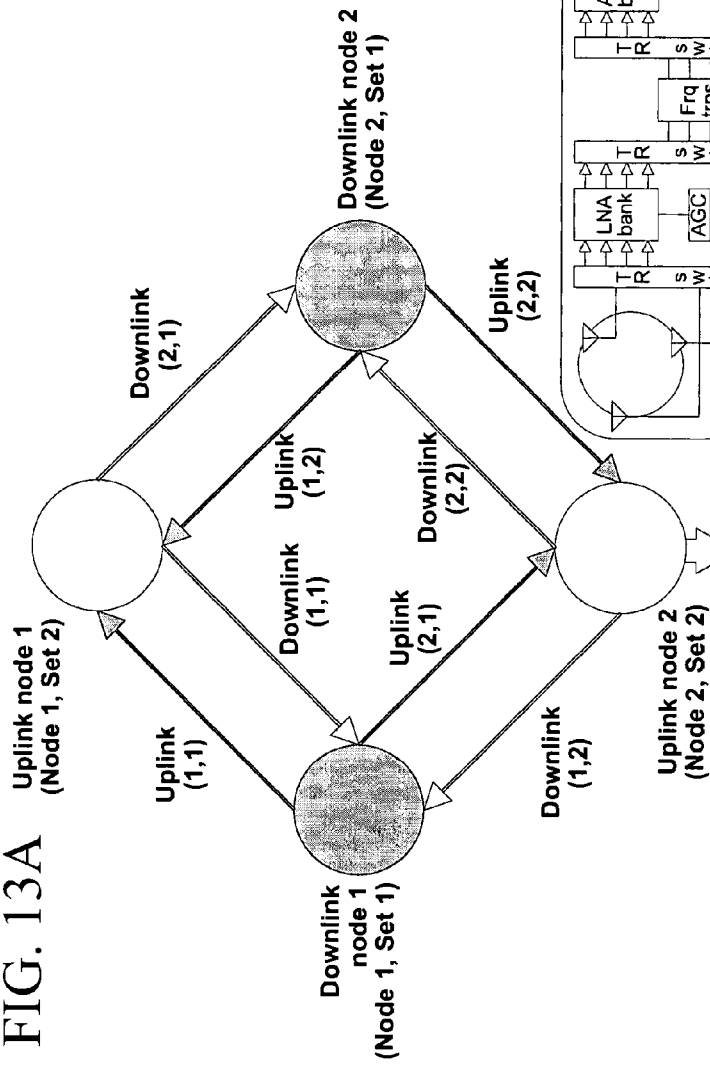

FIG. 12
Prior Art

FIG. 13A



frq chn l, \dots, m
time slot t
 $\{s_l(t; k, l)\}_{l=1, \dots, L}$
frq chn K, \dots, m
time slot t

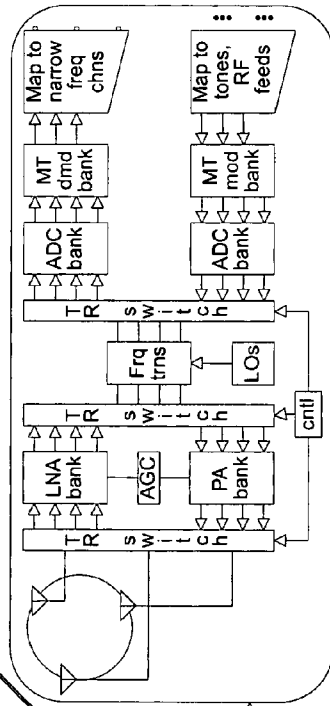

FIG. 13B

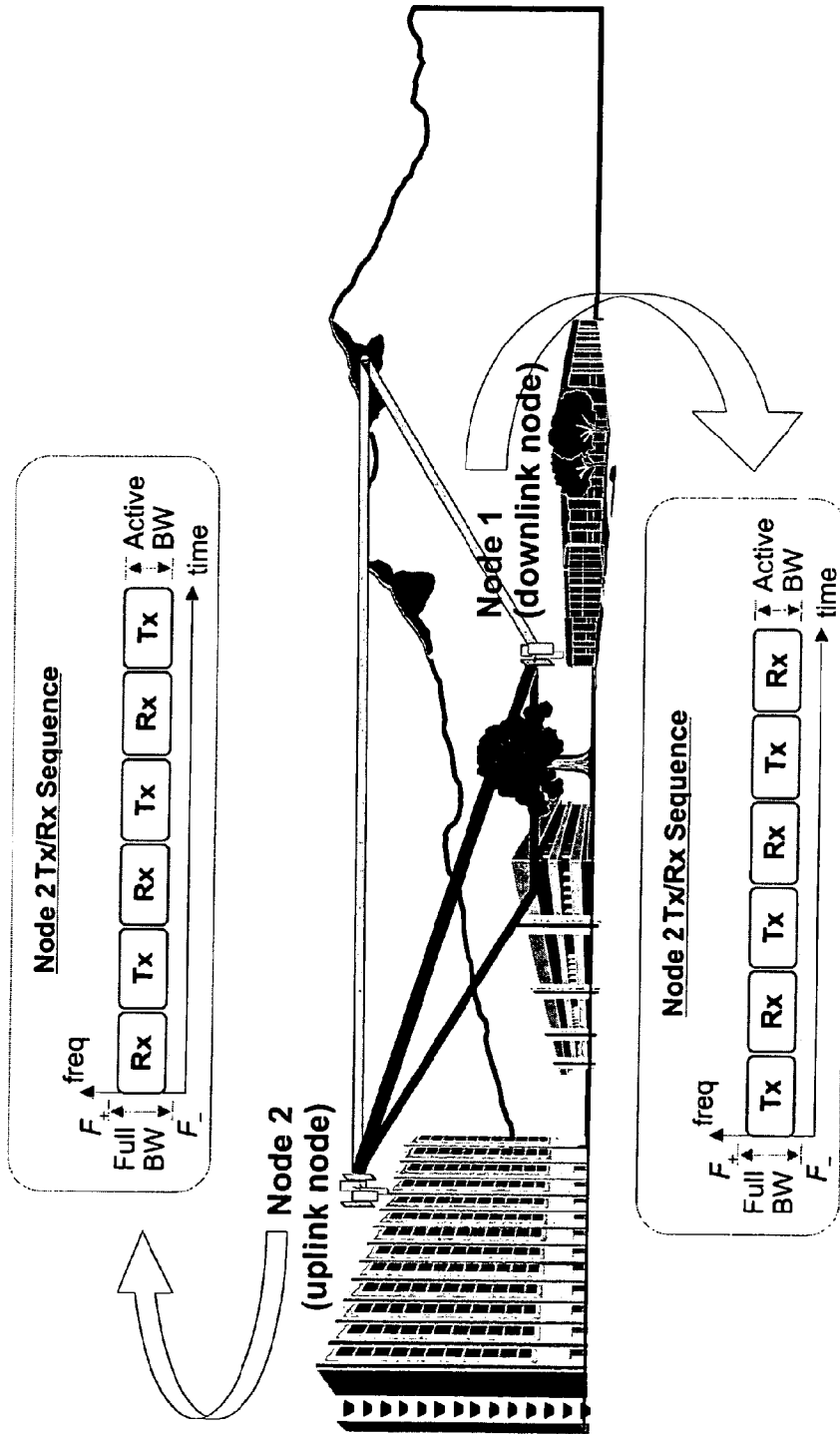

FIG. 14
Prior Art

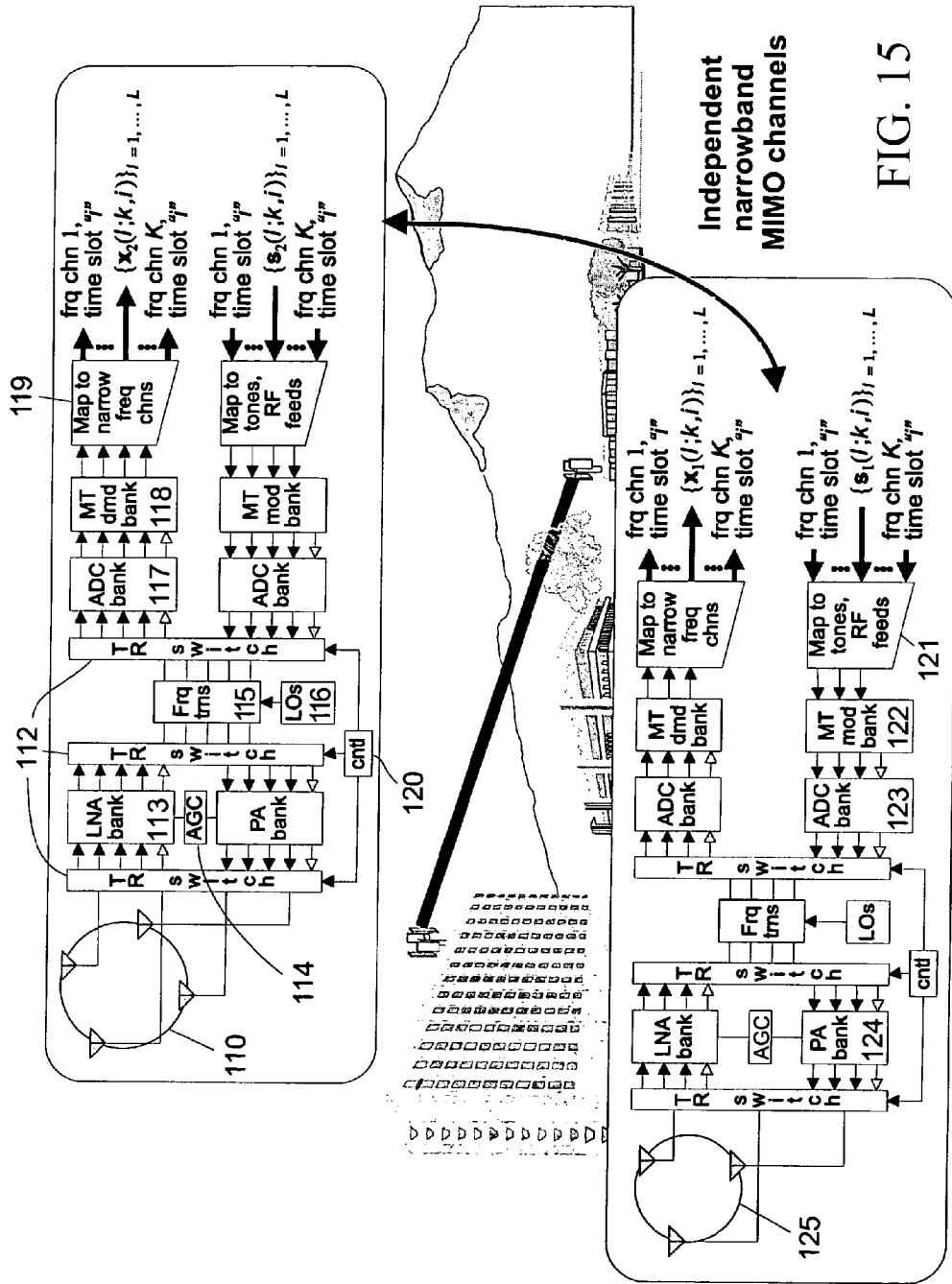

FIG. 15

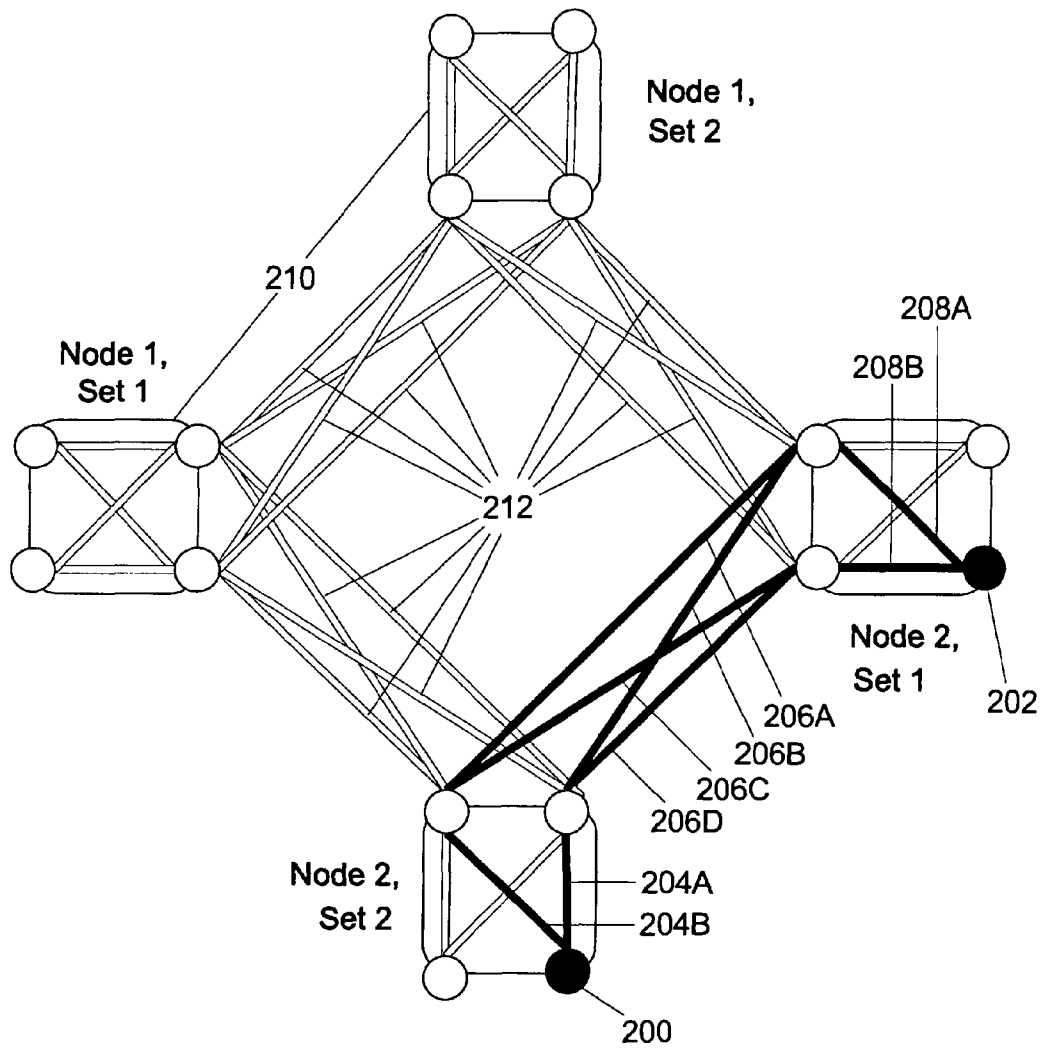

FIG. 16

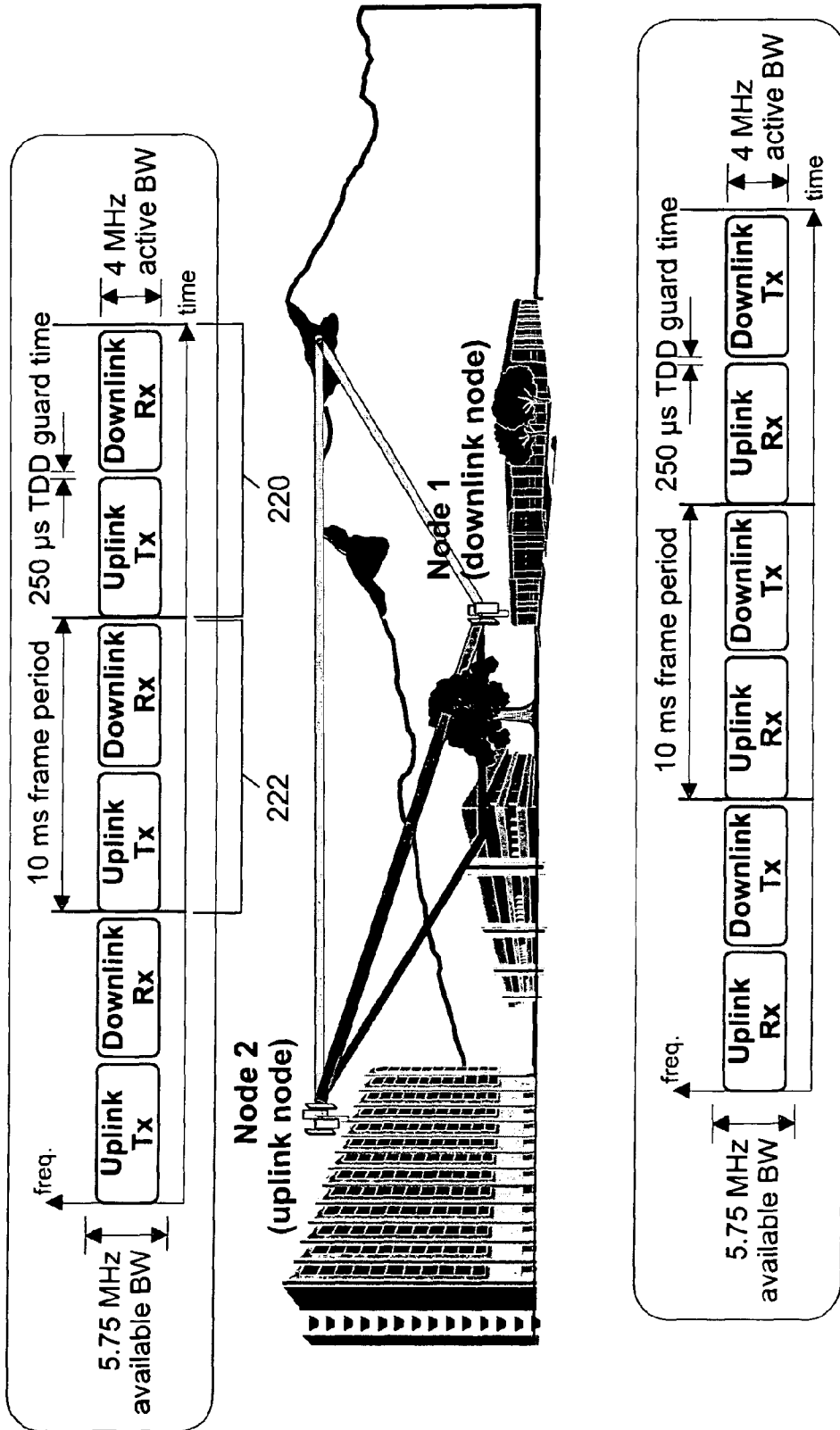

FIG. 17

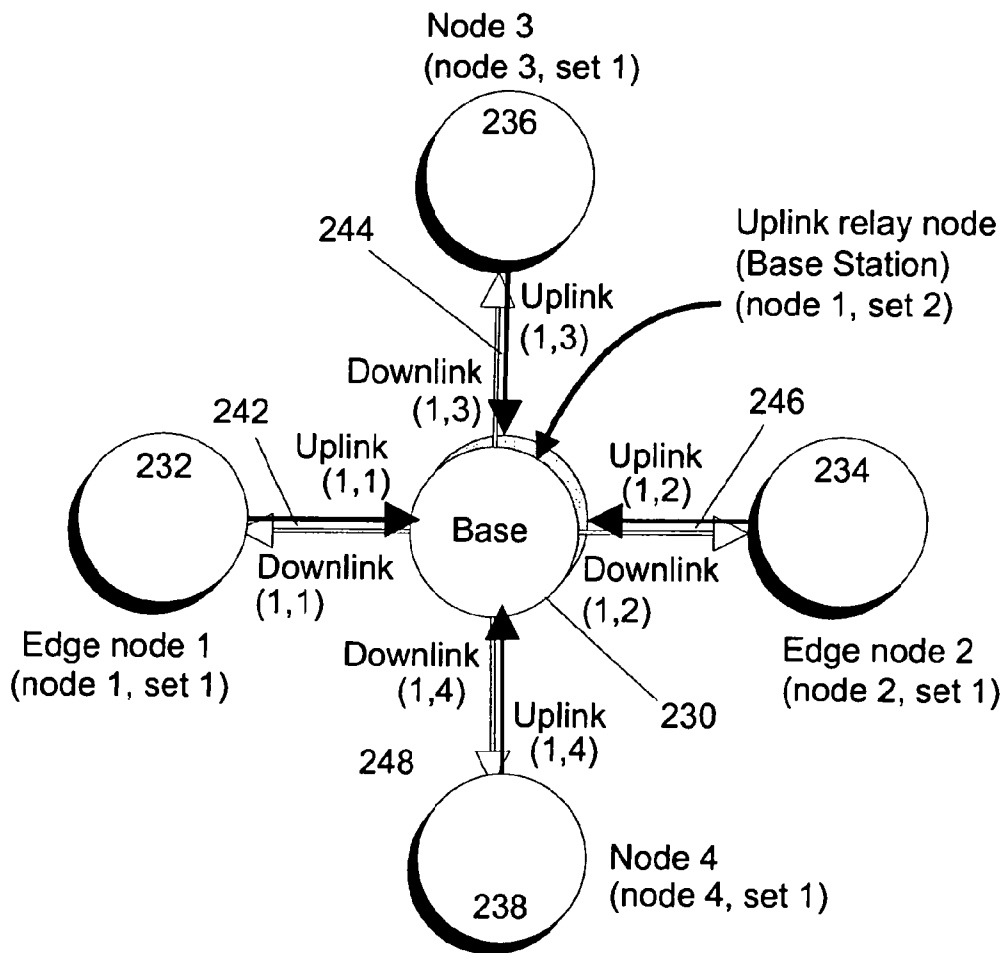

FIG. 18

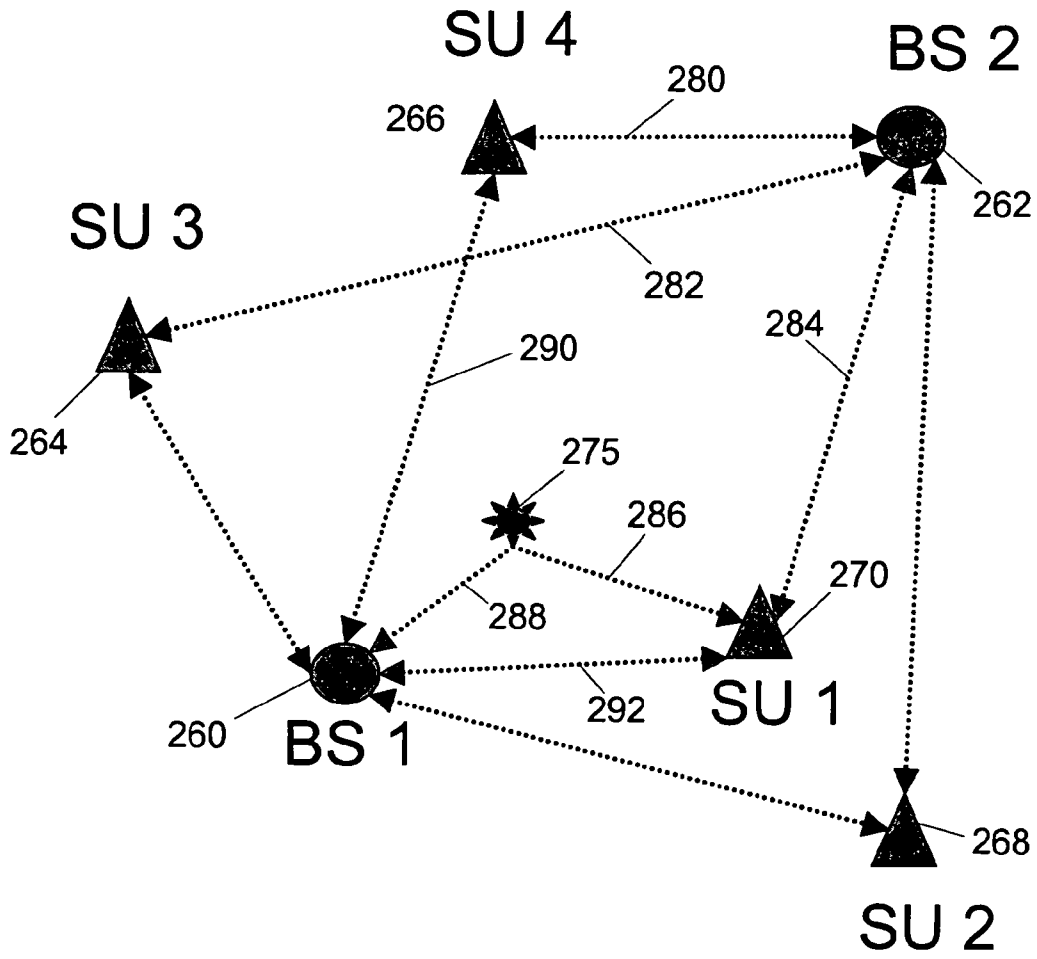

FIG. 19

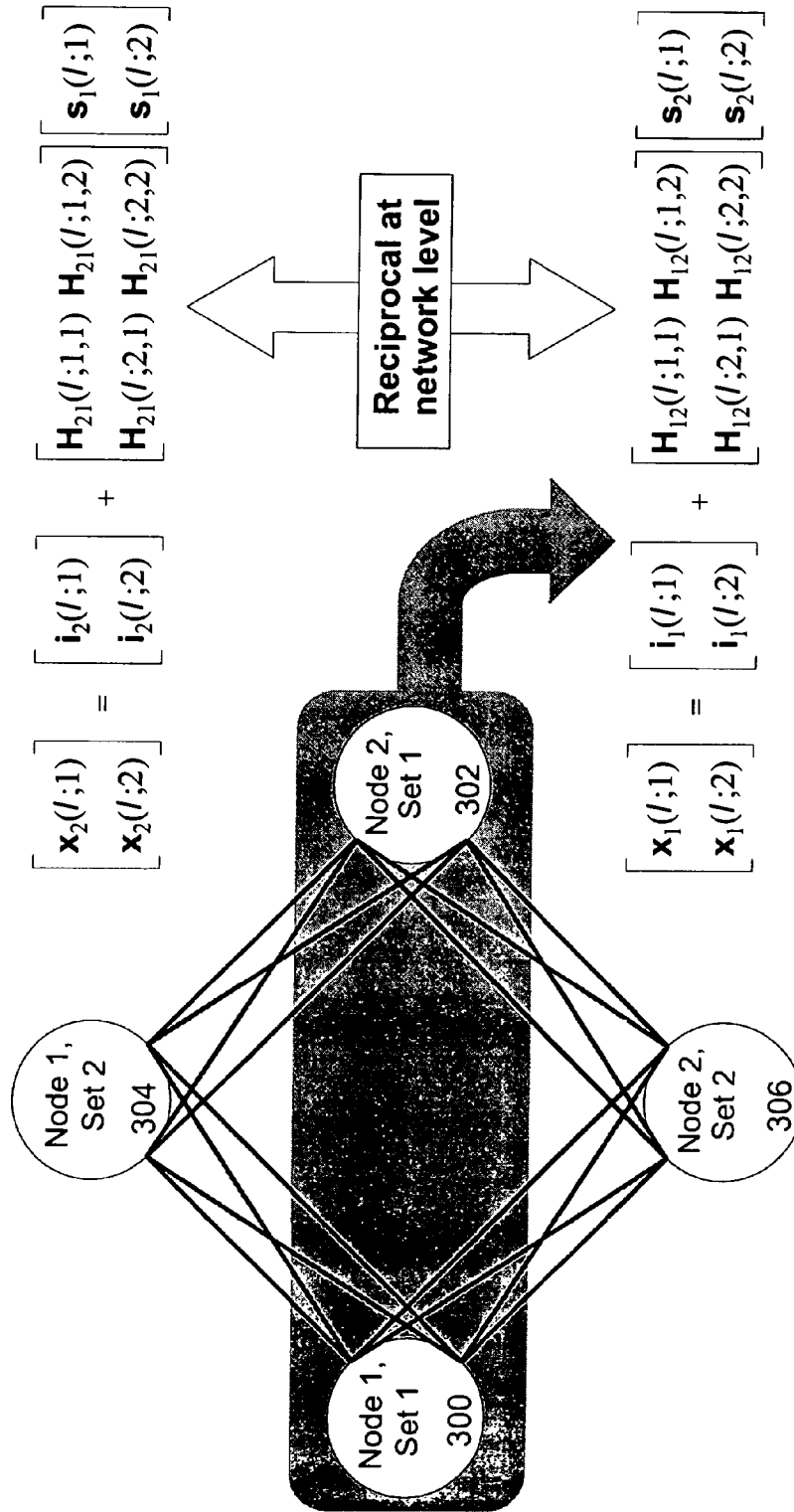

FIG. 20

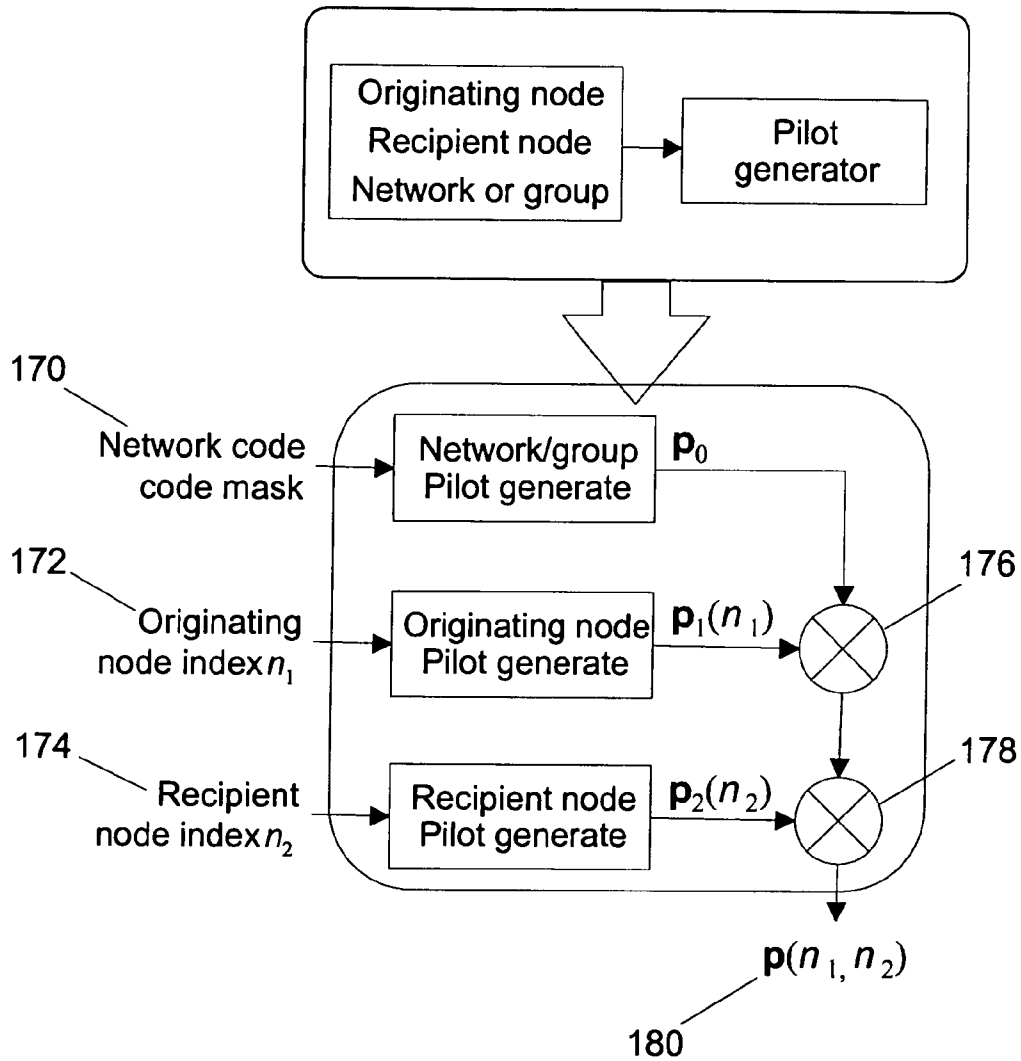

FIG. 21

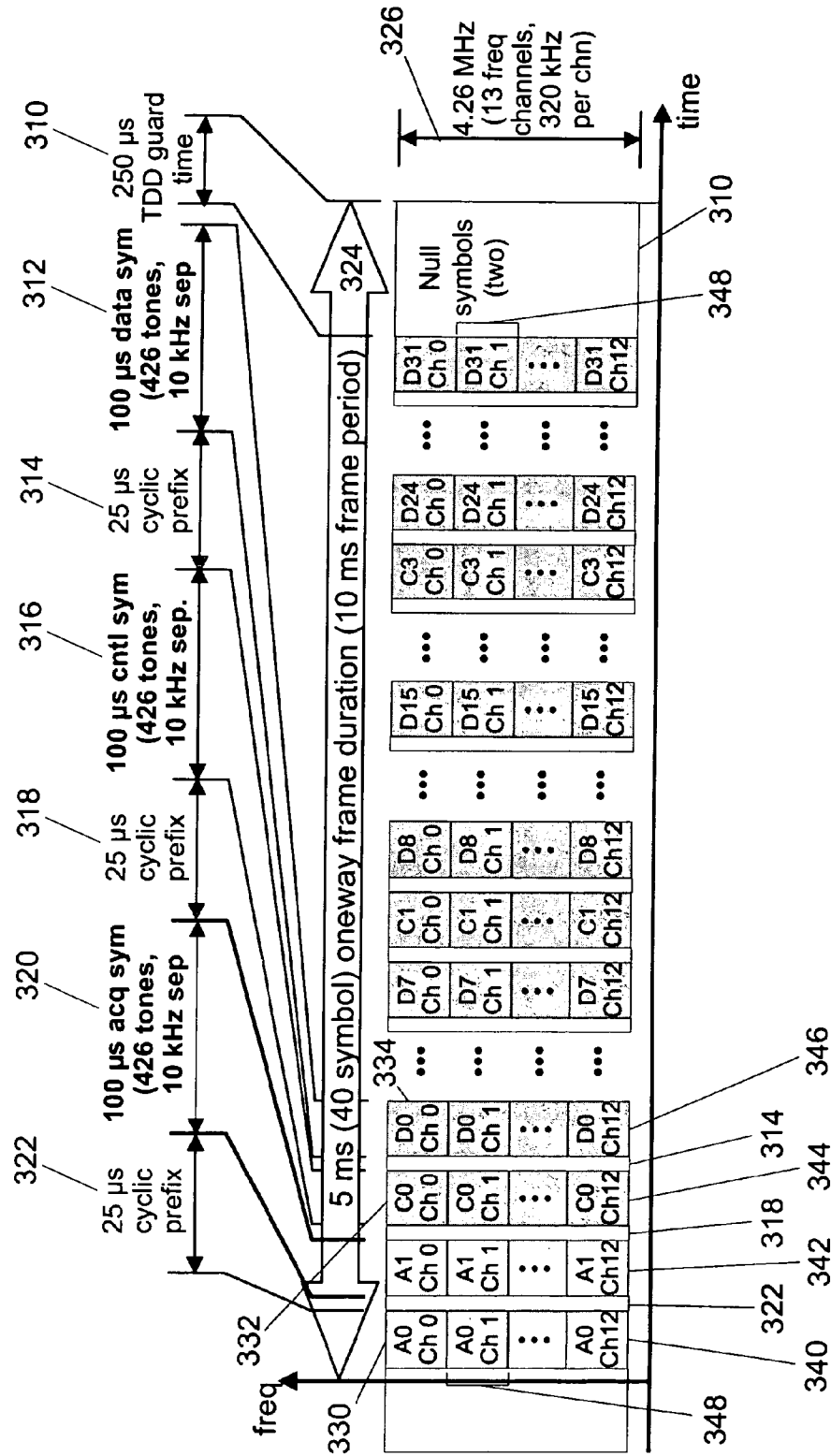

FIG. 22

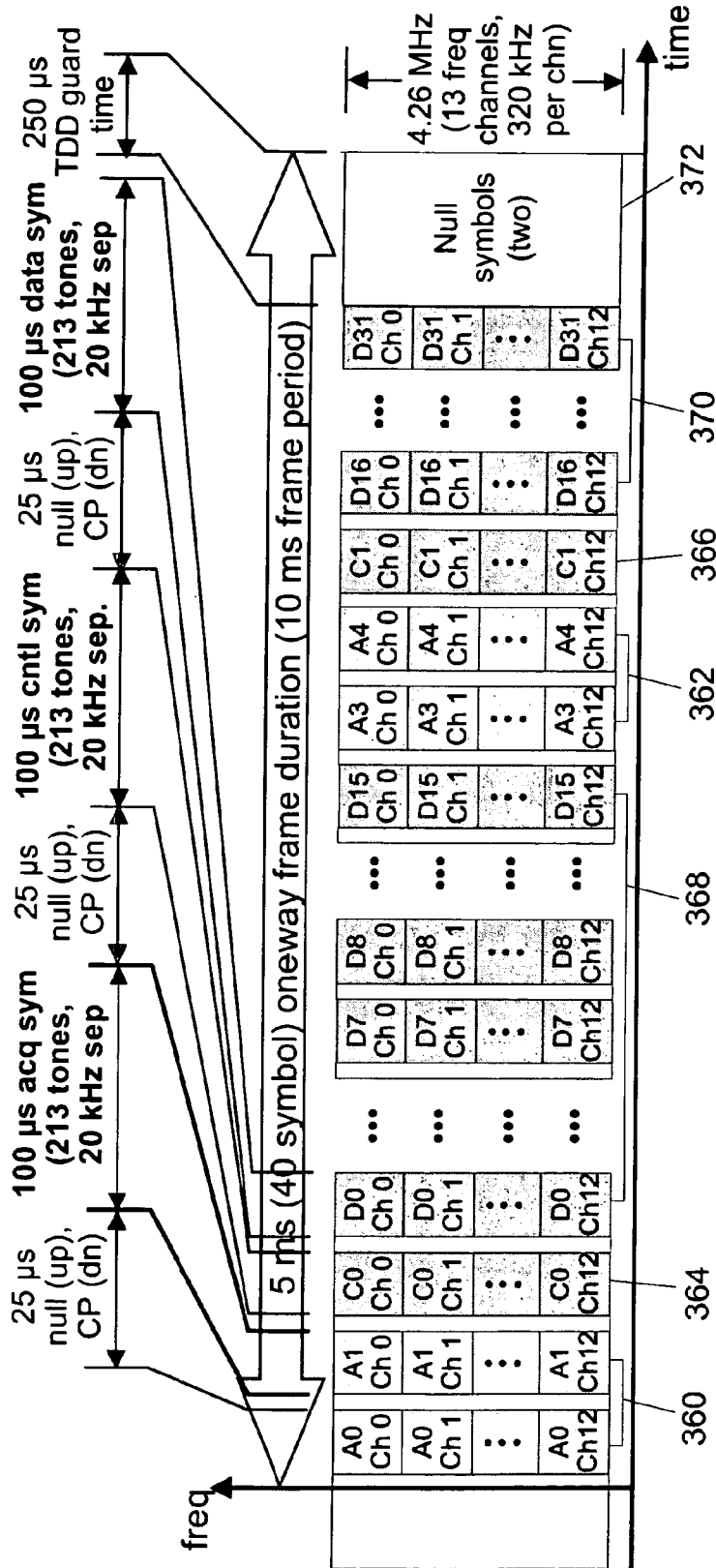

FIG. 23

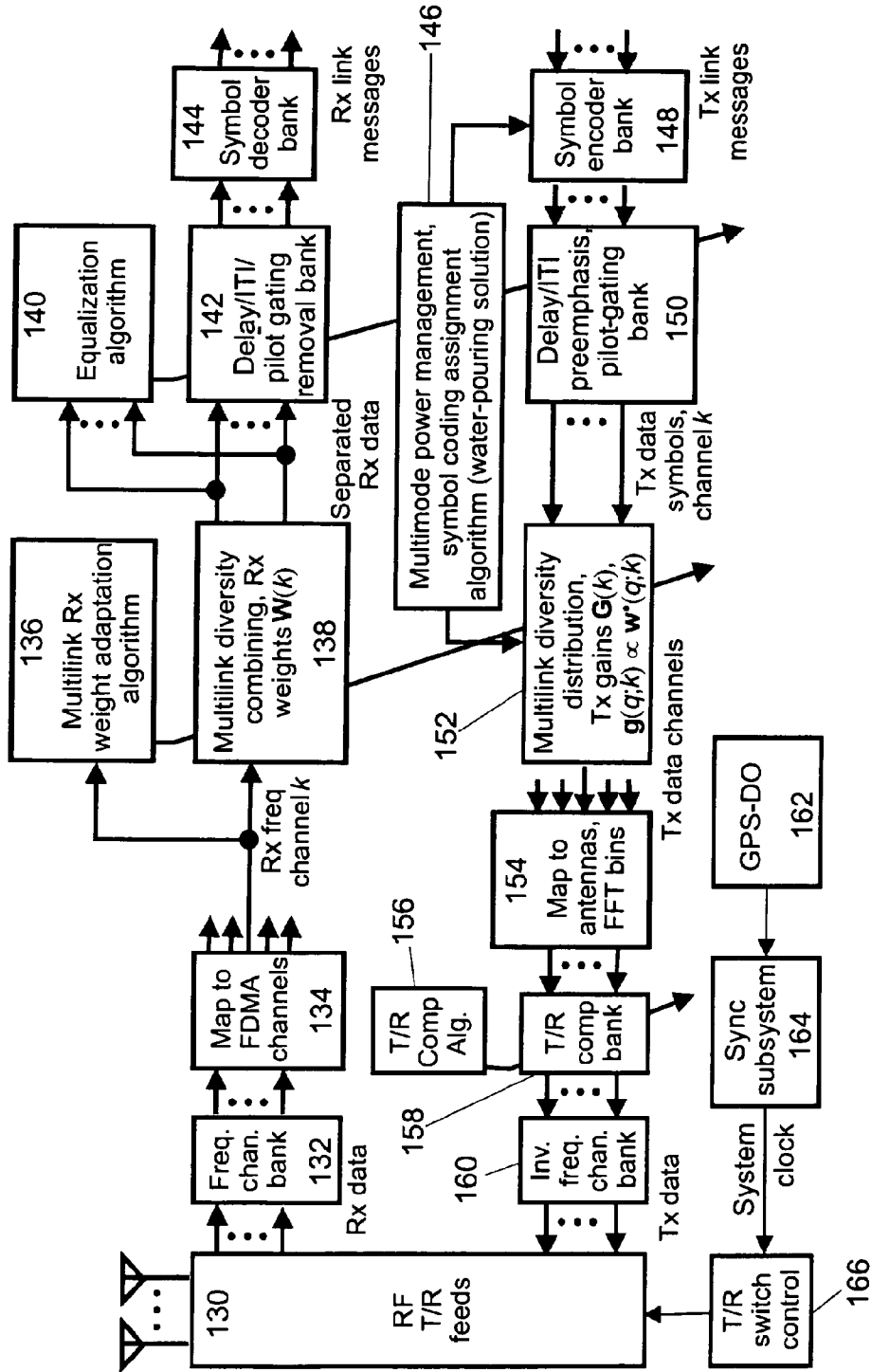

FIG. 24

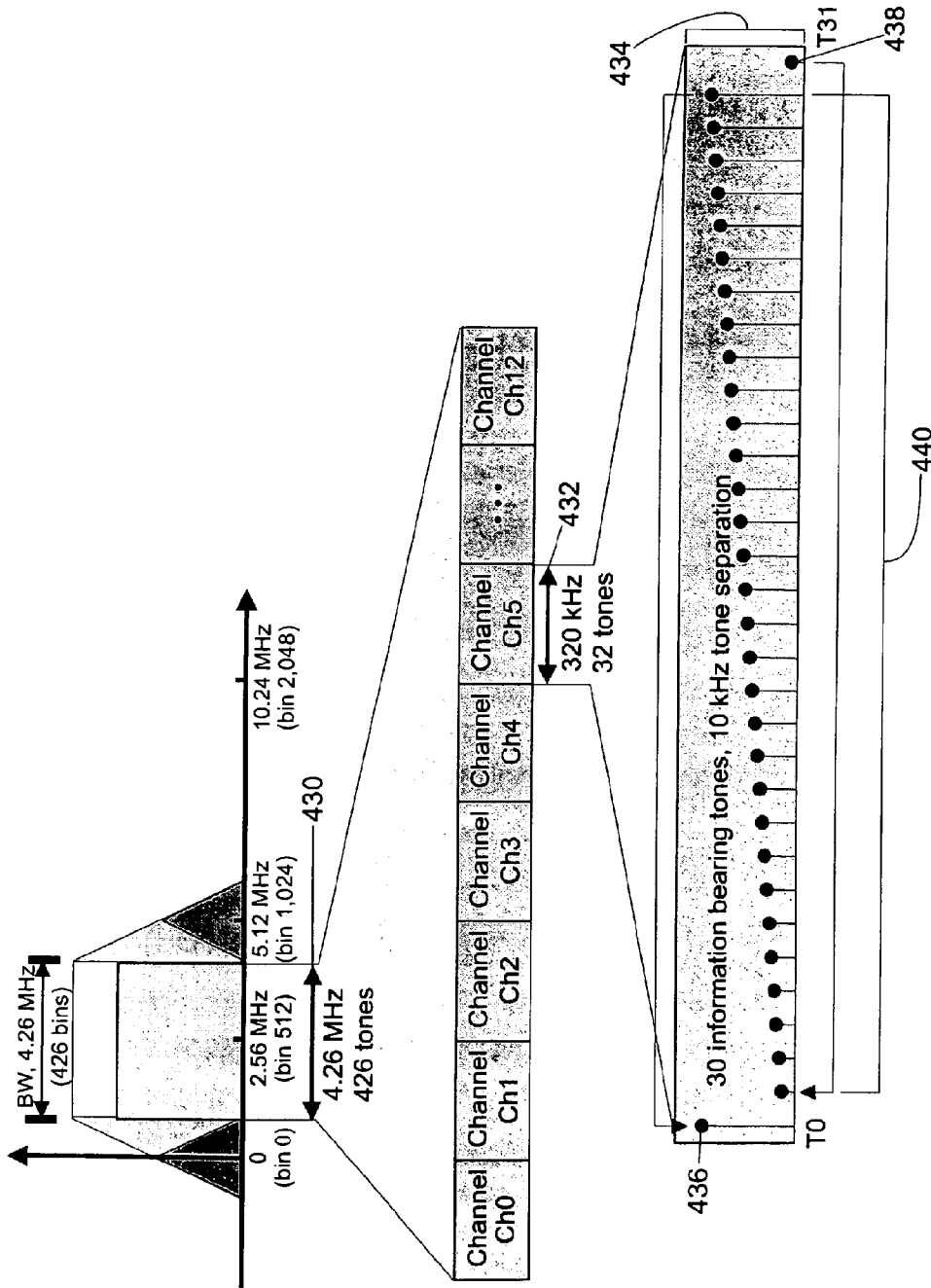

FIG. 26

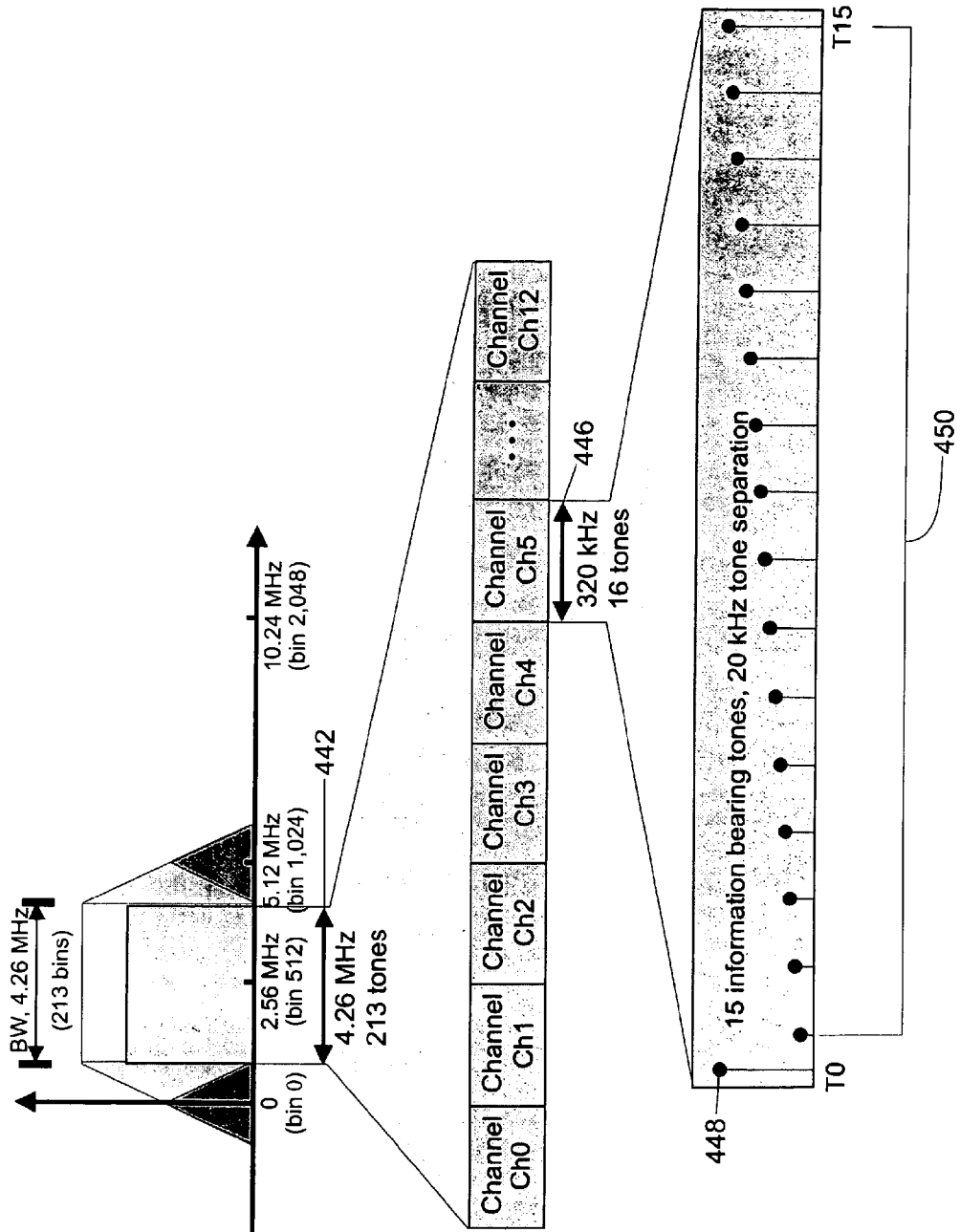

FIG. 27

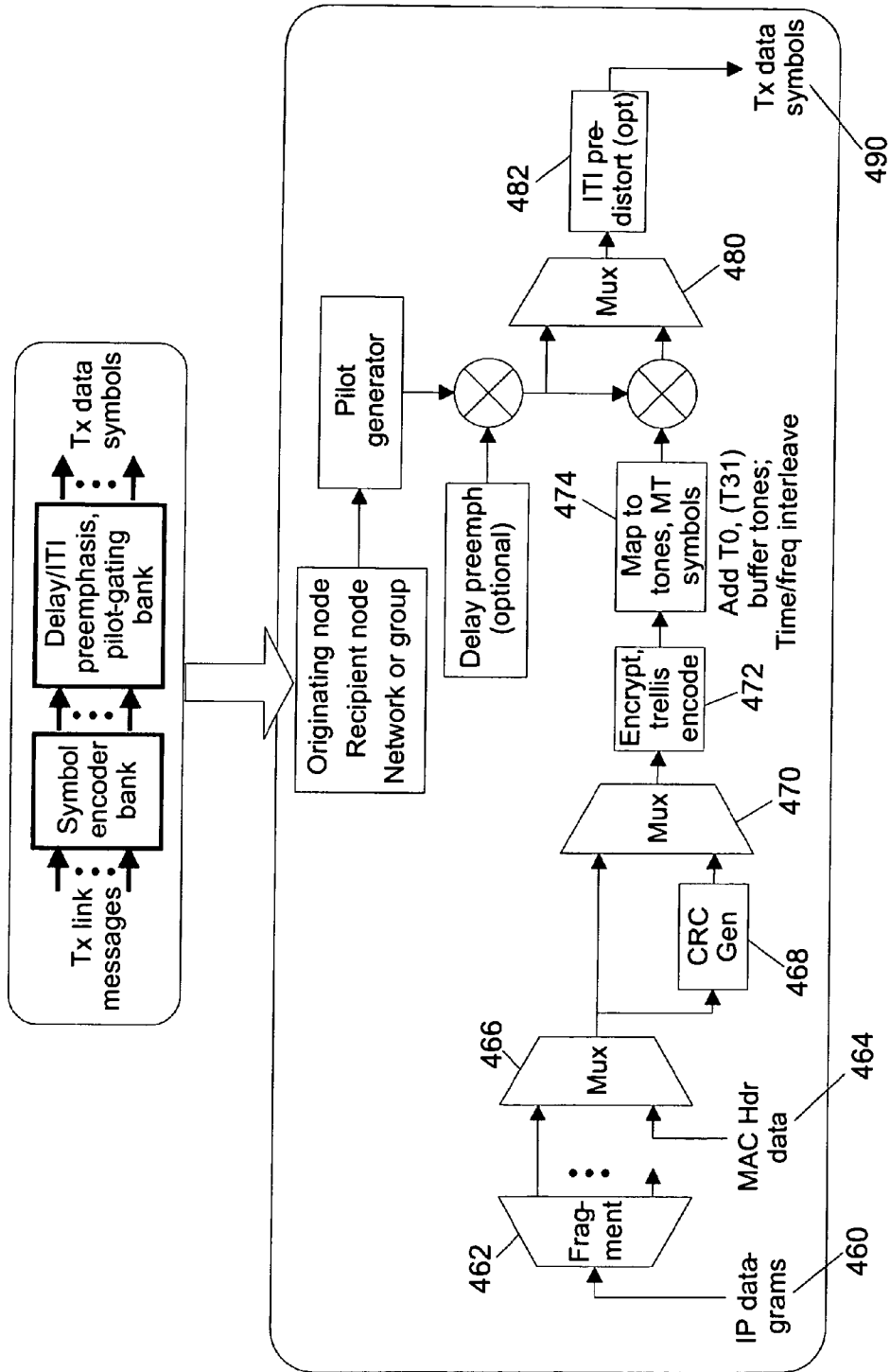
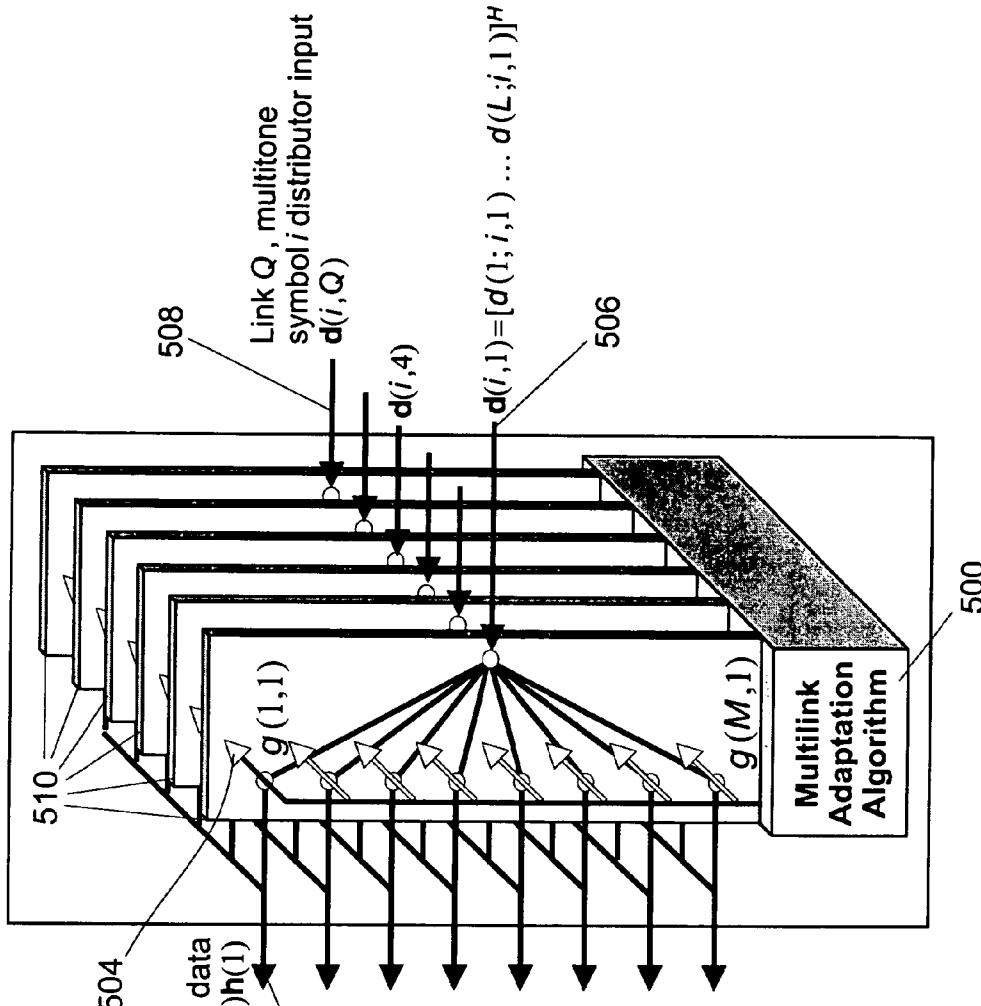

FIG. 28



Feed 1 Tx data
 $s(i,1) = D(i)h(1)$

502

504

510

508

Link Q, multitone
 symbol/distributor input
 $d(i,Q)$

$d(i,4)$

$d(i,1) = [d(1;i,1) \dots d(L;i,1)]^H$

506

Feed M Tx data $s(i,M) = D(i)h(M)$,
 $h(M) = [g(M,1) \dots g(M,Q)]^H$
 $D(i) = [d(i,1) \dots d(i,Q)]$
 $s(i,M) = [s(1;i,M) \dots s(L;i,M)]^H$

FIG. 29

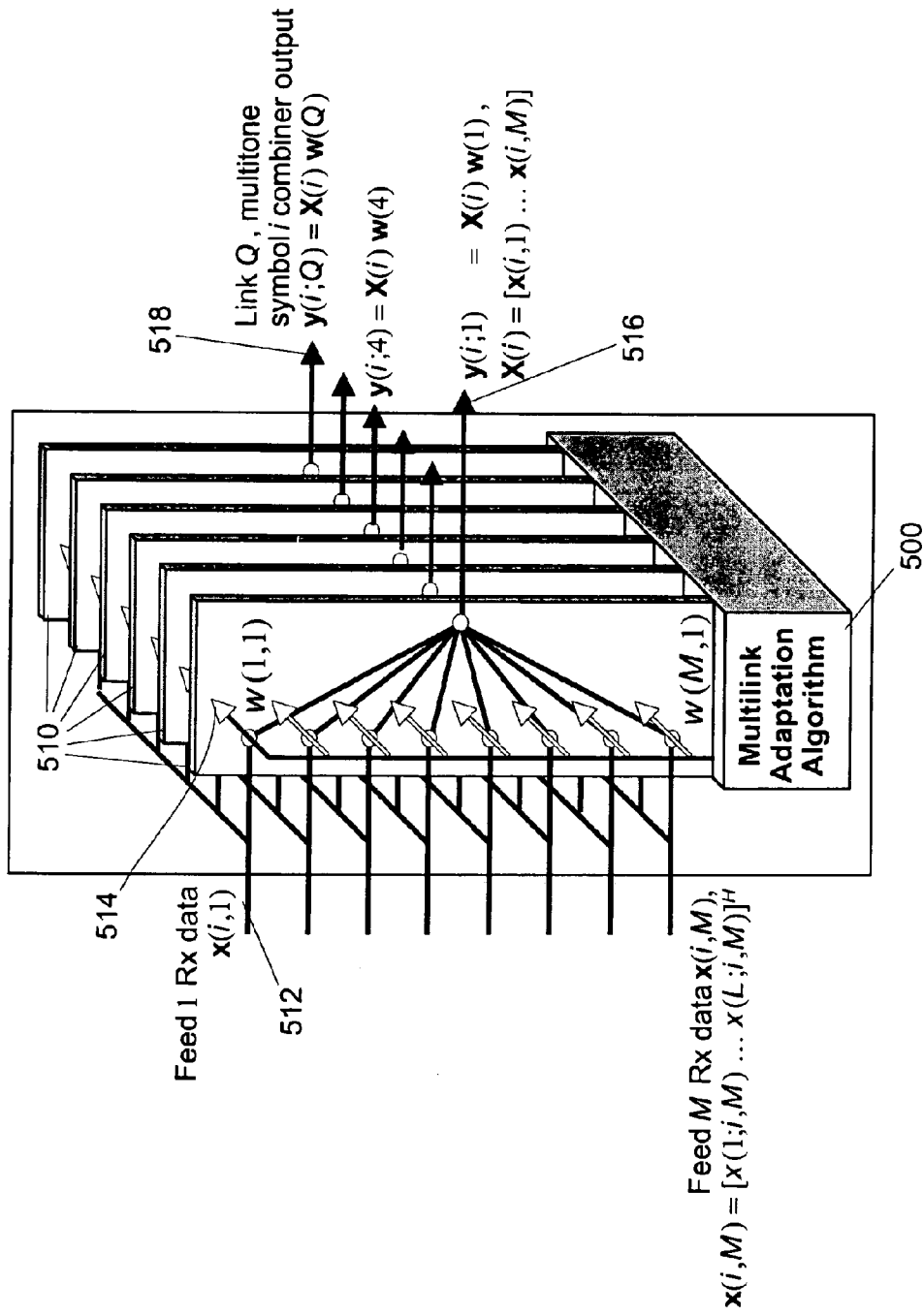

FIG. 30

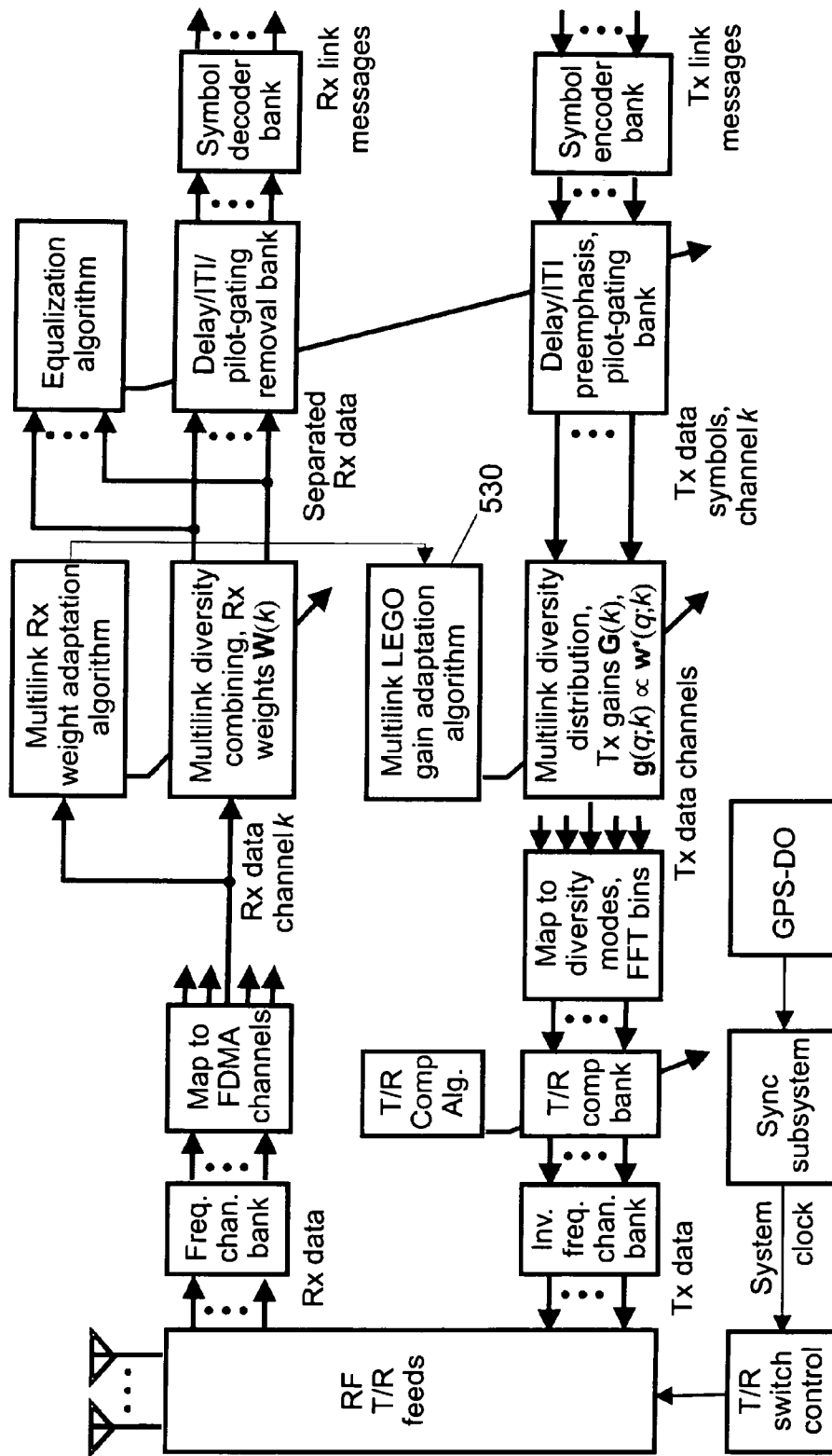

FIG. 31

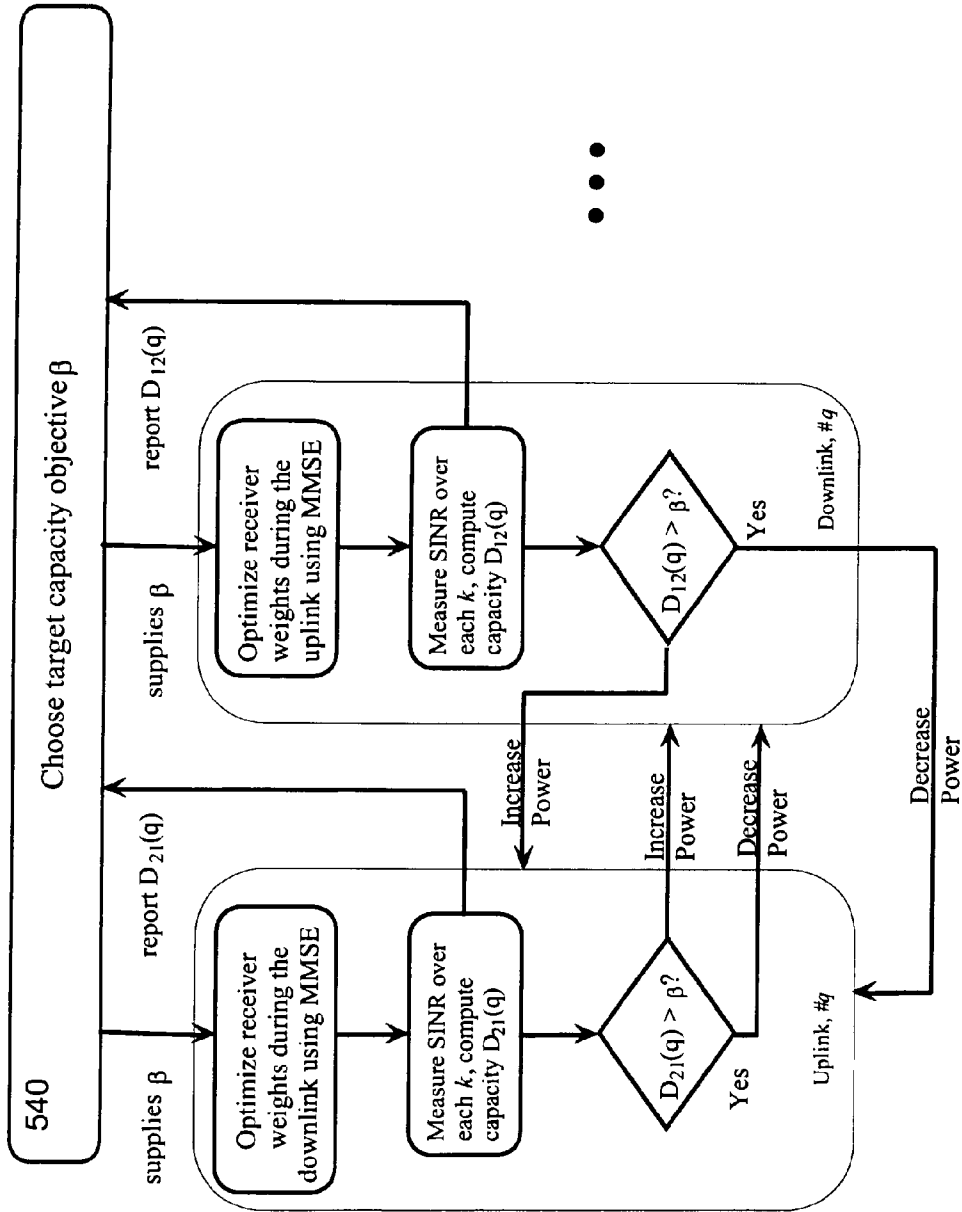

FIG. 32

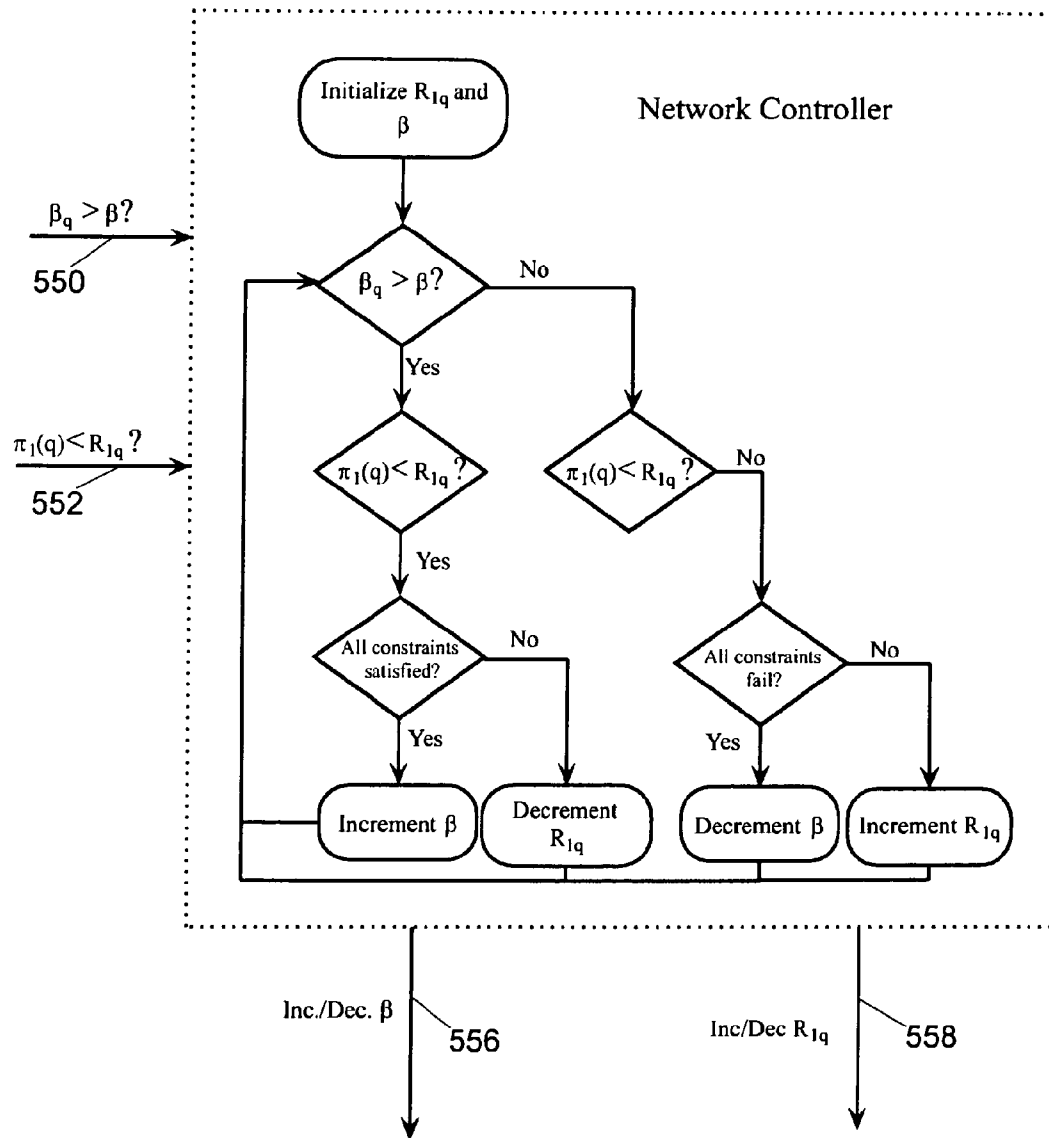

FIG. 33

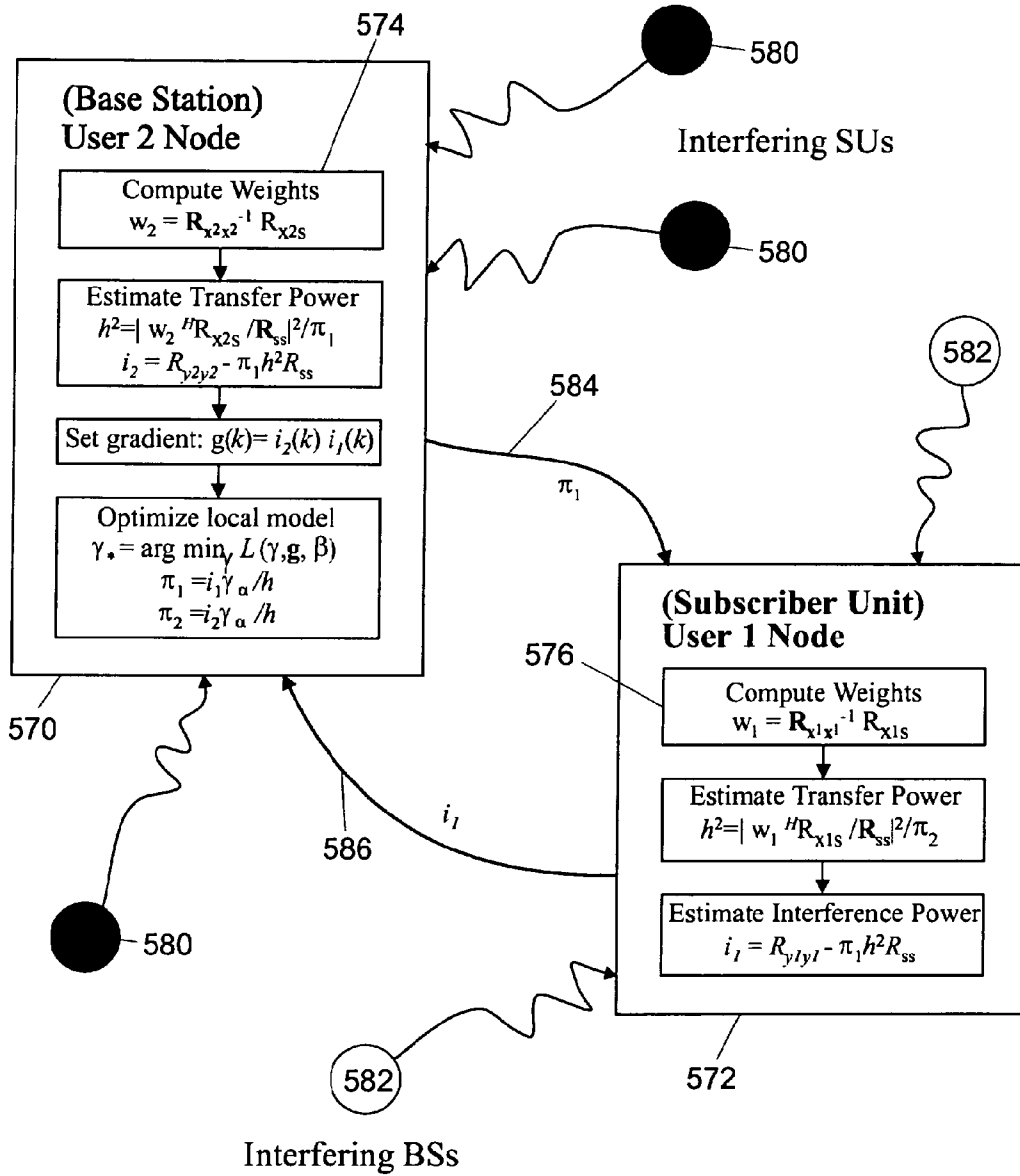

FIG. 34

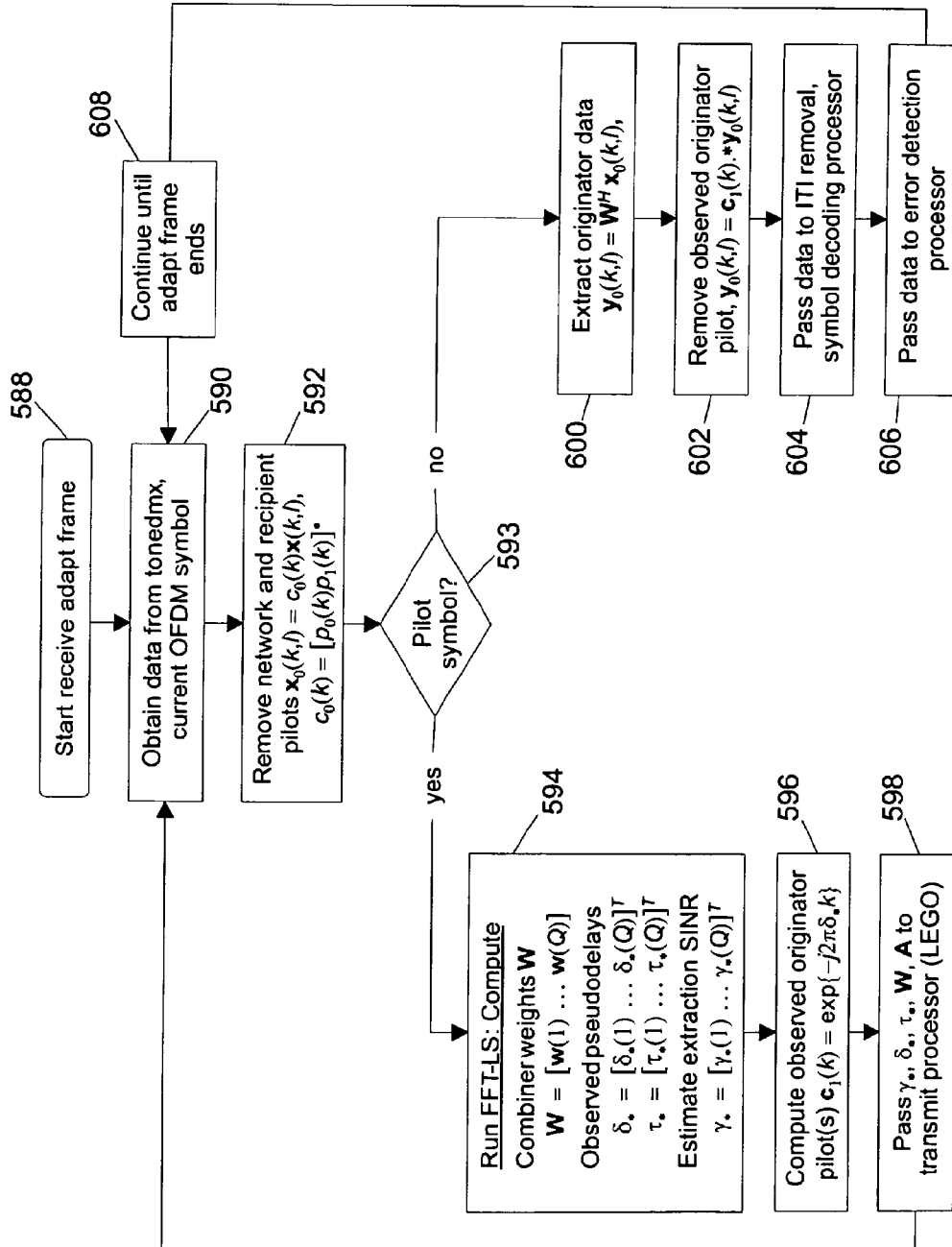

FIG. 35

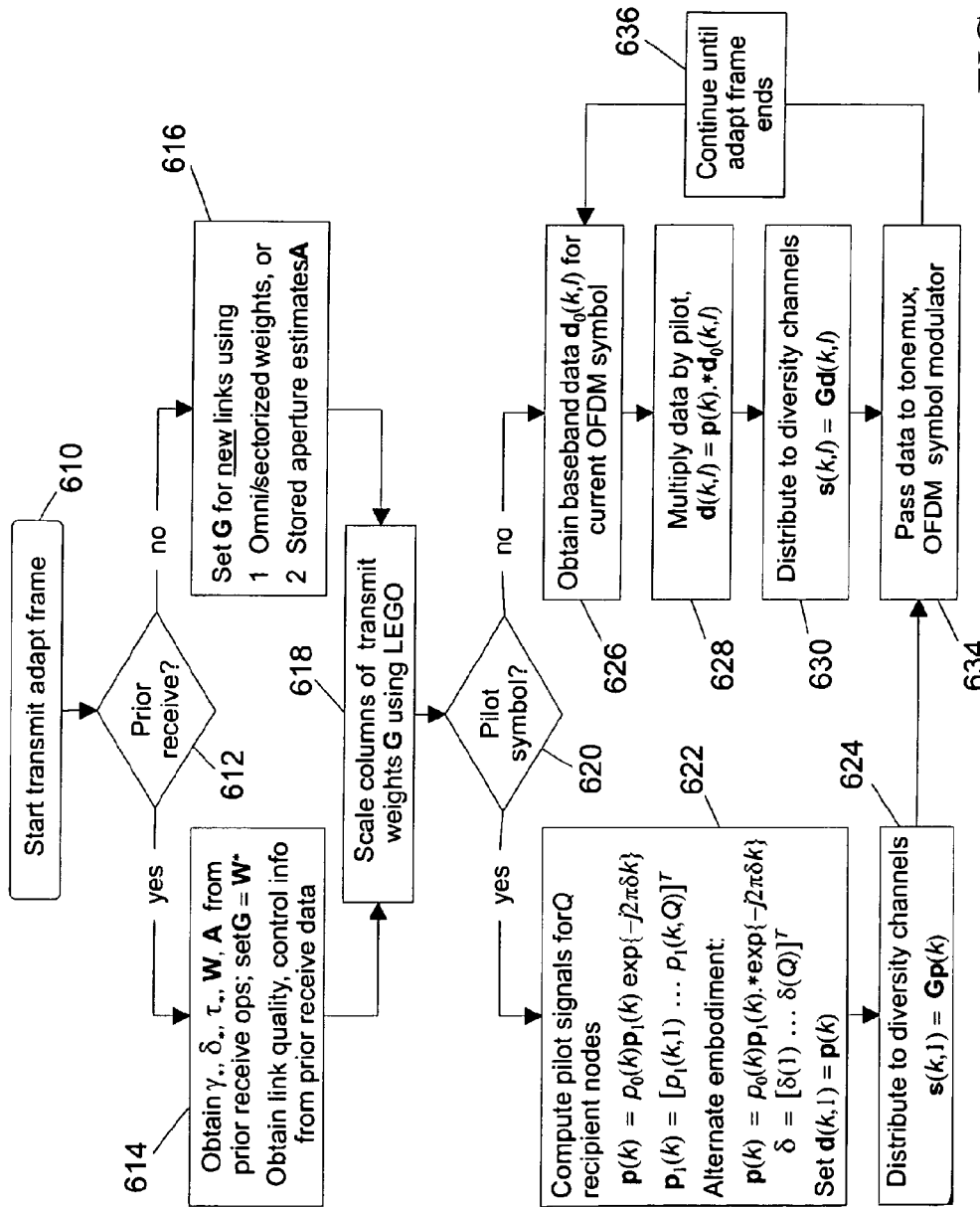

FIG. 36

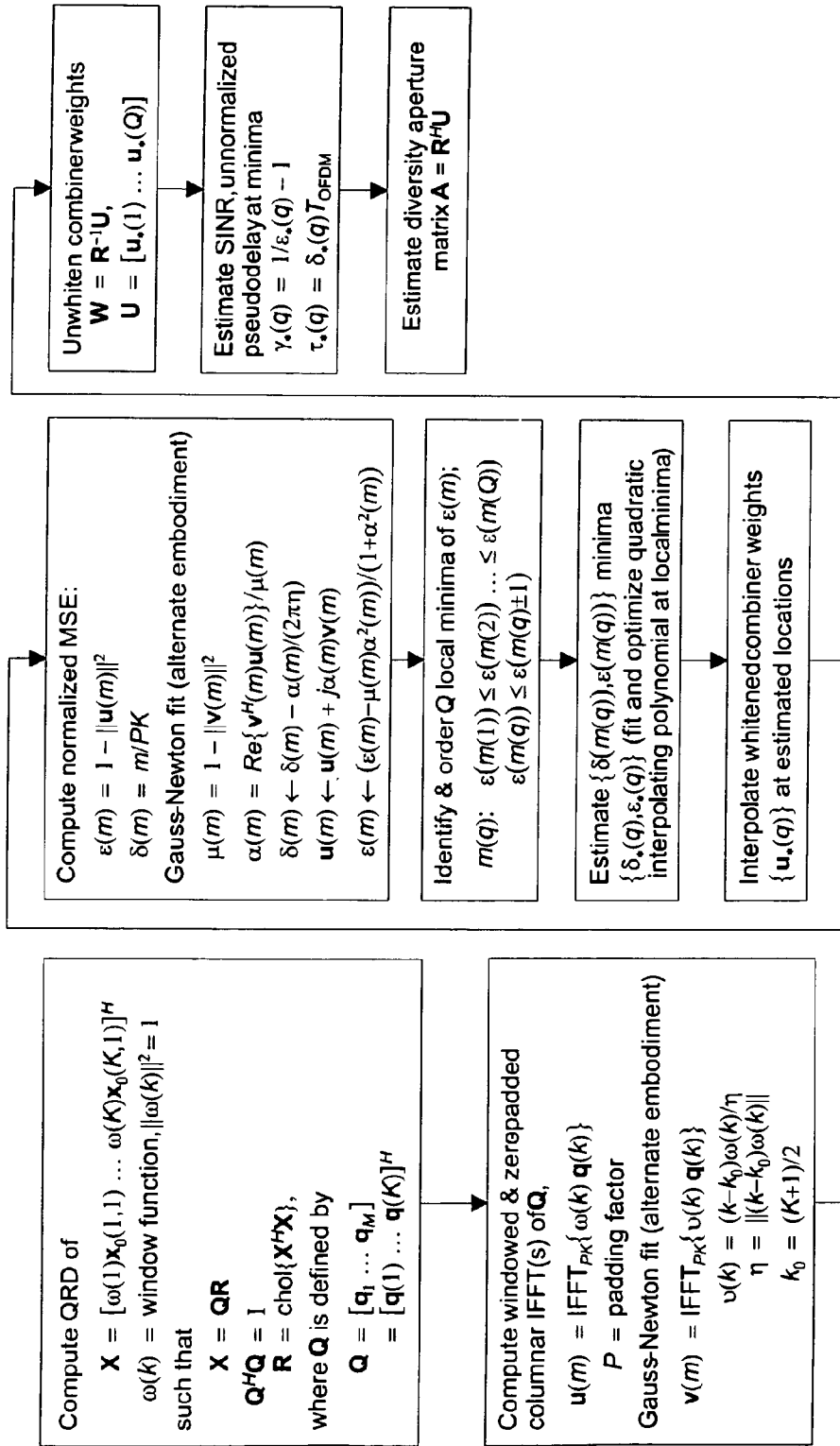

FIG. 37

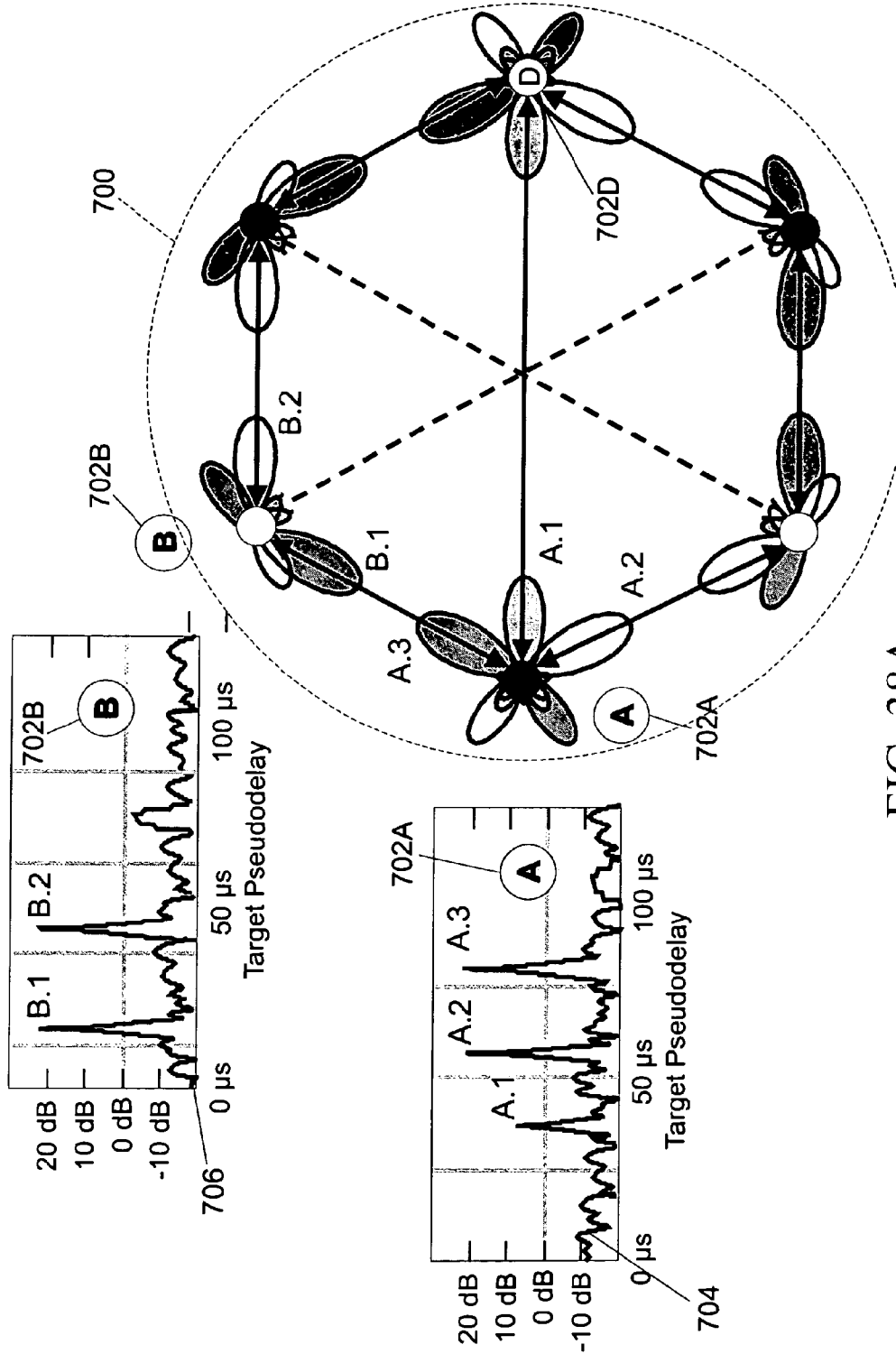

FIG. 38A

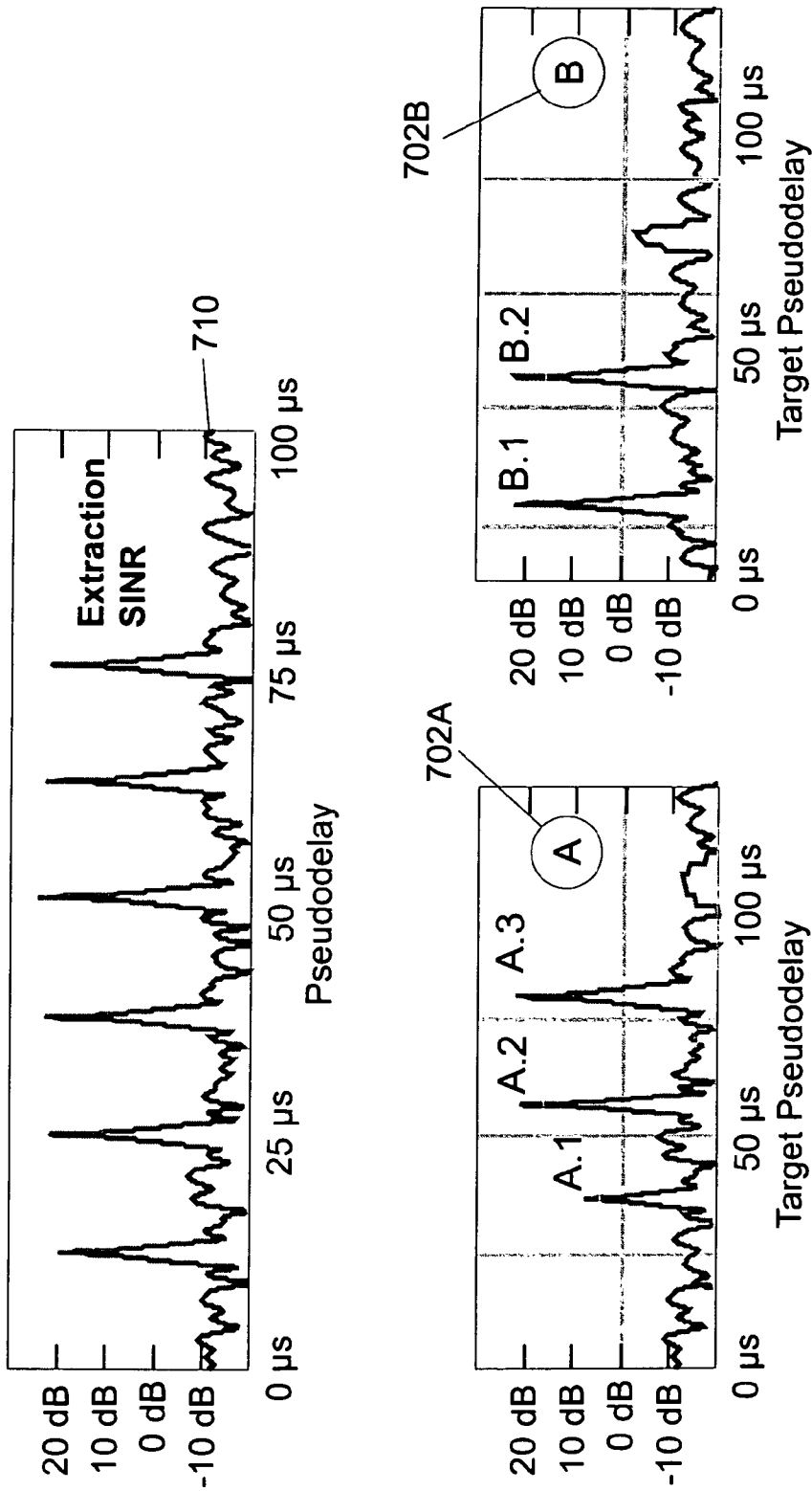

FIG. 38B

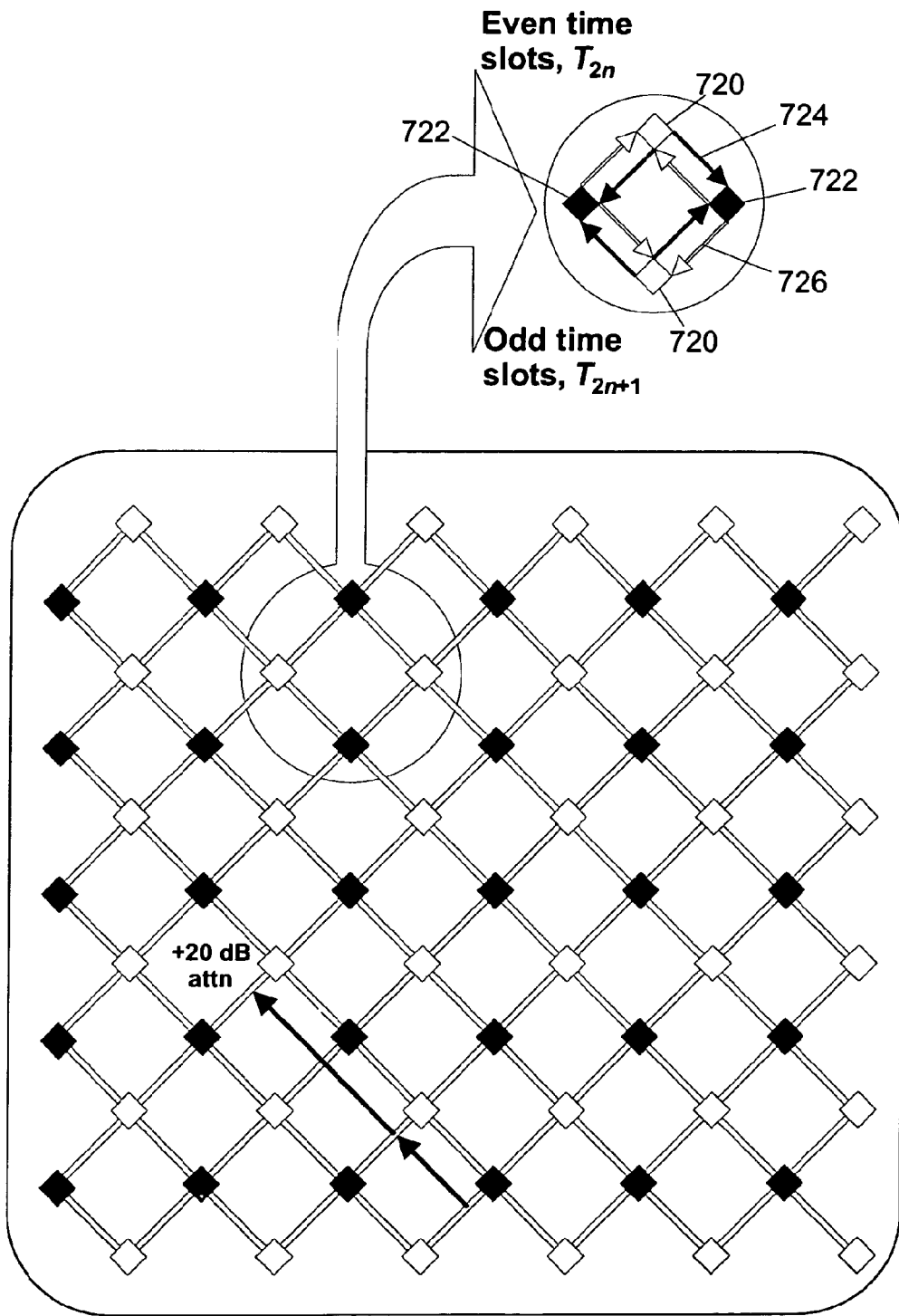

FIG. 39

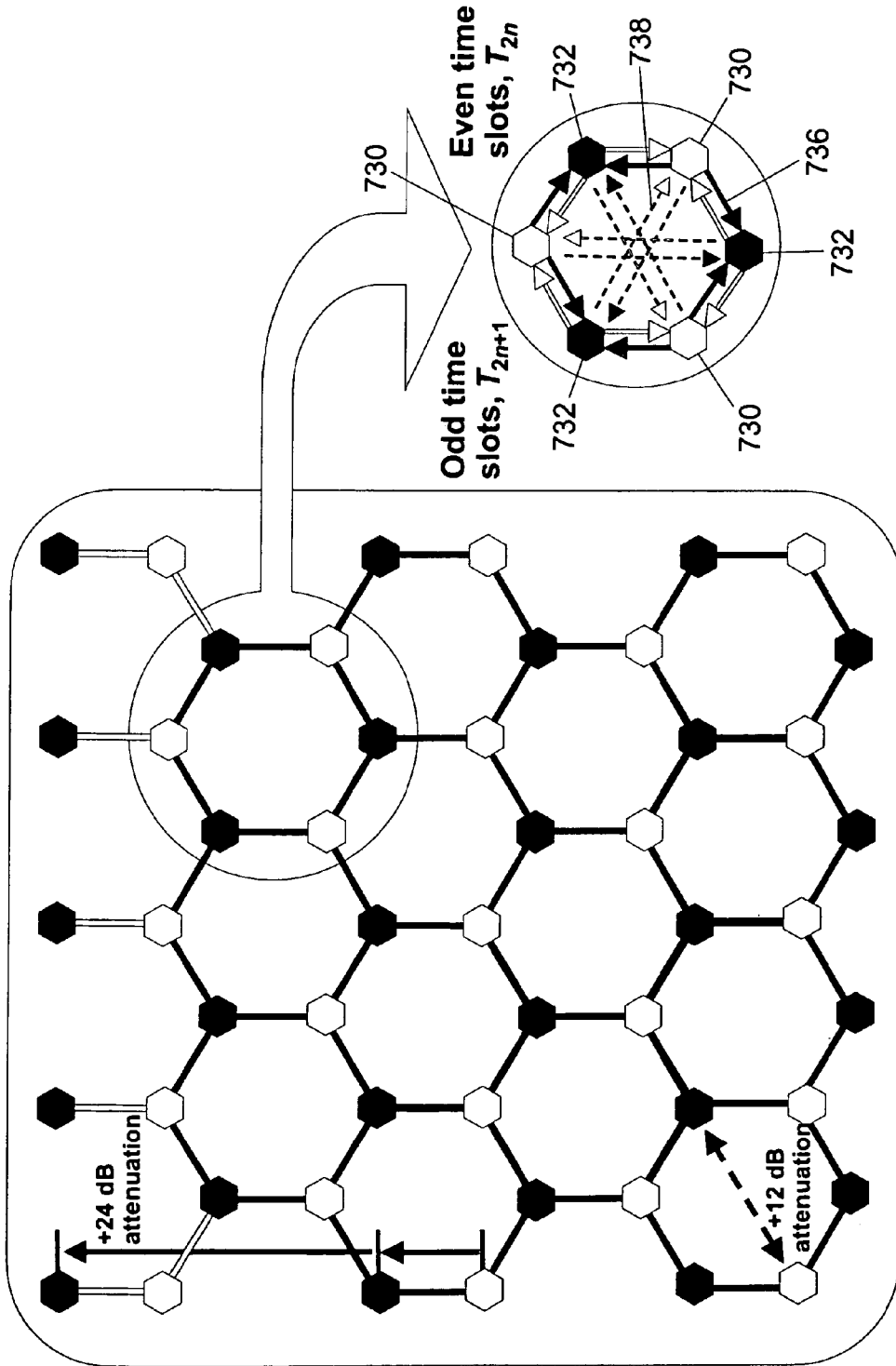

FIG. 40

MIMO network communicator flow -diagram

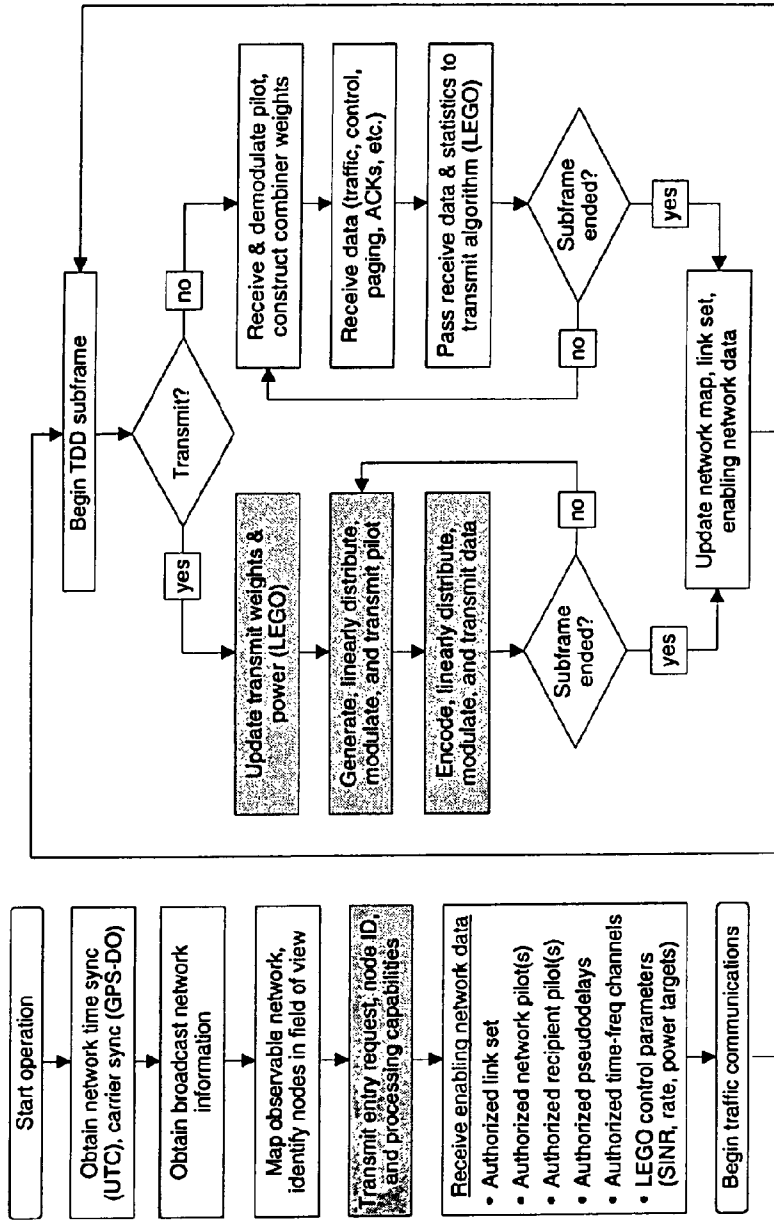

FIG. 41

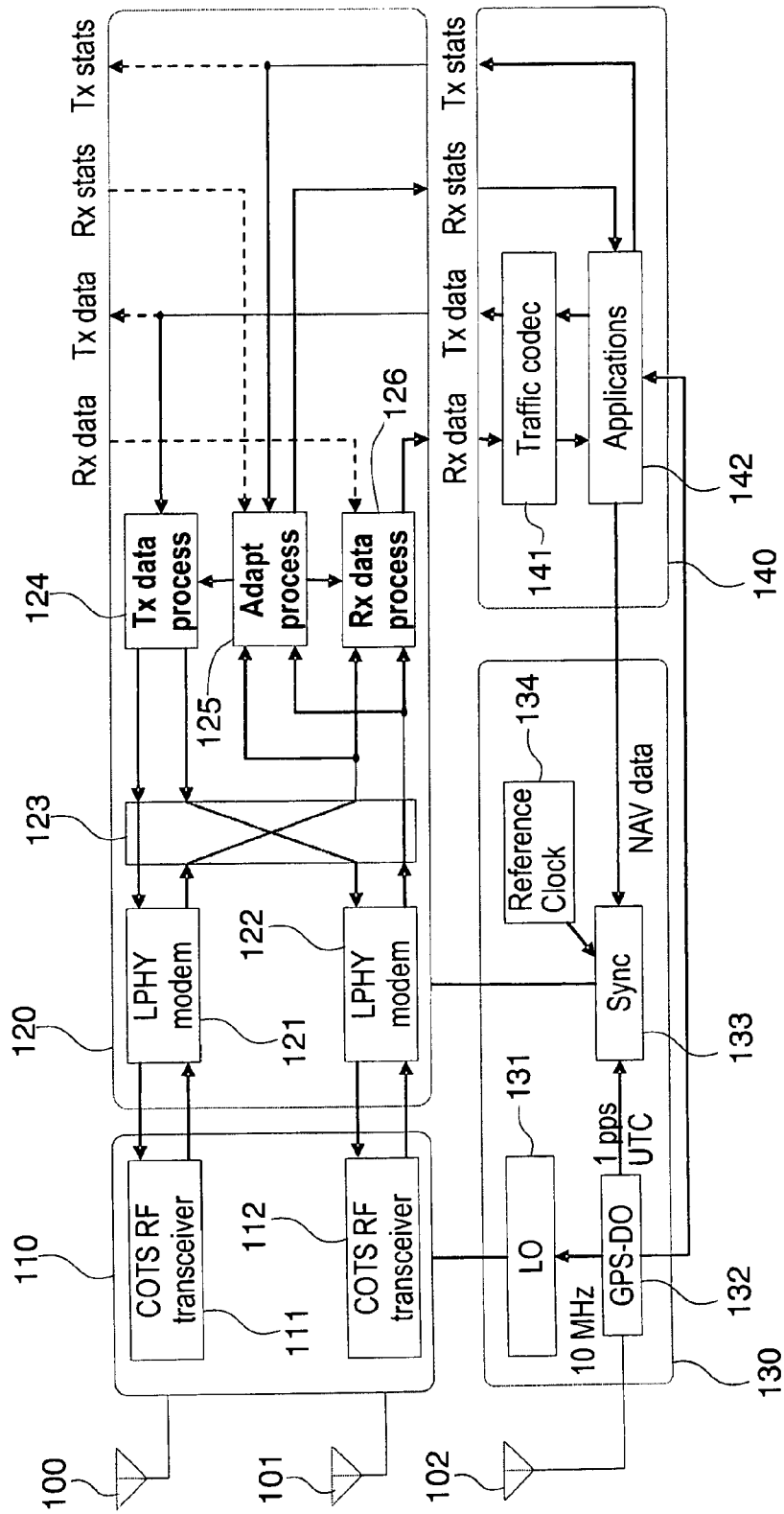

FIG. 42

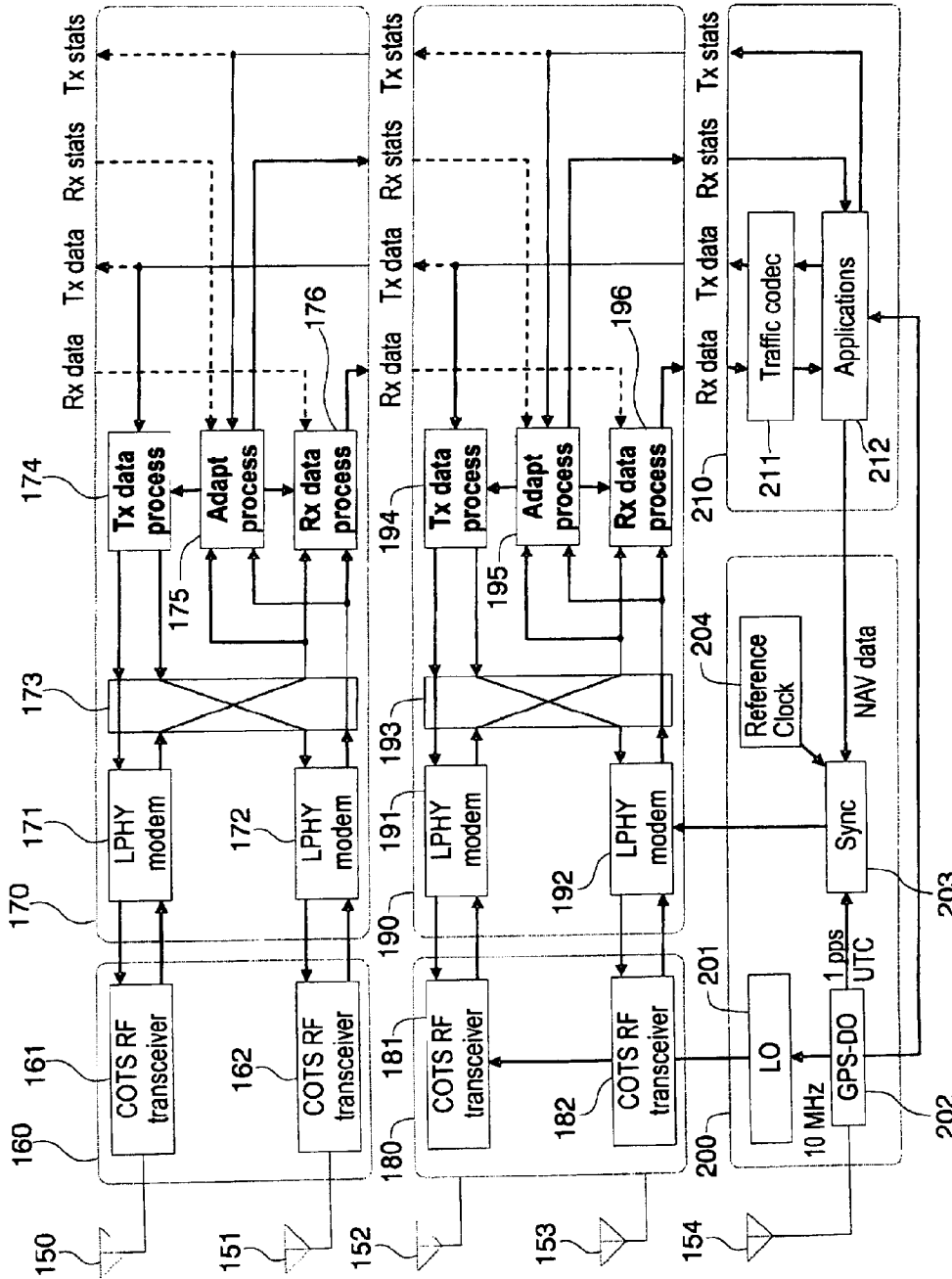

FIG. 43

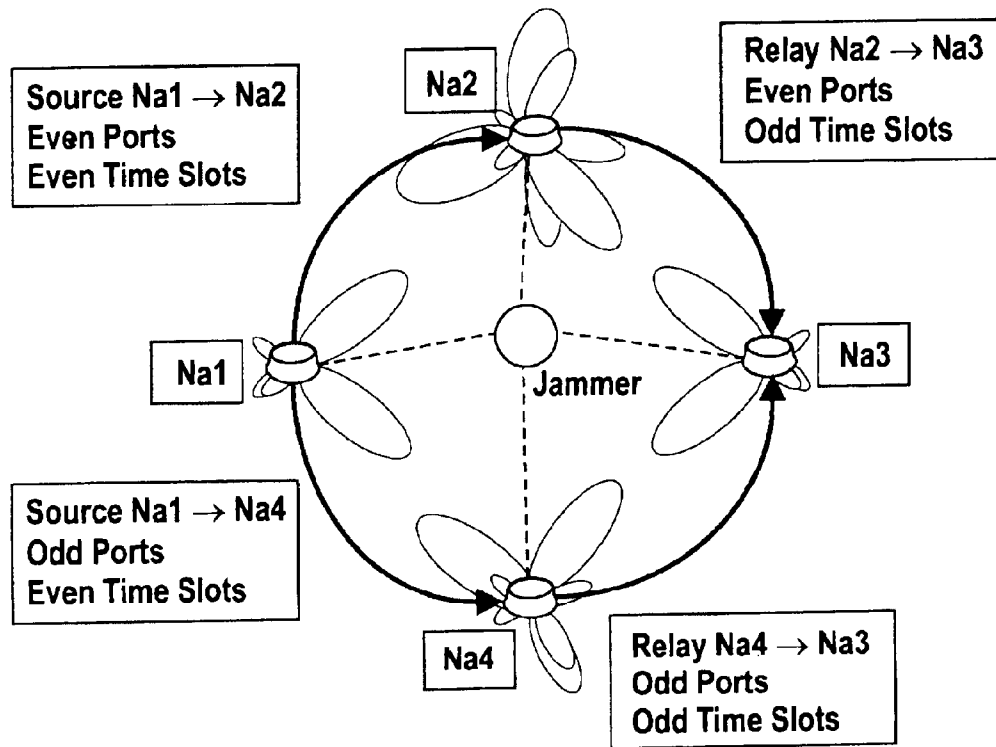

FIG. 44

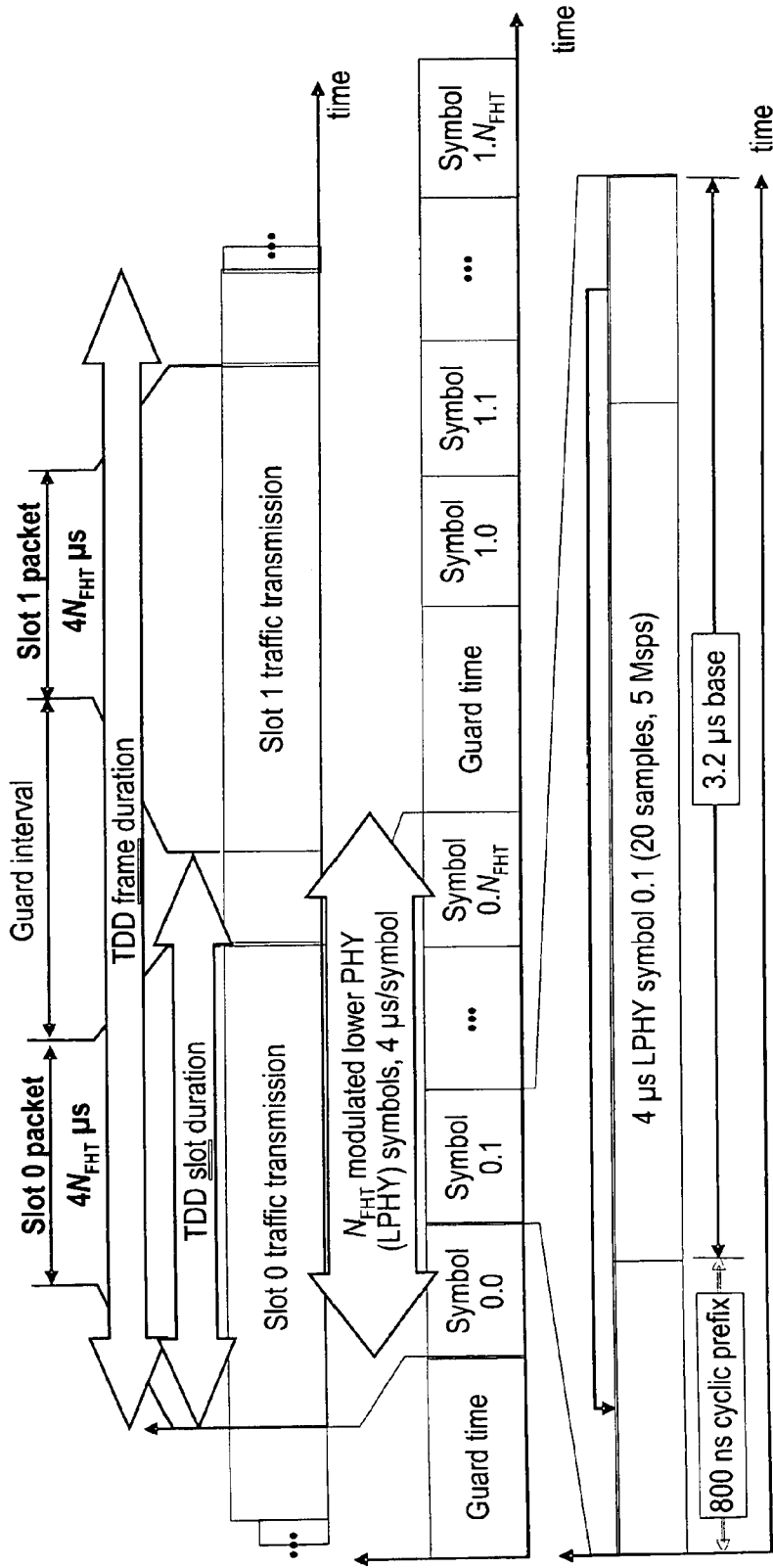

FIG. 45

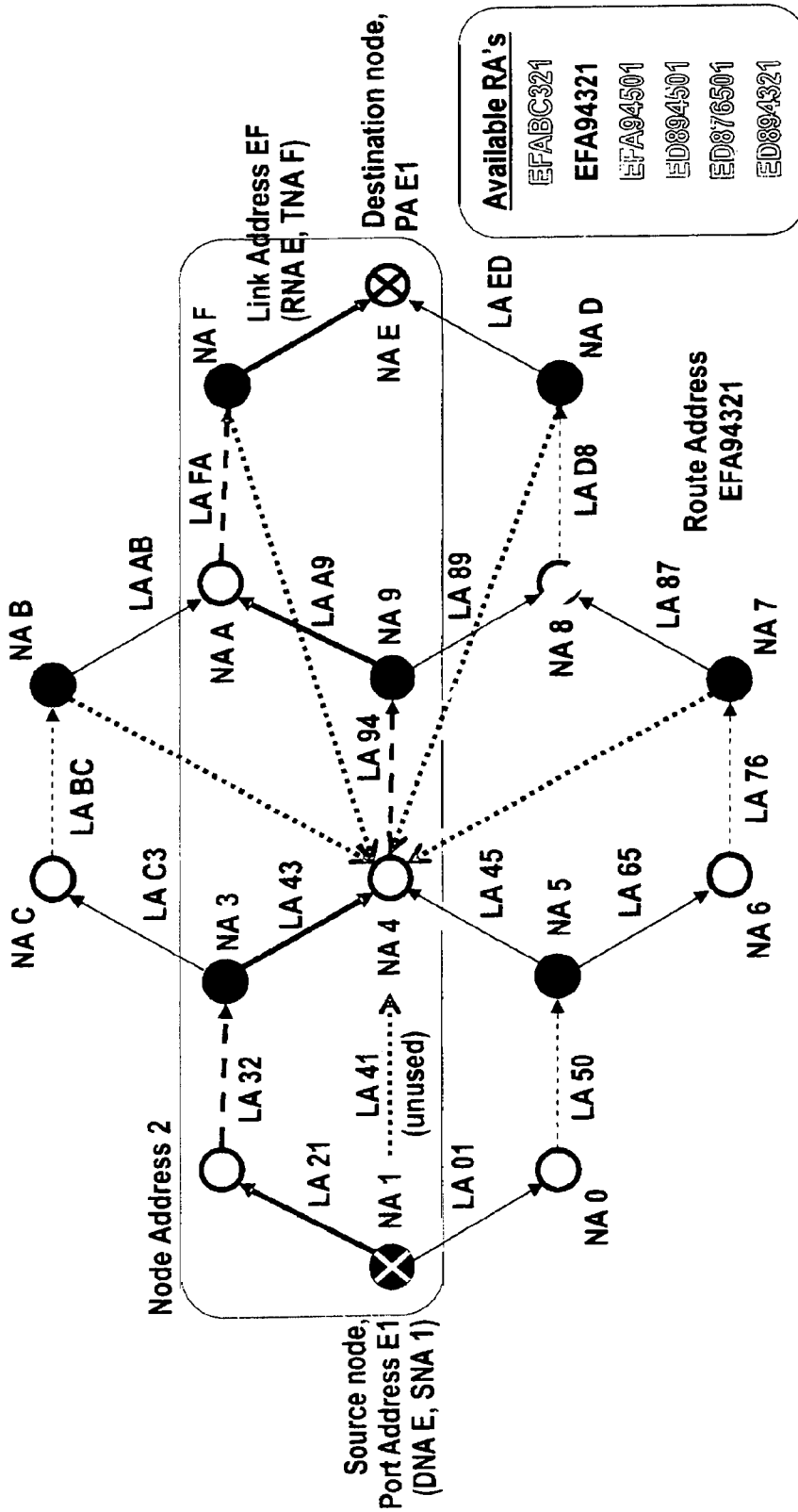

FIG. 46

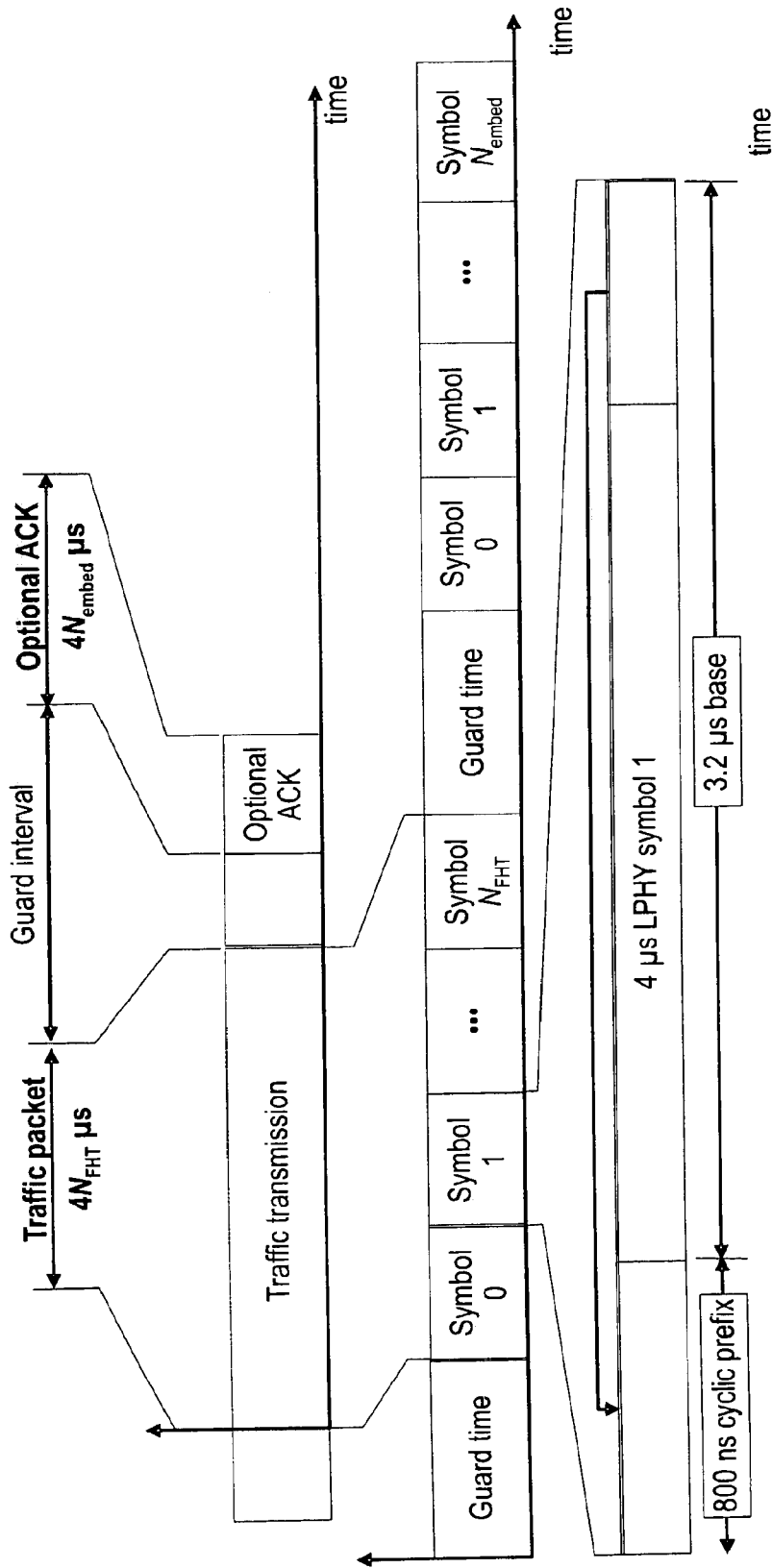

FIG. 47

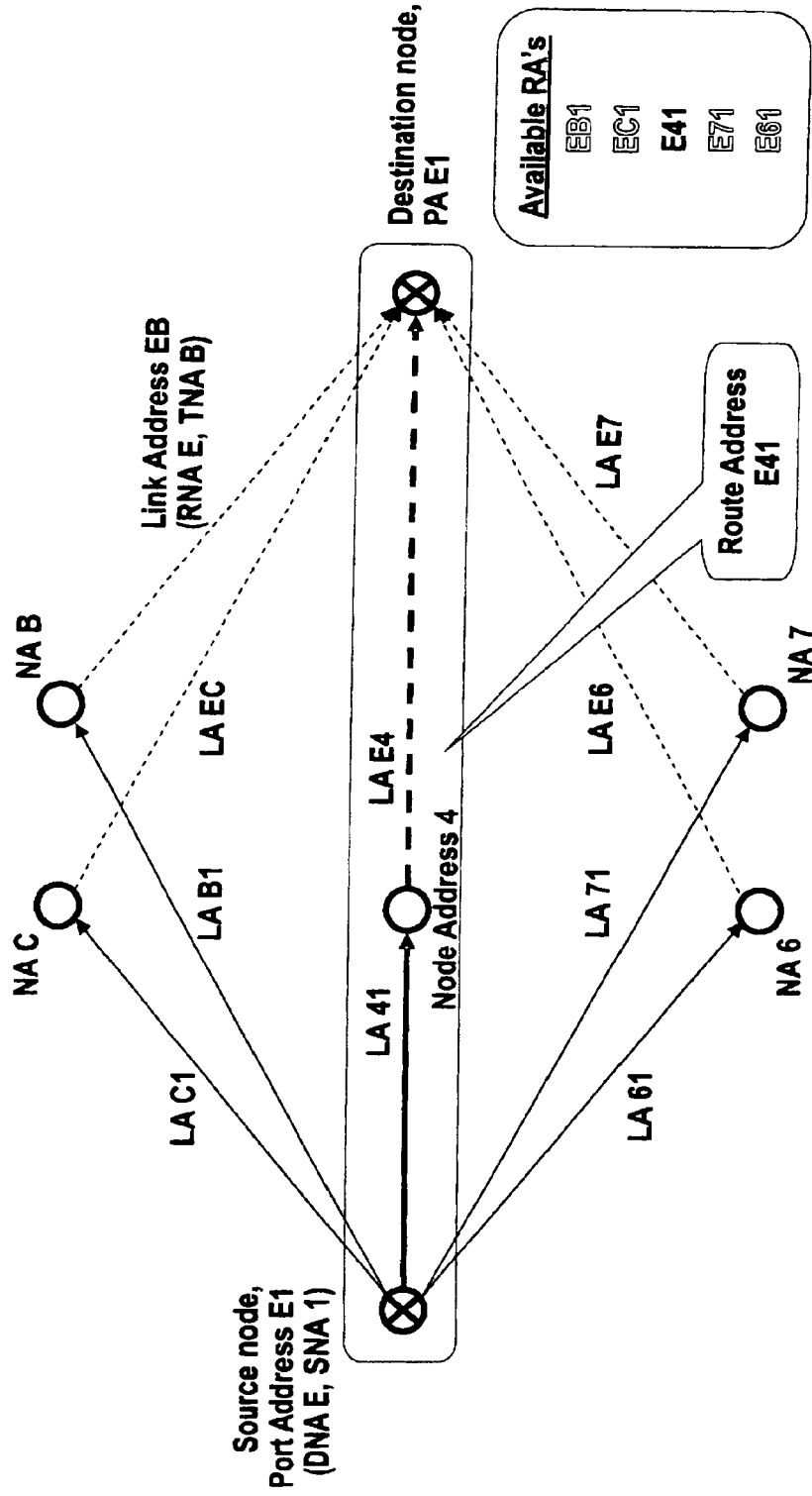

FIG. 48

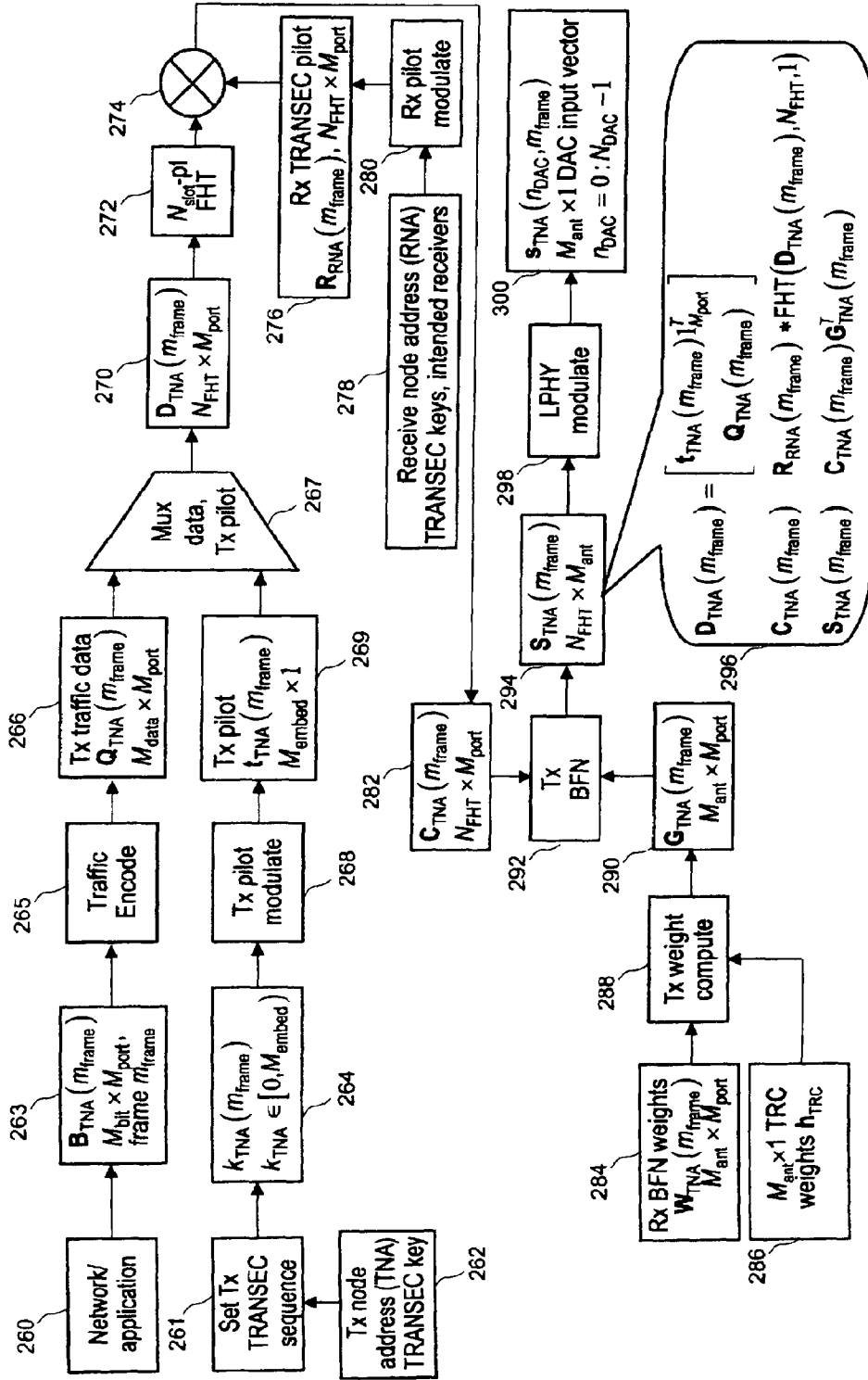

FIG. 49

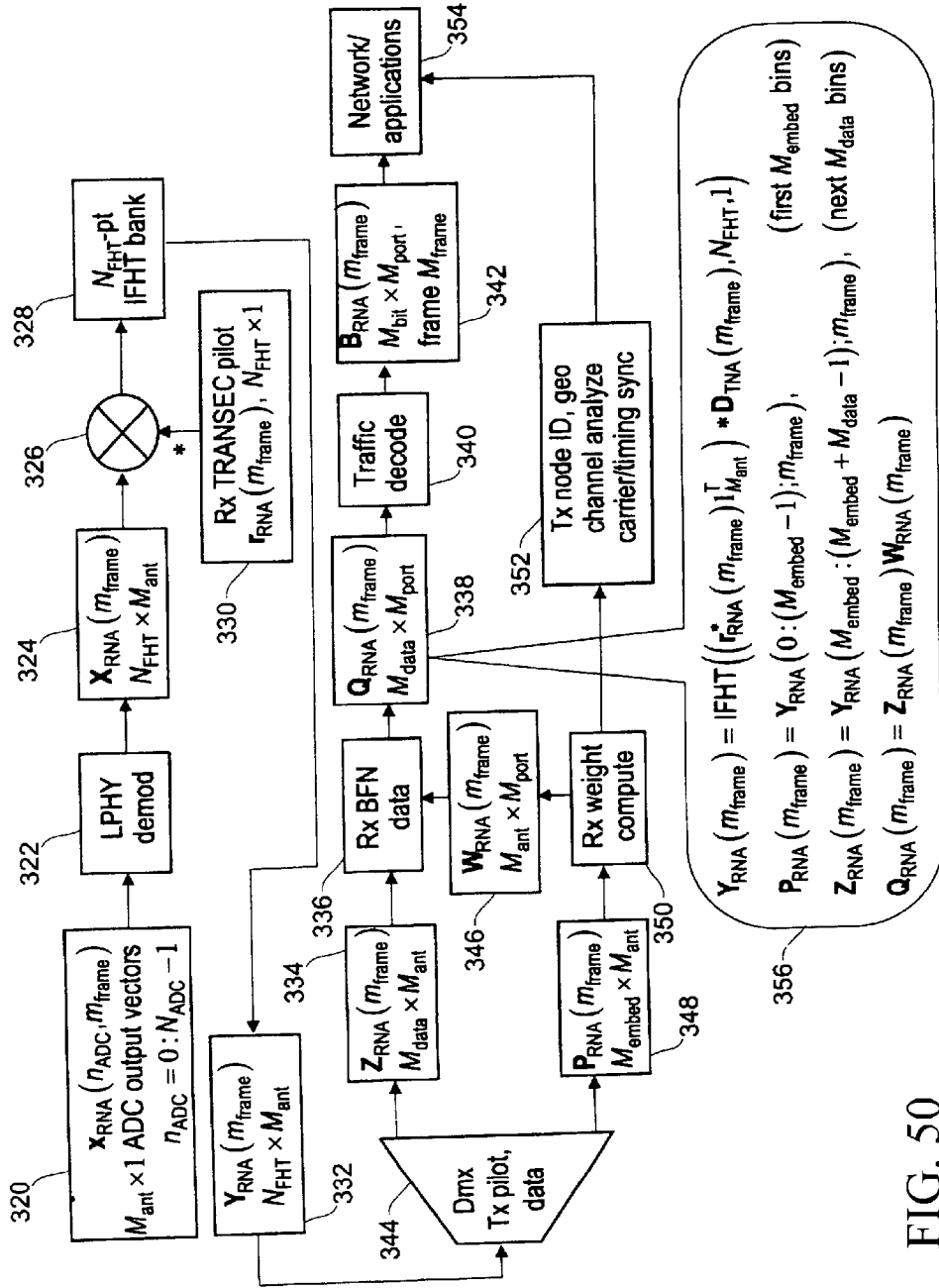

FIG. 50

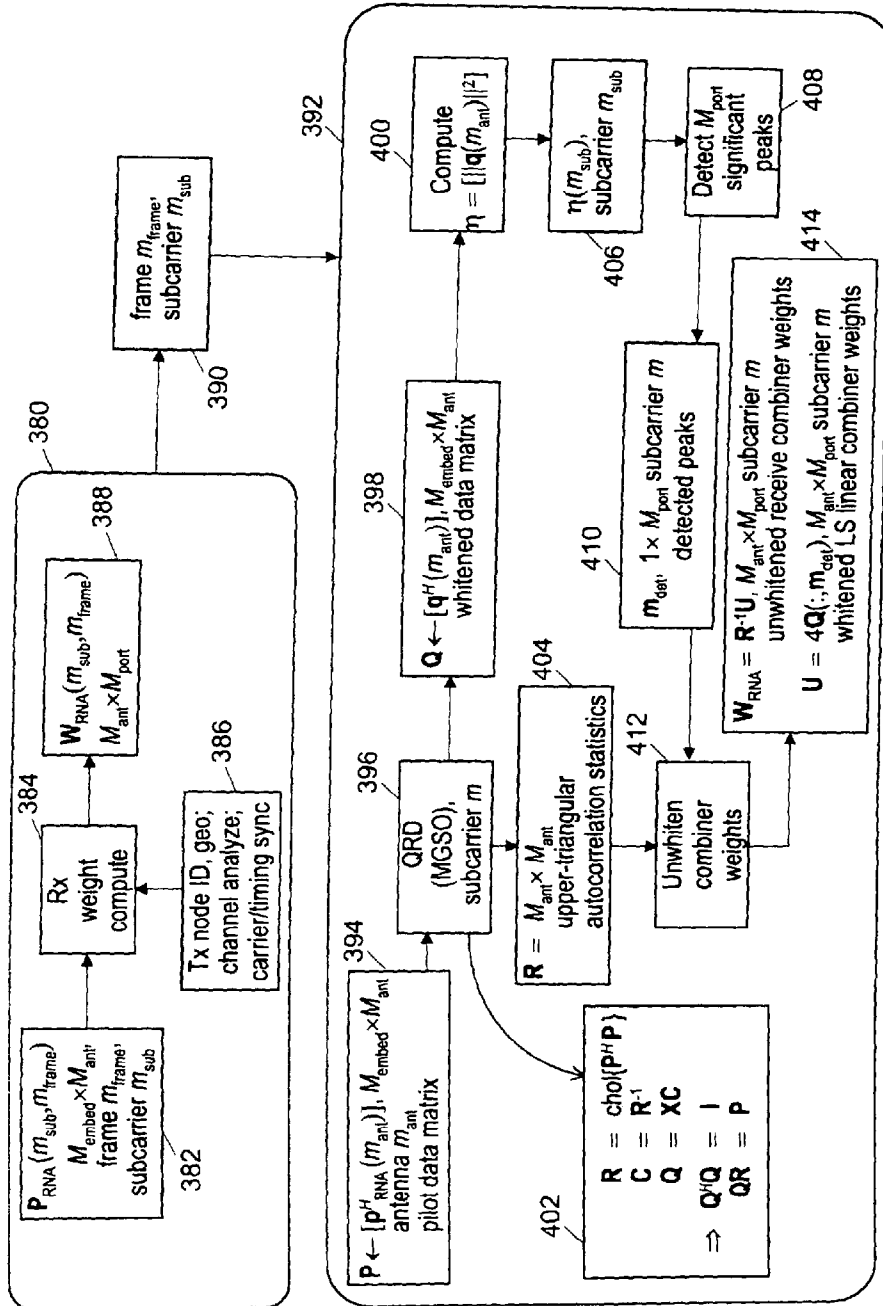

FIG. 51

430

Detect candidate pilots and spatially whitened adaptation weights

$$\eta(m_{\text{det}}; m_{\text{sub}}) = \frac{\eta(m_{\text{embed}}; m_{\text{sub}})}{\|q(m_{\text{det}}; m_{\text{sub}})\|}$$

$$\chi(m_{\text{det}}; m_{\text{sub}}) = \frac{\eta(m_{\text{embed}}; m_{\text{sub}})}{1 - \eta(m_{\text{embed}}; m_{\text{sub}})}$$

$$C_{\text{det}}(m_{\text{det}}) = \frac{1}{M_{\text{sub}} m_{\text{sub}}^{M_{\text{sub}} - 1}} \log_2(1 + \gamma(m_{\text{embed}}; m_{\text{sub}}))$$

$$\{m_{\text{embed}}(m)\}_{m=1}^{M_{\text{det}}} = m_{\text{embed}}(m) \begin{cases} C_{\text{det}}(m_{\text{embed}}(m)) \geq C_{\text{thresh}} \text{ and} \\ C_{\text{det}}(m_{\text{embed}}(m)) \geq C_{\text{det}}(m_{\text{embed}}(m+1)) \end{cases}$$

$$U_{\text{det}}(m_{\text{sub}}) = \sqrt{M_{\text{det}}} [q(m_{\text{embed}}(1); m_{\text{sub}}) \dots q(m_{\text{embed}}(M_{\text{det}}); m_{\text{sub}})]$$

$$\eta(m_{\text{det}}; m_{\text{sub}}) = [\eta(m_{\text{embed}}(1); m_{\text{sub}}) \dots \eta(m_{\text{embed}}(M_{\text{det}}); m_{\text{sub}})]$$

$$\gamma_{\text{det}}(m_{\text{sub}}) = [\gamma(m_{\text{embed}}(1); m_{\text{sub}}) \dots \gamma(m_{\text{embed}}(M_{\text{det}}); m_{\text{sub}})]$$

If spatial signatures available associate detects with ports and links.

$$u_{\text{port}}(m_{\text{det}}; m_{\text{sub}}) = C^H(m_{\text{sub}}) B_{\text{port}}(m_{\text{det}}; m_{\text{sub}})$$

$$\rho(m_{\text{det}}; m_{\text{port}}; m_{\text{sub}}) = \frac{|u_{\text{det}}^H(m_{\text{det}}; m_{\text{sub}}) u_{\text{port}}(m_{\text{port}}; m_{\text{sub}})|^2}{N_{\text{NA}} T_{\text{det}}(m_{\text{det}}; m_{\text{sub}}) \|u_{\text{port}}(m_{\text{port}}; m_{\text{sub}})\|^2} \leq 1$$

$$C_{\text{match}}(m_{\text{det}}; m_{\text{port}}) = \frac{1}{M_{\text{sub}} \sum_{m_{\text{sub}}=1}^{M_{\text{sub}}} \log_2(1 + \gamma(m_{\text{det}}; m_{\text{sub}})) \rho(m_{\text{det}}; m_{\text{port}}; m_{\text{sub}})}$$

$$\{m_{\text{det}}(m_{\text{port}})\}_{m_{\text{port}}=1}^{M_{\text{port}}} = \arg \max_{m_{\text{det}}} \{C_{\text{match}}(m_{\text{det}}; m_{\text{port}})\}$$

432

434

Drop and add ports, based on $C_{\text{match}}(m_{\text{det}}; m_{\text{port}})$

$$\{m_{\text{drop}}\}_1^{M_{\text{drop}}} = \arg \max_{m_{\text{port}}} \{C_{\text{match}}(m_{\text{det}}; m_{\text{port}})\} < C_{\text{thresh}}$$

$$\{m_{\text{add}}\}_1^{M_{\text{add}}} = m_{\text{det}} \notin \{m_{\text{det}}(m_{\text{port}})\}_{m_{\text{port}}=1}^{M_{\text{port}}}$$

$$M_{\text{port}} \leftarrow M_{\text{port}} - M_{\text{drop}} + M_{\text{add}}$$

$$\{m_{\text{det}}(m_{\text{port}})\}_{m_{\text{port}}=1}^{M_{\text{port}}} \leftarrow (\{m_{\text{det}}(m_{\text{port}})\} \setminus \{m_{\text{drop}}\}) \cup \{m_{\text{add}}\}$$

436

Assign receive ports and link SINR $\gamma_{LA}(m_{\text{sub}})$

$$\eta_{LA}(m_{\text{port}}; m_{\text{sub}}) = \eta_{\text{det}}(m_{\text{det}}(m_{\text{port}}); m_{\text{sub}})$$

$$\gamma_{LA}(m_{\text{port}}; m_{\text{sub}}) = \gamma_{\text{det}}(m_{\text{det}}(m_{\text{port}}); m_{\text{sub}})$$

$$u(m_{\text{port}}; m_{\text{sub}}) = u_{\text{det}}(m_{\text{det}}(m_{\text{port}}); m_{\text{sub}})$$

$$U(m_{\text{sub}}) = [u(1; m_{\text{sub}}) \dots u(M_{\text{port}}; m_{\text{sub}})]$$

438

Estimate spatial signatures and combiner weights

$$A_{\text{SVA}}(m_{\text{sub}}; m_{\text{port}}) = C^H(m_{\text{sub}}) U(m_{\text{sub}})$$

$$W_{\text{SVA}}(m_{\text{sub}}; m_{\text{port}}) = C(m_{\text{sub}}) U(m_{\text{sub}})$$

FIG. 52

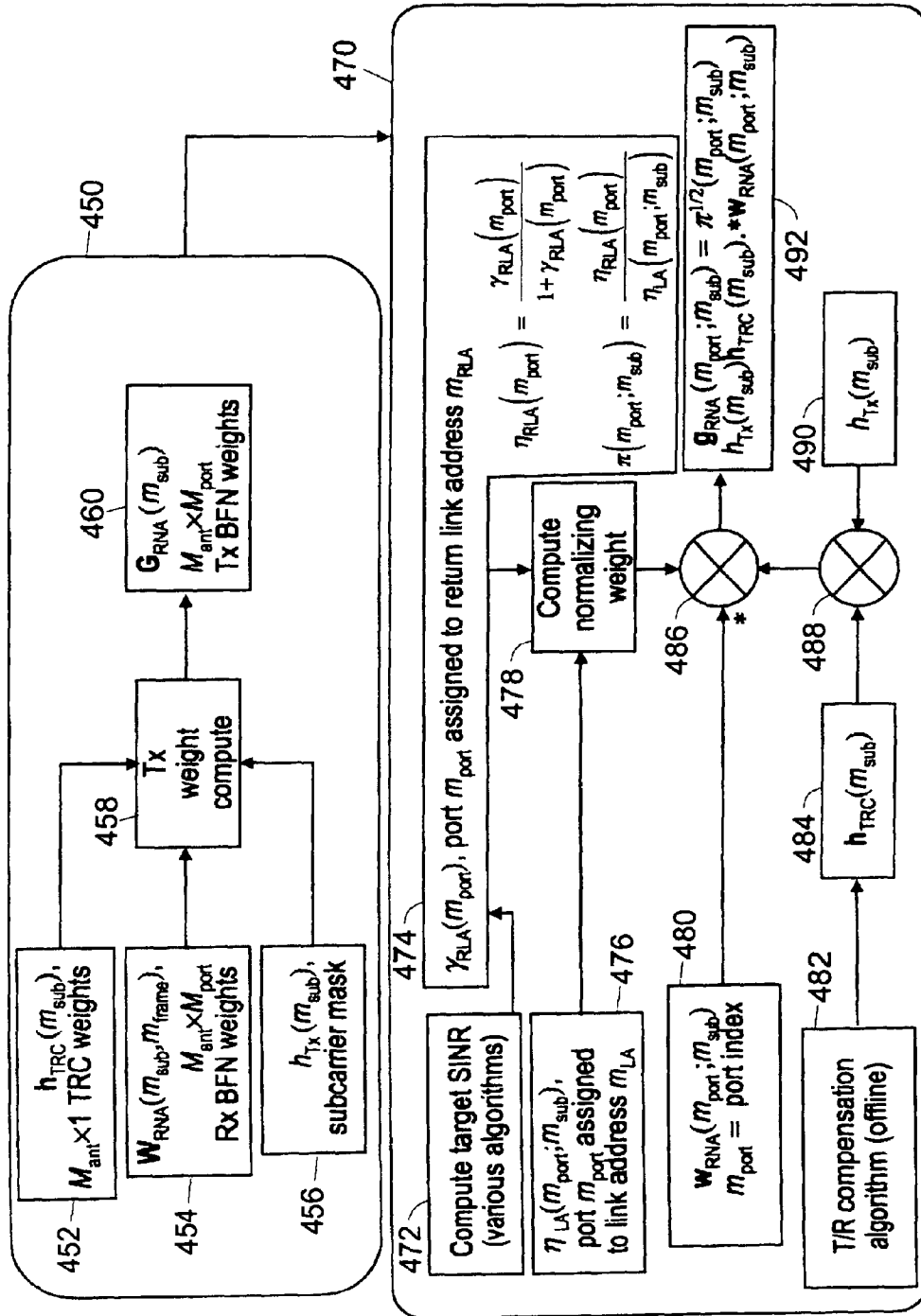

FIG. 53

**METHOD AND SYSTEM FOR ROBUST,
SECURE, AND HIGH-EFFICIENCY VOICE
AND PACKET TRANSMISSION OVER
AD-HOC, MESH, AND MIMO
COMMUNICATION NETWORKS**

Matter enclosed in heavy brackets [] appears in the original patent but forms no part of this reissue specification; matter printed in italics indicates the additions made by reissue; a claim printed with strikethrough indicates that the claim was canceled, disclaimed, or held invalid by a prior post-patent action or proceeding.

CROSS-REFERENCE TO RELATED
APPLICATIONS

[This] *The present application is a reissue application of U.S. Pat. No. 8,363,744, issued Jan. 29, 2013 and filed as U.S. patent application Ser. No. 11/880,825 on Jul. 23, 2007, which is a continuation in part of patent application Ser. No. 09/878,789, filed on Jun. 10, 2001, issued as U.S. Pat. No. 7,248,841 on Jul. 24, 2007, which claims priority to U.S. provisional patent application Ser. No. 60/211,462, filed Jun. 13, 2000, and to U.S. provisional patent application Ser. No. 60/243,831, filed Oct. 27, 2000.* This continuation-in-part application is filed to continue the prosecution, separately, of the invention below, and expressly incorporates both herein and by reference all of the original application's specification and drawings.

STATEMENT REGARDING FEDERALLY
SPONSORED RESEARCH OR DEVELOPMENT

Not Applicable

DESCRIPTION OF ATTACHED APPENDIX

Not Applicable

BACKGROUND

The field of wireless communication networks has challenged implementers with continuously discovered synergies, both positive and negative. The sea of signaling has long grown from scattered and isolated sparks of Morse code to the modern-day roar of intermingling transmissions. The simplicity of the directional link (Point to Point) was replaced by the broadcast (Point to Multipoint) and is being replaced by the mesh (Multipoint to Multipoint) and even the relaying, multi-hop, interactive mesh; also, the continuous-transmission format is being replaced by short and varying packets. The complexities of variations in real world conditions—constantly changing topography, overlapping wave signals, and unpredictable and intermittent faults or blockages—all challenge the existing methods and systems. Further description of some of these problems can be found in the parent application's text and will not be repeated here. This invention is concerned with the problems described below.

Problems Forming the Opportunity for the Invention

The primary problem solved through the invention is communication of short, intermittent packets, in particular Voice over IP (VoIP) communication signals, over communication networks subject to significant time-and-frequency co-incident ("co-channel") interference from other network users

and external emissions. A secondary problem solved through the invention is efficient physical routing of packets over multiple network nodes, e.g., using multihop relay techniques, in order to improve rate, robustness (immunity to interference and information warfare measures), reliability, and availability of communications between Source and Destination nodes in the network. A tertiary problem solved through the invention is means for rapid configuration and scalability of transceiver capabilities in highly dynamic environments where the density and severity of interferers, numbers and capabilities/requirements of communication nodes, and nature of channel propagation may change rapidly and dynamically between communication opportunities and/or over the course of a single communication opportunity.

Advantages of the Invention

The invention provides the following capabilities and advantages:

Common, scalable transceiver blocks that can be implemented at individual nodes in the communication network (allowing phased addition of hardware and software without immediately rendering obsolete the previous infrastructure).

Integration into a signal's waveform structure ("overhead structure") of overhead bits associated with point-to-point links in the network, e.g., Transmit and Receive Node Addresses (TNA's and RNA's), and then use of the resulting unified waveform structure both to securely identify nodes attempting to communicate with a receiver, and to develop linear combiner weights that can extract those signals from co-channel interference incident on that receiver (including interference from other nodes attempting to communicate with that receiver). This approach thereby eliminates bits needed for transmission of TNA and RNA in headers attached to data packets transmitted over each link in the network, as well as overhead needed for transmission of pilot tones/sequences, training signals, preambles/midambles, Unique Words, etc., typically used to train receivers in the network; thus reducing the transmission overhead and improving information-transmission efficiency.

Ability to further exploit overhead structure to increase transmit power and data rate, or to allow same-rate communication at reduced power to nodes in the network, thereby regaining link capacity lost by that overhead structure, with the most capacity regained at low receive signal-to-interference-and-noise-ratio (SINR).

Optional integration of overhead bits associated with multipoint routes in the network, e.g., Source and Destination Node Addresses (SNA's and DNA's) into the waveform structure used for adaptation of the communication transceivers ("overhead structure"), further reducing bits needed for transmission of SNA and DNA in headers attached to data packets transmitted in multihop networks, and allowing the use of macrodiverse relay networks in which data is coherently transmitted over multiple geographically separated nodes in a network.

Rapid (single packet) node detection/discovery and join/leave algorithms, allowing individual transceivers to enter or exit the network quickly to exchange traffic, update security codes, etc., and to allow rapid and/or ad hoc configuration of the network as users encounter dynamic changes in multipath, fading, or interference.

Information assurance (IA) measures, e.g., antijamming and antispoofing capability, at the node and network level, including spreading means that defeat denial-of-

service measures in which the frequencies and/or time periods containing synchronization and training bits are selectively jammed by an adversary.

Adaptive power management and cyclic feature reduction at node, link, and network levels, in order to minimize transmitted power and/or detectable features of emitters in the network.

Extreme low complexity (<200 kcps DSP software operations, <30 Mcps ASIC or FPGA coreware operations) for communications commensurate with VoIP communication, allowing maintenance of a collaborative networking information commensurate with pedestrian networking applications.

Collaborative communication applications that can be additionally handled by these transceivers include the following:

- Distributed Kalman state circulation to enable wide-baseline network geolocation algorithms

- Internode channel measurement and range/timing/carrier offset estimation algorithms used to enable wide-baseline network geolocation algorithms.

- Collaborative interference avoidance methods during transmission and reception operations, e.g., allowing wide-area communications in presence of jammers in military communication systems, or incumbent broadcast emitters in commercial communication systems (e.g., 802.22).

- Collaborative communication over long-range to out-of-theatre nodes, e.g., reachback nodes in military communication networks, or LEO/MEO/GEO satellites in commercial satellite communication networks.

BRIEF DESCRIPTION OF THE DRAWINGS

The invention is depicted in the Figures below.

FIG. 1 illustrates a Point-To-Point or PTP network; each pentagon indicates a node, or transmission and reception (a.k.a. transceiver) station, and each arrow indicates a link along which communication flows between nodes.

FIG. 2 illustrates a Point-To-Multipoint network. The large pentagon indicates a Base Station (BS) capable of communicating with many individual Subscriber Units (SU), indicated by the small pentagons.

FIG. 3 illustrates a more complex PMP network with multiple BS and SU nodes, and multiple links. The solid lines indicate one diversity channel and the dotted lines a second diversity channel.

FIG. 4 illustrates a multipath environment, where a single BS with a complex antenna radiates multiple beams to a single SU (the car), wherein the beams also arrive from reflections off the surrounding features.

FIG. 5 illustrates a null-steering effort by a single node (Item 101), possessing at least three antennae, which is capable of directing towards two unintended recipients (Item 102) null transmissions (Item 105) and directing a focused beam (Item 104) towards an intended recipient (Item 103).

FIG. 6A illustrates a more complex multipoint network, where the BSs communicate with each other and with individual SUs, even if a BS to BS link may risk interfering with communications between the BSs and a particular SU.

FIG. 6B illustrates a more effective use of the existing diversity of channels, whereby the BS to BS signal passes through a (possible multiplicity of) channel(s) from one BS to the intervening SUs thence to the second BS.

FIGS. 7A and 7B illustrate a capacity problem that may arise with a prior art PMP network when a new node attempts to enter and existing nodes are not capable of dynamically

adapting diversity channels to form the new subsets. Although nodes C and E can readily talk with D, by substituting their direct link to each other for intervening links with D, nodes D, A, and B, being limited to 3 existing channels, cannot adapt to connect with each other by dropping either E or C depending on traffic needs.

FIG. 8 illustrates a Time-Division Duplex communications protocol, whereby alternating uplink and downlink, or transmission and reception, slices of network activity take place at a node.

FIG. 9 illustrates an asymmetric network where nodes C and D have greater capacity than nodes A and B, which in turn have greater capacity than node D, but where the network cannot dynamically allocate this capacity to meet signal density needs to differing subsets of nodes.

FIG. 10 illustrates a multipath network, where transmissions between node 1 and node 2 are both direct and reflected off environmental features both near and far.

FIG. 11 illustrates a data flow diagram in a PTP MIMO link, where signal flows from one CODEC in node 2 through all of node 2's antennae, thence into all of node 1's antennae, and finally into one CODEC of node 1. Existing multipath potential of either or both reflectors, and dynamic allocation of less or more of the possible diversity modes, is ignored.

FIG. 12 illustrates a physical PTP multipath, consisting of one direct and two reflective links, using all of node 1's antennae and transceivers, and all of node 2's antennae and receivers.

FIG. 13A illustrates a network of MIMO-capable nodes, that is, nodes with multiple antennae, multitone transceivers with DSP capability (FIG. 13B), wherein the network has two subsets with preferentially reciprocal uplinks and downlinks and diversity channel capacity between the subsets.

FIG. 14 illustrates MIMO-capable nodes wherein each node transmits and receives signal energy during alternating time slots (or sequences of time slots in TDD-TDMA systems).

FIG. 15 illustrates more details of the MIMO-capable node, including on the receiving side: receiving spatially and/or polarization diverse antennae in a multiple antennae array (Item 110), a vector OFDM transceiver switch (Item 112), a LNA bank (Item 113), an AGC (Item 114), a Frequency translator (Item 115), a LOs (Item 116), an ADC bank (Item 117), a MultiTone Demodulator Bank (Item 118), means for mapping received data over each diversity channel, on each frequency channel and receive time slot (Item 119), and a transceiver controller (Item 120); and including on the transmitting side means for mapping transmitted data for each frequency channel and transmit time slot (Item 121), a MultiTone Modulator bank (Item 122), a DAC bank (Item 123), the transceiver switch, a PA bank (Item 124), and transmitting spatially and/or polarization diverse antennae in a multiple antennae array (Item 125) which may be distinct from those used in receiving (Item 110).

FIG. 16 illustrates a MIMO-capable network of the preferred embodiment, wherein an originating transceiver Node 2 in an uplink transmit set (Item 200) distributes a signal through multiple antennae (Items 204A and 204B), which goes over the channel matrix of diversity channels available (Items 206A, B, C, and D) to an uplink receive set node, which receives the signals over its multiple antennae and combines them (Items 208A and B) to the desired recipient (Item 202); leaving all other transmissions and channel diversity available (Item 212) for other network communications. FIG. 17 illustrates a PTP MIMO node layout employing TDD, but one using a guard-time prefix (Item 220) and a 10 ms content

frame period (Item 222), where the uplink Tx for Node 2 is at the time for the Uplink Rx for Node 1.

FIG. 18 illustrates a MIMO network in a star topology, where the uplink relay node (Node 1, Set 2) talks to 4 edge nodes (Nodes 1-4, set 1) with distinct channels for uplinks and downlinks.

FIG. 19 illustrates a complex network topology with multiple BSs (Items 260, 262), SUs (Items 264, 266, 268, and 270), and a potentially interfering non-network node (Item 275), with transmissions amongst the network (280, 282, 284, 290, 292) competing with transmissions from outside the network which are perceived as interference at BS1 (Item 260) and SU1 (Item 270).

FIG. 20 illustrates a MIMO network in a ring configuration with reciprocity at the network level.

FIG. 21 illustrates the means for generating the pilot tone mask with network code mask pseudodelay (Item 170), originating node index mask element (Item 172), and Recipient node index mask element (Item 174) being combined by two element-wise MUX units (Items 176, 178), to create the final pilot tone signal (Item 180).

FIG. 22 illustrates a time-frequency mapping pattern of an acquisition channel (Item 340, 342), control channel (Item 344), 32 Data channels (Item 346, not shown for D1 through D31), with cyclic prefixes (Items 322, 318, 314) and a guard time (Item 310) with 100 μ s acquisition symbols (Item 320), control symbols (Item 316), and then 32 data symbols (Item 312, again not shown for D1-D31).

FIG. 23 illustrates an alternative time-frequency mapping pattern for high-mobility situations, where the acquisition, control, and data elements are repeated (Items 362, 366, and 370), but the number of data-bearing channels is halved to allow the duplication within the same bandwidth and time.

FIG. 24 illustrates one embodiment of the MIMO transceiver, with the RF feeds (Item 130), the Frequency channel bank (Item 132), the mapping element (Item 134), the Multilink Rx weight adaptation algorithm (Item 136), the Multilink diversity Rx weights combining element (Item 138), the equalization algorithm (Item 140) and Delay/ITI/pilot gating removal bank (Item 142), symbol decoder bank (Item 144), multimode power management, symbol coding assignment algorithm element (Item 146), the synchronization elements (Items 162, 164), and T/R comp. Algorithm (Item 156) and element (Item 158), and multilink diversity distribution of Tx Gains element (Item 152).

FIG. 25 illustrates in more detail the frequency translator, detailing the Band Pass Filters, element wise multiplier, sinusoids, SAW BPF, and LPF elements.

FIGS. 26 and 27 illustrate tone-mapping to frequency bins approaches for low and high mobility situations, respectively.

FIG. 28 illustrates in more detail the implementation of the Delay/ITI preemphasis, pilot-gating bank, tying the details of FIG. 21 into the mapping element (Item 474), the Trellis encryption and encoding element (Item 472), the pilot signal and information signal MUX (Item 480), leading to the final Tx data symbols signals (Item 490).

FIGS. 29 and 30 illustrate the antennae feeds (502, 512) across diversity modes and multilinks through the Multilink Adaptation Algorithm element (500) to and from the Link and multitone symbol distributor/combiner inputs and outputs (506, 508; and 516, 518 respectively).

FIG. 31 illustrates the incorporation of the preferred embodiment of the Multilink LEGO gain adaptation algorithm and element (Item 530) into the diversity combining and distribution elements of the MIMO transceiver hardware.

FIG. 32 illustrates the LEGO optimization function for a target capacity objective β .

FIG. 33 illustrates the network LEGO optimization function for a network controller, using constraint $R_{1,q}$ and target objective β , to determine for the network or node which should be incremented or decremented.

FIG. 34 illustrates two nodes using dynamic, feedback driven information from transmissions and receptions to perform a particular LEGO optimization, involving observed interference power from non-subset or non-network BSs (528) or SUs (580).

FIGS. 35 and 36 illustrate the FFT-based LS algorithm used in the preferred embodiment that adapt $\{w_1(k,l;n_2,n_1)\}$ and $\{w_2(k,l;n_1,n_2)\}$ to values that minimize the mean-square error (MSE) between the combiner output data and a known segment of transmitted pilot data.

FIG. 37 illustrate the FFT-based LS algorithm used in the preferred embodiment for the normalized MMSE or, in an alternative embodiment, the Gauss-Newton algorithm.

FIGS. 38A and 38B illustrate a MIMO network with null-steering and pilot-tone transmissions, with the overall transmission shown as the Extraction SINR, and the mask-fitted transmissions perceived at 702A and 702B which correctly account through the imposed pilot pseudodelay for the intended transmission peaks.

FIGS. 39 and 40 illustrate alternative topological layouts for proper uplink receive and uplink transmit subsets with links and expected attenuation.

FIG. 41 illustrates, for a TDD MIMO network as in the preferred embodiment, an algorithm for any node entering the network.

FIG. 42 shows MIMO-capable hardware transceiver means for, and the processing steps performed, in the baseline two-channel transceiver used in the invention.

FIG. 43 shows enhanced MIMO-capable hardware means for, and the processing steps in combining, baseline two-channel transceivers to provide additional degrees of freedom (receive combining and transmit distribution) in larger networks.

FIG. 44 shows an exemplary MIMO networking routing scenario in which four transceivers with four spatial degrees of freedom are used to route data around a four-node network in the presence of a strong jammer.

FIG. 45 shows the baseline symbol and timing structure for each transmission, when transceivers are operated in a symmetric time-division duplex (TDD) multinode network.

FIG. 46 shows an exemplary deployment and instantiation of the invention in a communication over a TDD mesh network topology

FIG. 47 shows the baseline symbol and timing structure for each transmission, when transceivers are operated in an ad-hoc multinode network.

FIG. 48 shows an exemplary deployment and instantiation of the invention in a communication over an ad hoc mesh network topology.

FIG. 49 shows multipoint PHY transmit operations and processing performed at transceivers using the invention.

FIG. 50 shows multipoint PHY receive operations and processing performed at transceivers using the invention.

FIG. 51 shows multipoint PHY receive adaptation operations and processing performed in the primary embodiment of the invention.

FIG. 52 shows receive packet detection, address association, and link SINR estimation processing performed in the preferred embodiment of the invention.

FIG. 53 describes transmit adaptation algorithms operations and processing performed in the preferred embodiment of the invention.

Resolving many of the prior art's weaknesses by enabling true, opportunistic, MIMO networks is one of the principle objects of the invention. Creating a truly adaptive, flexible, multi-protocol wireless electromagnetic communications network is a second of the principle objects of the invention. A third is to simultaneously resolve the interplay between transmission power and network capacity by considering and using the interplay between one local node's transmissions as a signal and other nodes' reception of the same as either a signal (if the receiving node is an intended target) or as environmental noise (if the receiving node is an unintended target).

A secondary objective under this third objective is to provide methods which improve signal quality received by a targeted recipient node while simultaneously reducing interference energy received by other untargeted recipient nodes, so as to enable improved capacity amongst existing nodes, adding more nodes, increasing coverage area, and improving communications quality, or any sub-combination thereof.

Another secondary objective under this third objective is to provide an adaptive method which accounts for multipath interaction amongst the nodes and network, and minimizes unwanted effects while maximizing potential useful effects thereof.

Another secondary object under this is to provide improved load balancing amongst nodes and communication paths or links within the network with a minimum of overall control.

Another secondary object under this is to enable improved access to new nodes to the network.

Another secondary object under this is to enable multiple, competing, yet cooperating sub-networks that are mutually and automatically adaptive and responsive.

A second of the principal objects of the invention is to simultaneously resolve the interplay between local optimization, which demands detailed consideration of the immediate environmental details that affect each link between that node and others over which communications are flowing, and global optimization, which demands a minimum of control information be exchanged across the network and amongst the nodes in lieu of otherwise usable signal capacity.

A secondary object under this is to use the reception of signal information from other nodes, both those targeting the recipient and those not targeting the recipient, to enhance both reception and transmission quality to and from the receiving node while minimizing the explicit and separate feedback signals that must be exchanged amongst the nodes and network.

Another secondary object under this is to provide methods for optimization that can use or be independent of antenna array geometry, array calibration, or explicit feedback control signals from other nodes, whether the same are continuous, regular, or reactive to environmental changes affecting the link between the receiving node and the other nodes.

A third of the principal objects of the invention is to maximize the communications capacity and minimize the power usage both locally and globally across the network for any given set of hardware, software, and protocols.

A secondary object under this is to provide higher content throughput in underloaded networks, thereby providing faster perceived access or usage.

A secondary object under this is to provide higher reliability for any given hardware and software implementation.

A fourth of the principal objects of the invention is to provide a method for network optimization that can be extended to mixed networks, whether such mixing is amongst

wireless and fixed links, or amongst electromagnetic spectra, or amongst types of nodes (BSs, dumb terminals, single- or limited-purpose appliances, or human-interactive input/output), and across both access schema and communications protocols with a minimum of particularization.

A fifth of the principal objects of the invention is to provide relatively simple and powerful methods for approximation which enable improvement that rapidly converges to the best solution for any optimization.

A secondary object under this is to provide a computationally efficient mechanization for cross-correlation operations that takes maximal advantage of multipoint signals on particular single channels

A sixth of the principle objects of the invention is to maximize the use of local information and minimize the use of global information that is required for approximation and approach to the best solution for any optimization.

SUMMARY OF THE INVENTION

The multiple-input, multiple-output (MIMO) network approach summarized here can incorporate as lesser, special cases, point-to-point links, point-to-multipoint networks, and disjoint (e.g., cellular) point-to-point links and point-to-multipoint networks. It can also be applied to spatial, temporal, or frequency-based access schemes (SDMA, TDMA, FDMA) employing combinations of spectral, temporal, spatial or polarization diversity, and to fixed, mixed, and mobile communications, as its focus is on the network in context rather than on the signal differentiation methodology, access determinations, or basing structure. One key to this approach is employment of spatially (or more generally diversity) adaptive transmit and receive processing to substantially reduce interference in general multipoint links, thereby optimizing capacity and/or other measures of network quality in multiply connected networks. A second key to this approach is the minimization of secondary consequences of signaling, and a second is using internalized feedback, so that the signaling process itself conveys information crucial to the optimization. Rapid, dynamic, adaptation reactive to the changing environment and communications within and surrounding each node and the entire network is used to promote both local and global efficiency. Unlike Varanesi, the feedback is neither limited to BSs only, nor effectively independent of the continual, real-world, signal and network environmental adaptation.

Instead of avoiding diversity, or fighting diversity, the present embodiment of the invention exploits and makes use of spectral, temporal, polarization, and spatial diversity available at each node, as well as and route (location based) diversity provided over the network of nodes. The network of nodes uses MIMO-capable nodes, that is, nodes with multiple antennae, multitone transceivers and preferentially reciprocal uplinks and downlinks (FIG. 13A and FIG. 13B). In the preferred embodiment each node transmits and receives signal energy during alternating time slots (or sequences of time slots in TDD-TDMA systems) (FIG. 14); has a spatially and/or polarization diverse multiple-antenna array, a vector OFDM transceiver that downconverts, A/D converts, and frequency channelizes data induced on each antenna (or other diversity channel) during receive time slots, and inverse channelizes, D/A converts, and upconverts data intended for each antenna (or diversity channel) during transmit time slots; linearly combines data received over each diversity channel, on each frequency channel and receive time slot; redundantly distributes data intended for each diversity channel, on each frequency channel and transmit time slots; and computes

combiner and distributor weights that exploit the, narrow-band, MIMO channels response on each frequency channel and time slot (FIG. 15).

The concept of a 'diversity channel' is introduced to permit a distinction to be made between "channels" that data is redundantly distributed across during receive (or transmit) operations, from "channels" that data is transported over (e.g., frequency channels or time slots). Data is redundantly transported over diversity channels, i.e., the same data is transported on each diversity channel with weighting determined by the methods described in detail below, while independent data is generally transported over the second flavor of channel. Effectively exploiting available diversity dimensions, the present embodiment of the invention can maximize its ability to attain Rank 2 capacities, since multiple redundant transmissions can be made over the plurality resources, whether that plurality comes from different frequencies, multipaths, time slots, spatially separable antennae, or polarizing antennae. This is distinct from prior art approaches which required multiple redundant transmissions over a plurality of frequencies to attain Rank 2 capacities. Because the signal flow between nodes is not limited to a particular dimension of substantive differentiation the preferred embodiment of the network can at every point in time, and for every node in the network, exploit any and all diversity opportunities practicable and attainable for the network's communication channels.

The signal flow between the multiplicity of nodes in the network comprises a multiplicity of information channels, emanating from and being received by a set of antennae at each node (FIG. 16). The physical channel flow in a network with $M(n)$ diversity channels (e.g., $M(n)$ antennae per node, at each node n in the network) means that for each transmitting node's pair of antennae, as many as M distinguishable receptions are feasible at each receiving node it can communicate with (FIG. 15, $M=4$, for a PTP link example).

The preferred embodiment performs complex digital signal manipulation that includes a linear combining and linear distribution of the transmit and receive weights, the generation of piloting signals containing origination and destination node information, as well as interference-avoiding pseudo-random delay timing (FIG. 17), and both symbol and multi-tone encoding, to gain the benefit of substantive orthogonality at the physical level without requiring actual substantive orthogonality at the physical level.

The network is designed such that a subset of its nodes are MIMO-capable nodes, and that each such node can simultaneously communicate with up to as many nodes in its field of view as it has antennae. The network is further designed such that it comprises two or more proper subsets, each proper subset containing members who cannot communicate directly with other members of the same proper subset. So if the network contained only two proper subsets, First and Second, the members of First could transmit only to, and receive only from, the members of Second, and the members of Second could transmit only to, and receive only from, the members of First. Independent information is then transmitted from every member of First and is independently processed by each member of Second. (See FIG. 18, exemplifying one such topology, a 'Star' topology; and FIG. 19, exemplifying another such topology.)

A non-MIMO-capable node may belong to any subset containing at least one MIMO-capable node that has at least one antenna available to that non-MIMO-capable node that has the non-MIMO-capable node in its field of view.

Diversity channels, rather than antennae, limits the number of non-set members a MIMO-capable node may communi-

cate with simultaneously, that is, the number with which it may hold time/frequency coincident communications. Also, this limiting number is a function of number of users attempting to communicate over the same diversity channels—users on different time-frequency channels do not affect this limit. Thus a node with 128 time frequency channels (8 TDMA time slots \times 16 FDMA frequency channels) and a 4 antennae (4 diversity channels per time-frequency channel) can support up to $4\times 128=512$ links, to as many users. If the internode channel response to a given user has rank 1 (e.g., if antennae are on same polarization and multipath is absent), then only a single link can be established to that user on each time-frequency channel, e.g., 128 separate links (one on each time-frequency channel) in the example given above. Higher internode channel rank allows more channels to be established; for example if nodes are polarization diverse, then the internode channel response has rank 2 and 256 channels (2 per time-frequency channel) can be established. The MIMO channel response equation determines power on each channel—depending on needs of network and pathloss to user, some or most of channels nominally available may be turned off to optimize the overall network capacity.

A significant element is that the diversity channel distribution need not be equal; one recipient node may have half the channels, if the traffic density requires it, while the transmitting node may divide its remaining channels evenly amongst the remaining nodes. Therefore the more users that have rank 2 or better capacity, the greater the available channels for those who have only capacity 1. This supports incremental optimization as improvement for the network is not dependent upon global replacement of every lesser-capacity node, but results from any local replacement.

The preferred embodiment details the means for handling the two alternative cases where the interference is, or is not, spatially white in both link directions, the means for handling interference that is temporally white over the signal passband. Preferentially, each link in the network possesses reciprocal symmetry, such that:

$$H_{12}(k;n_1,n_2)=H_{21}^T(k;n_2,n_1), \quad \text{EQ. 1}$$

Where $H_{12}(k;n_1,n_2)$ is the $M_1(n_2)\times M_2(n_1)$ MIMO transfer function for the data downlinked from node 1 to node 2 over channel k , less possible observed timing and carrier offset between uplink and downlink paths,

and,

$H_{21}(k;n_2,n_1)$ is the $M_2(n_2)\times M_1(n_1)$ MIMO transfer function for the data uplink from node 2 to node 1 over channel k , and where $()^T$ denotes the matrix transpose operation.

In the preferred embodiment, this is effected by using the TDD protocol, and by sharing antennae during transmit and receive operations and performing appropriate transceiver calibration and compensation to remove substantive differences between transmit and receive system responses (this can include path gain-and-phase differences after the transmit/receive switch, but does not in general require compensation of [small] unequal observed timing and carrier offset between uplink and downlink paths). However, simplex, random-access packet, and other alternative methods are also disclosed and incorporated herein.

The network is further designed such that at each MIMO-capable node n with $M(n)$ antennae, no more than $M(n)$ other actively transmitting nodes are in node n 's field of view, enabling node n to effect a substantively null-steering solution as part of its transmissions, such that each node belonging to a downlink receive set can steer independent nulls to every uplink receive node in its field of view during transmit and receive operations, and such that each node belonging to

an uplink receive set can steer independent nulls to every downlink receive node in its field of view during transmit and receive operations.

The preferred embodiment also has means for incorporation of pilot data during transmission operations, and means for computationally efficient exploitation of that pilot data during subsequent reception operations. This is to enable transmitting nodes to unambiguously direct information to intended recipient nodes in the network; to enable receiving nodes to unambiguously identify information intended for them to receive; to enable nodes to rapidly develop substantively null-steering receive weights that maximize the signal-to-interference-and-noise ratio (SINR) attainable by the link, to enable nodes to reject interference intended for other nodes in the network, to enable nodes to remove effects of observed timing offset in the link, and to enable the nodes and network to develop quality statistics for use in subsequent decoding, error detection, and transmit power management operations.

The preferred embodiment prefers a network designed to create and support a condition of network reciprocity, where the uplink and downlink criteria are reciprocal at the network level. (FIG. 19). The present form of the invention further exploits the reciprocity to attain both local and global optimization, of both capacity and power, through locally enabled global optimization of the network (LEGO).

LEGO is enabled by exploiting substantive reciprocity of the internode channel responses, together with appropriate normalization of transmit power measures, to design uplink and downlink network quality metrics $D_{21}(W_2, G_1)$ and $D_{12}(W_1, G_2)$ that satisfy network reciprocity property:

$$D_{12}(W, G) = D_{21}(G^*, W^*) \quad \text{EQ. 2}$$

where (W_2, G_1) and (W_1, G_2) represent the receive and transmit weights employed by all nodes in the network during uplink and downlink operations, respectively. If equation 1 holds, then equal network quality can be achieved in each link direction by setting $G_1 = W_1^*$ and $G_2 = W_2^*$, such that each node use the receive combiner weights as transmit distribution weights during subsequent transmission operations, i.e., the network is preferentially designed and constrained such that each link is substantially reciprocal, such that the ad hoc network capacity measure can be made equal in both link directions by setting at both ends of the link:

$$g_2(k, q) \propto w_2^*(k, q) \text{ and } g_1(k, q) \propto w_1^*(k, q)$$

where $\{g_2(k, q), w_1(k, q)\}$ are the linear transmit and receive weights to transmit data $d_2(k, q)$ from node $n_2(q)$ to node $n_1(q)$ over channel k in the downlink, and where $\{g_1(k, q), w_2(k, q)\}$ are the linear transmit and receive weights used to transmit data $d_1(k, q)$ from node $n_1(q)$ back to node $n_2(q)$ over equivalent channel k in the uplink; thereby allowing Eq. 1 to be satisfied for such links.

The invention further iteratively optimizes network quality (as defined by D_{12} and D_{21}) over multiple frames, by first adapting combiner weights to locally optimize link (and therefore network) performance during receive operations, and then using Eq. 1A and the reciprocity property (Eq. 1) to further optimize network quality in the reverse direction over subsequent transmit operations.

The invention further improves on this approach by using Eq. 1 to scale each transmit vector, based on a partial linearization of the network quality metrics, to either minimize the total transmit power in the entire network subject to a network quality constraint, preferentially capacity, or maximize network quality, preferentially capacity, subject to a total transmit power constraint. This constraint is defined and managed as a control parameter that is updated by the network. The total transmit power at a given node is then reported as an output to the network.

By using target criteria such as (1) for a cellular network, a max-min capacity criterion subject to a power constraint, or

(2) for a wireless LAN, a max-sum capacity that is subject to a power constraint, and using simple comparative operations in feedback for the network to optimize towards those criteria, this invention enables flexibility and stability for any given hardware and software combination that underlies a wireless electromagnetic communications network and improves, for the entire network and at each particular node thereof, the communication capacity and power requirements. Furthermore, the present form of the invention does not ignore but rather directly addresses and resolves both the overhead vs. content and the power vs. capacity conundrums which otherwise limit present-day state of the art approaches to optimization. It does this using the experienced environment as part of the direct feedback, rather than requiring additional control information or signaling that reduces content capacity.

When combined with the substantively null-steering approach described here, which helps to minimize the generated noise from all other signals sent from a node, the network power requirement for clear communication drops as the links effectively decouple; that is, the 'other' channels, since they are being null-steered, do not form part of the background noise against which the intended signal's power must be boosted to be accurately received by the intended recipient. (See FIG. 7.)

The LEGO power optimization and null-steering then feed back (reciprocally) into the requirements for the network and network's hardware at each node, inasmuch as the minimization of unused and unintentional interaction (or interference) reduces the precision and power necessary for frequency and other differentiation means at the node's transceiver, and reduces the number of antennae in each array by increasing the effective bandwidth within each multipath channel, by reducing the amount of bandwidth, frequency, time, or channel, or all of the above, that must be devoted to error avoidance or correction. That in turn simplifies the codec and other element designs for each node and lowers the cost of the transceiver front-ends.

The preferred embodiment of the invention employs a network of fully-adaptive PHY-1A MIMO Network Capable Transceivers, in which each transceiver implementing an upper PHY that performs transmit and receive TRANSEC, node signaling/detection protocol, transmit/receive beamforming, and receive-side node discovery and adaptation algorithms, and a lower PHY that can meet the needs of intermittent, burst packet communications such as VoIP.

Communication between source and destination nodes, defined by unique two-hex port addresses comprising the source and destination node addresses (SNA's and DNA's) for the packet transmission, is accomplished by routing traffic packets over at least one and possibly several routes or collections of sequential links between the source and destination node. Means for partitioning traffic data into individual data packets at the source node, and collecting data packets into traffic packets at the destination node, are accomplished in this invention using existing network routing protocols. For each combination of a transmitting node, a receiving node, and a communication channel (diversity link), the unique link address and identifying transmit node address and receive node address for the respective nodes are used as part of the messaging context.

Combining packet-specific, structural and origin/destination network information into a unified overhead allows implementation of orthogonal transformations of that overhead, through the use of specific power-of-two integer number of lower PHY (LPHY) symbols (which are preferably an OFDM waveform or PAM signal); and using a unique and identifying link address for each node-to-node link currently instantiated, which incorporates source, destination, and channel rank information, enables informational efficiency for short transmissions where otherwise structural and rout-

ing information might outweigh content, e.g. in each packet. Working within bounds (time intervals, frequency ranges, or transmission strengths) that guard against intrasystemic interference, the use of MIMO transformations and reciprocity-based pilot or signal weighting calculations for the correct weighting of signals transmitted and received, enables the individual packets and messages to adapt, in a bottom-up, flexible, and responsive fashion to the real-world dynamics of a continuously varying EM flux. Using adaptively-derived diversity weighting, the method and system can rapidly take advantage of reciprocity between each node pairings' transmit and receive channels to distinguish the desired signal from the general noise and potential interference. Upon RF reception at any node, downconversion and ADC operations on the diversity channels passes the incoming signal(s) through a set of inverting transformations that, for the desired incoming signal(s), strip off known structural elements and continuously updates the combiner weights to reflect the dynamically varying environmental and signal context, thereby continuously matching necessitated signal and waveform transformations to the environmental and signal effects and sources. By successive iterations of the transmit and receive adaptation algorithm each node can have its transceiver adapt its multipoint combiner and distribution weights to the eigenmodes (left and right eigenvectors) of their MIMO internode channel response, so that the resultant fully adaptive link can approach the Shannon capacity of the MIMO communication channel, regardless of the rank or distribution of the eigenvalues of that channel.

In addition, the fully adaptive system provides an automatic power control mechanism (LEGO Algorithm) that can be used to maximize capacity (high throughput applications) or minimize transmit power (LPD applications), depending on the requirements of the system at any point during a mission.

The resultant network is able to pass data with high spectral efficiency relative to non-MIMO networks, or to meet specified packet transmission rates at much lower power levels relative to non-MIMO networks, due to its ability to pass data over multiple time-and-frequency coincident links and routes, and to exploit the much lower pathloss between intermediate nodes in the network. Moreover, the network is able to provide this performance in the complete lack of any opportunistic multipath (although that multipath can be exploited if it is available).

DETAILED DESCRIPTION OF THE DRAWINGS

Glossary And Definitions

ACK Acknowledgement
 ADC Analog-to-Digital Conversion
 ADSL Asynchronous Digital Subscriber Line
 AGC Automatic Gain Control
 BS Base Station
 BER Bit Error Rate
 BW Bandwidth
 CBR Committed Bit-Rate service
 CDMA Code Division Multiple Access
 CE&FC RWA Computationally Efficient And Fast-Converging Receive Weight Algorithm
 CMRS Cellular Mobile Radio Systems
 CODEC Encoder-decoder, particularly when used for channel coding
 CPU Central Processing Unit
 CR Channel Reciprocity
 DAC Digital-to-Analog Conversion
 DEMOD Demodulator

DMT Digital MultiTone,
 DSL Digital Signal Loss
 DMX De-multiplexer
 DOF Degrees of Freedom
 5 DSP Digital Signal Processing
 EDB Error-Detection Block
 EEPROM Electronically Erasable, Programmable Read Only Memory
 FDD Frequency Division Duplex
 10 FDMA Frequency Division Multiple Access
 FFT Fast Fourier Transform(s)
 FPGA Freely Programmable Gate Array
 GPS Global Positioning Satellites
 GSM Global System for Mobile Communications
 15 LEGO Locally Enabled Global Optimization
 LMS Least Mean-Square
 LNA Low Noise Amplifier
 LS Least-Squares (An alternative form can be 'matrix inversion')
 20 MAC Media Access Control
 MGSO Modified Gram-Schmidt Orthogonalization (most popular means for taking QRD)
 MOD Modulator
 MIMO Multiple-Input, Multiple-Output
 25 MMSE Minimum Mean-Square Error
 MSE Mean-Square Error
 MT Multitone
 MUX Multiplex, Multiplexer
 NACK Negative acknowledgement & request for retransmission
 30 NAK Negative Acknowledgement
 OFDM Orthogonal Frequency Division Multiplexing
 PAL Programmable Array Logic
 PDA Personal Data Assistant
 35 PHS Personal Handiphone System
 PHY Physical layer
 PMP Point-to-Multipoint (An alternative form can be 'broadcast')
 PSTN Public Switched Telephone Network
 40 PSK Phase-Shift Key
 $\pi/4$ QPSK (pi/4)-Quadrature Phase Shift Key
 $\pi/4$ DQPSK (pi/4)-Digital Quadrature Phase Shift Key
 PTP Point-to-Point
 QAM Quadrature Amplitude Modulation
 45 QoS Quality of Service
 QRD Matric {Q,R} decomposition (see, MGSO)
 RF Radio Frequency
 RTS Request To Send, recipient ready for traffic
 SDMA Spatial Division Multiple Access
 50 SINR Signal to Noise Ration (An alternative form can be S/N)
 SOVA Soft-Optimized, Viterbi Algorithm
 SU Subscriber Unit
 TCM Trellis-Coded-Modulation
 55 TCP/IP Transmission Control Protocol/Internet Protocol
 TDMA Time Division Multiple Access
 TDD Time Division Duplex
 T/R Transmit/Receive (also Tx/Rx)
 UBR Uncommitted Bit-Rate (services)
 60 ZE-UBR Zero-error, Uncommitted Bit-Rate (services)
 Groundwork: the Network as a Dynamic Connected Set
 A network is generally viewed as the combination of a set of nodes (where transmissions originate and are received) and the connections between those nodes through which the information is flowing. FIGS. 1A, 1B, and 1C are graphical representation of a simple network of five nodes (A through E) and a varying number of channels, indicated by the lines

drawn between pairs of nodes. In FIGS. 1A and 1C, all five nodes are active and able to communicate with all or most of their neighbors. In FIG. 1B, node D is inactive and unable to communicate. The two-step channel, from C to D and from D to E, in FIG. 1A is replaced by a one-step channel from C to E in FIG. 1B, and co-exists with the two-step channel in FIG. 1C. A connection between any two nodes without any intervening nodes is also known as a 'link'.

Because each node may both transmit (send) and receive, and because the connections amongst the set of nodes may change over time, the network is best thought of as a dynamic structure, i.e. one that is constantly shifting yet which still occupies the same general 'space' in the communications world. While traditional broadcast networks, or PTP or PMP networks generally tried to 'fix' at least the originating node, a MIMO network begins with the presumption that the communications are dynamically allocated amongst the nodes and throughout the network. In the present embodiment of the invention, diversity in spatial, spectral, temporal, or polarization attributes of the potential channels are not seen as variations that must be controlled or limited, but as opportunities for enhancing performance.

Limitations of Existing Art

The approaches currently described in the field, especially in Raleigh and Cioffi, G. Raleigh, J. Cioffi, "Spatio-Temporal Coding for Wireless Communications," in Proc. 1996 Global Telecommunications Conf., November 1996, pp 1809-1814, and in Foschini and Gans (G. Foschini, M. Gans, "On Limits of Wireless Communication in a Fading Environment When Using Multiple Antennas", Wireless Personal Comm., March 1998, Vol. 6, Nol. 3, pp. 311-355), require additional hardware at each node comprising one end of a channel per diversity path to exploit that diversity path. This creates a geometric growth in the hardware complexity for each particular node, and a linear growth in cost for each diverse path exploited by a given network, that rapidly renders any network attempting to exploit such diversity uneconomic. Moreover, such an approach 'muddies its own stream' in that it reduces the capacity increase by the power increase needed to power the more complex transceiver. Exploitation of this multipath approach requires both high power (to permit data transport over the relatively weaker additional diversity path) and complex codecs (to permit data transports at high rates on the dominant path by filtering out the diversity path transmissions). To the extent that the nodes differ in their antennae mix, this approach complicates the administration and management of the network by constraining the potential path exploitation to previously-known or approved channels where the required equipment for each diverse path is known to exist.

Spatially distributed networks overcome this particular limitation by exploiting the inherent diversity between inter-node channel responses in the network. This diversity exists regardless of any multipath present on any individual path in the network, i.e. it does not require high levels of opportunistic multipath to be exploitable by the system. Moreover, such spatial diversity can be designed into the network by careful choice of topologies for the nodes during the deployment process, in order to provide linear growth in capacity as transceivers are added to the network. As a side benefit, the network can spatially excise transmissions from compromised nodes and emitters, allowing secure, high quality service in environments with external interference.

A downside to such an approach is its obvious weakness to unexpected growth, dynamic changes in topology (from mobile, transitory, or transient nodes), or dramatic changes in relative channel densities. Unlike the present form of the

invention, such an approach does not handle well unplanned-for competition, environmental changes, or readily exploit opportunities arising from surprisingly (i.e. unplanned for) good network performance.

MIMO Networks: Shapes and Spaces

The complex MIMO environment and multiple dimensions of differentiation (spatial, frequency, time, code), the physical geography of any network (ring, star, mesh), the physical geographies of the surrounding terrain (creating the multipaths) and the other wireless signals from outside the network, and the internal network environment (of traffic patterns and node differences) create a diversity explosion.

To create and manage optimal network capacity, the preferred embodiment creates a network topology that enforces a constraint where each node with $M(n)$ antennae has $\leq M(n)$ other nodes in its view with whom it communicates at any particular interval of time. This may take the form of a ring (see FIG. 16), star (FIG. 18), mesh (FIGS. 39, 40), or combination thereof, depending on the individual nodes' hardware and geographic specifics. Moreover, this may dictate the placement of nodes, geographically or in uplink or downlink transmission subsets. This enables the creation of reciprocal subspaces for each sub-set of the network and therefore for the network as an entirety. However, the approach in the preferred embodiment can manage with other network shapes and spaces, just as it can manage with the hardware or protocol or software constraints inherent in particular nodes.

While the preferred embodiment works with reciprocal subspaces, wherein the network maintains reciprocity according to Eq. 1 between nodes over all links joining them, some parameters may be allowed to vary and create asymmetric spaces. For example, in a carrier offset case, the channel responses are actually invariant but for the complex scalar sinusoid which creates the frequency offset; physically, this is a non-reciprocal link but logically it remains (assuming signal content density on both sides is kept equal) a substantively reciprocal link. Other adaptation means are permissible as long as the network design rule of Eq. 1 is kept as a high priority.

One major difference in the present embodiment of the invention from prior art is that by making the control and feedback aspects part of the signal encoding process, and thereby eliminating or at least reducing the need for a separate channel(s) for control and feedback, the network content overhead is reduced and an additional range within the signal dimension is available for signal content. The LEGO reduction to single, or small, bit sized power management signals can be similarly echoed for other network management, depending on the target objective the network elects.

Furthermore, because the MIMO and LEGO approach described herein is usable in any network topology, and with existing protocols and schema (PSK/QAM; FDD; CDMA, including modulation-on-symbol, or synchronous, CDMA; TDMA; SDMA, etc.) the network can adapt to a diverse environment of users rather than requiring all to have the identical hardware, software, and standards.

The diversity of transmission and reception at all nodes in the network, rather than just at a subset of hub nodes or BSs, means that every node can use in its local environment any redundancy in transmission or reception of data over multiple channels, whether they be spatial, polarization, spectral, temporal, or any combination thereof. The maximum use can be made of all available (i.e. unused by others) signaling lacunae, with the nodes adaptively adjusting to the traffic and external environmental conditions according to the objectives set by the network.

Furthermore, the present embodiment of the invention does not require a preliminary calibration of the transceiver array, the communications channel, or geographic site as do many approaches used in the prior art. The continuous feedback and rapid convergence of the approach allow for flexibility and adaptivity that will permit correction of miscalibrated data, when the miscalibration represents a no-longer valid model of the environment for the receiving node.

Additionally, the MIMO network of the present embodiment is adaptive to channel response changes due to network point failures. This includes: the ability to survive element failure at individual nodes (i.e. one antenna, or transceiver, fails) without loss of communication to that node (though it may incur possible loss of capacity); the ability to survive failure of links without loss of communication to that node (e.g., by routing data through other paths); the ability to survive failure of node (all links terminating at that node) without unduly affecting connectivity or capacity of network; and the ability to achieve network reliability that is higher than reliability of any node in that network. The network will automatically adjust itself to optimal performance in event of any of these failures; potentially by rerouting active links based on available SINR experienced at that link.

Application Areas and Advantages: MIMO

The incorporation of the control and feedback signal as part of the process rather than as discrete, separate, and particular parts of the signal, can decrease the complexity of apparatus by removing the need for a separate channel for network control. It also can decrease the complexity of the processing by removing the need for particular dedication of a time aspect of the reception, or by removing the need for additional detection and interpretation of control signal from other content through either software or hardware. Moreover, such incorporation also integrates the entire aspect of power management and control into the signaling process rather than artificially and needlessly separating it from the network dynamics. This integration allows both capacity and power control to cooperatively handle packet acknowledgment, signal synchronization, and transmit/receive functionality at each node, and to optimize their conjoined functionality to the needs of the environment, the user, or the node rather than being constrained to disparate, pre-set and non-dynamic dictates by network administration that are only responsive to the real world environment to the extent that the system designers' assumptions accurately modeled the real-world and unknowable complexities.

Because the control and feedback signaling is incorporated into the process, the present form of the invention does not impose overhead constraints or capacity demands upon the network to nearly the same degree as the prior art does. For a given infrastructure and environment, therefore, the present form of the invention provides increased capacity and performance through dynamic, and self-moderating signal processing algorithms, with a minimal overhead.

Additionally, because the method does not require a strict hierarchical division between Base Station and Subscriber Unit nodes, but rather adapts to the diversity of reception and transmission at each particular node depending on its then-current environmental context, the method allows for rapid and responsive deployment of mixed hardware units being conditioned by factors external to the network, such as user choice or economic limitations.

Unlike prior art, the present form of the invention will work with each of CDMA, FDD, TDMA, SDMA, and PSK/QAM implementations, and with any combination thereof. Because the present form of the invention will work with diverse environments, where the diversity may come from within the

network (rather than from sources external to it), this protects users and companies' investments in prior infrastructure and avoids creating either a 'captive service market' subject to crippling and sudden innovation, or creating a network which will suffer when a Christiansen-style disruptive technology advance arrives. Moreover, diversity reception, which is the redundant transmission and reception of data over multiple channels (whether the diversity comes in spatial, polarization, spectral, or temporal form, or any combination thereof), permits successful operation in environmental conditions which would otherwise block any particular channel or perfect subset of channels. This means that the present form of the invention will continue to operate in dirty, bursty, or difficult conditions, whether the impact of the negative force is on the nodes or the external environment.

As such, there are a number of potential implementations which immediately become feasible for a dynamically adaptive network, in the military and security fields. These include military and civilian applications where individual unit or node failure can be anticipated and therefore must not bring down the network, and where environmental conditions can become disruptive for particular nodes or links. These would also include support and exploration applications where the external environment (including node location) and network internal environment (traffic, connectivity) may change over time, as the component nodes move and change capabilities and capacities.

Among the effects which enhance the ready establishment and dynamic use of security advantages through the present form of the invention are the three-layer pilot signal (network mask plus originator mask plus recipient mask) detailed below (See FIG. 21). This allows users to communicate both on an unsecured overall network and a separately secure sub-network, on discrete (possibly encrypted) subnets through a subnet mask. This also allows network establishment and alteration of any subnet through designation and adaptation of shared subnet masks, wherein layers of encryption become algorithmically establishable. The present form of the invention also allows the fast detection, acquisition, interference excision, and reception of originators attempting to talk with the recipient, prioritizing the same according to their match to any set of subnet masks (highly secured signals presumably taking priority over less secured or open signals). Alternative uses of origination masks or recipient masks allow dual-natured communication priorities and the ability to suppress unintended recipients via the imposition of either origination or recipient masks, the secure transmission through interim nodes not provided with either mask, and the ability to determine and remove group delay as a fundamental part of the FLS algorithm.

Unlike the prior art, the present form of the invention will also allow for optional specialization (e.g. in transmission, reception, flow-through channelization) at any particular node in a dynamic fashion, thereby allowing the network as a whole to adapt to transient environmental fluctuations without concomitant alteration in on-the-ground hardware or in-the-system software alterations. Such ready adaptivity increases the total cost-effectiveness, as well as the dynamic stability for the entire network.

Unlike prior art, the present form of the invention supports diversity reception and transmission at all nodes in the network. This creates a level of flexibility, adaptivity to environmental or network changes, and dynamic stability which increases the ready scalability over multiple distinct approaches simultaneously or serially accepted by the network. Since the core reciprocity and protocols can be used by distinctly different hardware and signals, the present form of

the invention permits local accretive growth rather than demanding top-down, network-wide initial standardization, thereby decreasing the capital and planning cost for implementing or changing a network.

Another advantage of the present form of the invention is that it permits shared antenna usage amongst multiple nodes, thereby decreasing the number of antenna necessary for any given node to attain a particular capacity, and thereby decreasing for the network as a whole the cost and complexity required for that same level of capacity. Furthermore, it also permits any set of nodes to use a diversity of channels without requiring an increase in the antenna or internal complexity (in both hardware and software) at every node in said set of nodes.

A further advantage of the present form of the invention is the ability to adaptively select and use ad-hoc, single-frequency networks on all or part of the network, under conditions when network traffic is 'bursty', that is, when there are significant disparities between the high and low content volumes of traffic being communicated amongst that part of the network.

A particularly significant advantage of the present form of the invention is that using the reciprocity equation equalizes the processing or duty cycle for message transmission and reception across both directions of a link, thereby lowering the processing imbalance which otherwise might be created between transmission and reception modes. This in turn reduces the average complexity which must be built into each particular node by decreasing the maximal capacity it must be created to handle for an overall network minimal capacity average.

Another advantage of the present form of the invention is that, unlike much of the prior art, the present form of the invention will work in uncalibrated areas where the environmental context is either previously unknown or altered from previous conditions. This allows for rapid, uniphase adoption and expansion in any given area without requiring prior to the adoption the precise calculation of all environmental effects upon transmissions and receptions within said area at all planned or possible node locations. This further allows the adoption and use for transient, or mobile, nodes in areas without requiring all possible combinations of channel responses amongst said nodes first being calibrated and then said channel responses matched to current conditions, or constrained to pre-set limitations.

Another advantage of the present form of the invention is that it provides rapid correction for miscalibrated data, thereby reducing the cost of inaccurate measurement, human or other measurement error, or incorrect calibration calculations. This in turn reduces the overhead and planning required for adaptation for any given network to a particular environment, either initially or as the environment changes over time, as the channel responses in the real world can be readily adapted to.

A concomitant advantage of the present form of the invention is the rapid and dynamic adaptation to channel response changes when a network failure, at any particular node or sub-set of nodes, occurs. This greatly increases the stability and durability of any network incorporating the present form of the invention without the level of cost, complexity, or duplication required by the present state of the art. Amongst the advantages conveyed are the ability for the network to survive partial failure at any particular node without being forced to drop or lose that node (i.e. maintaining maximal attainable capacity between that node and all others to which is can communicate), the ability to survive the total loss of any particular node, by sharing the signal traffic amongst

alternative channels. The present form of the invention also permits the rerouting of active links around 'lost' or 'damaged' nodes without human intervention by adherence to the new reciprocity measurements. And the increase in network stability to exceed not just the reliability of each particular node, but the average reliability of all nodes for, while any subset of nodes still remains operable, the maximal network capacity for that set can be maintained. This is unlike the present state of the art, where if 50% of the nodes of a network fail then the average network communication drops to zero, as all the channels lose one half of their pairs. Furthermore, the present form of the invention enables the network to automatically adjust itself and its optimal performance in the event of any partial failure without requiring human intervention, thereby decreasing the cost and increasing the responsiveness of the network. Even more important is the fact that, upon incremental re-instatement or restoration of particular node or channel function, network optimization continually advances without manual re-establishment.

Another advantage of the present form of the invention is that it minimizes the complexity, and increases the accuracy, of the signal weight update operation at each particular node and for the network as a whole.

Another advantage of the present form of the invention is that it provides a computationally efficient mechanization of cross-correlation operations for both nodes and channels across and within the network. As the number of signals simultaneously processed on a single time-frequency channel grows, the marginal complexity increase caused by addition of those signals drops, for fast adaptation methods such as autocorrelation approaches, e.g. inverse-based or least-squares). This is because the Digital Signal Processing (DSP) cycles needed for high-complexity operations in fast techniques, such as matrix computations, QR decompositions, or data whitening operations common to DSP processing, can be amortized over the larger number of signals. The higher overhead of hardware and software complexity needed to handle signal complexity thereby is lowered on a per-signal basis the greater the complexity actually used by the system. For certain techniques such as pilot-based or least-squares signal weighting, the fast techniques become less complex than the current conventional approaches such as Least-Mean-Squares or stochastic gradient, wherein the overhead remains indifferent to the increasing complexity of the signals being processed. When the number of signals that must be processed is equal to one-half the number of combiner weights used at an adaptive receiver, for example, then the crossover in overhead complexity vs. speed occurs between least squares and least mean squares.

Because the present form of the invention is dynamically adaptive, it can use any subordinate portion (in time, channels, or network subset) of the process wherein a 'reciprocal subspace' exists to implement its full value. Even though the parameters of the signal processing may vary between the uplink (transmission) and downlink (reception) phases between any two nodes on any given channel or link, to the extent that they overlap such a reciprocal subspace can be effectuated and used. For example, a reciprocal subspace can be created where there is a carrier offset, where the channel responses are distinguished solely by a scalar complex sinusoid (e.g. a frequency offset), between the two nodes, regardless of which is, at any particular moment, transmitting or receiving.

Since the present form of the invention with its non-orthogonal multitone capability allows the addition of mobile, transient, or temporary nodes to any network, it creates a system that can manage and provision any combination of

fixed, portable, low mobility, and high mobility nodes and links. The capacity constraints being node and channel specific rather than network delimited also permits the heterogeneous combination of differing capacities, thereby allowing peripheral distinctiveness, creating the potential for a system with a hierarchy of nodes including high-function, base-function, and limited-function or even single-function (e.g. appliance) nodes.

The present form of the invention permits the ability to achieve nearly linear increases in capability, even superlinear increases (in dirty environments) for increases in infrastructure, namely the RF transceiver capacities within the network. This is a significant advance over the prior state of the art for PTP networks which achieve sublinear capacity growth with network infrastructure growth.

In non-fully loaded networks using the present form of the invention, the MIMO connectivity can provide sharply higher data rates to individual channels or nodes where the additional information flow, to the maximal capacity of the particular nodes, is routed through nodes which have intended reception or transmission capacity available. This is a 'water balancing' approach to traffic maximization available only when multiple rather than single path capabilities are established through a network, or any network structure that instantiates fixed bottlenecks (e.g. 'star' or 'hub' topologies, BS PMP networks, or fixed-channel PTP networks).

Additionally, the reciprocity approach enables an automatic and dynamic load sharing amongst the channels and nodes which minimizes bottlenecks or, in the military or security environment, desirable targets of opportunity for 'hot centers' of traffic. Commercially this is more valuable by reducing the power and complexity requirements of what in PTP and PMP networks are BSs to attain a given network capacity and power efficiency.

The preferred embodiment of the present form of the invention includes a number of interacting and synergistic elements, both in hardware and in operational software. The preferred embodiment, as a network, will incorporate particular functional elements at individual nodes, as well as overall systemic features which may not be shared by or incorporated in the hardware of each particular node (i.e. there may exist specialization amongst the nodes). As stated in the summary, each node preferentially has an antennae array; multiple, multitone, transceivers (one per antenna); and constrains itself to reciprocal uplinks and downlinks (FIGS. 13A and 13B). The antennae array is spatially and/or polarization diverse and transmits and receives signal energy during alternating time slots (or sequences of time slots in TDD-TDMA systems). Each transceiver is a vector OFDM transceiver, with digital signal processing elements, that downconverts, A/D converts, and frequency channelizes data induced on each antenna (or other diversity channel) during receive time slots, and inverse channelizes, D/A converts, and upconverts data intended for each antenna (or diversity channel) during transmit time slots; linearly combines data received over each diversity channel, on each frequency channel and receive time slot; redundantly distributes data intended for each diversity channel, on each frequency channel and transmit time slots; and computes combiner and distributor weights that exploit the, narrowband, MIMO channels response on each frequency channel and time slot (FIG. 15). Although the preferred embodiment of the invention allows individual nodes to vary greatly in their capacities, a set of nodes preferentially will incorporate the hardware capabilities detailed in the following paragraphs.

The first preference is that the transmission element be a multi-tone front end, using OFDM with cyclic prefixes at

fixed terminals (generally, BS) (FIG. 22, Items 314, 318, 322.) and generalized multitone with guard-time gaps (FIG. 22, Item 310) at mobile terminals (generally, SU). To minimize aperture blur, the system uses tone grouping into narrowband frequency channels (FIG. 22, Item 348). The OFDM can be readily implemented in hardware using Fixed-Fourier Transform enabling chips; it also simplified the equalization procedure, eliminated decision feedback, and provides a synergistic blend with adaptive arrays. An alternative uses frequency-channelized PSK/QAM with modulation-on-symbol CDMA (that is, synchronous CDMA).

Each node of the network incorporates a MIMO transceiver. FIG. 24 displays a functional representation of such, and the hardware and processing is detailed over the next several paragraphs.

Each MIMO transceiver possesses an antennae array where the antennae are spatially separated and the antennae array itself is preferentially circularly symmetric (FIG. 15, Item 110). This provides 1-to-M modes (RF feeds) for the signals to be transmitted or received over, maximizes the separability of transmission links, enables a scalable DSP backend, and renders the MIMO transceiver fault-tolerant to LNA failures.

In an alternative embodiment the transceiver sends the transmission signal through Butler Mode Forming circuitry (FIG. 25, Item 380), which includes in a further embodiment a Band Pass Filter (FIG. 25, Item 382) where the transmission is reciprocally formed with the shared Receiver feeds, and the number of modes out equals the numbers of antennae, established as an ordered set with decreasing energy. The Butler Mode Forming circuitry also provides the spatial signal separation adaptation, preferentially with a FFT-LS algorithm that integrates the link separation operation with the pilot/data sorting, link detection, multilink combination, and equalizer weight calculation operations. This Butler Mode Forming approach means that the transmission forming is readily reciprocal with the receiver feeds (also shared), makes the transmission fault tolerant for PA (Phase-Amplitude) failures, and enables a readily scalable DSP front end; it also enables the transceiver to ratchet the number of antennae used for a particular transmission or reception up or down.

Having passed through the Butler Mode Forming circuitry, the transmission is then sent through the transmission switch (FIG. 15, Item 112), with the uplink frequencies being processed by the LNA bank (FIG. 15, Item 113), moderated by an AGC (FIG. 15, Item 114), and the downlink frequencies being processed by a PA bank (FIG. 15, Item 124). The LNA bank also instantiates the low noise characteristics for the outgoing signal and communicates the characteristics to the PA bank to properly manage the power amplification of the incoming signals to moderate the transmission overlap.

Further transmission switch processing then hands off the transmission to the frequency translator (FIG. 15, Item 115), which is itself governed in part by the Los circuit (FIG. 15, Item 116). The transmission switch throughout is controlled by a controller (FIG. 15, Item 120) such that baseband link distribution of the outgoing signals takes place such that energy is distributed over the multiple RF feeds on each channel, steering up to K_{feed} beams and nulls independently on each FDMA channel in order to enhance node and network capacity and coverage. This control further greatly reduces the link fade margin and that node's PA requirements.

From the transmission switch the transmission goes to an ADC bank (FIG. 15, Item 117), while a received signal will come from a DAC bank (FIG. 15, Item 123), the complexity of the analog/digital/analog conversion determining the circuit mix within the banks.

Then from the ADC bank the transmission flows through a Multitone Demodulator Bank (FIG. 15, Item 118), which splits it into 1 through K FDMA channels, where K is the number of feeds. The now separated tones (1 through M for each channel) in aggregate forms the entire baseband for the transmission, which combines spatial, polarization, either, or both, feeds across the FDMA channels or even combines up to K FDMA channels as transmission data density requires. This combination enables steering a greater number of beams and nulls than the RF feeds, up to the number of feeds times the number of FDMA channels. It also separates up to K_{feed} links per FDMA channel, improves overall transmission link error and/or retransmission rates, improves overall network capacity and coverage, and reduces the link fade margins, reduces the PA cost, and reduces battery consumption at the other ends of the link.

From the Multitone Demodulator Bank the Rx data is passed to circuitry for mapping the received broadband multitone signal into separated, narrowband frequency channels and time slots (FIG. 15, Item 119).

An outgoing transmission signal experiences the reverse of the above process; having been mapped to tones and RF feeds (FIG. 15, Item 121), it passes into a Multitone Modulator bank (FIG. 15, Item 122), an DAC bank (FIG. 15, Item 123), the transceiver switch, the Frequency Translator, the transceiver switch, the PA bank element (FIG. 15, Item 124), the transceiver switch, and thence in the preferred embodiment through the Butler Mode Form and on to the RF T/R feeds (FIG. 24, Item 130) and to the antennae array and the particular transmission antennae therein (FIG. 15, Item 125)

The transmission switch throughout is controlled such that baseband link distribution of the outgoing signals takes place such that energy is distributed over the multiple RF feeds on each channel, steering up to K_{feed} beams and nulls independently on each FDMA channel in order to enhance node and network capacity and coverage. This control further greatly reduces the link fade margin and that node's PA requirements.

The particular Multitone MOD and DEMOD elements (FIG. 15, Item 118 and 119) in a node vary according to whether it will be handling Fixed, Portable, Low-Mobility, and/or High-Mobility Nodes. Generally, a signal passing into the MT DEMOD may be passed through a comb filter, where a 128-bit sample is run through a 2:1 comb; then passed through an FFT element, preferably with a 1,024 real-IF function; and then mapped to the data using 426 active receive 'bins'. Each bin covers a bandwidth of 5.75 MHz with an inner 4.26 MHz passband, so each of the 426 bins has 10 MHz. The middle frequency, bin 256, will be at 2.56 MHz, leaving a buffer of 745 kHz on either side of the content envelope. Within the transmission, when it passes through the MT MOD, presuming each link is 100 μ s, 12.5 μ s at each end of the transmission is added as a cyclic prefix buffer and cyclic suffix buffer, to allow for timing error. (FIG. 22, Items 314, 3181, 322.) In an alternative embodiment, presuming that only a cyclic prefix is needed, the system can either double the size of the prefix (FIG. 22, Item 310) or add the suffix to the signal time. The reverse processing as appropriate (i.e. stripping off the cyclic prefix and suffix buffers) is not shown but is well known to the art.

The 426 bins form 13 channels and 426 tones, (FIG. 26, Item 430), with each Channel forming 320 kHz and 32 tons (FIG. 26, Item 432), being further organized with an upper and lower guard tone (FIG. 26, Items 438 and 436, respectively) and 30 information bearing tones (FIG. 26, Item 440). An alternative embodiment for a high-mobility environment halves the numbers of tones and doubles the MHz, so there are only 213 bins (and tones) for 4.26 MHz (FIG. 27, Item 442),

and each channel only carries 16 tones (FIG. 27, Item 446), with 1 being an guard tone (FIG. 27, Item 448) and fifteen being information-carrying tones (FIG. 27, Item 450).

For non-fixed embodiments, the timing modifications may be varied. The signal being processed is handed first to a MUX where an element-multiply with a Tx or Rx (for transmit or receive, respectively) window is performed. The guard time is retained to serve as dead time between signals, effectively punctuating them. The high-mobility embodiment halves the number of bins, doubling the average bin size, and uses duplication to increase QoS within the multitone. (FIG. 26.)

The next stage through the MIMO transceiver is the incorporation (on the transmission side) or interpretation (on the reception side) of the QAM/PSK symbols, prior to the signal's passing through the MIMO transceiver exits (if being transmitted) or enters (if being received) through a Link codec. Each FDMA channel will separate through the codec into 1 through M links, and each Link codec will incorporate tone equalization and ITI remove as necessary. The Link codec also includes SOVA bit recovery, error coding and error detection, and package fragment retransmission methodologies.

An optional alternative embodiment would at this point further include tone/slot interleaving (for the reception) or delevaing (for the transmission). A further optional alternative embodiment would replace the TCM codec and SOVA decoder with a Turbo codec.

Another optional alternative will incorporate dual-polarization. (See FIG. 25.) Fundamentally, this halves the modes and complexity of the transmissions and receptions, while doubling the capacity for any particular link/PA power constraint. In this alternative embodiment, the antennae array provides 1-to-(M/2) modes (RF feeds) for downconversion and demodularization. The Butler Mode Forming splits the modes into positive and negative polarities, where the negative polarization has the opposite, and normally orthogonal, polarization to the positive path. Preferentially the Butler Mode Forming works with circular polarizations. This alternative embodiment enables scalable DSP transmission and reception paths and renders the entirety fault tolerant to LNA/PA failures. At the last stage (for transmission; the first stage, for reception) the signal passes through a dual-polarized Link codec. That links the nodes over the dual polarizations, doubles the capacity under any particular link/PA power constraint, greatly reduces the codec complexity (and thus cost), and the link/PA power requirement for any particular link rate constant.

The Transceiver DSP backend for the preferred embodiment is detailed in FIG. 15. The Butler Mode Forming element with its RF transmission and reception leads, is controlled by the T/R switch control, which in turn is subject to the system clock and synchronization subsystem. An transmission signal (which can be continuous, periodic, triggered, human-determined, reactive, context-sensitive, data quality or quantity sensitive) that forms a Tx link message passes through a symbol encoder bank and into the circuitry where Delay/ITI/pilot gating are imposed, said circuitry being linked to its reciprocal for received signals. The transmission data symbols, over k channels, now pass through the multi-link diversity distribution circuitry, where for each channel k transmission gains $G(k)$ are adapted to the proper weighting, as determined by the multilink, LEGO gain adaptation element (with both algorithms and circuitry). From the multilink diversity distribution the transmission next is mapped over diversity modes and FFT bins, then handed to the transmission/reception compensation bank. Here, according to the

perceived environment of transmissions and reception and the particular Transmission/Reception compensation algorithm used, the transmission is passed to the inverse frequency channel bank and, finally, into the Butler Mode Forming element. This Transceiver DSP backend also passes the information about the transmission signal from the compensation bank element to the synchronization subsystem.

The LEGO gain adaptation element at each node enables the network to optimally balance the power use against capacity for each channel, link, and node, and hence for the network as a whole. FIG. 32 discloses the fundamental form of the algorithm used.

A capacity objective β for a particular node 2 receiving from another node 1 is set as the target to be achieved by node 2. Node 2 solves the constrained local optimization problem:

$$\min_{\pi_1(q)} \sum_q \pi_1(q) = 1^T \pi_1 \text{ such that} \quad \text{EQ. 3}$$

$$\sum_{q \in Q(m)} \log(1 + \gamma(q)) \geq \beta(m), \quad \text{EQ. 4}$$

where $\pi_1(q)$ is the SU (user 1 node) transmit power for link number q ,

$\gamma(q)$ is the signal to interference noise ratio (SINR) seen at the output of the beamformer,

1 is a vector of all 1s,

and

π_1 is a vector whose q^{th} element is $p_1(q)$.

The aggregate set $Q(m)$ contains a set of links that are grouped together for the purpose of measuring capacity flows through those links.

An example of this would be if SU had connections to multiple BSs, and we were primarily concerned with the total information flow into and out of a given node. In this case all of the links that connected to that node would be in the same aggregate set. Also in this description, we have adopted the convention that each transmit path from a transmitter to a receiver for a given narrow-band frequency channel is given a separate link number, even if the BS and SU are the same. Thus multiple transmit modes, that say exploit multipath or polarization diversity, are each given different link numbers, even though the source and destination nodes might be identical. Moreover, if a BS/SU pair transmit over multiple frequency channels, then each channel is given a separate link number. (This simplifies notation considerably.)

An example of this is shown in FIG. 19. The BSs are represented by circles and the SUs by triangles. Each arrow represents a communication link. The BSs and SUs can be dynamically combined into proper subsets of transmit uplink and receive uplink. The choice of aggregate sets can be arbitrary, provided no link is in multiple aggregate sets. However in a preferred embodiment, the aggregate sets are links that share a common node and hence common, readily available channel parameters.

The downlink objective function can be written as:

$$\min_{\sum_q \pi_2(q)} \sum_q \pi_2(q) = 1^T \pi_2 \text{ such that} \quad \text{EQ. 5}$$

$$\sum_{q \in Q(m)} \log(1 + \gamma(q)) \geq \beta(m) \quad \text{EQ. 6}$$

The required feasibility condition, that $\sum_{q \in Q(m)} \pi_1(q) \leq R_1(m)$ is reported to the network, and in the preferred embodiment, reported to a network controller, so that $\beta(m)$ can be modified as needed to stay within the constraints.

In an alternative embodiment, the capacity constraints $\beta(m)$ are determined in advance for each aggregate set, based on known QoS requirements for given nodes or group of

nodes. The objective function then seeks to minimize the total power in the network as suggested by EQ. 4.

By defining the noise normalized power transfer matrix by:

$$P_{rr}(q,j) = |w_r^H(q) H_{rr}(q,j) g_r(j)|^2, \quad \text{EQ. 7}$$

where $W_r(q)$ is a receiver weight vector for link q , and,

$g_r(j)$ is the transmit weight vector for link j .

By unit normalizing the receive and transmit weights with respect to the background interference autocorrelation matrix, the local model can state:

$$w_r^H(q) R_{1,r_i}(q) = 1, \text{ and } g_r^T(q) R_{1,r_i}(q) g_r^*(q) = 1 \quad \text{EQ. 52}$$

enabling the nodal model to express the SINR equation as:

$$\gamma(q) = \frac{P_{rr}(q, q) \pi_r(q)}{1 + \sum_{j \neq q} P_{rr}(q, j) \pi_r(j)} \quad \text{EQ. 8}$$

Accordingly, a matrix condition can be defined on the range of possible output SINRs; and from this, π_r has a feasible, that is non-negative solution, if and only if:

$$\rho(\delta(\gamma)(P_{rr} - \delta(P_{rr})) < 1, \quad \text{EQ. 9}$$

where $\rho(M)$ is the spectral radius of a matrix M ,

the non-negative power transfer matrix P_{rr} has qj^{th} element given in EQ. 7,

$\delta(\gamma)$ is a diagonal matrix whose q^{th} element is $\gamma(q)$

and

$\delta(P_{rr})$ is a diagonal matrix with the same diagonal as P_{rr} .

The weight normalization in EQ. 52, and the assumption of reciprocal channel matrices leads to the reciprocity equation (EQ. 1), and the fact that the uplink and downlink objective functions in EQ. 3 and EQ. 4 are identical for the same target SINRs.

Various means for solving the optimization in EQ. 3 exist; the preferred embodiment uses a very simple approximation for $\gamma(q)$, as very weak constraints to the transmit powers are all that are needed to yield objective functions which satisfy the reciprocity equation (EQ. 2).

Another approach can take advantage of the case where all the aggregate sets contains a single link, and we have non-negligible environmental noise or interference. For smaller networks, all the channel transfer gains in the matrices P_{12} and P_{21} are estimated and the transmit powers are computed as Perron vectors from:

$$\begin{aligned} D_{21} &= \log\left(1 + \frac{1}{P_{21} - 1}\right) \\ &= \log\left(1 + \frac{1}{P_{12}^T - 1}\right) \\ &= D_{12} \end{aligned} \quad \text{EQ. 10}$$

In this case a simple power constraint is imposed upon the transmit powers, so that they remain feasible. The optimization is alternating directions, first the weights are optimized, then the powers are obtained from the Perron vectors, and the process is repeated.

Another embodiment assumes effectively that the denominator in Eq. 8 remains approximately constant even after changes to the power levels in other nodes in the network (hence the local optimization approach), because the beamformer weights in the network (transmit and receive) in the MIMO approach will attempt to cancel the co-channel interference in the network, making it insensitive to power level

changes of the interferers. The denominator in Eq. 8 represents the post beamforming interference seen by the receiver associated with link q for the forward link (downlink) if $r=1$, and the reverse link if $r=2$.

With this approximation, and a rewriting of Eq. 8 (for the uplink) to:

$$\gamma(q) \approx \frac{P_{21}(q, q)\pi_1(q)}{i_2(q)} \quad \text{EQ. 11}$$

where

$$i_2(q) = 1 + \sum_{j \neq q} P_{21}(q, j)\pi_1(j) \quad \text{EQ. 12}$$

is the post beamforming interference energy, and is assumed constant for the adjustment interval for current transmit power values, the node can solve EQ. 3 in closed form using classic water filling arguments based on Lagrange multipliers. A similar equation is established for the downlink.

An alternative embodiment of Eq. 11 is to measure, provide, and use actual information for additional, available, or important terms in the denominator of Eq. 8 and to incorporate them into Eq. 12, and then rather than closed form use successive applications thereof to the modified problem using local data.

Another alternative embodiment is to solve, at each node, the constrained optimization problem:

$$\max_m \sum_{q \in Q(m)} \log(1 + \gamma(q)), \text{ such that} \quad \text{EQ. 13}$$

$$\sum_{q \in Q(m)} \pi_1(q) \leq R_1(m), \gamma(q) \geq 0 \quad \text{EQ. 14}$$

using the approximation in Eq. 11, which is a water-filling solution similar to that described above for Eq. 3. This solution requires a high-level network optimizer to control the power constraints, $R_1(q)$, to drive the network to a max-min solution.

The preferred embodiment, however, solves the local problem by attempting to minimize the total power as a function of the target output SINR. The output SINR will be the ratio of square of the channel transfer gain times the transmit power, divided by the interference power seen at the output of the beamformer, where:

$$\gamma(q) = |h^2(q)|\pi_1(q)/i_2(q) \quad \text{EQ. 15}$$

$$\gamma(q) = |h^2(q)|\pi_2(q)/i_1(q) \quad \text{EQ. 16}$$

where $|h(q)|^2$ is the square of the channel transfer gain, $\pi_1(q)$ is the transmit power for link q during the reverse link or uplink transmission,

$\pi_2(q)$ is the transmit power for link q during forward link or downlink transmission,

$i_1(q)$ is the interference power seen at the output of the beamformer used by the SU associated with link q ,

and,

$i_2(q)$ is the interference power seen at the output of the beamformer used by the BS associated with link q .

This makes the output SINR a function of all the transmit powers at all the other SUs in the network. Additionally, by normalizing the beamforming weights with respect to the

background interference, it is possible to maintain the reciprocity equation even in the presence of arbitrary interference and noise, due to non-cooperative signal sources, such as jammers or co-channel communication devices. Maximizing the SINR yields optimal receiver weights that can remove the effect of jammers and co-channel interferers. The reciprocity equation insures that the optimal transmit weights puts substantive nulls in the direction of these same co-channel interferers. For military applications, this implies that the network reduces its probability of detection and interception, and for co-channel communication systems, it reduces its transmitted interference, and is effectively a 'good neighbor' permitting system deployment in otherwise unacceptable environments. Commercially, this allows a network employing the present embodiment of this invention to cope with competitive, impinging, wireless network nodes and transmissions.

It can be shown that there is a 1-1 mapping between all the transmit powers and all of the output SINRs, i.e. there exists a vector valued function F_1 such that $F_1(\gamma) = \pi_1$.

The function has an inverse so that $F_1^{-1}(\pi_1) = \gamma$. A key result that is exploited by this embodiment is the fact that if the channels are reciprocal, then the objective functions, and the constraint set imposed by (1) is identical as a function of γ for both the uplink and downlink objective functions. Mathematically this means these objective functions can be stated in general terms as:

$$f(\gamma) = 1^T F_1(\gamma) = 1^T F_2(\gamma), \text{ EQ. 17}$$

where $\pi_2 = F_2(\gamma)$ is the mapping between the SINRs and the BS transmit powers.

In the preferred embodiment, each node uses the above as it defines and generates its local model as follows:

Given an initial γ_0 generate the model,

$$L(\gamma, g, \beta) = g^T \gamma \quad \text{EQ. 20}$$

$$\sum_{q \in Q(m)} \log(1 + \gamma(q)) \geq \beta(m) \quad \text{EQ. 21}$$

$$g = \nabla_{\gamma} f(\gamma_0) \quad \text{EQ. 22}$$

where $L(\gamma, g, \beta)$ is a linearized model of the objective function,

$g^T \gamma$ is an inner product between the gradient of the objective function and a set of target SINRs,

$\sum_{q \in Q(m)} \log(1 + \gamma(q)) / 24 \beta(m)$ is the capacity constraint for aggregate set m ,

and,

$g = \nabla_{\gamma} f(\gamma_0)$ is the gradient of the objective function (the total transmit power) as a function of the target SINRs.

The new γ_{α} is updated from

$$\gamma_* = \arg \min_{\gamma} L(\gamma, g, \beta) \quad \text{EQ. 23}$$

$$\gamma_{\alpha} = \gamma_0 + \alpha(\gamma_* - \gamma_0) \quad \text{EQ. 24}$$

The constant α is chosen between 0 and 1 and dampens the update step of the algorithm. This determines a target SINR that the algorithm adapts to. The update for the transmit power for link q becomes,

$$\pi_2(q) = \gamma_{\alpha} i_1(q) / |h(q)|^2 \quad \text{EQ. 25}$$

$$\pi_1(q) = \gamma_{\alpha} i_2(q) / |h(q)|^2 \quad \text{EQ. 26}$$

Where $i_1(q)$ and $i_2(q)$ are the post beamforming interference power seen at the SU and the BS respectively for link q .

The present embodiment of this invention uses advantageously the fact that the q^{th} element of the gradient of the objective function can be written as the product of the interference powers divided by the square of the transfer gain:

$$\{\nabla_{\gamma} f(\beta_0)\}_q = i_1(q) i_2(q) / |h(q)|^2. \quad \text{EQ. 27}$$

The transmit power update relationship in Eq. 25 and Eq. 26 can be applied repeatedly for a fixed feasible γ_α and the convergence of $\pi_1 \rightarrow F_1(\gamma_\alpha)$ is guaranteed. In fact some assert this convergence will be guaranteed if we optimize the receive weights at each iteration. (See Visotsky, E; Madhow, U, "Optimum Beamforming Using Transmit Antenna Arrays", Vehicular Technology Conference, 1999 IEEE 4th, Volume 1, pp 851-856, though he only considered the effects in a Rank 1 channel, that is a single narrowband rather than a MIMO channel). A similar statement holds for $\pi_2 \rightarrow F_2(\gamma_\alpha)$. In an alternative embodiment where the proper relationship is unknown, or dynamically changing, then a suitably long block of N samples is used to establish the relationship, where N is either 4 times the number of antennae or 128, whichever is larger, with the result being used to update the receive weights at each end of the link, optimize the local model in Eq. 23 and Eq. 24, and then apply Eq. 25 and Eq. 26.

The algorithm used in the preferred embodiment enables the network, and local nodes thereof, to attain several important results. First, for each aggregate set m, the optimization of the local model(s) at each node(s) completely decouples the network optimization problem to an independent (set) of local problem(s) that is solved among the aggregate set links. Accordingly, within a given aggregate set, we inherit the network objective function model:

$$L_m(\gamma, \mathbf{g}, \beta) = \sum_{q \in Q(m)} \mathbf{g}_q \gamma(q) \quad \text{EQ. 28}$$

$$\sum_{q \in Q(m)} \log(1 + \gamma(q)) \approx \beta(m) \quad \text{EQ. 29}$$

$$\mathbf{g}_q = \mathbf{i}_1(q) \mathbf{i}_2(q) / |\mathbf{h}(q)|^2 \quad \text{EQ. 30}$$

where $L_m(\gamma, \mathbf{g}, \beta)$ is the sum of the separable, linearized, objective functions corresponding to the aggregate set number m, where each localized objective function depends only on variables that pertain to the given aggregate set,

$\mathbf{g}_q \gamma(q)$ is the product of the q'th element of the gradient vector with the SINR for link q,

\mathbf{g}_q is the q'th element of the gradient vector,

and,

$|\mathbf{h}(q)|^2$ is the square of the channel transfer gain from the transmit beamformer, through the channel to the output beamformer (not including the transmit power).

Second, this approach eliminates matrix channel estimation as a necessary step, as solving the local problem only requires that an estimate of the post beamforming interference power, a single real number for each link, be transmitted to the other end of the link, or in another embodiment to the node assigned to computing the transmit powers for a given aggregate set. For each link, a single real number, the transmit power, is then propagated back to the transmitter. This is true even for networks with large rank MIMO channel matrices.

Third, the optimization problem, which is stated in general terms in Eq. 17, when you plug in a formula for π as a function of γ into the objective function, i.e. $1^T F_r(\gamma)$ for the SINR to power mapping $F_r(\gamma)$, is reduced from a complex and potentially unsolvable problem to one that has a simple closed form solution, and thus can use a well known water filling problem seen in classical information theory (see T. Cover, T. Joy, Elements of Information Theory, Wiley; 1991); Matthew Bromberg and Brian Agee, "The LEGO approach for achieving max-min capacity in reciprocal multipoint networks," in Proceedings of the Thirty Fourth Asilomar Conf. Signals, Systems, and Computers, October 2000.

Fourth, even when starting from non-feasible starting points, the algorithm rapidly converges; in the preferred embodiment, where all parameters are updated after every receive block, it converges to a fixed point within the vicinity

of the optimal solution; and in an alternative embodiment, where the γ_α vector is held fixed until $\pi_1 \rightarrow F_1(\gamma_\alpha)$ and $\pi_2 \rightarrow F_2(\gamma_\alpha)$ before updating the weights and updating γ_α again.

A figure illustrating the computational tasks at the BS and the SU for a given link q is shown in FIG. 34. It is assumed that the BS is assigned the task of computing the transmit gains for this particular example. The figure shows that only two numbers are transferred from the BS to the SU and from the SU to the BS. The basic computational tasks at each node are also shown.

In the preferred embodiment, only one side of the link need perform the power management computations. One of the principle advantages and strengths of the present embodiment of the invention is that it replaces half of the prior art's explicit, dual computations with an implicit computation that is performed by the physical transmission of data, which generates the real-world interference (and thus interference values) used by the power control algorithm.

The estimation of the transfer gains and the post beamforming interference power is done efficiently in the preferred embodiment with simple least squares estimation techniques.

The problem of estimating the transfer gains and the post beamforming interference power (in the preferred embodiment, by using a least squares algorithm) is equivalent to solving for the transfer gain h as follows:

$$\mathbf{y}(n) = \mathbf{h} \mathbf{g} \mathbf{s}(n) + \mathbf{e}(n) \quad \text{EQ. 31}$$

where $\mathbf{y}(n)$ is the output of the beamformer at the time sample, $\mathbf{h} = \mathbf{w}_r^H \mathbf{r}(q) \mathbf{H}_{21}(q, q) \mathbf{g}_r(q)$, whose square modulus is $P_{rr}(q, q)$,

$\mathbf{w}_r(q)$ is the receive weight vector for link q,

$\mathbf{g}_r(q)$ is transmit weight vector for link q,

\mathbf{g} is the square root of the transmit power $\pi_r(q)$,

$\mathbf{s}(n)$ is the transmitted complex symbol at time sample n,

and

$\mathbf{s}(n)$ represents all of the remaining co-channel interference and noise. (Indexing is dropped to avoid clutter.) Then $\mathbf{y}(n)$ is defined as the output after applying the unit normalized despread weights to the received data. This is simply the usual beamformer output divided by the norm of the despread weights with respect to the noise covariance matrix; and for many applications, this will be a scaled multiple of the identity matrix.

Using a block of N samples of data, h is then estimated as:

$$\mathbf{h} = \frac{\sum_{n=1}^N \mathbf{y}(n) \mathbf{s}^*(n)}{\sum_{n=1}^N |\mathbf{s}(n)|^2 \mathbf{g}} \quad \text{EQ. 32}$$

where h is the channel transfer gain,

$\mathbf{S}^*(n)$ is the conjugate of $\mathbf{s}(n)$,

$\mathbf{y}(n)$ is the output of the beamformer at the time sample n,

and,

$\mathbf{s}(n)$ is the transmitted complex symbol at time sample n.

From this an estimation of the residual interference power, \mathbf{R}_e , which is identified with $\mathbf{i}_1(q)$ in Eq. 11 by:

$$\mathbf{R}_e = \langle \mathbf{e}(n) \rangle = \frac{1}{N} \sum_{n=1}^N (|\mathbf{y}(n)|^2 - |\mathbf{h} \mathbf{g} \mathbf{s}(n)|^2). \quad \text{EQ. 33}$$

where

$\mathbf{g} \mathbf{h}$ is the product of the transmit gain and the post-beamforming channel gain.

The knowledge of the transmitted data symbols $s(n)$ in the preferred embodiment comes from using remodulated symbols at the output of the codec. Alternative embodiments use the output of a property restoral algorithm used in a blind beamforming algorithm such as constant modulus or constellation restoral, or by using a training sequence explicitly transmitted to train beamforming weights and asset the power management algorithms, or other means known to the art. This information, and the knowledge of the data transmit power values $\pi_1(q)$ will be at the receiver and can be transmitted to the transmitter as part of a data link layer message; and if the processing occurs over fairly large blocks of data the transfer consumes only a small portion of the available bandwidth. Means for handling the case when a transmit mode is shut off, so that one of the $\pi_1(q)=0$, include removing the index (q) from the optimization procedure and making no channel measurements.

In the preferred embodiment, a link level optimizer and decision algorithm (See FIGS. 32A and 32B) is incorporated in each node; its inputs include the target and the bounds for that node, and its outputs include the new transmit powers and indications to the network as to how the node is satisfying the constraints. FIG. 33 indicates a decision algorithm used by the link level optimizer.

In an alternative embodiment, the solution to Eq. 3 is implemented by using a variety of Lagrange multiplier techniques. In other alternative embodiments, the solution to Eq. 3 is implemented by using a variety of penalty function techniques. All of these embody techniques known to the art for solving the local problem. One such alternative takes the derivative of $\gamma_{(q)}$ with respect to π_1 and uses the Kronecker-Delta function and the weighted background noise; in separate alternative embodiments, the noise term can be neglected or normalized to one. An approximation uses the receive weights, particularly when null-steering efforts are being made, and as the optimal solution will have weights that approach the singular vectors of the interference-whitened MIMO channel response. In the situation where the links of a given aggregate set $Q(m)$ are all connected to a single node in the network, all information pertaining to the subchannels and propagation modes of the MIMO channel associated with that node are available, hence the norm squared transfer gain $P_{21}(q,q)$ is available for all $q \in Q(m)$ from the processing used to obtain the MMSE receive beamforming weights.

In the preferred embodiment, adaptation of the power is done in a series of measured and quantized descent steps and ascent steps, to minimize the amount of control bits that need to be supported by the network. However, in an alternative embodiment, a node may use more bits of control information to signal for and quantize large steps.

Various alternative methods can be used to develop the local model for each node. The preferred embodiment's use of measured data (e.g. function values or gradients) to develop the local model valid in vicinity of the current parameter values, is only one approach; it can, however, be readily optimized within the node and network. The usual model of choice in prior art has been the quadratic model, but this was inadequate as elements of the functions are monotonic. One alternative embodiment is to use a log-linear fractional model:

$$\beta_q \approx \log\left(\frac{a\pi_1(q) + a_0}{b\pi_1(q) + b_0}\right) = \hat{\beta}_q(\pi_1(q)) \quad \text{EQ. 34}$$

where β_q is the achievable bit capacity as a function of the transmit gains $\pi_1(q)$; and to characterize the inequality

$$\hat{\beta}_q(\pi_1(q)) \geq \beta \quad \text{EQ. 35}$$

with a linear half-subspace, and then solving the approximation problem with a simple low dimensional linear program.

Another alternative embodiment develops the local mode by matching function values and gradients between the current model and the actual function. And another develops the model as a solution to the least squares fit, evaluated over several points.

Because of the isolating effect of the transmit and receive weights the fact that the transmit weights for the other nodes in the network may change mitigates the effect on the local model for each node. Yet another alternative broadens the objective function to include the effect of other links in the network, viewing them as responding to some extent to the transmit values of the current link q . A finer embodiment reduces the cross-coupling effect by allowing only a subset of links to update at any one particular time, wherein the subset members are chosen as those which are more likely to be isolated from one another.

In the preferred embodiment, and as shown in the figures, Node 2 optimizes the receiver weights during the uplink (when sending) using a MMSE function; then measures the SINR over all paths k for a particular channel q , and informs the sending node 1 both of the measured capacity for channel q , that is, $(D_{12}(q))$ and, if the measured capacity experienced for that channel is too high, to lower the power, or, if the measured capacity for that channel is too low, to increase the power, with the power increase or decrease being done by small, discrete increments. Node 2 then sets, for that channel, the transmit weights to the receive weights and repeats this sub-process for the downlink case. By successive, rapid iteration node 2 rapidly informs node 1 of the precise transmission power needed at node 1 to communicate over channel q with node 2.

This process is performed for every channel q which is active at node 2, until either the target capacity is attained, or the capacity cannot be improved further. It is also repeated at every node in the network, so node 1 will be telling node 2 whether node 2 must increase or decrease the power for node 2's transmissions to node 1 over channel q .

In an alternative embodiment, the network contains one or more network controllers, each of whom govern a subset of the network. The network controller initiates, monitors, and changes the target objective (in the preferred alternative embodiment, capacity) for the set of nodes it governs and communicates the current objective to those nodes and the rest of the network as necessary. (See FIG. 33.) Different sub-networks can use different capacity objectives depending on each network's localized environment (both external and internal, i.e. traffic density).

The network controller, once it has initialized the reciprocal set and objective continually monitors the network of nodes it governs, continually compares if the desired capacity has been reached, and for each node n , perform a fitting function. (See Figure LE2) If a node n is compliant with the power constraints and capacity bound, then $R_1(n)$ should be reduced by a small amount; but if node n has both power constraints and capacity violations than $R_1(n)$ should be incremented for that node. These increments and decrements are preferably quantized to fixed small numbers. In an alternative embodiment of the invention the scalar and history of the increments and decrements are recorded to feed into experientially modified approximations, effectively embodying a real-world adaptation learning for each node.

One important consequence of this approach is that compliance with any network constraint or objective can be conveyed with a single bit, and increment or decrement with two bits, thereby reducing the control overhead to a minimum.

From the Butler Mode Forming element received signals are first passed through the frequency channel bank, then mapped to the FDMA channels. The received data on channel k will be passed through both the Multilink Receive weight adaptation algorithm and the Multilink diversity combining, Receive weights $W(k)$ element, which in turn both feed into the Multilink LEGO gain adaptation algorithm and thus feed-back into the multilink diversity distribution element for outgoing transmissions. The Multilink Receive weight adaptation algorithm passes the adapted data from channel k over to the Multilink Diversity combining, Receive Weights $W(k)$ element passes on the signal to both the circuits for the Equalization algorithm and the Delay/ITI/plot-gating removal bank, that strips out the channel-coordinating information and passes the now combined signal to the symbol decoder bank to be turned into the information which had been sent out from the originating transceiver, the inverse process, generally, from the symbol encoding at the transmission end.

These Signal Encoding Operations are graphically displayed in FIG. 21. (Because the decoding is both the inverse and well enough known, given a particular encoding, to be within the state of the art for any practitioner in the field, there is not a for the inverse, Symbol Decoding Operations.) A given signal, such as an IP datagram, is formed into a fragment and passed along to a MUX element. (Any signal which can be equated to or converted into an IP datagram, for example an ATM, would either be converted prior to this point or handled similarly.) The desired MAC header data, which in one alternative embodiment is optionally time-stamped, is also fed into the same MUX element where the two combine. This combined signal now passes through a CRC generator as well as feeding into a second MUX that combines the CRC output with it. Next, the signal passes into an encryption element that also performs trellis encoding. (In an alternative embodiment one or both of these operations are eliminated, which reduces the transceiver's hardware and software complexity but decreases the network's security and reliability.) (For more information on the alternative use of Trellis coded modulation, see, Boule, et al., "An Overview of Trellis Coded Modulation Research in COST 231", IEEE PIMRC '94, pp. 105-109.) The now-encoded signal is next passed to the element where it is mapped to the individual tones and the MT symbols, and where buffer tones and time and frequency interleaving is done. A second, optional, delay preemphasis signal element, and a third signal element from a pilot generator, taking input from the originating node, recipient node, group, or network, or any combination or sub-combination thereof, now are combined with the signal from the mapping element in a MUX. This MUX may use the first two slots for a pilot without modulation by the information tones, using the remaining slots for the pilot modulated by the information tones to further harden the pilot/signal combination. An alternative embodiment would at this point further pass the transmission signal through an ITI pre-distortion element; otherwise, the now-encoded, piloted, and mapped transmission signal is ready.

Pilot tone generation, summarily disclosed on FIG. 21, is further detailed in FIG. 28. Information concerning one or more of the originating node, recipient node, and network or group channel organization flow into a pilot signal generator, and the resulting pilot signal is further modified by a network code mask. This multilayer mask then is used to form a signal with a pseudorandom sequence that is shared by all nodes in the same network or group, though the sequence may vary over channels and MT symbols to allow further coordination amongst them at the receiving end. Passing on the signal is modified in an element-wise multiplication (typically a

matrix operation, embedded in hardware) by a signal that indexes on the originating node, which in an optional variation includes a nodal pseudodelay, unique to that node in the network or group, which overlay again may vary over channels and frames to improve security. The originating node index overlay is a complex, exponential phase ramping. The combined signal now mixes with a recipient node index, another pseudorandom sequence that is unique to the recipient node, modifying the whole in a second element-wise multiplication. Thus the final pilot tone reflects the content signal, modified to uniquely identify both the originating node and its context, and the receiving node and its context, effecting a signal composition that allows the network to pilot the communication through the network from origin to destination regardless of the intervening channels it takes.

When a communication is transmitted, it will be received; and the MIMO reception is, like the transmission, adaptive. See FIG. 30, detailing the logical processing involved. Received data passes through both a Multilink weight adaptation algorithm and (to which that part is combined) a Multilink diversity combining of the Reception weights. This reweighted transmission now passes through the equalization algorithm and (to which that is combined) a Delay/ITI/pilot-gating removal bank stage. These sort out the properly weighted tones, perform the recombinations, and undo the pilot-gating distortion to effectively reassemble at the reception end the symbol pattern of the original signal. That now passes through a symbol decoder bank to recover the message from the symbolic representation and the whole now is joined with the other received and linked messages for final reassembly. The functional and firmware processing (fixed logic hardware, limited purpose firmware, or combined software, processors and circuitry). The received symbol $x(i,1)$, comprising a matrix combination of L Link and M multitone elements, is first modified by the pilot tone generator that sends the recipient node, network, and group modifications for an element-wise reverse multiplication, to strip off that component of the signal and identify if the received symbol is from any originating source trying to send to this particular recipient. If the recipient pilot signal matches, then the signal passed on to a circuit that separates the pilot signal elements from the data signal elements. The pilot signal elements are passed through a link detection circuit that preferentially uses a FFT-LS algorithm to produce link quality statistics for that particular received transmission, identifies the weighting elements that were contained in the pilot signal and passes those over to the multilink combination circuit, and sends the pilot weights over to the circuit for equalizing weight calculations. The data signal, combined with the pilot weighting elements, now is combined with the equalizer calculated factors to strip off all pilot information from the traffic data. Next, the refined traffic data passes through a link demodulator to produce the original channel-by-channel link streams of data. In an alternative embodiment, the first channel, which has been reserved for decryption, decoding, and error detection signaling, not passes through the ITI correction circuitry and thence to the instantiated decryption, decoding, or retransmission circuitry as indicated by the data elements of the first channel signal; meanwhile, the remaining data channel elements are available, having been refined from the combined received elements.

A MIMO transceiver contains and uses simultaneously a multiple of single RF feeds. A signal passes between the Butler Mode Forming element and a Band Pass Filter, or preselection, element, and then between the Band Pass Filter element and the Transceiver switch. If the signal is being transmitted, it goes through a Low Noise Amplifier element

and then back into the Transceiver switch; if the signal is being received, it goes through a Phase Amplifier and back into the Transceiver switch. The signal passes between the Transceiver switch and the Frequency translator, and then back into the Transceiver switch. In the Frequency translator (FIG. 25), the signal passes through a second Band Pass Filter with a Surface Acoustic Wave (SAW) Frequency greater than three, then between that second Band Pass Filter and a first mixer, where it will be mixed (or unmixed, depending on direction) with (or by) another waveform which has come from the timing element(s), which may be any of the system clock, synchronization subsystem, and GPS time transfer, or their combination. The combined timing and content signal passes between the first mixer and a SAW element where it is combined (or separated) with a saw frequency of less than or equal to 1.35 times that of the signal. The SAW-modified signal passes between the SAW element and a second mixer, where the saw-modified signal is mixed (or unmixed, depending on direction) by the waveform which also has come from the timing element(s) mentioned above. The signal passes between the second mixer and the LPF element with a SAW Frequency greater than three; the next transition is between the frequency translator and the Transceiver switch. Depending on the direction of the signal, it passes between the Transceiver switch and the ADC element or the DAC element (the ADC and DAC together are 'the converter elements') and the Transceiver switch, and between the ADC element and the FFT/IFFT element or between the FFT/IFFT element and the DAC element. Both the DAC and ADC elements are linked to and governed by the system clock, while the signal's passage through the Transceiver switch and the other elements (LNA or PA, Frequency Translator, and between the Transceiver switch and the converter elements, is governed by the Switch Controller element. This approach is used because the Frequency Translator can be implemented as a single piece of hardware which lowers the cost of the overall unit and lessens the signal correction necessary.

Different multitone formats are used at different transceivers, thereby enabling ready distinction by and amongst the receivers of the transmitter frequency tone set. For fixed transceivers (BS or fixed SU), rectangular windows with cyclic prefixes and/or buffers are used; for mobile transceivers, non-rectangular windows and guard times are used. This provides the network with a capacity fall-back as the network environment and traffic dynamics vary. In the preferred embodiment the guard times are matched to the cyclic prefixes and buffers, the multitone QAM symbols are matched at all windows, and the different windows and capacity are used in different modes.

The multitone (multifrequency) transmission that occurs between every pair of nodes when they form a communications link exploits the multipath phenomena to achieve high QoS results. Each node, when it is acting as a receiver, optimizes the receive weights, using the MMSE technique. This goes directly against Varanesi's assessment that "de-correlative and even linear MMSE strategies are ill-advised for such channels because they either do not exist, and even if they do, they are plagued by large noise-enhancement factors".

An alternative embodiment uses the Max SINR technique, and any combination of these and other industry-standard receiver optimization algorithms are feasible alternative implementations. Then the transmit weights for that node in its reply are optimized by making them proportional to the receive weights. Finally, the transmit gains (gain multipliers that multiply the transmit weights) are optimized according to a max-min capacity criterion for that node, such as the max-min sum of link capacities for that transceiver node at that

particular time. An alternative embodiment includes as part of the network one or more network controllers that assist in tuning the local nodes' maximum capacity criterion to network constraints, e.g. by enforcing a balancing that reflects an intermediate nodes' current capacity which is lower than the local, originating node's current capacity.

The MIMO network model for the aggregate data transmitted between N_1 "Set 1 nodes" $\{n_1(1), \dots, n_1(N_1)\}$, receiving data over downlink time slots and transmitting data over uplink time slots, and N_2 "Set 2 nodes" $\{n_2(1), \dots, n_2(N_2)\}$ receiving data over uplink time slots and transmitting data over downlink time slots, can be approximated by

$$x_2(k,l) \approx i_2(k,l) + H_{21}(k,l) s_1(k,l) \quad \text{EQ. 36}$$

(uplink network channel model)

$$x_1(k,l) \approx i_1(k,l) + H_{12}(k,l) s_2(k,l) \quad \text{EQ. 37}$$

(downlink network channel model)

within frequency-time channel (k,l) (e.g., tone k within OFDM symbol 1) transmitted and received at uplink frequency $f_{21}(k)$ and time $t_{21}(l)$ and downlink frequency $f_{12}(k)$ and time $t_{12}(l)$, where

$s_1(k,l) = [s_1^T(k,l;n_1(1)) \dots s_1^T(k,l;n_1(N_1))]^T$ represents the network signal vector transmitted from nodes $\{n_1(p)\}$ within uplink channel (k,l);

$s_2(k,l) = [s_2^T(k,l;n_2(1)) \dots s_2^T(k,l;n_2(N_2))]^T$ represents the network signal vector transmitted from nodes $\{n_2(q)\}$ within uplink channel (k,l);

$x_1(k,l) = [x_1^T(k,l;n_1(1)) \dots x_1^T(k,l;n_1(N_1))]^T$ represents the network signal vector received at nodes $\{n_1(p)\}$ within uplink channel (k,l);

$x_2(k,l) = [x_2^T(k,l;n_2(1)) \dots x_2^T(k,l;n_2(N_2))]^T$ represents the network signal vector received at nodes $\{n_2(q)\}$ within uplink channel (k,l);

$i_1(k,l) = [i_1^T(k,l;n_1(1)) \dots i_1^T(k,l;n_1(N_1))]^T$ models the network interference vector received at nodes $\{n_1(p)\}$ within downlink channel (k,l);

$i_2(k,l) = [i_2^T(k,l;n_2(1)) \dots i_2^T(k,l;n_2(N_2))]^T$ models the network interference vector received at nodes $\{n_2(q)\}$ within uplink channel (k,l);

$H_{21}(k,l) = [H_{21}(k,l;n_2(q),n_1(p))]$ models the channel response between transmit nodes $\{n_1(p)\}$ and receive nodes $\{n_2(q)\}$ within uplink channel (k,l); and

$H_{12}(k,l) = [H_{12}(k,l;n_1(p),n_2(q))]$ models the channel response between transmit nodes $\{n_2(q)\}$ and receive nodes $\{n_1(p)\}$ within downlink channel (k,l);

and $()^T$ denotes the matrix transpose operation, and where

$s_1(k,l;n_1)$ represents the $M_1(n_1) \times 1$ node n_1 signal vector transmitted over $M_1(n_1)$ diversity channels (e.g., antenna feeds) within uplink frequency-time channel (k,l);

$s_2(k,l;n_2)$ represents the $M_2(n_2) \times 1$ node n_2 signal vector transmitted over $M_2(n_2)$ diversity channels within downlink frequency-time channel (k,l);

$x_1(k,l;n_1)$ represents the node n_1 signal vector received over $M_1(n_1)$ diversity channels within downlink frequency-time channel (k,l);

$x_2(k,l;n_2)$ represents the $M_2(n_2) \times 1$ node n_2 signal vector received over $M_2(n_2)$ diversity channels within uplink frequency-time channel (k,l);

$i_1(k,l;n_1)$ models the $M_1(n_1) \times 1$ node n_1 interference vector received over $M_1(n_1)$ diversity channels within downlink frequency-time channel (k,l);

$i_2(k,l;n_2)$ models the $M_2(n_2) \times 1$ node n_2 interference vector received over $M_2(n_2)$ diversity channels within uplink frequency-time channel (k,l);

$n_{21}(k,l;n_2,n_1)$ models the $M_2(n_2) \times M_1(n_1)$ channel response matrix between transmit node n_1 and receive node n_2 diversity channels, within uplink channel (k,l) ; and $H_{12}(k,l;n_1,n_2)$ models the $M_1(n_1) \times M_2(n_2)$ channel response matrix between transmit node n_2 and receive node n_1 diversity channels, within downlink channel (k,l) .

In the absence of far-field multipath between individual nodes, $n_{21}(k,l;n_2,n_1)$ and $H_{12}(k,l;n_1,n_2)$ can be further approximated by rank/matrices:

$$H_{21}(k,l;n_2,n_1) \approx \lambda_{21}(n_1,n_2) a_2(f_{21}(k), t_{21}(l); n_1, n_2) a_1^T(f_{21}(k), t_{21}(l); n_2, n_1) \times \exp\{-j2\pi(\tau_{21}(n_2, n_1) f_{21}(k) - v_{21}(n_2, n_1) t_{21}(l))\}$$

$$H_{12}(k,l;n_1,n_2) \approx \lambda_{12}(n_2, n_1) a_1(f_{12}(k), t_{12}(l); n_2, n_1) a_2^T(f_{12}(k), t_{12}(l); n_1, n_2) \times \exp\{-j2\pi(\tau_{12}(n_1, n_2) f_{12}(k) - v_{12}(n_1, n_2) t_{12}(l))\}$$

where

- $\lambda_{21}(n_2, n_1)$ models the observed uplink pathloss and phase shift between transmit node n_1 and receive node n_2 ;
- $\lambda_{12}(n_1, n_2)$ models the observed downlink pathloss and phase shift between transmit node n_2 and receive node n_1 ;
- $\tau_{21}(n_2, n_1)$ models the observed uplink timing offset (delay) between transmit node n_1 and receive node n_2 ;
- $\tau_{12}(n_1, n_2)$ models the observed downlink timing offset between transmit node n_2 and receive node n_1 ;
- $v_{21}(n_2, n_1)$ models the observed uplink carrier offset between transmit node n_1 and receive node n_2 ;
- $v_{12}(n_1, n_2)$ models the observed downlink carrier offset between transmit node n_2 and receive node n_1 ;
- $a_1(f, t; n_2, n_1)$ models the $M_1(n_1) \times 1$ node n_1 channel response vector, between node n_2 and each diversity channel used at node n_1 , at frequency f and time t ; and
- $a_2(f, t; n_1, n_2)$ models the $M_2(n_2) \times 1$ node n_2 channel response vector, between node n_1 and each diversity channel used at node n_2 , at frequency f and time t .

In many applications, for example, many airborne and satellite communication networks, channel response vector $a_1(f, t; n_2, n_1)$ can be characterized by the observed (possibly time-varying) azimuth and elevation $\{\theta_1(t; n_2, n_1), \phi_1(f, t; n_2, n_1)\}$ of node n_2 observed at n_1 . In other applications, for example, many terrestrial communication systems, $a_1(f, t; n_2, n_1)$ can be characterized as a superposition of direct-path and near-field reflection path channel responses, e.g., due to scatterers in the vicinity of n_1 , such that each element of $a_1(f, t; n_2, n_1)$ can be modeled as a random process, possibly varying over time and frequency. Similar properties hold for $a_2(f, t; n_1, n_2)$.

In either case, $a_1(f, t; n_2, n_1)$ and $a_2(f, t; n_1, n_2)$ can be substantially frequency invariant over significant breadths of frequency, e.g., bandwidths commensurate with frequency channelization used in 2G and 2.5 G communication systems. Similarly, $a_1(f, t; n_2, n_1)$ and $a_2(f, t; n_1, n_2)$ can be substantially time invariant over significant time durations, e.g., large numbers of OFDM symbols or TDMA time frames. In these cases, the most significant frequency and time variation is induced by the observed timing and carrier offset on each link.

In many networks of practical interest, e.g., TDD networks, the transmit and receive frequencies are identical ($f_{21}(k) = f_{12}(k) = f(k)$) and the transmit and receive time slots are separated by short time intervals ($t_{21}(l) = t_{12}(l) + \Delta_{21} \approx t(l)$), and $H_{21}(k,l)$ and $H_{12}(k,l)$ become substantially reciprocal, such that the subarrays comprising $H_{21}(k,l)$ and $H_{12}(k,l)$ satisfy $H_{21}(k,l;n_2, n_1) \approx \delta_1(k,l;n_1,n_2) H_{12}^T(k,l;n_1,n_2)$, where $\delta_1(k,l;n_1,n_2)$ is a unit-magnitude, generally nonreciprocal scalar.

If the observed timing offsets, carrier offsets, and phase offsets are also equalized, such that $\lambda_{21}(n_2, n_1) \approx \lambda_{12}(n_1, n_2)$, $\tau_{21}(n_2, n_1) \approx \tau_{12}(n_1, n_2)$, and $v_{21}(n_1, n_2) \approx v_{12}(n_2, n_1)$, for example, by synchronizing each node to an external, universal time and frequency standard such as Global Position System Universal Time Coordinates (GPS UTC), then $\delta_{21}(k,l;n_1, n_2) \approx 1$ can be obtained and the network channel response becomes truly reciprocal, $H_{21}(k,l) \approx H_{12}^T(k,l)$. However, this more stringent level of reciprocity is not required to obtain the primary benefit of the invention.

In order to obtain substantive reciprocity, each node in the network must possess means for compensating local differences between transmit and reception paths. Methods for accomplishing this using probe antennas are described in Agee, et. al. (U.S. patent application Ser. No. 08/804,619, referenced above). A noteworthy advantage of this invention is that substantive reciprocity can be obtained using only local transmit/receive compensation means.

The channel model described above is extendable to applications where the internode channel responses possess substantive multipath, such that $H_{21}(k,l;n_2,n_1)$ and $H_{12}(k,l;n_2,n_1)$ have rank greater than unity. This channel response can also be made substantively reciprocal, such that the primary benefit of the invention can be obtained here.

The preferred embodiment uses a substantively null-steering network wherein each node transmits baseband data (complex symbols provided by a multirate codec) through the multiplicity of reciprocal linear matrix operations prior to transmission into the antenna array during transmit operations, and after reception by the antenna array during receive operations, in a manner that physically separates messages intended for separate recipients. This is accomplished by (1) forming uplink and downlink transmit signals using the matrix formula

$$\begin{aligned} s_1(k,l;n_1) &= G_1(k,l;n_1) d_1(k,l;n_1) \\ s_2(k,l;n_1) &= G_2(k,l;n_2) d_2(k,l;n_2) \end{aligned} \tag{EQ. 40}$$

where

$$d_1(k,l;n_1) = [d_1(k,l;n_2(1),n_1) \dots d_1(k,l;n_2(N_2),n_1)]^T$$

represents the vector of complex data symbols transmitted from node n_1 and intended for each of nodes $\{n_2(q)\}$, respectively, within uplink channel (k,l) ;

$$d_2(k,l;n_2) = [d_2(k,l;n_1(1),n_2) \dots d_2(k,l;n_1(N_1),n_2)]^T$$

represents the vector of complex data symbols transmitted from node n_2 and intended for each of nodes $\{n_1(q)\}$, respectively, within downlink channel (k,l) ;

$$G_1(k,l;n_1) = [g_1(k,l;n_2(1),n_1) \dots g_1(k,l;n_2(N_2),n_1)]$$

represents the complex distribution weights used to redundantly distribute symbol vector $d_1(k,l;n_1)$ onto each diversity channel employed at node n_1 within uplink channel (k,l) ; and

$$G_2(k,l;n_2) = [g_2(k,l;n_1(1),n_2) \dots g_2(k,l;n_1(N_1),n_2)]$$

represents the complex distribution weights used to redundantly distribute symbol vector $d_2(k,l;n_2)$ onto each diversity channel employed at node n_2 within downlink channel (k,l) ; (2) reconstructing the data intended for each receive node using the matrix formula

$$y_1(k,l;n_1) = W_1^H(k,l;n_1) x_1(k,l;n_1)$$

$$y_2(k,l;n_2) = W_2^H(k,l;n_2) x_2(k,l;n_2)$$

where $(\)^H$ denotes the conjugate-transpose (Hermitian transpose) operation, and where

$$y_1(k,l;n_1) = [y_1(k,l;n_2(1),n_1) \dots y_1(k,l;n_2(N_2),n_1)]^T$$

represents the vector of complex data symbols intended for node n_1 and transmitted from each of nodes $\{n_2(q)\}$, respectively, within downlink channel (k,l) ;

$y_2(k,l;n_2)=[y_2(k,l;n_2(1),n_2) \dots y_2(k,l;n_2(N_2),n_2)]^T$ represents the vector of complex data symbols intended for node n_2 and transmitted from each of nodes $\{n_1(p)\}$, respectively, within uplink channel (k,l) ;

$$W_1(k,l;n_1)=[w_1(k,l;n_2(1),n_1) \dots w_1(k,l;n_2(N_2),n_1)]$$

represents the complex combiner weights used at node n_1 to recover symbol symbols $\{d_1(k,l;n_2(q),n_1)\}$ intended for node n_1 and transmitted from nodes $\{n_2(q)\}$ within uplink channel (k,l) ; and

$$W_2(k,l;n_2)=[w_2(k,l;n_1(1),n_2) \dots w_2(k,l;n_1(N_1),n_2)]$$

represents the complex combiner weights used at node n_2 to recover symbol symbols $\{d_2(k,l;n_1(p),n_2)\}$ intended for node n_2 and transmitted from nodes $\{n_1(p)\}$ within uplink channel (k,l) .

(3) developing combiner weights that $\{w_1(k,l;n_2,n_1)\}$ and $\{w_2(k,l;n_1,n_2)\}$ that substantively null data intended for recipients during the symbol recovery operation, such that for $n_1 \neq n_2$:

$$|w_1^H(k,l;n_2,n_1)a_1(f_{12}(k),t_{12}(l);n_2,n_1)| \ll |w_1^H(k,l;n_1,n_1)a_1(f_{12}(k),t_{12}(l);n_1,n_1)| \text{EQ. 42}$$

and

$$|w_2^H(k,l;n_1,n_2)a_2(f_{21}(k),t_{21}(l);n_1,n_2)| \ll |w_2^H(k,l;n_2,n_2)a_2(f_{21}(k),t_{21}(l);n_2,n_2)| \text{EQ. 43}$$

(4) developing distribution weights $\{g_1(k,l;n_2,n_1)\}$ and $\{g_2(k,l;n_1,n_2)\}$ that perform equivalent substantive nulling operations during transmit signal formation operations;

(5) scaling distribution weights to optimize network capacity and/or power criteria, as appropriate for the specific node topology and application addressed by the network;

(6) removing residual timing and carrier offset remaining after recovery of the intended network data symbols; and

(7) encoding data onto symbol vectors based on the end-to-end SINR obtainable between each transmit and intended recipient node, and decoding that data after symbol recovery operations, using channel coding and decoding methods develop in prior art.

In the preferred embodiment, OFDM modulation formats is used to instantiate the invention, and substantively similar distribution and combining weights are computed and applied over as broad a range of tones (frequency channels k) and OFDM symbols (time slots l) as is practical. The range of practical use is determined by the frequency selectivity (delay spread) and time selectivity (Doppler spread) of the communications channel, which determines the degree of invariance of the channel response vectors a_1 and a_2 on (k,l) ; the dynamics of interference i_1 and i_2 ; latency requirements of the communications network; and dimensionality of linear combiners used at each node in the network, which determine the number of frequency-time channels needed to determine reliable substantively null-steering distribution and combining weights.

In the preferred embodiment, substantively nulling combiner weights are formed using an FFT-based least-squares algorithms that adapt $\{w_1(k,l;n_2,n_1)\}$ and $\{w_2(k,l;n_1,n_2)\}$ to values that minimize the mean-square error (MSE) between the combiner output data and a known segment of transmitted pilot data. Operations used to implement this technique during receive and transmit operations are shown in FIGS. 35 and 36, respectively. The preferred pilot data is applied to an entire OFDM symbol at the start of an adaptation frame

comprising a single OFDM symbol containing pilot data followed by a stream of OFDM symbols containing information data. The pilot data transmitted over the pilot symbol is preferably given by

$$p_1(k;n_2,n_1) = d_1(k,l;n_2,n_1) = p_{01}(k)p_{21}(k;n_2)p_{11}(k;n_1) \text{EQ. 44}$$

$$p_2(k;n_1,n_2) = d_2(k,l;n_1,n_2) = p_{02}(k)p_{12}(k;n_1)p_{22}(k;n_2) \text{EQ. 45}$$

where symbol index l is referenced to the start of the adaptation frame, and where

$p_{01}(k)$ is a pseudorandom, constant modulus uplink "network" or "subnet" pilot that is known and used at each node in a network or subnet;

$p_{02}(k)$ is a pseudorandom, constant modulus downlink "network" or "subnet" pilot that known and used at each node in the network;

$p_{21}(k;n_2)$ is a pseudorandom, constant modulus uplink "recipient" pilot that is known and used by every node intending to transmit data to node n_2 during uplink transmission intervals;

$p_{12}(k;n_1)$ is a pseudorandom, constant modulus downlink "recipient" pilot that is known and used by every node intending to transmit data to node n_1 during downlink transmission intervals;

$p_{11}(k;n_1) = \exp\{j2\pi\delta_1(n_1)k\}$ is a sinusoidal uplink "originator" pilot that is used by node n_1 during uplink transmission intervals;

$p_{22}(k;n_2) = \exp\{j2\pi\delta_2(n_2)k\}$ is a sinusoidal downlink "originator" pilot that is used by node n_2 during downlink transmission intervals;

The "pseudodelays" $\delta_1(n_1)$ and $\delta_2(n_2)$ can be unique to each transmit node (in small networks), or provisioned at the beginning of communication with any given recipient node (in which case each will be a function of n_1 and n_2). In either case, the minimum spacing between any pseudodelays used to communicate with a given recipient node should be larger than the maximum expected timing offset observed at that recipient node. This spacing should also be an integer multiple of $1/K$, where K is the number of tones used in a single FFT-based LS algorithm. If K is not large enough to provide a sufficiency of pseudodelays, additional OFDM symbols can be used for transmission of pilot symbols, either lengthening the effective value of K , or reducing the maximum number of originating nodes transmitting pilot symbols over the same OFDM symbol (for example, the recipient node can direct 4 originators to transmit their pilot symbols over the first OFDM symbol in each adaptation frame, and 4 other originators to transmit their pilot symbols over the next OFDM symbol, allowing the recipient node to construct combiner weights for 8 originators). In the preferred embodiment, K should also be large enough to allow effective combiner weights to be constructed from the pilot symbols alone.

The remaining information-bearing symbols in the adaptation frame are then given by

$$d_1(k,l;n_2,n_1) = p_1(k;n_2,n_1)d_{01}(k,l;n_2,n_1) \text{EQ. 46}$$

$$d_2(k,l;n_1,n_2) = p_2(k;n_1,n_2)d_{02}(k,l;n_1,n_2) \text{EQ. 47}$$

where $d_{01}(k,l;n_2,n_1)$ and $d_{02}(k,l;n_1,n_2)$ are the uplink and downlink data symbols provided by prior encoding, encryption, symbol randomization, and channel preemphasis stages.

Preferably, the adaptation frame is tied to the TDD frame, such that the TDD frame comprises an integer number of

adaptation frames transmitted in one link direction, followed by an integer number of adaptation frames transmitted in the reverse link direction. However, the OFDM symbols in the adaptation frame may be interleaved to some degree or any degree. The pilot data may also be allowed to pseudorandomly vary between adaptation frames, providing an additional layer of "physical layer" encryption in secure communication networks.

At the recipient node, the pseudorandom pilot components are first removed from the received data by multiplying each tone and symbol by the pseudorandom components of the pilot signals

$$x_{01}(k,l;n_1)=c_{02}(k;n_1)x_1(k,l;n_1) \quad \text{EQ. 53}$$

$$x_{02}(k,l;n_2)=c_{01}(k;n_2)x_2(k,l;n_2) \quad \text{EQ. 48}$$

where $c_{02}(k;n_1)=[p_{02}(k)_{12}(k;n_1)]^*$ and $c_{01}(k;n_2)=[p_{01}(k)p_{21}(k;n_2)]^*$ are the derandomizing code sequences.

This operation transforms each pilot symbol authorized and intended for the recipient node into a complex sinusoid with a slope proportional to the sum of the pseudodelay used during the pilot generation procedure, and the actual observed timing offset for that link (observed pseudodelay). (See FIGS. 21, 28.) Unauthorized pilot symbols, and symbols intended for other nodes in the network, are not so transformed and continue to appear as random noise at the recipient node (See FIG. 38A, 38B).

The FFT-based LS algorithm is shown in FIG. 37. The pilot symbol, notionally denoted $X_0(k,l)$ in this Figure (i.e., with reference to uplink/downlink set and node index suppressed), is multiplied by a unit-norm FFT window function, and passed to a QR decomposition algorithm, preferably a block modified-Gram-Schmidt Orthogonalization (MGSO), and used to compute orthogonalized data $\{q(k)\}$ and upper-triangular Cholesky statistics matrix R. Each vector element of $\{q(k)\}$ is then multiplied by the same window function, and passed through a zero-padded inverse Fast Fourier Transform (IFFT) with output length PK, with padding factor P, preferably $P=4$, to form uninterpolated, spatially whitened processor weights $\{u(m)\}$, where lag index m is proportional to target pseudodelay $\delta(m)=m/PK$. The whitened processor weights are then used to estimate the mean-square-error (MSE) obtaining for a signal received at each target pseudodelay, $\epsilon(m)=1-|u(m)|^2$, yielding a detection statistic (pseudodelay indicator function) with a minimum (valley) at IFFT lags commensurate with the observed pseudodelay (alternately, combiner output SINR $\gamma(m)=\epsilon^{-1}(m)-1$ can be measured at each target pseudodelay, yielding a detection statistic (peak) at FFT lags commensurate with that pseudodelay. The pilot symbol, notionally denoted $X_0(k,l)$ in this Figure (i.e., with reference to uplink/downlink set and node index suppressed), is multiplied by a unit-norm FFT window function, and passed to a QR decomposition algorithm, preferably a block modified-Gram-Schmidt Orthogonalization (MGSO), and used to compute orthogonalized data $\{q(k)\}$ and upper-triangular Cholesky statistics matrix R. Each vector element of $\{q(k)\}$ is then multiplied by the same window function, and passed through a zero-padded inverse Fast Fourier Transform (IFFT) with output length PK, with padding factor P, preferably $P=4$, to form uninterpolated, spatially whitened processor weights $\{u(m)\}$, where lag index m is proportional to target pseudodelay $\delta(m)=m/PK$. The whitened processor weights are then used to estimate the mean-square-error (MSE) obtaining for a signal received at each target pseudodelay, $\epsilon(mm)=1-|u(m)|^2$, yielding a detection statistic (pseudodelay indicator function) with a minimum (valley) at IFFT lags commensurate with the observed pseudodelay (al-

ternately, combiner output SINR $\gamma(m)=\epsilon^{-1}(m)-1$ can be measured at each target pseudodelay. The IFFT windowing function is dependent on the minimum spacing between pseudodelays, and is designed to minimize interlag interference ("picket fence" effect) between pilot signal features in the pseudodelay indicator function. In the preferred embodiment, and for a node capable of forming four links, a Kaiser-Bessel window with parameter 3 is preferred.

A valley (or peak) finding algorithm is then used to detect each of these valleys (or peaks), estimate the location of the observed pseudodelays to sub-lag accuracy, and determine additional ancillary statistics such as combiner output SINR, input SINR, etc., that are useful to subsequent processing steps (e.g., LEGO). Depending on the system application, either the Q lowest valleys (highest peaks), or all valleys below a designated MSE threshold (peaks above a designated SINR threshold) are selected, and spatially whitened weights U are interpolated from weights near the valleys (peaks). The whitened combiner weights U are then used to calculate both unwhitened combiner weights $W=R^{-1}U$, used in subsequent data recovery operations, and to estimate the received channel aperture matrix $A=R^T U$, to facilitate ancillary signal quality measurements and fast network entry in future adaptation frames. Lastly, the estimated and optimized pseudodelay vector δ_* is used to generate $c_1(k)=\exp\{-j2\pi\delta_*k\}$ (conjugate of $\{p_{11}(k;n_1)\}$ during uplink receive operations, and $\{p_{22}(k;n_2)\}$ during downlink receive operations), which is then used to remove the residual observed pseudodelay from the information bearing symbols. (See FIG. 38A, Items 702A, 704, 702B, 706, and FIG. 38B, Item 710, for illustration of the overall signal and the signal modified by the correct origination, target, and pilot mask.)

In an alternate embodiment, the pseudodelay estimation is refined using a Gauss-Newton recursion using the approximation

$$\exp\{-j2\pi\Delta(k-k_0)/PK\} \approx 1 - j2\pi\Delta(k-k_0)/PK$$

This algorithm first estimates Δ , providing an initial sublag estimate of pseudodelay, before estimating the lag position to further accuracy. The resultant algorithm can reduce the padding factor P, and reduces interpolation errors in the receive combination weights. However, it requires estimation of an additional IFFT using a modified FFT window, and is therefore not preferred in applications where DSP complexity is of overriding importance.

The optimized combiner weights are substantively null-steering, in that the combiner weights associated with each originating signal will (notionally, in absence of multipath) form a composite antenna pattern that steers nulls in the direction of all other time-and-frequency coincident signals (signals transmitting on the same time slot and frequency channel) impinging on the array. However, the weights will also (notionally, in absence of multipath) form a beam in the direction of the originating signal, further improving performance of the overall network. In the presence of multipath, a clear gain pattern of this sort may not necessarily form; however, the effect of this processing will be the same, and is typically be improved due the added diversity provided by multipath.

In additional alternate embodiments, the combiner weights can be further refined by exploiting known or added structure of the information bearing symbols using blind property-restoral algorithms. Algorithms of this sort are described in Agee (U.S. Pat. No. 6,118,276) and Agee, et. al., (U.S. patent application Ser. No. 08/804,619, referenced above) as well as other disclosures in the public domain. These alternate embodiments can reduce the size of K, or allow the airlink to

be extended into more complex systems where the linear combiner dimensionalities are too large to allow computation of effective weights given the value of K employed in an existing system.

The resultant network has several useful attributes over prior art. It is computationally efficient, especially for nodes receiving data from large numbers of originating nodes, since the complex operations employed in the FFT-LS algorithm can be amortized over multiple links. It is also rapidly convergent, allowing computation of 4-element diversity combiner weights to attain nearly the maximum SINR obtainable by the combiner using 8-to-16 pilot data tones. It automatically detects and reconstructs data from nodes that have been authorized to communicate with the network, or with recipient nodes within the network, and rejects nodes that are not so authorized, allowing the network to adjust and control its topology and information flow at the physical layer, and providing an important level of security by rejecting signals that do not possess appropriate network or recipient pilots. It also provides an additional level of data scrambling to prevent occurrence of correlated interlink symbol streams that can cause severe misadjustment in conventional linear combiner adaptation algorithms.

In reciprocal channels, the linear combiner weights provided during receive operations can be used to simply construct linear distribution weights during subsequent transmit operations, by setting distribution weight $g_1(k,l;n_2,n_1)$ proportional to $w^*_1(k,l;n_2,n_1)$ during uplink transmit operations, and $g_2(k,l;n_1,n_2)$ proportional to $w^*_2(k,l;n_1,n_2)$ during downlink transmit operations. The transmit weights will be substantially nulling in this system, allowing each node to form frequency and time coincident two-way links to every node in its field of view, with which it is authorized (through establishment of link set and transfer of network/recipient node information) to communicate.

Among other advantages, this capability allows nodes to independently adjust transmit power directed to other nodes in the network, for example, to optimize capacity achievable at that node given the total power available to it, or to minimize power emitted into the network by that node given an aggregate power requirement. This capability also allows the node to adjust its contribution to the overall network, for example, to maximize the total aggregate (max-sum) capacity of the network, or to minimize network power subject to a network-level capacity constraint. In addition, this capability can allow the node to provide two-way communication to authorized nodes, or in defined subnets, in the presence of other nodes or subnets that it is not authorized to communicate with, for example, adjacent cells in CMRS networks, and adjacent (even interpenetrating), and virtual private nets. In wireless LAN's and MAN's.

This capability is illustrated in FIGS. 39 and 40, the latter being for a hexagonal network of six nodes arranged in a ring network, with an additional direct connect between nodes A and D. In this example, each node has been provided with a recipient pilot for its adjacent node, e.g., node B has been provided with recipient pilots for nodes A and C, facilitating time-frequency coincident communication with those adjacent nodes. In addition, Node A has been provided with recipient pilots for node D, i.e., node A can communicate with nodes B, D, or F.

The pseudodelay indicator functions (provided as a function of SINR, i.e., with peaks at observed pseudodelays) are shown for each of the nodes. Indicator functions generated at nodes B, C, E, and F have two strong peaks, corresponding to pseudodelays used at their connecting nodes, plus a 10 microsecond time-of-flight delay (assuming all nodes are synchro-

nized to GPS UTC). In addition, nodes A and D have a third peak at their respective delays, plus a 20 microsecond time-of-flight delay. The pseudodelays are minimally separated by 25 microseconds for each of the originating nodes (12.5 microsecond minimal separation between all nodes), which is easily wide enough to allow peaks from different originators to be discerned. In addition, the peak values (near 20 dB SINR for all links except the A-to-D link) are detectable with a 0 dB threshold. As Figure ## shows, the receive and transmit weights form beam and null patterns that allow independent links to be formed between authorized nodes, and that allow unauthorized signals to be screened at the points of reception and transmission.

The aperture estimates A will (also notionally, in absence of multipath) form beams in the direction of the originating node; however, they will ignore all other nodes in the network. For this reason, they cannot be used in general to sustain independent links. However, the aperture estimates can be used to allow rapid reentry into the network, for example, in packet data systems where users may quickly begin and end signal transmissions over brief time periods (e.g., such that the channel response has not changed substantively between transmissions). The aperture estimates can also be combined with combiner/distribution weights to form rapid nulls again other links or nodes in the network.

The primary application area for the fully adaptive MIMO arrays of the preferred embodiment will be below 10 GHz, where the abilities to achieve non-LOS and to exploit multipath are still possible, and where pathloss, weather effects, and channel dynamics can be handled by adaptive arrays. The preferred embodiment's MIMO network will provide a strong advantage over conventional MIMO links, by not requiring antenna separation of 10 wavelengths to provide effective capacity gain. The present state of the art considers 10 wavelengths to be the rule of thumb for the distance between antennas that provides spatially independent antenna feeds due to disparate multipath at each antenna. This rule has greatest applicability in worst-case mobile environments subject to Rayleigh fading, i.e., where the (typically much stronger) direct path is obscured, and propagation occurs over many equal-power reflection paths.

The MIMO network of the preferred embodiment, however, exploits route diversity due to reception of signals from widely separated nodes, and does not need multipath to provide the capacity gains cited for MIMO links in the present state of the art. This enables the preferred embodiment to employ antennas with much smaller separation, e.g., circular arrays with half-to-full wavelength diameter, to provide effective capacity or QoS gains. The preferred embodiment's exploitation of multipath can further improve performance, by providing additional differences between gain and phase induced at each antenna in the array. In this regards, a smaller aperture is also better, as it reduces frequency selectivity across individual frequency channels. Polarization diversity can also be employed between antennas with arbitrary spacing (e.g., in "zero aperture" arrays), as well as "gain diversity" if the antennas have distinct gain patterns.

The MIMO network of the preferred embodiment has application in the 10-100 GHz region (for example, LMDS bands around 25-35 GHz where mesh networks are of increasing interest), even though these networks are likely to employ nonadaptive directional antennas, or partially adaptive antennas, e.g., arrays in focal plane of directional dish antennas, that direct high gain or "pencil" beams at other ends of the link, rather than fully adaptive beam-and-null steering networks. This is due to small form factor of such antennas, as

well as pathloss, atmospheric absorption, and weather effects prevalent above the 10 GHz band.

The next preference is that for each channel that is dynamically established, the uplink and downlink share a common frequency (that is, the transmission and reception are on the same frequency). This enables the establishment and exploitation of channel reciprocity (CR) between pairs of nodes, the sharing of antennae and diversity channels in transmit and receive operations in particular nodes, and other network advantages. The network advantages include the use of ad hoc, single-frequency networks in bursty (data-intensive) networks, such as packet-switched networks, random-access networks, or at the network "edges" (where the SINR level threatens to overcome the network capacity). This also allows the establishment of a two-layer time-division duplex schema in persistent networks or channels (e.g. ones that are circuit-switched, or perform connectionless datagram backhaul functions), where there is an equal duty cycle in both directions. An alternative embodiment will permit asymmetric duty cycles, and yet a third configurable balancing of duty cycles. Additionally, in the multitone case of dual-frequency approach (uplink and downlink using distinct frequencies), the network uses a frequency division duplex (FDD) protocol, preferably in combination with channel-based transmission and reception weights.

The network advantage to the preferred embodiment is that, instead of the network serving as a Procrustean bed to which the communications links must be fitted out of the combination of its environmental SINR, established protocols, and channel approach, each communications link can use the environmental SINR, protocols, and channel approach to dynamically adapt the network's functioning to maximize capacity and minimize power consumption.

The second preference is that the network uses and exploits diversity frequency transmission and reception at all nodes in the network. This particular aspect of the preferred embodiment carries the complexity and hardware cost of requiring that each node incorporate spatially separated and shared receive/transmit antennae, although the separation need only be measured in tens of lambdas of the lowest frequency (longest wavelength) used by that particular node. This pragmatically can create a situation where BS nodes are equipped with larger antennae which are spatially separated by feet or meters, and thus use far lower frequencies for 'backhaul' or BS to BS transmissions; this also carries, however, the advantage that SU nodes lacking such spatial separation will be intrinsically deaf to such frequencies. (Care must be taken to consider harmonics between BS backbone frequencies and SU channel frequencies.)

Optionally, in an enhancement to the preferred embodiment, the network would include and make use of frequency polarization, spectral diversity, or any combination thereof, at any subset (including a proper subset) of the network's nodes to provide further coding and differentiation potential. And in another, further enhancement, the network would employ Butler RF networks to provide common RF front-end and scalable and expandable transceiver DSP backends in peer-to-peer network implementations.

The third preference is that the nodes include a multitone QAM encoder, whereby individual tones would be multiplied by Quadrature-Amplitude-Modulated symbols to further differentiate the signals between nodes, even those using the same frequencies. Alternative QAM approaches would include PSK, $\pi/4$ QPSK, and $\pi/4$ -DQPSK symbols to increase the variation potentialities. These symbols would be generated using Trellis-Coded-Modulation (TM) encoding over individual frequency channels and would include sev-

eral-to-one multitone symbols. One alternative embodiment would use Reed-Solomon codes and direct mapping to symbols; other alternatives would use Turbo encoding, either at the baseband or as part of the TM, or any combination thereof. To aid the Viterbi decoding at the receiver the "tail-biting" approach would be used at the edge of the symbol blocks. To assist the maximum capacity solution for each frequency channel, the network would use variable information bits per frequency channel rather than a fixed set of information bits per frequency channel, in a method analogous to the Digital MultiTone, Digital Signal Loss (DMT DSL) approach, trading the need for information density encoding as part of the signal overhead for the need for all channels to be constrained to the minimum guaranteed capacity of any environmentally or hardware constrained channel, to avoid pathloss for the most tightly constrained link or channel. However, rather than insist upon this approach, the network would include the capability to shift to a constant bits per frequency channel approach with appropriate LEGO power management, to enable and support the minimum-power solution for the network when either power or capacity constraints determine this is preferable.

The fourth preference is that the network adds pseudorandom modulation to the symbols after encoding. This is to eliminate the need to increase the signaling overhead by runs of correlated symbols, as it aids in the receive adaptation algorithms, provides discrete link encryption, thereby greatly increasing both channel and network security, and enables pilot-gated fast acquisition and timing recovery algorithms. An extension to the pseudorandom modulation is the analysis and elimination of certain detectable features by the network in one alternate embodiment. A distinct extension is the embedding of invariance for exploiting broader modulation, using gated SCORE. And a third extension combines the two extensions just described.

The fifth preference is the addition of an error detection syndrome, or CRC block to transmissions to detect bit errors, which would enable the initiation of a retransmission request at the end of a packet's reception when an error is signaled.

The sixth preference is using a computationally efficient and fast-converging receive weight algorithm (CE&FC RWA) to reduce the computational and hardware overhead for each channel's transmission and node. Variations of such CE&FC RWA that would be used include any one, subcombination, or combination, of the following: Least-Squares Like (LS), which are also known as matrix-inversion; Block-Update implementations (on a per-packet basis) that amortize matrix operations over multiple data snapshots (using tones and/or multitone symbols); and recursive single-snapshot algorithms. Furthermore, the preferred embodiment may use one, more than one, or all of the following for the same purposes: calculation of autocorrelation statistics in voltage domain (e.g. using QRD, MGSO) to minimize the complexity and increase the accuracy of the weight-update operation; multiport adaptation (simultaneous processing of multiple co-channel links) on each frequency channel to amortize autocorrelation operations over multiple users (more at BS than SU nodes); or single-step, single-port adaptations (more at SUs than BSs). Depending on the network constancy and dynamic state, or static constancy, the network may vary between uncalibrated techniques which are not dependent upon knowledge or calculation of channel information (e.g. the emitter location, or the elevation/azimuth separating transmitter and receiver), non-blind and blind weight adaptation techniques such as pilot-based initial weight acquisition signaling, blind and/or pilot-aided decision-direction weighting in persistent links, and blind embedded-invariance tech-

niques such as gated SCORE, in an alternative embodiment. For pilot-aided and gated SCORE techniques the network would preferentially use the computationally efficient mechanization of cross-correlation operations employing fast transform (and in a specific embodiment, FFT) methods. In yet other alternative embodiments the network may use combined channel sounding, channel-based weight estimation, or any combination of the foregoing.

The seventh preference is using post-combining in-channel tone equalization to remove timing and carrier offset. This could include multiplication by constant modulus weights, as the first preference, to remove timing and/or delay offsets; alternatively, it could include low-complexity intertone filtering to remove carrier offset and Doppler errors; and, of course, a combination of both could be employed depending on the environmental and hardware complexity needs, constraints, and costs.

The eighth, and most important preference for the preferred embodiment is that each node of the network be capable of employing and employ retrodirective transmission and reception modulation, wherein the transmit gains are set proportional to the actually experienced reception weights for the frequencies used. For single frequency links, this exploits their potential reciprocity (especially for TDD or ad-hoc networks). When a TDD approach is used each data frame is encapsulated in smaller guard frames, and the entire transmission occupies a smaller portion of the available bandwidth to similarly encapsulate it in the available bandwidth. The signal for a one-way frame duration is further broken down to incorporate a guard time, a data symbol, an encapsulating cyclic prefix, a control symbol, a cyclic prefix separation the control symbol from the acquisition symbol, and a final encapsulating cyclic prefix. The frequency channels that occupy the bandwidth carry bearer data fragments over fractional subfragments. One embodiment for low-mobility, fixed or portable TDD uses a 120B Bearer Data Fragment which is comprised of eight 15B subfragments, 8 differentiating and coordinating multitone symbols, and of 5.75 MHz available only 4.26 MHz bandwidth, said bandwidth being divided into 13 frequency channels, each with 320 kHz, to provide 2 fragments per frame per link, or 6.24 Mbytes each frame, or 4.608 Mbps as one channel (Channel 0) is reserved for fragment resends, thereby providing the equivalent in wireless transmission of 3 land-based T1 lines with, thanks to the reservation and resend provision, a 10^{-4} BER. This embodiment further uses for each 15B subfragment a MAC header providing 2B CRC and 13B MAC data, providing 52 MAC channels and at full duplex 10.4 kbps per channel. The acquisition symbols have 30B pilot or synchronization data per 320 kHz frequency channel, 32 to 64 pilot tones per channel, and thereby provide fast acquisition for up to 32 Degrees of Freedom; and if the area is sparsely populated or for other reasons (downtime, occupied by other transmissions) less than 17 Degrees of Freedom were needed, the excess DOF could be reused and reprovioned to enable dynamic channels and thereby further increase the local flexibility.

The high-mobility TDD link replaces the cyclic prefixes with nulls on the uplink and CP on the downlink, halves the number of tones and doubles the separation of tones (from 426 to 213 tones, from 10 kHz to 20 kHz separation), and provides half the DOF, but doubles the amount of overlap that can be tolerated for the same QOS.

In the preferred embodiment for fixed, portable, and low-mobility links, the tone layout divides the 4.26 MHz into 426 'bins', each of 10 kHz separation; these are then shared such that thirteen channels, each with 32 tones covering 320 kHz,

from Channel 0 to Channel 12 are formed, with each channel further carrying of the 32 tones a network-information-bearing tone at the bottom and top of the channel (T0 and T31) that encapsulate the content-carrying tones T1 through T30. Each channel is modulated by a 32-tone pilot to facilitate the acquisition and fine time synchronization. The 10 kHz tone separation controls reasonable levels of time selective Multipath (± 100 MHz), with a cyclic buffer being added at channel edges. The network can, should environmental or network conditions suggest, 'step down' the overall frequency spread to 160 kHz BW without affecting the fundamental stability of the traffic algorithms or network. (See FIG. 26)

However, for high-mobility TDD links the number of bins, pilot size, and information-bearing tones per channel are halved, while the tone separation is doubled. This will permit high levels of Doppler shift (± 5 kHz) without sacrificing QoS or content integrity; and again, the network can step down the overall frequency spread and thus the bandwidth per bin can be halved (from 320 kHz to 160 kHz) without affecting the fundamental stability of the traffic algorithms or network. (See FIG. 27)

Preferentially transmit gains are set proportionally to the conjugate of the receive weights for that particular node and channel. An alternative approach uses channel-based retrodirective transmit gains (more for SU than BS); a second alternative uses channel-based directive (beam-pointing) transmit gains (more for BS than SU); a third applies retrodirection to in-channel preemphasis gains; and any combination of these alternative approaches may be employed. For any such single-frequency link the transmitting node breaks periodically (in one particular alternative embodiment every 5 msec) to collect ACKs, NACKs, or RTSSs, that is, to monitor the link performance as perceived by the receiving node. This approach, though it provides all the capacity in a particular link to a user as needed, is very compatible with small, stationary networks but less compatible with LEGO network management due to the effects of nonstationary network fields.

The ninth preference is that the network employs Locally-Enabled Network Optimization (LEGO) to manage the transmit power for each node (BS and SU) operating, dynamically. This requires that relatively complex computational operations (e.g. receive weight and transmit gain calculations, multitone, QAM, TCM, and the above-mentioned signal/symbol/weight/frequency calculations) be carried out autonomously at each node in the network, rather than limited to one class of nodes. This further requires that as part of the network overhead simple, network-level control parameters be passed to, or shared by (for certain time intervals, though such may either be hard-set invariances in the hardware, subject to change signal, or network-alterable) all nodes in the network. Additionally, each node would implement its power-management algorithm to minimize transmit power and manage its links, thereby indirectly optimizing performance over the entire network. An alternative embodiment would effect network-level optimization; and a third would combine node-driven local determined optimization with network-level optimization.

Although the preferred embodiment uses an algorithm that presumes that power capacity will vary over the network, and that establishes local maxima by favoring capacity maximization for the power constraint at each particular node in the network (i.e. a goal driven minimization algorithm), various alternative LEGO algorithms could be employed. For example, if power shortfalls or constraints on any part of the network are anticipated, then a capacity maximization subject to that power constraint algorithm could be used. A third

alternative, presuming that the network capacity (as opposed to the power) is the guiding constraint, sets the power minimization subject to the capacity attainment to the limit possible over the entire network. And a fourth, which is better, sets the power minimization at each particular node in the network subject to the capacity constraint at that particular node.

The preferred embodiment incorporates into each node a multitone QAM decoder, with a soft-optimized, Viterbi algorithm (SOVA) embodied in the decoder, such that the network can effect changes in the decoder at its nodes by a software or information transmission that re-sets the hardware (EEPROM, FPGA, PAL, or other semiconductor chip) and software at that node for the new decoding scheme. An alternative embodiment with lesser cost and complexity at each node, but lesser flexibility, is to use hard-optimized, Viterbi or Reed-Solomon, decoders at each node in the network. A third alternative is to combine both SOVA and HOVA decoders in the network and establish hierarchies wherein the more flexible stations moderate as needed to communicate with their less flexible but simple contacts.

The preferred embodiment of the present form of the invention also incorporates synchronization means for its communications, which encompass timing estimation, carrier estimation, and synchronization operations as part of the network communication and control methodologies. The preferred synchronization is to a single, universal, and commonly observable timing signal such as that used in GPS operations, and occurs as part of the carrier signal (also known as 'GPS Sync'). An alternative embodiment would use synchronization to a timing, carrier, or mutual offset which would be observed at the transmission or master node during the reception process, wherein the slaved receiver synchronization would introduce a $\times 2$ delay and carrier error at the slaved transmitter, to avoid interference with the master transmission. Another alternative embodiment would use precompensation (in timing, carrier advancement, or both), to equalize any timing or carrier offset observed at both ends of the link (a means to synchronize the slaved node's transmission). Combinations of universal, offset, or precompensation synchronization methods would be yet further alternative embodiments.

Synchronization would be performed by including in the transmission dedicated multitone signals (such forming part of the set of QAM symbols used by the preferred embodiment), or by using dedicated tones in each multitone symbol, or most preferentially, by combinations of dedicated tones and slots to maximize the synchronization possible for the minimal transmission density. Coarse synchronization would be performed prior to the multitone demodulation, using the envelope features of the waveform. Fine synchronization would be performed after multitone demodulation, using dedicated QAM synchronization symbols and tones. For embodiments using universal observed timing through GPS synchronization, or using slaved transmission synchronization, these would be performed using control or MAC channels. An alternative embodiment would bypass the synchronization operation entirely by using GPS-based timing and carrier acquisition methods. A separate alternative embodiment would use blind, data-based synchronization methods, minimizing the use of specific synchronization data.

In the preferred embodiment Transmit/Receive (T/R) compensation means are employed to remove nonreciprocal channels after shared transmit or receive operations. These would be employed intermittently on an 'as-needed' basis through transmission of specialized T/R compensation packets to initiate the compensation processing. An alternative

embodiment would use dedicated T/R compensation channels to initiate the compensation processing. And the network would employ loops back of the received signal data to provide the initial transmitter with the T/R channel differences.

The preferred embodiment further includes methods for datagram network instantiations, particularly applicable for conditions such as edge networks (e.g. where the wireless electromagnetic communications network is connecting to the Internet) and entirely interior networks (e.g. the 'backhaul', dedicated, data-heavy, and often fiber-optic networks of other carriers). These enable the transmission of data in discrete datagrams, or fragments of datagrams, over multiple routes, such as neighboring nodes, according to the availability of transmission channel capacities. The recipient nodes would then reconstitute the original data stream from the received and re-ordered datagrams or datagram fragments. The preferred embodiment mechanizes the process by incorporating, or enabling, both TCP/IP and FTP protocols, and further uses fragment-level CRC's, error detection, and retransmission protocols to provide Zero-error, Uncommitted Bit-Rate (ZE-UBR) services. By using reservation protocols such as VoIP RSVP common to the industry, the preferred embodiment can also provide Committed Bit-Rate (CBR) service.

The preferred embodiment also incorporates means for resolving scheduling and capacity problems, preferentially the soft-contention and Demand-Assigned, Multiple-Access (DAMA) scheduling means. These would primarily be employed at network edges, though they also can serve at 'bursty' edge networks or handle 'unconcentrated' data streams. The soft contention means minimize the effects of data collisions and the latency due to retransmissions and/or backoff network effects; the DAMA scheduling is principally employed over longer sessions to maximize the network efficiency.

The topology of the wireless electromagnetic communications network affects the local details of implementation of the preferred embodiment, as different constraints and needs dictate how the best adaptation occurs. For small network embodiments where most, if not all of the nodes are in a common field of view, it is not important whether the network be in a star, ring, bus, or mesh topology. Under these conditions the preferred embodiment matches each transceiver's Degrees of Freedom (DOF) to the nodes in the possible link directions and equalizes them to provide node-equivalent uplink and downlink capacity. An alternative embodiment may also be used, depending on network traffic or user payment/preferences, wherein asymmetric transceiver assignments reflect the desired capacity weighting. After the DOF matching is completed, each node adapts the Receive Weights to form a hard (max-SINR, null-steered) or soft (max SINR) solution for multipath resolution for transmissions to that node. Then explicit interference whitening for in-network nodes, or implicit data whitening for soft nulling of out-of-network interferers are employed for conditions, e.g. as in Part 15 applications. Finally, retrodirective transmit gains (whitened or unwhitened as above) are used during subsequent transmission operations during a channel communication. In an alternative embodiments, the Receive Weights are directive, whitened, channel-based, or a combination thereof.

For large network embodiments the fundamental conditions are different and thus a different implementation and adaptation strategy is usually required. These include mesh extensions of star, ring, and bus networks (see FIG. 4); and the principal difference is that most nodes are not in a common field of view. A greater amount of network 'passing over' is required and nodes must more often serve as intermediary

rather than terminal transceivers. Under these conditions, for each node the transceiver DOF is matched to those nodes that are observable during the Receive operation, and then performs the symmetric equalization (or alternative, asymmetric equalization) and other operations (and alternatives) as described in the preceding paragraph. Under these conditions the LEGO parameters used for management of the network are disseminated throughout the network.

A third possible topology and concomitant operating conditions occurs when the network is cellular, or has overlapping subordinate or coordinating networks. Under these conditions, which are particularly likely to occur under competition, not all the nodes will be connected to the same wireless electromagnetic communications network. A greater potential for signal interference which is beyond the network's control results and the preferred embodiment adapts to this constraint. Furthermore, there may be some minimal transmissions of control, network health, or network OAMP data through a disparate infrastructure (wired or wireless), or even a high-rate connection through a wired infrastructure in an alternative embodiment.

When these conditions occur and networks are in view of each other, they can experience signal or physical overlapping; in many situations, such as urban areas, there may be heavy interpenetration. In principle there will be physical separation of the disparate networks' nodes, at least as to their geographic identity (two mobile phones generally do not share the exact, same physical location and continue to work when so crushed together); in practice, however, all the networks' nodes share the same physical layer of the electromagnetic spectrum and the real world geography and hardware. What ensures the continued separation of the networks is and enforced separation at the non-physical, information and communication layer. Alternative embodiments may allow low-rate communication, or means for limited, or even allowable full inter-network communication, depending on the differing networks' contract agreement as to communications and provisioning sharing.

Under these conditions the nodes in the preferred embodiment direct nulls (hard or soft) at all observed Transmission nodes in other networks, to minimize the interference from and with the other network's signals. This same approach may be used, in an alternative embodiment, to enforce a 'lock out' of unauthorized nodes in a secure network. The nulls are further enabled using network-wide scrambling, gating, or encryption means as described elsewhere, to differentiate the two networks' internal signals.

An alternative embodiment incorporates one or more broadcast modes from network master controllers, that would enforce common timing standards and provide broadcast, i.e. network common information, without requiring two-way bandwidth for such effort.

Advantages: LEGO

Among the advantages of the preferred embodiment's solution of the local optimizations to obtain global optimization are the following: (1) the working target capacity objective for any given set of nodes may be rapidly reached by iterating from an initial approximation to an acceptably-constrained solution with many fewer iterations overall; (2) the power levels that solve the local target capacity objective minimize the transmitted energy at the local node, thereby minimizing the co-channel interference to other users in the network; and (3) the quantities needed for the local solution only require local information to solve, thereby reducing substantially the ratio between 'control' and 'content' information, thus further enhancing the overall capacity of the network.

Additional advantages of the preferred embodiment's LEGO approach are (1) that it can be solved at each node using a very simple but powerful approximation technique that converges rapidly to the correct solution; (2) the power levels, at each respective node, that solve Eq. 3 actually minimize the transmitted energy at each respective node, hence (3) minimizing co-channel interference to other users (nodes) in the network while achieving the targeted capacity rates; and (4) most of the quantities required for the optimization only require local information.

Further advantages of the preferred embodiment include the lack of any need for estimating any channel matrices, and substantial lessening of detailed and fine calculation and recalculation of both (1) the initial SINR ratios and (2) the effect on each node of changing the power usage of any other node in the network. This latter has a secondary effect of reducing the amount of 'control' information that needs to be sent across the network, and reduces the amount of work or complexity that has to be managed by the network controller. LEGO Effect on the MIMO Network

By solving the optimization at the local level for each node of the network, the problem of network optimization becomes a hierarchical one, where the overall problem is reduced to a series of subproblems. The preferred embodiment's implementation as described above, is then generalized to handle both the power constrained unconstrained (negligible noise) objective functions.

For the channel capacity value D_{21} , the network performs the optimization

$$\begin{aligned}
 D_{21} &= \max \beta \text{ such that} \\
 \beta &\leq \sum_{q \in U(m)} \sum_k \log(1 + \gamma(k, q)), \\
 \gamma(k, q) &\geq 0, \\
 \sum_m R_1(m) &\leq R, \\
 \pi_1(k, q) &\geq 0, \\
 \sum_{q \in U(m)} \sum_k \pi_1(k, q) &\leq R_1(m)
 \end{aligned}
 \tag{EQ. 49}$$

where $U(m)$ is a collection of links in a given aggregate set m , k is a transmission mode index, reflecting the fact that a single link may transmit over multiple diversity channels, $\pi_1(k, q)$ is the transmit power for mode k and link q , $\gamma(k, q)$ is the post beamforming signal to interference noise ration, and $R_1(m)$ is the total allowed transmit power for aggregate set m ; by solving first the reverse link power control problem; then treating the forward link problem in an identical fashion, substituting the subscripts 2 for 1. The solution for the link-level optimization as described above is then implemented at each node, and the network solution derived therefrom.

The means used to solve D_{21} optimization are chosen to minimize the amount of auxiliary channel information, or network control information that displaces network content. For most of the max-min objective functions described herein, a necessary condition of optimality is that all of the links over each link index q achieve the same capacity. We can therefore require the constraint in Eq. 49 to be an equality For this embodiment, the objective function that is solved at each aggregate set m , becomes:

$$\min_{\pi_r(q)} \sum_{q \in Q(m)} \pi_r(q), \text{ such that} \quad \text{EQ. 50}$$

$$\beta = \sum_{q \in Q(m)} \log(1 + \gamma(q))$$

The preferred embodiment linearizes this objective function as a function of $\gamma(q)$ and optimizes it using the formulation in EQ 28, EQ 29 and EQ 30.

For each aggregate set m , the network now attempts to achieve the given capacity objective, β , by (1) optimizing the receive beamformers, using simple MMSE processing, to simultaneously optimize the SINR; (2) based on the individual measured SINR for each q index, attempt to incrementally increase or lower its capacity as needed to match the current target; and (3) step the power by a quantized small step in the appropriate direction. When all aggregate sets have achieved the current target capacity, then the network can either increase the target capacity β , or add additional users (opportunistically or by signal) to exploit the now-known excess capacity. The network controller of the preferred embodiment is computationally extremely simple and requires a very small feedback channel, or portion of the control channel otherwise unused, to accomplish its tasks.

As the network evolves each independent channel is assigned a variable rate codec optimized for the currently achieved SINR for that link, whereby a code and associated rate are chosen to achieve the desired bit error using any of the Trellis Codes, interleavers, and/or Reed-Solomon codes known to the literature.

Good network performance includes, generally, a measure of uniform minimum performance level for all links assigned the same quality of service (QoS). The preferred embodiment uses Max-Min capacity criterion as disclosed above to attain this, as it is generalizable to a wide variety of network configurations. Minimizing the total power subject to arbitrary capacity constraints $\beta(m)$, as in EQ 3 and EQ 4 is also an embodiment of interest and is easily accommodated by the current invention. The addition of reciprocity as a feature of the preferred embodiment allows us to state the decoupled objective function:

$$D_{rr} = \max_{\pi_q(k,q)} \min_m D_{rr}(m) \text{ where} \quad \text{EQ. 51}$$

$$D_{rr}(m) = \sum_{q \in U(m)} \sum_k \log(1 + \gamma(k, q))$$

as the largest possible mutual information that can be obtained, as the one to be used to obtain network optimality.

The reciprocity equation, Eq. 2, establishes that the network's uplink capacity will equal its downlink capacity provided that the receive weights are used to transmit and the transmit weights to receive. Implementing the network optimization in this fashion provides the following benefits: (1) transmit weights can be obtained from receive weights; (2) transmit and receive weights require only local information at each node, thereby eliminating the 'network God' and 'common knowledge' problems; and (3) local optimization done using this optimizes the entire network, both making it stable and converging. The reciprocity equation is used particularly to tell each node how to choose its transmit weights optimally.

An improvement over blindly substituting transmit and receive weights, however, is in using the proper form of the

objective function that satisfies the reciprocity equation, for that determines how to optimally adjust and select the gain over multiple outputs and multiple inputs. The choice of the objective function specified above dictates the algorithmic procedure that is also specified above to optimize the network.

Alternative embodiments of the network controller include having it set the entire network target capacity objective (β), using the network controller to add a node, drop a node, or change the target capacity objective for the nodes it governs or the network. FIG. 41 illustrates one feasible algorithm whereby a new node (or a node which had earlier dropped out of the network) enters the network. Further embodiments include using a network control element that may, either in addition to or in replacement for altering β , add, drop, or change channels between nodes, frequencies, coding, security, or protocols, polarizations, or traffic density allocations usable by a particular node or channel. In yet another embodiment the network control element selects and manages differing constraints, not being limited just to power and capacity, but also QoS, the amount of frequency spread between channels, the multipath density allocated to any particular pairing of nodes, or to any particular user, or any combination and subcombination of all of the above.

Although the present invention has been described chiefly in terms of the presently preferred embodiment, it is to be understood that the disclosure is not to be interpreted as limiting. Various alterations and modifications will no doubt become apparent to those skilled in the art after having read the above disclosure. Such modifications may involve other features which are already known in the design, manufacture and use of wireless electromagnetic communications networks, systems and MIMO networks and systems therefore, and which may be used instead of or in addition to features already described herein. The algorithms and equations herein are not limiting but instructive of the embodiment of the invention, and variations which are readily derived through programming or mathematical transformations which are standard or known to the appropriate art are not excluded by omission. Accordingly, it is intended that the appended claims are interpreted as covering all alterations and modifications as fall within the true spirit and scope of the invention in light of the prior art.

Additionally, although claims have been formulated in this application to particular combinations of elements, it should be understood that the scope of the disclosure of the present application also includes any single novel element or any novel combination of elements disclosed herein, either explicitly or implicitly, whether or not it relates to the same invention as presently claimed in any claim and whether or not it mitigates any or all of the same technical problems as does the present invention. The applicants hereby give notice that new claims may be formulated to such features and/or combinations of such features during the prosecution of the present application or of any further application derived therefrom.

FIG. 42 depicts the baseline transceiver employed in the primary embodiment. The radio consists of a pair of antennas and RF transceivers (frequency up/down converters and PA's); a digital ASIC, FPGA, or software radio component to implement lower-PHY (LPHY) symbol modulation/demodulation operations, linear combining of LPHY modem output signals during receive operations and corresponding linear weighting and distribution of LPHY model input signals during transmit operations; an LO employing a GPS disciplined oscillator (GPS-DO); and a software computer to implement optional higher-layer codec and collaborative

radio applications. Typical commercially available GPS-DO's can provide <100 ns relative node-to-node timing error (well within the 800 ns delay error budget provided by the lower PHY modulation format) and <1 Hz carrier offset error (separate from Doppler shift between nodes), stable to within 300 ns over periods of >1 hour in event of GPS outage, e.g., due to foliage or man-made obstructions. In TDD network instantiations, this can allow fast (1.25 ms) node entry to the network without the need for detailed and distributed timing synchronization mechanisms. In absence of GPS-DO's collaborative means can be implemented to allow the radios to synchronize to a common shared time reference by monitoring broadcast signals transmitted from adjacent transceivers, or to synchronize to GPS time and frequency standards if just one of the transceivers in the network possesses a GPS-DO, allowing the transceivers to be implemented at greatly reduced cost. The baseline transceiver can employ two degrees of freedom during receive and subsequent transmit operations, to set up independent ports to up to two other transceivers in the network during transmit or receive operations, or to null one external interferer during receive operations. Antennas in the network can be polarization diverse (transmitting and receiving on linearly independent, preferably orthogonal polarizations), spatially diverse (deployed at spatially separated locations), or combinations of polarization and spatially diverse. It is also possible to have a single channel transceiver capable of communicating with the network, or any number of ad-hoc combinations of transceivers of varying capabilities, likewise.

FIG. 43 depicts means for extending the baseline transceiver to larger numbers of antenna channels. The baseline transceiver and adaptation algorithm include provisions for routing of transmit and receive data and a modified Gram-Schmidt orthogonalization (MGSO) statistics between boards, in order to allow the radio to be scaled up to as many as 8 antennas by combining 2, 3, or 4 Transceiver boards together. A transceiver employing L baseline transceivers can employ up to 2L degrees of freedom during receive and subsequent transmit operations, to establish independent channels to up to 2L separate transceivers in a network, or to excise up to 2L-1 external interference during receive operations.

FIG. 44 depicts an exemplary MIMO networking routing scenario in which four transceivers with four spatial degrees of freedom are used to route data around a four-node network in the presence of a strong jammer. Each transceiver employs two of its four available degrees of freedom to establish connections with its neighboring transceivers. The remaining degrees of freedom are then used to excise the jammer in the center of the network, and to increase signal-to-noise ratio (SNR) in the direction of its neighboring transceivers. In a time-division duplex (TDD) communication network, these connections can be used to simultaneously route data in clockwise and counter-clockwise directions to form a counter rotating ring network. In lightly loaded networks, this can double the capacity available to any node in the network; moreover, this can greatly increase availability of the network to each node, by providing a redundant path for transmission of data between network ports.

FIG. 45 depicts the baseline symbol and timing structure allowing transceivers to connect with each other in a symmetric time-division duplex (TDD) multinode network. Packets are transmitted to and from uplink receive nodes and downlink receive nodes during alternating time slots, with an appropriate guard time, e.g., for switching between transmit and receive modes, transmission of signaling/control and network maintenance/provision packets, computation of

receiver CRC's and decoding algorithms, and operation of higher-layer data routing procedures. Within each slot, an integer number of lower PHY (LPHY) symbols is transmitted. The number of symbols is chosen to have a value that allows implementation of efficient orthogonal transformations over the symbol time index. In the primary embodiment, this number is set equal to a power-of-two, e.g., 256 symbols, in order to use of fast Hadamard transform (FHT) operations; however, other embodiments can employ different numbers of symbols, e.g., allowing implementation of mixed-radix fast Fourier transforms (FFT's) or other linear orthogonal operations. Each LPHY symbol is assumed to possess a base symbol and a cyclic prefix that is discarded during the LPHY symbol demodulation operation, allowing the transceivers to be insensitive to delay and multipath with maximum substantive value that is less than the cyclic prefix. In the preferred embodiment, the cyclic prefix and base symbol is set to 800 ns and 3.2 μ s, commensurate with the 802.11 OFDM traffic PHY, and may include additional synchronization and signaling symbols (external to symbols carrying traffic information) in order to maximize commonality with 802.11 hardware, and/or promote eventual coexistence and/or integration of the invention into 802.11 networks. In the preferred embodiment, the LPHY symbol is also either an OFDM waveform comprising multiple subcarriers (modulated OFDM tones) or a PAM signal equivalent to a single carrier of an OFDM waveform, e.g., for low-rate applications. However, the invention is compatible with many different LPHY modulation formats besides OFDM or PAM, including spread spectrum modulation formats that spread the signal over wide bandwidth, and LPI/LPD modulation formats that reduce or eliminate cyclic features of the waveform.

FIG. 46 depicts exemplary means for deploying the preferred embodiment in a TDD mesh network topology, in order to transmit data between a widely separated source and destination node. In this embodiment, the network nodes are first separated into uplink transmit nodes (downlink receive nodes), depicted with light interiors in FIG. 46, which transmit data over even time slots and receive data over odd time slots, and uplink receive nodes (downlink transmit nodes), depicted with dark interiors in FIG. 46, which receive data over even time slots and transmit data over odd time slots. Each transceiver is assumed to possess sufficient spatial channels to allow it to communicate simultaneously with at least two of its nearest neighbors over each time interval, i.e., to form two links between its nearest neighbors in the network, suppress any network or external interference impinging on the nodes, and close each individual link under channel propagation conditions observed by that node. At high spectral efficiency, e.g., in applications where the nodes must transmit data at high rate, each node (and especially internal nodes) may require as many as eight antennas, or four baseline transceivers, to support MIMO networking communication. Conversely, in applications where the nodes must transmit data at modest rates, e.g., VoIP communications, each transceiver could operate with as few as two diversity channels, or a single baseline transceiver, to support needs of the network.

Each link is given a unique link address (LA), defined by the transmit node address (TNA) and receive node address (RNA), i.e., the node address (NA) of the nodes originating and terminating that link, and the channel rank of that particular link if a true multirank MIMO link exists and is exploited by those nodes. In the sixteen-node network shown in FIG. 46, each LA is defined as a two-hex address comprising the (RNA,TNA) for that link, with a third hex number (equal to zero in every LA shown in the Figure) reserved to

capture the mode index (0=dominant rank) of that link. In FIG. 46, uplinks instantiated over odd time-slots and passing data from uplink transmit nodes to downlink receive nodes are depicted as solid arrows, and downlinks instantiated over even time slots and passing data from downlink transmit nodes to downlink receive nodes are depicted as dashed arrows. In this Figure, packets can be transported across the entire network in 7 time slots (3.5 TDD frames).

FIG. 47 describes the baseline symbol and timing structure for the invention, when transceivers are operated in an ad-hoc multinode network. In the preferred ad hoc embodiment, traffic data is transmitted over a preset numbers of LPHY symbols, e.g., determined at the beginning of data communications, which is larger than a minimum number of signals N_{embed} determined by the overhead structure set aside to implement receive adaptation algorithms at each transceiver, and which is a convenient number, e.g., power-of-two, allowing implementation of efficient data transformations in subsequent processing steps. However, the preferred ad hoc embodiment employs an overhead structure that allows implementation of alternate methods that do not require exact knowledge of the full packet length to implement receive adaptation algorithms, and that can allow transmission of packets of different length to different nodes in the network.

For certain levels of quality-of-service, the traffic packet may be followed by an acknowledgment packet sent from the receive node(s) back to the transmit node, comprising N_{embed} LPHY symbols. As in the TDD instantiation, the traffic and acknowledgement packets are separated by a guard time interval; however, the time interval between traffic and acknowledgement packets may be very short, e.g., on the order of the Short Interframe Space (SIFS) in 802.11 communications.

FIG. 48 depicts exemplary means for deploying the invention in an ad hoc mesh network topology. In this network, any node can communicate with any other node in its field of view, allowing the source node to simultaneously transmit packets to any available node in the network. In FIG. 48, for example, the source node transmits packets to five separate intermediate (relay) receive nodes over a first traffic time slot, and directs those nodes to transmit packets directly to the destination node over a subsequent traffic time slot. In the preferred ad hoc embodiment, each of the relay nodes receive independent data, e.g., one of five subsets of data, from the source nodes, similar to the approach employed in the TDD embodiment. However, the invention supports an additional macrodiverse mode in which the source node transmits identical traffic data to each intermediate node. In this case, the intermediate nodes will form a macrodiverse transmitter that can exploit the full network transfer function between the source node and intermediate nodes during the first traffic time slot, and the full network transfer function between the relay nodes and the destination node over the second traffic time slot.

FIG. 49 describes multiport PHY transmit operations performed at transceivers using the invention; and these are described in detail below. In order to minimize complexity of the Figure, operations are shown for a single-carrier LPHY modulation format, e.g., a PAM format employing a cyclic prefix as shown in FIG. 45 and FIG. 47, or for a single subcarrier of an OFDM LPHY. In the latter case, all operations are replicated across subcarriers, with possible exception of subcarriers that may be reserved for synchronization purposes or for compatibility with existing wireless air interfaces, e.g., 802.11ag, and additional variations that may be introduced to increase security of the network.

On the traffic path, data bits intended for each of m_{port} receive node are first encoded into N_{data} complex traffic data symbols, e.g., complex QPSK or QAM symbols, using conventional encoder technology. These symbols are then multiplexed onto the upper N_{data} input bins of an efficient orthogonal transform operator such as a fast Hadamard transform (FHT), such that at least N_{embed} bins of the transformation are not modulated by data during the subsequent transform operation. On the overhead or "pilot" path, at least one of N_{embed} bins is modulated. This bin location is chosen based on the node address of the transmit node, and a network-wide (e.g., time-of-day based) Transmission Security (TRANSEC) operation known to each node in the network, e.g., by modulo- N_{embed} adding the TNA to a common TRANSEC word, such that each node is modulating a unique bin during any given traffic or acknowledgement time slot. Each port of modulated traffic and pilot symbols are then passed through the fast orthogonal transformation, yielding N_{FHT} transformed output symbols. Each port of transformed output symbols are then multiplied by a second, pseudorandom constant modulus TRANSEC receive code based on the node address of the receive node that the transmit node is attempting to communicate with over that port and time slot, and other information known only to the network users. The resultant symbols are then multiplied by the $m_{port} \times M_{ant}$ transmit diversity weights employed at the transmitter, where M_{ant} is the number of antennas employed at the transmitter. If those weights are determined adaptively, e.g., using knowledge of reciprocity of the communication channel, this data is further multiplied by a set of transmit-receive compensation weights that enforce reciprocity between the transmit and receive channels at the node. These symbols are then passed through the LPHY symbol modulator (in combination with symbols corresponding to other subcarriers if the transceiver employs an OFDM LPHY), and onto the subsequent DAC, upconversion, power amplification, and RF transmission operations.

FIG. 50 describes multiport PHY receive operations performed at transceivers using the invention; and these are described in detail below. In order to minimize complexity of the Figure, operations are shown for a single-carrier LPHY modulation format, e.g., a PAM format employing a cyclic prefix as shown in FIG. 45 and FIG. 47, or for a single subcarrier of an OFDM LPHY. In the latter case, all operations are replicated across subcarriers, with possible exception of subcarriers that may be reserved for synchronization purposes or for compatibility with existing wireless air interfaces, e.g., 802.11ag, and additional variations that may be introduced to increase security of the network.

After RF reception, downconversion, and ADC operations on M_{ant} spatial or polarization diverse antennas, data received at each antenna is passed through an LPHY demodulator that converts that data to $N_{FHT} \times M_{ant}$ complex matrix representation (M_{ant} columns of $N_{FHT} \times 1$ complex data), on each subcarrier if the transceiver is employing an OFDM LPHY. Each $N_{FHT} \times 1$ complex data vector is then multiplied by the conjugate of the TRANSEC receive code for that node, which removes that TRANSEC receive code added at the transmitter for that port (and only for ports that were intended to pass data to that receive node). This data is then passed through the inverse of the orthogonal transformation employed at the transmitter, e.g., an inverse FHT, and separated into the lower N_{embed} output bins (an $N_{embed} \times M_{ant}$ complex pilot data matrix) corresponding to the pilot signal(s) employed at each transmit node attempting to communicate with that receive node, and N_{data} output bins (an $N_{data} \times M_{ant}$ complex traffic data matrix) corresponding to the traffic data transmitted to

the receive node, as well as interference generated by other nodes in the network or external emitters.

On the pilot path, the $N_{embed} \times M_{ant}$ complex pilot data matrix is then passed to an adaptation algorithm that detects bins modulated by the transmitters attempting to communicate with the receiver; identifies those transmitters based on the detected bins and the TRANSEC transmit code algorithm employed in the network, determines quality of the received pilot symbols and (by extension) traffic data, and develops combining weights that can extract the traffic data from the $N_{data} \times M_{ant}$ complex traffic data matrix at the maximum signal-to-interference-and-noise ratio (max-SINR) achievable by the transceiver. On the training path, these combiner weights are then applied to the traffic data matrix, and the extracted data is then passed to a traffic decoder that decodes the traffic data back into bits and performs additional operations employed by the communication link, e.g., bit-level data decryption and error detection operations.

In the preferred TDD and ad hoc embodiments, each transmitter uses an orthogonal transformation of the same length during its transmit operation, generating packets of the same time duration as well. However, in some alternate embodiments different transmitters may transmit signals with different numbers of traffic data symbols. In this case, if an appropriate orthogonal transformation is employed at the transmitters, e.g., a radix-2 FHT, and the pilot symbols are restricted to an appropriate subset of input bins in that transformation, e.g., the first $N_{embed} = 2P$ bins of an FHT, then the first N_{embed} symbols (or a multiple of the first N_{embed} symbols) can be used in the receive adaptation algorithm. This can allow the invention to be used in fully ad hoc networks where nodes can transmit packets of arbitrary length. However, receive combiner weights obtained through this process may exhibit misadjustment relative to optimal weights for the traffic data, as the pilot symbols may not experience the full processing gain of the FHT.

FIG. 51 describes multiport PHY receive adaptation operations performed in the primary embodiment of the invention; and these are described in detail below. On each subcarrier, the $N_{embed} \times M_{ant}$ complex pilot data matrix is first passed to a whitening operation such as a modified Gram-Schmidt orthogonalization (MGSO) or other QR decomposition (QRD) that separates the pilot data X into an $N_{embed} \times M_{ant}$ whitened data set satisfying $Q^H Q = I$, and an $M_{ant} \times M_{ant}$ static vector R that captures the autocorrelation of X , e.g., the Cholesky decomposition of $X^H X$. The Q matrix is then analyzed (across multiple subcarriers for OFDM LPHY's) to detect all of the modulated pilot bins. This information is used to unambiguously determine the TNA of each node attempting to communicate with the receiver. Once this determination has been made, the link SINR, whitened linear combiner weights, and subsequent unwhitened combiner weights are computed for each transmitted signal (and subcarrier for OFDM LPHY's).

FIG. 52 describes receive packet detection, address association, and link SINR estimation performed in the primary embodiment of the invention; and these are described in detail below. The adaptation algorithms are uncalibrated, i.e., they do not exploit knowledge of the shaping, polarization, or physical placement of antennas used by the transceiver, and can be used to instantiate arbitrary network topologies, including point-to-point links, star networks, ring networks, or full mesh networks. When deployed in point-to-point links, successive iterations of the transmit and receive adaptation algorithm causes each transceiver to adapt its multiport combiner and distribution weights to the eigenmodes (left and right eigenvectors) of their MIMO internode channel

response, typically in 2-to-4 TDD frames (5-10 ms). The resultant fully adaptive link can approach the Shannon capacity of the MIMO communication channel, regardless of the rank or distribution of the eigenvalues of that channel.

FIG. 53 describes transmit adaptation algorithms performed in the primary embodiment of the invention. The baseline system employs network-wide collaborative link optimization rules referred to in [2] as locally enabled global optimization (LEGO), which optimize network-wide measures of network quality using retrodirective transmit weight adaptation and local (link layer) power management instructions. The approach exploits the ability to form nulls during transmit operations to intelligently manage interference presented to other nodes transmitting or communicating in the same frequency channel. This includes other nodes operating on the same network, and nodes operating on disconnected networks, without the need for higher-layer cross-communication between interference nodes or networks.

Also described below is also describe an alternate embodiment in which the adaptive receive combining weights are adapted to completely separate intended links with maximum signal-to-interference ratio rather than SIR, i.e., to direct "hard nulls" at each transmitter attempting to communicate with the node during the receive time slot so that interlink interference is completely removed during the receive operation, and to direct corresponding hard nulls back at the intended links during subsequent transmission opportunities. Although this algorithm does introduce some misadjustment (particularly during receive operations), it can improve the stability of the LEGO transmit adaptation algorithms in highly dynamic communication networks.

The resultant fully-adaptive system provides a much more versatile solution than competing multilayer receive-adaptive techniques such as BLAST and STP, which only approaches the Shannon capacity in full-rank (i.e., high multipath) channels. In particular, the fully-adaptive system can use its diversity degrees of freedom (DoF's) to provide substantive transmit gain in low-rank channels found in airborne and rural conditions. The fully-adaptive system can also use these DoF's to excise interference impinging on either end of the link due to other nodes operating in the same frequency band, hostile jamming of the link. In addition, the fully adaptive system provides an automatic power control mechanism (LEGO Algorithm) that can be used to maximize capacity (high throughput applications) or minimize transmit power (LPD applications), depending on the requirements of the system at any point during a mission. These attributes greatly increase the flexibility, range of operation, and application of the approach.

Moreover, the weight adaptation procedure is decoupled from operations used to encode data onto each transmitter port (channel eigenmode) and decode data taken from the corresponding receive port at the other side of the link, without expensive multilayer decoding, encoding, and cancellation procedures employed in receive-adaptive methods. This greatly reduces the complexity and reaction time of the transceiver, by allowing the transmit/receive weights to quickly adjust to highly dynamic environments encountered in military use scenarios.

The fully adaptive point-to-point link seamlessly extends to collaborative multimode networks. In particular, each transceiver employs the same multiport linear processor structure to form simultaneous links to multiple neighbors in multimode networks. The resultant MIMO networking strategy (first disclosed in [1]) exploits the additional inherent route diversity of star, ring, or mesh networks, to provide the benefits of MIMO processing in a network setting.

The MIMO network illustrated in FIG. 44 displays a minimalist-model, four-node, network that is operating in the presence of a jammer. In this figure, nodes employ the multipoint linear receive and transmit operations discussed above, to establish multiple simultaneous links with their neighbors. In the presence of point-to-point link diversity (high-rank MIMO channel response between communicators), e.g., polarization or multipath diversity, nodes may establish multiple connections between their neighbors. In the absence of such link diversity, or if desired by the network, the nodes may alternately establish simultaneous connections with their neighbors. These connections can be used to directly source data to these neighbors, or transmit data through these neighbors to more distant destination nodes. In the example shown in FIG. 46, this strategy doubles the amount of data transportable to or from any node in the network—even if no link diversity exists on any of the internode channels (rank-1 internode channel response). More generally, this strategy allows the capacity of each node to grow linearly with the number of antennas at that node, even in nondiverse communication scenarios such as airborne systems, desert combat scenarios, and ship-to-ship/shore naval communication networks, while maintaining the ability to provide superlinear throughput increases at low power levels. Moreover, this strategy allows unused DoFs to be used for other purposes, including excision of strong jamming likely to be encountered in battlefield conditions.

The symbol and timing structure for the baseline Phase I Lower-PHY (LPHY) is illustrated in FIG. 45. In order to simplify the Phase I lower PHY and requisite RF transceiver hardware, the method and system can employ a linear PAM LPHY with a 250 kHz symbol rate (4 μ s lower PHY symbol period). In FIG. 45, the PAM symbol shape is assumed to be a 4 μ s rectangle comprising a 3.2 μ s base pulse, used during demodulation operations, and an 800 ns cyclic prefix that is discarded during demodulation operations. The resulting LPHY modem can be consequently be modeled as a single subcarrier of an 802.11g-like OFDM symbol, allowing the radio to be easily scaled to much wider bandwidths in later program phases. In addition, many other linear-PAM LPHY's are also consistent, including spread spectrum modulation formats that spread the signal over wide bandwidth, and LPI/LPD modulation formats that reduce or eliminate cyclic features of the waveform. The nominal ADC and DAC rates for the transceivers can be 5 Msps, well within the capability of low SWaP/cost systems.

The multipoint PHY transmit/receive operations are illustrated in FIG. 47. At the transmitter, a frame of data intended for each transmit port is encoded to QAM using forward error correcting (FEC) encoding, organized into blocks of 240 QAM symbols, multiplexed with a transmit pilot that is unique to each node or transmit node address (TNA) in the network, and spread over the frame and PHY subcarriers using a fast Hadamard transform (FHT). The transmit pilot is designed to allow implementation of computationally efficient adaptive detection and reception algorithms at the intended receiver(s) in the network, without the need for prior knowledge of that pilot at the receiver. Sixteen Hadamard bins (software provisionable at each node based on the number of antennas employed by that node) set aside for pilot transmission add only 6.25% ($1/256$) overhead to the communications network, allowing effective node detection, receive adaptation, and node data extraction in one TDD slot (1.25 ms), with as many as eight antennas per transceiver. However, the number of pilot bins can be easily modified in software, or even provisioned on a dynamic basis, e.g., to improve the performance of receive adaptation algorithms when more

complex transceivers enter the network, or to increase link throughput as those radios leave the environment.

After the FHT, the combined information and transmit pilot are modulated by a pseudorandom receive TRANSEC pilot, unique to the intended receiver or receive node address (RNA) in the network. If needed, the TRANSEC pilot is also frequency compensated to remove Doppler shift anticipated at the intended receiver, allowing the link to operate effectively velocities much higher than those anticipated in the Phase I demo. The TRANSEC output data is then passed through a linear distribution network (transmit beamformer) that can place beams in the direction of up to M_{ANT} targeted receive nodes for a transceiver with M_{ANT} transmit antennas. Alternately, the transmit beamformer can place up to $20 \log_{10}(M_{ANT})$ energy in the direction of a single targeted receive node, allowing effective data transfer at a much lower power and consequent intercept footprint.

At the receiver, the processor strips off the receive TRANSEC pilot, simultaneously scrambling signals from any unauthorized user, and revealing the unique transmit pilots from each authorized user attempting to contact the receiver during that receive frame. The resultant data is passed to a computationally efficient, Modified Graham-Schmidt Orthogonalization (MGOS) based joint detection and signal extraction processor, which simultaneously detects each authorized pilot in the environment, and develops multipoint receive combiner weights that excise interference in the communication channel (including self-interference from other authorized users). These weights are dewhitened and applied to the information-bearing signal after the inverse FHT (IFHT), and used to adapt retrodirective distribution weights used during subsequent transmit operations. The combined receive TRANSEC and IFHT spreading operations guarantees that the receive algorithm will apply equal interference rejection to the pilot and data symbols, for any interferer impinging on a node during its receive time slot.

The baseline system employs network-wide collaborative link optimization rules referred to as locally enabled global optimization (LEGO), which optimize network-wide measures of network quality using retrodirective transmit weight adaptation and local (link layer) power management instructions. The approach exploits the ability to form nulls during transmit operations to intelligently manage interference presented to other nodes transmitting or communicating in the same frequency channel. This includes other nodes operating on the same network, and nodes operating on disconnected networks, without the need for higher-layer cross-communication between interference nodes or networks. This capability, originally developed for optimization of point-to-multipoint cellular networks in wireless local-loop (AT&T Wireless Project Angel) and wireless metropolitan area networks (IEEE 802.16), cannot be employed in systems that do not perform transmit adaptation. This method and system can extend the LEGO approach to game theoretic methods that may perform this network optimization over a wider range of applications, networks, and optimization criteria.

The complexity of the method and system are shown in FIGS. 49-53. System complexity can be divided into two components: an FPGA coreware component, comprising regular operations that are easily implemented using field-programmable gate arrays or ASIC's, and a DSP software component. FPGA coreware operations can include the lower PHY modem, transmit and receive beamforming (linear distribution and combining operations), transmit/receive TRANSEC operations, and FHT/IFHT operations. The DSP software operations can include the MGSO operation, node

discovery, and weight dewhitening operation. In both such cases, complexity is calculated in DSP clock cycles per second, for a hypothetical DSP hardware element that can compute a simultaneous real add and a real multiply in 4/3 clock cycle (1 clock cycle with 33% derating for memory transfer operations). Complexity is further divided by the number of transceiver ports (simultaneous transmit and receive channels), to provide a measure of the DSP cost of each link used accessed by the transceiver.

The overall complexity of the DSP component of transceiver operations (adaptive algorithm) is less than 200 kcps for the phase 1 system, or well within the capabilities of a low-cost DSP components. Similarly, the overall complexity of the FPGA component of transceiver operations is less than 30 Mcps, which easily fits on the commercially available FPGA and in fact can be implemented using moderate cost DSP components.

Assuming low power rate-1 BPSK QAM encoding on each link, the resultant system can provide a PHY throughput (data rate into the MAC layer) of 96 kbps (192 kbps full duplex), or establish 12 simultaneous 48 kbps full-duplex data links (576 kbps network transfer rate) between each node-pair in a four-node ring network, using a single two-channel transceiver at each node in that network and a simple 250 kcps PAM lower PHY. Assuming an active bandwidth of 250 kHz, this corresponds to a spectral network efficiency of over 2 bps/Hz. This efficiency and bandwidth scales linearly with the number bits/symbol employed in the QAM encoding operation. Because the ring network establishes a counterrotating ring that can transfer data over two simultaneous routes, the reliability of the collaborative network increases dramatically—by over 2 nines if each node in the network as a two nines reliability!

DETAILED EMBODIMENT DESCRIPTION

Parameter Definitions, Equations and Glossary
Network Parameters:

Network parameters:	Default	Index #
M_{NA} = Number of node addresses (active nodes) in the network	Variable	(1.1.01)
M_{LA} = Number of link addresses (active links) in the network	Variable	(1.1.02)
M_{PA} = Number of network-layer port addresses in the network	$M_{NA}(M_{NA} - 1)$	(1.1.03)
M_{RA} = Number of network-layer route addresses in the network	Variable	(1.1.04)
Network addresses:	Range	
m_{NA} = Node address (NA)	1: M_{NA}	(1.1.05)
m_{TNA} = Transmit node address (TNA)	1: M_{NA}	(1.1.06)
m_{RNA} = Receive node address (RNA)	1: M_{NA}	(1.1.07)
m_{SNA} = Source node address (SNA)	1: M_{NA}	(1.1.08)
m_{DNA} = Destination node address (DNA)	1: M_{NA}	(1.1.09)
m_{LA} = Link address (LA)	1: M_{LA}	(1.1.10)
m_{RLA} = Return link address (RLA)	1: M_{LA}	(1.1.11)
m_{PA} = Network-layer port address (PA)	1: M_{PA}	(1.1.12)
m_{RA} = Network-layer route address (RA)	1: M_{PA}	(1.1.13)
Network mappings:		
$\mu_{NA}(m_{LA}) = [m_{TNA} m_{RNA}]$ connected by link m_{LA} .		(1.1.14)
Alternate notation $\mu_{TNA}(m_{LA}), \mu_{RNA}(m_{LA})$ can also be used to refer to individual elements of μ_{NA} .		
TDD subframe used by link m_{LA} $\mu_{TNA}(m_{LA})$ transmits over		(1.1.15)
$\mu_{TDD}(m_{LA})$ = TDD subframe		
$\mu_{TDD}(m_{LA})$		

-continued

$\mu_{LA}(m_{TNA}, m_{RNA})$ = Address of link connecting TNA m_{TNA} to RNA m_{RNA} (0 if no LA)		(1.1.16)
$\mu_{NA}(m_{LA}) = [m_{TNA} m_{RNA}] \Rightarrow \mu_{LA}(m_{RNA}, m_{TNA}) = m_{LA}$		(1.1.17)
$\mu_{RLA}(m_{LA})$ = Return link address (RLA) for link m_{LA} :		
$\mu_{NA}(m_{LA}) = [m_{TNA} m_{RNA}] \Rightarrow \mu_{NA}(\mu_{RLA}(m_{LA})) = [m_{RNA} m_{TNA}]$		
$k_{TNA}(m_{frame})$ = Adapt bin used by TNA m_{TNA} (same for all Links emanating from m_{TNA}) over frame m_{frame} . Same for all links emanating from m_{TNA} .		
Address-independent datalink parameters:	Default	
N_{codec} = Maximum data encoding rate (can be noninteger)	8	(1.2.01)
N_{FHT} = Hadamard bins per frame	256	(1.2.02)
N_{embed} = Hadamard bins reserved for adaptation ($\leq N_{FHT}$)	16	(1.2.04)
M_{embed} = Modulated bins per port ($\leq N_{embed} N_{port}$)	16	(1.2.05)
N_{data} = Hadamard bins reserved for data ($\leq N_{FHT} - N_{embed}$)	240	(1.2.03)
M_{data} = Hadamard bins modulated by data ($\leq N_{data}$)	240	(1.2.03a)
N_{sub} = Subcarriers per OFDM symbol	64	(1.2.06)
N_{sub} = Modulated subcarriers per OFDM symbol	52	(1.2.07)
M_{QAM} = QAM data symbols per physical data frame	12,480	(1.2.08)
N_{OFDM} = OFDM symbols per physical data frame	312	(1.2.09)
M_{OFDM} = Modulated OFDM symbols per PPDU	256	(1.2.10)
N_{TDD} = Data frames (TDD subframes) per TDD frame	2	(1.2.11)
$T_{FFT}(\mu s)$ = Duration of OFDM FFT in microseconds (μs)	3.2 μs	(1.2.12)
$T_{symbol}(\mu s)$ = Duration of OFDM symbol in μs	4 μs	(1.2.13)
$T_{prefix}(\mu s)$ = Duration of OFDM cyclic prefix (guard interval) in μs	0.8 μs	(1.2.14)
$T_{PPDU}(\mu s)$ = Duration of data PPDU in μs	1,024 μs	(1.2.15)
$T_{frame}(\mu s)$ = Duration of data frame in μs	1,250 μs	(1.2.16)
$T_{TxRx}(\mu s)$ = Duration of TxRx turnaround time in μs	2 μs	(1.2.17)
$T_{IFS}(\mu s)$ = Duration of interframe space (guard time interval) in μs , inclusive of T_{TxRx}	226 μs	(1.2.18)
$T_{TDD}(\mu s)$ = Duration of OFDM cyclic prefix (guard interval) μs	2,500 μs	(1.2.19)
$f_{sub}(\text{MHz})$ = Subcarrier spacing in MHz (OFDM LPHY)	0.3125 MHz	(1.2.20)
$W_{active}(\text{MHz})$ = Active bandwidth of signal in MHz	16.25 MHz	(1.2.21)
Node-address dependent datalink parameters:	Default	
N_{ant} = Antennas available at node	Variable	(1.2.22)
M_{ant} = Antennas used at node ($\leq N_{ant}$)	Variable	(1.2.23)
N_{port} = Physical ports supportable at node ($\leq N_{ant}$)	Variable	(1.2.24)
M_{port} = Physical ports used at node ($\leq N_{port}$)	Variable	(1.2.25)
Link-address dependent datalink parameters:	Default	
M_{codec} = Codec rate employed on link (0 \Rightarrow no data transported)	Variable	(1.2.26)
M_{bit} = Bits/frame Tx'd over the link ($M_{bit} * M_{codec}$), 0 \Rightarrow none	Variable	(1.2.27)
Node-address independent datalink indices:	Range	
n_{FHT} = Physical FHT input bin index	1: N_{FHT}	(1.2.28)
m_{FHT} = Logical FHT input bin index	1: M_{FHT}	(1.2.29)
m_{data} = Logical data bin index	1: M_{data}	(1.2.30)
M_{embed} = Logical adaptation bin index	1: M_{embed}	(1.2.31)
n_{sub} = Physical subcarrier index	1: N_{sub}	(1.2.32)
m_{sub} = Logical subcarrier index	1: M_{sub}	(1.2.33)
m_{QAM} = Logical QAM data index	1: M_{QAM}	(1.2.34)
n_{OFDM} = Physical OFDM symbol index	1: N_{OFDM}	(1.2.35)
m_{OFDM} = Logical OFDM symbol index	1: M_{OFDM}	(1.2.36)

-continued

n_{TDD} = TDD subframe index (TDD instantiations)	1: N_{TDD}	(1.2.37)
n_{frame} = Data frame index (ignores TDD framing)	—	(1.2.38)
Node-address dependent datalink indices:		
	Range	
n_{ant} = Physical antenna index	1: N_{ant}	(1.2.39)
m_{ant} = Logical antenna index	1: M_{ant}	(1.2.40)
n_{port} = Physical port index	1: N_{port}	(1.2.41)
m_{port} = Logical port index	1: M_{port}	(1.2.42)
m_{frame} = Logical frame index, shared by consecutive node receive and transmit frames	≥ 0	(1.2.43)
Link-address dependent datalink indices:		
	Range	
m_{bit} = Logical data bit (codec input) index	1: M_{bit}	(1.2.44)

-continued

Datalink mappings:		
$v_{embed}(m_{embed})$ = Physical Hadamard bin modulated by logical transmit pilot bin m_{embed}	(1.2.45)	5
$v_{data}(m_{data})$ = Physical Hadamard bin modulated by logical data bin m_{data}	(1.2.46)	
$v_{sub}(m_{sub})$ = Physical subcarrier modulated by logical subcarrier m_{sub}	(1.2.47)	
$f_{sub}(m_{sub})$ = Physical baseband link frequency of logical subcarrier m_{sub}	(1.2.48)	10
$v_{frame}(m_{frame}, m_{TDD})$ = Physical frame carrying PPDU with frame index m_{frame} , TDD subframe index m_{frame} .	(1.2.49)	
$\mu_{port}(m_{LA})$ = Logical transmit or receive port (as appropriate) providing data for link address m_{LA} . By convention, the same logical port is used on the return path, $m_{port}(m_{LA}) = v_{port}(m_{RLA})$,	(1.2.50)	
$\mu_{RLA} = \mu_{RLA}(m_{LA})$.		15
$m_{LA}(m_{port})$ = LA serviced by port m_{port} . Inverse of $\mu_{port}(m_{LA})$.	(1.2.51)	

Data and Parameter Arrays:

Dimensions

Transmit data arrays:

$$B_{TNA}(m_{frame}) = \text{Transmitted bits transmitted, frame } m_{frame}$$

$$B_{TNA}(m_{frame}) = [b_{TNA}(1; m_{frame}) \dots b_{TNA}(M_{port}; m_{frame})]$$

$$b_{TNA}(m_{port}; m_{frame}) = \text{bits Tx'd from node } m_{TNA} \text{ over port } m_{port}$$

$$m_{port} = \mu_{port}(m_{LA}), \text{ where } \mu_{TNA}(m_{LA}) = m_{TNA}$$

$$M_{bit} \times M_{port} \quad (1.3.1)$$

$$Q_{TNA}(m_{sub}, m_{frame}) = \text{QAM data transmitted, subcarrier } m_{sub}, \text{ frame } m_{frame}$$

$$Q_{TNA}(m_{sub}, m_{frame}) = \begin{bmatrix} q_{TNA}^H(1; m_{sub}, m_{frame}) \\ \vdots \\ q_{TNA}^H(M_{data}; m_{sub}, m_{frame}) \end{bmatrix}$$

$$q_{TNA}(M_{data}; m_{sub}, m_{frame}) = \text{QAM data Tx'd on data bin } m_{data}$$

$$M_{data} \times M_{port} \quad (1.3.2)$$

$$D_{TNA}(m_{sub}, m_{frame}) = \text{FHT input data, subcarrier } m_{sub}, \text{ frame } m_{frame}$$

$$D_{TNA}(m_{sub}, m_{frame}) = \begin{bmatrix} d_{TNA}^H(1; m_{sub}, m_{frame}) \\ \vdots \\ d_{TNA}^H(M_{FHT}; m_{sub}, m_{frame}) \end{bmatrix}$$

$$M_{OFDM} \times M_{port} \quad (1.3.3)$$

$$C_{TNA}(m_{sub}, m_{frame}) = \text{TRANSEC-scrambled FHT output data, subcarrier } m_{sub}, \text{ frame } m_{frame}$$

$$C_{TNA}(m_{sub}, m_{frame}) = \begin{bmatrix} c_{TNA}^H(1; m_{sub}, m_{frame}) \\ \vdots \\ c_{TNA}^H(M_{OFDM}; m_{sub}, m_{frame}) \end{bmatrix}$$

$$M_{OFDM} \times M_{port} \quad (1.3.4)$$

$$S_{TNA}(m_{sub}, m_{frame}) = \text{OFDM modulator input data, subcarrier } m_{sub}, \text{ frame } m_{frame}$$

$$S_{TNA}(m_{sub}, m_{frame}) = \begin{bmatrix} s_{TNA}^H(1; m_{sub}, m_{frame}) \\ \vdots \\ s_{TNA}^H(M_{OFDM}; m_{sub}, m_{frame}) \end{bmatrix}$$

$$M_{OFDM} \times M_{ant} \quad (1.3.5)$$

Transmit parameter arrays:

$$R_{RNA}(m_{sub}, m_{frame}) = \text{RNA TRANSEC code, subcarrier } m_{sub}, \text{ frame } m_{frame}$$

$$\text{row } m_{port} = \text{receive code for node } m_{RNA} = \mu_{RNA}(\mu_{LA}(m_{port}))$$

$$r_{RNA}(m_{port}; m_{sub}, m_{frame}) = r(m_{sub}, m_{frame}; \mu_{RNA}(\mu_{LA}(m_{port})))$$

$$M_{OFDM} \times M_{port} \quad (1.3.6)$$

$$G_{TNA}(m_{sub}, m_{frame}) = \text{TNA distribution weights, subcarrier } m_{sub}, \text{ frame } m_{frame}$$

$$M_{ant} \times M_{port} \quad (1.3.7)$$

$$\gamma_{RLA}(m_{frame}) = \text{Target return-link SINR's, frame } m_{frame}$$

$$1 \times M_{port} \quad (1.3.8)$$

-continued

Data and Parameter Arrays:		Dimensions
$h_{TX}(m_{sub})$ = Transmit subcarrier mask (OFDM LPHY),		$M_{ant} \times 1$ (1.3.9)
$h_{TX}(m_{sub}) = \left(\frac{\pi f_{sub}(m_{sub}) \Gamma_{DAC}}{\sin(\pi f_{sub}(m_{sub}) \Gamma_{DAC})} \right) h_{TRC}(m_{sub})$		
where $\Gamma_{DAC} = 1/f_{DAC}$ is the (node-specific) DAC output sample period.		
$h_{TRC}(m_{sub})$ = Transmit-recieve compensation weights, equalizes path differences between the RF switch and the DAC (transmit path) and ADC (receive path) at each node in the network. Computed during scheduled Transmit/receive compensation events.		$M_{ant} \times 1$ (1.3.10)
Receive data arrays:		
$X_{RNA}(m_{sub}, m_{frame})$ = OFDM demod output data, subcarrier m_{sub} , frame m_{frame} .		$M_{OFDM} \times M_{ant}$ (1.3.11)
$Y_{RNA}(m_{sub}, m_{frame})$ = TRANSEC-descrambled FHT output data, subcarrier m_{sub} , frame m_{frame} .		$M_{FHT} \times M_{ant}$ (1.3.12)
$Y_{RNA}(m_{sub}, m_{frame}) = \begin{bmatrix} y_{RNA}^H(1; m_{sub}, m_{frame}) \\ \vdots \\ y_{RNA}^H(M_{OFDM}; m_{sub}, m_{frame}) \end{bmatrix}$		
$P_{RNA}(m_{sub}, m_{frame})$ = Deembedded pilot data, subcarrier m_{sub} , frame m_{frame} .		$M_{embed} \times M_{ant}$ (1.3.13)
$P_{RNA}(m_{sub}, m_{frame}) = \begin{bmatrix} p_{RNA}^H(1; m_{sub}, m_{frame}) \\ \vdots \\ p_{RNA}^H(M_{embed}; m_{sub}, m_{frame}) \end{bmatrix}$		
$Z_{RNA}(m_{sub}, m_{frame})$ = Deembedded QAM data, subcarrier m_{sub} , frame m_{frame} .		$M_{data} \times M_{ant}$ (1.3.14)
$Q_{RNA}(m_{sub}, m_{frame})$ = Demodulated QAM data, subcarrier m_{sub} , frame m_{frame} .		$M_{data} \times M_{port}$ (1.3.15)
$B_{RNA}(m_{frame})$ = Decoded bits, frame m_{frame} .		$M_{bit} \times M_{port}$ (1.3.16)
Receive parameter arrays:		
$r_{RNA}(m_{sub}, m_{frame})$ = NA TRANSEC code, subcarrier m_{sub} , frame m_{frame} . Used at node m_{RNA} during receive operations, and at nodes attempting to communicate with node m_{RNA} during their transmit operations		$M_{OFDM} \times 1$ (1.3.17)
$W_{RNA}(m_{sub}, m_{frame})$ = Rx combiner weights, subcarrier m_{sub} , frame m_{frame} .		$M_{ant} \times M_{port}$ (1.3.18)
$A_{Rx}(m_{sub}, m_{frame})$ = Rx spatial signature estimates, subcarrier m_{sub} , frame m_{frame} .		$M_{ant} \times M_{port}$ (1.3.19)
$\gamma_{LA}(m_{sub}, m_{frame})$ = Estimated link SINR's, subcarrier m_{sub} , frame m_{frame} .		$1 \times M_{port}$ (1.3.20)
Conceptual parameter arrays (not generated, but referred to in operations):		
$t_{INA}(m_{frame})$ = [Sparse] NA transmit pilot, subcarrier m_{sub} , frame m_{frame} .		$M_{embed} \times 1$ (1.3.21)
$t_{INA}(m_{frame}) = \sqrt{M_{embed}} e^{j k_{INA}(m_{frame})}$		
C_{FHT} = Unitary Walsh transformation matrix		$M_{FHT} \times M_{FHT}$ (1.3.22)
S_{data} = Shift matrix, maps logical data bins to FHT input bins		$M_{FHT} \times M_{data}$ (1.3.23)
S_{pilot} = Shift matrix, maps logical pilot bins to FHT input		$M_{FHT} \times M_{pilot}$ (1.3.24)
S_{FHT} = Shift matrix, maps logical bins to physical FHT input bins,		$M_{FHT} \times M_{FHT}$ (1.3.25)
$S_{FHT} = [S_{pilot} S_{data}]$		

Upper-PHY Signal Processing Operations:
Transmit Operations

Starting with the transmit bits $B_{TNA}(m_{frame})$ to be transmitted over logical subcarrier m_{sub} and logical frame m_{frame} , perform the following operations.

Step TP1: Separately encode each row of transmitted bits $B_{TNA}(m_{frame})$ into QAM symbols, and map to subcarriers to form QAM transmit data $Q_{TNA}(m_{sub}, m_{frame})$. The bit-to-QAM encoder is not specified here. However, the default encoder will be operations cited in the 802.11a standards specification.

Step TP2: Embed the transmit pilot, and map pilot & data to FHT input bins

$$D_{TNA}(m_{sub}, m_{frame}) = S_{FHT} \begin{bmatrix} t_{TNA}(m_{frame}) \mathbf{1}_{M_{port}}^T \\ Q_{TNA}(m_{sub}, m_{frame}) \end{bmatrix} \quad (2.1.1)$$

$$= S_{pilot}(t_{TNA}(m_{frame}) \mathbf{1}_{M_{port}}^T) + S_{data} Q_{Tx}(m_{sub}, m_{frame}) \quad (2.1.2)$$

Step TP3: Embed receive pilot for RNA's communicating with the node.

$$C_{TNA}(m_{sub}, m_{frame}) = R_{RNA}(m_{sub}, m_{frame}) * (C_{FHT} D_{TNA}(m_{sub}, m_{frame})) \quad (2.1.3)$$

Step TP4: Distribute the embedded data over the output antennas.

$$S_{TNA}(m_{sub}, m_{frame}) = (\mathbf{1}_{M_{OFDM}} \mathbf{1}_{Tx}^T(m_{sub})) * (C_{TNA}(m_{sub}, m_{frame}) \bar{G}_{TNA}^T(m_{sub}, m_{frame})), \quad (2.1.4)$$

where “*” denotes the element-wise multiply operation, and $\mathbf{1}_m$ is the $M \times 1$ all-ones vector.

Two algorithms are specified here to adapt transmit distribution weights

$$\{G_{TNA}(m_{sub}, m_{frame})\},$$

A retrodirective max-SINR approach that sets $\{G_{TNA}(m_{sub}, m_{frame})\}$ proportional to the receive weights that maximize signal-to-interference-and-noise ratio (SINR) on the return path, and

A retrodirective max-SIR approach that sets $\{G_{TNA}(m_{sub}, m_{frame})\}$ proportional to the receive weights that maximize signal-to-interference ratio (SIR), i.e., that provide hard transmit nulls, on the return path.

The max-SIR approach is recommended for initialization of new links; the max-SINR approach is recommended for steady state operation and tracking. The max-SINR transmit weight adaptation algorithm is described in Section 3.2. The max-SIR transmit weight adaptation algorithm is described in Section 4.2.

Receive Processing Operations

Starting with the multiantenna data $X_{RNA}(m_{sub}, m_{frame})$ received and OFDM-demodulated over logical subcarrier m_{sub} and logical frame m_{frame} , perform the following operations.

Step RP1: Remove the receive pilot, and inverse-FHT descrambled data

$$Y_{RNA}(m_{sub}, m_{frame}) = \quad (2.2.1)$$

$$C_{FHT}^H((r_{RNA}(m_{sub}, m_{frame}) \mathbf{1}_{M_{ant}(RNA)}^T) * X_{RNA}(m_{sub}, m_{frame})) \quad (2.2.1)$$

Step RP2: Separate pilot & data components

$$P_{RNA}(m_{sub}, m_{frame}) = S_{pilot}^T Y_{RNA}(m_{sub}, m_{frame}) \quad (2.2.2)$$

$$X_{RNA}(m_{sub}, m_{frame}) = S_{data}^T Y_{RNA}(m_{sub}, m_{frame}) \quad (2.2.3)$$

Steps RA, Detect transmit pilots and estimate their SINR's $\gamma_{LA}(m_{sub}, m_{frame})$ (Sections 3.1, 4.1).

TA:

Compute combiner weights $\{W_{RNA}(m_{sub}, m_{frame})\}$ (Sections 3.1, 4.1).

Compute distribution weights $\{G_{TNA}(m_{sub}, m_{frame})\}$ to be used on the return path (Sections 3.2, 4.2).

Step RP3: Recover the QAM link data:

$$Q_{RNA}(m_{sub}, m_{frame}) = Z_{RNA}(m_{sub}, m_{frame}) W_{RNA}(m_{sub}, m_{frame}) \quad (2.2.4)$$

Two algorithms are specified here to adapt receive combiner weights $\{W_{RNA}(m_{sub}, m_{frame})\}$,

A retrodirective max-SINR approach that adapts $\{W_{RNA}(m_{sub}, m_{frame})\}$ to maximize signal-to-interference-and-noise ratio (SINR) of the received pilot data, and

A retrodirective max-SIR approach that adapts $\{W_{RNA}(m_{sub}, m_{frame})\}$ to maximize signal-to-interference ratio (SIR) of the received pilot data, i.e., that provide hard receive nulls to separate the signals of interest to the node.

The max-SIR approach is recommended for initialization of new links; the max-SINR approach is recommended for steady state operation and tracking. The max-SINR transmit weight adaptation algorithm is described in Section 3.2. The max-SIR transmit weight adaptation algorithm is described in Section 4.2.

Max-SINR Adaptation Algorithm

Adaptive Receive Algorithm

Starting with the multiantenna received and deembedded pilot data (referred to as $P_{RNA}(m_{sub})$ or P_{RNA} as appropriate to simplify arguments) received and OFDM-demodulated over logical subcarrier m_{sub} and logical frame m_{frame} , perform the following operations

Step RA1: Compute QRD of $P_{RNA}(m_{sub}, m_{frame})$

$$\{Q(m_{sub}), R(m_{sub})\} = \text{QRD}\{P_{RNA}(m_{sub}, m_{frame})\}, \quad (3.1.1)$$

such that

$$R(m_{sub}) = \text{chol}\{P_{RNA}^H(m_{sub}, m_{frame}) P_{RNA}(m_{sub}, m_{frame})\} \quad (3.1.2)$$

$$= \text{chol}\{P_{RNA}^H P_{RNA}(m_{sub}, m_{frame})\} \quad (3.1.3)$$

$$C(m_{sub}) = R^{-1}(m_{sub}) \quad (3.1.5)$$

$$Q(m_{sub}) = P_{RNA}(m_{sub}, m_{frame}) C(m_{sub}), \quad (Q^H(m_{sub}) Q(m_{sub}) = \mathbf{I}_{M_{ant}})$$

$$= \begin{bmatrix} q^H(1; m_{sub}) \\ \vdots \\ q^H(M_{embed}; m_{sub}) \end{bmatrix} \quad (3.1.6)$$

Step RA2: Detect candidate TNA transmit pilots and spatially whitened adaptation weights

$$\eta(m_{embed}; m_{sub}) = \|q(m_{embed}; m_{sub})\|^2 \quad (3.1.7)$$

$$\gamma(m_{embed}; m_{sub}) = \frac{\eta(m_{embed}, m_{sub})}{1 - \eta(m_{embed}, m_{sub})} \quad (3.1.8)$$

-continued

$$c_{det}(m_{embed}) = \frac{1}{M_{sub}} \sum_{m_{sub}=1}^{M_{sub}} \log_2(1 + \gamma(m_{embed}, m_{sub})) \quad (3.1.9)$$

$$\{m_{embed}(m)\}_{m=1}^{M_{det}} = \quad (3.1.10)$$

$$m_{embed}(m) \text{ satisfying } \begin{cases} c_{det}(m_{embed}(m)) \geq c_{thresh}, \\ \text{and} \\ c_{det}(m_{embed}(m)) \geq c_{det}(m_{embed}(m+1)) \end{cases}$$

$$u_{det}(m_{sub}) = \sqrt{M_{embed}} [q(m_{embed}(1); m_{sub}) \dots q(m_{embed}(m_{det}); m_{sub})] \quad (3.1.11)$$

$$u_{det}(m_{sub}) = [\eta(m_{embed}(1), m_{sub}) \dots \eta(m_{embed}(m_{det}), m_{sub})] \quad (3.1.12)$$

$$\gamma_{det}(m_{sub}) = [\gamma(m_{embed}(1), m_{sub}) \dots \gamma(m_{embed}(m_{det}), m_{sub})] \quad (3.1.13)$$

Step RA3: If spatial signature estimates $A_{port}(m_{sub})$ are available, where $A_{port}(m_{sub})$ is the import column of $A_{RNA}(m_{sub})$ (see Step RA6), associate detected transmit pilots with receive ports and link addresses.

$$u_{port}(m_{det}; m_{sub}) = C^H(m_{sub})a_{port}(m_{port}; m_{sub}) \quad (3.1.14)$$

$$\rho(m_{det}, m_{port}; m_{sub}) = \frac{|u_{det}^H(m_{det}; m_{sub})u_{port}(m_{port}; m_{sub})|^2}{M_{embed}\eta_{det}(m_{det}; m_{sub})\|u_{port}(m_{port}; m_{sub})\|^2} \leq 1 \quad (3.1.15)$$

$$c_{match}(m_{det}, m_{port}) = \quad (3.1.16)$$

$$\frac{1}{M_{sub}} \sum_{m_{sub}=1}^{M_{sub}} \log_2(1 + \gamma(m_{det}; m_{sub})\rho(m_{det}, m_{port}; m_{sub}))$$

$$\{m_{det}(m_{port})\}_{m_{port}=1}^{M_{port}} = \underset{m_{det}}{\operatorname{argmax}} \{c_{match}(m_{det}, m_{port})\} \quad (3.1.17)$$

Step RA4: Drop and add ports, based on the port matching statistic $c_{match}(m_{det}, m_{port})$.

$$\{m_{drop}\}_1^{M_{drop}} = \underset{m_{port}}{\operatorname{argmax}} \left\{ \max_{m_{det}} \{c_{match}(m_{det}, m_{port})\} < c_{thresh} \right\} \quad (3.1.18)$$

$$\{m_{add}\}_1^{M_{add}} = m_{det} \notin \{m_{det}(m_{port})\}_{m_{port}=1}^{M_{port}} \quad (3.1.19)$$

$$M_{port} \leftarrow M_{port} - M_{drop} + M_{add} \quad (3.1.20)$$

$$\{m_{det}(m_{port})\}_{m_{port}=1}^{M_{port}} \leftarrow (\{m_{det}(m_{port})\} \setminus \{m_{det}(m_{drop})\}) \cup \{m_{add}\} \quad (3.1.21)$$

Step RA5: Assign receive ports and link statistics $\eta_{LA}(m_{sub})$ and $\gamma_{LA}(m_{sub})$.

$$\eta_{LA}(m_{port}; m_{sub}) = \eta_{det}(m_{det}(m_{port}); m_{sub}) \quad (3.1.22)$$

$$\gamma_{LA}(m_{port}; m_{sub}) = \gamma_{det}(m_{det}(m_{port}); m_{sub}) \quad (3.1.23)$$

$$u(m_{port}; m_{sub}) = u_{det}(m_{det}(m_{port}); m_{sub}) \quad (3.1.24)$$

$$U(m_{sub}) = [u(1; m_{sub}) \dots u(m_{port}; m_{sub})] \quad (3.1.25)$$

Step RA6: Estimate spatial steering matrices $\{A_{RNA}(m_{sub}, m_{frame})\}$.

$$A_{RNA}(m_{sub}, m_{frame}) = C^H(m_{sub})U(m_{sub}) \quad (3.1.26)$$

Step RA7: Compute combiner weights $\{W_{RNA}(m_{sub}, m_{frame})\}$.

$$W_{RNA}(m_{sub}, m_{frame}) = C(m_{sub})U(m_{sub}) \quad (3.1.27)$$

Adaptive Transmit Algorithm

Starting with the receive weights $W_{RNA}(m_{sub}, m_{frame})$ given in (3.1.27) and target SINR's γ_{RLA} for the return link, perform the following operations.

5 Step TA1: Scale whitened transmit weights,

$$\eta_{RLA}(m_{port}) = \frac{\gamma_{RLA}(m_{RLA})}{1 + \gamma_{RLA}(m_{RLA})}, \quad (3.2.1)$$

$$m_{port} = \mu_{port}(m_{RLA}) = \mu_{port}(m_{RLA}) \quad (3.2.2)$$

$$\pi(m_{port}; m_{sub}) \leftarrow \frac{\eta_{RLA}(m_{port})}{\eta_{LA}(m_{port}, m_{sub})}, \quad (3.2.2)$$

($\eta_{LA}(m_{port}; m_{sub})$ given in (3.1.22))

Step TA2: Compute distribution weights $\{G_{TNA}(m_{sub}, m_{frame})\}$.

$$G_{TNA}(m_{sub}, m_{frame}) = \frac{\sqrt{\pi(1, m_{sub})} w_{RNA}(1, m_{sub}) \dots}{\sqrt{\pi(M_{port}, m_{sub})} w_{RNA}(M_{port}, m_{sub})} \quad (3.2.3)$$

The target SINR's can also be derived from rate targets based on performance of the codec's used in the system, or from capacity targets $\{C_{RLA}(m_{RLA})\}$ or spectral efficiency targets $\{c_{RLA}(m_{RLA})\}$, via the formula

$$c_{RLA}(m_{RLA}) = 1.63 C_{RLA}(m_{RLA}) / W_{active} \quad (3.2.4)$$

$$\gamma_{RLA}(m_{RLA}) = \lambda_{gap} (2^{C_{RLA}(m_{RLA})} - 1) c_{RLA}(m_{RLA}) \quad (3.2.5)$$

Where $1.63 = 1/0.6144$ is the inverse efficiency of the airlink, which includes overhead for transmit pilots (0.9375 efficiency), the OFDM cyclic prefix (0.80 efficiency) and TDD framing (0.8192 efficiency), and where λ_{gap} is the SNR coding gap of the QAM codec. Target SINR, rate, or capacity can be set at either end of the link, i.e., as a transmitter design goal or as a control parameter passed from the link or network. In the first two cases, this adaptation is referred to here as locally enabled network optimization (LEGO).

Note that steps (3.2.1)-(3.2.3) adjust output power to meet a link SINR (or link rate or capacity) criterion. That is, the system will attempt to adjust transmit power at each node to meet this criterion. Also note that steps (3.2.1)-(3.2.3) require no information from other links in the network, including links originating from the same node. While this can be a highly desirable attribute in many applications, it has some drawbacks in practice. In particular, if the target SINR's are set too high, the resultant network can fail to converge and drive its transmitters into saturation. This event can be detected by computing the conducted power into each antenna,

$$P_{RLA}(m_{ant}) = M_{sub} \sum_{m_{port}=1}^{M_{port}} |g(m_{ant}, m_{port})|^2 \quad (3.2.6)$$

and monitoring $P_{RLA}(m_{ant})$ to ensure compliance with conducted power requirements.

In addition, the convergence time of the LEGO algorithm can be slow, especially during initial acquisition of multiple links. This performance can be improved by employing a max-SIR algorithm that forms hard nulls during the initial link acquisition period. This algorithm is easily implemented as an extension of the max-SINR algorithm described above.

Max-SIR Adaptation Algorithm

Adaptive Receive Algorithm

Starting with the multiantenna received and deembedded pilot data $X_{Px}(m_{sub}, m_{frame})$ (referred to as $X_{Px}(m_{sub})$ or X_{Px}

as appropriate to simplify arguments) received and OFDM-demodulated over logical subcarrier m_{sub} and logical frame m_{frame} , perform the following operations.

Step RA1: Compute QRD of $P_{RNA}(m_{sub}, m_{frame})$, using (3.1.1)-(3.1.6).

Step RA2: Detect candidate TNA transmit pilots and spatially-whitened max-SINR adaptation weights using (3.1.7)-(3.1.13).

Step RA3: If spatial signature estimates $A_{RNA}(m_{sub})$ are available (see Step RA7), associate detected transmit pilots with receive ports and link addresses, using (3.1.14)-(3.1.17).

Step RA4: Drop and add ports using (3.1.18)-(3.1.21).

Step RA5: Assign max-SINR whitened transmit/receive weights and link statistics using (3.1.22)-(3.1.25).

Step RA6: Estimate spatial steering matrices $\{A_{RNA}(m_{sub}, m_{frame})\}$ using 3.1.26.

Step RA7: Compute combiner weights $\{W_{RNA}(m_{sub}, m_{frame})\}$, using (3.1.27).

Step RA7.1: Compute null-steering receive weights and SINR's

$$C_{\perp}(m_{sub}) = (U^H(m_{sub})U(m_{sub}))^{-1} \tag{4.1.1}$$

$$\eta_{LA}(m_{port}, m_{sub}) \leftarrow 1 / \text{diag}\{C_{\perp}(m_{sub})\} \tag{4.1.2}$$

(replaces $\eta_{LA}(m_{port}, m_{sub})$ provided by (3.1.22))

$$\gamma_{LA}(m_{port}, m_{sub}) \leftarrow \frac{\eta_{LA}(m_{port}, m_{sub})}{1 - \eta_{LA}(m_{port}, m_{sub})} \tag{4.1.3}$$

(replaces $\gamma_{LA}(m_{port}, m_{sub})$ provided by (3.1.23))

$$W_{RNA}(m_{sub}, m_{frame}) \leftarrow W_{RNA}(m_{sub}, m_{sub})C_{\perp}(m_{sub}) \tag{4.1.4}$$

Adaptive Transmit Algorithm

Starting with the transmit weights $W_{RNA}(m_{sub}, m_{frame})$ given in (4.1.4) and target SINR's γ_{RLA} for the return link, perform the following operations.

Step TA1: Compute $\eta_{RLA}(m_{port})$ using (3.2.1).

Step Compute power scaling $\pi(m_{port}, m_{sub})$ using

TA1.1:

$$\pi(m_{port}, m_{sub}) = \eta_{RLA}(m_{port}) \eta_{LA}(m_{port}, m_{sub}) / \eta_{LA}(m_{port}, m_{sub}) \tag{4.2.1}$$

Step TA2: Compute combiner weights $\{G_{RNA}(m_{sub}, m_{frame})\}$ using 3.2.3

The target SINR's can also be derived from rate targets based on performance of the codec's used in the system, or from capacity targets $\{C_{RLA}(m_{RLA})\}$ or spectral efficiency targets $\{c_{RLA}(m_{RLA})\}$ using (3.2.4)-(3.2.5), and conducted power can be monitored using (3.2.6). In addition, the SINR and SIR estimates given by (3.1.23 and (4.1.3) can be used to detect "overloaded network" conditions where the max-SIR solution is misadjusting significantly from the max-SINR result. While this invention has been described with reference to one or more illustrative embodiments, this description is not to be construed in a limiting sense. Various modifications and combinations of the illustrative embodiments, differing order of the sub-steps (including parallel and partial processing for one or more operations thereof), as well as other embodiments of the invention will be apparent to those skilled in the art upon referencing this disclosure. It is therefore intended this disclosure encompass any combination of the specifics described here and such modifications or embodiments. Furthermore, the scope of this invention includes any combination of the subordinate parts from the different embodiments disclosed in this specification, and is not limited to the spe-

cifics of the preferred embodiment or any of the alternative embodiments mentioned above. Individual configurations and embodiments of this invention may contain all, or less than all, of those disclosed in the specification according to the needs and desires of that user. The claims stated herein should further be read as including those elements which are not necessary to the invention yet are in the prior art, particularly that referenced and incorporated herein thereby, and are necessary to the overall function of that particular claim, and should be read as including, to the maximum extent permissible by law, known functional equivalents to the specification's disclosure, even though those functional equivalents are not exhaustively detailed herein or individually claimed below due to the legal preferences for limiting the number of claims and the law's intent to negate any requirement for combinatorial explosion for overly-detailed description and claiming of known and foreseeable alternatives.

Although the present invention has been described chiefly in terms of the presently preferred embodiment, it is to be understood that the disclosure is not to be interpreted as limiting. Various alterations and modifications will no doubt become apparent to those skilled in the art after having read the above disclosure. Such modifications may involve other features which are already known in the design, manufacture and use of adaptive and transitional MIMO systems, both hardware and associated software therefore, and which may be used instead of or in addition to features already described herein. The examples herein are not limiting but instructive of the embodiment of the invention, and variations which are readily derived through programming or embedded hardware transformations which are standard or known to the appropriate art are not excluded by omission. Accordingly, it is intended that the appended claims are interpreted as covering all alterations and modifications as fall within the true spirit and scope of the invention in light of the prior art.

Additionally, although claims have been formulated in this application to particular combinations of elements, it should be understood that the scope of the disclosure of the present application also includes any single novel element or any novel combination of elements disclosed herein, either explicitly or implicitly, whether or not it relates to the same invention as presently claimed in any claim and whether or not it mitigates any or all of the same technical problems as does the present invention. The applicants hereby give notice that new claims may be formulated to such features and/or combinations of such features during the prosecution of the present application or of any further application derived there from.

What is claimed is:

1. An apparatus, comprising:
 - a spatially diverse antenna array of M antennas, where M is greater than or equal to two;
 - at least one multiple-input and multiple-output/orthogonal frequency division multiplexing-capable transceiver in communication with the spatially diverse antenna array of M antennas;
 - encoding circuitry capable of causing first data to be encoded;
 - decoding circuitry capable of causing second data to be decoded; and
 - processing circuitry capable of causing diversity combining, the processing circuitry in communication with the multiple-input and multiple-output/orthogonal frequency division multiplexing-capable transceiver, the encoding circuitry, and the decoding circuitry, the processing circuitry capable of causing the apparatus to: receive at least two first diverse signals,

combine at least two of the at least two first diverse signals,
 generate at least two second diverse signals based on at least one aspect of the at least two first diverse signals, simultaneously transmit the at least two second diverse signals, wherein the apparatus is configured to operate in a mesh network including at least one first multiple-input and multiple-output-capable node and at least one second multiple-input and multiple-output-capable node in a separate physical location than the at least one first multiple-input and multiple-output-capable node of the mesh network, such that at least one of the at least two second diverse signals is capable of being received by the at least one first multiple-input and multiple-output-capable node of the mesh network,

dynamically change a transmit frequency of the at least one of the at least two second diverse signals capable of being received by the at least one first multiple-input and multiple-output-capable node of the mesh network, and

dynamically re-route the at least one of the at least two second diverse signals to the at least one second multiple-input and multiple-output-capable node of the mesh network;

wherein the apparatus is configured such that the dynamically re-routing of the at least one of the at least two second diverse signals to the at least one second multiple-input and multiple-output-capable node of the mesh network in the separate physical location than the at least one first multiple-input and multiple-output-capable node of the mesh network includes re-routing the at least one of the at least two second diverse signals based on a perceived unacceptable interference associated with the at least one first multiple-input and multiple-output-capable node of the mesh network.

2. The apparatus of claim 1, wherein the apparatus is configured such that a first set of the spatially diverse antenna array of M antennas are capable of receiving the at least two first diverse signals.

3. The apparatus of claim 2, wherein the apparatus is configured such that a second set of the spatially diverse antenna array of M antennas are capable of simultaneously transmitting the at least two second diverse signals.

4. The apparatus of claim 3, wherein the apparatus is configured such that the first set of the spatially diverse antenna array of M antennas capable of receiving the at least two first diverse signals is distinct from the second set of the spatially diverse antenna array of M antennas capable of simultaneously transmitting the at least two second diverse signals.

5. The apparatus of claim 3, wherein the apparatus is configured such that the first set of the spatially diverse antenna array of M antennas capable of receiving the at least two first diverse signals is the same as the second set of the spatially diverse antenna array of M antennas capable of simultaneously transmitting the at least two second diverse signals.

6. The apparatus of claim 1, wherein the apparatus is configured such that the spatially diverse antenna array of M antennas is circularly symmetric.

7. The apparatus of claim 1, wherein the apparatus is configured such that the processing circuitry includes digital signal processing circuitry capable of performing digital signal processing to convert analog radio signals into digital signals and digital signals into analog radio signals.

8. The apparatus of claim 1, wherein the apparatus is configured such that the at least one multiple-input and multiple-

output/orthogonal frequency division multiplexing-capable transceiver includes a multitone transmission element.

9. The apparatus of claim 8, wherein the apparatus is configured such that the at least one multiple-input and multiple-output/orthogonal frequency division multiplexing-capable transceiver including the multitone transmission element is capable of multitone transmitting a first multitone format capable of being used by a first transceiver that is different than a second multitone format capable of being used by a second transceiver.

10. The apparatus of claim 1, wherein the apparatus is configured such that the processing circuitry includes a transceiver controller.

11. The apparatus of claim 1, wherein the apparatus is configured such that the at least one multiple-input and multiple-output/orthogonal frequency division multiplexing-capable transceiver includes at least one Fixed-Fourier Transform enabling chip.

12. The apparatus of claim 11, wherein the apparatus is configured such that the at least one multiple-input and multiple-output/orthogonal frequency division multiplexing-capable transceiver is capable of implementing orthogonal frequency division multiplexing utilizing the at least one Fixed-Fourier Transform enabling chip.

13. The apparatus of claim 1, wherein the apparatus is configured such that the at least one multiple-input and multiple-output/orthogonal frequency division multiplexing-capable transceiver is a vector orthogonal frequency division multiplexing transceiver.

14. The apparatus of claim 13, wherein the apparatus is configured such that the vector orthogonal frequency division multiplexing transceiver is capable of linearly combining data received over each antenna in the spatially diverse antenna array of M antennas.

15. The apparatus of claim 1, wherein the apparatus is configured such that the encoding circuitry is capable of incorporating QAM or PSK symbols prior to transmission.

16. The apparatus of claim 1, wherein the apparatus is configured such that the decoding circuitry is capable of interpreting QAM or PSK symbols.

17. The apparatus of claim 1, wherein the apparatus is configured such that the encoding circuitry is capable of performing trellis encoding.

18. The apparatus of claim 1, wherein the apparatus is configured to operate in the mesh network including the at least one first multiple-input and multiple-output-capable node, the at least one second multiple-input and multiple-output-capable node, and at least one third multiple-input and multiple-output-capable node, the at least one third multiple-input and multiple-output-capable node including a destination node for data associated with the at least two second diverse signals.

19. The apparatus of claim 18, wherein the apparatus is configured to dynamically re-route the at least one of the at least two second diverse signals to the at least one second multiple-input and multiple-output-capable node of the mesh network for routing to the destination node.

20. The apparatus of claim 1, wherein the apparatus is further configured such that dynamically re-routing the at least one of the at least two second diverse signals to the at least one second multiple-input and multiple-output-capable node of the mesh network in a separate physical location than the at least one first multiple-input and multiple-output-capable node of the mesh network includes re-routing the at least one of the at least two second diverse signals based on a

perceived unacceptable SINR associated with the at least one first multiple-input and multiple-output-capable node of the mesh network.

21. The apparatus of claim 1, wherein the apparatus is configured such that the at least one of the at least two second diverse signals is capable of being received by a relay node located in the mesh network.

22. The apparatus of claim 1, wherein the apparatus is configured such that the at least two second diverse signals are capable of being simultaneously transmitted as frequency coincident communications.

23. The apparatus of claim 1, wherein the apparatus is configured such that the at least two second diverse signals are capable of being transmitted as time and frequency coincident communications.

24. The apparatus of claim 1, wherein the apparatus is configured such that generating the at least two second diverse signals includes generating spatially diverse signals.

25. The apparatus of claim 24, wherein the apparatus is configured such that generating the spatially diverse signals includes transmitting the spatially diverse signals from the spatially diverse antenna array of M antennas.

26. The apparatus of claim 1, wherein the apparatus is configured such that generating the at least two second diverse signals includes generating polarization diverse signals.

27. The apparatus of claim 26, wherein the apparatus is configured such that generating the polarization diverse signals includes transmitting the spatially diverse signals from a polarization diverse antenna array.

28. The apparatus of claim 1, wherein the apparatus is configured such that generating the at least two second diverse signals includes generating route diverse signals.

29. The apparatus of claim 28, wherein the apparatus is configured such that generating the route diverse signals includes transmitting the spatially diverse signals to a node in a location separate than a location of the apparatus.

30. The apparatus of claim 1, wherein the apparatus is configured such that simultaneously transmitting the at least two second diverse signals includes transmitting such that at least two of the at least two second diverse signals are capable of being received by a non-multiple-input and non-multiple-output capable node.

31. The apparatus of claim 1, wherein the apparatus is configured to perform transmit beamforming utilizing one or more digital signal processing (DSP) techniques.

32. The apparatus of claim 31, wherein the apparatus is configured such that the transmit beamforming includes constructing linear distribution weights.

33. The apparatus of claim 1, wherein the apparatus is configured such that linear combiner weights obtained during a receive operation are capable of being used to construct linear distribution weights for a subsequent transmit operation.

34. The apparatus of claim 1, wherein the apparatus is configured such that linear combiner weights obtained during a receive operation are capable of being used to construct linear distribution weights for a subsequent transmit operation by setting transmission gains proportional to the distribution weights.

35. The apparatus of claim 1, wherein the apparatus is configured such that the at least two second diverse signals include at least one cyclic prefix.

36. The apparatus of claim 1, wherein the processing circuitry is further capable of causing the apparatus to calculate weights associated with the at least two first diverse signals.

37. The apparatus of claim 36, wherein the processing circuitry is further capable of causing the apparatus to apply the calculated weights to transmit data.

38. The apparatus of claim 37, wherein the processing circuitry is further capable of causing the apparatus to add a cyclic prefix to the transmit data; and

wherein the apparatus is configured such that the spatially diverse antenna array of M antennas is capable of transmitting the at least two second diverse signals of data including the transmit data.

39. The apparatus of claim 1, wherein the apparatus is configured such that generating the at least two second diverse signals based on the at least one aspect of the at least two first diverse signals includes constructing linear distribution weights based on the at least two first diverse signals.

40. The apparatus of claim 1, wherein the apparatus is configured such that generating the at least two second diverse signals based on the at least one aspect of the at least two first diverse signals includes utilizing linear combiner weights obtained during a receive operation to construct linear distribution weights for a subsequent transmit operation.

41. The apparatus of claim 1, wherein the apparatus is configured such that generating the at least two second diverse signals based on the at least one aspect of the at least two first diverse signals includes utilizing linear combiner weights obtained during a receive operation to construct linear distribution weights for a subsequent transmit operation by setting transmission gains proportional to the distribution weights.

42. An apparatus, comprising:

at least two antennas;

a multiple-input and multiple-output/orthogonal frequency division multiplexing-capable transceiver in communication with the at least two antennas;

encoding circuitry capable of causing first data to be encoded;

decoding circuitry capable of causing second data to be decoded;

processing circuitry capable of causing diversity combining, the processing circuitry in communication with the multiple-input and multiple-output/orthogonal frequency division multiplexing-capable transceiver, the encoding circuitry, and the decoding circuitry, the processing circuitry capable of causing the apparatus to:

receive a first spatially diverse signal, calculate weights associated with the first spatially diverse signal,

apply the weights to transmit data, and

add a cyclic prefix to the transmit data;

wherein the apparatus is configured to operate in a mesh network including at least one first multiple-input and multiple-output-capable node and at least one second multiple-input and multiple-output-capable node in a separate physical location than the at least one first multiple-input and multiple-output-capable node of the mesh network, such that the at least two antennas are capable of transmitting a second spatially diverse signal including the transmit data to the at least one first multiple-input and multiple-output-capable node of the mesh network,

dynamically change a transmit frequency of the second spatially diverse signal including the transmit data transmitted to the at least one first multiple-input and multiple-output-capable node of the mesh network, and

dynamically re-route the second spatially diverse signal including the transmit data to the at least one second multiple-input and multiple-output-capable node of the mesh network;

wherein the apparatus is further configured such that the dynamically re-routing of the second spatially diverse signal to the at least one second multiple-input and multiple-output-capable node of the mesh network in the separate physical location than the at least one first multiple-input and multiple-output-capable node of the mesh network includes re-routing the second spatially diverse signal based on a perceived unacceptable interference associated with the at least one first multiple-input and multiple-output-capable node of the mesh network.

43. The apparatus of claim 42, wherein the apparatus is configured to operate in the mesh network including the at least one first multiple-input and multiple-output-capable node, the at least one second multiple-input and multiple-output-capable node, and at least one third multiple-input and multiple-output-capable node, the at least one third multiple-input and multiple-output-capable node including a destination node for data associated with the second spatially diverse signal including the transmit data.

44. The apparatus of claim 43, wherein the apparatus is configured to dynamically re-route the spatially diverse signal including the transmit data to the at least one second multiple-input and multiple-output-capable node of the mesh network for routing to the destination node.

45. The apparatus of claim 42, wherein the apparatus is further configured such that dynamically re-routing the spatially diverse signal including the transmit data to the at least one second multiple-input and multiple-output-capable node of the mesh network includes re-routing the spatially diverse signal including the transmit data based on a perceived unacceptable SINR associated with the at least one first multiple-input and multiple-output-capable node of the mesh network.

46. The apparatus of claim 42, wherein the apparatus is configured such that the second spatially diverse signal including the transmit data is capable of being received by a relay node located in the mesh network.

47. The apparatus of claim 42, wherein the apparatus is configured such that the second spatially diverse signal includes at least two signals.

48. The apparatus of claim 47, wherein the apparatus is further configured to simultaneously transmit the at least two signals.

49. The apparatus of claim 48, wherein the apparatus is further configured such that the at least two signals are capable of being simultaneously transmitted as frequency coincident communications.

50. The apparatus of claim 48, wherein the apparatus is further [configured] configured such that the at least two signals are capable of being simultaneously transmitted as time and frequency coincident communications.

51. The apparatus of claim 48, wherein the apparatus is further configured such that simultaneously transmitting the at least two signals includes transmitting such that at least one of the at least two signals are capable of being received by a non-multiple-input and non-multiple-output capable node.

52. The apparatus of claim 47, wherein the apparatus is further configured such that the at least two signals are spatially diverse signals.

53. The apparatus of claim 47, wherein the apparatus is further configured such that the at least two signals are polarization diverse signals.

54. The apparatus of claim 47, wherein the apparatus is further configured such that the at least two signals are route diverse signals.

55. The apparatus of claim 42, wherein the apparatus is configured to perform transmit beamforming utilizing one or more digital signal processing (DSP) techniques.

56. The apparatus of claim 42, wherein the processing circuitry is further capable of causing the apparatus to receive at least two first diverse signals.

57. The apparatus of claim 56, wherein the processing circuitry is further capable of causing the apparatus to combine at least two of the at least two first diverse signals, the combining of the at least two of the at least two first diverse signals including implementing beamforming.

58. The apparatus of claim 57, wherein processing circuitry is further capable of causing the apparatus to generate at least two second diverse signals utilizing the combined at least two of the at least two first diverse signals.

59. The apparatus of claim 56, wherein the apparatus is configured such that the at least two first diverse signals include at least one cyclic prefix.

60. The apparatus of claim 42, wherein the apparatus is further configured such that the calculated weights include beamforming weights.

61. The apparatus of claim 42, wherein the apparatus is further configured such that the calculated weights include transmit weights.

62. An apparatus, comprising:

at least one circuit configured to operate with a spatially diverse antenna array of M antennas, where M is greater than or equal to one, the at least one circuit further configured to operate with a multiple-input and multiple-output/orthogonal frequency division multiplexing-capable transceiver in communication with the spatially diverse antenna array of M antennas, the at least one circuit configured to cause the apparatus to:

receive a first spatially diverse signal,
identify information associated with the first spatially diverse signal,

increase a signal-to-interference-and-noise ratio (SINR) associated with the first spatially diverse signal, based on the identified information,

simultaneously transmit at least two second spatially diverse signals, wherein the apparatus is configured to operate in a mesh network including at least one first multiple-input and multiple-output-capable node and

at least one second multiple-input and multiple-output-capable node in a separate physical location than the at least one first multiple-input and multiple-output-capable node of the mesh network, such that at least one of the at least two second spatially diverse signals is capable of being received by the at least one first multiple-input and multiple-output-capable node of the mesh network,

dynamically change a transmit frequency of the at least one of the at least two second spatially diverse signals capable of being received by the at least one first multiple-input and multiple-output-capable node of the mesh network, and

dynamically re-route the at least one of the at least two second spatially diverse signals to the at least one second multiple-input and multiple-output-capable node of the mesh network;

wherein the apparatus is configured such that the dynamically re-routing of the at least one of the at least two second spatially diverse signals to the at least one second multiple-input and multiple-output-

capable node of the mesh network in the separate physical location than the at least one first multiple-input and multiple-output-capable node of the mesh network includes re-routing the at least one of the at least two second spatially diverse signals based on a perceived unacceptable interference associated with the at least one first multiple-input and multiple-output-capable node of the mesh network.

63. The apparatus of claim 62, wherein the apparatus is configured such that the information is received from pilot data.

64. The apparatus of claim 62, wherein the apparatus is configured such that increasing the SINR associated with the first spatially diverse signal includes maximizing the SINR associated with the first spatially diverse signal, based on the identified information.

65. An apparatus, comprising:

at least one circuit configured to operate with at least two antennas, the at least one circuit further configured to operate with a multiple-input and multiple-output/orthogonal frequency division multiplexing-capable transceiver in communication with the at least two antennas, the at least one circuit configured to cause the apparatus to:

receive a first spatially diverse signal,
calculate weights associated with the first spatially diverse signal,
apply the weights to transmit data, and
add a cyclic prefix to the transmit data;

wherein the apparatus is configured to operate in a mesh network including at least one first multiple-input and multiple-output-capable node and at least one second multiple-input and multiple-output-capable node in a separate physical location than the at least one first multiple-input and multiple-output-capable node of the mesh network, such that the at least two antennas are capable of transmitting a second spatially diverse signal including the transmit data to the at least one first multiple-input and multiple-output-capable node of the mesh network,

dynamically change a transmit frequency of the second spatially diverse signal including the transmit data transmitted to the at least one first multiple-input and multiple-output-capable node of the mesh network, and
dynamically re-route the second spatially diverse signal including the transmit data to the at least one second multiple-input and multiple-output-capable node of the mesh network;

wherein the apparatus is further configured such that the dynamically re-routing of the second spatially diverse signal to the at least one second multiple-input and multiple-output-capable node of the mesh network in the separate physical location than the at least one first multiple-input and multiple-output-capable node of the mesh network includes re-routing the second spatially diverse signal based on a perceived unacceptable interference associated with the at least one first multiple-input and multiple-output-capable node of the mesh network.

66. The apparatus of claim 65, wherein the apparatus is configured such that dynamically re-routing the second spatially diverse signal including the transmit data to the at least one second multiple-input and multiple-output-capable node of the mesh network includes re-routing the second spatially diverse signal including the transmit data based on a per-

ceived unacceptable SINR associated with the at least one first multiple-input and multiple-output-capable node of the mesh network.

67. The apparatus of claim 65, wherein the apparatus is configured to operate in the mesh network including the at least one first multiple-input and multiple-output-capable node, the at least one second multiple-input and multiple-output-capable node, and at least one third multiple-input and multiple-output-capable node, the at least one third multiple-input and multiple-output-capable node including a destination node for data associated with the second spatially diverse signal including the transmit data.

68. The apparatus of claim 67, wherein the apparatus is configured to dynamically re-route the second spatially diverse signal including the transmit data to the at least one second multiple-input and multiple-output-capable node of the mesh network for routing to the destination node.

69. The apparatus of claim 65, wherein the apparatus is configured such that the second spatially diverse signal including the transmit data is capable of being received by a relay node located in the mesh network.

70. The apparatus of claim 65, wherein the at least one circuit is further configured to cause the apparatus to incorporate network control data in the second spatially diverse signal including the transmit data.

71. The apparatus of claim 65, wherein the at least one circuit is further configured to cause the apparatus to incorporate feedback data in the second spatially diverse signal including the transmit data.

72. The apparatus of claim 65, wherein the apparatus is configured to perform transmit beamforming utilizing one or more digital signal processing (DSP) techniques.

73. The apparatus of claim 65, wherein the apparatus is configured to perform dynamic digital beamforming.

74. The apparatus of claim 1, wherein the apparatus is configured such that each communication includes communication via at least one other component.

75. The apparatus of claim 1, wherein the apparatus is configured such that the processing circuitry includes a plurality of components for collectively causing the apparatus to receive, combine, generate, transmit, dynamically change, and dynamically re-route.

76. The apparatus of claim 1, wherein the apparatus is configured such that the processing circuitry includes a plurality of components for causing the apparatus to receive, combine, generate, transmit, dynamically change, and dynamically re-route; and the receive and the combine are capable of being carried out by a single component of the processing circuitry.

77. The apparatus of claim 1, wherein the apparatus is configured such that the dynamically re-route includes dynamically re-routing a link on which the at least two second diverse signals are transmitted.

78. A sub-system, comprising:

a spatially diverse antenna array of M antennas, where M is greater than or equal to two;

at least one multiple-input and multiple-output/orthogonal frequency division multiplexing-capable radio circuit in communication with the spatially diverse antenna array of M antennas;

encoding circuitry capable of causing first data to be encoded;

decoding circuitry capable of causing second data to be decoded; and

processing circuitry in communication with the multiple-input and multiple-output/orthogonal frequency division multiplexing-capable radio circuit, the encoding

83

circuitry, and the decoding circuitry, the processing circuitry capable of causing the sub-system to:
 receive at least two first diverse signals,
 combine at least two of the at least two first diverse signals,
 generate at least two second diverse signals based on at least one aspect of the at least two first diverse signals,
 simultaneously transmit the at least two second diverse signals, wherein the sub-system is configured to operate in a mesh network including at least one first multiple-input and multiple-output-capable node and at least one second multiple-input and multiple-output-capable node in a separate physical location than the at least one first multiple-input and multiple-output-capable node of the mesh network, such that at least one of the at least two second diverse signals is transmitted to the at least one first multiple-input and multiple-output-capable node of the mesh network,
 dynamically change a transmit frequency to another frequency different from a previous frequency of the at least one of the at least two second diverse signals transmitted to the at least one first multiple-input and multiple-output-capable node of the mesh network, and

dynamically re-route additional signals via another route different from a previous route of the at least one of the at least two second diverse signals, the another route being to the at least one second multiple-input and multiple-output-capable node of the mesh network;

wherein the sub-system is configured such that the dynamically re-routing of the additional signals to the at least one second multiple-input and multiple-output-capable node of the mesh network in the separate physical location than the at least one first multiple-input and multiple-output-capable node of the mesh network includes re-routing the additional signals based on a perceived unacceptable interference associated with at least one link with the at least one first multiple-input and multiple-output-capable node of the mesh network.

79. A sub-system, comprising:

at least one circuit configured to operate with a spatially diverse antenna array of M antennas, where M is greater than or equal to one, the at least one circuit further configured to operate with a multiple-input and multiple-output/orthogonal frequency division multiplexing-capable radio circuit in communication with the spatially diverse antenna array of M antennas, the at least one circuit configured to cause the sub-system to:

receive a first spatially diverse signal,
 identify information associated with the first spatially diverse signal,

increase a signal-to-interference-and-noise ratio (SINR) associated with the first spatially diverse signal, based on the identified information,

simultaneously transmit at least two second spatially diverse signals, wherein the sub-system is configured to operate in a mesh network including at least one first multiple-input and multiple-output-capable node and at least one second multiple-input and multiple-output-capable node in a separate physical location than the at least one first multiple-input and multiple-output-capable node of the mesh network, such that at least one of the at least two second spatially diverse signals is transmitted to the at least one first multiple-input and multiple-output-capable node of the mesh network,

84

dynamically change a transmit frequency to another frequency different from a previous frequency of the at least one of the at least two second spatially diverse signals transmitted to the at least one first multiple-input and multiple-output-capable node of the mesh network, and

dynamically re-route additional signals via another route different from a previous route of the at least one of the at least two second spatially diverse signals, the another route being to the at least one second multiple-input and multiple-output-capable node of the mesh network;

wherein the sub-system is configured such that the dynamically re-routing of the additional signals to the at least one second multiple-input and multiple-output-capable node of the mesh network in the separate physical location than the at least one first multiple-input and multiple-output-capable node of the mesh network includes re-routing the additional signals based on a perceived unacceptable interference associated with at least one link with the at least one first multiple-input and multiple-output-capable node of the mesh network.

80. A sub-system, comprising:

at least one circuit configured to operate with at least two antennas, the at least one circuit further configured to operate with a multiple-input and multiple-output/orthogonal frequency division multiplexing-capable radio circuit in communication with the at least two antennas, the at least one circuit configured to cause the sub-system to:

receive a first spatially diverse signal,
 calculate weights associated with the first spatially diverse signal,
 apply the weights to transmit data, and
 add a cyclic prefix to the transmit data;

wherein the sub-system is configured to operate in a mesh network including at least one first multiple-input and multiple-output-capable node and at least one second multiple-input and multiple-output-capable node in a separate physical location than the at least one first multiple-input and multiple-output-capable node of the mesh network, such that the at least two antennas are capable of transmitting a second spatially diverse signal including the transmit data to the at least one first multiple-input and multiple-output-capable node of the mesh network,

dynamically change a transmit frequency to another frequency different from a previous frequency of the second spatially diverse signal including the transmit data transmitted to the at least one first multiple-input and multiple-output-capable node of the mesh network, and dynamically re-route an additional signal via another route different from a previous route of the second spatially diverse signal including the transmit data, the another route being to the at least one second multiple-input and multiple-output-capable node of the mesh network;

wherein the sub-system is further configured such that the dynamically re-routing of the additional signal to the at least one second multiple-input and multiple-output-capable node of the mesh network in the separate physical location than the at least one first multiple-input and multiple-output-capable node of the mesh network includes re-routing the additional signal based on a perceived unacceptable interference associated with at least one link with the at least one first multiple-input and multiple-output-capable node of the mesh network.

85

81. An apparatus, comprising:
 a multiple-input-and-multiple-output/orthogonal frequency division multiplexing-capable transceiver; and processing circuitry in communication with the at least one multiple-input-and- multiple-output/orthogonal frequency division multiplexing-capable transceiver, the processing circuitry capable of causing the apparatus to: link with a plurality of multiple input-capable nodes including a first multiple input-capable node and a second multiple input-capable node, utilizing a wireless cellular network, by:
 linking with the first multiple input-capable node utilizing a first diversity channel, and
 linking, in association with the linking with the first multiple input-capable node utilizing the first diversity channel, with the second multiple input-capable node utilizing a second diversity channel that differs from the first diversity channel in at least one aspect including a spatial aspect or a polarization aspect;
 receive a first signal from at least one of the plurality of multiple input-capable nodes utilizing the wireless cellular network;
 identify information associated with the at least one multiple input- capable node, the information including first information that is received from the at least one multiple input-capable node utilizing the wireless cellular network and is capable of being used to base weights upon, the information further including second information that is capable of being used to base third information upon;
 modulate transmit data utilizing a coding that is variably determined;
 apply the weights to the transmit data, where the weights are based on the first information;
 add a cyclic prefix to the transmit data; multiplex the transmit data with a second signal; and
 generate the third information based on the second information and the first signal;
 wherein the apparatus is configured for causing transmission of at least one transmit signal including at least a portion of the transmit data and at least a portion of the second signal to the at least one multiple input-capable node utilizing the wireless cellular network;
 wherein the apparatus is further configured for causing transmission of the at least one transmit signal such that the at least portion of the transmit data is redundantly transmitted utilizing a plurality of different diversity channels utilizing the wireless cellular network;
 wherein the apparatus is further configured for causing transmission of the third information to the at least one multiple input-capable node for setting a power level with which the at least one multiple input-capable node transmits;
 wherein the apparatus is further configured for dynamically changing a particular channel to another channel different from a previous channel;
 wherein the apparatus is further configured for dynamic routing utilizing another route different from a previous route;
 wherein the apparatus is further configured such that the dynamic routing includes allowing routing as a function of an interference associated with at least one link.

82. The apparatus of claim 81, wherein the apparatus is operable such that at least a portion of the redundantly transmitted transmit data is transmitted in a time and frequency coincident manner; the first information includes weight-

86

related information; the second information is specific to at least one node; and the third information is based on a power constraint.

83. A network, comprising:
 a plurality of multiple input-capable nodes including a first multiple input-capable node and a second multiple input-capable node; and
 a plurality of base stations in communication via a backhaul network, at least one of the base stations including:
 a multiple-input-and-multiple-output/orthogonal frequency division multiplexing-capable transceiver; and
 processing circuitry in communication with the at least one multiple-input-and-multiple-output/orthogonal frequency division multiplexing-capable transceiver, the processing circuitry capable of causing the at least one base station to:
 link with the multiple input-capable nodes, utilizing a wireless cellular network, by:
 linking with the first multiple input-capable node utilizing a first diversity channel, and
 linking, in association with the linking with the first multiple input-capable node utilizing the first diversity channel, with the second multiple input-capable node utilizing a second diversity channel that differs from the first diversity channel in at least one aspect including a spatial aspect or a polarization aspect;
 receive a particular signal from at least one of the plurality of multiple input-capable nodes utilizing the wireless cellular network;
 identify information associated with the at least one multiple input-capable node, the information including first information that is received from the at least one multiple input-capable node utilizing the wireless cellular network and is capable of being used to base weights upon, the information further including second information that is capable of being used to base third information upon;
 modulate transmit data utilizing a coding that is variably determined;
 apply the weights to the transmit data, where the weights are based on the first information;
 add a cyclic prefix to the transmit data;
 multiplex the transmit data with another signal; and
 generate the third information based on the second information and the particular signal;
 wherein the at least one base station is configured for causing transmission of at least one transmit signal including at least a portion of the transmit data and at least a portion of the another signal to the at least one multiple input-capable node utilizing the wireless cellular network;
 wherein the at least one base station is further configured for causing transmission of the at least one transmit signal such that the at least portion of the transmit data is redundantly transmitted utilizing a plurality of different diversity channels utilizing the wireless cellular network;
 wherein the at least one base station is further configured for causing transmission of the third information to the at least one multiple input-capable node for setting a power with which the at least one multiple input-capable node transmits utilizing the wireless cellular network;

87

wherein the at least one base station is further configured for dynamically changing a particular channel to another channel different from a previous channel; wherein the at least one multiple input-capable node and the at least one base station are configured so as to allow dynamic routing utilizing a particular route different from a previous route, where the dynamic routing includes allowing routing as a function of an interference associated with at least one link.

84. An apparatus, comprising:

multiple-input-capable circuitry for:

linking with a multiple-input-and-multiple-output-capable node utilizing a particular link in a wireless cellular network;

receiving first information from the multiple-input-and-multiple-output-capable node that is capable of being used for power setting;

modulating uplink data;

multiplexing the uplink data with at least one separate signal;

transmitting at least one uplink signal including at least a portion of the uplink data and at least a portion of the at least one separate signal to the multiple-input-and-multiple-output-capable node, utilizing a power that is set based on the first information;

communicating, to the multiple-input-and-multiple-output-capable node, second information that is capable of being used by the multiple-input-and-multiple-output-capable node to base at least one base node weight upon;

wherein the apparatus is operable to cooperate with the multiple-input-and-multiple-output-capable node which takes the form of a base node including multiple-input-and-multiple-output-capable circuitry for:

generating the first information for communication with the apparatus;

receiving the second information from the apparatus;

applying to downlink data the at least one base node weight that is determined based on the second information;

transmitting at least one downlink signal including at least a portion of the downlink data to the apparatus; and

cooperating with the apparatus for interference-based routing.

85. An apparatus, comprising:

multiple-input-and-multiple-output-capable hardware including at least one wireless transmitter element that is orthogonal frequency division multiplexing-capable, and at least one wireless receiver element;

circuitry in communication with the multiple-input-and-multiple-output-capable hardware and operable to:

receive feedback from at least one of a plurality of multiple input-capable nodes utilizing a wireless cellular network;

modulate transmit data utilizing a coding that is variably determined;

utilize weights in association with the transmit data, based on at least a portion of the feedback;

incorporate at least one particular signal with the transmit data;

transmit at least one transmit signal including at least a portion of the transmit data and at least a portion of the at least one particular signal to the at least one multiple input-capable node utilizing the wireless cellular network; and

88

generate information for communication with the at least one multiple input-capable node for setting a power-related value capable of being utilized by the at least one multiple input-capable node during communication utilizing the wireless cellular network;

wherein the apparatus is further operable to perform multiple-user communication with multiple of the plurality of multiple input-capable nodes including a first multiple input-capable node and a second multiple input-capable node, utilizing a same time-frequency resource over the wireless cellular network, by: communicating with the first multiple input-capable node utilizing a first spatial or polarization diversity channel, and communicating with the second multiple input-capable node utilizing a second spatial or polarization diversity channel;

wherein the apparatus is further configured for dynamic routing utilizing a particular route different from a previous route;

wherein the apparatus is further configured such that the dynamic routing includes routing as a function of an interference associated with at least one link.

86. The apparatus of claim **85**, wherein the apparatus is operable such that the feedback includes data.

87. The apparatus of claim **85**, wherein the apparatus is operable such that the feedback is configured to reduce network control information that displaces network content that is communicated.

88. The apparatus of claim **85**, wherein the apparatus is operable such that the feedback includes link quality-related information.

89. The apparatus of claim **85**, wherein the apparatus is operable such that the information is generated based on at least a portion of the feedback.

90. The apparatus of claim **85**, wherein the apparatus is operable such that the information is generated as a function of a power constraint and a power minimization function.

91. The apparatus of claim **85**, wherein the apparatus is operable such that the coding is determined based on at least a portion of the feedback.

92. The apparatus of claim **85**, wherein the apparatus is operable such that the coding is determined based on a signal-to-interference-and-noise-ratio (SINR).

93. The apparatus of claim **85**, wherein the apparatus is further operable to perform single-user communication with the at least one multiple input-capable node such that downlink data is redundantly transmitted utilizing a plurality of different spatial or polarization diversity channels utilizing the wireless cellular network.

94. The apparatus of claim **85**, wherein the apparatus is further operable to perform single-user communication with the at least one multiple input-capable node such that downlink data is redundantly transmitted utilizing a plurality of different spatial or polarization diversity channels utilizing the wireless cellular network, in a manner that the multiple-user communication is performed in association with a first communication, and the single-user communication is performed in association with a second communication.

95. The apparatus of claim **85**, wherein the apparatus is further operable to perform the multiple-user communication in a first mode of operation, and single-user communication with the at least one multiple input-capable node such that downlink data is redundantly transmitted utilizing a plurality of different spatial or polarization diversity channels utilizing the wireless cellular network, in a second mode of operation.

96. An apparatus, comprising:
 multiple-input-capable hardware including at least one
 wireless receiver element that is orthogonal frequency
 division multiplexing-capable, and at least one wireless
 transmitter element; 5
 circuitry in communication with the multiple-input-capable
 hardware and operable for:
 communicating with a multiple-input-and-multiple-out-
 put-capable node via a link in a wireless cellular net-
 work; 10
 receiving at least one value from the multiple-input-and-
 multiple-output-capable node that is capable of being
 used for power control;
 modulating uplink data;
 incorporating at least one particular signal with the 15
 uplink data;
 transmitting at least one uplink signal including at least
 a portion of the uplink data and at least a portion of the
 particular signal to the multiple-input-and-multiple-
 output-capable node, utilizing a power that is controlled 20
 based on the at least one value;
 communicating, to the multiple-input-and-multiple-
 output-capable node, feedback that is capable of being
 used by the multiple-input-and-multiple-out-
 put-capable node to base at least one weight upon; and 25
 interference-based routing utilizing a particular route
 different from a previous route, the interference-
 based routing including routing as a function of an
 interference associated with the link with the multiple-
 input-and-multiple-output-capable node; 30
 wherein the apparatus is operable to cooperate with a
 base station that is capable of:
 communication with the apparatus and another node,
 utilizing a same time-frequency resource over the
 wireless cellular network, by: communicating with 35
 the apparatus utilizing a first spatial or polarization
 diversity channel, and communicating with the
 another node utilizing a second spatial or polariza-
 tion diversity channel; and
 communication with the apparatus such that at least 40
 some downlink data is redundantly transmitted to
 the apparatus utilizing a plurality of different spa-
 tial or polarization diversity channels utilizing the
 wireless cellular network.

97. An apparatus, comprising: 45
 multiple-input-and-multiple-output-capable hardware
 including at least one wireless transmitter element that is
 orthogonal frequency division multiplexing-capable,
 and at least one wireless receiver element;
 circuitry in communication with the multiple-input-and- 50
 multiple-output-capable hardware and operable to:
 receive feedback from at least one of a plurality of mul-
 tiple input-capable nodes utilizing a wireless cellular
 network;
 modulate transmit data utilizing a coding that is variably 55
 determined;
 utilize weights in association with the transmit data,
 based on at least a portion of the feedback;
 incorporate at least one particular signal with the trans-
 mit data;

transmit at least one transmit signal including at least a
 portion of the transmit data and at least a portion of the
 at least one particular signal to the at least one mul-
 tiple input-capable node utilizing the wireless cellular
 network; and
 generate information for communication with the at
 least one multiple input-capable node for setting a
 power-related value capable of being utilized by the at
 least one multiple input-capable node during commu-
 nication utilizing the wireless cellular network;
 wherein the apparatus is further operable to perform com-
 munication with the at least one multiple input-capable
 node such that downlink data is redundantly transmitted
 utilizing a plurality of different spatial or polarization
 diversity channels utilizing the wireless cellular net-
 work;
 wherein the apparatus is further configured for dynamic
 routing utilizing a particular route different from a pre-
 vious route;
 wherein the apparatus is further configured such that the
 dynamic routing includes routing as a function of an
 interference associated with at least one link.

98. An apparatus, comprising:
 multiple-input-and-multiple-output-capable hardware 5
 including at least one wireless transmitter element that is
 orthogonal frequency division multiplexing-capable,
 and at least one wireless receiver element;
 circuitry in communication with the multiple-input-and-
 multiple-output-capable hardware and operable to:
 receive feedback from at least one of a plurality of mul-
 tiple input-capable nodes utilizing a wireless cellular
 network;
 modulate transmit data utilizing a coding that is variably
 determined;
 utilize weights in association with the transmit data,
 based on at least a portion of the feedback;
 incorporate at least one particular signal with the trans-
 mit data;
 transmit at least one transmit signal including at least a
 portion of the transmit data and at least a portion of the
 at least one particular signal to the at least one mul-
 tiple input-capable node utilizing the wireless cellular
 network; and
 generate information for communication with the at
 least one multiple input-capable node for setting a
 power-related value capable of being utilized by the at
 least one multiple input-capable node during commu-
 nication utilizing the wireless cellular network;
 wherein the apparatus is further operable to dynamically
 change a particular channel to another channel different
 from a previous channel;
 wherein the apparatus is further configured for dynamic
 routing utilizing a particular route different from a pre-
 vious route;
 wherein the apparatus is further configured such that the
 dynamic routing includes routing as a function of an
 interference associated with at least one link.