



US00D748931S

(12) **United States Design Patent**
Corigliano

(10) **Patent No.:** **US D748,931 S**

(45) **Date of Patent:** **** Feb. 9, 2016**

(54) **FOREARM CUSHION**

(71) Applicant: **Ralph Corigliano**, Aurora, CO (US)

(72) Inventor: **Ralph Corigliano**, Aurora, CO (US)

(**) Term: **14 Years**

(21) Appl. No.: **29/506,185**

(22) Filed: **Oct. 14, 2014**

(51) **LOC (10) Cl.** **06-09**

(52) **U.S. Cl.**
USPC **D6/601**

(58) **Field of Classification Search**
USPC D6/595-601, 604; D21/803, 804;
D24/183
CPC A47C 7/021; A47C 7/383; A47C 7/428;
A47C 7/546; A47C 16/00; A47C 20/00;
A47C 20/02; A47C 20/021; A47C 20/026;
A47C 20/027; A47G 9/10; A47G 9/1027;
A47G 9/1045; A47G 9/1054; A47G 9/1063;
A47G 9/1072; A47G 9/1081; A47G 9/109;
A47D 13/00; A47D 13/08
See application file for complete search history.

4,071,031 A * 1/1978 Lowman A61F 7/0085
128/DIG. 20
D330,978 S * 11/1992 Vasquez 297/183.8
6,065,166 A * 5/2000 Sharrock A61G 7/065
5/636
D471,050 S * 3/2003 Haubner D6/601
D489,561 S * 5/2004 Corbett D6/596
D494,404 S * 8/2004 Corbett D6/596
D557,464 S * 12/2007 Novak D30/160
D713,165 S * 9/2014 Robinson D6/391
D718,456 S * 11/2014 McNamee D24/171
2004/0139548 A1 * 7/2004 Hwang-Pao A47G 9/1009
5/636
2006/0055215 A1 * 3/2006 Potosky A47D 13/083
297/219.1

* cited by examiner

Primary Examiner — Mary Ann Calabrese
(74) *Attorney, Agent, or Firm* — Rod D. Baker

(57) **CLAIM**
I claim the ornamental design for a forearm cushion, as shown and described.

DESCRIPTION

FIG. 1 is a perspective view of the forearm cushion showing my ornamental design;
FIG. 2 is a front elevation view thereof;
FIG. 3 is a rear elevation view thereof;
FIG. 4 is a right side elevation view thereof;
FIG. 5 is a left side elevation view thereof;
FIG. 6 is a top plan view thereof; and,
FIG. 7 is a bottom plan view thereof.

1 Claim, 5 Drawing Sheets

(56) **References Cited**
U.S. PATENT DOCUMENTS
1,836,604 A * 12/1931 Meyer C13B 50/02
127/30
3,946,451 A * 3/1976 Spann A61G 7/0755
5/650

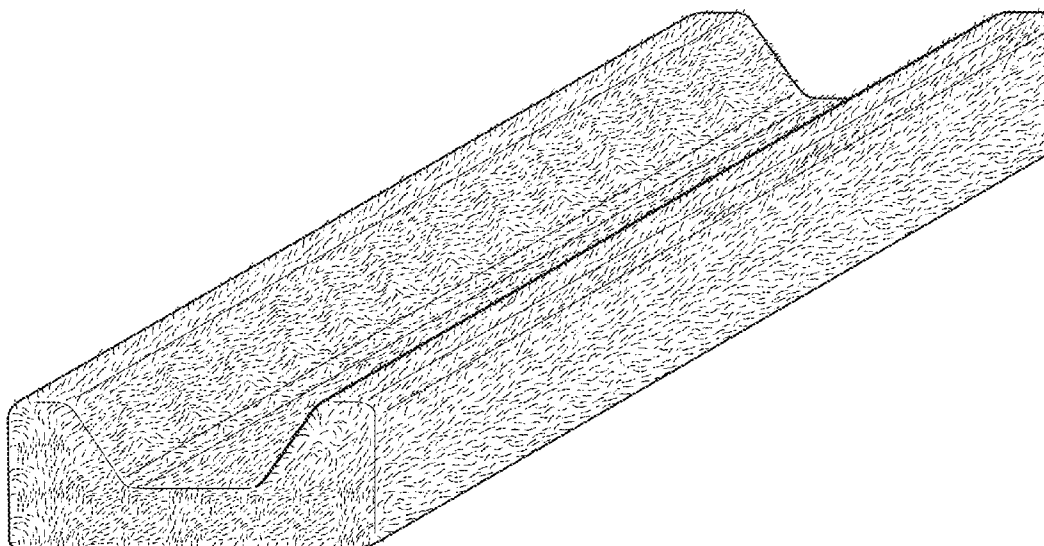

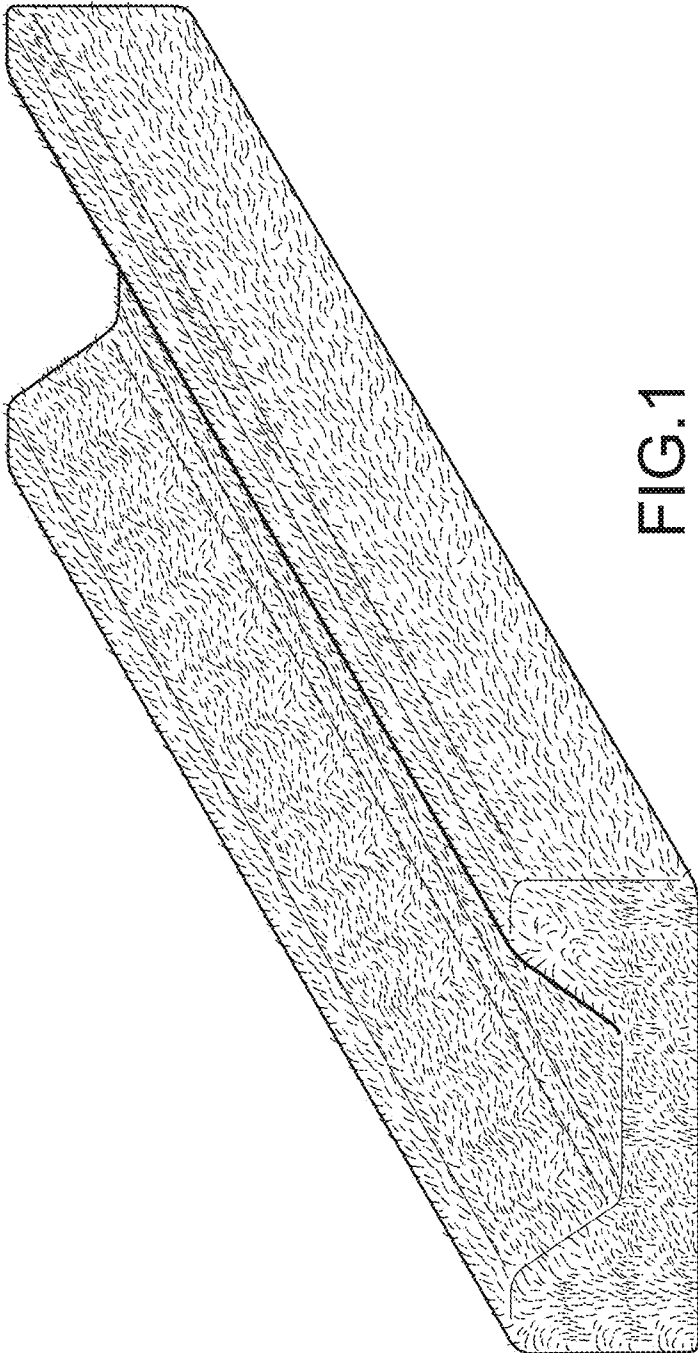

FIG. 1

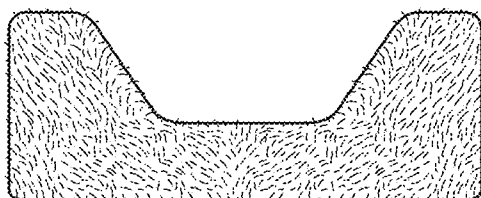

FIG. 2

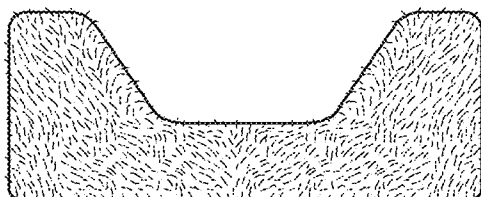

FIG. 3

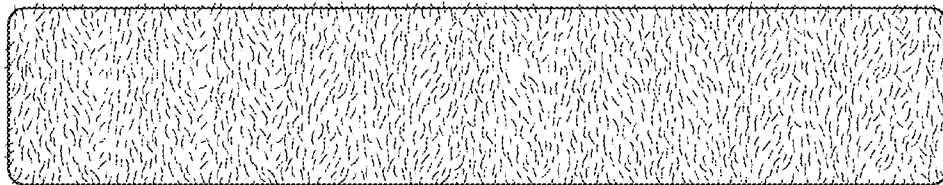

FIG. 4

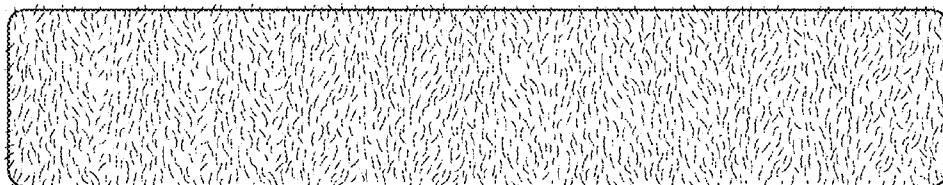

FIG. 5

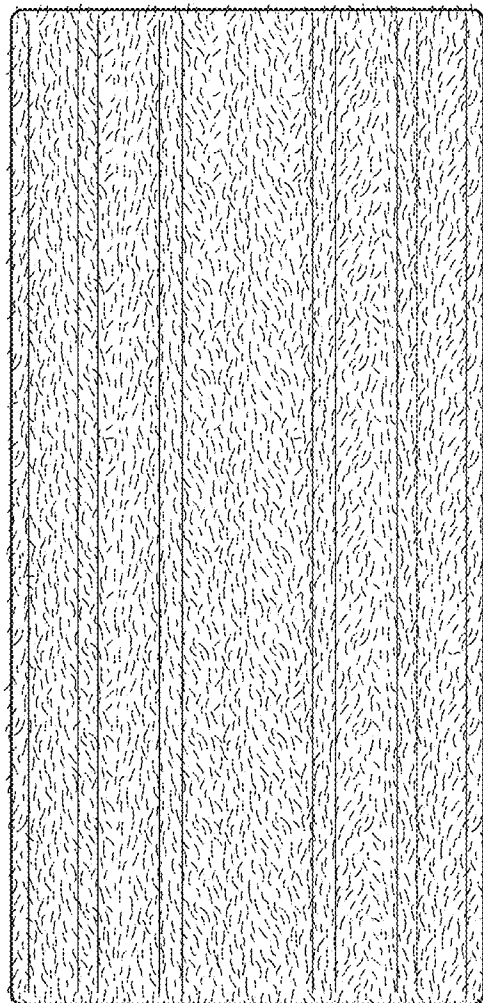

FIG.6

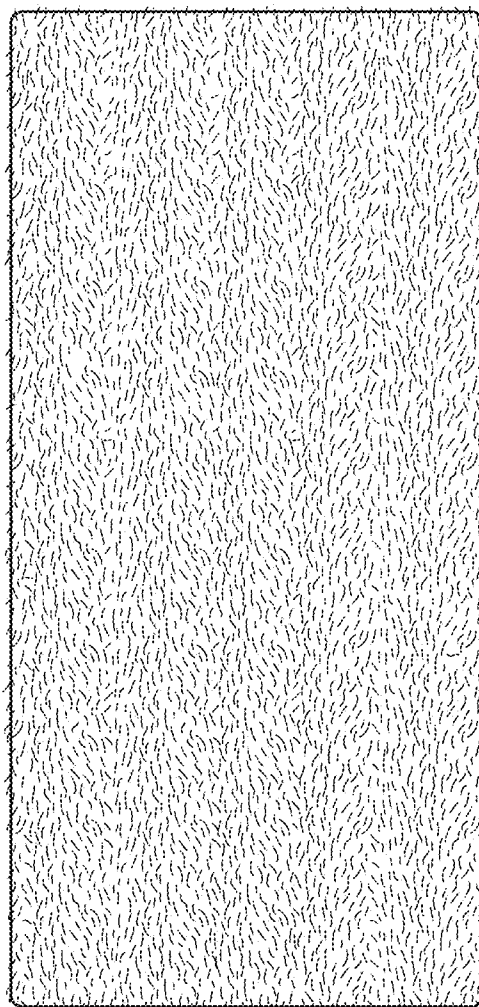

FIG.7