



US00D832207S

(12) **United States Design Patent**
Gorin et al.

(10) **Patent No.:** **US D832,207 S**

(45) **Date of Patent:** **** Oct. 30, 2018**

(54) **CHARGING DEVICE**

(71) Applicants: **Thomas Michael Gorin**, Atlanta, GA (US); **Cassidy Amber Jones**, Mableton, GA (US); **Kenneth Alford McCrary**, Grayson, GA (US)

(72) Inventors: **Thomas Michael Gorin**, Atlanta, GA (US); **Cassidy Amber Jones**, Mableton, GA (US); **Kenneth Alford McCrary**, Grayson, GA (US)

(73) Assignee: **Data:Comm Electronics, Inc.**, Norcross, GA (US)

(**) Term: **15 Years**

(21) Appl. No.: **29/601,356**

(22) Filed: **Apr. 21, 2017**

(51) **LOC (11) Cl.** **13-02**

(52) **U.S. Cl.**
USPC **D13/107**

(58) **Field of Classification Search**
USPC D13/107, 108, 109, 110, 118, 119, 184, D13/103; D14/251, 253, 432, 434
CPC Y02E 60/12; Y02T 90/14; Y02T 90/122; Y02T 90/128; Y02T 90/163; H02J 7/025; H02J 7/0042; H02J 7/0044; H02J 7/0045; H02J 7/0003; H02J 2001/008; H02J 3/32; H02J 3/008; H02J 7/0027; H02J 7/0013; H02J 7/0054; H02J 7/00; H01F 38/14; H01R 13/6675; H01M 2/1022; H01M 2/1055; H01M 10/44; H01M 10/46; H01M 10/425; B60L 11/182; B60L 11/1809; B60L 11/1861; B60R 16/03

See application file for complete search history.

(56) **References Cited**

U.S. PATENT DOCUMENTS

D424,028	S	*	5/2000	Vaiani	D13/184
D428,384	S	*	7/2000	Maeyama	D13/103
D552,081	S	*	10/2007	Yano	D13/110
D567,776	S	*	4/2008	Wells	D13/184
D680,952	S	*	4/2013	Henderson	D13/108
D692,378	S	*	10/2013	Esses	D13/110
D699,179	S	*	2/2014	Alexander	D13/103
D742,819	S	*	11/2015	Nuovo	D13/107
D746,227	S	*	12/2015	Lemire-Elmore	D13/107
D749,509	S	*	2/2016	Blau	D13/108
D764,410	S	*	8/2016	Alesi	D13/110
D790,464	S	*	6/2017	He	D13/110
D800,651	S	*	10/2017	Voller	D13/103
2003/0000788	A1		1/2003	Skowronski		

* cited by examiner

Primary Examiner — Rosemary K Tarzca

Assistant Examiner — Christy M Nemeth

(74) *Attorney, Agent, or Firm* — Thomas I Horstemeyer, LLP

(57) **CLAIM**

The ornamental design for a charging device, as shown and described herein.

DESCRIPTION

FIG. 1 is a top, front, right side perspective view of a charging device of our new design;
FIG. 2 is a left side elevation view thereof;
FIG. 3 is a right side elevation view thereof;
FIG. 4 is a front elevation view thereof;
FIG. 5 is a back elevation view thereof;
FIG. 6 is a top plan view thereof; and,
FIG. 7 is a bottom plan view thereof.

1 Claim, 5 Drawing Sheets

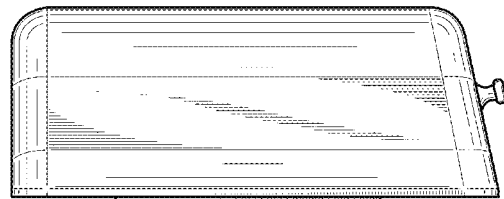
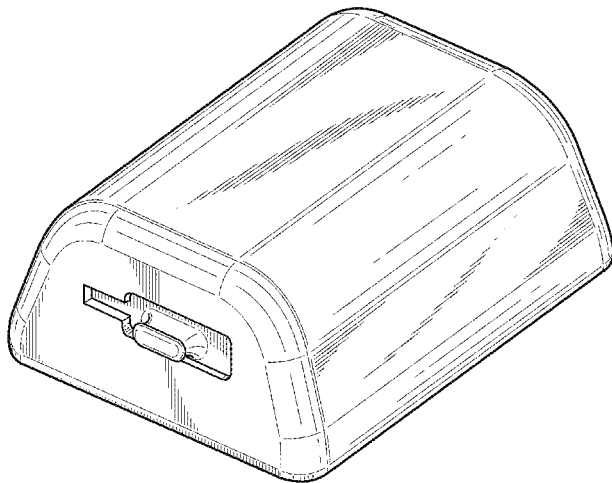

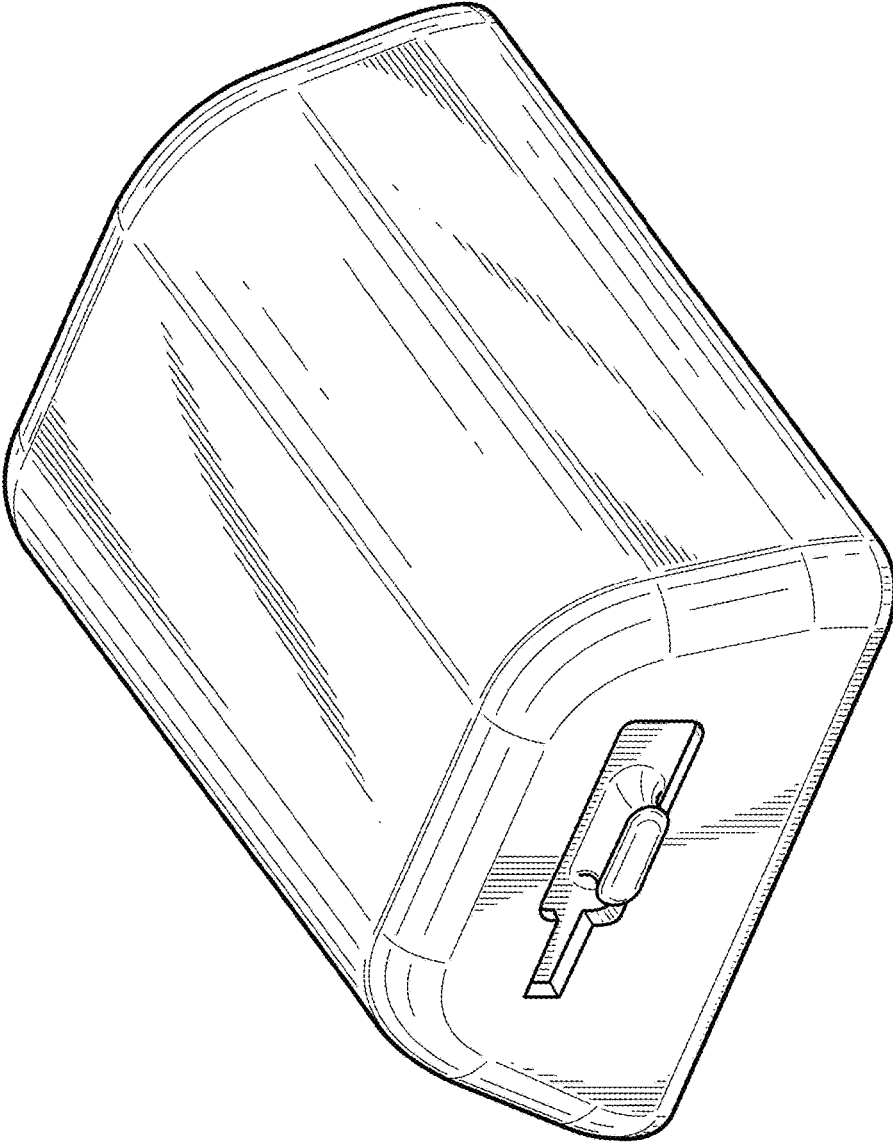

FIG. 1

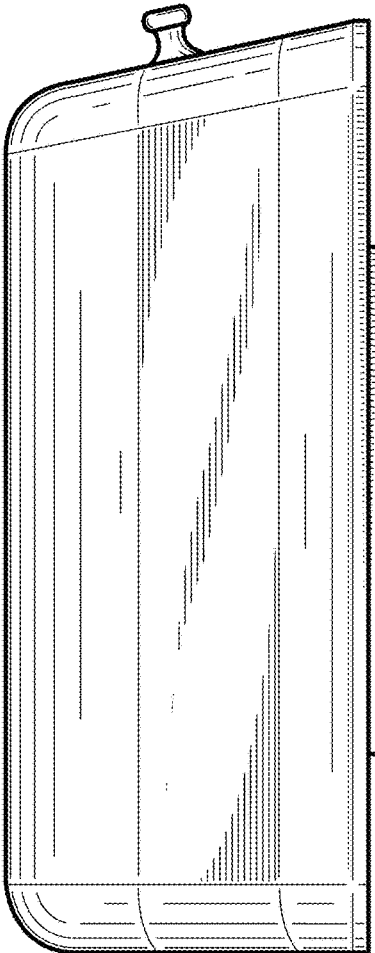

FIG. 2

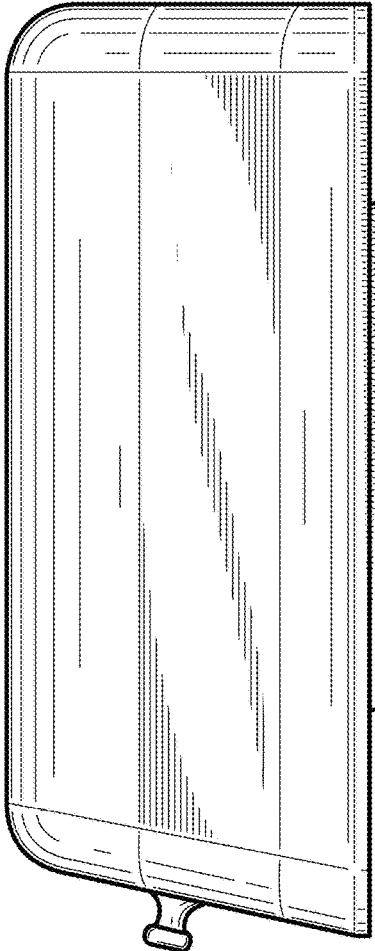

FIG. 3

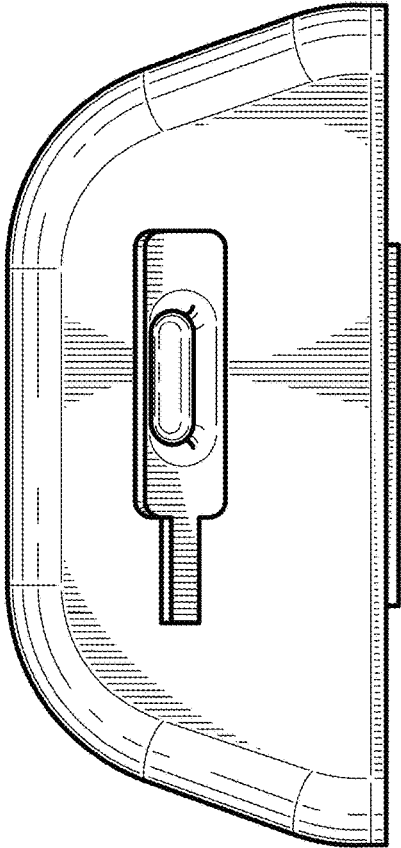

FIG. 4

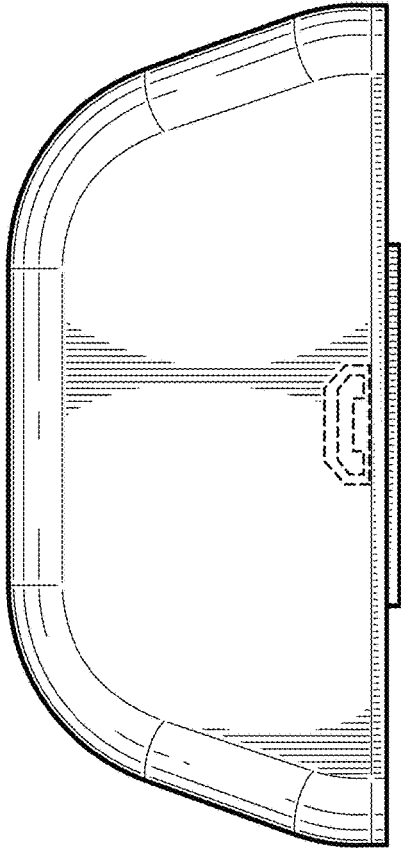

FIG. 5

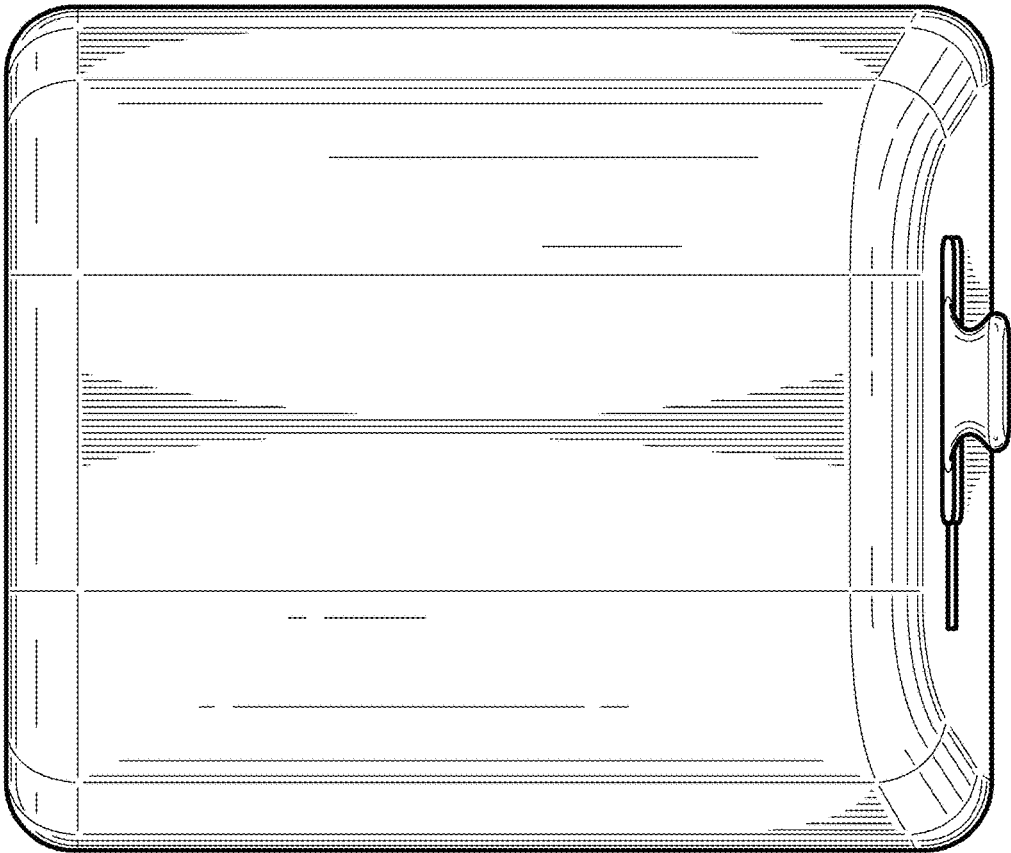

FIG. 6

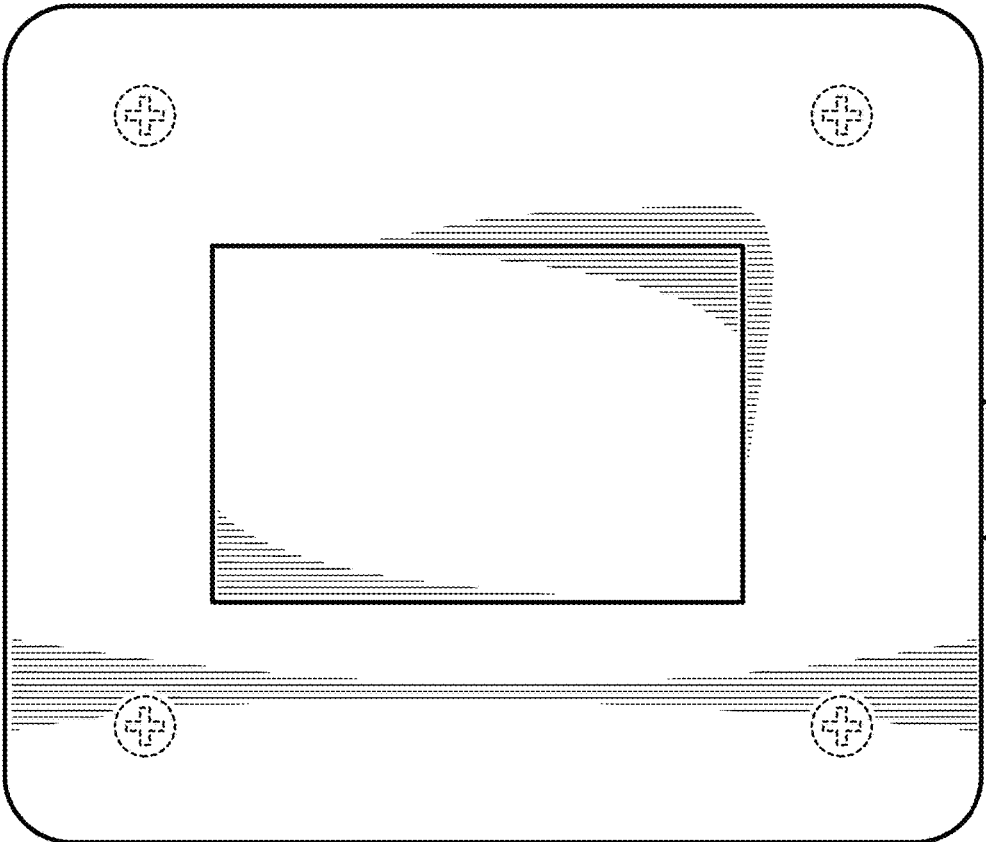

FIG. 7