



Grope cobordism of classical knots[☆]

James Conant^a, Peter Teichner^{b,*}

^aDepartment of Mathematics, Cornell University, Ithaca, NY 14853-4201, USA

^bDepartment of Mathematics, University of California in San Diego, 9500 Gilman Dr, La Jolla, CA 92093-0112, USA

Received 5 September 2002; received in revised form 23 January 2003; accepted 13 February 2003

Abstract

Motivated by the lower central series of a group, we define the notion of a *grope cobordism* between two knots in a 3-manifold. Just like an iterated group commutator, each grope cobordism has a type that can be described by a rooted unitrivalent tree. By filtering these trees in different ways, we show how the Goussarov–Habiro approach to finite type invariants of knots is closely related to our notion of grope cobordism. Thus our results can be viewed as a geometric interpretation of finite type invariants.

The derived commutator series of a group also has a three-dimensional analogy, namely knots modulo *symmetric* grope cobordism. On one hand this theory maps onto the usual Vassiliev theory and on the other hand it maps onto the Cochran–Orr–Teichner filtration of the knot concordance group, via symmetric grope cobordism in 4-space. In particular, the graded theory contains information on finite type invariants (with degree h terms mapping to Vassiliev degree 2^h), Blanchfield forms or S-equivalence at $h=2$, Casson–Gordon invariants at $h=3$, and for $h=4$ one finds the new von Neumann signatures of a knot.

© 2003 Elsevier Ltd. All rights reserved.

MSC: 57M27

Keywords: Grope cobordism; Vassiliev invariants

1. Introduction

A modern perspective on 3-manifolds is through topological quantum field theory, following ideas of Jones, Witten and many others. These have inspired tremendous activity but so far have not

[☆] The first author is partially supported by NSF VIGRE grant DMS-9983660, and the second by NSF grant DMS0072775.

* Corresponding author.

E-mail addresses: jconant@math.cornell.edu (J. Conant), teichner@math.ucsd.edu (P. Teichner).

contributed much to the topological understanding of 3-manifolds. In particular, the Vassiliev–Goussarov theory of finite type invariants of knots, which in some sense gives universal quantum knot invariants, has developed a fascinating life quite independent of the rest of geometric topology. Which low-dimensional topologist has not been inspired by the appearance of univalent graphs in the enumeration of these finite type invariants? These graphs ultimately derive from the Feynman rules associated to perturbative Chern–Simons theory, and the residue of Gauge symmetry introduces certain relations on the diagrams, now known as *antisymmetry*- and *Jacobi*- (or IHX-) relations. On the other hand, it is well known that rooted univalent *trees* can be used to label iterated (non-associative) operations, and that the above relations arise exactly for Lie algebras. In our context the most interesting Lie algebras arise from a group G by first considering its *lower central series* G_c defined inductively by the iterated commutators

$$G_2 := [G, G] \quad \text{and} \quad G_c := [G, G_{c-1}] \quad \text{for } c > 2.$$

Then $L(G) := \bigoplus_c G_c$ is a Lie algebra with group multiplication as addition and group commutators as Lie bracket.

In this paper we shall give a geometric implementation of iterated commutators in fundamental groups G via the notion of a *grope cobordism* between two knots in a 3-manifold. From the above point of view, one should rather think of the associated graded Lie algebra $L(G)$ and thus it is not surprising that the notion of grope cobordism is closely related to finite type knot invariants. We shall make this statement precise and hence our results can be viewed as the long desired *geometric* interpretation of finite type knot invariants.

This relation between grope cobordism and finite type invariants was first announced by Habiro at the very end of his landmark paper [14]. Without providing proofs, he correctly announces a version of Theorem 2 below, but makes an incorrect assertion about (uncapped) grope cobordism. The correct statement is our main result, Theorem 3. Our proofs of these theorems rely heavily on Habiro’s work.

Other geometric interpretations of finite type invariants include Stanford’s beautiful work [21] on the relationship with the lower central series of pure braid groups PB_n . Stanford shows that two knots in 3-space have the same finite type invariants of degree $< c$ if and only if they differ by a finite sequence of operations as follows: Grab any number n of strands of one knot and tie them into a pure braid in the c th term of the lower central series of PB_n .

The first relation between finite type invariants and gropes was announced by Kalfagianni and Lin in [15]. Their notion is very different from ours since they consider gropes in 3-space whose first stage bounds a knot and is embedded with free complementary fundamental group. However, arbitrary intersections are allowed among the higher grope stages. In that context the precise relation between grope class and Vassiliev degree is not understood and only a logarithmic estimate is given in [15]. In his thesis Conant [5], discovered a more precise relationship between finite-type invariants and gropes. There he proved that a knot bounding an *embedded* grope of class c in 3-space must have vanishing finite type invariants up to $\lceil c/2 \rceil$, and that this bound is the best possible. The methods of the thesis are applied in the short note [6] to get a similar result for gropes with more than one boundary component. This result is an ingredient of the proof of Theorem 3 below.

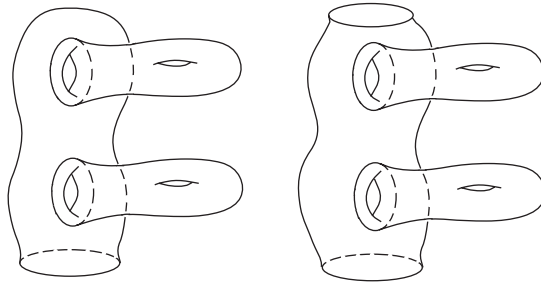

Fig. 1. Gropes of class 3, with one and two boundary circles.

1.1. A geometric interpretation of group commutators

We first want to motivate the use of gropes from scratch, without any reference to quantum invariants. Recall that the fundamental group of an arbitrary topological space X consists of continuous maps of the circle S^1 into X , modulo homotopy (i.e. 1-parameter families of continuous maps). Quite analogously, classical knot theory studies smooth *embeddings* of a circle into 3-space, modulo isotopy (i.e. 1-parameter families of embeddings).

Recall further that a continuous map $S^1 \rightarrow X$ represents the trivial element in the fundamental group $\pi_1 X$ if and only if it extends to a map of the disk. Moreover, ϕ represents a commutator in $\pi_1 X$ if and only if it extends to a map of a surface (i.e. of a compact oriented 2-manifold with boundary S^1). The first statement has a straightforward analogy in knot theory: A knot is trivial if and only if it extends to an embedding of the disk into 3-space. However, every knot “is a commutator” in the sense that it bounds a *Seifert surface*, i.e. an embedded surface in 3-space. Thus all of knot theory is created by the difference between a surface and a disk. The new idea is to filter this difference by introducing a concept into knot theory which is the embedded analogue of iterated commutators in group theory. Namely, there are certain finite 2-complexes (built out of iterated surface stages) called *gropes* by Cannon [2], with the following defining property: $S^1 \rightarrow X$ represents an element in the c th term of the lower central series of $\pi_1 X$ if and only if it extends to a continuous map of a *grobe of class c* . By construction, such gropes have a single circle as their boundary, but one can also consider gropes with more boundary circles as in Fig. 1.

Gropes, therefore, are not quite manifolds but the singularities that arise are of a very simple type, so that these 2-complexes are in some sense the next easiest thing after surfaces. Two sentences on the history of the use of gropes in mathematics are in order, compare [8, Section 2.11]. Their inventor Stan’ko worked in high-dimensional topology, and so did Edwards and Cannon who developed gropes further. Bob Edwards suggested their relevance for topological 4-manifolds, where they were used extensively, see [8,9], or [10]. It is this application that seems to have created a certain angst about studying gropes, so we should point out that the only really difficult part in 4 dimensions is the use of *infinite constructions*, i.e. when the class of the grope goes to infinity.

One of the purposes of this paper is to show how simple and useful (finite) gropes are when embedded into 3-space.



Fig. 2. A class three grope cobordism.

1.2. Grope cobordism of knots in 3-space

The idea behind a *grope cobordism* is to filter the difference between a surface and a disk in 3-space. The following definition should be thought of as a three-dimensional *embedded* analogue of the lower central series of a group. Let \mathcal{K} be the set of oriented knot types, i.e. isotopy classes of oriented knots in 3-space.

Definition 1. Two knot types $K_1, K_2 \in \mathcal{K}$ are *grope cobordant* of class c , if there is an embedded grope of class c (the *grope cobordism*) in 3-space such that its two boundary components represent K_1 and K_2 .

At first glance, gropes do not appear to embed in an interesting way in 3-space. However, since every grope cobordism has a one-dimensional spine, it can then be isotoped into the neighborhood of a 1-complex. As a consequence, grope cobordisms abound in 3-space! An example of such a grope cobordism of class three is given in Fig. 2. This is an embedded version of the grope on the right of Fig. 1, except that all surface stages are of genus one. The genus one surface with two boundary components is the thin, partially transparent surface. One symplectic basis element, the core of one of the thin bands, is glued to the boundary of the thicker genus one surface. It is important to point out that the two boundary components of a grope cobordism may link in an arbitrary way, but that we do not record this information.

It turns out (Lemma 15) that the relation of grope cobordism is in fact an equivalence relation (for each fixed class c) on the set \mathcal{K} of knot types. This is why we were careful to talk about *knot types* rather than actual knots. Moreover, the resulting quotients are extremely interesting abelian groups under connected sum. Before explaining these groups in detail, we want to point out a way to directly relate to finite type knot invariants à la Vassiliev, see [22] or [1]. For that purpose, we have to consider *capped* gropes which are gropes with disks (the *caps*) as their top surface stages.

If two knots cobound an *embedded capped* grope then they are isotopic because the caps can be used to surger the grope cobordism into an annulus. Thus in order to get an interesting notion of

capped grope cobordism, we allow the (disjointly embedded) caps to have intersections with the bottom stage of the embedded grope.

Theorem 2. *Two oriented knots are capped grope cobordant of class c if and only if they share the same finite type invariants of Vassiliev degree $< c$.*

The proof of this result has two ingredients. One is Habiro’s beautiful translation of finite type invariants into his theory of tree claspers [14], and the other is our translation from tree claspers to capped gropes given in Theorem 4.

Remarks. In Section 2.3 we will prove that it is sufficient to consider gropes which have genus one in all stages except at the bottom. The genus at the bottom is responsible for the transitivity of the grope cobordism relation.

Another simplification is predicted by group theory: Since the lower central series of a group is generated by commutators which are “right-normed”, the question arises as to whether (capped) grope cobordism is generated by the corresponding *half-gropes*, see Fig. 6. This question will be answered in the affirmative in Section 3.3.

Even though capped grope cobordism is very useful because of Theorem 2, the analogy with group theory is more natural in the absence of caps. Thus the question arises whether grope cobordism (without caps) can also be translated into the finite type theory. In order to explain how this can be done, we first have to review an approach to finite type knot invariants developed by Goussarov, Habiro and others.

1.3. Finite type filtrations and grope cobordism

Again the starting point are certain Feynman diagrams, i.e. unitrivalent graphs. The main idea is to think of such graphs as operating on the space of knots as follows. Consider a unitrivalent graph Γ embedded in 3-space, with exactly its univalent vertices on a knot K , its edges framed and each trivalent vertex cyclically ordered. There is a procedure to replace Γ by a framed link in the complement of K , with a copy of the Hopf link at each edge of Γ and a copy of the Borromean rings at each trivalent vertex. See Section 3.1. Surgery on that link replaces the knot K by a new knot type K_Γ , the *surgery of K along Γ* . In the simplest case where Γ_0 has a single edge, one recovers the original idea of a crossing change on a knot: Surgery on a single Hopf link leads to the knot K_{Γ_0} which differs from K by a single crossing change. The next simplest case is shown in Fig. 3.

Varying the embeddings and framings of a given graph, one obtains an infinite class of operators on the set \mathcal{K} of oriented knot types in 3-space, indexed by abstract unitrivalent graphs. Assume that each such graph Γ is equipped with a *degree* $\text{deg}(\Gamma) \in \mathbb{N}$. Then one obtains a descending filtration

$$\mathcal{K} = \mathcal{F}_0^{\text{deg}} \supseteq \mathcal{F}_1^{\text{deg}} \supseteq \mathcal{F}_2^{\text{deg}} \supseteq \dots$$

defined as follows: $\mathcal{F}_k^{\text{deg}}$ consists of all knots that can be obtained from the unknot by a finite sequence of surgeries along unitrivalent graphs Γ of degree $\text{deg}(\Gamma) \geq k$. There is also a natural

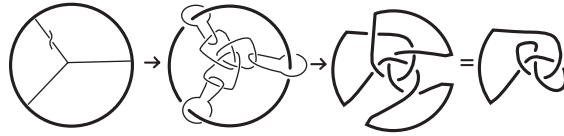

Fig. 3. Surgering the unknot to the figure-of-eight knot. The framing is the blackboard framing, except at the indicated half-twist.

notion of the quotients $\mathcal{K}/\mathcal{F}_k^{\text{deg}}$: These are defined to be the equivalence classes of the equivalence relation on \mathcal{K} generated by surgeries along rooted univalent graphs of degree $\geq k$.

As an example, one can use the *Vassiliev degree*

$$v(\Gamma) := (\text{number of vertices of } \Gamma)/2$$

to obtain exactly the well-known *Vassiliev filtration* used in Theorem 2: The main theorem of Habiro [14] states that two knots represent the same element in $\mathcal{K}/\mathcal{F}_k^v$ if and only if they share the same Vassiliev invariants of degree $< k$. This follows from the fact that a surgery on a univalent graph is the same as a *simple clasper surgery*, compare Section 3. In this language, Theorem 2 can be reformulated as follows:

Theorem 2'. *Two oriented knots in 3-space are capped grope cobordant of class c if and only if they represent the same element in $\mathcal{K}/\mathcal{F}_c^v$.*

The Vassiliev degree is also used as the degree in defining a version of graph cohomology. Then it turns out that the differential in this chain complex preserves another degree, namely the *loop degree* $\ell(\Gamma) := b_1(\Gamma)$, the “number” of loops in Γ . Regardless of its relation to graph cohomology, one can use the loop degree to obtain a second filtration \mathcal{F}_k^ℓ of the set of knot types. It turns out that in our context the *grope degree*

$$g(\Gamma) := v(\Gamma) + \ell(\Gamma)$$

is most relevant, leading to the precise uncapped analogue of Theorem 2':

Theorem 3. *Two oriented knots in 3-space are grope cobordant of class c if and only if they represent the same element in $\mathcal{K}/\mathcal{F}_c^g$.*

Remarks.

- The grope degree arises naturally as follows. Given a univalent graph Γ , there exists a set of $\ell(\Gamma)$ edges such that cutting these edges yields a trivalent tree. The grope degree of Γ is precisely the Vassiliev degree of this tree (which is the same as the degree of the tree in the sense of the lower central series).
- The groups $\mathcal{K}/\mathcal{F}_c^v \otimes \mathbb{Q}$ are well known to be isomorphic to the corresponding diagram spaces via the Kontsevich integral. In particular, the Kontsevich integral is an invariant of capped grope cobordism.
- Garoufalidis and Rozansky [11] have proven the remarkable result that the Kontsevich integral also preserves the “loop filtration” \mathcal{F}_*^ℓ . In particular, the Kontsevich integral also preserves the

grope filtration \mathcal{F}_*^g (in the sense that it sends the c th term \mathcal{F}_c^g to a linear combination of diagrams with grope degree $\geq c$). Hence the Kontsevich integral gives obstructions to the existence of grope cobordisms.

- In fact, the groups $\mathcal{K}/\mathcal{F}_c^g \otimes \mathbb{Q}$ are isomorphic to the corresponding diagram spaces (via the Kontsevich integral) just like for the Vassiliev degree. This result will be explained in [7]. It shows how interesting, yet understandable, the relation of grope cobordism in 3-space is. Moreover, it also gives a geometric interpretation of the Kontsevich integral!
- Using the methods of Habiro [14] one shows that all quotients, $\mathcal{K}/\mathcal{F}_c^v$ and $\mathcal{K}/\mathcal{F}_c^g$, are finitely generated abelian groups under connected sum. Hence the same is true for the quotients of knots modulo (capped) grope cobordism.
- In the preceding theorems we are dividing out by graphs which have grope degree *larger than* or equal to c . In fact the theorems are also true if we only divide out by those of exactly degree c . For the Vassiliev degree this is contained in [14], for the grope degree we shall give a proof in [7].

Theorem 3 will be proven by explaining the precise relation between an embedded grope and the link obtained from a rooted univalent graph. At the heart of the issue lies a well known relation between Borromean rings and surfaces and more generally between iterated Bing doublings of the Hopf link and gropes of higher class. This relation has been used extensively in four-dimensional topology and it has also occurred previously in the study of Milnor invariants of links, see for example [3].

1.4. Gropes and claspers

The following result is our main contribution to Theorems 2 and 3. It uses an obvious generalization of grope cobordism in 3-space to arbitrary 3-manifolds and also the language of *claspers* which makes the “surgery on univalent graphs” from the previous section more precise.

Theorem 4. *Let \mathcal{T} be a rooted trivalent tree and let M be a 3-manifold:*

- (a) *two knots are \mathcal{T} -grope cobordant in M if and only if they are related by a finite sequence of \mathcal{T} -clasper surgeries, and*
- (b) *two knots are capped \mathcal{T} -grope cobordant in M if and only if they are related by a finite sequence of capped \mathcal{T} -clasper surgeries.*

All the relevant definitions will be introduced in the next sections. In particular, we shall explain the correspondence between rooted trees, gropes and claspers.

1.5. Four-dimensional aspects

By a result of Ng [19], no finite type knot invariant but the Arf invariant is a concordance invariant. The analogous result for links can be very well expressed in terms of the loop degree and its relation to gropes. Even though our (grope) proof is new, the following result seems well known to experts. Compare in particular the rational analogue of Habegger and Masbaum [13] and the homological version of Levine [17].

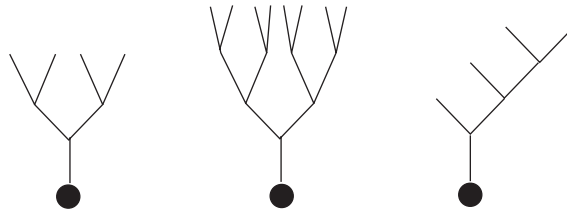

Fig. 4. The symmetric trees of height 2 and 3, and a non-symmetric tree of class 4.

Theorem 5. *If a link L_Γ is obtained from a link L by surgery along a connected univalent graph Γ with $\ell(\Gamma) \geq 1$ then L_Γ is ribbon concordant to L .*

This result says that in the four-dimensional setting, it is best to consider rooted trivalent *trees* instead of all graphs as operators. We will thus concentrate on trees from now on (by the STU-relation trees are sufficient for the Vassiliev theory \mathcal{F}_*^v as well, see [14]). Note that grope degree (or grope class) agrees in this case with the Vassiliev degree. In this setting the Vassiliev invariant of degree 2, corresponding to the letter Y has been generalized to an invariant of immersed 2-spheres in 4-manifolds by Schneiderman and Teichner [20]. It takes into account the fundamental group (i.e. the edges of the letter Y are labeled by elements of the fundamental group with a holonomy relation around each trivalent vertex) and is a second order obstruction for embedding a single 2-sphere or mapping several 2-spheres disjointly into a 4-manifold. It is expected that higher order invariants of this type can be constructed for all labeled trees, modulo antisymmetry, holonomy and IHX-relations.

Returning to knots, it turns out that a slight refinement of the theory *does* allow concordance invariance. The idea is to allow surgery only along *symmetric* trees, corresponding to *symmetric* grope cobordism. These are related to the derived series rather than the lower central series of the fundamental group. Symmetric trees have a new complexity called the *height* h (and the class c , defined for any rooted tree, is given by the formula $c = 2^h$) (Fig. 4).







Recently, Cochran, Orr and Teichner defined a highly nontrivial filtration $\mathcal{F}_{(h)}$ of the knot concordance group. They prove in [4, Theorem 8.11] that two knots represent the same element in $\mathcal{F}_{(h)}$ if they cobound an embedded symmetric grope of height $\geq (h + 2)$ in $\mathbb{R}^3 \times [0, 1]$. It is clear that a symmetric grope cobordism in 3-space can be used to obtain such a grope cobordism in 4-space. Thus the following consequence implies that the Casson–Gordon invariants vanish on $\mathcal{F}_4^{\text{sym}}$ and that the higher order von Neumann signatures of Cochran et al. [4] are invariants of $\mathcal{K}/\mathcal{F}_5^{\text{sym}}$.

Corollary 6. *Define a filtration $\mathcal{F}_h^{\text{sym}}$ on \mathcal{K} by allowing symmetric trees of height $\geq h$ as operators. Then the natural map from \mathcal{K} to the knot concordance group maps $\mathcal{F}_{h+2}^{\text{sym}}$ to the term $\mathcal{F}_{(h)}$ in the Cochran–Orr–Teichner filtration.*

1.6. Open problems

Instead of studying symmetric gropes, one can also restrict attention to any particular grope type, parameterized by the underlying rooted tree type. The precise definition can be found in Section 2.4.

What follows is a summary of our low degree calculations whose proofs will be found in [7].

Tree Type \mathcal{T}	$\mathcal{K}/c\mathcal{T}$	\mathcal{K}/\mathcal{T}	$\mathcal{K}/\mathcal{T}^4$
	$\{0\}$	$\{0\}$	$\{0\}$
	$\mathbb{Z}(c_2)$	$\mathbb{Z}_2(\text{arf})$	$\mathbb{Z}_2(\text{arf})$
	$\mathbb{Z}(c_3) \oplus \mathbb{Z}(c_2)$	$\mathbb{Z}(c_2)$	$\mathbb{Z}_2(\text{arf})$
	$\mathbb{Z}(c_3) \oplus \mathbb{Z}(c_2)$	$\mathbb{Z}(c_2)$	$\mathbb{Z}_2(\text{arf})$
	$\mathbb{Z}(c_4) \oplus \mathbb{Z}(c'_4) \oplus \mathbb{Z}(c_3) \oplus \mathbb{Z}(c_2)$	$\mathbb{Z}_2(c_3) \oplus \mathbb{Z}(c_2)$	$\mathbb{Z}_2(\text{arf})$
	$\mathbb{Z}(c_4) \oplus \mathbb{Z}(c'_4) \oplus \mathbb{Z}(c_3) \oplus \mathbb{Z}(c_2)$	$\mathbb{Z}_2(c_3) \oplus \mathbb{Z}(c_2)$	$\mathbb{Z}_2(\text{arf})$
	?	S-equivalence or BI-forms	cobordism of BI-forms

Here BI-form stands for the Blanchfield form which is the equivariant linking form on the infinite cyclic cover of the knot complement. The notation $(c)\mathcal{T}$ refers to the equivalence relation given by (capped) grope cobordisms in 3-space using gropes of tree-type \mathcal{T} , as explained in Section 2. One can also study grope cobordism in $\mathbb{R}^3 \times [0, 1]$ which is denoted by \mathcal{T}^4 above.

Observe that all sets in the above table are actually abelian groups (under #), except for the last row. In this case, $\mathcal{K}/\mathcal{T}^4$ is the “groupification” of \mathcal{K}/\mathcal{T} in the sense that only the relations

$$K + (\text{reversed mirror image of } K) = 0$$

are added. Note that in general, this can only be true rationally because of the occurrence of $c_3 \bmod 2$ in the above table. These calculations also imply that $c_3 \bmod 2$ is an invariant of S-equivalence, a fact which cannot be true rationally by [18].

We would like to finish with the following questions and challenges for the reader.

- (1) Find invariants of $\mathcal{K}/\mathcal{F}_h^{\text{sym}}$ for $h \geq 4$.
- (2) Find a good notion of grope cobordism allowing non-orientable surface stages.
- (3) Can one express four-dimensional grope cobordism $\mathcal{K}/\mathcal{T}^4$ in terms of algebraic operations, like the above relations, on the three-dimensional sets \mathcal{K}/\mathcal{T} ?
- (4) A central tool in our work is the algorithm in Theorem 35, which reduces every clasper surgery to a sequence of simple clasper surgeries. It would be very useful to implement this algorithm on a computer.

2. Gropes

2.1. Basic definitions

Gropes are certain 2-complexes formed by gluing layers of punctured surfaces together. In our context, a punctured surface is defined to be a closed oriented surface with an open disk deleted. Groves are defined recursively using a quantity called *depth*. This differs from the definitions in [10] only in that it is formally correct.

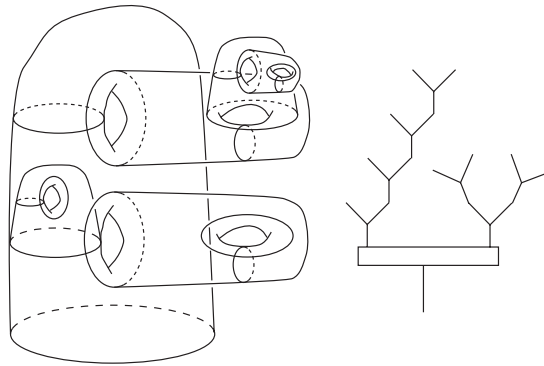

Fig. 5. A grope of class 4 and depth 5, and its associated rooted tree-with-boxes.

A *grope* is a special pair (2-complex, circle), where the circle is referred to as the *boundary* of the grope. There is an anomalous case when the depth is 1: the unique grope of depth 1 is the pair (circle, circle). A grope of depth 2 is a punctured surface with the boundary circle specified. To form a grope G of depth n , take a punctured surface, F , and prescribe a *symplectic basis* $\{\alpha_i, \beta_j\}$. That is, α_i and β_j are embedded curves in F which represent a basis of $H_1(F)$ such that the only intersections among the α_i and β_j occur when α_i and β_i meet in a single point. Now glue gropes of depth $< n$ along their boundary circles to each α_i and β_j with at least one such added grope being of depth $n - 1$. (Note that we are allowing any added grope to be of depth 1, in which case we are not really adding a grope.)

Definition 7. The surface $F \subset G$ is called the *bottom stage* of the grope and its boundary is the boundary of the grope.

Definition 8. The *tips* of the grope are those symplectic basis elements of the various punctured surfaces of the grope which do not have gropes of depth > 1 attached to them.

For instance in Fig. 5 there are 9 tips. Depth was just a tool in defining gropes. More important is the *class* of the grope, defined recursively as follows.

Definition 9. The class of a depth 1 grope is 1. Suppose a grope G is formed by attaching the gropes of lower depth $\{A_i, B_j\}$ to a symplectic basis $\{\alpha_i, \beta_j\}$ of the bottom stage F , such that $\partial A_i = \alpha_i$, $\partial B_j = \beta_j$. Then

$$\text{class}(G) := \min_i \{\text{class}(A_i) + \text{class}(B_i)\}.$$

Associated to every grope is a rooted tree-with-boxes. This tree is constructed by representing a punctured surface of genus g by the following figure:

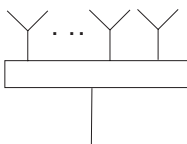

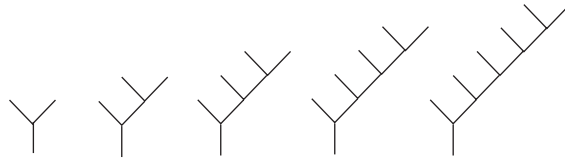

Fig. 6. The half-gropes of class 2–6 and genus 1.

The bottom vertex is the root and it represents the boundary of the surface. There are g of the Υ trees and the $2g$ tips of the Υ trees represent the symplectic basis of the stage, with dual basis elements paired according to the Υ structure. Then we glue all these trees together as follows. If a stage S is glued to a symplectic basis element of another stage, then identify the root vertex of the S tree, with the tip of the other tree representing that symplectic basis element. Also, by convention, if a stage is genus 1, we drop the box and represent that stage by a Υ .

For instance the rooted tree-with-boxes associated to the grope in Fig. 5 is given on the right in that figure. Note that depth of a tip is the distance to the root. We will show in Section 2.3 that for our purposes it is enough to understand gropes of genus one, i.e. gropes such that all surface stages have genus one. These can be represented by rooted trees (without boxes) on which we concentrate from now on.

A very special class k grope is the class k half-grope (of genus one). It corresponds to a right-normed commutator of length k at the lower central series level. The class 2 half-grope tree is just a Υ . The class k half-grope tree type is defined recursively by adding a class $k - 1$ half grope tree to one of the two tips of a Υ , see Fig. 6.

From these definitions, the reader should now be able to prove the following result, see also [10].

Proposition 10. *Given a continuous map $\phi : S^1 \rightarrow X$, the following statement are equivalent for each integer $k \geq 2$:*

- (1) ϕ represents an element in $\pi_1 X_k$, the k th term of the lower central series of $\pi_1 X$.
- (2) ϕ extends to a continuous map of a half-grope of class k into X .
- (3) ϕ extends to a continuous map of a grope of class k into X .

There are also symmetric gropes, corresponding by a theorem just like above to the derived series of a group, as opposed to the lower central series. A Υ represents a symmetric grope of class 2. Inductively, a symmetric grope tree of class 2^n is formed by gluing symmetric gropes of class 2^{n-1} to the two tips of a Υ as in Fig. 7. A symmetric grope of class 2^h is said to be of height h .

Sometimes we consider a grope to be augmented with pushing annuli. A pushing annulus is an annulus attached along one boundary component to a tip of the grope as in Fig. 8. It is clear that every embedding of a grope into 3-space can be extended to an embedding of the augmented grope.

Definition 11. A capped grope is a grope with disks (the caps) attached to all its tips. The grope without the caps is sometimes called the body of the capped grope and the rooted tree type is unchanged by attaching caps.

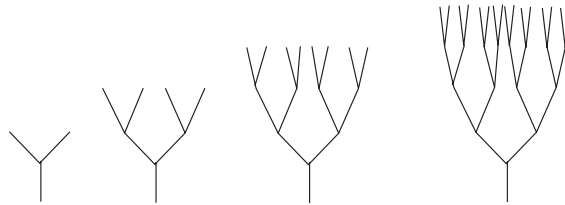

Fig. 7. The symmetric gropes of height 1 to 4 and genus 1.

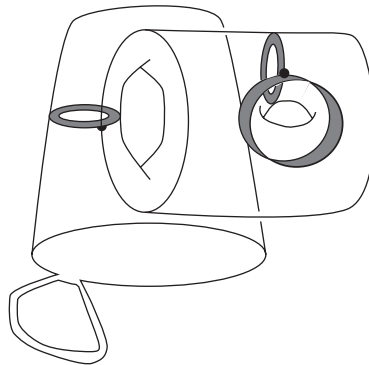

Fig. 8. A grope cobordism with pushing annuli.

The (capped) gropes we have just described have a single boundary circle, a fact that was convenient in the inductive definitions. But in general we allow (capped) gropes with an arbitrary closed 1-manifold as boundary. Such gropes are obtained from a grope as above by deleting open disks from the bottom surface stage. In particular, the relevant gropes for a *grope cobordism* between two knots will have two boundary components as in Fig. 1. They can also be viewed as gropes with a single boundary circle with an annulus attached as in Fig. 8. By definition, removing disks from the bottom stage does not alter the corresponding rooted tree, and adding caps does not change the boundary of the grope.

2.2. Grope cobordism of knots in 3-manifolds

Fix an oriented 3-manifold M and recall the basic Definition 1 from the introduction. Let \mathcal{K}_M be the set of oriented knot types, i.e. isotopy classes of oriented knots, in M .

Definition 12. Two knot types K_1 and K_2 in \mathcal{K}_M are *grope cobordant* if there is an embedding of a grope G with two boundary components into M so that the restrictions of the embedding to the two boundary components represent the knot types K_i . The grope G is also called a *grope cobordism* between K_1 and K_2 . Only the orientation of the bottom stage of G is relevant.

It is essential to note that the two boundary components of a grope cobordism may link nontrivially in M . Gropes have natural complexities associated to them. One way to make this precise is used in our main results, Theorems 2 and 3:

Definition 13. Consider $K_1, K_2 \in \mathcal{K}_M$ and fix an integer $c \geq 2$.

- (a) K_1 and K_2 are *grope cobordant of class c* if there is a grope cobordism of class $\geq c$ between them.
- (b) If there is a grope cobordism G of class c between K_1 and K_2 which extends to a map of a capped grope, such that the (interiors of the) caps are embedded disjointly and only intersect G along the bottom stage, then K_1 and K_2 are called *capped grope cobordant of class c* .

Remark. If we do not allow the caps to intersect the grope body in (b) then one can do surgery on the grope (along a choice of caps) to turn it into an annulus, implying that K_1 and K_2 are isotopic. Therefore, one has to somehow weaken the notion of an embedded capped grope.

In dimension 4 one considers *proper immersions* of a capped grope [8, Section 2.2]. This means that the grope body is embedded, the caps are disjoint from the body, but the caps can self-intersect and intersect each other. However, this notion cannot be useful in dimension 3 because of Dehn’s lemma: Immersed disks in 3-manifolds can usually be promoted to embedded disks, thus again giving an isotopy between K_1 and K_2 in our context.

This is the reason why we picked the above Definition (b). Asking that the caps only intersect the bottom stage simplifies the discussion, and is inspired by dimension 4, where one can always *push down* intersections along the grope [8, Section 2.5]. It turns out that in our three-dimensional discussion the same exact statement is true:

There is another natural definition of “capped”, as suggested by the above remark, but this turns out to be the same as the one we give:

Theorem 14. *Two knot types are capped grope cobordant of class c if and only if there is a grope cobordism of class c with disjointly embedded caps (intersecting the grope body in an arbitrary way).*

The proof of this theorem is much more difficult than in dimension 4 and it requires a careful analysis of all the steps in the proof of Theorem 2. We leave this proof to the interested reader.

We were so careful about *knot types* versus actual knots in Definition 12 because we wanted the following Lemma to hold. Recall that not even the relation “two knots cobound an embedded annulus” is an equivalence relation on the space of knots. Therefore, one needs to work modulo isotopy all along.

Lemma 15. *The relations (a) and (b) are equivalence relations on \mathcal{K}_M .*

Proof. Symmetry holds by definition. An annulus can be used to produce a grope of arbitrary class by gluing a trivial standard model into a puncture. Thus annuli can be used to demonstrate reflexivity in all cases. Transitivity should follow from gluing two grope cobordisms together. This can be done ambiently in M but extra care has to be taken to keep the glued grope embedded. For case (a) it can be seen as follows.

One proves by induction on the number of surface stages that a grope cobordism $G \subset M^3$ can be isotoped arbitrary close to a one-dimensional complex $g \subset G$. One may assume that this *spine* g contains all the tips of the grope and *one* boundary circle $\partial_0 G$. Since we may use a strong

deformation retraction of G onto g , the spine g (and in particular, $\partial_0 G$) is not moved during the isotopy. However, the other boundary circle $\partial_1 G$ then undergoes quite a complicated motion and ends up running parallel to all of g . This means that in the following we have to be careful about introducing crossing changes on g because that might change the knot types of *both* boundaries of G .

To prove transitivity of grope cobordism, we assume that two grope cobordisms $G, G' \subset M$ of class c are given with the knots $\partial_0 G$ and $\partial_0 G'$ being isotopic. After pushing long enough towards the spines g, g' , we may assume that G and G' are disjointly embedded. This isotopy does not change the knot types on the boundaries of the gropes, even though it may change the 4 component link type of these boundaries (but that is irrelevant for our purposes). We now use our assumption and start moving the knots $\partial_0 G$ and $\partial_0 G'$ closer to each other until they are parallel. At this point, we have to be careful not to change the knot types of $\partial_1 G$ and $\partial_1 G'$, e.g. we cannot just arbitrarily push $\partial_0 G$ around in M . In fact, as pointed out above, $\partial_0 G$ may *not* cross g at all, whereas it can cross g' without changing any knot types. The same applies vice versa to $\partial_0 G'$.

To avoid changing our knot types, we first embed an isotopy between $\partial_0 G$ and $\partial_0 G'$ into an ambient isotopy and run it until these knots are parallel, but with possibly parts of g, g' still sitting in between them. Then we push g across $\partial_0 G'$ and g' across $\partial_0 G$ until $\partial_0 G$ and $\partial_0 G'$ are honestly parallel in M . Finally, we consider tiny thickenings of the newly positioned g and g' to gropes and glue them together using our parallelism. This may require twisting the annular region around, say $\partial_0 G$, so that the gluing in fact produces an embedded grope of class c as desired. Notice that the twisting does not affect the isotopy class of $\partial_0 G$ or $\partial_1 G$.

Now we turn to case (b), i.e. transitivity of capped grope cobordism. We use the same notation as in the previous case. In addition, we denote by C_1, \dots, C_n the caps of the grope G . By definition, the boundaries ∂C_i are the tips of the grope and hence contained in the spine g . Hence the isotopy which pushes G towards the spine g can be done relative to ∂C_i and we decide to do this isotopy with *all of* C_i fixed. This implies that the relevant data are the disjointly embedded caps C_i (except for the usual intersection points on ∂C_i), together with the spine g which intersects the interiors of the caps.

Next we implement the assumption that the caps only intersect the *bottom* stage of the original grope G . Since $g \subset G$ this will still be true for a tiny neighborhood of g in G , which we now proceed to call G . By general position, the intersections of this thin grope G with the interiors of the caps are thus given by short arcs which run either from $\partial_1 G$ to $\partial_1 G$, or from $\partial_0 G$ to $\partial_1 G$. The case $\partial_0 G$ to $\partial_0 G$ does not occur because we chose $\partial_0 G$ to be part of the spine g .

Before proceeding with the argument, we devote a paragraph to what happens if a cap were allowed to intersect higher stages of the original grope. Then the intersections with the thin grope G would not be short arcs but rather certain univalent trees which represent a normal slice through a grope. For example, for each intersection with the second stage one would see a small H-shaped tree in the cap, and the four univalent vertices of the H would lie on $\partial_1 G$. This can be illustrated in Fig. 2 (which is not capped). The second surface stage is the big evident Seifert surface with two dual bands. An intersection of some disk through one of these bands also picks up intersections with the grope's bottom stage, which has one band which traces around the boundary of the second stage. Similarly, for each intersection of a cap with the r th stage of the grope one would see a small tree with $(2^r - 2)$ trivalent vertices and 2^r univalent vertices (which would lie on $\partial_1 G$). Thus the topology of these intersections distinguishes the different stages of the grope. In the following, we

shall refer to all such intersections with stages of the grope above the bottom as “H-shaped”. Only the bottom stage produces arcs of intersections, and only in this case can the preferred boundary $\partial_0 G$ appear in the interior of a cap.

Now consider two capped gropes of class c with caps C_i respectively C'_j and grope bodies G, G' which we already assume to be pushed close to the spines g, g' (keeping the caps constant). We then do the same move as in the uncapped case, making $\partial_0 G$ and $\partial_0 G'$ parallel in M . This can be done keeping the caps constant because $\partial_0 G$ and ∂C_i are disjoint parts of g , and similarly for g' . After twisting an annulus as before, we may glue the grope bodies along the common boundary $\partial_0 G$ to obtain an embedded grope $G \cup G'$ of class c . The intersection arcs of the caps with the glued up annular regions (around $\partial_0 G$ and $\partial_0 G'$) now all run from $\partial_1 G$ to $\partial_1 G'$, hitting the intersection $G \cap G' = \partial_0 G$ once on the way. These are intersections of the caps with the new grope’s bottom stage, and hence are allowed.

We need to clean up the intersections of the caps which intersect each other and also the higher stages of the new grope. These intersections are totally arbitrary, except the two sets of caps are disjoint and the C_i caps avoid the higher stages of G and the C'_j caps avoid the higher stages of G' . A consequence of the first fact is that there are no triple points of intersection among the caps. After pushing little fingers across the boundary of the caps, there are no circles of double points, but we gain some new intersections of caps C_i with a top stage of G' and vice versa. Now consider one cap C_i and recall that near its boundary a normal slice of G is H-shaped, with $\partial_1 G$ on the univalent vertices. This implies that we may push every intersection that does not contain this knot $\partial_1 G$ off C_i and across the normal slice. In particular, all intersections with C'_j can be removed this way: Every ribbon and clasp intersection can be pushed across the boundary of C_i because only crossing changes between $\partial_1 G$ and $\partial_1 G'$ are introduced (and all knot types stay the same). Doing this clean up procedure with each of the caps C_i , we end up with disjointly embedded caps for $G \cup G'$, but possibly intersecting all stages of this grope.

The next step, now that all the caps are disjoint, is to remove intersections of the caps C_i with higher stages of the grope G' , and vice versa. Suppose that a cap C_i intersects higher stages of G'_i . It will do so along some univalent graph, but any univalent vertices are part of $\partial_1 G'$. Thus we may push all of these intersection out of the cap C_i and across the normal slice, introducing crossings of $\partial_1 G'$ and $\partial_1 G$, which do not change the isotopy class of either. Similarly, higher stages of G will only intersect caps C'_j so that they can be pushed off again without changing the knot types. This leads to a capped grope cobordism of class c between $\partial_1 G$ and $\partial_1 G'$ and thus transitivity is proven. \square

2.3. Grope refinement

We will presently refine the notion of grope cobordism by prescribing the rooted tree type of the grope instead of just restricting its class. However, it is technically easier to just do this for genus one gropes. Therefore, we first discuss how to reduce to this case by presenting the three-dimensional version of a technique discovered by Krushkal [16] to refine gropes in 4-manifolds into genus one gropes.

Proposition 16. *Every (capped) grope cobordism G in M can be realized as a sequence of (capped) genus one grope cobordisms G_i . Moreover, the rooted tree types of G_i can be obtained from the*

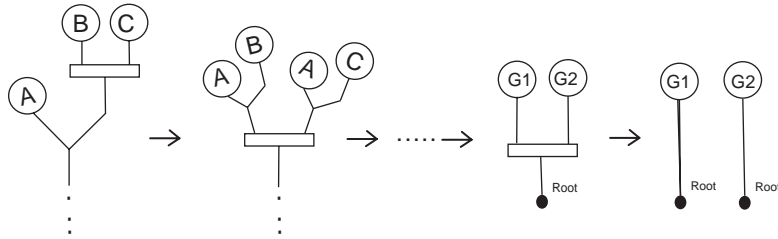

Fig. 9. Pushing genus down the grope.

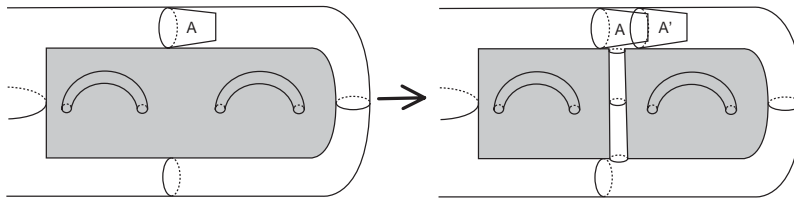

Fig. 10. Krushkal's grope refinement.

rooted tree-with-boxes of G by iteratively applying the algorithm of Fig. 9 to push boxes (or genus) down to the bottom.

Proof. The way to push genus down the grope is shown in Fig. 10. It shows how to trade genus of a stage with the previous stage. You run an arc from the previous stage across the current stage in such a way as to separate the genus. Then run a small tube along the arc, increasing the genus of the previous stage. The dual stage is depicted by A in the picture. In order to make the tree type of the grope behave as on the left of Fig. 9, we push off a parallel copy of A . (In the capped situation, A will have caps, which should be included when pushing off a parallel copy. The new caps will also only intersect the bottom stage.) The parallel copies of A may intersect, a fact we have depicted in Fig. 10. (In 4 dimensions, however, they do not intersect if the grope is framed, so there is no further problem.)

However, we can still iteratively apply this procedure, despite the self intersections until all the genus is at the bottom stage. But we can further subdivide the resulting grope cobordism with genus g at the bottom stage into a sequence of g cobordisms with genus one at the bottom stage, as on the right of Fig. 9. We claim that each genus one grope cobordism G_i is embedded. This can be seen schematically in Fig. 11 which is supposed to show that the only intersections that arise come from parallel copies A and A' which will eventually belong to distinct gropes G_i and G_j . This follows from the fact that the tree type of the gropes only changes as in Fig. 9 which implies that at each step parallel copies correspond to distinct branches emanating out of a box. In the last step of the pushing down procedure, these different branches actually become distinct gropes G_i .

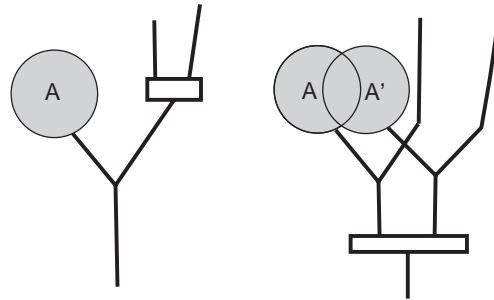

Fig. 11. Schematic of self-intersections arising from grope refinement.

If there are caps, note that they will still only intersect the bottom stage of the grope G_i they are attached to, even though they may intersect higher stages of G_j , $j \neq i$. \square

2.4. \mathcal{T} -grope cobordism of knots in 3-manifolds

We have seen in the previous section that it is enough to consider genus one grope cobordisms in a 3-manifold M . However, the genus of the bottom surface should not be restricted to one.

Definition 17. Let \mathcal{T} be a rooted trivalent tree. If a grope G can be cut along the bottom surface into genus one gropes of type \mathcal{T} then we call G a \mathcal{T} -grope. Adding caps to all the tips of G makes it a capped \mathcal{T} -grope.

This definition is introduced to make the following notions of grope cobordism in M into equivalence relations by composing cobordisms. This is much more natural than taking the equivalence relation *generated by* genus one grope cobordisms of fixed tree type. Transitivity is potentially useful for applying 3-manifold techniques to the study of Vassiliev invariants.

Definition 18. Let $K_1, K_2 \in \mathcal{K}_M$ be oriented knot types and \mathcal{T} be a rooted trivalent tree.

- (a) K_1 and K_2 are \mathcal{T} -grope cobordant if there is an embedding of a \mathcal{T} -grope into M whose two boundary components represent K_1 and K_2 .
- (b) K_1 and K_2 are capped \mathcal{T} -grope cobordant if there is a mapping of a capped \mathcal{T} -grope into M whose boundary components are K_1 and K_2 . This mapping is required to be an embedding except that the (disjointly embedded) caps are allowed to intersect the bottom stage surface of the grope.

The following result was implicitly proven in Lemma 15:

Lemma 19. *The relations (a) and (b) are equivalence relations.*

Corollary 20. *The equivalence relation generated by genus one (capped) \mathcal{T} -grope cobordism is exactly the same as (capped) \mathcal{T} -grope cobordism (where the bottom stage has arbitrary genus).*

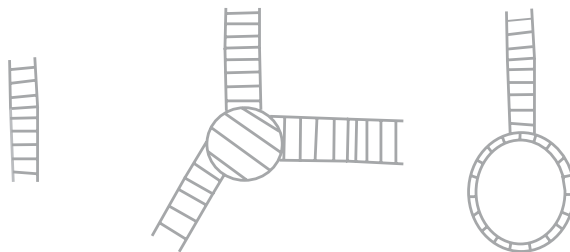

Fig. 12. An edge, a node and a leaf.

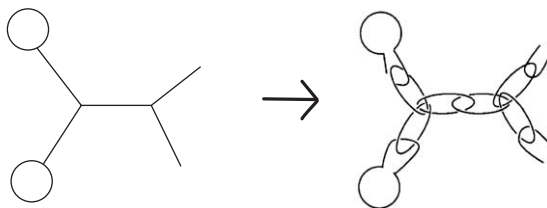

Fig. 13. Associating a link to a clasper.

3. Claspers

3.1. Basic definitions

We recall the main notions from Habiro's paper [14], making an attempt to only introduce the notions relevant to grope cobordism and the relation to finite type invariants. In particular, we completely avoid all the boxes in claspers since we can always reduce to this case.

A clasper is a compact connected surface made out of the following constituents (Fig. 12):

- *edges* are bands that connect the other two constituents,
- *nodes* are disks with three incident edges, and
- *leaves* are annuli with one incident edge.

Thus a clasper collapses to a univalent graph such that the nodes become one type of trivalent vertex and each leaf has exactly one trivalent vertex of a second type. However, it is common to think of this second type as a univalent vertex (ignoring the leaves momentarily) and to only consider those vertices as trivalent that come from nodes. If Γ is the underlying univalent graph of a clasper (again ignoring the leaves), then we call it a Γ -clasper, and we call Γ the *type* of the clasper. A *tree clasper* is a clasper whose type is a tree.

Assume a clasper C is embedded in a 3-manifold M . Then one can associate to it a framed link L_C in M by replacing each edge by the (positive) Hopf-link and each node by a 0-framed (positive) Borromean rings, see Fig. 13. The framing (slope along which to attach a 2 handle) of each link component associated to a leaf is determined in the obvious way by the framing of the leaf. There, and in most figures to follow, only the spine of the clasper is drawn and the blackboard framing

is used to thicken it to a surface. Two thickenings differ by twistings of the bands and annuli, and also by reordering the three edges incident to a node. Note that a 0-framing is well defined for components that lie in small balls, usually the neighborhoods of a trivalent vertex or edge.

If one of the leaves of a clasper C bounds a disk into $M \setminus C$, we call it a *cap* because of the relation with gropes explained below. In the presence of a cap, surgery on the framed link L_C does not change the ambient 3-manifold M . This implies that if C lies in the complement of a knot K , then surgery on L_C gives a new knot K_C in the same manifold M , the *surgery of K along C* . Fig. 3 shows how one can obtain a Fig. 8 knot as surgery on the unknot along a Y-clasper.

Definition 21. A clasper C is called *capped* if the leaves bound disjoint disks (the caps) into $M \setminus C$. If it happens that only some of the leaves of C bound disks into $M \setminus C$ then we only call those disks *caps* if they are embedded disjointly.

The following notions for claspers all depend not only on the position in M but also on the relative position with respect to a knot K .

Definition 22. Let C be a clasper in the complement of a knot $K \subset M^3$.

- C is a *rooted* clasper if one leaf has a cap which intersects K transversely in a single point. In particular, the surgery K_C is defined as a knot in M . The particular leaf becomes also the root of the underlying type of the clasper.
- Conversely, if one has given a *rooted univalent* graph Γ , then a Γ -clasper is a rooted clasper of type Γ .
- If Γ is a rooted univalent graph then a capped Γ -clasper is a capped clasper of type Γ such that the cap corresponding to the root intersects the knot K transversely in a single point.
- C is a *simple* clasper if it is capped such that each cap intersects the knot transversely in a single point.
- There are several degrees associated to claspers. By definition, these are the degrees of the underlying type (which replaces the leaves by univalent vertices). We have mentioned three different possibilities in the introduction, the Vassiliev, loop and grope degrees.
- For any such degree deg , the equivalence relation on \mathcal{H}_M defined by $\mathcal{F}_k^{\text{deg}}$ in the introduction is generated by simple clasper surgeries of degree $\text{deg} \geq k$.

Remark. The notions of rooted and capped claspers are new and replace notions like admissible, strict and special in [14]. We feel that descriptive names are very important.

The surgery on univalent graphs described in the introduction is by definition given by clasper surgery on *the simple* clasper defined by the graph. Thus simple clasper surgeries define the relevant quotients of \mathcal{H} defined in the introduction and used in our main Theorems 2 and 3.

There are many identities among claspers, perhaps the most basic of which is as follows. Let the clasper C' be obtained from C by cutting an edge and inserting a Hopf-linked pair of tips as in Fig. 14. Then surgery on C is equivalent to surgery on C' . This follows from standard Kirby calculus, or more precisely from Morse canceling the Hopf-pair viewed as a 1-handle and a 2-handle in the four-dimensional world.

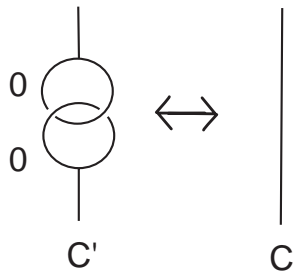

Fig. 14. First Morse cancellation.

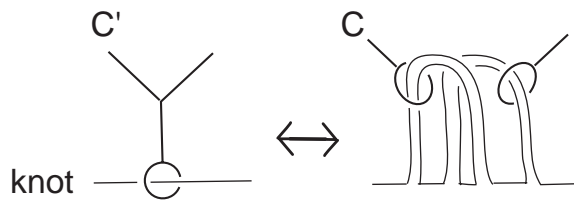

Fig. 15. Second Morse cancellation.

A second often used Morse cancellation occurs if one thinks of one of the three Borromean rings as a 1-handle and cancels it with a 2-handle coming from an adjacent leaf as in Fig. 15.

3.2. *Claspers and gropes*

In this section we show that a three-dimensional grope cobordism of genus one is the same as a rooted tree clasper surgery. The rooted tree type of the clasper is the same as the rooted tree type of the grope. We first outline the construction of a clasper, given a grope cobordism, and subsequently give the reverse construction.

Theorem 23. *Let \mathcal{T} be a rooted trivalent tree. Then a \mathcal{T} -grope cobordism of genus one can be realized by a \mathcal{T} -clasper surgery, supported in a regular neighborhood of the grope.*

Remarks.

- The clasper we obtain from the grope is not unique. This indeterminacy leads to a set of identities on claspers.
- This theorem could be strengthened to give a correspondence between gropes with genus and claspers with boxes, but for clarity we do not consider this greater generality.

Theorem 23 will follow from the following relative version.

Theorem 23'. *Let H be an oriented 3-manifold with two distinguished points x_0 and x_1 on its non-empty boundary. Let α and $\tilde{\alpha}$ be two properly embedded arcs in H , with disjoint interiors,*

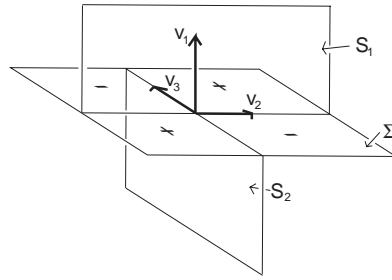
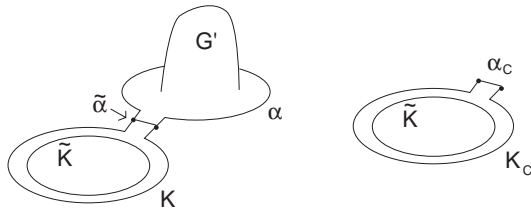

Fig. 16. Positive quadrants.

running from x_0 to x_1 . Suppose $\alpha \cup \tilde{\alpha}$ bounds a \mathcal{T} -grope in H . Then there is a \mathcal{T} -clasper C embedded in $H \setminus \alpha$, with root a meridian to α , such that α_C is isotopic to $\tilde{\alpha}$ rel boundary.

To see that this implies Theorem 23, recall from Fig. 8 that a grope cobordism between knots K and \tilde{K} can be thought of as a grope G' with one boundary component, band summed with an annulus with core (say) \tilde{K} . Consider the handlebody H which is a regular neighborhood of G' . Then K intersects H in an arc α and the boundary ∂H hits the cobordism along an arc $\tilde{\alpha}$. Together $\tilde{\alpha} \cup \alpha$ bound the grope G' and hence there is a \mathcal{T} -clasper C in H which takes α to $\tilde{\alpha}$ rel boundary. In a regular neighborhood of the original cobordism, C therefore takes K to a parallel copy of \tilde{K} :



Proof of Theorem 23' (Construction of the unframed clasper). Assume the grope is augmented with pushing annuli. Then each surface stage of the grope has two surfaces which attach to it, and these are either pushing annuli or higher surface stages of the grope. In order to simplify terminology, refer to both these types of surface as *higher surfaces*.

Let Σ be a surface stage of the embedded grope, with higher surfaces S_1 and S_2 attaching to it. Then $S_1 \cap S_2$ is a point s_0 , and in a neighborhood of this point s_0 , $S_1 \cup S_2$ divides Σ into four quadrants. We distinguish two of these as follows. Let (v_1, v_2, v_3) be an ordered basis of the tangent space $T_{s_0}M$ constructed as follows. Let v_1 be transverse to Σ and pointing into S_1 . Choose v_2 tangent to $\Sigma \cap S_1$. Choose v_3 tangent to $\Sigma \cap S_2$ in such a way that $v_1 \wedge v_2 \wedge v_3$ is a positive orientation of \mathbb{R}^3 . The two quadrants lying between v_2 and v_3 and between $-v_2$ and $-v_3$ are called *positive quadrants*, see Fig. 16. There were two choices in selecting v_1, v_2, v_3 , namely which surface is called S_1 (v_1 versus $-v_1$) and which direction of $\Sigma \cap S_1$ the vector v_2 points along (v_2 versus $-v_2$). Changing v_2 to $-v_2$ will also change v_3 to $-v_3$ in order to preserve the orientation $v_1 \wedge v_2 \wedge v_3$. Therefore, the positive quadrants do not change. If one changes v_1 to $-v_1$, then the role of v_2 and v_3 is reversed. But $-v_1 \wedge v_3 \wedge v_2$ is still positive, and hence the positive quadrants are those between v_3 and v_2 , as before.

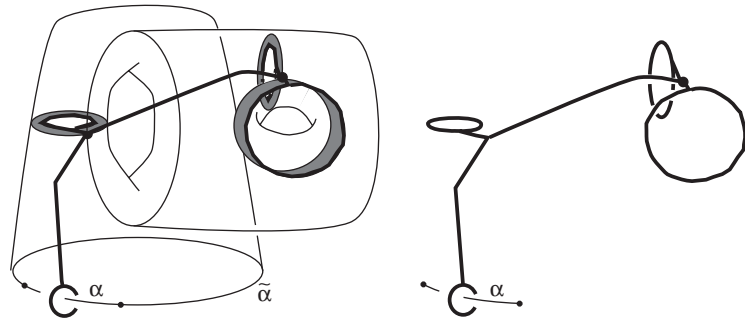

Fig. 17. Associating an unframed clasper to a grope.

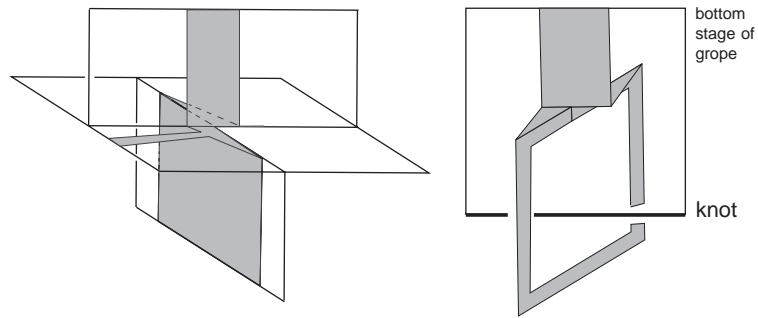

Fig. 18. Extending the framing to nodes and to the root leaf.

We are now ready to define the unframed clasper C^u in $H \setminus \alpha$. The leaves include those ends of the pushing annuli which are not attached to anything. (These are the *tip leaves*.) There is one more leaf which is a meridian to α . (This is the *root leaf*.) This leaf punctures the bottom stage of the grope in a single point. Every surface stage contains a node of C^u where the higher surfaces intersect. Hence each pushing annulus has a node on its boundary. This is connected by an embedded arc in the annulus to the tip leaf at the other end. Each surface stage except the bottom stage contains two nodes: one on the boundary and one in the interior. Connect these by an embedded arc in the surface stage whose interior misses the attaching regions for the higher surfaces, and such that it emanates from the interior node in a positive quadrant. Finally connect the node on the bottom stage to the intersection of the root leaf with the stage by an embedded arc whose interior avoids the attaching regions for the higher surfaces, and which emanates from the node in a positive quadrant.

Fig. 17 shows the construction for a grope of class 3.

3.2.1. Figuring out the framing

The tip leaves of the clasper have obvious framings along the annuli they are contained in. Similarly each edge has an obvious framing as a subset of a surface.

Framing a node is depicted in Fig. 18. Notice that the edge on the surface stage is approaching via a positive quadrant. We glue together the perpendicular framings of the two edges associated to

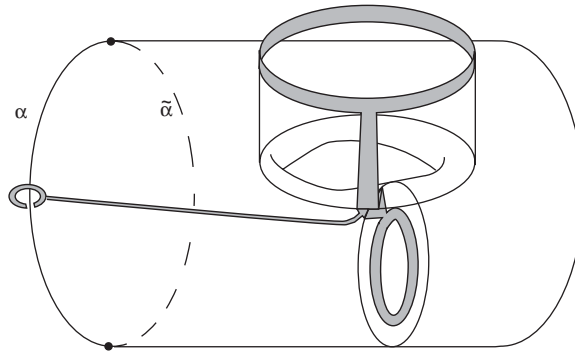

Fig. 19. A standard model of (Σ^a, C) .

the higher surfaces with two triangles inside the positive quadrants. The framing of the approaching edge is naturally glued to one of these triangles.

We can frame the root leaf using the meridional disk it bounds. This needs to be glued to the perpendicular framing of the incident edge. This is shown in Fig. 18, where we again use two triangles to glue up different parts of the clasper. Notice that this is the only place at which the clasper is not a subset of the grope but the triangles are defined as in the discussion of positive quadrants.

3.2.2. Proving that this works

We proceed by induction on the number of surface stages, the base case being a surface of genus one. Let Σ be the base surface, Σ^a the augmented surface and C the clasper we just constructed.

Lemma 24. *The pair (Σ^a, C) in H can be realized as the restriction of an orientation preserving embedding into H of the genus two handlebody which is a regular neighborhood of the standard picture given in Fig. 19.*

Proof. By definition Σ^a is an embedding of the given picture, ignoring the clasper C . We precompose this embedding with a suitable orientation preserving automorphism of the regular neighborhood which fixes $\partial\Sigma$ pointwise and Σ^a setwise. Clearly the edges on the pushing annuli can be straightened out by twists supported in the annuli’s interiors, and these twists extend to the regular neighborhood. Hence it suffices to straighten out the edge η which runs along Σ . Let the annuli be called S_1 and S_2 . The interior of η lies in the (open) annulus $\Sigma \setminus (\partial S_1 \cup \partial S_2 \cup \partial\Sigma)$. It can therefore be straightened via Dehn twists. It also can approach $\partial S_1 \cup \partial S_2$ in two ways: by the two positive quadrants. There is an automorphism of Σ^a rel $\partial\Sigma$ taking one quadrant to the other. This is depicted in Fig. 20. \square

Because of this lemma, it suffices to check that $\alpha_C = \tilde{\alpha}$ in the standard model of Fig. 19. (We need the embedding to preserve orientations because an orientation is required to associate a well-defined link to the clasper.)

The standard model is redrawn in Fig. 21, with heavy lines deleted from the ambient 3-ball to make it a regular neighborhood of Σ . The clasper is cleaned up a little bit in the second frame, and

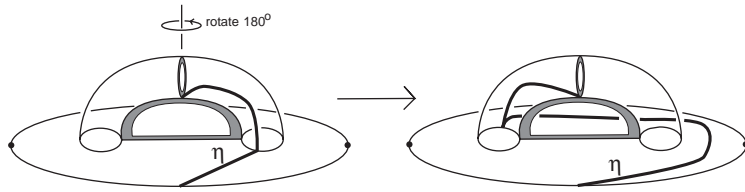

Fig. 20. Exchanging positive quadrants.

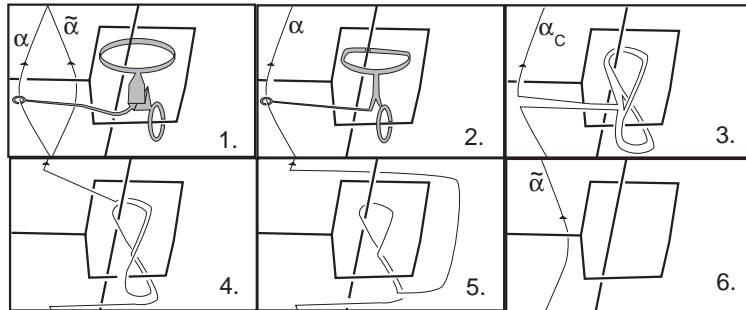

Fig. 21. The base case.

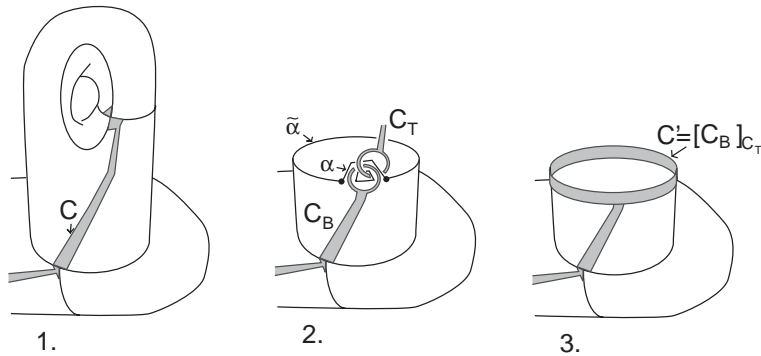

Fig. 22. The inductive step.

then the second Morse cancellation from Fig. 15 is used to produce α_C in the third frame. Finally, an isotopy moves α_C to the knot $\tilde{\alpha}$ as shown in the remaining frames.

Now for the inductive step. This follows from Fig. 22. Pictured is a top stage of the grope and part of the clasper C we constructed. In frame 2 we have broken the edge of the clasper that lies on the top surface into two claspers C_T and C_B . This is the first Morse cancellation from Fig. 14 and gives $\alpha_C = (\alpha_{C_B})_{C_T}$. By induction we know that the clasper surgery C_T has the pictured effect on C_B since the indicated section, β of the leaf of C_B cobounds the surface stage corresponding to the clasper C_T with the pictured arc $\tilde{\beta}$. This gives rise to a new clasper $C' = (C_B)_{C_T}$ which corresponds to the grope which is gotten by forgetting about the indicated surface stage. α and $\tilde{\alpha}$ still bound this new grope, and by induction $\tilde{\alpha} = \alpha_{C'}$ which we saw is equal to α_C . \square

We next come to the converse of Theorem 23.

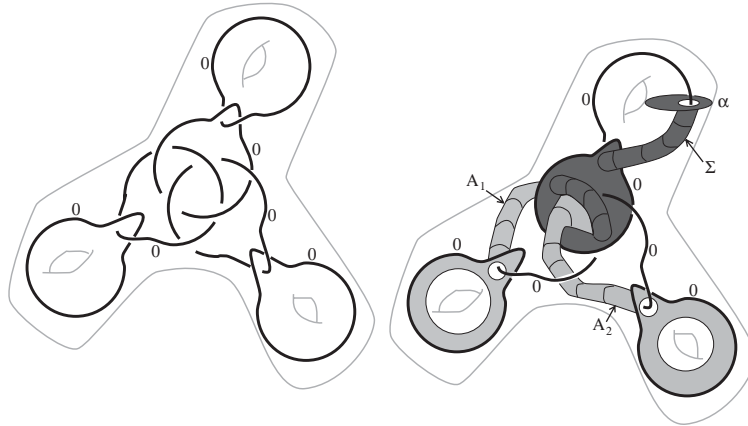

Fig. 23. The proof of Proposition 27.

Theorem 25. *Let \mathcal{T} be a rooted trivalent tree. Then every \mathcal{T} -clasper surgery is realized by a \mathcal{T} -grope cobordism of genus one, with the grope being in a regular neighborhood of the clasper and knot.*

As before, it will be more convenient to prove a relative version, but first we introduce some notation.

Definition 26. If C is a clasper in a 3-manifold M , let M_C denote the 3-manifold which is obtained by surgery on C .

Theorem 26'. *Let N be a regular neighborhood of a \mathcal{T} -clasper C . A meridian on ∂N of the root leaf bounds a properly embedded \mathcal{T} -grope in N_C .*

To see that Theorem 26' implies Theorem 25, suppose a \mathcal{T} -clasper C has a root leaf on the knot K . Let \tilde{K} , be the knot in $M \setminus C$ where the intersection with the root leaf's disk has been removed by a small perturbation which pushes K off that disk. Then K and \tilde{K} differ by a meridian of the root leaf and hence cobound a \mathcal{T} -grope in M_C by Theorem 26'. That is K_C and \tilde{K}_C cobound a \mathcal{T} -grope in M . But $\tilde{K}_C = \tilde{K} = K$ in M , since C has a disk leaf that doesn't hit \tilde{K} .

By expanding edges of claspers into Hopf-linked pairs of leaves, Theorem 26' is easily seen to follow from the following proposition.

Proposition 27. *Let C be the unique Vassiliev degree 2 clasper, i.e the letter Y. Let N be a regular neighborhood of C . Then a meridian $\alpha \subset \partial N$ to any leaf bounds a properly embedded genus one surface in N_C . This surface can be augmented with two pushing annuli which extend to ∂N as parallel copies of the other two leaves.*

Proof. We have drawn N in Fig. 23, and replaced the clasper by 0-framed surgery on the associated link. The curve α bounds the genus one surface Σ . Note that part of Σ travels over an attached 2 handle. Two dual curves on Σ each cobound an annulus with a parallel copy of the

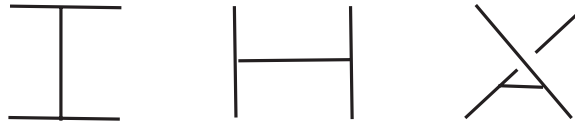

Fig. 24. IHX.

two lower leaves. These annuli are denoted A_1 and A_2 , and each also runs over an attached 2-handle. \square

3.3. Geometric IHX and half-gropes

In this section we answer the question whether grope cobordism is generated by half-gropes, just like the lower central series is generated by right normed commutators. Only for this purpose do we use concepts developed in [14], which have not been covered in this paper. Denote by \mathcal{H}_k the rooted tree type that corresponds to a genus one half-grope of class k , as in Fig. 6.

Theorem 28. *Let K_1, K_2 be oriented knots in a 3-manifold M .*

- (a) K_1 and K_2 are grope cobordant of class k if and only if there is an \mathcal{H}_k -grope cobordism between K_1 and K_2 .
- (b) K_1 and K_2 are capped grope cobordant of class k if and only if there is a capped \mathcal{H}_k -grope cobordism between K_1 and K_2 .

The proof of this result uses a very nice unpublished result of Habiro, which is a geometric realization of the IHX-relation for capped tree claspers.

Theorem 29 (Habiro). *Let I, H and X denote univalent trees which only differ at one location as in Fig. 24. Given an embedded capped clasper Γ_I of type I on a knot K , then there exist capped clasps Γ_H and Γ_X of type H and X , such that $K_{\Gamma_I} = (K_{\Gamma_H})_{\Gamma_X}$.*

To prove this theorem, we first need the following:

Proposition 30. *Let K be an oriented knot in a 3-manifold M , \mathcal{T} a rooted trivalent tree, and E an edge of \mathcal{T} :*

- (a) *If Γ is a capped clasper on K of type \mathcal{T} then there is a knot \tilde{K} , and two clasps Γ_0 and Γ_1 of type $\mathcal{T} \setminus E$ on \tilde{K} , such that Γ_1 is gotten from Γ_0 by a single finger move, the guiding arc of which corresponds to the edge E*

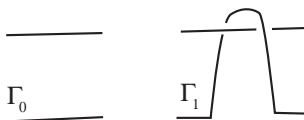

and such that $\tilde{K}_{\Gamma_0} = K$ and $\tilde{K}_{\Gamma_1} = K_{\Gamma}$.

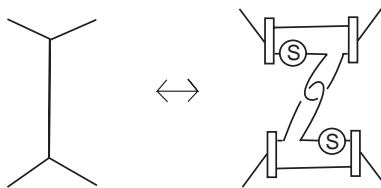

Fig. 25. An inverse to Habiro's move 12.

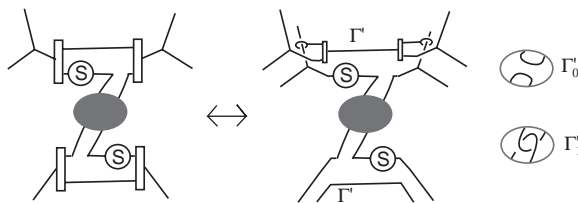

Fig. 26. A zip move.

(b) Conversely, start with two claspers Γ_0, Γ_1 of type $\mathcal{T} \setminus E$ on K that differ by a finger move as above. Then there is a clasper Γ of type \mathcal{T} such that

$$K_{\Gamma_1} = (K_{\Gamma_0})_{\Gamma}.$$

Proof. Part (a) is proven similarly to Proposition 4.6 of Habiro [14], using a sort of inverse to Habiro's move 12, which is the identity in Fig. 25.

Now consider Fig. 26. One can plug either of the two pairs of arcs (clapsed respectively unclapsed) on the right of Fig. 26 into the shaded region. After applying Habiro's version of the zip construction (using claspers with boxes) as shown in the figure, one obtains a (disconnected) clasper with boxes Γ' , and two claspers Γ'_0 and Γ'_1 , containing the S -twists. Whether one gets Γ'_0 or Γ'_1 depends on what one plugs into the shaded region.

There is an important subtlety here. Surgery along a rooted clasper (without boxes by definition) only affects the pair (M, K) inside a regular neighborhood of the clasper and its root disk, and is fixed outside of this neighborhood. On the other hand, for claspers with boxes, one may have to choose many roots, modifying the pair (M, K) inside a regular neighborhood of the clasper and its root disks. In Fig. 26, these added roots must include some of the little "lassoes" coming out of the boxes. Hence the clasper Γ' actually modifies Γ'_1 and Γ'_2 to two claspers $\Gamma_i = (\Gamma'_i)_{\Gamma'}$ for $i = 1, 2$. Note that since Γ'_i differ by a finger move, so do Γ_i .

By the above move $K_{\Gamma} = K_{\Gamma' \cup \Gamma'_1} = (K_{\Gamma'})_{\Gamma_1}$. On the other hand by Habiro's move 4, $K = K_{\Gamma' \cup \Gamma'_2} = (K_{\Gamma'})_{\Gamma_2}$. Thus we have found a knot $\tilde{K} := K_{\Gamma'}$ in S^3 and two claspers Γ_i which differ by a finger move in S^3 and satisfy the desired identities: $\tilde{K}_{\Gamma_0} = K$ and $\tilde{K}_{\Gamma_1} = K_{\Gamma}$.

Part (b) is Proposition 4.6 of Habiro [14] and the proof is essentially the reverse of the above argument. \square



Fig. 27. The claspers Γ_I, Γ_0 and Γ_1 , from left to right. Recall $K = \tilde{K}_{\Gamma_0}$.

Proof of Theorem 29. We only prove the cases when the tree I has at least 6 edges. The other case is similar.

By Part (a) of Proposition 30 a clasper surgery on K along Γ_I can be thought of as changing the clasper surgery on some knot \tilde{K} from Γ_0 to Γ_1 as in Fig. 27. Now apply part (b) of Proposition 30 twice as follows:

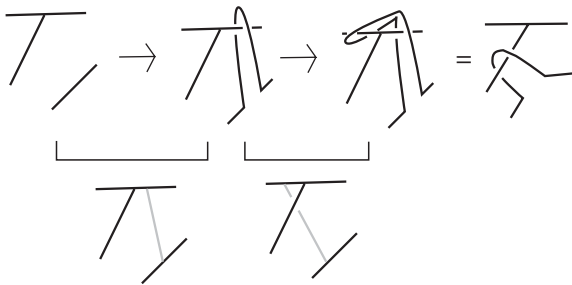

This implies our claim $(K_{\Gamma_H})_{\Gamma_X} = ((\tilde{K}_{\Gamma_0})_{\Gamma_H})_{\Gamma_X} = \tilde{K}_{\Gamma_1} = K_{\Gamma_1}$. \square

Corollary 31. Recall that \mathcal{H}_k is the simplest possible rooted tree of class k .

- (a) Capped \mathcal{H}_k -clasper surgeries generate all capped tree clasper surgeries of Vassiliev degree (=class) k .
- (b) \mathcal{H}_k -clasper surgeries generate all rooted tree clasper surgeries of Vassiliev degree k .

Proof. (a) Any tree of class k can be changed into a sequence of \mathcal{H}_k -trees using geometric IHX. This can be proved by introducing the following function on rooted class k trees $\tau: l(\tau)$ is the maximum length of a chain of edges. Given τ , consider a chain of maximal length c , and suppose it misses some internal vertices. Let v be an internal vertex of distance 1 from c . Then, by geometric IHX, this tree can be realized as a sequence of two trees with higher l :

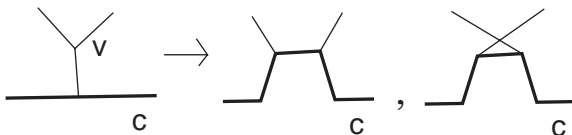

Hence we can keep applying IHX until we have a sequence of trees with maximal l , which as we have seen means that a maximal chain hits every internal vertex. This is just a rooted \mathcal{H}_k -tree.

(b) Let \mathcal{C}_k denote the set of knots related to the unknot by capped tree clasper surgeries of Vassiliev degree k . Similarly let $\mathcal{H}\mathcal{C}_k$ denote those knots which are related to the unknot by degree

k capped tree claspers whose tree type is that of the half grope. Define \mathcal{R}_k to be those knots related to the unknot by degree k rooted tree clasper surgeries, and let $\mathcal{H}\mathcal{R}_k$ be the analogous object, restricting to half grope trees. (By Theorems 2 and 3, $\mathcal{C}_k = \mathcal{F}_k^v, \mathcal{R}_k = \mathcal{F}_k^g$.)

We have the following map of short exact sequences:

$$\begin{array}{ccccccccc}
 0 & \longrightarrow & \mathcal{H}\mathcal{C}_k / \mathcal{H}\mathcal{R}_k & \longrightarrow & \mathcal{H}\mathcal{C}_k & \longrightarrow & \mathcal{H}\mathcal{R}_k & \longrightarrow & 0 \\
 \downarrow & & \downarrow_{\text{onto}} & & \downarrow_{\cong} & & \downarrow_{\text{onto}} & & \downarrow \\
 0 & \longrightarrow & \mathcal{C}_k / \mathcal{R}_k & \longrightarrow & \mathcal{C}_k & \longrightarrow & \mathcal{R}_k & \longrightarrow & 0
 \end{array}$$

and, by Part (a), the middle map is an isomorphism. By Habiro [14], $\mathcal{H}/\mathcal{C}_k$ is a group, a fact which implies that everything in the above diagram is a group (under connected sum). By the 5 lemma, the right hand map $\mathcal{H}/\mathcal{H}\mathcal{R}_k \rightarrow \mathcal{H}/\mathcal{R}_k$ is an isomorphism, as desired. Recall that all of the above quotients are defined as in the introduction, and are in particular not just quotient monoids. \square

The proof of Theorem 28 is now just an application of our translation between gropes and claspers, Theorem 4, to the above Corollary 31.

4. Proofs of the main results

4.1. Proof of Theorem 4

Part (a) follows from Theorems 23 and 25.

To see Part (b), given a cap of a grope, this will become a disk bounding the corresponding leaf of the constructed clasper, and by definition we need to arrange that its interior is disjoint from the clasper. As the cap avoids the higher stages of the grope, the only place it might hit the clasper is along the edge that connects the root leaf to the bottom stage node. Push these intersections off the end of this edge across the root leaf. This introduces new (pairs of) intersections of the cap with the knot, which are allowable.

Conversely, if a leaf of a clasper has a cap, in the constructed grope the cap will only hit the annulus part of the bottom stage. See the discussion after Theorem 26'. \square

4.2. The zip construction

To prove Theorems 2 and 3 we need a construction that will simplify a grope cobordism to a finite sequence of moves that are simple clasper surgeries. This will be provided in Theorem 35 which relies on the Habiro–Goussarov zip construction. Habiro’s version is not well suited to the present setting, since it produces claspers with boxes, the removal of which leads to complicated behavior of the edges of one of the produced claspers. We state and prove a version of the zip construction better suited to our needs. An earlier version of this paper contained an erroneous statement of the zip construction, which led to an error in the statement of the original Lemma 17 which is now replaced by Theorem 35. The original proof of Theorem 2 stays unchanged whereas the proof of Theorem 3 now has to be supplemented by using Corollary 4 of Conant [6].

Lemma 32. *The following two clasper surgeries give isotopic results.*

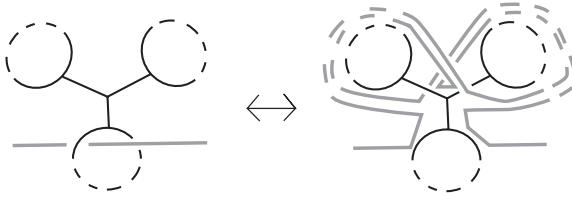

The pictured object being slid can be part of another clasper or a strand of the knot.

Proof. Write out the left-hand side clasper surgery as a surgery on the usual 6 component link corresponding to the Y-clasper. Then slide the visible part of the knot or clasper over one component of the Borromean rings. □

Corollary 33. *Given an arc of a knot, or a piece of another clasper that intersects a cap of a clasper C , then one can slide this arc or piece of clasper over C to remove the intersection point. That is, the slid piece lies in a regular neighborhood of C minus the leaf, and avoids any caps C may have.*

Proof. Break C into a union of Y-claspers and inductively apply Lemma 32. □

Let L be a leaf of a rooted tree clasper C on a knot K , and let η be a framed arc from L to itself. Cutting the leaf along η splits it into two halves.

Assertion. Surgery on C has the same effect on K as surgery on the union of two daughter claspers C_1 and C_2 , satisfying the following properties:

- (1) C_1 is identical to C except at L where only one half of L is used, and
- (2) the leaves of C_2 are parallels of the leaves of C except at L , where the other half of L is used. The edges and nodes of C_2 lie in a regular neighborhood of C_1 and avoid any caps that C_1 may have.

Note that in this construction one has a choice of which half of L is used for the almost-identical copy C_1 of C , and which half is used for the more complicated daughter C_2 .

A low degree example is shown below.

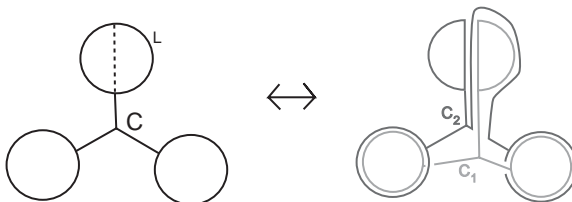

This is in [12], but their Borromean rings are oriented oppositely, so the figure should not look identical! One can also apply the technique of Proposition 6 to obtain this picture.

Proof of zip construction (i.e. of the assertion above). The statement follows from the following more general statement: Inside a regular neighborhood, N , of $C \cup \eta$, there are two claspers C_1 and C_2 as above, such that N_C is diffeomorphic rel boundary to $N_{C_1 \cup C_2}$. Notice that since C_2 avoids any caps that C_1 may have, it in particular avoids the root leaf.

We proceed by induction, the picture above serving as the base case. In the pictures that follow, the thicker lines denote a regular neighborhood of a clasper. To induct, we break the clasper C into a union of two simpler claspers as follows:

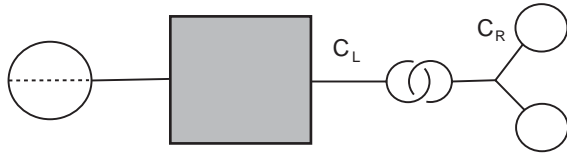

The big box is a pictorial convenience to represent an arbitrary clasper. Inductively we get the following picture:



Then using the base case on the left leaf of the right-hand clasper, we obtain

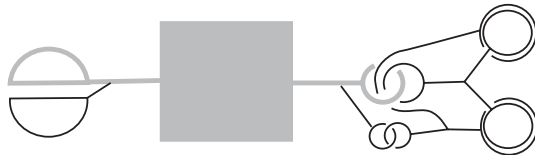

By Corollary 33 applied to the grey leaf on the right and a cancellation of the bottom Hopf pair, we get

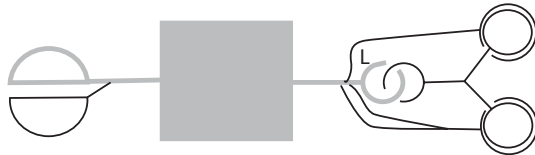

Next we would like to cancel the gray–black Hopf pair above. This requires some care because parts of C_2 run parallel to the grey leaf L . However, in our construction, C_2 avoids the caps of C_1 . Thus we can split the regular neighborhood of L apart into the leaf, plus a parallel copy of that leaf through which other claspers wander:

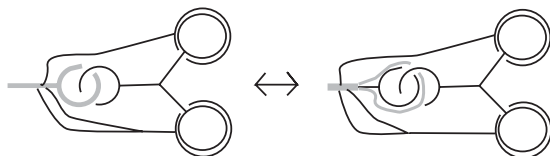

After that we apply a sequence of Corollary 33 moves to obtain a clean Hopf pair that can be cancelled. In the figure below we also push some black arcs into the grey area which after all only represents some neighborhood of the clasper:

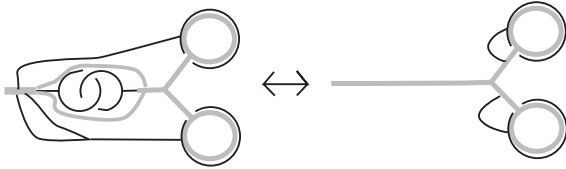

Thus we have finished the inductive step. \square

4.3. Simplifying a grope cobordism

Lemma 34. *Let C be a rooted tree clasper of type \mathcal{T} with a leaf L bounding a disk that only intersects edges of C (and is disjoint from the knot K). Then the surgery on C may be realized as a sequence of clasper surgeries along claspers C_1, \dots, C_n which come in two types:*

- (a) C_1 is identical to C , except that the leaf L is replaced by a leaf that has a cap. In particular, C_1 has type \mathcal{T} , and
- (b) C_i , for $i > 1$, have type \mathcal{T}' , where \mathcal{T}' is the tree formed from \mathcal{T} by gluing a “Y” onto the univalent vertex representing L . In particular, the degree of \mathcal{T}' is bigger than that of \mathcal{T} .

Proof. Push each intersection point of an edge with the given disk bounding L out toward the other leaves, using little fingers following the spine of the clasper C . Each such finger splits into two at a trivalent vertex of C , and stops right before a leaf (which is necessarily distinct from L). This describes a new disk D bounding L which has the property that on each edge E_i incident to a leaf $L_i \neq L$ there are several parallel sheets of D being punctured by E_i (and there are no intersections of D with edges other than E_i). If the leaf L_i happens to be the root leaf, we push these sheets over the cap of L_i , introducing intersections with the knot, but eliminating the intersections with E_i . If L_i is not the root, we add a series of nested tubes that go around L_i , trading the intersections with E_i for genus on D .

Thus L now bounds an embedded surface which intersects K but is disjoint from the clasper C . We perform the zip construction on L to segregate the knot intersections, where the first daughter C_1 will inherit the half of L bounding a disk intersecting the knot. This first daughter is of type (a). The second daughter has the leaf coming from the half of L bounding a surface disjoint from the clasper C_2 . Converting the clasper to a grope we get a grope of tree type \mathcal{T} whose tip corresponding to L bounds a surface disjoint from the grope. Hence we really have a grope of increased class, but it has high genus at the tip L . Proposition 6 now yields a sequence of cobordisms of type \mathcal{T}' as claimed. \square

The following cleaning up procedure is the heart of this section. It is in spirit similar to the procedure described in Section 4.3 of [12]. There the authors work in the context of Goussarov’s finite type theory (using alternating sums to define a filtration on the span of all knots). Here we

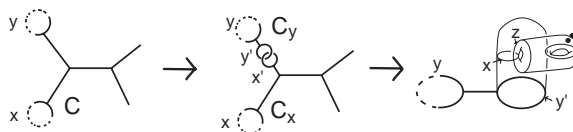
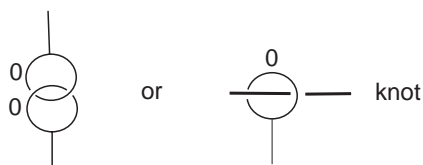

Fig. 28. Making x 0-framed.

need to strictly work with clasper moves on knots, there are no linear combinations that can help with cancellations. Therefore, the geometric arguments have to be much more subtle.

Theorem 35. *Let \mathcal{T} be a rooted trivalent tree. We can realize any \mathcal{T} -grope cobordism in S^3 by a sequence of clasper surgeries each of which either has higher grope degree than the original, or is a \mathcal{T} -clasper surgery which has tips of the following form:*



Proof. By Proposition 16 we may assume that all surface stages of the given grope are of genus one. Such a grope cobordism corresponds to a \mathcal{T} -clasper surgery, which we proceed to simplify.

Step 1: First we make the leaves 0-framed. This is accomplished using the following simple observation. Suppose x and y represent symplectic basis elements on a punctured genus one surface embedded in S^3 . These have framings $\sigma(x), \sigma(y)$, the diagonal terms of the Seifert matrix. There is also the intersection pairing $\mathcal{I} : H_1(F) \otimes H_1(F) \rightarrow \mathbb{Z}$. By assumption $\mathcal{I}(x, y) = 1$. The formula

$$\sigma(a + b) = \sigma(a) + \sigma(b) + \mathcal{I}(a, b)$$

implies that if $\sigma(x) = n$ and $\sigma(y) = 0$, then $\sigma(x - ny) = 0$. By Dehn twisting one can represent $x - ny, y$ by embedded curves meeting at a point. So $x - ny, y$ represent a 0-framed basis of F . In particular, suppose F is a surface stage of the grope for which x is a tip, and y bounds a higher surface stage. Then $\sigma(y) = 0$ and we can let $x - ny$ be the tip in place of x . This takes care of all possibilities except the case when x and y are both tips of the grope which have nonzero framings. Here we perform some sleight-of-hand using claspers. Convert the grope to a clasper C . Then insert a Hopf-linked pair of leaves on the edge incident to y . This disconnects the clasper into two pieces C_x, C_y as in Fig. 28.

The tips x and y each lie on exactly one of these claspers. The other leaf y' of C_y bounds a grope \tilde{G} gotten from C_x , by considering x' as the root leaf. z is the curve on the bottom stage of \tilde{G} which bounds the next surface stage, as pictured. By changing x to $x - nz$ as before, we convert the tip x of \tilde{G} to a zero-framed tip. Changing \tilde{G} to a clasper C'_x by our procedure, we again have the clasper C_y with the leaf y' Hopf-linking the root x' of C'_x . Convert this back to an edge to achieve a clasper of the same type as C , but with one more tip zero framed. This clasper may be converted back to a grope if we wish. Notice that under our grope-clasper correspondence, the framings of tips (leaves) do not change. Do this until all tips are zero-framed.

Step 2: Next we make the leaves unknotted. It is an exercise to prove that there is a set of arcs from a knotted leaf to itself, such that cutting along these arcs yields a collection of unknots. Hence, given a knotted leaf, one can apply the zip construction to such a set of arcs, thereby reducing the number of knotted leaves in each resultant clasper. Repeat this procedure until you have a set of clasps with unknotted leaves.

Note that we have now proved that any \mathcal{T} -clasper surgery can be reduced to a sequence of \mathcal{T} -clasper surgeries, each of which has 0-framed leaves bounding disks. To continue, we need to clean up the intersection pattern of the disks. By pushing fingers of disks out to the boundary, one may assume each pair of disks intersects in clasp singularities; i.e. the intersection pattern on each disk is a set of arcs from interior intersections with the clasper to the boundary of the disk. Secondly, we eliminate triple points. After we did the first step, there is a triple point which is connected by a double point arc to the boundary of one of the disks, such that there are no intervening triple points. Push a finger of the disk which is transverse to this arc along the arc and across the boundary. Repeat this until all triple points have been removed. This homotopes the disks into a position such that the intersection pattern consists of disjoint clasp singularities.

Step 3: We now start with a clasper C which has 0-framed leaves bounding disks D_i with only clasp intersections between each other. In addition, the disks D_i may have several types of intersections with C and the knot K , which we proceed to organize. Note that our theorem states that, modulo higher grope degree, we can reduce to only two types of singularities for the D_i : Either there is a single clasp (and no other intersections with C or K), or there is a single intersection with the knot K (and no intersections with C). We call such disks *good* for the purpose of this proof. The bad disks fall into several cases which we will distinguish by adding an index to the disk D which explains the failure from being good. The cases are as follows, where we list *exactly* the singularities of the disk, so unmentioned problems do not occur.

If a disk D has

- intersections with edges of C , we call it D_E .
- more than one intersection with K , we call it D_K .
- has more than one clasp, we call it D_{Cl} .
- intersections with edges of C and with K , we call it $D_{E,K}$.
- intersections with edges of C or with K , and has clasps, we call it $D_{EK,Cl}$.

Just to be clear, the cases D_E , D_K and $D_{E,K}$ above represent disks without clasps, whereas D_{Cl} has no intersections with edges of C or with K .

It is clear that these cases represent all possibilities for a bad disk. Recall that a disk D was called a cap if it is embedded disjointly from C . In our notation, this means that a cap is either bad of type D_K (more than one intersection with K), or it is good (exactly one intersection with K). We ignore the case of a cap without intersections with K since then the surgery on the clasper has no effect on K .

We now introduce a complexity function on clasps with given disks D_i as above. It is defined as a quintuplet $(c_1, c_2, c_3, c_4, c_5)$ of integers c_i , ordered lexicographically. The c_i are defined as follows:

- c_1 is minus the number of disks D_i which are caps.
- c_2 is the total number of intersections of the knot with caps D_i .

- c_3 is the total number of clasps.
- c_4 is the number of bad disks of type $D_{E,K}$.
- c_5 is the number of bad disks of types $D_{EK,C1}$.

The proof proceeds by using the zip construction to split a bad disk of a clasper into two daughters. In each of the five cases given below we check that both daughter clasps have either smaller complexity or higher grope degree, so they are “cleaned up”. The five cases can be applied in an arbitrary order and they are performed as long as there is a bad disk on a daughter clasper (where we do not work on clasps of higher grope degree). Since each c_i is bounded below, this cleaning up process must terminate. This can only happen if all disks are good (or the clasper has higher grope degree), which is the statement of our theorem.

We now describe the five cases of the cleaning up process. In each case the label says which bad disk is being split, then we have to specify the splitting arc and the order of the daughter clasps.

(E) Suppose there is a bad disk of type D_E . By Lemma 34, this splits into a daughter clasper C_1 of the same degree but with an extra cap, and into a sequence of clasps of higher grope degree. For C_1 the number c_1 is reduced.

(K) Suppose there is bad disk of type D_K . Split along an arc that divides the intersections with K into two smaller sets. Each daughter clasper inherits a cap with fewer intersections, so c_2 goes down for both daughters (whereas c_1 is unchanged).

(C1) Suppose there is bad disk of type D_{C1} . Draw an arc along the disk separating the clasps into two smaller groups. The zip construction produces two daughter clasps C_1 and C_2 for which (c_1, c_2) are preserved. To calculate the change in c_3 we need only consider the leaves of C_1 and C_2 as c_3 does not see knot or edge intersections. The leaves of C_i differ from those of C , only by cutting off part of the leaf we are splitting along. By construction, this has fewer clasps, i.e. c_3 is reduced for both daughters C_i .

(E,K) Suppose there is bad disk of type $D_{E,K}$. Split along an arc separating the two types of intersections, such that C_1 inherits the part of the leaf with just edge intersections. Since the intersection pattern for C_1 is just a subpattern of the original, the entire complexity function cannot increase. But c_4 clearly decreases for C_1 because a new disk with only edge intersections has been created. On the other hand C_2 has a new cap, so c_1 decreases for it.

(EK,C1) Suppose there is bad disk of type $D_{EK,C1}$. Split along an arc which separates the clasps from the other types of intersections. Split in such a way that C_1 inherits the part of the leaf which has the clasps. Now (c_1, c_2) is preserved in C_1 . The cut leaf now has only clasp intersections, and since the intersections of the disks of C_1 with everything are decreased, new disks with both clasp and other types of intersections are not created. Hence c_5 decreases for C_1 . Now we analyze C_2 . Since (c_1, c_2) can only go down when we split, it suffices to show that c_3 decreases. This follows by the same argument as case (C1).

We note that in the above five cases, when we split along a disk, the caps away from the split disk are preserved, as are the number of intersections of the knot with these caps. Furthermore, in the first daughter clasper C_1 the four complexity functions c_1, c_3, c_4, c_5 must each stay the same or go down, because the intersection pattern of C_1 is just a subpattern of the one for the original clasper. The number c_2 can only increase during an (E)-move, but then c_1 goes down for the first daughter C_1 (and C_2 has higher grope degree).

The intersection pattern for C_2 changes in a more complicated way. The first problem is that it sits on a different knot: the knot modified by C_1 , which adds intersections of the knot with the disks D_i . (We are applying C_1 and C_2 sequentially!) The second problem is that the edges of C_2 wander around inside a neighborhood of C_1 and add intersections as well. Therefore, the complexities c_4 and c_5 may increase from C to C_2 in all moves above, except for (E).

We summarize the information of these moves in the following table. Observe that performing a move always implies a reduction of the relevant complexity c_i , which we have written first in its row. Other complexities may or may not increase, and in some cases they actually decrease. In that sense the table contains the worst case scenario for the complexities c_i of the two daughter clasps. The notation $c_i \uparrow$ means that c_i may increase (which is bad), whereas $c_i \downarrow$ is the good case where the complexity definitely decreases. Unmentioned complexities c_i either stay unchanged or decrease.

Move	First daughter	Second daughter
(E)	$c_1 \downarrow, c_2 \uparrow$	higher grope degree
(K)	$c_2 \downarrow$	$c_2 \downarrow, c_4 \uparrow, c_5 \uparrow$
(Cl)	$c_3 \downarrow$	$c_3 \downarrow, c_4 \uparrow, c_5 \uparrow$
(E,K)	$c_4 \downarrow$	$c_1 \downarrow, c_2 \uparrow, c_4 \uparrow, c_5 \uparrow$
(EK,Cl)	$c_5 \downarrow$	$c_3 \downarrow, c_4 \uparrow, c_5 \uparrow$

We see from this worst scenario table that for all the five moves the total complexity goes down for both daughter clasps (or the grope degree increases). This completes our argument. \square

4.4. Proof of Theorem 3

Consider a grope cobordism of tree type \mathcal{T} (and class c) between two knots K_1 and K_2 in 3-space. The preceding Theorem 35 allows us to reduce each of these to a sequence of \mathcal{T} -clasper surgeries with leaves of only two possible good types, together with clasps of higher degree. Applying Theorem 35 again to these higher degree terms, and iterating, we obtain a sequence of clasps of degrees c to $2c$ each of which has only the two good types of leaves, together with some clasps of degree $(2c + 1)$. By Theorem 3 of Conant [6] a rooted clasper C of degree $(2c + 1)$ preserves Vassiliev-Goussarov equivalence of degree c . Then, by the main theorem of [14], surgery on C can be realized as a sequence of simple tree clasper surgeries of degree c . Recall that a *simple* tree clasper in Habiro’s sense has by definition only the simplest type of leaf, namely bounding a cap which intersects the knot once. This is one of the good leaf types from Theorem 35.

Thus we get a sequence of tree clasps in degrees c to $2c$ each of which only has the two good types of leaves. For each such tree clasper, convert the Hopf-linked pairs of leaves to edges (or half-twisted edges). Observe that the resulting graph clasps are simple, i.e. they are capped and the knot intersects each cap in exactly one point. Let G be the graph type of one of these simple clasps. Then the loop degree $\ell(G)$ is the number of Hopf-linked pairs of leaves because we started with a tree T and glued up pairs of tips. Each such gluing reduces the number of vertices by two and hence the grope degree is unchanged from T to G :

$$g(G) = \ell(G) + v(G) = g(T) = v(T) \in [c, 2c].$$

This implies that $[K_1] = [K_2] \in \mathcal{K} / \mathcal{F}_c^g$ because by definition the equivalence relation corresponding to \mathcal{F}_c^g is generated by simple clasper surgeries of grope degree $\geq c$.

Conversely, if C is a simple clasper of type G (and grope degree c), then we can convert $\ell(G)$ edges into Hopf-linked leaves as in Fig. 14 to obtain a simple tree clasper of the same grope degree, which now has class c . Picking any leaf as the root, our main construction, Theorem 4, gives a grope cobordism of class c . \square

4.5. Proof of Theorem 2'

By Theorem 4, two knot types are capped grope cobordant of class c if and only if they are related by a sequence of capped tree clasper surgeries of class (or Vassiliev degree) c . Applying the algorithm of Theorem 35 (case (K) is all that is needed) to a capped tree clasper, we get a sequence of *simple* tree claspers of the same type (and hence class). This uses the fact that the algorithm never introduces intersections between a cap and the clasper. Thus two knots which are capped grope cobordant of class c do represent the same element in $\mathcal{K}/\mathcal{F}_c^v$ (the equivalence relation generated by simple clasper surgeries).

Conversely, if two knots represent the same element in $\mathcal{K}/\mathcal{F}_c^v$, then by Habiro's main theorem they are also related by a sequence of simple *tree* clasper surgeries of class c , and thus they are capped grope cobordant of class c . \square

4.6. Proof of Theorem 5

Turn the simple clasper C into a tree clasper by converting some edges into Hopf-linked pairs of leaves. Notice that all the resulting leaves bound disks into the complement of L . Picking a root of C , and hence the corresponding component L^0 of L , this gives a three-dimensional grope cobordism between L and L_C . Since $\ell(C) \geq 1$ there is one tip which bounds a cap into the complement of L . Push the interior of this cap slightly up into $S^3 \times I$. Now extend L by annuli up to $\mathbb{R}^3 \times 1$. These annuli miss the pushed-up cap by construction. The result is an embedded grope connecting L_C^0 and L^0 in $\mathbb{R}^3 \times [0, 1]$, with one tip bounding an embedded cap. The usual procedure of iterated surgery on this cap produces an annulus which is disjoint from the straight annuli connecting the other component of L_C and L . Thus we have constructed a concordance, which at closer inspection turns out to be a ribbon concordance. This follows from the fact that the only nontrivial parts come from copies of the cap which was pushed up from \mathbb{R}^3 into $\mathbb{R}^3 \times [0, 1]$. Hence reading from L_C to L , the concordance has only local minima and saddles, but no local maxima. \square

Acknowledgements

It is a pleasure to thank Stavros Garoufalidis and Kazuo Habiro for helpful discussions.

References

- [1] D. Bar-Natan, On the Vassiliev knot invariants, *Topology* 34 (1995) 423–472.
- [2] J.W. Cannon, The recognition problem: what is a topological manifold?, *Bull. AMS* 84 (1978) 832–866.
- [3] T. Cochran, Derivatives of links: Milnor's concordance invariants and Massey's products, *Memoirs AMS* 84 (1990) 427.

- [4] T. Cochran, K. Orr, P. Teichner, Knot concordance, Whitney towers, and L^2 -signatures, math.GT/9908117, Ann. Math. 157 (2003) 433–519.
- [5] J. Conant, A knot bounding a grope of class n is $[\frac{n}{2}]$ -trivial, math.GT/9907158, Ph.D. Thesis, University of San Diego (2000).
- [6] J. Conant, On a theorem of Goussarov, math.GT/0110057, J. Knot Theory Ramifications 12 (2003) 47–52.
- [7] J. Conant, P. Teichner, Grope cobordism and Feynman diagrams, in preparation.
- [8] M. Freedman, F. Quinn, The Topology of 4-Manifolds, in: Princeton Mathematical Series, Vol. 39, Princeton University Press, Princeton, NJ, 1990.
- [9] M. Freedman, P. Teichner, 4-Manifold topology I: subexponential groups, Invent. Math. 122 (1995) 509–529.
- [10] M. Freedman, P. Teichner, 4-Manifold topology II: Dwyer’s filtration and surgery kernels, Invent. Math. 122 (1995) 531–557.
- [11] S. Garoufalidis, L. Rozansky, The loop expansion of the Kontsevich integral, abelian invariants of knots and S -equivalence, math.GT/0003187, Topology, to appear.
- [12] S. Garoufalidis, M. Goussarov, M. Polyak, Calculus of clovers and finite type invariants of 3-manifolds, Geom. Topology 5 (2001) 75–108.
- [13] N. Habegger, G. Masbaum, The Kontsevich integral and Milnor’s invariants, Topology 39 (2000) 1253–1289.
- [14] K. Habiro, Claspers and finite type invariants of links, Geom. Topology 4 (2000) 1–83.
- [15] E. Kalfagianni, X.-S. Lin, Regular seifert surfaces and Vassiliev knot invariants, math.GT/9804032S. Preprint (1998), UC Riverside and University of Michigan.
- [16] V. Krushkal, Exponential separation in 4-manifolds, Geom. Topology 4 (2000) 397–405.
- [17] J. Levine, Homology cylinders: an expansion of the mapping class group, Algebraic Geom. Topology 1 (2001) 243–270.
- [18] H. Murakami, T. Ohtsuki, Finite type invariants of knots via their Seifert matrices, Asian J. Math. 5 (2001) 379–386.
- [19] K.Y. Ng, Groups of ribbon knots, Topology 37 (1998) 441–458.
- [20] R. Schneiderman, P. Teichner, Higher order intersection numbers of 2-spheres in 4-manifolds, Algebraic Geom. Topology 1 (2001) 1–29.
- [21] T. Stanford, Braid commutators and Vassiliev invariants, Pacific J. Math. 174 (1996) 269–276.
- [22] V.A. Vassiliev, Cohomology of knot spaces, in: V.I. Arnold (Ed.), Theory of Singularities and its Applications, American Mathematical Society, Providence, RI, 1990.