

Microfluidic Paper-Based Analytical Devices (μ PADs) and Micro Total Analysis Systems (μ TAS): Development, Applications and Future Trends

Piotr Lisowski · Paweł K. Zarzycki

Received: 18 October 2012/Revised: 26 December 2012/Accepted: 30 January 2013/Published online: 22 February 2013
© The Author(s) 2013. This article is published with open access at Springerlink.com

Abstract Microfluidic paper-based analytical devices and micro total analysis systems are relatively new group of analytical tools, capable of analyzing complex biochemical samples containing macromolecules, proteins, nucleic acids, toxins, cells or pathogens. Within one analytical run, fluidic manipulations like transportation, sorting, mixing or separation are available. Recently, microfluidic devices are a subject of extensive research, mostly for fast and non-expensive biochemical analysis but also for screening of medical samples and forensic diagnostics. They are used for neurotransmitter detection, cancer diagnosis and treatment, cell and tissue culture growth and amplification, drug discovery and determination, detection and identification of microorganisms. This review summarizes development history, basic fabrication methods, applications and also future development trends for production of such devices.

Keywords Microfluidic paper-based analytical devices (μ PADs) · Micro total analysis systems (μ TAS) · Micro-chip chromatography · Micro-planar chromatography (micro-TLC) · Detection systems · Biochemical analysis

Introduction

Over the past 20 years, there is a rapid development and increasing interest of microfluidic devices also called a micro total analysis system (μ TAS), lab-on-chip (LOC) or microfluidic paper-based analytical devices (μ PADs) [1, 2]. The ability to perform laboratory operations on nano- or pico-scale, using miniaturized equipment (laboratory glass, laboratory reactors) has opened new ways in modern analytical chemistry, medicine, genetic, cell biology and many other research areas. Manipulation of small volumes of fluids using channels with dimension of tens to hundred of micrometers is very appealing and has been regarded as the most powerful advantage of lab-on-chip [3]. Recently, chemists apply mini-laboratories to synthesize new molecules or materials. Biologists use them to study complex cellular processes in the extensive study of many areas of cell biology. For analytical chemists, microfluidic devices are convenient tools for detection and determination of many organic and inorganic compounds. These simple devices offer analytical and diagnostic abilities that could revolutionize medicine and pharmaceutical industry. They are small, light, portable, and have low manufacturing, usage and disposal costs. Specific to the field of microfluidics is the benefit of low consumption of reagents and analytes [4, 5]. They have been used for wide range of practical applications in many research fields: biomedical science, genomics, forensics, toxicology, immunology, environmental studies, chemistry or biochemistry. Up to this date, microfluidics were successfully used in clinical analysis of blood [6–9], to detect and identify pathogens, proteins [10–13] and environmental contaminants [14–16], in genetic research [17, 18] and drug industry [19–21]. In developing countries, miniaturized portable medical diagnostic tools are especially important for the people having

Published in the topical collection *Miniaturized and New Featured Planar Chromatography and Related Techniques* with guest editor Paweł K. Zarzycki.

P. Lisowski (✉) · P. K. Zarzycki
Section of Toxicology and Bioanalytics,
Koszalin University of Technology, Śniadeckich 2,
75-453 Koszalin, Poland
e-mail: dathor@tlen.pl; piotr.lisowski@tu.koszalin.pl
URL: <http://www.wbiis.tu.koszalin.pl/labtox>

no direct access to medical laboratories with basic diagnostic and analytical facilities [3].

History and Development of Microfluidic Devices

It is assumed that the first microfluidic device was developed in 1975 [22, 23]; however, some of them evolved from separation techniques based on thin-layer and gas chromatography. In 1938, Ukrainian scientists N.A. Izmailov and his student M.S. Shraiber published the article “Spot chromatographic method of analysis and its applications in pharmacy” in the journal *Farmatsiya* (Pharmacy) [24]. They were searching for appropriate methods for the rapid analysis of plant extracts. They coated microscope slides with a suspension of various adsorbents (calcium, magnesium, and aluminum oxide), deposited one drop of the sample solution on this layer and added one drop of the solvent. The separated sample components appeared as concentric rings that fluoresced in various colors under a UV lamp, and from that reason one of their conclusions was described as follows: “*A spot chromatographic method of analysis was developed; this method consists in that the separation of substances into zones is observed in thin layers of adsorbents using a drop of the substance*” [25]. In 1947 T.I. Williams described a further improvement of the method of Izmailov and Shraiber [26]. He prepared the adsorbent-coated glass plates in the form of a sandwich, where the adsorbent layer was covered by a second glass plate with a small hole through which the sample (and solvent) drops could be applied. For years, simplified methodology called micro planar chromatography was frequently applied for efficient separation and quantification of inorganic and organic substances [27–31]. Most recently, thermostated micro-TLC protocols were successfully applied for qualitative and quantitative analysis, fractionation, screening and fingerprinting of highly organic compounds loaded biological and environmental samples [32–38]. First publication concerning construction of microfluidic separation device based on miniaturized gas chromatograph and involving integrated circuit processing technology was published in 1975. It consisted of a 5-cm-diameter silicon wafer with an open-tubular capillary column, two sample injection valves and a thermal conductivity detector. This separation device was able to separate a simple mixture of compounds in a matter of seconds [22, 23]. No further research on given miniaturized gas chromatographs was initiated until the 1990s. The response of the scientific community to this first silicon chip device was virtually none, presumably because of the lack of technological experience and the research work focusing on fabrication of the key components like micro-pumps, microvalves and chemical sensors [1]. Progress in

molecular biology greatly stimulated development of capillary electrophoresis for the separation and analysis of DNA and proteins. Also, similar to advances with integrated circuits in electronic and computer industry, biological and chemical analysis devices miniaturization efforts have been made. In 1990, Manz and co-workers presented a miniaturized open-tubular liquid chromatograph using silicon chip technology [39]. Manz is also author of the concept of “miniaturized total chemical analysis system” or μ TAS [5]. In his article, he presented a silicon chip analyzers incorporating sample pretreatment, separation, and detection devices and disclosed the ideas of integrating a capillary electrophoresis setting onto a chip. In the last two decades, development of new microfabrication techniques and materials, separation and detection methods (see Table 1) used in μ TAS devices was very fast and it is widely described [1, 40, 41]. Currently, the concept of paper-based analytical devices (μ PADs) was originated. The first one was invented and described by Whitesides Group of Harvard University in 2007 [42] but its origins date back to the 1940s of the last century, to the work of Müller and Clegg [43], excluding paper strips for the determination of pH. They used a filter paper, made a wax barrier on it and observed that the restricted channel sped up the pigments sample diffusion process, amount of sample consumption and micrograms separation order of magnitude [43]. In recent times, μ PADs are widely used in health diagnostics, biochemical analysis, forensic and food quality control [44].

Components of Microfluidic Devices (μ TAS)

Generally, considering the publications dealing with the development of microdevices, we can see them clearly divided into two groups. The first one (μ TAS) contains the microfluidic devices manufactured by variety of methods and materials that are connected to the external units such as to a sampling unit, detector unit and electronic unit [3]. The second type of microfluidic devices include a cheap, simple in production, paper-based laboratory chips, which in themselves are fully equipped laboratory unit, designed to perform specific tasks, mainly for the detection of various types of substances [44].

The main components of the microfluidic units from the first group are injectors, channels, pumps, valves, storage containers, mixers, electromagnets, microheaters, droplet and bubble generators [1, 3] (see Table 1). Manufacturing methods used for LOC devices were developed in the semiconductor industry [45]; therefore, substrates such as silicon, glass (first microfluidic devices were made in silicon and glass [39]), quartz, soft or hard polymers are used in their production (see Table 1). In addition, various

Table 1 Basic materials and components for assembling of typical micro total analysis systems (μ TAS) working under different separation and detection modes

μ TAS fabrication method	Device body materials	Separation processes	Detection systems	Device main components
Molding [147, 152]	Polymers (PDMS [21, 48, 147, 160, 161] PMMA, [149, 151, 153, 156, 157], PC [152, 156, 157] COC [157, 159, 172] SU-8 [154, 155, 162])	Capillary electrophoresis [152, 160–162, 175]	Conductometry [39]	Inlets, outlets, connectors, microchannels, microchambers [21, 160]
Micromolding in capillaries (MIMIC) [147]	Ceramic [147]	Micellar electrokinetic chromatography [165, 168]	Laser-induced fluorescence [160, 164]	Valves, pumps [21, 57, 160]
LIGA (Lithographie, Galvanoformung, Abformung) [149, 150, 155]	Glass [39, 119, 147, 161, 169]	Capillary electrochromatography [172–175]	Electrochemical [161, 162]	Mixers [64, 160, 176]
Etching [148, 169]	Silicon [23, 39, 119]	Gas chromatography [23]	Fluorescence [21]	Electromagnets [65]
Lithography [21, 48, 160, 162]	Quartz [148]	Liquid chromatography [39, 175]	Absorbance [120, 163]	Microheaters [66]
Phase-changing sacrificial layers (PCSL) [151]		Solid-phase extraction [166]	Atomic fluorescence spectrometry (AFS) [165]	Droplet and bubble generators [67, 69, 96]
Imprinting [153, 160]		Isotachoforesis [169]		
Injection molding [156, 157]			Chemiluminescence [167]	
Conventional machining [158]		Isoelectric focusing [170, 171]	Normal Raman spectroscopy [169]	
Laser ablation [181, 182]			Mass spectrometry [177–180]	
Hot embossing [182, 183]				

biomaterials including calcium alginate, cross-linked gelatin or hydrogels were applied. They have been useful to provide a physiologically relevant cellular microenvironments that are necessary to cell and tissue culture growth [46, 47]. Silicon is chemically and thermally stable, and channels can be fabricated in this material by etching or photolithography [48]. However, silicon wafers are expensive, brittle and opaque in the UV and visible regions and are therefore not suitable for devices where detection is based on optical sensors [49]. Glass was an early replacement for silicon, being less expensive, transparent, negatively charged, and a good support for electroosmotic flow [50]. Polymers are inexpensive, which allow for the manufacture of disposable devices. They also offer interesting properties for microfluidic devices. Elastomeric materials have good structural rigidity and strength and enable the fabrication of small and rigid microfluidic devices. Channels can be formed in polymers by moulding and various soft lithography processes and sealing of discrete parts can be achieved thermally or with adhesives. However, their surface chemistry is more complex than that of silicon or

glass. They are often incompatible with organic solvents and cannot be used at high temperatures [48]. Etching in quartz and glass is also too expensive and time-consuming [48] in comparison to other materials like polymers, photopatternable silicone elastomers, thermoset polyesters, poly(methylmethacrylate) (PMMA), poly(dimethylsiloxane) (PDMS), polyamide (PA), cyclic olefin copolymer (COC) and SU-8 (negative photoresist). Applications of above-mentioned microfluidics body materials, which are currently most commonly used materials, enable to minimize the cost of microfabrication [51].

Flow Control in μ TAS

Fluid transport and flow in microfluidic devices is achieved and controlled by passive (surface tension, capillary forces) or active (generally pumping—with electrokinetic, electrohydrodynamic, magnetohydrodynamic, electroosmotic pumps; centrifugal force,) mechanisms [52, 53] and is defined by Reynolds number (Re), which is the ratio of the

active forces (inertial forces) to the passive forces of internal friction in the fluid, appearing as a dynamic viscosity:

$$\text{Re} = \frac{\rho v d}{\mu}$$

where ρ is the density of the fluid (kg/m^3), v is the mean fluid velocity (m/s), d is the channel diameter and μ the dynamic viscosity of the channel ($\text{kg/m}\cdot\text{s}$). When $\text{Re} \ll 1$, the flow is laminar and very smooth. When $\text{Re} > 10^3$, the flow is turbulent and mainly characterized by vortices [54]. Flow within microstructures typically has Reynolds numbers of 10^{-3} – 10^{-5} and is characterized by a laminar flow. Contrary to fluid dynamic in larger scales devices, in microfluidic devices viscous forces dominate and turbulences are non-existent. Surface tension can be an important driving force and mixing is slow and occurs through diffusion [55]. Microvalves allow controlling flow and can be segregated in two categories: passive valves (which do not require mechanical actuation) and active valves (which do) (Fig. 1). Typical passive valves are cantilever valves, diaphragm valves, diffuser/nozzle valves [56]. Actuation of active valves is generally piezoelectric, thermopneumatic, electrostatic and electromagnetic, but pneumatically actuated, flexible membrane-based valves (and pumps) are most popular forms of active elements in microfluidic devices [56, 57].

For many biological and chemical applications, mixing of transported fluids in microchannels is very important. Mixers are therefore essential in enhancing mixing efficiency and for rapid homogenization of the reagents. All mixing ultimately occurs due to molecular diffusion and therefore the basic idea is reducing the distance over which mixing must occur [59]. They can be classified as active (needed external energy) or passive (mixing in specific geometry of the channel). Passive mixers are usually easier to fabricate than active mixers and are more suitable for applications [60]. Typical active mixers based on electrowetting [61], nonlinear electrokinetic effects [62] and acoustic streaming [63] are usually complicated to fabricate. However, simple, portable, hand-powered mixer that exploits movement of bubbles in microchannels was developed by Garstecki and co-workers [64]. More complicated procedures are needed to incorporate (especially on polymer-based devices) metal building components into microfluidic systems, for applications such as on-chip heating and magnetic sorting. A microsolidics method has been developed to fabricate complex metallic structures (like microheaters or magnets) by injecting liquid solder into microfluidic channels, and allowing the solder to cool and solidify [65, 66] (Fig. 2).

Microsolidics simplifies the incorporation of metals into microfluidic channels, but has several disadvantages. They

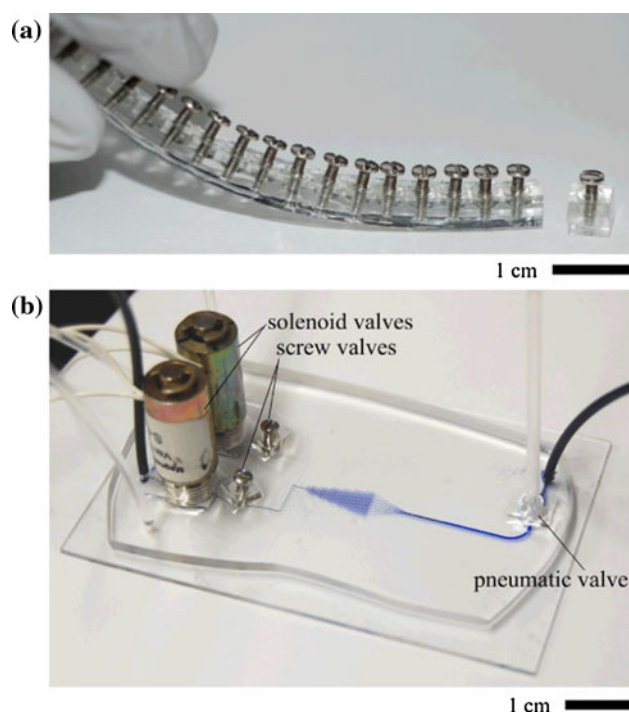

Fig. 1 **a** General view of a strip of prefabricated screw valves. A single valve has been separated from the strip using a razor blade. **b** Microfluidic gradient generator containing two embedded solenoid valves, two embedded screw valves and one embedded pneumatic valve (by Hulme et al. 2009 [58]; reproduced by permission of the Royal Society of Chemistry)

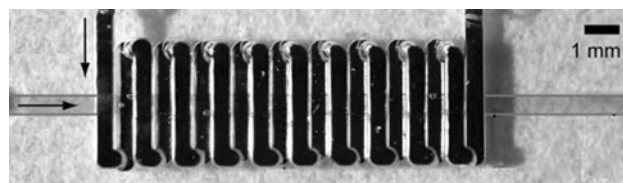

Fig. 2 Microheater incorporated in polymer-based (PDMS) microfluidic systems (by Siegel et al. 2007 [66])

can only be used with metals (or alloys) characterized by low-melting point ($<300\text{ }^\circ\text{C}$) and affinity for the surface of the channel wall. These solders are usually more expensive than commonly used, and some are not biocompatible, particularly those that contain heavy metals like Pb or Cd. This method cannot be used to fill “dead-end” channel, and it is currently difficult to use this process to fabricate wires with cross-sectional dimensions $<10\text{ }\mu\text{m}$ [65, 66].

The other components used in microfluidic devices are droplet and bubble generators. It has been shown that droplet and bubble-based microfluidics can perform Boolean logic functions [67]. The use of immiscible fluids for the formation of emulsions in microfluidic devices in controlled, individual segments (droplets) enabled rapid mixing of fluids and is a potent high-throughput platform

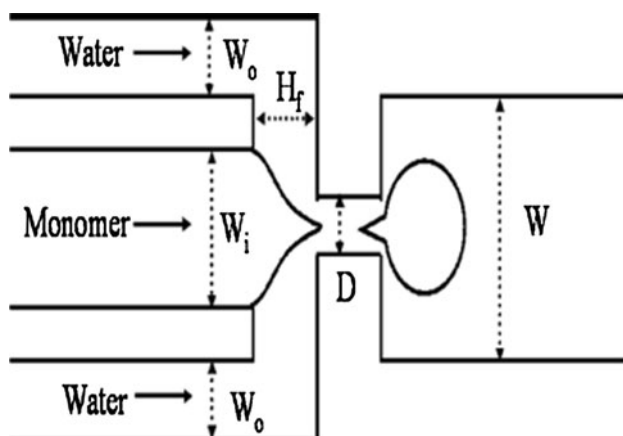

Fig. 3 Typical scheme of flow-focusing microfluidic device. An orifice is placed at a distance $H_f = 250 \mu\text{m}$ downstream of three coaxial inlet streams. Water is supplied to the two side channels which have widths $W_0 = 120 \mu\text{m}$; monomer is forced into the central channel which has a width $W_i = 100 \mu\text{m}$. The width of the orifice is $D = 80 \mu\text{m}$; the width of the downstream channel is $W = 240 \mu\text{m}$ (Nie et al. 2008 [68]; with kind permission from Springer Science + Business Media)

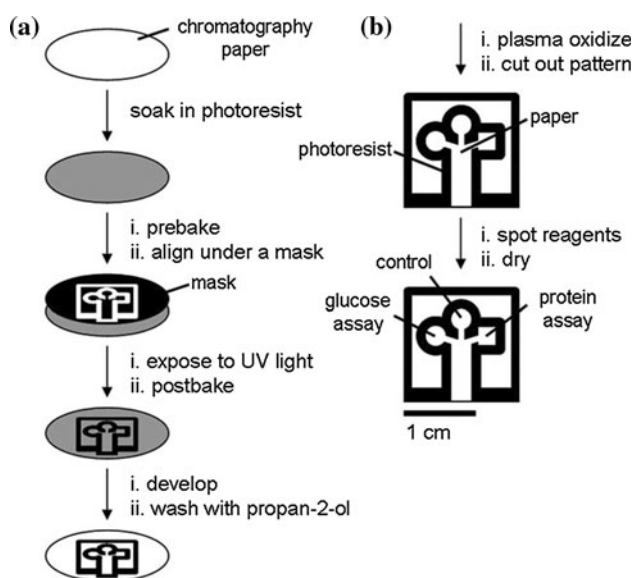

Fig. 4 Fabrication of paper-based microfluidic device using photolithography technique (described by Martinez et al. 2007 [42])

for biomedical and chemical research and applications. Droplet-based systems have been used to directly synthesize particles with diameters from several micrometers to hundreds of micrometers and encapsulate many biological entities for biomedicine and biotechnology applications [68, 69]. There are several ways to generate droplets and bubbles in microfluidic systems but two common methods that depend on the geometry of the channel namely the flow-focusing (Fig. 3) and the T-junction are commonly applied [69].

μ PADs Manufacturing Process

On the other side, manufacturing process of the second group of microfluidic devices—Microfluidic paper-based analytical devices (μ PADs) is very easy, cheap (estimated price is $< \$10$ per square meter even for high-quality chromatography paper), and can be performed literally at home [2]. The first team that made such a device was a Whitesides Group of Harvard University [42] (Fig. 4). Recently, there are many techniques reported in the literature for fabricating paper-based microfluidic devices including photolithography [42, 70, 71], plotting with an analogue plotter [72], ink jet etching [73], plasma treatment [74], knife cutting [75, 76] (Fig. 5), wax printing [77, 78] (Fig. 6) and variation (wax screen printing) [79], ink jet printing [80] flexography printing [81] and laser treatment [82]. The main objective of those techniques' applications is to create hydrophobic barriers on sheet of hydrophobic cellulose that constitute the walls of millimeter-sized, capillary channels. To prevent leakage and to keep the applied solution in the channels, paper strip may be surrounded by a polypropylene material, for example a stick tape or may be hidden in plastic cover [44]. To create hydrophilic microchannels on paper, a variety of hydrophobic substances are used such as photoresist SU-8, wax or as alkyl ketene dimer (AKD) ($\$0.1$, $\$0.01$ and $\$0.00001$, respectively, for patterning filter paper of 100 cm^2). Depending on the hydrophobic agents, the paper pores can be blocked (after using SU-8 or PDSM), covered by physical deposition (polystyrene or wax) or cellulose fibers can be modified chemically (after using AKD) [44]. After chemical modification, paper hydrophobicity cannot be removed by organic solvent extraction [83]; paper hydrophobicity caused by physical deposition can be largely removed by organic solvent washing, making it possible to use organic solvent etching methods to fabricate paper-based microfluidic devices [84].

Flow Control in μ PADs

A number of valving mechanisms have been developed for controlling the pressure-driven flow of fluids in conventional μ TAS; however, these technologies cannot be applied to μ PADs in which the movement of fluids is based on capillary flow. To achieve multi-steps in analysis and diagnostic procedures (e.g. premixing or filtering samples, controlling fluid flow), improve sensitivity and separation selectivity changes made by the researchers refer to both the spatial structure and materials used for their production. For example, Li and co-workers (2008) [74] designed cellulose mechanical switches, filters and separators on μ PADs made by plasma treatment. One of the solutions is

Fig. 5 Paper cutting technique for fabrication of paper-based microfluidic device (reprinted with permission from Fenton et al. 2009 [75]; copyright (2012) American Chemical Society)

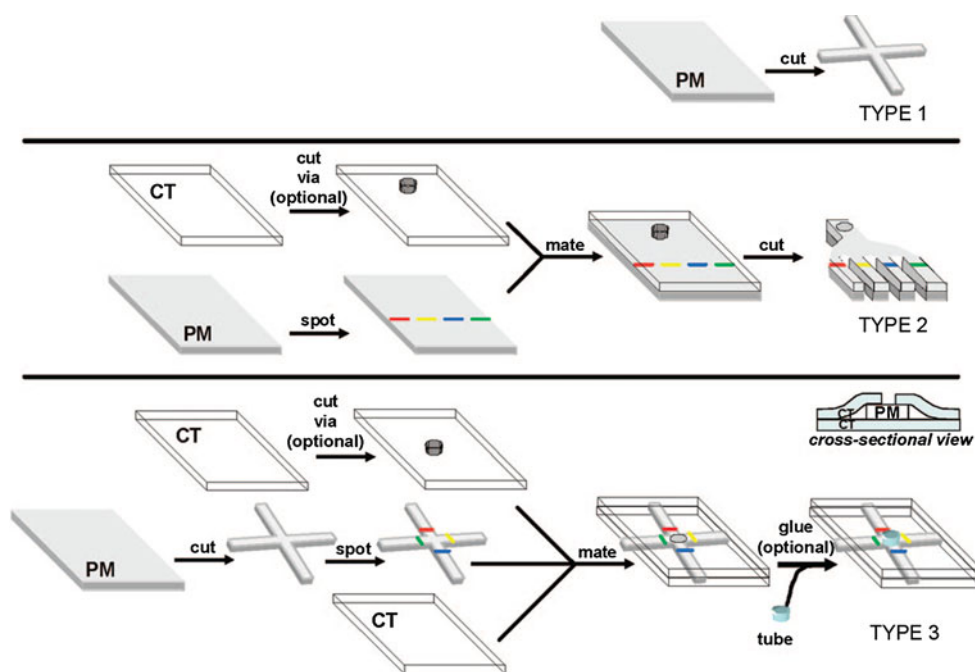

hydrophobic paper strip with a small hydrophilic area matched with hydrophilic channel in device and is simply activated by mechanical pulling [74, 85]. Other options to achieve the above-mentioned purposes are μ PADs designed in 3D technique, which enable the transport of fluids both vertically and laterally from a single inlet to numerous detection zones [86]. Three-dimensional μ PADs offer several potential advantages over 2D devices. They can incorporate intricate networks of channels connected to large arrays of test zones, and each layer in a 3D μ PAD can be made of a different paper. Therefore, multiple functionalities provided by different types of paper can be combined into a single device [2]. Interestingly, Liu and Crooks [87] developed μ PAD using origami principles (Fig. 7). Whitesides group [88] reported a device with buttons for connecting and disconnecting the fluid flow between channels. Chen et al. [89] created a fluidic diode (two-terminal component that promotes or stops wicking along a paper channel) and functional circuit to manipulate two fluids in a sequential manner.

Detection Techniques, Separation Methods and Applications of Microfluidic Devices

All primary detection methods and their variations have been successfully integrated or coupled with μ TAS devices, including optical detectors based on UV–Vis light, chemiluminescence and fluorescence. Moreover, electrochemical detectors, magneto-resistive sensors (GMR), mass spectrometric (MS) and nuclear magnetic resonance

(NMR) [13, 40] have been extensively applied (see Table 1). Four detection methods have been reported for the detection of analytes in paper-based microfluidics: colorimetric, electrochemical (EC) [90], chemiluminescence (CL), and electrochemiluminescence (ECL), but most studies have been focusing on colorimetric detection (which is typically related to enzymatic or chemical color-change reactions) and EC detection. CL and ECL performed in the dark and are independent of ambient light and also are the most common optical detection methods in microfluidics area [44, 91]. However, they have not been widely used in μ PADs [82, 92].

In recent years, all the basic fluidic manipulations (mixing, diluting, etc.) have been adapted to microfluidic chips [93]. LOC connected with micellar electrokinetic chromatography (MEKC) and electrochromatography (CEC) have been applied to the separation of various components in multidisciplinary field, but techniques based on microchip capillary electrophoresis (MCE) are the most common methods integrated with μ TAS devices and many studies were based on it. Practical applications of that separation protocols are widely used in many studies in genetics and molecular biology, including polymerase chain reaction (PCR) [94] amplification of DNA in nanoliter droplets [95, 96], reverse transcription (RT)-polymerase chain reaction (PCR) [97, 98], DNA extraction and real-time PCR for rapid pathogen identification [97, 99, 100], simultaneous DNA amplification and detection [101], removal of PCR inhibitors [102], mRNA isolation and amplification [103], mRNA quality and quantity control, nucleic acid detection, amplification and purification [104, 105], single cells genetic

Fig. 6 Schematic illustration of the processes to produce patterned paper with wax (described by Lu et al. [78])

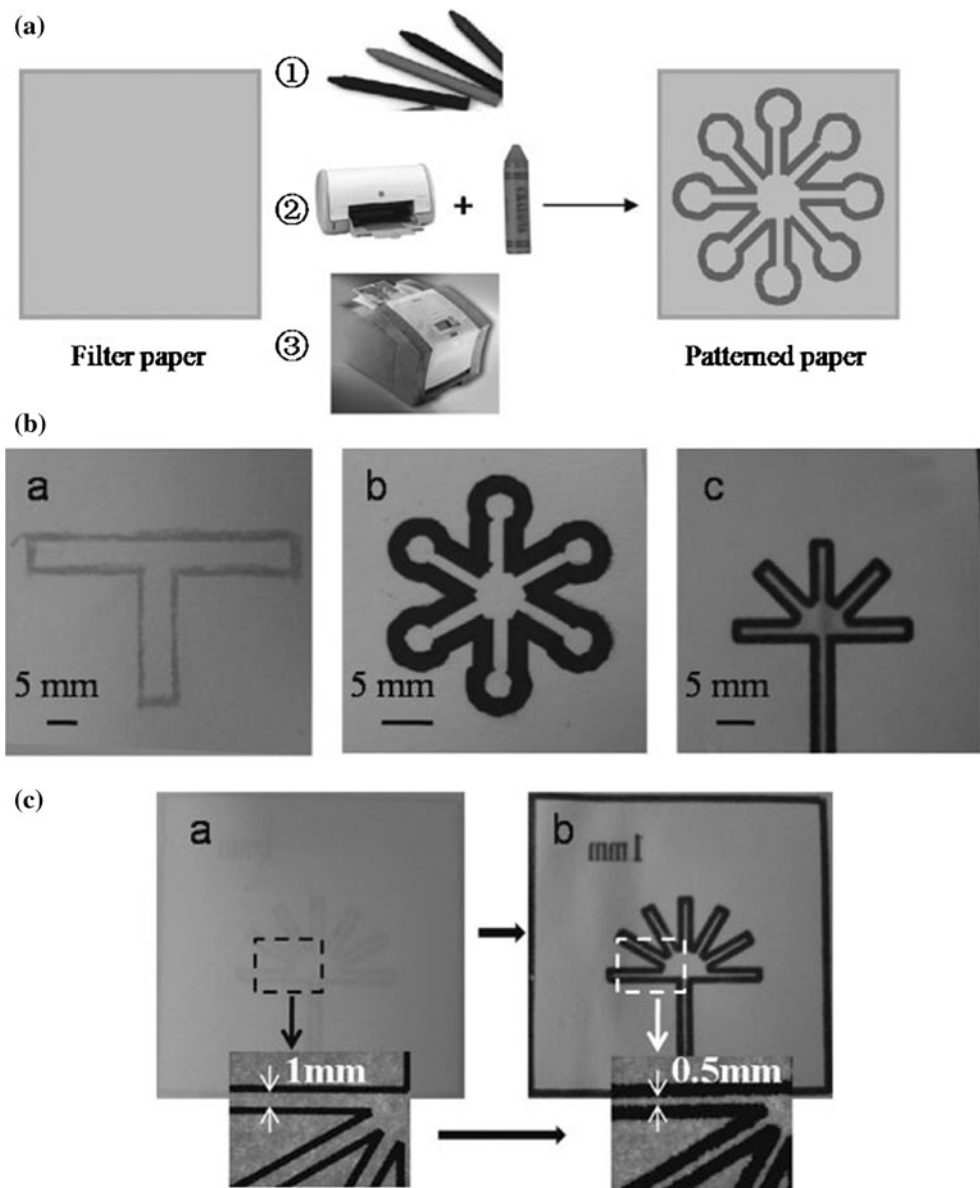
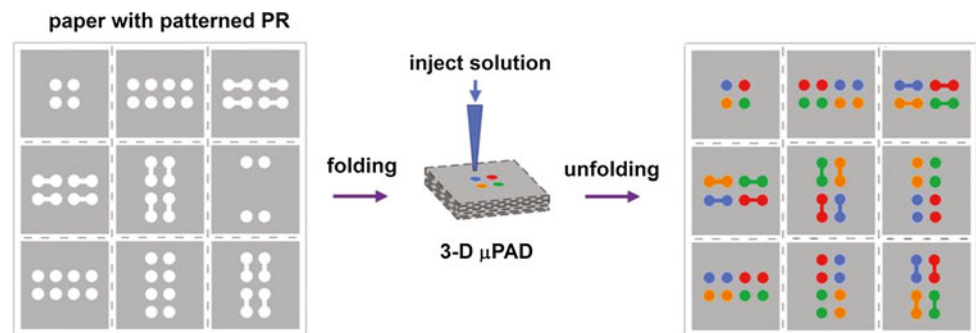

Fig. 7 Three-dimensional paper microfluidic devices assembled using the principles of origami (reprinted with permission from Liu and Crooks, 2011 [87]; copyright (2012) American Chemical Society)



research and manipulations [106–109], gene expression research [108, 110], forensic DNA analysis [17] and many others. In molecular biology, the ability to manipulate and analyze single cells is important to understand the molecular mechanisms underlying cellular function [111].

In medicine field, they are used for neurotransmitters detection, cancer diagnosis and treatment [112, 113], cell and tissue culture growth and amplification [114–116], drug discovery and determination [19, 117, 118], detection and identification of microorganisms, pathogens [10, 11,

97, 99, 119] and proteins [12]. LOC devices combined with different detectors have been applied to detect environmental pollutants in order to separate metal ions [120–122], phenols [123, 124], explosives [125, 126] nitroaromatics [127], organic peroxides [128], and other environmentally relevant substances [15, 40, 93]. Most of these applications were performed in aqueous solution, except for one non-aqueous MCE example developed by the group of Collins [120] for measuring six toxic metal cations including Cd^{2+} , Pb^{2+} , Cu^{2+} , Co^{2+} , Ni^{2+} , and Hg^{2+} .

In recent years, the second group of microfluidic devices— μ PADs are a subject of research activities, mostly for biochemical analysis but also for medical and forensic diagnostics. In the laboratory, paper filters are commonly used for chromatography and filtration purposes. One of the first paper-based diagnostic devices created was for urinalysis [42]. These devices utilize colorimetric assays to measure glucose and protein concentration in urine. Carriho et al. [129] designed paper-based plates as a low-cost alternative to the conventional plastic microliter plates. This allowed mixing of different analytes for different assays that were not possible in a plastic plate. Another important application for paper-based devices is pathogen and toxin detection. One of the first functioning paper-based detection devices had been developed by Brennan's research group—the paper-based device was able to detect neurotoxins paraoxon and aflatoxin B1 within five minutes at low concentrations, ~ 100 and ~ 30 nM, respectively [130]. Lateral flow paper chromatography and vertical flow diagnostic sensors based on bioactive paper are recently used to determine human blood type [8, 131–134]. Bioactive paper strips are also applied in genetic and biochemical analyses, like DNA detection [135] or ELISA tests [136, 137].

Currently, most paper-based devices utilize colorimetric assays, although there have been reports of electrochemical sensing in paper-based devices for detection of glucose, lactate, and uric acid in biological samples [90] and heavy metal detection in water [138, 139]. In this work, a novel method of electrokinetic sensing in a paper-based microfluidic device was proposed. Chemiluminescence [82] and electrochemiluminescence [92] detection techniques are described; however, they have not been widely used in μ PADs. Several studies on bioactive paper [130, 135–137, 140] have proposed a few promising ideas to enhance the sensitivity and selectivity of the colorimetric detection for paper-based microfluidic devices.

LOC Development and Future Trends

Most important for our future is environmental protection and ensuring the people health. Healthcare procedures

(monitoring, control, prevention) and diagnostic tests are expensive. In poor and development countries infectious diseases, that would be treatable in a developed nation, are often deadly. Healthcare clinics, even if they have drugs to treat a certain illness, often suffer from the lack of diagnostic equipment and qualified staff. This creates a need to develop low-cost, simple to-use, point-of-care (POC) diagnostic methods for diagnosis and monitoring the treatment of patients [141]. The same problem—lack of diagnostic tools—exists in case of environmental monitoring. Lab-on-chip technology can be important and vital component of efforts to improve both a global health through the development of point-of-care testing devices [141] and environmental protection trough development analytical devices for environmental samples. In genetic research and molecular biology field, understanding the cell biology will become accessible through high-throughput single-cell data analysis. For example, multiplex quantitative polymerase chain reaction (qPCR) is limited in the number of reactions. If we wish to measure 100 genes from 100 cells, we need 10,000 reactions. Microfluidic chips can be used to overcome these limitations by combinatorially mixing the samples and gene detectors and by performing thousands of reactions in parallel on a single chip and can provide high mRNA-to-cDNA efficiency and decreased risk of contamination [110, 142]. It is also possible to isolate and amplify single chromosomes from a single cell. Fan et al. [109] developed a microfluidic device capable of separating and amplifying homologous copies of each chromosome from a single human metaphase cell in independent chambers. This enabled them to study the two alleles (or haplotypes) of each chromosome independently. This method can be used to obtain accurate haplotype information in personal genome sequences, to understand meiotic recombination and to directly study the human leukocyte antigen haplotypes of an individual. Molecular biologist needs particular devices for rapid isolation and characterization of single cells from small biological specimens. Future challenges include sensitive, high-throughput and simple-to-use microdevices for characterizing proteins, signaling, epigenetic, and metabolic states in single cells, and correlating these measurements with physiological characteristics. Existing techniques for whole-genome/transcriptome amplification prior to sequencing suffer from bias and non-specific products that have to be characterized and eliminated. In particular, there is a need to develop methods for multiplexing samples and precise unbiased counting of molecules, which is possible with using microfluidic devices. Depending on the chip platform being used, several thousand to several hundred thousand distinct oligonucleotides can be synthesized on a single chip. In principle, these massive parallel microarrays can reduce the cost of

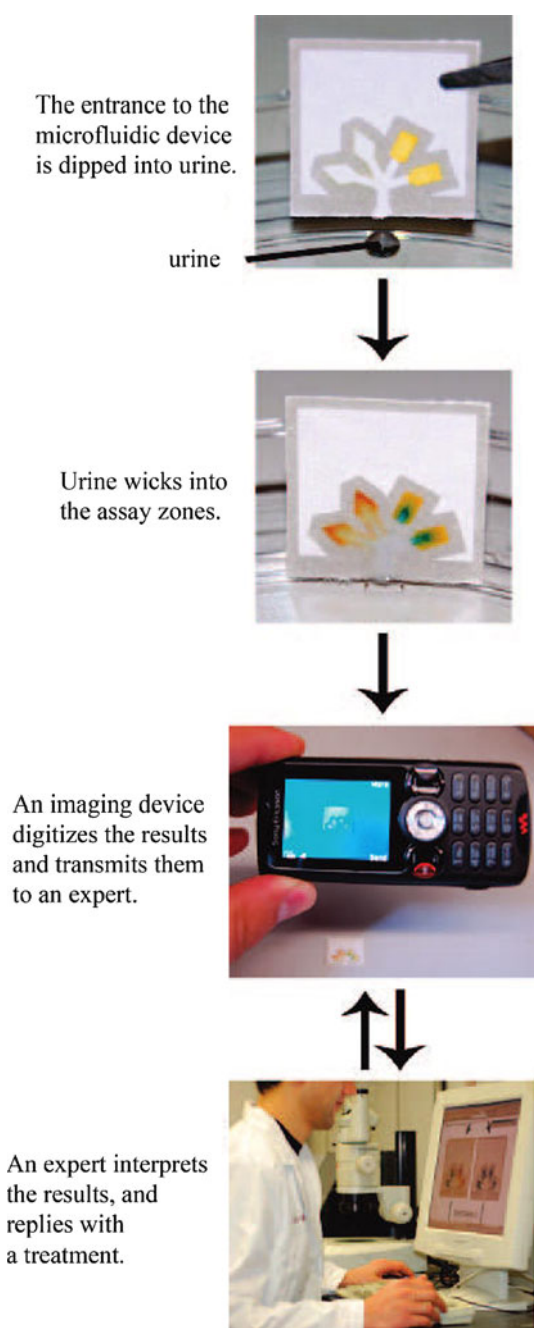

Fig. 8 General strategy for performing inexpensive bioassays in remote locations and for exchanging the results of the tests with offsite technicians (reprinted with permission from Martinez et al. 2008 [70]; copyright (2012) American Chemical Society)

oligonucleotides by orders of magnitude [105]. In developed countries, there are many valued features of diagnostic tools, including speed, sensitivity and specificity. In developing countries, with limited resources, where the healthcare infrastructure is less well developed, many difficulties must be overcome to apply the LOC device; therefore, ease of use must also be considered. In this case, paper-based devices can be extremely useful.

New techniques for making paper devices and their use in clinical and environmental laboratory will be evaluated in accordance with the principles of economics—mainly in terms of material costs and production in mass production—the utility and ease of use. Their advantage is the simplicity of design and ease of interpretation of test results. In contrast to more complicated LOC devices, they are self-contained and independent from the other devices. These features also do not exclude the possibility of cooperation μ PADs with other units. Their compatibility to telemedicine, particularly with mobile phone transmission or interpretation of test results is study [70, 143]. Whitesides' group in Harvard University showed that an image of the device can be taken by a camera on a mobile phone and then sent to a remote location for analysis [70] (Fig. 8). Liu and Crooks [144] reported, for point-of-care diagnosis, microelectrochemical biosensing platform that is based on paper fluidics and powered by an integral metal/air battery. Vella and co-workers [145] described micropatterned paper device designed for blood from a fingerstick uses to measuring markers of liver function. These studies are just beginning to show the potential for paper-based diagnostic devices for developing countries. However, paper-based microfluidic devices that rely on complicated instrumentation for result interpretation may only have value for laboratory uses [44]. The possibility of using paper in preconcentration is obvious, since it is already widely used in chromatographic applications and is much cheaper than conventional materials used in SPE. Furthermore, paper spray ionization has been recently reported as a direct sampling ionization method for mass spectrometric analysis [146]. Thus, the use of paper as a platform for preconcentration and mass spectrometric analysis can be an excellent low-cost alternative to the conventional analytical methods for trace compounds. The combination of paper spray with miniature mass spectrometers offers a powerful impetus to wide application of mass spectrometry in non-laboratory environments [146]. μ PADs area research is still at an early stage and significant efforts will be needed to nurture it into a more matured platform technology in diagnostic, point-of-care (POC), and environmental monitoring applications [44].

Open Access This article is distributed under the terms of the Creative Commons Attribution License which permits any use, distribution, and reproduction in any medium, provided the original author(s) and the source are credited.

References

1. Reyes DR, Dimitri I, Auroux PA, Manz A (2002) Micro total analysis systems. 1. Introduction, theory, and technology. *Anal Chem* 74:2623–2636

2. Martinez AW, Phillips ST, Whitesides GM (2010) Diagnostics for the developing world: microfluidic paper-based analytical devices. *Anal Chem* 82:3–10
3. Whitesides GM (2006) The origins and the future of microfluidics. *Nature* 442:368–373
4. Craighead H (2006) Future lab-on-a-chip technologies for interrogating individual molecules. *Nature* 442:387–393
5. Manz A, Graber N, Widmer HM (1990) Miniaturized total chemical analysis systems—a novel concept for chemical sensing. *Sens Actuat B-Chem* 1:244–248
6. Lauks IR (1998) Microfabricated biosensors and microanalytical systems for blood analysis. *Acc Chem Res* 31:317–324
7. Floris J, Staal SS, Lenk SO, Staijen E, Kohlheyer D, Eijkel JCT, van den Berg A (2010) A prefilled, ready-to-use electrophoresis based lab-on-a-chip device for monitoring lithium in blood. *Lab Chip* 10:1799–1806
8. Khan MS, Thouas G, Shen W, Whyte G, Garnier G (2010) Paper diagnostic for instantaneous blood typing. *Anal Chem* 82:4158–4164
9. Hou HW, Bhagat AAS, Lee WC, Huang S, Han J, Lim CT (2011) Microfluidic devices for blood fractionation. *Micromachines* 2:319–343
10. Liu RH, Munro SB, Nguyen T, Siuda T, Suci D, Bizak M, Slota M, Fuji HS, Danley D, McShea A (2006) Integrated microfluidic custom array device for bacterial genotyping and identification. *J Assoc Lab Autom* 11:360–367
11. Bunyakul N, Edwards KA, Promptmas C, Baemner AJ (2009) Cholera toxin subunit B detection in microfluidic devices. *Anal Bioanal Chem* 393:177–186
12. Diercks AH, Ozinsky A, Hansen CL, Spotts JM, Rodriguez DJ, Aderem A (2009) A microfluidic device for multiplexed protein detection in nano-liter volumes. *Anal Biochem* 386:30–35
13. Mairhofer J, Roppert K, Ertl P (2009) Microfluidic systems for pathogen sensing: a review. *Sensors* 9:4804–4823
14. Marle L, Greenway GM (2005) Microfluidic devices for environmental monitoring. *Trends Anal Chem* 24(9):795–802
15. Li HF, Lin JM (2009) Applications of microfluidic systems in environmental analysis. *Anal Bioanal Chem* 393(2):555–567
16. Lafleur JP, Jensen TG, Kutter JP (2011) Gold nanoparticle-based microfluidic sensor for mercury detection. 15th International Conference on Miniaturized Systems for Chemistry and Life Sciences ICMSCLS; October 2–6, Seattle, Washington, USA
17. Hopwood AJ, Hurth C, Yang J, Cai Z, Moran N, Lee-Edghill JG, Nordquist A, Lenig R, Estes MD, Haley JP, McAlister CR, Chen X, Brooks C, Smith S, Elliott K, Koumi P, Zenhausem F, Tully G (2010) Integrated microfluidic system for rapid forensic DNA analysis: sample collection to DNA profile. *Anal Chem* 82(16):6991–6999
18. Shui L, Bomer JG, Jin M, Carlen ET, van den Berg A (2011) Microfluidic DNA fragmentation for on-chip genomic analysis. *Nanotechnology* 22(49):494013–494019
19. Kang L, Chung BG, Langer R, Khademhosseini A (2008) Microfluidics for drug discovery and development. *Drug Discov Today* 13:1–13
20. Sekhon BS, Kamboj S (2010) Microfluidics technology for drug discovery and development—an overview. *Int J Pharm Tech Res* 2(1):804–809
21. Liu C, Wang L, Xu Z, Li J, Ding X, Wang Q, Chunyu L (2012) A multilayer microdevice for cell-based high-throughput drug screening. *J Micromech Microeng* 22:1–7
22. Terry SC (1975) A gas chromatographic air analyser fabricated on silicon wafer using integrated circuit technology. PhD Thesis. Stanford CA
23. Terry SC, Jerman JH, Angell JB (1979) A gas chromatographic air analyzer fabricated on a silicon wafer. *IEEE Trans Electron Devices* 26(12):1880–1886
24. Izmailov NA, Shraiber MS (1938) A drop-chromatographic method of analysis and its applications to pharmacy. *Farmatsiya* 3:1–7
25. Shostenko YV, Georgievskii VP, Levin MG (2000) History of the discovery of thin-layer chromatography. *J Anal Chem* 55(9):904–905
26. Berezkin VG (2007) N.A. Izmailov i M.S. Shraiber: odkrycie tonkosloinoi khromatografii (N.A. Izmailov and M.S. Shraiber: the discovery of thin-layer chromatography). GEOS, Moscow
27. Brinkman UATH, de Vries G, van Dalen E (1966) Chromatographic techniques using liquid anion exchangers* III. Systematic thin-layer chromatography of the elements in HCl systems. *J Chromatogr* 23:447–463
28. Merkus FWHM (1969) Inorganic micro-thin-layer chromatography. *J Chromatogr* 41:497–499
29. Svetashev VI, Vaskovsky VE (1972) A simplified technique for thin-layer microchromatography of lipids. *J Chromatogr* 67:376–378
30. Vaskovsky VE, Dembitzky VM (1975) Determination of plasmalogen contents of phospholipid classes by reaction micro-thin-layer chromatography. *J Chromatogr* 115:645–647
31. Dembitzky VM (1988) Quantification of plasmalogen, alkylacyl and diacyl glycerophospholipids by micro-thin-layer chromatography. *J Chromatogr* 436:467–473
32. Zarzycki PK (2008) Simple horizontal chamber for thermostated micro-thin-layer chromatography. *J Chromatogr A* 1187:250–259
33. Zarzycki PK, Zarzycka MB (2008) Application of temperature-controlled micro planar chromatography for separation and quantification of testosterone and its derivatives. *Anal Bioanal Chem* 391(6):2219–2225
34. Zarzycki PK, Zarzycka MB (2008) Evaluation of the water and organic liquids extraction efficiency of the spirulina maxima dyes using thermostated micro-thin-layer chromatography. *J AOAC Int* 91(5):1196–1202
35. Zarzycki PK, Ohta H, Harasimiuk FB, Jinno K (2007) Fast separation and quantification of C60 and C70 fullerenes using thermostated micro thin-layer chromatography. *Anal Sci* 23:1391–1396
36. Zarzycki PK, Ślęczka MM, Zarzycka MB, Bartoszek MA, Włodarczyk E, Baran MJ (2011) Temperature-controlled micro-TLC: a versatile green chemistry and fast analytical tool for separation and preliminary screening of steroids fraction from biological and environmental samples. *J Steroid Biochem Mol Biol* 127:418–427
37. Zarzycki PK, Zarzycka MB, Clifton VL, Adamski J, Głód BK (2011) Low parachor solvents extraction and thermostated micro-TLC separation for fast screening and classification of spirulina from pharmaceutical formulations and food samples. *J Chromatogr A* 1218:5694–5704
38. Zarzycki PK, Ślęczka MM, Zarzycka MB, Włodarczyk E E, Baran MJ (2011c) Application of micro-thin-layer chromatography as a simple fractionation tool for fast screening of raw extracts derived from complex biological, pharmaceutical and environmental samples. *Anal Chim Acta* 688:168–174
39. Manz A, Miyahara Y, Miura J, Watanabe Y, Miyagi H, Sato K (1990) Design of an open-tubular column liquid chromatograph using silicon chip technology. *Sens Actuat B* 1:249–255
40. Aurox PA, Iossifidis D, Reyes DR, Manz A (2002) Micro Total Analysis Systems. 2. Analytical standard operations and applications. *Anal Chem* 74:2637–2652
41. Sharma H, Nguyen D, Chen A, Lew V, Khine M (2011) Unconventional low-cost fabrication and patterning techniques for point of care diagnostics. *Ann Biomed Eng* 39(4):1313–1327
42. Martinez AW, Phillips ST, Butte MJ, Whitesides GM (2007) Patterned paper as a platform for inexpensive, low-volume, portable bioassays. *Angew Chem Int Ed* 46:1318–1320

43. Müller RH, Clegg DL (1949) Automatic paper chromatography. *Anal Chem* 21(9):1123–1125
44. Li X, Ballerini DR, Shen W (2012) A perspective on paper-based microfluidics: current status and future trends. *Biomicrofluidics* 6:011301–011313
45. Vilkner T, Janasek D, Manz A (2004) Micro total analysis systems recent developments. *Anal Chem* 76:3373–3385
46. Braschler T, Valero A, Colella L, Pataky K, Brugger J, Renaud P (2010) Fluidic microstructuring of alginate hydrogels for the single cell niche. *Lab Chip* 10:2771–2777
47. Chueh BH, Zheng Y, Torisawa YS, Hsiao AY, Ge C, Hsiong S, Huebsch N, Franceschi R, Mooney DJ, Takayama S (2010) Patterning alginate hydrogels using light-directed release of caged calcium in a microfluidic device. *Biomed Microdevices* 12(1):145–151
48. McDonald JC, Duffy DC, Anderson JR, Chiu DT, Wu H, Schueller OJ, Whitesides GM (2000) Fabrication of microfluidic systems in poly(dimethylsiloxane). *Electrophoresis* 21:27–40
49. Shoji S, Esashi M (1994) Microflow devices and systems. *J Micromech Microeng* 4(4):157–171
50. Yao SH, Hertzog DE, Zeng SL, Mikkelsen JC, Santiago JG (2003) Porous glass electroosmotic pumps: design and experiments. *J Colloid Interface Sci* 268:143–153
51. Whitesides GM (2003) The ‘right’ size in nanobiotechnology. *Nat Biotechnol* 21:1161–1165
52. Laser DJ, Santiago JG (2004) A review of micropumps. *J Micromech Microeng* 14:r35–r64
53. Fiorini GS, Chiu DT (2005) Disposable microfluidic devices: fabrication, function, and application. *Biotechniques* 38:429–446
54. Kundu PK, Cohen IM (2008) *Fluid Mechanics*, 4th edn. Academic Press, Burlington
55. Purcell EM (1977) Life at low Reynolds numbers. *Am J Phys* 45:3–11
56. Koch M, Evans A, Brunnschweiler A (2000) *Microfluidic Technology and Applications*. Research Studies Press, Baldock
57. Amirouche F, Zhou Y, Johnson T (2009) Current micropump technologies and their biomedical applications. *Microsyst Technol* 15:647–666
58. Hulme SE, Shevkopylas SS, Whitesides GM (2009) Incorporation of prefabricated screw, pneumatic, and solenoid valves into microfluidic devices. *Lab Chip* 9(1):79–86
59. Squires TM, Quake SR (2005) Microfluidics: fluid physics at the nanoliter scale. *Rev Mod Phys* 77:977–1026
60. Sudarsan AP, Ugaz VM (2006) Multivortex micromixing. *Proc Natl Acad Sci U. S. A.* 103:7228–7233
61. Paik P, Pamula VK, Pollack MG, Fair RB (2003) Electrowetting-based droplet mixers for microfluidic systems. *Lab Chip* 3:28–33
62. Takhistov P, Duginova K, Chang HC (2003) Electrokinetic mixing vortices due to electrolyte depletion at microchannel junctions. *J Colloid Interface Sci* 263:133–143
63. Yang Z, Matsumoto S, Goto H, Matsumoto M, Maeda R (2001) Ultrasonic micromixer for microfluid systems. *Sens Actuators A* 93:266–272
64. Garstecki P, Fuerstman MJ, Fischbach MA, Sia SK, Whitesides GM (2006) Mixing with bubbles: a practical technology for use with portable microfluidic devices. *Lab Chip* 6:207–212
65. Siegel AC, Shevkopylas SS, Weibel DB, Bruzewicz DA, Martinez AW, Whitesides GM (2006) Cofabrication of electromagnets and microfluidic systems in poly(dimethylsiloxane). *Angew Chem Int Ed* 45:6877–6882
66. Siegel AC, Bruzewicz DA, Weibel DB, Whitesides GM (2007) Microsolids: fabrication of three-dimensional metallic microstructures in poly(dimethylsiloxane). *Adv Mater* 19:727–733
67. Prakash M, Gershenfeld N (2007) Microfluidic bubble logic. *Science* 315:832–835
68. Nie Z, Seo MS, Xu S, Lewis PC, Mok M, Kumacheva E, Whitesides GM, Garstecki P, Stone HA (2008) Emulsification in a microfluidic flow-focusing device: effect of the viscosities of the liquids. *Microfluid Nanofluid* 5:585–594
69. Teh SY, Lin R, Hung LH, Lee AP (2008) Droplet microfluidics. *Lab Chip* 2:198–220
70. Martinez AW, Scott TP, Carrilho E, Thomas SW III, Sindi H, Whitesides GM (2008) Simple telemedicine for developing regions: camera phones and paper-based microfluidic devices for real-time, off-site diagnosis. *Anal Chem* 80(10):3699–3707
71. Klasner SA, Price AK, Hoeman KW, Wilson RS, Bell KJ, Culbertson CT (2010) Paper-based microfluidic devices for analysis of clinically relevant analytes present in urine and saliva. *Anal Bioanal Chem* 397:1821–1829
72. Bruzewicz DA, Reches M, Whitesides GM (2008) Low-cost printing of poly(dimethylsiloxane) barriers to define microchannels in paper. *Anal Chem* 80:3387–3392
73. Abe K, Kotera K, Suzuki K, Citterio D (2008) Inkjet-printed microfluidic multianalyte chemical sensing paper. *Anal Chem* 80(18):6928–6934
74. Li X, Tian J, Nguyen TH, Shen W (2008) Paper-based microfluidic devices by plasma treatment. *Anal Chem* 80(23):9131–9134
75. Fenton EM, Mascarenas MR, López GP, Sibbett SS (2009) Multiplex lateral-flow test strips fabricated by two-dimensional shaping. *ACS Appl Mater Interfaces* 1(1):124–129
76. Wang W, Wu WY, Zhu JJ (2010) Tree-shaped paper strip for semiquantitative colorimetric detection of protein with self-calibration. *J Chromatogr A* 1217(24):3896–3899
77. Carrilho E, Martinez AW, Whitesides GM (2009) Understanding wax printing: a simple micropatterning process for paper-based microfluidics. *Anal Chem* 81:7091–7095
78. Lu Y, Shi W, Jiang L, Qin J, Lin B (2009) Rapid prototyping of paper-based microfluidics with wax for low-cost, portable bioassay. *Electrophoresis* 30:1497–1500
79. Dungchai W, Chailapakul O, Henry CS (2011) A low-cost, simple, and rapid fabrication method for paper-based microfluidics using wax screen-printing. *Analyst* 136(1):77–82
80. Li X, Tian J, Garnier G, Shen W (2010) Fabrication of paper-based microfluidic sensors by printing. *Colloids Surf B* 76(2):564–570
81. Olkkonen J, Lehtinen K, Erho T (2010) Flexographically printed fluidic structures in paper. *Anal Chem* 82(24):10246–10250
82. Chitnis G, Ding Z, Chang CL, Savran CA, Ziaie B (2011) Laser-treated hydrophobic paper: an inexpensive microfluidic platform. *Lab Chip* 11:1161–1165
83. Shen W, Filonanko Y, Truong Y, Parker IH, Brack N, Pigram P, Liesegang J (2000) Contact angle measurement and surface energetics of sized and unsized paper. *Colloids Surf A* 173(1–3):117–126
84. Abe K, Kotera K, Suzuki K, Citterio D (2010) Inkjet-printed paperfluidic immuno-chemical sensing device. *Anal Bioanal Chem* 398:885–893
85. Shen W, Li X, Tian J, Nguyen TH, Gil G (2010) Switches for microfluidic systems. *Pat nr WO 2010(017578):A1*
86. Martinez AW, Phillips ST, Whitesides GM (2008) Three-dimensional microfluidic devices fabricated in layered paper and tape. *Proc Natl Acad Sci USA* 105(50):19606–19611
87. Liu H, Crooks RM (2011) Three-dimensional paper microfluidic devices assembled using the principles of origami. *J Am Chem Soc* 133:17564–17566
88. Martinez AW, Phillips ST, Nie Z, Cheng CM, Carrilho E, Wiley BJ, Whitesides GM (2010) Programmable diagnostic devices made from paper and tape. *Lab Chip* 10(19):2499–2504
89. Chen H, Cogswell J, Anagnostopoulos, Faghri M (2012) A fluidic diode, valves, and a sequential-loading circuit fabricated on layered paper. *Lab Chip* 12:2909–2913

90. Dungchai W, Chailapakul O, Henry CS (2009) Electrochemical detection for paper-based microfluidics. *Anal Chem* 81:5821–5826
91. Baker CA, Duong CT, Grimley A, Roper MG (2009) Recent advances in microfluidic detection systems. *Bioanalysis* 1(5):967–975
92. Delaney JL, Hogan CF, Tian J, Shen W (2011) Electrogenerated chemiluminescence detection in paper-based microfluidic sensors. *Anal Chem* 83(4):1300–1306
93. Verpoorte E (2002) Microfluidic chips for clinical and forensic analysis. *Electrophoresis* 23:672–712
94. Kopp MU, de Mello AJ, Manz A (1998) Chemical amplification: continuous-flow PCR on a chip. *Science* 280:1046–1048
95. Waters LC, Jacobso SC, Kroutchinina N, Khandurina J, Foote RS, Ramsey JM (1998) Multiple sample PCR amplification and electrophoretic analysis on a microchip. *Anal Chem* 70:5172–5176
96. Kumaresan P, Yang CJ, Cronier SA, Blazej RG, Mathies RA (2008) High-throughput single copy DNA amplification and cell analysis in engineered nanoliter droplets. *Anal Chem* 80:3522–3529
97. Lee SH, Kim SW, Kang JY, Ahn CH (2008) A polymer lab-on-a-chip for reverse transcription (RT)-PCR based point-of-care clinical diagnostics. *Lab Chip* 8:2121–2127
98. Kim YT, Chen Y, Choi JY, Kim WJ, Dae HM, Jung J, Seo TS (2012) Integrated microdevice of reverse transcription-polymerase chain reaction with colorimetric immunochromatographic detection for rapid gene expression analysis of influenza A H1N1 virus. *Biosens Bioelectron* 33(1):88–94
99. Lee JG, Cheong KH, Huh N, Kim S, Choi JW, Ko C (2006) Microchip-based one step DNA extraction and real-time PCR in one chamber for rapid pathogen identification. *Lab Chip* 6:886–895
100. Wang Z, Sekulovic A, Kutter JP, Bang DD, Wolff A (2006) Real-time PCR using a PCR microchip with integrated thermal system and polymer waveguides for the detection of *Campylobacter jejuni*. MEMS, Istanbul, pp 542–545
101. Lee TMH, Carles MC, Hsing IM (2003) Microfabricated PCR-electrochemical device for simultaneous DNA amplification and detection. *Lab Chip* 3:100–105
102. Perch-Nielsen IR, Bang DD, Poulsen CR, El-Alia J, Wolff A (2003) Removal of PCR inhibitors using dielectrophoresis as a selective filter in a microsystem. *Lab Chip* 3:212–216
103. Marcus JS, Anderson WF, Quake SR (2006) Microfluidic single-cell mRNA isolation and analysis. *Anal Chem* 78:3084–3089
104. Hong JW, Studer V, Hang G, Anderson WF, Quake SR (2004) A nanoliter-scale nucleic acid processor with parallel architecture. *Nat Biotech* 22:435–439
105. Lee CC, Snyder TM, Quake SR (2010) A microfluidic oligo-nucleotide synthesizer. *Nucleic Acids Res* 38(8):2514–2521
106. Hong JW, Chen Y, Anderson WF, Quake SR (2006) Molecular biology on a microfluidic chip. *J Cond Matt Phys* 18:691–701
107. Marcy Y, Ouverney C, Blik EM, Losekann T, Ivanova N, Martin HG, Szeto E, Platt D, Hugenholtz P, Relman DA, Quake SR (2007) Dissecting biological “dark matter” with single cell genetic analysis of rare and uncultivated TM7 microbes from the human mouth. *PNAS* 104(29):1889–1894
108. Diehn M, Cho RW, Lobo NA, Kalisky T, Dorie MJ et al (2009) Association of reactive oxygen species levels and radioresistance in cancer stem cells. *Nature* 458:780–783
109. Fan HC, Wang J, Potanina A, Quake SR (2011) Whole-genome molecular haplotyping of single cells. *Nat Biotechnol* 29:51–57
110. Spurgeon SL, Jones RC, Ramakrishnan R (2008) High throughput gene expression measurement with real time PCR in a microfluidic dynamic array. *PLoS One* 3(2):e1662
111. Sims CE, Allbritton NL (2007) Analysis of single mammalian cells on-chip. *Lab Chip* 7:423–440
112. Tan SJ, Yobas L, Lee GY, Ong CN, Lim CT (2009) Microdevice for the isolation and enumeration of cancer cells from blood. *Biomed Microdevices* 11:883–892
113. Mohamed H, Murray M, Turner JN, Caggana M (2009) Isolation of tumor cells using size and deformation. *J Chromatogr A* 1216(47):8289–8295
114. El-Ali J, Sorger PK, Jensen KF (2006) Cells on chips. *Nature* 442:403–411
115. Hufnagel H, Huebner A, Gülch C, Güse K, Abell C, Hollfelder F (2009) An integrated cell culture lab on a chip: modular microdevices for cultivation of mammalian cells and delivery into microfluidic microdroplets. *Lab Chip* 9:1576–1582
116. Ni M, Tong WH, Choudhury D, Rahim NAA, Iliescu C, Yu H (2009) Cell culture on MEMS platforms: a review. *Int J Mol Sci* 10:5411–5544
117. Chiem NH, Harrison DJ (1998) Microchip systems for immunoassay: an integrated immunoreactor with electrophoretic separation for serum theophylline determination. *Clin Chem* 44(3):591–598
118. Winkle RF, Nagy JM, Cass AEG, Sharma S (2008) Towards microfluidic technology-based MALDI-MS platforms for drug discovery: a review. *Exp Opin Drug Discov* 3:1281–1292
119. Pal R, Yang M, Lin R, Johnson BN et al (2005) An integrated microfluidic device for influenza and other genetic analyses. *Lab Chip* 5:1024–1032
120. Deng G, Collins GE (2003) Nonaqueous based microchip separation of toxic metal ions using 2-(5-bromo-2-pyridylazo)-5-(N-propyl-N-sulfopropylamino)phenol. *J Chromatogr A* 989:311–316
121. Qu S, Chen X, Chen D, Yang P, Chen G (2006) Poly(methyl methacrylate) CE microchips replicated from poly(dimethylsiloxane) templates for the determination of cations. *Electrophoresis* 27:4910–4918
122. Kou S, Nam SW, Shumi W, Lee MH, Bae SW, Du J, Kim JS, Hong JI, Peng X, Yoon J, Park S (2009) Microfluidic detection of multiple heavy metal ions using fluorescent chemosensors. *Bull Korean Chem Soc* 30(5):1173–1176
123. Wang J, Chatrathi MP, Tian B (2000) Capillary electrophoresis microchips with thick-film amperometric detectors: separation and detection of phenolic compounds. *Anal Chim Acta* 416:9–14
124. Ding Y, Garcia CD (2006) Pulsed amperometric detection with poly(dimethylsiloxane)-fabricated capillary electrophoresis microchips for the determination of EPA priority pollutants. *Analyst* 131:208–214
125. Wang J, Chen G, Chatrathi MP, Musameh M (2004) Capillary electrophoresis microchip with a carbon nanotube-modified electrochemical detector. *Anal Chem* 76:298–302
126. Pumera M (2008) Trends in analysis of explosives by microchip electrophoresis and conventional CE. *Electrophoresis* 29:269–273
127. Yao X, Wang J, Zhang L, Yang P, Chen G (2006) A three-dimensionally adjustable amperometric detector for microchip electrophoretic measurement of nitroaromatic pollutants. *Talanta* 69:1285–1291
128. Wang J, Escarpa A, Pumera M, Feldman J (2002) Capillary electrophoresis-electrochemistry microfluidic system for the determination of organic peroxides. *J Chromatogr A* 952:249–254
129. Carrilho E, Phillips ST, Vella SJ, Martinez AW, Whitesides GM (2009) Paper microzone plates. *Anal Chem* 81:5990–5998
130. Hossain SMZ, Luckham RE, Smith AM, Lebert JM, Davies LM, Pelton RH, Filipe CDM, Brennan JD (2009a) Development of a bioactive paper sensor for detection of neurotoxins using piezoelectric inkjet printing of sol-gel-derived bioinks. *Anal Chem* 81:5474–5483

131. Al-Tamimi M, Shen W, Rania Z, Huy T, Garnier G (2012) Validation of paper-based assay for rapid blood typing. *Anal Chem* 84:1661–1668
132. Li M, Tian J, Al-Tamimi M, Shen W (2012) Paper-based blood-typing device that reports patient's blood type "in writing". *Angew Chem Int Ed* 51:5497–5501
133. Jarujamrus P, Tian J, Li X, Siripinyanond A, Shiwatana J, Shen W (2012) Mechanisms of antibody and red blood cell interactions in paper-based blood typing devices. *Analyst* 137:2205–2210
134. Su J, Al-Tamimi M, Garnier G (2012) Engineering paper as a substrate for blood typing bio-diagnostics. *Cellulose* 19:1749–1758
135. Ali MM, Aguirre SD, Xu Y, Filipe CDM, Pelton R, Li Y (2009) Detection of DNA using bioactive paper strips. *Chem Commun* 43:6640–6642
136. Cheng C-M, Martinez AW, Gong J, Mace CR, Phillips ST, Carrilho E, Mirica KA, Whitesides GM (2010) Paper-based ELISA. *Angew Chem Int Ed* 49:4771–4774
137. Curry PS, Elkin BT, Campbell M, Nielsen K, Hutchins W, Ribble C, Kutz SJ (2011) Filter-paper blood samples for ELISA detection of *Brucella* antibodies in caribou. *J Wildl Dis* 47(1):12–20
138. Nie ZH, Nijhuis CA, Gong J, Chen X, Kumachev A, Martinez AW, Narovlyansky M, Whitesides GM (2010) Electrochemical sensing in paper-based microfluidic devices. *Lab Chip* 10(4):477–4
139. Shi J, Tang F, Xing H, Zheng H, Bi L, Wang W (2012) Electrochemical detection of Pb and Cd in paper-based microfluidic devices. *J Braz Chem Soc* 23(6):1124–1130
140. Hossain SMZ, Luckham RE, McFadden MJ, Brennan JD (2009) Reagentless bidirectional lateral flow bioactive paper sensors for detection of pesticides in beverage and food samples. *Anal Chem* 81:9055–9064
141. Yager P, Domingo GJ, Gerdes J (2008) Point-of-Care diagnostics for global health. *Annu Rev Biomed Eng* 10:107–144
142. Liu J, Hansen C, Quake SR (2003) Solving the "world-to-chip" interface problem with a microfluidic matrix. *Anal Chem* 75:4718–4723
143. Li X, Tian J, Shen W (2010) Quantitative biomarker assay with microfluidic paper-based analytical devices. *Anal Bioanal Chem* 396:495–501
144. Liu H, Crooks RM (2012) Paper-based electrochemical sensing platform with integral battery and electrochromic read-out. *Anal Chem* 84(5):2528–2532
145. Vella SJ, Beattie P, Cademartiri R, Laromaine A, Martinez AW, Phillips ST, Mirica KA, Whitesides GM (2012) Measuring markers of liver function using a micropatterned paper device designed for blood from a fingerstick. *Anal Chem* 84:2883–2891
146. Liu J, Wang H, Manicke NE, Lin JM, Cooks RG, Ouyang Z (2010) Development, characterization, and application of paper spray ionization. *Anal Chem* 82(6):2463–2471
147. Kim E, Xia Y, Whitesides GM (1996) Micromolding in capillaries: applications in materials science. *J Am Chem Soc* 118:5722–5731
148. Danel JS, Delapierre G (1991) Quartz: a material for microdevices. *J Micromech Microeng* 1:187–198
149. Becker EW, Ehrfeld W, Hagemann P, Maner A, Münchmeyer D (1986) Fabrication of microstructures with high aspect ratios and great structural heights by synchrotron radiation lithography, galvanofarming, and plastic moulding (LIGA process). *Microelectron Eng* 4(1):35–56
150. Ehrfeld W, Hessel V, Löwe H, Schulz C, Weber L (1999) Materials of LIGA technology. *Microsys Tech* 5(3):105–112
151. Fuentes HV, Wolley AT (2008) Phase-changing sacrificial layer fabrication of multilayer polymer microfluidic devices. *Anal Chem* 80:333–339
152. Liu Y, Ganser D, Schneider A, Liu R, Grodzinski P, Kroutchinina N (2001) Microfabricated polycarbonate CE devices for DNA analysis. *Anal Chem* 73(17):4196–4201
153. Tseng WL, Lin YW, Chen KC, Chang HT (2002) DNA analysis on microfabricated electrophoretic devices with bubble cells. *Electrophoresis* 23:2477–2484
154. Agirregabiria M, Blanco FJ, Berganzo J, Arroyo MT, Fullaondo A, Mayora K, Ruano-López JM (2005) Fabrication of SU-8 multilayer microstructures based on successive CMOS compatible adhesive bonding and releasing steps. *Lab Chip* 5:545–552
155. Zhang J, Tan KL, Hong GD, Yang LJ, Gong HQ (2001) Polymerization optimization of SU-8 photoresist and its applications in microfluidic systems and MEMS. *J Micromech Microeng* 11:20–26
156. Attia UM, Marson S, Alcock JR (2009) Micro-injection moulding of polymer microfluidic devices. *Microfluid Nanofluid* 7:1–28
157. Piottet V, Mueller K, Plewa K, Ruprecht R, Hausselt J (2002) Performance and simulation of thermoplastic micro injection molding. *Microsys Tech* 8:387–390
158. Schaller Th, Bohn L, Mayer J, Schubert K (1999) Microstructure grooves with a width of less than 50 nm cut with ground hard metal micro end mills. *Prec Eng* 23:229–235
159. Stachowiak TB, Mair DA, Holden TG, Lee LJ, Svec F, Fréchet JM (2007) Hydrophilic surface modification of cyclic olefin copolymer microfluidic chip using sequential photografting. *J Sep Sci* 30:1088–1093
160. Duffy DC, McDonald JC, Schueller OJA, Whitesides GM (1998) Rapid prototyping of microfluidic systems in poly(dimethylsiloxane). *Anal Chem* 70:4974–4984
161. Jang L, Lu Y, Dai Z, Xie M, Lin B (2005) Mini-electrochemical detector for microchip electrophoresis. *Lab Chip* 5:930–934
162. Álvarez-Castaño M, Fernández-Abedul MT, Costa-García A, Agirregabiria M, Fernández LJ, Ruano-López JM, Barredo-Presa B (2009) Fabrication of SU-8 based microchip electrophoresis with integrated electrochemical detection for neurotransmitters. *Talanta* 80:24–30
163. O'Toole M, Diamond D (2008) Absorbance based light emitting diode optical sensors and sensing devices. *Sensors* 8:2453–2479
164. Chang I-H, Tulock JJ, Liu J, Kim W-S, Cannon DM Jr, Lu Y, Bohn PW, Sweedler JV, Cropek DM (2005) Miniaturized lead sensor based on lead-specific DNase in a nanocapillary interconnected microfluidic device. *Environ Sci Technol* 39:3756–3761
165. Li F, Wang DD, Yan XP, Su RG, Lin JM (2005) Speciation analysis of inorganic arsenic by microchip capillary electrophoresis coupled with hydride generation atomic fluorescence spectrometry. *J Chromatogr A* 1081:232–237
166. Masaki H, Hoshi J, Amano S, Sasaki Y, Korenaga T (2006) Integration of the cleanup process: pretreatment of polycyclic aromatic hydrocarbons from diesel exhaust particles on silica gel beads in a microchannel. *Anal Sci* 22:345–348
167. Som-aum W, Li H, Liu J, Lin JM (2008) Determination of arsenate by sorption preconcentration on polystyrene beads packed in a microfluidic device with chemiluminescence detection. *Analyst* 133:1169–1175
168. Moore AW, Jacobson SC, Ramsey JM (1995) Microchip separations of neutral species via micellar electrokinetic capillary chromatography. *Anal Chem* 67:4184–4189
169. Walker PA, Morris MD, Burns MA, Johnson BN (1998) Iso-tachophoretic separation on a microchip Normal Raman spectroscopy detection. *Anal Chem* 70:3766–3769
170. Hofmann O, Che D, Cruickshank KA, Müller UR (1999) Adaptation of capillary isoelectric focusing to microchannels on a glass chip. *Anal Chem* 71:678–686

171. Huang T, Pawliszyn J (2002) Microfabrication of a tapered channel for isoelectric focusing with thermally generated pH gradient. *Electrophoresis* 20:3504–3510
172. Ladner Y, Crétier G, Faure K (2010) Electrochromatography in cyclic olefin copolymer microchips: a step towards field portable analysis. *J Chromatogr A* 51:8001–8008
173. Broyles BS, Jacobson SC, Ramsey JM (2003) Sample filtration, concentration, and separation integrated on microfluidic devices. *Anal Chem* 75(11):2761–2767
174. Li HF, Zeng H, Chen Z, Lin JM (2009) Chip-based enantioselective open-tubular capillary electrochromatography using bovine serum albumin-gold nanoparticle conjugates as the stationary phase. *Electrophoresis* 30(6):1022–1029
175. Regnier FE, He B, Lin S, Busse J (1999) Chromatography and electrophoresis on chips: critical elements of future integrated, microfluidic analytical systems for life science. *Trends Biotechnol* 17(3):101–106
176. Stroock AD, Dertinger SKW, Ajdari A, Mezit I, Stone HA, Whitesides GM (2002) Chaotic mixer for microchannels. *Science* 295:647–651
177. Lee J, Soper SA, Murray KK (2009) Microfluidic chips for mass spectrometry-based proteomics. *J Mass Spectrom* 44(5):579–593
178. Figeys D, Gygi SP, McKinnon G, Aebersold R (1998) An integrated microfluidics tandem mass spectrometry system for automated protein analysis. *Anal Chem* 70:3728–3734
179. Jiang Y, Wang PC, Locascio LE, Lee CS (2001) Integrated plastic microfluidic devices with ESI-MS for drug screening and residue analysis. *Anal Chem* 73:2048–2053
180. Gao J, Xu JD, Locascio LE, Lee CS (2001) Integrated microfluidic system enabling protein digestion, peptide separation, and protein identification. *Anal Chem* 73:2648–2655
181. Wang SH, Lee CH, Chen HP (2006) Thermoplastic microchannel fabrication using carbon dioxide laser ablation. *J Chromatogr A* 1111(2):252–257
182. Locascio LE, Ross DJ, Howell PB, Gaitan M (2006) Fabrication of polymer microfluidic systems by hot embossing and laser ablation. *Methods Mol Biol* 339:37–46
183. Becker H, Heim U (2000) Hot embossing as a method for the fabrication of polymer high aspect ratio structures. *Sens Actuat A* 83:130–135