

An Intelligent Four-Electrode Conductivity Sensor for Aquaculture

Jiaran Zhang^{1,2,3}, Daoliang Li^{1,2,3,*}, Cong Wang^{1,2,3}, and Qisheng Ding^{1,2,3,4}

¹ China-EU Center for Information and Communication Technologies in Agriculture of China Agriculture University, Beijing 100083, P.R. China

² Beijing Engineering & Technology Research Center for Internet of Things in Agriculture, Beijing 100083, P.R. China

³ Key Laboratory of Agricultural Information Acquisition Technology, Ministry of Agriculture, Beijing 100083, P.R. China

⁴ Jiangsu Normal University, Xuzhou, Jiangsu, P.R. China
dliangl@cau.edu.cn, li_daoliang@yahoo.com

Abstract. Conductivity is regard as a key technical parameter in modern intensive fish farming management. The water conductivity sensors are sophisticated devices used in the aquaculture monitoring field to understand the effects of climate changes on fish ponds. In this paper a new four-electrode smart sensor is proposed for water conductivity measurements of aquaculture monitoring. The main advantages of these sensors include a high precision, a good stability and an intrinsic capability to minimize errors caused by polarization. A temperature sensor is also included in the system to measure the water temperature and, thus, compensate the water-conductivity temperature dependence. The prototype developed is appropriate for conductivity measurement in the range of 0-50mS/cm, 0-40 °C. A cure relationship was found between the out-put value of each standard solution measured by the sensor and the electric conductivity concentration.

Keywords: four-electrode, water-conductivity, intelligent sensor.

1 Introduction

As we all known, fish require levels of salinity (salt), hardness (Calcium and Magnesium) and low levels of various nutrients like Phosphorus, Ammonium and nitrate to maintain their daily lives. Therefore, understanding the concentrating of these ionized chemicals in water of fishponds is critical to successful aquaculture.

Electrical conductivity is commonly used in hydroponics, aquaculture systems to monitor the amount of salts, nutrients or impurities in the water[1]. The nominal values of water-conductivity are generally used to measure the concentration of ionized chemicals in water, though it does not distinguish individual concentrations of

* Corresponding author. Postal address: P.O. Box 121, China Agricultural University, 17 Tsinghua East Road, Beijing 100083, PRC.

different ionic chemicals mixed in water. Water-conductivity measurements are of paramount importance in water-quality monitor of aquaculture since high or low conductivity levels, relative to their nominal values, can be used to detect the environmental changes of aquaculture fishpond.

Temperature is also an important variable when conductivity measurements are concerned. Temperature is itself a water quality parameter and an influence variable that affects conductivity measurements[2]. For raw water the temperature coefficient is about 2% per °C. This means that acceptable conductivity measurement accuracy implies temperature measurement in order to obtain a temperature compensated conductivity measurement for a given reference temperature, typically 25 °C or 20 °C.[3]

There are two main types of conductivity sensors: electrode (or contacting sensors) and toroidal or inductive sensors[4][5][6]. Electrode sensors contain two, three, or four electrodes. The conductivity (σ) is directly proportional to the conductance ($1/R$). The proportionality coefficient (KC) depends on the geometry of the sensor that must be designed according to the target conductivity range[7][8]. Toroidal or inductive sensors usually contain two coils, sealed within a nonconductive housing. The first coil induces an electrical current in the water, while the second coil detects the magnitude of the induced current, which is proportional to the conductivity of the solution.[9]

As far as water conductivity measurement by electrodes is concerned, several solutions have been proposed[10], and many commercial types of equipment are available from many manufacturers[11][12]. Well known limitations of a two or three electrodes sensor have been identified in literature[13]—The main problems associated with water-conductivity measurements are sensitivity to polarization effects in the situation of long time power, measurement selectivity, and too expensive price to application of aquaculture in china. Also this measurement solution implies a large number of repeated calibration procedures are required as the fouling drawback.

In this paper, the attention is focused on the smart four-electrode conductivity sensor for water-quality monitoring in aquaculture. The main advantages associated with the designed sensing unit are its high precision, an intrinsic capability to minimize errors caused by polarization. Another important advantage of the proposed solution for conductivity measurements are its simple, accurate method of temperature compensation, good linear behavior that enables the calibration of conductivity sensor to have the better accuracy by using several standard solutions. This paper includes the design of water-conductivity measurement hardware, description of temperature compensation, calibration of conductivity sensor and capability test experiments of the developed prototype.

2 Design of the Four-Electrode Conductivity Sensor

The intention of this part is to present and characterize a prototype for water-conductivity measurements based on a four-electrodes sensing unit which using in the

aquaculture. The smart sensor also includes a temperature sense part to provide compensation of conductivity measurements caused by temperature variation.

2.1 Principle of Measurement

For sensing water conductance, metal-solution interface modeling should be taken into account as shown in Fig. 1[14][15]. Assuming the behavior of electrolyte resembles a pure resistor and neglecting the polarization, the charge transfer back and forth the interface results in the reduction-oxidation reaction, and the double layer capacitive effects caused by charging of the electrode-solution at the interface. The two processes can be modeled as a resistive (R_{CT} and Z_W) and a capacitive (C_{DL}) component in parallel.

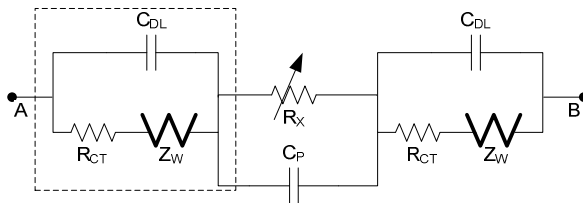

Fig. 1. Equivalent circuit for an electrochemical cell

The charge transfer resistance R_{CT} is highly nonlinear and depends on both the concentration of ions in the solution and the applied potential. The Warburg impedance Z_W is due to the ion diffusion process in proximity to the interface. The double layer capacitance C_{DL} depends on the material of the electrodes and on the ion concentration, with typical values in the range $10\text{--}40\mu\text{F}/\text{cm}^2$.

To minimize these factors, a four-electrode cell was projected and implemented. This type of cell is like a four-terminal precision resistor: Two electrodes are used to force a uniform time varying electric field and the other two measure the voltage.

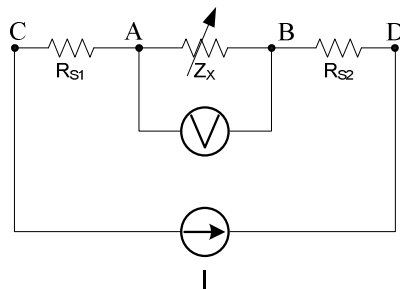

Fig. 2. Impedance sensing by four terminal sensing technique

Four-electrode water-conductivity sensors are widely used to reduce contact and interface interference in conductance measurements[16]. The primary advantage is that the current and voltage electrodes of sensors are separated, eliminating the contribution of wiring impedance and contact resistances R_S as illustrated in Fig. 2. While the alternating current running through two connections, C and D, a voltage drop can be measured across the impedance Z_x by voltage sensing in A and B connections. Disregarding wiring resistances, sensed impedance can be determined by Ohm's law as the current is known. The approach, based on current-forcing and voltage-sensing, is particularly suited for the water-conductivity sensors which are used to eliminate polarization and fouling effects in aquaculture.

2.2 Design of the Hardware

The structure of intelligent water-conductivity sensor mainly contained excitation current source model, constant-current source, conductivity measurement system, temperature sensor, signal conditioning model, power source model, RS485 field bus, microprocessor and Sensors Electronic Data Sheets (TEDS), hardware structure is shown in Fig. 3.

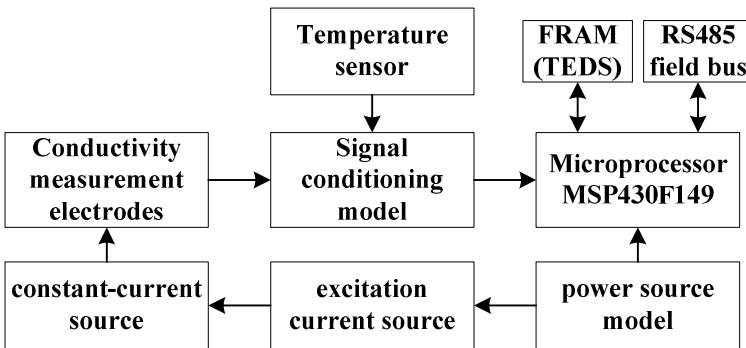

Fig. 3. Hardware structure of the sensor

Excitation current source generates equal and opposite current by means of a dual, bidirectional and single-pole/double-throw (SPDT) CMOS analog switches. It is of paramount importance in water-conductivity sensing unit. Constant current source is used to avoid the fluctuations of output current due to the change of load variations. The system is proposed in this paper adopts the following circuit as shown in Fig. 4.

The alternating current via two excitation electrodes EI1 and EI2, hence magnetic field is generated in solution, a voltage drop can be measured across the measure electrodes EV1 and EV2. Alternating voltage transform to direct current by signal conditioning model. Standardized RS-485 interface is integrated with and possesses self-recognition capability provided by its TEDS. Power source model ensure each model fully functional at supply voltages.

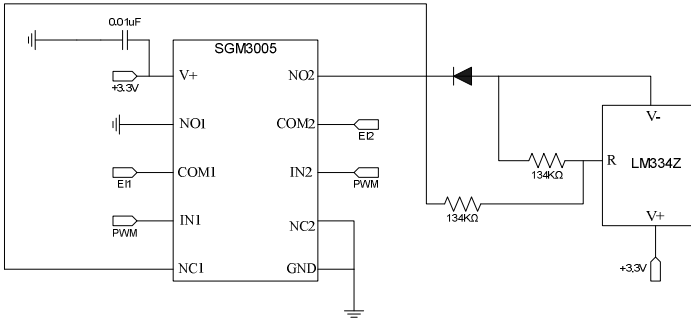

Fig. 4. Circuit diagram for the sensor

A negative temperature coefficient thermistor precision achieved 0.1°C is adopted to temperature sensing unit.

2.3 Temperature Compensation

Temperature compensation is of important to water-conductivity measurement as well. Generally, the conductivity of common electrolytes increases with increasing temperature. In this paper, a valid temperature-compensated method by software is given out.

The measurements for different concentrations of KCl confirm the linear variation of the conductivity with temperature:

$$\sigma_t = \sigma_{ref} \times [1 + \alpha \cdot (t - t_{ref})] \tag{1}$$

where σ_t is the conductivity at any temperature t (in degrees celcius), σ_{ref} is the conductivity at the reference temperature t_{ref} (in degree celcius), and α is the temperature coefficient of the solution at t_{ref} . α can be calculated of every solution at the reference temperature t_{ref} by measured the values of σ_t , σ_{ref} and t . A temperature value of 20 °C is chosen at the temperature reference in this paper.

3 Experiment

The basic experiments were conducted to evaluate the characteristics of the water-conductivity sensor. All solutions were prepared with distilled water and analytical grade chemicals. The KCl solutions of different electric conductivity were prepared. All experiments were carried out in the lab. In addition to distilled water, five KCl solutions of different concentrations are presented as standard solutions to calibrate the water-conductivity of the sensor. They are 4.6mS/cm, 10.4mS/cm, 20.7mS/cm, 32.1mS/cm and 52.6mS/cm.

After the calibration was completed, measurements are repeated 10 times in standard solutions of 4.10mS/cm and 9.20mS/cm every ten minutes to test the reproducibility of sensor. Besides, the experiments of accuracy analysis, stability test and effect of temperature compensation have been done by measure different conductivity KCl solutions.

4 Result and Discussion

The results of experiments were listed to evaluate the characteristics of the water-conductivity sensor at this part. By these experimental data, the characteristics of conductivity curve, reproducibility, accuracy, stability and effect of temperature compensation are verified.

4.1 Water-Conductivity Sensor Calibration

The curvilinear relation of out-put voltage values changing with different of conductivity at the reference temperature(20°C) is presented respectively in Fig 5. The conclusion that a better measurement effect the sensor has when the conductivity is lower than 32.1mS/cm, a low resolution at 32.1mS/cm to 52.6mS/cm the sensor has can be draw from the Fig.5. It indicates that the low sensitivity the sensor has when the water-conductivity is higher than 32.1mS/cm.

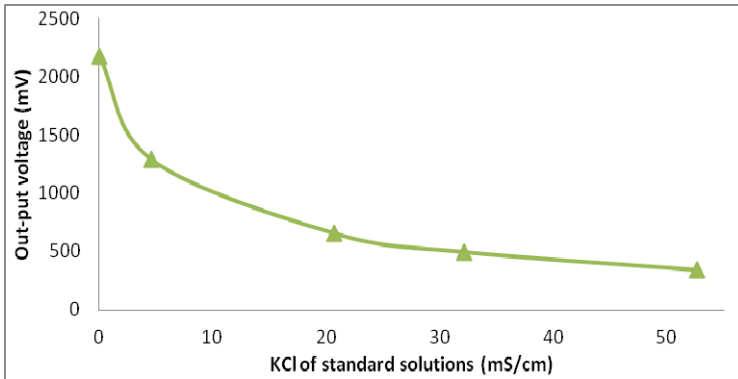

Fig. 5. Curve between out-put voltage and KCl standard solutions

4.2 Reproducibility of the Sensor

Fig. 6 shows the results of repeatedly measuring the water-conductivity of the sensor. As the Fig. shows, the measurement reproducibility is very high and the absolute measurement error is between -0.04~ +0.05 for these samples.

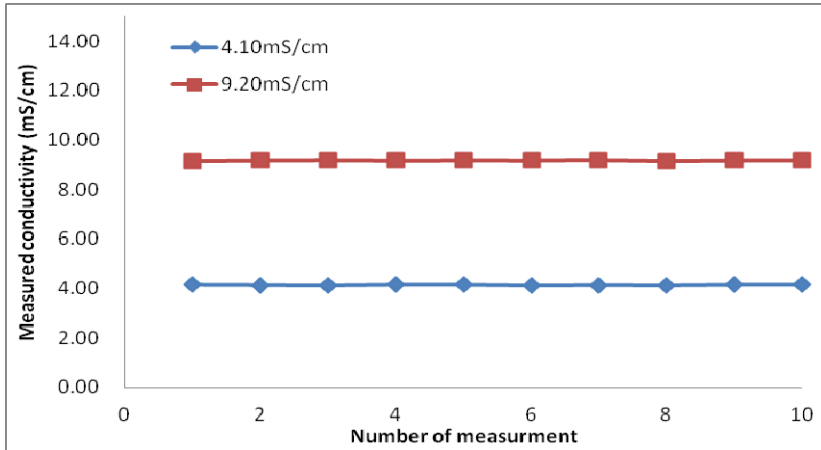

Fig. 6. Reproducibility of measured water-conductivity

4.3 Accuracy Analysis

Measurement accuracy reflects the closeness between the measurement result and the true value of the measure. Table 1 shows the results of continuous monitoring of KCl standard solutions (0.5, 10.0, 20.7, 32.1 and 50.0mS/cm) with the sensor. As the table shows, the measurement accuracy is very high and the relative measurement error is within $\pm 1.5\%$ for all these samples.

Table 1. The results of accuracy testing

Water sample	Measurements								Average value	Absolute measurement error	Relative measurement error	
	1	2	3	4	5	6	7	8				
0.50	0.50	0.49	0.51	0.48	0.52	0.50	0.47	0.53	0.49	0.01	1.50%	
10.00	9.91	9.93	9.90	9.92	9.94	10.00	10.06	10.08	9.96	9.97	0.03	0.30%
20.70	20.57	20.77	20.89	20.90	20.98	20.62	21.04	20.71	20.75	20.75	0.05	0.23%
32.10	31.77	31.87	32.12	32.29	32.01	32.05	32.31	32.01	32.05	32.05	0.05	0.15%
50.00	50.04	50.44	50.04	49.34	50.46	50.02	50.18	50.2	50.09	50.09	0.09	0.18%

4.4 Stability Test

Generally stability refers to the ability of metrological characteristics of the measuring instrument does not change with time. Fig. 7 shows the results of measuring the water-conductivity of KCl standard solution (4.20mS/cm, 9.20mS/cm) using the sensor. Measurements of one half day at 5 min intervals were recorded. Results show

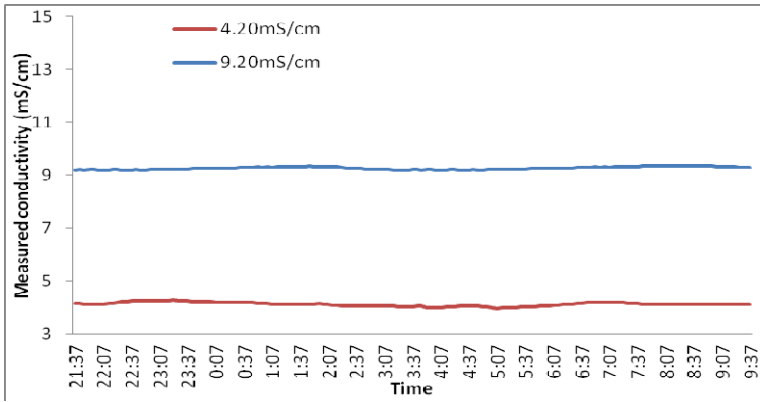

Fig. 7. Experimental results of Stability

no significant change and the variation is within $\pm 0.2\text{mS/cm}$ for each samples. The sensor gives a stable output value.

4.5 Effect of Temperature Compensation

The effect of temperature compensation in accordance with the method mentioned in this paper is shown in Fig. 8. Measurements of one half day at 5 min intervals were recorded for KCl standard solution of 4.20 and 9.20mS/cm. As the Fig. shows, the effect of temperature compensation is relative effective at 0~30°C, however, the values of measured conductivity are absolutely lower than the actual value at 40 °C. The data indicates that the method of temperature compensation have a certain error when the temperature above 30°C.

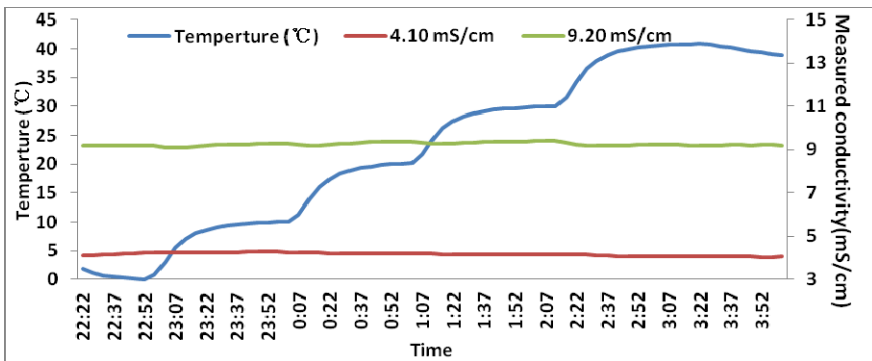

Fig. 8. Effect of temperature compensation

5 Conclusion

The proposed prototype is an attractive solution for water quality measurements systems in fishery. The sensor is based on a novel four-electrode conductivity cell that eliminates errors caused by fouling and polarization. Main characteristics of the proposed prototype include an automatic temperature compensation of conductivity measurements, a low sensitivity to disturbances caused by electrolytic polarization, double layer. Measurement system's conditioning signal circuitry and digital signal processing assure an appropriate conductivity measuring range, good measurement reproducibility, accuracy and stability.

Future works will focus on improving the resolution at the solution of high conductivity so that expanding measurement range, in addition, a more simple and effective method of temperature compensation needs to be presented.

Acknowledgments. The authors would like to thank Development and Applications of sensor network applied to monitor bloom of blue-green algae in Taihu lake (2010ZX03006-006), and Beijing Natural Science Foundation "Integrations methods of digitalization technologies in intensive fish farming" (4092024) for their financial support.

References

- [1] Wei, Y., Ding, Q., Li, D., Tai, H., Wang, J.: Design of an Intelligent Electrical Conductivity Sensor for Aquaculture, pp. 1044–1048 (June 2011)
- [2] Standard Test Methods for Electrical Conductivity and Resistivity of Water, D1125, American Society for Testing and Materials, Conshohocken, PA
- [3] Komarek, M., et al.: A DSP Based Prototype for Water Conductivity Measurements. In: Proceedings of the IEEE Instrumentation and Measurement Technology Conference on IMTC 2006 (2006)
- [4] Fougere, A.J.: New non-external field inductive conductivity sensor (NXIC) for long term deployments in biologically active regions. In: OCEANS 2000 MTS/IEEE Conference and Exhibition, vol. 1, pp. 623–630 (September 2000)
- [5] Karbeyaz, B., Genr, N.: Electrical Conductivity Imaging via Contactless Measurements: An Experimental Study. *IEEE Transactions on Medical Imaging* 22(5), 627–635 (2003)
- [6] Ripka, P.: Advances in Fluxgate Sensors. *Sensors and Actuators A* 106, 8–14 (2003)
- [7] Orion, T., Webster, J.: *The Measurement, Instrumentation, and Sensors Handbook*. CRC Press (1999)
- [8] Keitlley.: Four-Probe Resistivity and Hall Voltage Measurements with the Model 4200-SCS. App. Note 2475 (2002)
- [9] Ramos, P.M., et al.: A Four-Terminal Water-Quality-Monitoring Conductivity Sensor. *IEEE Transactions on Instrumentation and Measurement* 2008 57(3), 577–583 (2008)
- [10] Stogryn, A.: Equations for calculating the dielectric constant of saline water. *IEEE Trans. Microw. Theory Tech. MTT-19*(8), 733–736 (1971)
- [11] TBI-Bailey Controls.: Process monitoring instruments, Product Specification—E67-23-1
- [12] <http://www.coleparmer.com>

- [13] Kiszka, A.: The capacitance of the electric double layer of electrodes in molten salts. *Electroanal. Chem.* 534(2), 99–106 (2002)
- [14] Hyldgard, A., Mortensen, D., Birkelund, K., Hansen, O., Thomsen, E.V.: Autonomous multi-sensor micro-system for measurement of ocean water salinity. *Sensors and Actuators A* 147, 474–484 (2008)
- [15] Bard, A.J., Faulkner, L.R.: *Electrochemical methods*, 2nd edn. John Wiley and Sons (2001)
- [16] Crescentini, M., Bennati, M., Tartagni, M.: Design of integrated and autonomous conductivity–temperature–depth (CTD) sensors. *International Journal of Electronics and Communications* (2012)